

hi-fi WORLD

www.hi-fiworld.co.uk

AUGUST 2003

UK £3.20

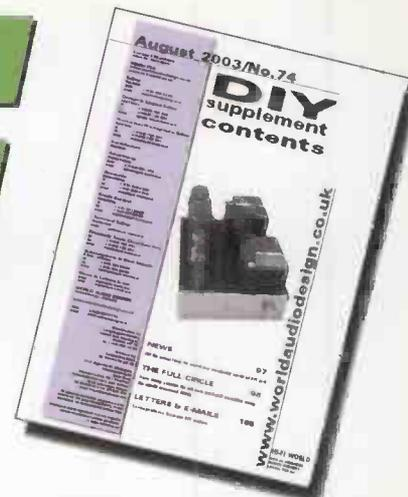

DIY SUPPLEMENT No. 74
INSIDE THIS ISSUE!

& computer audio

EIGHTH WONDER The new Cyrus CD8



3000

TUNER SPECIAL! VHF and DAB tuners group test, aerials - and much more!

- Linn Kremlin - classic wireless
- Mission 782SE loudspeakers - full review
- Creek A50iR amplifier - middleweight class
- Quad 909 power amplifier - poise meets muscle
- Audionote TT1 turntable - affordable analogue
- **NEW!** World Standards - the best new kit
- **NEW!** World Classics - seminal hi-fi designs

COMPUTER AUDIO WORLD

- Websheriff - the music industry strikes back!
- Verbatim DVD+RW - universal PC recording

COMPETITION
Win Monitor Audio's
superb B4 floorstanding
loudspeaker in our great
competition!

+ 100s of classified ads full of secondhand bargains!!!



Digital has truly come of age

Our old first generation friend, CD, is already looking decidedly like Old Hat. Super Audio CD and DVD Audio are with us, assuming you can find the titles you want (rather than the titles they want you to have) at a record shop near you, or indeed in a record shop anywhere. Music (and gadget) lovers can revel in the multitude of ways to store and play their (compressed) music, from home or portable hard disk players, hand-held memory card players, or the humble home computer itself.

So why do we fill our adverts (and our shop) with obsolete mechanical machines from a bygone age to spin huge discs at 33.3 and 45rpm with a sharp diamond on the end of a moving arm to read tiny squiggles in the vinyl? How quaint!

amazon
amphion
apollo furniture
argento
audible illusions
audio physic
breuer dynamic
brinkmann
carfrae
cartridge man
cawsey
chord electronics
clearaudio
decca london
dnm
duevel
dynamvector
ear yoshino
ecs
es lab
final lab
gamut
graham slee
hadcock
incognito
infinity
jbl k2
klimo
korato



Amazon Model 3 inc
RB250 arm - £995.00

Brinkmann La Grange inc 10.5
Tonearm (cart extra) - £6995.00



Origin Live Aurora (arm &
cart extra) - £997.00



Michell Orbe SE (arm & cart extra) £1916.00



Michell Gyro SE (arm & cart extra) - £870.00

We have the largest selection of vinyl players anywhere in the UK (and possibly further afield too) - just a small selection on this page



More importantly, nobody assembles and tunes turntables like we do - to perfection!



Nottingham Analogue Horizon inc
RB250 arm - £528.75



Nottingham Analogue Spacedeck
(arm & cart extra) - £889.75



Origin Live Resolution (arm & cart
extra) - £1979.00

Warning!

We have a huge selection of accessories for the vinyl enthusiast which can be purchased either by personal callers to our shop, or by mail order world-wide. Please consult our web site for product details, and how to order.

lavardin
loricraft
lyra
michell engineering
morch
musical fidelity
nordost
nottingham analogue
origin live
ortofon
papworth
pink triangle
pluto
rega turntables
ringmat
rose
shun mook
shanling
shelter
sme
sonneteer
spender
stax
sugden
sumiko
tci cables
tivoli audio
tom evans
townshend audio
transfiguration
trichord
van den hul

Latest!

- * The amazing state of the art JBL K2 speakers on demo now
- * Shanling CDT-100 CD player on demo
- * Naim Aro tonearm and Armageddon PSU on demo
- * Rose and Korato preamps on demo
- * At last - the new Michell Engineering Tecnodeck - on demo



For info on these, and much more, including our numerous second-hand items, please visit our popular website: www.walrus.co.uk

* interest free credit available on most items, subject to status *

tel: 020 7724 7224
fax: 020 7724 4347
email: mail@walrus.co.uk
web: www.walrus.co.uk

the crew

Contact Numbers Mon-Fri 9am-5pm

Editor

David Price
tel/fax +44 (0) 0117 968 8264
e-mail: editorial@hi-fiworld.co.uk

Design & Layout Editor

Faiza Chunara
tel: +44 (020) 7625 3129
fax: +44 (020) 7328 1844
e-mail: adproduction@hi-fiworld.co.uk

Production & Photography Editor

David Noble
tel: +44 (020) 7625 3134
fax: +44 (020) 7328 1844
e-mail: classifieds@hi-fiworld.co.uk

Contributors

Simon Pope
Dominic Todd
Andy Grove
Haden Boardman
LJK Setright

Advertising

Amanda Sweeney
tel/fax +44 (020) 8864 4760
e-mail: advertising@hi-fiworld.co.uk

Accounts

Sharon Mehlhorn
tel: +44 (0) 20 8841 8892
fax: +44 (0) 20 8841 9144
e-mail: accounts@hi-fiworld.co.uk

Credit Control

Louise Palfrey
tel: +44 (0) 1923 270 833
fax: +44 (0) 1923 260 588
e-mail: creditcontrol@hi-fiworld.co.uk

WORLD AUDIO DESIGN

Technical Manager – Nick Lucas
www.worldaudiodesign.co.uk

tel/fax: +44 (0) 1908 218 836
e-mail: nick@worldaudiodesign.co.uk

Publisher

Noel Keywood
e-mail: publisher@hi-fiworld.co.uk

Private & Trade Classified Ads

tel: +44 (020) 7625 3134
fax: +44 (020) 7328 1844
e-mail: classifieds@hi-fiworld.co.uk

Subscriptions & Back Issues

9:30am - 12:00 noon
tel: +44 (0) 1923 270 833
fax: +44 (0) 1923 260 588
e-mail: subscriptions@hi-fiworld.co.uk

Distributed by

Comag Magazine Marketing,
Tavistock Road, West Drayton,
Middlesex UB7 7QE
Tel: +44 (0) 1895 444 055

Printed by

Southern Print, Dorset
Tel: +44 (0) 1202 628 300

Our Agents in Malaysia

Millennium Hi-Fi & AV
Simon Chang
Showroom & office, 500-1-3 First Floor
Wisma Indah (Shen Court), Jalan Tun Razak
50400 Kuala Lumpur, Malaysia
Tel: 603 9283 8171 Fax: 603 9281 3762
e-mail: info@millennium-audio.com

All unsolicited submissions and goods are at the owner's risk. We accept no responsibility for such submissions, nor do we undertake to return them.

No material may be reproduced from this magazine without the publisher's written permission.

© Audio Publishing Ltd



david price

Radio, as Elvis Costello once wrote, "is a sound sensation". I couldn't agree more - which is why this issue tunes in to the great radio debate. Audience figures are on the up, and there's a vast number of new digital - and even internet - stations being launched.

Where then does that leave good old FM stereo? Well, as our group test shows, it still reigns supreme if sonics are your priority. Quite simply, nothing with a DAC inside can touch a well designed, well set-up VHF tuner running a decent twig. Radio 3 is famously capable of stunning fidelity and with programmes like *Late Junction*, it's even reaching out in search of a new wave of listeners reared on alternative, ambient and world music - with interesting results. Not everyone approves though - read p24 and then let us know your thoughts.

After so much talk of DVD-Audio and SACD, this summer is seeing a number of new bespoke CD players, competitively priced and dedicated to squeezing the best out of 'ye olde' 16bit. This month's cover star is Cyrus's super CD8. Read the low down on the CD spinner that's set to give the best of the rest something to worry about on p36...

Elsewhere we have Quad's 909 power amplifier, ancestor of the classic 405, complete with Current Dumping circuitry. It's a big smoothie and precisely the sort of thing that Mission's new 782SE loudspeakers need. With an incredibly grippy and incisive sound, they're riveting listening but you'll have to partner carefully if you want to keep your blood pressure down!

And finally, just what you've all been waiting for! After literally years of head-scratching, we've come up with the most complete guide to hi-fi you'll find. Whether it's the latest Linn or a classic Quad, we've got it covered in our brand new World Standards and World Classics guides, starting on p87. Of course, you're bound to disagree so write in and let us know - or why not even nominate something yourself? This is your magazine, so don't just turn on, tune in and drop out!

David Price

how we test the products

- Hi-Fi World has its own advanced test laboratory and acoustically treated listening room.
- Hi-Fi World has a dedicated in-house team of experienced listeners. We review thoroughly by extensive auditioning, rather than by quick-fire group listening tests.
- Hi-Fi World's engineering team designs a wide range of products in-house. No other hi-fi magazine is so expert and dedicated.

WORLD VERDICTS: This issue marks a change in our rating system, to make it clearer and better understood. As a rule we only review products we find interesting, so don't expect too many low scores. Likewise, five globe awards will be few and far between because there's only one superlative product of its type. The £ sign remains, as we often come across flawed gems that are great value for money.

| | | |
|--|--------------------|----------------------|
| | OUTSTANDING | - Simply the best. |
| | EXCELLENT | - Extremely capable. |
| | GOOD | - Worth auditioning. |
| | MEDIOCRE | - Unremarkable. |
| | POOR | - Seriously flawed. |
| | VALUE | - Keenly priced. |

www.hi-fiworld.co.uk

HI-FI WORLD

SUITE G4, ARGO HOUSE
KILBURN PARK ROAD
LONDON, NW6 5LF

contents

reviews

digital players

CYRUS CD8 36

David Price tries Cyrus's latest high end 16bit machine, with and without optional PSX-R power supply.

amplifiers

CREEK A50iR 40

The new mid-price integrated from Mike Creek is a case of 'traditional values in a modern setting', finds Noel Keywood.

MF AUDIO PASSIVE PREAMP 60

Here's an expensive, high end preamplifier with a twist – transformers! David Price listens in.

QUAD 909 62

Haden Boardman pits Quad's latest big transistor power amp against his beloved 405, with interesting results...

loudspeakers

MISSION 782SE 56

Celebrating twenty five years of innovative loudspeaker design comes Huntingdon's latest floorstander – an 'audiophile' reworking of the best selling 782. David Price tries it for size.

systems

DENON UDM31 59

Haden Boardman improves his lifestyle with Denon's latest micro system...

vinyl

AUDIONOTE TT1 54

Peter Quortrop's entry level vinyl spinner gets the treatment from Haden Boardman.

tuners

GROUP TEST 13

Seven top analogue and digital tuners from Arcam, Cambridge Audio, Denon, Myryad, NAD, Primare and Pure get the treatment.

features

GOLDEN AGE OF WIRELESS

10

Noel Keywood traces the past, present and future of UK radio.

AERIAL VIEWS

22

There's no point in owning a top tuner without a decent twig, as Noel Keywood explains.

THIRD CLASS?

24

Is today's Radio 3 a pale, populist shadow of its former self, or totally in tune with modern music? LJK Setright and Simon Pope face off.

STATION TO STATION

34

Radio in Britain is changing apace – and David Price brings you the latest developments.

FRANKFURT IN PICTURES

51

David Price experiences the other side of life at the Frankfurt High End Show 2003.

CLASSIC CUTS

78

Andy Giles salutes Ralph Vaughan Williams' Second Symphony, 'The London'.



PAGE 54



PAGE 36



PAGE 13

computer audio

SOUNDBYTES 71

The latest tantalising tidbits from the world of computer audio.

SHERIFF AND THE BANDITS 72

David Price talks to top music industry lawyer John Giacobbi about the latest legal developments in online music distributions.

VERBATIM OMNIA DVD+R/RW 74

Need a serious DVD+R burner? David Price has one for you here.

supplement No 74

DIY CONTENTS 95

DIY NEWS 97

All the latest from the weird and wonderful world of Do-It-Yourself hi-fi.

300B POWER 98

Andy Grove creates push-pull monoblocs using the world renowned 300B triode valve.

DIY LETTERS 106

Correspondence and queries from our DIY readership.

BUYING GUIDE

www.hi-fiworld.co.uk

visit our website for a comprehensive list of all the products we have reviewed over the past 11 years

SUBSCRIPTIONS HOTLINE

01923 270833

MON - FRI 9.30AM - 12.00 NOON

FAX: +44 01923 260 588

regulars

WORLD NEWS 7

NEXT ISSUE 9

READERS LETTERS 42

Hi-Fi World's wise men will reply to your letters and e-mails and put you back on the right course. And don't forget, every letter or e-mail we print wins a superb prize.

HI-FI WORLD KITS 64

Solder in one hand, glue in the other, satisfy your creative urges with a World kit.

HI-FI WORLD LIBRARY 68

A comprehensive selection of titles covering audio, valve amplifiers, loudspeakers, solid state electronics and more.

SUBSCRIPTIONS 70

Spare yourself the frenzied riot as you struggle with the hordes to claim the last copy of Hi-Fi World in the newsagent - Subscribe today!

COLUMNS 77,79,81

The World team get to grips with issues facing both the industry and hi-fi alike.

OLDE WORLDE 80

LJK Setright eulogises over Linn's classic Kremlin tuner

DIAL-A-DEALER 82

Look before you leap, or alternatively listen before you buy. These are the people to talk to.

MEET YOUR MAKER 84

Not a call to the spiritual, but a list of manufacturers detailing who makes what, and how to get in touch.

SPECIALIST HI-FI DEALERS 85

The perfect mix - excellent coffee, a comfortable sofa, and someone who really knows how to guide you through the world of hi-fi.

WORLD CLASSICS 87

Our list of products that have stood the test of time.

WORLD STANDARDS 92

Thinking of an upgrade or even a new system? Here's where to find our recommendations from the mass of hi-fi we've reviewed.

MARKETPLACE 107

READERS CLASSIFIEDS 125

The definitive place to find classic audio components.

ADVERTISERS INDEX 130

competition

Win Monitor Audio's superb B4 floorstanding loudspeakers in this month's great competition!

PAGE 26



PAGE 74

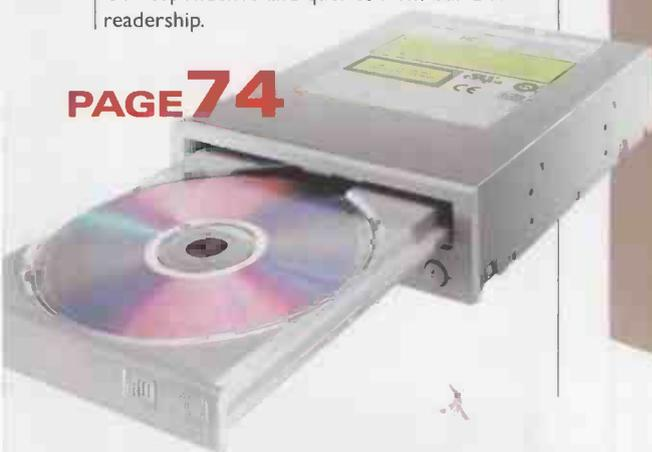

PAGE 80

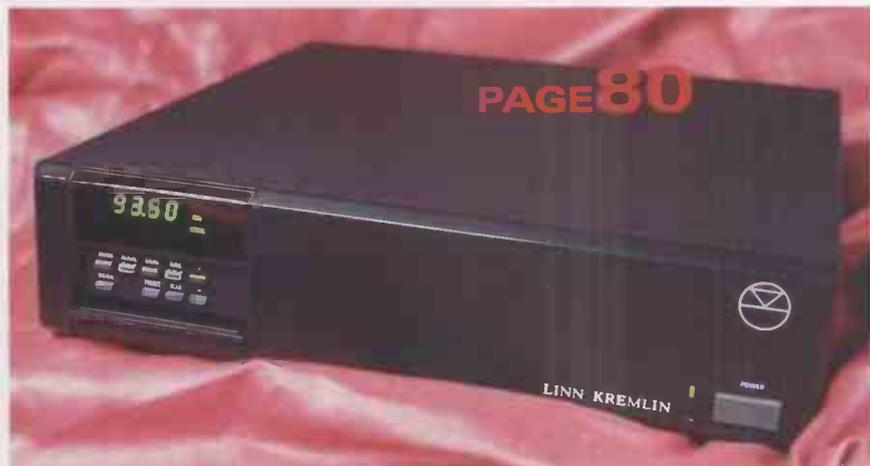

Put The Needle



On The Record



And The Drum Beat



Goes Like This



Pro-ject,
stunning record playing systems from £115

Distributors: **Henley Designs Ltd, 01235 511166**
www.henleydesigns.co.uk, e-mail info@henleydesigns.co.uk

The following dealers have been chosen for their exceptionally high standards in customer service, staff training and demonstration facilities.

We recommend them wholeheartedly.

Scotland / Ireland / Wales

Glasgow - Glasgow audio 0141 332 4707
Edinburgh - HiFi Corner 0131 5567901
Edinburgh - Russ Andrews 0131 557 1672
Aberdeen - Sevenoaks HiFi 01224 587070
N Ireland - Kronos HiFi (Dungannon) 02887 753606
Cardiff - Sevenoaks HiFi 0292 0472899
Swansea - Sevenoaks HiFi 01792 465777

North East

Hull - Sevenoaks HiFi 01482 587171
Newcastle - Lintone Audio 0191 460 0999
Newcastle - Global HiFi 0191 230 3600

North West

Darlington - HiFi Experience 01325 481418
Doncaster - The HiFi Studios 01302 727274
Preston - Sevenoaks HiFi 01772 825777
Manchester - Sevenoaks HiFi 0161 831 7969
Manchester - Practical HiFi 0161 839 8869
Sheffield - Moorgate Acoustics 0114 275 6048
Castleford - Eric Wiley 01977 556774
Leeds - Sevenoaks HiFi 0113 245 2775
Huddersfield - Huddersfield HiFi 01484 544668
Chester - Audio Excellence 01244 345576
Warrington - Doug Brady HiFi 01925 828009
Cheadle - Audio Works 0161 428 7887

Midlands

Bedford - Richards A/V 01234 365165
Dunstable - Technosound 01582 663297
Peterborough - Sevenoaks HiFi 01733 897697
Cambridge - The Audiofile 01223 368305
Leicester - Leicester HiFi 0116 2539753
Nottingham - Sevenoaks HiFi 0115 911 2121
Ashby De-La-Zouch - Zouch audio 01530 414128
Lincoln - sevenoaks HiFi 01522 527397
Leamington Spa - Stratford HiFi 01926 888644
Walsall - Sound Cinergy 01922 457926
Solihull - Music Matters 0121 742 0254
Birmingham - Music Matters 0121 429 2811
Kidderminster - Midland Audio 01562 822236

London

Euston - Kamla electronics 0207 323 2747
Holburn - Sevenoaks HiFi 0207 837 7540
Swiss Cottage - Sevenoaks HiFi 0207 722 9777
Harrow - Harrow Audio 0208 863 0938
New Malden - Unilet 0208 942 9567
East Sheen - Choice HiFi 0208 392 1959

South West

Maidenhead - Audio Venue 01628 633995
Reading - Audio T 0118 958 5463
Reading - B & B HiFi 0118 958 3730
Newbury - B & B HiFi 01635 62474
Cornwall - Sounds Perfection 01326 221372
Exeter - Sevenoaks HiFi 01392 218895
Oxford - Oxford Audio 01865 790879
Bristol - Audio Excellence 0117 926 4975
Bristol - Radford HiFi 0117 924 0878
Yeovil - Mike Manning 01935 479361
Tiverton - Audio Destination 01884 243584
Southampton - Phase Three 0238 022 8434
Salisbury - Salisbury HiFi 01722 322169
Basingstoke - Audio T 01256 324311

South East

Colchester - Grayston S & V 01206 577682
Brentwood - Audio T 01277 264730
Hitchin - David Orton A/V 01462 452248
Rainham (Kent) Progressive Audio- 01634 389004
Ipswich - Sevenoaks HiFi 01473 286977
Norwich - Sevenoaks HiFi 01603 767605
Worthing - Phase Three 01903 245577

UNIVERSAL LINN!

"True convergence with compelling audio and video performance regardless of format" is how Linn describes its new UNIDISK 1.1 player. An original Linn design, it is an integrated universal digital disc player that claims unsurpassed sound and picture quality with simplicity of use. It automatically recognises all major audio and AV optical disc formats, uniquely configuring audio and video playback almost instantly using Linn's adaptive SILVER DISK ENGINE technology. Linn is licensing this system, which automatically recognises and optimises playback for two-channel and multi-channel Super Audio CD, CD, DVD-Video and DVD-Audio, to third party users. Vital statistics are 368x80x381mm, 4.9Kg and £6,500.



Linn has also announced a summer promotion, which enables existing Linn customers who own selected Linn source products to obtain guaranteed value against the purchase of a new UNIDISK 1.1 machine. Owners of the 5103 system controller can also get a guaranteed trade in allowance to ease the purchase of the new KISTO system

controller. This follows on from Linn's Elite Retailer scheme, which awards special status to, "a select group of distinguished Linn specialist retailers around the world who aspire to set the highest standards in the market". LINN ELITE branding will be used to identify these dealers. For further information, call 0500 8888 909, or click on www.linn.co.uk.

AZUR LIKE IT

Hats off to Cambridge Audio, who had the brass neck to launch its new Azur range of sub-£250 separates at the Frankfurt High End 2003 Show – where most exhibits cost at least twenty times as much! Two new amplifiers, the 540A and 640A, deliver 50W and 65W a side for £199.95 and £249.95 respectively. They boast oversized toroidal power transformers, short path circuitry, low resonance acoustically damped chassis and aluminium alloy front panels. An intelligent CAP5 protection system constantly monitors levels and a clipping sensor reduces volumes if need be. Optional phono inputs are available. The matching 540C and 640C CD players, at the same price points, use the latest 24bit, 192kHz Wolfson DACs with separate power supplies for the digital, audio filter and regulator circuitry, plus data-reclocking. The 640T DAB tuner completes the set, using a Radioscape platform with Texas Instruments digital signal processing. Wolfson DACs again feature. Price is £199.95. Contact Richer Sounds on 0870 900 1000 for more information, or click on www.richersounds.com

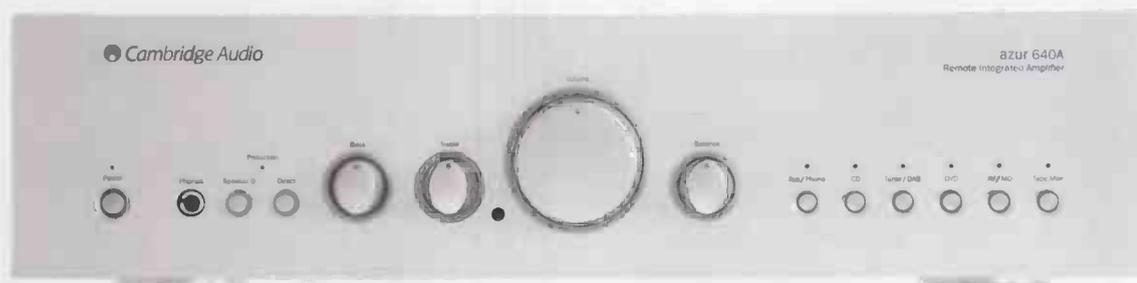



BEST BEYER

The new £159.99 DT990 high-fidelity headphone is based largely on the hugely successful DT990pro, used in countless professional recording studios the world over. It boasts a near linear response from 5-35,000Hz with high quality transducers, robust design and good comfort.

For further information contact XYZ at Beyerdynamic on 01444 258258 or visit

www.beyerdynamic.co.uk

TUNES IN!

Last month, Apple launched its iTunes Music Store, an online music website that lets US-based customers quickly find, purchase and download the music they want for just 99 cents per song, without subscription fees. It offers innovative personal use rights, including burning songs onto an unlimited number of CDs for personal use, listening to songs on an unlimited number of iPods, playing songs on up to three Macintosh computers, and using songs in any application on the Mac. Apple's CEO Steve Jobs said, "Consumers don't want to be treated like criminals and artists don't want their valuable work stolen. The iTunes Music Store offers a ground-breaking solution for both".

Featuring over 200,000 songs from music companies including BMG, EMI, Sony Music Entertainment, Universal and Warner, the entire music store can easily be searched by genre, artist and album. Users can listen to a free 30-second high-quality preview of any song in the store, then purchase and download their favourite songs or complete albums. Artists include Bob Dylan, U2, Eminem, Sheryl Crow and Sting. AAC is used for music storage, at 128kbps.

The service has proved remarkably popular, with over two million songs having been purchased within the first two weeks. Interestingly, over half of the songs purchased were as albums, dispelling music industry concerns that selling music on a per-track basis will destroy album sales. Its success has been welcomed by industry figures, such as Talal Shamoan, president and chief executive of Intertrust Technologies Corp., who quipped, "It's about time someone succeeded at trying to sell music online". Consumers have shown little interest in existing subscription-based online music services such as Musicnet.com and Pressplay.com, but the Apple service has obviously added the required convenience and utility. Apple users can freely download iTunes 4 software from www.apple.com/uk/itunes.

PULSE POWER

Monopulse is a new British loudspeaker company which wryly states that "the answer to life, the universe and everything is a combination of precise detail and clean, undistorted, bass power", which its new 42H top-of-the-range loudspeaker of course delivers. This £995 product is an 8 ohm design using precision Danish drive-units with large diameter, long-throw voice-coils. Power handling is quoted at 20-200W, with a sensitivity of 90dB. For more details, visit

www.monopulse.co.uk



WE HEAR...

SME has a new tonearm out this summer. The 'M Series' is a refinement of the 3009 Series 2, which it replaces after a very long production life. Out go the latter's knife-edge bearings and S-shape arm tube, and in come ball race bearings and a straight tube tipped with a magnesium headshell - making it far more suitable for moving coil cartridges. With prices around the £500 mark, it isn't substantially more expensive, either.

PIRACY AT A RECORD HIGH

The British Phonographic Institute estimates that unauthorised and pirated music in the UK reached a new record total of 184m units in 2002. This represents a doubling of unauthorised music in just two years, and represents an increase of one third in a year. BPI executive chairman Peter Jamieson, says piracy and illegal copying are growing at an alarming rate. The BPI's annual survey of music piracy found that there was an 81% increase in the value of commercial piracy in the UK - this has now more than trebled in just three years. There's also an explosion in the number of people burning CDs at home on their computers, which could overtake those bought in stores in 2004.



NEW LISTENING PANEL

Pioneer has launched a new 'lifestyle' audio system featuring interesting NXT-based loudspeakers. The X-PR9DV, available in Japan from June, uses 'speakers with a silver coloured acrylic panel as the main face of the design. This is floated on a larger clear acrylic panel, which

creates a visual border. This is the first time that NXT's SurfaceSound technology has been applied in this way, and Pioneer's General Manager, Katsuhiko Oamaru is impressed, "NXT's SurfaceSound technology has given us a design freedom that we believe other technologies cannot match". Should sound pretty good, too – if the last new NXT design (the TDK S80) is anything to go by!

WHERE ARE THEY NOW # 84: AUDIOLAB

Spotted – on the Greek island paradise of Kos. Could it be that Phil Swift has traded in his Porsche to start his beloved brand up again, from this top secret location?



ACHTUNG, STUDENT!

A German student has been arrested for allegedly distributing over seven million MP3 files a week. The International Federation of the Phonographic Industry reports that German police arrested a 25-year-old computer programming student and seized eight computers.

The IFPI says he was using a clone of a Napster file-sharing server to distribute over a million MP3 music files daily to some 3,000 individual users over several weeks. A spokesman said the IFPI had calculated that about 620 million MP3s were illegally downloaded in Germany alone in 2002, translating into a lost revenue of over 1bn Euros.

next issue

September's Hi-Fi World is all about analogue. Whether it's our top moving coil cartridge test, the low down on Nottingham Analogue's Hyperspace turntable or an in-depth look at Garrard, we're really getting into the groove. You'll also see:

CROFT TWIN STAR AMPLIFIER

A brilliant hybrid from the men behind the Micro.

PURE EVOKE-1 VS. TIVOLI RADIOS

Let the battle for your kitchen table begin!

ARCAM DV89 DVD-A PLAYER

A serious sounding DVD spinner from Huntingdon.

THE VINYL CUT Using PCs to burn vinyl to DVD!

next issue

OPTICAL DVD-RW ARRIVES

Toshiba has developed a working prototype of a dual-layer, single-sided, Blue-Laser rewritable optical disk. It has the key advantage that it can easily be productionised with only minimal adjustments to current DVD manufacturing facilities, and that its current capacity can be increased significantly. It is also expected to promote lower production costs for next generation optical disks, while offering simple implementation of backward compatibility with today's generation of DVD formats.

While the write-only discs offer 15GB in single-layer, single-sided read-only form or 30GB in dual-layer, single-sided, read-only form, the new rewritable disc gives 20GB in single-layer, single-sided form. These capacities significantly improve on the 8.5GB capacity of current dual-layer, single-sided read-only DVD disks and 4.7GB single-layer, single-sided read-and-write DVD disks. The proposed format uses a short wavelength blue laser and the same disk structure used in current DVDs-back-to-back bonding of two 0.6mm thick, 120mm disks. The Toshiba-NEC format also employs an objective lens with a numerical aperture of 0.65, very close to that of current DVD.

THE GOLD AGE OF

After years of being overlooked, suddenly radio is enjoying a renaissance. The wealth of new digital stations has shifted the public gaze back on to this much-maligned medium, and listening figures are back on the rise. In this month's tuner special, we review seven top analogue and digital tuners, show how to get the best from them, discuss the 'rise of fall of Radio 3', look at the latest listening figures and revisit Linn's classic Kremlin. First, Noel Keywood gives you the story so far...



When the BBC installed Britain's national VHF radio network

throughout the nineteen sixties and seventies, it was done with a good deal of planning and a lot of effort. The idea was to use a web of powerful main transmitters dotted around the country - usually on wind swept hilltops with exotic names like North Hessary Tor - backed up by numerous fill-ins to illuminate dead spots. This is the system that remains today unchanged, and that works to such great effect, as anyone with decent FM tuner will tell you.

Of course, there are drawbacks to analogue, but - interestingly - these affect broadcasters more than listeners. Kilowatt transmitters need a lot of electrical power, not to mention maintenance. They also bring radio to moorland sheep more effectively than humans, who generally live elsewhere! The solution has been to use numerous, compact solid-state transmitters sited along motorways and near to - and within - population centres. They are less expensive, easy to install, easy to maintain and their diffuseness maintains service and maximises the potential listening audience, seen as important nowadays when audience figures

reign supreme.

The other issue is the large amount of the precious airwaves that the established analogue system takes, something that successive governments have been all too aware of. Enter Digital Audio Broadcasting, also known as DAB and Digital Radio.

A new transmission system, known as COFDM (Coded Orthogonal Frequency Division Multiplexing) is used to overcome mutual interference between transmitters. This allows vehicles to move seamlessly from one DAB transmitter to the next along a motorway, with no need to re-tune, making the most out of one of the best audiences for radio - motorists.

Because DAB transmitters can operate in a Single Frequency Network (SFN) like this, the overall amount of radio bandwidth is far less than that demanded by frequency-offset VHF transmitters. Currently DAB in the UK is transmitted on Band III in 'ensembles' of stations, from 217MHz-230MHz. There are seven ensembles in this range, a more efficient use of spectrum space than VHF (88-108MHz). DAB is more flexible too, since it can carry programme-related data, such as text, or it can carry unrelated data and even pictures. This ability was demonstrated recently by Radioscape, but with data running in

DEN WIRELESS



64kps bursts, DAB isn't a fast transmission channel by any means.

In the long term the British Government wants to 'switch off' analogue television transmissions altogether, a recent suggestion being that this should occur between 2006-2010, when 95% of the population will be able to receive digital TV, it hopes. Ultimately VHF/FM radio - good as it is - will follow analogue TV into oblivion, leaving us with just DAB. This will not happen for some time - even with the cost of DAB now falling - but it appears to be the future of radio in Britain.

THE DIGITAL DEBATE

A DAB tuner will often give clear, hiss-free reception with the simple aerial supplied. To many people, especially those unable to erect an aerial, this is a useful benefit.

However, reception is by no means guaranteed. Since DAB transmissions are fairly short range, those not in the vicinity of a local transmitter will not be able to receive it.

Also, DAB doesn't effectively penetrate concrete buildings and basements if they are far from a transmitter or shielded by other buildings, or a hill perhaps. In circumstances like this a DAB tuner will not work at all and an outdoor aerial will be needed.

City centres are another problem area. For example, ntl

installed a powerful transmitter in Croydon to provide London coverage and then had to use a fill-in in Oxford Street to augment it. The BBC transmits DAB from Crystal Palace in South London and Alexandra Palace in North London to provide coverage, yet still there are plenty of local dead spots.

Of course, high gain aerials are available and may well pull in distant transmitters if there are no obstructions. In a sense though, this detracts from Digital Radio's claimed 'user friendliness'.

When initially released, Digital Radio was celebrated for its excellent 'CD quality' sound, which would help sell it to a sceptical buying public already fairly satisfied with what they'd got. But as people have become aware of the impact of digital data-reduction (compression) upon sound quality, based partly upon the low relative quality level of MP3, this aspect of DAB has drawn criticism rather than praise.

Our measurements clearly show modern VHF/FM tuners give a data rate equivalent to approximately 800kbps, whereas DAB works at 128kbps or less, equivalent or worse than MP3. It provides just 20% or less of the data that a good VHF tuner can deliver to listeners. It is this aggressive data reduction carried out by Musicam compression that enables digital programmes to be packed into an ensemble so tightly. Quality is sacrificed for quantity - it's a direct trade-off between the two.

With this in mind, the BBC - which is the key driving force behind Digital Radio in the UK - has had to redefine the benefits of DAB in terms of the wide variety of new stations available (such as BBC Five Live Sports Extra, BBC6 and BBC7), ease of use, no retuning,

interference-free reception and its text and data services. Sonics have mysteriously been dropped from the list!

By contrast, the achievements of Britain's national VHF network should not be understated. Modern VHF tuners have a flat audio response to 15kHz, as our measurements clearly show, almost matching DAB's 20kHz. Providing a good aerial is used, hiss will be inaudible, and distortion is minimal too, reaching around 0.3% maximum. Very respectable figures, allied to FM's completely uncompressed nature, make for potentially superb sound.

SO WHAT SHOULD I BUY?

Whilst VHF offers best quality, DAB offers fantastic variety. A lot of stations on DAB, like Kerrang and Kiss, are unavailable on VHF. If you want quantity rather than quality, DAB has it - just make sure your area can receive it. Coastal regions are a problem because UK DAB is likely to interfere with French and Irish DAB! Northern England is lightly served too.

If you are happy with what's available on VHF, stay with it. Upgrade your aerial if need be and then audition some tasty top-end tuners to see just what VHF can do. Live programme from VHF can hardly be bettered. It is startlingly good.

CONTENTS:

| | |
|--------------------|-----|
| TUNER SUPERTEST | p13 |
| AERIAL VIEWS | p22 |
| THIRD CLASS? | p24 |
| STATION TO STATION | p34 |
| LINN KREMLIN | p80 |



A3.2 SERIES.
MACHINED, MIL-SPEC ALUMINIUM FRONT PANEL.
PLATINUM PLATED FITTINGS. REMOTE CONTROLLED. PHONO STAGE.
POWERFUL, ROBUST, BUILT.



ARCAM T61 £250

Arcam, along with Naim, has always taken tuners seriously, as valid hi-fi products. It has consequently had a long line of good radios, and was one of the first to consider digital radio as a serious audiophile proposition with its high-end DAB tuner. The T61 you see here is a far more conventional design - the mid price option in the company's range, sitting between the T51 analogue tuner and the T81 digital.

The look is typical of the smart DiVA range, with clean lines and a clear green display that shows plenty of information, including signal strength. Both FM and AM are catered for, with thirty presets for FM and sixteen for AM. Radio stations can be named by the user, should you wish. It also includes RDS information and has two sets of audio outputs, making it useful for inclusion in a multi-room system.

Joining these at the rear are inputs for remote control and remote switching through a 12-v trigger jack. A DiVA system remote control comes as standard. This is a quite large tuner when compared to

the others in the test, which are either shorter or less wide than your average full size hi-fi, but the Arcam uses the same dimensions as its brothers in the range - ideal for perfect visual matching.

It's a good tuner to use. Operation is easy and hassle-free and everything you need is at hand and clearly labelled. Most functions can be mastered without a peek into the manual - which is a good thing, although not recommended by manufacturers, who have to cover their backsides in case something goes wrong!

SOUND QUALITY

In true Arcam style, the T61 does everything you want it to do - 'exactly what it says on the box', as they say. It has a good rounded sound, with commendable detail and impressive depth of stage. Listening to Radio 3, you'll find that voices are clean and precise but instruments, whilst detailed, lack a touch of colour and life. This makes chamber and orchestral music, dependant on colour and mood, sound a tad lifeless and flat. This is fine for the news but Mahler will be ectoplasmic and

lifeless, alas. Radio 4 was good, with clean voices and a nice stereo image with atmospherically mixed plays.

Radio 1 and Capital FM's pop tunes were well handled and adequately restrained. The T61's lack of immediate sparkle means that in-car EQing is kept on a leash, making commercial stations a viable listening proposition for once without taking one's teeth out. The Arcam has good bass extension - it's dry and tight, and the top-end isn't bright or edgy. Only the midrange lets the side down by being slightly restricted, compressing vocals slightly.

Overall the Arcam is a good 'meat and two veg' buy. It won't break down or blow up and will play everything to a high - if not brilliant - standard. It won't upset you, the wife or the horses and it's actually a very good buy for these reasons. Solid stuff - nothing fishy here!

Arcam T61 £250

Arcam
Tel: +44 (0)1223 203200
www.arcam.co.uk

MEASURED PERFORMANCE

Arcam avoid treble lift as seen with the NAD and Pure, going for a softer sound, although not too soft measurement suggests. The T61 produced a little more distortion than its rivals, but being 2nd and 3rd only it should not be apparent at 0.3% or so maximum.

This tuner was not especially sensitive, but works normally with a good aerial, reaching full quieting with 1mV. Selectivity was very good so nearby stations will be rejected strongly. Arcam fit a useful signal

strength meter that peaks at 0.3mV.

The T61 measured well, but it was not distinguished. **NK**

| | |
|-------------------------|-------------|
| Frequency response | 5Hz-15.5kHz |
| Stereo separation | 47dB |
| Distortion (50% mod.) | 0.2% |
| Hiss (IEC A) | -70dB |
| Signal for minimum hiss | 1mV |
| Selectivity (at 0.4MHz) | 80dB |
| Sensitivity | |
| mono | 6µV |
| stereo | 50µV |
| output | 750mV |

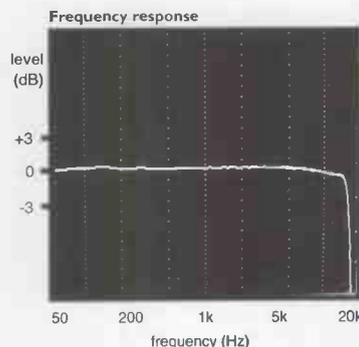

World Verdict £ ●●●●
Sleek looking and refined sounding, but not the last word in musical involvement. Excellent value, nonetheless.



CAMBRIDGE AUDIO DAB300 £150

Cambridge Audio has the resources and engineering experience to deliver superb performing products at bargain basement prices, as previous CD players and amplifiers have proven. Now it's the turn of digital radio with the launch of the digital-only DAB300.

It's a very good looking design with a simple LCD backlit display and a small array of buttons and a rotary knob. The silver finish (it's also available in black) front plate is good quality and the rotary knob has a decent enough feel to it. Inside the DAB300 is the Frontier Silicon third-generation single chip DAB/Audio processor. The Enigma DAB IP is licensed from Imagination Technologies, holding company of rival manufacturer, PURE. This is combined with a high quality 24-bit/96kHz DAC with 4x upsampling from Wolfson, as used by the likes of Arcam.

Simple controls on the front are for auto-tuning, information and menu, and the high quality display has two brightness settings. There's

accommodation for ten direct access preset stations and a signal strength meter, viewed by holding in the rotary knob.

Build quality is mediocre, but not bad for the money and it feels pretty good in use. Ten direct presets are available. No remote is included, so you have to get up off your butt to change stations like in the good old days!

Setting up is a proverbial walk in the park. Switch it on and wait for the stations to load. Turn the knob to find your station, press it and listen! To get a station or broadcast information you simply press the relevant button on the fascia and all will be revealed.

SOUND QUALITY

Kicking off with Radio 3, as always, the DAB300 showed commendable body and depth but not enough to match FM at its best. This is where the two really differ. Voices were clear but not full bodied and the same applied to the orchestra in some lush Strauss waltzes, which weren't so much Viennese whipped cream as Isle of Wight cold custard. It's fine if you merely want the notes

but if emotion is needed as well (as it should be) the Cambridge trips up a bit. With The Archers on Radio 4, the voices were again clear and separation good but the DAB300 lacked some depth of stage and atmosphere.

Radio 1's pop tunes fared a little better. Bass was good and tuneful and the treble, although a bit thin, wasn't rough or too edgy. There's a brightness there, but not to the detriment of the overall picture.

Capital and BBC local stations were next and the Cambridge sounded fine with them.

This tuner has its limitations both technologically and sonically, but when you look at the price it's hard to knock it. No other stereo DAB tuner is around at this price so it's a bargain just in this respect. If you don't look for sonic sophistication, you may well think it's a steal! Digital for the masses.

Cambridge Audio DAB300 £150

Cambridge Audio Ltd.
Tel: +44 (0)207 827 9001
www.cambridgeaudio.com

MEASURED PERFORMANCE

The DAB 300 was measured using off-air transmissions of test tones and music. Frequency response was flat across the audio spectrum, unlike the Pure tuner which is equalised to make DAB sound less bright.

The DAB300 produced almost no distortion with a single test tone. There was very little hiss too. The only point to note is that conventional tests do not highlight the effects of signal compression, so they give the results achieved with a statistically average audio signal, not

under strenuous conditions. This applies to all DAB tuners of course.

The DAB 300 measured very well. It delivers an accurate sound, due to its flat response, with more treble energy but less bass than the Pure. **NK**

| | |
|--------------------------------|------------|
| Frequency response | 25Hz-20kHz |
| Stereo separation | 62dB |
| Distortion | 0.009% |
| Hiss (IEC A) | -103dB |
| Signal for minimum hiss output | 10uV |
| | 1.2V |

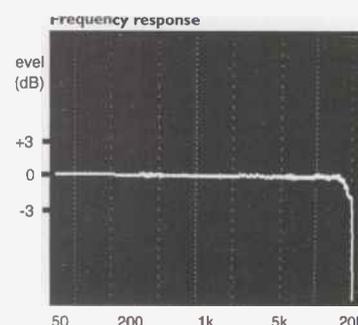

World Verdict 
Fine ergonomics allied to great ease of use and respectable DAB sound makes this superb value.



DENON TU-260L Mk II £130

In any group test it's always great fun to throw in a dark horse! This tuner is known to all who take an interest in serious audio as something of a classic – a genuine giant-killer in the mould of the late, lamented NAD 4020, for example. The original Denon was launched back in 1990 and became one of the industry's best loved bits of kit, as reviewers around the globe discovered its multitude of merits, not least the incredibly low price tag.

The mkII version has updated features more in tune – so to speak – with today's technological expectations (although that never stopped Naim – who make some of the best sounding and least-equipped tuners!) All the features of the original are kept, such as AM reception, but RDS is introduced along with a front placed rotary knob, which is always preferable to us old fashioned types. There's also a claimed improvement of performance and a remote sensor on the front, for system remote use.

Cosmetically it doesn't touch the

Primare or NAD, but they're far more expensive, of course. The tuner itself is remarkably small for a 'full-size' component and is aesthetically, ermm, understated. So light is it that a good blast from an indoor fan could almost have it across the room! Forty station presets are included, plus the aforementioned RDS capability and that's about it. The display is clear but nothing special, and the antenna connections are standard. It's very user friendly – just scan and store. Simplicity is the key.

SOUND QUALITY

Forget the light build – when it comes to good old fashioned sound quality, this design has few rivals at or anywhere near the price. Tune in to Radio 3 or 4 and you'll get a big, spacious and incredibly well imaged acoustic that rivals some of the best tuners three times the price – and more! It really has the demeanour of a quality high-end source component rather than the hi-fi also-ran you'd expect for £130.

Radio 4's Today programme had me entranced with the lush sound emanating from my loudspeakers.

Spoken voices were incredibly realistic, which is a real treat with a true budget tuner. Orchestral music on Radio 3 sounded rich and full bodied, with very little thinning out of the texture, every layer of the orchestra was clear and precise with no vagueness or imprecision. There's an essential sense of vibrancy and life, which really sorts the men from the boys in the tuner world.

One bonus point is that the Denon made great work of sonically below par commercial stations, which sounded big and bold without too much 'synthesis'. Radio 1 was good too, with fine imaging, while BBC local stations sounded clean and tidy. The TU-206L mkII is one cracker of a product that deserves to go down the annals of hi-fi history. The one to reel in, for those fishing for bargain.

Denon TU-260L MkII £130

Hayden Labs Ltd.
Tel: +44 (0)1753 888447
www.denon.co.uk

MEASURED PERFORMANCE

Always a favourite, the TU-260L still measures well by today's standards. It has a flat audio response with just a small roll down – just enough to ensure a smooth sound. Channel separation was wide and distortion very low, especially at full modulation. With little pilot or sub-carrier and plenty of output the audio side of this tuner measured unusually well.

Sensitivity was high and selectivity the best of the group by a useful margin. The TU-260L was also a little quieter than the others, noise

measuring –72dB in stereo at full quieting. In every area this tuner was a notch ahead of its rivals. **NK**

| | |
|-------------------------|-----------|
| Frequency response | 5Hz-15kHz |
| Stereo separation | 53dB |
| Distortion (50% mod.) | 0.14% |
| Hiss (IEC A) | -72dB |
| Signal for minimum hiss | 1mV |
| Selectivity (at 0.4MHz) | >80dB |
| Sensitivity | |
| mono | 1µV |
| stereo | 40µV |
| output | 1V |

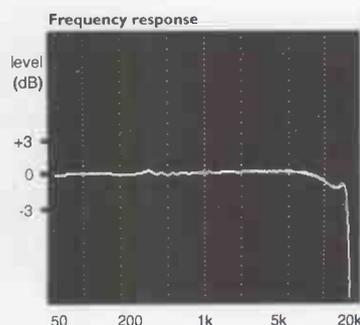

World Verdict £ Superb sound at the price makes this a truly classic tuner.

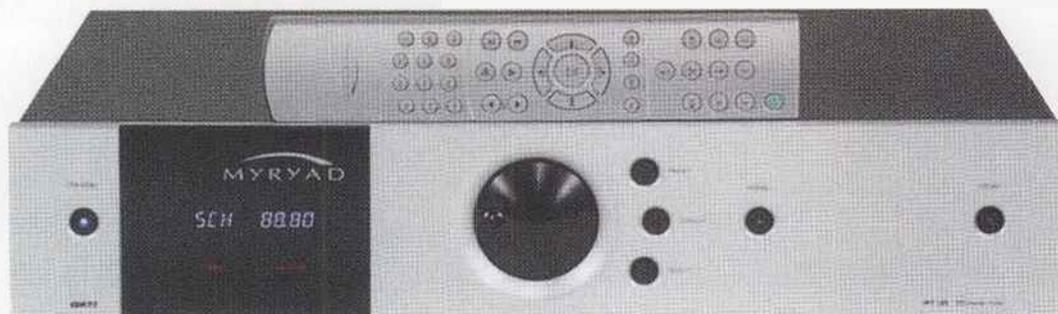

MYRYAD MT100 £600

This bit of kit has actually been around for a while, but is included here as a well recognised all rounder, worthy of judging others by. A high quality, well balanced product with fine build and nice, almost Art Deco styling, it has solid construction, although is not quite as robust as the NAD or Primare. There are certainly a lot of technical goodies inside the MT 100. It employs a high quality discrete front end with a low noise dual gate MOSFET input amp, three tuned RF stages and a buffered local oscillator. This oscillator is tuned by a crystal-locked frequency synthesiser for stable tuning.

Nineteen preset stations can be stored. The display is clear, with a mix of blue and red information which makes for interesting viewing. The overall feel of the controls is of a very high quality. The rotary control, with its finger indent, moves smoothly and freely, giving plenty of control. It can be used for either manual or automatic tuning.

Six fascia buttons, including the power on/off, are on the front panel

and all functions are possible from this array. The circuit board for the controls is sandwiched between the fascia and the sub-chassis so that noise from the circuitry won't affect the performance. RDS is standard, so all the clock updating and programme type info is present. Like the Primare, the Myryad has a standby mode and can be linked to other Myryad devices for synchronised operation and standby. A Myryad system remote comes with the unit.

SOUND QUALITY

By chance, Radio 3's In Tune was playing the sublime choral piece 'O Sacrum Convivium' by Olivier Messiaen when I switched this tuner on. A great piece to demonstrate detail, it uses very thick harmony and colour, and the Myryad coped superbly, displaying excellent timbre and richness, and fine detailing. This was a proper hi-fi sound, with a deep stage depth and fine separation. There then followed a cello sonata in which both the 'cello and piano sounded incredibly realistic and natural. Voices on Radio 4 were delivered incisively - it's very hard to

find fault with the Myryad here.

Moving onto the 'charms' of Radio 1 loudmouth Chris Moyles (so that's why they use compression!), the Myryad had good bass extension but the treble could have an edge at times. This is more down the uncouth source material than any fault of the tuner's, however...

Snoop Doggy Dogg's latest oeuvre had a solid grounding and a big sound that was actually quite appealing. Finally, Capital and local BBC stations came through the test with flying colours. The balance between the commercial sound and the slightly more refined BBC touch was deftly handled.

The MT 100 is a very fine tuner indeed. Yes, it costs quite a bit of money but really is worth it. Your money buys fine build, neat looks and a highly refined and sophisticated sound. Tuner surprise.

Myryad MT100 £600

BBG Distribution
Tel: +44 (0)20 8863 9117
www.bbg.eu.com

MEASURED PERFORMANCE

The MT100 has a smooth wide audio response that cuts off sharply above 15kHz with a deep mpX filter. This tuner will sound tonally

accurate - and there's no treble lift to make things sound bright.

Distortion wasn't quite as low as some but comprising only 2nd and 3rd this should not be noticeable.

Alternate channel selectivity measured a little low at 72dB overall. This will only become noticeable under difficult conditions. Sensitivity was high and hiss at full

quieting in stereo a low -71dB.

The Myryad measured well in every area **NK**

| | |
|-------------------------|-----------|
| Frequency response | 5Hz-15kHz |
| Stereo separation | 56dB |
| Distortion (50% mod.) | 0.12% |
| Hiss (IEC A) | -71dB |
| Signal for minimum hiss | 0.63mV |
| Selectivity (at 0.4MHz) | 72dB |
| Sensitivity | |
| mono | 0.4µV |
| stereo | 32µV |
| output | 800mV |

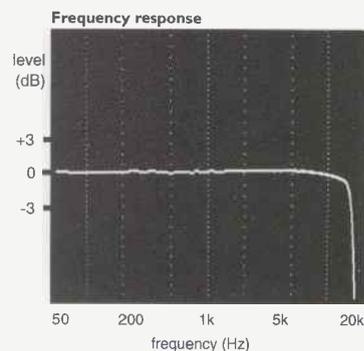

World Verdict
Deliciously svelte sound really justifies its high price. Superb.



NAD S400 £600

From NAD's upmarket Silverline Series comes this neat machine. Not content with having the mass market sewn up, this company has raised the stakes by going off to play with the posh boys! Hewn from solid metal with a thick front fascia plate, the S400 is impressively put together. It has easily the best display in the test, with a clear, blue dot matrix configuration. It's also loaded with facilities and functions, the majority of them very useful indeed. There are dual antenna inputs at the rear, both of which have a fully independent, low-noise, dual-gate MOSFET RF amplifier. This is very unusual and is included to avoid interference between inputs, being aimed at radio buffs with two antennas oriented for different signal directions, or those with a regular antenna plus a cable system.

There's triple IF filtering that offers selectable wide or narrow bandwidth tuning, something that comes in handy when trying to maximize a weak signal. A 'blend' control is also present, which triggers 'quieting' whilst retaining a

full, rounded stereo image. The S400 has a total of thirty presets but the tuner is unique in that it shows both the station name (also programmable) and also the antenna input, IF mode setting and mono or stereo status. The supplied remote is nice and simple; most of the advanced features are executed from the numerous buttons on the front panel.

One way of testing a tuner's user-friendliness is to try and work out the basics, such as program storing and tuning without a peek at the manual. Thanks to the two antenna inputs and various other configurations this wasn't an easy task.

SOUND QUALITY

Kicking off with Radio 3, the S400 gave a clean sound with a good, forward presence. Voices were on the nasal side, but music had a good spread of sound and a decent depth of stage. There's a decent amount of realism in the S400's sound, although one trait is its forwardness which takes the form of a hardened treble edge at times. Violins weren't as smooth as perhaps you'd expect at

this level, and vocals were pushed at climaxes. Overall, though, the NAD gave a realistic performance which impressed with both Radio 3 and the slightly drier Radio 4.

Moving to Radio 1 was a good test of the S400's imaging properties, which were spot on, with good stereo separation from chart tracks. Vocals were spitty at times, a mix of studio processing and the tuner's intrinsic 'presence', as was the lively upper treble in music.

A nice go-between for commercial and 'serious' stations is local radio, and here the NAD sounded full and robust when handling the mix of chat and boring MOR tunes. Overall, it's a well-equipped tuner that looks great and gives a very clean sound. However, the upper mid and treble peak can sometimes make it sound sterile and processed. Close, but no cigar.

NAD S400 £400

Lenbrook UK Ltd.
Tel +44 (0)1980 319360
www.nad-hifi.co.uk

MEASURED PERFORMANCE

The S400 unusually uses a steep low pass filter at 20kHz to attenuate unwanted sub-carrier products around 38kHz. The S400 was unusually free from intermodulation products, but also the filter introduced some treble lift which will make the sound a little bright. Distortion was low and, with low noise, the S400 is very 'clean'.

Sensitivity was extremely high, the highest of the group. Selectivity was good, although Wide/Narrow IF had little affect upon alternate

channel rejection.

The NAD S400 performs strongly in most areas. **NK**

| | |
|-------------------------|-------------|
| Frequency response | 5Hz-16.2kHz |
| Stereo separation | 55dB |
| Distortion (50% mod.) | 0.08% |
| Hiss (IEC A) | -70dB |
| Signal for minimum hiss | 0.8mV |
| Selectivity (at 0.4MHz) | 78dB |
| Sensitivity | |
| mono | 0.5µV |
| stereo | 25µV |
| output | 700mV |

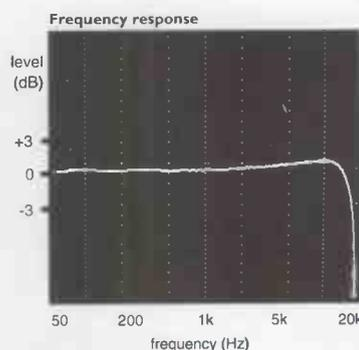

World Verdict ●●●●●
Although well built with some excellent facilities, its sonics mean that it can't quite match the best of the rest.

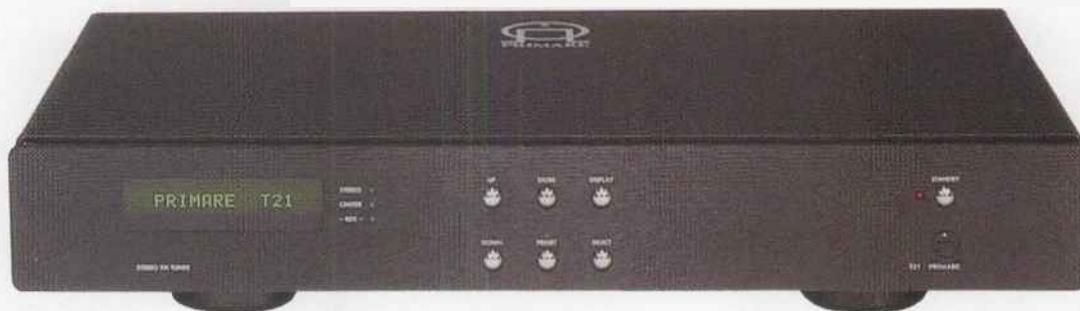

PRIMARE T21 £600

This company keeps something of a low profile, but is well known for its very fine sounding hi-fi and home theatre electronics. Indeed, Primare has made a good name for itself by plugging away from the sidelines, producing some exceedingly well engineered and consequently applauded kit. The T21 is the cheaper of the two tuners in its hi-fi separates range. Its build is excellent, with good weight and robust construction, topped off by a beautiful finish. The look is pure Scandinavian minimalism - elegant in its simplicity. The display window and green dot matrix LED looks stunning - it's one of the most legible displays I've come across. Simplicity is the key to this tuner, although the fuss-free fascia hides some advanced features, available through menu selection. It has all that the NAD S400 has, for example, (although only one antenna input), and does it with far less buttons.

There's a selection of three display options - pressing the display button chooses RDS station name,

followed by Radio Text, followed by frequency and signal strength. Three green LEDs determine stereo, centre (for exact tuning) and RDS. Pressing the preset buttons swaps between presets and auto/manual tuning. More advanced features include personal station naming, IF wide and narrow settings for accurate tuning of weaker signals and a 'bland' control for hiss (and stereo separation!) reduction. There's also muting for suppressing stations with too weak a signal. A choice of up to thirty presets is possible. It's an easy and enjoyable tuner to use, with everything you need.

SOUND QUALITY

Generally speaking, sonics were most impressive. Radio 3 had a nice sound, with voices and instruments natural and detailed. Cranking up the volume resulted in a little background noise - not usually present with reference products, but it didn't detract from the enjoyment much. Here, more than with any other tuner in the test, instruments had realistic body, and clarinets sounded warm and woody and brass clean and metallic - lesser models didn't differentiate this so

well. It takes a good tuner to convey real timbre, and the Primare did this well. A Radio 4 play was wonderfully atmospheric and rich, with warm and exact presence.

Switching to local commercial radio, the Primare did a good job with Jamiroquai's 'Virtual Insanity' without too much shriek or edge - soundstaging was more than commendable and separation superb. Throughout the frequency range the T21 delivered a full and detailed sound. This too was the case with Radio 1, which actually appeared quite pleasant, with an energetic and lively response that didn't grate or annoy! Primare's T21 is something of a dark horse, then. It impressed with its style, ease of use, facilities and sound. It doesn't have that real inky black background the likes of a NAT01 can deliver but it's a very worthy option at the price. Unexpected catch.

Primare T21 £600

CSE Solutions
Tel: +44 (0) 1423 359054
www.csesolutions.co.uk

MEASURED PERFORMANCE

Primare roll down high frequency energy from the T21 to soften out its sound. Our analysis shows this at rights. With an otherwise smooth frequency response characteristic this tuner will sound balanced.

Distortion levels were low on mono and stereo and in-band products well suppressed. With good channel separation and high output the T21 measured well on the audio side.

A nearby station causes the T21 to mute. It also mutes when signals

become very weak. It's RF performance was satisfactory though. **NK**

| | |
|-------------------------|-----------|
| Frequency response | 5Hz-15kHz |
| Stereo separation | 55dB |
| Distortion (50% mod.) | 0.11% |
| Hiss (IEC A) | -70dB |
| Signal for minimum hiss | 0.8mV |
| Selectivity (at 0.4MHz) | 71dB |
| Sensitivity | |
| mono | 3µV |
| stereo | 40µV |
| output | 900mV |

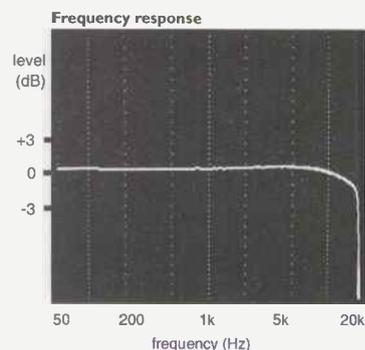

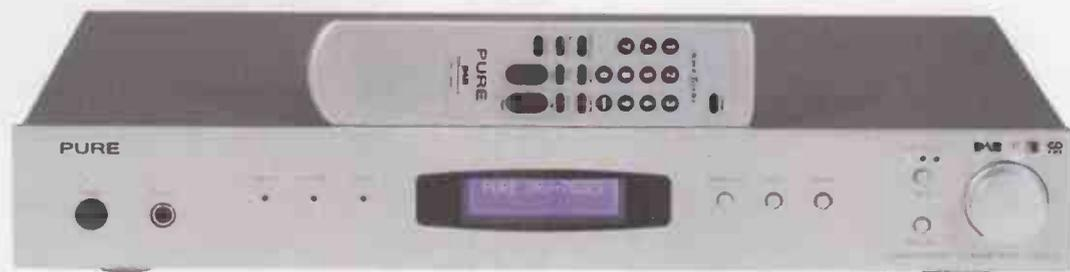

PURE DIGITAL DRX-702ES £329.99

From the world's largest manufacturer of digital radios comes this new hybrid, offering FM and AM analogue, in addition to DAB. It features the latest DAB processor from Frontier Silicon in addition to multi-language support and dual-band reception for use throughout Europe.

Crammed with features, you get analogue auto tune (very handy) and selection by station name, plus naming of non-RDS FM stations. There's USB connectivity for software upgrading and future DAB data access; configurable DAB station programming, ninety nine presets each for DAB, FM and AM; RDS capability and full signal strength and aerial diagnostics. Build is acceptable, and the overall look quite elegant

At the rear we have a real socket-fest, with balanced XLR outputs (!), stereo RCA outputs, a loop for auxiliary devices, coaxial and optical digital outputs, three antenna sockets and a USB connector.

Although there's so much to master, this is still a very user friendly design and a doddle to use. One great thing is that with FM you simply turn the rotary knob until the required station appears a press it in – hey presto - just like DAB! You even get a comprehensive remote unit and quarter-inch headphone socket to boot.

SOUND QUALITY

This machine works well on analogue FM. Radio 3 had a decent amount of warmth and depth, although there was a definite lack of fullness and roundness. Voices were natural with just a tad of chestiness. Moving to Radio 3 on DAB, and contrary to popular journalistic belief, it sounded better! This is down to PURE's own Psycho-Acoustic Compensation-II technology (PAC-II), which applies plateau lift to low frequencies, and equivalent cut to highs, via the analogue outputs only. This adds body and warmth to the sound. It also means the Pure will not sound like other DAB tuners. It works very well indeed, making digital Radio 3 a force to be reckoned with.

Radio 1 in analogue was a bit of

a nightmare – due to the PURE picking upon the worst aspects of studio processing. Upper frequencies were tinny and edgy and bass, although deep and full was overblown. This, however, mainly disappeared with the same broadcast in digital, which tidied things up nicely, vocals clean and tidy and bass as tight as could be expected. Again the PURE delivered a slightly better response in DAB than analogue with local commercial and BBC stations, the digital side of the machine did a much better job with pop music than many rivals do in analogue.

The 702 is an interesting and brilliantly well equipped bit of kit, which can't be bettered when it comes to facilities and features. Still, by squeezing so much in, some refinement and focus has been lost. It's an easy 'one box' solution for those wishing to solve their analogue versus digital dilemma. Twice as nice!

Pure Digital DRX-702ES £329.99

PURE – VideoLogic
Tel: +44 (0)1923 260511
www.videologic.com

MEASURED PERFORMANCE

The Pure vhf/fm lacks an mpX filter. The tuner has an extended treble response, and a small bass peak too, of +0.6dB at 40Hz. These characteristics will give the Pure a livelier sound than rivals, but pilot and subcarrier levels were higher than normal due to lack of filtering, and so were in-band IM products, the spectrum analyser showed

This tuner had around 7dB more hiss on VHF than the others. Otherwise, selectivity was good and sensitivity adequate to keep up with

the pack. DAB measured well but has bass lift and treble reduction.

NK

| | |
|-------------------------|-------------|
| Frequency response | 5Hz-17.3kHz |
| Stereo separation | 41dB |
| Distortion (50% mod.) | 0.14% |
| Hiss (IEC A) | -63dB |
| Signal for minimum hiss | 0.5mV |
| Selectivity (at 0.4MHz) | 80dB |
| Sensitivity | |
| mono | 1.6µV |
| stereo | 63µV |
| output | 1V |

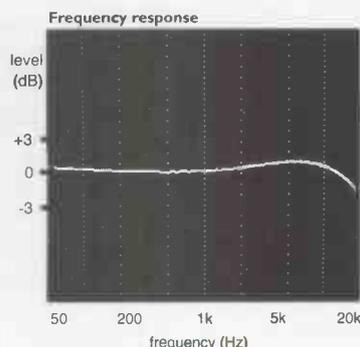

World Verdict £ 
Great with digital, but thin sounding on FM. A top hybrid, nonetheless.

3 years of proven reliability.
2 years guarantee.

Shop prices are expensive because of rent, rates, wages, etc. Buy direct & save £££.

Price is not a guarantee of sound quality.

We have signed testimonials to prove that customers prefer our amplifiers to
£8,000 preamp + 320 watts power amplifier,
£4,000 pre/power amp & power supply,
£2,600 pre/power amp & power supply,
£1,400 well reviewed 150 watts amplifier.

Money back guarantee (less £30 UK or £100 overseas) that you prefer :-

£1,000 or £1,450 "KT88 Triode Connection" amplifiers to most transistor amplifiers, most transistor / valve hybrid amplifiers, most Single Ended valve amplifiers, most Ultra Linear valve amplifiers selling for £2,000 to £20,000

£2,500 or £1,800 "10 inch High End" speakers + our £1,450 amplifiers to overpriced pretentious £100,000 systems (at realistic life-size volume)

£700 EL34 valve amplifiers (40 watts + 40 watts) to most transistor amplifiers and transistor / valve hybrid amplifiers costing £1,000 to £2,000

£500 EL34 valve amplifiers (40 watts + 40 watts) to most £700 amplifiers.

£380 to £800 valve phono stages to most transistor phono stages.

Telephone 01634 268662 anytime or 01634 373410 for Mr Andrew Everard's review in Gramophone Magazine and Summary of 21 testimonials from satisfied customers.

www.affordablevalvecompany.com

Amplifier shown without CE safety cage, to prove that these are genuine valve amplifiers. Customers must not remove CE safety cage.

Free UK delivery.

Subsidised £50 UPS delivery to other countries.



definitive audio

Peddlers of fine wares, including:

Record players: SME models 10, 20 and 30; Kuzma Stabi, Stabi Reference; Nottingham Analogue Interspace, Space Deck, Hyperspace and Dais; Michell Orbe; VPI AriesScout; Avid Volvere, Sequel and Acutus.
Arms: Rega 300/600/900; SME Series IV and V; Kuzma Stogi; Triplanar.
Cartridges: VanDenHul Grasshopper and Collibri; Kuzma KC Ref; EMT; Reson Reca and Elite; Cartridge Man Musicmaker; Benz-Micro including Ruby Open Air; Kondo lo J.
Amplifiers: Border Patrol; Canary; Sugden; Art Audio; Monarchy; Western Electric; Icon; Tom Evans Audio Designs; SJS.
CD Players: Wadia; Sugden; Primare; Resolution.
Louspeakers: Living Voice; Vitavox; Lowther.
Cables and Tables by Living Voice.

| Sale of part exchanged and ex-dem items | Sale | New |
|--|-------|--------|
| Clear Audio Solution - no arm - SME cutout | £500 | £900 |
| Horning Agathon - 98dB 2 way horn - Mahogany - PM6A (alico) | £1600 | £3800 |
| Living Voice Avatar - natural santos rosewood - ex-review bargain | £2200 | £2900 |
| Canary Audio CA 301 - 300B - 22 watts - juicy | £3400 | £5400 |
| Canary Audio CA 309 - 300B parallel p.p. - 45 watts - juicy and beefy | £9500 | £13500 |
| Canary Audio CA 300 - single ended monos - valve rect. - 8 watts | £2000 | £3500 |
| Jamo Concert 8 - loudspeakers - 2½ years old - maple - spotless | £700 | £1365 |
| Townsend Seismic - speaker stands - ugly and bouncy | £450 | £695 |
| Tube Technology MAC - mm and mc phono - nearly new - not bad | £600 | £1400 |
| Audio Innovations Series 1000 - silver circuit - 50 watts class A | £1100 | £2500 |
| Alchemist Forsetti ADP 15A - integrated amp - broken and horrid | £100 | £1400 |
| AudioNote Soro - phono integrated - serviced/new valves - smooth & soft | £700 | £1900 |
| Clear Audio Master Reference - turntable - no arm | | |
| 2 years old - Perfect condition. Go on, be crazy, it's only... | £6000 | £8500 |
| Audio Research LS2 B - line pre - fine condition - giveaway | £1000 | |
| Pink Triangle PT TOO Export - black - vgc - great sound | £300 | |
| B&W DM603 S3 - black - good condition - dismal | £350 | £600 |
| Snell Type EII - walnut - industry classic - new bass-mid drivers | | |
| high mass Pirate stands - lovely sound - 92 db per watt sensitivity | £700 | |
| Snell Type JII - french polish walnut - industry classic - very nice sound | £400 | |
| AudioNote ANJ-D - walnut - Huygens high mass stands | £600 | £1400 |

Tel: 0115 973 3222 Fax: 0115 973 3666
internet: www.definitiveaudio.co.uk email: shout@definitiveaudio.co.uk

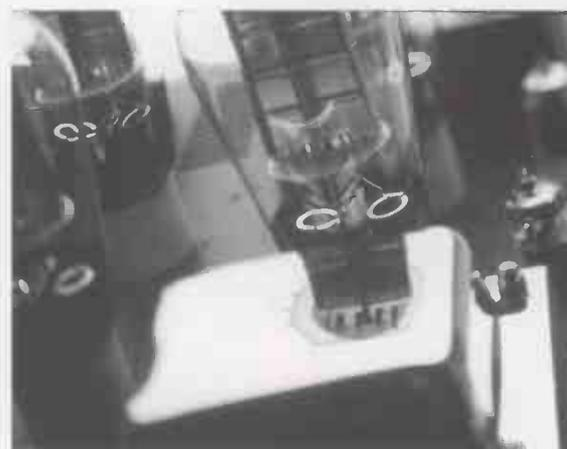

The BorderPatrol P20

'One of the best music appreciation devices available.'
Jason Kennedy Hi-Fi Choice Summer 2002.
EDITORS CHOICE

Full details on the P20 and other BorderPatrol amplifiers and power supplies can be found on line at www.borderpatrol.net

Tel/fax 00 44 (0) 1242 717171
e-mail bp@borderpatrol.net
www.borderpatrol.net



BorderPatrol

CONCLUSION

It won't surprise hard bitten audiophiles to read that all the analogue designs here better their digital rivals outright – on sonic grounds, at least. The overall winner, thanks to its combination of build, functionality and sound, is Myryad's MT 100. It has superbly refined sonics and is impressively engineered, which shows in the performance. It even looks the part too, being not too flash nor too drab. If you take radio seriously and you have a top-notch system, then this is the product out of all in the test that you should audition first. It's expensive for a tuner, but ultimately worth it.

At the other end of the scale – at least price wise – comes the cracking Denon TU-206L MkII. If you're after high fidelity radio, then you simply can't rule this one out. Those not bothered by aesthetics or into impressing their friends with flashy finishes could do a lot worse than to buy this. In blind tests it trounces rivals at twice and even three times its price. With a full and detailed performance – so rare with budget FM radio – for just £130, it's a fearsome product and an automatic audio classic. It's by far the best value for money here, at being one of the best sounding designs.

Next comes the Primare, which very nearly took top billing, but lacked that last ounce of body necessary to better the Myryad. This apart, it's hard to fault. Build is superlative, and the overall look is a knockout, without being in the slightest bit flash. It fared well with commercial stations as well as the BBC classics and no quirks or odd surprises up its sleeve. An extremely solid proposition, it's

the automatic choice for those who've already invested in Primare electronics.

Arcam's T61 offers fine build and finish at the price, and represents the best middle market buy here. There's nothing absolutely earth-shattering about it, but neither is it boring or staid. There's good body and separation to the sound but if we have to find a criticism, it's a bit dynamically flat and grey toned. Nonetheless, it's a decent enough buy.

Next, the NAD enters the fray. This is actually a very well crafted bit of kit with a shed load of goodies on board. However, not all of these facilities are actually that necessary and it could be a case of over gilding the lily. The sound is good and detailed but a little bright at the top end. Perhaps if a few facilities were chopped and the components made even better you'd have a world beater on your hands. It's good – but disappoints simply because it's no world-beater in the mould of classic NADs of yore, such as the 4020 or 4140.

Lastly, but by no means least come both the Cambridge Audio and PURE digital designs. The PURE was slightly better sounding than the Cambridge, as you'd expect, but the Cambridge is obviously the better value buy. The PURE offers superb versatility, yet the Cambridge is brilliantly easy to use. However, they both lack the depth and warmth that makes a tuner hi-fi and not merely stereo radio. By all means, purchase either of these if you've decided that Digital Radio is for you – both are superb value for money.

However, to play music, we'd advise you to get the Myryad or failing that, the Denon.



Myryad MT 100



Denon TU-206L MkII



Primare T21



Arcam T61



NAD S400



Cambridge DAB 300



Pure Digital DRX-702ES

STATION TO



Radio in Britain is flourishing. An explosion in the number of stations, of both analogue and digital varieties, is offering greater choice than ever – and new technology is transforming things still further. David Price tunes in...

Traditionally, British radio listeners had a choice of just four national BBC networks, a couple of local BBC and commercial stations and not a lot more. Yet in the past few years, UK radio broadcasting has transformed itself an altogether different entity. Now, a substantially expanded number of commercial stations have appeared, and our national broadcaster, the BBC, has responded with three new networks available through Digital Radio.

The upshot is that what was traditionally called 'broadcasting' is becoming 'narrowcasting', as stations change their programming to target specific niche demographic markets. Mark Story, managing director of programming for Emap Radio, says, "we've moved from programming to programmes with presenters who mean something to listeners and who can captivate them". The result is burgeoning audiences right across the radio band, as GfK's Media Director Nick North confirms, "electronic measurement of radio audiences confirms the radio industry is in excellent shape, with

very healthy audiences in both the public and private sectors".

ANALOGUE

The BBC's main national analogue networks, Radios One to Four, are experiencing differing fortunes. Radio 1 is continuing to see its audience shrink, with an average of 10.34 million listeners aged 15 and over tuning in each week, down 200,000 from the same quarter last year. This means its share of all radio listeners dropped from 8.4 per cent in March 2002 to 7.9 per cent in March 2003 [source: Radio Joint Audience Research].

The same changing demographics responsible for this also explain the fact that most other BBC national stations are increasing their audiences. Radio 2's famous recent replacement of Jimmy Young with Newsnight presenter Jeremy Vine has not damaged listening figures, the station continuing to be the Beeb's most popular network with 13.23 million listeners per week, up from 12.9 million and forming 15.7% of the total UK audience. This contrasts to Radio 3, with its 2.1 million listeners and 1.1% of the total audience.

Radio 4 and 5 posted significant gains. Thanks to listeners wishing to keep abreast of developments in the Gulf War, demand for news-based radio rose considerably during the

first quarter of 2003. Radio 4 reached a record 10 million listeners a week, compared with 9.95 million last year, and walked away with the top Sony radio award to boot. This gives it 11.8% of the total audience. Radio 5 Live also did well, bringing in 6.42 million listeners, which is its third highest figure ever and 4.7% of the total audience.

DIGITAL

After the BBC launched Digital Audio Broadcasting four years ago to a deafening silence, the demand for Digital Radio has finally arrived in earnest, with over 1.5 million listeners now receiving the broadcasts. This is music to the ears of media groups such as Emap, who have been investing heavily in the wide range of content possible with the new system. Its stations such as Kiss FM, Magic, Kerrang! and Smash Hits! are available via the new radio sets, as well as on the internet and by satellite TV.

Although just three digital stations had their audience figures recorded by the latest Rajar survey, the results have proved impressive. Simon Cole, chief executive of UBC Media, commented that, "We have waited three years for concrete evidence that digital radio is being embraced by the British people... nobody can now doubt that digital



Nicky Campbell and Victoria Derbyshire's first quarter in charge of Radio 5's breakfast show produced an increase of 50,000 listeners.

STATION

VITAL STATISTICS

As the figures for the total radio listening hours for the first quarter of the past three years show, radio is becoming increasingly popular despite the vast expansion in the number of digital and satellite TV channels.

| | |
|------|---------------|
| 2001 | 1,032,080,000 |
| 2002 | 1,089,575,000 |
| 2003 | 1,093,531,000 |

listening will be a significant and growing part of the radio landscape over the next two years".

Intriguingly, Emap has reported that almost as many people are tuning in to its Kiss 100 network on digital as they are in analogue. Its weekly listening figures total 2.4m, with 1.5m tuning from the London analogue station and 932,000 tuning into Kiss via digital. The spectacle of hitherto 'niche' digital stations moving into the analogue domain, where there are – currently – more listeners, may soon be with us. For example, Emap is reportedly hoping to transfer Kerrang! to analogue with the new West Midlands license that it is bidding for!

Targeting audiences more carefully than national networks such as Radio 1 can is how the independents are growing their audiences, according to Mark Story. The result is that niche stations can get surprisingly strong listening figures via digital - the all-pop Smash Hits radio got more than 750,000 listeners a week, which isn't enough to threaten Radio 1, but it is still sufficient to worry it.

The BBC has launched a raft of new digital stations. Radio 5 Live Sports Extra gives sports fans welcome extra choice, while Radio 6, the BBC's new network for serious music fans has received great critical acclaim. Radio 7 is broadcasting a wide variety of comedy, from classic to modern. The BBC has now pledged that Rajar will in future track these new stations.



Six appeal: BBC 6, a new network for serious music fans has received great critical acclaim.

DIGITAL TV

While Digital Radio has been on a slow-burning fuse, the success enjoyed by Freeview, the digital terrestrial television platform which replaced ITV Digital - which also carries a number of digital radio stations - has given the medium a significant boost. Listening to radio via digital television has been one of the great unreported developments in listening patterns, so much so that Rajar estimates that 13% of all radio listening is now done via digital TV.

Interestingly, Sky digital is the biggest digital radio platform in the country, carrying over sixty different radio stations and used by 39% of Sky's 6.7 million subscribing homes [source: Continental Research], up from 33% one year ago. To wit, a number of commercial radio stations are launching on this medium. LBC 97.3 FM has announced it would be available to Sky digital subscribers from the 9th June 2003, giving the station its first ever national presence. This means that several leading analogue networks, including Heart and Galaxy, can now all be heard throughout the UK via Sky digital.

or 10.8% of adults. Online listening is most popular among regular Internet users (25.8%) 15-24's (20.3%) and men (15.0%). Interestingly, the RAR states that, "music is the most popular online activity, with 13% listening to online radio".

CONCLUSION

Despite a number of new digital and satellite TV networks, radio is undergoing something of a renaissance - and this looks set to continue thanks to the new technologies. Both analogue and digital radio are seen to be coexisting happily, with the unusual spectacle of a number of digital stations now trying to obtain analogue licenses. The rise of broadband is finally making internet radio a realistic proposition, too. In the words of Jenny Abramsky, the BBC's Director of Radio and Music, "the whole industry goes from strength to strength, with more people listening to radio". So much for 'video killed the radio star'...

Bob Harris
2200 - 0100

LISTEN LIVE

INTERNET RADIO

www.live365.com ****

Although theoretically possible with dial-up, broadband makes internet radio a seamless proposition. Thus equipped, a welter of stations are near-instantaneously available from all around the world, with the only problem being how to make sense of them. This is where Live365 comes in, offering direct access to everything from Ambient to Comedy. Simple but powerful searches are offered on the menu page's centrally mounted radio tuner, plus extensive browsing by genre or location. A handy 'listening wizard' makes the connection and you're off - simple as that. There's little to criticise here.

INTERNET

Finally, online radio is proving to be another great fillip for radio broadcasting. Rajar figures, in conjunction with the Radio Advertising Bureau, show that the number of UK adults using the Internet once a week or more has grown by 13.6% to 39% since last year, and now exceeds 19 million. Internet radio listenership has grown by 19.6% year-on-year to 5.3 million



THE GREAT DEBATE

THIRD CLASS ?

LJK Setright charts the course of BBC Radio 3, lamenting its move towards populism, while Simon Pope celebrates the station's new-found emphasis on the contemporary...

"Its whole content will be directed to an audience that is not of one class, but that is perceptive and intelligent." For some reason Sir William Haley, then Director-General of the BBC, was on the defensive when he introduced The Third Programme in 1946, but smarting post-war Britain was ridden by class-consciousness in those days, and so was the BBC.

To its eternal credit, that did not stop it establishing the most civilised radio channel in the world. Wartime experience had shown the BBC what an astounding capacity it had for educating the public – countless thousands had acquired some sort of musical upbringing in those clamped-down years – and with the lofty aspirations of founding father Lord Reith still setting high standards, the BBC could match its capacities to its responsibilities.

**BBC
RADIO**



90-93FM

The best of classical music, and in particular the best of chamber music, found its way to all manner of perceptive and intelligent ears. The spoken word, thanks to some producers who (like Louis MacNeice, though none could match his poetry) were first-class writers, was also celebrated: where else could one hear the Greek tragedies so

” Radio 3 is now the stalking-ground of aggressively political populists

unashamedly presented? Where else could one hear the reflections of great minds such as Bertrand Russell, who gave the first of the Reith lectures in 1948?

Where else could The Word be heard spoken with such authority, and so beautifully? The rigorous training of announcers and scriptwriters ensured that nothing would be mispronounced, nothing incorrectly stressed, nothing would offend an ear that might perceive the faintest departure from the sacrosanct rules of grammar, or be pained by the slightest want of musicality in the voice.

No harm seemed to ensue when The Third Programme, now 21 years old, was renamed BBC Radio 3. On the contrary, Britain's increasing resort to FM transmissions prompted a growing indulgence in stereo in the late 1960s, and it was Radio 3 that undertook this most promptly and most properly. That was when those discerning and intelligent ears became aware that this station offered not only the highest quality of programme content but also the highest quality of transmission.

It is still worthwhile having a

tuner that will do justice to it, for live music can still be heard better via BBC Radio 3 than through any other broadcasting medium. There is some compression during the rush hour, for in-car perception, but for most of the day and night this is still the least corrupted station.

Would that this were as true of the programme content nowadays, as it is of the technical quality. Politics, materialism, and a monstrous hash of reorganisation by people more at home with the standards of business management than hallowed institutions, have assaulted the discerning ear and insulted the intelligent. Radio 3 is now the stalking-ground of aggressively political populists.

Beautiful speech (remember Patricia Hughes, the last of the paragons, and rage against the strident harridans who have supplanted her!) is scarcely to be heard. Beautifully formed music is at a discount, and much airtime is now devoted to the scarcely congealed vomit of rebellious 'modern' composers (Bach was 'modern' in his day, but how differently!) and to a welter of cheap international pop masquerading as a synthesis of world culture. A children's programme, most afternoons, reaches down into the gutter – where, a discerning ear suggests, the new authorities must have found most of their current crop of announcers, whose mispronunciations do nothing to conceal a sheer unmusicality which is painfully at odds with what is still, on balance (and however precarious that balance may be), a programme largely devoted to good music.

Yet, whatever it may be that it broadcasts, Radio 3 still transmits it better than any other. For that, at least, we should be grateful.

LJK Setright

It isn't just about a Schubert string quartet played by four tweed besuited music teachers from Hampstead. The 'classical' music genre now encompasses different forms, including the dreaded title 'world music' and even experimental electronic dance music.

Getting more – and younger – people into classical music is tough. It's hard to make classical 'cool' and most attempts to do so are just plain naff. Members of Sonic Youth, the New York feedback-loving 'noise smiths' recently embarked on a project involving the music of avant garde American composer John Cage. Now, that's a lot 'cooler' than Bond, the laughable Russell Watson or Nigel Kennedy - believe you me!

The more savvy people in the industry caught onto this, including someone at that supposed bastion of traditional musical elitism, Radio 3. The stroke of genius here was to launch Late Junction, a hyper-eclectic late evening trawl through the world of 'anything goes as long as it's good', much in the style of the classic John Peel evening shows on Radio 1. There will be many readers who feel nauseous that the likes of Kraftwerk, Radiohead and Mercury Rev sit nightly along side the likes of Ravi Shankar, Miles Davis, Messiaen and – Heaven forbid! - Tallis and Chopin, but indeed they do.

The point, however, is that it isn't merely cynical programming to get to a wider audience by chucking in lumpen music with wider appeal. Everything on this programme is musically valid, and there is no deadwood. The fact is that the people that present and produce this show are far more musically 'qualified' and literate than any critic would like them to be! That the show attracts audience figures which were hitherto 'pie-in-the-sky' for Radio 3 is merely an added bonus for the station.

Over the past ten years or so, as people have tired of traffic jams, the hassle of commuting and life in the fast lane, so we've looked for ways to relax. Music is the obvious and most accessible format with which to do this. Sales of Gregorian chant CDs shot up, numerous 'chill-out' compilations hit the shelves and

there is now an attraction for anything musically relaxing to ease tired executive minds. Whether intentionally or not, it was amid this that Late Junction was born, amidst a gentle reinvention of Radio 3 that carries on still today.

It all started back in September 1999 with an appropriately eclectic mix of pieces that was to set the precedent for the programme's future style. Controller Roger Wright let job-share presenters Verity Sharp and Fiona Talkington loose with their record collections and musical radars. As the months progressed so

” The show brings new works to new minds -and educates, edifies and eradicates musical prejudice...

the programme has gone from strength to strength – it could, of course, have proved to be dreadful, but this has not been the case.

As someone once said, there are only two types of music - the good and the bad. Most of that which is played on Late Junction falls in the former category; all is beautifully relaxing, serene and often strangely hypnotic. The lack of programming boundaries can leave the door open to all sorts, but it never reaches the embarrassing. The show is a great success, and perhaps a surprise to some, that attracts listeners of up to 300,000 and now has its own record label with four compilations.

Late Junction is one of the best things to happen in the wider classical

LATE JUNCTION:

Radio 3, 10.15pm Monday to Thursday

music field for a very long time, and it is to Radio 3's eternal credit that it dared to programme it. The show brings new works to new minds and educates, edifies and also eradicates musical prejudice – all of which are essential. It gets you thinking. Never, ever say 'I don't like classical music' again. Oh, and here's the hi-fi edge – I can't think of a better excuse to buy a decent tuner than for Late Junction – most pieces played are also superbly recorded. All you need is a decent radio and an open mind - not a five thousand pound catalogue of Compact Discs - and the musical world is your oyster. As this inspired piece of programming proves, Radio 3 is changing, and for the better.

Simon Pope

THE EDITOR SAYS:

The changes at Radio 3 epitomise the general drift of the BBC from its old Reithian credo of informing and educating to being a savvy, mass market 'people's broadcaster'. I have mixed reactions – I understand Setright's position but think we have to move on. What do you think? Email us at editorial@hi-fiworld.co.uk



Late Junction's Verity Sharp: one of the new faces of BBC Radio 3

HI-FI WORLD'S GREAT COMPETITION GREAT GIVEAWAY

WIN A FABULOUS PAIR OF **MONITOR AUDIO B4 STANDMOUNTING LOUDSPEAKERS** IN THIS MONTH'S GREAT COMPETITION!

Audiophiles know Monitor Audio for its pioneering use of metal drive unit technology, stretching right back to the nineteen eighties. Back in July, we tried the company's latest adventure in hi-fi, the MA B4. This £350 loudspeaker impressed us greatly - the sound quality left its mark. Rather than lavishing production costs on fancy finishes, this neat looking loudspeaker benefits from a compliment of seriously good drive units. And frankly, as soon as you feed it a signal, it shows!

To wit, the B4s get a pair of the company's latest MMP Mk2 6.5" mid/bass drivers, developed from MA's original Metal Matrix Polymer cone material using a high-pressure injection moulding process to achieve different thickness at critical points of the cone geometry.

Another great point in its favour - one which really impressed us - is its 'two and a half way' design. The

lower drive unit handles bass only, down to a claimed 36Hz, while upper unit handles upper bass and midband right up to the 2.6kHz crossover point, whereupon the latest evolution of MA's C-CAM gold dome tweeter takes over. Effectively, then, it's a three way - which is a rare treat at this price!

The crossover sports high grade polypropylene film crossover capacitors and low distortion laminated core and air-core inductors. The 850x185x255mm cabinet boasts 'rigid construction' with multiple bracing positioned at critical resonance nodes.

Interestingly, two bass ports are used, a small front baffle mounted affair and a larger rear port. This twin port system is claimed to enable maximum airflow at low frequencies, as well as reducing air pressure that can lead to bass compression effects. The result is one of the very best sounding loudspeaker systems at the price. Here's what we said in our July review:

"They sound very 'couth' indeed. There's no sense of having your senses assaulted, no feeling of needing to tread carefully with them. Bass is warm and full. So much so that it's quite reminiscent of 1970s loudspeakers.... It really doesn't sound like so many anaemic modern boxes - you can tell large amounts of air are being moved by the B4's big, sumptuous sound.... Moving up the spectrum, the midband was surprisingly detailed, yet tonally warm and smooth.... Don't expect a forward, shrill and analytical sound from these metal mothers! In a phrase, the B4s are big smoothies -



but not loose and overblown with it... the overall quality of the tweeters themselves is absolutely superb at the price. They integrate brilliantly with the mid/bass unit too - with everything from snare drums to female vocals having a surprisingly smooth, seamless nature. Allied to a deep and full bass, the overall effect was most impressive for £350!"

If you'd like to win these fine loudspeakers, then all you have to do is answer our four easy questions and on a postcard together with your name, title, address and telephone number and send it to our address on the left. Good luck!

Competition Questions:

[1] since when has Monitor Audio been using metal cones?

- [a] 1980s
- [b] 1890s
- [c] 2003
- [d] 1707

[2] what does MMP stand for?

- [a] Mucho Metal Polymer
- [b] Magnetic Metal Polythene
- [c] Metallic Magnesium Potassium
- [d] Metal Matrix Polymer

[3] what is MA's gold dome tweeter called?

- [a] C-CAM
- [b] N-SYNC
- [c] P-MACHINERY
- [d] D-MOB

[4] what port arrangement does the B4 use?

- [a] Bristol
- [b] serial
- [c] free
- [d] twin

August Competition
Hi-Fi World Magazine
Unit G4 Argo House
The Park Business Centre
Kilburn Park Rd.
London NW6 5LF

Hi-Fi & Computer Audio World Competition rules and conditions of entry

1. Only one entry per house hold.
2. Multiple entries will be automatically disqualified.
3. Purchase of the magazine is not a pre-condition of entry.
4. No correspondence will be entered into.
5. The Editor's decision is final.
6. No employees of Audio Publishing Limited, or of any companies associated with the production or distribution of the prizes may enter.

CONGRATULATIONS

...to Mr. John Hoatson, of Plymouth, the winner of our June 2003 competition. A pair of Revolver R33 Standmount loudspeakers are on their way to you.

Sevenoaks SOUND & VISION



Sevenoaks Sound & Vision stocks a wide range of Hi-Fi separates, DVD players, amplifiers, speakers, plasma screens, LCD televisions and projection systems from all the leading manufacturers.

From starter systems to custom designed multi-room and home cinema installations, our friendly staff are available in all outlets to advise, demonstrate and guide you through the home entertainment jungle. If you're interested in home entertainment and want to avoid the confusion, contact your local Sevenoaks Sound & Vision outlet and **experience more**. 0% interest free option* is available on most products. *Written details on request. Licensed credit brokers. Minimum balance £400. Subject to status.



LINN

The **CLASSIK MOVIE DI** is Linn's latest integrated audio and video source product. This offers the performance and features of the Classik Movie together with the added benefits of greater flexibility, additional processing power, superior audio and video performance plus surround sound decoding from external digital and analogue sources.

Developed from the new Linn Unidisk 1.1 flagship Universal disc player, the Classik Movie Di integrates DVD and CD playback with an AM/FM tuner, multi-channel power amplification and multiroom distributed audio. With two digital audio inputs for external sources as well as composite video, S-video and component video inputs and outputs, the CLASSIK Movie Di outputs concurrent digital and analogue audio. Linked audio and video sources ensure simple operation. Hi-Fi World (July 2003) concludes - "It's probably the best performing one-box multichannel machine on the market."



NEW LINN CLASSIK MOVIE DI SYSTEM



**DENON DVD-2900 UNIVERSAL DISC PLAYER
WITH PAL PROGRESSIVE SCAN**

with maximum surround sound separation and dynamic range. The DVD-2900 also offers full digital bass management for DVD-Audio and Super Audio CD, with selectable crossover slopes to optimise sonic performance with any loudspeakers and room environment. In addition, the player includes built-in Dolby Digital and DTS decoding with 5.1-channel outputs, plus built-in MP3 decoding that provides up to 10 hours of music playback from a single MP3-encoded CD-R or CD-RW disc. The video performance of the DVD-2900 is equally exceptional. The player incorporates precision Analog Devices 12-bit, 108MHz video D/A converters, and Denon's PureProgressive Scan™ technology featuring the Silicon Image Si1504 decoding engine. The processor is capable of real-time computation at more than 6 billion operations per second-massive computing power that assures seamless, artifact-free image quality.

NEW DVD-2900 Universal Disc Player

Marking one of most significant product introductions in the company's history, Denon has introduced the **DVD-2900** player, the company's first-ever all-format universal disc player. Offering both DVD-Audio and Super Audio Compact Disc playback, it includes a host of leading-edge technologies and features to offer ultimate-performance multichannel audio and PAL progressive scan video playback.

Consistent with Denon's philosophy that a DVD player is a high-end audio component as much as it is a video playback device, the DVD-2900 is designed for unsurpassed sound quality. It incorporates leading edge Burr-Brown 24-bit, 192kHz audio D/A converters for the highest possible resolution and fidelity along

Custom Installation

Are you are looking to neatly and seamlessly integrate a Home Cinema or Hi-Fi System into your home? Our Custom Installation experts are fully trained in all areas and provide a prompt, reliable and professional service. Whether you're looking for lighting control systems, a dedicated home cinema installation with a retractable screen and built-in speakers or an integrated control system, Sevenoaks Sound & Vision has the solution.



48 Outlets Nationwide

Bedford • Birmingham • Brighton • Bristol • Bromley • Cambridge
Cardiff • Chelsea • Cheltenham • Crawley • Croydon • Edinburgh
Epsom • Exeter • Glasgow • Guildford • Holborn • Hull • Ipswich
Kingston • Leicester • Leeds • Lincoln • Liverpool • Maidstone
Manchester • Newcastle • Norwich • Nottingham • Oxford • Peterborough
Plymouth • Poole • Preston • Reading • Sevenoaks • Sheffield • Solihull
Southampton • Southgate • Swansea • Swindon • Swiss Cottage
Tunbridge Wells • Watford • Witham (Essex) • Wolverhampton

Please refer to Page 7 for full address and telephone number details.



FREE ortofon CARTRIDGE
With selected Turntables - Ask in-store for details

PROJECT

RPM4 Turntable £349.95

Turntables & Tuners

| | |
|---|----------|
| Arcam DiVA T61 Tuner..... | £249.95 |
| Cyrus FM X Tuner..... | £499.95 |
| Denon TU260L MKII Tuner..... | £119.95 |
| Marantz ST4000 Tuner..... | £109.95 |
| Michell Gyro SE/RB300 Turntable..... | £1049.95 |
| Michell TecnoDec Turntable..... | £599.95 |
| Project Debut Phono SB Turntable..... | £169.95 |
| Project Debut II Turntable (Black)..... | £119.95 |
| Project Debut II Turntable (Colours)..... | £134.95 |
| Pure Evoke 1 DAB Radio..... | £99.95 |
| Pure DRX-702ES Analogue/DAB Tuner..... | £329.95 |
| Sony ST-D777ES FM/DAB Tuner..... | £499.95 |

"If you want severe turntable styling on a budget, you need look no further than this. The shape of the main plinth here follows the outline of the record platter and arm to give a cut away look to the deck, and while it looks a bit like a cakestand with the dustcover in place, in use the RPM4 looks much more the business.

The RPM4 soon impresses with the quality feel of its arm and the screw-down clamp to hold and flatten records, and as soon as the stylus settles into the groove it's clear this is a superior player. There's much less surface noise than with the Debut, and the music has much greater scale and power, allied to closer detailing. That lovely organic feel you only seem to get from great vinyl playback is apparent... This is a very grown-up record player for reasonable CD player money: it's well worth exploring."

WHAT IS IT? August 2002

Selected outlets are Project Turntable Centres. Colour Options are available at additional cost



Michell Gyro SE/RB300
£1049.95

STARTER SYSTEM

marantz®

CD4000 (Black) CD Player
PM4200 (Black) Amplifier

MISSION

m71i Speakers

List Price £420

£299.95 • SAVE £120

Includes Speaker Cable Worth £20 FOC

PURE DRX-701ES Digital Tuner £229.95

"This new tuner from the recently renamed Pure is based on the 2001 Award winning Videologic DRX-601ES, but under the lid is an all-new third-generation digital radio engine, in the form of Frontier Silicon's Chorus FS1010.

The tuner uses 24-bit/192kHz conversion with 4x upsampling and data interpolation, and is

powered by a low-noise toroidal transformer - such attention to

sonic detail pays off. Digital outputs are provided on electrical and optical feed, but most people will use the analogue out, and these sound very good indeed. As usual the tuner is subject to the signal quality off-air, but when it's fed from a high-quality outdoor aerial and a good signal it's capable of a crisp, powerful and detailed presentation. Even more populist music stations like Radio 6 benefit from the mix of a neutral balance and fine weight, while speech is also neutral and easy to follow... If you want a quality home tuner for digital radio, you need look no further."

WHAT IS IT? ★★★★★ October 2002



WHAT IS IT?
Product of the year 2002
DIGITAL HOME CINEMA AWARDS
TUNERS
Pure DRX-701ES

SAVE £20

CD Players

| | |
|---|----------|
| Arcam DiVA CD62T..... | £369.95 |
| Arcam DiVA CD72T..... | £449.95 |
| Arcam DiVA CD82T..... | £599.95 |
| Arcam DiVA CD93T..... | £949.95 |
| Arcam FMJ CD33T..... | £1299.95 |
| Cyrus CD6..... | £599.95 |
| Cyrus CD8..... | £999.95 |
| Denon DCD485..... | £129.95 |
| Linn Genki..... | £994.95 |
| Linn Ikemi..... | £1949.95 |
| Marantz CD4000..... | £99.95 |
| Marantz CD6000K1 Signature..... | £369.95 |
| Marantz CD17/II M..... | £799.95 |
| Meridian 507..... | £1194.95 |
| Musical Fidelity A308 ^{CR} | £1999.95 |
| Musical Fidelity Tri-Vista SACD..... | £3994.95 |
| Quad 99 CD-P..... | £999.95 |
| Roksan Kandy KD1 MKIII..... | £544.95 |
| Roksan Caspian..... | £994.95 |
| Rotel RCD1070..... | £494.95 |
| Sony CDPXE570..... | £99.95 |

Please Note: Some products may not be available at all outlets. *Not in conjunction with any other offer. E&OE. Advertisement valid until at least 30th July 2003, E&OE.

Wharfedale

Pacific Evo 30 Speakers £649.95

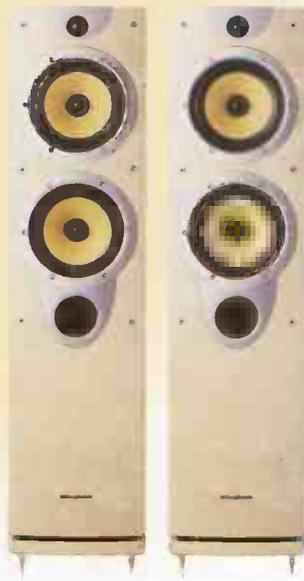

"Evolution? This is more like a revolution: Wharfedale's new range is more than just an upgrade of its Pacific series. The changes are radical, but the most obvious transformation is the removal of the original's unattractive tweeter module, which was situated on top of the speaker. The tweeter housing is now sunk into the Evo 30 cabinet, the intention being to improve dispersion and benefit from the improved rigidity of the strongest point of the cabinet.

Listen to the Evo 30s and the sonic changes leap out at you. Sitting on their chunky spikes and situated in free space, the speakers sound wonderful: low frequencies delve deep and delivery is punchy and fast...

You'll have gathered by now that we love the Evo 30s. They're beautifully made and are great all-rounders."

WHAT IS IT? ★★★★★ March 2003



Also Available
Mission 782SE
£899.95

FREE
SPEAKER CABLE*
WORTH £65
WHEN YOU PURCHASE
WHARFEDALE
PACIFIC EVO 30 SPEAKERS



experience **more**



Amplifier Selection

| | |
|--|----------|
| Arcam DiVA A65 Plus Amplifier | £369.95 |
| Arcam DiVA A80 Amplifier | £599.95 |
| Arcam DiVA A85 Amplifier | £799.95 |
| Arcam FMJ A32 Amplifier | £1149.95 |
| Cyrus 6 Amplifier | £599.95 |
| Cyrus 8 Amplifier | £799.95 |
| Denon PMA355 Amplifier | £199.95 |
| Harman Kardon HK670 | £299.95 |
| Linn Kolektor Pre Amplifier | £494.95 |
| Linn LK85 Power Amplifier | £494.95 |
| Marantz PM4200 Amplifier (Black) | £149.95 |
| Marantz PM7200 Amplifier (Black) | £329.95 |
| Musical Fidelity A3.2 Pre Amplifier | £999.95 |
| Musical Fidelity A3.2 Power Amplifier | £999.95 |
| Musical Fidelity A308 Amplifier | £1999.95 |
| Musical Fidelity Tri-Vista 300 Amplifier | £3994.95 |
| Quad 99 Power Amplifier | £549.95 |
| Roksan Caspian Amplifier | £894.95 |
| Rotel RA-01 Amplifier | £249.95 |



ARCAM

SOUND & VISION

FREE INTERCONNECT CABLE* WORTH £60
WHEN ANY DIVA CD & AMPLIFIER PURCHASED TOGETHER

DiVA CD82T CD Player

£599.95

DiVA A85 Integrated Amplifier

£799.95

DiVA CD82T "Arcam's latest sounds like a more mature version of its little brother. On an initial listen the increased solidity and refinement are obvious, but over time the subtler dynamic shading and more assured handling of transients come to the fore... The Arcam CD82T is one of the best CD players available at this price point." **WHAT HI-FI?** ★★★★★ Sept 2002

DiVA A85 "You'll have realised by now that we rather like this amp. It took us completely by surprise, and further strengthens Arcam's already impressive product range... The A85 is superb, and we can't wait to put it up against its peer in a group test." **WHAT HI-FI?** ★★★★★ March 2001



B&W Bowers & Wilkins

DM602S3 Speakers £299.95

FREE SPEAKER CABLE* WORTH 10% OF THE
SPEAKER VALUE WITH ANY 600 S3 OR CDM NT SERIES SPEAKERS

"But the B&W 602 S3 are our winners. They're big and not particularly beautiful, yet if it were our money they're what we would buy. No rival can match the wide ranging dynamics or low frequency performance of these not so compact standmounters. Add all-round sonic excellence and the choice is easy. Give them sufficient space to breathe, then sit back and enjoy the music."

WHAT HI-FI? ★★★★★ Supertest Winner August 2002

Also Available (Pictured Right)
B&W CDM NT Series • Prices start from £749.95



ROTEL RCD-02 CD Player £379.95

RA-02 Amplifier £349.95

FREE INTERCONNECT CABLE* WORTH £60
WHEN ANY ROTEL CD & AMPLIFIER PURCHASED TOGETHER

RCD-02 CD Player "Whether it's the raw, and sometimes just plain barking vocals of Tom Waits, or the stinging guitar stabs of Pete Townsend on some old Who tracks, the Rotel is one of those players that can't help but bring a smile to the face - it's a breath of fresh air." **WHAT HI-FI?** ★★★★★ Sept 2002

RA-02 Amplifier "The amp has a fast, detailed and yet satisfyingly full presentation. That allows it to make a fine job of the beats of Groove Armada's *Goodbye Century* set without losing sight of the fine details of the mix, and also husking out Marianne Faithfull's deliciously smutty vocals on *Kissing Time* with real relish. Add in decent levels of equipment - and the convenience of remote control, and we reckon Rotel has a winner on its hands." **WHAT HI-FI?** ★★★★★ August 2002



pricing policy

We always try to ensure our prices are highly competitive. In the event you can find the same products and excellent service at a lower price, please bring it to our store managers' attention.



CYRUS

CD8 CD Player £999.95
8 Integrated Amplifier £799.95

Cyrus has been developing high performance hi-fi systems for nearly 20 years. Today their upgradeable, modular product range includes multi-room systems, home cinema and some of the world's finest hi-fi systems. Cyrus products are hand finished, half size die-cast enclosures and include a hidden digital command system that allows simple operation of any size system.

Joining the new Cyrus 8 amplifier is the stunning new high performance, upgradeable CD player, the CD8. Other new models in the 8 series include the AV8 digital AV processor and a new disc player, DVD8, featuring specially tuned video and audio circuitry.

Cyrus 8 Amplifier "The 8 is a large step forward from older generations of Cyrus amplifiers, and takes the company back into the leading pack in the sub-£1000 integrated amp sector... The Cyrus 8 is a must-audition product."

WHAT HI-FI? ★★★★★ January 2003



Also Available
DVD8 • £1199.95

ROKSAN

Kandy KA1 MKIII Amplifier £544.95

FREE INTERCONNECT CABLE* WORTH £60
 WHEN KANDY CD & AMPLIFIER PURCHASED TOGETHER

"When we last reviewed Roksan's Kandy integrated amp in February it fought off serious competition to come top in a *Supertest*. This is its replacement, the MkIII.

Internal changes include an upgraded power supply for the preamp section and identical mono modules for the left and right power amp sections. Roksan also claims 50 percent lower distortion on line-level inputs and a whopping 150 percent less on the phono input. The rated power output is an impressive 120 watts per channel into 8 ohms, and this amp has a confident, muscular way with music that bears this out. But don't be fooled into thinking this amp is raw but unrefined. With Van Morrison's *Down the Road* the Kandy has the guts to render the performance exciting and dynamic, but also the guile to deliver subtle details.



The upgraded Kandy MkIII is an excellent amp; the MkII version was impressive, but MkIII is a stunner. It betters all the amps here in the timing department, and has a wonderfully robust character that works well with all types of music. It manages to retain the good points of the MkII while adding extra resolution and subtlety. All the amps here have a place in the market. It's just that at £550 the Kandy really does set the pace."

WHAT HI-FI? ★★★★★ October 2002



QUAD

11L Speakers £379.95

"Quad is best known for its superlative electrostatic designs, which start at £3500. So any £379 pair of speakers that carries the company's name has to be going some to avoid tarnishing the family reputation. The first surprise is that the 11Ls come in real-wood veneers covered with piano-gloss lacquer. This type of finish is almost unheard of at the £1000 mark, let alone at this price. Has anything been sacrificed for such a luxury finish? Here's the second surprise: apparently not.

The final surprise? Well, saving the best for the last, the sound quality of the 11Ls is phenomenally good. These are small speakers at just 33cm tall, but the scale and authority of their performance is terrific. The laws of physics dictate bass extension limitations, but thanks to a clever dual rear firing port arrangement the 11Ls plumb the depths with the determination of a rottweiler, even when placed in free space.

If you're in the market for a pair of top quality standmounters these Quads are a must listen. Quite simply, they're good enough to scare the competition big time."



Also Available
Mission 780SE £349.95



WHAT HI-FI? ★★★★★ August 2002

Speaker Selection

- Acoustic Energy Aegis Evo One**£179.95
- Acoustic Energy Aegis Evo Three**.....£349.95
- Acoustic Energy AE1 MKIII (From)**£1699.95
- B&W CDM 1NT**.....£749.95
- B&W CDM 7NT**.....£1249.95
- B&W DM303**.....£179.95
- B&W DM601 S3**.....£249.95
- B&W DM602 S3**.....£299.95
- KEF Q1**£249.95
- KEF Q3**£399.95
- KEF XQ1**.....£999.95
- Linn Katan (Cherry/Maple)**.....£634.95
- Linn Ninka (Cherry/Maple)**.....£1044.95
- Mission 780SE**.....£349.95
- Mission 782SE**.....£899.95
- Monitor Audio Bronze B2**.....£199.95
- Monitor Audio Silver S1**.....£299.95
- Monitor Audio Gold Reference 10**.....£799.95
- Monitor Audio Gold Reference 20**.....£1499.95
- Quad 22L**.....£894.95
- Ruark Epilogue II**.....£344.95
- Wharfedale Pacific EVO 30**£649.95

Please Note: Some products may not be available at all outlets.
 *Not in conjunction with any other offer. E&OE
 Advertisement valid until at least 30th July 2003, E&OE.





MUSICAL FIDELITY **A3.2 Series**

A3.2 CD Player £999.95

A3.2 Amplifier £979.95

FREE INTERCONNECT CABLE* WORTH £100
WHEN ANY MF CD & AMPLIFIER PURCHASED TOGETHER

Replacing the **WHAT HI-FI? SOUND AND VISION** Award Winning A3 CD and Amplifier, the new A3.2 models have been further refined and re-styled. The A3.2 CD Player now incorporates the same DAC, filter assembly and control mechanism as the highly-acclaimed Nu-Vista CD Player. The A3.2 Amplifier draws on experience gained through the development of the Nu-Vista M3 amplifier and as such has inherited many of its qualities, producing a sense of ease and flexibility that is normally only associated with far more expensive designs.



MONITOR AUDIO Silver S6 Speakers £599.95

FREE SPEAKER CABLE* WORTH 10% OF THE
SPEAKER VALUE WITH ANY SILVER OR GOLD REF SPEAKERS

British loudspeaker manufacturer Monitor Audio has introduced a replacement series for its

acclaimed and award winning Silver Series speakers. "The aim has been to offer real advances in performance and value", says technical director Dean Hartley. "New Models include the S1 and S2 standmounters, the S6, S8 and S10 floorstanders.

"With a close-miked track such as James Taylor's *Line 'Em Up* from SACD they really deliver the character of the singer's voice and they're just as expressive with the cultured rhythms of Groove Armada's latest outing, having just the right mix of rhythmic control and fluidity... But amazingly the best is yet to come: these are simply beautiful speakers for classical music, once a few days' thrashing has tamed their initial rawness. With the latest release of Holst's *The Planets* on DVD-Audio, they thunder out *Mars* with true conviction.



Also Available
Gold Reference
GR10 & GR20

These are rather magical speakers, with a poise and grace that belies their ability to turn on the power when required. Pair them with a good CD player and suitably accomplished amp, and you won't go far wrong."

WHAT HI-FI? ★★★★★ October 2002

Pioneer

PDR609 CD-RW Recorder £199.95

"While it looks simple, the Pioneer has an impressive array of features, including the handy double-speed disc finalization and CD-Text compatibility. Internally, the PDR609 is a big step up from the Award-winning PDR-509 it replaced: the DAC is now a 24-bit/96kHz number, aided and abetted by Pioneer's Legato Link conversion technology, and it has 24-bit A-to-D conversion, which is ideal for copying your vinyl onto CD. If this is your plan, you'll appreciate that the Pioneer makes it easy to create first-rate copies from any source, helped by the manual recording-level controls. It was hard to tell our copy of Jim White's *No Such Place* from the original.

While the Pioneer's replay quality can't match the Marantz, it costs £120 less, which would buy you a lot of blank discs. If you've already got a dedicated CD player, we'd go with this recorder."

WHAT HI-FI? ★★★★★ August 2001



WHAT HI-FI? SOUND AND VISION
Product of the year 2002
RECORDER
Pioneer PDR-609



Also Available
Sony CDR-W3
CD-RW Recorder • £219.95

Recorder Selection

- Harman Kardon CD-R30 CD-RW.....£499.95
- Sony RCDW3 CD-RW.....£219.95
- Yamaha KX393 Cassette Deck.....£119.95
- Yamaha KX580SE Cassette Deck.....£199.95
- Yamaha CDR-HD1300 CD-RW.....£499.95

pricing policy

We always try to ensure our prices are highly competitive. In the event you can find the same products and excellent service at a lower price, please bring it to our store managers' attention.



TAG McLaren

AV30R AV Processor £1799.95
100x5R Power Amplifier £2994.95

TAG McLaren's AV30R AV Processor is aimed at the home cinema enthusiast who is concerned with keeping up-to-date with the latest surround formats. When partnered with TAG's 100x5R Power Amplifier it makes an exceptional combination.

According to What Hi-Fi? Sound and Vision magazine in their October 2002 issue: "In use, the AV30R, connected to TAG's 100x5R power amp, is superb. True, it can't quite match the clarity and power of the latest-specification TAG flagship, the AV32Rbp-192, but by any AV standard this is a very high-end piece of kit, with excellent impact and fine detail across a range of movie soundtracks from Once Upon A Time In America to the explosive actionfests. Channel steering is immaculate, and the sense of a soundfield wrapped around you - even in 5.1-channel mode - entrancing, with spine-tingling rear-channel effects.

The fine Pro Logic II implementation serves music as well as it does non-discrete AV soundtracks, and with an SACD machine hooked up via the 5.1 channel inputs, the lack of coloration and sheer bass oomph is extraordinary."

WHAT HI-FI? ★★★★★ October 2002



XQ One Speakers £999.95



By combining technologies from its Reference and Q Series, KEF has introduced the new XQ speaker range.

Featuring KEF Uni-Q® 'point source' arrays for unrivalled off-axis performance and 'super audio' Hypertweeters™, the XQ range fully exploits the wide bandwidth of digital formats like SACD and DVD-A. The range comprises the XQ One and Three stand mounters, the XQ Five floorstanders and XQ Two c centre speaker. All XQ models are available in a variety of finishes.

When tested in a group test, the **XQ Ones** received top honours - "KEF's new XQ Ones really are in a class of their own. With a depth of insight that is unmatched, plus a sense of cohesion that is rare - the XQ Ones are startling" concludes Hi-Fi World - April 2003.

Please Note Price Excludes Stands



19mm Titanium Dome Hypertweeter™

Developed directly from the Reference Series and time-aligned with the main array in its own low diffraction steel pod, KEF's new 19mm titanium dome Hypertweeter™ has the same wide dispersion characteristics at 'super audio' frequencies. With a flat response to 55kHz, it provides the high frequency extension needed to take full advantage of SACD and DVD Audio.

ACOUSTICS
REL

FREE INTERCONNECT CABLE* WORTH £100
 WHEN YOU PURCHASE ANY REL SUBWOOFER OVER £700.

Strata III Subwoofer (Wood) £699.95

REL is an audiophile company who take great pride in designing and building their highly acclaimed subwoofers. Because of their total commitment to performance, REL sometimes adopt unusual solutions to otherwise straight-forward problems.

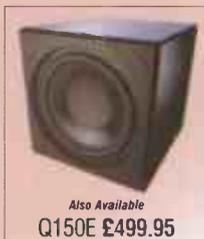

"The aggression of Rage Against The Machine's Take The Power Back is near-tangible, the midrange a spitting, spiteful companion for the tight, deep, air-agitating bassline. As for the more deft creations of Chick Corea, the REL's articulate nature serves subtly to underpin basslines, rather than swamp them. The adaptability makes the Strata III a highly recommended subwoofer - it's a very versatile, musical piece of kit, and it doesn't cost the earth." **WHAT HI-FI? ★★★★★ July 1999**

SAVE £100



Please Note: Some products may not be available at all outlets. *Not in conjunction with any other offer. E&OE Advertisement valid until at least 30th July 2003, E&OE.



experience **more**



outlets nationwide

- Bedford** 29-31 St Peters Street **01234 272779**
Birmingham Arch 12, Livery Street **0121 233 2977**
Brighton 57 Western Road, Hove **01273 733338**
Bristol 92b White Ladies Road, Clifton **0117 974 3727**
Cambridge 17 Burleigh Street **01223 304770**
Cardiff 104-106 Albany Road **029 2047 2899**
Cheltenham 14 Pitville Street **01242 241171**
Crawley 32 The Boulevard **01293 510777**
Edinburgh 5 The Grassmarket **0131 229 7267**
Exeter 28 Cowick Street **01392 218895**
Glasgow 88 Great Western Road **0141 332 9655**
Guildford 73b North Street **01483 536666**
Hull 1 Savile Row, Savile Street **01482 587171**
Ipswich 12-14 Dogs Head Street **01473 286977**
MOVED Leeds 62 North Street **0113 245 2775** Open Sunday
Leicester 10 Loseby Lane **0116 253 6567**
Lincoln 20-22 Corporation Street (off High Street) **01522 527397**
Liverpool 16 Lord Street **0151 707 8417**
Maidstone 96 Week Street **01622 686366** Open Sunday
Manchester 69 High Street, City Centre **0161 831 7969**
Newcastle 19 Newgate Street **0191 221 2320**
Norwich 29-29a St Giles Street **01603 767605**
Nottingham 597-599 Mansfield Road **0115 911 2121**
Oxford 41 St Clements Street **01865 241773**
Peterborough 36-38 Park Road **01733 897697** Open Sunday
Plymouth 107 Cornwall Street **01752 226011**
NEW Poole Latimer House, 44-46 High Street **01202 671677**
Preston 40-41 Lune Street **01772 825777** Open Sunday
Reading 3-4 Kings Walk Shopping Centre **0118 959 7768**
Sevenoaks 109-113 London Road **01732 459555**
Sheffield 635 Queens Road, Heeley **0114 255 5861** Open Sunday
NEW Solihull 149-151 Stratford Road **0121 733 3727**
Southampton 33 London Road **023 8033 7770**
Swansea 24 Mansel Street **01792 465777** Open Sunday
NEW Swindon 8-9 Commercial Road **01793 610992**
Tunbridge Wells 28-30 St Johns Road **01892 531543**
Witham (Essex) 1 The Grove Centre **01376 501733**
NEW Wolverhampton Burdett House, 29-30 Cleveland St. **01902 312225**

within the M25

- Bromley** 39a East Street **020 8290 1988**
Chelsea 403 Kings Road **020 7352 9466**
Croydon 369-373 London Road **020 8665 1203** Open Sunday
Epsom 12 Upper High Street **01372 720720** Open Sunday
Holborn 144-148 Grays Inn Road **020 7837 7540**
Kingston 43 Fife Road **020 8547 0717** Open Sunday
Southgate 79-81 Chase Side **020 8886 2777**
Swiss Cottage 21 Northways Parade, Finchley Rd **020 7722 9777** Open Sunday
Wattford 478 St Albans Road **01923 213533** Open Sunday

Please call to verify hours of business.
 Contact our outlets via E-Mail outlet@sevenoakssoundandvision.co.uk

who are sevenoaks?

Founded in 1972, Sevenoaks Sound & Vision is one of the largest and most successful hi-fi and home cinema retailers in the country.

Each Sevenoaks Sound & Vision outlet stocks a wide range of quality products, covering all categories of specialist home entertainment, from Hi-Fi Separates to Widescreen Plasma Televisions and Projection Systems, all at highly competitive prices.

Friendly staff are available in all stores to advise, demonstrate and guide you through the home entertainment jungle.

new outlets now open

We are delighted to announce that we have opened new stores in the following locations. **Poole** 01202 671677 • **Solihull** 0121 733 3727 • **Swindon** 01793 610992 and **Wolverhampton** 01902 312225. Also, our **Leeds** store has re-located to larger premises.

custom installation

Sevenoaks Sound & Vision's Custom Installation Service enables the integration of a home cinema or hi-fi system into your home as neatly and seamlessly as possible. All electronics can be hidden away, speakers discreetly mounted either in the wall or ceiling and the complete system operated via remote control.

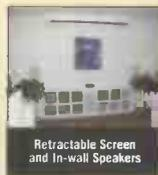

Retractable Screen and In-wall Speakers

Our installation experts are fully trained to the highest standards in all areas and provide a prompt, reliable and professional service. Whether you're looking for a multi-room system, a dedicated home cinema installation with a retractable screen and built-in speakers or an integrated control or lighting system, Sevenoaks Sound & Vision has a diverse range of products available to cater for all your requirements.

sevenoaks online

The Sevenoaks Sound & Vision website has news and information on the Sevenoaks group and its 48 outlets nationwide. The website is designed to provide you with answers to the questions you may have when buying new equipment.

There are regularly updated stock clearance lists with hundreds of products on offer and detailed pages to help you locate your nearest outlet.

For impartial advice and information, just click on sevenoakssoundandvision.co.uk

stock clearance

With 48 outlets nationwide, the Sevenoaks Sound & Vision group stock and display a wide range of products. As individual models and product ranges are changed or superseded, the preceding models are made available at a reduced price, for clearance. Visit our Website for an up-to-date list of the clearance stock, listed by outlet, within the Sevenoaks Sound and Vision group.

0% finance option†

Spread the cost of buying. 0% finance option is available on the vast majority of products we stock. †Written details on request. Licensed credit brokers. Minimum balance £400. Subject to status.

pricing policy

Whilst we do not claim always to be the cheapest, we try to ensure our prices are highly competitive. Take into account the expert advice, unrivalled product selection, demonstration facilities and excellent pre, during and after sales service and the lower price might not look such good value.

In the event you can find the same products and excellent service at a lower price, please bring it to our store managers' attention. We will always endeavour to offer you the best deal.

AERIAL VIEWS

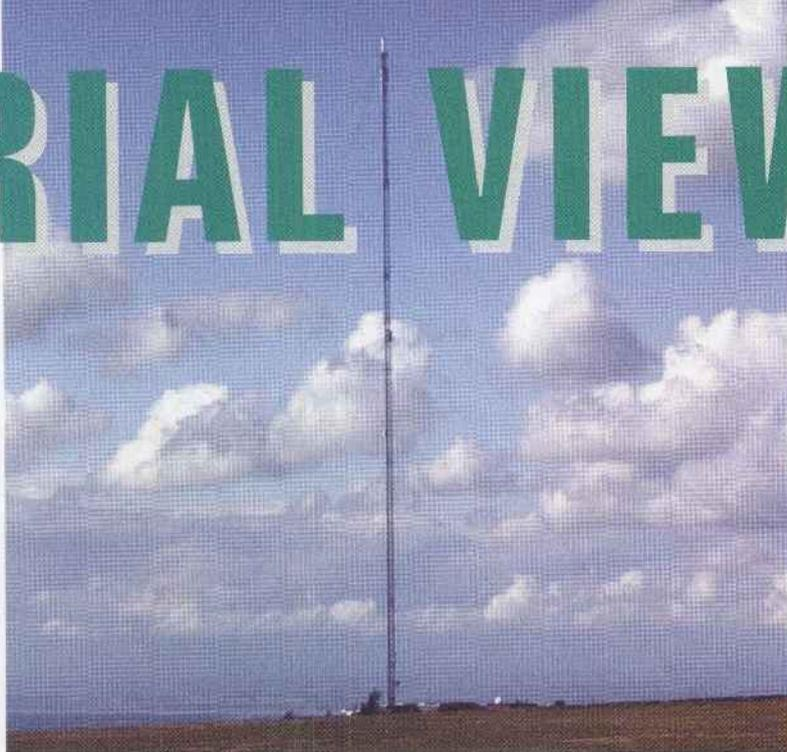

It's all very well buying the tuner of your dreams, but it's nothing without a good antenna. Noel Keywood tells you how to get the best reception...

Most people think that upgrading their aerial simply banishes the small amount of residual hiss they get on FM, but it's much more than that. Give a VHF tuner a strong signal to work with and lo and behold, it develops smoothness and depth. Silences become inky black, and studio acoustics suddenly appear! DAB may often need a decent aerial too.

The aerial is the first stage of a tuner, and arguably the most important one. It collects a strong signal and minimises interference. The sensitivity and selectivity of a tuner is of little consequence when the aerial can make up any performance shortfall. Just as you'd never use a poor turntable for your high-end arm and cartridge, you shouldn't skimp on your antenna.

Anyone serious about radio should budget for a roof mounted aerial on top of the purchase price of their tuner. The advice these days is to get an aerial fitter to do the job. They have knowledge of local transmitters and reception problems, and are equipped for an often dangerous job. They should also have test equipment to measure signal strength. A simple installation typically costs £100, a more complex

one £200. For those with a flat roof and a DIY streak, here's what to look for...

ANALOGUE

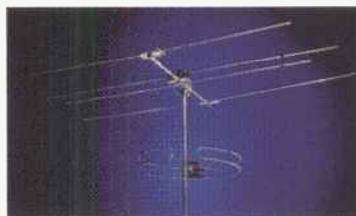

An Antiference 3 element VHF aerial and an All-Rounder dipole.

Conventional analogue tuners need a horizontally polarised Band II aerial – for up to 10 miles or so from a transmitter a dipole high up or a 3-element aerial should do. Relative to a dipole, a multi-element aerial has 'gain', so they are used for weak signals. For example, Central London is served by Wrotham in Kent (BBC only), no less than 30 miles away (South East) and at this distance a large-ish aerial is often necessary. All VHF/FM tuners need at least 1mV for optimum performance (Full Quietening) and this is a strong signal, especially 30 miles from a transmitter. So although Wrotham is a chunky 250kW transmitter, London does not have a strong signal and a large aerial is often a must.

In many areas there will be a choice of transmitters, often one

local and one distant. Maps with transmitter details for an area, including location and grid references, have traditionally been provided by the BBC and they still publish this information in some detail on the internet at www.bbc.co.uk/reception/radio_transmitters. Commercial stations commonly share a transmitter site with the BBC.

VHF aerials need to be mounted as high as possible, but adjusted in situ for maximum signal, to avoid nulls. Loft aerials can work well, but should be kept away from metal water tanks and pipework. A high gain, multi-element aerial not only gives a tuner a strong signal, but it is directional and rejects off-axis stations and interference.

Television aerials are tuned to a higher frequency than VHF/FM and rarely give enough signal. Hi-fi tuners need a proper Band II aerial and, preferably, an independent down lead (with no Y connectors). The downlead itself should be low loss and well screened, with a thick copper braid – some have two layers. Cheap downlead can be identified by scraggy screening!

VHF tuners have a 75ohm input impedance, so they need to be fed by 75ohm cable from a 75ohm aerial. Band II VHF aerials are all 75ohms. We have tested many of those funny



WAVE GUIDES

- www.bbc.co.uk/reception/radio_transmitters – transmitter site maps
- www.bbc.co.uk/digitalradio – UK DAB information
- www.uk-dab.info - UK DAB information
- www.ukdigitalradio.com - UK DAB information
- www.digitalradionow.com - UK DAB information
- www.cai.co.uk – aerial installers trade body
- www.maxview.co.uk – VHF and DAB aerials and accessories

shaped indoor set-top aerials with integral amplifiers that promise to make any TV and VHF work well – and they are poor. There is no alternative to a good outdoor array!

Most hi-fi tuners have signal strength meters that can provide a valuable indication of just what is coming in from the aerial, but beware those fitted to many Japanese tuners, which often indicate full strength with very little signal, for added showroom appeal!

DIGITAL

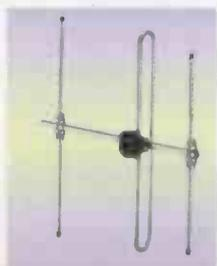

A Maxview DAB aerial for Band III, vertically polarised.

DAB tuners need a Band III vertically polarised aerial, since DAB was designed to match vertical car aerials. Working at a slightly higher frequency than VHF, they are smaller, although not by much. A vertically mounted DAB dipole is not directional and in theory can collect signal from more than one transmitter. However, this assumes

the transmitters are part of the same network transmitting the same signals, and are not too far apart. It is best to use a high gain directional DAB aerial pointing at the strongest station only, which means a multi-element aerial. The elements must sit vertically, and be spaced away from a rear metal pole.

DAB aerials should be mounted as high as possible for the cleanest and strongest signal, just like VHF. TV aerials often provide a reasonably strong signal but it is best to use an independent aerial with its own downlead if possible. Indoor DAB aerials are often satisfactory, but if possible use a full sized rigid dipole, not a piece of wire.

DAB aerials are 50ohm, so they need a 50ohm downlead, preferably of good low loss cable, well screened. DAB tuners have F connectors and a 50ohm input, so they will not accept a coaxial plug.

Some DAB tuners have signal strength meters and these will provide a valuable guide to aerial performance. In theory a DAB tuner needs just 10uV (microvolts) or so to work properly, where a VHF tuner needs 1000uV for best results, or 100x more. However, to lessen error correction it's best to give a DAB tuner a reasonably strong signal of up to 1mV or so. Overly strong signals may need attenuation.

NOISE ANNOYS

VHF radio has always been criticised for being 'hissy' and 'prone to interference' – now so more than ever, thanks to the silent backgrounds of Digital Radio. However, it was designed to be neither of these things, so if this is the case then the cure is a better aerial.

FM tuners will work over a huge signal range from the aerial, from one millionth of a volt (microvolt) to one-hundredth of a volt – a massive x10,000 ratio. Down at the low end there will be lots of hiss, but the signal will be intelligible. DAB gives no hiss, but it can't resolve weak signals.

As the aerial signal gets stronger, the hiss produced by a VHF tuner gently decreases, until it reaches a minimum.

The perception of hiss arises because in the real world most tuners don't get enough aerial signal to reach minimum hiss, a condition termed Full Quieting. A typical ribbon aerial will supply a few hundred microvolts and, at this level, VHF tuners produce as much hiss as a cassette, around -60dB. The published stereo sensitivity value for VHF tuners, by the way, assumes lots of hiss (-50dB) so it gives a misleadingly low figure; it's a yester-year view of things.

All VHF tuners need a strong signal for best results, and in most cases this demands a good aerial – usually an outdoor aerial. A transmitter will need to be within ten miles or so for a simple aerial to be adequate.

Given enough signal VHF tuners are effectively silent. At -72dB or so hiss is inaudible, even in long silences from Radio 3. If hiss can be heard it is usually from the original source, a broadcast tape interview or an old tape recording.

VHF tuners also suppress a.m. (amplitude modulated) general interference; they are not prone to it. If interference is apparent the tuner is not getting enough signal for its suppression circuits to work. A directional aerial mounted high up discriminates against interference and any VHF tuner will be silent as a church mouse under these conditions.

Although DAB tuners can't make sense of weak and noisy digital signals from the aerial, they have very sensitive (analogue) front-ends and don't need much signal to work properly – around 10uV is enough. So although a DAB tuner isn't as sensitive as a VHF design, with a good aerial it can still pull in distant stations. And when it works there will be no audible hiss at all, even with a weak signal of a few hundred microvolts. DAB tuners are therefore quieter than VHF types when the signal is weak, but there's no perceptible difference between the two when it is strong.

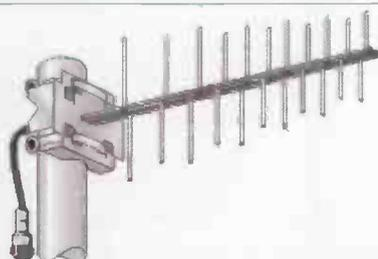

In 2007 Britain will get L-Band DAB transmissions at 1.2GHz. Here is a Blankenburg L-Band aerial.

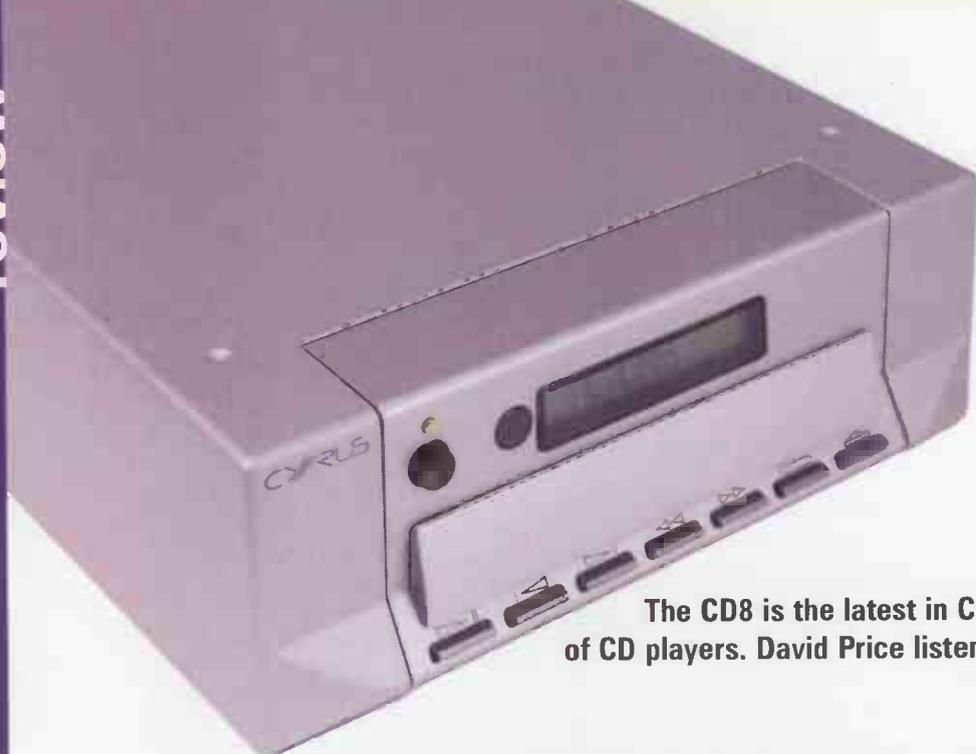

The CD8 is the latest in Cyrus's highly successful line of CD players. David Price listens in...

EIGHTH WONDER?

One thousand pounds is a lot of money for a small box that plays CDs and outputs a line level signal. But there's more to the

Cyrus CD8 than meets the eye. While it retains the company's trademark half width aluminium 'shoobox' casing - first seen with 1996's dAD3 - it sports a wealth of new features over its CD7 predecessor. Indeed, the company says it's a 'clean sheet' design with virtually nothing carried over. And from the second you plug it in, load a disc and turn up the volume, you can hear the difference!

The CD8 is based on a completely new 'CD platform', designed to give Cyrus options. For example, purchasers of the new CD6 will be able to factory upgrade it to the full CD8 specification at a later date. CD8 customers will also be able to upgrade their machines using 'expansion opportunities' available later in the year. The CD8 also brings the PSX-R port, which gives the

option of plugging in Cyrus's PSX-R offboard power supply for £350 (more of which later). This flexibility, I feel, is a real point in Cyrus's favour.

The new machine's elaborate power supply uses twin low noise toroidal transformers - specially developed to squeeze into the close confines of the CD8's case - and eleven separately regulated power supplies. The triple beam laser mechanism is, according to Cyrus's Peter Bartlett, one of "the last" dedicated Philips CD player transports - which he believes gives better results with CD than converted DVD drives.

The CD8 also sports new Wolfson digital convertors, claimed by Cyrus to be "the best sounding 24-bit ICs available" in dual balanced configuration, with fully balanced analogue filter topology. These DACs are certainly proving popular, if nothing else, and are definitely flavour of the month right now. The machine uses rigorous re-clocking, with extensive attention paid to jitter

reduction - the result being a claimed figure of less than 80ps.

The case is as per Cyrus CD7, which means a beautifully hewn low-resonance affair with inverted die-cast alloy chassis. Vital statistics are 78x215x360mm and 3.5kg, and colour options are silver or satin black. The front mounted controls are simple enough to master, with the usual play/pause, stop/open and track search controls joined by a single repeat button - all the other features require use of the handset.

The display is superb - crisp and easy to read, and it boasts a neat switchable backlight. The player integrates with other Cyrus components via the rear panel mounted Master Control BUS sockets, which join the PSX-R port, IEC mains, digital outputs and two pairs of analogue outputs.

The player is satisfying to use, with an upmarket feel which gives one the sense of something exotic. So it should - as the new price of £1,000 puts it up against some



serious bits of kit from the likes of Meridian's 507, priced at £1,195.

SOUND QUALITY

Cyrus was at pains to point out to me that this was not just simply a 'reheated' CD7, but a completely new design. Having unpacked it, switched on, fed it my favourite test disc and pressed 'play', they needn't have bothered. Even from cold, relatively un-run in, it sounded oh-so-different. Plugged into an MF Audio Passive Preamp and Pioneer SPEC2 power amplifier driving Perigee FK-1L ribbon hybrid loudspeakers, it was soon obvious that the CD8 was an altogether more 'challenging' listen. Whereas the CD7 was as smooth as a baby's bottom at the high end, the CD8 has a very lively high treble which – when used in conjunction with spitty loudspeakers – can intrude. In my reference system, complete with its oh-so-smooth ribbon tweeters and super clean LFD Spirolink 3 interconnects, it proved merely 'brightly lit'.

I started with 4hero's 'Cosmic Tree'. Having played this ever so many times through the CD7/PSX-R I lived with for over a year, it was a fascinating moment. The CD8 does sound quite different – that's for sure – any by and large I'd say it is better. There's a lot more grip, articulation and focus than its predecessor. Listening to the CD8 after the CD7 is like removing an unnecessary outer layer of clothing. It feels less constrained. The CD8 lilts along in a natural and musical way, throwing far much more ambient information at you than you'd have got from the '7 – in short, it takes you closer to the 'sensual world' that is the music.

From the first bars of 'Cosmic Tree', the difference was plain to hear. The singer's voice felt so much better resolved – you really got deep into its 'grain', its textural imprimatur. Interestingly though, what was going on behind it was all the more

surprising. The Fender Rhodes keyboard work was far more natural and organic sounding, with brilliantly resolved microdynamics. When the snare drums kicked in, the CD8 proved itself to be a fast and grippy performer. Deliciously propulsive, the song bounced along with heady abandon. Out and out dynamics weren't particularly well articulated, but the gaps between the notes were superbly timed, giving a nicely beguiling listen which rather reminded me of the lucid midband of a good valve amplifier.

Next, I cued up LFO's 'We Are Back'. This early nineties slice of electro is far darker than most house music of the time, and has a really menacing feel when played on a serious CD spinner. The CD8 proved perfectly capable of capturing the spirit of the song, and duly obliged with the incredible subsonics – the very ones that prompted Warp Records to print a disclaimer on the US long box edition, to the effect that 'this album can damage your stereo system or loudspeakers'. I duly 'stamped on the loud pedal' and sat back waiting to be amazed – and I was. The CD8 isn't overly endowed in the bass department – methinks its Meridian rival is far more sumptuous sounding – but showed fine grip and tunefulness.

It was when we arrived at this track's end section arrived that the CD8's true colours became clear. This is an extremely 'dense' musical moment, with vast tracts of sub-bass being hammered out beneath a thick mix of hard sounding electronics, above which some gated synthesiser snare sounds kick in and out. It is 'hold on to your hats' time for most CD players, but the CD8 proved effortlessly in control. Totally unfazed by the scale of it all, it just hung on in there as I glanced across the room to see my Pioneer power amp registering over 150W per side on the power meters. That the Cyrus

can sound so clean and clear at all frequencies, yet highly involving and musical too, is to its great credit.

The midband is this player's tour de force. As Herbie Hancock's 'I Have a Dream' proved, it is very clear and well ordered. Depth perspective is very good, while lateral image definition is impressive. Instruments seem to stand out on their own far more obviously than with other CD players at this price point. Bass integrates smoothly into its usefully transparent midband. Tonally, it's on the 'lean' side of neutral – but it isn't hard or steely sounding in the midband. Yet if you refer back to the CD7, it does sound rather brighter – where the CD7 is sweet and smooth, the CD8 lighter yet tighter.

It was only when I cued up The Pixies 'Velouria' that the CD8's rising high end made itself known. On most discs, the effect of things taking an upward turn above 10kHz is to invest a sense of air and atmosphere, as there isn't so much HF content. (I also believe that the midband is enhanced, in a round about way, as the harmonics from voices and strings are more easily discernible). Yet with this heavy, aggressively mixed rock track with oodles of high frequency energy courtesy of the frenetic ride cymbal work, the CD8 began to sound aggressively forward. Admittedly, it was a fantastic listen – this player bringing the track to life like few others – but it was still apparent that there was too much high frequency action. Moving to Air's 'All I Need', with its crisp synth sounds and beautiful, haunting female vocals, confirmed this – sometimes, the CD8 sounds bright.

As a £1,000 machine, it is a very capable performer – if you match it carefully. Partner it with a Cyrus 8 amplifier (which is decently smooth) and Castle Conways (which are positively warm), for example, and you'll have a brilliant synergistic match. But it wasn't until I plugged in a PSX-R that the CD8 really came into its own, and moved from being 'really rather good' to downright riveting. Hitherto a fine design with plenty of detail, depth and rhythmic bounce, it becomes something of an audio giant slayer.

Going back to the 4hero track with the CD8/PSX-R, and the already very respectable soundstaging was transformed, the song becoming an

EXPERIENCE THE CHORD EFFECT!

The first time you hear your sound system with Chord interconnecting cables will be the first time you've really heard it.

Be warned - the effect can be shattering.

Your eyes and ears will be opened. Your music will never sound the same again.

Specify Chord cables - Hear the light!

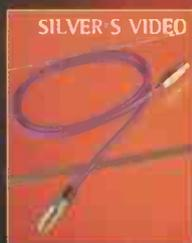
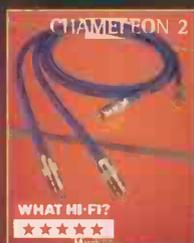
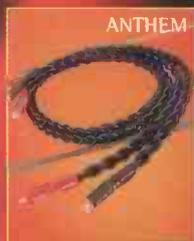

FOR SALES AND INFORMATION
CALL: 01722 331674 FAX: 01722 411388
E-MAIL: CHORD@CHORD.CO.UK
OR VISIT US AT WWW.CHORD.CO.UK

There are well-known amplifiers. There are highly regarded amplifiers. Then there is Spectral – recognised throughout the world as the leader.

Spectral – the “Reference”

The keys to the Spectral sound – startling immediacy, fine detail, dancing rhythms and amazing clarity – stem from their **ULTRA-FAST RESPONSE** and **MEGAHERTZ BANDWIDTH**.

Spectral amplifiers both **RISE AND SETTLE** in 10 millionths of a second after the **FAST TRANSIENTS** and **COMPLEX HARMONICS** of a violin or trumpet, or the 1,000,000 to one ratio of loudest to quietest signals.

We hear the astonishing nimbleness as natural “**PRESENCE**”, increased **DYNAMICS** and a wider palette of **TONE COLOURS**. We also hear more of the musicians’ technique – bowing, plucking, breathing – and so much more of the emotion.

Does speed = aggression? – no, because it’s not forced, just natural.

Spectral products evolve from the **LIVE EVENT**. Designer Prof Keith Johnson is the driving force behind **REFERENCE RECORDINGS**, and also the inventor of HDCD recording.

Spectral draw on techniques from high-tech fields such as microwave engineering, instrumentation and computing, where state-of-the-art is essential, then adapt them as **REVOLUTIONARY AUDIO** solutions.

For an insight into this technology visit www.spectralaudio.com

Customers say we make some of the **BEST SOUNDS** they have ever heard, so you know we can do the same in your home. Our advice will take account of your best components and guide you where change is needed, in stages you can afford.

You **AVOID EXPENSIVE MISTAKES**, enjoy music along the way and save money in the long run.

JUST LISTEN AND YOU’LL KNOW

The
Right
Note

Music in the home

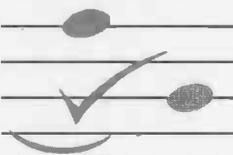

BATH

01225 874728

CD: ACCUPHASE, ACCUSTIC ARTS, AUDIO SYNTHESIS, dCS (ELGAR, DELIUS PURCELL, VERDI), MERACUS, SUGDEN, WADIA. **VINYL:** BASIS, CLEARAUDIO, CROWN JEWEL, DNM, GRAHAM, THE GROOVE, LEHMANN, MICHELL, SUMIKO BLUE POINT SPECIAL, TRANSGURATION. **AMPLIFIERS:** ACCUPHASE, ADVANTAGE, BEL CANTO, CAT, DNM, GAMUT, HOVLAND, NAGRA, SONNETTEER, SPECTRAL, SUGDEN. **LOUDSPEAKERS:** AUDIO PHYSIC, BKS, ETHOS, NEAT, TOTEM, VERITY AUDIO. **TUNERS:** ACCUPHASE, MAGNUM DYNALAB. **CABLES:** ARGENTO, CHORD Co., DNM, NORDOST, SILTECH, YAMAMURA CHURCHILL ETC. **SUPPORTS:** ARCICI, KINABALU, STANDS UNIQUE

amazing journey into three dimensions. The ease and power with which the Cyrus combo placed the aforementioned drum kit in space, and held on for dear life as the drummer pounded out those drum'n'bass beats on a good, old fashioned kit, was quite mesmerising. Although not quite up to the standards of Naim's CDS-2/XPS2 reviewed a few months back, it certainly gave a strong taste of this 'super player' in action. What I loved was the timing. Instead of a nice, beguiling rhythmic flow, you got the sense of being inches from the drummer, and being able to see the whites of his eyes as he laboured (or is that 'toiled' in the case of this high beats-per-minute opus) with his sticks.

The Pixies track was another ear opener – with vast amounts of extra detail there for the taking. The CD8/PSX-R's ability to place all the elements of the mix in space was seriously special – very few CD machines at this price can do this as well. Soundstaging became so much more explicit and dimensional, with stacks of low level detailing being thrown out at the listener right from the very back of the recorded acoustic. Once again, the stunning attack transients the PSX-R brought to the party really dominated proceedings – investing the disc with speed and grip more familiar to

DVD-A aficionados. Dynamics – of the micro and macro variety – were stunning. With the PSX-R, this machine can go from very quiet to very loud with tremendous verve. The add-on power supply also adds an altogether more muscular bass. Although it doesn't so much as approach its rival Meridian in the sumptuousness stakes, you get a strong, lithe and insistent low frequency performance that the non-PSX-R machine simply lacks.

Tonally, the PSX-R adds just a touch more bite, which considering the CD8's rising treble response, isn't necessarily a welcome addition. I was both surprised and disappointed with the Air track. Allied to a gripping, seat-of-the-pants rendition of this hitherto laid-back ballad, I could hear a touch too much hiss (from the studio!) – very few other, if any CD spinners I've heard have picked up on this. I guess it's nice to know it's there (!), but it also demonstrates this player's upper frequency plateau. Likewise, the flutes on Herbie Hancock's 'I Have A Dream' a touch too forward for my tastes, thanks no doubt to all those high harmonics that otherwise remain overlooked.

So the CD8 is something of a mixed bag. Partnered with its matching PSX-R power supply, it's one of the cleanest, most detailed and three-dimensional CD spinners I've heard anywhere near its price. It

really takes music by the scruff of the neck and forcibly ejects it from the loudspeakers with breath-taking brio, and in doing so makes its price rivals sound drab and characterless. However, that treble peak reduces the range of ancillaries you can use it with. If you run a smooth and loose valve amplifier or bass-heavy loudspeakers that seem to stifle everything you put into them, this may be the answer to your prayers. By contrast, those with a TAG McLaren transistor integrated and a pair of the latest Mission 782SEs will probably need root canal surgery after playing The Pixies through this.

Cyrus has come up with an capable and characterful machine in the CD8, but voiced it for a relatively limited number of systems and types of music. While the old CD7 it replaces was in many ways less accomplished, its smooth and easy going nature was part of its charm – which is something the new Cyrus lacks. Recommended, but only if you listen to it in the context of your own system first.

Cyrus CD8 £1,000
Cyrus PSR-X £ 350

Cyrus Electronics Ltd
Tel: + 44 (0) 1480 4355 77
www.cyrusaudio.com

MEASURED PERFORMANCE

Our response analysis shows the CD8 has, unusually, steeply rising treble. With discs containing strong treble energy, such as sibilance from close miked vocals and transient energy from cymbals, this is likely to result in some sharpness in its sound, especially with loudspeakers like the Mission 782s. A response like this is unusual and means care is needed in matching to other items.

Otherwise, the CD8 measured well in all respects, with low noise, very little distortion at all levels and high dynamic range.

In all respects it is up amongst the best in measured terms, except for the non-flat response. **NK**

| Frequency response | 4Hz-21.3kHz | | |
|--------------------|-------------|--------|--|
| Distortion | left | right | |
| -6dB | 0.004 | 0.004 | |
| -30dB | 0.005 | 0.005 | |
| -60dB | 0.35 | 0.35 | |
| -90dB | 3 | 3 | |
| Separation | left | right | |
| 1kHz | 128 | 128 | |
| 20kHz | 109 | 109 | |
| Noise (IEC A) | | -110dB | |
| Dynamic range | | -111dB | |
| Output | | 2.24V | |

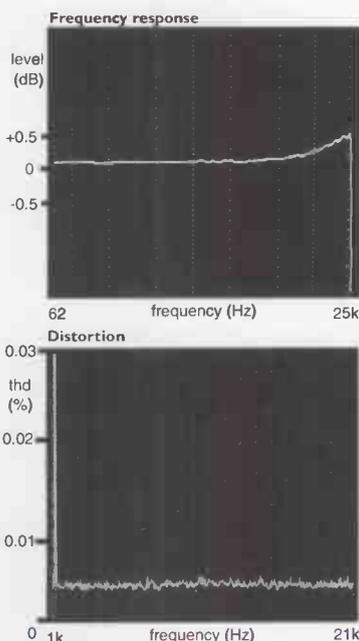

World Verdict

Ultra articulate and engaging player, but a brightly lit high treble demands careful matching with ancillaries. Factor in great build, finish, ergonomics and a clever upgrade path and it's an impressive package.

FIFTY, SOMETHING?

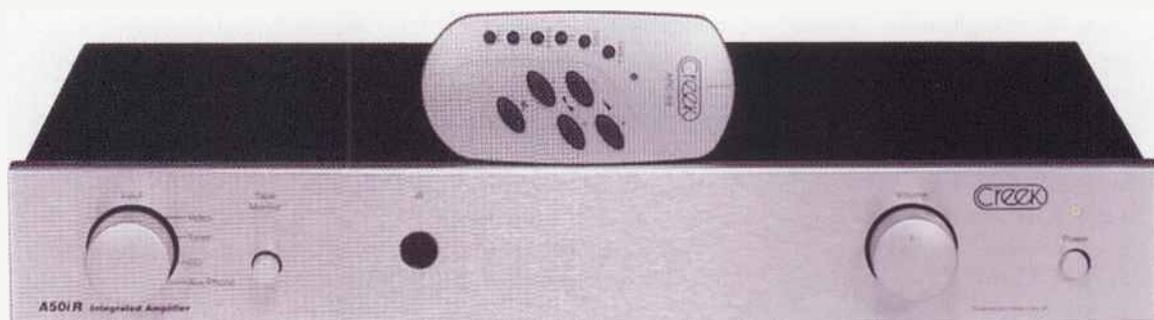

From a past master of budget amplifiers comes this new mid-price design. Noel Keywood gives his verdict on Mike Creek's sleek new A50iR integrated.

Ah, Creek! To me, the brand connotes one thing – high quality budget transistor integrated amplifiers. Of course, Mike has done some rather natty tuners too, but the company was established on the back of the late, lamented CAS4040. This, lest we forget, was the budget blockbuster that took on NAD's seminal 3020 at its own game – and won. Back in the early eighties, this cracking little product was even smoother and more refined than the already highly capable NAD.

Of course, part of the deal was lacklustre styling and 'unimpressive' build quality, but when the 4040 sounded so good, it almost seemed churlish to criticise. The amplifier went from strength to strength, spawning the likes of the CAS4140 along the way, which followed the late eighties minimalist credo of no tone controls and 'source direct' circuitry. Lately however, the company has been improving the appearance and strengthening the build of its products, and the A50iR you see before you is the result – it promises the sound of the 'old school' with a new, 'quality' look and feel.

Personally, I have always had a soft spot for Creek products. Over the years they have won me over on the grounds of sound quality alone. I could put up with the lightweight (but adequate) build of something like the 4140 because its sound was so good. The Creek signature was smoothness and a sense of depth to the sound, plus a lack of grain, all without blandness creeping in. True, Creek has always offered a warm balance and an atmospheric presentation that would appeal to a valve head like myself, but at the same time there really is a need and a place for an amplifier that can nicely balance out ancillaries like bright loudspeakers. There's also a need for solid-state amplifiers that can resolve tonal colour, stage depth – and lack graininess. To a large degree Creek amplifiers have managed this better than anyone else.

It's easy for reviewers to ignore build quality – I have learnt from experience that flashy exteriors don't tell you much about what's inside and can mislead. But out in the real world there's an expectation that a hi-fi product, by its nature, should make a quality statement and perhaps innocuous amps like the 4140 didn't do so powerfully enough to convince

waverers. So here we have the new A50iR, dressed in fashionable clothes.

A glance at the casework is enough to show that the basic proportions haven't altered much. At 430mm long, 250mm deep and 65mm high it is low and slim, and could just squeeze onto a 10in shelf with some front overhang. The front panel is now a one-piece machined slab of aluminium that looks and feels solid. It bolts onto a rear steel chassis, a solution used by many companies, but the only difficulty here is that thick aluminium can contain air pockets that suddenly surface whilst machining, ruining the job. The time wastage adds to cost – it's a low volume technique but it does give a lovely, solid feel with good end-finish. Behind this panel there's the usual folded steel chassis. The whole shebang comes in at a weighty 6kgs, surprisingly heavy for a product of the size.

A Creek product is about simplicity and the front panel shows it. There's a volume control at right, with a nice solid action, and a power button sits alongside it. At left lies the input selector that links to four line level inputs at the rear. The one marked phono/aux accepts a normal line-level input as standard, but by

removing an internal link and inserting a pre-amp board it will accept a phono module that can accept MC or MM cartridges. An earth terminal is provided, along with a tape monitor. The pre-amp output can feed an external power amp. The loudspeaker terminals have plugs that can be eased out to allow 4mm loudspeaker plugs, and there are 4mm radial holes as well, making bi-wiring possible. Finally, the A50iR comes with a small remote control with all functions, including channel balance and input switching.

SOUND QUALITY

Feeding KEF Reference 201 loudspeakers, the new Creek showed it has moved away from the nature of the old 4140 that I remember, gaining a little more sheen, plus a cleaner and more specific sound. Celine Dion's 'I'm Alive' was alive – large and wonderfully clear, without that edginess that creeps in when solid-state amplifiers try to get explicit. There was perhaps a little less apparent depth than in the past, but an easy and natural clarity that let Celine Dion sound fulsome, with a creamy smooth delivery and a nicely conveyed sense of expression. This album can sound over-mixed and a trifle mechanical, like so many multi-layered modern mixes, so I was pleasantly surprised to find that it can be sorted out quite nicely by a good modern design like this. I'm reminded too that as UK designers become steadily more aware of component quality and the affect it can have upon an amplifier's sound, and as better components become available, amplifiers are generally sounding tidier and smoother than ever before – the A50iR included.



Tidy rear panel echoes fascia's clean design.

The Reference 201s are a brightly balanced loudspeaker with no lack of treble or high frequency extension. They worked nicely with the Creek, although I can't say it much compensates for their brightness. Similarly, it wouldn't smooth out loudspeakers like the Mission 782SEs reviewed in this issue, whereas a 4140 of yore may well have done. That mid-band warmth and soft, almost warm, treble have been replaced by an altogether brighter sound that is very explicit. Spinning the stereo mix of 'Riding With the King', a 24bit/88.2kHz DVD-A recording, the Creek showed it could deliver modern DVDs like this with verve, bass sounding strong and resonant, cymbals crashing brightly. There was plenty of inner detail, the KEFs and Creek working well to resolve vivid stereo. Clapton and King were strongly voiced, the A50iR working to differentiate between them in texture and delivery, King sounding gravelly and Clapton more melodic by way of contrast.

Generally there was a little less bass push than was needed for the 201s and here the A50iR wasn't as muscular as some rivals. It has clout, but lacks their depth or the low-end resolution. I suspect that the extra emphasis now apparent though the mid-band and treble regions draws attention away from the low end, which in itself is good, if not exceptional, much like before.

The same strengths were apparent with classical, coming

through as deliciously detailed strings that could sound positively vivacious at times, as basses grumbled in the background and Ashkenazy's piano was more strongly illuminated than I am used to. The busy strings in Wagner's *Rienzi Overture* were given prominence and grabbed my attention; the A50iR really does mine into a recording to pull out large amounts of detail. It also has a wonderfully clear midband, yet one that isn't glassy or hard.

Creek has changed its sound; gone is the warm, atmospheric delivery that some hard rock reviewers failed to appreciate in the past. The A50iR offers vivid clarity coupled with an amenable smoothness that suits vocals in particular. The amplifier can't really be used to balance out today's bright loudspeakers and I feel it is best matched with care in this respect. The easy sound of Mordaunt Short 912s or 914s may suit.

This is still a first class amplifier that retains the essence of old strengths, if not their full body. It has a new, altogether more forward, explicit and modern sound. The A50iR amplifier remains a specialised and committed hi-fi product with strong appeal. It remains a force to be reckoned with

Creek A50iR £550

Creek Audio Ltd.

Tel: 01 442 260146

www.creekaudio.co.uk

MEASURED PERFORMANCE

The Creek produced 50watts into 8ohms and 80watts into 4ohms, exactly as per Creek's spec. This is enough for high volume levels from most loudspeakers.

Distortion levels were low and only second, third and fourth harmonics were present. However, below half volume power supply rectifier spikes appeared in the noise floor and noise increased, disappointing for a hi-fi amplifier.

Bandwidth was satisfactory,

running from a low 3Hz up to 36kHz (-1dB). There's enough gain at 50kHz for 96kHz sample rate digital.

The A50iR measured satisfactorily, but power supply noise could usefully have been lower. **NK**

| | |
|--------------------|-----------|
| Power | 50watts |
| CD/tuner/aux. | |
| Frequency response | 3Hz-36kHz |
| Separation | 50dB |
| Noise | -99dB |

| | |
|-------------|-------------|
| Distortion | 0.01% |
| Sensitivity | 500mV |
| dc offset | 3.4 / 4.6mV |

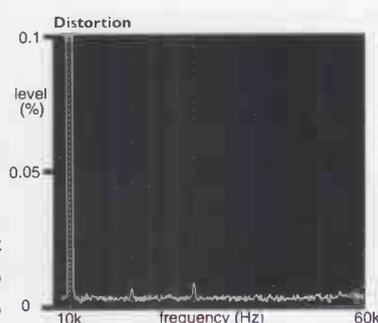

World Verdict 
Consummately smooth yet engaging sound makes it a serious player at the price, but don't expect Creek's traditional sumptuousness. Fine value nonetheless!

Visit our website at www.hi-fiworld.co.uk or send your e-mails to letters@hi-fiworld.co.uk. Letter of the month wins a pair of Precious Metals interconnects and a FREE subscription to Hi-Fi World!!

letters & emails

letter of the month

DIG THE NEW BREED?

It really is at odds that young Mr Price, your editor, on one hand sings the delights of vinyl and valves with whatever today's fave rave is, and at the same time tells us that we should all rush out and buy the latest piece of software for our audio-computers.

It isn't what the buying public wants and it doesn't do the industry any good in the long term. All we want is good sounding reliable bits of kit that we can mix and match, yet still get a good performance that enables us to listen to our chosen music.

How does something which in its day had an inadequate 16 bit performance become almost the greatest CD player ever made? i.e. anything with Philips TDA1541 chips in it. Listened to an awful (pun intended) lot of them and some were just plain, well awful really. The Japanese Sony players were to my mind some of the finest exponents of that particular chip set, used with incredibly fine and long lasting transport mechanisms that will track anything. Damn and blast I've agreed with something the young Mr Price wrote, how did that slip by?

What do I listen to? Seriously, the kit is unexceptional, Arcam Alpha 7R used as a preamp, Project Debut, Sony CDP227ESD, Yamaha TX492RDS, Sharp MDR2, big old Aiwa XK007 and pair of Philips 2-way motional feed back loudspeakers. Once had a very early A60, tried countless other amps including a Lentek, but came back to Arcam via the Alpha 7R.

The Aiwa is donkey's years old and still makes great copies for use in the car, as good as some of the Nakamichis I'd say. Loves ferric tape and they cost nothing these days. Tried buying metals recently - the staff in the shop hadn't got a clue what I was talking about, directed me towards CD-R machines instead!

The Sony? Bought cheaply with a faulty DAC chip. Put a new pair of TDA1541 Crown chips in and guess what? Said goodbye to the SACD player that's for sure.

The Project does exactly what it says on the box, started me buying vinyl

again. If you search around on the net you can still get good quality records, some unplayed and still shrink-wrapped! Even more are used, but in excellent condition - and what a choice, all virtually as cheap as chips, as the man said.

And now we come to the speakers, bought for almost nothing. Always been tempted following your articles, so tried them out. Result, I think they are fantastic and are much better than a whole load of other stuff I've either heard or owned. That includes Proacs and Snells etc. I would rate the internal power amps as good, especially considering their age and easily on a par with the Arcams. Not bad me thinks for forty quid when one considers I was looking at stuff up to the £800 mark for speakers alone. Please don't tell me about their problems, the built in tweeter crossovers and sound failings etc. - yes I know they have them but for the life of me they sound just right to these ears and I don't hear it, just the music. Even CDs that in the past were a little bit edgy now sound full and clear, with no lack of top end or detail.

My next step would be a dedicated remote control pre-amp if I could find one at a reasonable price. Thought about making my own if I could find a good design. Hoped you guys would feature one in the supplement that used, horror of horrors, solid-state and was easy to build. Seems that's all valve, and the only place transistors and chips get a look in is Computer Audio.

So a plea - less of the nerdy stuff and more of the DIY please! More of the Olde Worlde stuff would be nice

but not the rare, exotic examples. Why not obtain samples of old gear and do a comparison between them and the modern day equivalents? I would hazard a guess a lot of it still sounds good today, majority of it Japanese, the exact opposite of all the 70s/80s philosophy preached north of the border.

If you read this, then I thank you for your time. If you or any of your readers agree with any tiny little bit of it then I venture I'll be speechless. Still I won't lose any sleep about it, just keep on listening to the music now that common sense has finally prevailed and I buy what I like the sound of, irrespective of the format or price. (But not the computer stuff, God it's boring.)
Gary Francks

Thanks for the lengthy missive. As my first Linn Naim system arrived back in 1985, I am not a recent convert. I also love valves however, and do not accept your contention that it's a question of either/or. Personally I find myself in the position of loving all hi-fi that truly plays music - and in hi-fi as in life, there's more than one way of skinning a

TRIO's NEW, MIKE-MIXER KR-6160 IS MANY STEREO STEPS AHEAD



100-WATT 100% BJT SOLID STATE AM/FM STEREO TUNER AMPLIFIER KR-6160

TRIO's KR-6160 boosts qualitative stereo research and design to the newest degree of top-standard superiority. This 70/70-watt (BMS 6N) solid state stereo receiver is also the life of every party because of its easy, instant, exact microphone mixing. Announcements—singing, too—can be expertly accompanied with music since the right and left microphone input jacks operate individually with easy-does-it m/s-level control adjustment. And the KR-6160's bass, middle and treble step-type control enable you to receive accurate tone nuances.



the sound approach to quality—
TRIO
TRIO ELECTRONIC INDUSTRIES, INC.
TORYO, JAPAN

Sole Agent for the U.S.A.: B&W MORRIS & CO., (TRIO) LTD., 4330 Ashton Street, Essex-Haven, London, E.1. Phone: 0270 424
Sole Agent for the South Africa: Sanyo Corporation (Pty) Limited, Johannesburg P.O. Box 7770, Tel. 74 420; Cape Town P.O. Box 417, Tel. 55 937
Dubai: P.O. Box 979, Tel. 31-4351; Port Elizabeth: P.O. Box 270, Tel. 4140; Bloemfontein: P.O. Box 277, Tel. 2997; Windhoek: P.O. Box 912, Tel. 252

A taste of the 1970s, with analogue meters on Trio's KR6160 receiver.

cat. Hearing the Naim CDX2 reminded me why I love Naim - and also why I love music. Yet I get that same magic sense of wonder when I listen to the very different presentation of valves and vinyl. To use an automotive analogy, does loving classic Jaguars preclude you from appreciating a new BMW M5? Surely good design is good design, whatever the era?

Gary, no one is forcing you to read the Computer Audio World section, but don't try to deny other people the chance! Whether you like it or not, the hi-fi paradigm that I suspect we both grew up with is now gone forever. While you and I and many other readers will reserve the right to listen to music on physical formats [LP, CD, DVD-A], the new generation of music buyers, weaned on Napster, Kazaa, et al., hold no attachment to discs. This isn't just my theory, the latest music industry statistics speak for themselves. I think it would be remiss of us to ignore this, and I'm sure young Mr Keywood would agree! Also, many hard bitten 'trad' audiophiles now go to work on a iPod, so to speak. That's why we're covering computers.

Interestingly, CD has found a new identity as the modern day Compact Cassette - it's a great cheap recording medium, and computers give you the power to really exploit this in a way that the last generation of cassette users could only dream of. Archiving vinyl and tape is another 'killer application', one that I use all the time. I don't think 16bit offers brilliant quality, but it makes damn fine portable music replay.

Couldn't agree more with you about the built-in obsolescence of hi-fi. One minute, magazines are shouting about some obscure technical improvement or mod, and the next it's meaningless as something even newer has come along. Essentially, manufacturers want us to think their stuff is replaced because they've found a way to improve it, but as often as not it's because the chip manufacturers have discontinued the guts of their machines and they have to change whether they'd like to or not. The replacement of the TDA1541 DAC with Bitstream is a case in point - Bitstream was touted as being superior by all and sundry at the time, but now most agree it's just different - smoother but less engaging in my opinion! **DP**

Gary,
I am sure a lot of readers agree with you. I certainly sympathise, being happy about my Leak Troughline and Garrard 401. But all the same there is a lot of good new kit that is way better than that we've had in the past. You will see we clearly don't include DAB in that, so not all shiny new technology automatically gets a thumbs up here.

Computer audio I treat as a form of DIY and have just assembled a new Pentium PC - with a valve on the motherboard of course - to support a Sony recording DVD drive that can cope with various formats. O.K., computers are horribly jargonised, but once you overcome the bull and get fluent with da lingo, they are powerful audio tools and fun too.

Oh, and if it makes you feel any better, many people in audio, including reviewers, hate PC audio! **NK**



Computer audio - you don't have to like it, but you can't ignore it!

MONO STEREO RADIO - OH!

I recently became aware that many of the programmes broadcast on BBC FM radio are only in mono. I use a vintage Trio KT-7500 tuner (in perfect working order) with a roof-mounted 3-element aerial, Naim Nait 3 amp and Epos M12 loudspeakers. I do not live in a difficult reception area.

Last Saturday evening while I was listening to "The Saturday Rock Show" on Radio Newcastle (it is broadcast simultaneously on Radio Newcastle, Radio Cleveland and Radio Cumbria) I noticed that the stereo sound stage sounded rather "flat". The DJ then played a very familiar Led Zeppelin track. In a certain part of this track I would normally expect to hear the sound come from the left speaker and then the right, but while listening to this broadcast the sound stayed in the

middle of the two speakers. It then dawned on me - I was hearing MONO output, not stereo!!

I then checked the stereo beacon on my tuner and it was lit, indicating a "stereo" broadcast. I then checked the signal strength and tuning meters. The station was correctly centre tuned and the signal meter was very close to the very top of the scale. I then re-tuned to the same program on the Radio Cleveland frequency and the result was the same - MONO!

Thinking that there may be a problem with my tuner, I "tested" several other FM stations including Classic FM, Radio 2 and Radio 3 and ILR and they were all producing stereo output as one would expect. I rang the Radio Newcastle "admin" number to enquire whether it was now policy to transmit BBC local radio in mono and I was told that I would need to speak to an engineer to get an answer to "such a technical query". I eventually managed to speak to a "Roger Haas", a BBC engineer, who, after some investigation, was able to tell me that although the programme in question is broadcast in "stereo" as far as the transmitter is concerned, the feed from the studio is only mono, which explained why I received only mono output despite the stereo indicator on my tuner lighting up. Mr Haas also said that "the Saturday Rock Show" will continue to be produced in mono for the foreseeable future due to "several technical difficulties".

I have tuned to several BBC FM broadcasts over the past few days and every time I have tuned to Radio Newcastle the output has been mono. I have also found that several (but not all) of the programmes on Radio Cleveland had been mono. Also, it seems that the Today Programme on Radio 4 is now also being broadcast in mono!!!!

This is the 21st century, not the 1950's!!! I feel very strongly that that all FM output should be in stereo. It is not acceptable to broadcast programmes (especially those with music content) on FM in mono in 2003. Not only that, but it seems to me that the BBC is neither informing it's listeners (license payers and tax payers!) that some of it's radio programmes are mono only, nor is it apologising for it. It seems to me that the BBC is hoping that no one will notice. This falls far below the standards that one has a right to expect from a supposedly world-class broadcasting company!

I would now like to mention DAB radio as a separate but related issue. I

have learned that in order to squeeze as many stations as possible into a limited bandwidth, the BBC has resorted to outputting some DAB radio transmissions with a bit rate as low as 128kbs - insufficient for true high fidelity and far worse than FM!

Also, I understand that certain Radio 4 programmes on DAB are being broadcast in mono for the same reason. I can't help wondering, therefore, if the same programmes are also being broadcast in mono on FM to avoid a public perception that FM is better than DAB when it is the stated aim of the government (and therefore of the BBC) to eventually turn off the FM transmitters once there has been sufficient take-up of DAB radio.

Whatever the reasons, it is totally unacceptable that certain BBC radio programmes cannot be received in stereo (whether DAB or FM) in this day and age. I am part of a worldwide FM radio enthusiasts community on the internet (with members in North America, Europe and Asia) who react in disbelief when I tell them that the BBC is still broadcasting in mono on FM. The BBC is at risk of making itself a laughing stock amongst radio enthusiasts around the world.

I would urge the readers of your excellent magazine who feel as strongly as I do about this issue to make strong representations to the BBC and also to write to their MP in order to get the BBC to do something about it. The British tax payer and license payer (the BBC often remind us that the TV license is for radio too) is being short-changed!

Gordon Hamilton
County Durham



Providing the transmitter is sending out a pilot tone, your stereo beacon will light, but you may be receiving mono all the same. Do bear in mind that quite a lot of broadcast programme can be mono in any case, interviews and speech often being captured by a directional mono mic. for example.

Unfortunately, DAB has its own difficulties, and they don't help. Broadcasters are very distracted by all this and programme quality has really taken a back seat as a result. All the same, DAB has increased programme variety. Perhaps the issue of quality will be addressed in the future - and then we may start to enjoy decent stereo again! **NK**

There are periods when BBC local radio has to use a mono circuit for some contributions as a stereo feed costs more than a mono one. Obviously, we would love to use a stereo feed for everything but there are financial limitations in BBC radio. Each expenditure has to be carefully weighed against the total budget for the station. It is only by careful husbandry of resources BBC local radio is able to broadcast a such a wide variety of programmes of diverse appeal.

In his e-mail to you Gordon also commented on DAB bitrates and stereo, with particular regard to BBC Radio 4. For DAB the BBC has one block of broadcast spectrum on which to offer a multiplex of its national radio services. Although the capacity of one multiplex is fixed, DAB is unique as it provides the broadcaster with significant flexibility in the way this is used. Both the number of services can be changed as well as the space devoted to each. We therefore manage this capacity in a way which balances the technical quality requirements of different types of programme with the provision of services of sufficient range to meet the diverse interests of our audience. However the extreme demand on capacity which leads to mono broadcasting of some programmes is rare.

If we had we limited our aims on DAB to the provision of existing services without providing new ones this challenge would have been eased. However such an approach

would have failed to meet our objective in serving audiences beyond the editorial range of the services already available, and would certainly have presented a less attractive proposition for those listeners considering the adoption of digital radio. kind regards

KEVIN JOINER,
THE BBC.

THE GRATEFUL HEAD

Regarding Ian Dixon's letter in the June issue, there are a number of portable (battery powered) headphone amplifiers available that will really make his Grados sing. Please direct him to www.headphone.com - the home page of the HeadRoom Corporation in the US who sell a range of battery and

mains headphone amplifiers as well as headphones and accessories. The site is also a wealth of information for anything to do with headphone listening. Perhaps you could pass this information on to him before the next issue - the image of the poor chap struggling on to a train with his Sony Discman, Grados, MF Xcans tube and a 12V car battery may be amusing, but not kind!

Stephen Blake

Thanks for that Steve, but while he might have a bit of a handful, his ears would love him for it...**DP**

FROM ACROSS THE HER-RING POND

I've long enjoyed my CD player, a Rotel 955 that I bought in 1993, but suspect that I could do better. I keep reading that the technology has come a long way in the past few years, and the sounds from my turntable (a Rega unit) are more persuasive somehow.

My question is, do you think something like the Rega Planet will clearly improve on my Rotel machine? If not, what will I need to spend to hear a clear difference? I could probably swing up to something up to the Creek CD53, if it's worth it. I always find your magazine highly enjoyable and informative.

Doug Barnes
New Haven, Connecticut, USA

Hi Doug - if you got the last issue, you'd know that even the Creek can't match Marantz's CD6000KI Signature, and the Planet is a little off the pace right now, fine as it is to listen to nonetheless. So I'd go for the Marantz. Meanwhile, watch out for an interview with Ken Ishiwata himself in the next issue, as he reveals his CD tweaking secrets! **DP**

Yep, the CD6000 KIS blew me away; it's a fantastic CD player, head and shoulders above others. This player really demonstrates tonality, as well as detail retrieval. It even gave a wider sound stage than I am used to from CD. **NK**

THE LOW DOWN

I acquired a pair of Celestion 6000s without the crossover so I built the one you published in April 96. The sound has been disappointing; Using a mic and a wobulator, I found the sub runs out of steam very quickly below 50Hz. The article spoke of the LF extension and although I have confirmed the drive at LF into the speakers, the acoustical output is lacking. I can also see the

peaks at 145 and 220 which were put into the crossovers and therefore I plan to remove these. The results are so poor that I suspect a fault. How should the two speakers in each sub be wired?
Anon.

Hello anon. The 6000s should be used as wired, which is each driver pair in phase. They have to handle a lot of power, because the acoustic efficiency falls as cancellation increases. This is why the external EQ unit applies +6dB/octave bass boost. These things produce monster bass with almost no lower limit, but as acoustic dipoles with cancellation zones either side they have to be steered for best results. Often it was best to toe them outward, putting the cancellation zone into the corners of the room in effect. You must also ensure the power amplifier is really beefy to avoid clipping or output limiting, and that it can work down to 5Hz or so. There is no reason otherwise for the SL6000s not to drive a room down to 5Hz or so unless there is something clearly wrong. **NK**

made me upgrade the whole system, and I have found myself in a whirlpool of continuous investment.

First, I had bought second hand Dynaudio Contour 1 speakers, a forerunner of the current 1.3 series. Changing the speakers alone, however, did not bring substantial differences to my system. It became more transparent to the music and with a better soundstage, but that was not such a shocking difference. It seemed that my good old NAD 3240PE amplifier did not have sufficient resources to drive these rather insensitive and tricky speakers. It forced me to look after a new amplifier.

By chance, on the used equipment market, I have found a Musical Fidelity F2-FX2 pre-power amplifier combo. Replacing the NAD to the F2-FX2 combo made an unbelievable change. The NAD 3240PE amplifier was a fairly good one. It had speed, it had "soul" to communicate the music, and gave a fairly detailed pictures of large orchestral works. I could live with it without any problem, although the music had its nicely communicated surface, but it lacked depth and was not able to deliver sufficient bass. But what the F2-FX2 combo does with music is simply incomparable to that entry-level amplifier. Suddenly the music has body, has depth, immediacy and presence. I had to realise how important a piece the amplifier is in a system. The F2-FX2 combo has the ability to allow hearing both the warmth of the music and the dynamic climaxes of big orchestral works, with sharp trumpets and drumbeats. Even such complicated works like Mahler II symphony (EMI, Klemperer, LSO) or Bartók Concerto (Philips, Fischer Iván, Budapesti Fesztivál Zenekar) came to life, quite closely approaching a real concert experience.

In the next round of investment I upgraded my interconnects. I bought Harmonic Technology Prosilway interconnects and I have bought 3 sets of Nordost Pulsar Points to underpin the equipment. Actually, I am now looking for a set of speaker cables to replace my current ones. Currently, I am using a pair of plain cheap OFC speaker cables, which I bought a good decade ago.

A friend of mine gave me for a few days his Nordost SPM reference cables. What a difference compared to my cables in detailing, transparency and soundstage! I realised that I really should do an upgrading in this front also. My problem is that I really need a fairly long run of cable, around 2x4.5 metres, due to the placement of the equipment. I have two small children and I simply can't put the equipment in

the middle of the room in the next 10-15 years. Such a long run of high quality speaker cable cost a fortune, which I simply could not afford. As far as I see, the Nordost Blue Heaven, Harmonic Technology Pro12 Melody line, or a cheaper VandenHul cable is what I could afford in such a long run. In principle, the most neutral sounding cable should be the best. However, it seems to me that there is a certain lack of involvement in the system. Maybe it is due to the slightly dry character of the speakers. Could you give me an advice what sort of cables would fit to my system?

Additionally, I would like to upgrade my tuner. I frequently hear the local classical radio station, which regularly broadcasts live concerts. Currently, I have a Harman Kardon TU940 and I am using a Magnum Silver Ribbon indoor antenna. I am fairly happy with it, but it maybe also worthwhile to invest to have a pricier but better sounding model. Do you think that upgrading the TU940 to a model, like Cyrus FM7.5, Creek T50 or Musical Fidelity T3.2 would represent a real jump in listening quality? Which model would you recommend?

Andras

Unless you live very close to a transmitter, within a few kilometres, you need an outdoor aerial. VHF/FM tuners need 1mV or more for best signal quality and indoor aerials cannot provide this. You will be surprised at just how much clearer and cleaner and more solid the sound becomes; people always are! The TU940 is a nice enough tuner, but you will get better results from the models you mention, although differences will not be great. **NK**



A good tuner upgrade is an outdoor aerial, like these Antiference models. You need plenty of signal with VHF for the best sound.

A QUICK FLUTTER

I am writing to you regarding the sound quality of DAB Radio broadcasts. On all the models I have tried personally I have always heard some sort of high frequency fluttering sound that accompanies high pitched instruments

Hi-Fi WORLD SUPPLEMENT
No. 19 (MAY 2003) £1.99

DIPOLE BASS FOR THE QUAD ESL-63 ELECTROSTATIC

BOOK REVIEWS -
ELECTROSTATIC LOUSPEAKER DESIGN COOKBOOK
THE LOUSPEAKER DESIGN COOKBOOK - 5TH EDITION

WE VISIT THE EGHAM AUDIO FAIR

FREE D.I.Y. SUPPLEMENT No. 19

The unusual and rare Celestion SL6000 open dipole subwoofer beneath Quad ESL-63s.

ROUND THE HOUSES

I have recently renewed my hi-fi system. Earlier I had a Denon 1400 CD player, NAD 3240PE and Heybrook HB1 speakers. The Denon went wrong and I was forced to buy a new CD player. I bought a Musical Fidelity A3 CD player, which got rave reviews. Inserting it into the chain, suddenly, the music had life and spirit! Additionally, a host of new details emerged from the rather uninspiring and mechanical soup of voices I had with the Denon. The jump in the quality of music reproduction

BARGAIN BULBS



If you've always thought of valve amps as temperamental and expensive beasts, think again. World Audio Design's latest kit is designed with the budget conscious beginner in mind.

The Kec182 was created from a brief that demanded simplicity, ease of build and a super low cost. In order to achieve a reasonable power output we went for a push-pull amplifier.

We chose the ECL82, a triode/output pentode. This tube is readily available and has a good sound. In push-pull mode it delivers 8Watts. Realistically you need a speaker of around 89dB or above. This is possible at a budget price - try the smaller Triangle models, or a Tannoy mX3 or even one of the older Missions like the 773e, or if you like building your own speakers, try the Adire Audio HE10.1, as reviewed in HFW October 2002 issue.

You will see that the front has only a volume control, and it is fed by one pair of phono sockets. A selector and tape/source switch were not used in this amplifier as they are tricky to wire up, and the aim was to make it easy to build. In fact, in many ways the Kec182 would be great powering a second system, using a CD player as a source, and will definitely give you a taster of what valves can offer. Measuring 30cm wide, 23.5cm deep and 11cm height with feet, it is entirely self-enclosed. The valves are visible through the four upper circular vent holes (one directly above each valve). We have kept the look simple with the minimalist front panel holding the volume potentiometer. The two-part chassis is constructed from 1.6mm mild steel with a durable black powder-coat finish. The whole unit is very sturdy, weighing in at 9kgs.

The signal input is in the form of a pair of gold plated RCA phono sockets that sit at the rear of the chassis. The speaker sockets accept 4mm banana plugs as well as bare wire. The mains switch is positioned at the rear of the amplifier, on the right hand corner for easy access. Mains power is received via an IEC lead. The Kec182 is based on a printed circuit board (PCB). The PCB is easy to follow with all component names, locations and orientations shown clearly. The amplifier requires no set up, you just turn it on. The kit will come with comprehensive instructions taking you through the build step-b-step.

SOUND QUALITY BY SIMON POPE

Purity is the key to this amplifier's design and sound. Because there's very little to get in the way of the signal what you get is an exceptionally sweet and simple sound that also has a superbly wholesome roundness to it. A high quality recording of Mahler's Das Lied Von Der Erde on Reference Recordings showed that the Kec182 faithfully reproduced all the depth and space of a full symphonic orchestra without any problems. Violins were smooth and sweet, as was percussion (which virtually sparkled) and the woodwind section was especially impressive, with a spacious and airy sound.

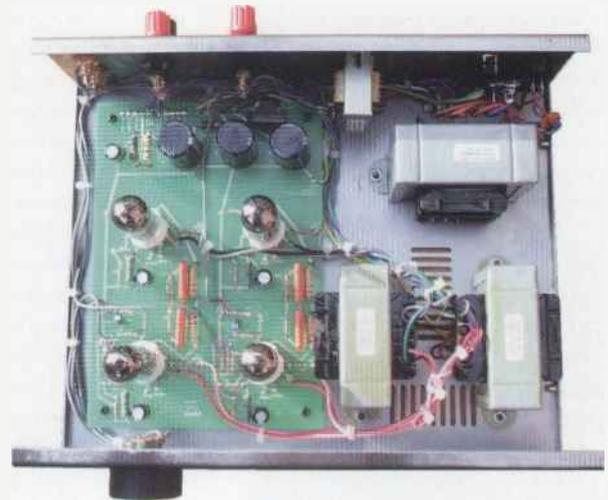

A run through Miles Davis's Kind Of Blue saw the little integrated delivering a detailed and precise sound that highlighted the warmth of Coltrane's tenor sax and the rich, deep sound of the upright bass. Rock and Pop records such as Radiohead's 'Lucky' demonstrated that the valves inside the amp, whilst small, are quite robust sounding, with commendable clout and bass depth for a humble budget 8W valve amp. This is a great introduction to the sonic art of the valve amp and a big upgrade for anybody with a mid-price solid-state amp that wishes to swap over to something more musically engaging, for a price that's virtually as cheap as chips!

MEASURED PERFORMANCE

| | |
|--------------------|----------------------------|
| Frequency response | +/-3dB 15Hz - 75kHz |
| power output | 8 watts into an 8 ohm load |
| sensitivity | 850mV (suitable for CD) |
| hum | 0.5mV |

**The Kec182 amplifier kit is available from World Audio Design
Tel/fax: 00 44 (0) 1908 218836 or order on-line at
www.worldaudiodesign.co.uk**

**Kec182 amplifier kit (UK price) £195.00
(inc. vat & carriage)**

**Kec182 amplifier kit (EU price) £195.00
(inc. vat, exc. carriage)**

**Kec182 amplifier kit (Overseas price) £170.00
(exc. carriage)**

such as flutes etc. I have asked the guys at the BBC to try and explain this particular problem (I mainly listen to Radio 3), but they didn't really know about it. It was only very recently that I have seen anything mentioned about this, it was in the June issue of Hi-Fi Choice magazine, in an article by Richard Black. He acknowledges that the problem exists and gives an explanation why it does.

I would be interested if anyone else has had this problem, or if you have anything to add on this subject. For me it totally wipes out the benefits of Digital broadcasting, as again, just like when listening to FM, I am on the edge of my seat waiting for the sound to be spoiled by some sort of distortion, or interference.

Ian Knight
The Leicester Hi Fi Company

I have heard what I would term a 'swimmy' quality behind violins on DAB. This is almost certainly down to Musicam data reduction, as Richard Black suggests. Faced with a full level, full bandwidth signal all data reduction systems will crack up after a short period, because they are unable to sustain the continuous data rate required, but DAB is generally the poorest sounding, likely because the music signal is often so ropery even out of the studio, before it gets Musicam'd.

Broadcasters were having trouble with their music feeds back in the 1970s, but then it was hiss and hum. Today they have just as many problems it seems, even reverting back to mono, as the previous letter points out. **NK**

WATCH YOUR BASS BINS!

I have a Roksan Xerxes/Artemiz/DV20xHI Dino Plus, Lavardin IS Refl Rogers LS3/5A and AB1 bass units. I love the sound it makes, especially with vocal and "real" instrumentation - it's very much to my taste. However, I also listen to plenty of loud electronic music and volume capability is becoming an issue as the sound hardens and goes awry at high volumes. It's usually fine, but still I'd like to explore what can be done. I really love my system and would like to keep the style of presentation intact. Could you suggest some easy to drive speakers I might like or some other course of action maybe (the amp stays as I love it)? Budget for 'speakers isn't massive - £2k max. I'd also like a bit of a cheapish digital player, any suggestions?

Julian Shuttle

Firstly, you have a good, well-balanced system. Unfortunately it's perhaps not quite perfect for the job you require of it! The Lavardin amplifiers are superb, being transparent and fluid but very musical - a bit in the Sugden mould both sonically and philosophically. But like Sugden amplifiers they work best when they can bring out lyricism and subtlety in music as opposed to mere volume. This is the same with the Rogers boxes. If you like jazz, classical and acoustic music only then you wouldn't have to write to us. As I know only too well, audiophiles with eclectic and varied tastes in music always have to find a medium - it perhaps explains why certain hi-fi fanatics only have a handful of discs and very,

er, blinkered musical tastes.

Stick with the front end, it's a good set-up that's often overlooked. Now let's make some suggestions if you have to change it. You want a system that can do low level detail and subtlety that you need with vocal and acoustic music but you also want to bust a few Underworld dance tunes, I presume. My option for this would be a second-hand air of Quad ESL-63s and a pair of REL Quake subwoofers - it's a uniquely flexible option. Stick on the subs when you want some welly, when you want Joan Baez warbling and strumming, turn them off! Quads with a good pair of subwoofers can give a massive, almost PA-like sound that really fills a room (or larger) but, of course, they'd need driving with something more brutish than the Lavardin, which is a pity. A powerful 100W valve/solid-state hybrid is a good match for Quads if you want plenty of poke. Electrostatics are woefully insensitive and the Lavardin may well struggle.

A very different, cheaper but good alternative would be to consider a pair of Elac JET518. For around £2,000 or less, this is a big and bold floorstander which features Elac's superbly smooth and detailed folded ribbon tweeter. This ensures sweet and detailed sound with vocal and acoustic music but with a sensitivity of 89dB and a very deep and tight bass would also suit your banging electronic nights and should match well with the Lavardin. **SP**

SEEING THE LIGHT

About a year ago I realised the size of my music collection (over 1000 CDs and records) and decided to spend some money on a decent hi-fi system to complement them. I bought a Rotel 991 CD player, Audio Note TT1/Arm1/IQ2 turntable, Rotel 931/III amplifier and Monitor Audio Bronze 2 speakers. Wow! Suddenly I had a new record collection! I don't understand now how I managed to survive for over a decade with a £100 midi system! I then realised how much I was missing, and decided to move a step further and get a really satisfying system. I did a lot of shopping around (Arcam, Cyrus, Rotel, Roksan, Primare, Naim NAD, Marantz, Denon, Audio Note Zero) and finally decided on a Sugden A21/CD21. As an aside, I'm still not sure I prefer this CD player to the Rotel 991 I had before, which if not as musical as the Sugden had much more control in the lower frequencies and better microdynamic detail,

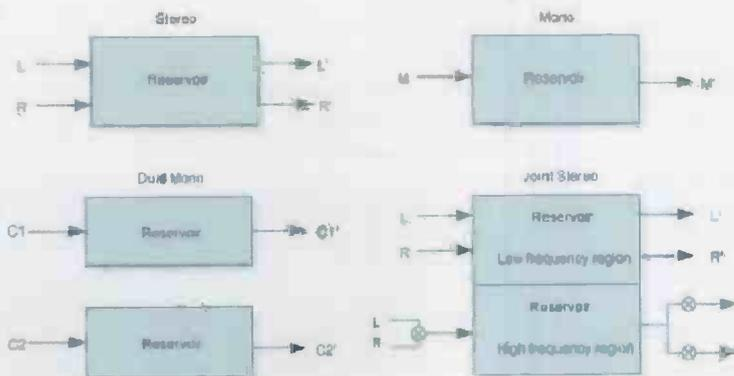

The 'reservoir' or 'bit pool' becomes exhausted if music exceeds expected limits for loudness and bandwidth over time. With Joint Stereo, to reduce data rate even further, at high frequencies Musicam reverts to dual channel mono - desperate measures indeed (diagram - ntl).

although it was maybe a bit thin and forward. Interconnects are PHY-HP module.

I have listened to several loudspeakers so far: B&W, Dynaudio, Rega, PMC, Monitor Audio GR10, Elac, Mission, KEFs... So far my favourites are ProAc D15, although I still want to listen to the smaller 1sc and the Audiophysic Tempo III. Music tastes vary from high-tech jazz, down-tempo electronica and some jazz-funk too sometimes. I know I cannot afford things like Gamut D200, Modulus 3A, AudioPhysicVirgo III or Avanti, Avalon speakers or an SME turntable even if I love how they sound, so I have to make a compromise and try to make the most of my available funds. The problem is that even when I auditioned the ProAc D15's with my system at a store, I realised that even if the tonal balance was okay for me, dynamics were not amazing and the soundstage was not as wide as I dreamt of... So, I would like to ask you for some advice.

Which would be your ideal speakers to partner my system with? Would you consider adding a second power amp? (The preamp would still be the same, so I don't know if the difference would justify £900!) Or maybe I should consider adding a good DAC to the CD player, such as the Perpetual Technologies, which gives me the opportunity to upgrade in the future via the correction engine and the power supply? I also need advice on a cartridge to upgrade my TT as well as a good phono stage to use with my amp. (Tom Evans Microgroove, Lehman Audio BlackCube SE, EAR, Trichord, the Sugden phono card at £100?) I have asked many dealers around to demo different products but have been unsuccessful so far... please help me out here...! I will also consider changing the deck, the arm or whatever you feel is necessary...even if I need to save for some time. I am truly starting to lose faith, so I hope you can give me a hand on this one and make me believe! I am already spending more money than I should and I really want to be satisfied with the system I end up with at home, because I will not be able to upgrade in a very LONG time. So, as I said, I will just close my eyes and trust your advice because this is starting to be the most difficult decision in my life. (I hope my wife doesn't read about this!) I look forward to hearing from you, and thank you in advance for the help...

Borja LS

For 'speakers I'd tend to agree with many distributors and retailers

around the world when it comes to the A2I and recommend Living Voice's Auditorium range. They are widely acknowledged as an 'industry match'. The Auditorium itself is £1,500 and for this you get 92dB sensitivity and the clean, detailed and full sound. Another grand spent on the Avatar will reap rewards if you can stretch to it. Careful matching and auditioning is necessary, though, as they could sound a little tubby with wrong room placement but they are a very worthy match for the little Sugden. When singing properly, they will deliver a sound that also has an amazingly wide and deep soundstage with an impressive three-dimensional quality. Both models are good low level 'speakers, too, giving a big, detailed sound at low volumes.

For phono duties, the £100 Sugden phono card offers superb value for money and of course will save you space and money on extra cables! If you want a dedicated external stage, then Tom Evans's Microgroove has a very fine sound (if not build quality) that you'll never tire of. Vinyl source? Well, what you have now is no mug at all, but an obvious choice would be to splash out on a better cartridge such as one of the Ortofon Kontrapunkt A or B moving coils (at £350 and £600). This will really open doors as far as vinyl playback is concerned for relatively little outlay as our arm and turntable should do you just fine for years to come. **SP**

MULHOLLAND'S DRIVE

I have only recently rekindled my interest in audio by changing my speakers to a pair of Triangle Lyrrs and the CD player to the Cyrus Q7. My amplification is courtesy of an old Naim 42/110, to which I have added phono sockets and rewired inside with silver cable. Since I feel these amps are bass light, will tweaking ever improve them or am I better giving up and replacing the amp? I like the idea of building my own and like the look of the World Audio KAT34 integrated amp. What do they sound like? I listened to a wide range of music from Eva Cassidy to Metallica. Thoughts?

Andrew Mulholland

Triangle loudspeakers are one of the few 'affordable' brands that match well with valve amplifiers – and affordable ones such as the kit you mention. They are an easy load and sound superb when used with a relevant valve amp. Taking absolutely

nothing away from Naim – as what they do, they do very well indeed – but they will sound edgy and hard with Triangle, when compared to the fullness that tubes would bring to the sound. So if you don't want to change your 'speaker than opt for something tubular, without doubt. The only tweaking that will seamlessly match your Naims to Triangle would be to stick a valve in each of them – which incidentally is a joke, don't try that at home, even if you are a Hi-Fi World reader! **SP**

AI POSITION?

Thanks for the articles on the Classic Olde World products especially the articles on the Musical Fidelity A1 and the NAD 3020. I have both these units along with a Naim Nait II, Dynaco SCA-35, Scott 299D, Wavelength Junior etc. I am still impressed by the Musical Fidelity A1 but I always wondered how it stands up to a new integrated amp like the Sugden, Nait 5, Cyrus, etc. I would love to see a real review and comparison of the A1 against the modern amps. Listener magazine was doing this before they closed their doors. Is this possible?

Christopher Sullivan

We'll try – my A1s started smoking more than Dot Cotton so I can't do one right now, but past experience teaches me that it's less incisive and spacious than the Sugden, and lacks its tonal variety. Still, it really is a music maker, and even a non-PSX-R'd Cyrus 7, for example, would struggle to reach its level of lucidity. Naim's NAIT 5 would have the legs on it in terms of kick and punch, but again I doubt if it would comprehensively outclass it. I was chatting to Anthony Michaelson last week about this very product, and he's still very proud of it – justifiably in my experience. There is the issue of build and reliability, however, which he willingly acknowledged; MF had QC problems with it. **DP**



Musical Fidelity A1 SE pre-power amplifier combo.

NEW BLACK

I have just received the June issue of Hi-Fi World with the ELS-3 review featured, and I wonder if I might point out a couple of points which I would appreciate you clarifying in your next issue.

First of all the reviewer refers to the 'drab black vinyl' finish. Whilst the speakers are undeniably a vinyl wrap, they are also available in both dark and light cherry. I have attached an image of the light cherry, which I have to say has attracted favourable comment from everyone who has seen it! It would be unfortunate if consumers chose not to consider the 'speaker because they believed it was available in black only. The other point which I feel needs clarification is that the speaker is in fact a 4 ohm speaker and not 8 ohm as stated.

regards

Jacki Pugh,
Creek Audio Ltd.

REAR OF THE YEAR

Dear David

I hope you don't mind me dropping you a line on the old chestnut of underslung weights, as mentioned in your review on the new Michell tonearm. We have long had a bit of a running battle with the Expressimo rear stub mod on this issue because customers keep asking us why we don't adopt the same philosophy as it is so "advantageous".

The problem is that it's superficially a plausible idea which makes for great reading in a marketing brochure.

Underslinging the weight is of course an enormous advantage on a unipivot arm because of stability issues in the azimuth plane. However as soon as you move to an arm that is supported by bearings either side then stability is not an issue. What is an issue (especially as far as cantilever suspension is concerned) is "inertia" and moments of inertia under the laws of physics tells us that the further we undersling the weight the more we increase inertia, which is of course detrimental.

We actually used to produce underslung counterweights many years ago until we tested them against non underslung and found there was no difference in the sound at all - which is unusual because normally the slightest change does affect things. When the Expressimo came along we revisited the whole area just in case there were something we had missed - the results were the same - no advantage. I've asked a few other designers what they think and they agree with the above. Anyway, knowing your keen interest in the history and development of

tonearms I thought this bit of information might be useful to you.

Mark Baker

Origin Live

Hi Mark - interesting! Not being a devout disciple of 'counterweight dynamics', I feel unable to comment authoritatively on this, apart from to point out that other, very capable non-unipivot tonearm designs - such as SME's Series V - also undersling their massy bits! Comments from readers or designers on this issue would be most welcome. **DP**

HI-FI BARGAINS

A while ago I moved house, and had to sell all my hi-fi equipment in the process. I soon found myself suffering from acute withdrawal symptoms, and needed to build a sound system as quickly and cheaply as possible. So I decided to concentrate on buying used items, as my budget was low hundreds, rather than thousand of pounds. I now find myself with a Sugden A 28B amp (very smooth and detailed), Thorens TD160s turntable with Hadcock unipivot arm and Decca London Cartridge (wonderful, temperamental but worth it!), and a Marantz CD6000 KIS CD player (bags of detail without the stridency of cheap CD players).

I was using, up until a few months ago, an old pair Mordant-Short Pageants (pleasant but lacking), when I inherited a pair of Tannoy 611s. I am amazed at the sound quality of these 'speakers. I am used to the open and rather measured sound of KEFs, having owned a couple of the Reference Series in the past. These small floorstanders have the ability to project a three dimensional sound stage very much like the KEFs, and have a certain vitality without sounding strident or harsh. They're my biggest surprise, as they have lifted the sound to another level. Is it that I've just hit upon this sound by accident, or it could it be that these speakers are in fact second-hand gems?

Excluding cabling I only spent £385 on my 'new' system (and £250 of that was on the Marantz), having sold the

Pageants for £60 this brings my total spend to £325. The sound I now enjoy is a magnitude above what I would have expected, had I bought from new, even with a £500-£600 budget. So you don't have to spend a king's ransom to achieve a high quality sound if you're prepared to mix and match used equipment. Providing you do your research and keep a wary eye open for tired and worn equipment, there's really is a lot of good stuff out there. To pinch a popular phrase, "It's cheap as chips". It might be interesting for your reviewers to put together a series of bargain basement systems using older equipment.

J Smith

Agreed - you don't need masses of money to get great sound. The secret is to buy sensibly, match carefully and tweak until you're where you want to be. I find that I use a mixture of new and old in my system, sometimes spending more on the old than I do on the new, sometimes picking up equipment for peanuts at car boot sales, hi-fi shows, etc., and tweaking it. I think yours works so well because (a) you've got fine kit in the first place, and (b) it's well matched, although this may have been - as you say - almost by accident! Watch out for a retro system review in a forthcoming issue. **DP**

Fantastic kit - with one glaring exception - the Decca London. Yes, I know how good they sound, hair-trigger transients, taut bass, blah, blah - but when you remove this thing and go back to a normal cartridge you will find your LPs irreparably damaged. They have little lateral compliance and don't track well at all; it's the mistracking that gouges the grooves, but you won't hear it. And my measurements showed they produce 9% third-harmonic distortion, hence the sharp, fast sound. The nearest match sonically is the Shure V15VxMR, which is a lovely sounding device, quite unlike earlier V15s. My advice is get it quick! **NK**

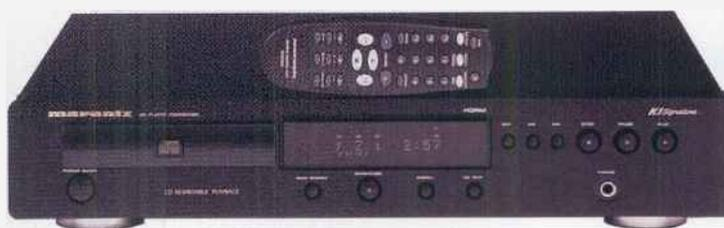

Marantz CD 6000 SE K1 of Mr Smith's system.

As good as it gets - just hear the B2.2 Revelation!



Music lovers - forget 5.1 ch HT, stereo is here again! In fact, the 2 ch sound from SETs and really good single-driver horn speakers has never been bettered for pure musical enjoyment. And horns don't come any better than the new B2.2 Revelation (right). The dynamics and transparency are phenomenal - they give a depth of sound stage and image focus which is just so believable.

The Beauhorn Virtuosos simply manage to make music of all kinds more interesting and involving than conventional speakers. Paul Messenger Hi-Fi+ Once you get the location

and toe-in right the B2 is very definitely a Beauhorn. It has the same tactile immediacy and directness that its more sophisticated elder brother possesses. Roy Gregory Hi-Fi+



Beauhorn™

website: www.beauhorn.com e-mail: infow@beauhorn.com Hastings TN35 4NB England Telephone: +44 (0)1424 813888



the AUDIO.VISUAL Lounge

see hear believe.

STOCKISTS OF
 AVID
 ANATEK
 ANTONY GALLO
 B&W
 CHORD ELECTRONICS
 DALI
 KEF
 NORDOST
 PRIMARE
 REL
 TANNOY
 VDH

Specialist in audio and visual entertainment systems from the world's best manufacturer's

STOCKISTS OF
 HARMON KARDON
 MONITOR AUDIO
 NAD
 ORTOFON
 PRIMARE
 PRO-AC
 PRO-JECT
 ROKSAN
 REGA
 SME
 VIENNA ACOUSTICS

Musical Fidelity Tri-Vista - full range in Stock



E: info@theavlounge.com T: 020 73753691 F: 020 73771756
 Opening times: Mon-Fri 10.30 to 6.00 Sat-Sun 11.00 to 5.00
 A: 135-137 Commercial Street, Spitalfields, London, E1 6BJ, UK



campaign audio design

HI-FI Cables Manufacturer and Supplier

"Watt's the Solution"

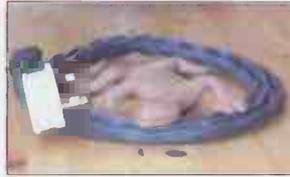

The AC mains is the most vital link in the hi-fi chain. Pollution and voltage inconsistencies all play a part in spoiling musical enjoyment. Just listen to your equipment late at night - it will sound less grainy more fluid and involving.

We have a range of mains cabling starting from £22.99 (or £7.00 per metre) which will open up and focus your system providing transparency and speed. Our silver OFC cables, due to their high current capacities (up to 240 Amps), produce effortless music from current hungry devices. All mains connections are treated with a contact enhancer prior to shipping and soldered with Lead free 4% silver solder.

Our analogue, video and digital cables make the most of available resolution. With precisely manufactured high bandwidth video cables you will experience an immediate improvement in picture quality. High purity silver and silver plated copper interconnects and speaker cables offer superior quality at down to earth prices.

We have a cure for your noisy fridge or central heating boiler (£3.50) enabling you to throw away that big noise suppressor that has been giving you that "sat upon" sound for years. There's lots we can do to bring you closer to the emotion and energy of the performance. So confident are we that you will be delighted that we offer a 21 day no quibble guarantee.

CAMPAIGN AUDIO DESIGN
 Ty-Mawr Road (HW)
 Cardiff CF3 3BS
 Tel:- 02920 779401
 Website: <http://business.virgin.net/cad.cables/>



Trade and International Enquiries Welcome.



FRANKFURT IN PICTURES

One sweltering May day, Hi-Fi World's roving editor David Price made his way along the leafy lanes of Frankfurt to the Hotel Kempinski, to experience the delights of the High End 2003 Show. So just in case you've ever wondered, here's how the other half live...

FOCUL JMLAB is another company with high ambitions – in this case 120cm high, 53cm wide and 37cm deep. The Alto Utopia Beryllium boasts, as its name cunningly suggests, a 27mm Beryllium dome tweeter. Being far lighter and stiffer than aluminium or titanium, they claim it gives better transients and lower distortion. The Alto is a serious bit of kit, and providing we can find someone tough enough to lift its 86kg bulk, we'll look forward to reviewing it soon. At 7,500E each, we'd better not drop one!



Vinyl and valves were the theme to Frankfurt's High End 2003, and CLEARAUDIO provided the show-stopper! This exquisite 'palace of Perspex' was one of a vast range of models, ranging from the affordable Emotion at 690E to the Maximum Solution/Master TQI, which you can't afford if you want to know the price. Needless to say, they sounded as stunning as they looked...

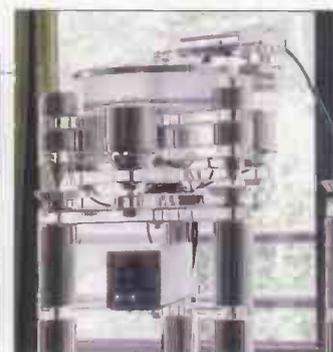

An unexpected surprise. A curious looking pair of 'speakers beckoned me in to this room, whereupon I was bowled over with what I heard. DYNAVOX's Dynastation CD player - complete with tube output stage - (1,490E), DynaControl tube preamp



(4,990E), Dynawatt 2A3SE power amp (4,990E) and UniQorn loudspeakers (1,995E) have no UK distribution (as yet), but we're arranging a review nevertheless. Big, fat, full and fast sounding, it's all the more enjoyable thanks to the 'way out' styling and wacky design touches. Who says Germans don't have a sense of humour?

Never let it be said that LORICRAFT don't know how to party. The irrepressible Terry O Sullivan and Nigel Pearson were deluged with admiring visitors. Unsurprising, considering the **tasty** wares they had on show – a Garrard 501 with bespoke Bentley wine red paint finish and brass platter, a sneak preview of the new 601 and the forthcoming Garrard unipivot tonearm, a cut-price (£2500!) variant of a respected German design. With



so much chat, I'm surprised these guys ever get any work done – yours truly couldn't get a word in edgewise... which surely has to be a first!





Another new name to me was **PROGRESSIVE AUDIO**, which managed a truly spiffing sound within the confines of its rather small room. Loads of air and space, allied to a nice smooth tonality gave me a great

excuse to take to a chair and rest my weary feet. The CD1 is another example of bonkers high end styling, but worked brilliantly in practice. It was one of many new 16bit machines used at the show – lots of these well healed high end folks still seem to swear by the system, despite the onslaught of DVD-A and SACD.

I must have called in to the NAIM room at a strange time, because none of the usual Salisbury suspects were there to be seen. Surely Doug Graham hadn't nipped down to the hotel bar for his customary half pint of lager shandy and a puff of ready-rubbed? Anyway, there were plenty of punters within, all looking deadly serious about what was before them – as if to say, "for what we are about to receive, may Paul make us truly thankful..." With all the new toys on display, a nice noise could be heard. However, I couldn't stop looking at Naim's new Music Line Powertube – allegedly a mains distribution unit, but to me it looked more akin to a certain Swedish something that Austin Powers might own...

Yank vinyl specialists **CLASSIC RECORDS** made quite a splash considering that – unlike most exhibitors there – they didn't have any new £30,000 tube amps to show off. Instead, a rapidly expanding range of exquisite vinyl titles – including the Zep and Peter Gabriel back catalogues – wowed visitors. Better still, they announced a new disc profile. From the early 1950s, every LP pressed has been slightly thicker at the edges than at the inner run-out groove. This 'Groove Guard' system was designed to protect record surfaces with autochangers. Classic's boffins recently got out their micrometers and discovered that perfectly flat discs (without Groove Guard) sound "louder and cleaner". To wit, its new Quiex SV-P discs available from next month onwards are flat as the proverbial pancake.



At last – some serious high end hi-fi styled to confirm all my worst prejudices about serious high end hi-fi. **GRYPHON** electronics are exquisitely built, finished in piano black and have absurdly pretentious names. The large, finned behemoth you see here is no mere mortal power amplifier, but 'The Antileon Signature' no less. Okay, I'll admit it sounded quite superb – incredibly transparent and effortless. In fact, I mistakenly took Gryphon's CD spinner for a DVD-A machine, so incisive was its midband. I wonder if they'll do a limited edition system in gold plate, to match my bathroom taps?





Well, after the riot of black and gold that is German high end, how about a nice, humble, unreconstructed British offering in the shape of this AUDIONOTE system? Unprepossessing as it looked, I can happily report that it was one of the best sounds I heard all day. When I asked Peter Quortrop, the company's charismatic head, for his assessment of the quality of the other exhibitors, he gave a terse and to-the-point one word reply... I stayed around to listen to a spot of jazz, and pondered that the soundstaging from this valves'n'vinyl delight was better with two 'speakers than any of the digital surround systems I'd heard with five. Vorsprung durch technik?



Having just come from the Linn room, where I'd heard five larger than life Komri loudspeakers firing all around me, I hadn't expected to be bowled over by another set of transducers. My mouth duly dropped, however, when I chanced upon the ACAPELLA room to witness the sight of two Triolon Excaliburs. Standing at over two and a half metres, and sporting plasma tweeters, chromium plated baffles and cherry red enamelled horns bigger than a moon crater, it was very much a case of 'and now for something completely different'. They sounded exquisite, with a massive walk-around soundstage and great smoothness. And as for the transients, it was 'hold onto your hats' time... All this was possible with a Class A single ended triode amp with less power than the headphone output of my MP3 player. I didn't dare ask how much.



The strikingly attired Ken Ishiwata - sporting a silk jacket of a hue last seen on a 1970s Ford Capri - proudly demonstrated his new babies, Marantz's statement SC-7S1/MA-9S1 pre-power combo. "Do you know why it's called seven and nine?", asked Ken. Go figure, classic audiophiles! These 'statement' products sport 300W per side and a combined weight of 93kg. Price is around twenty grand or so, available in October. I wonder if he'll do me a deal on my PM6000K!?

The Brits were out in force in Frankfurt, and LINN had the biggest dem of all. Vast amounts power aspirated the mighty Komri loudspeakers, and not two of them, but five. The reason for this was the presence of the new Unidisk multichannel 'universal disc player'. Yours truly wasn't over-impressed with the DVD-A sound, but a Roger Waters SACD in surround mode turned in a massively spacious yet gripping performance. Shame about the Sondek, which I thought sounded a little out of tune...



I'm not easily impressed by the sight of monster turntables, but one glance at the VYGER ATLANTIS blew my conceit right out of the water! A vast, towering symphony in spun aluminium and other exotically machined metals, it makes a Goldmund Reference look like an Audio Technica Sound Burger. (That's 'huge', by the way...) I was bedazzled by the sheer audacity of this thing, and it sounds as big as it looks. The price tag makes it the province of captains of industry, military dictators and estate agents only.



THE HIGH LIFE - DP REFLECTS ON ALL THINGS HIGH END

If you can't get a decent sound after spending a couple of thousand pounds, then frankly you don't deserve to. There are some very capable mid-price separates out there, which if cleverly mixed, matched and fettled will give most high end set-ups a hard time. So what's the point of high end? Cynics will question the psychology involved - maybe some folk find owning vast shiny boxes dripping with gold, Perspex and carbon fibre - in some way life affirming? It becomes a kind of lifestyle statement, male jewellery for those who should get out more.

Speaking personally, I think there is a lot of this going on in the high end scene, and the Frankfurt show makes this all too clear - but there are also some genuinely superb bits of kit with performance to back up the striking aesthetics. Interestingly, all the inspirational products I came across this year involved either valves or vinyl. Funny, I mused to myself, that - despite the massive effect digital and solid-state has wrought on audio en masse - the most exciting high end designs of 2003 use technology that's well over half a century old!



NOTE

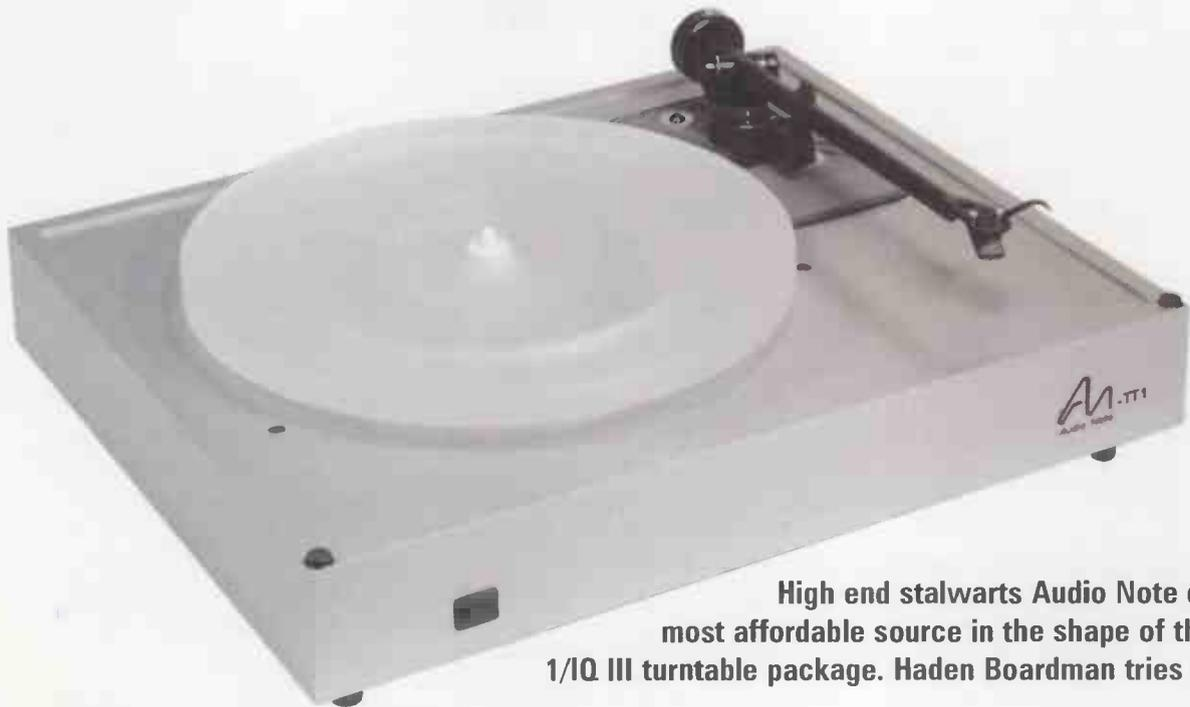

High end stalwarts Audio Note offers us its most affordable source in the shape of the AN-TT1/ARM 1/IQ III turntable package. Haden Boardman tries it out.

Audio Note has brought us some jaw-dropping ear candy, from the infamous Ongaku single ended triode amp to the oversampling-free valve powered digital to analogue converters. More recently, the company has increasingly spread its wings by offering a whole range of equipment, from small compact audio systems (valve based of course!), loudspeakers, CD players, kits - and of course turntables and cartridges.

I have been using their 'budget' LP spinner, comprising TTI turntable, fitted with an ARM 1, which carries a IQ III moving magnet cartridge.

Priced at £300, the cartridge is not far from the £425 price tag of the actual turntable... clearly

Audio Note have faith in the capabilities of this little turntable!

The deck itself is a descendent of the Systemdeck IIX turntable, which itself is a distant relative of the classic Dunlop Systemdeck of 1978 - one of the few British belt drives to challenge the ubiquitous Linn LP12, if I remember rightly...! It shares the suspended chassis system, acrylic sub and main platters and wood plinth, now finished in silver paint. Despite the Audio Note hyperbole about the high quality finish, I have to say it was not too impressive to my eyes.

The deck is shipped with sub platter in place and the instructions make it clear never to remove it, so I didn't. The ARM-1 arm is not fitted, nor the cartridge. Following Audio Note's clear instruction, I removed the arm board, bolted through the Audio Note branded Rega RB 250 (with had been much improved with Audio Note cable), fitted the cartridge and began to assemble the deck. I was not terribly impressed with the cut-out for the Rega arm - it was at least three millimetres too large. Even less impressive was the amount of play available when relocating the arm board to the sub chassis. The deck's instructions inform us to align the arm parallel with the edge of the arm board, sounding off about this being purely cosmetic.. Maybe, but to get the best

lateral tracking error compromise, the correct spindle to arm pivot distance should be more tightly controlled in my opinion. Someone without a massive amount of experience could make a real mess of this; I would recommend letting your dealer set the deck up for you.

Audio Note include a simple cartridge alignment gauge, although I stuck with my Townsend Elite gauge from a few years back, which is a tad more accurate. The armboard was lined up cosmetically to the plinth, and the IQ III cartridge aligned with it.

One really neat feature is the sub chassis levelling set up. There are three 4mm Allen bolts on top of the chassis. Once the transit screw is removed, the three bolts can be used to adjust the suspension to its correct height of 5mm from platter to plinth - this reminded me of the old Alphason Sonata which was similarly equipped!

My reference system comprised valve amplification in the form of a Croft Vitale preamp and my own Class A EL84 power amp (think up spec. Leak Stereo 20!), with Audio Classics Model C loudspeakers. The deck took a while to settle down, the suspension needed constant readjustment for the first few days of



PERFECT?

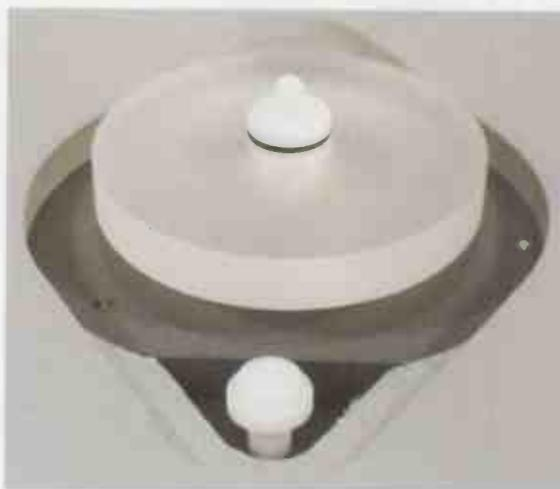

An acrylic platter hub is driven through a belt from the motor pulley.

use - at one point I ended up stripping the whole thing down and starting again! With a brand new cartridge, I left the deck running in with some fairly hard dance tunes, giving it a good twenty hours before taking a serious listen.

I threw the deck right in at the deep end, straight on with Jimmy Smith's 'Walk on the Wild Side'. The results were reasonably detailed, smooth, but a little lacklustre. This is a very upfront recording that requires a well balanced system to enjoy. The midrange and treble were almost a little too smooth, and bass weight a tad lacking. My views on the compressed sound given by the Rega arm has been well documented on these pages before, and clearly in the six years that have passed since I last had a serious listen to one, not a lot has changed.

The Ike Québec disc Bossa Nova Soul Samba on Blue Note suited the deck much better. A super smooth recording, the little Audio Note did a decent stab; without all that upfront brass section of the Jimmy Smith disc, the TT1 really played it well. I still thought the bass slightly lacking - it was there, but appeared to be about two foot further back in the sound stage than what I was expecting. Still, it was toe-tapping good fun.

Next, I removed the IQ III

cartridge, and replaced it with an Ortofon 510, a cartridge one fifth the cost. Other than a slight loss of detail, it suited the deck better. Bass was a little more rounded, not as detailed, not as much definition, but the difference given the huge price difference was not

enormous. The 510 is a little more laid back in the treble than the AN cart, which really helped balance the light bass end of the TT1.

I then popped the IQ III on to my Nottingham Analogue Hyperspace and Space arm, whereupon sanity returned. The Goldring-derived IQ III is a very fine cartridge, detailed, defined, and yes, just a tiny bit laid back in the bass. I was seriously impressed with the performance of the cartridge, but this little experiment clearly underlined it was massively outclassing the AN-TT1 deck.

I reinstated the complete AN turntable package and stuck to a more middle of the road repertoire. Fleetwood Mac, Pink Floyd, Paul Simon, Donald Fagan, all played smoothly, but just lacked that bit of bounce, boogie factor, that ability to make your toes really tap. The overall sound is just a little too light, and a little forward, the biggest disappointment being the bass end. Clean and defined, but lacking in oomph. Imaging was held rigidly between the speakers, no matter how expansive the recording, it just did not fill the room.

The deck suited small scale jazz and classical very well. But where a little more whiz and bang could be required, it simply failed to grab hold of the recording and make it come

alive. Comparing the deck to a Project RPM4 highlighted the TT1 was in difficulties. At £350 complete with cartridge, the Czech made deck had stronger bass, and was much better balanced. It was not as smooth as the Audio Note combo or quite as detailed, but for half the price...

So, a mixed bag. Despite the fairly lacklustre finish and middling build quality (especially around the arm mounting) I do feel the deck may be worth auditioning. Yet competition from the likes of Rega, Project and more recently Michell is fierce. Its smooth, bright sound may suit some, but simply didn't suit me.

As supplied with the IQ III cartridge, the combined price of £725 is steep though. On its own with a more sensible cartridge in the sub £100 category, it would be well worth a listen.

The IQ III cartridge is system dependant and no bargain, but it is a worthy alternative to the dominant moving coils in the £300 class, with the bonus for valve amp enthusiasts of having reasonably high output. Detailed and engaging, it massively outclassed the TT1.

Audio Note AN-TT1 £425

Audio Note Arm-I £169

Audio Note IQ III £300

Audio Note

Tel: +44 (0) 01273 220511

THE EDITOR SAYS:

"So, Mr Bond, we meet again..." I thought I'd seen this deck before - it's a reheated Systemdeck IIX - and sounds like one, too! This was a fine machine in its day (ten years ago), but how times change... Vinyl replay has come on in leaps and bounds. It's smooth and sweet, but lacks the grip, punch and authority of the latest models. Still, the IQIII cartridge is a smasher and we'll be doing a full review soon.

World Verdict

Decent sound, but poor build and finish let the side down. Ultimately outclassed by more modern rivals, which offer better value.

ESPECIALLY FOR YOU?

Special Editions are often more about marketing than music reproduction, so buyers shouldn't believe the hype. So what of Mission's new 782SE loudspeaker – launched to celebrate the company's twenty fifth birthday – asks David Price?

It's an old trick, going back – methinks – to Rotel's BX versions of its mid-eighties amplifiers. You take a bog standard product from your range, give it fresh coat of paint, specify one 'audiophile' capacitor, gold plated connectors and a large shiny badge – and Bob's your funny uncle! Limited Edition, 'i', 'iSE', Special Edition, Original Special Edition, New Original Special Edition, the list goes on. To be frank, it's a cynical, lazy and rather sad marketing trick, but I can only assume it works because if it didn't then manufacturers wouldn't bother...?

So then, to what do we owe the honour of Mission's new 782SE? Well, it's the company's silver jubilee, so I suppose this is as good occasion as any to give the popular 782SE the full treatment. But is it the hi-fi equivalent of, say, a Ford Mondeo special edition – some jazzy seat covers, free furry dice and a different type of plastic wheel trim? Or have the Huntingdon boys gone to town and done something worthwhile? If so, it rather embarrassingly begs the question 'why didn't they do it before, to the standard loudspeaker'...?

Okay, I'll lay off. It is said to have been "extensively reworked", using a new treble unit and the "highest quality audiophile components" To wit, a selected version of Mission's unique microfibre treble unit is fitted to the front baffle and mechanically isolated from the cabinet by a foam damping suspension. Crossover components include audiophile grade polypropylene capacitors and high power Silicon Iron cored inductors,



hard wired on a new crossover board. Internal wiring is special Mission designed OFC (Oxygen Free Copper) twisted cores in Expanded polyethylene insulation, with specific strand construction chosen individually for each bass, midrange and treble frequency section. Finally, the cabinetry gets a new fine grain Alder real wood veneer.

The changes are more than skin deep then, so one assumes most or all of them will make it to the standard 782? Speaking of which, this loudspeaker – selected tweeters, shiny capacitors and better wire or not – is an extremely impressive performer in its own right. It costs £899, for which you get some very intelligent engineering and construction methods. Best of all, to this unreconstructed seventies-throwback, is its three-way design – because ultimately, three drivers pump air better than two. The 782 boasts the usual front baffle-mounted 25mm microfibre dome tweeter and 130mm Keraform midrange unit, plus a side firing 165mm Nomex woofer. These are mirror-imaged, meaning that in a small room where they're close to side walls, you can position the speakers' bass units to fire inward, while in large rooms they can fire out for optimum extension and scale. Crossover points are 195Hz and 2.5kHz.

And so to the cabinets, upon which much thought has been expended. They're very rigid and feel 'all-of-a-piece'. Contours machined into the inner sides of the box, clever use of foam damping and Mission's Damped Driver Isolation System are all featured. The midrange enclosure is asymmetrically inclined with a secondary baffle strengthening system, and even the port tube exit is flared and foam lined to reduce the effects of turbulence. Vital statistics are 795 x 165 x 295mm, 19 litres and 14kg. The real wood veneer finish is superb, admittedly not quite up to Castle standards, but not so far off. Multi-way, gold-plated, biwirable binding posts complete the picture around the back.

SOUND QUALITY

These are very bright sounding loudspeakers, ones which had I not 'persisted' with, I would not have

taken a shine to at all. They're hard work. Put it this way – if you want an inoffensive pair of boxes which make a nice noise whatever you play or use, then turn the page now. My reference system started with a Sony CDP-X77ES CD player (nice and warm) and Rose Scion integrated amplifier (nice and warm) and what I got was a headache. It wasn't until I'd rammed the 782SEs against a back wall, put the grilles on, toed them in and switched my turntable on that things got better. And then, when the Rose ran out of puff, I switched to an MF Audio passive pre/250W Pioneer SPEC2 power combination. At last I managed to get strong bass out of them, and smooth highs too, and suddenly the 782SEs got into the



groove. All well and good, but frankly I'm not sure if most buyers would have the resources to fettle them as extensively... 'plug and play' these are not.

Essentially, they're a razor-sharp loudspeaker. They have superb ability to capture leading edges of notes, and convey the entire envelope (detail, sustain, reverb) of the note. They have fine dynamic definition – they'll tell you when instruments and instrumentalists are at full tilt or just cruising. They are very tight and sinuous, making it easy to follow individual instruments in the mix right throughout the song. They also breathe well, meaning that – in true three-way style – no matter how

WHAT IS KERAFORM

The 782SE's midrange driver is a Keraform ceramic matrix. Unlike the so-called 'ceramic' hardening applied to aluminium cones, Keraform is a true ceramic material impregnated into a fibre matrix and then oven cured. Mission says it has a greater stiffness to mass ratio than any previous drive unit material.

hard the bass guitar pounds, the vocal floats above it all oblivious. Imaging is also superb, as the 782SEs can hang things in the mix in space with the best of them. It's all very clever stuff, yet so inaccessible.

I kicked off with 4hero's 'Escape That', where I heard tremendous speed and bite, the percussion track thumping away with joy as those sweet female vocals soared above.

Tonally, they're bright, as I've said. However, they're also clean, so are not painful to listen to. Female vocals are smooth, if brightly lit, with no glare or lumpiness as they crossover from mid to treble. The midband is generally very open, with fine projection and the ability to throw out very subtle elements in the mix with real eagerness – these 'speakers hide no light under bushels. Again, the side firing woofers allied to narrow cabs give an unusual but welcome effect – tight, vice-like imaging allied to a widescreen, large scale sound. Bass is light, yet commendably lacking in boom; certainly no showroom-friendly artificial bass peaks here.

Herbie Hancock's 'The Prisoner' showed the 782SE's real mettle. It's not warm, and it doesn't have oodles of tonal colour. No rich palette here... Still, it's not grey and monochrome either, it's just that this 'speaker chooses to play to its strengths, which are speed, grip and attack. To wit, the Missions gave a very fast, pacey, propulsive rendition of this piece of music, failing to give the pleasing 'atmosphere' that jazz of this type demands.

Classical music, in the shape of Beethoven's 5th (DG, Karajan), showed a more happy face. Most obvious was the superb soundstaging and fine depth perspective, along with a heady disregard for dynamic peaks, on which the 782SEs remained utterly unfazed and unflapped. They can really shift air and serve up sledgehammer bass when properly



AERO-CHARGED!

Mission has a history of using innovative cone materials, stretching right back to 1978's 770. This used large polypropylene mid/bass drivers – old hat now, but cutting edge back then! One of our favourite classic Missions is the late, great 752, however. A brilliant, Henry Azima-designed product sporting HDA (High Definition Aerogel) drivers, it combined a fast and expressive sound with beguiling tonal warmth – interesting, inasmuch as it didn't sound like any other HDA-coned loudspeakers that followed. Despite its middling metal dome tweeter, this 'speaker was a consummate smoothie, and thanks to its fine efficiency and benign load characteristics worked a treat with everything from punchy, hard transistor amps to low powered valves. The super-tight 782SE makes the 752 sound surprisingly slow and ponderous, but we can't help thinking this new design could use some of the 752's warm, forgiving character!

driven, but they're often reluctant so to do.

Overall, a very impressive loudspeaker – but only if you can be bothered to build your entire system around it. It is brighter than I remember the original 782, and a long way from my fave rave 752 from the mid-nineties which was positively warm and woolly. Mission has produced a no-nonsense audiophile product here capable of superb results, providing you like its emphasis on rhythms and dynamics

as opposed to tone and texturality. It's just that I fear most folk in the market for a £900 loudspeaker may not want such an uncompromising and focussed product. Oh, and by the way, happy birthday Mission!

Mission 782SE £899.00

Symphonix Ltd.
Tel: +44 (0) 01480 423700
www.mission.co.uk

MEASURED PERFORMANCE

It's clear with these 'speakers that Mission decided to make them a near-perfect load, in this case a 6ohm resistive load. This minimises reactive energy storage and any likely influence it may have upon amplifier feedback networks. It certainly gets the best from all amplifiers, including valve amps, lessening differences between them I find. The big difference between the 782SE and most others is the absence of 'twin bass peaks' (actually, cone resonance punctuated by port resonance) that characterise reflex working.

Transmission lines are Z-flat and they generally have smooth sounding bass. With its floor positioned, side-firing bass driver the 782SE reaches down to 40Hz, but it doesn't go lower. In fact, bass output rolls down slowly in what looks like an over-damped configuration, with no subsonic port output at all. This usually results in very dry, tight and light bass, usually counteracted by

near-wall placement. However, the bass unit works against the floor as a plane surface, effectively driving a room's vertical mode which, with an 8ft high room is 70Hz - nicely tuned to augment the 'speakers bass output. I suspect the 782SE's bass measured bass roll down is needed to compensate for this phenomenon. In all, I would expect the 782SE to have clean, well-defined bass, minus subsonics.

Mission have otherwise given the 782SE a reasonably smooth, flat frequency response, albeit with some treble lift from an audibly bright tweeter. Sensitivity was unfortunately low at just 81dB from one nominal watt, worse than most loudspeakers currently available – unusual for Mission. The 782SEs will need at least 60watts to go loud, with 100watts or more

preferable. It looks like the 782SE is meant to be super fast and tight. Technically this 'speaker is interesting but it may not be to everyone's taste. It needs a powerful, smooth amp like an Arcam. **NK**

Frequency response

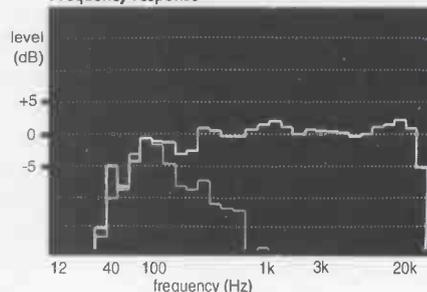

Impedance

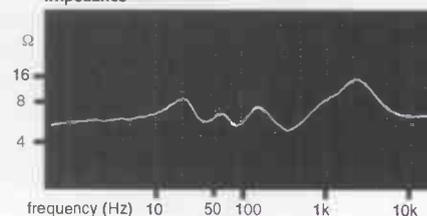

World Verdict

Superb, but too focussed for many systems or tastes. Smooth, sweet and powerful ancillaries are essential to balance their sound.

METAL MINI



It's small and stylish all right, but can Denon's new UD-M31 microsystem cut it in the sonic stakes? Haden Boardman investigates...

Denon has long since pioneered the compact audio system, kicking off the sector back in 1990 with the D90. The D-M3 of a few years back marked a move from mini to micro and recently the D-M30 became the one to have at the price. The new D-M31 here seeks to repeat the trick in an increasingly competitive environment.

Build is superb at the price - the "chameleon titanium" metal fascias look great, with buttons neatly arranged, albeit a tad fiddly. Only the most major controls have direct access on the fascia, with some sub-functions such as bass and treble being accessed via a small function button. Main functions are easy, but something like setting the radio stations was not as simple as one may have thought. Oh, and the instructions are horrid - a straight translation from Japanese to English, difficult to read with tiny print and in seven languages.

Setting up was quite straightforward - the back of the main system featuring two line in and line outputs (Denon can also supply a matching cassette recorder, the DRR-M31), pair of speaker spring clip terminals, optical digital output, system connector control, switched mains output, subwoofer port and

antenna points. The matching MiniDisc recorder came complete with all cables, including an optical connection. Set up was easy, and it boasts useful facilities like MDLP to allow four full albums to squish on to one single little MiniDisc. The little Mission-designed speakers are quite sweet, and the whole thing aesthetically gels very nicely, and takes up very little space.

Popping in the CD tray, a Smoker Delight compilation "Car Boot Soul" (which is a fairly laid back dance orientated disc), was quite a surprise. This CD features some quite heavy bass lines, and I simply was not expecting the Denon to even attempt to play them, but play them it did. Even the usual Jimmy Smith torture tracks were played with reasonable aplomb. I was quite happy listening to all kinds of stuff on this little system. Detail was reasonable for the price, and the little thing had plenty of "boogie factor". As a bedroom system it played more than loud enough. Rated at 22W (at 1kHz) maximum output power, it is no terrifying power house, but given its diminutive size it was more than adequate, and capable of filling quite a decent sized room.

The biggest surprise for me, was the radio quality, it was simply excellent. No sibilance worth talking about, crystal clear, even off the supplied wire FM antenna! I was a little surprised, as I have heard tuners costing more than this entire set up which were not actually as nice! The

tuner had a nice open sound and it was more than possible to fully appreciate a live Radio 3 live broadcast with this set. Amazing for the money!

MiniDisc has never really been my thing, but I was keen to see just how good or bad this was. Recording from the CD player was straightforward enough, but the MDLP (Long Play) mode did exactly what I was expecting, pushing the barriers of sound lower than I was prepared to tolerate. On simple acoustics such as the Water Lily's 'A Meeting by the River', it made a mess of a very fine recording. In standard mode, it was much better, but I remain to be convinced of MD's merits.

This small Denon CD receiver is a worthy competitor to any entry level budget amp and CD and the fact that a superb tuner comes for free is just a bonus. The UD-M31 and SCMS1 are fine value for money, but the MD is too expensive and makes the overall price of the system high at £550. For £300 I can find little to rival it, but I would personally be tempted to upgrade the 'speakers - the little SCM-51s are quite excellent, but the system can offer quite a lot more.

Denon D-M31 CD Receiver £250
Denon SCM-51 Loudspeakers £70
Denon DMD-M31 MD Recorder £250

Denon
Tel: +44 (0)1234 741200
www.denon.co.uk

World Verdict 
Excellent package with surprising sonics and a brilliant tuner as a bonus. MD only mediocre, and compromises its value.

PASSIVE POWER!



Music First Audio's Passive Magnetic Preamplifier is an impressive box of tricks, says David Price.

A new passive preamplifier – have the eighties come back to haunt us? Okay, I'm being facetious, but you've got to admit that they were flavour of the month towards the end of that decade, when every manufacturer seemed to be releasing one. Along with this, countless DIY audiophiles started making their own, by putting ALPS volume pots in little metal boxes. And then...nothing. The whole genre suddenly seemed to die a death and it was back to active for one and all. Funny that!

It's true that passive preamps do have something going for them – the short signal paths and lack of circuit complexity make for a clean, detailed sound. However, they're not a miracle cure for the problem

controlling your source. Traditionally, they have relied on resistive networks selected with a switch or rotary variable resistors, which can cause substantial impedance mismatches at either the source or the load end, making for a perceived loss of dynamics.

So what can the silver box before you bring to the party? Well, MF Audio's Passive Magnetic Preamplifier overcomes these problems by using a custom made transformer, claimed to feature the largest commercially available 80% nickel Permalloy core, making it passive with gain. So if you have a low gain power amplifier, you can flick the switch around the back to get an additional 6dB of grunt, thus driving it to its maximum efficiency. This is achieved by the use of a volume control featuring two

attenuating transformers and ELMA switches, point-to-point hand-wired into a custom case.

Indeed, for a so-called 'passive preamp', it has a lot of features. There's a choice of balanced or unbalanced inputs and outputs, and all internal connections use 0.6mm silver coated, solid core copper wire with PTFE insulation. Top quality Neutrik and Deltron connectors, and Swiss made ELMA silver contact rotary switches are used. A three way grounding switch allows any grounding issues to be addressed easily, and the transformer isolates components, breaking ground loop problems and reducing noise. The Mumetal shielding can give protection from external magnetic fields. The three-way rear mounted grounding switch offers a choice between a floating output ground, or



the RCA phono or XLRs connecting to the internal ground reference (and to input ground).

Construction quality is good, although not in the sumptuous mould of Japanese high-end, for example. Six inputs (four unbalanced, two balanced) are provided, numbered and selected from the corresponding front panel knob. The twenty-position volume and six-position source switches move reasonably cleanly (although the review sample had a little noise when clicking between inputs), and the rear mounted connectors are good stuff. Before listening in earnest, I burned the MF Audio preamp in for the recommended one hundred hour period, with a CD player on repeat, my Pioneer SPEC2 power amp off and the MF volume control set to maximum. Preamp references included Pioneer's matching SPEC1 discrete transistor design and a World Audio KLPP1 valve preamplifier.

SOUND QUALITY

I have to say that this device impressed me in a way that few passive preamplifiers have. It has an extremely self-effacing nature that means that, when you switch to it

from your traditional active solid-state or valve preamp, it throws your previous machine's character into sharp relief. In my system, after using Pioneer's ultra-high end SPEC1 for several weeks, I found the MF Audio quite dull through Perigee's superb FK-1L loudspeakers. However, careful listening revealed that it was more of a case of losing the Pioneer's chrome-plated edge, which I had rather got used to.

Via vinyl, using Trichord's latest Delphini phonostage (watch this space!) to drive one of the MF's unbalanced inputs, itself fed from my Michell Orbe/Origin Live Illustrious/Dynavector DV20X-H, the true character of the cartridge shone through in a way the Pioneer pre had not permitted. This high-output MC is very warm and rich – rather akin to a 1970s Supex SD900 – and this preamp underlined the fact. Via the Pioneer, it had seemed bright and breezy, somewhat akin to an Audio Technica! Admittedly, the extra zest the SPEC1 imparted made for a lively and enjoyable listen, but it wasn't an accurate one.

The MF did the same with CD, too. It isn't dull sounding so much as very 'neutral', resolutely refusing to add anything in the way of zing

(which you get from solid-state) or bloom (courtesy of valves). The result can initially feel a tad characterless, but it does allow you to settle in and hear through to your source, rather than have it all dictated by your preamplifier. Nick Drake's Pink Moon via Meridian MCD Pro made for

a very smooth and silky listen, mainly thanks to the choice of CD spinner. So I moved to Sony's CDP-X77ES and suddenly things got altogether tighter and more incisive – almost excessively so – showing just how transparent this thing can be.

De la Soul's A Roller-skating Jam Named Saturdays, via vinyl, proved this machine's mettle. The lack of grain and edge meant I could crank up the volume very high and give the Perigees a real workout. This 45rpm twelve incher has some serious bass notes and firecracker dynamics, which shone through with the MF. One recurring sample, of Frankie Valley's Grease, sounded shrill and digital, but then the lead female vocal kicked in, sounding exquisitely smooth, rich and fulsome. This demonstrated that this pre is transparency personified, and when coupled to like-minded ancillaries can muster a tremendously varied tonal palette. Factor in brilliantly tight and punchy breakbeats and silky percussion sounds, and it was a damn fine listen.

Ultimately, Music First Audio's Passive Magnetic Preamplifier sounds neither as dull as other passive preamps I've heard, nor as tonally constrained. You may miss the lack of transistor fizz or tube colouration that you're used to living with, but then again you're bound to enjoy the superb transparency. Warm brass instruments sound warm, hard and wiry strings sound hard and wiry. Voices are deliciously clean and unsullied, and percussion fast and tight but with no artificial added edge.

Another great strength is its soundstaging. You get a wide and capacious recorded acoustic that falls back behind the speakers surprisingly far. Within this, instruments are located precisely and accurately in space. This product is about transparency, neutrality and – if the truth be told – just the very smallest amount of euphonic silkiness. With its tremendously open yet finessed sound, it's a veritable high-end audiophile bargain.

MF Audio Passive Magnetic Preamplifier £1,499

MF Audio
Tel: +44 (0)1825 890970
www.mfaudio.co.uk

World Verdict £

Extremely open and sophisticated musical performer that betters a number of even more expensive designs. Pricey, but fine value nonetheless.



PLUS C'EST LA CHANGE...



Some things never change! Quad's 909 two channel power amplifier is the latest in the line of the company's famous current dumping designs. Haden Boardman finds it continues the Quad tradition with style.

There are but a handful of quality audio separates that can trace their roots back through nearly three decades, and still offer the kind of measured performance that is up there with the current state of the art. The original Quad 405 power amplifier was an amazing piece of kit, technically a tour de force. Through 405/II and 606, from which the 909 is directly developed, there is a clear and strong family heritage. So is the 909 little more than nineteen seventies amplifier in swish new millennium clothes?

From the outset, the 909 looks to be good value, being priced under a grand and offering oodles of effortless power, claimed to be 140W RMS per channel, this figure virtually doubling in to four ohm 'speakers. Like the 405, the 909 is a compact beast, measuring 321mm wide, 140mm high deep and 240mm deep - and of course featuring bomb proof construction techniques. Input

connections to the rear are either via two phono sockets, or a dedicated Quad link for the 99 pre-amplifier (sadly not compatible with the older 77 range). Output terminals are standard 5-way posts which take 4mm plugs, a detachable IEC mains lead provides power, and the amplifier sports a safety cut-out button, in case of severe overheating or overload.

SOUND QUALITY

My Marantz CD12 and Pioneer DVD 656 (SACD & DVD-A only!), passive preamp and both Dynaudio Contour 1.8s and my own high efficiency loudspeakers were pressed into service, all using Russ Andrews standard power cables and a Purifier. Arguments have raged about the effect of the current dumper in the real world, but one thing is for sure - lots of warm up time is needed. I can see why the power switch is on the back, because you can never turn the thing off! From cold, it was frankly a bit off the pace. After six hours

however, the amp settled down to making some very nice noises indeed.

If you're looking for a big, beefy, 'kick-ass' sound then this is not your amplifier. Rather, it lies on the smooth and restrained side - but some will think too much so. Mid-band is open and articulate, bass smooth and treble tidy enough, but it fails to give that feisty, gutsy sound that many crave from solid-state. Rather it falls between two stalls. In my high efficiency system, the current dumpers would not have a lot to do (93dB/watt speakers do not need much more than 6 watts!) and to be honest it showed. I was expecting the low power Class A amp to have more of an effect, but it still sounded Class B. Sonics were compressed and veiled - everything was there but somehow pushed back into the 'speakers. Still, 'In My Secret Life' from Leonard Cohen's Ten New Songs the 909 gave a very well presented soundstage, with openness and finesse. Some of my usual

torture tracks (Jimmy Smith!) proved the 909 to be sounded tonally smooth yet a tad restrained. Bass was perhaps a bit too light, which underlined its over-polite nature.

Switching loudspeakers to the more demanding Dynaudios gave the amplifier something more to get its teeth into, and it duly rose to the occasion. Here, the Quad seemed to have more get up and go, showing real authority with Pink Floyd's 'Dark Side Of The Moon' when the loud pedal was pushed. This amp has impressive dynamic capabilities, keeping firm control of the difficult Dynaudios. At higher levels, bass and dynamic balance became far more alive – the amplifier loves to flex its muscles! Although it works better at high volumes into more demanding loads, the tonality is such that it suits smooth jazz more than big beats. Playing Charlie Haden's 'Nocturne' (which is a competent, but unchallenging recording), the 909 shone. Smooth, effortless and easy, through out it gave good levels of detail with decent clarity.

The key to Quad's 909 is solid, fuss-free performance – and 'twas ever thus the way. In some respects it left me wanting more, though - it delivered a thoroughly solid performance, but there was a degree of 'English reserve' that lost a little of the music's emotion. Perhaps this is to miss the point, however. In truth, the 909 embodies the traditional Quad virtues of rock-solid dependability and safe, smooth sound. It will clearly go on to give many years of service. A worthy successor to the 405 and 606, the 909 is represents

fine value, especially as part of a QUAD system.

Quad 909 £899.99

Quad Electroacoustics Ltd
Tel: +44 (0) 845 458 0011
www.quad-hifi.co.uk

QUAD 405 - THE GENUINE ARTICLE

The first award winning current dumping amplifier was the 405, introduced over a quarter of a century ago. The last ones rolled off the production line around twelve years ago (it was still listed along side the 606 for a while, and interestingly, was actually around 10% more expensive!) and have found homes not just in our front rooms, but in recording studios and night clubs. For many, it was the reference amplifier, boasting technical perfection in a small neat enclosure.

The earliest models featured a 4 pin DIN input socket, spring clip speaker terminals and an IEC mains socket, but most owners seem to have taken a drill to the back and fitted phono sockets! The final versions featured decent phono sockets and good quality banana speaker terminals. The amplifier did become the Quad 405/II but, interestingly, not a lot seems to have been done! Rumour has it that the operation points of the current dumping circuit were changed, the Mk I delivering full power into eight ohms, and half of that in to four. With modern loudspeakers drawing more current the 405 was at a disadvantage so the Mk II delivered more power in to four ohm loads.

Comparing the 405 to the 909 is surprising, inasmuch as just how similar these two amplifiers sound! The 405 has nowhere near the grunt and authority of the 909, but the midband and treble is close. If anything, it's a touch more open than the 909 and more involving - although this could be more down to twenty years of running in! The 405 sounds like a small 909; not bad for a twenty five year old amplifier...

WHAT IS CURRENT DUMPING?

This has always been controversial in audio circles. In very simple terms, the output section has two halves, one is a small Class A power amplifier of exceptional quality, but only around 6 watts output, and a more powerful Class B amplifier of good, but not outstanding quality. The input of this is wired up from the output of the smaller Class A amplifier. Through the use of a bridge circuit, incorporating both negative and positive feedback, the smaller amp has the dominant effect on sound quality. It controls the larger Class B amplifier so it literally 'dumps' current on top of its own output when the extra grunt is required. The feedback circuits make sure the whole thing is tied together in a seamless (i.e. distortion-free) fashion. As a bonus, the amplifier will not be affected by more difficult loads, in theory the current dumpers will just adjust accordingly.

Quad claims its current dumpers are virtually perfect, the signal presented to the input terminals will be exactly the same as the one on the output terminals, but amplified. As a circuit goes, it has a hell of a lot going for it, it even won a Queen's award for technical innovation, and of course this beast is totally stable in to any of the Quad electrostatic loudspeakers.

THE EDITOR SAYS

To coin that well worn phrase, this amplifier is all about 'traditional values in a modern setting'. It doesn't set the world alight with its sublime emotional fluency, or amaze with its entrancing musicality. Rather, it provides oodles of clean, fuss-free power that's tonally smooth and sweet. It images decently, goes loud when called upon so to do, and isn't afraid of any loudspeaker you present it with. This is precisely why people have always bought Quad power amplifiers. If these admirable characteristics – plus the company's peerless customer service and product support – appeal, then you'll love it. If not, look elsewhere.

MEASURED PERFORMANCE

The compact 909 stereo power amplifier produces a healthy 120watts into 8ohms and 200watts into 4ohms, plenty enough for high volume levels through all loudspeakers. Only in the largest rooms would power like this be insufficient.

Frequency response extended from 7Hz up to 33kHz (-1dB), wide enough for 24/96 stereo if need be, although more extension is needed for 24/192. A roll off at this low-ish frequency usually helps toward a

sound free from obvious brightness. Also contributory to a smooth sound are low distortion figures and an even-order spectrum at all power levels, like the one shown here. The 909 produced mainly second harmonic, plus a little fourth harmonic. **NK**

| | |
|--------------------|-----------|
| Power | 120watts |
| CD/tuner/aux. | |
| Frequency response | 7Hz-33kHz |
| Separation | 77dB |
| Noise | -109dB |

| | |
|-------------|-----------|
| Distortion | 0.01% |
| Sensitivity | 700mV |
| dc offset | 0.1/0.1mV |

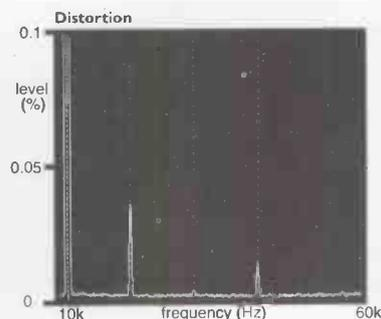

World Verdict £

Clean, open and powerful but not the most incisive or engaging at the price. Nonetheless, Quad owners will find it is an ideal upgrade for their ageing 405s.



**DEMONSTRATION ROOM AT 12A SPRING GARDENS, NEWPORT PAGNELL, MILTON KEYNES,
BUCKS MK16 0EE BY APPOINTMENT ONLY - CALL FOR DETAILS ON 01908 218836**

KECL82 VALVE AMPLIFIER KIT

The Kecl82 is our latest introduction for the true beginner and designed by Andy Grove. A simple and elegant design based on the classic ECL82 valve, a triode and power pentode sharing the same glass envelope. The amplifier consists of two ECL82s per channel, the triode sections work as the input/phase splitter and the pentode sections work in push-pull for the output stage. The amplifier offers 8 watts into an 8 ohm load, the hum level is extremely low, comparison to solid state standards. The chassis is constructed of 1.6mm mild steel with a black powder coat finish. There is only one signal input pair controlled at the front by a volume control for that simple touch. The speaker connects as the standard 4mm banana type, positioned at the rear, as are the mains input which is received through an IEC lead, mains switch and earth post. We have made the construction as simple as is humanly possible with comprehensive instructions. The circuitry is based on a single printed circuit board. Ultimately this kit is for the guy who has always fancied a go at building a kit, but never dared. Simon Pope says, "It's a great introduction to the valve sound. For its humble price it delivers a full and rich sound with great detail and good depth." Kecl82 weighs 9kg. External dimensions are 30cm(w)x23.5cm(d)x11cm(h)

NEW KIT

£195



KIT6550 VALVE INTEGRATED AMPLIFIER KIT & KAT6550 VALVE POWER AMPLIFIER KIT

£615



**KIT6550
upgrade kit now
available £130**

£580



**KaT6550
upgrade kit now
available £120**

These are our new 6550 series amplifiers. A pure class A design providing 40 watts into a 8 ohm load. (available in a 4 ohm version if required) A truly high end design by Andy Grove, using Svetlana 6550Cs in push-pull (any 6550 or KT88 tube can be used with this amp). It features valve rectification (5U4) a choke pi filter power supply and is hard wired. Weighs 19kg with dimensions 390mm(w) x

330mm(d) x 190mm(h) with valves or 220mm(h) with cage. Simon Pope says - "If you favour attack and rhythmic grip, together with a smoothness of sound that's incredibly easy to live with, the KIT6550 could well be the kit amp for you. The 6550 is one for those who like a valve sound married to the attack and clout of a good quality solid state design".

Kel84 VALVE INTEGRATED AMPLIFIER KIT

The Kel84 features a pair of EL84 valves per channel in push-pull configuration. They give 15 watts into an 8 ohm load. The output transformers are Ultra Linear. Up front the ECF80 input/phase splitter valve has an extremely smooth sound. The Kel84 has very low hum, for simplicity the kit is built on a printed circuit board. A strong steel chassis is fronted by a 3mm anodised front panel and attractive chromed custom made knobs. There are five line level inputs, plus one monitor input, with a tape output included, all controlled from the front panel. At the rear is a mains switch/IEC power input, earth post, phonos, and 4mm banana sockets. Simon Pope says, "The quality that can be gleaned from this amp is a fine introduction to the joys of the valve sound. The Kel84 will highlight all the intricacies and depth of detail in your favourite recordings whilst retaining a warmth and fullness that is almost exclusive to pure valve amps and is rare at this price point." Kel84 weighs 10kg. External dimensions with valves are 300mm(w) x 270mm(d) x 150mm(h).

£298



2A3 PSE INTEGRATED AMPLIFIER KIT

The 2A3 PSE integrated amplifier offers a seriously hi-end sound, but without the cost usually associated with single-ended amplifiers. The stereo chassis houses, on the output, 2 x 2A3 in parallel single ended configuration and a single 6SN7 as the driver tube per channel. The valve rectified power supply consists of a 5U4 and a 10h choke. This feedbackless design provides 8.5watts into an 8 ohm load, so a good sensitivity speaker is required above 90dB. It can accept 6 line-level inputs fully controllable from the front panel. We provide the excellent Alps Blue potentiometer as standard. The amplifier is hard wired so plenty of scope for tweaking in the future. Simon Pope says, "The 2A3 PSE is extremely impressive piece of kit, good imaging, wide sound stage, nicely extended on the high frequency and tremendous bass thump. Weight - 20kg, external dimensions with valves fitted - 390mm(w) x 360mm(d) x 220mm(h)

£570



ALL NEW SERIES II MODULAR PRE-AMP KIT

The PRE-II is a valve pre-amplifier with six inputs, tape monitor and two sets of output sockets. It utilises a high quality line driver transformer and x5 gain. The PHONO-II is a dedicated valve phono stage that incorporates a step-up transformer for MC users. Finally, PSU-II is a power supply unit that feeds both the PRE-II and PHONO-II.

| | |
|---------------------------------|---------|
| Power Supply Unit (PSU-II) | £205.00 |
| Pre-amplifier (PRE-II) | £215.00 |
| Phono Stage (PHONO-II) | £110.00 |
| Moving coil step-up transformer | £77.00 |
| Passive pre-amplifier (PAS-II) | £235.00 |



KAT34 VALVE POWER AMPLIFIER KIT & KIT34 VALVE INTEGRATED AMPLIFIER KIT

£480



KaT34
upgrade kit now
available £120

£515



KiT34
upgrade kit now
available £130

KiT34 is a 32 watt stereo valve integrated amplifier, featuring a pair of EL34s, in push-pull mode, per channel, plus an ECF80 pentode/triode as input/phase splitter. The power supply is valve rectified (2 x 5U4), using a heavy duty choke to achieve exceptional smoothing. The output transformers are 14% Ultra Linear tapped to keep distortion down to its lowest level and the kit is totally hard wired utilising three tag boards. It has five line level inputs, plus a tape-in and tape out, all

controllable from the front. Simon Pope says, "This integrated brings together the best sonic virtues of our KiT88, Kel34 and top of the range 300B PSE in an affordable package. The highlights of the sound are a deep and taut bass response, together with an open and highly detailed mid and high frequency response that only the best valve designs can achieve... a true valve classic." Weight 22kg, External dimensions with valves fitted - 390mm(w) x 360mm(d) x 210mm(h)

300B PSE MONOBLOC KIT

£895
A pair

Our Parallel Single Ended amplifiers offer ultimate sound quality. Each monobloc has two of the beautifully linear 300B directly heated triode in its output stage, producing 20 watts into an 8 ohm load. At the front we have a 6AU6 pentode and an ECC82 as the driver valve. This design utilises a 5U4 rectifier valve in the power supply, in combination with a 10H choke, giving an extremely quiet supply. Both mains and output transformers use E/I pattern.

For purists, feedback is switchable and the kit is totally hard-wired. For those that require valves we provide the superb Tesla 300Bs, Russian 5U4s and European 6AU6s & ECC82. Simon Pope says, "Not to put too fine a point on it, the sound these monoblocs create is among the finest that can be encountered in hi-fi." Our 300B PSE kit bears an affordable price of £895.00 (UK price) excluding valves. Each monobloc weighs 23kgs, external dimensions with valves: 25cm(w) x 38cm(d) x 22cm(h) per monobloc.



300B PP MONOBLOC KIT NEW

£895
A pair

The 300B PP monobloc shares the same look and chassis as the 300B PSE monobloc. The 300B PP kit has been created for those who

prefer a bit more dynamics and drive to their valve sound. With a pair of 300Bs in push-pull configuration providing 26 watts output, these beauties will drive most modern loudspeakers to perfection. Andy Grove's design is totally feedbackless, using a 6AU6 pentode as the input valve and a 5687 as the phase splitter, the power supply uses a Russian 5U4 for rectification. The kit is constructed by point to point wiring so some experience is required. 300B PSE owners do have the option to buy the

conversion kit for £250.00 to turn their monoblocs to push-pull status. Each monobloc weighs 23kg.

HD83 VALVE HEADPHONE AMPLIFIER KIT

The HD83 headphone amplifier is a beautifully simple design using Mullard ECL83 valves, a triode and power pentode housed in the same envelope. It works directly from any source, be it CD, tape, tuner etc., or from an amplifier's tape out or pre-amp out sockets. The circuit uses high specification E/I output transformers that will drive any headphone load from 16 ohms to over 300 ohms depending on how the secondaries are wired up. The HD83 is a single-ended design with the power pentode wired up in triode configuration for added sonic purity, and it is as quiet as a mouse. For sound quality Jon Marks says, "The bass is punchy and controlled without becoming artificial, while treble has the crispness of the best solid-state, with the tonal purity, delicacy and speed associated with valves." External dimensions 18cm(w) x 30cm(l) x 8cm (h) weight 4kg.

£195



NEW DEMONSTRATION ROOM NOW OPEN AT 12A SPRING GARDENS, NEWPORT PAGNELL,
MILTON KEYNES, BUCKS MK16 0EE - CALL FOR DETAILS ON 01908 218836

Kel84 Upgrade kit
1 x 100K Alps blue Potentiometer
2 x 1000uF, 16V Black Gate
4 x 100uF, 50V Black Gate
4 x 0.22uF, 630V Jensen paper
in oil **£100**

Ki76550 Upgrade kit
1 x 100K Alps blue Potentiometer
2 x 2200uF, 16V Black Gate
4 x 100uF, 100V Black Gate
4 x 0.22uF, 630V Jensen paper
in oil **£130**

KaT6550 Upgrade kit
2 x 2200uF, 16V Black Gate
4 x 100uF, 100V Black Gate
4 x 0.22uF, 630V Jensen paper
in oil **£120**

Ki734 Upgrade kit
1 x 100K Alps blue Potentiometer
2 x 1000uF, 16V Black Gate
4 x 100uF, 50V Black Gate
4 x 0.22uF, 630V Jensen paper
in oil **£130**

KaT34 Upgrade kit
2 x 1000uF, 16V Black Gate
4 x 100uF, 50V Black Gate
4 x 0.22uF, 630V Jensen paper
in oil **£120**

300B PSE Upgrade kit
2 x 470uF, 16V Black Gate
4 x 100uF, 100V Black Gate
2 x 0.22uF, 630V Jensen paper in oil
2 x 0.47uF, 630V Jensen paper in oil
4 x 35A Bridge Rectifier KBPC3502
4 x 4700uF, 16V **£150**



"Kit34 Upgrade Kit"

BARGAIN BASEMENT

2A3 PSE chassis and base plate (without face plate), slight flaw on paint work, can hold 1 x 120 lam, 2 x 78 lam E/I transformer, 3 x octals and 4 x UX4s, hardwired. **Price - £50.00**

Kel84 chassis and base plate (Without face plate), slight flaw on paint work, can hold 1 x 78 lam, 2 x 29 lam E/I transformers and 6 x B9A. **Price - £40.00**

Audax drive unit, HMI 30Z0, aerogel, 5 inch mid/base unit
UK price £35.00 each

5687 valves, double triode
UK price £7.00 each

Kit34 chassis - **UK price £50.00 each**

Pls fax/tel
00 44 (0) 1908 218836
to order

Mains transformers & Chokes

KIT6550/KAT6550 mains transformers
2 inch stack, 130mm(h)x120mm(w)x135mm(d) drop through fitting with zinc cap. Secondaries: 0V-240V 300mA, 0V-5V, 6A, 3.15V-0V-3.15V, 9A. Suitable for 120V & 240Vac operation

KEL84 mains transformer
1.5 inch stack, 90mm(h)x 80mm(w)x 95mm(d) drop through fitting with zinc cap. Secondaries: 0V-240V 300mA, 3.15V-0V-3.15V, 5.5A, suitable for 120/240V operation

KIT88/KAT88 mains toroidal transformer
120mm dia. x 60mm(h). Secondaries: 195V-0V-95V, 450mA/0V-27V, 100mA/3.15V-0V-3.15V, 9A, suitable for 120/240V operation

KIT34/KAT34/KIT6550/KAT6550 choke
1.25 inch stack, 65mm(h)x105mm(w) with fitting holes x 60mm(d), clamp fitting, 2.5 H, 350mA

300B PSE mains E/I transformer
130mm(h) x 95mm(w) x 115mm(d). drop through fitting with zinc cap. Secondaries: 380V-0V-380V, 180mA/150-0V-150V, 25mA/0V-5V, 1.2A/0V-5V, 1.2A/0V-5V, 3A/3.15V-0V-3.15V, 0.4A suitable for 120/240V operation

KEL80 mains toroidal transformer (encapsulated)
130mm dia. x 65mm(h). Secondaries: 195V-0V, 195V, 390mA/0V-27V, 100mA/3.15V-0V-3.15V, 7.5A, suitable for 120/240V operation

HD83 mains toroidal transformer
80mm dia. x 35mm(h). Secondaries: 0V-165V, 75mA/3.15V-0V-3.15V, 1A, suitable for 120/240V operation

PSU-II mains toroidal transformer
80mm dia. x 35mm(h). Secondaries: 0V-270V, 60mA/0V-10V, 2A, suitable for 120/240V operation

TRANSI mains toroidal transformer
95mm dia. x 50mm(h). Secondaries: 0V-370V, 150mA/0V-6.3V, 3.5A 300B E/I choke 65mm(h) x 70mm(d) x 80mm(w) open frame fitting, 10H, 180mA.

KEL84 E/I choke
0.5 inch stack, 40mm(h)x 35mm(d)x 70mm(w) clamp fitting, 1H, 250mA

PSU-I E/I
40mm(h)x 35mm(d) x 70mm (w) clamp fitting, 15H, 20mA

KIT34/KAT34 mains transformer
2.5 inch stack, 120mm(h)x115mm(w)x95mm(d), drop through fitting with zinc cap. Secondaries 365V - 0V - 365V, 300mA/0V - 5V, 6A/3.15V - 0V - 3.15V, 7.5A. Suitable for 120/240V operation.

Output transformers

KIT6550/KAT6550 E/I 16% TAPPED UL push-pull output transformer
2 inch stack, 80mm(w) x 95mm(l) x 100mm(h), drop through fitting with zinc cap. Primary-secondary 4.5K, 16% UL tapped. Secondary 4 Oh - 8 ohm, pls specify on order. max output 45 watts, max current 180mA, valves, KT88, 6550 etc

KEL84 E/I Ultra Linear push-pull output transformer
1.25 inch stack, 76mm(h)x 65mm(w)x 76mm(d) Primary - secondary, 8K with 12.5% UL tap - 8ohms, max o/p-15watts, max current 150mA valves EL84 etc

KIT88/KAT88 E/I push-pull output transformer
80mm(w)x95mm(l)x100mm(h). Primary-secondary 10K - 8ohms, max o/p-40watts, max current-160mA valves-KT88, 6550, EL34

KIT34/KAT34 E/I 14% tapped Ultra Linear push-pull output transformer
2 inch stack, 80mm(w)x95mm(l)x100mm(h), drop through fitting with zinc cap. Primary-secondary 6.4K, 14% UL taps, Secondary 8ohm, max output 34watts, max current 150mA, valves EL34, 6L6, 6CA7

HD83 E/I single ended output transformer
40mm(w)x30mm(l) x 55mm(h). Primary-secondary 4K - 4 x 64ohms windings, max o/p-1watts, max current-25mA valves-ECL83 etc

Pre-II E/I driver transformer
80mm(w)x60mm(l) x 65mm(h). 6:1 step down transformer, max current-10mA valves-6922 etc pre-amp stage

300B PSE E/I parallel single ended output transformer
130mm(h) x 95mm(w) x 115mm(d). drop through fitting with zinc cap. Primary 1K5 Secondary 8R, output .

Printed circuit boards

- Kel84 Printed Circuit Board 280mm(w) x 135mm(l) x 1.6mm(d).
- KIT88/KaT88 Printed Circuit Board 140mm(w) x 310mm(l) x 2.4mm(d)
- Kel34 Printed Circuit Board 140mm(w) x 310mm(l) x 2.4mm(d).
- Kel80 Printed Circuit Board (a pair) 120mm(w) x 215mm(l) x 2.4mm(d)
- HD83 Printed Circuit Board 140mm(w) x 160mm(l) x 1.6mm(d).
- PSU-II Printed Circuit Board 105mm(w) x 130mm(l) x 1.6mm(d)
- PRE-II Printed Circuit Board 105mm(w) x 130mm(l) x 1.6mm(d).
- PHONO-II Printed Circuit Board 105mm(w) x 130mm(l) x 1.6mm(d)



Hi-Fi World in Malaysia at Millennium Hi-Fi & Av. Kuala Lumpur, Malaysia

Hi-Fi World is now distributed through good bookshops and newstands in Malaysia. For back issues, general enquiries and advertising, contact Simon Chang at Millennium Hi-Fi & Av.

Also available are products by World Audio Design, Michell, Trichord, Lowther and ReThm loudspeakers.

Millennium Hi-Fi & Av
500-1-3 First Floor, Wisma Indah (Shen Court),
Jalan Tun Razak 50400 K.L.

tel: 603 9283 8171 fax: 603 9281 3762

137 Jalan Pendekar 2, Taman Skudai Baru, 81300 Skudai, Johor DT
tel: 607 554 5171 fax: 607 554 7645

e-mail: info@millennium-audio.com



WE HAVE OVER 30 TITLES ON OFFER!!!

AUDIO ELECTRONIC THEORY BOOKS

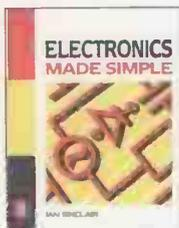

Electronics made Simple
by Ian Sinclair
This book covers the basic theory and principles of electronics. A good read for the beginner.
Code No 1420
£12.99 + £2.50 P&P (UK)



Build your own High-End Audio Equipment
by Elektor
Build your own High-End Audio equipment contains construction projects for solid state preamplifiers and power amplifiers, active cross-over filters, an active subwoofer, a mono/stereo compressor and a headphone amplifier.
Code No. 1390
£14.95 + £2.50 P&P (UK)



Audio/Radio Handbook
By National Semiconductor
National Semiconductor's manual is an essential aid to engineers and experienced hobbyists in the application of National's line of consumer audio and radio ICs. Not only does it hold comprehensive data of their ICs but discusses theory aspects of amplifiers and pre-amps and covers electronic principals.
paperback 200pp, Code No. 1810
£13.95 + £2.00 P&P (UK)



Build your own Electronic Test Instruments
by Elektor
This book contains designs for 17 measuring instruments, seven generators and analysers, ten miscellaneous instruments and a number of test ancillaries and auxiliaries. The designs range from a simple multicore cable designs contain a special printed circuit, drawing of which are given in an appendix.
Code No. 1400
£15.95 + £3.25 P&P (UK)

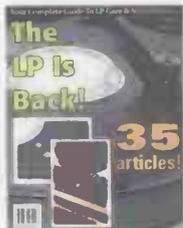

The LP is back
by Audio Amateurs
Your complete guide to LP care and maintenance designed to offer you everything useful for those who love and enjoy this older music medium. This covers the theory and care of LPs and the electronics and mechanics of its players.
154pp Paperback, Code No.1620
£8.00 + £2.00 P&P (UK)



The Joy of Audio Electronics
by Charles Hansen
This is a fail-safe guide to the pleasures of hands-on electronic construction. This book covers test and measurement projects, how to build simple kits, safety issues, the workplace, theory and resources. A must for the beginner who plans to build more advanced electronic projects in the future.
124pp Paperback, Code No.1650
£10.50 + £2.50 P&P (UK)

VALVE BOOKS



Audio Measurements
by Norman Crowhurst
Famous compendium of measurement and test techniques for audio reproduction equipment of the tube era includes discussion of all instruments needed. Covers amps, transformers, preamps, turntables, changers, tonearms, cartridges, tape recorders.
Code No. 1830
£13.95 + £2.00 P&P (UK)

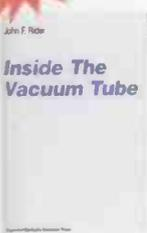

Inside the Vacuum Tube
by John F. Rider
One of the most thorough (and funny) books ever written on the way vacuum tubes function. Rider's mastery of analogies common to most of us makes the book especially useful to those who want to learn about vacuum tubes.
Code No. 1840
£24.00 + £2.50 P&P (UK)



GEC Audio Tube Data
Full of data and circuits concerning the three most well known MO Valve power tetrodes, the KT66, KT77 and KT88. (the KT77 was GEC's answer to Mullard's EL34) and some data on the PX4 and PX25 triodes. The first section concerns preamplifiers of various types, with information regarding equalisation, tone controls, filters and suchlike. An excellent book for all valve heads.
Paperback Code No. 1780
£14.95 + £2.00 (UK)



Understanding Hi-Fi Circuits
by N.H. Crowhurst
Originally published in 1957. Discusses all aspects of amplifiers, pre-amplifiers and equalisation circuitry, well written, easy to understand. The author does concentrate on valve circuits, so no transistors here.
Paperback, 224pp Code No. 1820
Price £13.95 + £2.00 UK p&p



Glass Audio Projects - 17 Vacuum Tube Designs
This book features 17 valve project, designed, tried and tested by some of the best authors state side. Designs such as a 300B push-pull amp, a 33 power amp a 652B single ended, a 300B parallel single-ended amp, a 6C33C-B single ended amp, a 70V KT88 push-pull amp, a 2A3 single ended amp to name a few. All information is provided so most projects can be built from scratch.
Paperback 73pp, Code 1790,
£8.00 + £1.50 P&P (UK)



An Approach to Audio Electronic Valves in Audio Frequency Amplifiers
by E. Rodenhuis
Discussing the use of valve data, the function of different amplifier stages and includes detailed descriptions of eight designs. A wealth of practical data, measurements and interesting features will be found. A very good read.
Paperback 147pp, Code No. 1520
Price £12.95 + £2.00 P&P (UK)



The Best of Audion editorial projects
by Luciano Marci
This book contains six excellent audio projects - a high sensitivity speaker, a superb tube pre-amp, a 2A3 amplifier design, a project using the Russian 6C33CB and two projects using 300Bs as output valves. Overall the book is a fabulous read.
62pp, paperback book code 1750
£12.00 + £2.00 UK p+p

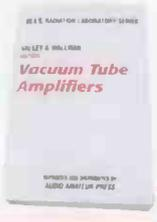

Vacuum Tube Amplifiers
by Valley & Wallman
This book is a well known reference valve text book and is assembled from pieces by ten knowledgeable authors. An absolute bible when it comes to valve electronics.
734pp, Paperback, Code 1770
£29.95 + £ 4.30 P&P (UK)

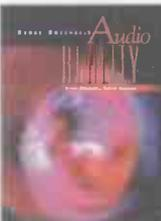

Audio Reality
by Bruce Rozenblitz
Investigates conductors, skin effect, impedance, interconnects, speaker cables, balanced lines, transmission lines, isolation transformers, tubes, acoustics and much more. Also, includes 6 excellent detailed valve design projects, 80watt OTL, 25watt OTL, grounded grid pre-amp, 150watt amp, 6550 SE amp, and a grounded grid cascode phono preamp.
Paperback 128pp, Code No. 1640
Price 21.50 + 2.50 P&P (UK)

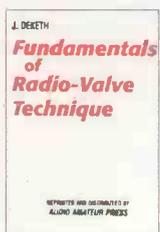

Fundamentals of Radio-Valve Technique
J. Deketh
This is part of the Philips technical series written in 1947. It was one of the most authoritative and comprehensive treatments of the nature and function of the vacuum tube.
534pp, Paper back
Code No. 1630
£21.50 + £2.50 P&P (UK)



Build your own Audio Valve Amplifiers
by Rainer Zur Linde
This book covers construction projects for preamplifiers, power amplifiers and two amplifiers for musical instruments aimed at the practical audio/hifi enthusiasts. It offers much information on the operation of electron tubes, while the first chapter gives a short history of the thermionic valve.
paperback, 251pp, Code No. 1320
£14.95 + 2.50 P&P (UK)

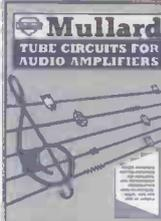

Mullard Tube Circuits for Audio Amplifiers
Includes full designs for eleven power and control amps, including 5-20, using valves. Begins with a four chapter tutorial on getting the best sound from valve amplifiers.
142pp 8" x 10" Paperback Code 1030
£13.95 + £2.00 P&P (UK)



The Williamson Amplifier
by D.T.N. Williamson.
Offers practical advice on how to build and set up the amplifier for best results.
40pp Paper back
Code No. 1040
£9.95 + £1.50 P&P (UK)



RCA Receiving Tube Manual
Technical Series RC-14
This book presents RCA's commercial valve line-up as it was in 1940. The manual covers valve terminology, Technology and application, valve testing and then a larger section giving some of our best ideas and plenty of data on numerous valves e.g. 6L6, 6N7, 6SN7.
255pp, Paperback, Code No. 1800
£13.95 + £2.00 p&p (UK)



The Beginner's Guide to Tube Design
by Bruce Rozenblitz
This book takes a comprehensive look at tube audio design. It explains how vacuum tubes work and how to design with them. Rozenblitz covers stabilisation and testing, a description of 13 famous and classic amps and preamps and how to work effectively as a designer. A hands-on guide to construction techniques, tools and choosing components and tubes is provided. 1997,
132pp Paper back Code No. 1340
£15.50 + £2.50 P&P (UK)

UK SUBSCRIPTION £27

VISIT OUR WEBSITE: www.hi-fiworld.co.uk



YES! I want to subscribe to Hi-Fi World for:-

£27.00 for 12 months

Your Details

Title _____ Initial _____ Surname _____

Address _____

Post Code _____

Daytime Tel: _____

Start Issue _____

Delivery Address (if different)

I would like to pay by cheque made payable to Audio Publishing Ltd.

Please debit my VISA MASTER SWITCH AMEX

Security No: (last three digits printed on the signature strip)

Switch card issue No: Expiry Date: ____/____/____

Cardholder Signature: _____



Please choose service:-

Airmail Middle East & South-East Asia £60

Airmail Europe £50

Airmail USA, Canada, Australia, Japan, Korea & China £70

Surface Mail £40

Send this form to:

Hi-Fi World, Freepost LON3478,
London, NW6 6YR



Get your issue of hi-fi world straight to your door!

Get to our amazing classified ads first and grab a bargain!!

- *Run by dedicated hi-fi engineers and enthusiasts.*
- *Hi-Fi World has become famous for its informative reviews and radical kit designs.*

Credit Card Hotline
+44 01923 270 833
Monday - Friday 9.30am - 12.00 noon: Fax +44 01923 260 588

MISSED AN ISSUE?

Back issues also available at a cost of £3.50 only (includes P&P), payment by cheque only -

overseas please contact subscriptions department for details.

Send cheque to: Hi-Fi World, Freepost LON3478,
London, NW6 6YR.

computer audio world

advertising@computeraudio.co.uk
editorial@computeraudio.co.uk
news@computeraudio.co.uk www.computeraudio.co.uk

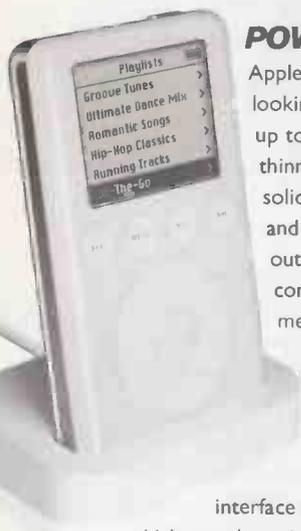

POWER PODS

Apple's new third generation iPod is a stunning looking hard disk-based music portable that holds up to 7,500 songs in a case that's lighter and thinner than two CDs. It boasts a completely solid-state, "no moving parts" navigation wheel and buttons, plus an elegant new dock with audio out for fast and easy connection to your computer or stereo. The customisable main menu lets users promote the features they

access most often to their top level menu, while Apple's Auto-Sync feature automatically synchronises the host computer's music library with the iPod. The new iPod plays AAC files, and uses a FireWire interface for Mac connection, but will also support high-speed syncing via USB 2.0 with Windows PCs starting in June via a free software download. A CD containing iTunes for Mac OS X and MusicMatch Jukebox Plus 7.5 software is included. Prices are £249 for the 10GB model, £299 for 15GB and £399 for 30GB, available from the Apple Store (www.apple.com/ukstore) or by calling 0800 039 1010.

TOWER OF POWER

Here's something for those seeking to build the ultimate audio computer. Aopen's A600A Super Tower is hewn from aluminium for durability and drop-dead-gorgeous looks. An ATX/microATX/Full AT super tower, it features an ample supply of drive bays; excellent ventilation and the option of an additional fan, screwless functions for optical, FDD and HDD drives and a powerful 350W ultra low noise switching power supply. There's front access for 2x USB 2.0, audio and 6-pin firewire (IEEE-1394) connections, plus the latest Intel-defined air guide for a 38-degrees system, so users need not worry about the system overheating, nor Aopen's silent power supply. Its 'mirror coated' chassis gives a piano black gloss akin to high-end hi-fi! Dimensions are 491x200x450mm.

The company also has a new CD burner, complete with black faceplate, to match. The CRW5224 Chameleon contains two front bezels in addition to the traditional PC beige, in silver and black, with an easy swapping mechanism to make face changes easy. Another great feature for audio computer fans is its new generation AOpen Silent Optical drive mechanism, which is claimed to be the quietest around. Just Link buffer underrun protection, plus 52x CD-R writing and 26x rewriting complete an impressive package. For more info, check out www.aopen.nl.



SOUNDBLASTER GOES PORTABLE

From the makers of the original SoundBlaster soundcard comes the first portable incarnation, the SoundBlaster MP3+. Said to be an ideal upgrade for PC and notebook users who want to upgrade their bundled audio, it costs £39.99. Smaller than a typical PDA, it comes with quality digital and analogue inputs and outputs, including a microphone input and headphone jack with volume control, plus a USB lead for connection to PCs. A removable clip enables the Sound Blaster MP3+ to be mounted on the back of a notebook display. Point your browser at www.europe.creative.com for more information.

WAY DOWN!

TerraTec Electronic has announced a range of price cuts to its popular soundcards and audio products. The Aureon 5.1 Sky 24/96 soundcard is now £79.99 from £99.99, the Aureon 7.1 Space 24/96 soundcard is £89.99 from £129.99 and the CAR4000 40GB hard disk hi-fi recorder is £599.99 from £799.99. See www.terratec.com for details.

AMBIENT MUSIC

US loudspeaker manufacturer Ambiance Acoustics has made the move into computer audio with its new Multimedia Control Center. A high-end PC that tightly integrates with a hi-fi system, it includes the ability to play and record both CDs and DVDs and rip, burn and play MP3s. Company president Robert Salvi says, "a major problem facing most OEM PC builders today is one of software/hardware compatibilities. In that vein, we've decided to design and manufacture a competing product that addresses those challenges". Prices start at US \$2,399. Click on www.ambianceacoustics.com for details.



SHERIFF AND

After years of floundering and prevarication, the music business is finally beginning to grapple with the knotty issue of online music. On one hand, pay-per-download sites are launching successfully, and on the other, industry lawyers are actively closing down illicit file swapping sites. David Price takes up to the story, and speaks to Websheriff's John Giacobbi.

Most people have grown up in a world where they heard their favourite songs on the radio, and then went to their local record or CD shop to buy them. Now though, this is rapidly becoming a thing of the past. Computer audio is beginning to seriously impact upon the nation's music consumption habits, and this is beginning to reflect in both sales figures and the music industry's bottom line.

According to the British Phonographic Institute, album shipments to music shops are down 5% by volume and 9% by value compared to this time last year – meaning people are buying fewer discs and paying even less for those that they do. Singles are doing worse still, with a fall of 13% in value for the first 3 months of 2003, compared to the same time last year. Annual figures for the 12 months ending March fell by 19% in units and value, continuing the consistent decline since mid 1998 – which was when Napster originally came to people's attention.

However, the demand for recorded music is higher than ever, according to Peter Jamieson, the BPI's Executive Director. He cites the launch of new online services as evidence of "the industry's willingness to offer the music consumer new alternatives alongside the established

CD format". Apple's new iTunes online music store famously reported over two million downloads in its first sixteen days of trading, last month. "Response to the iTunes Music Store has been phenomenal - we've clearly hit a chord with users," said Steve Jobs, Apple's CEO. Featuring over 200,000 songs from major music companies including BMG, EMI, Sony Music Entertainment, Universal and Warner, it's proof that it is the convenience that people like about online music downloads, and not just the fact that it has traditionally been free.

Historically, the music industry's legal response to online music distribution has been a troubled one. It failed to prevent the manufacture of MP3 portables, in the RIAA's 1999 case against Diamond Multimedia, makers of the original Rio, arguing unsuccessfully that it was a 'recording device'. Next, it turned on the source of its woes – Napster. Shaun

” Even though what the pirates were doing was totally illegal, who could blame consumers for using them when there was no legal alternative?

Fanning's mould-breaking site was eventually closed, but a wave of new file-swapping sites which didn't contain a central music library, appeared. These 'peer to peer' (P2P) sites simply put music fans in touch with one another using clever software. Those wanting a download

of, say, a classic Nirvana tune would be given a list of people who had it on their computer, online and ready for download. This made it very difficult for lawyers used to suing large companies to act.

Now though, a more sophisticated approach is being used by companies such as Websheriff. Just as P2P sites can search the net to find individual users offering music for free download, so lawyers can use intelligent software to search the net looking for them. Duly located, legal action can be started against the Internet Service Providers (ISPs) for those offering the illicit downloads. It's a long and tortuous process, but seems to be proving effective. I spoke to John Giacobbi of Websheriff, which specialises in precisely this kind of 'rights enforcement' action.

DP: WHAT IS WEBSHERIFF, AND WHAT DOES IT DO?

JG: *A rights protection agency, that protects against on-line piracy of copyrights and trademarks and on-line libels.*

WHO ARE YOUR CLIENTS, AND WHY DO THEY NEED YOU?

Showbiz and sports personalities, such as pop-stars, film actors and footballers. All of these people have rights that are infringed (legal speak for 'ripped-off') on the internet and need protecting.

HOW DOES IT WORK?

Basically, we monitor the internet 24 hours a day for infringements of our clients' rights and then implement counter-measures to take-down offending web-sites and/or have individual IPs unplugged from their networks.

THE BANDITS

CAN ILLEGAL P2P SITES REALLY BE TRACED?

It's the actual IP addresses that are traced-back to their Internet Service Provider (ISP) using special programs not available to the public. The ISPs are then notified of the infringing activity and have the choice of either disconnecting their infringing user or getting sued - funnily enough, most of them go for the first option!

WHEN SITES ARE FOUND, HOW ARE THEY CLOSED?

Usually in much the same way as individual IPs, insofar as we trace their ISPs and then give them an ultimatum: for the cost of one year's hosting fees from the site concerned, it's just not worth their while taking-the-bullet! With sites, we also go after the actual site owners directly; in one instance telephoning a site owner at his flat in San Francisco and telling him that, if he didn't take down his pirate site, the next contact would be from the 'real' Sheriff knocking on his front door!

HOW DID THE MUSIC INDUSTRY REACT INITIALLY TO FILE DOWNLOADING?

Like a rabbit frozen in the headlights of new technology. There were conflicting views at the highest level as to whether to fight or harness this technology and, for too long, the 'Flat-Earthers' had the upper hand (due, no doubt, to the age of the top-brass at most of these corporations at the time)...

DO YOU THINK THE BIZ HAS BEEN REMISS IN ITS TREATMENT OF FILE DOWNLOADING, AND WHY?

It has been so slow to provide legal, user-friendly platforms that illegal web-sites and P2P communities have been able to flourish in the vacuum: even though what the pirates were doing was totally illegal, who could blame consumers for using them when there was no legal alternative?

HAVE YOU NOTICED A NEW

UNDERSTANDING, ON THE PART OF THE INDUSTRY?

Most definitely, the turning-point came when it started to hit their bottom-line-profits to such an extent that they could no longer simply wish the problem away - record companies and artists had to stand and fight. As an example, last year Universal were forced to bring forward the US release of Eminem's new album due to the fact that it was already Number One in the Digital Download Charts (before it was even released)! These charts are compiled by analysing samples of the millions of downloads that take place daily on the internet.

WHY DO YOU THINK APPLE'S I-TUNES HAS SUCCEEDED?

Because they have a good platform and formula: great content from all the 'majors' at a commercially realistic price. In order to be able to 'compete' with the likes of KaZaa, legal providers shall have to offer the magic combination of good repertoire, user-friendly technical operation and, importantly, a micro-transaction price that means that it's simply not worth the bother of trying to find the MP3 you're looking for on P2P.

DO ARTISTS STILL PREFER PHYSICAL FORMATS?

New artists definitely prefer on-line availability, as it gives them free exposure and means that they don't necessarily have to rely upon a record company to achieve a commercial release. Established artists have tended to prefer physical formats, because it ensured that they got paid, although the new internet landscape of legal platforms shall mean that on-line distribution will inevitably become the norm.

HOW CAN MUSIC FANS BE PERSUADED TO PAY FOR ONLINE MUSIC, WHEN IT'S FREE FROM P2P SITES...?

As with i-Tunes, the secret shall be in offering a better service at a price that puts convenience before cost. The music



industry in particular should definitely offer 'carrots' as well as sticks, such as an 'air-miles' type scheme that offers legal downloaders priority status for new release information and concert tickets, etc.

HOW DO YOU THINK THE FUTURE WILL LOOK?

In the future physical formats shall become more for the specialist/collector, much as with 12in vinyl now. MP3 (and its successors) shall predominate, with digital files simply being transferred from the net to portable walkman type players, to your home hi-fi unit, which will soon be an integral part of your combined home PC entertainment centre. This is when the internet will start to eclipse television as the primary form of home entertainment, I think.

HOW DO YOU LISTEN TO MUSIC?

The internet naturally, with Real One, Windows Media Player and Creative Play Centre. We listen to Capital Radio Live On-Line at the Web Sheriff office, whilst at home I have a collection of 1950s Blaupunkt radiograms - forget micro-technology, you still can't beat the combination of valve sound and a five foot, multi-speaker wooden case!

PRO PLUS

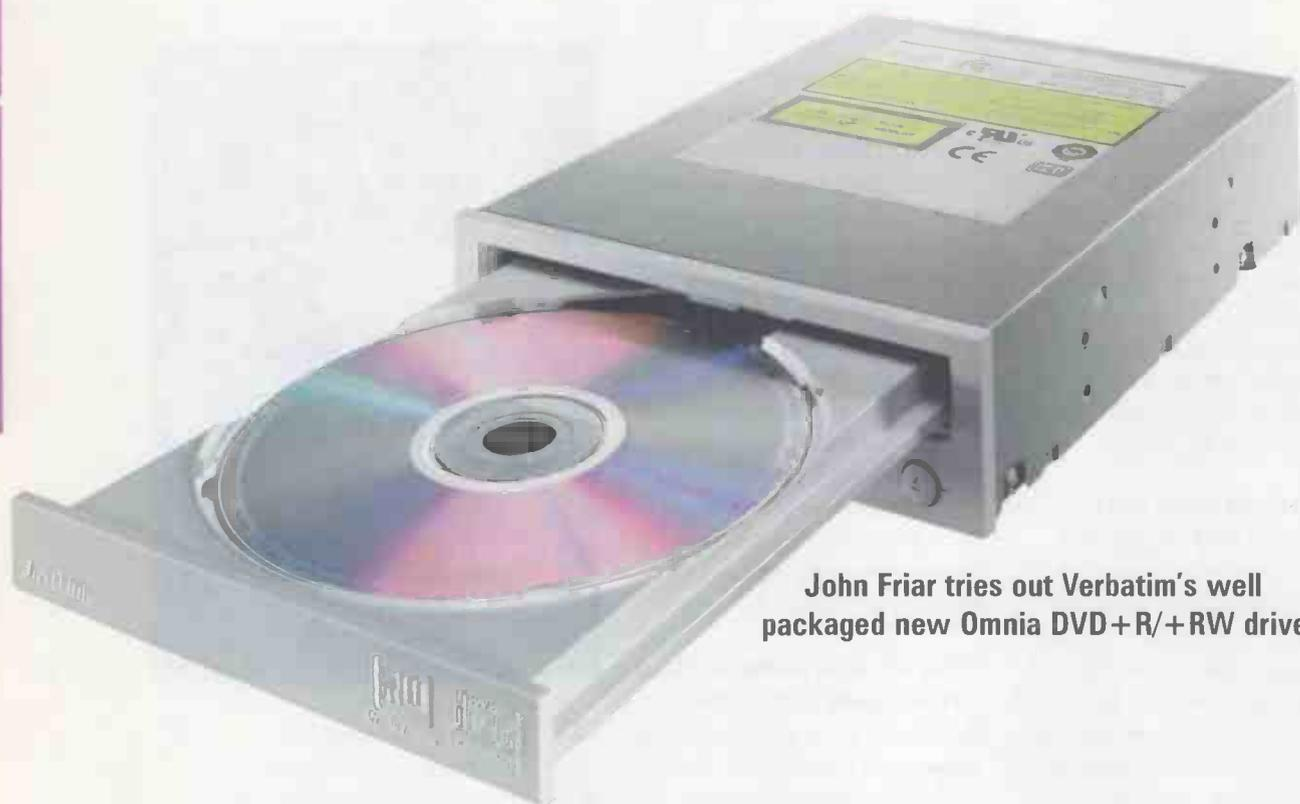

John Friar tries out Verbatim's well packaged new Omnia DVD+R/+RW drive.

SPECIFICATIONS:

WRITE SPEEDS

| | |
|--------|-----------------|
| DVD+RW | 2.4x |
| DVD+R | 2.4x |
| CD-R | 2x, 4x, 8x, 12x |
| CD-RW | 2x, 4x, 10x |

READ SPEED

40x max

RECORDING CAPACITY

| | |
|--------------|--------------|
| DVD+RW/DVD+R | 4.7GB |
| CD-R/CD-RW | 650MB, 700MB |

ACCESS TIMES

| | |
|-----|----------------|
| DVD | 140msec. (8x) |
| CD | 120msec. (32x) |

WRITE MODES

| | |
|------------------|---|
| DVD+RW | Random Access Write, |
| Sequential Write | |
| DVD+R | Sequential Write |
| CD-R/CD-RW | Disc At Once, Session At Once, Track At Once, Multi-Session, Packet Write |

WRITING FORMATS

DVD+RW/DVD+R, DVD-ROM,
DVD-Video, CD-R/CD-RW,
CD-DA, CD-ROM, CD-ROM,
XA, CD Extra, Mixed-ModeCD,
VideoCD, CD TEXT

INTERFACE

IDE/ATAPI

BUFFER SIZE

2MB with JustLink and JustSpeed

In the best traditions of hi-fi, we now have a format war brewing. Recordable DVD – being the world's new favourite optical disc storage media – is naturally the object of the scrap, and to wit there's a welter of competing versions – some of which are totally incompatible with one another!

In a nutshell, DVD+R/+RW, DVD-RAM and DVD-R/-RW are all facing off against one another, but only DVD+R/+RW has been designed from the start to be compatible with our existing DVD-ROM drives and DVD-Video players, both physically and logically. To wit, any DVD+R or DVD+RW disc recorded by any DVD+R/+RW burner or equivalent video recorder can be played in virtually any DVD-Video player or DVD-ROM drive. Moreover, any DVD+R or DVD+RW data disc should be readable by any DVD-ROM drive.

By contrast, DVD-R and DVD-

RW weren't initially designed as DVD-Video compatible recording systems, despite apparently using the same discs. As its DVD-Video compatibility was added later, it isn't as robust. DVD-R/-RW is also less suited to data applications, thanks to technical constraints. DVD-RAM's different physical recording method ensures total incompatibility with DVD, even if you pull it out of its cartridge! Various compatibility programs for DVD players to rectify this, such as DVD-Multi and VR, have appeared are still few and far between. Essentially, the message is – if it's overall compatibility with your existing DVD systems you want, DVD+RW is the one!

Verbatim puts it this way, "With the ability to read, play, and record and re-record digital video, the DVD+RW / +R drive may finally be the successor to everyday VCR". DVD recordable for the masses is the message, hence the 'universal' sounding appellation, "Omnia"! The

company says that DVD+RW or DVD+R discs recorded in this drive can be played back in almost all DVD players and DVD-ROM drives on the market today, "the drive simply fits into your PC and turns it into your very own multimedia machine". Of course, the drive also reads and writes Compact Disc.

The Omnia boasts a 2.4x write speed for DVD+R and DVD+RW (equivalent of 22x in terms of CD speeds), 8x read speed of DVD Video and DVD-ROM discs, 12x write speed for CD-R media, 8x write speed for CD-RW and 32x read speed for CD-R.

It's a comprehensive kit to bring PC users to the brave new world of recordable DVD. Verbatim's Omnia package comprises the drive itself, an IDE cable and analogue audio cable, installation manual and two software CDs containing Nero Burning ROM, DVD editing software and WinDVD



player. If this wasn't enough, then the company has thoughtfully bundled one each of its DVD+R, DVD+RW, CD-R and Hi-Speed CD-RW blank discs, so you shouldn't be stuck for things to experiment with!

The drive itself is based on the Ricoh 5125 DVD+R+RW burner and is quite plain in appearance, looking at first glance like any other internal IDE CD burner. It measures the standard 145.6x42x196.4mm and weighs 1.2kg. There is a single button to operate the eject mechanism, a headphone socket, a volume control and an LED that glows orange when reading from or writing to a disc.

Close inspection of the grey/beige front panel reveals four logos: 'JustLink', 'High Speed Compact Disc Re-Writable', 'RW' and below this the all-important 'DVD RE-Writable' label. While the latter are self explanatory, JustLink refers to one variant of buffer underrun protection, which works in conjunction with the Nero CD burning software to prevent the PC running out of data to write, and crashing as a consequence. These

WHAT IS DVD+RW?

Co-developed by Philips, Sony, Yamaha, Ricoh, Hewlett-Packard, Mitsubishi, Thomson and Dell, DVD+RW has the broadest support across the IT industry of all recordable DVD formats. Standard 12cm DVD+R and DVD+RW discs have 4.7GB capacity, designed to be compatible with existing DVD players. However, the format supports a smaller 8cm discs containing approximately 1GB of data, also fully compatible with conventional DVD players. It allows for double sided DVD+R/+RW discs, lifting the storage capacity per disc to 9 GB or up to 12 hours of video, but dual-layered discs won't appear. DVD+R/+RW PC drives and DVD+R/+RW video recorders are intended to be completely compatible with one another. However, it will be possible for manufacturers to create media optimised for video or data applications.

The format has been proven to have a re-recording capability of over 1,000 times, but in practice should be much higher. DVD+RW discs do not need to be finalised (unlike DVD-Rs) because every time they are ejected from either a DVD+R/+RW PC drive or video recorder, they are updated with information needed for the disc to be read in a DVD-Video player or DVD-ROM drive.

machines hang up readily enough anyway, so there's no need to give them another excuse!

Installation was quite straightforward, with the DVD burner set as master and the DVD/CD reader as slave on the secondary IDE interface. As Nero points out, this can cause problems when copying 'on-the-fly'. However, my setup, with two fast UDMA hard drives and only two IDE interfaces, left me with no real choice but to connect them as master and slave on the same interface. So far this has not led to any such problems, but an additional IDE interface could well be desirable in the future.

In action the drive responds to open/eject requests quickly and vigorously and gets up to speed smoothly and with very little delay – impressive stuff! In conjunction with Nero Burning ROM 5.5 (with the latest upgrade from the Ahead website) it performed all the usual functions of a CD burner perfectly with write speeds up to x12 for CD-R and x10 for CD-RW. The DVD functions were eventually equally successful. I managed to burn video clips to both DVD+R and DVD+RW discs, which were readable on the computer via WinDVD and my domestic Philips DVDR 880 recorder. It seems to be the case that the computer can read DVD+R/+RW discs produced on the domestic recorder and vice versa, but you cannot write on a disc that was initially formatted in the other type of machine. I tried writing a data DVD to DVD+RW and found that it completed a backup of 1300MB of

data in 7.5 minutes using the faithful Nero Burning ROM. Altogether a very useful piece of kit to have!

Nero has become the standard bundled software for burners and is very reliable; together with the 2MB buffer and 'JustLink' function it carried out all operations without buffer underruns or other stoppages that ruin the media in the drive. The Intervideo WINDVD software provides a useful viewer for home grown or commercial DVDs on the computer. Intervideo Winproducer 2 is an early version of an application for assembling personal video, digital images and audio to produce professional-quality (?) movies.

Depending on the available video capture card, it allows: capture and record; import of files of popular formats (MPEG 1, MPEG2, AVI, JPEG etc); application of special effects and output in various movie formats. MedioStream neoDVD Standard is a basic form of software that allows real-time capture, creation and archiving to HD of DVD-ready files. These are suitable for playing on most consumer domestic equipment. It can also apply automatic audio/video format conversion to DVD compliant formats. This looks quite useful, although an upgrade would be recommended for serious use - this version would not recognise my capture card! Overall though, a fine and well packaged machine with all you need for speedy DVD burning at a very keen price. Thoroughly recommended.

Verbatim Omnia £295
www.verbatim-europe.com



Golden Dragon



Elites



Svetlana

Tube Shop

.com

a lot easier!

'My tubes are impossible to get hold of'

Visit The Tube Shop

www.tube-shop.com



You can even telephone your order

0870 9220404

Why choose Tube-Shop.Com

- Over 2,500 different tube types in stock at all times
- We offer you the best prices around, Guaranteed
- UK's first fully online tube ordering system
- Expert matching service by PM Valve Labs
- We sell only the world's BEST brands
- Next day delivery (if ordered before 3pm)
- Free delivery (on all orders over £50)
- MONEY BACK GUARANTEE
- Trade enquires welcome



beyer dynamic



AURAL STIMULATION

Distributed by: Henley Designs
01235 511166 www.henleydesigns.co.uk
e-mail: info@henleydesigns.co.uk

MANTRA AUDIO

Specialist Suppliers of Audio Accessories
www.mantra-audio.co.uk

| CARTRIDGE SELECTION | | STYLUS | | REPLACEMENT STYLUS | |
|---|------|--------|----------|--|--------|
| Goldring | | | | Swiss Quality Diamond Styli | |
| 1006 | £76 | £62 | GEX £52 | ADC XLM Mk III | £16.00 |
| 1012 GX | £95 | £76 | GEX £67 | Akai AN 5, AN 60 | £12.00 |
| 1022 GX | £124 | £100 | GEX £86 | AN2, AN 70 | £14.00 |
| 1042 | £143 | £114 | GEX £100 | Dual DN 145 E, DN 165 E | £16.00 |
| Eroica LX/H | £133 | £109 | GEX | JVC G800 | £14.00 |
| Elite | £232 | £190 | GEX | DT 55, DT 60 | £12.00 |
| GEX - Exchange price for a Goldring Any make/model of cartridge accepted | | | | National EPS 24 CS, P 30 D, P 33 D | £12.00 |
| Audio Technica | | | | Ortofon FF 15 E II, VMS 20 E II, OM 20 | £16.00 |
| AT 95 E | £23 | | £15 | Pioneer PN 210, PN 220, PN 240 | £12.00 |
| AT 110 E | £28 | | £16 | Shure N 75 C, SC 35 C, | £12.00 |
| AT OC 9 ML | £330 | £280 | EX | N 75 ED T2, N 75 EJ T2 | £16.00 |
| Denon | | | | N 95 ED, N 95 EJ, N 75 3 (78) | £16.00 |
| DL 110 | £79 | | | VN 35 E | £18.00 |
| DL 160 | £95 | | | N 95 HE, N 97 HE, VN 35 HE | £25.00 |
| Grado | | | | Sony ND 142 G, ND 155 G, CN234 | £12.00 |
| Prestige Black | £40 | | £27 | ND 143 G, ND 150 G, ND 200 G | £14.00 |
| Prestige Gold | £110 | | £73 | *** Over 500 Styli Types Stocked *** | |
| Ortofon | | | | HEADPHONE SELECTION | |
| 510 Mk II | £34 | | £22 | GRADO | |
| MC 15 Super II | £130 | £110 | EX | Prestige Series | |
| MC 25 FL | £227 | £193 | EX | SR-60 | £85 |
| MC 10 Supreme | £304 | £258 | EX | SR-80 | £104 |
| MC 20 Supreme | £382 | £323 | EX | SR-125 | £152 |
| MC 30 Supreme | £452 | £365 | EX | SR-225 | £199 |
| Kontrapunkt B | £643 | £548 | EX | SR-325 | £294 |
| Rohmann | £837 | £742 | EX | Reference Series | |
| Shure | | | | RS-1 | £641 |
| M 97 XE | £98 | | £58 | RS-2 (new) | £495 |
| V 15 V XMR | £304 | | £204 | | |
| Sumiko | | | | | |
| Blue Point Special | £265 | £237 | EX | | |

EX - Exchange price for MC from above companies

All items guaranteed authentic new originals
see our website for full selection of accessories
order direct from our secure online catalogue

MAIL ORDER (1-10 DAYS) PRICES (INC P&P) + INSURANCE FOR UK DELIVERY - £5 FOR EUROPE DELIVERY & £12 FOR US/WORLDWIDE DELIVERY TO COVER INSURANCE ON ORDERS OVER £50 VALUE

Tel/Fax (01757) 288652 e-mail: enquiry@mantra-audio.co.uk
MANTRA AUDIO (HFW), 22 GARTH AVENUE, NORTH DUFFIELD, SELBY, NORTH YORKS YO8 5RP



Of all the subjects we deal with in hi-fi, I find Digital Audio Broadcasting one of the most disappointing. There is steady progress in high fidelity and a good appreciation by artists and producers of music that quality is an important issue. But this outlook, once pursued in radio, has evaporated with DAB. Radio nowadays is dominated by the exigencies of geographical coverage and audience figures. Quality has been pushed aside, and because DAB lacks any special strengths it can only be sold by association (i.e. 'digital' equals better).

DAB is new, digital, and doesn't suffer from hiss or interference. Delve into the technology and yes, it does look clever, but then all modulation schemes do. They are always incomprehensible to outsiders, and to make matters worse, carry their own, intimidating jargon set. But once you start to look a little more closely, such things as symbol bits apart, it isn't quite so smart.

Transmitting compressed audio at the lowest data rate possible is the first bad idea. The Musicam system that does this is based on MPEG compression, and broadcasters push it to the limit, getting data rate down to 96kbps or lower. Data reduction is a child of the early 1990s, when DAB was conceived. Like the flared jeans and moustaches you sometimes see in late night BBC Learning Zone programmes made back in the 1970s, it's looking horribly dated already. Transmitting audio on a serious national basis using an outdated and sonically crude music compression system like Musicam is now starting to look absurd.

A close relative of Musicam is

MP3, widely used for storing and transmitting music on the internet. It's very handy for audio portables, but certainly isn't a serious music transmission system. With ten years of music compression experience, we now know that all compression schemes will crack up if pushed too hard for too long. On a sustained orchestral crescendo, or with a rock

With ten years of music compression experience, we now know that all compression schemes will crack up if pushed too hard for too long.

band at full tilt, compression systems run out of bits to describe the music and start to limit. Multi-tone test signals show that even robust encoders like Sony's ATRAC, which uses a sensible 5:1 compression ratio (384kbps) perform abominably when pushed to their limit. This is a matter of observable fact, not conjecture. Such a severe shortcoming is hardly the sort of thing you would normally choose for a professional music transmission system and, not surprisingly, it is only DAB that uses such a system.

Another drawback of music compression is music compression! Putting music through two stages of compression can lead to variable results. If you record DAB onto MiniDisc you will in effect be compressing the music twice, first through the transmission medium and then in the storage medium. Compression systems shouldn't be stacked in this way, the only saving grace here likely being that the audio signal is so bereft of information after leaving the DAB

signal-chain re-compressing it with MiniDisc's ATRAC is unlikely to make things any worse! All the same, it isn't a good idea to use compression in a transmission medium if you can possibly avoid it and, quite frankly, I think it could have been avoided.

Quality sells - DVD video is the success story we are all aware of, and both DVD Audio and SACD are doing well. It's against this background, and the inevitable disappearance into history of old, low data technologies like the floppy disc and digital data compressors like Disc Doubler, that DAB looks so out of place. Whilst the world moves ahead to embrace higher quality and greater data density, broadcasters are happy, even delighted, to do just the opposite! They have somehow reached the conclusion that worse is better! Not only that, but a cranky old early 1990s compression system is somehow 'clever', and represents advanced technology!

This isn't a view shared by everyone; a BBC engineer friend of mine despairs about programme quality. The horrors of low data rate music compression are all too obvious to him, but it's too late as DAB is just about to 'take off', buoyed by the promise of improved quality from digital. This may be a justified claim with digital terrestrial TV, which gives a pin-sharp picture, but sadly isn't with DAB. All the same, the word in broadcasting nowadays is diversity, and despite DAB's questionable sonics, I have to say I do like its programming variety. Ultimately though, the crux of the matter is that sonic quality and programming variety should not be mutually exclusive - and the new DAB system has been structured in such a way that they are. The result is that Digital Radio will be nothing more than a modern day equivalent of Medium Wave. Is this progress? ●

classic cuts

Ralph Vaughan Williams, one of England's finest composers, is still not as well regarded for his symphonic output as he should be argues Andy Giles, offering the composer's Second Symphony, 'The London' as proof of his genius.

The son of a clergyman, Ralph Vaughan Williams was born of solid English middle-class stock in Down Ampney, deep in rural

Gloucestershire, on October 12th 1872. His intellectual and financial roots were sound enough, with lawyers on his father's side and Josiah Wedgwood and Charles Darwin, no less, on his mother's. Educated at Charterhouse school, then Trinity College, Cambridge, he was later a pupil of Stanford and Parry at the Royal College of Music and went on to study with Maurice Ravel in Paris, in order, as he put it, to acquire 'a little French polish'.

His career in composing was, it seems, a natural progression, commencing at Charterhouse when he was 15 and ranging across the next seventy years until he died in 1958, aged 85. Although he wrote nine symphonies – and not a duffer amongst them – he is probably best remembered for his choral and shorter orchestral works, notably the brilliantly engaging *Lark Ascending* which has become for him what the *Adagio for Strings* is for Samuel Barber.

Nothing wrong with that says I, but what of the symphonies? As I've hinted, they are all pretty damn good but the best for me is his second – the London.

As the 20th Century dawned, Vaughan Williams, who had hitherto only experimented with composition, started on the enormously ambitious *A Sea Symphony*, moving on to

compose his first purely orchestral symphony *A London Symphony* in 1913 at the initiation of the composer George Butterworth. He then spent about twenty years revising with it, publishing the final version in the mid-1930s.

The final account proved to be shorter (by about 20 minutes on record) to the original 1913 version, a stunning performance of which was released a couple of years ago on Chandos, conducted by Richard Hickox. I intend, however to bring to your attention the final revised and more familiar piece and have chosen the 1987 recording by Bernard Haitink with the London Philharmonic.

This superlative performance should convince anyone that *A London Symphony* is a masterpiece by any benchmark. Haitink, a native of Amsterdam, brings a deeply discerning approach to the music and demonstrates its stature amongst the great music of its time, alongside Mahler and Stravinsky – honestly!

The recording is quite excellent too; the EMI balance is wonderfully natural and one hears the entire orchestra playing, with solos in perspective, as they would be in a live performance.

The symphony itself is a marvellous portrayal of Edwardian London, painting pictures captured in time. The opening *Lento Allegro* depicts a city at the centre of the industrialised world awakening with chimes of bells over a misty, slumbering metropolitan landscape. The fuming first subject explodes out of the morning bells, a chromatic profusion of short motifs. The city then stirs itself for the day. In the second movement *Lento*, described by Vaughan Williams as a "Bloomsbury Square on a November afternoon" a simple and quite beautiful set of variations on three themes, is played on cor anglais,

characterised by tender strings under a mournful isolated horn call. Then, introduced by a solo viola, comes the "Lavender" tune, which is expansively and fervently elaborated, flowing into a magnificent coda nostalgically calling to mind each theme in turn.

More London scenes appear in the third movement *Scherzo - Nocturne: Allegro vivace*, with piano-accordion mimicry announcing a street party in the pending swirling gas-lit haze. This gives way to the final movement. The *Andante com moto - Maestoso alla marcia - Allegro - Lento - Epilogue*, which commences with a plaintive paean followed by a stately march striding sombrely to an imposing climax, from where it is succeeded by a rowdy second subject. The first subject's varied reprise closes a simple ternary form, but the movement is far from over: a vast, climax dissolves into the first movement's, setting us on that road back out of town as the three-quarter chimes, as London returns to sleep.

Haitink's is a physically powerful, wide ranging and, above all, heart-rending interpretation of *A London Symphony*. Throughout he finds immense rhyme in the breathtaking passages for strings and harps, pursued by suggestive wind solos, all magnificently played by the LPO.

But it is in the finale that Haitink brings home most vigorously the humanitarianism of the music, its tragic awareness of a world on the brink of devastation, a city on the path to decay and an Empire passing into history.

Vaughan Williams 'A London Symphony' - EMI CDC 749394 2, conductor Bernard Haitink.

The original 1913 version under Richard Hickox and The London Symphony Orchestra is on Chandos 9902



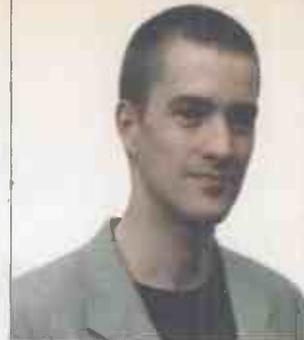

The inclusion of a Marantz SR6300 in these pages a couple of months ago may have raised a few eyebrows from hi-fi purists. We need only have gone back a year or two and the very thought of including such a product would have been seen as heresy. Yet, I feel we should be grateful and inclusive of the better A/V products, for two good reasons.

Firstly, although not on a par with stereo products at the same price, both AV amps and DVD players have improved immensely over the past couple of years in terms of their audio performance. This is due in no small part to DVD-A, which placates the audiophile with a sampling rate and frequency response designed to get the best yet from digital audio.

Yet praise must also be given to the DVD player manufacturers for upping the anti in terms of their 16-bit audio playback. Whilst it still isn't as good as a CD player of the same price, on a sound per pound basis, the stereo playback quality of DVD has come on greatly over the past couple of years. Just £120 will now get you a machine with a more than respectable Crystal DAC.

A/V amps haven't evolved quite as much as these players, in spite of the higher demands placed on them by broad frequency sources such as SACD and DVD-A. Manufacturers seem to be catering for those with no more than just a passing interest in audio. After all, as they slim down their two-channel ranges, the top boffins in the company are free to concentrate on tweaking the multi-channel A/V amps. It surely can't be long before Ken Ishiwata turns his hand to the likes of the SR6300 can it?

The second reason is rather less

obvious and down to aspiration. I was first aware of this in the 1980s with the arrival of CD. Anyone, even those with a complete lack of interest in audio had, by the end of the decade, heard of the format. It created something of a buzz and gave the hi-fi industry exactly the shot in the arm it needed. Purists may have scoffed at the time, but it

„ A new type of customer can be introduced to SACD, DAB and - just maybe - even the delights of a decent vinyl system.

can be agreed that CD brought people into hi-fi shops and, furthermore, brought them into hi-fi.

I'm sure I wasn't alone in starting off with a CD based system and then being introduced to the joys of vinyl by my local hi-fi emporium. It was also a decade that made real stars of a new breed of audio manufacturers that fed of this new enthusiasm. Mission, Linn and Nakamichi products all gained kudos during this decade, and rightly so, for they produced some inspiring products of both the analogue and digital variety. Attractive new technologies can really set the ball rolling, even exposing unrelated esoteric hi-fi components like the Linn LP12 (born long before the CD arrived) and Nakamichi Dragon cassette decks to a whole new audience, awoken by the arrival of CD.

The momentum generated by CD was dissipated by the early recession of the 1990s and the industry began to lose its way a little.

So where does this leave us today? Well, in the retail side of the

industry we've a lot to thank A/V for. It is bringing people back to the aspiration in hi-fi that is founded upon seriously desirable technology. The whirl of contrived lifestyle systems during the 1990s did nothing to help lift us out of recession, but A/V has started to take hold in a big way - not seen since CD.

I have to say that wonderful plasma screens have brought a new type of customer into the store. They would never have even considered buying a decent hi-fi system before - but can be persuaded now. A big picture needs a big sound to go with it, and all-in-one units just don't cut the mustard. The biggest winners appear to be the 'speaker manufacturers (again!), yet there are some pretty decent A/V amps and DVD players complementing many a plasma screen that we sell. They fit together well and roll out of the door as one.

Enlightened retailers also realise that once in the store, a new type of customer can also be introduced to SACD, DAB and - just maybe - even the delights of a decent vinyl system.

Then there are the cables. Even the most basic A/V system often requires a wiring loom that would shame a sophisticated stereo system, thereby introducing the customer to the benefits of system tweaking, often without them even being aware!

The up-shot is that the industry must accept A/V just as it accepted CD. Rather than scoff, we should encourage the development of the audio side of the A/V market and entice A/V customers about the glories of good sound, just as those stepping into their first hi-fi store in the 1980s were enthused by what they heard. The good news is that, despite fragile economic times, just such a buzz is out there on the high street today. Yes, the sun is shining! ●

JUST IN TIME

LJK Setright does justice to the Linn Kremlin tuner.

In a long life I have heard a lot of radios. Before the war there were what I cosily assumed to be the best around; after that war came the Beau-Decca and the baffleboard Murphy, and the antithetical one-valver that I built into a shoebox and secreted in the sixth-form library, with a single earphone on a wire that I hid in my sleeve. Much later I began to take a more real interest, when I bought Michael Creek's still-revered CAS 3040 tuner; later still I relied for a long time on Anthony Michaelson's Musical Fidelity 250 tuner. What I have not yet heard is my Linn Kremlin.

It was Murphy, with that famous baffle-board, whom I remember first challenging in their advertising the popular notion that a radio had to have 'good tone'. A radio, they assured us, should have no perceptible tone, but simply reproduce as flawlessly as possible what had been broadcast.

By the 1990s the Kremlin was doing just that. When Linn's Ivor Tiefenbrun had been asked which was better for listening to music, the new CD or the dear old LP, he had

retorted that best of all was to listen to a live broadcast on the radio. With the assistance of BBC Radio 3, his Kremlin proved him right.

It was born into the Linn line in 1991. After 3 years gestation and perhaps another 1 of painful labour, it was delivered by Linn engineers McErlean and Steel to complete the array that had begun with the Kairn, the quietest pre-amplifier yet, and the Karik CD machine, all three exploiting the same new technologies that Linn had been developing. They had identified the redoubtable Revox tuner as their benchmark, and privately Revox agreed that Linn had beaten it; but I remember thinking that the Kremlin, with its 80 presets, its exceptional sensitivity to faint stations, and its daunting price, was a remarkable example of overkill.

It took a long time to realise that I was wrong. It was so easy for me, living on a line-of-sight from Wrotham Hill transmitter, to suppose that any respectable music-lover should be content with Radio 3 and not go a-whoring after distant stations like some short-wave anorak browsing through random junk broadcasts. Only when I heard about

the people who did not live in such favoured areas, and who had to rely on the acute perception of the Kremlin if they were to listen well to good music, did it dawn upon me how important a faint signal might be.

We Setrights can recognise the undeniable, especially when it has been staring us in the face for a few years. We can also endorse the unimpeachable, regardless of contemporary opinion. At long blessed last I obtained a Kremlin and began to appreciate what flawless reception meant. I have never heard my Kremlin; I hear, and listen to, the music.

Admitting that my family gave me a good start, I owe much of my musical education to the BBC. I still rely on the radio to a greater extent than on my collection of recorded music, still find things to learn, still resort to things that I think I know, and still believe that it is better to listen to music than to listen to apparatus. The only difference now is that it is a rare LP (they were by no means all good, you know) that still challenges my Kremlin as the best means by which to do so. It is not pride that I feel in owning this remarkable tuner, so much as a sense of immense relief.

It was such a near thing, you see. Two or three years ago, Linn stopped making the Kremlin. It was costly to manufacture; I believe that there is only one man left who can align the chassis properly; the press was lackadaisical in reviewing it – so, whatever the chances of actually hearing it, not many people heard about it, and at that price even fewer actually bought it. Mine may well have been the last to leave the factory. I was just in time.

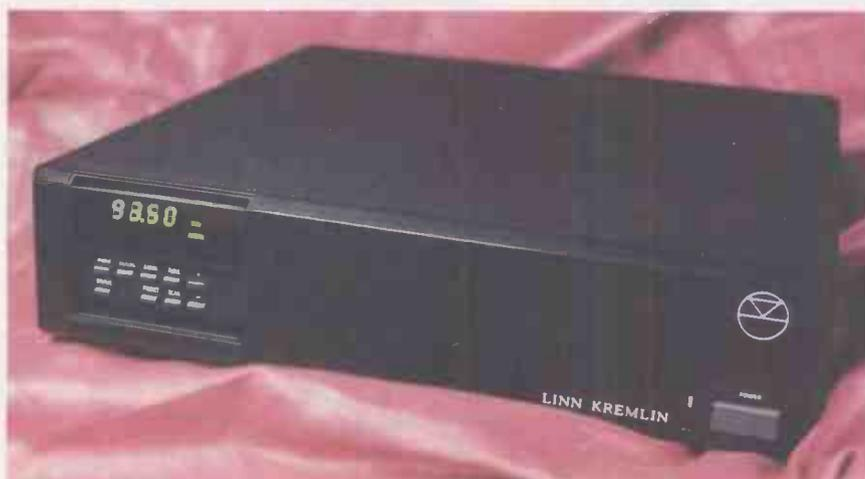



A funny thing happened when I started working for Hi-Fi World back in 1994. Overnight, large amounts of letters started pouring in to the office singing the praises of Trichord's Clock Two CD player modification. Having no experience of this particular mod or of Trichord Research, and a naturally suspicious nature, I began wondering if Trichord themselves weren't actually behind all this correspondence – after all, what better way to advertise a product than by (supposedly) 'word of mouth' means...?

Well, since then I've met Trichord's Graham Fowler and realised how unfounded my suspicions were – indeed, I'd say he'd be the last person to pull a trick like that. At the time however, the post bag was positively bulging with hearty recommendations, and I hadn't actually heard the Clock 2.

Could it really be as good as everyone was saying? The answer was a resounding 'yes' – as soon as I clapped ears upon what it did to my CD player, I was so surprised that I too wanted to write into Hi-Fi

World to rave about it. Fortunately, being on staff, I saved myself the price of a stamp!

Warp forward nine years and the Clock has now reached its fourth incarnation. Essentially a series of improvements to Clock 3, including far superior grounding and controlled waveform shaping of the output for minimum emc

” **Could it really be as good as everyone was saying?**

generation, its main claim to fame is the inclusion of Trichord's Never Connected Clock power supply, said to give the Clock board a really clean, low noise supply. Trichord duly fitted a Clock 4 to my beloved Sony CDP-X77ES, a £1200 player I've used solidly since 1989 and which has beaten a great many more expensive designs. Only recently have I found it lacking against high end CD spinners. One of Sony's first ever Bitstream machines, it was beginning to sound a tad vague and woolly to my ears.

When I first got it back from Graham, the machine sounded

absolutely appalling. A country mile away from its hitherto smooth and sweet nature, it was harsh, hard, spitty and forward. After three weeks of intense use however, with a whole week on repeat, the Sony is transformed. It has regained its smooth and enveloping tonality, but gained a massive amount of speed and clarity in the process.

Clock 4 brings an incredible focus to the music. It gives the machine immense speed and transient attack, rock solid left-to-right image location and truly three-dimensional depth perspective. Despite a slightly leaner tonality, the ever-so-slightly hard midband has disappeared and in its place is tremendous open, even sound with cut-glass transparency. Bass is altogether tighter and more tuneful, and dynamics – another obvious area where the CDP-X77ES was 'behind the times'. Treble is a tad leaner, but smoother, faster and more atmospheric.

Overall, it has taken many of the characteristics of the Sony that I'd ascribed to 'CD' and banished them. This classic player is no Meridian DVD-A beater, but now gives superb CD replay with incredible transparency. I suspect that the better your CD player ultimately is, the more it will respond to Clock 4 treatment, but even mid-price machines should benefit usefully.

What impresses me most about Trichord's Clock mods are that they don't invest machines with any particular character – rather, they bring whatever their nature is far closer to neutral. For example, the Clock 3 mod made my bright, fuzzy multibit Sony CDP-557ESD sound altogether smoother and more beguiling, whereas my woolly Bitstream Sony CDP-X77ES is tighter and cleaner. As such, it's great for any digital disc spinner – just give its Oscon capacitors a few weeks to run in! ●



dial a dealer

This is a comprehensive directory of Hi-Fi Dealers throughout the UK and Ireland.

BEDFORDSHIRE

RICHARD'S AUDIO VISUAL 4 Greyfriars Bedford. Tel: 01234 365165. Stockists of: Arcam, Audioquest, Beyer, B&W, Bose, Cable Talk, Cyrus Denon, Marantz, Mission, Moth, Ortofon, Pioneer, Pro-Ject, Quad, REL, Rotel, Ruark, Sennheiser, Sound Style, Stands Unique, Teac, van den Hul & more! Expert friendly service: Listening room. Pioneer Reference Point. Visa / Access.

BRISTOL & BATH

THE RIGHT NOTE Tel: (01225) 874728. Just think: most audiophiles listen for most of the time to systems that are 'not quite right'. Are you happy with yours? Forget the reviews and trying to put together a system like a patchwork quilt with the 'best' bits around. It's our job to do the assessing, you judge our results. We'll help you to plan a system for the future, even if you spread the purchases. Leave the 'up-grade-itis' behind, save money and enjoy music all the time. Just listen, and you'll know. CD: Acuras, Audio Synthesis, Classe, DCS, Enlightened Audio Design, Meracus, Orelle, Vadia, XTC. Vinyl: Basis, Crown, Jewel, Graham, Michell, Sumiko, Transfiguration. Amps: Acuras, Audio Sculpture & more. Speakers: Audio Artistry, Audio Physics & more. Tuners: Fanfare, Magnum Dynalab & many more. Cables: Chord, DNM, Silver Sounds & more. (Credit Cards Accepted).

V/AUDIO Hi-Fi Consultants: 36 Druid Hill, Stoke Bishop, Bristol. B59 1EJ. Tel: 0117 968 6005. ATC, AVI, Alon, Audio Analogue, Audiomeca, Cadence Valve, Chord Amps, Electrocompaniet, Harman Kardon, Haysbrook, Jamo, LFD, Lyra, Opera, Ortofon, Pink Triangle, Ruark, Mark Levinson, Michell, REL, SME. Shearline, Sonic Link, Sugden, Townshend, Triangle, Unison Research Valve Amps. Home Cinema demonstrated including, A/V Amps, DVD Players, Video Projectors and Screens. Demos by appointment only. Home trial facilities. Free installations. We are not a shop.

BUCKINGHAMSHIRE

NORTHWOOD AUDIO 98 Cambridge St, Aylesbury. Tel: 01296 428790. Established since 1992. Independent specialist retailer. Extensive Hi-Fi, A/V and Multiroom experience catering to your needs. From Vinyl to SACD, Valve to Solid State, from LCD to Plasma, Audiomeca, Audio Note, Cable Talk, Castle, Chord, The Chord Company, Cura, Denon, Elac, Epos, Exposure, Heart, JM Labs, KEF, Linn, Marantz, Michell, Micromega, Monitor Audio, NAD, Nakamichi, PMC, ProAc, Quadraspire, Rega, REL, Revox, Roksan, Rose, Rotel, Ruark, Sony, Sennheiser, Sonus, Talk Electronics, Tannoy, Teac, Tube Technology, Videologic, Vienna Acoustic. Export orders welcome. 2 demo rooms. Credit facilities available. Website: www.northwoodaudio.co.uk Email: Info@northwoodaudio.co.uk

TECHNOSOUND 8 Granville Square, Willen, Milton Keynes, MK15 9JL. Tel: (01908) 604949. Fax: (01908) 202166. Audiophile Hi-Fi and Home Cinema specialists. All major brands stocked from Arcam to Yamaha, Meridian Digital Home Theatre dealer. Video projection, Plasma screens. Custom installation. 2 dem rooms and expert advice. Email: hifi@technosound.co.uk www.technosound.co.uk

CAMBRIDGESHIRE

THE AUDIO FILE 41 Victoria Road, Cambridge. Tel: 01223 368305. 'For the best in British Hi-Fi and Home cinema entertainment'. Visit or call to arrange a dem with products from: Arcam, Linn, Naim, Rega, Cyrus, Absolute Sounds, Kef, Sony, Yamaha, Rel, Ruark, Denon.

CHESHIRE

ACOUSTICA 17 Hoole Rd, Chester CH2 3NH. www.acoustica.co.uk Tel: 01244 344227. All the best in HiFi & Home Cinema from Naim, Rega, Rotel, Sugden, Tube Technology, Primare, Isotek, Harman Kardon, Teac, Acoustic Energy, JM Lab, B&W, Spondor, Royd, REL, Quadraspire, SIM2 & Sanyo projectors and much more. We offer full demonstration facilities, interest free credit and delivery & install systems throughout Cheshire, Merseyside & North Wales. Opening hours are Tuesday to Saturday 10.00 to 5.30.

ACTON GATE AUDIO 4 Ruabon Road, Wrexham, North Wales, Tel: 01978 364500. Audio Visual Specialists. Arcam, Audio Analogue, Bose, B&W, Celestion, Castle, Denon, Harman Kardon, Jamo, Marantz, Michell, Mission, Onkyo, Pro-Ject, Musical Fidelity, NAD, Micromega, Myrad, QUAD, Radford, Rotel, Ruark, Tannoy, TDL, Teac, Thorens, UKD, Unison Research, Yamaha, DSP Club Member, Demo Room, Installation service. Easy Parking and Motorway access. All major credit cards accepted: 9.30 - 5.30 daily. Closed Sunday & Monday.

DOUG BRADY HI-FI Kingsway Studios, Kingsway North, Warrington, WA1 3NU Tel: 01925 828009 Fax: 01925 825773. Visa, Mastercard, Lombard Tricity, 2 dem rooms, home trial. Agencies include: Arcam, Tag McLaren, AVI, B&W, Castle, Caspian, Chord Electronics, Exposure, Harbeth, Heybrook, Krell, LFD, Michell, Meridian, Musical Fidelity, Monitor Audio, Naim, Nautilus 800 series, Pink Triangle, ProAc, Roksan, SME, Wilson Benesch, XTC and many more.

CORNWALL

SOUNDS PERFECTION 'Cornwall's most exclusive Audio retailer'. Agencies include: Audio Analogue, Audio Design, Audio Note, AudioQuest, Audio Spectrum, AR, Avid, Border Patrol, Boston, Dynavector, Electrocompaniet, Graaf, Henley, JM Labs, Lexicon, Michell, Monitor Audio, Musical Fidelity, Ortofon, Parasound, Primare, Project, NAD, Nakamichi, Nordost, Philoshopy, REL, Roksan, Ruark, Rotel, Totem, Tom Evans, Tsunami, S.M.E., Sudgen, Stands Unique, Unison Research, Teac, Vienna Acoustics, Triangle, Trichords, WBT, Sonic Link. Home Demonstrations by Appointment. Tel/Fax: 01326 221372 Mobile 07798 554357 email nigel@soundsperfection.co.uk website www.soundsperfection.co.uk

DEVON

AUDIO DESTINATION Hi-Fi/Home Cinema specialists. 2 demonstration rooms, child's play area, interest free credit. Relaxed friendly service. Systems/components to suit all budgets. Musical fidelity, Ruark, Monitor Audio, Nad, Roksan, Project, Primare, Nordost, Chord plus many more tel: 01884 243584, fax: 01884 258887. email: audiodestination@btconnect.com

DORSET

MOVEMENT AUDIO 588 Ashley Road, Poole, Parkstone, Dorset BH14 0AQ. Tel: (01202) 730865/380018. Arcam, B&W, Castle, Chord Electronics, Cyrus, Denon, Marantz, Michell, Mission, Pioneer, Tannoy Dimension, Yamaha. 2 Dem rooms. Listen to the available choice and decide at your leisure - no pressure, no obligation. Our staff enjoy music, with our choice of products, you can too! Service Department. Free installation. Home trial facilities. Access, Visa, Amex, Diners Card. Credit facilities available. Open Tuesday-Saturday 10.5-3.0. www.movement-audio.co.uk

MOVEMENT AUDIO 926 Wimborne Road, Winton, Bournemouth, Dorset, BH9 4DH. Tel: (01202) 529988/520066. Arcam, B&W, Denon, KEF, Marantz, Mission, Musical Fidelity, Opera, Pioneer, Quad, Roksan, Ruark, Yamaha. Full dem facilities available, also home dem. Friendly expert advice. Service Department. Free installation. Home trial facilities. Access, Visa, Amex. Open Tuesday-Saturday 9.30-5.30

DAWSONS OF WESTBOURNE Home Cinema Specialists. Main agents for Bang & Olufsen, Harman Kardon, JBL, REL, Mordaunt Short, Sony, Technics and TDL. Demonstration facilities include our unique Dolby pro-logic system comparator for the ultimate way to choose the perfect system. Also on demonstration large screen televisions from Thomson, Sony and Ferguson with video projectors from Sharp and Seleco. Dawson's, 23 Seamoor Road, Westbourne, Bournemouth 01202 764965

WEYMOUTH HI-FI 33-35 Maiden Street, Weymouth, Dorset DT4 8BA.

Tel: (01305) 785729/766345. Arcam, B&W, Denon, KEF, Marantz, Mission, Musical Fidelity, Panasonic, Pioneer, Quad, Sony, Tannoy, Yamaha. Dem room. Friendly professional advice. Only quality hi-fi dealer in Weymouth area. Service Department. Free installation. Home trial facilities. Access, Visa, Amex, Switch, Delta Mastercard. Interest free credit. Instant credit. Open Mon-Sat 9.30-5.30

ESSEX

GRAYSTON SOUND & VISION 33 Sir Isaac's Walk, Colchester, (01206) 577682. Alchemist, Arcam, B&W, Boston Acoustics, Castle, Denon, Harman Kardon, KEF, Linn, Loewe Opta, Meridian, Michell, Musical Fidelity, Philips, Pioneer, Project, Rotel, Sennheiser. Superb demo rooms, free regional delivery and installation. Regular musical and surround evenings, home demonstrations. Excellent credit facilities.

GLOUCESTERSHIRE

THE RIGHT NOTE - Bath. For specialist advice and home demonstrations. See BRISTOL & BATH.

HEREFORDSHIRE

ENGLISH AUDIO 37 Whitecross Road, Hereford, HR4 0DE. (01432) 355081. Arcam, A.T.C., B&W, Castle, Cura, Cyrus Centre, Elac, Denon, JM Lab, KEF,

Loewe, Marantz, Mission, Musical Fidelity, NAD, Naim, Pink Triangle, Pioneer, Project, QED, Systemline, REL, Rotel, Ruark, John Shearline, Stax, System Audio, Teac, Vienna Acoustics, Wadia, and Yamaha. Single speaker dem room, home trial facilities, free installation, service dept, Access/Visa, Credit arranged. Open Mon-Sat, 9.30-5.30pm. BADA members.

HERTFORDSHIRE

AUDIO FILE (THE) 27 Hockerill Street, Bishops Stortford, Herts. Tel. (01279) 506576.

DARBY'S OF ST. ALBANS. 6 Market Place, St Albans, Herts. Tel: (01727) 851596. Fax: (01727 812217) Email: sales@darbystvhi.co.uk Hertfordshire's premier Hi-Fi/Audio Visual specialists established 1946. Full Home Cinema demonstration suite. Whether your needs are large or small, we stock it all; Arcam, Cyrus, JVC, Yamaha, Quad, Denon, Sony, Bang & Olufsen, Pioneer, REL, KEF, Mission, Ruark. Celestion and many more. Free planning service. Free Delivery and basic installation. Full workshop facilities. Open 9-6 Mon-Sat.

LANCASHIRE

ADVENTURES IN HI-FI 5, Bishopgate, off Hallgate, Wigan, WNI 1NL Tel: 01942 234202. For the best hi-fi and home cinema products from quality manufacturers including Naim, Rega, Cyrus, NAD, KEF, Denon, Dynavector, Rotel, Shahinian, JM Lab, PMC, Project, Quadraspire, Seleco and Sanyo projectors. We offer friendly advice, excellent demonstration facilities, 0% finance, free delivery and installation throughout the North West. Opening hours 10.00 - 5.30pm Tuesday to Saturday evenings by appointment.

LEICESTERSHIRE

LEICESTER HI-FI 6 Silver Walk, St Martins Square, Leicester LE1 5EW. Tel: (0116) 2539753. Email: info@leicesterhifi.co.uk www.leicesterhifi.co.uk Arcam, B&W, Chord Electronics, Copland, Cyrus, Denon, Greig Loudspeakers, KEF, Marantz, Michell, Miller & Kreisell, Musical Fidelity, NAD, Nakamichi, Nautilus, Mission, Project, Rotel, Sanyo Projection, Talk Electronics, Teac, Technics, Yamaha, and many more. 4 Listening areas over 3 floors. We can demonstrate, deliver and install. Including A.V. and Multiroom. Credit Facilities. All cards taken, open 6 days 9.30-5.30.

LONDON

BABBER ELECTRONICS SERVICE CENTRE 158 Uxbridge Road, West Ealing, London, W13 8SB. Tel: 020 8579 6315 Akai, Aiwa, A&R, Celestion, Dual, Goodmans, Harman Kardon, JBL, JVC, Kenwood, Marantz, Panasonic, Sennheiser, Sony, ES range, Tannoy, Technics, Wharfedale, Yamaha and many more. Auth. Service Dept. Credit Facilities, Open 10.30 - 5.30 Mon-Sat.

INFIDELITY 9 High Street, Hampton Wick, Kingston-upon-Thames. Tel: (020) 8943 3530. for full details see entry under SURREY

HIFI EXPERIENCE 227 Tottenham Court Road, London W1. 020 7580 3535. Arcam, Cyrus, Denon Gold, Quad, Kef, Meridian, Yamaha, Marantz, McCormack, Mirage, Nakamichi, Musical Fidelity, PAFF and many more. Open 10.00-7.00 Mon-Fri, 9-6 on Sat. Service dept, Credit facilities, delivery and free installation.

THE LISTENING ROOMS 161 Old Brompton Road, London SW5 0LJ. (020) 7244 7750/59. Fax (020) 7370 0192. Linn, Quad, Meridian, Nakamichi, Arcam, Audiolab, Acoustic Energy, SME, Audio Research, Krell, Wadia, Theta, Apogee, Martin Logan, Pioneer, Tannoy, Systemdek, Stax, Pink Triangle, Michell, Monitor Audio, Yamaha, Marantz, KEF, Bose, Celestion, Epos, Mission, Denon, Neat Petite. Mon-Sat 10-6pm.

THOMAS HEINITZ LTD 35 Moscow Road, Bayswater, London, W2 4AH. Tel: 020 7229 2077.

Fax: 020 7277 9348. Email: info@thomasheinitz.com. Web site: www.thomasheinitz.com. Established in 1952, Thomas Heinitz has a long history of providing the best music and AV systems available. We continue to offer the highest standard of service in the most relaxed atmosphere. Whatever your needs, from multiroom and home cinema to a high quality stereo system, we offer consultation, design specification, architect liaison and installation in order to ensure your system is tailored to your exact requirements. For quotes contact our manager Johnny Drum.

GREATER MANCHESTER

ADVENTURES IN HI-FI 5, Bishopgate, off Hallgate, Wigan, WNI 1NL Tel: 01942 234202. See our main entry under LANCASHIRE

MANCHESTER

REPLAY AUDIO 64 Flixton Road, Urmston, Manchester, M41 5AB Tel 0161 202 9922. Audio Analogue, Bryston, Creek, DNM, Exposure, LFD, Michell, Myrriad, NAD, Onkyo, Ortofon, Pink Triangle, Project, Sonneteer, Sugden, Trichord, Unison Research, Teac. Loudspeakers from Acoustic Energy, A.R.T. Audio Physic, AVI, Blueroom, Epos, Harbeth, Living Voice, Monitor Audio, Neat, PMC, Royd. Lots of cables and accessories available. We are just off Junction 10 of the Manchester Ring Road (M60), five minutes from The Trafford Centre. Our demonstrations are relaxed and informal and help and advice is free! Phone or visit our web site www.replay.dial.pipex.com or email replay@dial.pipex.com

MERSEYSIDE

ACOUSTICA 17 Hoole Rd, Chester CH2 3NH. Tel 01244 344227. See our main entry under "Cheshire".

MIDDLESEX

RIVERSIDE HI-FI 422 Richmond Road, East Twickenham, Middlesex, TW1 2EB. Tel: 020 8892 7613 Fax: 020 8892 7749. www.riversidehifi.co.uk Arcam, Bose, B&O, Castle, Copland, Denon, Krell, Marantz, Martin Logan, Michell, Monitor Audio, Musical Fidelity, NAD, Pioneer, Project, Rel, Sonus Faber, Sony, Tag McLaren Audio, Tannoy, Teac, Theta, Wilson. Finance available. Subject to status. Written details available on request. Export orders welcome. UK mail order available. 3 demonstration rooms. All major credit cards. Open 10am-5.30pm Mon-Sat.

NORFOLK

BASICALLY SOUND The Old School, School Road, Bracon Ash (Nr Norwich), Norfolk, NR14 8HG. Tel: 01508 570 829. Stockists of the following leading Hi-Fi: Audio Analogue, Beyer, Bryston, Denon, Dynavec, Epos, Grado, Naim, PMC, ProAc, Rega, Royd, Sennheiser, Talk Electronics, Teac and more. Bada members, 2 comprehensive demo rooms.

NORTHAMPTON

CLASSIC HI-FI At Classic Hi-Fi we cover the best in quality sounds. Be it a question of taste, a question of balance or a question of price, we're the ones to help. We stock: Marantz, Nad, Pioneer, Roksan, Yamaha, Heybrook, LFD, Sugden, Rotel, Kenwood, B & W, Kef, Rogers, Monitor Audio, Musical Fidelity, Tannoy, Shearne Audio, Royd, Audio Alchemy, Teac and many more. For more details call: 01536 310855

LISTEN INN 32 Gold Street, Northampton NN1 1RS. Tel: 01604 637 871. The World's Finest Hi-Fi from Arcam, Audio Analogue, Chord Company, Copland, Denon, FMJ, Fujitsu, KEF, Krell, Linn, Loewe, Martin Logan, Meridian, Miller & Kreisell, Mission, NAD, Naim, Proac, Rega, Rotel, Sennheiser, Sonus Faber, Wilson Benesch, Yamaha. Dedicated Viewing & Listening Rooms, Friendly Staff, Fresh Coffee, 2 Full Years Warranty, Part Exchange Welcome, Free Car Parking, Interest Free Credit, Members of BADA. Open 10am-5.30pm (Closed Thursday).

NOTTINGHAMSHIRE

NOTTINGHAM HI-FI CENTRE 120-122 Alfreton Road, Nottingham, Tel: 0115 9786919. Multi-room specialists. Hi-Fi, Home cinema. All leading brands stocked. Three superb demonstration areas. Two year parts and labour guarantee. Home trials. On site service facility. Full delivery and installation service. Easy free parking. BADA Dealer. Established 1968. Mon-Sat 9.00-5.30

OXFORDSHIRE

OVERTURE HI-FI 3 Church Lane, Banbury, Oxon OX1 6RL. Tel (01295) 272158. Email sales@overture.co.uk Website: www.overture.co.uk Arcam, Bose, Cura, Denon, KEF, Linn Products, Miller and Kreisell, Mission, NAD, Naim Audio, Yamaha. For sensible unbiased advice, call Oxfordshire's audio experts. Superb demo facilities. No appts necessary. Home Cinema, Plasma TV, Projectors, Lutron Lighting, MultiRoom and Commercial installations. Access/Visa, Instant credit. Mon-Fri 10-6, Sat 9.30-5.30.

SHROPSHIRE

ADAMS & JARRETT Hi-Fi and Home Cinema Specialist. Phone or visit us at 6-18, Norman Road, St. Leonards-on-Sea, E.Sussex. (01424) 437165/432398. Stocklist of quality equipment including: Audio Innovations, Meridian, KEF, Ruark, Marantz, NAD, JBL, Royd, Dali, Jamo, Onkyo, Rel, Traget, Cable Talk, Technics, TDC, Yamaha, Kenwood. Air conditioned listening rooms, on site service and repair facilities

STAFFORDSHIRE

ACOUSTICA 114 Wolverhampton Rd, Stafford ST17 4AH. www.acoustica.co.uk Tel 01785 258216. All the best in HiFi & Home Cinema from Naim Audio, Rega, Arcam, Rotel, Sugden, Tube Technology, Primare, Isotek, Harman Kardon, Onkyo, Teac, Acoustic Energy, Jm Lab, B&W, Spendor, Kef, Royd, REL, Quadraspire, SIM2 & Sanyo projectors and much more. We offer full demonstration facilities, interest free credit and delivery & install systems

throughout Staffordshire & the Midlands. Opening hours are Tuesday to Friday 10.00 to 5.30, Saturday 10.00 until 5.00.

SUFFOLK

ANGLIA AUDIO The Street, Hesselst, Bury St Edmonds, Suffolk, IP30 9AZ. Tel. 01359 270212. "Hi-Fi and speaker centre dedicated to quality hi-fi since 1971. Open 10-6. Closed Weds and Sundays. Evening and Sunday Demos by appointment.

AUDIO IMAGES 128 London Road North, Lowestoft, Suffolk, NR32 1HB Tel: 01502 582853. Arcam, Acurus, Castle, Rotel, Moth, Triangle, QTA, Sugden, Denon, Yamaha, Mirage, M & K, Definitive, Musical Fidelity, plus the incredible Rothwell range. Refreshingly different selection. Dem Room, Professional AV installer's from budget to high end. Full credit facilities. 9.30 to 5.30 Mon & Sat ~ 9.30 to 6.00 Tues to Fri.

EASTERN AUDIO 41 Bramford Road, Ipswich, Tel. 01473 217 217. Fax 01473 215705. Quad, Arcam, Audiolab, Meridian, Mission, Denon, Rotel, Marantz, NAD, Sony, Rogers, Nakamichi, Systemdek, Technics, Celestion, B&W, Tannoy, Marel Thorens and Top Tape. Also stock a wide range of accessories, usual credit facilities. A BADA dealer.

SURREY

INFIDELITY 9 High Street, Hampton Wick, Kingston upon Thames, Surrey, KT1 4DA. Tel. 020 943 3530. Email: infidelity@compuserve.com - Web Address: infidelity.co.uk Stockists of: Linn, Naim, Arcam, Meridian, Rega, B&W, Nautilus, Neat, Proceed, Royd, M&K, Rotel, Stax, Shahnian, Dynavecator. Open 10.30 - 7.00 Tues - Fri, 10.00 - 6 Sat.

SUSSEX (EAST)

ADAMS & JARRETT For the best Audio Visual Specialist with friendly helpful staff phone or visit us at 6-18 Norman Road St. Leonards-On-Sea, East Sussex. Tel. 01424 437165/432398. Copland, Castle, Denon, Densen, Dynaudio, Jamo, Kef, Kenwood, Marantz, Meridian, Musical Fidelity, NAD, Onkyo, Primare, Rel, Rotel, Ruark, Tannoy, Technics, Yamaha. Interest free credit available subject to status. Visa, Mastercard.

WEST MIDLANDS

ACOUSTICA 114 Wolverhampton Rd, Stafford ST17 4AH. See our main entry under "STAFFORDSHIRE".

MUSIC MATTERS

Birmingham - 363, Hagley Road, Edgbaston, B17 8DL. Tel: 0121 429 2811.
Solihull - 93-95, Hobs Moat Road, B92 8JL. Tel: 0121 342 0254.
Stourbridge - 9, Market Street D48 IAB. Tel: 01384 444184.
Sutton Coldfield - 10, Boldmere Road, B73 5TD Tel: 0121 354 2311. Arcam, Alchemist, Apollo, Audioquest, Audio Research, B&W, Cable Talk, Castle, Celestion, Chord, Copland, Cyrus, Denon, DPA, JBL, Kef, Krell, Marantz, Martin Logan, Meridian, Musical Fidelity, Panasonic, Pioneer, REL, Rotel, Ruark, SME, Sennheiser, Sonus Faber, Tag McLaren, Teac, Theta, Yamaha etc. Classical CD's available at Birmingham only. Demonstration rooms, service and installation. BADA member. VISA / MASTERCARD / AMEX / SWITCH. Open: 10-5.30 Tuesday to Saturday, Late night Thursday till 7.00 (not Stourbridge).

SOUND ACADEMY

For the Midlands. The Parade, Sutton Coldfield, Tel. 0121 321 2445 & High Street, Bloxwich, Nr Walsall, (sharing the ASDA shopping centre) Tel 01922 493499. Hosts 4 private studios plus a Home Theatre Cinema with Tube & LCD Projectors. The best in hi-fi from Naim, Arcam, Audiolab, Chord, Meridian, Monitor Audio and many more. So...if you've taken time to read this, please let us make you welcome. Phone 0121 321 2445 for Sutton or 01922 493499 for Walsall. Call in and to browse our exciting display of hi-fi and home cinema equipment. Mail order available. interest free credit S.T. Status. Open 6 days, 9am to 5.30pm. Please call for late night. Expert Advice, Cable Dressing and Installation.

WILTSHIRE

SALISBURY HI-FI LTD 15 Catherine Street, Salisbury, Wiltshire SP1 2DF. Tel (01722) 322169/330841. Arcam, B&W, Celestion, Denon, KEF, Marantz, Meridian, Mission, Musical Fidelity, NAD, Opera, Pioneer, Ruark, Tannoy, Yamaha, 2 Dem rooms. Friendly, relaxed atmosphere. Professional advice. Home dem available. Service department, Free installation. Home trial facilities. Access, Visa, Amex. Interest free credit. Instant credit. Open Mon-Sat 9-5.30.

THE RIGHT NOTE - See under BATH & BRISTOL heading.

YORKSHIRE (NORTH)

SOUND ORGANISATION YORK, 2 Gillygate, York YO3 17EQ. Tel (01904) 627108. Carefully chosen Hi-Fi and AV equipment includes Arcam, B&W, Nautilus, Denon, Linn, Naim, Rega, Rotel, Stax etc 3 dem rooms Incl. Home Cinema and Linn connection. Service Department. Home installations. Instant Credit and major credit cards. Closed Mondays. Phone for chat and more details. www.soundorg.co.uk

YORKSHIRE (EAST)

THE AUDIO ROOM 2 George Street, Hedon, Hull, HU12 8JH. tel 01482 891375. www.theaudiroom.co.uk. The North East's premier hi fi dealer, stunning showrooms and dedicated listening rooms, authorised agents for, Naim, Linn, Cyrus, Mark Levinson, Sugden, Pathos, Unison Research, Audio Analogue, Graaf, Rega, Rotel, B&W, Spendor, Revel, Sonus Faber, Wilson Benesch. Home demonstrations and credit facilities available. Open Mon-Sat, 9am-6pm. The North East's friendliest hi-fi dealer.

ZEN AUDIO 35 George Street, Hull Tel. 01482 587397. "Comfortable listening rooms; Home dems; Personal, friendly service; Free installations. Agencies include: Arcam, Audiolab, Atacama, Audio Innovations, Audio Note, Audion, Alchemist, B&W, Cable Talk, Chord CO, DPA, Densen, Denon, DNM, EAR, Exposure, Fi-Rax, Harbeth, Heybrook, Impulse, KAR, KEF, Michell, Micromega, Monitor Audio, Musical Technology, Myrriad, NAD, NAIM, Pioneer, REL, Rehdeko, Rotel, Royd, Ruark, Shearne Audio, Stands Unique, Sugden, Spendor, Sonic Link, TEAC, TDL, Tube Technology, Vivanco and many others.

YORKSHIRE (SOUTH)

THE HI-FI STUDIOS

Hi-Fi - Home Cinema - Custom Installation Tel: Doncaster 01302 727274 or 01302 725550. E-Mail: info@thehifistudios.freeserve.co.uk Web Site: www.thehifistudios.co.uk Musical Fidelity, Electrocompaniet, ProAc, PMC, JM Lab, Ruark, Castle, TEAC, Unison Research, Monitor Audio, Impulse, Primare, Harbeth, NAD, Michell Turntables, Nottingham Analogue Studios, Audio Analogue, Living Voice, Densen, Celestion, KEF, Opera, Trichord Research, Nordost, Stands Unique, Ortofon, Project, Goldring, REL, Denon, TAG McLaren, Rotel, Yamaha, Proceed - plus many more. Viewing & Demonstration by appointment in a unique setting. Home trials and installation. Card facilities and 0% available. Please phone for more information. BADA. CEDIA.

YORKSHIRE (WEST)

HUDDERSFIELD HI-FI CENTRE

Hi-Fi • A/V • Widescreen Plasma • Installation Service 4 Cross Church St, Huddersfield, 01484 544668. Brands Inc. Arcam, B&W, Castle, Cyrus, Denon, KEF, Marantz, Mission, Musical Fidelity, NAD, Project, Sonus etc. 3 Dem Rooms. Mon-Sat 9-5.30, Thurs 9-8, Closed Wed.

HUDDERSFIELD HI-FI CENTRE HALIFAX

3-5 King Cross St, Halifax. 01422 366832. Brands inc, Arcam, B&W, Castle, KEF, Marantz, Mission, Musical Fidelity, NAD, PRO-AC, Project, Sugden etc. 2 Dem Rooms, Mon-Sat 9-5.30, Closed Thursday.

PREMIER AUDIO - now demonstrating - Room 1: DCS Elgar, Purcell & Verdi Transport, Plinius CD Lad & 250 Power, Verity Fidelo & Sonus Faber Speakers, Siltech Cables, Isotek Sub Station, BDA Equipment Stands Room 2: Audio Aero, Audio Synthesis, Kora Pre & Power, Pink Triangle CD/Amp, Martin Logan / Audio Physics Speakers, Arcici Equipment Stand, Isotek Sub Station P/S Audio Synthesis, Audio Physics, Audio Aero, Absolute Sounds, DCS, Kora, Plinius, Siltech, Arcici, BDA, Pink Triangle, Avid Turntables, Project, Ortofon, Van den Hul, Mirage, P/X welcome Home demonstration good selection of S/hand. We are 10mins J39 - M1 10mins J30 M62 Tel: Wakefield 01924 255045 - Colin Grundy.

AUDIO REPUBLIC, 78 Otley Road, Leeds 0113 2177294, www.audio-republic.co.uk for the very best in quality hi fi in West Yorkshire and beyond, our relaxed and professional approach stems from over 10 years experience in designing and installing high quality music systems. We believe the following offer outstanding results: Naim Audio, Rega Research, Dynavecator Systems (amplifiers and cartridges) Totem Acoustic, Roksan Engineering, Beyer, Ortofon, Creek Audio, Shahnian, JM Lab, Epos, TEAC, PMC, Bryston, Quadraspire, Chord Cables, Custom Design, Alphonson Designs. Choice of shop or home demonstrations, open Tues - Sat 9.30am to 5.30 pm, most credit cards welcome. Please phone for a chat and directions.

WALES

NORTH WALES

ACOUSTICA 17 Hoole Rd, Chester CH2 3NH. Tel 01244 344227. See our main entry under "Cheshire".

ACTION GATE AUDIO 4 Ruabon Road, Wrexham, North Wales, Tel. 01978 364500. See our main ad under Cheshire.

VINYL/RECORD MAIL ORDER

DIVERSE VINYL 10 Charles Street, Newport, NP20 1JU. Tel/Fax: 01633 259661/256261. Email: sales@diverse-music.co.uk Probably the most varied and impressive selection of brand new LPs you'll find anywhere: international new releases, reissues and audiophile products. Also UK distributor of the Disco Anti Stat LP Cleaning Device. Call for a free catalogue, or visit www.diverse-music.co.uk

meet your maker

A reference guide to Britain's manufacturers and distributors

AUDIO SYNTHESIS Manufacturers of the the outstanding DAX digital to analogue converter, comes DAX-2, a new Hi-End reference converter able to dig deeper into the digital source than ever before! A new addition to the superb PASSION series of all Vishay controllers has just been introduced in the form of PASSION 8, a fully remote controlled uniquely transparent passive preamplifier, the perfect match for DESIRE. By word of mouth our DESIRE power amplifier is rapidly convincing listeners, whether passive or active! New for 1997 is TRANSCEND a state of art CD transport with AES, coaxial, AT&T glass and Toslink outputs. Audio Synthesis, PO BOX 50, Nottingham, NG9 1DZ, Tel: (+44) (0)115 922 4138. Fax: (+44) (0)115 922 9701.

BORDER PATROL 63 Berriedale Avenue Hove BN3 4JD Tel/Fax 01273 276716. Manufacturers of Power Supply Units for valve amplifiers, Single-Ended Power Amplifiers and high quality Transformers. The Border Patrol PSU: valve-rectified choke input filter power supply units which dramatically improves the sound of valve amplifiers: models available to suit Audionote, Audio Innovations, Audion, Art Audio, Cary, Unison Research, World Audio Designs. The Border Patrol 300B SE single-ended valve amplifier featuring interstage driver transformers and valve rectified choke input filter power supplies. Border Patrol transformers: high quality output (PP and SE), interstage and pre-amp output transformers and high value inductors.

CREEK AUDIO LTD 12 Avebury Court, Mark Road, Hemel Hempstead, Herts, HP2 7TA. Tel. 01442 260146 E-mail: info@creekaudio.co.uk Internet: www.creekaudio.co.uk - Creek Audio build stylish Hi-Fi products in the UK, combining state of the art electronic design, with full bodied, accurate and musically rewarding sound. Our standard size products come in two award-winning ranges, the entry level 43 series and higher priced 53 series. These include: CD43 Mk2 - CD player with 24 bit resolution DAC, T43 AM/FM Tuner, Integrated Amps - 5350, 5350SE and 4330 Mk2 (described by Stereophile Magazine as the best amp under \$1000). Our A43 Mk2 and A53 Power Amps range from 50 to 250 Watts and both P43 and P53 Pre-Amps offer passive and active operation with remote control. In addition we have an award winning OBH range of small products: OBH-8/8SE MM and OBH-9 MC Phono Pre-Amplifiers, OBH-11 and 11 SE Headphone Amplifiers, OBH-10 and 12 Remote Control Passive Pre-Amps and OBH-14 - 24 bit DAC. See our home page for further details or call us for leaflets.

DBS AUDIO. PO BOX 91, Bury St Edmunds, Suffolk, IP32 7JU. Phone: 01284 723933 Fax: 01284 723933. Suppliers of Electro-Acoustic measuring equipment and CAD software to the audio industry. NEW: Clio win and Clio win Lite, the latest Windows versions of the Globally-established Clio Electro-Acoustic measuring system, used for loudspeaker design, Quality Control and electronics testing by many major audio companies. Clio win is the full (lab) system and Clio win Lite a lower-cost version for smaller companies and serious hobbyists. Both use the same purpose-built Clio HR200 ISA card, with its in-built mic, preamp and phantom powering. The matching Mic 01 (or Mic Lite) plugs straight in to make a complete system. Both versions offer the same high accuracy and ease of use: Clio win Lite simply has fewer functions. Common features include MLS testing (to eliminate sound reflections), sine and third-octave analysis, impedance, Thiele Small Parameters, LC

meter, software and manual on CD ROM -- plus much more. Measurements may be exported to our Netcalc software for accurate and easy crossover design. Also available: Boxcalc and Boxdraw bass optimisation packages and Outline speaker measuring turntable. Write or E mail and we will send fuller information and prices. Also, visit Audiomatica's new Website at: www.audiomatica.com

EPOS ACOUSTICS 2 Avebury Court, Mark Road, Hemel Hempstead, Herts, HP2 7TA. Tel. 01442 260146. Email: info@epos-acoustics.com Website: www.epos-acoustics.com Innovative design and superior sound distinguish EPOS speakers from other brands in a similar price category. Adhering to the EPOS tradition of musicality and communication, the new M12 follows closely the style of the successful ES12, and was awarded five gold stars in the March 2001 edition of *What Hi-Fi?* For more information about the M12 or the new M15 please see our home page or call us for leaflets.

FALCON ACOUSTICS LTD Tabor House, Norwich Road, Mulbarton, Norwich, Norfolk, NR14 8JT. Tel. (01508) 578272. U.K. distributors of FOCAL drive units and SOLEN (Chateauroux) polypropylene capacitors and the largest inductor manufacturer in the U.K. Comprehensive range of DIY Speaker Parts and Kits, Sub-Bass and Electronic Filters. "Everything but the wood" Enquiries should be accompanied by a 44p stamped addressed envelope.

LANGREX SUPPLIES LTD 1 Mayo Road, Croydon, Surrey. CR0 2QP. Tel: 020 8684 1166. Fax: 020 8684 3056. One of the largest distributors of electronic valves, tubes and semi-conductors in the UK, and USA manufacturers. stock. We specialise in obsolete types including original UK and USA made audio valves. Telephone or fax for an immediate quotation.

NORTON TECHNOLOGIES LTD Manufacturers of the acclaimed AirPower LP12 Power Supply. 14 Rothesay Avenue, Chelmsford CM2 9BU. (01245) 283125

PLATFORM 7 High density marble ISOLATION PLATFORMS for all makes of equipment RACKS/STANDS. An elegant way to UPGRADE. improves clarity: better BASS control. 3 Abbots Drive, North Wembley, Middlesex HA0 3SB. Tel: 020 8904 2646. Also NEALGAR DISTRIBUTION Tel/Fax 01296 24756.

PMC/BRYSTON Emmy award winning manufacturers of the highest quality loudspeakers and amplification. Industry standard in Mastering, Film Scoring, Broadcast and Post Productions. (5.1 & Stereo) PMC Products: Compacts, Floorstanders, and Large passive & active monitors. Prices range from £500 to £32,000. Finished in a large selection of exquisite real wood veneers, all PMC loudspeakers are available in horizontal mirrored pairs, centre channels and complementary subs for 5.1 surround systems. Bryston's balanced range of products include R/C Preamps, Integrated, Amp modules for all the PMC range, Mono, Stereo 150W to 800W per ch, 3 Ch, 4 ch and 5 channel THX amplifiers, Surround processors, all with distortion figures and build quality to die for. Every product is available in silver or black backed by a 20 year warranty. PMC Ltd 43-45 Crawley Green Road, Luton, LU2 0AA. Tel: 08704 441044 Fax: 08704 441045 Email: sales@promonitor.co.uk Web: www.pmc-speakers.com

REL ACOUSTICS North Road, Bridgend Ind Est, Bridgend, Mid Glamorgan, CF31 3TP. UK. Tel. 01656 768 777, international +44 656 768 777. Fax. 01656 766 093. international. +44 656 766 093. Email: contact@rel.net Web: http://rel.net The UK's only specialist sub-bass speaker manufacturer. "The only one that works". Get your dealer to give you a home demo and find out what the fuss is all about.

RDE TANDBERG HI-FI SERVICES Holly Tree House, The Green, Full Sutton, YORK YO4 1HW. Tel: 01759 372795. The service, overhaul and reconditioning of all Tandberg hi-fi products regardless of age.

SOUND IMAGE UK LTD. 52 Milton Road, London SW14 8JR. Tel: 020 -8255-6868. Importers and distributors of the finest audio equipment, featuring the stunning Boulder 2.000 series and the complete range from Norwegian manufacturer Electrocompaniet.

SUGDEN AUDIO PRODUCTS Designed and manufactured in the UK each Sugden product is hand-built by one highly skilled technician. A full range of pure class A amplifiers are available including integrated, stereo power and the incredible Masterclass balanced monoblocks. Our stunning Bijou system now comes with a single-ended pure class A power Amplifier with optional integral stand. Two analogue tuners have joined the range matching our A21 and Bijou series, offering a digital user interface with excellent facilities. Each amplifier series has a matching CD player with a class A output stage and heavily modified transport. The class A HeadMaster offers a pre-amp with three inputs a fixed and variable output with remote control. The HeadMaster can be used as a control unit in a high quality audio system and excels with headphones. Please contact us for product information, dealer list and brochures. 01924 404088 email info@jesugden.co.uk.

TALK ELECTRONICS Unit 12, Farnborough Business Centre, Eelmoor Road, Farnborough, Hampshire, GU14 7XA. Tel: 01252 378383. Please ring for details

TAG McLAREN AUDIO - The Summit, 11 Latham Road, Huntingdon, Cambs, PE18 6ZU. Tel +44 (0) 1480 415600 Fax +44 (0) 1480 52159. Combining science and technology with distinct style, TAG McLaren Audio's complete range of audio and audio-visual products are designed to bring maximum pleasure to the discerning listener. To find out more visit our website at www.tagmclarenaudio.com, email us on HelpDesk@tagmclarenaudio.com or contact our helpdesk on freephone 0800 783 8007.

tech+link distributes some of the best performing hi-fi and a/v accessories currently available in the U.K. These include: Puresonic, best known for its range of high performance interconnects and connectors, and cable adapters for a wide variety of hi-fi and a/v applications in its range; tech+link's own brand of high quality interconnects and connectors - digital compatible, 24k gold plated metal connectors; and hi-fi furniture - a selection of high quality speaker floor stands, surround sound stands and hi-fi racks. For more information, contact: tech+link International, Unit 8, Bat and Ball Enterprise Centre, Bat and Ball Road, Sevenoaks, Kent, TN14 5LJ. Tel: +44 (0) 1732 779400 Fax: +44 (0) 1732 449344

To advertise in Meet Your Maker please call
Amanda Sweeney on
020 8864 4760

specialist hi-fi dealers

specialist hi-fi dealers

LONDON



THE INNOVATIVE HI-FI,
HOME CINEMA AND MULTI ROOM
RETAILER/INSTALLER
SERVING LONDON
FROM BATTERSEA

ORANGES & LEMONS

Friendly and efficient service
0% finance

JUICY FRUIT FROM LONDON'S FRESHEST RETAILER

ARCAM B&W CABLE TALK CASTLE CHORD
CREEK DENON EPOS LINN MARANTZ
NAM NAD NEAT PMC QED REGA ROKSAN
ROTEL RUARK STANDS UNIQUE SOUNDSTYLE
YAMAHA XANTECH and many others

020-7924 2040

61/63 WEBBS ROAD, SW11

website: oandlhifi.co.uk



We aim to provide a well chosen
selection of quality hi-fi and
accessories including
FMJ, ARCAM, B&W, NAUTILUS,
DYNAVECTOR, LINN, LOEWE, MERIDIAN,
M&K, NAIM, PIONEER, PROCEED,
NEAT, REGA, ROTEL, SHAMINIAN,
YAMAHA + more

Infidelity
INDECENTLY GOOD HI-FI

9 High Street, Hampton Wick,
Kingston upon Thames, Surrey KT1 4DA
Tel: 020 8943 3530

Open:
Tues-fri
10.30am-
7pm,
Saturday
10am-6pm

~~AUDIO CONSULTANTS~~

27 BOND STREET, EALING
LONDON W5 5AS
TEL. 081 - 567 8703

Audio Analogue, Art Glass, Ash Designs, Avik, B&O,
B&W, Cabletalk, Chord Company, Creek, Denon, Epos,
Harman Kardon, Infinity, KEF, Lat. Marantz, Musical
Fidelity, NAD, Nakamichi, Nordost, Orelle, Onkyo,
Primare, Quad, Roksan, Rotel, Ruark, Sennheiser,
SonicLink, Sound Style, Stands Unique, Straightwire,
Supra, Tag McLaren, Target, Teac, Thorens, van den Hul.

10 - 6 pm Mon., Tues., Friday, & Sat.
Late night Thur., closed Wed.

Two demonstration rooms.
Free local delivery and installation.
Repairs and Services

SOUTH

WORTHING AUDIO

20 Treville Gate, W.Sussex BN11 1UA
(01903) 212133

The friendly shop with the best sound system in the South
Talk Electronics - Friendly Advice - 3 Year Guarantees
Easy Parking - Open Mon-Sat. 10am-6pm.
Late Night Wed 7.30pm.

Agencies include: Dynaudio, Ruark, Gradient, Roksan,
Restek, Orelle, Sonneteer, Kora, Cymbol, Talk Electronics,
and many more.....

SOUTH WEST

SOUTH WEST ANALOGUE

SME - MICHELL - NOTTINGHAM ANALOGUE -
LORICRAFT GARRARD - PROJECT - ORTOFON -
TUBE TECHNOLOGY 64bit Valve CD Player, Remote
Control Hybrid Integrated Valve Amplifier CROFT
VOODOO Isolation platforms/Loudspeakers,
Equipment Stands and T/Turntable lift off Perspex Covers.
Record cleaning service - Secondhand equipment
01643 851 351

graham@southwestanalogue.fsnet.co.uk



Basically Sound

NORWICH • NORFOLK

Audio Analogue, Bryston, Cabletalk, Chario,
Chord Co, Denon, Epos, Final, Isoblu, e,
Naim Audio, PMC, Prolog, Rega, Stax,
Talk Electronics, Teac, UKD Opera,
Audio Note and many others

The Old School
School Road, Brackley Ash
Nr Norwich, Norfolk NR14 8HG
Tel (01508) 570829

EAST

STOWSOUNDS

audio consultants
These And More Available From:

Creek
Epos
Exposure

JM Labs
Living Voice
Neat Acoustics

For A Demonstration & Expert Advice Call
Stowmarket (01449) 675060

Stone Farm, Borough Lane, Gt. Finborough, Stowmarket

VALVES & TUBES



Chelmer Valve Company
for audio valves

Buy CVC. PREMIUM HI - FI valves direct from us.
All valves processed for improved performance.
We also have stock of MAJOR BRAND types inc.
MULLARD, GEC, BRIMAR, RCA, GE, PHILIPS, etc.

The Stables, Baddow Park, Great Baddow,
Chelmsford, Essex, CM2 7SY
Tel: 01245 241301 Fax: 01245 241309
Email: sales@chelmervalue.com

SERVICES & CONSULTANTS

Front End Problem?

contact

The Cartridge Man

It doesn't have to cost an arm and a
leg to get the best - listen to my
Koetsu - and Decca - eater.

Also agents for Croft, Hadcock,
E.A.R, Michell &
Moth.

plus cartridge re-tipping service

020 8688 6565

Website: www.thecartridgeman.com

MAIL ORDER

SUMMER SALE NOW ON!

ENDS 23RD JULY 2003

- Mains Products
- Interconnects
- Speaker Cables
- Accessories
- Equipment Supports



If your cartridge doesn't sound as good as it used
to, or starts to mistrack, the chances are that it
simply needs a clean. Our NEW TipTonic is
perfect for gently removing the hard deposits
that accumulate on the tip of your stylus,
restoring their sound and prolonging the life of
both your stylus and your records.

Exclusive to Russ Andrews

TipTonic stylus cleaner

WAS £9.95 NOW £8.95

Cable Upgrade
Scheme

60 Day
Home Trial

FREE Delivery
(UK Mainland)

Expert
Advice

Call UK Freephone 0800 373467 quoting AH83

or BUY ONLINE at www.russandrews.com



Quality Cables & Accessories
for Hi-Fi & Home Cinema
Mail Order Direct

Sole UK Distributor for



Russ Andrews Accessories Ltd,
FREEPOST NWW88TA, KENDAL LA8 9ZA
Tel: 0044 1539 825500 Fax: 0044 1539 825540
E-mail: AH83@russandrews.com

atv

ATV SERVICES
LEATHERHEAD
01372 456921

- Service & Repairs
- Valve & transistor amplifiers
- Vintage valve Radios
- Hi-Fi VCR's
- Valves Tested

VINYL

THE DIRECT DISC VINYL VINYL VINYL

Thousands of records always in stock.

+ a full range of sought after compact discs.

Extensive search service for wanted albums.

Comprehensive 96 page full catalogue

available at £1.50

Telephone / Fax 01992 447764

Or visit our web site on

www.directdisc.demon.co.uk

HI - FI

HOME CINEMA

MULTIROOM INSTALL

BUY / SELL

Quarterly Sale Items

| | | |
|--------------------------------------|---------|-----------|
| Kenwood L1000C pre/ L1000M Power Amp | £795.00 | £2,500.00 |
| Exposure VII pre + XII psu | £595.00 | £1,200.00 |
| Harmon Kardon AVPI | £175.00 | £ - |
| Magnum Dynalab P 200 Pre | £695.00 | £1,900.00 |
| dpa Enlightenment DAC | £395.00 | £ - |

New this month

POWER AMPLIFIERS

| | | |
|------------------|------------|------------|
| Krell FPB 600c | £6,500.00 | £14,000.00 |
| Krell FPB 700cx | £11,995.00 | £15,000.00 |
| Krell FPB 400 cx | £9,600.00 | £12,000.00 |
| Naim Nait 3 | £475.00 | £608.00 |

PRE AMPLIFIERS

| | | |
|---------------------------|-----------|-----------|
| Audio Research LS25 mk II | £4,250.00 | £5,995.00 |
| YBA 2a | £1,295.00 | £1,995.00 |

LOUDSPEAKERS

| | | |
|------------------------------------|-----------|------------|
| Proac Future 2 Walnut | £6,995.00 | £10,985.00 |
| JM Lab Mini Utopia + Stds Rosewood | £2,495.00 | £4,899.00 |
| JM Lab Nova Utopia | £On Dem | £1,999.00 |
| Dynaudio Audience 50 | £395.00 | £577.00 |

CD PLAYERS & DACS

| | | |
|-----------------------------|-----------|-----------|
| Musical Fidelity NuVista cd | £2,495.00 | £3,000.00 |
| Sony SCD1 SACD | £2,495.00 | £4,000.00 |

TURNTABLES, ANALOGUE, VARIOUS

| | | |
|--------------------------|---------|-----------|
| Tara Lab Decade 8ft pair | £895.00 | £2,000.00 |
|--------------------------|---------|-----------|

AV COMPONENTS

| | | |
|-------------------------|---------|-----------|
| Lexicon MC8 Processor | £On Dem | £5,000.00 |
| Lexicon RT10 DVD Player | £On Dem | £2,300.00 |

Power amplifiers

| | | |
|--------------------------------------|--------------|------------|
| Rowland Model 12 (4 chassis) | £8,995.00 | £14,500.00 |
| Michell Alecto Monoblocks | £1,195.00 | £2,000.00 |
| Chord 5PM 1203 (3 Channel) | £3,995.00 | £5,500.00 |
| Cary 805 Monoblocks "new" | £4,995.00 | £8,250.00 |
| E.S. Lab DX S8 | £On Dem | £2,995.00 |
| Plinius SA50 | £1,795.00 | £2,700.00 |
| Plinius 8200P | £On Dem | £1,550.00 |
| Krell FPB 200 | £3,995.00 | £8,000.00 |
| Krell FPB 600 | £5,995.00 | £12,998.00 |
| Plinius SA 102 "new" | £On Dem | £3,750.00 |
| Musical Fidelity P180 (x2) | £395.00 each | £900.00 |
| Musical Fidelity CRPS | £395.00 | £900.00 |
| Vincent T.A.C SV 236 Integrated | £On Dem | £1,495.00 |
| Bryston 4 BSST | £On Dem | £2,350.00 |
| Michaelson Audio Odyssey | £695.00 | £1,500.00 |
| Jadis Defy 7 mk III | £2,750.00 | £6,000.00 |
| Mark Levinson No 27 | £1,995.00 | £6,000.00 |
| Linn Bass Active Card | £69.00 | £120.00 |
| Audio Research VT150se Monoblocks | £7,995.00 | £16,800.00 |
| Gamut D200 "new" | £On Dem | £3,250.00 |
| Musical Fidelity F15 | £1,395.00 | £2,500.00 |
| Audio Innovations S1000 mk III monos | £1,395.00 | £3,000.00 |
| Krell FPB250M | £6,430.00 | £10,000.00 |
| Krell MDA 300 | £4,995.00 | £12,000.00 |
| Cary SLA 70 mk II Silver | £1,295.00 | £1,900.00 |
| Boulder 500 AE | £3,495.00 | £5,500.00 |
| Krell FPB 300 | £5,995.00 | £9,990.00 |
| Linn Klassik CD/Amp silver | £895.00 | £1,030.00 |
| Boulder 1060 Power "new" | £On Dem | £16,500.00 |
| Primare 30.1 mk II Integrated | £1,350.00 | £1,500.00 |
| YBA Passion Stereo "new" | £3,995.00 | £5,995.00 |
| Sunfire 300 Power Amp | £995.00 | £2,400.00 |
| Plinius 250 mk IV "new" | £On Dem | £6,350.00 |

AV components

AV COMPONENTS

| | | |
|------------------------------|-----------|-----------------|
| Lexicon DC2 | £1,995.00 | £3,500.00 |
| SIM 2 HT 300 | £7,500.00 | £9,000.00 |
| Primare P30 Processor | £1,295.00 | £2,000.00 |
| Linn Klassik DVD | £On Dem | £2,000.00 |
| Audio Refinement Pre 5 "new" | £On Dem | £895.00 |
| Lexicon MC1 "new" | £3,500.00 | £5,500.00 |
| Lexicon MC12 / MC12B | £On Dem | £890.00/£990.00 |
| Loewe Xenix DVD "new" | £On Dem | £495.00 |

PLASMAS/LCD/PROJECTORS

| | | |
|--|-----------|-----|
| From NEC/Panasonic/Pioneer/Sharp from Electrograph Delphi/Selec/Sony/Sanyo | £4000.00 | POA |
| Panasonic TH-42 PWD5 "new" | £4,995.00 | POA |

Pre amplifiers

| | | |
|---|-----------|------------|
| Croft Super Micro A mk III | £395.00 | £ - |
| Audible Illusions P3A Pre MM mk II | £2,250.00 | £3,374.00 |
| DNM 3c Primus Pre (3c psu) | £1,195.00 | £2,000.00 |
| Audio Research SP14 (blk) | £1,395.00 | £ - |
| AVI 2000 MP | £395.00 | £800.00 |
| Plinius 16P (Phono) | £1,995.00 | £3,600.00 |
| ATC SCA2 Pre | £1,795.00 | £2,500.00 |
| Tom Evans The Vibe Pre | £On Dem | £2,900.00 |
| Krell KRC | £2,495.00 | £6,949.00 |
| Graff 13.5 Pre | £1,495.00 | £3,000.00 |
| Chord DSC 1500E (dac/pre) | £3,995.00 | £6,500.00 |
| Arcam Delta 110 pre amp | £295.00 | £750.00 |
| Audio Research LS7 | £995.00 | £1,800.00 |
| Audio Research LS1 | £895.00 | £2,000.00 |
| McCormak Line Drive | £395.00 | £995.00 |
| Audio Research LS3 | £995.00 | £1,997.00 |
| Musical Fidelity F22 | £695.00 | £1,500.00 |
| AVI S2000 MP remote pre | £395.00 | £800.00 |
| Cary SLP98L Remote Pre x-demo | £1,795.00 | £2,794.00 |
| Boulder 1012 (pre amp/ 24.96 dac/ Phono) | £On Dem | £13,000.00 |
| YBA Passion Pre (inc Phono) | £3,995.00 | £5,995.00 |
| Boulder 2010 Pre | £POA | £30,000.00 |
| Plinius 16L "new" | £On Dem | £3,200.00 |
| C.A.T. ultimate reference Pre Amp Inc/Phono "new" | £On Dem | £5,750.00 |
| Naim 42.5 | £150.00 | £450.00 |

Quality speakers

| | | |
|---|-----------|------------|
| JM Lab Aito Utopia BE | £On Dem | £9,999.00 |
| Wilson Witt mk I | £3,750.00 | £9,000.00 |
| Avante Garde Duo (White) | £4,950.00 | £8,000.00 |
| JM Lab Utopia | £9,995.00 | £18,000.00 |
| JM Lab Mini Utopia + Stand | £2,495.00 | £4,700.00 |
| B&W Matrix 805 (Walnut) | £295.00 | £650.00 |
| ClaraVox Magnifica | £5,495.00 | £14,500.00 |
| JM Lab Micro Utopia + Stand | £2,195.00 | £4,349.00 |
| Wilson 5.1 | £7,995.00 | £19,600.00 |
| Reference 3A | £1,750.00 | £2,250.00 |
| Audio Physic Spark | £1,150.00 | £1,795.00 |
| Talon Kite Centre & Bracket | £795.00 | £1,750.00 |
| Ensemble PA1 | £895.00 | £2,000.00 |
| Audio Physic Caldera | £4,995.00 | £10,000.00 |
| Aerial Acoustic SW12 Sub Woofer, Maple/remote | £2,995.00 | £5,200.00 |
| Mirage M3 si | £1,495.00 | £4,100.00 |
| Linn Kabers (Active) | £995.00 | £2,500.00 |
| Rel Q 200 E | £On Dem | £650.00 |
| Rel Q 150 E | £On Dem | £500.00 |
| Audio Physic Luna Sub (wood) | £On Dem | £1,799.00 |
| Audio Physic Yara | £On Dem | £999.00 |
| Vienna Acoustics Mahler | £On Dem | £6,000.00 |
| Vienna Acoustics Mozart | £On Dem | £1,700.00 |
| Vienna Acoustics S.1 | £On Dem | £3,500.00 |
| Cabasse io 5.1 | £On Dem | £2,170.00 |
| JM Lab Sib & Cub (5.1 splk sys) | £On Dem | £859.00 |
| Blue Room Minipod (White) | £225.00 | £298.99 |
| Blue Room Minipod + Sub (Blue) | £625.00 | £749.00 |
| Blue Room Minipod Sub | £415.00 | £468.99 |
| SD Acoustics SD1 | £595.00 | £1,650.00 |
| B+W DM 602 S2 | £195.00 | £330.00 |
| ATC SCM 20A | £1,995.00 | £3,300.00 |
| Audio Physic Avanti III X-dem | £6,499.00 | £7,499.00 |
| Genelec 205 Active Monitors | £On Dem | £750.00 |
| Audio Physic Virgo III "new" | £On Dem | £4,000.00 |
| Audio Plan Contrast 3 | £995.00 | £3,200.00 |
| Avalon Ascents | £6,995.00 | £12,000.00 |
| Audio Physic Tempo III "new" | £On Dem | £2,000.00 |
| Naim SBL's | £995.00 | £2,225.00 |
| Rogers LS55 "new" | £330.00 | £430.00 |

CD players DACS

| | | |
|--|------------|------------|
| Theta Data Pro Basic IIIa | £1,795.00 | £3,495.00 |
| Bow Vizzard | £2,795.00 | £4,000.00 |
| Theta DS Pro Prime II a | £995.00 | £1,800.00 |
| Mark Levinson ML 31 | £3,750.00 | £9,000.00 |
| Audio Alchemy Digital Drive III/DDE III/PS III | £695.00 | £1,495.00 |
| Trichord PD-S 503 | £295.00 | £500.00 |
| Pink Triangle Ordinal | £295.00 | £600.00 |
| Wadia 2000S Transport | £2,250.00 | £6,000.00 |
| Mark Levinson 30.6/ 31.5 | £13,995.00 | £27,450.00 |
| YBA CD1 Delta (Twin psu) | £3,995.00 | £5,500.00 |
| Teac P30 Transport | £1,495.00 | £2,500.00 |
| DCS Delius | £4,900.00 | £7,300.00 |
| Audio Synthesis DAX | £1,995.00 | £4,000.00 |
| Krell KPS 20i | £4,795.00 | £9,900.00 |
| Linn Karik Numerik | £1,595.00 | £3,300.00 |
| Helios Stargate "new" | £2,495.00 | £3,500.00 |
| Mark Levinson 39 | £2,995.00 | £5,000.00 |
| Marantz 17 Ki Sig (Black & Gold) | £695.00 | £1,200.00 |
| Miryad MDV 200 DVD | £750.00 | £995.00 |
| Arcam Delta 170 Transport | £295.00 | £650.00 |
| YBA CD 3 Delta | £On Dem | £2,200.00 |
| Audiomeca Damnation CD Transport | £750.00 | £1,600.00 |
| Vincent T.A.C CD S3 | £On Dem | £1,300.00 |
| Primare V20 DVD/CD | £750.00 | £1,000.00 |
| Audio Aero 321/192 Capitole CD (Ver. 4) | £On Dem | £4,500.00 |
| Primare V25 CD/DVD | £On Dem | £1,000.00 |
| Thule Spirit CD | £495.00 | £900.00 |
| Theta Pro Geny | £595.00 | £1,295.00 |
| YBA CD Speciale | £395.00 | £675.00 |
| Boulder 2020 dac | £POA | £24,000.00 |
| Krell KPS 25sc 24/96 | £15,995.00 | £23,498.00 |
| Theta Data II Transport AT + link | £1,995.00 | £4,000.00 |
| YBA CD Integre "new" | £On Dem | £1,195.00 |

Turntables & analogue

| | | |
|---|------------|-----------------|
| EAR 834p phono stage | £350.00 | £500.00 |
| Transparent Ref 20ft Spk | £3,295.00 | £5,000.00 |
| Rockport Sirius System 3 | £40,000.00 | £78,000.00 |
| Loricraft record cleaning machine | £On Dem | £1,100.00 |
| Air Tangent 2B | £1,295.00 | £4,000.00 |
| Lyra Beta | £295.00 | £595.00 |
| Tara Labs The One Balanced 1m | £999.00 | £2,250.00 |
| Michel Gyro SE/ SME 309 | £1,195.00 | £1,850.00 |
| Ortofon Kontrapunkt a | £295.00 | £500.00 |
| Earmax Pro | £On Dem | £425.00 |
| Revox B160 Tuner | £450.00 | £995.00 |
| Decca London Gold (original Garratt Brothers) | £1,495.00 | £ Priceless |
| SME 30/2 A "new" | £10,495.00 | £12,289.00 |
| Moth Record Cleaning m/c | £395.00 | £ - |
| Project RPM4/ Ortofon S10 "new" | £On Dem | £325.00 |
| Project RPM9/ arm | £On Dem | £1,050.00 |
| Ortofon Rohmann | £On Dem | £1,050.00 |
| Ortofon Kontrapunkt a/b "new" | £On Dem | £500.00/£750.00 |
| Michel Gyro SE/ RB300 "new" | £795.00 | £1,017.00 |
| Michell Orbe/ QC | £1,495.00 | £2,200.00 |
| Audio Synthesis Phono Eq mm/mc | £795.00 | £ - |
| Gryphon Phono Pre-Amp (dual mono) Head Amp | £795.00 | £1,600.00 |
| Parasound TQ1600 (remote tuner) | £295.00 | £400.00 |
| SME Series V Arm "new" | £1,350.00 | £1,650.00 |
| Pink Triangle PT Ext psu | £495.00 | £ - |
| Triang 14 Phono "new" | £On Dem | £2,750.00 |
| Nackamichi DR 3 | £195.00 | £400.00 |
| Tom Evans - The Groove "new" | £On Dem | £1,795.00 |
| Clear Audio Reference Mc phono stage X-demo | £1,695.00 | £2,065.00 |
| Rega Planer 3 + Hi Fi News Out Board Power Supply | £320.00 | £423.00 |
| Clear Audio Symphono phono stage X-demo MM/MC | £640.00 | £740.00 |
| Lavardin Reference Phono "new" | £On Dem | £2,500.00 |

Choice hi-fi

you choose

Choice hi-fi make it easy for you to fulfill your sonic dreams. Quality hi-fi is not just about expensive brandnames. It's about aspiring to the very best sound, about choosing your ideal system from the widest selection in the country, in a unique no-pressure environment.

your choice

- Acoustic Energy
- Advantage
- ATC
- Audible Illusions
- Audio Physic
- B.A.T
- Boulder
- Bryston
- Cary
- C.A.T.
- Chord
- Clear Audio
- Denon
- DNM
- Egglaston Works
- Electrograph Delphi
- Genelec
- Gryphon
- Graham
- Imerge
- J M Lab
- Krell
- Lexicon
- Linn
- Loewe
- Lutron
- Lyra
- Mark Levinson
- Michell Eng.
- Musical Fidelity
- Naim
- NEC
- Nordost
- Oracle
- Ortofon
- Plinius
- P.M.C.
- Primare
- Project
- Quadraspire
- REL
- Rockport
- Roksan
- Rotel
- Ruark
- Seleco
- SME
- Straight Wire
- Sugden
- Tara Labs
- Teac
- Totem
- Transfiguration
- Trichord
- Trilogy
- Van den Hul
- VPI
- Wilson Audio
- Wilson Research
- YBA

tel: 020 8392 1959 & 020 8392 1963
fax: 020 8392 1994 info@choice-hifi.com

Open from 10am to 6pm Mon-Sat and other times by appointment.

Buy, sell, exchange quality hi-fi equipment.

We accept all major credit cards. Finance available subject to status.

world classics

In this heavily revised section, you'll find the great and the good from audio's glorious past. Most are seminal designs which have earned their place in hi-fi history, but you'll also see some oddities which aren't classic as such, but are great used buys. The year of introduction is given, alongside the original UK launch price. Think we've overlooked something? Then write in and let us know!

DIGITAL

CAMBRIDGE AUDIO CD11986 [£1500]

Inspired Stan Curtis redesign of Philips CD104, complete with switchable digital filter. Lean but tight and musical performer.

CAMBRIDGE AUDIO CD 4SE 1998 [£200]

A touch soft in the treble and tonally light, but outstanding in every other respect.

LINN KARIK III 1995 [£1775]

The final Karik was a gem. Superb transport gives a brilliantly tight, grippy dynamic sound, albeit tonally dry.

MARANTZ CD73 1983 [£700]

A riot of gold brushed aluminium and LEDs, this distinctive machine squeezed every last ounce from its 14x4 DAC -super musical

MARANTZ SA-1 2000 [£5,000]

The greatest argument for SACD. This sublime Ken Ishiwata design is utterly musically convincing with both CD and SACD, beating most audiophile CD spinners hands down.



MERIDIAN MCD 1984 [£600]

The first British 'audiophile' machine was a sweeter, more detailed Philips CD100. 14x4 never sounded so good, until the MCD Pro arrived a year later.



MERIDIAN 207 1988 [£995]

Beautifully-built two-box with pre-amp stage. Very musical although not as refined as modern Bitstream gear. No digital output.

NAIM CDS 1990 [£ N/A]

Classic Philips 16x4 chipset with serious attention to power supplies equals grin-inducing sonics.

SONY CDP-101 1982 [£800]

The first Japanese CD spinner was powerful and involving. Brilliant transport more than compensated for 16x2 DAC, and you even got remote control!

SONY CDP-RI/DAS-RI 1987 [£3,000]

Sony's first two boxer was right first time. Tonnally lean, but probably the most detailed and architectural sounding machine of the eighties.

COMPACT DISC TRANSPORTS

ESOTERIC P0 1997 [£8,000]

The best CD drive bar none; TEAC's Tokyo boys pushed the boat out in style. Brilliantly incisive, ridiculously over engineered.

KENWOOD 9010 1986 [£600]

The first discrete Jap transport was beautifully done and responds well to re-clocking even today.

TEAC VRDS-T1 1994 [£600]

Warm and expansive sound made this a mid price hit. Well built, with a slick mech.

DACs

CAMBRIDGE AUDIO DACMAGIC 1995 [£99]

Good value upgrade for budget CD players with extensive facilities and detailed sonics.

DCS ELGAR 1997 [£8500]

Extremely open and natural performer, albeit extremely pricey - superb.

DPA LITTLE BIT 3 1996 [£299]

Rich, clean, rhythmic and punchy sound transforms budget CD players.

PINK TRIANGLE DACAPO 1993 [£ N/A]

Exquisite; the warmest and most lyrical 16bit digital audio we have ever heard. Clever plug-in digital filter modules really worked!

QED DIGIT 1991 [£90]

Budget bitstream performer with tweaks aplenty. Positron PSU upgrade makes it smooth, but now past it.

TURNTABLES

ARISTON RD11S 1972 [£94]

Modern evolution of Thorens' original belt drive paradigm, Scotland's original super-deck was warm and musical, albeit soft. Still capable of fine results today.

DUAL CS505 1982 [£75]

Simple high quality engineering and a respectable low mass tonearm made for a brilliant budget buy. Polished, smooth and slightly bland sound.

GARRARD 301/401 1953 [£19]

Heavy metal - tremendously strong and articulate with only a veiled treble to let it down. In many respects, better than the seventies 'superdecks' that succeeded it.

GOLDRING LENCO 88/89 1963 [£15.65]

Simple, well engineered middleweight with soft, sweet sound and reasonable tonearms. Good spares and servicing support even today from specialists.

LINN AXIS 1987 [£253]

Simplified cut-price version of the Sondek complete with LVX arm. Elegant and decently performing mid-price package. Later version with Akito tonearm better.

LINN SONDEK LP12 1973 [£86]

For many, the Brit superdeck; constant mods meant that early ones sound warmer and more lyrical than modern versions. Beguilingly musical but now off the pace.



MARANTZ TT1000 1978 [£ N/A]

Beautiful seventies high end belt drive with sweet and clean sound. Rare in Europe, but big in Japan.

MICHELL GYRODEC 1981 [£599]

Thanks to its stunning visuals, this bold design wasn't accorded the respect it deserved until recently. Early examples sound cold and mechanical, but now right on the pace. Clean, solid and architectural sound.

REGA PLANAR 3 1978 [£79]

Brilliantly simple but clean and musical performer, complete with Acos-derived S-shape tonearm. 1983 saw the arrival of the RB300, which added detail at the expense of warmth. Superb budget buy.

ROKSAN XERXES 1984 [£550]

Supposedly the first to 'better' the LP12. Super tight and clean sound, with excellent transients. Less musical than the Sondek, but more neutral. Sagging plinth top-plates make them a dubious used buy.

TECHNICS SP10 1973 [£400]

Seminal Japanese engineering. Sonics depend on plinths, but a well mounted SP10/II will give any modern a hard time, especially in respect of bass power and midband accuracy.

THORENS TD124 1959 [£ N/A]

The template for virtually every 1970s 'superdeck', this iconic design was the only real competition for Garrard's 301. It was sweeter and more lyrical, yet lighter and less impactful in the bass.

TOWNSHEND ROCK1979 [£ N/A]

The product of academic research by the Cranfield Institute, this novel machine has an extremely clean and fluid sound. Substantially modified through the years, and capable of superb results even today.

TRIO LO-7D 1978 [£600]

The best 'all-in-one' turntable package ever made, Trio/Kenwood threw their 'engineering best practice' book at this one with startling results. Clean, powerful and three-dimensional sound, ultimately limited by the tonearm.

Digital has truly come of age

Our old first generation friend, CD, is already looking decidedly like Old Hat. Super Audio CD and DVD Audio are with us, assuming you can find the titles you want (rather than the titles they want you to have) at a record shop near you, or indeed in a record shop anywhere. Music (and gadget) lovers can revel in the multitude of ways to store and play their (compressed) music, from home or portable hard disk players, hand-held memory card players, or the humble home computer itself.

So why do we fill our adverts (and our shop) with obsolete mechanical machines from a bygone age to spin huge discs at 33.3 and 45rpm with a sharp diamond on the end of a moving arm to read tiny squiggles in the vinyl? How quaint!

amazon
amphion
apollo furniture
argento
audible illusions
audio physic
breuer dynamic
brinkmann
carfrae
cartridge man
cawsey
chord electronics
clearaudio
decca london
dnm
duevel
dynavector
ear yoshino
ecs
es lab
final lab
gamut
graham slee
hadcock
incognito
infinity
jbl k2
klimo
korato



Amazon Model 3 inc
RB250 arm - £995.00

Brinkmann La Grange inc 10.5
Tonearm (cart extra) - £6995.00



Origin Live Aurora (arm & cart extra) - £997.00



Michell Orbe SE (arm & cart extra) £1916.00



Michell Gyro SE (arm & cart extra) - £870.00

We have the largest selection of vinyl players anywhere in the UK (and possibly further afield too) - just a small selection on this page



More importantly, nobody assembles and tunes turntables like we do - to perfection!



Nottingham Analogue Horizon inc
RB250 arm - £528.75



Nottingham Analogue Spacedeck
(arm & cart extra) - £889.75



Origin Live Resolution (arm & cart extra) - £1979.00

lavardin
loricraft
lyra
michell engineering
morch
musical fidelity
nordost
nottingham analogue
origin live
ortofon
papworth
pink triangle
pluto
rega turntables
ringmat
rose
shun mook
shanling
shelter
sme
sonneteer
spendor
stax
sugden
sumiko
tci cables
tivoli audio
tom evans
townshend audio
transfiguration
trichord
van den hul

Warning!

We have a huge selection of accessories for the vinyl enthusiast which can be purchased either by personal callers to our shop, or by mail order world-wide. Please consult our web site for product details, and how to order.

Latest!

- * The amazing state of the art JBL K2 speakers on demo now
- * Shanling CDT-100 CD player on demo
- * Naim Aro tonearm and Armageddon PSU on demo
- * Rose and Korato preamps on demo
- * At last - the new Michell Engineering Tecnodec - on demo



For info on these, and much more, including our numerous second-hand items, please visit our popular website: www.walrus.co.uk

* interest free credit available on most items, subject to status *

tel: 020 7724 7224
fax: 020 7724 4347
email: mail@walrus.co.uk
web: www.walrus.co.uk

TO NEARMS

ACOS LUSTRE GST-1 1975 [£46]
The archetypal S-shaped seventies arm; good, propulsive and involving sound in its day, but ragged and undynamic now.

AUDIOTECHNICA AT1120 1978 [£75]
Fine finish can't compensate for this ultra low mass arm's limited sonics - a good starter arm if you've only got a few quid to spend.

ALPHASON HR100S 1981 [£150]
First class arm, practically up to present-day standards. Buy carefully, though, as there is no service available now. Totally under priced when new, exceptional.

GRACE G707 1974 [£58]
This early Japanese example of the tonearm art has a smooth, lyrical sound. Imported by Linn, fitted to early LPI2s. Sonically way off the pace now, though.

HADCOCK GH228 1976 [£46]
Evergreen unipivot with lovely sweet, fluid sound - although bass and dynamics are limited. Excellent service backup.

LINN ITTOK LVII 1978 [£253]
Arguably the first 'superarm'; Japanese design to Linn specs made for a muscular, rhythmic sound with real dynamics. Now off the pace, but the final LVIII version worth seeking out.

NAIM ARO 1986 [£875]
Truly endearing and charismatic performer - wonderfully engaging mid-band makes up for softened frequency extremes.

REGA RB300 1983 [£88]
Inspired budget esoterica. Detailed, tight, neutral sound but tonally grey sounding in absolute terms. Responds well to tweaking, and its cheaper RB250 brother better still.

SME 3009 1959 [£18]
Once state of the art, but long since bettered. Musical enough, but weak at frequency extremes and veiled in the midband. Legendary serviceability has made it a cult, used prices unjustifiably high.

SME SERIES III 1979 [£113]
Clever variable mass design complete with Titanium Nitride tube tried to be all things to all men, and failed. Charming nonetheless, with a warm and inoffensive sound.

TECHNICS EPA-501 1979 [£ N/A]
Popular partner for late seventies Technics motor units. Nice build and Titanium Nitride tube can't compensate for middling sound.

INTEGRATED AMPLIFIERS

A&R A60 1977 [£115]
Sweet and musical feature-packed integrated; the Audiolab 8000A used its blueprint to great effect.

AUDIOLAB 8000A 1985 [£495]
Smooth integrated with clean MM/MC phono stage and huge feature count. Extremely reliable, too. Post '93 versions a top used buy.

CREEK CAS4040 1983 [£150]
More musical than any budget amp before it; CAS4140 loses tone controls, gains grip.

MCINTOSH MA6800 1995 [£3735]
Effortlessly sweet, strong and powerful with seminal styling to match.

MISSION CYRUS 2 1984 [£299]
Classic eighties minimalism combines arresting styling with clean, open, lively sound. Further upgradeable with PSX power supply.

MUSICAL FIDELITY A1 1985 [£350]
Beguiling Class A integrated with exquisite styling. Questionable reliability.

MYST TMA3 1983 [£300]
Madcap eighties minimalism, but a strong and tight performer all the same.

NAD 3020 1979 [£69]
Brilliantly smooth, sweet and punchy at the price and even has a better phono stage than you'd expect. The archetypal budget super-amp.



NAIM NAIT 1984 [£350]
Superb rhythms and dynamics make it truly musical, but tonally monochromatic. Fine phono stage, very low power.

ROGERS CADET III 1965 [£34]
Sweet sounding valve integrated, uses ECL86 output valves, even has a half useable phono stage, sweet, warm a good introduction to valves

ROTEL RA-820BX 1983 [£139]
Lively and clean budget integrated that arguably started the move to minimalism.

SUGDEN A21 1969 [£ N/A]
Class A transistor integrated with an eminently likeable smoothness and musicality. Limited inputs via DIN sockets.

PREAMPLIFIERS

AUDIOLAB 8000C 1991 [£499]
Tonally grey but fine phono input and great facilities make it an excellent general purpose tool.

CROFT MICRO 1986 [£150]
Budget valve pre-amp with exceptionally transparent performance.

LEAK POINT ONE STEREO 1958 [£ N/A]
Good for their time, but way off the pace these days. Use of EF86 pentode valve for high gain rules out ultra performance. Not the highest-fi!

LECSON AC-1 1973 [£ N/A]
Amazing styling courtesy of Allan Boothroyd can't disguise its rather cloudy sound, but a design classic nonetheless.



LINN LK-1 1986 [£499]
A brave attempt by the Glasgow boys to bring remote controlled user-friendliness to hair-shirt audiophile hi-fi. Didn't quite work, but not half bad for under £100.

Billy Vee
SOUND • SYSTEMS

248 Lee High Rd, London SE13 5PL (Mon - Sat 10am to 6.30pm Closed Thurs & Sun)

A cool new look for a superior sound

Call (020) 8318 5755 or 8852 1321 now.

New long term choices for a fast moving industry

In a fast moving industry it makes sense to base choices around established companies that employ new technology to enhance, not compromise their standards of performance. Our enthusiastic, knowledgeable staff will be pleased to assist you explore these new advances, book your audition now.

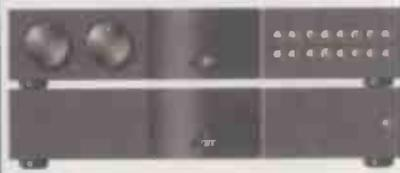

The Full Naim Range, inc CDS3 on dem now.

Building on the strengths of previous designs, the new Naim series combines elegant new styling with a new level of technical and musical performance including re-designed circuitry, improved power supplies and new user features.

The AV8 Preamp Processor offers Dolby Digital, THX-EX, Pro Logic II & DTS decoding with THX Ultra II certification, it is a true audiophile powerhouse and the 7 channel P7 Power Amplifier delivers over a kilowatt of power from seven channels.



The Arcam FMJ AV8/P7 Cinema Powerhouse

NAIM NAC32.5 1978 [£ N/A]
The Salisbury company came of age with this, their classic high end pre. Brilliantly fast and incisive sound that's a joy with vinyl but a tad forward for digital.

QUAD 22 1958 [£25]
The partner to the much vaunted Quad II monoblocs - cloudy and vague sound means it's for anacrophiles only.

QUAD 33 1968 [£43]
Better than the 22, but Quad's first tranny pre isn't outstanding. Responds well to tweaking/ rebuilding though...

POWER AMPLIFIERS

LEAK POINT ONE, TL10, TL12.1 1949 [£28]
Early classics that are getting expensive. Overhauling is de rigeur before use, using original parts if possible. Surprisingly crisp and musical sound, that's far more modern than Quad IIs. Deeply impressive when in fine fettle.



LEAK STEREO 20 1958 [£31]
Excellent workaday classic valve amplifier with decent power and drive. Surprisingly modern sounding if rebuilt sympathetically. Irrepressibly musical and fluid.

LECSON API 1973 [£ N/A]
Madcap cylindrical styling alluded to its 'tower of power' pretensions, but it wasn't. Poor build, but decently clean sounding when working.

MARANTZ MODEL 9 1997 [£8000]
Authentic reproduction monoblocs still more than cut the sonic mustard. Highly expensive and highly sought after.

MICHELL ALECTO 1997 [£1989]
Crisp, clean and beautifully controlled with gorgeous styling. Partnered with the £1650 Orca this sounds delclous!

MUSICAL FIDELITY XA200 1996 [£1000PR]
200W of sweet smooth transistor stomp in a grooved tube! Under-rated oddity.

QUAD II 1952 [£22]
The all-time classic valve amplifier, with a deliciously fluid and lyrical voice. In other respects though, it sounds hopelessly dated. Low power and hard to partner properly.

QUAD 303 1968 [£55]
Bullet proof build, but woolly sound. Off the pace, but endearing nonetheless. Some pipe smoking slipper wearers swear by them!

QUAD 405 1978 [£115]
The first of the current dumpers is a capable design with smooth, effortless power and a decently musical sound. 606 and 707 continue the theme with greater detail and incision.

PHONO STAGES

CREEK OBH-8 SE 1996 [£180]
Punchy, rhythmic character with oodles of detail makes this a great budget audiophile classic. Partner with a Goldring GI042 for an unbeatable budget combination.

LINN LINNK 1984 [£149]
Naim-designed MC phono stage built to partner the original Naim NAIT - yes, really! Fine sound, although off the pace these days.

MICHELL ISO 1988 [£ N/A]
This Tom Evans-designed black box started the trend for high performance offboard phono stages. Charismatic, musical and punchy - if lacking in finesse.

TUNERS

CREEK CAS3140 1985 [£199]
Excellent detail, separation and dynamics - brilliantly musical at the price. T40 continued the theme...

MARANTZ ST-8 1978 [£353]
Marantz's finest radio moment. Warm, organic sound plus an oscilloscope for checking the signal strength and multipath.



NAD 4040 1979 [£79]
Tremendously smooth and natural sound allied to low prices and good availability make this budget analogue esoterica. Needs a good antenna to work properly, however.

LEAK TROUGHLINE 1956 [£25]
Series I an interesting ornament but limited to 88-100MHz only. II and III are arguably the best-sounding tuners ever. Adaptation for stereo easy via phono multiplex socket. Fed by a modern outboard decoder they're deliciously lucid with true dimensionality.



NAD 4140 1995 [£199]
Brilliant affordable digital tuner has a smooth, detailed musical sound plus sensible real-world facilities.

NAIM NAT03 1993 [£595]
The warm, atmospheric sound is further proof of Naims proficiency with tuners.

PIONEER TX-9500 1976 [£295]
Another of the serious classic solid-staters. Boasts the usual high end Jap package of fine sound, brilliant sensitivity and superb build.

YAMAHA CT7000 1977 [£444]
Reputedly the best of the classic Jap analogues, this combines sleek ergonomics, high sensitivity and an explicit, detailed sound.

ANALOGUE RECORDERS

AIWA XD-009 1989 [£600]
Aiwa's Nak beater didn't, but it wasn't half bad nonetheless. Massive spec even included a 16x4 DAC!

NAKAMICHI CR-7E 1987 [£800]
The very best sounding Nakamichi ever - but lacks the visual drama of a Dragon.

REVOX A77 1968 [£145]
The first domestic open reel that the pros used at home. Superbly made, but sonically off the pace these days. B77 better, but couldn't match the Japanese.

SONY WM-D6C 1985 [£290]
Single capstan transport on a par with a Swiss watch, single rec/replay head better than most Naks. Result: sublime.

Billy Vee
SOUND SYSTEMS

SAVE UP TO 50% ON EX-DISPLAY BARGAINS

SOME AS NEW WITH 2 YR WARRANTY. 24HR DEL ONLY £5. CHECK AVAILABILITY BEFORE ORDERING

CALL SALES: (020) 8318 5755 or 8852 1321 - 248 Lee High Road, London, SE13 5PL

0% APR is available on purchases of more than £660. Please call for details. Prices set at time of press. E&OE

| | | | | | |
|---|-----------|----------|---|-----------|----------|
| Arcam A85 Amplifier (1Yr G/tee) | (799.00) | £599.00 | Marantz RC5000 Prog remote (1Yr G/tee) | (299.00) | £195.00 |
| Arcam DT26 DAB Tuner (2Yr G/tee) | (999.00) | £659.00 | Marantz DV7000 DVD Player (1Yr Gtee) 60% | (599.00) | £229.00 |
| Arcam FMJ CD23 CD Player (1Yr G/tee) | (1199.00) | £785.00 | Naim CDS/2 Player (2Yr G/tee) | (6256.00) | £4595.00 |
| Arcam FMJ DV27 DVD Player (2Yr/Gtee) | (1599.00) | £1150.00 | Naim 52 Preamplifier (2Yr G/tee) | (3850.00) | £2795.00 |
| Celestion Compact A Spkrs R/nut (1Yr G/tee) | (600.00) | £325.00 | Naim XPS2 Power Supply (2Yr G/tee) | (2300.00) | £1895.00 |
| K.E.F. Q5 Speakers-Cherry (2Yr G/tee) | (599.00) | £419.00 | Naim Naxo 2/4 Crossover (2Yr G/tee) | (893.00) | £469.00 |
| K.E.F. PSW 3000 SubWoofers (2Yr G/tee) | (599.00) | £475.00 | Naim Credo Speakers (2Yr G/tee) | (1350.00) | £890.00 |
| Linn Classik K CD system (2Yr G/tee) | (999.00) | £749.00 | ProAc Response 1.5 Spkrs-Ch (2Yr G/tee) | (1800.00) | £1095.00 |
| Linn Classik Movie System (2Yr G/tee) | (1995.00) | £1595.00 | Rotel RV985 DVD Player (1Yr G/tee) 60% | (625.00) | £229.00 |
| Linn LK85 Power Amp (2Yr G/tee) | (495.00) | £295.00 | Rega Planet 2000 CD Silver (1Yr G/tee) | (498.00) | £369.00 |
| Linn Klout Power Amp-As New (5Yr G/tee) | (2400.00) | £1600.00 | Rega Brio 2000 Amp Silver (1Yr G/tee) | (298.00) | £219.00 |
| Linn KAN Speakers (2Yr G/tee) | (325.00) | £185.00 | Rega Mira 2000 Amp Silver (1Yr G/tee) | (498.00) | £365.00 |
| Lexicon MC1 Processor (2Yr G/tee) | (5500.00) | £2795.00 | Sugden Bijou Ampmaster (2Yr G/tee) | (689.00) | £495.00 |

PIONEER CTF-950 1978 [£400]

Not up to modern standards sonically, but a great symbol of the cassette deck art nonetheless.



YAMAHA TC-800GL 1977 [£179]

Early classic with ski-slope styling courtesy of Mario Bellini. Middling sonics by modern standards, but cool nonetheless!



DIGITAL RECORDERS

KENWOOD DM-9090 1997 [£500]

Serious and sophisticated sound thanks to well implemented ATRAC 4.5; surprisingly musical MD recorder.

MARANTZ DR-17 1999 [£1100]

Probably the best sounding CD recorder made; built like a brick outhouse with a true audiophile sound and HDCD compatibility.

PIONEER PDR-555RW 1999 [£480]

For a moment, this was the CD recorder to have. Clean and detailed.

SONY TCD-8 DATMAN 1996 [£599]

Super clean sound makes this an amazing portable, but fragile.

SONY MDS-JE55SES 2000 [£900]

The best sounding MD deck ever, thanks to awesome build and heroic ATRAC-DSP Type R coding.

LOUDSPEAKERS

JR 149 1977 [£120]

Infamous cylindrical speaker that was ignored for decades but now back in fashion! Based on classic KEF T27 / B110 combo as seen in the BBC LS3/5a. Doesn't play loud, needs a powerful transistor amplifier, but rewards with fine clarity in imaging.

LEAK SANDWICH 1961 [£39 EACH]

Warm sounding infinite baffle that, with a reasonably powerful amplifier can sound quite satisfying.

LOWTHER PM6A 1957 [£18 EACH]

This seminal full-range driver is still manufactured. High sensitivity, as fitted to many classic horn designs.

MAGNEPLANAR SMGA198X [£800]

Technological loudspeaker with genuinely musical abilities; fast, smooth, open, dry.

MISSION 752 1995 [£495]

Cracking Henry Azima-designed floor-standers combined HDA drive units and metal dome tweeters with surprisingly warm results. Benign load characteristics makes them great for valves.



MISSION 770 1980 [£375]

Back in its day, it was an innovative product and one of the first of the polypropylene designs. Warm, smooth, clean and powerful sound.

MISSION X-SPACE 1999 [£499]

The first mass production sub and sat system using NXT panels is a sure-fire future classic - not flawless, but a tantalisingly unboxy sound nevertheless!



QUAD ESL57 1956 [£45 EACH]

Wonderfully open and neutral sound puts box loudspeakers to shame. Properly serviced they give superb midband performance, although frequency extremes less impressive. Ideally, use in stacked pairs or with subwoofers and supertweeters.

QUAD ESL63 1980 [£1200]

An update of the ESL57, with stiffer cabinets. Until the 989, the best of the Quad electrostatics.

YAMAHA NS1000 1977 [£532]

High tech Beryllium midband and tweeter domes and brutish 12" woofers in massive sealed mirror image cabs equals stunning transients, speed and wallop allied to superb transparency and ultra low distortion. Partner carefully!

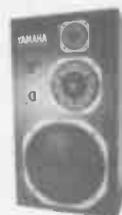

TANNOY WESTMINSTER 1985 [£4500]

Folded horn monsters which certainly sound good if you have the space. Not the last word in tautness but can drive large rooms and image like few others.



EXCELLENT VALUE PRE - OWNED BARGAINS

SECONDHAND UNITS WITH WARRANTY. 24HR DEL ONLY £5. CHECK AVAILABILITY BEFORE ORDERING

CALL SALES: (020) 8318 5755 or 8852 1321 - 248 Lee High Road, London, SE13 5PL

0% APR is available on purchases of more than £660. Please call for details. Prices set at time of press. E&OE

| | | | | | |
|---|-----------|----------|--|-----------|----------|
| Arcam Diva CD72 Player (6Mth G/tee) | (399.00) | £259.00 | Marantz DV890 DVD Player (1Yr G/tee) . . . | (399.00) | £149.00 |
| Arcam A22/P75 Dave AV Amp (1Yr G/tee) (2849.00) | | £1495.00 | Naim NAC 32.5+SNAPS Pre/Supply (6Mth G/tee) N/A | | £145.00 |
| Arcam Alpha 8 Tuner (6Mth G/tee) | (399.00) | £169.00 | Naim 42/90 Pre-Power amp (6Mth G/tee) | (700.00) | £350.00 |
| Arcam Alpha 7 Tuner (6Mth G/tee) | (279.00) | £149.00 | Naim NAC72 Preamp (6Mth G/tee) | (745.00) | £245.00 |
| Epos ES11 Spks in Stands (6Mth G/tee) | (469.00) | £195.00 | Naim NAP 90 Power Amp (6Mth G/tee) | (495.00) | £275.00 |
| Linn Karik 3 C D Player (6Mth G/tee) | (1850.00) | £650.00 | Naim Hi-Cap Power Supply (1Yr G/tee) | (799.00) | £395.00 |
| Linn Numerik D A Converter (6Mth G/tee) . . . | (1100.00) | £529.00 | Naim PSX Power Supply-CDX (1Yr G/tee) . . | (2100.00) | £1695.00 |
| Linn Kolektor Preamp (1Yr G/tee) | (495.00) | £369.00 | Naim NAP 135 Power Amps (1Yr G/tee) . . . | (3200.00) | £1600.00 |
| Linn Wakonda Preamp (1Yr G/tee) | (845.00) | £489.00 | Naim SBL Speakers-Black (1Yr G/tee) | (2362.00) | £1095.00 |
| Linn Kairn Pro Preamp (1Yr G/tee) | (1400.00) | £599.00 | Pioneer PDR609 CD Recorder (6Mth G/tee) (249.00) | | £169.00 |
| Linn Kairn Phono Preamp (1Yr G/tee) | (1700.00) | £799.00 | Pioneer DV909 DVD/Laser Sil (6Mth G/tee) . | (899.00) | £269.00 |
| Linn LK100 Power Amp (1Yr G/tee) | (695.00) | £349.00 | Rega Luna Amplifier (6Mth G/tee) | (498.00) | £249.00 |
| Linn KAN/2 Spkrs/Stands Blk (6Mth G/tee) . . . | (450.00) | £199.00 | Spendor S3 Speakers (1Yr G/tee) | (600.00) | £449.00 |

world standards

These are the best products we've heard that are currently on sale in the UK, complete with the date they were originally launched and their current retail prices. Watch out for regular updates...!

TURNTABLES

ANTTI/ARM ONE/IQ1 1998 £725
Redesigned Systemdek IIX now off the pace, but the arm and cartridge are both star performers.

LINN LP12/ LINGO 1973 £2100
The quintessential belt drive superdeck offers a beguilingly musical midband at the expense of lumpy bass and nebulous imaging. Latest Lingo brings a new lease of life, with even more punch and polish.

MICHELL TECNODEC 2003 £575
Superb introduction to Michell turntables on a budget. Top quality build and elegant design make it the class of the mid-price field right now.

MICHELL GYRODEC SE 2002 £870
Its beauty is more than skin deep - superbly build and finish allied to clever design equals class leading performance. Latest DC motor with 'Never Connected' PSU make it all the more unassailable.

MICHELL ORBE SE 2002 £1916
Cost-no-object evolution of the Gyro adds massy acrylic platter and two-stage isolation. Fantastically capable all rounder with commanding, powerful, detailed sound that gets the best from almost any arm and cartridge.



PRO-JECT DEBUT II PHONO SB 2002 £170
Fuss-free all in one starter turntable, complete with built in phono stage. Not a star performer, but a fine midi system upgrade all the same.

REGA P3 2000 £298
Great entry level audiophile deck with fine bundled tonearm. Tweakable, and responds well to careful siting on a Base platform.

REGA P25 2001 £619
Until the TecnoDec, the best mid-price turntable package. Fine build and elegant styling. Clean, open sound but limited at frequency extremes in absolute terms.

SME MODEL 10A 1995 £3333
Exquisitely engineered deck and arm combo, but dry and clinical sounding compared to rivals. Accomplished performer with classical music, nonetheless.

TECHNICS SL1200/III 1973 £395
Slick build makes it a respectable performer, although the cheapo arm limits it - fit a Rega RB250 and it's suddenly a serious mid-price machine.

TO NEARMS

HADCOCK 242 SE 2000 £649
Latest of a long line of unipivots, with added mass, revised geometry and better finish. Musical like few others at or near the price, but poor frequency extremes.

LINN EKOS 1987 £1700
Subtle mods over the years, including revised bearings and the recent new wiring has kept it a serious contender in the superarm stakes. Lacks the SME's slam, the OL's clarity or the ARO's emotion, but has a feisty musicality all of its own.

MICHELL TECNOARM 2003 £346
John Michell's brilliant reworking of Rega's classic adds a classy counterweight and end stub, plus Cardas cable. The result is a near transparent sound with plenty of power and poise.

NAIM ARO 1987 £1425
Charismatic unipivot is poor at frequency extremes but sublime in the midband; truly emotive and insightful.

ORIGIN LIVE SILVER 2502001 £625
This fully developed and expertly fettled Rega boasts a superbly even, transparent and tuneful sound. Gives away only a small degree of finesse and dimensionality to top arms.

ORIGIN LIVE ILLUSTRIOUS 2002 £1570
A modern superarm with battleship build. Extremely strong, even and open sound in the mould of the late, lamented Zeta, plus fine tonal colouring. Exquisite.

REGA RB250 1984 £112
Sold through Moth Marketing, this is capable far beyond its price point, with a tight, lean and detailed sound. Responds brilliantly to Origin Live counterweight modification, and well to rewiring.

SME 309 1989 £767
Entry level SME complete with cost-cut aluminium armtube and detachable headshell. Tight, neutral sound with good tonality, but lacks the IV's pace and precision.

SME SERIES IV 1988 £1127
Offers nine tenths of the SME V's magic at just over half price. Exquisitely built and finished, and a design classic. Faces stiff competition these days, but lovely nevertheless.

SME SERIES V 1987 £1614
The so-called Best Pickup Arm in the World isn't, but comes close. Vice-like bass with incredible weight, ultra clear midband and treble. Does everything except beguile the listener.

CARTRIDGES

AUDIO TECHNICA AT-110 1984 £29
Great starter cartridge that's refined, detailed and musical beyond its price.

DYNAVECTOR DV10X5 2003 £250
A distant descendent of the classic Ultimo 10X, this has warmth and sweetness in spades, allied to a punchy bass. Beats G1042 comfortably.

DYNAVECTOR DV20X-H 2003 £299
The best modern budget MC combines deliciously sweet sound with fantastic get-up-and-go. High output version works a treat with valve phono stages too.

GOLDRING G1042 1994 £135
One of the best MMs going, with sweet and extended treble and punchy, muscular bass.

LYRIA LYDIAN BETA 1998 £600
An altogether more beguiling listen than the MC30S, although not quite as incisive. Superb all rounder, nonetheless.

LYRA PARNASSUS DCT 1997 £1895
Jonathan Carr's masterpiece is a brilliantly lyrical and fluid performer, with a deliciously sweet tone and immense subtlety and polish.

ORTOFON MC25FL 1994 £285
Strong budget MC with a cleaner and more detailed sound than the Dynavector; more sterile and less emotive, however.

ORTOFON MC30 SUPR' 1995 £550
Beautifully clean and detailed device with real finesse, albeit a tad mechanical sounding.

ORTOFON KONTRA' B 1999 £720
Surprisingly articulate performer by Ortofon standards. All the brand's usual polish and detail allied to real vim. Loves making music!



SHURE V15XMR 1994 £350
The most musical MM yet made - brilliantly dynamic and punchy in the classic Shure mould, yet refined and tidy too.

SUMIKO BPS 1995 £250
Charismatic performer with rhythm aplenty, but in other respects way off the pace - lacks smoothness and sophistication of the DV10X5.

DIGITAL DISC PLAYERS

ARCAM DIVA CD82T 2002 £600

Oodles of finesse, but not the most gripping performer at the price. A fine all rounder in the classic Arcam mould.

CAMBRIDGE AUDIO

DVD57 2003 £200

Crisp, lively DVD-A sound makes this superb value for money, but 16bit playback is way behind similarly priced CD spinners.

CREEK CD50 2003 £699

Lyrical and musically engaging mid-price machine, but lacks its Marantz rival's tonal exuberance

CYRUS CD8 2003 £1000

Highly incisive, engaging, grippy and dynamic sound, but needs careful matching to smooth ancillaries. Optional PSX-R adds bass and dimensionality.

DENON DVD-AI 2002 £2500

Middling CD performance, but a genuinely strong DVD-A sound with masses of space and detail. Excellent pictures, too!



LINN GENKI 1999 £995

Undeniably fast, lithe, musical and fun - but some won't take to its dry, wry character. Works best in all-Linn systems, where it really rises to the challenge!

LINN IKEMI 1999 £1950

Has the brilliant focus and clarity of the previous Karik III with a dose more tonal richness and polish. More grip and poise than most at any price - still superb!

MARANTZ CD6000K1 2001 £500

Brilliantly warm and voluptuous sound will endear it to vinylphiles and tube lovers alike. Musical, colourful, polished and powerful like none others at or near its price.

MARANTZ CD17 II 2002 £800

Oft-overlooked middleweight boasts a truly beguiling sound with lots of tonal flavour. Sits awkwardly between the £600 and £1000 price points, where some brilliant value buys reside, though.

MARANTZ DV8300 2002 £1500

An extremely well designed universal player, offering a beguilingly natural sound whatever you feed it.

MERIDIAN 507 2003 £1195

Quintessentially Meridian mid-price machine; smooth, warm, expansive and seductively musical. The best all rounder at this competitive price point.

MUSICAL FIDELITY

TRIVISTA 2002 £4000

When playing SACDs, the sweetest, most lucid and lyrical digital disc spinner we've heard. Old school stereo, pure DSD design. CD sound is up in the £1000 class, too! Future classic.

NAD C5411 2002 £330

Highly musical and articulate budget machine in the classic NAD mould. Second only to Cambridge's CDS00SE in the value stakes.

NAIM CD5 2001 £1195

Taut and grippy like no others at the price, but lacks the warmth of the Marantz CD6000K1 at half the price. To wit, it's a very focussed product, best used in Naim systems.

NAIM CDX2-XPS2 2003 £4950

A fine high end machine, but add an XPS2 and it becomes one of the most charismatically engaging 16bit machines we've ever heard. Plays music with such passion!

NAIM CDS3 2003 £7050

The most polished Naim CD to date; tremendously capable and musical, but lacks the Rotweiler quality of the cheaper CDX2-XPS2.

PHILIPS DVD963SA 2003 £400

Creamy CD sound allied to superb SACD and DVD video playback makes this brilliant value for money.

REGA PLANET 2002 £498

Rhythmic and beguiling performer, although lacks the warmth of tone needed to better its Marantz rival. Superb ergonomics and design, nonetheless.

REGA JUPITER 2002 £1000

A Planet on steroids, this machine adds depth and breadth to its baby brothers already impressive sound. Good, but facing stiff competition.

DIGITAL RECORDERS

PIONEER PDR-609 2001 £200

Brilliant value CD recorder that makes excellent recordings from its digital inputs. Half decent digital converters, too.

PHILIPS DVDR880 2003 £370

Poor CD audio playback, but makes great DVD video recordings and boasts fine ergonomics. Top AV value.

SONY RCD-W3 2002 £250

Usual superb Sony ergonomics make for nonsense budget buy. Fine direct digital copies, but analogue input poor. Middling sonics, but there's a digital output!

YAMAHA CDR-HD1300E 2002 £600

HD means MD-style ease of editing, but compromises recording quality ever-so slightly. Add decent CD replay and it's a fine all rounder nonetheless - top value.



ONKYO MB-S1 2001 £1100

An interesting machine complete with MP3 functionality, but high price, fussy ergonomics and over-smooth sound make it mediocre value against the Yamaha.

PHONO STAGES

CREEK OBH-21SE 2003 £250

Musically enjoyable yet highly refined for the price - a superb buy. Gives the Dino a real hard time.

EAR 834P 1993 £400

Classic tube design with a deliciously warm and expansive sound - shame about the loose bass and velled treble!

LINN LINTO 2000 £900

A musical and incisive performer, with more speed than the Delphini at the expense of detail and tonal colour.

MUSICAL FIDELITY X-LP 1999 £149

Clarity and detail allied to decent smoothness make it a solid first phonostage. MM/MC.

QED DISCSAVER 1995 £35

Rhythmic, bouncy sound via battery, although it's bright and forward. Great value, but £100 more on the X-LP is well worth it!

TRICHORD DINO 2002 £299

Great all rounder with switchable MM/MC. Fast, fluid and smooth like no others at the price.

TRICHORD DELPHINI 2003 £995

The very latest 'Never Connected' variant is easily the best, bringing velvety smoothness to an already refined and engaging performer. Neutral to a fault - some will mourn the passing of the charismatic ISO.

AMPLIFIERS

ARCAM DIVA A65 PLUS 2002 £370

Classic budget Arcam fare - decently sweet and open with sensible facilities and plenty of power.



ARCAM FMJ A32 2001 £1150

For those who value serious power and labyrinthine facilities over outright clarity or grip. A very impressive all rounder with an unusually muscular power amp at this price.

AUDIO ANALOGUE

PUCINNI 1999 £495

Brilliant value mid-pricer is a real step up from budget designs. Smooth, fluid, natural sound with adequate power and no nasties. Fine phono stage too!

AUDIO NOTE OTO SE 2000 £1199

This baby tuber is beautifully sweet and creamy, but lacks solid-state's clarity, detail and incisiveness. Low, low power means speaker choice critical.

AUDIO NOTE SORO SE 2000 £1699

Wonderfully out-of-the-box sounding tube middleweight is all about sweetness and fluidity. Limited power and loose bass, but little the worse for it.

CYRUS 6 2003 £600

Cracking do-it-all mid price design, bringing svelte sound, good connectivity and upgradeability and stunning style and build.

CYRUS 8 2003 £800

Unusually warm and lyrical for a solid-stater, with decent power and punch. PSX-R adds dynamics, detail and dimensionality.



MERIDIAN 551 1994 £895

Evergreen middleweight is a serious performer even now. Tonally a tad dry, it's still very smooth and svelte with bags of power, detail and grip. Class act.

MUSICAL FIDELITY

A308 2002 £2400

Impressive monster integrated. Vast power delivered with clarity, even-handedness and finesse. Musical, with real tonal colour. Separate pre-power version better still, but less good value.

NAD C320 2002 £220

Not the giant killer that the 3020 once was, but a very strong budget design. A great starting point; forms a fine system with NAD's partnering C5411 CD player.

NAIM NAIT 5 2001 £845

A fast and thrilling listen, thanks to taut and articulate bass and midband. Surprisingly polished for a budget Naim amp, both sonically and ergonomically.



SUGDEN A21A 1993 £1020

The most musical amplifier at the price, bar none. Delicious Class A sound is smooth, sweet and wonderfully transparent with true tonal colour. Low power, so match carefully.

PREAMPLIFIERS

CREEK OBH-12 2000 £220

Brilliant value budget passive, giving little away in sonics to far more expensive designs. Connectivity and build aren't great, but what do you expect at this price?



MF AUDIO PASSIVE PRE 2003 £1010

Novel and effective pre with switchable gain via a transformer, and balanced operation. Open and incisive sound, yet makes most active rivals sound edgy by comparison.

NAIM NAC112 2002 £660

Affordable admission ticket to the Salisbury high end experience. Detailed and dynamic, if tonally rather lacklustre.

POWER AMPLIFIERS

LINN LK140 2000 £800

Dry and grey sounding, but decently dynamic and musically engaging all the same. A worthy worker in a budget Linn system.

NAIM NAPI50 2002 £795

Driven by a decent source and a NAC112, this gives highly enjoyable results - providing you like the Naim sound! Taut, fast and feisty despite its relative lack of power.

MARANTZ SM-17 2001 £700

Useful budget power amp with plenty of clean transistor power. Not the most transparent, but sweet and clean all the same. Fine build completes a great value package.



MUSICAL FIDELITY

A308 CR 2003 £2400

Superb transistor behemoth, worth partnering with any high end CD player or preamp. Oodles of grunt served up with poise and purpose.

QUAD 909 2001 £900

The latest current-dumper has a smooth and expansive character with enough wallop to drive most loads. Not the most musical, but super value all the same. Lovely build, finish and Quad's legendary service are nice.

LOUDSPEAKERS

B&W CDM1 NT 2002 £750

Fine clarity and imaging allied to pleasing warmth and great rhythmic cohesion make these standmounters an essential audition.

CASTLE CONWAY 3 2003 £930

Superbly smooth and crisp performers, with a big hearted musical sound. Ultimately coloured though, with a slow, plummy bass.

CYRUS CLS70 2001 £800

Charismatic performer with a fast, tight and open midband, but lacks cohesion and scale.

EPOS ELS-3 2003 £200

Plenty of brio and a decent degree of refinement makes this budget baby a fine value contender.



KEF Q1 2003 £250

Highly polished and articulate standmounters at the price, but demand good ancillaries for best results.

KLIPSCH HERESY II 1997 £1100

An outstanding high sensitivity loudspeaker with midrange and treble horns coupled with infinite baffle 12" bass driver. Effortless, fast and accurate.

LINN NINKA 2001 £995

Major on rhythms and dynamics, making them an involving listen. Reasonably refined, too - but tonally disappointing.

MISSION 782SE 2003 £900

Bright and tight design capable of brilliant speed and grip, at the expense of warmth. Demands high quality, high powered ancillaries.

MONITOR AUDIO B4 2003 £350

An unusually smooth and lucid performer at the price, and its 3-way design means it drives rooms well. Fine engineering, but build and finish so-so.

MORDAUNT SHORT 914 2002 £300

Warm, detailed and articulate performer, but a touch loose in the bass and veiled up top. Fine partner for budget valve amps.

NAIM ALLAE 2002 £1990

Taut and grippy like few others, this speaker majors on transient speed. Surprisingly smooth for a Naim box, with nicely etched treble. As always, tonally dry.

TDK S-80 2002 £90

Ingenious NXT multimedia sub/sat system has a wonderfully even and open sound - like baby electrostatics.

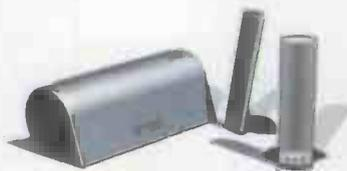

QUAD ESL-988 2001 £3400

Wonderfully neutral and self-effacing with sublime imaging and projection. Treble lacks extension, bass lacks weight - although the pricier 989 answers the latter resoundingly.

PERIGEE FK-1L 2002 £5000

Charismatic Aussie ribbon design with deliciously open mid and treble, allied to fine bass weight. The right room and ancillaries essential. Engaging, musical and powerful sound. Superb.

W'DALE DIAMOND 8.1 2001 £120

Still the best baby budget standmounters around. Tight and grippy thanks to Kevlar drivers, but invariably limited in the frequency extremes.



HEADPHONES

JECKLIN FLOAT TWO 1998 £99

Wonderful panel-like sound from these esoteric-looking headclamps.

SENNHEISER MX-500 1999 £19

Our unqualified recommendation for those seeking a serious sounding pair of in-ear phones. Smooth, detailed and musical.

SENNHEISER PX-100 2002 £29

Cracking pair of lightweight open back cans ideal for personals, but good enough for real hi-fi use. Superb build allied to a smooth and engaging performance make them the spiritual successor to the HD400s.

SENNHEISER HD-590 1998 £199

The company's best real-world cans to date. Open and smooth with plenty of detail. Brightly lit midband makes them an ideal partner for a valve headphone amp.



INTERCONNECTS

CHORD CO. CHAMELEON 2 £90/M

One of our favourites, these are musical performers with a smooth yet open sound.

DNM RESON £40/M

Neutral and transparent - a steal!

NORDOST BLUE HEAVEN £150/M

Some of the fastest and most transparent cable around.



VDH ULTIMATE THE FIRST £260/0.6M

Carbon interconnects that help you forget the electronics and concentrate on the music. Miraculous transparency. Tight and tuneful bass mixed with air and space results in a cracking cable for the money.

Contact Numbers
Mon-Fri 9am-5pm

WEBSITES

www.worldaudiodesign.co.uk
www.hi-fiworld.co.uk

Editor

Nick Lucas
tel/fax: +44 (0) 1908 218 836
e-mail: nick@worldaudiodesign.co.uk

Design & Layout Editor

Faiza Chunara
tel: +44 (020) 7625 3129
fax: +44 (020) 7328 1844
e-mail: adproduction@hi-fiworld.co.uk

Production/Photography Editor

David Noble
tel: +44 (020) 7625 3134
fax: +44 (020) 7328 1844
e-mail: classifieds@hi-fiworld.co.uk

Contributors

Andy Grove

Advertising

Amanda Sweeney
tel/fax: +44 (020) 8864 4760
e-mail: advertising@hi-fiworld.co.uk

Accounts

Sharon Mehlhom
tel: +44 (0) 20 8841 8892
fax: +44 (0) 20 8841 9144
e-mail: accounts@hi-fiworld.co.uk

Credit Control

Louise Palfrey
tel: +44 (0) 1923 270 833
fax: +44 (0) 1923 260 588
e-mail: creditcontrol@hi-fiworld.co.uk

Technical Editor

Noel Keywood
e-mail: publisher@hi-fiworld.co.uk

Private & Trade Classified Ads

tel: +44 (020) 7625 3134
fax: +44 (020) 7328 1844
e-mail: classifieds@hi-fiworld.co.uk

Subscriptions & Back Issues

9:30am - 12:00 noon
tel: +44 (0) 1923 270 833
fax: +44 (0) 1923 260 588
e-mail: subscriptions@hi-fiworld.co.uk

News & Letters Email

e-mail: diynews@hi-fiworld.co.uk
e-mail: diyletters@hi-fi-world.co.uk

WORLD AUDIO DESIGN

Technical Manager – Nick Lucas

www.worldaudiodesign.co.uk

tel/fax: +44 (0) 1908 218 836
e-mail: nick@worldaudiodesign.co.uk

Distributed by

Comag Magazine Marketing,
Tavistock Road, West Drayton,
Middlesex UB7 7QE
Tel: +44 (0) 1895 444 055

Printed by

Southern Print, Dorset
Tel: +44 (0) 1202 628 300

Our Agents in Malaysia

Millennium Hi-Fi & AV
Simon Chang
Showroom & office, 500-1-3 First Floor
Wisma Indah (Shen Court), Jalan Tun Razak
50400 Kuala Lumpur, Malaysia
Tel: 603 9283 8171 Fax: 603 9281 3762
e-mail: info@millennium-audio.com

All unsolicited submissions and goods are at the owner's risk. We accept no responsibility for such submissions, nor do we undertake to return them.

No material may be reproduced from this magazine without the publisher's written permission.
© Audio Publishing Ltd

DIY supplement contents



NEWS 97

All the latest from the weird and wonderful world of DIY hi-fi.

THE FULL CIRCLE 98

Andy Grove creates the ultimate push-pull monobloc using the world renowned 300Bs.

LETTERS & E-MAILS 105

Correspondence from our DIY readers.

www.worldaudiodesign.co.uk

HI-FI WORLD

SUITE G4, ARGO HOUSE
KILBURN PARK ROAD
LONDON, NW6 5LF

Falcon Acoustics Ltd

Falcon Electronics, Basically Sound
<http://www.falcon-acoustics.co.uk>

Full Price List and Focal details on Web Site

DRIVE UNITS: by FOCAL & seas, and a pick of the best from other manufacturers.

100+ CROSSOVER NETWORKS: - Active & Passive, Components, Accessories,

New LS3/5A type Crossovers
 COMPONENTS

SOLEN Polypropylene capacitors. 0.1mFd. to 100mFd.

Polyester and Polycarbonate Film Capacitors. 0.1mFd. to 10mFd.

ALCAP Reversible Electrolytic Capacitors (Non-Polar); 50v, 100v & Low Loss. 2mfd. to 600mFd.

FALCON Custom-wound Inductors.

FERRITE:- Standard, High Power, Super Power, Super-Super Power

AIRCORED 0.56 - 1.25mm wire; IRON DUST. 1mm wire

TAPPED INDUCTORS:- 0-10mH in 1mH steps & 0-1mH in 0.1mH steps

AUDIO AMATEUR PUBLICATIONS

Back year sets of Speaker Builder, Audio Amateur & Glass Audio, plus the Audio Anthology Set.

Altogether 50+ books and 50+ Audio Amateur's magazine year sets.

2001 & 2002 year sets on CD-R only

FOCAL 'State of the Art' Units & Kit Designs'

Focal Unit Range

as pioneered in the Utopia range of systems.

Price List & Unit Specs FREE on Web site - available in .pdf format

Summer Sale

10% off all Focal Units; Publications & Software.

(Ref. PL31, Stock items only)

On all orders received during July & August 2003.

SUPPLIERS TO THE TRADE SINCE 1972

Send for our FREE price list PL31: Just send a large S.A.E. (46p stamp) or US\$2 bill overseas, Europe US\$1 bill or 3 International Reply Coupons (IRC) to:-
 (Dept HFW) Unit 12 Damgate Lane Industrial Estate, Damgate Lane
 ACLE, Norwich, Norfolk, NR13 3DJ Tel: 01493 751100

Rediscover
 the beauty of
 pure sound...

NEW!

Visit our web site at
www.chelmervalue.com
 to view our entire valve
 catalogue and buy on
 line!

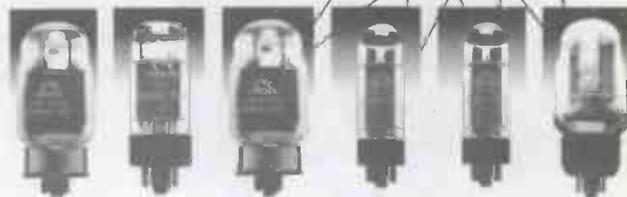

We have been supplying tubes to the audio market for over 40 years. Only valves that pass our stringent in house QC tests are used for the CVC Premium brand, and our no fuss guarantee ensures your complete peace of mind. When available, we also stock the justifiably famous brands such as Brimar, GEC, Mullard, RCA Telefunken etc. So why compromise? Our sales and technical staff are just a telephone call away. To put it simply.....

YOUR NEEDS...OUR BUSINESS.

CVC Chelmer Valve Co Ltd

The Stables, Baddow Park, Great Baddow,
 Chelmsford, Essex CM2 7SY

Tel: +44 1245 241300 Email: sales@chelmervalue.com
 Fax: +44 1245 241309 www.chelmervalue.com

audioXpress... It Just Sounds Better

Your Favorite Audio - One New Magazine!

- PROJECTS
- REVIEWS
- THE NEWEST TECHNOLOGIES
- AUDIO CLASSROOM
- and Much More!



Subscribe To This
 Great Monthly
 Publication Today!

Only \$59.95 us
 for 12 Issues!

audioXpress • PO Box 876 • Peterborough, NH

03458-0876 USA • Phone: 603-924-9464

Fax: 603-924-9467 • E-mail: custserv@audioXpress.com

ORDER ONLINE AT: www.audioXpress.com

WHITE NOISE

AUDIO KITS, MODULES, COMPONENTS

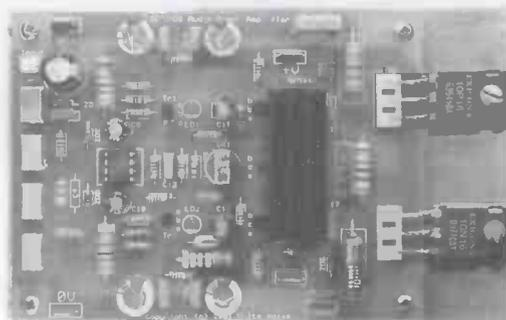

PRODUCTS INCLUDE:- Power Amplifiers 30-250W, Preamplifiers, Phono stages, Active Crossovers, Power Supplies, Buffer Amplifiers, Balanced line drivers / receivers, Stepped attenuators, Gold plated connectors, Cables, Capacitors, Resistors, Semiconductors, Transformers, Subwoofers, Loudspeaker drive units

WHITE NOISE
 11 STATION ROAD
 BEARSDEN
 GLASGOW
 G61-4AW

Web:- <http://www.wnaudio.com>
 Email:- david.white38@ntlworld.com
 Tel:- 0141-942-2460 (until 9pm)
 Fax:- 0141-587-7377

diy news

FAIR FUN

This year's Vintage Valve Technology Fair is the brainchild of two friends, Trevor and Steve, who have been keen collectors of tube technology for many years. It represents the culmination of eighteen months of planning to bring vendors and customers alike a great fair at a great venue. It will be held at Haydock Park Racecourse, Newton le Willows, Merseyside WA12 0HQ on July 27th 2003. Public entry is from 10am to 4pm.

Entry charge is £2.50 per person, with bored wives and kids free. Parking is also free, and access is easy as it's only five minutes from M6 Junction 23. And in case you were wondering, there's even a bar! For more information see



The organisers

www.myciunka.supanet.com/VVTF2003
<http://www.myciunka.supanet.com/VVTF2003>
 or telephone +44 (0)1274 824816

DUNKING AMPS

This site is a superb resource for those into valve amps, a definite for your favourites. It has various sections, and a "tube data sheet locator", which does exactly that. There is a large database; click "tube data" and input your desired valve and

away you go. As a test I put in EL34 and three variants came up, I went for the EL34G. The site provided a pinout diagram, substitutions, ratings, application data and a further twenty links if I needed to find out more. You can also learn about two Duncan guitar amps (not for sale, unfortunately). There is also various tube related software for free download. With 1199 valve related schematics you will find this site very informative.

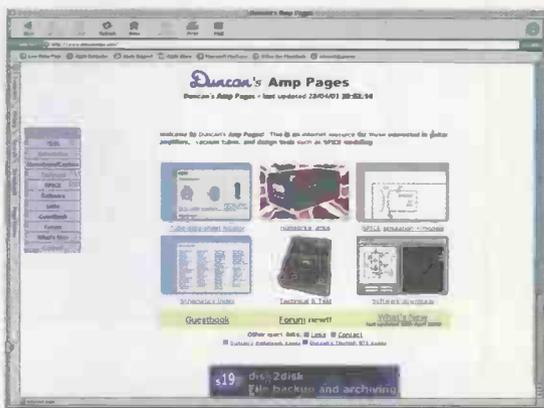

www.duncanamps.com

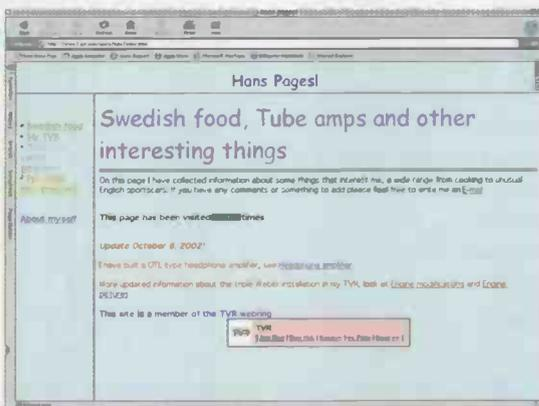

HANS ON

Here's a personal site created by Hans, a Swede living in Japan. He basically loves to design, build and listen to vacuum tube amplifiers. He has made a 6I45B push-pull amplifier, a Dynaco PAS3 pre-amp copy, a 6C33C SE amp., a 6C33C output transformerless (OTL)

amp and an OTL headphone amp using 6DJ8s. All details are listed about his kits. One thing to note is that they look very professional. He has also a pair Lowther Fidelio Horns, home built, on the site. He also talks about the other loves of his life, namely Swedish food and his TVR car.

www2.gol.com/fusers/tubelindex.html

TUBE DOCTOR

This is a very informative site, built by a Dutch guy who refers to himself as Dr Tube. He offers a repair service for valve equipment, if you can make it to Rotterdam. The great thing about www.drtube.com is the circuit database of well known valve based equipment. There are circuits here from Copland, Conrad-Johnson, McIntosh and Grant Lumley to name a few. Also, it features guitar amp circuits and a whole section dedicated to Marshall amps. An added bonus is the valve datasheet section, with full valve characteristics of numerous valves. There are seven different files for the ECC83 as supplied by seven different manufacturers of the valve. An excellent resource.

<http://www.drtube.com/audiodmp.htm>



300B POWER

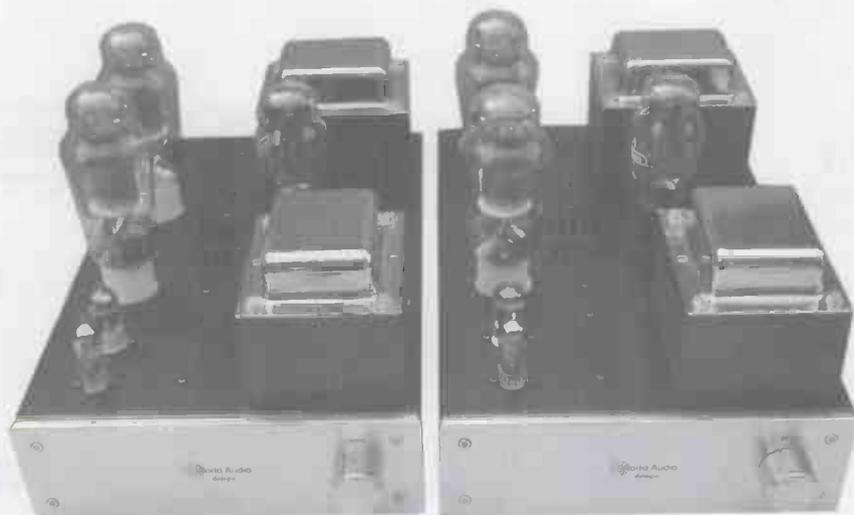

Andy Grove creates push-pull monoblocs using the world renowned 300B triode valve.

Of all the power valves available, the 300B triode is one of the most respected. It is a super-linear triode, designed specifically for low distortion in high power audio amplifiers. The 300B is one of the few amplifying devices available today that produces so little distortion it doesn't need feedback. This makes it virtually unique in a solid-state world where all circuits must have feedback applied to suppress high levels of intrinsic distortion.

We first used the 300B way back in 1993 (Issue No4, August 1993), in a stereo push-pull amplifier giving 32watts per channel. In keeping with the 300B's reputation around the world as one of the finest audio amplifying devices this design gave a wonderfully smooth, open sound quite unlike anything else.

The World Audio Design 300B push-pull (PP) monobloc featured here has the same layout as our highly regarded 300B Parallel Single-Ended design. Less tightly packed than the original stereo amp, each monobloc has component and hardware orientation for optimised low hum pickup.

The push-pull has a slightly different valve lineup to the single-ended. Its 6AU6 7-pin pentode remains as the input valve, but for the phase

splitter we have employed the wonderful power house 5687 double-triode valve. It also featured in the old push-pull version, though in this application it drove the interstage transformer that created the two 180degree phase shifted waveforms to drive the 300B output valves.

We have stuck with the JJ 300Bs, finding them both reliable and musical the last few years that we have used them in the PSE.

The power supply is valve rectified using the Russian 5U4, a real toughy in the power supply stakes. See Simon Pope's review at the end of this article to see how this amplifier sounds in comparison to the parallel single-ended.

THE DESIGN

Andy Grove created this cracking design for us. With nearly 20 years of experience, Andy's design skills are sophisticated, especially in the critical area of output transformers. These provide full power bandwidth, giving an accurate tonal balance free of the artificial softness introduced by transformer limitations.

Part of the brief for Andy was to incorporate the same mains transformer, choke, valve rectifier and basic power supply as used for the PSE kit, to make a possible transition to the PP version easier. As a direct response to Andy's last article enti-

tled "Valve Loading Explained" as published in DIY Supplement No 73 (HFW June '03 issue), the output transformers have a six ohm winding on the secondary which is more suited to modern loudspeakers. Andy goes into more detail about the circuit below.

THE CIRCUIT - BY ANDY GROVE

The input amplifier is a venerable 6AU6 pentode (v1) strapped as a triode via R14, a 100ohm resistor being used to damp any possible parasitics. Both the screen (g2) and suppressor (g3) are connected to the anode as this configuration gives slightly better triode characteristics. Resistors R12 and R13 combine as the anode load resistor, R10 is a grid stopper and R11 is the grid leak.

For the 300B PSE amplifier kit we had switchable feedback, a feature that we now believe to be redundant as just about everybody uses the monoblocs without feedback. So for the 300B PP, we decided to make it a purist feedbackless design. In brief, the fact that your signal is passing through a switch, travelling an extra 60cm and is altered slightly by the feedback network injecting slight noise, does compromise the sound, so no feedback here (Noel says - I have lived with our original 300B for 10 years and never use its optional feedback. It improves measured per-

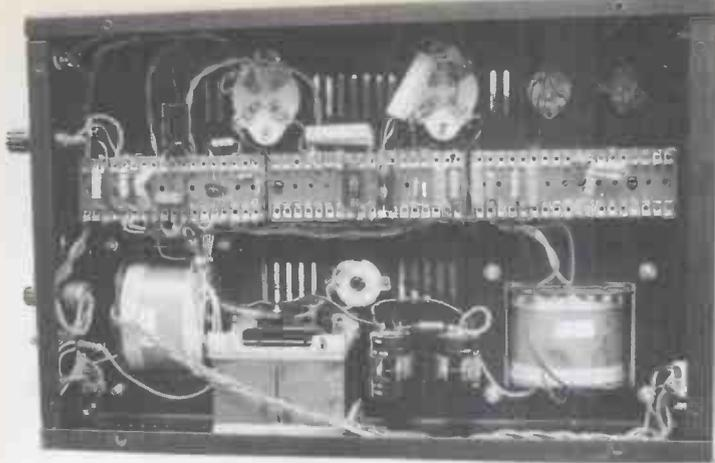

formance, but not sound quality).

The phase splitter, V2, is of the cathode-coupled type and uses a 5687 double triode. This is a very linear, high prevalence triode which sounds superb and is ideal for driving triode output valves. The load resistors, R16 and R19 are of slightly different values to make up for the loss in the common cathode resistor R18. The second, or in-phase, half of the phase splitter needs to be of a higher value. Resistor R17 keeps both grids at the same DC voltage while C12 decouples the AC from the grid of the second half of the inverter so it receives its signal via its cathode.

Capacitors C11 and C13 are the coupling capacitors to the grids of the 300B output valves, the grid leak resistors are R20 and R25. Resistors R21 and R26 are the 300B grid stoppers and besides preventing parasitic oscillation they reduce the effects of grid current when the amplifier is overloaded, reducing recovery time. A small amount of negative bias is applied to the grids to increase efficiency and reduce the HT requirement. The voltage across the cathode resistors is still enough to stabilise the 300Bs operating point. R22 and R23 form a divider across the filament of 300B V3 to give a balanced return point. An adjustable potentiometer is provided for V4 in order to balance out filament supply induced hum. The anodes of the valves are of course taken to the two primary connections of the output transformer in the usual manner.

The H.T. power supply uses valve rectification via a Russian 5U4 (5u3c) valve. Two capacitors (C1 and C2) are connected in series at the filter input to increase the voltage rating as ripple here adds to the peak voltage seen by the capacitors. Resistors R2 and R3 are used to balance the

voltage across them. The choke L1 and capacitor C3 reduce the ripple to an acceptable level for the output stage, R4 and C4 reduce this further for the input stages. A small LT supply is provided using a solid-state bridge, BR2 and reservoir and smoothing elements C6, R5, and C7. The voltage is then dropped to the required voltage by R7 and R8 and then further filtered and decoupled by C8.

A basic DC heater supply is provided to reduce hum in the input stages, this reduction is further improved by raising the base voltage to +45V DC above earth to stop any interaction with the signal earth, R5 and R6 act as a voltage divider and is decoupled by C5.

POWER ISSUES

The output power of this amplifier, at 26 watts, is a little lower than the 32watts maximum output of the original. With the experience we have gathered over the years we have discovered that it doesn't pay to drive output valves close to their maximum ratings. The 300B's maximum plate dissipation is 40 watts. In this design we are running them at 30 watts, this was the hardest we could drive them at the 390V DC HT the amplifier uses. This will give long valve life.

If you are one of those who like to make your tubes work, higher output power can be achieved by raising the HT voltage by 60V DC or so. This would require a new mains transformer with a winding of something in the region of 440V-0V-440V 230mA feeding the anodes of the 5U4. Sonically the difference would be minimal.

THE KIT

The kit is of the usual high standard we insist upon. It features chunky

gold plated insulated phono sockets at the rear. The power is received via an IEC mains lead into a chassis mounted socket and controlled by a switch located on the front panel. Gold plated 4mm speaker connectors are used.

For best quality the kit uses hard wiring, not a circuit board. All valve sockets are chassis mounted and of the white ceramic variety. They project up through the chassis without exposing the ring fittings. Three tag boards are provided, each carrying 18 pairs of terminals, onto which the components are soldered. This crucially leaves plenty of room for larger audio grade components to be used if wanted.

The chassis is made from heavy duty 2.4mm mild steel with a black powder coat finish. The 6mm anodised aluminium alloy front panel is sturdy in a way rarely encountered these days, and it is complemented by custom chrome knob. The transformers are topped with chromed shrouds.

The components we supply are of a high standard. There is a mix of carbon film resistors at 0.5W rating, metal oxides for the 3W types and the standard axial wirewound ceramic resistors for the cathode resistors of the 300Bs.

For the capacitors we use a mix of Hua Lien T series high voltage axial electrolytics and F&T 500V electrolytics for the power supply. Forever RB series electrolytics are used as the bypass capacitors and BC (once Philips) orange 386 series for the signal capacitors; they are excellent sounding caps.

The wires used vary, but note we supply silver plated copper PTFE wire for low current use. The humbucker potentiometers are the high quality 2W Cermet type, the bridge rectifiers are standard National Semiconductor types. All our transformers are custom made by a UK company very experienced with valve equipment and high voltages! We are confident their skilled winding and layering of our complex output transformers cannot be beaten.

THE BUILD

The 300B Monobloc kit is a challenge to build, due to its hardwire construction, but rest assured there are plenty of diagrams to guide you through. As long as you follow the

instructions carefully it should be plain sailing. There are no tricky set-up procedures; the only thing that needs adjusting is the hum-bucker potentiometer, which basically tune the 300B valves to the near-zero hum level.

We have a help-line manned 9am to 5pm weekdays, and a full back up service to the point of arranging collection of your amplifier, to fix all problems.

SOUND QUALITY BY SIMON POPE

After the success of the Parallel Single Ended monobloc, there was a demand for the tube to be used in an amp that could create slightly more power and grip – enough to drive a hungry pair of loudspeakers. Hence the birth of the new push-pull version, the 300B PP monobloc. This configuration and design should have enough grunt and power to drive most mainstream loudspeakers – remember that valve power has more apparent drive than its equivalent solid-state cousin.

Kicking off the listening with Badly Drawn Boy's *Hour of the Bewilderbeast* album it was immediately apparent that this monobloc can deliver the goods when it comes to drive and rhythm. Bass is awe-

somely full, yet tight and tuneful - and drums are delivered in an incredibly realistic manner.

Contrary to popular myth, a good valve amplifier can do speed and timing and the 300Bs in push-pull mode proved this. The sound is fast and speedy but also highly detailed in the traditional valve mould.

With classical orchestral music, the push-pull effect is shown in both scale and dynamics. Put on something 'big' such as Mahler or Stravinsky and you'll be transported to the Albert Hall without the pain-in-the-butt echo! Dynamics are realistic; the massive climaxes in Mahler's second symphony are delivered with power and intensity, yet also the more tender moments of thinner orchestration show that a sense of transparency is also present. Those who think that a push-pull design sacrifices refinement for power will be surprised here.

Likewise, Stravinsky's *Rite of Spring* had me jumping from my chair every time the bass drum thumped, such was the shock-realism effect. Again, the lighter side of the sound was displayed by the airiness to which the amp treated the varying timbres of the woodwind section.

Lastly, moving onto jazz in the shape of Coltrane's *A Love Supreme*,

the 300B PP showed that it could also be as smooth as the proverbial baby's hind quarters. Cymbals were sweet and fluid and the saxophone had a rich and lyrical sound that will grace any jazz-lover's lounge.

Most of my listening was done using Quad's ESL-988 'speakers but the amplifier also proved it could handle almost anything chucked at it. They drove a whole host of 'speakers from Diapason's luxurious miniature, the Karis, to more 'difficult loads such as Mission's 782s and Jamo's 'old' classic, the Concert 8.

Anyone wanting to indulge in a valve amp that delivers control, dynamics, depth and power, in addition to detail and transparency, should discover the 300B PP monobloc. It's a very fine design indeed, and one that betters many at least four or five times the kit price. And that's a fact.

300B PP MONOBLOC MEASURED PERFORMANCE

(into a 60hm load)

| | |
|--------------------|----------------|
| Power output | 26 watts |
| Frequency response | 12Hz - 26kHz |
| Distortion (thd) | less than 0.1% |
| Noise | 0.5mV |
| Sensitivity | 300mV |

PARTS INVENTORY FOR TO CONVERT A 300B PSE MONOBLOC PAIR TO 300B PP MONOBLOC PAIR

RESISTORS:

PART NUMBER

R1

R4

R5

R6

R7

R8

R9

R10

R11

R12

R13

R14

R15

R16

R17

R18

R19

R20

R21

R22

R23

R24

R25

R26

R27

R28

R29

PARTS DESCRIPTION

10R, 2W

2.2K, 3W

470K, 3W

56K, 3W

100K, 0.5W

330K, 0.5W

1K, 1W

2.2K, 0.5W

100K, 0.5W

68K, 3W

68K, 3W

100R, 0.5W

820R, 1W

27K, 3W

1M, 0.5W

12K, 3W

33K, 3W

220K, 0.5W

10K, 0.5W

15R, 3W

15R, 3W

330R, 7W

220K, 0.5W

10K, 0.5W

4.7R, 2W

4.7R, 2W

330R, 7W

QUANTITY

2

2

2

2

2

2

2

2

2

2

2

2

2

2

2

2

2

2

2

2

2

2

2

2

2

2

2

CAPACITORS:

PART NUMBER

C8

C12

C13

5687 valve

PARTS DESCRIPTION

10uF, 250V

0.47uF, 400V

0.47uF, 400V

QUANTITY

2

2

2

2

HARDWARE:

DESCRIPTION

output transformer

self adhesive clips

tie wraps

earth post

wire (various) tag strip

QUANTITY

2

10

10

2

6

300B PP MONOBLOC CIRCUIT DIAGRAM SIGNAL CIRCUIT

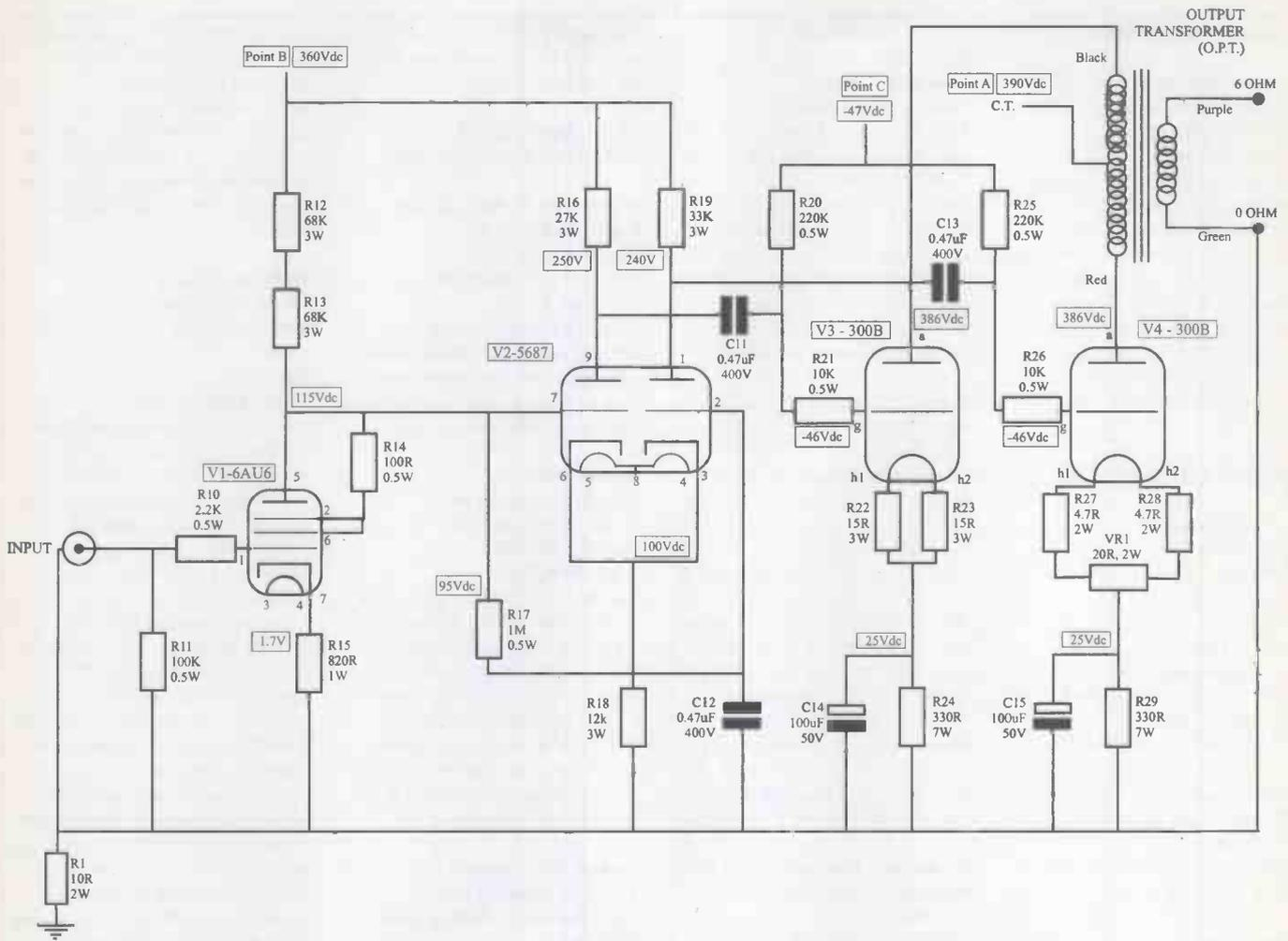

VALVE PIN LAYOUT

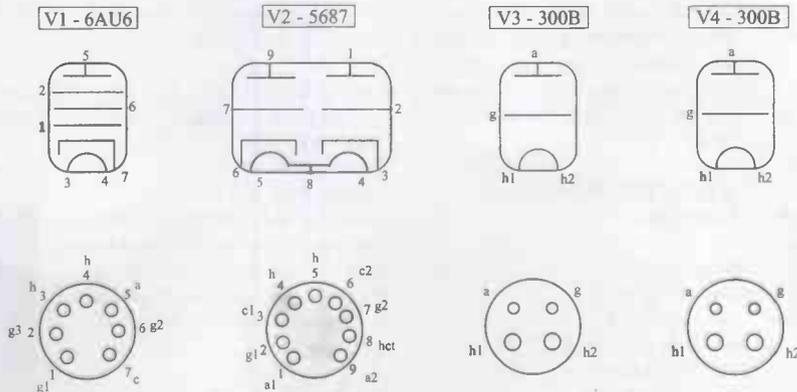

Views are from underneath valve or valve holder
 h, h1, h2 = heater hct = heater centre tap c = cathode a = anode g = grid nc = no connection

ALL TEST VOLTAGES WERE MEASURED WITHOUT THE SIGNAL INPUT GROUNDED.
 OUTPUTS CONNECTED TO A 60HM LOAD, RUNNING OFF A 230Vac SUPPLY. PLEASE
 NB. TEST VOLTAGES CAN VARY WITHIN 20% OF STATED VOLTAGES, DUE TO VARIATIONS
 IN MAINS SUPPLY AND VALVE CHARACTERISTICS.

kit & component suppliers

CLASSIC TURNTABLES

Technical & General
 P.O. Box 53, Crowborough,
 East Sussex TN6 2BY.
 Tel: 01892 65 45 34.

The original specialist source of spares, replacements and expertise for the classic turntables. Years of actual experience and comprehensive range of parts (originals and re-manufactures), manuals, ancillaries, No dubious 'improvements' - no harmful 'modifications'. Our specialities: Connoisseur; Garrard; Goldring; Lenco; S.M.E.; Thorens; Watts; Ortofon; Shure; Cartridges and styli for 78s, Mono LPs, Stereo LPs.

COMPONENT SUPPLIERS

"A" Audiosolutions
 63 Love Lane
 Pontefract
 West Yorkshire
 WF8 4EG
 01977 798844
 email: Audiosolutions@aol.com
 KIWAME resistors - 2w £1.10ea,
 5w £2.20ea
 GOLDPOINT stepped attenuators -
 true ladder type stereo/mono
 JJ - electrolytic capacitors 100uf + 100uf /
 500v 32uf + 32uf / 500v £9.00ea
 others available
 BARTOLUCCI - c-core mains and
 output transformers.

White Noise
 11, Station Road, Bearsden
 Glasgow G61 4AW
 Tel: 0141 942 2460
 Fax: 0141 587 7377
 Email: david.white38@ntlworld.com
<http://www.wnaudio.com>
 Supplier of the widest range of standard
 and audiophile kits for solid state preamplifiers,
 power amplifiers, headphone
 amplifiers, power supplies, MM/MC
 phono stages, active crossovers, balanced
 i/o modules, and stepped attenuators;
 more kits in the pipeline. All kits use the
 highest quality, glass fibre, solder masked,
 silkscreened, PCBs. We also supply a wide
 range of active (esp. Japanese transistors
 and Exicon mosfets) and passive compo-
 nents, gold plated connectors, and silver
 plated wires. Write, phone or email for a
 free catalogue. Mail order only.

Audio-Links
 7 Fairmont Crescent,
 Scunthorpe,
 North Lincolnshire DN16 1EL
 Tel: 01724 870432
 Fax: 01724 875340
 Email: audiolinks@ukonline.co.uk
 Extensive stock of specialist audiophile
 components for valve and solid state
 enthusiasts. Supplier of the largest range
 of high-end audio volume controls in
 Europe. 30 page catalogue - Free via
 e-mail or £3.00 posted.

LOUDSPEAKER KIT SUPPLIERS

Audio Note (UK Ltd)
 Unit C, Peacock Ind. Est.
 125-127 Davigdor Road
 Hove, East Sussex BN13 1SG
 Tel: 01273 220511
 Fax: 01273 731298

Suppliers of a large amount of compo-
 nents for the Audiophile Kit builder. Valve
 amplification data and vintage circuits also
 available. See the double page spread in
 the back section of the main issue for
 extra & more detailed information.

Falcon DIY Speakers
Falcon Acoustics Ltd.,
 Tabor House,
 Norwich Road, Mulbarton,
 Norfolk
 NR14 8JT.
 Tel: 01508 578272

UK distributors of FOCAL drive units &
 kits, and ETON loudspeakers, plus
 SOLEN (SCR-Chateauroux) polypropy-
 lene capacitors. We are the largest spe-
 cialist Audio inductor manufacturer in the
 UK. We also stock Audio Amateur
 Publications and Audio Computer
 Software and a comprehensive range of
 D.I.Y. speaker kits, parts, accessories and
 books. Please send large SAE (44p) for
 free price list. "Everything but the wood".

IPL Acoustics, Chelsea Villa, Torrs Park,
Ilfracombe, North Devon,
EX34 8AY
 Tel/Fax: 01271 867 439
 Website: www.iplacoustics.co.uk
 IPL Acoustics supply a range of 7 trans-
 mission line, 3 conventional, speaker kits,
 and kits for centre speakers and active
 subwoofers. We also supply a full range of
 drive units from Audax, SEAS, Morel and
 Legend Acoustics (Ribbon Tweeters) as
 well as custom built metal coned drivers.
 Also included is a range of capacitors,
 inductors and quality cabinet accessories
 as well as Silver Plated PTFE insulated
 cables.

SPECIALIST UPGRADE SERVICES

AudioCom (UK),
 Unit 14 Pier Road
 Pembroke Dock
 Pembrokeshire, SA72 6TR
 Tel: 01646 685601
 Fax: 01646 685602
 Website: www.audiocom-uk.com
 E-Mail: enquiries@audiocom-uk.com
 Release the full potential of your digital
 source with CD/DVD upgrades from
 audiocom. Available is the highly
 acclaimed SUPERCLOCK master clock
 oscillator. (Dave Berriman fits the S-Clock
 to the Teac VRDS-10SE and
 comments...."there was not one area of
 music reproduction which didn't improve".)
 SUPERCLOCK super low noise power
 supply, & Q-power ultra-low noise dis-

crete regulators. Why not contact us to
 see how this service can be adapted to
 suit your requirements?

VALVE AND OUPUT TRANSFORMER SUPPLIERS

Wilson Valves, 28 Banks Avenue,
Golcar, Huddersfield,
West Yorks HD7 4LZ.
 Tel: 01484 654650/844554
 Fax: 01484 655699
 E-mail: wilsonv@zoo.co.uk
 We stock over 2,500 different types of
 valves, N.O.S. and New. Please send a
 S.A.E. for full list. No charge for matching.
 Most major credit cards accepted.

Watford Valves
 3 Ryall Close, Bricket Wood,
 St. Albans, Herts AL2 3TS
 Tel: 01923 893270
 Fax: 01923 679207
 Specialist in new old stock and current
 production valves. Sole UK distributor of
 the Harma Diamond range selected for
 their superior performance. Huge range
 held, stockists of Mullard, GE, Philips,
 National, Brimar, Sylvania, Telefunken,
 RCA, MOV and many more. All valves
 are new boxed and guaranteed. For free
 price list and specialist advice call or fax
 Derek Rocco, Watford Valves.

Chelmer Valve Company Ltd
The Stables, Baddow Park
Great Baddow, Chelmsford, Essex
CM2 7SY
 Tel: 01245 241301
 Fax: 01245 241309.
 Email: sales@chelmervalue.com
 Web Site: www.chelmervalue.com
 Supplier of premium range of audio
 valves, other valves and components also
 available. (Please see our main advertise-
 ment in this supplement).

Langrex Supplies Ltd
 1 Mayo Road, Croydon,
 Surrey CRO 2QP
 Tel: 020 86841166
 Fax: 020 86843056
 One of the largest distributors of elec-
 tronic valves, tubes and semi-conductors
 in the UK by original UK and USA man-
 ufacturers. Obsolete types are a speciality.
 Telephone or fax for an immediate
 quotation.

Billington Export Ltd.
IE Gillmans Trading Estate,
Billingshurst,
West Sussex
RH14 9EZ
 Visitors by appointment only please
 Fax: 01403 783519
 E-Mail: sales@bel-tubes.co.uk
 Website: www.bel-tubes.co.uk
 Specialists in guaranteed new/old stock,
 current production valves & tubes. Also
 CRT for audio, hi fi (as well as industrial
 uses). A vast archive of vintage and obso-

lete types including limited quantities of
 Mullard, GEC, Sylvania, Philips, Brimar,
 Telefunken, RCA and others. Large
 stocks of Chinese, Russian, El and Tesla
 etc. A 50-page valve catalogue is available
 on request. Major stockists of the excel-
 lent Billington Gold brand. Contact us for
 quotations - attractive price on larger
 orders.

Audio Specialists
73 Stoneyford Road
Sutton-In-Ashfield
Notts
NG17 2DL
 Tel/Fax: 01623 461122
 Email: audiospecialists@talk21.com
 UK distributors for Cardas Audio, Tobias
 Jensen, Orca & Raven products. Product
 line includes Silver, copper & tin foil paper
 in oil signal capacitors, 12AWG &
 14AWG 99.99% (O.F.C.) copper foil
 inductors. Any intermediate value avail-
 able from 0.00mH to 8mH, copper &
 aluminium loudspeaker capacitors,
 Cardas Audio patented 6N 99.99998%
 golden section litz cable, 99.9997% 5N
 silver. Full superb range of Cardas Audio
 connectors. Full range of Orca drive units.
 Raven (R1-R3) ribbon transducers (95-
 100dB sensitivity). electro Harmonix
 valves. Vast range of audio componets
 and accessories. Extensive range of trans-
 formers available for modern and vintage
 audio equipment. One off a speciality.
 replacement and upgrade transformers
 for W.A.D., Leak, Marantz, Radford, Quad,
 (potted) Williamson and many more.
 Superb range of interconnect loudspeaker
 and power cord cables. Choke input
 power supplies available for solid state
 and valve equipment. (Made to order
 bespoke range of transformers shunt
 (parallel) feed a speciality. All products use
 the very best materials currently available
 in the world. All types of repairs, modifi-
 cations & restoration undertaken to
 valve and solid state equipment. Classic
 and vintage equipment always sought,
 working or not. Catalogue £3.50
 redeemed on first order over £30.00

**TO ADVERTISE IN
 THE KIT &
 COMPONENT
 SUPPLIERS PAGE
 PLEASE CALL
 020 8864 4760**

Email:

diyadvertising@hi-fiworld.co.uk

PARTS INVENTORY FOR A PAIR OF 300B PP MONOBLOC AMPLIFIER KITS

RESISTORS:

| PART NUMBER | PARTS DESCRIPTION | QUANTITY |
|-------------|-------------------|----------|
| R1 | 10R, 2W | 2 |
| R2 | 220K, 2W | 2 |
| R3 | 220K, 2W | 2 |
| R4 | 2.2K, 3W | 2 |
| R5 | 470K, 3W | 2 |
| R6 | 56K, 3W | 2 |
| R7 | 100K, 0.5W | 2 |
| R8 | 330K, 0.5W | 2 |
| R9 | 1K, 1W | 2 |
| R10 | 2.2K, 0.5W | 2 |
| R11 | 100K, 0.5W | 2 |
| R12 | 68K, 3W | 2 |
| R13 | 68K, 3W | 2 |
| R14 | 100R, 0.5W | 2 |
| R15 | 820R, 1W | 2 |
| R16 | 27K, 3W | 2 |
| R17 | 1M, 0.5W | 2 |
| R18 | 12K, 3W | 2 |
| R19 | 33K, 3W | 2 |
| R20 | 220K, 0.5W | 2 |
| R21 | 10K, 0.5W | 2 |
| R22 | 15R, 3W | 2 |
| R23 | 15R, 3W | 2 |
| R24 | 330R, 7W | 2 |
| R25 | 220K, 0.5W | 2 |
| R26 | 10K, 0.5W | 2 |
| R27 | 4.7R, 2W | 2 |
| R28 | 4.7R, 2W | 2 |
| R29 | 330R, 7W | 2 |
| VR1 | 20R, 2W | 2 |

CAPACITORS:

| PART NUMBER | PARTS DESCRIPTION | QUANTITY |
|-------------|-------------------|----------|
| C1 | 47uF, 450V | 2 |
| C2 | 47uF, 450V | 2 |
| C3 | 100uF, 500V | 2 |
| C4 | 100uF, 500V | 2 |
| C5 | 10uF, 250V | 2 |
| C6 | 100uF, 250V | 2 |
| C7 | 100uF, 250V | 2 |
| C8 | 10uF, 250V | 2 |
| C9 | 4700uF, 16V | 2 |
| C10 | NOT USED | |
| C11 | 0.47uF, 400V | 2 |
| C12 | 0.47uF, 400V | 2 |
| C13 | 0.47uF, 400V | 2 |
| C14 | 100uF, 50V | 2 |
| C15 | 100uF, 50V | 2 |

BRIDGE RECTIFIERS:

| PART NUMBER | PARTS DESCRIPTION | QUANTITY |
|-------------|-------------------|----------|
| BR1 | WO8 | 2 |
| BR2 | 2KBP02 | 2 |

HARDWARE:

| DESCRIPTION | QUANTITY |
|--|----------|
| mains transformer | 2 |
| output transformer | 2 |
| choke | 2 |
| main chassis | 2 |
| chassis base | 2 |
| chassis front plate | 2 |
| chrome knob | 2 |
| mains switch rotary | 2 |
| Fuse 1.6A slow blow | 2 |
| black phono, gold plated & insulated | 1 |
| red phono, gold plated & insulated | 1 |
| 4mm speaker sockets, gold plated & insulated | 2 pairs |
| IEC lead | 2 |
| self adhesive feet | 4 |
| IEC + fuse inlet socket | 2 |
| stand-offs 25mm | 12 |
| self adhesive clips | 10 |
| tie wraps | 10 |
| M3 fibre washers | 12 |
| earth post | 2 |
| M4 x 10 screw | 4 |
| M4 x 50 screw | 4 |
| knob for VR1 | 2 |
| M4 x 12 hex | 8 |
| M3 x 12 screw | 64 |
| m3 x 6 screw | 4 |
| M3 nut | 52 |
| M4 nut | 16 |
| grub screw | 2 |
| capacitor clips | 4 |
| UX4 valve base | 4 |
| Octal valve base | 2 |
| B9A valve base | 2 |
| B7G valve base | 2 |
| wire (various) | |
| tag strip | 6 |

VALVES (FOR WITH VALVE KITS ONLY)

| DESCRIPTION | QUANTITY |
|-------------|----------|
| 300B Tesla | 4 |
| 5U4 | 2 |
| 6AU6 | 2 |
| 5687 | 2 |

LANGREX SUPPLIES LTD

DISTRIBUTORS OF ELECTRONIC VALVES, TUBES AND SEMI-CONDUCTORS AND I.C.S.

1 MAYO ROAD • CROYDON • SURREY CRO 2QP

24 HOURS EXPRESS MAIL ORDER SERVICE ON STOCK ITEMS

E-MAIL: LANGREX@AOL.COM

PHONE

020 8684 1166

FAX

020 8684 3056

A selection of our stocks of **New Original Valves/Tubes.**
Many other brands available

| STANDARD TYPES | | | SPECIAL QUALITY TYPES | | | OTHER TYPES | | |
|----------------|---------|-------|-----------------------|----------|-------|-------------|--------|-------|
| ECC83 | E.I | 4.00 | A2900/CV6091 | GEC | 17.50 | 12BY7A | GE | 7.00 |
| ECC85 | RFT | 5.00 | E82CC | SIEMENS | 7.50 | 5687WB | BCG | 6.00 |
| ECC88 | BRIMAR | 6.00 | E83CC | TESLA | 7.50 | 5814A | GE | 5.00 |
| ECC88 | MULLARD | 10.00 | E88CC | BRIMAR | 15.00 | 6072A | GE | 10.00 |
| ECH81 | MULLARD | 3.00 | E88CC/CV2492 | TESLA | 8.50 | 6146B | GE | 15.00 |
| ECL82 | MULLARD | 5.00 | E88CC GOLD PIN | MULLARD | 6.00 | 6201 | GE | 6.00 |
| ECL86 | PHILIPS | 10.00 | ECC81/CV4024 | MULLARD | 7.50 | 6336A | RCA | 35.00 |
| EL36 | MULLARD | 5.00 | ECC81/M8162 | MULLARD | 10.00 | 6550C | SVET | 20.00 |
| EL37 | MULLARD | 30.00 | ECC81/6201 | MULLARD | 15.00 | 6922 | ECG | 6.00 |
| EZ81 | MULLARD | 10.00 | ECC82/CV4003 | MULLARD | 17.50 | 7027A | GE | 25.00 |
| EZ80 | MULLARD | 5.00 | ECC82/M8136 | MULLARD | 40.00 | 7308 | SYL | 5.00 |
| GZ33/37 | MULLARD | 20.00 | ECC83/CV4004 | MULLARD | | | | |
| GZ32 | MULLARD | 25.00 | | | | | | |
| 5Z4G | BRIMAR | 7.50 | | | | | | |
| 6V6GT | BRIMAR | 7.50 | | | | | | |
| 12BH7 | BRIMAR | 12.00 | | | | | | |
| 12E1 | STC | 10.00 | | | | | | |
| 13E1 | STC | 85.00 | | | | | | |
| 807 | HYTRON | 7.50 | | | | | | |
| 811A | RCA | 25.00 | | | | | | |
| 6080 | MULLARD | 10.00 | | | | | | |
| | | | AMERICAN TYPES | | | | | |
| | | | 5R4GY | RCA | 7.50 | E88CC | TESLA | 4.00 |
| | | | 5U4GB | SYLVANIA | 15.00 | ECC81 | RFT | 3.00 |
| | | | 5Y3WGT | SYLVANIA | 5.00 | ECC82 | RFT | 6.00 |
| | | | 6BX7GT | GE | 7.50 | ECC83 | RFT | 8.00 |
| | | | 6B4G | SYLVANIA | 22.00 | EF86 | USSR | 5.00 |
| | | | 6FQ7 | SYLVANIA | 7.50 | EL84 | USSR | 3.00 |
| | | | 6L6GC | GE/SYL | 20.00 | EL34G | SOVTEK | 5.00 |
| | | | 6L6WGB | SYL | 15.00 | EL34 | E.I | 6.00 |
| | | | 12AX7WA | SYLVANIA | 6.00 | 6SL7GT | USA | 7.50 |
| | | | | | | 6SN7GT | USA | 7.50 |

THESE ARE A SELECTION FROM OUR STOCK OF OVER 6000 TYPES. PLEASE CALL OR FAX FOR AN IMMEDIATE QUOTATION ON ANY TYPES NOT LISTED. WE ARE ONE OF THE LARGEST DISTRIBUTORS OF VALVES IN THE UK. SAME DAY DESPATCH VISA/ACCESS ACCEPTABLE. OBSOLETE TYPES A SPECIALITY.

CREDIT CARD MIN ORDER £10.00.

OPEN TO CALLERS MON. - FRI. 9AM - 4PM. CLOSED SATURDAY

U.K. P&P 1-3 VALVES £2.00, 4-6 VALVES £3.00 ADD 17.5% VAT TO TOTAL INC P+P O'SEAS P & P PLEASE ENQUIRE



Watford Valves

7 DAYS A WEEK 9AM - 9PM The Audiophiles Choice
All output valves multi-tested and digitally matched
Full no quibble guarantee. Expert advice on all valve amps

| | | | | | |
|------------|------------|----------|-----------|------------|---------|
| AC701 | Telefunken | £ 150.00 | EF86/806S | Tesla | £ 20.00 |
| ECC81 | Philips | 7.00 | EF86/6267 | Siemens | 20.00 |
| ECC81 | Siemens | 15.00 | EF86/6267 | Telefunken | 40.00 |
| ECC82 | RT | 12.00 | EL34EH | Sovtek | 8.50 |
| E82CC | Siemens | 25.00 | EL34 | Svetlana | 10.64 |
| ECC802S | Tesla | 25.00 | E34L | JJ/Tesla | 8.50 |
| ECC83 | Sovtek | 3.83 | EL84 | Harma | 7.00 |
| ECC83 | Philips | 12.00 | EL84 | JJ/Tesla | 7.00 |
| ECC83/5751 | G.E. | 12.00 | EL84 | Philips | 25.00 |
| ECC83/7025 | Harma | 12.00 | EL519 | EI | 12.00 |
| ECC83 | Sylvania | 15.00 | EZ81 | Tesla | 12.00 |
| E83CC/803S | Tesla | 20.00 | GZ32 | Harma | 9.00 |
| ECC84 | R.F.T. | 7.00 | GZ34 | Sovtek | 8.00 |
| ECC85 | R.F.T. | 8.00 | KT88 | Sovtek | 20.00 |
| ECC88 | Tesla | 6.00 | KT88 | JJ/Tesla | 25.00 |
| E88CC/6922 | Philips | 8.00 | KT88 | Svetlana | 34.00 |
| E88CC/6922 | Harma | 15.00 | PL519 | Siemens | 15.00 |
| ECC99 | J.J./Tesla | 10.00 | 300B | JJ/Tesla | 68.00 |
| ECF80 | G.E. | 8.00 | 5R4WGB | Cetron | 12.00 |
| ECF80 | R.C.A. | 10.00 | 5881WXT | Sovtek | 7.00 |
| ECF82 | Tungsrarn | 6.00 | 6L6 | Vissaux | 30.00 |
| ECL82 | Citfe | 12.00 | 6550C | Svetlana | 22.00 |
| ECL83 | Mullard | 10.00 | 6550EH | EH/Sovtek | 22.00 |
| ECL85 | Polam | 5.00 | 6550WE | Sovtek | 18.00 |
| ECL86 | A.E.G | 10.00 | 7581A | Philips | 25.00 |
| EF80 | Telefunken | 10.00 | 7591A | EH/Sovtek | 16.00 |

SVETLANA EL34R SUMMER SPECIAL OFFER

This new tube uses a unique grid block construction, which gives higher output whilst eliminating odd order harmonies, resulting in deeper tighter bass and more high end definition. All tested and matched by Watford Valves at only £8.51 each.



WORLD AUDIO DESIGN UPGRADES

KIT 6550 & KAT 6550 Upgrade

KIT 34 & KAT 34 Upgrade



4 x 6550C Svetlana matched
2 x ECF80 GE
2 x 5U4G Russian



£99 the set + vat & carriage



4 x EL34 Svetlana matched
2 x ECF80 GE
2 x 5U4G Russian



£60 the set + vat & carriage

KAT6550

KAT34

WATFORD VALVES 3 Ryall Close,
Bricket Wood, St Albans, Herts AL2 3TS

Fast mail order/next day delivery/World Wide shipping
1000's more valves stocked. Prices exclude VAT and carriage.



01923 893270

Fax: 01923 679207

www.watfordvalves.com



300B PP MONOBLOC CIRCUIT DIAGRAM POWER SUPPLY CIRCUIT

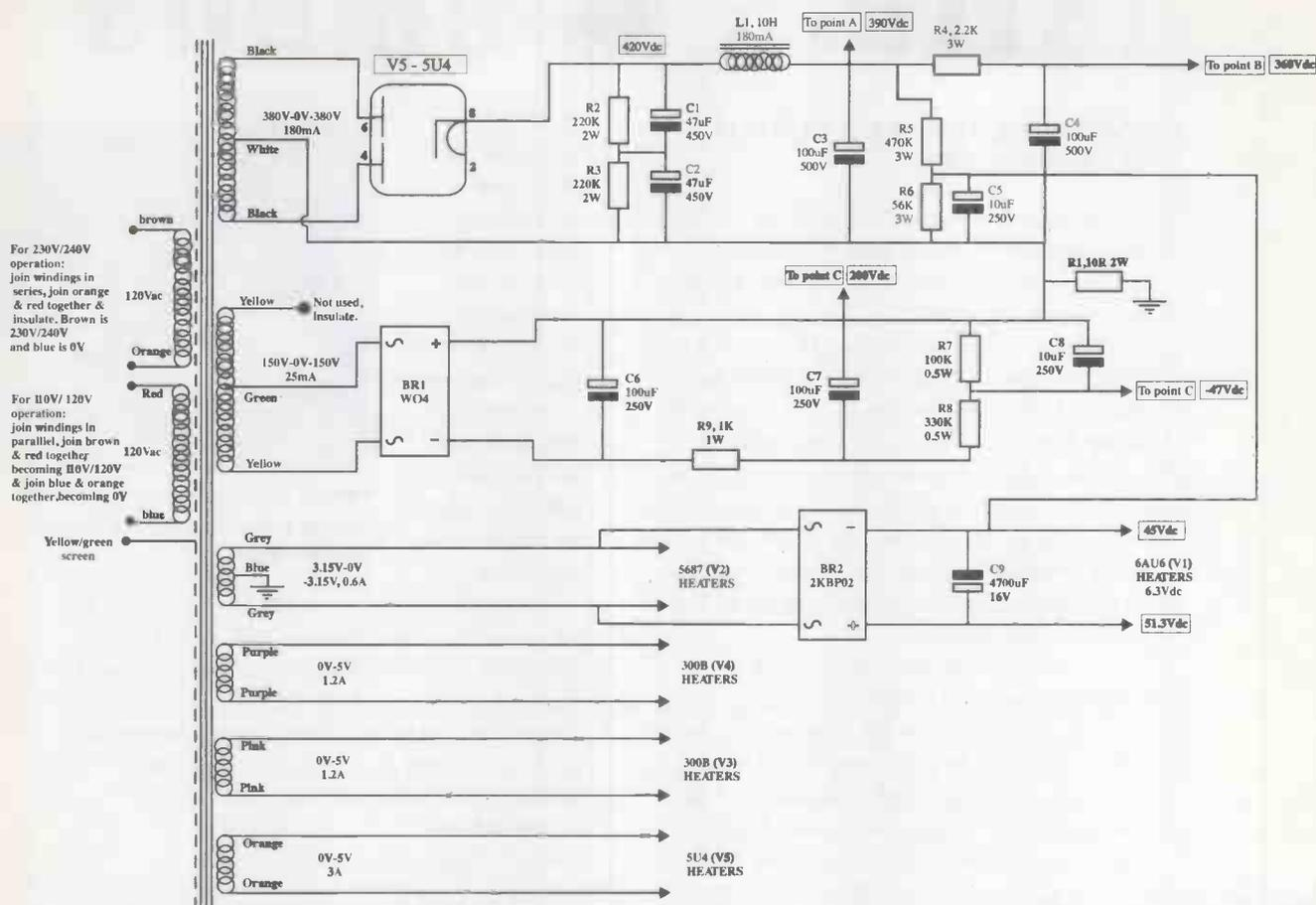

For 230V/240V operation: join windings in series, join orange & red together & insulate. Brown is 230V/240V and blue is 0V

For 110V/120V operation: join windings in parallel, join brown & red together becoming 110V/120V & join blue & orange together, becoming 0V

Yellow/green screen

V5 - 5U4



Views are from underneath valve or valve holder
h1, h2 = heater c = cathode mc = no connection

ALL TEST VOLTAGES WERE MEASURED WITHOUT THE SIGNAL INPUT GROUNDED, OUTPUTS CONNECTED TO A 60HM LOAD, RUNNING OFF A 230Vac SUPPLY. PLEASE NB. TEST VOLTAGES CAN VARY WITHIN 20% OF STATED VOLTAGES, DUE TO VARIATIONS IN MAINS SUPPLY AND VALVE CHARACTERISTICS.

300B Push-Pull monobloc amplifier is available as a kit from World Audio Publishing Ltd

| | UK (Inc. vat & p&p) | Overseas (exc. vat & p&p) |
|----------------------------------|---------------------|---------------------------|
| 300B PP monoblocs | £1197.00 | £1020.00 |
| K240/120 (with valves), a pair | | |
| 300B PP monoblocs | £895.00 | £765.00 |
| K240/120 (without valves) a pair | | |
| 300B PP Conversion pack | £250.00 | £215.00 |
| (Converts a 300B PSE to 300B PP) | | |

Call or fax Nick Lucas on: +44 (0) 1908 218836 (9am-5pm, Monday-Friday)

e-mail: orders@worldaudiodesign.co.uk

order online at www.worldaudiodesign.co.uk

For overseas freight charges, please call, fax or e-mail.

letters & emails

SCREENING THE PRE II OUTPUT TRANSFORMERS

I thought I would put 'finger to keyboard' to describe my experience with the screening of the Pre II output transformers and isolation of the output earths that you described in DIY Supplement 73.

Having removed the transformers from my Pre II, I had little difficulty dismantling them using the method you described. I first cleaned the varnish from the slot and the threads of the screws clamping the frames to the transformers. They unscrewed with little difficulty and the frames came away using the Stanley knife as per your article. I managed to get 4 turns around each transformer and only covered the bobbin area as per the diagram in your article, not the whole core as shown in your photographs. I then re-assembled the transformers.

I turned my attention to the isolation of the output earths. Fortunately, I had separate links to the earth tag for all the inputs, the PSU earth, the PCB earth and the outputs earth. I disconnected the output earth and left the others intact. I had soldered all the left and right channel phono earth tags together and run a wire between them all, so what I had to do was to remove the earth tags from the pair of

outputs and replace them to connect the two left and two right phono earths together. Fortunately, the sockets are in a square layout so I just transposed the tags and re-assembled them, being careful with the re-soldering of the Zobel network and the transformer output leads.

Apart from looking nice with their new shiny copper look - has it improved the hum? I certainly think it has. It hasn't eliminated it completely, but any residual hum is only heard when I put my ear up to the speakers and, more importantly, is pure 50Hz. I used to get a slight buzz from the harmonics, which has completely gone. I also think that the image placement has improved as a result of the upgrade.

Neville Roberts

Thanks for your confirmation Neville. **NL**

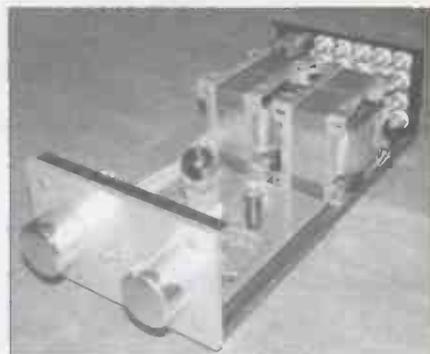

View of the upgraded PRE II with copper screening on the driver transformers.

WATCH THIS SPACE

For A Really, Really, Exciting Announcement (at least, WE think so!)

from
The U.K.'s Premier Repair & Restoration Centre

Whether your equipment is Old, New,
in Kit form, Valve, Solid-state, Audio or R.F.,

we will....

Repair, Restore, Re-calibrate, Re-align:-
Tape recorders by Revox, Tascam (up to 1") and Teac
Valve amps., pre-amps., tuners, cinema amps.,
theatre-organ amps., industrial p.a. amps. from Radford, Quad, Leak,
RCA, Altobass, Grant, Parmeko, Kalee, Clarke & Smith, Compton, etc.
Valve Communications Receivers and Transmitters
(to 30MHz/2KW/6'3" tall) by KW, Marconi, Labgear, Eddystone,
Redifon, Ajax, RCA, Tiger... and so on.

We will....

Build that Kit for you or
Re-build it if you've had a go but it's gone pear-shaped.

We will....

Custom-build for you a published Classic design.
(Fancy a Williamson?? Or a 912?? A 3-3, maybe? No problem.)
Design something special and build the prototype.

All this,

as well as being an Authorised Service Centre for such respected
names of the Digital Era as Denon, Citronic, Kenwood, Yamaha.

Overall,

some pretty comprehensive facilities....and it will take only
a few minutes of your life plus a few pence from your pocket to call/fax
and discuss your requirements: **0113 244 0378.**

Or e-mail: audiolabs@aol.com Or write!

We are:

AUDIO LABORATORIES (LEEDS)

3 Kildare Terrace Industrial Estate,
Leeds LS12 1DB, England.

VA

audioXpress... It Just Sounds Better

Your Favorite Audio - One New Magazine!

- PROJECTS
- REVIEWS
- THE NEWEST TECHNOLOGIES
- AUDIO CLASSROOM
- and Much More!



Subscribe To This
Great Monthly
Publication Today!

Only \$59.95 us
for 12 Issues!

audioXpress • PO Box 876 • Peterborough, NH
03458-0876 USA • Phone: 603-924-9464

Fax: 603-924-9467 • E-mail: custserv@audioXpress.com

ORDER
ONLINE AT: **www.audioXpress.com**

WELCOME TO OUR MARKET PLACE

Here are a wide variety of specialist hi-fi products and services. Keep an eye open for regular advertisers, who know the market and serve their customers in a friendly and reliable manner.

Sound Investment

If you have invested expertise and money in building up a sound system to your own unique specifications, then why compromise with indifferent housing units?

Fi-Rax offers a new dimension in audio visual racking - from a range of standard designs to the flexibility to custom create a unit to suit your particular sound system and lifestyle.

- *High quality aluminium construction.
- *Finishes available to your choice.
- *Fully adjustable 6mm glass shelving.
- *Sound isolation on shelving/feet.
- *Custom created to suit your system.
- *Free delivery throughout the UK.

Fi-Rax - a sound investment for those who want the best from their equipment.

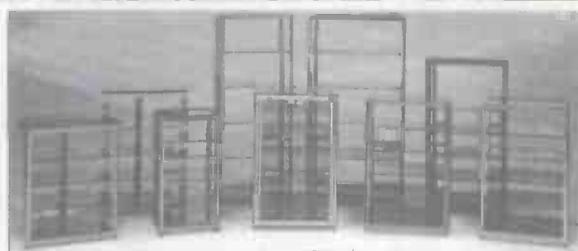

Audio Visual Furniture

For further information or a free brochure contact: JEM Distribution, Springfield Mills, Spa Street, Ossett Wakefield WF5 0HW.
Tel: 01924 277626 Fax: 01924 270759

RETRO Reproduction

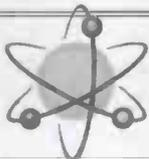

Used equipment for sale

Amplifiers

| | |
|--|--------|
| Arcam 10 Power Amp | £395 |
| Audionote M1 Valve Pre Amp with Phono Stage | £395 |
| Audio Research VT100 MkII | £2,300 |
| Beard BB3060 stereo integrated amp the last amp released new £1400 | £795 |
| Conrad Johnson PF1 pre amplifier new £1200 excellent phono stage | £495 |
| EAR 834P Valve Phono Amp | £235 |
| EAR 834L Valve Line Stage | £275 |
| Exposure pre/power anniversary 8 model | £495 |
| Heart 300b monoblocs as reviewed In July 03 Issue of Hi-Fi World superb sounding new £2000 | £995 |
| Linn 280 power amplifier with Linn Spark (ideal for Linn Isobarik) | £350 |
| Marantz PM 66 K1 Sig Int Amp | £245 |
| Meridian 103D pre/power combination | £295 |
| Meridian 104 FM Tuner boxed | £150 |
| Meridian 505M MonoblocksMint | £1,095 |
| MicroMega Tempo 1 Integrated Amp remote control with great phono stage new £800 | £395 |
| Moth 100W Monoblocks with Passive Pre new £1400 | £895 |
| NAD Silverline Power Amp | £995 |
| Naim Nait 3 Integrated Amp | £375 |
| Naim NAP90 Power Amp | £295 |
| Pass Aleph 3 Power Amp mint boxed | £1095 |
| Pioneer A400 Integrated Amp | £175 |
| Pioneer A400X Int Amp | £195 |
| Primar A20 Integrated Amp boxed mint | £350 |
| Quad 303 Power Amp | £195 |
| Quad 306 Power Amp | £195 |
| Quad 34 Pre Amp mint boxed | £250 |
| Quad 77 Pre and Power Amp | £195 |
| Quad 44 Pre - old style | £595 |
| Quad 405 Power Amp boxed | £195 |
| Reqa EX5 Power Amp | £295 |
| Roksan 6 Channel Power Amp | £195 |
| Roksan Caspian Integrated Amp mint | £395 |
| Sonic Frontiers Anthem Integrated Valve Amp - Hi-Fi World recommended new £1400 | £795 |
| Sony TA/FB30R Integrated Amp with remote | £195 |
| Sugden A48 Integrated Amp | £195 |

Turntables

| | |
|---|-------|
| Fons CQ30 78rpm facility | £125 |
| Linn Axis with Linn tonearm | £275 |
| Mission 775 SM with 774 tonearm | £235 |
| Originive classic turntable acrylic platter | £395 |
| Odyssey Tonearm mint boxed | £295 |
| Tri-Plannar MK6 Tonearm serviced new £3600 | £1795 |
| Source MK2 Turntable | £375 |
| SME V Tonearm boxed | £495 |
| System Deck III turntable ...UPGRADE | £995 |
| YOUR REGA from | £150 |
| Thorens TD125 | £175 |

| | |
|--|-------------------|
| Thorens TD125 with SME plinths mint | £250 |
| Townshend Rock Elite with optional extras plinth & lid | £595 |
| Various Thorens TD150s ...from | £50 |
| Varous Rega turntable's | phone for details |

Speakers

| | |
|--|-------|
| ATC Active 100 custom piano black finish 3 mths old new £10000 | £8995 |
| Audiomaster Studio Monitors | £995 |
| Audiophysic Spark MK3 latest edition new £1850 | £995 |
| B&W P4 rosewood finish | £295 |
| Epos ES11 with matching stands | £275 |
| Epos ES14 mint with stands | £350 |
| Gale 301 speakers | £125 |
| Gale 401 chrome ended speakers | £595 |
| JBL T1 2K boxed | £795 |
| Meridian 0600 Digital Active Speakers | £695 |
| Mission 780 Speakers | £175 |
| Mission 751 Bookshelf Speakers | £95 |
| Mission 700 Bookshelf Speakers | £195 |
| Musical Fidelity MC2 Bookshelf Speakers | £995 |
| ProAc Tablette 2000 Signature yew finish mint boxed | £895 |
| ProAc Response TSC burr walnut finish | £895 |
| QLN Splitfield Signatures | £995 |
| Quad ESL57 refurbished | £595 |
| Rogers LS33 with AB 33 new £600 | £275 |
| Royd Abbot floorstanding Speakers ideal for valve amp | £395 |
| Ruark Equinox american walnut last edition boxed new £2000 | £795 |
| Shiel Type K Speakers - Kimber Silver | £795 |
| Triangle Zays Floorstanding Speakers new £1600 | £795 |
| Tannoy GRF Memory 15" drive units walnut cabinet AWESOME PRESENCE new £5500 mint | £2950 |
| Wired (Boxed Mint) | £295 |
| Spendor BCI Speakers | £175 |
| Tannoy D100 Bookshelf Speakers | £375 |

CD Players, DACs

| | |
|--|--------|
| Meridian 204 Tuner | £1,600 |
| Audio Research CD2 CD Player | £1,095 |
| Audio Research CDT1 Transport (new £3000) | £1,175 |
| Arcam Alpha 5 | £195 |
| Arcam Alpha 7 SE | £595 |
| Marantz CD33 top loading CD Player | £595 |
| Micromega CD Player Stage 3 (new £900) | £295 |
| Meridian 208 CD Player + Pre Amp | £395 |
| Rotel RCD 865X CD Player (Fitted with Black Gate Caps as standard) | £175 |
| Revox B225 | £295 |
| Revox G36 Open Reel Mint | £375 |
| Sony CDRX3 3000 ES | £395 |
| Teac VRDS10 | £450 |

Tuners, Reel to Reel, Cassette Deck, misc

| | |
|---|------|
| Meridian 204 Tuner | £375 |
| Quad FM3 Tuner (boxed mint) | £145 |
| Quad FM3 Tuner | £95 |
| Quad FM4 Tuner old style | £275 |
| Quad FM4 Tuner new style | £295 |
| Quad 66 FM Tuner | £295 |
| Rotel RT1930 AX Tuner | £395 |
| Revox G36 Open Reel Mint | £395 |
| Tascam 22/2 Open Reel | £395 |
| Leak Troughline Tuner 3 various ...from | £50 |

Due in

| | |
|-----------------------------------|--|
| Kimber cable various | |
| Rogers LS3/5 Speakers 15 Ohm | |
| Quad II Monoblocks | |
| Quad wooden sleeve for 33 and FM3 | |

New web address : www.retroreproduction.com

28a Haddington Place Edinburgh EH7 4AF Phone/Fax 0131 558 9989

Open 11.00am - 5.30pm - closed Monday & Sunday

"NOW DEMONSTRATING"
ATC SCM 7, 12, & 35 SPEAKERS PROBABLY THE FINEST SPEAKERS
AVAILABLE - PRICES START FROM £480

Now stocking Sonneteer's new Bronte product range including digital amp from £800 and matching CD player



Ear 869 single ended triode integrated amplifier

Improved version of the classic 859 with revised output transformers modified input stage with the addition of an extra signal valve which has allowed an increase to 15watt of single ended power, also the 869 can be used as a power amp. Don't be fooled by its modest power output this amp drives real world speakers. price £2498.00

Ultimate Ear Phono Stage

This is the ultimate esoteric Phono Stage as used in the world wide acclaimed Ear 312 Control Centre - Pre Amp. This has to be the ultimate Vinyl Replay purchase. price £2095

** FOR A LIMITED PERIOD ONLY **

Full value Trade in on Ear Phono Stages and other selected models.

WE ARE PROUD TO ANNOUNCE THE NEW **BEAUHORN B2 HORN LOUDSPEAKERS** IDEAL FOR LOW POWERED SINGLE ENDED VALVE AMPS

ALSO DEMONSTRATING THE NEW **GRAHAM SLEE PROJECTS** RANGE OF AFFORDABLE PHONOSTAGES

"HARMONIC TECHNOLOGY SINGLE CRYSTAL CABLE"

NOW IN STOCK "AT LAST I HAVE A CABLE TO DO ALL THE THINGS THE MANUFACTURE CLAIMS AND AT A RIDICULOUSLY LOW PRICE" PHONE FOR MORE DETAILS



There are now four models in the EAR lineup:

The classic 834P uses the same circuit architecture as its more expensive brothers, and shares the same high quality sound through MM type cartridges, it is enclosed in a tough, rigid metal case and is fully "CE" type approved. price £495.00

The signature builds on the Classic 834P specification by adding a superb moving coil (MC) input stage, as well as the no-extra-price option of a high quality volume control. price £590.00

Top to the range, the Deluxe 834P comes in stunning chrome and gold cabinet, and has extra attention and quality control. With different moving coil input options, this unit will fit the most demanding of audiophile systems. For the true vinyl enthusiast. price £895.00

MC3 - The ultimate stage for MC matching with 3 fixed transformer taps to cover all types of moving coil cartridges, and separate left/right grounding. MC3 is used in the new £10,000 312 pre. price £630.00

Selected products from: ATC, Audio Physic, EAR Yoshino, Nottingham Analogue, Dynavector.

It's the end of our 'High Season' and time for a COMPLETE CLEARANCE

VINYL REPLAY

| | | |
|--------------------------------------|---------|-------|
| DUNLOP Systemdeck 3 / Basik LVX / K5 | £750 | £249 |
| GARRARD 301 | | £150 |
| LINN LP12 (Black) + Mission 774 | | £298 |
| LINN LP12 (Black) + Ittok (Black) | | £895 |
| LINN LP12 (Afro) + Grace 707 / Supex | | £398 |
| LINN LP12 (Afro) + Ittok LVII | | £895 |
| MICHELL Gyrodec | | £740 |
| MICHELL ISO HR Phono Stage Ex-dem | £895 | £646 |
| MICHELL ISO/HERA Phono Stage | £895 | £448 |
| SME 10A with 309 Tone Arm Ex-dem | £3410 | £2896 |
| VOYD Reference inc arm | £14,995 | £5000 |
| WILSON BENESCH Full Circle (Mint) | £1995 | £1495 |

CD • DVD

| | | |
|---|---------|---------|
| ARCAM Alpha Plus CD | £300 | £89 |
| ARCAM Alpha One CD | £300 | £149 |
| ARCAM Alpha 9 CD | £900 | £498 |
| ARCAM Delta Black Box 3 | £349 | £59 |
| AUDIO ALCHEMY V1 + PSU | £489 | £129 |
| AUDIO ALCHEMY V3 DAC + PSU | £900 | £429 |
| AUDIO MECHA Kreatura Trans | £1500 | £439 |
| AUDIO MECHA Damnation Tran + Upgrade | £1250 | £439 |
| EXPOSURE CD Player | £999 | £629 |
| KENWOOD DP7090 CD Player | £399 | £129 |
| KENWOOD DP-X9010 Trans | £400 | £199 |
| KRELL KPS 25 CD/Pre | £24,998 | £14,996 |
| LINN Karik CD | £1850 | £1098 |
| MERIDIAN 203 DAC | £499 | £228 |
| MERIDIAN 207 CD Player/Pre-amp | £700 | £299 |
| MERIDIAN 518 Trans | | £548 |
| MICROMEGA DAC 1 | £750 | £320 |
| MICROMEGA Micro-DAC | £499 | £149 |
| MICROMEGA T-Drive -Trans | £999 | £399 |
| NAIM CD1 | | £948 |
| NAIM CD3 | £780 | £479 |
| NAKAMICHI 7 disc CD player | £400 | £129 |
| ORELLE DA10T Trans | £900 | £349 |
| PIERRE LURNE Audio Mecca Kreatura Trans | £950 | £598 |
| PROCEED PDT3/PDP3 Trans/DAC | | £2500 |

| | | |
|--|-------|-------|
| QED Reference DAC | £299 | £99 |
| REGA Planet | £500 | £350 |
| ROKSAN kandy CD Player | £500 | £199 |
| ROTEL RCD99 CD Player | £799 | £399 |
| SUGDEN SDA-1 DAC | £750 | £279 |
| SUGDEN SDD-1 Trans | £950 | £399 |
| TEAC VRDS 10 (CD Player) | | £450 |
| THETA DATA Basic Trans | £2400 | £749 |
| THORENS TDC2000(Trans) + TDA2000(DAC)£2000 | | £1198 |

AMPLIFIERS • TRANS

| | | |
|---|-------|-------|
| AUDIOLAB 8000A Integrated | £700 | £300 |
| BAT VK40 | £4950 | £1998 |
| BRYSTON 7B Pro Monoblocks | £5000 | £2498 |
| CONRAD JOHNSON PV 10AL Pre | £1600 | £849 |
| CYRUS Pre | £700 | £349 |
| CYRUS Power | £700 | £358 |
| DENON AVP-A1D Digital Pre-amp | £2500 | £698 |
| DEVA 250 Integrated + Matching Power | £1000 | £269 |
| EAR 834 Pre-amp | £950 | £369 |
| ELECTROCOMPANIE EC3 MC | £2200 | £1188 |
| EXPOSURE 7/8 pre & Power | £1100 | £400 |
| EXPOSURE 18/21 pre & Power | £2000 | £1099 |
| HARMON KARDON AVR85 AV Rec | £1000 | £498 |
| HARMON KARDON Citation 17 Pre | £750 | £129 |
| HARMON KARDON Citation Power | £1200 | £249 |
| KRELL KSA 50 Power amp | | £998 |
| KRELL KST 100 Power amp | £3000 | £1499 |
| KRELL FPB650 Mono's. 3 available (£14,000) each | | £8000 |
| LFD LS1 Pre-amp | £1900 | £349 |
| LINN LK1 | £450 | £194 |
| LINN LK2 | £550 | £299 |
| LINN Kairn Pre | £1700 | £1098 |
| McINTOSH 7100 power amp | £2000 | £599 |
| MARK LEVINSON 27.5 Power | £6000 | £3299 |
| MUSICAL FIDELITY The Pre-Amp 3a | £1300 | £159 |
| MUSICAL FIDELITY (Dr Thomas) | | £350 |
| NAIM NAP90 (Power) | £600 | £378 |
| NAIM NAP90 (Power) | £600 | £400 |
| QUAD 34 | | £194 |
| QUAD 306 | | £218 |
| ROGERS A100 Integrated | £400 | £154 |

| | | |
|---------------------------------|-------|-------|
| ROTEL RC1070 | | £195 |
| ROTEL RB1080 | | £495 |
| SONY SDPEP9ES (Digital) | | £298 |
| TALK ELECTRONICS Storm (Intgtd) | £650 | £299 |
| TESSERAC Pre | £1500 | £798 |
| VERITAS P400 Power | £3000 | £2496 |

AMPLIFIERS • VALVE

| | | |
|---|---------|-------|
| ARION Electra Integrated | £1200 | £598 |
| AUDIO INNOVATIONS 800 Mk11 | £1500 | £748 |
| AUDION Silver Knight 300B Mono's | £2250 | £1390 |
| AUDIONOTE M2 Pre | £1000 | £600 |
| AUDIO PRISM Debut (Red Rose) | £2800 | £1700 |
| AUDIO PRISM Mantissa (Red Rose) | £3000 | £1800 |
| AUDIO RESEARCH LS2 Pre | £2800 | £1798 |
| AUDIO RESEARCH LS2B Mk2 pre | | £1500 |
| AUDIO RESEARCH BL1 | £699 | £496 |
| AUDIO RESEARCH Classic 120 Monoblocks (Transparent Power link 15amp cables, Hard wurd, balanced cables) | | £2498 |
| AUDIO RESEARCH VT100 Mk1 Power Amp | £5500 | £3498 |
| CARY Pre-amp | £3500 | £1490 |
| CARY CAD300SE monoblocks (As new) | £5000 | £3998 |
| CLASSE CA200 + DR6 | £7700 | £3500 |
| CONRAD JOHNSON Premier 17 Pre | £4750 | £2750 |
| CONRAD JOHNSON Premier 8 Monos | £16,000 | £9750 |
| CR DEVELOPMENTS Carmeto (Pre) | £900 | £428 |
| JADIS DA30 Integrated | £3500 | £2246 |
| JADIS Defy 7 Power | | £2698 |
| PAPWORTH TVAS0 | £2000 | £1198 |
| PATHOS Twin Towers | £3250 | £2495 |
| QUAD 22 + 2 monoblocks | | £450 |

TUNERS / TAPE HEADPHONES

| | | |
|-------------------------------------|------|------|
| LUXMAN ST50 (Rare) | £900 | £550 |
| REVOX D36 Reel to Reel | | £348 |
| REVOX E36 (Reel to reel) | | £298 |
| REVOX B77 3.75/7.5 Reel to Reel | | £598 |
| REVOX B77 Mk2 3.75/7.5 Reel to Reel | | £648 |
| STAX Lamba Nova Classic Headphones | | £498 |

WANTED

TOP QUALITY, MINT CONDITION
HI-FI EQUIPMENT & SYSTEMS
CASH, COMMISSION SALES AND
GREAT PART-EXCHANGE OFFERS
AGAINST NEW EQUIPMENT

NEW, NEW, NEW

WE CAN SUPPLY MANY TOP
HI-FI & HOME-CINEMA BRANDS
AND YOU'LL GET THE BEST TRADE-IN
ALLOWANCES FOR YOUR UNWANTED
HI-FI EQUIPMENT & SYSTEMS

GUARANTEE

FULL MANUFACTURERS WARRANTY
ON NEW AND EX-DEM PRODUCTS
THIRTY DAYS TO THREE MONTHS
WARRANTY ON ALL USED ITEMS
Please check at time of purchase

**This is a GENUINE STOCK CLEARANCE
with most remaining items open to
SENSIBLE OFFERS - just give us a call.**

La Creme de la Creme

McINTOSH C200 Pre Amp/Controller
RRP: £7,190 **Our Price: £5,500**

McINTOSH MC2000SE Power Amp
RRP: £13,000 **Our Price: £9,250**

McINTOSH C200 Pre Amp/Controller
complete with

McINTOSH MC2000SE Power Amp
RRP: £21,190 **Our Price: £14,500**

For your convenience a personal demonstration of these items can be arranged either here in Peterborough or in central London. Please call for details

LOUDSPEAKERS

| | | |
|--------------------------------------|---------|--------|
| ACOUSTAT Model 2 Electrostatics | £2500 | £674 |
| AUDIONOTE AN/E (Inc stands) | £2900 | £1748 |
| AUDIO PRO B250 Sub | £1000 | £169 |
| B&W P4 (Cherry but marked) | £700 | £349 |
| CANON V100 Corner speakers | £200 | £99 |
| CASTLE Chester (Walnut) | | £478 |
| CASTLE Warwick (Black) | £180 | £49 |
| CASTLE Durham (Marked) | £230 | £99 |
| CASTLE Howard S2 | £1400 | £848 |
| CASTLE Howard S2 | £1400 | £848 |
| CHARIO Millenium inc Stands | | £1698 |
| EPOS ES30 | | £1098 |
| ENSEMBLE Primadonna VERY RARE | £10,000 | £2,999 |
| GAMMA ACOUSTICS Epoch 5 | £3000 | £998 |
| GERSHMAN X1 | £2500 | £1298 |
| HALES Signature System 2 | £4000 | £1848 |
| HARBETH HL-P3 | | £395 |
| HEYBROOK Heystack (Rosewood) | £500 | £297 |
| IMPULSE H7 (Black) | £1000 | £299 |
| KEF Ref Mod 1 | | £798 |
| KEF Q30 (Black) | £350 | £129 |
| KEF Q35 (Black) | £350 | £179 |
| KEF Cube (EQ Box) | £700 | £246 |
| LINN Nexus (Black + stands) | £500 | £239 |
| LINN Keilidh | | £378 |
| LINN Kaber (Rosewood) ACTIVE | £2500 | £999 |
| MAGNA PLANAR 1a Imp | £1400 | £599 |
| MAGNA PLANAR MG111A | £3500 | £749 |
| MARTIN LOGAN SL3 | | £1995 |
| MEADOWLARK Shearwater | £2990 | £1990 |
| MERLIN TSM-SE (Mint) | £1600 | £1148 |
| MISSION 733 (Black) | £200 | £99 |
| MISSION 751 (Choice - Black or Rose) | £330 | £189 |
| MISSION 753 (Rosewood) | | £425 |
| MONITOR AUDIO Studio 14 (Marked) | £900 | £299 |
| MONITOR AUDIO 705 (Black) | £800 | £399 |
| MORREL Bass Master (Oak but marked) | £1600 | £599 |
| NAIM Credo Ex-dem | £1425 | £994 |
| OPERA Pavorotti | | £695 |
| PINK TRIANGLE Ventral | £1500 | £950 |
| PRISTINE 2 Full Range Electrostatic | £8500 | £3998 |
| PROAC Tablette Mk3 | | £448 |
| QNR Monitors (Black) | £1200 | £369 |
| QUAD ESL57's modified by Linley | | £1458 |
| REGA XEL (Black) | £990 | £640 |
| RUARK Equinox (Black) | £2200 | £999 |
| RUARK Broadsword (Rosewood) | £700 | £329 |
| RUARK Sceptre | £700 | £348 |
| RUARK Logrhythm (Sub) | £900 | £498 |
| SNELL J3 High Sensitivity Monitors | £770 | £349 |
| SOUNDLAB Dynastats | £3200 | £1100 |
| SYSTYM 165 (Mahogany) | £500 | £244 |
| TANNOY Buckingham | | £1600 |
| TANNOY Berkeley | | £500 |
| TANNOY Lancaster | | £498 |
| THIEL CS2.2 Discoloured veneer | £2500 | £1149 |

EX-DEMONSTRATION AND NEW STOCK SALE

Sold in 'as new' condition unless otherwise stated, with boxes, instructions and full manufacturer's warranties. Some excess stock items are new.

| | | |
|---|--------|--------|
| ARIEL ACOUSTICS Mod 8 + stands EX-DEM | £5679 | £3596 |
| AUDIO ANALOGUE Maestro EX-DEM | £2600 | £1796 |
| AUDION Silver Knight 3008 Intgrtd EX-DEM | £1125 | £876 |
| AUDIO RESEARCH LS16 Pre-amp EX-DEM | £2999 | £2398 |
| AUDIO RESEARCH VT100/3 Pwr EX-DEM | £6400 | £5198 |
| B&W THX System EX-DEM | £4975 | £2498 |
| GOLDMUND Mimesis 6 Amp EX-DEM | £2900 | £1726 |
| GOLDMUND Mimesis 4 Tuner EX-DEM | £6100 | £2996 |
| GRAAF 13.5 Bil Pre EX-DEM | £3950 | £2746 |
| HARBETH Compact 7ES EX-DEM | £1299 | £996 |
| HARBETH HLP-3ES EX-DEM | £799 | £596 |
| KRELL KPS28 CD Player EX-DEM | £8998 | £6746 |
| KRELL KAV300i EX-DEM | £3965 | £3168 |
| KRELL FP8300 EX-DEM | £9998 | £6946 |
| KRELL KCT Pre-amp EX-DEM | £9998 | £6998 |
| M&K VX100 Sub EX-DEM | £754 | £634 |
| M&K VX7 Mk2 Sub EX-DEM | £474 | £384 |
| MERIDIAN 596 DVD Player EX-DEM | £2549 | £1996 |
| MERIDIAN 563 EX-DEM | £700 | £446 |
| MICHELL ISO HR Phono Stage EX-DEM | £895 | £646 |
| MICHELL Gyra SE EX-DEM | | £740 |
| MICHELL Delphini Phono LPSU EX-DEM | £895 | £738 |
| MICHELL Delphini Phono SPSU EX-DEM | £998 | £798 |
| MONRIO MP1 135w EX-DEM | £600 | £395 |
| MONRIO MP2 135w X 2 NEW | £950 | £595 |
| MONRIO MP3 135w X 3 NEW | £1225 | £795 |
| MONRIO MP2 135w X 5 NEW | £1500 | £895 |
| MONRIO Asty Cd Plyr NEW IN BOX | £750 | £495 |
| MONRIO 1882 DAC EX-DEM | £600 | £295 |
| NAGRA VPA Monoblocks EX-DEM | £9350 | £7246 |
| NAIM NAC 102 Pre EX-DEM | £1210 | £964 |
| NAIM NAC 82 Pre EX-DEM | £2500 | £1994 |
| NAIM CDS/XPS Mk2 EX-DEM | £6265 | £4994 |
| NAIM CDX EX-DEM | £2470 | £1974 |
| NAIM Credo EX-DEM | £1425 | £994 |
| NAGRA PLL Pre EX-DEM | £5395 | £3996 |
| NAGRA PL-P Pre EX-DEM | £6995 | £5496 |
| NAGRA VPA Monoblocks EX-DEM | £9350 | £7246 |
| MERIDIAN DSP33C Centre EX-DEM | £1355 | £1146 |
| MERIDIAN DSP5500 (20 bit) EX-DEM | £6995 | £4796 |
| MERIDIAN DSP5000C (Dig Centre) EX-DEM | £1995 | £1594 |
| MISSION 783 (Beech) EX-DEM | £999 | £794 |
| MISSION 78C (Centre) EX-DEM | £350 | £274 |
| MISSION MCL (Black) EX-DEM | £100 | £74 |
| OPERA SP1 (Cherry) EX-DEM | £525 | £426 |
| PATHOS Classic One EX-DEM | £995 | £848 |
| PRIMARE V20 DVD Plr EX-DEM | £998 | £848 |
| PROAC Response 1.5 (Rosewood) EX-DEM | £1970 | £1296 |
| PROAC Response 2.5 (Li Oak) EX-DEM | £2700 | £2148 |
| REGA Naos (Cherry) EX-DEM | £998 | £794 |
| REGA ARA (Cherry) EX-DEM | £255 | £214 |
| ROKSAN Ojan EX-DEM | £1000 | £590 |
| SME 10A with 309 Tone Arm EX-DEM | £3410 | £2896 |
| SONUS FABER Grand Piano EX-DEM | £1699 | £1399 |
| SONUS FABER Gravis Sub EX-DEM | £999 | £798 |
| SONUS FABER Amati Homage EX-DEM | £11850 | £9996 |
| SONUS FABER Cremona Homage EX-DEM | £4995 | £4196 |
| SONUS FABER Concertino EX-DEM | £599 | £529 |
| SONUS FABER Electra EX-DEM | £1789 | £1349 |
| SPENDOR S8 Cherry - Slight cabinet damage | £1700 | £1346 |
| THETA Casanova Pre EX-DEM | £4478 | £2996 |
| TRIANGLE Zephyr XS EX-DEM | £595 | £395 |
| TRIANGLE Lyrr XS EX-DEM | £1600 | £895 |
| TRIANGLE Titus XS EX-DEM | £335 | £225 |
| TRIANGLE Comete XS EX-DEM | £395 | £275 |
| TRIANGLE Antoi XS EX-DEM | £875 | £595 |
| UNISON RESEARCH Feather 1 EX-DEM | £795 | £495 |
| UNISON RESEARCH Power 35 EX-DEM | £1500 | £895 |
| WILSON Cub (Black Laminate) EX-DEM | £5495 | £3496 |
| WILSON Cub (Gloss) EX-DEM | £6890 | £3996 |
| WILSON 6 (Black) EX-DEM | £19998 | £12996 |
| WILSON 6 - still in their crates! | £18500 | £12030 |
| WILSON BENESCH Orator EX-DEM | £2900 | £2524 |
| WILSON BENESCH Actor EX-DEM | £3999 | £2998 |
| WILSON BENESCH Act-1 EX-DEM | £6999 | £4499 |
| WILSON BENESCH Act-2 EX-DEM | £8999 | £5999 |

Much More Always Available
Please Check Our Web Site
hifitradingstation.com

ALL ABOVE ITEMS IN STOCK
AT TIME OF GOING TO PRESS

The Hi-Fi Company's

Trading Station

35 Cowgate
Peterborough PE1 1LZ

PHONE:

0870 608 8211

OPEN: Tues - Sat: 10am - 5.30pm

**NEXT DAY DELIVERY
WITH CREDIT CARD PURCHASES**



S/hand and ex-demo clearance items - AUGUST 2003

CD players DACs & Transport

| | Was | Now |
|-------------------------------------|------|------|
| Cyrus DAD3 24Q DAC S/H | 899 | 499 |
| Pink Triangle DaCapo DAC 24 Bit S/H | 1700 | 699 |
| Primare D30.2 CD Player S/H | 1500 | 899 |
| Teac P30 Transport S/H | 2500 | 995 |
| Wadia 830CD Player S/H | 3295 | 1899 |

Turntables Tonearms & Cartridges

| | | |
|---|------|------|
| Alr Tangent 1C with Wisa Pump X-demo | 5800 | 3999 |
| Benz Micro LP New& Boxed | 2200 | 1799 |
| EAR 834P MM Phono Stage S/H | 399 | 279 |
| Heed Audio Quazar 2 Box Phono Stage New and Boxed | 599 | 399 |
| Lehmann Audio Black Cube SE New& Boxed | 650 | 429 |
| Lyra Lydian Beta New& Boxed | 599 | 499 |
| Michell ISO Phono Stage S/H | 549 | 250 |
| McCormack Phono Stage New and Boxed | 650 | 399 |
| Nottingham Analogue Hyperspace/Paragon 1 S/H | 3100 | 1499 |
| Systemdeck S/H | N/A | 199 |

Preamplifiers

| | | |
|--|-------|------|
| Advantage S2 Balanced Silver S/H | 2750 | 1399 |
| Audio Synthesis Passion 8 Remote Preamplifier S/H | 1800 | 795 |
| CAT SL 1MKII Reference Phono Pre amplifier S/H | 6500 | 3799 |
| Einstein "The Tube" Preamplifier x-Demo | 6000 | 3999 |
| Musical Fidelity A3 Preamplifier S/H | 899 | 499 |
| Graaf GM13.5BII Valve Preamplifier x-demo S/H | 4000 | 2999 |
| Krell KSL 2 Signature Analog Series S/H | 5800 | 1850 |
| Krell KAV-S Processor/Preamplifier DTS/AC3/Pro Logic S/H | 14989 | 2999 |
| McIntosh C100 2 Box Valve Remote Controlled Preamplifier S/H | 6500 | 2999 |
| Roksan L2 preamplifier S/H | 1295 | 399 |
| Spectral DMC12 s Phono x-demo | 4750 | 3299 |
| Spectral DMC30 Remote x-demo | 8500 | 6500 |

Amplifiers

| | | |
|---|-------|------|
| 47 Labs Gain Card25w / Humpty S/H | 3250 | 1899 |
| Audio Analogue Maestro Integrated x-demo | 2700 | 1899 |
| Electrocompaniet AW120Dmb S/H | 2395 | 1599 |
| Krell FPB600c Power Amplifier | 14000 | 8500 |
| Roksan S1.5 Stereo Power Amplifier S/H | 1500 | 699 |
| Unison Research S2K Remote x-demo | 1295 | 995 |
| World Audio KaT6550 Valve power amplifier S/H | 995 | 399 |

Loudspeakers

| | | |
|--|------|------|
| Avalon Eclipse Maple x-demo | 9800 | 7249 |
| BKS 107 MKII Supreme Ribbon Hybrids x-demo | 2199 | 1599 |
| Indigo Model Two Centre Channel Cherry S/H | 199 | 129 |
| Jm Lab Micro Utopia Dark Cherry/inc stands New and Boxed | 4500 | 3799 |
| JM lab Mini Utopia Ebony S/H | 3999 | 2499 |

Cables & Accessories

| | | |
|---|------|------|
| Air Pod size 1 x3 S/H | 210 | 99 |
| Acoustic Zen Silver Signature Balanced 12ft | 2700 | 1499 |
| Cogan Hall EM-D 0.6m S/H | 199 | 99 |

Midland Audio X-change is looking for good used British & American Hi-Fi

cash paid call John Roberts on 01562 822236

| | | |
|--|------|------|
| Kimber Select KS 3033 2X10ft S/H | 1750 | 995 |
| Opera Lux 3 Tier Table Clear/Stainless x-Demo | 950 | 499 |
| Partington Dreadnaught 24" Stands S/H | 250 | 149 |
| Roksan HA01 1M Interconnect S/H | 99 | 49 |
| Roksan HAO1D 0.5m Digital Interconnect S/H | 49 | 25 |
| Target HR60 Silver Stands S/H | 199 | 109 |
| Target R1 Stands S/H | 299 | 175 |
| Target R2 Stands S/H | 329 | 199 |
| Transparent Music Link RCA-RCA 2m S/H | 299 | 149 |
| Transparent Music Link Balanced 2m S/H | 499 | 249 |
| Transparent Music Link Reference Balanced 1.5m S/H | 3300 | 1599 |
| Transparent Music Link Ultra Balanced 7.26m S/H | 2349 | 1499 |
| Transparent PL20XL Power cord S/H | 1260 | 799 |

Tuners & Tape Decks, Power Supplies

| | | |
|--|-----|-----|
| AKG C1000 Condenser Mic S/H | 241 | 120 |
| Magnum Dynalab FT-R Remote Switcher for FT101A/Etude (New&Boxed) | 450 | 299 |
| Rega RadioR Silver x-demo | 498 | 299 |

Bargains under a £100

| | | |
|---|-----|----|
| Sony TCK-461s 2 head cassette decks new&boxed | 199 | 99 |
|---|-----|----|

Midland Audio X-change are looking Audio Research, Krell, Mark Levinson, Naim Audio, Dcs, Wadia, cash paid call John Roberts



Suppliers and installers of High Quality Audio Systems

- 47 Laboratory
- Accuphase
- Audio Note
- Audio Research
- Avid
- Basis
- Cabasse
- Cardas
- Clearaudio
- Conrad Johnston
- Copland
- Dcs
- DNM / Reson
- Einstein
- Electrocompaniet
- Final
- Finite Elemente
- Graff
- Gryphon
- Lavardin
- Mark Levinson
- Martin Logan
- Michell
- Nagra
- Primare
- ProAc
- Rega
- Resolution Audio
- Sonus Faber
- Spectral
- SPM
- Sugden
- UKD

WE HAVE MOVED

New address:-

www.midlandaudiox-change.co.uk

call John Roberts Tel: 01562 731100

or fax on: 01562 730228

The Old Chapel, Forge Lane, Belbroughton
Worcestershire, DY9 9TD

e-mail sales@midlandaudiox-change.co.uk

Mobile 07721 605966

Sound Stage
2nd User Hi-Fi & audio

01376 521132
07802 483698
CHELMSFORD, ESSEX
E-MAIL: soundstage@netlineuk.net
BY APPOINTMENT ONLY

PRE-OWNED EQUIPMENT

| | |
|---|-------|
| ARCAM ALPHA 10 AMP BOXED AND IMMACULATE | £499 |
| ARCAM ALPHA 7 TUNER BOXED AND IMMACULATE-2 YEARS OLD | £179 |
| AUDIOLAB 8000A-BLACK-PHONO 'E' SERIAL NUMBER | £299 |
| CYRUS FM7 TUNER BOXED AND IMMACULATE | £299 |
| CYRUS SMART POWER BOXED AND IMMACULATE | £449 |
| DEFINITIVE TECHNOLOGY PRO SUBWOOFER 80 BOXED AND SUPERB | £279 |
| DENON AVP-A1 GOLD BOXED AND IMMACULATE (£3000 NEW) | £995 |
| DENON AVC-A1SE BLACK BOXED AND SUPERB 7.1 DTS ES AC3-RF | £1795 |
| KRELL KSA80B POWER AMP SUPERB CONDITION | £1595 |
| LINN NUMERIK DAC 20 BIT NON SMP5 VGC | £399 |
| MARANTZ CD63 SE KI SIGNATURE | £299 |
| MERIDIAN 606 DAC BOXED AND IMMACULATE | £595 |
| MICROMEGA DRIVE 2 CD TRANSPORT | £395 |
| MICROMEGA STAGE 5 IMMACULATE AND BOXED | £429 |
| MICROMEGA DRIVE 3/DAC BOXED AND IMMACULATE | £995 |
| MISSION DADS/DAC5 TWO BOX CD PLAYER NO REMOTE SUPERB CONDITION | £299 |
| MONITOR AUDIO SILVER 9i CHERRY BOXED AND SUPERB | £595 |
| MONITOR AUDIO MA1800 REFERENCE GOLD LOUDSPEAKERS-BOXED | £595 |
| MUSE MODEL 3 PRE-AMP REMOTE BLACK BOXED AND IMMACULATE | £995 |
| MUSICAL FIDELITY HTP/HT600 AV SILVER 5 MONTHS OLD AS NEW (WERE £4K) | £2995 |
| MUSICAL FIDELITY A220 INT AMP PIANO BLACK BOXED AND SUPERB | £499 |
| NAIM CREDO BEECH 1998 BOXED AND IMMACULATE | £895 |
| NAIM NAC 82 GREEN FRONT INC NAPSC 3 YEARS OLD SUPERB CONDITION | £1695 |
| NAIM NAP140 NEW STYLE BOXED SUPERB CONDITION | £449 |
| NAIM NAC 102 BOXED AND IMMACULATE 2001 MODEL | £795 |
| NAIM NAC 92 PRE AMP BOXED AND IMMACULATE | £279 |
| NAIM NAIT3/PRE OUT MODIFICATION BOXED AND IMMACULATE(1999 MODEL) | £399 |
| NAIM IXO 2-WAY ACTIVE X-OVER WITH VARIABLE FREQUENCY | £299 |
| NAIM NAT 101/SNAPS 2 BOX TUNER LOVELY CONDITION BOXED | £595 |
| NAIM NA CD-X CD PLAYER 3 YRS OLD SUPERB | £1795 |
| NAKAMICHI OMS5E/II CD PLAYER-WAS £1500 NEW-LOVELY CONDITION | £399 |
| NAKAMICHI CASSETTE DECK 2 | £179 |
| PIONEER CLD 925 DOLBY DIGITAL LASER DISC PLAYER | £299 |
| PRIMARE A30.1 INTEGRATED AMPLIFIER BOXED-SLIGHT MARK HENCE | £995 |
| PRO-AC TABLETTE 50 CHERRY-IMMACULATE | £395 |
| PROCEED PCD SERIES 3 CD PLAYER (£3500 NEW) | £1495 |
| QED A240CD INTEGRATED AMPLIFIER | £99 |
| RUARK EPILOGUE REFERENCE ROSEWOOD SUPERB AND BOXED | £299 |
| RUARK CL20 BEECH VERY GOOD CONDITION | £895 |
| VIENNA ACOUSTICS MOZART BEECH WOOD GOOD CONDITION BOXED | £995 |

PROFESSIONAL RECORD CLEANING SERVICE - KEITH MONKS MACHINE -
PLEASE RING FOR FURTHER DETAILS AND PRICES.

THREE MONTH WARRANTY ON ALL ITEMS

www.sound-stage.co.uk

WILLIAMS HART ELECTRONICS

HART ELECTRONIC KITS TRADED FOR OVER 30 YEARS



Mosfet Monoblock Power Amp Kits
ONE OF THE BEST AMPLIFIERS YOU WILL HEAR! Regardless of price
REVIEWED IN HI-FI NEWS AS "...EXCEPTIONAL...
SELF EVIDENTLY CORRECT"

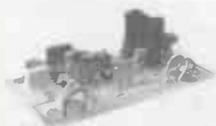

Single Ended Class A Valve Sound
15Watt Power Amp modules
FOR THOSE WHO WANT THAT VALVE
MIDBAND BUT BASS AND TREBLE TO MATCH

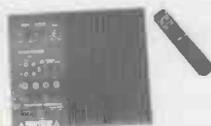

ACTIVE R/Control SUBWOOFER MODULE £177.30



Speakers Designed & Built to Order

Advertise your Hi-Fi on my website (FREE)

Also: Award Winning Phono Stage Kit, Active Crossover Modules, Speaker Drive Units, M Cap Capacitors, Caddock Resistors, Remote Control Volume and much more.

WEB SITE: www.williamshart.com e-mail: sales@williamshart.com

Tyn-Y-Coed, Llidardau, Bala, Gwynedd, LL23 7SG Tel/Fax for catalogue 01678 520757.

PERSONAL VISITORS SHOULD PHONE FIRST TO AVOID DISAPPOINTMENT

Run by former Technical Director of Willslow Audio



MUSICAL IMAGES

| PRODUCT | LIST | NOW |
|---|----------------|--------|
| ARCAM A75PLUS Silver AMP | NEW £470 | £350 |
| ARCAM ALPHA5CD CD Player | SH £450 | £150 |
| ARCAM ALPHA6AMP AMP | SH £300 | £150 |
| ARCAM ALPHA9AMP AMP | SH £500 | £275 |
| ARCAM ALPHA9POWER Power Amp | SH £400 | £250 |
| ARCAM CD72 Silver CD Player | EX/DEMO £450 | £280 |
| ARCAM T61 Silver Tuner | NEW £250 | £180 |
| DENON AVC-A1SE Black AV Amp, THX | EX/DEMO £2,500 | £1,500 |
| DENON AVR1602 Black AV Receiver | EX/DEMO £350 | £280 |
| DENON AVR2802 Gold AV Receiver | EX/DEMO £650 | £550 |
| DENON AVR3802 AV Receiver | EX/DEMO £850 | £600 |
| DENON DVD2800 DVD Player | EX/DEMO £750 | £600 |
| DENON DVD2800 DVD Player | S/H £750 | £450 |
| HARMON KARDON AVR4500 AV Receiver | NEW £650 | £375 |
| HARMON KARDON AVR5500 AV Receiver | NEW £750 | £450 |
| HARMON KARDON AVR8500 AV Receiver | NEW £1,800 | £1,200 |
| HARMON KARDON TU940RDS Tuner | NEW £180 | £135 |
| KEF 200CENTRE Centre Speakers | EX/DEMO £700 | £550 |
| KEF KHT2005 5 Speakers & SUB | EX/DEMO £800 | £600 |
| KEF REFERENCE 4-2 Cherry Speakers | EX/DEMO £3,650 | £2,800 |
| LINN AKTIVMOD Aktiv Modules | EX/DEMO £125 | £50 |
| MARANTZ ECLIPSE 70 DVD Combi System | EX/DEMO £1,500 | £750 |
| MARANTZ LC1700 17" LCD 16:9 TV | EX/DEMO £1,500 | £1,000 |
| MERIDIAN 558 Multi-channel Amp | EX/DEMO £3,395 | £2,000 |
| MERIDIAN 568 Digital processor | EX/DEMO £3,885 | £2,500 |
| MERIDIAN DSP33 DSP Active Speaker | EX/DEMO £2,595 | £1,500 |
| MERIDIAN DSP5000 Cherry Speakers | EX/DEMO £3,885 | £2,500 |
| MERIDIAN DSP5000C Black Centre Speaker | EX/DEMO £1,995 | £1,000 |
| MERIDIAN DSP5500HC Centre Speaker | EX/DEMO £3,750 | £2,500 |
| MERIDIAN M33 Speakers | EX/DEMO £1,560 | £750 |
| MISSION 78C Centre Speaker | EX/DEMO £300 | £150 |
| MISSION 78DS Speakers | EX/DEMO £300 | £150 |
| MUSICAL FIDELITY A3CR Pre Amp | EX/DEMO £1,000 | £800 |
| MUSICAL FIDELITY HTP AV Pre Amp | EX/DEMO £2,000 | £1,000 |
| MUSICAL FIDELITY NUVISTA 3DCD CD Player | NEW £3,000 | £2,000 |
| NAIM INTRO Black Speakers | EX/DEMO £790 | £395 |
| PANASONIC DMRE30EBS Recordable DVD Player | EX/DEMO £550 | £475 |
| PANASONIC NVFJ630BS Silver VCR | NEW £150 | £120 |
| PIONEER NS DV1000 Home Cinema System | NEW £1,300 | £1,000 |
| ROTEL RB951 Power Amp | EX/DEMO £300 | £200 |
| ROTEL RB985 Power Amp, 5 Channel, THX | EX/DEMO £625 | £450 |
| SELECO HT300DG Projector | EX/DEMO £9,000 | £6,750 |
| SONY DVPNS 900 Silver DVD Player | NEW £450 | £225 |
| SONY STRDB1070 Black A/V Receiver | EX/DEMO £600 | £375 |
| SONY STRVA555ESN AV Receiver | EX/DEMO £1,000 | £750 |
| SONY STSE370 Tuner | NEW £110 | £80 |
| SONY VPLHS1 Projector | EX/DEMO £1,800 | £1,000 |
| SONY VPLW11HT Projector | EX/DEMO £5,300 | £3,300 |
| YAMAHA DPX-1 Projector | EX/DEMO £6,500 | £4,500 |
| YAMAHA RXV620RDS AV Receiver | EX/DEMO £450 | £300 |

**PLEASE VISIT OUR SHOWROOMS
OR CALL OUR HOTLINE
NUMBER FOR DETAILS.
MANY ARE ONE-OFF ITEMS!!**

HOTLINE 020 7497 1346

Convent Garden
18 Monmouth Street
Convent Garden
London WC2H 9HB
Tel: 020 7497 1346

E-Mail: sales@musical-images.co.uk

NOT VALID WITH ANY OTHER OFFERS OR PROMOTIONS E&OE

WANT TO SAVE MONEY

Well if you do V'Audio could be the best way of saving loads of money. I could make considerably more profit than I do by selling basically poor sounding systems, so that customers come back time and again to try and get that illusive sound. But I talk directly to customers, generally visit their homes and listen to their system/problems. I then recommend what I think should be done and then evaluate the results. I may initially be wrong; I recently took an AVI/ALR Jordan system to a customer who had a £15k system - mine was £2.5k and it wiped the floor with his. My initial reaction was to blame his speakers, but after further testing it turned out to be his £6k power amp! It may not be a bad amp but it didn't work in that system. It's no good just buying well reviewed components and hoping they will work together. That's why most reviews are irrelevant and why V'Audio isn't, as we will avoid expensive mistakes. So if you are not happy with your sound, why not give me a ring and see how I can save you money as well as improving your sound.

P.S. P/E Linn LP12/Lingo/Ekos/Circus/Trampoline /Lyra Beta (£1700).

P/E EAR 534 valve power amp, balanced input, 50w/ch (£1400)

P.P.S. Now in stock-Alon Thunderbolt Subwoofer (£1600) & Napoleon Satellites (£800/per pair) superb!

V'audio HI-FI Consultants
36 Druid Hill, Stoke Bishop, Bristol BS9 1EJ
Tel/Fax 0117 968 6005

THE VINTAGE VALVE TECHNOLOGY FAIR 2003

HELD AT HAYDOCK PARK RACECOURSE,
NEWTON LE WILLOWS,
MERSEYSIDE WA12 0HQ
- ON THE A49, 5 MINUTES FROM M6
JUNCTION 23 & A580

ON SUNDAY JULY 27TH 2003
PUBLIC ENTRY 10:00 TO 16:00

- Easy to find & easy to get to!
- Stall holder and Public car parking FREE!
- Stalls still available ONLY £25!
- Public entry ONLY £2.50 accompanied bored wives & kids FREE!
- On site catering & licensed bar in operation at the fair!

<http://www.myciunka.supanet.com/VVTF2003>
Tel: 01274 824816



Connoisseur Audio



Tel/Fax : 01436-670-928 Email : connoisseuraudio@btopenworld.com

PERPETUAL TECHNOLOGIES Signature PACKAGES £1750 < First 10 Orders Only >
Comprising Full Sig. Versions P3A, MSP & Standard P1A - Standard Versions Complete Set : P1A, P3A & Monolithic PSU £1499
PSAUDIO POWER PLANTS : P300 £1499 P600 £2299

SELECTION FROM NEW/EX DEM & PRE-OWNED EQUIPMENT

Please Call Us or Visit Our Web-site For Full Range - Part Exchanges Welcomed

| | New | Ex-dem | | New | Ex-Dem | | |
|--------------------------------|--------------------------|--------|--------------------------------------|------|--------|--|-----------------------|
| Pathos Acoustics | | | Bluenote by Villa | | | Racks & Miscellaneous | |
| New Logos | 2495 | | A6 Speakers Ex-Dem | 1100 | 899 | Clearlight Audio Ex-dem Racks | Call for Availability |
| TT-RR | 3250 | 2875 | Twinstar Ex-Dem | 1700 | 1499 | Audusa , LAT & KE Mains Cables, Isotek , Nordost | |
| Classic One 50W Version | 999 | | Epoch Pre Ex-Dem | 1500 | 1299 | Ecosse, Vibrapods, Interconnects etc | |
| New Classic One 70W | 1275 | 1039 | Bellavista TT Ex-Dem | 999 | 899 | Speakers - Full range Diapason, Horning, Triangle | |
| In Control | 3500 | | Bluenote CD Players | | | Gerschman , Loth X, Bluenote - Call us ! | |
| In Power Monobloc | 3350 | | Stibbert | 2499 | | Perpet. Technology Single Products Prices | |
| Unison Research | | | Contz | 4199 | | P3A DAC Standard | 749 |
| SR1 | 1250 | | Pink Tri-Angle Int Amp | 3995 | | P1A | 699 |
| S.6 | 1675 | 1499 | Croft | | | MSP PSU | 349 |
| S.8 | 3100 | 2799 | Croft Puritan CD | 1999 | | PRE-OWNED ITEMS | Price Cost New |
| Mystery One/Two | 1750 | | New Epoch Pre | 1499 | | Pathos Logos Int Amp | 1999 2495 |
| Unico Pre Line & Phono | 1250 | | Dakshini | 3299 | | Pathos Classic One | 795 1275 |
| Graaf | | | Opera Speakers | | | In Control - PreAmp | 2399 3500 |
| Venticinque (old model) | | 1499 | Super Pavarotti II | 1150 | 799 | Opera Pavarotti Speakers Immac. | 699 1375 |
| Venticinque (new model) | 2250 | | SP2 | 1375 | 1149 | Paganini CD Player | 645 795 |
| Graf GM 100 OTL P/Amp | 4600 | 4140 | SP3 | 1750 | 1499 | EAR V20 Integrated | 1799 2800 |
| EAR Yoshino | | | Diapason Speakers | | | Donizetti Monos Pair | 649 990 |
| V20 Integrated | 2800 | | Adamantes LE & Stand | 3995 | 2995 | PS Audio P600 | 2199 2800 |
| 869 Integrated | 2300 | 1849 | Adamantes III | 1975 | 1599 | PS Audio P300 Power | 1399 1700 |
| 864 Pre-Amp | 2800 | | Cartridges | | | EAR 869 Integrated | 1499 2300 |
| 861 Power Amp | 3800 | | Dynavector, Lyra & Sumiko Ranges | | | Unison Research S8 | 2099 3100 |
| Audio Analogue | | | Benz LP Ebony | 1599 | | Wilson Benesch Actors Cherry | 2499 4000 |
| Full product range | Call For Prices ! | | STAX | | | Plinius SA102 | 2825 3750 |
| Plinius - Full Range Available | | | Full Range & Part Exchange Available | | | Manley Purist Pre-Amp | 649 1400 |
| 8200P Power. Amp | 1550 | | | | | EAR 864 Pre-Amp | 1075 1530 |
| 8200/2 Integrated | 2250 | | | | | | |

www.connoisseuraudio.co.uk

HEATHCOTE AUDIO

TEL: 01992 653999 MOBILE: 07860 511111 E-MAIL ADDRESS: HeathcoteAudio@aol.com

SUMMER SALE ALL REDUCED THIS MONTH

| | WAS | NOW |
|--|----------------------|--------------------|
| UNISON RESEARCH SMART 845 MONOBLOCKS | £2350 | MINT/BOXED £2150 |
| ART AUDIO QUINTET POWER AMP | £1150 | MINT £795 |
| VINTAGE RADIO RESTORATION ADUR MONOBLOCKS | £995 | GC £695 |
| QUAD QC-24 PRE & QUAD II/40 MONOBLOCKS (RETAIL £4000 SUPERB) | £2850 | BOXED £2650 |
| AUDIO RESEARCH LS22 REMOTE PRE AMP BALANCED/SE RE-VALVE | £2950 | MINT/BOXED £2750 |
| AUDIO RESEARCH LS-2 PRE AMP (MULLARD REVALVE) | £1395 | MINT/BOXED £1250 |
| AUDIO RESEARCH SP-14 PRE C/W PHONO STAGE (£4000) | £2295 | MINT £1995 |
| LUMILEY REFERENCE PP-40 PRE & ST-40 POWER AMPS (CHROME) | £995 | MINT/BOXED £850 |
| AUDIONOTE KIT 1 SIGNATURE BLACK GATES HOWLAND MUSICAPS ETC | £1395 | MINT/BOXED £1195 |
| PINK TRIANGLE INTEGRAL (1 MONTHS USE NOW PRICE £3995) | £2995 | AS NEW/BOXED £2750 |
| COPLAND CSA-28 REMOTE INTEGRATED C/W PHONO STAGE | £795 | MINT £750 |
| THETA PEARL TRANSPORT/DS PRO BASIC-11 DAC | £2250 | MINT/BOXED £1895 |
| PINK TRIANGLE CARDINAL/ORDINAL 22 BIT/CLOCKING CABLES ETC | £1175 | MINT/BOXED £995 |
| ROKSAN ROK-1 TRANSPORT WITH POWER SUPPLY UPGRADE | £650 | MINT/BOXED £475 |
| ROKSAN OJAN 3X & OJAN 3S SUB SYSTEM (ROSEWOOD) RARE | £1450 | MINT/BOXED £1150 |
| SD OBS FLOORSTANDERS (OPEN BAFFLE) SMALLER BROTHER TO SD1 | £495 | BOXED £375 |
| CABLE HOWARD-2 PREMIUM BEECH FINISH | £795 | MINT £650 |
| LEHMAN BLACK CUBE SE (LAST ONE RETAIL £650?) | £450 BRAND NEW/BOXED | £375 |
| CASTLE AVON FLOORSTANDERS | £450 | MINT £375 |
| NORDOST SPM REFERENCE 2.5 METRE PAIR | £1450 | AS NEW BOXED £1250 |

VALVE AMPS

| | |
|---|--------------------|
| AUDIO RESEARCH VT-50 POWER AMP EX DISPLAY | AS NEW/BOXED £2750 |
| UNISON RESEARCH S-6 REMOTE INTEGRATED EX DEM | MINT/BOXED £1275 |
| GRANT G200 AMS LTD. EDITION 200 WATT MONOBLOCKS & G100P PRE AMP | EXCLT £2250 |
| CONRAD JOHNSON PREMIER 14 REMOTE CONTROL PRE AMP | EXCLT £1995 |
| UNISON RESEARCH CSP PRE AMP WITH PHONO STAGE | MINT £695 |
| MONRIO ASTY VALVE PRE-AMP (VERY PRETTY) 3 MONTHS OLD | MINT BOXED £375 |
| JOLIDA SJ 202A AMERICAN EL34 INTEGRATED AMP (VERY PRETTY) | MINT/BOXED £650 |

SOLID STATE

| | |
|--|-------------------|
| TALK CYCLONE-1 REMOTE AMP EX DISPLAY/NEW | AS NEW/BOXED £375 |
| TOCA SEGA 20 WATT CLASS A AMP MARBLE FRONT VERY RARE /GOOD | EXCLT £1250 |
| REGA CURA REMOTE PRE AMP | AS NEW £295 |
| CONRAD JOHNSON EV-1 PRE AMP (GOLD) | MINT/BOXED £895 |
| PIONEER M-90 POWER AMP WITH VOLUME CONTROL/3 INPUTS | MINT £550 |
| SUGDEN AU-51 POWER AMP (EX DISPLAY LAST ONE) | MINT/BOXED £895 |

CD

| | |
|---|-------------------|
| TECHNICS SL-Z1000/SH-X1000 FLAGSHIP TRANSPORT & DAC (GOLD/WALNUT) | BOXED £2450 |
| ACCUPHASE DP-80 TRANSPORT | EXCLT/BOXED £1750 |
| DPA T-1 TRANSPORT (WITH DELTRAN) | MINT/BOXED £495 |
| MICROMEGA CD 3.1 TRANSPORT (TOPLOADER) | EXCLT/BOXED £695 |
| ORELLE CD107 TRANSPORT | MINT/BOXED £375 |
| COUNTERPOINT DA11E TRANSPORT | MINT/BOXED £495 |
| THETA DS PRO GEN III (AT&T, COAX ETC.) WAS £6000 APPROX | MINT/BOXED £2395 |
| TRICHORD PULSAR DAC & LARGE SEPARATE PSU. | MINT/BOXED £695 |
| DPA PDM-1 MKIII 2 BOX DAC (WITH DELTRAN) | MINT/BOXED £695 |
| DPA ENLIGHTENMENT DAC (WITH DELTRAN) | MINT/BOXED £695 |
| AUDIONOTE DAC-1X SIGNATURE | AS NEW/BOXED £695 |
| AUDIOLAB 8000 DAX (HDD COMPATIBLE ONE OF THE VERY LAST MADE) | MINT/BOXED £695 |
| MONRIO 188 DAC & SEPARATE PSU. | MINT £475 |
| TECHNICS SL-P2000 REFERENCE CD | MINT £595 |
| TEAC VRDS 25 | MINT £795 |
| MARANTZ CD17 KI-SHIP MK11 (GOLD) | MINT/BOXED £750 |
| SONY XA-50ES CHAMPAYNE GOLD | MINT/BOXED £595 |
| PIONEER PD-91 | MINT/BOXED £495 |
| TALK THUNDER-1 EX DISPLAY/NEW | AS NEW/BOXED £375 |
| TECHNICS SLPS 900 | EXCLT £175 |

VINYL

| | |
|--|------------------|
| SIMON YORKE ZARATHRUSTRA SERIES V/SERIES VII ARM | MINT/BOXED £3500 |
| NOTTINGHAM ANALOGUE STUDIO MENTOR REFERENCE & MATCHING ARM | MINT £3250 |
| ORACLE DELPHI SERIES 3 | MINT TBA |
| GRAHAM 1.5 TONEARM | MINT/BOXED TBA |
| REGA PLANNER-3/ARM/BIAS CARTRIDGE EX DEM | MINT/BOXED £275 |
| CONRAD JOHNSON EF-1 PHONO STAGE | MINT/BOXED £995 |
| TALK BREEZE PHONO STAGE MM/MC EX DISPLAY | EX-DIS TBA |
| NAD PP-1 PHONO STAGE | £25 |

LOUDSPEAKERS

| | |
|---|-----------------------|
| CELESTION A-2 HUGELY CAPABLE (ROSEWOOD VENEER) | BRAND NEW/BOXED £1250 |
| WILSON SYSTEM 5.1 PIANO BLACK | MINT/CRATED £7500 |
| B&W 801 MATRIX LOUDSPEAKERS SOUND ANCHOR STANOS / EQ.BOXES (COST £7000 +) | MINT/BOXED £2750 |
| APOGEE SCIMITILLA S (METALLIC BLACK LAQUER FINISH) | EXCLT £1750 |
| SHELL C MK-IV AMERICAN OAK VERY RARE/GOOD | EXCLT £1250 |
| TDL STUDIO MONITOR TRANSMISSION LINE WAS (£2500) | EXCLT £1250 |
| PROAC STUDIO 150 FLOORSTANDERS (CHERRY) SUPERB | MINT £1050 |
| ALR JORDAN NOTE-5 SPECIAL BOBINGA WOOD FINISH EX DISPLAY/AS NEW | BOXED £1195 |
| EPOS ES-11 LAQUER FINISH | MINT/BOXED £375 |
| DYNAUDIO AUDIENCE 80 (CHERRY/WOOD FINISH) | MINT £1000 |
| IMF PROFESSIONAL MONITOR VII | RING RING |
| AMPHION NEON MK1 EX.DEMO | MINT/BOXED £895 |
| AMPHION HELIUM 1 | MINT/BOXED £350 |
| TANNOY ARUNDEL 15*3839 HIGH PDWER DRIVERS 95 DB SENSITIVE VERY RARE | MINT £1500 |
| WILMSLOW AUDIO VORTEX VOLT DRIVERS PIANO BLACK EXT. X OVER | £475 |
| SHAN ACOUSTICS + MATCHING STANDS | EX DIS.MINT £275 |
| B&W 601 SERIES-2 | MINT £125 |

TUNERS /TAPE/DAT/MINIDISC/MISC

| | |
|--|------------------|
| PIONEER F-91 CLASSIC TUNER | MINT/BOXED £295 |
| SONY 3000ES TUNER CHAMPAYNE GOLD (RDS ETC) | MINT/BOXED £195 |
| TALK LIGHTNING 1.1 TUNER EX DIS. | AS NEW/BOXED TBA |
| NAKAMICHI DR-3 (VERY LITTLE USE) | MINT/BOXED £250 |
| PIONEER CTa-91 REFERENCE CASSETTE DECK | VGC £250 |
| SONY DTC-1000 DAT MACHINE (£1300) | VGC £575 |
| SONY JA-30ES MINIDISC (CHAMPAYNE GOLD) | MINT £375 |

RACKS/STANDS

| | |
|---|--------------------------|
| SOUNDSTYLE ST-105/AQUA GLASS (NEW MODEL £399?) | EX DIS/BOXED/AS NEW £275 |
| SOUNDSTYLE XS 105 5 SHELF (£320) | EX DIS. £195 |
| SOUNDSTYLE XS 310 AV TABLE (£320) | EX.DIS £195 |
| SOUNDSTYLE XS 105 5 SHELF CANCELLED ORDER | BRAND NEW BOXED £225 |
| SOUNDSTYLE XS 100 4 SHELF CANCELLED ORDER | BRAND NEW BOXED £195 |
| SOUNDSTYLE XS 250 CD STORAGE RACK CANCELLED ORDER | BRAND NEW BOXED £195 |
| ATTACAMA R724/ATTABITE (WAS £250) | VGC £175 |
| B&W STANDS FOR CD-INT SILVER/BLACK | VGC £95 |
| TARGET 24 INCH STANDS | MINT £75 |

SPECIAL OFFER

BLACK RHODIUM S-130X2 BI-WIRE CABLE BRAND NEW LTD QUANTITY £10 PER METRE
BLACK RHODIUM S-300 BI WIRE CABLE BRAND NEW LTD QUANTITY £25 PER METRE

MAINS CABLES/BLOCKS/CONDITIONERS ETC

| | |
|--|----------------|
| BLACK RHODIUM 8 WAY MAINS BLOCKS (CANCELLED ORDER) | BRAND NEW £225 |
| BLACK RHODIUM 25 MAINS CABLE (BLACK CLOTH BRAID) | BRAND NEW £65 |
| DPA 'THE POWER' MAINS FILTERS | £75 |

CABLES

| LOUSPEAKER CABLE | |
|---|-------------|
| VAN DEN HUL REVELATION 2 METRE PAIR TERMINATED EX DEM | £600 |
| MIT MH-750 12 FT PAIR | £850 |
| MIT MH-750 8 FT. PAIR | £650 |
| NIRVANA AUDIO SL-SERIES 2.5 METRE PAIR EX DEM. FACTORY TERMINATED | £175 |
| TRANSPARENT WAVE 200 2 METRE PAIR | £275 |
| CARDAS HEXLINK 2 METRE PAIR (FACTORY TERMINATED) | £275 |
| AUDIONOTE AN-SP 2 X 2 METRE PAIRS (FACTORY TERMINATED) | £375 |
| AUDIONOTE AN-L 4 METRE PAIR (FACTORY TERMINATED) | £225 |
| QED GENESIS SILVER SPIRAL 4 X 1.5 METRE TERMINATED | £175 |
| VANDEN HUL MC CS 122 2 X 3 METRE PAIR | (EACH) £75 |
| AUDIOQUEST CRYSTAL HYPERLITZ 2 METRE BI-WIRE TERMINATED | £75 |
| AUDIOQUEST INDIGO 3 METRE PAIR | £50 |
| LINN K-400 3 METRE PAIR (TERMINATED) | £35 |
| VAN DEN HUL TEATRACK BI-WIRE 5 METRE PAIR (TERMINATED) | EX DIS £165 |
| CABLE TALK BI-WIRE 5 METRE PAIR (TERMINATED) | |
| CHORD CO. 5 METRE PAIR (TERMINATED) | EX DEM £65 |

INTERCONNECT

| | |
|---|-------------------------|
| ACOUSTIC ZEN SILVER REFERENCE 1.5 METRE PHONO EX DEM | £795 |
| ACOUSTIC ZEN SILVER REFERENCE 0.5 METRE | £350 |
| HARMONIC TECH MAGIC LINK ONE 1 METRE EX DEM | £650 |
| ACOUSTIC ZEN MATRIX REFERENCE 1METRE PHONO EX DEM | £350 |
| BLACK RHODIUM REQUIEM-2 NORMALLY £1750/METRE LTD QUANTITY | BRAND NEW BOXED RING |
| BLACK RHODIUM ORATORIA 1 METRE | BRAND NEW PACKAGED £400 |
| BLACK RHODIUM ORATORIA 0.5 METRE | BRAND NEW PACKAGED £275 |
| BLACK RHODIUM SYMPHONY 1 METRE (SEVERAL) CANCELLED ORDER | BRAND NEW PACKAGED £85 |
| BLACK RHODIUM SYMPHONY 0.5 METRE (3 OFF) | BRAND NEW PACKAGED £65 |
| VAN DEN HUL INTEGRATION 0.6/ METRE | BRAND NEW PACKAGED TBA |
| VAN DEN HUL SECOND 2 METRE BALANCED | BOXED £300 |
| VAN DEN HUL SECOND 2.5 METRE BALANCED | BOXED £250 |
| LINDSAY AUDIOPHILE SATIN GRAY 2 METRE (AMERICAN NEW/PACKED WAS £480) | £175 |
| LINDSAY AUDIOPHILE GRAY 2 METRE | (NEW) £350 |
| AUDIONOTE AN-V KONDO SILVER INTERCONNECT 3.2 METRE | £175 |
| AUDIONOTE AN-V SILVER INTERCONNECT 1.5 METRE (PACKAGED AS NEW EX DEM) | £280 |
| DPA BLACK SLINK 5 METRE BALANCED PAIR | £580 |
| SUPRA EFF-ISL 2.5 FT PAIR NEW/PACKAGED | £50 |
| AUDIOQUEST DIAMOND 2 X 2 METRE PAIRS (* EACH) | (MINT) *£550 |
| AUDIOQUEST DIAMOND 2 X 2 METRE PAIRS (* EACH) | £650 |
| CABLE TALK MONITOR-3 3 X 1 METRE PAIRS (AS NEW PACKED) (*EACH) | *£25 |
| NORDOST BLUE ANGEL 1.5 METRE PAIR | BRAND NEW PACKAGED £90 |
| NORDOST BLUE ANGEL 0.5 METRE PAIR | £50 |
| NORDOST BLUE ANGEL 1.0 METRE 5 PIN DIN TO PHONO'S | £75 |
| NORDOST BLUE HEAVEN 0.6 METRE | £75 |
| LFD.4 FEET PAIR | £50 |

DIGITAL

| | |
|---|-------------------------|
| MADRIGAL AES/EBU 0.5 METRE | £150 |
| NIRVANA DIGITAL COAX LEAD 4 FT. | £200 |
| VAN DEN HUL FIRST 0.8 METRE | BRAND NEW PACKAGED £100 |
| VAN DEN HUL D-102 MK.111 HB. 4 FEET | EX DISPLAY/NEW £40 |
| CHORD CO.PRODAC SILVER PLUS (BNC) | £60 |
| CABLE TALK DIGITAL-3 | BRAND NEW PACKAGED £50 |
| REGA DIGITAL INTERCONNECT 1 METRE (NEUTRIK PHONO'S) | £30 |
| VAN DEN HUL AES/EBU | £40 |
| AUDIOQUEST OPTILINK X TOSLINK | £50 |

MOST EQUIPMENT STOCKED IS ONE OWNER MINT/BOXED, SIMILAR QUALITY VINTAGE AND MODERN EQUIPMENT REQUIRED FOR IMMEDIATE CASH PURCHASE. PLEASE PHONE GEORGE 10-6PM

Are you making the right connections?

Send for Britain's biggest catalogue of specialist cable and connections.

All available by mail order.

Phone 020-8942 9124 or clip the coupon for your Free copy
www.custom-cable.co.uk

CUSTOM CABLE
SERVICE

PO Box 4007, London SW17 8XG

Please send me your FREE Custom Cable Catalogue

Name

Address

Postcode

NO FURTHER INFORMATION REQUIRED

Send to: Custom Cable Service
 PO Box 4007
 London SW17 8XG

HFV 08/03



Oxford Audio Consultants Ltd.

OUR SUPERB SERVICE IS THE SAME REGARDLESS OF PRICE



Now Demonstrating



Ex-Demonstration & Previously Owned Equipment

SALE LIST

| | | |
|--|--------|----|
| Goertz Speaker cables | P.O.A. | SH |
| Denon DV5000 DVD Player | P.O.A. | SH |
| Onkyo TX DS 989 AV amplifier | P.O.A. | SH |
| Michell Orbe SE | £1195 | SH |
| Audio Research LS25 | £2995 | SH |
| Krell FPB700cx | P.O.A. | |
| Wilson System 6.1 Ferrari Grey NEW PRICE | £10995 | SH |
| Musical Fidelity F15 Power Amplifier | £695 | SH |
| Musical Fidelity F22 preamp | £595 | SH |
| Musical Fidelity FCD CD Player | £595 | SH |
| Martin Logan Ascents ex dem light oak | £3495 | XD |
| Exposure phono stage XIII MM | £495 | SH |
| Krell 250p preamplifier | £1295 | SH |
| Meridian 500 CD Transport | £795 | SH |
| Musical Fidelity A3.2CD CD Player | £695 | SH |
| dCS Delius | £2995 | SH |
| Lexicon MC1 | £1995 | SH |
| Martin Logan Aeon ex dem | £2295 | XD |
| Graaf 13.5 preamplifier | £1795 | SH |
| Theta Dreadnaught 5 channel | £4995 | XD |
| Onkyo Integra system - our dem models | £6995 | XD |
| Veritas P400 Power Amplifier as new | £2495 | XD |
| Theta Carmen DVD/CD Player silver ex dem | £2495 | XD |
| Audio Research VT60 Power Amp | £ 795 | SH |

SH - Second Hand XD - EX Demonstration

0% interest free credit

Licensed Credit Broker

REFER TO OUR WEBSITE FOR THE LATEST UPDATED SALE LIST.

Agencies include: Acoustic Energy, Alphasound, Alpacama, Audio Analogue, Audio Research, Beyer, BOSE, Castle, Chord Company, Copland, Creston, Denon, Dissonance, Dvsn Electronics, Fujitsu, GM Audio, Goldring, Graaf, Integra Systems, IKOS, Jads, Jamo, Kel, Koetsu, Krell, Laxson, Living Control, Loewe TV/Video, Linn Classic, Lyr, Marantz, Martin Logan, Michell, Musical Fidelity, NAD, Naim, NEC Gas Plasma Screens, Nakamichi, Nordost, Onkyo, Opera, Ortofon, Parasound, Pioneer, ProAc, Project Turntables, QED, Multroom, Quad, Quadraspire, REL Subwoofers, Sennheiser, Sharp LCD TVs, SME, Sonus Faber, Sonus Systems, Soundstyle, Stands Unique, Stax, Stewart Screens, Tag McLaren, Tannoy, Teac, Theta, Transparent Unison Research, Van den Hul, Vibe Acoustics subwoofers, Videologic, Vienna Acoustics, Wilson, Yamaha.

TAX-FREE EXPORT SERVICE
MAIL-ORDER AVAILABLE ON MANY ITEMS

Cantay House, Park End Street
Oxford OX1 1JD

Telephone: Oxford (01865) 790879

Facsimile: Oxford (01865) 791665

E-MAIL: oxford.audio@btinternet.com

WEBSITE: www.oxfordaudio.co.uk



THE SYMBOL OF SECURITY

V.A.T. No.
729580013



QUALITY USED
EQUIPMENT,
BOUGHT, SOLD,
PART EXCHANGE

TEL/FAX
0121 747 4246



URGENTLY REQUIRED
LINN, NAIM,
MERIDIAN, QUAD,
CASH WAITING

| | RRP | NOW £ |
|---|------|-------|
| ACOUSTIC ZEN SILVER REFERENCE XLR 1 MTR EX DEM | 815 | 595 |
| ADVANTAGE A300 POWERAMP | 2600 | 995 |
| ADVANTAGE S2 PREAMP | 2750 | 1495 |
| ATC SCM10 BLACK | 1000 | 395 |
| AUDIO RESEARCH LS15 | 3500 | 1795 |
| AUDIO RESEARCH SP16 | 2500 | 1695 |
| AUDIO RESEARCH VS55 | 2700 | 1795 |
| AUDIO RESEARCH CLASSIC 60 GROOVE TUBED FULL SERVICE | 3500 | 1695 |
| AUDIO RESEARCH VT50 BALANCED | 3500 | 1895 |
| AUDIO RESEARCH D130 | 2000 | 995 |
| AVANTGARDE UNO | 7200 | 3495 |
| BALANCED AUDIO TECHNOLOGIES VK51SE | 7950 | 5795 |
| BALANCED AUDIO TECHNOLOGIES VKD5SE CD | 5450 | 2795 |
| BALANCED AUDIO TECHNOLOGIES 6200/5 CHANNEL | 8275 | 5795 |
| BALANCED AUDIO TECHNOLOGIES VK75SE | 7950 | 5795 |
| BALANCED AUDIO TECHNOLOGIES 300X | 4000 | 2495 |
| BOW WIZARD CD | 3500 | 1695 |
| BURMESTER RONDO CD HDCD BALANCED EX DEM | 2095 | 1295 |
| CHORD CPA 3200 E | 4800 | 2995 |
| DENSEN B400 CD + GIZMO REMOTE | 1300 | 495 |
| EAR 534 POWER BALANCED | 2200 | 1395 |
| EAR THE HEAD PHONO TRANSFORMER | N/A | 295 |
| HOVLAND HP-100 + M/C PHONO | 5750 | 3995 |
| HOVLAND SAPHIRE POWER AMP | 7000 | 4495 |
| JAMO CONCERT 11 CHERRY | 2300 | 1095 |
| KRELL KAV 280 CD | 4000 | 2595 |
| KRELL KAV 300IL | 3700 | 2495 |
| LUXMAN K-351 CASSETTE DECK | N/A | 195 |
| MAGNUM DYNALAB FT11 | 500 | 295 |
| MARANTZ CD7 | 3500 | 2595 |
| MARANTZ 63KI SIG MK2 | 500 | 250 |
| MARK LEVINSON 331 | 5000 | 2395 |
| MARK LEVINSON 39 | 5000 | 3295 |
| MARTIN LOGAN AERIUS I | 2300 | 1195 |
| MERIDIAN 551 | 800 | 450 |
| MERIDIAN 555 | 850 | 395 |
| MERIDIAN 518 | 900 | 495 |
| MERIDIAN 561 | 3200 | 1695 |
| MERIDIAN DSP5000C 96/24 BLACK | 2200 | 1295 |
| MERIDIAN 500 TRANSPORT | 1400 | 695 |
| MERIDIAN 501.V | 950 | 450 |
| MERIDIAN 505 MONO | 900 | 550 |
| MUSE MODEL 8/296 DVD/CD TRANS & 24/96 KHZ DAC | 7000 | 1995 |
| MUSICAL FIDELITY X PRE | 200 | 125 |
| MUSICAL FIDELITY F25 | 1500 | 595 |
| MUSICAL FIDELITY F16 | 2500 | 995 |
| MUSICAL FIDELITY NUVISTA CD | 3000 | 2295 |
| NAIM Credo EBONY | 1425 | 595 |
| NORDOST BLUE HEAVEN 0.6 MTR XLR | 180 | 95 |
| NORDOST BLUE HEAVEN 1 MTR XLR | 200 | 110 |
| NORDOST BLUE HEAVEN 3 MTR BIAMP BANANA'S | 570 | 350 |
| NBS SIGNATURE SPEAKER CABLE 2 X 6 FT | 2600 | 695 |
| NVA THE INTEGRATED STATEMENT | 1300 | 395 |
| PATHOS CLASSIC 1 | 1000 | 395 |
| PROAC FUTURE 0.5 MAHOGANY | 3500 | 1995 |
| PROAC RESPONSE 2.5 CHERRY | 2500 | 1795 |
| QUAD QC 24 / 11 FORTY | 4000 | 2995 |
| QUAD ESL 63 BLACK | 3800 | 895 |
| REL STENTOR 11 WALNUT | 1700 | 895 |
| RED ROSE ROSEBUD | 3000 | 1695 |
| RUARK PRELUDE 11 COSMETIC MARKS HENCE | 950 | 250 |
| SONUS FABER EXTREMA WITH STANDS | N/A | 2995 |
| SOUND LAB MILLENIUM 3 | 8295 | 4995 |
| SUGDEN SAU51 PRE | N/A | 495 |
| TAG MCLAREN 60I INTEGRATED | 600 | 295 |
| TANNOY DIMENSION 8 | 4000 | 2495 |
| THETA PRO GENY | 1100 | 495 |
| VAN DEN HUL THE FIRST 0.8 MTR | 200 | 125 |
| VAN DEN HUL THE SECOND 1.2 MTR | 250 | 150 |
| VAN DEN HUL INTEGRATIO HYBRID 0.6 MTR | 160 | 95 |
| VPI JUNIOR BLACK REGA CUTOUT | 550 | 295 |
| VERITAS P400 | 3000 | 1495 |
| WADIA 6 | 4500 | 1495 |

OPEN MON-SUN 10.00 TO 8.00
Website: www.centralaudio.co.uk
E-mail: tony@centralaudio.co.uk

ALSO AGENTS FOR

Advantage. Balanced audio technologies. Boulder. Burmester. Egleston. Hovland. Kharma. Lumley. Pass labs. Sound lab. VTL.

HEATHERDALE PRE-OWNED GUARANTEED EQUIPMENT EXPORT FACILITIES AVAILABLE

| SPEAKERS | PRICE |
|---|-------|
| Pro AC Studio 1 Speakers Mk 2 | £395 |
| Thiel Cs.5 (New) | £995 |
| B+W Cdm 1 Speakers | £295 |
| Martin Logan Aelius | £795 |
| B+W matrix 1 Speakers | £295 |
| Mirage M3 S1 Speakers | £1495 |
| Thiel SCS 2 Speakers (Walnut Finish) (Brand New) Normal Price £2395 | £1595 |
| Mission 782 (Stand Mount Model) (Black Ash) Just Reduced From £250 | £150 |
| Audio Physics tempo speaker | £995 |
| Revel Ultima sub 15 with LE1 sub amp | £5995 |
| Altav Symphony floor standing speakers | £99 |
| Pro AC studio towers (alc drive) speakers | £995 |
| Orchid PLL1 Speakers x demo | £3745 |

| PRE AMPS | PRICE |
|--|-------|
| Mark Levinson MI 26 Pre Amp With Power Supply | £1295 |
| Naim nac 82 pre amp | £1495 |
| Mark Levinson reference 32 pre amp | £90A |
| Burmester 785 pre amp | £395 |
| Kinshaw perception pre amp with bal Output and phono stage, with psu | £395 |
| Exposure 11 & 12 Pre Amp & Power Supply Just Reduced From £300 | £650 |
| Toft Pre Amp (fully balanced) | £595 |
| Adcom GTP 450 Tuner/Pre-Amp | £350 |
| Exposure 21 Pre-Amp (Remote) (Ex Stock) Just Reduced From £890 | £750 |
| Music Fidelity MVT pre amp | £395 |

| AMPLIFIERS | PRICE |
|--|-------|
| Musical Fidelity P180 Power Amps With MF3a Pre Amp & Psu | £995 |
| Naim NAP 180 power amp | £695 |
| Mark Levinson 333 power amp | £4495 |
| Mark Levinson 334 power amp | £3750 |
| Mark Levinson m63 reference mono's | £795 |
| Naim NAP 303 power amp | £695 |
| Cyrus two Integrated amp with cyrus psx power supply | £395 |
| Mark Levinson 383 integrated amp | £995 |
| Arcam Alpha 9 pre amp | £195 |
| Revel Ultima sub 15 with LE1 sub amp | £5995 |
| Audiomote Negro Mono amps | £995 |
| Arcam Delta 280 Integrated amp | £5995 |
| Krell KST 100 Power Amp | £1695 |
| Nakamichi PA 5 Stasis Power Amp Cost New £1150 | £695 |
| Adcom GFA 5000 Power Amp | £350 |
| AVI 2000MI integrated amp | £750 |

| CD PLAYERS & TRANSPORT | PRICE |
|--|-------|
| Mark Levinson Reference 31.5 transport with ML30.6 | £1295 |
| DAC mint condition, boxed. | £1495 |
| Krell KAV 300 cd player | £395 |
| Marantz CD 72 mk2 SE CD Player (mint) | £395 |
| Marantz CD 63 SE CD Player | £295 |
| Mark Levinson No 37 CD transport | £195 |

| DAC'S | PRICE |
|-----------------------------------|-------|
| Meridian 566 Dac Balanced Outputs | £295 |

| MISCELLANEOUS | PRICE |
|---|-------|
| Slax 40/40 Headphones | £850 |
| 1mtr Kondo Ksl Lp Interconnect (Normal Price £2000) | £995 |
| Mit Balanced 1 Mtr Reference Interconnect (Was £2995) | £850 |
| Mit Balanced 2 Mtr Reference Interconnect (Was £3495) | £1195 |
| Mit Short Gun 750 8 Foot Bi-Wire Speaker Cable | £795 |
| Target Stance R2 | £150 |
| Yamaha Ct-810 Am/Fm Tuner £125 | |
| Nakamichi bx2 cassette deck | £195 |
| 5 mtr holland bi-wire speaker cable | £600 |
| jos labs high current power cord | £245 |
| Synergistic Research Coax Resolution Reference digital (with active shielding) | £250 |
| Slax S7007 omega ref (SR117 head phone & SR4007i dual infeed) Normal Retail £2995 | £1995 |
| Audio Note ANS7 MC Transformer with Phono Stage | £8495 |
| Audio Note (kondo) KSL-AC2 mains cable (new and boxed) | £650 |
| Audionote (kondo) 3mtr pair SPZ speaker cable | £2500 |
| Audio Note (kondo) ksl-LP Silver litz interconnect 1 mtr pair | £995 |

| TURNTABLES, CARTRIDGES & TONEARMS | PRICE |
|---|-------|
| Michell gyrodeck with dc power supply | £995 |
| Linn axis turntable with linn basic plus arm | £295 |
| Lumley strapstere turntable (gold plated) with dedicated stand & large power supply | £2995 |
| Eminent Technology air bearing arm with magnesium wand c/w pump | £1695 |
| Verdier Ebony Wood arm board Normal Retail £800 | £425 |
| Ortofon Jubilee Cartridge | £995 |

ALL USED CARTRIDGES ARE CHECKED UNDER A MICROSCOPE BEFORE BEING OFFERED FOR SALE.

VISA - SWITCH - MASTER CARD - AMEX - DINERS CLUB WELCOME.
 WE TAKE PART EXCHANGE ON NEW & USED STOCK and buy in for cash



Soundcraft HiFi.com

40 High Street, Ashford, Kent. TN24 8TE
 Tel: 01233 624441
 Check our web site: soundcraft.hifi.com

| Manufacturer | Product name | Product type | New/used | Price | Manufacturer | Product name | Product type | New/used | Price |
|---------------|-----------------------------|----------------------|----------|-----------|------------------|---------------------------------|--------------|----------|-----------|
| Arcam | DIVA CD92 Silver | CD | Ex-demo | £650.00 | Linn | HAJIK I Phono | Amplifier | Ex-demo | £499.00 |
| Arcam | A75 (black) | Integrated amplifier | Ex-demo | £299.00 | Linn | CD-12 | CD | Ex-demo | £749.00 |
| Arcam | FMI CD23T Silver | CD | Ex-demo | £895.00 | Linn | Karik CD (linn serviced) | CD | Used | £599.00 |
| Audio Quest | Opal x3 (RCA) | Cables | Ex-demo | £85.00 | Linn | Katans (Black) | Speaker | Used | £400.00 |
| B&W | Nautilus 803 Cherry | Speaker | Ex-demo | £2,750.00 | Linn | Index 2 | Speaker | Used | £179.99 |
| B&W | Nautilus 805's (Red Cherry) | Speaker | Ex-demo | £1,250.00 | Linn | Axis (Basik + Adikt) | Turntable | Used | £345.00 |
| Denon | DVD-A1 | DVD | Ex-demo | £1,649.00 | Loewe | DSP-I Pro-Logic Processor | Home Cinema | Ex-demo | £199.99 |
| Denon | AVR-3802 (gold) | Home Cinema | Ex-demo | £549.00 | Loewe | VCR Y 6336H | Television | Ex-demo | £1,995.00 |
| Denon | AVC-A1SR | Home Cinema | Ex-demo | £2,250.00 | Loewe | Acconda 32" Stratos Silver | Television | Ex-demo | £1,795.00 |
| Denon | DVD-800 (zone free) | DVD | Ex-demo | £199.00 | Loewe | Planus 32" TV + Cabinet (black) | Television | Used | £995.00 |
| Denon | DVD-2800 MkII (zone free) | DVD | Ex-demo | £549.00 | Marantz | DV4100 (zone free) | DVD | Ex-demo | £199.00 |
| Denon | AVR 3803 | Home Cinema | Ex-demo | £699.00 | Marantz | SR-6200 | Home Cinema | Ex-demo | £450.00 |
| Dual | 505 (inc cart) | Turntable | Ex-demo | £199.00 | Marantz | SR-7200 | Home Cinema | Ex-demo | £549.00 |
| Exposure | 9Pre/7PSU/8Super | Pre/power amplifier | Used | £599.00 | Marantz | DV4200 (zone free) | DVD | Ex-demo | £199.00 |
| Fine Woods | 4 shelf Hi-Fi Rack | Furniture | Ex-demo | £229.00 | Mission | 725's Rosewood finish | Speaker | Used | £299.00 |
| Harman Kardon | AVR 4500 | Home Cinema | Ex-demo | £499.00 | Mission | HTP (Processor) | Home Cinema | Ex-demo | £1,295.00 |
| Harman Kardon | DVD 2S | DVD | Ex-demo | £199.00 | Musical Fidelity | HT 600 5 Channel Power Amp | Power amp | Ex-demo | £1,499.00 |
| Harman Kardon | AVR-5500 | Home Cinema | Ex-demo | £699.00 | Naim | 32.5 | Pre amp | Used | £199.00 |
| Kef | KHT 2005 Silver | Home Cinema | Used | £599.00 | Naim | CDS+ PSU (serviced) | CD | Used | £2,495.00 |
| Lexicon | MCI2 Processor | Home Cinema | Ex-demo | £5,995.00 | Naim | AV-1 processor | Home Cinema | Used | £495.00 |
| Linn | Classic Movie (silver) | Home Cinema | Ex-demo | £1,599.00 | Naim | NAP 250 Pwr Amp | Power amp | Used | £1,495.00 |
| LINN | Kabers (black) | Speaker | Used | £995.00 | Naim | NAP 90.3 | Power amp | Ex-demo | £299.00 |

HERTFORDSHIRE /NORTH LONDON AUDIO/RECORD FAIR

**Sunday 10th August 2003
11:00 to 4.00pm**

**Stalls £20 Admission £3
9:30am Early Entry £10**

**At Cuffley Hall, Maynard Place
Cuffley, Herts.**

**5 minute from M25 Junction 25
5 minute from Cuffley Station**

Details 07944 909209

IAN HARRISON HI-FI

HIFI AT DISCOUNT PRICES. FREE NATIONWIDE DELIVERY

TEL: 01283 702875
9am - 9pm
INCLUDING SUNDAYS

TRADE IN YOUR OLD MOVING COIL CARTRIDGE & SAVE UP TO 60% OFF THE RRP.

| CARTRIDGES & STYLUS | HIFI FURNITURE | HEADPHONES | DVD |
|---------------------|----------------|----------------|--------------|
| DENON | OPTIMUM | STAX | SONY |
| SHURE | ASH DESIGN | SENNHEISER | DENON |
| AUDIO TECHNICA | APOLLO | SONY | PHONO STAGES |
| GOLDRING | SOUND STYLE | AKG | TRICHORD |
| SUMIKO | SOUND | GRADO | MOTH |
| TRANS- | ORGANISATION | AUDIO-TECHNICA | CREEK |
| FIGURATION | ALPHASON | DAT | NAD |
| LONDON (DECCA) | CABLES | TASCAM | EAR |
| GRADO | BLACK RHODIUM | SONY | ROKSAN |
| ROKSAN | TRANSPARENT | PANASONIC | TOM EVANS |
| ORTOFON | QED | CASSETTE DECKS | LOUDSPEAKERS |
| RESON | ORTOFON | PIONEER | SONY |
| CLEAR AUDIO | NORDOST | TEAC | HARBETH |
| KOETSU | ARGENTO | SONY | CABASSE |
| | AUDIO | DENON | SHUN MOOK |
| | | | EPOS |

| TONEARMS | TURNTABLES | MINI DISCS | AMPLIFIERS |
|-------------|-------------|------------|------------|
| SOUTHER | MICHELL | SONY | DENON |
| GRAHAM | CLEAR AUDIO | DENON | HALCRO |
| MOTH | AUDIO NOTE | | MOTH |
| CLEAR AUDIO | CD PLAYERS | TUNERS | C.A.T. |
| HADCOCK | SONY | SONY | GAMUT |
| | DENON | DENON | ALCIA |
| | | | EAR |

| ACCESSORIES | |
|---|-----|
| Hifi News Cartridge Alignment Gauge | £5 |
| Hifi News Test Record & Alignment Gauge | £15 |
| Shure SFG/2 Tracking Force Gauge | £25 |
| Audio Technica Stylus | £5 |
| Cleaning Fluid | £5 |
| Clearaudio Carbon Fibre Record | |
| Cleaning Brush | £14 |

PLEASE PHONE TO CONFIRM PRICE & AVAILABILITY PRIOR TO ORDERING. ALL GOODS ARE BRAND NEW & BOXED WITH FULL U.K. GUARANTEES. NO EX. DEM OR EX DISPLAY GOODS. NO GREY IMPORTS. GOODS ARE NOT SUPPLIED ON APPROVAL. SORRY, NO GENERAL CATALOGUES. PLEASE PHONE OR WRITE FOR SPECIFIC REVIEWS, BROCHURES OR PRICES.

MAIL ORDER ONLY FROM: IAN HARRISON, 7 MILL HILL, REPTON, DERBY, DE65 6GO. TEL: 01283 702875. 9am - 9pm INCLUDING SUNDAYS.

Sound Music

93-95 Nantwich Rd., Crewe, Cheshire.
Telephone: 01270 214143

- Linn Sizmik Maple Sub (XD) - £650
- Linn Kairn Pro Pre - Amplifier (XD) - £600
- Linn 5125 - 5 Channel Power Amp (XD) - £1350
- Linn Kollektor Pre - Amplifier (XD) - £275
- Linn Mimik CD Player (SH) - £350
- Musical Fidelity - The Preamp (SH) - £250
- Musical Fidelity Typhoon Pwr Amp (SH) - £250
- Infinity Kappa 400 Speakers (XD) - £500
- Tannoy Eyris 3 Maple Speakers (XD) - £650
- Tannoy Eyris 1 Rosewood Speakers (XD) - £300
- Meridian M33 Active Speakers (XD) - £1250
- Meridian 505 Mono Pwr Amps (XD) - £650 Each
- Meridian D2500 Active Subwoofer (XD) - £1500
- Linn 2250 Power Amps (XD) - 2 @ £1650 Each
- Audiolab 8000 S Amplifier (SH) - £450
- Audiolab 8000 M Monoblock Amps (SH) - £750
- Epos ES14 Speakers & Stands (SH) - £275
- Monitor Audio GR20 Beech (XD) - £1300
- Arcam CD72 CD Player (SH) - £300
- Linn Keleith Speakers (Black/SH) - £300
- Rotel RB985 - 5 Channel Amplifier (SH) - £450
- Castle Stirling Speakers (Oak/XD) - £600
- Castle Pembroke Spkr (Walnut/XD) - £300
- Castle Howard Spkr (Oak/XD) - £950
- Linn Klassik Movie System (XD) - £1650
- Onkyo DR90 DVD Receiver (XD) - £250
- REL Q400 Subwoofer (Maple/XD) - £650
- B&W P5 Speakers (SH) - £550
- JBL TIK 6 Speakers (Beech/XD) - £1500
- NAD T752 Receiver (XD) - £475
- Wharfedale EVO10 Speakers (Maple/XD) - £250
- Roksan Caspian 4 Channel Amp (XD) - £650

Agencies Include: Linn, Musical Fidelity, S.M.E., Origin Live, Monitor Audio, Castle, Quad, Wharfedale, Harman Kardon, Creek, Meridian, Tannoy, Infinity, Loewe, Sanyo, Ortofon, VDH, JBL, Pro-ject, Roksan, QED, Cable Talk, Michell, Arcam, Trichord, PMC,



We buy, sell & part exchange quality Hi-fi

| AMPLIFIERS / RECEIVERS | CD PLAYERS | SPEAKERS |
|---------------------------------------|------------------------------------|--|
| Revox B740 Power amp £525 | TRANSPORTS & DACS | Epos ES14 black £225 |
| Magnum MF140 pre amp (chrome) £225 | Sony MDS JES20 £85 | Mission 752s £195 |
| Sony STR0B940 receiver £225 | Sony CDPXB9300S £145 | Mission 753 £295 |
| Audiolab 8000A £245 | Mission DAD5/DACS £145 | Epos ES22 £525 |
| Alchemist Axion £225 | Marantz CD67 OSE £175 | Monitor Audio Monitor 3 £245 |
| Marantz PH7000 £185 | Linn Mimik/Numerik £875 | JBL XPL 90 £295 |
| Musical Fidelity XA1 £325 | Musical Fidelity CD2 £145 | Linn Nincas.ES25/Keleith £545 |
| Cyrus 3 £245 | Rega Planer £95 | Kef RDH3 Cherry £875 |
| NAD C350 Integrated £245 | Technics SLPA10 £175 | Henry Kloss Ambiance LS3/5 £195 |
| NAD C270 Power £345 | Technics SLPG480 £45 | Rogers DB101 red/marble £145 |
| NAD 3030 Integrated £125 | Marantz CD5000 £145 | Tannoy 609 £185 |
| Arcam Alpha one £145 | Many portable mini discs in stock. | Acoustic Energy AE109 black £275 |
| Audiolab Research D70 £1125 | | Sony APH22ES £145 |
| Sony STRDE40SDTS Receiver £185 | TUNERS | Ruark Templars £175 |
| Marantz DP870 and SR96 £295 | Arcam Alpha 7 £145 | Alesis Monitor one actives £279 |
| Cyrus 2 £175 | Rotel RT1024 £225 | |
| Electrocompaniet power amp £175 | Marantz TT2135 £725 | CASSETTES |
| Rotel RC970 BX/RB981 £345 | Luzman TD375 £95 | Teac V3000 £145 |
| Beard P35 valve power amp £495 | Denon TU260L £70 | Yamaha K3393 £75 |
| Alchemist Kraken Power amp £425 | Musical Fidelity T1 £115 | Nakamichi BX300 £225 |
| Nakamichi Receiver 3 £145 | Quad FM4 £245 | Nakamichi 582 £195 |
| Arcam Alpha 9 £275 | | Nakamichi BX1 £150 |
| Arcam Delta 60 £95 | TURNTABLES | Tascam 238 £275 |
| Rotel RB930Ax £175 | Systemdek IIX £245 | |
| Quad 405 £245.303.£125. | Technics SL1210MK3 £320 | SYSTEMS |
| 306 £175.34.£175 | Thorens TD 147 £125 | Bang & Olufsen Sound one £595 |
| Audiolab 8000S £425, 8000P £425 | Rega Planar 3 £175 | Bose Acoustic Wave £625 |
| Technics SUHA10 Power Amp £325 | Kenwood KD550 £145 | |

Please call us if you have any equipment to sell or are looking for anything in particular. New stock daily
All equipment is fully tested and guaranteed

Also: Music CDs, Games, Musical Equipment, Computers, TV, VCR & Photographic

Web page: www.xelectrical.com email: x@xelectrical.com
125 King Street Hammersmith 020 - 8563 7383
4 Station Bldgs Fife Road Kingston 020 - 8546 1233
Games & CDs upstairs at Kingston 020 - 8546 4442
43 Church Street Croydon 020 - 8680 0007

CLASSIQUE SOUNDS.(LEICESTER) INC ONE THING.

VINTAGE HIFI & VALVE SPECIALIST TEL 0845 123 5137 (local rate)(UKonly)

WANTED Vintage and modern hifi eqpt. Part exchange welcome.

FOR SALE.PRE/POWER AMPLIFIERS

| | |
|---|---|
| Croft Epoch Elite pre amplifier. Amazing sound. £ 695 | Croft Micro valve pre amplifier. £ 250 |
| Unison Research Unico i amplifier, 3 months old. £ 650 | Marantz PM66SE K1 signature integrated amplifier £ 199 |
| Audio Innovations L1 valve pre amplifier. Boxed. £ 200 | Sugden AU51 power amplifier. Boxed. £ 650 |
| Pair Leak TL10 valve power amps.Original cond. £POA | Heathkit MA12 Mono valve power amplifier. £ 150 |
| Magnum A.100 2 X huge mono power amplifiers. 350 watts output. Excellent condition. Cost around £2000 | £ 799 |
| Crimson Elektrik 510/520 pre/power amplifier.Boxed.£ 249 | Ion Obelisk I integrated amplifier. Mint. Boxed. £ 99 |
| CR Developments Carmenta Line valve pre-amp. £ 450 | Harmon Kardon HK1400 line amplifier.Mint/boxed £ 199 |
| Hart 1100RSA integrated amplifier. 80W.Superb. £ 375 | Kenwood KA660D integrated amplifier. Black. £ 600 |
| Sugden A25 amplifier. Excellent condition & instr £ 200 | Naim NAC 92 pre amp. S/NO 161840. Mint. Boxed £ 299 |
| Meridian Modular pre/power amplifier. Ex cond. £ 249 | Croft series 5 valve amplifier. Gorgeous sound 30W £ 395 |
| Quad 77 integrated amplifier. Mint. Boxed. Instr. £ 399 | Quad 77 remote control for amplifier etc. Cost £300 £ 149 |
| Musical Fidelity B1 integrated amplifier. Good cond£ 125 | Naim Nait 3R integrated amp & remote.Mint.Boxd £ 495 |
| Norse Eosce (electrocompaniet) class A amp.Rare £POA | Magnum MP.125 pre amplifier with MM/MC. £ 250 |
| Linn LK1 pre-amp and remote. Good condition. £ 249 | Linn LK2 power amplifier. Good condition. £ 299 |
| Copland CTAS01 power amplifier. Valve.£1800 | Naim Nap 180 power amplifier. Mint. Boxed. £ 799 |
| Quad 11s in various condition and prices £POA | Norse Eosce (electrocompaniet) pre amplifier. £POA |
| Leak Stereo 20 valve power amplifiers from.... £ POA | Harmon Kardon integrated valve amp.110V.V rare £ 299 |
| Quad 303 power amplifiers from £ 125 | Arcam Alpha 2 amplifier. Mint. Boxed/instr £ 650 |
| Nakamichi CA5 pre-amplifier. Ex cond. Cost £750 £ 375 | Nakamichi PA5 100W/CH power amp. Cost £1300 £ 95 |
| NVA A80 mono power amplifiers X 2. Good cond£ 799 | NVA A60 stereo power amplifier. Good condition. £ 295 |
| AV1 S2000 MI int amp & remote. Cost £999. Mint £ 549 | Linn LK100 power amplifier. Excellent condition. £ 395 |
| Musical Fidelity Pre-8 pre-amplifier. Mint. Boxed. £ 150 | Arcam Alpha 3 amplifier. Mint.Boxed/ Instructions £ 100 |
| Arcam Zeta 1 Pro logic Cinema amp. Cost £999.00£ 450 | Quad 33 pre amplifiers. From £ 75 |

TURNTABLES

| | |
|--|---|
| Rega Planer 3 turntable.C/w box/instr/regca cartridge £225 | Thorens TD125 with thorens tone arm. £ 125 |
| Transcriptors Hydraulic reference/Decca arm.Mint £ 800 | Project 1 record deck. Excellent condition. Boxed £ 95 |
| Dual C505-2 turntable. Mint condition. Boxed £ 89 | Garrard 301/401 chassis in various condition from £ 125 |
| Dual 505/4 record deck. Very condition/instr £ 100 | Trio KD550. Direct drive turntable. £ 95 |

SPEAKERS

| | |
|---|--|
| Tannoy Lancaster corner units.12 in Monitor golds £POA | Quad ESL57. Bronze pair. £550 |
| Roksan ROK-ONE speakers. Black. Mint. Boxed. £ 295 | B&W DM303 speakers. Mint. Boxed. Maple finish. £ 95 |
| Mordaunt short MS 3.10 in black. Ex condition. £ 40 | JPW active subwoofer. Mint,boxed,instructions £ 160 |
| SD Acoustics SD3 loudspeakers. Piano finish £ 275 | Rogers LS55 speakers. Rosewood. Boxed. Ex cond £ 199 |
| Heybrook Heylios. Black. Boxed. Ex condition. £ 199 | Celestion SL600 speakers. Good condition. Bi wire £ 375 |
| Rega EL8 floorstanding speakers. black ash Boxed £149 | Proac 3 loudspeakers. Ex cond. Rosewood. Boxed £ 450 |
| Tannoy Chatsworth with 12 inch monitor golds. £ POA | Mordaunt Short MS20f pearl. Brand new. Black £ 169 |
| Castle Kendal speakers. Good condition. £ 69 | B&W DMA4 speakers. Black finish £ 85 |
| Quad ESL57 speakers.All fully serviced with full 3 months warranty.Hear what ESL57s should sound like From: £750p | Pair Quad ESL57 spkrs. Fully rebuilt. le 4 Rec on bass & 2 recon treble units.All new electronics.12m warranty £1199 |
| Mission 773 floor standers. Mint/boxed. Half price £ 199 | Castle Pembroke. Good condition. Super sound. £ 90 |
| Kef C20 Bookshelf monitor speakers in black £ 60 | Magneplaner MG 1.4. Boxed with £400 oak stands £ 999 |

OTHER ITEMS

| | |
|---|--|
| Musical Fidelity X-Flora FM tuner. Boxed/remote £ 350 | Marantz CD50 Cd player. Ex condition. £ 79 |
| Arcam Delta 170.3 CD Transport.Mint.Boxed.£800 £ 399 | Leak Troughline 3 stereo valve tuner. Fully serviced £ 195 |
| SME 3009 tonearms from £ 125 | Rotel 950 CD player. Ex cond. Boxed. £ 100 |
| Syrinx PU2 tone arm in gold finish. £ 199 | GEC PX4 valve. Brand new. £ 100 |
| Quad 77 RDS FM tuner. Mint. Boxed. Instructions £ 399 | Nakamichi CDP 2E CD player. Ex condition. £ 250 |
| Sugden R21 tuner. Wooden case. Beautiful. £ 95 | Cogan Hall loudspeaker cable.1.5 metre pair. £ 150 |
| Naim 42.5 pre amp. MM boards fitted. £ 125 | Phillips 101 top loading cd player. Collectable. £ 125 |
| Marantz SD275 twin cassette deck. Dolby B/C £ 49 | Technics SL-PG440A Mash CD player/remote. £ 75 |
| Aiwa AD-S750 Dolby B-C-S/HX pro cassette deck. £ 75 | Technics SL-PS620A CD player/remote. £ 75 |
| Linn Tuner. Mint.Boxed. Very unusual. Cost £549 £ 249 | Quad FM3 tuner in excellent condition. £ 99 |
| Arcam Alpha 5 cd player. Mint. Boxed/remote £ 195 | Marantz CD63 top loader cd player. Collectable. £ 125 |
| Avantic Beam Echo valve tuner. BM611. AM/FM £ 149 | Trio KT880L synthesiser tuner. AM/FM. Black. £ 75 |

QUAD ESL57 & ESL63 PANELS/SERVICING ETC

NEW- B&W DM70 Electrostatic panels now undertaken. Price for one panel is £150.00

Reconditioned Quad ESL57 speakers from only £800.00.pr.Why spend £4000+? **Have your ESL57 SPEAKERS STANDARD SERVICE £375.PR.** Ring for info.

Exchange/recon ESL57 bass panel £130. Treble £109. ESL63 panels £ 100 refurbished. ESL63/ESL57 speaker stands, available in black or woodgrain @ £175.00 a pair.

New socks for ESL63s £38 pr. Many other spare parts available. Please ring.

"Classique Sounds servicing restores the Quads to a position where they can hold their head high", Jon Marks. HIFI WORLD. April 1999.Full servicing facilities available.

Troughline 3 tuner service & realignment £200.00. (excludes valves. Rarely needed). One thing stereo decoder (back in stock) £175.00 Ex review Hifi world.

TRANSLUCENT. (somewhat of a bargain) Hifi World. Jan 1999
PURE SILVER INTERCONNECT CABLE

99.99% pure silver conductors. Quality gold plated RCA phono plugs.

Half Metre terminated £70.00 One metre terminated £90.00. Available with Eichmann plugs + £30

New Translucent **ULTRA + Heavy duty. 99.99% pure silver (4N). Eichmann Solid silver plugs £249.M Or £199.00 per half metre. 7 day money back guarantee if not better than existing cable**

NEW. 1.0MM 99.99% Pure silver wire @£15m. 0.5mm pure silver wire @ £6.00m Translucent pure silver mains cable. 3 amp. £129.00 13 amp £249

One Thing Mains cables. Class 1 Rfi suppressed. Silver plated conductors. Voltage spike protection. only...£60.00.

NEW EAR/YOSHINO EQUIPMENT

Ear 834P MM/MC phono stage w/dti/without volume. Brand new. Boxed at only £559

Ear 834P MM phono stage. No volume control. Brand new. Boxed at only £399

Ear 834L Line only valve pre-amplifier.Amazing. Brand new. Boxed at only £499

TEL. 0845 123 5137 (Calls charged at local rate anywhere in the UK)

Tel 0116 2835821 or 07802 213740 (Mobile). Callers by appt only.

Opening times 10.00am-6.00pm Mon-Friday. 10.00am-2.00pm Saturday.

61 Aylestone drive, Aylestone, Leicester. LE2 8QE. Email

classique_sounds@yahoo.co.uk

HEATHCOTE AUDIO

TEL: 01992 653999 MOBILE: 07860 511111 E-MAIL ADDRESS: HeathcoteAudio@aol.com

SUMMER SALE ALL REDUCED THIS MONTH

| | WAS | NOW |
|---|-------|----------------------|
| UNISON RESEARCH SMART 845 MONOBLOCKS | £2350 | MINT/BOXED £1750 |
| ART AUDIO QUINTET POWER AMP | £1150 | MINT £795 |
| VINTAGE RADIO RESTORATION ADJR MONOBLOCKS | £995 | GC £695 |
| QUAD QC.24 PRE & QUAD I/40 MONOBLOCKS (RETAIL £4000 SUPERB) | £2850 | BOXED £2650 |
| AUDIO RESEARCH LS22 REMOTE PRE AMP BALANCED/SE RE-VALVED | £2950 | MINT/BOXED £2750 |
| AUDIO RESEARCH LS-2 PRE AMP (MULLARO REVALVE) | £1395 | MINT/BOXED £1250 |
| AUDIO RESEARCH SP-14 PRE C/W PHONO STAGE (£4000) | £2295 | MINT £1995 |
| LUMLEY REFERENCE PP-40 PRE & ST-40 POWER AMPS (CHROME) | £995 | MINT/BOXED £850 |
| AUDIIONOTE KIT 1 SIGNATURE BLACK GATES HOVLAND MUSICAPS ETC | £1395 | MINT/BOXED £1195 |
| PINK TRIANGLE INTEGRAL (1 MONTHS USE NEW PRICE £3995) | £2995 | AS NEW/BOXED £2750 |
| COPLAND CSA-28 REMOTE INTEGRATED C/W PHONO STAGE | £795 | MINT £750 |
| THETA PEARL TRANSPORT/DS PRO BASIC-11 DAC | £2250 | MINT/BOXED £1895 |
| PINK TRIANGLE CARDINAL/ORDINAL 22 BIT/RELOCKING CABLES ETC | £1175 | MINT/BOXED £995 |
| ROKSAN ROK-1 TRANSPORT WITH POWER SUPPLY UPGRADE | £650 | MINT/BOXED £475 |
| ROKSAN QJAN 3X & QJAN 3S SUB SYSTEM (ROSEWOOD) RARE | £1450 | MINT/BOXED £1150 |
| SD OBS FLOORSTANDERS (OPEN Baffle) SMALLER BROTHER TO SD1 | £495 | BOXED £375 |
| CASTLE HOWARD-2 PREMIUM BEECH FINISH | £795 | MINT £650 |
| LEHMAN BLACK CUBE SE (LAST ONE RETAIL £650?) | £450 | BRAND NEW/BOXED £375 |
| CASTLE AVON FLOORSTANDERS | £450 | MINT £375 |
| NORDOST SPM REFERENCE 2.5 METRE PAIR | £1450 | AS NEW BOXED £1250 |

VALVE AMPS

| | |
|---|--------------------|
| AUDIO RESEARCH VT-50 POWER AMP EX DISPLAY | AS NEW/BOXED £2750 |
| UNISON RESEARCH S-6 REMOTE INTEGRATED EX DEM | MINT/BOXED £1275 |
| GRANT G200 AMS LTD. EDITION 200 WATT MONOBLOCKS & G100P PRE AMP | EXCLT. £2250 |
| CONRAD JOHNSON PREMIER 14 REMOTE CONTROL PRE AMP | EXCLT. £1995 |
| UNISON RESEARCH C5P PRE AMP WITH PHONO STAGE | MINT £895 |
| MONRIO ASTY VALVE PRE-AMP (VERY PRETTY) 3 MONTHS OLD | MINT/BOXED £375 |
| JOLIDA SJ 202A AMERICAN EL34 INTEGRATED AMP (VERY PRETTY) | MINT/BOXED £650 |

SOLID STATE

| | |
|--|-------------------|
| TALK CYCLONE-1 REMOTE AMP EX DISPLAY/NEW | AS NEW/BOXED £375 |
| TOCA SECA 20 WATT CLASS A AMP MARBLE FRONT VERY RARE /GOOD | EXCLT. £1250 |
| REGA CURA REMOTE PRE AMP | AS NEW £295 |
| CONRAD JOHNSON EV-1 PRE AMP (GOLD) | MINT/BOXED £895 |
| PIONEER H-90 POWER AMP WITH VOLUME CONTROL/3 INPUTS | MINT £550 |
| SUGDEN AU-51 POWER AMP (EX DISPLAY LAST ONE) | MINT/BOXED £895 |

CD

| | |
|---|-------------------|
| TECHNICS SL-Z1000/SH-X1000 FLAGSHIP TRANSPORT & DAC (GOLD/WALNUT) | BOXED £2450 |
| ACCUPHASE DP-80 TRANSPORT | EXCLT/BOXED £1750 |
| DPA T-1 TRANSPORT (WITH DELTRAN) | MINT/BOXED £495 |
| MICROMEGA CD 3.1 TRANSPORT (TOPLOADER) | EXCLT/BOXED £695 |
| OURELLE CD10T TRANSPORT | MINT/BOXED £375 |
| COUNTERPOINT DA11E TRANSPORT | MINT/BOXED £495 |
| THETA DS PRO GEN III (AT&T, COAX ETC.) WAS £6000 APPROX | MINT/BOXED £2395 |
| TRICHORD PULSAR DAC & LARGE SEPARATE PSU | MINT/BOXED £695 |
| DPA PDM-1 MKIII 2 BOX DAC (WITH DELTRAN) | MINT/BOXED £595 |
| DPA ENLIGHTENMENT DAC (WITH DELTRAN) | MINT/BOXED £350 |
| AUDIIONOTE DAC-1X SIGNATURE | AS NEW/BOXED £650 |
| AUDIOLAB 8000 DAX (HDCD COMPATIBLE ONE OF THE VERY LAST MADE) | MINT/BOXED £695 |
| MONRIO 18B DAC & SEPERATE PSU | MINT £475 |
| TECHNICS SL-P2000 REFERENCE CD | MINT £595 |
| TEAC VRDS 25 | MINT £795 |
| MARANTZ CD17 KI-SIG MK11 (GOLD) | MINT/BOXED £750 |
| SONY XA-50ES CHAMPAYNE GOLD | MINT/BOXED £595 |
| PIONEER PD-91 | MINT/BOXED £495 |
| TALK THUNDER-1 EX DISPLAY/NEW | AS NEW/BOXED £375 |
| TECHNICS SLPS 900 | EXCLT £175 |

VINYL

| | |
|--|------------------|
| SIMON YORKE ZARATHRUSTRA SERIES V/SERIES VII ARM | MINT/BOXED £3500 |
| NOTTINGHAM ANALOGUE STUDIO MENTOR REFERENCE & MATCHING ARM | MINT £3250 |
| ORACLE DELPHI SERIES 3 | MINT TBA |
| GRAHAM 1.5 TONEARM | MINT/BOXED TBA |
| REGA PLANNER-3/ARM/BIAS CARTRIDGE EX DEM | MINT/BOXED £275 |
| CONRAD JOHNSON EF-1 PHONO STAGE | MINT/BOXED £995 |
| TALK BREEZE PHONO STAGE MM/MC EX DISPLAY | EX.DIS TBA |
| NAD PP-1 PHONO STAGE | £25 |

LOUDSPEAKERS

| | |
|---|-----------------------|
| CELESTION A-2 HUGELY CAPABLE (ROSEWOOD VENEER) | BRAND NEW/BOXED £1250 |
| WILSON SYSTEM 5.1 PIANO BLACK | MINT/CRAFTED £7500 |
| B&W 801 MATRIX LOUDSPEAKERS SOUND ANCHOR STANDS / EQ.BOXES (COST £7000 +) | MINT/BOXES £2750 |
| APOGEE SCINTILLA.S (METALLIC BLACK LAQUER FINISH) | EXCLT £1750 |
| SNELL C MK-IV AMERICAN OAK VERY RARE/GOOD | EXCLT £1250 |
| TDL STUDIO MONITOR TRANSMISSION LINE WAS (£2500) | EXCLT £1250 |
| PROAC STUDIO 150 FLOORSTANDERS (CHERRY) SUPERB | MINT £1050 |
| ALR JORDAN NOTE-5 SPECIAL BOBINGA WOOD FINISH EX DISPLAY/AS NEW | BOXED £1195 |
| EPOS ES-11 LAQUER FINISH | MINT/BOXED £375 |
| DYNAUDIO AUDIENCE 80 (CHERRYWOOD FINISH) | MINT £1000 |
| IMF PROFESSIONAL MONITOR VII | RING RING |
| AMPHION NEON MK1 EX.DEMO | MINT/BOXED £695 |
| AMPHION HELIUM I | MINT/BOXED £350 |
| TANNOY ARUNDEL 15"3839 HIGH POWER DRIVERS 95 DB SENSITIVE VERY RARE | MINT £1500 |
| WILMSLOW AUDIO VORTEX VOLT DRIVERS PIANO BLACK EXT. X OVER | £475 |
| SHAN ACOUSTICS + MATCHING STANDS | EX DIS.MINT £275 |
| B&W 601 SERIES-2 | MINT £125 |

TUNERS /TAPE/DAT/MINIDISC/MISC

| | |
|--|------------------|
| PIONEER F-91 CLASSIC TUNER | MINT/BOXED £295 |
| SONY 3000ES TUNER CHAMPAYNE GOLD (RDS ETC) | MINT/BOXED £195 |
| TALK LIGHTNING 1.1 TUNER EX DIS. | AS NEW/BOXED TBA |
| NAKAMICHI DR-3 (VERY LITTLE USE) | MINT/BOXED £250 |
| PIONEER CT-91 REFERENCE CASSETTE DECK | VGC £250 |
| SONY DTC-1000 DAT MACHINE (£1300) | VGC £575 |
| SONY JA-30ES MINIDISC (CHAMPAYNE GOLD) | MINT £375 |

RACKS/STANDS

| | |
|---|--------------------------|
| SOUNDSTYLE ST-105/AQUA GLASS (NEW MOOEL £399?) | EX DIS/BOXED/AS NEW £275 |
| SOUNDSTYLE XS 105 5 SHELF (£320) | EX DIS. £195 |
| SOUNDSTYLE XS 310 AV TABLE (£320) | EX.DIS £195 |
| SOUNDSTYLE XS 105 5 SHELF CANCELLED ORDER | BRAND NEW BOXED £225 |
| SOUNDSTYLE XS 100 4 SHELF CANCELLED ORDER | BRAND NEW BOXED £195 |
| SOUNDSTYLE XS 250 CD STORAGE RACK CANCELLED ORDER | BRAND NEW BOXED £195 |
| ATTACAMA R724/ATTABTE (WAS £250) | VGC £175 |
| B&W STANDS FOR CD-INT SILVER/BLACK | VGC £95 |
| TARGET 24 INCH STANDS | MINT £75 |

SPECIAL OFFER

BLACK RHODIUM S-130X2 BI-WIRE CABLE BRAND NEW LTD QUANTITY £10 PER METRE
BLACK RHODIUM S-300 BI WIRE CABLE BRAND NEW LTD QUANTITY £25 PER METRE

MAINS CABLES/BLOCKS/CONDITIONERS ETC

| | |
|--|----------------|
| BLACK RHODIUM 8 WAY MAINS BLOCKS (CANCELLED ORDER) | BRAND NEW £225 |
| BLACK RHODIUM 25 MAINS CABLE (BLACK CLOTH BRAID) | BRAND NEW £65 |
| DPA 'THE POWER' MAINS FILTERS | £75 |

CABLES

LOUDSPEAKER CABLE

| | |
|---|-------------|
| VAN DEN HUL REVELATION 2 METRE PAIR TERMINATED EX DEM | £600 |
| MIT MH-750 12 FT PAIR | £850 |
| MIT MH-750 8 FT. PAIR | £650 |
| NIRVANA AUDIO SL-SERIES 2.5 METRE PAIR EX DEM. FACTORY TERMINATED | £575 |
| TRANSPARENT WAVE 200 2 METRE PAIR | £175 |
| CARDAS HEXLINK 2 METRE PAIR (FACTORY TERMINATED) | £275 |
| AUDIIONOTE AN-SP 2 X 2 METRE PAIRS (FACTORY TERMINATED) | £375 |
| AUDIIONOTE AN-L 4 METRE PAIR (FACTORY TERMINATED) | £225 |
| QED GENESIS SILVER SPIRAL 4 X 1.5 METRE TERMINATED | £175 |
| VANDEN HUL MC CS 122 2 X 3 METRE PAIR | (EACH) £75 |
| AUDIOQUEST CRYSTAL HYPERLITZ 2 METRE BI-WIRE TERMINATED | £75 |
| AUDIOQUEST INDIGO 3 METRE PAIR | £50 |
| LINN K-400 3 METRE PAIR (TERMINATED) | £35 |
| VAN DEN HUL TEATRACK BI-WIRE 5 METRE PAIR (TERMINATED) | EX DIS £165 |
| CABLE TALK BI-WIRE 5 METRE PAIR (TERMINATED) | |
| CHORD CO. 5 METRE PAIR (TERMINATED) | EX DEM £65 |

INTERCONNECT

| | |
|--|-------------------------|
| ACOUSTIC ZEN SILVER REFERENCE 1.5 METRE PHONO EX DEM | £795 |
| ACOUSTIC ZEN SILVER REFERENCE 0.5 METRE | £350 |
| HARMONIC TECH MAGIC LINK ONE 1 METRE EX DEM | £650 |
| ACOUSTIC ZEN MATRIX REFERENCE 1METRE PHONO EX.DEM | £350 |
| BLACK RHODIUM REQUIEM-2 NORMALLY £1750/METRE LTD QUANTITY | BRAND NEW BOXED RING |
| BLACK RHODIUM ORATORIA 1 METRE | BRAND NEW PACKAGED £400 |
| BLACK RHODIUM ORATORIA 0.5 METRE | BRAND NEW PACKAGED £275 |
| BLACK RHODIUM SYMPHONY 1 METRE (SEVERAL) CANCELLED ORDER | BRAND NEW PACKAGED £65 |
| BLACK RHODIUM SYMPHONY 0.5 METRE (3 OFF) | BRAND NEW PACKAGED £55 |
| VAN DEN HUL INTEGRATION 0.6/ METRE | BRAND NEW PACKAGED TBA |
| VAN DEN HUL SECOND 2 METRE BALANCED | BOXED £300 |
| VAN DEN HUL SECOND 2.5 METRE BALANCED | BOXED £350 |
| LINDSAY AUDIOPHILE SATIN GRAY 2 METRE (AMERICAN NEW/PACKED WAS £480) | £200 |
| LINDSAY AUDIOPHILE GRAY 2 METRE | (NEW) £175 |
| AUDIIONOTE AN-V KONDO SILVER INTERCONNECT 3.2 METRE | £595 |
| AUDIIONOTE AN-V SILVER INTERCONNECT 1.5 METRE (PACKAGED AS NEW EX DEM) | £250 |
| DPA BLACK SLINK 5 METRE BALANCED PAIR | £550 |
| SUPRA EFF-ISL 2.5 FT PAIR NEW/PACKAGED | £50 |
| AUDIOQUEST DIAMOND 2 X 2 METRE PAIRS (*EACH) | (MINT) *£550 |
| AUDIOQUEST LAPIS 5 METRE PAIR | £650 |
| CABLE TALK MONITOR-3 3 X 1 METRE PAIRS (AS NEW PACKED) (*EACH) | *£25 |
| NORDOST BLUE ANGEL 1.5 METRE PAIR | BRAND NEW PACKAGED £90 |
| NORDOST BLUE ANGEL 0.5 METRE PAIR | £50 |
| NORDOST BLUE ANGEL 1.0 METRE 5 PIN DIN TO PHONO'S | £75 |
| NORDOST BLUE HEAVEN 0.6 METRE | £75 |
| LPD-4 FEET PAIR | £50 |

DIGITAL

| | |
|---|-------------------------|
| MADRIGAL AES/EBU 0.5 METRE | £150 |
| NIRVANA DIGITAL COAX LEAD 4 FT. | £200 |
| VAN DEN HUL FIRST 0.8 METRE | BRAND NEW PACKAGED £100 |
| VAN DEN HUL D-102 MK.111 HB. 4 FEET | EX DISPLAY/NEW £40 |
| CHORD CO.PRODAC SILVER PLUS (BNC) | £60 |
| CABLE TALK DIGITAL-3 | BRAND NEW PACKAGED £50 |
| REGA DIGITAL INTERCONNECT 1 METRE (NEUTRIK PHONO'S) | £30 |
| VAN DEN HUL AES/EBU | £40 |
| AUDIOQUEST OPTILINK X TOSLINK | £50 |

MOST EQUIPMENT STOCKED IS ONE OWNER MINT/BOXED, SIMILAR QUALITY VINTAGE AND MODERN EQUIPMENT REQUIRED FOR IMMEDIATE CASH PURCHASE. PLEASE PHONE GEORGE 10-6PM

Are you making the right connections?

Send for Britain's biggest catalogue of specialist cable and connections.

All available by mail order.

Phone 020-8942 9124 or clip the coupon for your Free copy

www.custom-cable.co.uk

CUSTOM CABLE SERVICE

PO Box 4007, London SW17 8XG

Please send me your FREE Custom Cable Catalogue

Name _____

Address _____

Postcode _____

NO FURTHER INFORMATION REQUIRED

Send to: Custom Cable Service
PO Box 4007
London SW17 8XG

HFW 08/03



5 MINS FROM M25

MATRIX HI-FI

VALVE AMP
REPAIRS

RECORD DECKS

LINN SONDEK BASIC PLUS MAHOGANY
 VPI JUNIOR+ RB301
 ROKSAN XERXES, SME CUT
 AUDIONOTE TT1, ORIGIN LIVE RB300
 THORENS TD160 no arm
 THORENS TD150
 PIONEER PLA35
 GARRAD 401, SME PLINTH + SME 3009

£PHONE
 £399-00
 £299-00
 £650-00
 £50-00
 £70-00
 £55-00
 £350-00

ROGERS JUNIOR EL84 I/XO/PUT XFMR SWAP
 ROGERS MASTER EXCELLENT
 ROGERS MASTER WORKS FINE
 LEAK STEREO 20 VGC
 LEAK STEREO 50
 QUAD 303
 GATES 300B PUSH PULL SEE WEB
 EL84 AMP CHROME UNUSUAL (BEARD?)
 UNISON RESERCH S6 IMACULATE
 VECTEUR CLASS A
 ARION ELICKTRA
 SHANGLING POWER AMPS (SEE WEB SITE)

£199-00
 £599-00
 £450-00
 £299-00
 £450-00
 £90-00
 £2,500-00
 £275-00
 £899-00
 £899-00
 £450-00
 £2,000-00

PRE-AMPS

FINESTRA TOM EVANS
 BURMISTER GERMAN QUALITY BOXED
 MERIDIAN MODULAR
 RAPPAPORT
 BALANCED AUDIO TECHNOLOGY VK31
 GATE VALVE PRE NEW
 HAFLER PRE
 BEARD VALVE PRE P500A
 DNM 2 BOX

£475-00
 £399-00
 £129-00
 £250-00
 £1099-00
 £649-00
 £120-00
 £350-00
 £650-00

TUNERS, CASSETTE DECKS ETC.

YAMAHA KX480 CASSETTE DECK
 YAMAHA KX500 CASSETTE DECK
 YAMAHA CT710 TUNER
 MISSION CYRUS FM7 TUNER

£80-00
 £85-00
 £45-00
 £175-00

CD/HDCD/SACD/DVD PLAYERS

MARK LEVINSON DIGITAL PROCESSOR No. 35 WITH HDCD UPGRADE AWESOME
 HELIOS CD2
 MARANTZ CD94
 CALIFORNIA AUDIO LABS TUBE ANALOGUE PROCESSOR DAC
 SHANGLING CD T100 HDCD (SEE WEB SITE)
 SHANGLING SCD T200 SACD (SEE WEB SITE)
 PHILIPS DVD 6125 NEW

£1,799-00
 £699-00
 £349-00
 £450-00
 £1,650-00
 £2,150-00
 £115-00

POWER AMPLIFIERS

ROGERS CADET II CHASSIS WITH PRE.
 ROGERS CADET III No1
 ROGERS CADET III No2
 AUDIO NOTE CONQUERER 300B STEREO
 AUDIO STERLING EL34 STEREO CHROME
 AUDIO GOLDEN KNIGHT MONO BLOCS
 EARLY, BOXED, MINT IN SILVER
 ROGERS HGG 88MK III
 ROGERS CADET III VGC
 ROGERS CADET III CHASSIS PRE + POWER
 ROGERS RAVENSBROOK
 ROGERS CADET II CHASSIS WITH PRE.
 ROGERS CADET III No1
 ROGERS CADET III No2

£199-00
 £150-00
 £150-00
 £phone
 £499-00
 £2,100-00
 £125-00
 £150-00
 £225-00
 £75-00
 £199-00
 £150-00
 £150-00

SPEAKERS

AUDIO NOTE ANK/B MAHOGANY
 AUDIO NOTE ANJ TEAK
 LINN KANN'S NEW CHERRY
 LINN KANN STANDS BLACK
 SNEEL JS III MAHOGANY
 CELESTION A1 BLACK ASH
 REGA ELA BLACK

£399-00
 £599-00
 £299-00
 £85-00
 £50-00
 £399-00
 £299-00



NEW HIGH QUALITY HIFI ● VINTAGE HIFI FOR SALE AND WANTED

● DEM ROOM AVAILABLE THREE MONTHS WARRANTY ON ALL USED HIFI *

SEE OUR WEB SITE FOR THE LATEST STOCK

SHOWROOM

SHANLING, MICHELLE, CELESTION, QED, AUDIOQUEST, SOUNDSTYLE, ETC...

65 DARENTH ROAD

NEW AND VINTAGE VALVES - INTERCONNECTS & SPEAKER - OFC & SILVER

DARTFORD

PHONE : (01322) 281700/292391 FAX: (01322) 229908

E-MAIL : info@matrixhi-fi.co.uk WEB: www.matrixhifi.co.uk

FREE EASY PARKING

KENT DA1 1LU

RESERVE YOUR COPY TODAY!

Complete this form and hand to your local newsagent

Please reserve/deliver*(delete as appropriate)
 Hi-Fi & Computer Audio World on a regular basis,
 commencing with the next issue, until further notice.

Name _____

Address _____

Signed _____ Date _____



Distributed to the newstrade by

COMAG
MAGAZINE MARKETING

Sound & Music

93-95 Nantwich Rd., Crewe, Cheshire.
Telephone : 01270 214143

Linn Sizmik Maple Super (XD) - £650
Linn Kairn Pro Pre - Amplifier (XD) - £600
Linn 5125 - 5 Channel Power Amp (XD)-£1350
Linn Kollektor Pre - Amplifier (XD) - £275
Linn Mimik CD Player (SH) - £350
Musical Fidelity - The Preamp (SH) - £250
Musical Fidelity Typhoon Pwr Amp (SH) - £250
Infinity Kappa 400 Speakers (XD) - £500
Tannoy Eyriss 3 Maple Speakers (XD) - £650
Tannoy Eyriss 1 Rosewood Speakers (XD)-£300
Meridian M33 Active Speakers (XD) - £1250
Meridian 505 Mono Pwr Amps (XD)-£650 Each
Meridian D2500 Active Subwoofer (XD) - £1500
Linn 2250 Power Amps (XD) - 2@£1650 Each
Audiolab 8000 S Amplifier (SH) - £450
Audiolab 8000 M Monoblock Amps (SH) - £750
Epos ES14 Speakers & Stands (SH) - £275
Monitor Audio GR20 Beech (XD) - £1300
Arcam CD72 CD Player (SH) - £300
Linn Keleith Speakers (Black/SH) - £300
Rotel RB985 - 5 Channel Amplifier (SH) - £450
Castle Stirling Speakers (Oak/XD) - £600
Castle Pembroke Spkrs (Walnut/XD) - £300
Castle Howard Spkrs (Oak/XD) - £950
Linn Classik Movie System (XD) - £1650
Onkyo DR90 DVD Receiver (XD) - £250
REL Q400 Subwoofer (Maple/XD) - £650
B&W P5 Speakers (SH) - £550
JBL TIK 6 Speakers (Beech/XD) - £1500
NAD T752 Receiver (XD) - £475
Wharfedale EVO10 Speakers (Maple/XD)-£250
Roksan Caspian 4 Channel Amp (XD) - £650

Agencies include : Linn, Musical Fidelity, S.M.E., Origin Live, Monitor Audio, Castle, Quad, Wharfedale, Harman Kardon, Creek, Meridian, Tannoy, Infinity, Loewe, Sanyo, Ortofon, VDH, JBL, Project, Roksan, QED, Cable Talk, Michell, Arcam, Trichord, PMC,

X
electrical

We buy, sell & part exchange quality Hi-fi

| AMPLIFIERS / RECEIVERS | CD PLAYERS | SPEAKERS |
|---|------------------------------------|---|
| Revox B740 Power amp£325 | TRANSPORTS & DACS | Epos ES14 black£225 |
| Magnum MF160 pre amp (chrome)£225 | Sony MDS JE520£85 | Mission 752s£195 |
| Sony STRDB940 receiver£225 | Sony CDPXB9300S£145 | Mission 753£295 |
| Audiolab 8000A£245 | Mission DADS/DACS£145 | Epos ES22£525 |
| Alchemist Axium£225 | Marantz CD67 05E£175 | Monitor Audio Monitor 3£245 |
| Marantz PH7000£185 | Linn Mimik/Numerik£875 | JBL XPL 90£295 |
| Musical Fidelity XAI£325 | Musical Fidelity CD2£145 | Linn Nincas.ES25/Melidh£545 |
| Cyrus 3£245 | Rega Planet£95 | Kel RDM3 Cherry£875 |
| NAD C350 Integrated£245 | Technics SLPA10£145 | Henry Klass Ambiance LS3/5£195 |
| NAD C270 Power£345 | Technics SLPG480£45 | Rogers DB101 red/marble£145 |
| NAD 3030 Integrated£125 | Marantz CD5000£145 | Tannoy 609£185 |
| Arcam Alpha one£145 | Many portable mini discs in stock | Acoustic Energy AE109 black£275 |
| Audio Research D70£1125 | | Sony APH22ES£145 |
| Sony STRDE48SDTS Receiver£185 | TUNERS | Ruark Templars£175 |
| Marantz DP870 and S896£295 | Arcam Alpha 7£145 | Alesis Monitor one actives£279 |
| Cyrus 2£175 | Rotel RT1024£225 | |
| Electrocompaniet power amp£475 | Marantz TT2135£725 | CASSETTES |
| Rotel RC970 BX/RB981£345 | Luxman TD735£95 | Teac V3000£145 |
| Beard P35 valve power amp£495 | Denon TU260L£70 | Yamaha KX393£75 |
| Alchemist Kraken Power amp£425 | Musical Fidelity TI£115 | Nakamichi BR300£225 |
| Nakamichi Receiver 3£145 | Quad FM4£245 | Nakamichi 582£195 |
| Arcam Alpha 9£275 | | Nakamichi BX1£150 |
| Arcam Delta 60£95 | TURNTABLES | Nakamichi 238£275 |
| Rotel RB930Ax£175 | Systemdek IIX£245 | |
| Quad A05£245,303,£125 | Technics SL1210MK3£320 | SYSTEMS |
| 306£175,34,£175 | Thorens TD 147£125 | Bang & Olufsen Sound one£595 |
| Audiolab 8000S £425, 8000P£425 | Rega Planar 3£175 | Bose Acoustic Wave£625 |
| Technics SUMA10 Power Amp£325 | Kenwood KD550£145 | |

Please call us if you have any equipment to sell or are looking for anything in particular. New stock daily. All equipment is fully tested and guaranteed.

Also: Music CDs, Games, Musical Equipment, Computers, TV, VCR & Photographic

Web page: www.xelectrical.com email: x@xelectrical.com
125 King Street Hammersmith 020 - 8563 7383
4 Station Bldgs Fife Road Kingston 020 - 8546 1233
Games & CDs upstairs at Kingston 020 - 8546 4442
43 Church Street Croydon 020 - 8680 0007

CLASSIQUE SOUNDS.(LEICESTER) INC ONE THING.

VINTAGE HIFI & VALVE SPECIALIST TEL 0845 123 5137 (local rate)(UKonly)

WANTED Vintage and modern hifi eqpt. *Part exchange welcome.*

FOR SALE.PRE/POWER AMPLIFIERS

| | |
|---|---|
| Croft Epoch Elite pre amplifier. Amazing sound. £ 695 | Croft Micro valve pre amplifier. £ 250 |
| Union Research Unico i amplifier. 3 months old. £ 650 | Marantz PM66SE K1 signature integrated amplifier £ 199 |
| Audio Innovations L1 valve pre amplifier. Boxed. £ 200 | Sugden AU51 power amplifier. Boxed. £ 650 |
| Pair Leak TL10 valve power amps. Original cond. EPOA | Heathkit MA12 Mono valve power amplifier. £ 150 |
| Magnum A.100 2 X huge mono power amplifiers. 350 watts output. Excellent condition. Cost around £2000 £ 799 | Crimson Electrik 510/520 pre/power amplifier.Boxed.£ 249 |
| On Obelisk 1 integrated amplifier. Mint. Boxed. £ 99 | CR Developments Carmenta Line valve pre-amp. £ 450 |
| Harmon Kardon HK1400 line amplifier.Mint/boxed £ 199 | Harwood KA660D integrated amplifier. Black. £ 60 |
| Hart 1100RSA integrated amplifier. 80W.Superb. £ 375 | Naim NAC 92 pre amp. S/NO 161840. Mint. Boxed £ 299 |
| Sugden A25 amplifier. Excellent condition & instr £ 249 | Croft series 5 valve amplifier. Gorgeous sound. 30W £ 395 |
| Meridian Modular pre/power amplifier. Ex cond. £ 299 | Quad 77 integrated amplifier. Mint. Boxed. Instr. £ 149 |
| Quad 77 remote control for amplifier etc. Cost £300 £ 149 | Musical Fidelity B1 integrated amplifier. Good cond.£ 125 |
| Naim Nait 3R integrated amp & remote.Mint.Boxed £ 495 | Norse Ecosse (electrocompaniet) class A amp.Rare.EPOA £ 250 |
| Magnum MP.125 pre amplifier with MM/MC. £ 299 | Linn LK1 pre-amp and remote. Good condition. £ 299 |
| Linn LK2 power amplifier. Good condition. £ 299 | Copland CTAS01 power amplifier. Valve. £1800 £ 799 |
| Naim Nap 180 power amplifier. Mint. Boxed. £ 799 | Quad 11s in various condition and prices EPOA |
| Norse Ecosse (electrocompaniet) pre amplifier. EPOA | Leak Stereo 20 valve power amplifiers from.... £ POA |
| Harmon Kardon integrated valve amp.110V.V rare £ 299 | Quad 303 power amplifiers from £ 125 |
| Arcam Alpha 2 amplifier. Mint. Boxed/instr £ 95 | Nakamichi CA5 pre-amplifier. Ex cond. Cost £750 £ 375 |
| Nakamichi PA5 100W/CH power amp. Cost £1300 £ 650 | NVA A80 mono power amplifiers X 2. Good cond.£ 799 |
| NVA A60 stereo power amplifier. Good condition. £ 295 | AV1 S2000 MI int amp & remote. Cost £999. Mint £ 549 |
| Linn LK100 power amplifier. Excellent condition. £ 395 | Musical Fidelity Pre-8 pre-amplifier. Mint. Boxed £ 100 |
| Arcam Alpha 3 amplifier. Mint.Boxed/ Instructions £ 100 | Arcam Zeta 1.Pro logic Cinema amp. Cost £999.00.£ 450 |
| Quad 33 pre amplifiers. From £ 75 | |

TURNTABLES

| | |
|--|---|
| Rega Planer 3 turntable.C/w box/instr/regta cartridge £225 | Thorens TD125 with thorens tone arm. £ 125 |
| Transcriptors Hydraulic reference/Decca arm.Mint £ 800 | Project I record deck. Excellent condition. Boxed £ 95 |
| Dual C505-2 turntable. Mint condition. Boxed £ 89 | Garnard 301/401 chassis in various condition from £ 125 |
| Dual 505/4 record deck. Good condition/instr £ 100 | Trio KD550. Direct drive turntable. £ 95 |

SPEAKERS

| | |
|---|---|
| Tannoy Lancaster corner units.12 in Monitor golds.£POA | Quad ESL57. Bronze pair. £550 |
| Roksan ROK-ONE speakers. Black. Mint. Boxed. £ 295 | B&W DML303 speakers. Mint. Boxed. Maple finish. £ 95 |
| Mordaunt short MS 3.10 in black. Ex condition. £ 40 | JPW active subwoofer. Mint,boxed,instructions £ 160 |
| SD Acoustics SD3 loudspeakers. Piano finish £ 275 | Rogers LS55 speakers. Rosewood. Boxed. Exe cond £ 199 |
| Heybrook Heylios. Black. Boxed. Ex condition £ 199 | Celestion SL600 speakers. Good condition. Bi wire £ 375 |
| Rega EL8 floorstanding speakers. black ash.Boxed £149 | Proac 3 loudspeakers. Ex cond. Rosewood. Boxed £ 450 |
| Tannoy Chatsworth with 12 inch monitor golds. £ POA | Mordaunt Short MS201 pearl. Brand new. Black £ 169 |
| Castle Kendall speakers. Good condition. £ 69 | B&W DM4 speakers. Black finish £ 85 |
| Quad ESL57 speakers.All fully serviced with full 3 months warranty.Hear what ESL57s should sound like From£ 750pr | Pair Quad ESL57 spkrs. Fully rebuilt. Je 4 Reoon bass & 2 recon treble units.All new electronics.12m warranty £1199 |
| Mission 773 floor standers. Mint/boxed. Half price £ 199 | Castle Pembroke. Good condition. Super sound. £ 99 |
| Kef C20 Bookshelf monitor speakers in black £ 60 | Magneplaner MG 14. Boxed with £400 oak stands £ 999 |

OTHER ITEMS

| | |
|--|--|
| Musical Fidelity X-Flora FM tuner. Boxed/ remote £ 350 | Marantz CD50 Cd player. Ex condition. £ 79 |
| Arcam Delta 170.3 CD Transport.Mint.Boxed.£800 £ 399 | Leak Troughline 3 stereo valve tuner. Fully serviced £ 195 |
| SME 3009 tonearms from £ 125 | Rotel 950 CD player. Ex cond. Boxed. £ 100 |
| Syrinx PU2 tone arm in gold finish. £ 199 | GEC PX4 valve. Brand new. £ 100 |
| Quad 77 RDS FM tuner. Mint. Boxed. Instructions £ 399 | Nakamichi CDP 2E CD player. Ex condition. £ 250 |
| Sugden R21 tuner. Wooden case. Beautiful. £ 95 | Cogan Hall loudspeaker cable.1.5 metre pair. £ 150 |
| Naim 42.5 pre amp. MM boards fitted. £ 125 | Phillips 101 top loading cd player. Collectable. £ 125 |
| Marantz SD275 twin cassette deck. Dolby B/C £ 49 | Technics SL-PG440A Mash CD player/remote. £ 75 |
| Aiwa AD-S750 Dolby B-C-S/SHX pro cassette deck £ 75 | Technics SL-PS620A CD player/remote. £ 75 |
| Linn Tuner. Mint.Boxed. Very unusual. Cost £549 £ 249 | Quad FM3 tuner in excellent condition. £ 99 |
| Arcam Alpha 5 cd player. Mint. Boxed/remote £ 195 | Marantz CD63 top loader cd player. Collectable. £ 125 |
| Avantic Beam Echo valve tuner. BM611. AM/FM £ 149 | Trio KT880L synthesiser tuner. AM/FM. Black. £ 75 |

QUAD ESL57 & ELS63 PANELS/SERVICING ETC

NEW-- B&W DM70 Electrostatic panels now undertaken. Price for one panel is £150.00

Reconditioned Quad ESL57 speakers from only £800.00.pr.Why spend £4000+? **Have your ESL57 SPEAKERS STANDARD SERVICE £375.PR.** Ring for info.

Exchange/ recon ESL57 bass panel £130.Treble £109. ESL63 panels £ 100 refurbished. ELS63/ESL57 speaker stands, available in black or woodgrain @ £175.00 a pair.

New socks for ELS63s £38 pr. Many other spare parts available. Please ring.

"Classique Sounds servicing restores the Quads to a position where they can hold their head high", Jon Marks. **HIFI WORLD.** April 1999.Full servicing facilities available.

Troughline 3 tuner service & realignment £200.00. (excludes valves. Rarely needed). One thing stereo decoder (back in stock) £175.00 Ex review Hifi world.

TRANSLUCENT. (somewhat of a bargain) Hifi World. Jan 1999 **PURE SILVER INTERCONNECT CABLE**

99.99% pure silver conductors. Quality gold plated RCA phono plugs.

Half Metre terminated £70.00 One metre terminated £90.00. Available with Eichmann plugs + £30

New Translucent ULTRA + Heavy duty. 99.99% pure silver (4N). Eichmann Solid silver plugs £249.M Or £199.00 per half metre. 7 day money back guarantee if not better than existing cable

NEW. 1.0MM 99.99% Pure silver wire @£15m. 0.5mm pure silver wire @ £6.00m Translucent pure silver mains cable. 3 amp. £129.00 13 amp £249 One Thing Mains cables. Class 1 RFI suppressed. Silver plated conductors. Voltage spike protection. only...£60.00.

NEW EAR/YOSHINO EQUIPMENT

Ear 834P MM/MC phono stage with/without volume. Brand new. Boxed at only £559

Ear 834P MM phono stage. No volume control. Brand new. Boxed at only £399

Ear 834L Line only valve pre-amplifier.Amazing. Brand new. Boxed at only £499

TEL. 0845 123 5137 (Calls charged at local rate anywhere in the UK)

Tel 0116 2835821 or 07802 213740 (Mobile). Callers by appt only.

Opening times 10.00am-6.00pm Mon-Friday.10.00am-2.00pm Saturday.

61 Aylestone drive. Aylestone, Leicester, LE2 8QE. Email classique_sounds@yahoo.co.uk

THE EMPORIUM

Tel/Fax: 01379 870873 email: emporium@despammed.com www.emporium.dircon.co.uk

"SEE WEBSITE FOR FULL LISTING"

| CD & SACD & DACS | COST | PRICE | ALTEC Voice of the Theatre | ing for desk | |
|--|------|-------|---|--------------|--|
| ARCAM ALPHA 9 cd | 450 | | ARCADIS speakers all rosewood boxed. | 350 | CRUMSON 620 stereo power amp. |
| AUDIOMECA TRANSPORT | 500 | | ART IMPRESSIONS series modular 3 way speakers, finished in metallic silver grey | 8000 | DMM 2 preamp, metal cased bar 3 boards, primus line level only |
| AUDIO NOTE DAC 2 black front | 750 | | AUDIO CLASSICS type c excellent with valves | 750 | EE AUDIO FINESTRA pre-amp, TOP F1W6, m/mvnc |
| AUDIO RESEARCH DAC120 upgraded | 1000 | | AUDIO NOTE AM-1 up light oak, boxed | 900 | ELECTROCOMPANET AW 100 power amp boxed |
| AUDIO SYNTHESIS D1R | 900 | | AVANTGARDE D405 white latest version silver wired option | 4000 | ELECTROCOMPANET 4.5 line pre balanced remote, boxed |
| AW 20 1st dac boxed | 375 | | BKS 1078 MK2 granite ribbon hybrids | 1200 | HAUFER DM110/220 pre-POWER |
| COUNTERPOINT CD 1110 transport/dac 20 BIT | 1250 | | CAEMER DS nice and efficient | 600 | KENWOOD MK2 200watt power amp |
| DENSON CD PLAYER beat 400 with game remote | 900 | | CASTLE HALLICES, neat floorstanders | 500 | KRELL KPS 250Wc, neat monoblocks |
| KRELL KPS200 transport | 3000 | | CELLO SENAPRIMS active speakers, | 4000 | LFD LS1 line pre-amp |
| KRELL STUDIO DAC, boxed, good full sound | 1000 | | DALI GRAND floorstanders, serious oomph | 3500 | LFD PAO power amp |
| KRELL KPS255 CD PLAYER, mini boxed | 9000 | | DALI GRAND COUPE, rosewood | 1000 | LINN L1000 |
| LECTOR CD PLAYER valves, paper in oil etc | 850 | | DIAPASON ADAMANTES mkII with stands | 1000 | LINN L1140 boxed |
| LINN KARU/NUMERIK transport/dac, boxed | 1000 | | DIESIS SOLITAIRE | 1400 | LINN WAKONDA with phono boards |
| MARANTZ CD94 cd dac excellent | 350 | | EPOS EST 1 black | 1000 | LINN KAIRN PNO (line level) boxed |
| MARANTZ CD94 cd player | 350 | | HALES CONCEPT 5 boxed | 350 | LINN KAIRN with phono, boxed |
| MERIDIAN 203 dac | 150 | | HEYBROOK QUARTETS with stands, | 2000 | MARANTZ MA24 monoblocks, class A boxed |
| MERIDIAN 500 transport mk2, boxed | 750 | | INFINITY KARPA 9x 2x 12" Woofers, EXC | 400 | MARANTZ PM94 class A AMP boxed |
| MERIDIAN 2007/263 TRANSPORT/DAC COMBO | 550 | | KEF q1 BOXED MKII with q10 subwoofer | 1500 | MARANTZ PM4 class A integrated amp |
| MERIDIAN 588 cd player with full remote | 1500 | | KEF REF 2.2 black ash boxed | 275 | METASAX CHARISMA PREAMP, chrome finish |
| MERIDIAN 706 CD Player, | 375 | | KEF REF 104 original model, | 275 | MICHEL ANGO HR with hera pau line pre |
| MUSICAL FIDELITY A308 CR 2 months old | 1400 | | KEF REF 1054 nice | 1100 | MICHEL ALECTO MONOBLOCKS MKII (tom Evans design) |
| NIM CD3 | 500 | | KEUSCH CONYVALLS like slightly smaller 1 scale | 150 | MICHEL ALECTO STEREO, latest version boxed |
| NIMACHAI DRAGON CD AND DAC3 box player, boxed | 3400 | | LINN KASERS stack passive with ku-stone stands | 550 | MUSICAL FIDELITY F22 preamp |
| PINK TRIANGLE ORIGINAL dac with 18 bit filter | 350 | | LINN KELEDIS, with ku-stone | 800 | MUSICAL FIDELITY A100 50 watts sweet class A |
| PS AUDIO LAMBDA transport, with infrared deck 3 | 1000 | | LONWYER MAJORMH, black, with ponds | 300 | MUSICAL FIDELITY A-A2 integrated amp, mint boxed |
| SHANGHAI CD T100 crazy value cd player, IN STOCK | 1650 | | MISION 755 boxed | 800 | NAIM 125pre/nap 160 very old style |
| SOMY CDP X3000 ES silver top loader, boxed | 300 | | MAR CREDOS veil/00, 100 watts etc, mini boxed | 800 | PAS LABS O monoblocks class A single ended 75 watts |
| TEAC VRDS10 cd player excellent | 400 | | NAIM CREDOS boxed | 600 | PINK TRIANGLE PIP-PAC pre amp and mc, one box, black |
| TEAC T17-D1 transport/dac 2) and dac | 750 | | NAIM INTROS boxed | 450 | PINK TRIANGLE PIP TMO integrated amp line level |
| THETA GEN W, balanced out | 2250 | | POSSELT ALBATROSS, EFFICIENT | 1400 | PUNLIS B100 integrated amp line level |
| THETA GEN V | 2000 | | PROAC RESPONSE 1, with test covers | 780 | QUAD 33/405 MKT 100 watts of power |
| TRICHORD PULSAR ONE DAC hdcd & osars | 600 | | PROAC RESPONSE 2, | 1250 | QUAD 33/405 MKT 100 with manual |
| WADA 12 DAC | 700 | | QUAD ESL 63 speakers, black #33000 & stands | 400 | QUAD 77 amp and cd player carbon, boxed, remote |
| WADA X32 DAC | 600 | | QUAD ESL 63 ARCO STANDS black, boxed | 700 | SIM AUDIO CELESTE integrated amp, with phono |
| z-systems rdg-1, DIGITAL EQ, USE FOR SYSTEM CORRECTION, | 1750 | | QUAD ESL 57 excellent fully serviced | 1100 | TALK ELECTRONICS HURRICANE 2 power amp |
| | | | ROGERS LS3/5A walnut boxed | 200 | THRESHOLD GAS 2 100 watt power amp, boxed |
| | | | RUBAK CRUSADERS walnut boxed, | 700 | YAMAHA F2200 professional 200 watts |
| AIR TIGHT ATM2 80 watt power amp, | 3250 | | SMELL E mk3 walnut boxed, the classics | 700 | |
| AUDIOBLE HELLSPRINGS MODULUS 3 pre, gold mc boards | 1150 | | SOMER DMS | 550 | |
| AUDIO RESEARCH CLASSIC 60 | 1500 | | SOMER FABER ELECITA AMATORS mk1, excellent | 100 | |
| AUDIO RESEARCH V160 | 1200 | | STIRLING BROOKDACT LS3/5A, black | 100 | |
| AUDIO RESEARCH V 140 monoblocks boxed | 3400 | | TANNON SUPER RED MONITORS, 400 | 500 | |
| AUDIO RESEARCH SP6 early mid sounding pre | 750 | | TANNON Q225, DUAL CONCENTRIC 10" AND ABR, glass tops nice | | |
| AUDIO RESEARCH LS1 pre line level valve pre | 600 | | TANNON chevron MKII, Good pair serviced | | |
| AUDIO RESEARCH LS7 boxed line level pre | 825 | | TANNON GRJ cabinets repro pair in walnut with 15" golds | | |
| AUDIO RESEARCH LS8 mk1 line pre black front boxed | 900 | | THEL 23, cherry, mint, boxed | | |
| AUDIO RESEARCH LS8 mk2 line pre black front boxed | 1100 | | THEL STUDIO 2 upgraded tweeters, black with stand | | |
| AUDIO RESEARCH LS15 line pre with remote, silver front | 1750 | | VIENNA ACOUSTICS BACH Jerech | | |
| AUDIO RESEARCH LS22 remote control upgrade | 2400 | | | | |
| AUDIO RESEARCH REFERENCE PHONO, black front, mint boxed, | 3750 | | | | |
| AUDION STIRLING phono stage | 350 | | | | |
| AUDION APOLLON, single ended 1st edition | 2800 | | | | |
| BEARD p35 mk2 POWER AMP | 450 | | | | |
| BORDER PATROL 300B amp/kit | 1250 | | | | |
| CARY SA70 power amp | 700 | | | | |
| CONCORDANT EXCELSON pre with phono and valve psu | 600 | | | | |
| CONCORDANT QUAD II MONOBLOCKS | 500 | | | | |
| CONRAD JOHNSON P10 pre with phono boxed | 850 | | | | |
| CONRAD JOHNSON P10AL boxed | 500 | | | | |
| CONRAD JOHNSON PREM 4 power amp, boxed | 1250 | | | | |
| CONRAD JOHNSON PREMIER 1B 2 box pre | 3400 | | | | |
| CONRAD JOHNSON PREMIER 4 monitor mc step up | 400 | | | | |
| CROFT EPOCH ELITE mahogany front, boxed | 400 | | | | |
| CROFT 3m OTL monoblocks | 1100 | | | | |
| CROFT 4:40 WATTS excellent | 650 | | | | |
| EAR Y20 amp | 1400 | | | | |
| EAR 802 pre with mc phono | 1100 | | | | |
| GAMMA SPACE REFERENCE, 300w integrated amp, | 1500 | | | | |
| GAMMA ERA REFERENCE, recently tweaked by gamma designer | 1500 | | | | |
| GAMMA AEOHS 211 valves 17 watts boxed | 6000 | | | | |
| GATE PREAMP with phono, handwired | 1200 | | | | |
| HBC BEASTIE 211 single ended power amp | 1250 | | | | |
| HEART 300B stereo power amp | 500 | | | | |
| LUMLEY 120 MONOBLOCKS BLACK, BOXED AND BEAUTIFUL | 3750 | | | | |
| LUMLEY amp much modified, 6550 output | 900 | | | | |
| MELLOS 333 two box pre line great dynamics,boxed | 1300 | | | | |
| MUSICAL FIDELITY F22 preamp | 550 | | | | |
| QUAD IS excellent resprayed pair with 1666 VALVES | 700 | | | | |
| QUAD IS special anniversary edition gold orig boxes etc | 3250 | | | | |
| QUAD 1140 pre and monoblocks excellent boxed | 2500 | | | | |
| SONIC FRONTIERS SES 40, power amp | 800 | | | | |
| SONIC FRONTIERS SFM160 monoblocks | 2500 | | | | |
| TRLOGY 901 preamp with phono, | 375 | | | | |
| UMISON SIMPLY 4 integrated amp, boxed | 800 | | | | |
| UMISON RESEARCH FEATHER ONE/POWER 35 pre/power, | 1250 | | | | |
| VTL TINY TRIODE monoblocks boxed | 900 | | | | |
| ALIANTE LINEA speakers, superb solid walnut | 900 | | | | |

www.soundexpensive.com

Hi-Fi & Audio Consultants, Sales and Service

Buy What Hi Fi's Award winners at the cheapest prices!

cartridges

denon
dnm
goldring
lyra
ortofan
sumiko

cables

chord company
dnm
lfd
nordost
qed
trichord
van den hul

headphones

beyer
ergo
grado
sennheiser
stax

stands

frameworks
sound or'gn
something solid
soundstyle
stands unique

accessories

creek
densen demagic
goldring
kontak
michell
milty
moth
nordost
pixall
qed
rms
shure
trichord
zerostat

hardware

atc
audio physic
densen
epos
harbeth
in-focus
lexicon
michell
naim
nordost
primare
red rose
sme
sugden
trichord

Second hand & ex dem deals



QLN Signature loudspeakers. New old stock. The boxes have been opened simply to check the contents. High quality, chunky, Scandinavian stand-mounts in unusual asymmetrical cabinets finished in maple veneer. Originally £1200 ish £695

Bow Wazoo XL amplifier. One of the most stylish integrated amps out there. Boxed, mint. S/H (£2600) £995



Densen B200 preamplifier. Black anodised aluminium case with chrome controls. Remote controllable with Densen "Gizmo" handset (not included). S/H, boxed, unmarked (£1000) £600



Primare A30.1 integrated amplifier. S/H a few weeks old, exchanged due to a compatibility issue with a REL sub. (£1500) £1150

Primare V20 DVD player. Latest spec of the V20 (before being replaced by the V25). Cost £995. Most video formats are catered for including component. Excellent condition, boxed. Set to multi region. Boxed S/H £550

Primare V25 DVD player. Most video formats are catered for including component. PAL progressive scan capable. Multi Region, boxed, fully warranted £675



Toshiba 9000E DVD player. Months old, boxed. (£1000 ish). Multi Region. S/H One owner £650



Toshiba 9000 DVD player. Must be an older model than above. Good but not unmarked condition. No box or manual (but it has the handset) . Region 1 only. Offers?

And the DVD machine generating these traded -in DVD players?

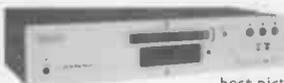

Lexicon RT10. All Formats (SACD, DVDA, DVD and CD). The best picture that I have seen and excellent Audio performance too. 5.1 output includes DTS. Priced at £2500 it is on demonstration now.

Nordost cables

Red Dawn Rev1 loudspeaker cable 4m pair single wire. Used, in good condition (£969) £500
Red Dawn balanced interconnect 3m pair ditto (£724) . £435
Superflat (gold) bi-wire 2.5m pair. New. (£180.95) . . . £135
Superflat (gold) bi-wire 7m pair. Used. (£369.95) . . . £220
1 x 2m pair SPM loudspeaker cables bi-wire (£2250) £1250
1 x 3m pair SPM cables bi-amp (boxed) (£2970) £1750



hi-fi for grown-ups



ipswich (01473) 655171
signals bucklesham
ipswich suffolk IP10 0DY
fax (01473) 655172
email: enq@signals.uk.com
www.signals.uk.com

diverse vinyl

10 charles st newport south wales np20 1ju
01633 259661/256261 sales@diversevinyl.com

NEW TITLES ON DIVERSE RECORDS:

RICHARD THOMPSON - THE OLD KIT BAG £21.90
RON SEXMITH - COBBLESTONE RUNWAY - £16.90
OTHER NEW ARRIVALS FOR JUNE/JULY:

| | | |
|--------------------------|-------------------------------|--------|
| Audio Bulls | Ego War | £15.90 |
| British Sea Power | The Decline Of | £12.90 |
| Canyon | Empty Rooms | £12.90 |
| Cinematic Orchestra | Man With A Movie Camera | £13.90 |
| Dave Gahan | Paper Monsters | £12.90 |
| Deftones | Deftones | £19.90 |
| Donnas | Spend The Night | £11.90 |
| Eels | Shootenany | £12.90 |
| Grandaddy | Sunday | £14.90 |
| Kosheen | Kokopelli | £TBC |
| Lou Reed | NYC Man (Ultimate Collection) | £TBC |
| Marilyn Manson | Golden Age Of Grotesque | £13.90 |
| McKay | McKay | £12.90 |
| Metallica | St Anger | £TBC |
| Micheal Franti/Spearhead | Everyone Deserves Music | £15.90 |
| Mogwai | Happy Songs For Happy People | £13.90 |
| New Pornographers | Electric Version | £13.90 |
| Radiohead | Hail To The Thief 2LP | £18.90 |
| Songs:Ohia | Magnolia Electric Company | £12.90 |
| Sparklehorse | It's A Wonderful Life | £14.90 |
| Stereophonics | You Gotta Get There To Come | £15.90 |
| The Thorns | The Thorns | £11.90 |
| The Thrills | So Much For The City | £TBC |
| The Tyde | Twice | £12.90 |
| Tindersticks | Waiting For The Moon | £13.90 |
| Various | Madlib Invades Blue Note | £15.90 |

ALBUM OF THE MONTH:

STEELY DAN "EVERYTHING MUST GO" £16.90

REISSUES:

| | | |
|---------------------|----------------------------------|--------|
| Grandmaster Flash | The Message | £14.90 |
| Lambretta | Beat Boys In A Jet Age | £14.90 |
| Leadbelly | Good Morning Blues 1936-40 | £14.90 |
| Led Zeppelin | 1,2,3 & 4 (Classic Records 200g) | £26.90 |
| Peter Gabriel | Peter Gabriel 4 | £26.90 |
| Peter Green Tribute | Man Of The World (audiophile) | £26.90 |
| Sonny Clark | Cool Struttin | £26.90 |
| The Who | Who's Next 3LP set | £17.90 |
| The Wicker Man | Full Soundtrack in Stereo | £16.90 |

LED ZEPPELIN "HOW THE WEST WAS WON" Live California 1972
LP Box Set from Classic Records - Released in September

DISCO ANTI STAT LP CLEANER

Probably the most economical LP cleaning device on the market

Only £41.95

Call for details

Call for a catalogue of over 3500

brand new LPs, or visit



www.diversevinyl.com



PHONE FOR LATEST LIST

NEW, EX-DEM AND CLEARANCE ITEMS

| | RRP | SALE | |
|----------------------------------|-----------|-----------|-----|
| Acoustic Energy AE1 MKII | £995.00 | £499.00 | D |
| Arcam Alpha 10 | £799.00 | £519.00 | D |
| Arcam FMJ P25 power amp | £750.00 | £489.00 | N |
| Arcam FMJ CD23 Cd player | £1099.00 | £699.00 | N |
| Arcam FMJ A22/Dave AC3 - DTS amp | £1849.00 | £1,199.00 | N |
| Arcam FMJ A22 | £1,100 | £769.00 | D |
| Arcam FMJ P35 power amp | £830.00 | £539.00 | N |
| Cyrus SL Amp | £400.00 | £199.00 | D |
| Cyrus AV Master Processor | — | £195.00 | D |
| Krell KAV 500i Int. Amp. | £5,498.00 | £2,495.00 | D |
| Linn Kaber | £1,995.00 | £695.00 | D |
| Meridian M33 Active speakers | £1,495.00 | £995.00 | N+D |
| Neate Mystique | £735.00 | £499.00 | D |
| Neate Elite | £1,200.00 | £779.00 | D |
| ProAc 3.8 | £3,990.00 | £2,299.00 | D |
| Rotel RX965RDS A/V receiver | £950.00 | £595.00 | D |
| Mission 781 | £399.00 | £219.00 | D |
| Mission 773 SE | £399.00 | £239.00 | N+D |
| Mission 78AS subwoofer | £699.00 | £449.00 | N |
| Mission 783 | £995.00 | £649.00 | D |
| Vienna Acoustics Beethoven | £2,500.00 | £1,795.00 | D |
| Vienna Acoustics Mozart | £1,500.00 | £1,195.00 | D |
| Vienna Acoustics Hayden rosewood | £750.00 | £569.00 | D |
| Vienna Acoustics Mahler | £6,000 | £4495.00 | D |

MUSICAL FIDELITY SPECIAL OFFERS

| | | | |
|------------------------------------|---------|---------|-----|
| A3 CD | £799.00 | £499.00 | D+N |
| A3 pre amp | £999.00 | £559.00 | D+N |
| Musical Fidelity XP100 BARGAIN!!!! | £799.00 | £549.00 | N |

D = EX DEMONSTRATION, N = NEW, S/H = SECOND HAND

Hi-Fi Multiroom and home cinema

ACOUSTIC ENERGY ARCAM ASH DESIGN AUDIO
 RESEARCH CELESTION COPELAND CYRUS
 DENON KEF KRELL LINN TAG MCLAREN MARTIN
 LOGAN MERIDIAN MICHELL MISSION MONITOR
 AUDIO MUSICAL FIDELITY NEAT ACOUSTICS
 PIONEER PROAC QED QUADRASPIRE REL SONUS
 FABER SME STANDS UNIQUE STAX THETA
 WILSON AUDIO ETC...

THE LISTENING ROOMS LTD

161 OLD BROMPTON ROAD LONDON SW5 0LJ

TEL: 020- 7244 7750/59 FAX: 020 - 7370 0192

www.listeningrooms.com E-mail: tlr@dial.pipex.com

Mon-Sat 10-6pm



PRE OWNED / EX-DEM EQUIPMENT FROM GLOBAL HIFI CENTRE

| MAKE | MODEL | RRP | GHP | STATUS |
|------------|----------------------------------|------|------|------------|
| CURA | CA10 SE LOUDSPEAKERS | 899 | 499 | EX DEM |
| CURA | CA30 ROSEWD SPEAKERS | 1995 | 995 | EX DEM |
| KEF | 1.2 REFERENCE SPEAKERS | 1350 | 950 | BOXED |
| ELTAX | LIBERTY 5 LOUDSPEAKERS | 250 | 100 | PRE-OWNED |
| REGA | ELA FLOORSTANDERS BLACK | 500 | 200 | PRE-OWNED |
| KEF | 4.2 REFERENCE ROSEWOOD | 4000 | 2000 | EX DEM |
| LINN | AV2150 LOUDSPEAKERS | 2000 | 1200 | PRE-OWNED |
| ROTEL | RSP985 THX AV PROCESSOR | 1750 | 1200 | EX DISPLAY |
| ROTEL | RDV985 MULTIREGION DVD | 625 | 350 | NEW SEALED |
| TALK | CYCLONE 1 AMP SILVER | 550 | 400 | EX DEM |
| TALK | THUNDER 1 CD PLAYER | 550 | 400 | EX DEM |
| CHORD | SPM1200 POWER AMP | 3790 | 3000 | EX DEM |
| CHORD | SPM600 POWER AMP | 2050 | 1600 | EX DEM |
| CHORD | CPA2200 PRE AMP | 2740 | 2200 | EX DEM |
| CHORD | SPM1900 5 CHANNEL POWER | 4210 | 3400 | EX DEM |
| JBL | T12K SPEAKERS AND STANDS | 1900 | 1350 | EX DEM |
| LEXICON | MC1 CONTROLLER | 5500 | 3500 | EX DEM |
| PARASOUND | HCA2205 5 CHANNEL POWER | 2500 | 2000 | EX DEM |
| RUARK | EQUINOX SPKRS AND STANDS | 2200 | 1000 | PRE-OWNED |
| ROTEL | RC971 PRE AMP | 175 | 125 | EX DEM |
| ROTEL | RB971 POWER AMP | 250 | 125 | EX-DEM |
| PANASONIC | SAHE7 DD AV AMPLIFIER | 250 | 150 | EX DEM |
| ROTEL | RSP966 AV PROCESSOR | 799 | 500 | EX DEM |
| KEF | TDM34DS THX DIPOLARS | 700 | 475 | EX DEM |
| LINN | NEXUS LOUSPEAKERES | | 175 | PRE-OWNED |
| SONY | MXDD40 CD/MINIDISC COMBI | 329 | 229 | NEW |
| NAD | C270 POWER AMP | 449 | 325 | EX DEM |
| ROKSAN | MK11 SYSTEM CD/AMP/TUNER | 1475 | 1150 | EX DISPLAY |
| SONY | VLPW12HTLCD PROJECTOR | 6000 | 3995 | NEW |
| SONY | CDPX3000ES/TA3000ES CD AMP | 1000 | 500 | EX DISPLAY |
| PRIMARE | A10 INTERGTATED AMP | 499 | 299 | EX DEMO |
| AUDIOLAB | 8000C PREAMP | | 200 | PRE-OWNED |
| JAMO | D590 LOUDSPEAKERS | 1000 | 499 | NEW |
| SONUSFABER | GRAND PIANO LOUDSPEAKERS | | 1299 | EX DEM |
| JBL | T12K SPEAKERS-MATCHING STANDS | 1900 | 1000 | EX DEM |
| MYRIAD | MC100 CD PLAYER 1 NEW/ 1 EX DEM | 699 | 449 | |
| MYRIAD | MT100 TUNER 1 NEW/ 1 EX DEM | 499 | 349 | |
| MYRIAD | MP100 PRE-AMP | 599 | 399 | |
| MYRIAD | MT120 INTERGRATED 1 NEW/1 EX DEM | 699 | 499 | |
| MYRIAD | MA120 POWER AMP | 599 | 399 | |
| MYRIAD | MA240 POWER AMP | 995 | 749 | |

87 CLAYTON STREET NEWCASTLE NE1 5PY

TEL:0191 230 3600 FAX: 0191 222 0286

INFO@GLOBALHIFICENTRE.COM

BARGAIN BULBS

£195



If you've always thought of valve amps as temperamental and expensive beasts, think again. World Audio Design's latest kit is designed with the budget conscious beginner in mind.

The Kecl82 was created from a brief that demanded simplicity, ease of build and a super low cost. In order to achieve a reasonable power output we went for a push-pull amplifier.

We chose the ECL82, a triode/output pentode. This tube is readily available and has a good sound. In push-pull mode it delivers 8Watts. Realistically you need a speaker of around 89dB or above. This is possible at a budget price - try the smaller Triangle models, or a Tannoy mX3 or even one of the older Missions like the 773e, or if you like building your own speakers, try the Adire Audio HE10.1, as reviewed in HFW October 2002 issue.

You will see that the front has only a volume control, and it is fed by one pair of phono sockets. A selector and tape/source switch were not used in this amplifier as they are tricky to wire up, and the aim was to make it easy to build. In fact, in many ways the Kecl82 would be great powering a second system, using a CD player as a source, and will definitely give you a taster of what valves can offer. Measuring 30cm wide, 23.5cm deep and 11cm height with feet, it is entirely self-enclosed. The valves are visible through the four upper circular vent holes (one directly above each valve). We have kept the look simple with the minimalist front panel holding the volume potentiometer. The two-part chassis is constructed from 1.6mm mild steel with a durable black powder-coat finish. The whole unit is very sturdy, weighing in at 9kgs.

The signal input is in the form of a pair of gold plated RCA phono sockets that sit at the rear of the chassis. The speaker sockets accept 4mm banana plugs as well as bare wire. The mains switch is positioned at the rear of the amplifier, on the right hand corner for easy access. Mains power is received via an IEC lead. The Kecl82 is based on a printed circuit board (PCB). The PCB is easy to follow with all component names, locations and orientations shown clearly. The amplifier requires no set up, you just turn it on. The kit will come with comprehensive instructions taking you through the build step-b-step.

SOUND QUALITY BY SIMON POPE

Purity is the key to this amplifier's design and sound. Because there's very little to get in the way of the signal what you get is an exceptionally sweet and simple sound that also has a superbly wholesome roundness to it. A high quality recording of Mahler's Das Lied Von Der Erde on Reference Recordings showed that the Kecl82 faithfully reproduced all the depth and space of a full symphonic orchestra without any problems. Violins were smooth and sweet, as was percussion (which virtually sparkled) and the woodwind section was especially impressive, with a spacious and airy sound.

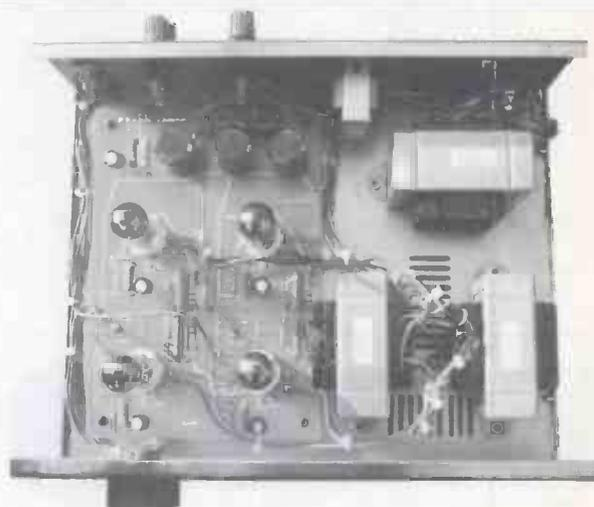

A run through Miles Davis's Kind Of Blue saw the little integrated delivering a detailed and precise sound that highlighted the warmth of Coltrane's tenor sax and the rich, deep sound of the upright bass. Rock and Pop records such as Radiohead's 'Lucky' demonstrated that the valves inside the amp, whilst small, are quite robust sounding, with commendable clout and bass depth for a humble budget 8W valve amp. This is a great introduction to the sonic art of the valve amp and a big upgrade for anybody with a mid-price solid-state amp that wishes to swap over to something more musically engaging, for a price that's virtually as cheap as chips!

MEASURED PERFORMANCE

| | |
|--------------------|----------------------------|
| Frequency response | +/-3dB 15Hz - 75kHz |
| power output | 8 watts into an 8 ohm load |
| sensitivity | 850mV (suitable for CD) |
| hum | 0.5mV |

**The Kecl82 amplifier kit is available from World Audio Design
Tel/fax: 00 44 (0) 1908 218836 or order on-line at
www.worldaudiodesign.co.uk**

**Kecl82 amplifier kit (UK price) £195.00
(inc. vat & carriage)**

**Kecl82 amplifier kit (EU price) £195.00
(inc. vat, exc. carriage)**

**Kecl82 amplifier kit (Overseas price) £170.00
(exc. carriage)**

Sound Stage

2nd User Hi-Fi & audio

01376 521132

07802 483698

CHELMSFORD, ESSEX

E-MAIL: soundstage@netlineuk.net

BY APPOINTMENT ONLY

PRE-OWNED EQUIPMENT

| | |
|---|-------|
| ARCAM ALPHA 10 AMP BOXED AND IMMACULATE | £499 |
| ARCAM ALPHA 7 TUNER BOXED AND IMMACULATE-2 YEARS OLD | £179 |
| AUDIOLAB 8000A-BLACK-PHONO 'E' SERIAL NUMBER | £299 |
| CYRUS FM7 TUNER BOXED AND IMMACULATE | £299 |
| CYRUS SMART POWER BOXED AND IMMACULATE | £449 |
| DEFINITIVE TECHNOLOGY PRO SUBWOOFER 80 BOXED AND SUPERB | £279 |
| DENON AVP-A1 GOLD BOXED AND IMMACULATE (£3000 NEW) | £995 |
| DENON AVC-A1SE BLACK BOXED AND SUPERB 7.1 DTS ES AC3-RF | £1795 |
| KRELL KSA80B POWER AMP SUPERB CONDITION | £1595 |
| LINN NUMERIK DAC 20 BIT NON SMP3 VGC | £399 |
| MARANTZ CD63 SE K1 SIGNATURE | £299 |
| MERIDIAN 606 DAC BOXED AND IMMACULATE | £595 |
| MICROMEGA DRIVE 2 CD TRANSPORT | £395 |
| MICROMEGA STAGE 5 IMMACULATE AND BOXED | £429 |
| MICROMEGA DRIVE 3/DAC BOXED AND IMMACULATE | £995 |
| MISSION DAD5/DACS TWO BOX CD PLAYER NO REMOTE SUPERB CONDITION | £299 |
| MONITOR AUDIO SILVER 9j CHERRY BOXED AND SUPERB | £595 |
| MONITOR AUDIO MA1800 REFERENCE GOLD LOUDSPEAKERS-BOXED | £595 |
| MUSE MODEL 3 PRE-AMP REMOTE BLACK BOXED AND IMMACULATE | £995 |
| MUSICAL FIDELITY HTP/HT600 AV SILVER 5 MONTHS OLD AS NEW (WERE £4K) | £2995 |
| MUSICAL FIDELITY A220 INT AMP PIANO BLACK BOXED AND SUPERB | £499 |
| NAIM Credo BEECH 1998 BOXED AND IMMACULATE | £895 |
| NAIM NAC 82 GREEN FRONT INC NAP3C 3 YEARS OLD SUPERB CONDITION | £1695 |
| NAIM NAP140 NEW STYLE BOXED SUPERB CONDITION | £449 |
| NAIM NAC 102 BOXED AND IMMACULATE 2001 MODEL | £795 |
| NAIM NAC 92 PRE AMP BOXED AND IMMACULATE | £279 |
| NAIM NAIT3/PRE OUT MODIFICATION BOXED AND IMMACULATE(1999 MODEL) | £399 |
| NAIM IFO 2-WAY ACTIVE X-OVER WITH VARIABLE FREQUENCY | £299 |
| NAIM NAT 101/SNAPS 2 BOX TUNER LOVELY CONDITION BOXED | £595 |
| NAIM NA CD-X CD PLAYER 3 YRS OLD SUPERB | £1795 |
| NAKAMICHI OMS5E/II CD PLAYER-WAS £1500 NEW-LOVELY CONDITION | £399 |
| NAKAMICHI CASSETTE DECK 2 | £179 |
| PIONEER CLD 925 DOLBY DIGITAL LASER DISC PLAYER | £299 |
| PRIMARE A30.1 INTEGRATED AMPLIFIER BOXED-SLIGHT MARK HENCE | £995 |
| PRO-AC TABLETTE 50 CHERRY-IMMACULATE | £395 |
| PROCEED PCD SERIES 3 CD PLAYER (£3500 NEW) | £1495 |
| QED A240CD INTEGRATED AMPLIFIER | £99 |
| RUARK EPILOGUE REFERENCE ROSEWOOD SUPERB AND BOXED | £299 |
| RUARK CL20 BEECH VERY GOOD CONDITION | £895 |
| VIENNA ACOUSTICS MOZART BEECH WOOD GOOD CONDITION BOXED | £995 |

PROFESSIONAL RECORD CLEANING SERVICE - KEITH MONKS MACHINE -
PLEASE RING FOR FURTHER DETAILS AND PRICES.

THREE MONTH WARRANTY ON ALL ITEMS

www.sound-stage.co.uk

WILLIAMS HART ELECTRONICS

HART ELECTRONIC KITS TRADED FOR OVER 30 YEARS



Mosfet Monoblock Power Amp Kits
ONE OF THE BEST AMPLIFIERS YOU WILL HEAR! Regardless of price
REVIEWED IN HI-FI NEWS AS "...EXCEPTIONAL...
SELF EVIDENTLY CORRECT



Single Ended Class A Valve Sound
£5Watt Power Amp modules
FOR THOSE WHO WANT THAT VALVE
MIDBAND BUT BASS AND TREBLE TO MATCH



ACTIVE R/Control SUBWOOFER MODULE £177.30

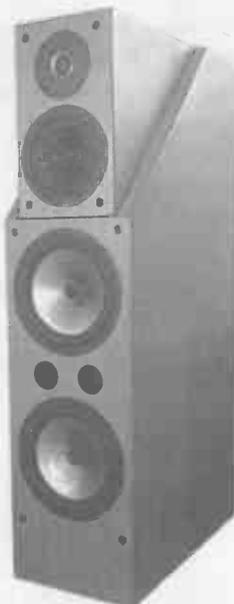

Speakers Designed & Built to Order

Advertise your HI-FI on my website (FREE)
Also: Award Winning Phono Stage Kit, Active Crossover Modules, Speaker Drive Units,
M Cap Capacitors, Caddock Resistors, Remote Control Volume and much more.

WEB SITE: www.williamshart.com e-mail: sales@williamshart.com

Tyn-Y-Coed, Llidiardau, Bala, Gwynedd, LL23 7SG Tel/Fax for catalogue 01678 520757.

PERSONAL VISITORS SHOULD PHONE FIRST TO AVOID DISAPPOINTMENT

Run by former Technical Director of Wilmslow Audio



MUSICAL IMAGES

| PRODUCT | LIST | NOW |
|---|----------------|--------|
| ARCAM A75PLUS Silver AMP | NEW £470 | £350 |
| ARCAM ALPHA5CD CD Player | SH £450 | £150 |
| ARCAM ALPHA6AMP AMP | SH £300 | £150 |
| ARCAM ALPHA9AMP AMP | SH £500 | £275 |
| ARCAM ALPHA9POWER Power Amp | SH £400 | £250 |
| ARCAM CD72 Silver CD Player | EX/DEMO £450 | £280 |
| ARCAM T61 Silver Tuner | NEW £250 | £180 |
| DENON AVC-A1SE Black AV Amp, THX | EX/DEMO £2,500 | £1,500 |
| DENON AVR1602 Black AV Receiver | EX/DEMO £350 | £280 |
| DENON AVR2802 Gold AV Receiver | EX/DEMO £650 | £550 |
| DENON AVR3802 AV Receiver | EX/DEMO £850 | £600 |
| DENON DVD2800 DVD Player | EX/DEMO £750 | £600 |
| DENON DVD2800 DVD Player | S/H £750 | £450 |
| HARMON KARDON AVR4500 AV Receiver | NEW £650 | £375 |
| HARMON KARDON AVR5500 AV Receiver | NEW £750 | £450 |
| HARMON KARDON AVR8500 AV Receiver | NEW £1,800 | £1,200 |
| HARMON KARDON TU940RDS Tuner | NEW £180 | £135 |
| KEF 200CENTRE Centre Speakers | EX/DEMO £700 | £550 |
| KEF KHT2005 5 Speakers & SUB | EX/DEMO £800 | £600 |
| KEF REFERENCE 4-2 Cherry Speakers | EX/DEMO £3,650 | £2,800 |
| LINN AKTIVMOD Aktiv Modules | EX/DEMO £125 | £50 |
| MARANTZ ECLIPSE 70 DVD Combi System | EX/DEMO £1,500 | £750 |
| MARANTZ LC1700 17" LCD 16:9 TV | EX/DEMO £1,500 | £1,000 |
| MERIDIAN 558 Multi-channel Amp | EX/DEMO £3,395 | £2,000 |
| MERIDIAN 568 Digital processor | EX/DEMO £3,885 | £2,500 |
| MERIDIAN DSP33 DSP Active Speaker | EX/DEMO £2,595 | £1,500 |
| MERIDIAN DSP5000 Cherry Speakers | EX/DEMO £3,885 | £2,500 |
| MERIDIAN DSP5000C Black Centre Speaker | EX/DEMO £1,995 | £1,000 |
| MERIDIAN DSP5500HC Centre Speaker | EX/DEMO £3,750 | £2,500 |
| MERIDIAN M33 Speakers | EX/DEMO £1,560 | £750 |
| MISSION 78C Centre Speaker | EX/DEMO £300 | £150 |
| MISSION 78DS Speakers | EX/DEMO £300 | £150 |
| MUSICAL FIDELITY A3CR Pre Amp | EX/DEMO £1,000 | £800 |
| MUSICAL FIDELITY HTP AV Pre Amp | EX/DEMO £2,000 | £1,000 |
| MUSICAL FIDELITY NUVISTA 3DCD CD Player | NEW £3,000 | £2,000 |
| NAIM INTRO Black Speakers | EX/DEMO £790 | £395 |
| PANASONIC DMRE30EBS Recordable DVD Player | EX/DEMO £550 | £475 |
| PANASONIC NVFJ630BS Silver VCR | NEW £150 | £120 |
| PIONEER NS DV1000 Home Cinema System | NEW £1,300 | £1,000 |
| ROTEL RB951 Power Amp | EX/DEMO £300 | £200 |
| ROTEL RB985 Power Amp, 5 Channel, THX | EX/DEMO £625 | £450 |
| SELECO HT300DG Projector | EX/DEMO £9,000 | £6,750 |
| SONY DVPNS 900 Silver DVD Player | NEW £450 | £225 |
| SONY STRDB1070 Black A/V Receiver | EX/DEMO £600 | £375 |
| SONY STRVA555ESN AV Receiver | EX/DEMO £1,000 | £750 |
| SONY STSE370 Tuner | NEW £110 | £80 |
| SONY VPLHS1 Projector | EX/DEMO £1,800 | £1,000 |
| SONY VPLVW11HT Projector | EX/DEMO £5,300 | £3,300 |
| YAMAHA DPX-1 Projector | EX/DEMO £6,500 | £4,500 |
| YAMAHA RXV620RDS AV Receiver | EX/DEMO £450 | £300 |

PLEASE VISIT OUR SHOWROOMS

OR CALL OUR HOTLINE

NUMBER FOR DETAILS.

MANY ARE ONE-OFF ITEMS!!

HOTLINE 020 7497 1346

Convent Garden
18 Monmouth Street
Convent Garden
London WC2H 9HB
Tel: 020 7497 1346

E-Mail: sales@musical-images.co.uk

NOT VALID WITH ANY OTHER OFFERS OR PROMOTIONS E&OE

Private Ads

Dealers must not advertise in the Private Classified section. Monthly consecutive insertions will be considered Trade advertising. The Publisher reserves the right to judge submissions.

Special Internet offer see page 130 for details

MERIDIAN 601 computerised pre amp £775. 602 CD and 606 DAC complete £900. M1 black ash active floor standers 225w each £775. Inclusive of all leads, interconns and remotes, all recently serviced, mint and boxed. Tel: 0771 007 4046 mobile, 020 8959 3611 day. (Aug/I)

FOR SALE Pair of ATC-SCM50ASL (Black), <30hrs play, excellent condition, will deliver in UK, £4000. Tel: 07974 330242 or Email: jknapper@cityairexpress.com (Sep/I)

REGA PLANET Mk1 excellent condition £250. Naim 42.5 offers, Sara stands offers. Please phone Martin 01494 462457 (Aug/I)

NAIM 82 preamp, 24 months old, mint, cost £2500, accept £1395. Hicaps serviced by Naim, one 3 months ago £320, the other 30 months ago £295. Snaic new £25. Tel 01302 865282 (Yorkshire) (Aug/I)

ORBE SE VC latest model boxed instructions £1295, will consider exchange for Voyd 0.5 or P/ex Garrard 301 silver Mordaunt Short Decca-Kelly units model 700 £195. Tel: 01273 727476 (Aug/I)

MUSICAL FIDELITY P270 power amp mint £525 ono. Sony MDS-JB930 MiniDisc £75, mint, boxed, Meridian 101 pre with pair 105 amps black rare £275. Sony ELS Elcasete £100 Tel: 07764 960127 (Sep/I)

MERIDIAN 500 transport. Meridian 518 processor. Audiosynthesis Dax-2. Shahinian Arc loudspeakers. Magneplanar MG 2.5R loudspeakers. Magneplanar MG1b loudspeakers. Valve amplifier Synn AP900 60 W.P.C. Quad 606 amplifier. Descadel silver interconnect. Tel: 01179 521341 (Bristol) (Aug/I)

WANTED GOODMAN'S
Audiom 81 15" bass unit. Tel: 01768 779201 (Aug/I)

MUSICAL FIDELITY X-A1 and X-Ray CD player, Mission 782 speakers, beech, X-link, intercon QED, silver speaker cable 2 x 3 mtrs. Mint condition, boxed £650 ono. Tel: 01977 675791 (West Yorkshire) (Aug/I)

KRELL KSA MkII £1050. Meridian 601 £500. 602 £450. 606 £400. 209 £50. Tag McLaren Gallipoli speakers with stands slightly marked hence £800 (£2600). Naim 101 tuner £400. Tel: 01279 724804 (Herts) (Sep/I)

CONRAD JOHNSON Premier 140 3A poweramp brand new 10 hours use, flagship model from Conrad Johnson £5500, new £7000. Tel: +35 3 9163 7745 or + 35 3 9170 8300 (Eire) (Aug/I)

HARBETH LS3/5A Gold Signature final production model with Rogers AB/I sub-woofers and Mana sound bases all excellent and boxed £1000. Tel: 01522 694871 evenings (Lincoln) (Aug/I)

TANDBERG STUDIO monitors cited by Haden Boardman in N.E.C. report superb authoritative sound, crisp tight bass, beautiful clear mid and treble, more info try: www.audioreview.com £325 ovno. Tel: 07976 904381 (Aug/I)

AS NEW Amati Homage with Hoveland HPI00 & Shaphire (£20,000) £8000 ono, may split. Also Sony SACD 777 MSB PS/DAC III (£3000) £1500 ono for estate. Tel: 029 20 369052 (Cardiff) (Aug I)

FERROGRAPH LOGIC 7 tape recorder (7622H). 3 3/4, 7 1/2, 15 I.P.S. 10 1/2" reels, 2 track, pushbutton, remote, internal amplifiers, speakers, walnut case, tapes, manual, serviced, excellent £600. Rogers Cadet III valve amplifier, cased, excellent, £200. Tel: 01625 861 728 (Aug/I)

THORENS 125 SME arm, immaculate £150. Garrard 401 nice plinth £125. NAD 3020 £50. NAD tuner £40. Sony 3000ES tuner £165. Rodgers Studio 7 rosewood boxed £325. Nakamichi BX150 £60. Creek OB4 9SE phono stage boxed £110. Tel: 0772 962 0621 (Aug/I)

AUDIO ANALOGUE Paganini CD £375 (£795). Audio Analogue Puccini SE amplifier £295 (£595). Sonus Faber Concertino speakers with Sonus stands £425 (£900). All mint and boxed. Tel: Paul 01159 783771 (Nottingham) (Aug/I)

ELECTROFLUIDICS MONOLITH 20/20 annealed copper speaker cable, 2 x 1m lengths £75. Campaign Audio Conqueror-mi silver plated mains cables, 1m £25, 2m £35. Nottingham Analogue Blue interconnects, various lengths £5/m Tel: 0115 937 3783 (Nottingham) (Aug/I)

DALI BLUE Series 5.1 speaker system. 6006 fronts, R1000 rears, C1000 centre, SWA-12 120 watt subwoofer. Unwanted competition prize. Never used. Further details www.dali.dk All items boxed £600 ono. Tel: 028 66 327885 or 07799 625516 (Aug/I)

LOWTHER DUAL position Acoustas pair for sale with good teak cabinets and PM6A units £350. Tel: 01732 850574 (Kent) (Aug)

SANSUI 9090 receiver requires attention £50. Sony TC177 cassette deck, flagship model £150. Aiwa C22 preamplifier, P22 amp, R22 tuner, L22 cassette, classic micro system £70. Tel: 020 8281 0029 (Aug/I)

WELL TEMPERED Classic mint condition Rega RB-1000, Thorens TD-126, SME 309 as new, RB-300 Incognito, Thorens TD-124 MkII excellent condition, Pro-Ac Response 2.5 New! Michell Mycro RB300 as new, Trichord Delphini-2 new. Tel: 0117 955 6555 or 07979 514450 (Aug/I)

DNM 3 Box £695. Revox 710 £450. Roksan 3 box CD £795. Monitor MA10 £395. Tannoy System 8 £395. Marantz CDA DAC £350. Trichord Pulse/pwr sup £650. Audio/Research D70 £795. C/Point SA12 £595. Crimson monoblocks/pre £795. Tel: 07966 267404 or Email: coom@btinternet.com (Aug/I)

QUAD 34 preamp bronze DIN good condition boxed £130. Nordost Solar Wind interconnects 1 mtr, pair boxed £45. DNM Reson Bullet plugs 1/2 mtr pair £30. Tel: Mike 01755 613790 (Aug/I)

AUDIO SYNTHESIS Transend transport 495 Audiostatic ES200RS electrostatics, speakers £1395. AVI pre/monos CD £1495. Gamma Rhythm £1295. Sony SCD1 £2095. Tel: 07966 267404 (Aug/I)

MUSICAL FIDELITY Nuvista valve preamplifier. Mint condition, boxed. Spare set of Nuvista valves. Cost £1200 new, sell for £650 ono. Tel: 0141 641 5526 (Glasgow) after six or Mobile: 07939 188613 (Aug/I)

PRIMARE A30.1 integrated amp, mint, boxed as new, cost £1500 will accept £750 ono. Also Ecosse Maestro 0.8m interconnect, cost £155 will accept £65. Tel: 07713 882489 or 02828 277129 (Aug/I)

NAIM 90 & 92 pre & power amps, remote control £650. Metaxa Charisma chrome pre & p/supply £250. Helios Cyrus .1. floor standing speakers (£2800) £850 exchange, small quality speakers A/E etc Albarry Devon PPI integrated £180. Analogue Jupiter integrated £150. Want Manaplanar SMGA chrm or brass. Tel: 01626 773781 (Aug/I)

ORBE SE VC latest £1295. SME V MCS ISO internal silver wire £950 includes Living Voice arm cable. Audionote arm (Rega) cartridge £275. Horning One loudspeakers £950. Tel: 01273 727476 (Aug/I)

CUSTOM BUILT 24" active subwoofers 1kw inbuilt amps with internal crossovers, two available £995 each or £1800 both. Sony SCD-1 SACD/CD player, mint, boxed £1900. Tel: 01502 582593 or Email: briggs111@btinternet.com (Lowestoft) (Aug/1)

LINN DIRAK power supply, for LKI/Aktiv crossover, mint condition, boxed £150. Tel: 01253 722836 (Aug/1)

AUDIO INNOVATIONS 1st audio amplifier with Border Patrol power supply Golden Dragon 2A3 valves, excellent condition, boxed £770. SJS Arcadia One preamp, rare item, in excellent condition £430. Townshend Isolda speaker cable 6 metre pair £235. Tel: 0141 339 7387 (Glasgow) (Aug/1)

LOWTHER ACOUSTAS PM7As, truly pristine condition throughout. Original manual. Photo available for serious enquiries. These are possibly the best examples you will find £675. Tel: 01722 334694 after 6pm weekdays, Sat-Sun anytime (Salisbury) (Aug/1)

MARANTZ 63SE Trichord Clock 3 £175. Solid silver speaker cables 10 foot biwire pair Vantage Audio transparent sound £450 ono. Tel: Alex 07780 522747 or Email: alexlandrum@onetel.net.uk SW London will demonstrate (Aug/1)

SPENDOR SP7/1 rare floor-standing speakers, beautiful rose-wood finish, lovely natural sound, £750 ono (£2000 new). Quad 77 stereo power amplifier, £295 ono (£600 new). Both superb condition with boxes. Tel: 023 8073 8935 (Aug/1)

SONUS FABER Extreama, complete with Slate Audio stands, top notch speakers with sound to match £2700. Tel: 01642 326681 (Middlesborough) (Aug/1)

ACURUS/MIRAGE CD System. Acurus DIA-100 amplifier (100W/channel) + ACD-11 CD player. Mirage M-7si speakers (75-150W). Amazing sound for the money. Lots of bass. £650 ono. Tel: 01444 414208 (Aug/1)

OL/RB250 £150. Pioneer A400 amp £100. Mission 761 speaker C/W stands £60. Thorens TD160 with Nagaoka MPII £60. Tel: evenings 01933 398744 (Aug/1)

MICRO SEIKI CD-M2 CD player £750. Albarry 4085II transistor monoblocks red £300. Garrard 401 £125. Leak FM Troughline 3 £75. Tel: 01406 364935 (Aug/1)

REVOX SYSTEM. Never used. 3 pieces. Top-rated. S26 FM tuner, S25 stereo amp. S22 CD deck. Still in sealed factory crates. 10 days old. Cost £1550. Best offer. Call 07810 284 943 or preferably message gordack7@yahoo.com (Aug/1)

SEXY TUBES. Unison Simply Four & Simply phono. Revalved with Svetlanas, mint condition. £850 (£2100) ono. Ring Rob 07976 621529. For a chat/demo Naim users may apply. (Aug/1)

CYRUS III £250. PSX £170. Micromega Stage One £250. Acoustic Energy AE100 including stands £175. Mana Acoustic Soundstage £50. Target Table £25. Jecklin Float Two £50. Tel: 01235 444 925 or Email: john.newton@innogy.com (Aug/1)

LEAK STEREO 20, grey, rebuilt by Classique Sounds, vgc, Mullard valves, Partridge choke, sounding excellent, call for more details 020 7633 0503 or Email: sensoroul65@yahoo.co.uk, mail for pictures (Aug/1)

QUAD IIL speakers, piano black, 10 months old, mint, boxed (£379) £319. Arcam FMJ 22 amp 100 wpc 8 ohms (170w 4ohms) silver 5 months old (£999) £699 Tel: 0115 960 3934 (Aug/1)

ELAC SPEAKERS. One pair CL-310i. Top-rated. Ten days old. Still in sealed factory crate. Cost £850. Best offer. Call 07810 284 943 or preferably message gordack7@yahoo.com (Aug/1)

LIVING VOICE Auditorium, unused, not yet run in, £1000 ono. Tel: 07739 374 620 (West Sussex) (Aug/1)

CELESTION A3 floorstanders and A4c centre speakers finished in black. Mint condition £1100 ono. Tel: Phil 01962 851233 or 07941 849601 (Aug/1)

QUAD QC-Twenty Four/pair II Forty Valve Amplifiers RRP £4000. Accept £3100 ono, Quad 989 Electrostatic Speakers, Nouveau, RRP £5000 Accept £3750 ono. All items new, boxed, unused, complete. Tel: 01274 731 817 (Aug/1)

LINN KANN speakers. Rosewood finish. Boxed. Mint. One year old. £199. No offers. Tel: 07740 929 404 or Email: Santran@bigfoot.com (Aug/1)

AUDIO NOTE ANJ SP speakers, light ash finish excellent condition, boxed, inc new Audio Note stands (£250), £800 ono. Michell Iso/Hera phono stage £350 ono. Audioquest Quartz interconnects 1 x 0.7m, 2 x 0.5m, £75 ono. Tel: 07711 855 599 or Email: jimtosg@hotmail.com (Aug/1)

NORDOST BLUE Heaven RCA phono £120. Toshiba 210E multi DVD £100. Tel: 020 8771 1818 (Aug/1)

THORENS TD160 Super turntable, Linn-Basik arm, Ortofon Leak 2050 speakers, sensible offers. Tel: 07786 907 713 (Aug/1)

Trade Ads

Dealers must not advertise in the Private Classified section. Monthly consecutive insertions will be considered Trade advertising. The Publisher reserves the right to judge submissions.

AMAZING CABLES! Silver hybrid and solid silver interconnects from £85, with world class plugs. Solid silver speaker cables from £220. Fantastic performance, refund guarantee. Details: 0115 982 5772 after 7pm, or E-mail Bob@skydivers.co.uk (Dec/1)

SEE NEW FARADAY Emperor loudspeakers at www.faradaysound.co.uk Low density ceramic cabinets. 'A sonic revelation'. The ultimate hi-fi is probably within your budget. Some ex-demo and kit form available. (Aug/1)

NEW VALVE Amps; powers £260; matching preamp £190; other valve related goodies at www.audioclassics.co.uk or telephone 01942 257525 for more information. Dealer enquiries welcome. (Oct/1)

CADENCE ANINA Hybrid Electrostatic speakers, mint & boxed £1395. Meridian 601 DSP MM/MC DAC/pre, A to D converter £895 mint, SME 20/A 12 months old £2595. SME V mint £1050 part exchange welcome. Tel: Audio 4 Sale 0118 981 5681 or 07909 697060 (Aug/1)

CABLEMAIL SPECIALISTS in new and used cables at good prices. Acoustic Zen, Audioquest, Cardas, Kimber, Nordost, Taralabs, Transparent, XLO etc. Email for further details and save. Email: cablemail@speedpost.net (Aug/1)

LONDON TAPE RECORDERS. Open reel to reel specialists, established 30 years, machines bought, sold and exchanged. Akai, Sony, Pioneer, Teac, Tascam, Revox, Technics. Servicing on selected machines. Tel: 020 7603 0303 or 07950 400 005 (Oct/1)

HERTFORDSHIRE/NORTH LONDON Audio/Record Fair. Sunday 10th August 2003. 11.00 to 4.00. 9.30am early entry £10. At Cuffley Hall, Maynard Place, Cuffley, Herts. 5 minutes from M25 Junction 25. Tel: 07944 909 209 for details (Aug/1)

AUDIOREPUBLIC, 78 Otley Road, Headingley, Leeds, 0113 217 7294. Yorkshire's newest Hi-Fi retailer, representing Naim, Rega, Creek, Totem, Quadraspire, Dynavector, Roksan, Teac and more. Used LP12's, Lingo's, Linto's stocked. Call for advice: Tel: 0113 217 7294 (Aug/1)

hi-fi
WORLD
& computer audio



S/hand and ex-demo clearance items - AUGUST 2003

CD players DACs & Transports

| | Was | Now |
|-------------------------------------|------|------|
| Cyrus DAD3 24Q DAC S/H | 899 | 499 |
| Pink Triangle DaCapo DAC 24 Bit S/H | 1700 | 699 |
| Primare D30.2 CD Player S/H | 1500 | 899 |
| Teac P30 Transport S/H | 2500 | 995 |
| Wadia 830CD Player S/H | 3295 | 1899 |

Turntables Tonearms & Cartridges

| | | |
|---|------|------|
| Air Tangent 1C with Wisa Pump X-demo | 5800 | 3999 |
| Benz Micro LP New& Boxed | 2200 | 1799 |
| EAR 834P MM Phono Stage S/H | 399 | 279 |
| Heed Audio Quazar 2 Box Phono Stage New and Boxed | 599 | 399 |
| Lehmann Audio Black Cube SE New& Boxed | 650 | 429 |
| Lyra Lydian Beta New& Boxed | 599 | 499 |
| Michell ISO Phono Stage S/H | 549 | 250 |
| McCormack Phono Stage New and Boxed | 650 | 399 |
| Nottingham Analogue Hyperspace/Paragon 1 S/H | 3100 | 1499 |
| Systemdeck S/H | N/A | 199 |

Preamplifiers

| | | |
|--|-------|------|
| Advantage S2 Balanced Silver S/H | 2750 | 1399 |
| Audio Synthesis Passion 8 Remote Preamplifier S/H | 1800 | 795 |
| CAT SL1MkII Reference Phono Pre amplfier S/H | 6500 | 3799 |
| Einstein "The Tube" Preamplifier x-Demo | 6000 | 3999 |
| Musical Fidelity A3 Preamplifier S/H | 899 | 499 |
| Graaf GM13.5BII Valve Preamplifier x-demo S/H | 4000 | 2999 |
| Krell KSL 2 Signature Analog Series S/H | 5800 | 1850 |
| Krell KAV-S Processor/Preamplifier DTS/AC3/Pro Logic S/H | 14989 | 2999 |
| McIntosh C100 2 Box Valve Remote Controlled Preamplifier S/H | 6500 | 2999 |
| Roksan L2 preamplifier S/H | 1295 | 399 |
| Spectral DMC12 s Phono x-demo | 4750 | 3299 |
| Spectral DMC30 Remote x-demo | 8500 | 6500 |

Amplifiers

| | | |
|---|-------|------|
| 47 Labs Gain Card25w / Humpty S/H | 3250 | 1899 |
| Audio Analogue Maestro Integrated x-demo | 2700 | 1899 |
| Electrocompaniet AW120Dmb S/H | 2395 | 1599 |
| Krell FPB600c Power Amplifier | 14000 | 8500 |
| Roksan S1.5 Stereo Power Amplifier S/H | 1500 | 699 |
| Unison Research S2K Remote x-demo | 1295 | 995 |
| World Audio KaT6550 Valve power amplifier S/H | 995 | 399 |

Loudspeakers

| | | |
|--|------|------|
| Avalon Eclipse Maple x-demo | 9800 | 7249 |
| BKS 107 MKII Supreme Ribbon Hybrids x-demo | 2199 | 1599 |
| Indigo Model Two Centre Channel Cherry S/H | 199 | 129 |
| Jm Lab Micro Utopia Dark Cherry/inc stands New and Boxed | 4500 | 3799 |
| JM lab Mini Utopia Ebony S/H | 3999 | 2499 |

Cables & Accessories

| | | |
|---|------|------|
| Air Pod size 1 x3 S/H | 210 | 99 |
| Acoustic Zen Silver Signature Balanced 12ft | 2700 | 1499 |
| Cogan Hall EM-D 0.6m S/H | 199 | 99 |

Midland Audio X-change is looking for good used British & American Hi-Fi
cash paid call John Roberts on 01562 822236

| | | |
|--|------|------|
| Kimber Select KS 3033 2X10ft S/H | 1750 | 995 |
| Opera Lux 3 Tier Table Clear/Stainless x-Demo | 950 | 499 |
| Partington Dreadnaught 24" Stands S/H | 250 | 149 |
| Roksan HA01 1M Interconnect S/H | 99 | 49 |
| Roksan HAO1D 0.5m Digital Interconnect S/H | 49 | 25 |
| Target HR60 Silver Stands S/H | 199 | 109 |
| Target R1 Stands S/H | 299 | 175 |
| Target R2 Stands S/H | 329 | 199 |
| Transparent Music Link RCA-RCA 2m S/H | 299 | 149 |
| Transparent Music Link Balanced 2m S/H | 499 | 249 |
| Transparent Music Link Reference Balanced 1.5m S/H | 3300 | 1599 |
| Transparent Music Link Ultra Balanced 7.26m S/H | 2349 | 1499 |
| Transparent PL20XL Power cord S/H | 1260 | 799 |

Tuners & Tape Decks, Power Supplies

| | | |
|--|-----|-----|
| AKG C1000 Condenser Mic S/H | 241 | 120 |
| Magnum Dynalab FT-R Remote Switcher for FT101A/Etude (New&Boxed) | 450 | 299 |
| Rega RadioR Silver x-demo | 498 | 299 |

Bargains under a £100

| | | |
|---|-----|----|
| Sony TCK-461s 2 head cassette decks new&boxed | 199 | 99 |
|---|-----|----|

Midland Audio X-change are looking Audio Research, Krell, Mark Levinson, Naim Audio, Dcs, Wadia, cash paid call John Roberts



Suppliers and installers of High Quality Audio Systems

- 47 Laboratory : Graff
- Accuphase : Gryphon
- Audio Note : Lavardin
- Audlo Research : Mark Levinson
- Avid : Martin Logan
- Basis : Michell
- Cabasse : Nagra
- Cardas : Primare
- Clearaudio : ProAc
- Conrad Johnston : Rega
- Copland : Resolution Audio
- Dcs : Sonus Faber
- DNM / Reson : Spectral
- Einstein : SPM
- Electrocompaniet : Sugden
- Final : UKD
- Finite Elemente :

WE HAVE MOVED
New address:-

www.midlandaudiox-change.co.uk

call John Roberts Tel: 01562 731100

or fax on: 01562 730228

The Old Chapel, Forge Lane, Belbroughton
Worcestershire, DY9 9TD

e-mail sales@midlandaudiox-change.co.uk

Mobile 07721 605966

www.midlandaudiox-change.co.uk

Trade Ads

Dealers must not advertise in the Private Classified section. Monthly consecutive insertions will be considered Trade advertising. The Publisher reserves the right to judge submissions.

Special Internet offer see page 130 for details

WADIA 16, 4yrs (£7450)
£3500 Basis Debut Gold Standard Turntable, custom dust cover, (£8,500) £4k Graham MkII tonearm, Delux gold (£2300) £1400 Koetsu Red, 20hrs, (£2200) £1300. All mint, boxed. Telephone Jules on 01792 280061, Email: info@sounddrjuleshifi.co.uk Web: www.sounddrjuleshifi.co.uk (Aug/1)

AUDIO RESEARCH LS25 Mk1, 4yrs, (£5000) £3500 Audio Research M300 Mono Blocks MkII status [£12000] £4300 Tom Evans the Groove, phono stage, 2yrs, (£1800) £1400 Sonus Faber Extrema's on stands (£7800) £3900 All mint, boxed. Telephone Jules on 01792 280061, Email: info@sounddrjuleshifi.co.uk Web: www.sounddrjuleshifi.co.uk (Aug/1)

TRANSPARENT ULTRA Bi Wire 12ft, WBT Bananas (£3440) £2200 Mandrake 1mtr, RCA-RCA (£600) £300 Siltec Arm cable, Icheman bullets RCA's 1.5mts (£400) £260 Siltec 1.0 mtr RCA-RCA (£300) £180 Telephone Jules on 01792 280061, Email: info@sounddrjuleshifi.co.uk Web: www.sounddrjuleshifi.co.uk (Aug/1)

ELAC CL310i 'Jet' speakers, c/w matching stands, silver 2 months old, mint and boxed. (£1000) £650. Krell KAV 300i Amp, mint as new. (£2300) £1250. Telephone Jules on 01792 280061, Email: info@sounddrjuleshifi.co.uk Web: www.sounddrjuleshifi.co.uk (Aug/1)

LINN KEILIDH'S, black ash, active cards, passive (£1000) £450 Audiolab Transport and DAC, Mint condition C/W manual and box £900 ono. Audio Technica OC9 cartridge brand new £270. Telephone Jules on 01792 280061, Email: info@sounddrjuleshifi.co.uk Web: www.sounddrjuleshifi.co.uk (Aug/1)

MUSIC LINK Ultra WBT's, RCA's interconnect, 2.0mtr (£900) £600 LFD Mistral CD player, stainless steel & gold livery, boxed. Mint (£1050) £450 Telephone Jules on 01792 280061, Email: info@sounddrjuleshifi.co.uk Web: www.sounddrjuleshifi.co.uk (Aug/1)

NAIM NAC 32.5 pre, with phono stage, mint condition £275. Linn Karik, mint, (£1850) £650. Rotel RT 830 AL tuner £60. Telephone Jules on 01792 280061, Email: info@sounddrjuleshifi.co.uk Web: www.sounddrjuleshifi.co.uk (Aug)

HIFI HUT in Harrogate offer the following quality brands: Bryston, Creek, Custom Design, Harman Kardon, Neat, PMC, Quad, REL, Wharfedale. Phone for details, directions, 01423 810 990 or 07736 392 852. www.hi-fihut.com (Aug/1)

QUALITY VALVE Amplifiers: Repaired, restored, modified. Custom designs commissioned. Kits assembled. Experienced Engineer. Free estimates and fair prices. Tel: 01525 756 935 <http://www.dhaen.co.uk/amps.htm> Email: amps@dhaen.co.uk (Aug/1)

EMT 950 £1200, Revox PR99 MkIII £950, B77MkI £400, B760 £750, A700 £400, Nagra 4-stereo QGB & ATN2 £1500, Studer A80 RC VU £550, B67 VU £650, A807 VU £750, A810 £650, A710 £500. Tel: 01246 275479 Email: j.i.tipping@amserve.net (Aug/1)

EX DEMONSTRATION Klipsch speaker systems, KSB 2.1 £200, KG 3.5 £350, KG 4.5 £450, KG 5.5 £550. Heresy £650, all tested. Tel: Midland Radio Supplies on 0121 430 7817 or Email: guyholdsworth@onetel.net.uk (Oct/1)

VINTAGE WIRELESS COMPANY LONDON
Website: www.vintagewirelesslondon.co.uk
Buy-Sell-Exchange. Vintage wireless and classical audio. Repairs, spares, restoration, modification to all valve equipment. Quad II, Leaks etc, shipped worldwide, best prices, call us at 17 Bell Street, London, NW1 5BY. Tel: 020 7258 3448 Fax 020 7258 3449 Email: vwirelesslondon@aol.com (Oct/1)

VINYL, VINYL and only vinyl. Stock clearance, limited titles. Re-issues, some latest releases, all new, not second-hand. Abba to Who, jazz, soul, rock. Contact Tel: 01474 825014 or Email: clearance@activevinyl.com for listing (Aug/1)

SYSTEM SOUNDS flat? Lack of ambience? Upgrade to SuperStereo with Dynavector's Adp-2 processor, Hi-Fi+ Product of the Year Editor's Choice awards 2002, £845 direct from Dynavector. Details and reviews: Dynavector SuperStereo 01202 767873 or Email: dynavector@onetel.net.uk Web: <http://web.onetel.net.uk~dynavector> (Aug/1)

TOM TOM Audio - Specialists in Naim Audio, supply top condition pre-loved and ex-demo Naim equipment with full 12 month money back guarantee. Demonstration facilities. Can deliver. stock list at: www.tomtomaudio.com Call 07971 202 742 or 01727 893 928 or Email: tunes@tomtomaudio.com with requirements. Wanted: mint Naim gear, cash waiting, will collect (Aug/1)

WORTHING AUDIO True Sound Series Crossoverless monitors 96dB efficiency, single 8" driver, perfect for low powered tube (S.E.T.) and solid state. Dynaudio Crafts, immaculate, boxed, with Dynaudio stands £1250. Amphion Argon loudspeakers £599. Musica Collins loudspeakers by Bernard Thiel & Partners (German) £1000. Audionote AN-ESEC lacquered finish + stands £5000. (RRP £13,600). Tel: Worthing Audio 01903 212 133 or 07900 918 882 (Aug/1)

EAR PRODUCTS on permanent demonstration, from the wonderful 869 to the rest of the range. Kora Explora 60 watt hybrid £450. Dynaudio Contours 1.3's Mk2 £699. Restek Consens fully remote and balanced £1100. Restek Challenger £600. Omega speaker systems TSRIR £1199. H-Cat P12 £2499. Kora Equinox pre-amplifier MIM £995. Kora Hermes 96-192 valve DAC £1199. Tel: Worthing Audio 01903 212 133 or 07900 918 882 (Aug/1)

SILVER ARROW 4N-Pure flat silver foil air interconnects and speaker cables with Boccino phono plugs. H-CAT P12 Zero distortion pre amplifier from America on permanent dem. Tel: Worthing Audio 01903 212 133 or 07900 918 882 (Aug/1)

CASH PAID for Arcam, Audiolab, Copland, Cyrus, Linn, MF, Myryad, Naim, Quad and most quality Hi-Fi. Turntables also purchased. Collection arranged. Email: aphifi@aol.com or call Adrian on 01782 267233 Mobile: 07799 415123 (Aug/1)

classifieds ads order form

RATES - ALL ADVERTS MUST BE PRE-PAID

Maximum length per advert is 30 words, each additional word is 50p extra. Telephone numbers and E-mail addresses are treated as one word. Model numbers are treated as one word i.e. Quad 303 = two words. Please tick the box for the advert required

In a rush to get your advert published? Why not use our Instant Internet Advert to get on our website immediately. Only £15 per week (7 days)

Dealers must not advertise in the Private Classified section. Monthly consecutive insertions will be considered Trade advertising. The Publisher reserves the right to judge submissions

SPECIAL OFFER

Book a private or trade classified advert, and get one months *FREE internet advert

*FREE internet adverts are published three weeks AFTER the magazine has been published

| | | |
|---|---------------|--------------------------|
| Instant Internet Only Advert Private or Trade published immediately | £15 per week | <input type="checkbox"/> |
| Private magazine advert plus *FREE internet advert | £10 per month | <input type="checkbox"/> |
| Private magazine advert display black box plus *FREE internet advert | £15 per month | <input type="checkbox"/> |
| Trade magazine advert plus *FREE internet advert | £10 per month | <input type="checkbox"/> |
| Trade magazine advert display black box plus *FREE internet advert | £15 per month | <input type="checkbox"/> |
| Please tick here if you DO NOT WANT your FREE internet advert <input type="checkbox"/> | | |

Please write or type your advertisement copy in block capitals with one word per box.

Please continue on a separate sheet if necessary.

WE WILL ACCEPT PHOTOCOPIES OF THIS FORM

| | |
|----|----|
| 1 | 2 |
| 3 | 4 |
| 5 | 6 |
| 7 | 8 |
| 9 | 10 |
| 11 | 12 |
| 13 | 14 |
| 15 | 16 |
| 17 | 18 |
| 19 | 20 |
| 21 | 22 |
| 23 | 24 |
| 25 | 26 |
| 27 | 28 |
| 29 | 30 |

Name _____
 Address _____
 Post Code _____
 Daytime Tel: _____

Please debit my VISA/MASTER/SWITCH Card No. (Switch card issue No _____)

Expiry Date: _____ Cardholder Signature: _____

I enclose a cheque/postal order for £ _____ Made payable to: Audio Publishing Ltd.

Send in your private classified ads with our NEW Freepost service. No need for a stamp!

Send this form together with your payment in an envelope marked:

Hi-Fi World, FREEPOST LON3478, LONDON NW6 6YR



ADVERTISERS INDEX

| | |
|-------------------------------|----------------------|
| Affordable Valve | 20 |
| AV Lounge | 50 |
| Beauhorn | 50 |
| Billy Vee | 89,90,91 |
| Campaign Audio Design | 50 |
| Central Audio | 114 |
| Choice Hi-Fi | 86 |
| Classique Sounds | 119 |
| Connoisseur Audio | 112 |
| Custom Cable | 117 |
| Definitive Audio (Brighton) | 20 |
| Definitive Audio (Nottingham) | 20 |
| Diverse Vinyl | 121 |
| Emporium (The) | 120 |
| Global Hi-Fi | 122 |
| Heathcote Audio | 117 |
| Heatherdale Audio | 115 |
| Henley Designs | 6,76 |
| Herts.Record Fair | 115 |
| Hi-Fi Trading Company | 108,109 |
| Ian Harrison | 115 |
| Jem Distribution | 107 |
| Mantra Audio | 76 |
| Matrix | 118 |
| Midland Audio Exchange | 110 |
| Mission | BC |
| Musical Fidelity | 12 |
| Musical Images | 111 |
| Oxford Audio Consultants | 114 |
| Retro Reproduction | 107 |
| Sevenoaks | 27,28,29,30,31,32,33 |
| Signals | 121 |
| Sound of Music (Crewe) | 119 |
| Soundcraft | 115 |
| Sounds Expensive | 120 |
| Soundstage | 111 |
| The Chord Company | 38 |
| The Listening Rooms | 122 |
| The Right Note | 38 |
| Tube Shop | 76 |
| V'Audio | 112 |
| Vintage Valve Tech. Fair | 112 |
| Walrus Systems | 1FC |
| Williams Hart | 111 |
| X-Electrical | 119 |

DIY SUPPLEMENT NO. 74

| | |
|------------------|-----|
| Audio Xpress | 96 |
| Chelmer Valve | 96 |
| Falcon Acoustics | 96 |
| Langrex Supplies | 104 |
| Watford Valves | 104 |
| White Noise | 96 |
| Audiolab Leeds | 106 |

PRIVATE & TRADE CLASSIFIED ADVERTS COPY DEADLINES

SEPTEMBER 2003 ISSUE - WEDNESDAY 9TH JULY 2003
 OCTOBER 2003 ISSUE - WEDNESDAY 6TH AUGUST 2003



▲ **Opera SuperPavarotti MkII £1150/pair**

Opera's loudspeakers constantly delight both the ear and the eye. This latest floorstander uses high quality drive units to deliver a high class sound from a beautifully crafted, elegant hardwood cabinet.



▲ **Triangle Magellan £20000/pair**

The Magellan is the new statement loudspeaker from Triangle. Five years of development have produced a true high-end reference design whose performance simply astounds.



▲ **Unison Research Unico CD Player £1095**

This new player employs a valve amplification stage in combination with a CD-Rom mechanism and advanced microprocessor control for supreme performance.



▲ **Audio Analogue Maestro CD Player £1600**

Featuring 24bit/96kHz upsampling, high quality audiophile components and Impeccable build quality, the Maestro is a truly musical performer.

AUDIO ANALOGUE Soundpleasure

B. E. D. Equipment Supports And Accessories
Engineering

DIAPASON Elegant Hardwood Loudspeakers

final Stylish Electrostatics
www.final.nl

GRAAF Purist Valve Amplification

Select High End Cables

EMPELEKTRONIKS Clean Mains The Professional Way

MONRIO Solid State Electronics

Handcrafted Hardwood Loudspeakers

PATHOS The Unorthodox Approach

TRIANGLE Loudspeakers That Love Music

UNISON RESEARCH For A Lifetime Of Musical Enjoyment

For more information on UKD products contact us or visit our website

23 Richings Way, Iver, Bucks, SL0 9DA, England
Tel: 01753 652 669 info@ukd.co.uk

www.ukd.co.uk

Delight your aural senses



Simple Perfect Sound

volare

MISSION

Tel: +44 (0) 1480 423700
www.mission.co.uk

Floor stands not supplied with bookshelf speakers.