

Hi-Fi
WORLD

Hi-Fi

Hi-Fi

WORLD

£2000
PHONE-IN
COMPETITION!

JULY 1999 £2.60

For the love of music

RIBBON MARVELS

ELAC
Jet 310i
'speakers



TOP CD PLAYERS

£600-£800 group test

ARCAM DIGITAL TUNER

Digital or VHF/FM?

DIY Supplement No46
FREE inside this issue

DENON

Alpha Processing



POWER

DISPLAY



NEW!

BUYING GUIDE

VERDICTS ON MORE THAN 1000 COMPONENTS

World Radio History



WORLD'S BEST AMPLIFIER UNDER £1,000?



MVL INTEGRAL A2

FEATURES

- **GREATER CLARITY AND REALISM** achieved through patented circuitry and extremely low distortion. All instruments and voices sound real and whatever warmth or coldness was originally recorded is revealed.
- **3 DIMENSIONAL SOUND STAGE** brings every performance into the room.
- **CONSISTENT SOUND QUALITY** regardless of volume quality remains constant, whether at 0.5 Watt or at maximum rated output.
- **CONSTANT CONTROL** speaker drivers are both pushed and pulled, never allowed to float, minimising back EMF effect.
- **EASY COMPONENT MATCHING** due to high tolerance to source components, leads, speaker impedance and sensitivity.
- **NO 'BURN IN' OR WARM UP REQUIRED** sound is correct from first turn on, with no degradation of sound for the life of the unit.
- **5 YEAR WARRANTY** provided free of charge.
- **100 Watts per channel RMS** (8 ohms, both channels driven).
- **SS 2 FREQUENCY CONTROL.** Improves speaker performance by adjustable matching of frequency response.
- **SS 3 PHONO STAGE.** Improves sound quality from Vinyl whilst reducing surface noise and rumble.
- **NINE LINE INPUTS.** Five record outputs. (All switchable)

"If you're after a genuinely transparent, natural and effortless performer, the A2+ is currently at the top of the pile."

JON MARKS, HI-FI WORLD

INTEGRAL A2

WORLD VERDICT



An excellent performer with any music. At present, it would be hard to imagine the A2 being beaten at the price.

HI-FI WORLD MAY 1999

INTEGRAL A2+

WORLD VERDICT



Seamless, natural and very open, the A2+ sets the pace at the price.

HI-FI WORLD JUNE 1999



PLUS A RANGE OF OPTIONAL FEATURES NOT AVAILABLE ON ANY OTHER AMPLIFIER

SS OPTION PACK

- **SS 1 TAPE** Eliminates tape hiss on analogue cassette/tape whilst increasing frequency range.
- **SS 5 CD** Enhances playback quality of CD by removing 'digital edge' yet retaining original attack.
- **SS 6 CD** Enhances playback from and recording to CD. Improves recordings, particularly from vinyl records.
- **SS 7 MINIDISC** Improves quality of record / playback on MD from all sources.
- **SS 8 FM** Improves quality of FM / AM receivers.
- **SS 10 DAB** Improves quality of Digital Radio.
- **SS 13 NICAM** Improves quality of NICAM receivers.
- **SS 15 DAT** Improves quality of record / playback on DAT.

MVL A2: £895 inc. VAT Option Pack: £354 inc. VAT. For more information ring 01953 850800

MVL

MVL Technology Limited, Northfield Mill, Wymondham, Norfolk NR18 0DF
Tel: +44 (0) 1953 850800 Fax: +44 (0) 1953 851022

Sound Sentinel® manufactured under licence from Sound Sentinel Systems. Sound Sentinel® is a registered trade mark.

World Radio History



If you've been holding your breath for the arrival of domestic DAB receivers, you would have gone blue in the face three or four years ago. Finally, though, the long wait is over as this month we clap ears on the first commercially-available DAB receiver, Arcam's Alpha 10 DRT.

The question on everyone's lips is, will Digital Audio Broadcasting be a sonically viable replacement for FM in the long term? Preliminary listening sessions have suggested that the system is off to a fair start in spite of DAB chopping out quite a lot of the audio data to squeeze it onto the airwaves and that it's a digital technology still in its infancy.

As is the case with all new ideas, DAB doesn't come cheap. Until manufacture is scaled up, the cost of the specialist receiver chip sets will remain high, with components such as the 10 DRT selling for around £800. Not helping is the fact that DAB is only going to be adopted in Europe, so there won't be the usual extra impetus provided by the Japanese



JON MARKS

and American markets to speed the process up.

Whatever transpires with future radio broadcasting, there are going to be many non-digiphile tuner owners not looking forward to the day when analogue transmissions cease. If you've invested hundreds or even thousands of pounds in a top-class tuner, having it turned into a museum piece by a network designed to improve in-car reception in mountainous regions isn't a happy prospect.

An older and more established source of music by numbers is, of course, Compact

Disc. To assess the state of the art at £600-£800 we rounded up five top performers including Alchemist's attractive Nexus and Denon's battleship DCD-1650AR, which is built along similar lines to the excellent DVD-5000 DVD player reviewed in March this year. It also features the company's 24-bit Alpha Processing which allowed the '5000 to achieve a superb sonic as well as measured performance.

One name welcomed back to the hi-fi fray in this issue is Nakamichi. After a long absence from the UK, this Japanese name, respected for its killer cassette decks, returns with fresh equipment including the RE-10 100watt receiver.

Last but by no means least, keeping up our commitment to that most aged of formats, the LP, we bring you a review of Project's gorgeous Classic turntable. Aimed at those who want a player that's not just another black box with an aluminium platter, this device combines a fetching Cherry veneer with bottle-green glass platter to great visual effect.

HOW WE TEST THE PRODUCTS

- *Hi-Fi World* has its own advanced test laboratory and acoustically treated listening room. No other hi-fi magazine has the benefit of such facilities.
- *Hi-Fi World* has a dedicated in-house team of experienced listeners, and uses selected freelance professionals. We review thoroughly by extensive auditioning, rather than by quick-fire group listening tests.
- *Hi-Fi World's* engineering team designs a wide range of products in-house. No other hi-fi magazine is so expert and dedicated.



WORLD VERDICT



OUTSTANDING - Superb sound, something we'd use ourselves.



GOOD - Has strong merit. Well worth an audition.



ADEQUATE - Mediocre in several areas. May be worth auditioning.



POOR - Seriously flawed. Not worth considering.

Contents



87... NAKAMICHI RE-10 RECEIVER



12... CD PLAYER GROUP TEST



58... ALESIS M1 ACTIVES

24... ARCAM ALPHA 10 DRT DAB TUNER



Reviews

Amplifiers

31... CYRUS aPA7 MONOBLOCKS

Cyrus take a step towards the high end with these £2000 zero-feedback muscle amps.

37... MUSICAL FIDELITY X-P100 AND X-AS100 PRE/POWER

Richard White enjoys MF's latest combo.

87... NAKAMICHI RE-10 RECEIVER

A tuner, pre-amp and 100watt power amp in one £400 box? Welcome back Nakamichi.

Compact Disc

12... £600-£800 CD PLAYER GROUP TEST

Five digital heavyweights fight it out for the top spot at £600-£800.

Loudspeakers

33... REL STRATA III SUBWOOFER

Small box, big bass is REL's recipe in the new Strata III active sub.

58... ALESIS M1 ACTIVES

These professional two-ways measure superbly, but how will they sound?

65... ELAC JET CL310i

ELAC's tiny two-ways match a folded-ribbon tweeter to a metal-cone mid/bass.

Vinyl

59... ORTOFON 510 MKII CARTRIDGE

If you're about to start out on the LP road, this £40 pick-up could be the first step.

83... PRO-JECT CLASSIC TURNTABLE

Pro-ject's Classic will set you back just £450.

Tuner

24... ARCAM ALPHA 10 DRT

Digital Audio Broadcasting is here at last! We put Arcam's Alpha 10 DRT to the test.

Cassette

39... DENON DRM-555

Noel Keywood wonders if the '555 continues the Denon tradition of capable cassette decks.

Features

41... THE GENESIS OF A BLUE HEAVEN

QED's Genesis Silver Spiral meets Nordost's Blue Heaven in a clash of 'speaker cables.

104... BITS AND PIECES

This month's topics are splendid support isolation and hi-fi cleanliness with accessories for the audiophile who has everything.

105... FALLING FLAT

If you thought Quad were the only major British manufacturer to attempt electrostatic loudspeakers, think again. Turn to page 23 and prepare to be surprised.

107... HI-FI WORLD SUPPLEMENT

This is where all the DIY action begins.

109... KIT NEWS

This month we pull the wraps off audiophile capacitors and Svetlana's 300B valve.

112... KLS12 LOUDSPEAKER

Kit builders on a budget, alert. Our new KLS12 stand mounter costs less than £200.

119... ELECTRIFYING

Jon Marks goes totally tubular with Western Electric's 300B valve.

121... BOOK REVIEW:

Dictionary Of Electronics, by SW & RS Amos.

123... DIY Q&A

Cool your fevered brow with some DIY advice from the professionals.

Regulars

7... NEWS

We track down the movers and shakers in the hi-fi scene.

11... NEXT ISSUE

Only 30 days stand between you and the next instalment of the HFV saga.

34... COMPETITION

Try your hand at this month's competition and you could win Rothwell's Indus pre-amp, Monsoon's MM-1000 panel loudspeakers, or a Teac Reference system and a pair of matching Tannoy Mercury m1 stand mounters.

42... READERS' LETTERS

Suffering from below-par performance in the stereo area? Fret not, World's wise men can put you back on the right course.

50... DIAL-A-DEALER

Money burning a hole in your pocket? Reach for the phone and put out that fire.

55, 93, 96... COLUMNS

The editorial team air their opinions on this thing called hi-fi.

62... SPECIALIST HI-FI DEALERS

No run-of-the-mill retailers, these audio outlets can offer you a guiding hand.

66... MEET YOUR MAKER

Nobody knows more about what goes on within those shiny black boxes.

67... HI-FI WORLD BUYING GUIDE

Putting a system together? First-time buyer or upgrading? You need to check out the hundreds of components in our brand new buying guide.

84... HI-FI WORLD LIBRARY

Where the printed word comes alive with DIY designs.

88... HI-FI WORLD KITS

If you think there's more to hi-fi than unboxing it and plugging it in, consider the kits here.

135... MEASURED PERFORMANCE

Noel Keywood peers into the innards of this month's reviewees in our test laboratory.

151... READERS' CLASSIFIEDS

Calling all bargain-hunters - it's that time again!

162... ADVERTISERS' INDEX

Music Reviews

97... ROCK AND POP

RECORD OF THE MONTH: Blur, 13

99... CLASSICAL

100... JAZZ

101... DANCE AND AMBIENT

RECORD OF THE MONTH: Seb Fontaine, Prototype



HI-FI WORLD

IMEX HOUSE,
THE PARK BUSINESS CENTRE,
KILBURN PARK ROAD, LON-
DON, NW6 5LF

WEB SITE

www.hi-fiworld.co.uk

MAIL ORDER

Tel: 0171-266 0461

(24 hour answerphone)

Subscriptions

See page 97 or our web site.

CONTACT NUMBERS

10am - 6pm

Editor:

Jon Marks

0171 625 8074

Email: edit@hi-fiworld.co.uk

Editorial Assistants

Richard White

Simon Pope

0171 328 8627

Fax: 0171 328 1844

Individual queries cannot be answered by telephone.

Contributors

David Price

Dominic Todd

Haden Boardman

Timothy Liu

Music Reviewers

Jon Clarke

Sara Davis

Stuart Lenz

Ian Nicolson

Design & Production

Editor

Fredrick Dittlau

Advertising Designer

Faiza Chunara

0 71-625 8033

Fax 0171 328 1844

Photography

David Noble

Sales and Marketing
Manager

Amanda Sweeney

0171-328 2213

Advertising Sales

Executive

Sarah Wrenn

0171 328 4892

Technical Manager

Nick Lucas

Tel/Fax: 0171-625 8032

wad@hi-fiworld.co.uk

Accounts

Michael Ogazi

0171 328 1711

Fax: 0171 328 1844

Credit Control Manager

Louise Palfrey

0171 328 1711

Publisher

Noel Keywood

Distributed by:
Comag Magazine Marketing,
Tavisstock Road,
West Drayton,
Middlesex UB7 7QE
Tel: 01895 444055

Printed by:

Southernprint, Dorset.

Tel: 01202 622226

All unsolicited submissions are made at the owner's risk. We accept no responsibility for such submissions, nor do we undertake to return them.

No material may be reproduced from this magazine without the publisher's written permission.
© Audio Publishing Ltd

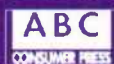

Natural Beauty

Loudspeakers from Vienna Acoustics

Turntables from Pro-ject

Music from Austria

Distribution by Henley

Your Hi-Fi system should be as pleasing to the eye as it is to the ear.
Spoil yourself with the latest affordable masterpieces from Austrian craftsmen



MAHLER



CLASSIC CHERRY



PERSPECTIVE



CLASSIC



BAOCH



HAYDN

Distributed in Great Britain by HENLEY DESIGNS LTD
The Old Coach House, The Street, Crowmarsh Gifford, Wallingford, Oxfordshire, OX10 8EH
TEL: 01491 834700 Fax: 01491 834702



SIX OF THE BEST

Recoton UK have announced that they are to be the sole distributors for six brands of loudspeakers in the UK from May 1st. The names in question are Advent, Acoustic Research, Heco, Jensen, Magnat and NHT.

Whilst on the subject, in June's Trade Winds we printed an article on the new Acoustic Research Phantom range, also handled by Recoton UK. Unfortunately, gremlins infiltrated the production system and we accompanied the piece with a picture of the new Magnat Needle loudspeakers. For those of you that want to see how the Phantoms really look, here they are!

Recoton UK
Lester Road,
Walkden,
Manchester M38 0PT
Tel: 0161 702 5000

ALBUMS ON THE INCREASE

1998's figures from the International Federation of the Phonographic Industry show that the British public bought 17 million more CD albums in that year than 1997. This makes Britons the world's third largest buyers of recorded music, constituting 7.4% of global sales after Japan's 16.9% and the USA's 34.1%.

In Europe as a whole, sales grew by 3% in value and 2% in number of discs sold, not the most impressive statistics compared to the USA, which experienced its largest surge in sales (11% and 7% respectively) for four years. Further East, things aren't so rosy. Apart from a rise in Japanese and Indian sales, the overall Asian market fell by a hefty 30% in value and 10% in numbers due to the economic crisis.

When it comes to market division by formats, CD takes the lion's share with 65% of all albums sold, a rise of 5% on 1997. Cassette is hanging doggedly in there with 34.7% while vinyl maintains its meagre toe-hold right at the bottom of the graph with 0.4%. Unfortunately for tape, sales dropped in every region, particularly in those such as Russia and South East Asia which buy the most pre-recordeds.



When it comes to singles, 82% of which are on CD, the so-called 'Candle In The Wind' effect (where Elton John's tribute to the Princess of Wales bumped up world-wide sales of singles) seems to have waned - there were decreases in all countries bar a few like Belgium and Sweden. Still, the UK bought 79.4million singles, not far off the whole of North America's total of 88.6million. By far the biggest singles buyers, though, are the Japanese with 144million discs.

As much as some pundits predict the demise of the record industry as we know it, it's worth remembering that its current trade is a not insubstantial US\$38.7billion. It will be interesting to see in future statistics what sort of impact the anticipated rise in Internet music downloads has on the existing music market.



TECHNO BASS

Musical Technology have taken the plunge into the sub-woofer market with two models, the PMS 45 and the Tercel.

The main differences between the two are in cabinet construction and drive units. The first has a 45litre, reflex-tuned enclosure of 18mm MDF which hosts MT's own 210mm aluminium cone. The second employs both 18mm and 25mm MDF panels in a 70litre enclosure loading a driver with a polystyrene and glass-fibre cone on a cast aluminium chassis.

The same 150watt amplifier/crossover (with adjustable low-pass filtering between 40Hz and 100Hz and switchable phase) is fitted to both subs. Connections come in balanced as well as unbalanced formats, and there's a dedicated Dolby 5.1 input which bypasses the crossover.

Prices are £499.95 for the PMS 45 and £699.95 for the Tercel (which can be clad in a range of finishes, Yew or Rosewood costing £50 extra).

Musical Technology
Unit 1,
Penllwyngwent Ind. Estate,
Saville Road,
Ogmore Vale,
Mid-Glamorgan CF32 7AX
Tel: 01656 842000



The world's finest sound systems don't come cheap
BUY NOW, BUT DON'T START PAYING UNTIL THE NEXT CENTURY!
but they do come easy at branches of KJ West One

Visit any branch of KJ West One and you'll discover a truly exciting range of the most desirable hi-fi and audio-visual equipment.

Stay awhile, and listen to some fabulous systems, like those featured above, alongside many others from the world's most highly regarded specialist manufacturers.

Relax in the knowledge that all of these superior products are so easy to own. We are always keen to accept older hi-fi equipment in part-exchange, and we offer a wide range of convenient payment options.

So, before simply buying hi-fi, think about investing in a real hi-fi system, at KJ West One.

FEATURED SYSTEMS

Audio Analogue Paganinni CD	£750	Musical Fidelity X-Ray CD	£800	Krell 250CD CD Player	£2490
Audio Analogue Puccini SE Amp	£635	Musical Fidelity X-P100 Pre	£800	Krell 300i Integrated Amp	£2495
Sonus Faber Signum Skrs	£1249	Musical Fidelity X-AS100 Pwr	£800	Martin Logan Aeries i Spkrs	£2199
		Wilson Benesch Orator Spkrs	£2900		
System Price	£2634	System Price	£5300	System Price	£7184
Minimum Deposit	£264	Minimum Deposit	£530	Minimum Deposit	£724
Maximum Balance	£2370	Maximum Balance	£4770	Maximum Balance	£6460

Defer Payments for 12 Months
then it's just £98.75 per month!

Defer Payments for 12 Months
then it's just £199 per month!

Defer Payments 12 for Months
then it's just £269 per month!

Deferred Payment Interest Rate 2.2% per month, 29.8% APR. Many other very competitive repayment plans available. Full details on request.

kj WestOne

IN PETERBOROUGH

THE HI-FI COMPANY

42 COWGATE PETERBOROUGH
TEL: (01733) 341755

kj WestOne

IN LONDON

THE WORLD'S FINEST HI-FI

26 NEW CAVENDISH STREET W1M 7LH
TEL: 0171 486 8262/3

kj WestOne

IN NORTHAMPTON

THE HI-FI SPECIALISTS

32 GOLD STREET NORTHAMPTON
TEL: (01604) 637871

NAIM THE PRICE

Naim Audio have received the Fast 50 Award for the South West from Deloitte & Touche in recognition of the fact that they have one of the fastest growing turnovers in the UK. What makes Naim different from most of the other recipients is that they have been in their particular line of business for 30 years, whilst most are smaller, more recent firms with more room for expansion and financial growth. Apparently Naim's success is mainly due to a strong record of international sales, which contribute to a third of its total income.



Naim Audio
Southampton Road,
Salisbury,
Wilts. SP1 2NL
Tel: 01722 332 266

SACD HITS JAPAN

Sony has officially launched the first Super Audio CD player, the SCD-1, in Japan. The player will be on sale only in that country from May 21, but it starts the ball rolling in the competition to find the successor to CD. According to Sony, the initial target for SACD is die-hard audiophiles forever seeking higher standards of sound quality. Obviously the main aim of the £2500 SCD-1 is to play SACD discs, but the player is also compatible with ordinary CDs.

Along with the player, a pre/power combination, a five-unit 'speaker and a Super Tweeter System were also launched at the same time. All have been specially designed to work with SACD and the extended frequency range it possesses.

Finally, as far as software is concerned, Polyhymnia International (formerly Philips' Classics Recordings Centre) are using Sony's Direct Stream Digital for albums with prominent Classical artists and orchestras. The emphasis on this genre implies that Sony and



Philips are targeting the more 'serious' listener in their SACD promotional drive.

Sony have told us that they expect SACD to arrive in the UK towards the end of the year. At this stage, however, it hasn't been decided if we'll be getting the SCD-1 or a different model.

Sony
The Heights,
Brooklands,
Surrey KT13 0XW
Tel: 01932 816000



EVEN MORE RICHER!

Julian Richer's audio empire recently expanded with the acquisition of the Mordant-Short brand, as mentioned in March's edition. Audio Partnership Ltd., who have already taken Cambridge Audio, Gale and Ariston amongst others under their wing, will deal in all Mordant-Short sales from now on.

The previous owner of Mordant-Short, Tannoy Goodmans International Ltd, have appointed Lockwood Audio to deal with spares and servicing of all M-S models purchased before AP's acquisition of the company.

Lockwood Audio
Imperial Studios,
Maxwell Road,
Borehamwood,
London WD6 1WE
Tel: 0181 207 4472

TRUE TRANSPARENCY

It would appear the development of NXT's flat-panel loudspeaker technology knows no bounds - the company has announced that they now have 88 licensees ranging from Swiss display manufacturers to German hi-fi companies. Aiding the spread of NXT is the new SoundVu loudspeaker, which apparently had to



be announced on the London Stock Exchange as it was deemed "price sensitive" by the powers that be.

NXT claim SoundVu is the world's first see-through loudspeaker. Products incorporating the transparent transducer won't be available for at least 18 months, but expect to see an emphasis

on the development of television and computer screens that double up as loudspeakers. Other possible uses include cellular telephones and even windows.

New Transducers Ltd.,
37 Ixworth Place,
London SW3 3QH
Tel: 0171 343 5050
e-mail: info@nxtsound.com
website: www.nxtsound.com

RELEASE *the* **FULL POTENTIAL** of YOUR SYSTEM

4TC Kimber Speaker Cable

Home Entertainment
EDITOR'S CHOICE

"...strong, deep, detailed bass, good imaging, clean treble and a feeling of authority and naturalness."
Home Entertainment, March 1998.

"...this cable is clearly capable of fine performance."
Hi-Fi Choice, No.180 1997.

STEP 2: THE CABLES

Once you have improved your mains cables, the next step is to choose interconnects, and then speaker cables. Discover for yourself the profound difference well designed cables make. With Kimber Cable your treasured records and CDs will come to life in your living room.

Call NOW for your free brochure quoting ref: AHW0799

PBJ Kimber Interconnect

Home Entertainment
EDITOR'S CHOICE

Hi-Fi Choice
BEST BUY

"...this wins in the sound per pound stakes."
Home Entertainment, August 1998.

Russ Andrews

MAIL ORDER *direct* 0800 373467 (UK ONLY)

Russ Andrews Accessories Ltd., Edge Bank House, Skelsmergh, Kendal, Cumbria LA8 9AS
Tel: +44 (0)1539 823247 Fax: +44 (0)1539 823317 E-mail: ahw0799@russandrews.com Website: www.russandrews.com

Your ship has come in!!



AUDIO ILLUSION

23 Langley Broom
Langley Berkshire SL3 8NB
TEL: (01753) 542761 : FAX: (01753) 772532
OPENING HOURS:
10am - 8pm Monday - Saturday (By appointment)

acurus

The Acurus ACT 3 is a breakthrough in surround sound processing preamplifiers.

Engineered and made in the USA its sonic performance and useful features are superior to processors selling for over £10,000.

At under £1,800 the ACT 3 is another very good reason Acurus is internationally acclaimed as the world's finest value in audio.

Performance:

DTS®: MPEG®: Dolby Digital®:
Dolby Prologic®: DSP Music Modes:
Custom Algorithms: DC Coupled Outputs:
Discrete Class A Output Stage:
20 Bit D/A Converters for all Channels

Features: Too many to list for the space left!!

FOR FURTHER INFORMATION OR YOUR NEAREST STOCKIST PLEASE CONTACT - AUDIO ILLUSION

A RETURN TO FORM

The return of Nakamichi to the UK hi-fi scene (first revealed in our Bristol Show report, May 1999 issue) continues apace with their new DVD player, the DVD-10. Features include a Dolby Digital (AC-3) decoder and

on-screen 'speaker configuration. The laser pick-up employed is a "high-precision", twin-focus device modestly said to offer "unbelievably high-fidelity". The DVD-10 is in shops now and could be yours for £799.99.

BBG Distribution
Unit 3,
Barrat Way,
Tudor Road,
Harrow,
Middlesex HA3 5QS
Tel: 0181 863 9117



KILLER CURA

A new British hi-fi manufacturer has come out of the wood work. Cura have designed their three loudspeakers specifically for "hi-fi enthusiasts" on the basis of comments from listening panels drawn from the music industry, technical experts and the general public. The result is two floor standing models, the CA-21 and CA-30, and one bookshelf, the CA-10. The numbers represent the relevant cabinet volumes in litres.

The company aims to combine the best elements of British design and engineering with "competitive pricing". The CA-10 is £699, the CA-21 £1199 and the CA-30 (pictured) £1799.

Cura
Unit 11, Arrow Industrial Estate,
Eelmoor Road,
Farnborough



Hants. GU14 7QN
Tel: 01252 401401

MERAK-ULOUS CONCEPTION

Distributed by Absolute Analogue, these Rockport Technologies 'speakers are described as "the ultimate" two-ways. The cabinet is made from 54mm high-tensile, glass-reinforced resin to obliterate coloration. Although great looking, they may not be a favourite with the bank manager at £13995, or £21000 with the Sheritan bass module.



Absolute Analogue
PO Box 1532,
Fordingbridge,
Hants. SP6 1BU
Tel: 01425 654488

NEXT MONTH'S ISSUE

Here's a brief selection to whet your appetite:

STUDENT SYSTEMS

Looking forward to throwing parties with thumping tunes and warm cider? Need a good system to impress your fellow freshers? We highlight three set-ups from £250 to £500. Featured names include Technics, Tangent Acoustics, Cambridge Audio, Rotel and Pro-ject.

ACOUSTIC PRECISION FRI LOUDSPEAKER

The cabinet is made from polystyrene and there's only one drive unit bolted onto the front. Sound unusual? It is. Acoustic Precision have produced a tiny stand mounter free from the problems created by crossovers.

TEAC A-E2000 INTEGRATED AMP

This new £180 50wattter from TEAC incorporates a radical Unifactor power supply which promises to change budget amplifiers as we know them. Hype or reality? See next month's issue for a full explanation, review and technical tests.

Quint-Essential

Richard White and Simon Pope set off in search of the best CD player at £600-£800 with five favourites from Alchemist, Denon, Helios, Marantz and Musical Fidelity.

Why spend hundreds of pounds on a CD player when you can get one for under a ton (which is where some of them belong)? Answering this question is the principle reason for our group test this month; all of our selected players are priced between £600 and £800. Hardly pocket-money prices these, so what is it that this month's quintet has which warrants the extra expenditure? Conversely, what do they have that would satisfy the well-heeled audiophile to whom money is no object? As always, it cuts both ways.

According to some, CD itself will soon be fighting a rear-guard action against Super Audio CD and DVD-Audio, while the whole concept of 'buying a record' might soon come under attack by the computer and Internet revolution.

Well, maybe, maybe not. There is a lot of very serious CD software out there. Because of the medium's inherent cheapness, the back catalogues of famous labels are being re-issued on CD where they would never have been on vinyl. Arguably, there has never been a broader choice of what you want to hear. In any case, are music collectors everywhere willingly going to scrap their music collections, in some cases for the second time in 20 years?

Our five competitors this issue positively ooze confidence in CD as an ongoing format. In the absence of an entry from Aardvark Audio, first onto the rostrum is the attractive Nexus from Alchemist. Following swiftly behind is Japanese company Denon, with the gold DCD-1650AR.

Gallic brand Helios are aiming to spread a little sunshine with their Model 3. Also making its way to the blocks is Marantz's tasty CD-17 in non-tweaked form. Musical Fidelity's £800 X-Ray is our final contender. This aluminium lozenge has gathered many plaudits to its brushed-alloy bosom since its release a year ago. It's included as a bench mark for the group after its original review in February 1999.



Hooray! Not a black box with knobs on! Alchemist have spared no brushed alloy to give their Nexus a distinctive look with an eye-catching geometrical front panel. Buttons are, to say the least, discreet - just little gold blobs set out in triangular configurations. Actually, there are more functions on the front panel than is usual nowadays, including skip-search, programming and so on.

Pressing the Open Sesame button called forth perhaps not the sturdiest tray arrangement you'll ever come across. Hi-Fi World readers are not in the habit of resting mugs of tea on disc trays, let's hope, but this particular example certainly won't stand up to careless handling.

Air seems to be the main ingredient inside the Nexus. The mechanism with its PCB is bolted directly to the casework in front of a small PSU board and two transformers, one E/I (for the transport and control sections), one toroidal (for the audio stages, both digital and analogue). A 24-bit Burr-Brown DAC does the conversion work.

SOUND QUALITY

Searching for an all-round earful, I kicked off with a live recording of Benny Waters playing in quintet surroundings in Stockholm. This beautifully-recorded disc has, as I know from previous players, a very pleasing three-dimensionality and succeeds in capturing all the club ambience, even down to the 'Oh, the end of a solo, that means clap. . . ' tradition which has unhappily grown to epidemic proportions in the 20-odd years since these tracks were taped.

Waters' harmonically rich saxophone tone was reproduced with its full

warmth by the Alchemist at the expense of a little attack. Old-time sax men were rightly proud of the layers of overtone with which they enlivened the saxophone's naturally rather boring tone. It says something for the smoothness of the Nexus' presentation that the ebullient Mr Waters came out sounding a little reticent. This may have a little to do with the slight roll-off we measured in the Alchemist's treble.

Determined to look a little closer at this, I dug out BMG's Rameau ballet music disc, which has a touch of the dazzling, not to say glaring, about it in a bright player. Cotton wool at the ready, I was pleased to find that the Alchemist made rather civilized sense of it. Baroque re-creations can sometimes lean too much on the crisp side with the violins in particular developing a cutting edge you could shave with. Through the Nexus,

these audio nasties were properly woven into a more uniform texture.

Searching for something to stretch the bass end just a little further brought me to my store of organ records. It used to be the case that no hi-fi could call itself tested unless the 32ft. end of a cathedral organ had shaken the cabinets of old fridge-size loudspeakers. We

don't go in for such extravagant coal-bunker transducers any more but that doesn't mean that organ records are necessarily passé.

A restrained re-issue of Simon Preston at York Minster was sufficient to show that bass had by no means been left out of the Nexus equation. Indeed, without becoming mushy, the warmth and smoothness shown by this player generally were paying dividends in the nether regions.

Power alone is not enough, however - we need finesse as well. Although people's ideas on this subject may differ, I think I am pretty safe holding Haydn's 'Prussian' string quartets above the parapet. Once more the Alchemist proved itself a cultured and relaxed performer, although I was a little concerned that the sprightly enthusiasm of these performances had become a little staid. Refinement is all very well in its way, but when it starts to flatten out sound staging and sapping vitality there's a clue that you're overdoing it.

I can see the Nexus being something like mana from heaven for those who have acquired a



Alchemist Nexus £599

Denon DCD-1650AR £699.99

If you've been a World reader for a while, you're bound to have read of products described as having "battle-ship build". Well, by those standards the '1650 is the whole Pacific Fleet; for a £700 player it's massive at 12kgs' weight.

The Denon is equally convincing when it comes to the parts side. Under the lid are four Burr-Brown 1702 DACs working with Denon's proprietary Alpha Processing to produce a claimed 20-bit resolution and very low levels of distortion (which were confirmed by our measurements). Almost all of the electrolytic caps are expensive Silmic types, and there are separate potted transformers for digital and analogue sections. Icing on the cake (if you can call it that) is the "protein material" applied to the tray and its guides to reduce vibrational problems. Digital connections amount to optical and co-axial; analogue is carried via phono sockets on the fixed and variable line outs.

Returning to the fascia and remote, you'll discover all the traditional functions (including Random and Repeat) as well as Intro, a natty five-second fade-in/out that pauses the CD when the volume hits zero.

SOUND QUALITY

Bomb-proof construction and tasty looks are all very well, but what does the Denon sound like? Rather good is the answer. Denon's gold range of equipment typically has a refined presentation; sure enough, the '1650AR delivered just this. With Miles Davis, a weighty and very smooth sound emanated from the Magneplanar SMGas, filling the room with the smoky atmosphere of the venue. This last was portrayed with an open airiness that created plenty of space between the various instruments in a sound stage where depth and width were up with the best at the price.

Keeping in 'gold' character was a bottom-end where a hint of warmth mixed happily with speed and control, while the treble had Denon's stamp of sweetness allied to a touch of roll-off (again mirrored in our measurements). This recipe yields very polished, clean results

sound staging, for example wasn't stretched too wide but was deep and naturally proportioned.

Apart from its slight bias towards the warm side of neutral, the

DCD-1650's tonal balance was near perfect. Strings were sumptuous - violins smooth as silk and double basses and cellos rich and vibrant. It was

good to note that the Denon doesn't sacrifice precision for refinement, as bass runs were deft and lively.

This player prefers string-based orchestral music to more up-beat and percussion-based pieces, such as the Rite Of Spring, for example. The Denon finds it hard to make anything sound particularly aggressive, even when it's meant to be. Barbarism isn't in its musical vocabulary.

With Madonna's 'Frozen' the Denon showed it was just as comfortable with commercial CDs as it was with Jazz and Classical. If anything, its civilised character took the roughest edges off recordings

and covered up some of their minor blemishes. Vocals were solidly-located ahead of the intricate electronic percussion. The Denon actually gave the best reading of this track that I've heard for quite a while, as most CDs at

£600-plus have too hard or bright a presentation to make this highly-processed album sound decent.

Listening to the DCD-1650AR is like visiting your favourite restaurant - the atmosphere is tasteful and you know you're going to get a high standard on all three courses. The Denon does a great job with any music, but seems to be marginally more at home with lush Classical fare than in-yer-face Rock. Although some could find it a little too rich for their blood, it stakes a strong claim for itself and is a very fine performer.



that are easy on the ear even if they don't always dig out 100% of the detail in a recording.

In terms of the Miles Davis album, what the above added up to sonically was a firm, precise drum kit (that propelled the tracks along with gusto), brushes on the snare skin in 'Blue On Green' very subtle yet clearly defined. So subtle were they, in fact, that I wondered if Mr. Davis was using an oxygen mask to get his breath back after a particularly gruelling solo. The DCD-1650AR handled this moody music more than commendably, with all the elegance and sophistication it requires.



Kleiber's Beethoven Ninth with the Vienna Philharmonic showed that the Denon was just as happy with Classical as it was with Jazz. The hammering triplets of the opening might have lacked some of their natural slam and power, but that's not to say the player lags in areas such as rhythm and dynamics. The energy the Denon would have used in banging out the opening notes was instead reserved for its handling of the rest of the instruments. Its rendition of a full orchestra was therefore more faithful than that you'd get from many other machines. The

This player is without doubt one of the best looking and well built at its price. It has a 10mm black acrylic fascia with a row of small silver buttons below its electric-blue display (warning: more than five feet away and you turn into Mr. Magoo!) Add to this a natty remote and you have all the makings of a very stylish and cool Gallic customer.

To find out if beauty was more than skin deep, I took a peek inside. DAC-wise the Helios relies on a Crystal Semiconductors CS4328 "with a theoretical resolution of 36 bits." Unfortunately for this machine, "theoretical" would appear to be the operative word as distortion at low levels was considerably higher than usual (over 60% at -90dB, where 20%-30% is more normal).

The transport is a Philips CDM 12.4, apparently modified to lighten the work load on the laser servo and reduce jitter levels. Outputs are a pair of RCAs and one coax for digital.

SOUND QUALITY

More than appropriately, Miles Davis' seminal *Kind Of Blue* was duly loaded into the drawer. Unlike many remasters of classic recordings, the team on this one have done a fine job retaining the life and breath of the music and performers, and the Helios responded with aplomb.

Sophistication was the order of the day as the familiar modal strains of Bill Evans' piano trickled in at the start of 'So What'. He was soon joined by the bass, drums and Mr Davis himself, the assembled band offering the Helios a chance to demonstrate its bass extension and solidity along with fine definition on cymbals.

With Jazz, this player showed itself to be as rich and cool as a wet night on the Champs Elysee, Davis' distinctive trumpet slipping smoothly in and out of the music without sounding raspy or harsh.

The entry of Coltrane's tenor confirmed, however, that the Helios has a clear but forward midrange. Combine the

textures of a Rioja Gran Reserva with a melted Belgian chocolate and you're starting to get somewhere near the combination of these traits.

In addition to all this fluidity I was pleased to

notice that the Helios maintained a sensible rhythmic grip on things - the piano accompaniment and drum kit held the track tightly together. Imaging was precise as well, but on detailing this French machine began to falter. If you're one for podium creaks and performers breathing asthmatically, then you might find the Model 3 a bit of a let-down. That's not to say the sound was muddy - it was actually very enjoyable - but it's neither neutral nor particularly transparent.

After the mellowness of Miles I gave myself a kick start with Carlos Kleiber and the Vienna Philharmonic opening Beethoven's Fifth. This is a powerful and rhythmic reading and the Helios matched it blow for blow with a commendable weight and scale. However, it opted to devote centre stage to the horns and timpani banging out the familiar triplets rather than the strings (which seemed to follow shortly afterwards, as if attempting to keep up).

With this recording the Helios sometimes showed itself to be processed in the treble - violins suffered occasionally from a tonal hardness and the oboes and clarinets had an unnatural sheen to them that

was slightly off-putting. There was a veiling of detail too, the customary strong vibrato phrasing of this orchestra not always apparent. That said, the Helios does handle Classical orchestral music very well in terms of enjoyability with its full-throated and robust presentation.

Swapping to studio-based fare with Madonna's 'Frozen' I was greeted by sweet sounds on the string intro but, as soon as the rest of the mix joined in,

things changed radically. The Helios revealed a forwardness that it had previously kept under its hat along with bass that was weighty but loose. The end product of these short-falls was muddle and confusion on climaxes. Because of the Helios' bias towards vocal lines (which were, admittedly, strong, clean and well positioned) and midrange instrumentation, the remainder of the mix suffered from being swamped.

The Model 3 is a bit of a recording snob. Whilst it copes more than adequately with Miles Davis and Uncle Ludwig, it turns its nose up to the commercial brashness of more Dance and

Rock-orientated CDs and responds with an over-blown sound. Smooth cabling helps, but the Helios lacks overall balance and would be difficult to accommodate in a system which has to deal with music of every genre.



Helios 3 £700

Hi-Fi MODIFICATION SERVICE

Your Hi-Fi
will only sound as good
as its weakest component

AMP

CD
PLAYER

SPEAKERS

DAC

Enhance your listening pleasure
with an upgrade from

AUDIOCOM

For Further Details Contact Audiocom

Tel. 01834 842803

e-mail: audiocom@scornet.co.uk

Fax. 01834 842804

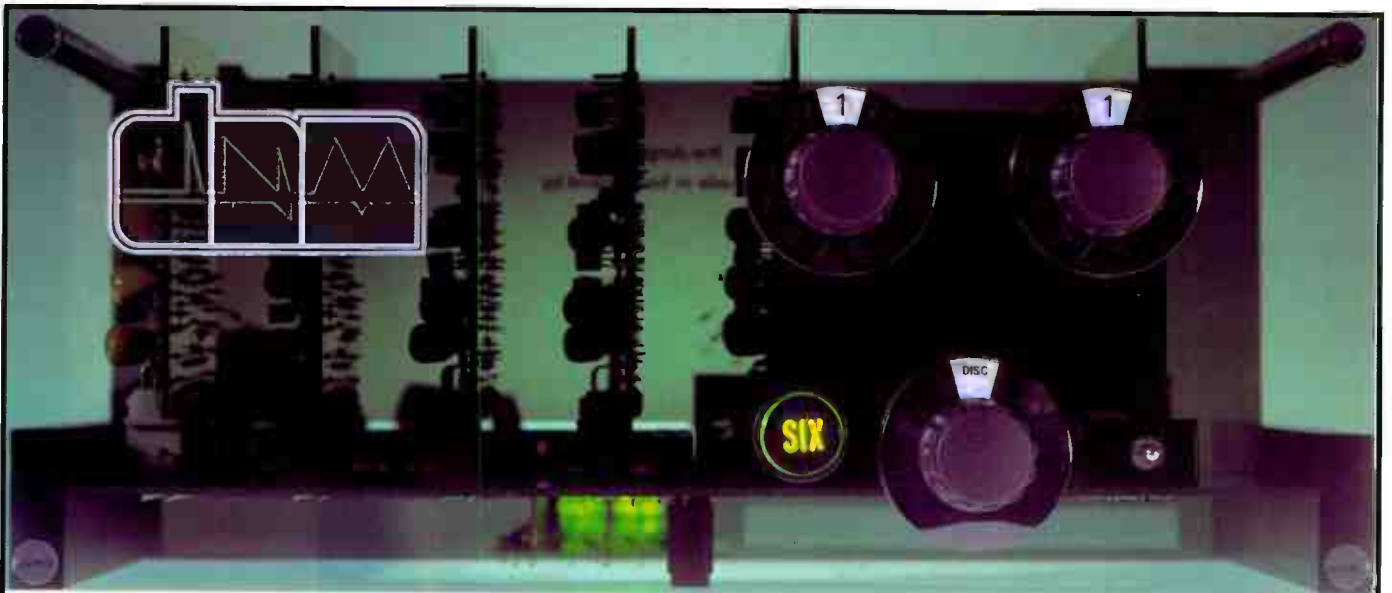

Thinking different...

Virtual Reality
Audio Systems Ltd.

P.O. Box 383
Brentwood CM14 4GB
Tel: 01277 227355
Fax: 01277 224103
email
info@virtual.demon.co.uk

Audio Scene
Chesterfield
01246 204005

Progressive Audio
Near Gillingham
01634 389004

Hazlemere Audio
High Wycombe
01494 865829

The Music Mill
Edinburgh
0131 555 3963

The Right Note
Bristol
01225 874728

Walrus Systems
London
0171 724 7224

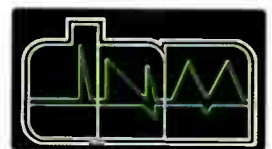

high-tech for music
British amplifiers handmade in Switzerland

Marantz have built a considerable following for their CD players over the years. This can be both an advantage and a handicap. The handicap is, of course, where do you go from here? On the other hand, the name is seen as a guarantee of a certain level of quality. At the budget end of the market, the succession of CD-63s and CD-67s, complete with SE and KI-Signature tags according to choice, has become something of a cult.

The CD-17 has had perhaps a less glamorous career but maintains an enviable reputation for solid virtue. As is customary for Marantz, this player is properly constructed with genuine weight and rigidity. Pressing the Open button brought forth a drawer every bit as thoroughly engineered as the rest.

This theme continues beneath the lid where

vector and another two phonos for daisy-chaining together Marantz components so they can be controlled from a single remote.

SOUND QUALITY

First in to bat were the Eberle Quartet playing Bridge's Novelletten. This Naim disc has some nice touches as regards recording balance. Arguably the microphones are a fraction close, but it makes a change to hear the bow really biting, especially on the 'cello. The Marantz passed on

chamber music, Diana Krall pulled out all the stops on 'I Miss You So'. Miss Krall's neat performer's trick of singing directly to the listener is helped along by her invariably close mic placement. This picks up every little regretful nuance and, provided your CD player is broad-minded enough to pass it all on, you are in a position to say that not only does love proverbially laugh at locksmiths, it also has something of a way with electronic recording media. Anyway,

to cut a long story short, this record sounded fine through the Marantz!

'Heartbreak Hotel' established itself in my sitting room and, had it not been for the nimble work of the excellent bass player, I might have ended up a touch blue.

To cheer myself up a bit and incidentally get a cross-bearing on clarity, I plugged in a version of Elgar's Chanson du Matin played, for a wonder, by a recorder quintet (well, it's the unexpected which opens your ears. . .!) This extraordinary track was delicately handled like the exquisite little gem it is, treble sweet and clear beyond doubt. Oddly enough, the combination of wind instruments with 19-century floridly gave a most convincing Mississippi caliope sound - with the addition of a leadman calling "Maaark Twain!", the illusion would have been complete!

At the risk of using two pieces too alike, I chose next a lengthy excerpt from Götterdämmerung. I was particularly impressed with the way in which it was possible to distinguish the quiet, reedy tones of the bass clarinet at a point where the double-basses were going at it hammer and tongs.

The CD-17 combines solid build with solid performance. Although not the most adrenal of machines, its unfussy ways and musical manners prove it's well able to keep up with some of the newer kids on the block. What's more, I can't see it wearing out in a hurry!



a single, low-profile E/I transformer feeds a large PCB. Elna audiophile capacitors dot the board along with Philips' TDA1547 'DAC 7' converter and a pair of copper-shielded Hyper-Dynamic Amp Modules built from surface-mount parts in the analogue output. The transport is, naturally, Philips' CDM1 2.3.

For those who feel dimming the display can improve sound quality, a four-step dimmer allows you to find the optimum brightness. Rear-panel socketry includes a pair of gold-plated RCAs for analogue, a lone coax for hooking up an external con-

these details almost without comment, unless it was contributing towards a warming richness on the QT.

Unlike many players, the CD-17 declined to make the top-end harsh in a bid to add any pseudo-sparkle. With the wealth of pizzicato passages, a 'slow' player would have been hard put to communicate the immediacy of the music, so the Marantz's rather courteous reading was not lacking horse-power when appropriate.

Moving on to a different sort of



Marantz CD-17 £799.90

In its relatively short life, the X series as a whole has already reached near-classic status thanks to its 'industrial chic' style. One of its higher profile members is the X-Ray 24-bit CD player, which we first reviewed in February of this year. Since then it's turned into one of our reviewing regulars as befits what is one of the benchmark machines at £800.

As for cosmetics, like the rest of the range the X-Ray plumps for the minimalist/functional approach. This gives the impression that the designers are saying four control buttons are all you require to play music. But while a first glance might have you wondering if the X-Ray comes with as many extras as a 1981 Lada, the inclusion of a large and fully-featured remote control puts paid to any such doubts.

Crammed inside the X-Ray (and there really is almost no space to spare) is a Sony mechanism bolted onto a steel plate which slides into the case. To the top rear of this is screwed a toroidal mains transformer and a small PCB sporting 5532 dual op amps and metal-film resistors. Ferrite rings on the analogue outputs (one pair), mains input and transformer secondary cables reduce RF. Out-board convertors can be connected via either coax or optical sockets.

SOUND QUALITY

When it comes to sound, the X-Ray is undoubtedly one of the most transparent players at its price. Miles Davis' Kind Of Blue found the X-Ray showing up the various musicians' 40-a-day breathing habits more clearly than many other machines. Confirmation came in the fil-

gree detailing on the drum kit - brushes on the snare hissed away realistically while cymbals shimmered brightly.

The MF continued its run of smooth, natural music-making on Coltrane's saxophone, whose breath-controlled vibrato was especially clear.

The last track on the CD, 'Flamenco Sketches', allowed the X-Ray to play its trump card - simplicity.



Bill Evans' piano was uncoloured and unprocessed, the MF refusing to get in the way of recordings, instead giving them the chance to speak for themselves.

On Classical pieces, this unaffected approach to reproduction worked particularly well with good, clean recordings like Kleiber's Beethoven Fifth. The rich and distinctive tone of the Vienna Philharmonic is usually attributed to the string section. However, the X-Ray proved that there were other strings (no pun intended) to the Vienna's bow.

Beethoven's delightful, airy, woodwind writing was brought to the fore in the second movement, the flutes floating above the orchestra and lacking nothing in melodic fluidity. The MF managed

to combine the brightness of high woodwind notes with a natural sweetness that is sadly lacking in a lot of other digital equipment.

Smooth and sweet is but one half of the story after speed and impact. Happily for the X-Ray, the opening blows of the Beethoven symphony had plenty of slam and attack. Timpani and double-basses had body and substance and, in spite of there not being sufficient extension to worry my glazing, what there was had control and grip.

Another tough disc the MF took in its stride was Madonna's Ray Of Light.

This CD suffers from a rather large dose of studio processing - it's in the nature of commercial recordings - but through the X-Ray it never sounded plastic or fake.

The string opening to 'Frozen' was tight and focused, Madonna's accompanying vocals well positioned without being too far forward in the mix. With the entrance of the percussion and bass, the player responded with a confidence that persuaded my toes to tap in time to the subtle break-beats that permeate the track.

When it comes to areas such as recreating a venue and the performers within it, the X-Ray's middle name once again happened to be "natural". There were none of the stretched left/right perspectives that normally go with two-dimensional sound staging - the bass and drums on 'Frozen' were well to the rear of the 'speakers.

As we discovered after our initial encounter with the X-Ray, its greatest assets are its clarity and the way it lets music flow. The sole slight foible (and I do mean slight) is a touch of boost at the top-end common to the X series, but this is subtle and merely adds to the midrange and treble detail. The only time CDs sound bad when played on the X-Ray is when they're badly recorded, and you can't say fairer than that.



It was a close finish, with all our reviewers scoring well, but the judges have made their decisions, which actually followed price quite closely. Of more than passing interest was the degree of smoothness favoured by most of the group. It seems that sonic 'courtesy' is held to be desirable in more up-market gear, so fair's fair; you pay more money, you generally take a smoother choice.

Where we differed from the manufacturers was the degree to which the player's polish helps or hinders the music - there were times when we were aching for just a smidgen more bite and edge from some of our contestants.

FIDELITY FIRST

It's worth noting that the Musical Fidelity X-Ray, our favourite by half a head and the most expensive entrant, showed no sign of over-smoothing at all. Next to the other players some might call it bright, but homing in on this aspect of its performance, we found that any brightness was down to the CD not the player - the X-Ray was simply passing on what was on the disc. This worthy attribute allied to an indestructible case and stylish looks won the X-Ray top spot.

PHOTO FINISH

Picking the overall leader of the pack wasn't too tough; grading the rest was much harder as they all had their strengths. Second place was eventually awarded to Marantz's CD-17, like the MF an £800 player. Although this machine does have the smooth top-end which characterises the group, the overall sensation would be better described as velvety rather than muffled.

Another common denominator of the group is commendably solid build (a sensible

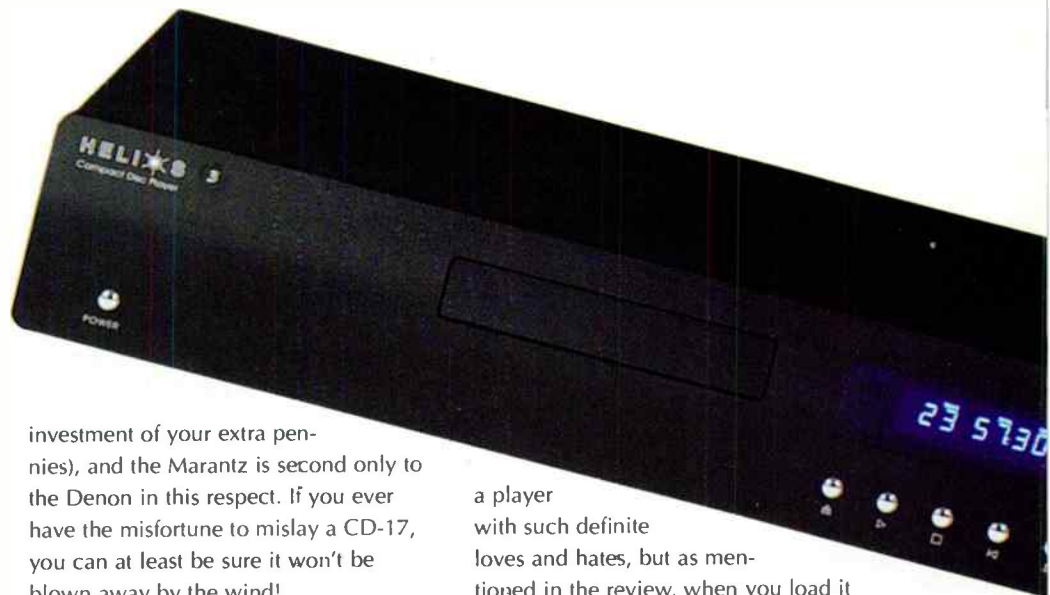

investment of your extra pennies), and the Marantz is second only to the Denon in this respect. If you ever have the misfortune to mislay a CD-17, you can at least be sure it won't be blown away by the wind!

GOLDEN EAR

Denon's £700 DCD-1650AR is a keen match for the Marantz in practically every respect, especially weight! The in-built smoothness sometimes got in the way of absolute transparency. To its credit, the Denon has a refinement and enjoyability to it when relaying more mellow compositions that can become addictive.

SMOOTHER THAN SMOOTH

Alchemists products are well known for their warm and relaxed sound. With the £600 Nexus, the cheapest in this month's line-up, the listening was never less than sumptuous, but perception of the fine detail was a little more difficult. Many will find this approach very much to their taste, but Rockers and fans of headbanging may not be so enthusiastic.

BRING ME SUNSHINE

For all its merits, the fortes of Helios' £700 Model 3 were too style-specific for a general recommendation. That's not to say there isn't a public for its style of reproduction, which favours acoustic recordings. It is unusual to find

a player with such definite loves and hates, but as mentioned in the review, when you load it with a suitable CD, the Helios can show many machines a thing or two.

Musical Fidelity
15/16 Olympic Trading Estate,
Fulton Road,
Wembley,
Middx. HA9 0TF
Tel: 0181 900 2866

Marantz
Padbury Oaks,
575-583 Bath Road,
Longford,
Middx. UB7 0EH
Tel: 01753 680868

Helios
Absolute Analogue,
PO Box 1532,
Fordingbridge,
Hants. SP6 1SB
Tel: 01425 654488

Denon
Hayden Laboratories,
Chiltern Hill,
Chalfont St Peter,
Bucks. SL9 9UG
Tel: 01753 888447

Alchemist
Henley Designs,
The Street,
Crowmarsh Gifford,
Wallingford,
Oxon. OX10 8EH
Tel: 01491 834700

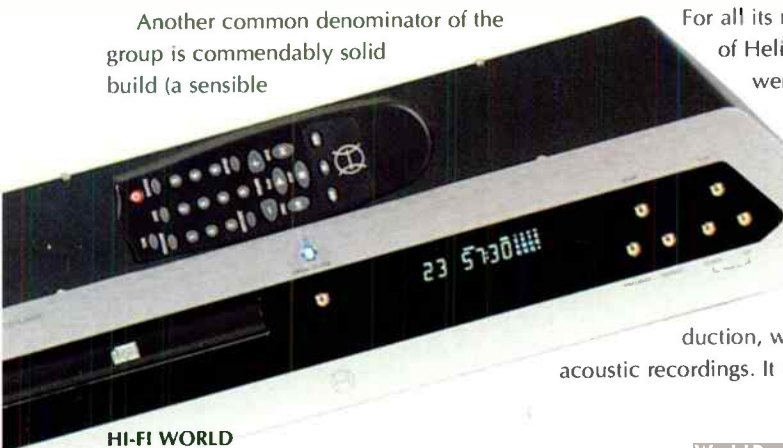

- ALPHASON
- ARCAM
- ATACAMA
- AUDIOQUEST
- AVI
- B&W
- BEYER
- BOSTON
- CABLE TALK
- CASTLE
- CHORD CO
- CREEK
- CYRUS
- DENON
- EPOS
- EXPOSURE
- FUJITSU
- GOLDRING
- IXOS
- JAMO
- JVC
- KEF
- KENWOOD
- LOEWE
- MARANTZ
- MERIDIAN
- MICHELL
- MISSION
- MONITOR AUDIO
- MUSICAL FIDELITY
- MYRYAD
- NAIM
- ON DIGITAL
- PANASONIC
- PARTINGTON
- PHILIPS
- PIONEER
- PROJECT
- QED
- REL
- ROKSAN
- ROTEL
- RUARK
- SELECO
- SENNHEISER
- SHEARNE AUDIO
- SONIC LINK
- SONY
- SOUND ORGANISATION
- SOUNDSTLYE
- STRAIGHTWIRE
- TAG MCLAREN
- TALK ELECTRONICS
- TANNOY
- TEAC
- TECHNICS
- THORENS
- VAN DEN HUL
- YAMAHA



digital experience



Pioneer DV717

£499.00



£5999.00

42" FUJITSU Plasma



YAMAHA RXV795

£549.00



The surround format of choice for DVD users, Dolby Digital (AC3) has five discreet digital channels plus a dedicated sub output giving amazing definition and thundering bass.



DTS is an alternative digital surround format to Dolby Digital. Sound quality is improved but the lack of available software is a problem. Needs a DTS compatible DVD Player, amp and disc.

Sony MDSJB920
only £249.00

Sony STRDB925
only £549.00

SONY MDSJE520



£139.00

Pioneer PDR555RW



£349.00

SAVE £130



the latest DVD titles in stock

You'll find a wide range of the latest region 2 DVDs in stock. Please note - not all titles available in all stores.

massive performance



Marantz CD63IIKi

- What Hi-Fi? Award Winner
- Bitstream Dac

Roksan Caspian CD

- Class Leading Sound
- Complete Caspian Range Available

Arcam Alpha 10

- Supertest Winner Jan 99
- Upgradeable to AC3/DTS surround

B&W 600 Series 2

- Nautilus Tweeter Technology
- Kevlar Mid/Bass Units



X-RAY CD

£799.95

XA1 AMP

£479.95

claim



van den Hul
D102

when you purchase both items together

where else can you **audition** these products?



Aegis One



£139.00

ROTEL New & boxed

RCD951



WHAT HI-FI?

£299.95

Claim

QED Qnect 2



TEAC

Reference 500 &

CASTLE
Clifton

£799.95

SAVE £150

Please note:

Advertisement valid until at least 7th July 1999 E&OE

SEVENOAKS

01732 459555

ABERDEEN

01224 587070

BEDFORD

01234 272779

BIRMINGHAM

0121 233 2977

BRIGHTON

01273 733338

BRISTOL

0117 974 3727

BROMLEY

0181 290 1988

CARDIFF

01222 472899

CARLISLE

01228 593775

CHELSEA

0171 352 9466

CHELTENHAM

01242 24 171

CROYDON

0181 665 1203

ESSEX Witham

01376 501733

EXETER

01392 218895

GUILDFORD

01483 536666

HOLBORN

0171 837 7540

HULL

01482 587171

IPSWICH

01473 286977

KINGSTON

0181 547 0717

LEEDS

0113 245 2775

MAIDSTONE

01622 686366

NEWCASTLE

0191 221 2320

NORTH LONDON

0181 886 2777

NORWICH

01603 767605

OXFORD

01865 241773

PETERBOROUGH

01733 397697

PLYMOUTH

01752 226011

PRESTON

01772 825777

READING

0118 959 7768

SHEFFIELD

0114 255 5861

SOUTHAMPTON

0 703 337770

SWANSEA

01792 465777

SWISS COTTAGE

0171 722 9777

TUNBRIDGE WELLS

01892 531543

WATFORD

01923 213533

WORCESTER

C1905 612929

MAIL ORDER

01732 458985

(EXCLUDES MARANTZ)



instant credit buy now pay later

Spread the cost of buying. Deferred finance available on the vast majority of products we stock. Written details on request. Ask in store for details.

- ACOUSTIC ENERGY
- ALPHASON
- ARCAM
- ATACAMA
- AUDIOQUEST
- AVI
- B&W
- BEYER
- BOSTON
- CABLE TALK
- CASTLE
- CHORD CO
- CREEK
- CYRUS
- DENON
- EPOS
- EXPOSURE
- FUJITSU
- GOLDRING
- IXOS
- JAMO
- JVC
- KEF
- KENWOOD
- LOEWE
- MARANTZ
- MERIDIAN
- MICHELL
- MISSION
- MONITOR AUDIO
- MUSICAL FIDELITY
- MYRYAD
- NAIM
- ON DIGITAL
- PANASONIC
- PARTINGTON
- PHILIPS
- PIONEER
- PROJECT
- QED
- REL
- ROKSAN
- ROTEL
- RUARK
- SELECO
- SENNHEISER
- SHEARNE AUDIO
- SONIC LINK
- SONY
- SOUND ORGANISATION
- SOUNDSTLYE
- STRAIGHTWIRE
- TAG MCLAREN
- TALK ELECTRONICS
- TANNOY
- TEAC
- TECHNICS
- THORENS
- VAN DEN HUL
- YAMAHA



outlets nationwide

At **Sevenoaks Sound & Vision** you'll find the widest range of quality products anywhere in the UK. Everything from the latest DVD players and Plasma Televisions to amazing special offers all with our outstanding service. From Aberdeen to Plymouth, we're great value nationwide.



Please note: Not all products are available at all outlets. Please check before travelling.

London & South East



SEVENOAKS
01732 459555
• 109-113 London Rd
9.00-5.30 Monday-Saturday



KINGSTON
0181 547 0717
• 43 Fife Road
9.30-5.30 Monday-Saturday
9.30-7.30 Late Night Thursday

BRIGHTON

01273 733338
• 57 Western Road, Hove
10.00-6.00 Monday-Saturday



NORTH LONDON

0181 886 2777
• 79-81 Chase Side, Southgate
10.00-6.00 Monday-Saturday

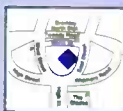

BROMLEY
0181 290 1988
• 39a East Street
9.00-6.00 Monday-Saturday



MAIDSTONE
01622 686366
• 96 Week Street
9.30-5.30 Monday-Saturday

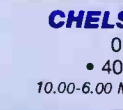

CHELSEA SW10
0171 352 9466
• 403 Kings Road
10.00-6.00 Monday-Saturday



SOUTHAMPTON
01703 337770
• 33 London Road
9.30-5.30 Monday-Saturday



CROYDON
0181 665 1203
• 369-373 London Road
9.30-5.30 Monday-Saturday
9.30-8.00 Thursday
11.00-4.00 Sunday



SWISS COTTAGE
0171 722 9777
• 21 Northways Parade
10.00-6.00 Monday-Saturday
12.00-4.00 Sunday



GUILDFORD
01483 536666
• 73b North Street
9.30-5.30 Monday-Saturday



TUNBRIDGE WELLS
01892 531543
• 28-30 St Johns Road
9.30-5.30 Monday-Saturday



HOLBORN
0171 837 7540
• 144-148 Grays Inn Rd
10.30-6.30 Monday-Friday
10.30-4.30 Saturday



WATFORD
01923 213533
• 478 St Albans Road
10.00-6.00 Monday-Friday
9.30-5.30 Saturday
11.00-4.00 Sunday

new outlets

Midlands & West



SWANSEA
01792 465777
• 24 Mansel Street.
10.00-6.00 Monday-Saturday
11.00-5.00 Sunday

London & South East



SWISS COTTAGE
0171 722 9777
• 21 Northways Parade
10.00-6.00 Monday-Saturday
12.00-4.00 Sunday

demonstration rooms in all stores

Everything we stock is available to audition in our dedicated hi fi and home cinema demonstration rooms.

The North



ABERDEEN
01224 587070
• 491 Union Street.
9.30-5.30 Monday-Saturday
9.30-7.30 Thursday



NEWCASTLE
0191 221 2320
• 19 Newgate Street
9.30-5.30 Monday-Saturday

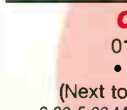

CARLISLE
01228 590775
• 3 Earls Lane
(Next to Bus Station)
9.30-5.00 Monday-Saturday



PRESTON
01772 825777
• 40-41 Lune Street
9.00-5.30 Monday-Saturday

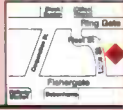

SHEFFIELD
0114 255 5861
• 635 Queens Rd, Heeley.
9.30-5.30 Monday-Saturday
10.00-4.00 Sunday



HULL
01482 587171
• 1 Savile Row, Savile St
9.30-5.30 Monday-Saturday



LEEDS
0113 245 2775
• 112 Vicar Lane
10.00-6.00 Monday-Friday
9.30-5.30 Saturday
12.00-5.00 Sunday



Midlands & West



BIRMINGHAM
0121 233 2977
• 12 Queensway Arches,
Livery Street
9.30-5.30 Monday-Saturday



EXETER
01392 218895
• 28 Cowick Street
9.30-5.30 Monday-Saturday



BRISTOL
0117 974 3727
• 92b White Ladies Road,
Clifton
9.30-5.30 Monday-Saturday



PLYMOUTH
01752 226011
• 107 Cornwall Street
9.00-5.30 Monday-Saturday
Late Night Thursday by
Appointment



SWANSEA
01792 465777
• 24 Mansel Street.
10.00-6.00 Monday-Saturday
11.00-5.00 Sunday



CARDIFF
01222 472899
• 104-106 Albany Road
9.30-5.30 Monday-Saturday



WORCESTER
01905 612929
• 2 Reindeer Court
9.30-5.30 Monday-Saturday



CHELTEMHAM
01242 241171
• 14 Pittville Street
9.30-5.30 Monday-Friday
9.00-5.30 Saturday



Midlands & East



BEDFORD
01234 272779
• 29-31 St Peters Street
10.00-6.00 Monday-Saturday



OXFORD
01865 241773
• 41 St Clements Street
10.00-6.00 Monday-Friday
9.30-5.30 Saturday

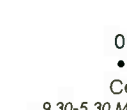

ESSEX
01376 501733
• 1 The Grove
Centre, Witham
9.30-5.30 Monday-Saturday



PETERBOROUGH
01733 897697
• 36-38 Park Road
9.15-5.15 Monday-Saturday

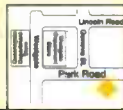

READING
0118 959 7768
• 3-4 Kings Walk
Shopping Centre
9.30-5.30 Monday-Saturday



IPSWICH
01473 286977
• 12-14 Dogs Head St.
9.30-5.30 Monday-Saturday



NORWICH
01603 767605
• 29/29a St Giles Street
9.30-5.30 Monday-Saturday



SEVENOAKS
01732 459555

ABERDEEN
01224 587070

BEDFORD
01234 272779

BIRMINGHAM
0121 233 2977

BRIGHTON
01273 733338

BRISTOL
0117 974 3727

BROMLEY
0181 290 1988

CARDIFF
01222 472899

CARLISLE
01228 590775

CHELSEA
0171 352 9466

CHELTEMHAM
01242 241171

CROYDON
0181 665 1203

ESSEX Witham
01376 501733

EXETER
01392 218895

GUILDFORD
01483 536666

HOLBORN
0171 837 7540

HULL
01482 587171

IPSWICH
01473 286977

KINGSTON
0181 547 0717

LEEDS
0113 245 2775

MAIDSTONE
01622 866366

NEWCASTLE
0191 221 2320

NORTH LONDON
0181 886 2777

NORWICH
01603 767605

OXFORD
01865 241773

PETERBOROUGH
01733 897697

PLYMOUTH
01752 226011

PRESTON
01772 825777

READING
0118 959 7768

SHEFFIELD
0114 255 5861

SOUTHAMPTON
01703 337770

SWANSEA
01792 465777

SWISS COTTAGE
0171 722 9777

TUNBRIDGE WELLS
01892 531543

WATFORD
01923 213533

WORCESTER
01905 612929

MAIL ORDER
01732 458985
(EXCLUDES MARANTZ)



two year warranty for **peace of mind**

As a member of BADA, all hi fi and home cinema separates come with a minimum two year warranty and ten day exchange.



Simon Pope and Noel Keywood get to grips with Digital Audio Broadcasting as the first commercial tuner, Arcam's Alpha 10 DRT, hits the High Street.

ABSOLUTELY DABULOUS?



We first mentioned DAB way back in January 1997's issue when Noel Keywood looked into what we could expect from next-generation radio, Digital Audio Broadcasting. Many of the points raised then are still very much relevant two years later, when we have a chipset from electronics company Roke Manor (to handle the digital processing) built into the world's first production DAB tuner from Arcam.

Initial information on DAB highlighted its freedom from RF interference (since it's digital, you either get reception or you don't!) and its ease of use. Couple this with the capability to squeeze more stations into the same bandwidth and simultaneous visual information, and apparently you have, in the words of the BBC, a

way of taking radio "into a new age just as CD has transformed the music industry".

In January '97, the only DAB units being made were in-car models, including the Grundig DCR-1000 at £2700 (and this wasn't even on offer to the general public!) Things have changed with the arrival of the Arcam, and now 66% of the UK population is within the DAB coverage area.

GOT IT COVERED?

When it comes to radio stations, all the usual BBC services are available on DAB, with the promise of new digital-only versions such as Radio 6 (BBC recordings of classic bands and performers) to woo Joe Public. Although the BBC blow their

trumpet louder than most, commercial stations are very much in on the act too. Whilst not all of them broadcast, many are running trials, as are local broadcasters.

As shown in the map on page 29, most of the coverage area is centred around towns and cities in the UK in addition to motorways and main roads. This gives an indication as to the future uses of DAB as hinted at by a BBC Research And Development document.

As is the case with the Radio Text with which most current FM tuners are equipped, DAB will allow text transmissions to receivers. For example, traffic information could be sent to in-car receivers and navigation systems in an attempt at traffic management on a

ultimate





From left to right: mains inlet, remote control bus, FM tuner input, two pairs of analogue outputs, Radio Data Interface On/Off with optical output, digital outputs (coax and optical) and the single aerial input.

national scale. News flashes, weather warnings and football results can, in theory, all be 'announced' during normal listening and there's even an option for warning the listener of a life-threatening situation (let's hope Boris Yeltsin keeps off the vodka!)

With an in-car FM receiver, if you wish to listen to the same national station as you travel across the country, you or your radio will have to re-tune to a different frequency as you go from one transmitter zone to another. There is no such hassle with DAB.

In spite of this again hinting at predominantly car use, companies are still working on domestic devices. As well as the Arcam tuner, Meridian and Cymbol are both soon to release components, while names like Roberts are working on portable models. And computer hardware firms have come up with DAB cards for computers. It appears that after three years of product speculation, the ball is finally rolling.

ALPHA ARRIVAL

Arcam have beaten all the other digital hopefuls to the line with the launch of their Alpha 10 DRT domestic tuner. After all the hype and on-paper specs, when it comes down to it, radio is an audio medium, so it's got to sound good. The proof of the pudding, as they say, is in the eating and, thanks to preliminary listens courtesy of Graham's Hi-Fi and a loan model from Arcam, we can now dispel all the rumours and reveal how DAB actually sounds.

First things first - to maximise sound quality you need optimum reception, which for most listeners will mean a Band 3 DAB outdoor aerial (the Alpha 10 DRT has a 50ohm input). If you're located in a strong reception area (near a transmitter or in the London area), the dipole supplied for indoor use or even a 75ohm outdoor FM aerial will still give a satisfactory reading on the Arcam's error counter.

HANDS-ON DAB

One of the main aims in the design of the Alpha 10 DRT was to make a tuner that could take a potentially very complex technology and turn it into something



The Arcam's error counter gives an idea of signal strength.

very easy to use. Switching the 10 DRT on and pressing the Search button will trigger the tuner into finding the different transmission blocks. The system is still settling down at the moment, but as a rule of thumb you'll find the BBC in one of the seven transmission blocks, commercial stations in another and local outfits in either. It's then simply a case of spinning the large rotary knob to the relevant station and pressing Store if you wish to preset it.

Two modes are available. One is the user mode which gives you the choice of displaying programme type, scrolling text, data rate (service data rate in k/bytes) and signal quality. The other is the engineering mode which when selected will show you transmitter details, error correction information and the raw RF signal strength.

If you need to raise the level a little for

background listening, there are five levels of compression that can be adjusted via the Menu button. These are, however, very subtle and do not have much of a detrimental effect on the sound.

SOUNDING OFF

The first thing you will notice once you're tuned in, all being well, is the inky black silence, especially on BBC Radio 3 or 4. These stations also add no studio compression to their digital signals, so realistic dynamics are more of a possibility (likewise, other BBC DAB stations have less compression than their VHF counterparts).

A lunchtime cappella choral concert on Radio 3 was just the right stuff for judging DAB's merits. There was no background noise (apart from passing cars outside the venue) and the voices were very clean and detailed. The clear reception highlighted the fact that the silences in this sort of music are just as important as the notes sung (in this instance by the Chamber Choir of Ireland as I discovered when I pressed Display once for text information).

A Mozart piano concerto performed by Kovacevich and the LSO was next, and it equalled the choral concert in terms of detail and dynamics. One small niggle was that, at high frequencies, violins could sound a bit thin, but the overall tonal balance was still good.

Radio 2 (MOR according to the Arcam) had quite a sweet treble and excellent separation. Sound stage depth was quite shallow, though. The human voice is always a good test with tuners, and so it was with the Arcam. An older female voice on Radio 4 was clear in so much as you could hear licking of lips and, I think, false teeth clacking! On the other hand, Terry Wogan's Irish brogue had raised an octave or so since I last heard it on the airwaves. This highlighted

statement



Full 4 way system · 5th generation Uni-Q® technology · 15" dual suspension LF driver
individually selected crossover components · 3 dedicated separate enclosures · 25mm
braced MDF construction · bespoke gold plated hardware · fine veneer and lacquer finish

Designed on computer · fine tuned by ear · hand built by music lovers

REFERENCE SERIES MODEL 109 THE MAIDSTONE



For details on KEF Reference Series please contact: KEF AUDIO (UK) LIMITED, DEPT HFW33, FREEPOST MAIL 333, ECCLESTON ROAD, TONIL, MAIDSTONE, KENT ME15 6BR. FREEPHONE 0800 7315620.
KEF and Uni-Q are registered trademarks. Uni-Q is protected under GB Patent 2,336,929. US Pat. Nos. 6,548,477 and 6,548,478. All other trademarks and patents pending.

WorldRadioHistory

www.kef.com



the Alpha 10 DRT's fast but rather light-weight bottom-end, which appeared to be playing a part in a lack of studio ambience as well.

GOING PRIVATE

While the Arcam did a good job with BBC broadcasts, it fared a little differently with commercial stations, especially those which had more studio compression. In contrast to all of the BBC stereo transmissions, which are at data rates of 192kbs (kilobits per second), some commercial alternatives such as Virgin measure in at 128kbs. Mind you, these are

still early days and data-rate trials are ongoing. Mono signals like the digital-only Parliament broadcasts (not, I would imagine, a deciding factor in purchasing a digital receiver unless you're an insomniac) come in at a pretty ropey 48kbs.

Virgin was actually fairly enjoyable, with some of the beefiest bass we came across on any digital station. Strangely, Classic FM, although put out at 192kbs, sounded very 'digital' in a clinical and dynamically squashed sort of way. Playing around with the Alpha 10's compression can help a little here, but it won't turn a sow's ear into a silk purse.

Arcam have succeeded in making DAB a piece of cake to get to grips with through the Alpha 10 DRT - it couldn't be simpler to use, and in this respect it actually has a slight edge over FM.

Gauged in isolation from a sonic viewpoint, the Arcam also allays fears that DAB was going to be another compressed digital disaster waiting to happen. It might err slightly to the cool and clinical side of accurate, but it steers well away from the nasties of early-days CD with its hard, two-dimensional and fatiguing presentation. The \$64million question is how does it stack up against FM, though.

DAB

FM



We decided to pit the Alpha 10 DRT head-to-head with Marantz's ST-17, reviewed in May's issue. This very able tuner can receive the same sort of text information as the Alpha 10 and sells for a price of £600. Having hooked the ST-17 up to a large outdoor VHF aerial, we switched between the two tuners on the same stations.

The results on less commercial stations, especially Radios 3 and 4, were surprising - the differences were minimal. In Classical concerts of solo piano or string quartets there was precious little in it, with DAB losing out only when it came to sheer vitality in a broadcast. With female voices on the BBC you could hardly tell analogue and digital apart, but male presenters lost some of their bass depth and power through DAB, sounding instead chesty and rather nasal.

The main differences occurred on broadcasts from Virgin, Radio 1 and Classic FM. With the Marantz, all of these had greater bass extension and a richer tonal balance than DAB.

The pluses to DAB's credit were excellent midrange detailing, particularly on guitars and vocals, which were as clear as the proverbial bell.

DAB has been a long time coming and it's received a fair amount of bad press from the hi-fi fraternity, which is understandable given that, on paper, it looks unpromising to say the least. This is, after all, a compressed system designed primarily for in-car use in mountainous regions of the Continent. Happily, in the flesh DAB would appear to have a rosier future.

Arcam's Alpha 10 DRT is only the first of what are sure to be many DAB receivers, and as CD has proved, digital technology needs time to mature - as chipsets become cheaper and better, DAB's sound will steadily improve. Still, it remains the case for the time being that anyone who has invested in a high-end analogue tuner like a Troughline or Naim NAT 01 won't be in a hurry to swap over.



WIRING FOR SOUND

Broadcasters crave an audience and know that a lot of radio listeners use portables at home or listen whilst driving. So DAB is vertically polarised to suit vertical whip aerials to reach the largest possible audience.

Digital radio doesn't get hissier as the radio signal gets weaker: it either works properly or not at all. Therefore, portables will always be free of hiss and crackles providing they can get enough signal. The aerial is important, because in poor reception areas there will be total silence from a DAB receiver - don't expect to hear a weak signal surrounded by hiss and static. Field strength varies greatly with height, which means a portable may work fine upstairs but not at all downstairs, especially if it has a short stub aerial.

BBC DAB transmitters work at 225MHz (VHF, Band 3). Since a wavelength at 225MHz is 1.3metres, a full-wave whip is about 95% of this length. In practice, most whips will be quarter-wave, or around 32cms. (13in.) A shorter aerial will be less efficient, unless it is tuned by a coil, so beware short aerials on portables or car radio set-ups; they may not be very effective.

Proper Band 3 DAB aerials are now becoming available from companies like Triax. Unlike conventional VHF/FM there's no need to discriminate between transmitters, so omni-directional, folded dipoles able to pick up signal from transmitters in any direction are used. At DAB frequencies they are compact and light. Trouble is, dipoles have little gain, so they are not suited to poor reception areas. A larger, multi-element array is needed under these conditions and it must be pointed straight at a transmitter, just like any TV or VHF/FM aerial.

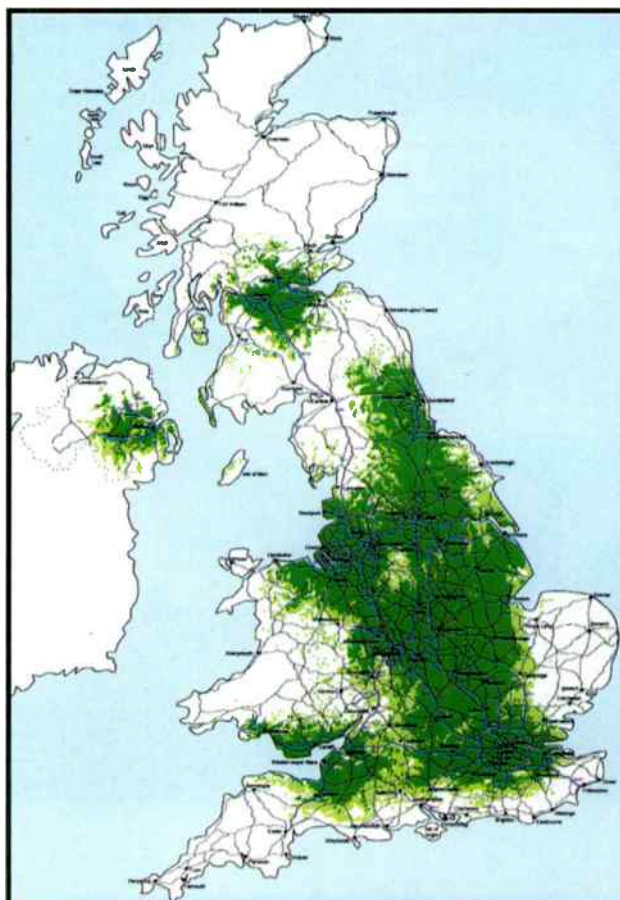

The BBC claim coverage of the UK population is currently at 66%, but as the map above shows, this is based around motorways, towns and cities. Anyone in Wales or remoter areas of Scotland will find their DAB receiver remains silent.



Triax's small DAB aerial.

Although DAB is digital, this doesn't influence aerial design. DAB aerials are much like VHF radio aerials but with

shorter elements arranged vertically rather than horizontally. Their characteristic impedance is meant to be 75ohms, so connection from a roof aerial down to a receiver is via conventional 75ohm coaxial cable. Like any aerial they should be mounted as high as possible to get a strong signal.

We used a large outdoor VHF/FM array, a DAB wire dipole supplied with the tuner, and a Triax DAB outdoor aluminium dipole.

The VHF/FM aerial faces south-east to Wrotham, the wrong way for DAB transmitters sited south (Crystal Palace) and north (Alexandra Palace). It gave enough signal

for BBC DAB stations but Virgin Radio and Sunrise occasionally dropped out for reasons unknown. Error-correction rates were low though (17-25).

The indoor wire seemed to suffer fading, with varying error-correction rates (20-500) and signal strength, but it worked most of the time.

The Triax rigid dipole was most effective, giving a very strong signal and negligible error rate (0-2) when used indoors. Mounted on a roof this simple aerial would be more than adequate.

Our tests confirm that DAB needs a simpler aerial than VHF/FM due to the evenness of coverage provided by a larger number of low-power transmitters, plus an RF signal requirement of around 100uV for optimum results. VHF/FM needs 10 times as much (1mV for full quieting).

These observations apply to north-west London, which is catered for by DAB. Large parts of the UK still lack coverage, as the map shows, and here reception is unlikely. To find out, it is best to speak to a local aerial installer. Triax do not supply direct and tell us the cost of an aerial will be included in a fitter's installation charge. Phone them for details of suppliers/installers. You could also

contact Antiference (tel: 01543 267160). It is still very much early days for DAB. Although the system looks good for portables, the basic digital chip set is so expensive that they won't be available for some years yet.

Triax UK Ltd
Thames Industrial Estate,
Marlow,
Bucks. SL7 1TB
Tel: 01628 488246
Fax: 01628 898268
(Not available direct - 'phone for installers)

TRIAx AERIALS

- 1) Omni-directional - DAB**
(Order code 100170)
- 2) Yagi five-element - DAB**
(Order Code 100171)



X-A RANGE.
MACHINED, MIL-SPEC ALUMINIUM
FRONT PANEL.

MILLED METAL KNOBS.

RUGGED, NON-RESONANT
METAL CASEWORK.

JUST IMAGINE HOW GOOD
THE ELECTRONICS MUST BE.

MUSICAL FIDELITY

INTEGRATED AMPS, PREAMPS, POWER AMPS, TUNER, AND CD PLAYER. FOR DETAILS OF YOUR NEAREST STOCKIST RING 0181 900 2866.

Less Is More

Jon Marks discovers Cyrus' latest aPA7 power amplifiers have taken a leaf out of the valve designer's handbook.

Finding the words "zero negative feedback" on valve amplification is easy.

Coming across this phrase on solid-state gear like Cyrus' aPA7 150watt monoblocs is much more of a rarity.

In measurement terms, most zero-feedback valve amps are what you might call anachronisms; they produce lots of distortion above milliwatt levels and have high output impedances, which means they're far more sensitive about their partnering loudspeakers than amps with feedback. However, not all distortion is immediately offensive to the ear, and as many who have sampled the sound of feedback-free amps can testify, there's something special about the presentation of a properly-engineered, single-ended or Class A push-pull rig built around extremely linear devices such as the 300B.

Which brings us back to the aPA7 monoblocs. Printed on the fascia of the traditional black Cyrus shoebox in small letters is "Zero feedback". However, as Cyrus' Design Brief document explains, when it comes to the internals of these amps, this actually means "Zero Global Feedback."

Feedback can be applied to a circuit in two different ways, global and local. The former indicates that feedback is taken from the output of an amplifier right back to its input, the latter that it is taken from the output of a given stage within an amplifier and returned to the input of that individual stage.

To find out what the above meant sonically, I partnered the Cyruses with a battery-powered DPA 50S as well as Mission's own aCA7 pre with its PSX-R power supply. The sources were a Pioneer DV-505 and a



clocked Kenwood DP-X9010 transport with a Pink Triangle Cordinal DAC and new 24-bit filter. Speakers were Magneplanar SMGs.

I started out by approaching these monoblocs with music from the lo-fi end of the spectrum in The Fall's latest, *The Marshall Suite*. From a reviewing point of view, the good thing about this album is that it has a midrange and treble coarseness which highlight any problems in an amp's rendition of these areas. Well, it was Round 1 to the aPA7s as future classics such as 'F-oldin' Money' and 'Early Life Of Crying Marshall' failed to wrinkle out any nasties on vocals or percussion. They also won Round 2 against 'Shake-Off' with its heavyweight synths and frenetic bassline punching meatily out of the Maggies thanks to the Cyruses' control and speed.

A slight change of course brought me to the Palladian Ensemble's *Trios For Four*. The aPA7s once more picked up plaudits for their way with this crisp but slightly bright recording. They pulled out of the hat a likeable tonal purity and naturalness which, together with their spacious portrayal of venues, made for a convincing version of events. Strong though they were here, hooked up to the DPA and the aCA7/PSX-R, they

couldn't equal the total lack of grain and resultant harmonic purity of Lavardin's *IT Reference* integrated.

Red Snapper's *Making Bones* album offered the Cyruses another chance to show off their grip in the lower octaves as drum machines and bass guitars both enjoyed plenty of punch and impact. Due to their freedom from confusion, the aPA7s had commendable focus to their imaging too, which meant vocals were always securely located between the Magneplanars while the aural fireworks went off behind them.

Cyrus have succeeded in squeezing a quart into a pint pot from the power point of view with the aPA7s - a genuine 150watts from such a small box is an achievement in itself. When it comes to sound quality, these monoblocs demonstrate the customary low-feedback prowess with sound staging and imaging without running into difficulties at low frequencies. Impressive as they are, however, I can't help thinking that £2000 per pair is a bit on the steep side - they didn't possess the sort of performance superiority over Musical Fidelity's X-A200s that you'd expect given the extra outlay. If you already have an all-Cyrus system, the aPA7s are an obvious upgrade, but the competition is keen●

Cyrus aPA7
£2000/pr

Cyrus Electronics
Stonehill,
Huntingdon,
Cams. PE18 6ED
Tel: 01480 451777

WORLD VERDICT



There's no shortage of clarity and control here, but the aPA7s don't come cheap.

Measured
Performance
see p135

ADVANTAGE



**" THE MOST AMAZING
NEW RANGE TO HIT
THESE SHORES FOR
DECADES."**

Single ended class A driver stage.
Fully balanced or single ended input.
Integral mains filtering and regulation.

Models available:

- * I200 Integrated Amplifier *
- * P1 Pre-Amplifier *
- * A300 Stereo Power Amplifier *
- * M300 Mono Block Amplifiers *
- * T1 CD Transport *
- * CD1 Integrated CD Player *
- * CDS S.O.A. Integrated CD Player *

**" GIVE YOURSELF AN ADVANTAGE - AN
ABSOLUTELY STUNNING RANGE"**

CALL FOR YOUR NEAREST DEALER TO:-

ZENTEK MUSIC LTD

Distributors of fine music products

PASSLABS • EGGLESTON WORKS • HALES •
CORULARE • BALANCED AUDIO TECHNOLOGY •
HOVLAND • WISDOM • REFERENCE 3A •

T: 01892 539595 F: 01892 616517

Crimson

Virtual Reality
P.O. Box 383 Brentwood Essex CM14 4GB
Tel: 01277 227355 Fax: 01277 224103 email: info@virtual.demon.co.uk

Vivante
Unit 4, 60 High Street
Hampton Wick, Surrey, KT1 4DB, England
Tel: +44 181 977 6600 Fax: +44 181 977 4445
E-Mail: vivantelondon@compuserve.com

**There's No Need To Be
'Traveling Miles' For
The Latest Cassandra
Wilson album!**

Can it get any better? The stunning
Cassandra Wilson put lyrics to Miles Davis' epic ballads!

Wilson's brand new release, *Travelling Miles* is now in stock as a 180g deluxe gatefold sleeve LP with special bonus track *Prancing (Francing)* or as a CD packaged in a deluxe slip case. Cassandra Wilson shot to audiophile fame following the release of her second album, the critically acclaimed *New Moon Daughter* which is also available on CD and double LP.

These two classics are available as:

Double Vinyl LP:	£20.95
CD:	£15.95

On The Record
The UK's leading bi-monthly audiophile news letter is free to *Hi-Fi World* readers. Simply give us a call and we'll be glad to forward the latest issue to you.

Back *to* Bassics

REL Acoustics have a new weapon in their subwoofer arsenal, the Strata III. Simon Pope bolts down the furniture and listens to those all-important low frequencies.

There is one word that causes argument and debate in the audio world like no other, the dreaded "b" word - "bass". Everyone wants it but few are satisfied with what they have. Should there be lots of it, even if it's a little loose at the seams? Or is it preferable to have quality not quantity? If you want that real floor-shaking, bone-crunching low-end which marries quality and quantity, the only thing to do is invest in a subwoofer like REL's Strata III.

Having built up a healthy respect for this company's subs in the wake of past models, I had high expectations of their new baby. The Strata III is (surprise, surprise) the 100watt replacement for the 60watt Strata II and so shares its dimensions. As far as connections are concerned, there's a single set of line-level inputs on a pair of phonos for use with pre-amps or integrateds with a Pre Out facility. Alternatively, you can use the two Neutrik Speakons, the first of which takes a high-level, unbalanced stereo signal from the main amp's speaker terminals. The second can accept a high-level, balanced single channel in a system where two subs would be operating to give stereo sub-bass.

Filling out the control section are two volume controls (for high and low inputs) and a new version of REL's 'ABC' filtering circuit. This is calibrated in 24 "musically correct" semitone increments on coarse and fine controls for tuning the frequency (between 22Hz and 96Hz) at which the subwoofer starts to kick in. Finally, a phase reversal switch is provided for optimal integration at the point where satellites meet sub.

After connecting the Strata III to a Musical Fidelity X-A1 integrated and a pair of very revealing but tiny Diapason Karis stand mounters, I launched straight into some mega-bass material. Grace Jones' 'Slave To The Rhythm' and Angelique Kidjo's 'Sound Of The Drums' both have massive extension (down to 25Hz at full level for the latter, according to our measurements). Keeping the filters at the lowest crossover point and the volume at three-quarters, I started the long process of finding the ideal crossover point after a spell with our FFT and measuring mic had pointed us in the direction of a net flat response.

There was no doubt the REL worked, and worked a treat. After the first minute of Angelique Kidjo's opening track, the bass drums kicked in with a vengeance. With proper filter tweaking, it all integrated seamlessly as well. The bass was powerful, fast, controlled and very extended considering the cabinet size.

On Grace Jones' 'Slave To The Rhythm', the strange 'elephant-herd'



rumblings between the drum beats accentuate the rhythm. The Strata III responded to frightening effect in a way that couldn't fail to bring a smile to the face of even the most hardened bass-freak.



As we've noted before, it's not just the bass that subs can improve - good ones are able to open out the midrange and sound staging too. For instance, on Stravinsky's *The Rite Of Spring* (performed by the Minnesota Orchestra under Eiji Oue) there was a superb, warehouse-like three-dimensionality to the presentation. In addition, every thump on the bass drum shook the listening seat with its power and accuracy, the Strata III never resorting to boom.

Hearing a competently-engineered subwoofer such as this can actually remind you of the first time you heard a decent system after years of mid-fi. The flexible filtering means you can alter the sound to taste, so it's a truly accommodating package. If you're considering investing in a subwoofer, you owe it to yourself to audition the Strata III●

REL Acoustics
North Road,
Bridgend Ind. Estate,
Bridgend,
Mid-Glamorgan
CF31 3TP
Tel: 01656 766093

WORLD VERDICT



A gifted 'little' sub with great power and grip.

Measured Performance
see p135

WIN A TEAC SYSTEM, ROTHWELL INDUS PRE AND TANNOY/MONSOON LOUDSPEAKERS WORTH £1400

Opportunity knocks yet again with a chance to win a Teac Reference system with Tannoy m1s, Rothwell's Indus passive pre and Monsoon MM-1000 panel loudspeakers and matching subwoofer.



Back in March 1999 we encountered a mini-separates system that took us all by surprise. The Teac Reference 300 series is a stylish, champagne-gold outfit that comprises an amplifier, CD player, tuner and cassette deck. After the sonic nasties produced by most Mini and Midi set-ups, sound-wise Teac have come up with a bit of a gem.

As Richard White mentioned in his review, Teac have paid a lot of attention to amplification in the '300. The treble and bass controls are subtle but effective in use and there's enough grunt on tap to ensure there's "no shortness of breath while playing demanding Dance music".

It's not just in the amp department that these little Teacs shine, either. Carefully designed to partner the amplifier, the CD

player possesses a "comfortable amount of bass slam" and a fine tonal balance. The RDS tuner has good stereo separation and clarity whilst the cassette deck, with its impress-the-neighbours horizontal drawer, has a wealth of facilities and decent sound to boot.

To complement Teac's prize we are adding a pair of the classic Tannoy Mercury m1 stand mounters. These small two-ways have been firm favourites here at Hi-Fi World since we first heard them back in June '98, and they have also recently picked up the title of EISA 1999 Loudspeaker Of The Year.

Part of the secret to the Tannoys' sonic solidity is the fact that their cabinets are made entirely from particle-board rather than the usual plastic mouldings. Jon Marks found listening to the



m1s an "uplifting and sobering" experience and was won over by their bass weight and transparency. He actually summed them up as being "the best at the price" and "capable of embarrassing many more expensive 'speakers'".

Next we have the exotically-named Indus pre-amp from Rothwell Electronics, the brainchild of ex-Ariston engineer Andrew Rothwell.

Dominic Todd gave it a listen in May's issue along with the company's Rubicon power amp.

For nigh-on eight years Mr. Rothwell has been producing passive pre-amps, all with stepped attenuators. To avoid the frequent problem of the ideal volume level being smack-bang between two settings, the Indus employs two 12-step attenuators, one for coarse adjustment and the other for fine. This combination yields a mammoth 132 settings that even the most finely-tuned ears couldn't grumble about.

The Indus earns its status in the passive pre-amp hall of fame not only for the above but also for its external and internal build quality. Behind the Cherrywood fascia there lie solid-core, silver-plated copper wiring and silver-plated switch contacts.

As far as sound is concerned, the Indus will win friends for its clarity, tonal purity and separation. Dominic Todd found that, in complex music passages, the Indus kept its cool with ease. He also noticed that it had a refreshingly high sound stage, something often lacking in the competition. He closed the review by commenting that "the resolution of fine detail and texture is superb, and gives more than just a glimpse of the high-end". Praise indeed.

In our quest to bring you something different in home audio, in May's issue we uncovered an unusual multi-media three-boxer. The Monsoon MM-1000 incorporates an active subwoofer paired with two panel satellite 'speakers. These small planar transducers measure just 4in. by 8in. and the sub has a volume of only 8.2 litres, but the sound they produce belies these dimensions. The MM-1000 can pump out window-rattling bass while the panels' transparency is unequalled by most multi-media (and a lot of budget hi-fi) loudspeakers.

Although they have been built with computer use in mind, one of the joys of the MM-1000 system is its transferability to the world of pure audio - in our review we found that the sound rivalled that of many hi-fi alternatives at the price. With a recording of Die Walkure conducted by Solti, we were taken aback by the bass extension coupled with a



deep sound stage and sharp imaging.

If you want the chance to bag one of these goodies, all you have to do is answer the questions below correctly and then complete the following verse in no more than 30 words. Stick the form, or a photocopy of it, on (not in) a sealed envelope or postcard and send it to the address below by July 6th. Don't forget to indicate your prize preference!

July Competition
Hi-Fi World Magazine,
Suite 29, Imex House,
Kilburn Park Road,
London NW6 5LF



COMPETITION ENTRY QUESTIONS

1) What type of drawer is used on the cassette deck of the Teac Reference 300 system?

- | | |
|--------------------------|------------------------|
| A. Mechanical horizontal | C. Mechanical vertical |
| B. Clockwork diagonal | D. Clockwork orange |

2) The Tannoy Mercury m1 was recently awarded Loudspeaker Of The Year by whom?

- | | |
|--------|---------|
| A. BSA | C. EISA |
| B. MSA | D. SAS |

3) How many volume settings does the Indus pre-amplifier have in total?

- | | |
|-------|--------|
| A. 24 | C. 120 |
| B. 72 | D. 132 |

4) What is the total volume of the Monsoon MM-1000 system's subwoofer?

- | | |
|---------------|------------------------|
| A. 3.5 litres | C. 10.7 litres |
| B. 8.2 litres | D. 5 pints and a curry |

5) What sort of loudspeakers are the MM-1000's satellites?

- | | |
|---------------------|--------------------|
| A. Horn | C. Panel |
| B. Omni-directional | D. Dual-concentric |

COMPETITION VERSE (obligatory)

Complete the following in less than 30 words

In the rainy Monsoon season there are many things to irk you

Re: Our Competition: how should you react?

Perhaps good luck will give your words the wingéd feet of Mercury

Or golden stacks of glory from Teac. . .

COMPETITION WINNERS

May's lucky winners were J. Rockett, Doncaster; J. Burke, Sleaford; K. Horner, London. Congratulations!



Who says vinyl's dead?

Stop Press: New bargain MVL Integrated Amp now on dem!

Amazon ARS Acoustica ATC Audio Physic Audio Synthesis Avantgarde Balanced Audio Technology CAT Clearaudio DNM EAR Yoshino Eggleston Works Electrocompaniet Final Graham Helios JM Lab Laverdin Living Voice Morch Musical Fidelity NotePerfect Nordost Ortofon Pass Labs Plinius Rega Stax Sugden Transfiguration Trilogy Van den Hul VPI Yamamura Churchill



Walrus Systems

11 New Quebec St, London W1 0171 724 7224

fax: 0171 724 4347
e-mail: mail@walrus.co.uk
Web: www.walrus.co.uk



WIRE & INSULATION

introduce **DESKADEL** Products

731/733 Ormskirk Road • Pemberton
Wigan • Lancashire • England • WN5 8AT
TEL/FAX. 44 - 1 - 942 887171

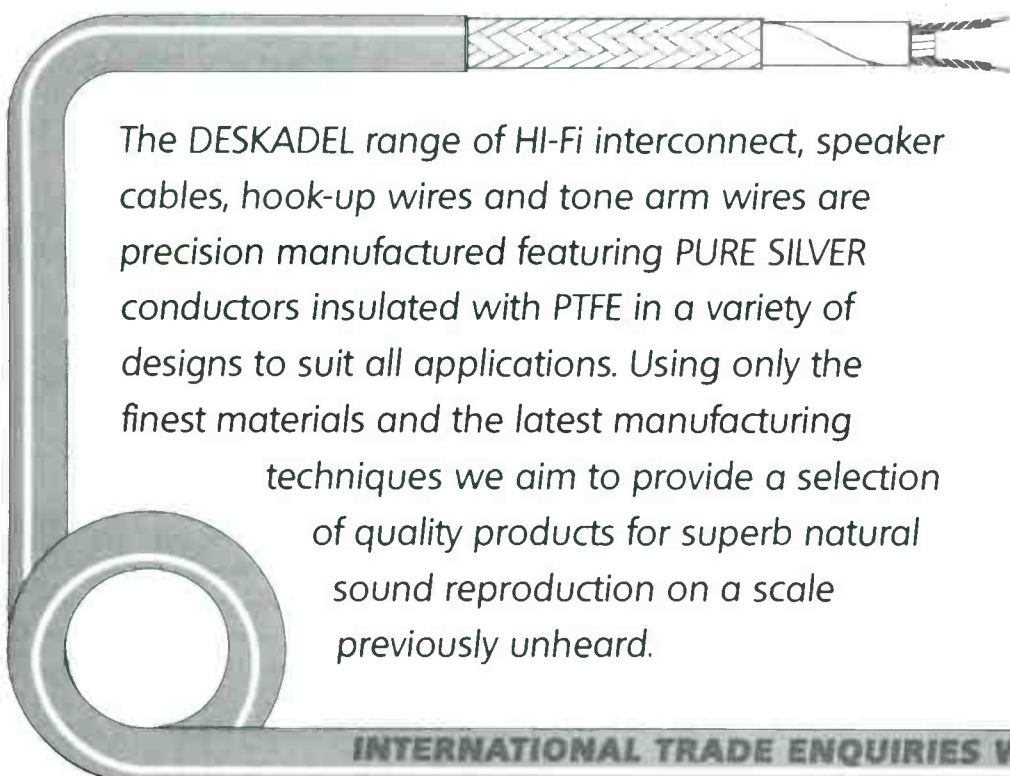

The **DESKADEL** range of Hi-Fi interconnect, speaker cables, hook-up wires and tone arm wires are precision manufactured featuring **PURE SILVER** conductors insulated with **PTFE** in a variety of designs to suit all applications. Using only the finest materials and the latest manufacturing techniques we aim to provide a selection of quality products for superb natural sound reproduction on a scale previously unheard.

DISTRIBUTORS

Switzerland
ARBELOS

Tel/Fax: 41-613616466

UK

AUDIO SYNTHESIS
Tel: 44-1-159224138
Fax: 44-1-159229701

Holland

ANALOGUE AUDIO PRODUCTS
Tel/Fax: 31-30-6044342

Belgium

DESKADEL INT BVBA
Tel: 32-3-8892231
Fax: 32-38609181

INTERNATIONAL TRADE ENQUIRIES WELCOME

X-Pedient

Richard White wonders whether Musical Fidelity's X-P100 pre-amp is a suitable consolation prize for non-Nu-Vista types.

In electronic essence, Musical Fidelity's X-P100 is a re-working of the circuit used for their acclaimed Nu-Vista pre-amp. Since the supply of Nuvistor miniature valves is unfortunately limited to say the least, MF kept back a spare set for every Nu-Vista they made and - not to put too fine a point on it - that's that. This is a little hard on those who were unable to shell out the required £1200 at the time. In the interests of avoiding a mass march on Wembley, the company have re-jigged the Nu-Vista circuit to use JFETs with a view to preserving the sonic signature with less scarce components. In the process, the 'Not Special Edition' nature of the beast has brought the price down to a needs-thinking-about but scarcely exorbitant £800.

You won't get far with a pair of passive loudspeakers and a pre, so the matching X-AS100 dual-mono power amplifier was born. Dual-mono in this case boils down to a pair of 100watt amps built into one box and powered from separate secondaries on the same transformer in the out-board PSU. This makes bridging a piece of cake with a push-button toggle on the back switching between 100watts mono at 60amps instead of two channels of 100watts at 35amps each.

Setting up is straightforward - the power-packs for X-AS and X-P can be tucked away discreetly, although you'll need to maintain access to the



On/Off switches. And immediately after switch-on, the pre-amp mutes for a few seconds, so don't turn the volume up high at the beginning!

Whilst in a volume-ish mood, I tried the digitally-recorded DGG Romeo and Juliet Overture. The famous duel sequence gave that crack in the ceiling something to think about with the dramatic bass drum bludgeoning its way through the soft furnishings. With the amount of headroom provided by 100watts into Klipsch Heresy horns, the MFs demonstrated admirable control with some of the potentially sharper 'digital' parts.

Having persuaded the divine Diana Krall to hop into my CD drawer, I was soon enjoying the refinements of 'dinner Jazz' par excellence. With the firm tone of the double-bass complementing the

blooming midrange of the guitar splendidly, it needed but Miss Krall's entrancing huskiness to run practically the whole audio bandwidth in one fell swoop, neither pre nor power amplifiers losing a single nuance along the way.

It was harpsichords to the fore with Trevor Pinnock's excellent version of the Goldberg Variations. If the upper treble is rough, harpsichord makes you feel all about it. And it wasn't! Let's be honest, the instrument was in vogue for scores of years; if it sounded horrifying, why or indeed how could it have been so popular? With the Musical Fidelity's internal MM phono stage, I was certain that 'the rest of it' was being provided with as clear a signal as could be desired.

Using the tuner input, I became keenly aware of the variations in recording quality on programmes like the 'New Releases' spot on In Tune. The game here was guessing which tracks would turn out to be full-price or budget; quality wasn't invariably highest on the dearest.

If you missed the Nu-Vista or are just wondering to what extent your current pre-amp may be letting the side down, the £800 X-P100 on its own deserves very careful scrutiny. It is well-designed, well made and well-behaved, with the added bonus of an MM phono stage. Considering the pre and power as a working unit, the combination of oomph, control and the usual Musical Fidelity clarity sounds like a fine way to invest £1600●

Musical Fidelity
X-P100 £800
Musical Fidelity
X-AS100 £800

Musical Fidelity
15/16 Olympic
Trading Est.,
Fulton Road,
Wembley,
Middx. HA9 0TF
Tel: 0181 900 2866



WORLD VERDICT



Clear, fast and flexible. 'Son of NuVista' is a substantial chip off the same block.

Measured
Performance
see p135

NEW PRODUCTS

from the designers of RINGMAT and STATMAT

The RINGMAT SUPPORT SYSTEM

A complete, modular system to help you achieve the perfect sound from your LPs

"The system is very effective... Surprise number one was the immediate beneficial effect on the bass... both the sound level and the accuracy were considerably improved... solo fiddle floated through the 'speakers with enchanting sweetness... the static-y clicks had disappeared. Records that generally track indifferently can be fine-tuned... this can make quite a difference..."

Richard White (Hi-Fi World, April 1999)

"The Ringmat Support System allows simple yet precise fine-tuning of stylus rake angle (SRA)...The improvement it makes to timing, articulation, transparency, fine detail and imaging is quite remarkable. Best of all, the music has a rhythmic snap and liveliness that made you want to dance... It's vital to appreciate that the changes go beyond hi-fi things like soundstaging, important as that is... An excellent product then, and very good value given the degree of improvements offered. ...Already I'm wondering how I ever listened to music without it."

Jimmy Hughes (Hi-Fi Choice, March 1999)

RINGMAT 330 MKII XLR £ 50.00

P&P £2.50 within UK, £5.50 outside UK

Full System with RINGMAT 330 MKII XLR £160.00

P&P £4.50 within UK, £10.00 outside UK

Separate prices are available for individual modules, platter inserts for Roksan Xerxes & Garrard 401 turntables, etc.

A MkII version of

STATMAT

for an even better sound from your CDs

STATMAT MKII £19.95

P&P £1.95 within UK, £5.05 outside UK

MkII replacements & exchanges (Post free) £ 12.50

RINGMAT and STATMAT have been extensively reviewed around the world. Extracts & copies of the reviews, brochures and price lists are available on request. Information on our products and other services can be found on our website: www.ringmat.com

Our products can be obtained through good hi-fi retailers. Also available on mail order with moneyback guarantee.

For further information, or to place an order, contact:
RINGMAT DEVELOPMENTS
PO BOX 200 BRENTWOOD ESSEX CM15 9FB GB
T: +44 (0)1277 200 210 F: +44 (0)1277 201 225
E-mail: enq-hfw@ringmat.com

The Advantage brand from Sweden is starting to make serious waves and re-writing the rules on performance and value for money.

Stunning...

from Advantage

All Advantage components – CD players, DACs, transports and amplifiers – offer outstanding results at amazing prices, around £2 – £4k.

The outright stars are the new **CDS** and the **A300 mono-block** amplifiers.

We would like to convince you with yards of meaningful techno twaddle but the literature is stark, to say the least. There is **clever circuitry** here but the designers clearly want you to listen, not read! We agree.

All we can say is that the amps have massive power supplies, most of the range operates in **balanced mode** and the CD players clamp the disc to limit flutter and hence servo action.

Oh, and they all look gorgeous, with black acrylic rounded fronts and piano black sides. Remote control operates throughout.

Customers say we make some of the best sounds they have ever heard, so you know we can do the same in your home.

Our advice will take account of your best components and guide you where change is needed, in stages you can afford.

You **AVOID EXPENSIVE MISTAKES**, enjoy music along the way and save money in the long run.

JUST LISTEN AND YOU'LL KNOW

The Right Note

Music in the home

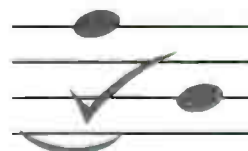

BATH

01225 874728

CD: ACCUPHASE, ADVANTAGE, AUDIO SYNTHESIS, BALANCED AUDIO TECHNOLOGY, dCS ELGAR, MERACUS, PASS, WADIA, XTC. **VINYL:** BASIS, CROWN JEWEL, DNM, GRAHAM, LEHMANN, MICHELL, STRATOSPHERE, SUMIKO BLUE POINT SPECIAL, TRANSFIGURATION. **AMPLIFIERS:** ACCUPHASE, ADVANTAGE, BALANCED AUDIO TECHNOLOGY, CAT, DNM, LUMLEY, NAGRA, PASS, SIEMEL, SIRIUS, SONNETEER, XTC. **LOUDSPEAKERS:** AUDIO PHYSIC, BKS, CHARIO, ETHOS, HALES, HARBETH, LUMLEY, MAGNEPLANAR, MIRAGE, NEAT, TOTEM. **TUNERS:** ACCUPHASE, FANFARE, MAGNUM DYNALAB. **CABLES:** ARGENTO, CHORD Co., DNM, NORDOST, YAMAMURA CHURCHILL ETC. **SUPPORTS:** DH CONES, STANDS UNIQUE, VIBRAPLANE ETC.

Tape Turnaround

Noel Keywood, Hi-Fi World's cassette king, samples Denon's latest budget contender, the DRM-555.

Here's an inexpensive way to keep your car player or portable fed with recordings. And Denon's budget DRM-555 is a tidy performer in the home too. At £150 it won't break the bank, but at the same time Denon have endowed it with a wide range of features, including auto-reverse.

You can have too much of a good thing, though - the '555 hovers close to the edge of hi-fi at times because it has so much packed into it. The result is compromised transport and head performance.

A large chunk of the budget has gone into an auto-reverse head that rotates so it will play in both directions, and record in reverse too. Set the deck into auto-reverse record and you will end up with half a song missing as the deck trundles down one side of the blank leader tape at the end of a cassette, reverses and does the same along the other side.

There are plenty more features where that came from: timer start, zero stop, switchable MPX for use when recording from tuners, variable headphone volume, balance and bias fine tune. The latter is used to tune the deck to suit different tapes. For example, TDK AR ferric tape needs bias turned down a bit to prevent it sounding dull, whilst TDK AD, also a ferric, needs it turned up to avoid brightness. Measurement showed the system managed a small change with metal tapes, enough to correct minor tonal imbalances in standard types like TDK MA.

Denon fit an effective record level display to the '555, with long bars that read from -40dB up to +10dB, 0dB being set to Dolby flux as usual. However, the head isn't really up to getting high levels onto metal tapes - it produces masses of low-frequency distortion at 0dB. Heavy basslines



from Angelique Kidjo's 'Wombo Lombo' sounded slurred and compressed on TDK MA metal tape; record levels are best kept low to avoid this. Vocals on the other hand were clear and percussion crisp.

With TDK AR I got the reverse. Basslines were taut and fast while treble sounded coarse and a little messy, with spitching on vocals. TDK AD high-coercivity ferric tape gave cleaner treble and was arguably the best compromise. Chrome tapes like TDK SA sounded a little blurred and soft all round. On all of these recordings I switched in Dolby B noise reduction because it suppresses hiss without causing too much sonic damage (the Denon has Dolby C in addition, but not Dolby S). The head rolls off fast below 50Hz, so there is no deep bass and subjectively the deck sounded a little light at times.

Pre-recorded tapes played well in both directions. There was no azimuth error, measurement showed. In use this meant the DRM-555 gave a clear, open sound without dullness, even with Dolby B switched in. Denon have been careful, as usual, to engineer in accurate

replay equalisation and make sure head adjustment is spot on.

One area of concern was the transport's speed stability. It was acceptable for most forms of music, adding flutter which dirtied the sound a tad, but no more than with any budget cassette deck. With more critical material like piano, though, the Denon started to show its weaknesses. Sustained notes sounded wiry and tonally impure. Just occasionally, sitting through Chopin's Opus 48, No1 I heard the deck judder and struggle to maintain its composure.

As you might have guessed, the DRM-555 is no Nakamichi Dragon, that's for sure. Still, for the money it does a neat enough job sonically and the provision of bias tuning means that, with a little experiment, the deck can be accurately matched to ferric tapes like TDK AD. To its credit, the Denon does a fine job of replaying most pre-recorded tapes, which also means it's great for putting together in-car and portable compilations. If facilities are as high on your list as sound quality, the '555 is worth investigation●

Denon DRM-555

£149.95

Hayden Laboratories
Chiltern Hill,
Chalfont St Peter,
Bucks. SL9 9UG
Tel: 01753 888447

WORLD VERDICT



Its slant towards features prevents the Denon taking the audio-ophile honours at the price.

Measured Performance see p135

Unique [you-neek]

..alone, exceptional, peerless, rare, single, sole, unmatched, one of a kind, unusual, unparalleled.



...and that's just the looks!

The Opal-25i SE Integrated Class 'A'

6 inputs incl phono of pure class A operation.

See it!.. Hear it!.. Want it!.. Own it?

For further details, Please contact:-

Sound Management Consultants Ltd



Tel/Fax 01709 579 010

Email:smcbsimpson@compuserve.com



ORGANICALLY CONCEIVED AMPLIFICATION
BECAUSE MUSIC IS ORGANIC

INGREDIENTS

Thermionic valves

High quality components

Remote power supplies

Care and attention to detail

No annoying artificial additives
or colourations

phone or fax 01931 712822

for a catalogue

PAUL HYNES DESIGNS P-J



SUGDEN audio products



Masterclass from the original CLASS A company

New products from Sugden

Wide-bandwidth d.c coupled high current class A power amplifier and matching pre-amplifier. Available as a stereo power amplifier you can upgrade or balanced monoblocks.

Handcrafted from the finest materials and components, Sugden guarantee to add an extra dimension to your listening pleasure. Our superior wide-bandwidth designs will increase the dynamic range and sonic accuracy of your audio system - without fatigue.

With over thirty years experience in design and manufacturing Sugden has become a reference for reviewers, musicians and audiophiles around the world. Prices start at £549.00 for the Audition series so why settle for anything less?

J. E. Sugden & Co Limited
Valley Works, Station Lane, Heckmondwike,
W. Yorks. WF16 0NF
Tel. 01924 404088 Fax 01924 410069
Email jesugden@compuserve.com

These Mortal Coils

Jon Marks and Simon Pope wire their loudspeakers with quality cables from QED and Nordost.



QED Genesis Silver Spiral £30/m

If you're after a 'speaker cable to slip unobtrusively under the carpet, the Genesis is unlikely to hit the spot. However, there are very good reasons for its chunky construction. Inside the PVC outer jacket is a twisted pair of conductors, each wrapped in an aluminium/mylar tape, their spacing maintained by two circular polyethylene 'fillers'. Making up the strands themselves are nine separate cores (each of 19 silver-plated OFC filaments) in a spiral arrangement around another central polyethylene filler.

Straight from fresh the Genesis proved to be something rather special. Dropping it in as a replacement for van den Hul's original Revelation hybrid, I was surprised to hear a performance very much on the same level, differing mainly in tonal balance with a leaner, brighter presentation.

With Eric Bibb travelling along its conductors, the QED demonstrated a crisp clarity and fast, controlled bass which actually made the vdH

appear a touch bloated in the bass and veiled in the treble.

The Genesis proved especially gifted when it came to retrieving low-level detail. One track which really gave the cable a chance to shine in this respect was Eric Bibb's 'Saucer And Cup'. EB's vocals and guitar (both of which possessed attractive tonal colour) were set within a convincing sound stage where individual images had a real three-dimensionality to them.

The Silver Spiral is a grower of a cable, its strengths (fine transparency, grip and speed) improving as it burns in. At £30/m, it isn't the world's most affordable cable, nor is it the most subtle with that eye-catching hose-pipe look, but it gives the competition at two or three times the money a very tough time.

QED
Ridgeway House,
Ridgeway Close,
Lightwater,
Surrey GU18 5XU
Tel: 01276 451166



Nordost Blue Heaven £58.95/m

These cables may resemble something you might hang up for party, but a load of crepe they most certainly aren't. The cable consists of 72 OFC conductors plated with 40microns of silver. Each conductor is then covered by a Teflon ribbon flat enough to hide under a carpet.

We recently had a listen to Nordost's less expensive cable, the Super Flatline, and found it to be a solid performer with real clarity and power. Well, the Blue Heaven takes all the best aspects of the Super Flatline and manages to improve on them.

Between Musical Fidelity's X-A50 monoblocs and a pair of Magneplanar SMGas, the Nordost produced clarity and space that would take a lot of beating. On powerful recordings such as Kleiber's Beethoven Fifth with the Vienna Philharmonic, strings had a robust bite and a distinct, rich timbre. In addition, woodwind had a delightful lightness to it while the tim-

pani hammered away at the rear of the sound stage in a gripping performance.

Spinning Massive Attack's Mezzanine album, I discovered the Blue Heaven revelled in the massive low-end of this dark bass-fest. The pumping heart beat on the opening track, 'Angel', thudded through the Maggies with crystal clarity. With the entrance of the guitar, the sound stage blossomed left to right, the Nordost managing to keep the whole mix cohesive, with no ragged ends or loose bass.

The Blue Heaven is by no means budget cable, but you do get exactly what you pay for. If you seek a wonderfully lucid sound coupled with bags of involvement, there are few non-mortgage cables to rival this one.

Nordost UK Ltd
First Floor, Unit 7,
Aber Park Ind. Estate,
Flint,
Flintshire CH6 5EX
Tel: 01352 730251

Letter of the Month

The writer of the 'Letter of the Month' wins a free subscription to Hi-Fi World.

AUDIOPHILE PATOIS

I am new to the audiophile world but I have adopted my new interest with some gusto, much to the concern of my financially prudent wife, bless her. The "worst day of her life" came when I heard a familiar piece on a Japanese friend's top(ish)-end system. I instantly realised that I had a new interest in my life.

My previous devouring interest was collecting wine, though I've now been retired on medical grounds - not enough collecting, I fear. Actually, it's my cellar that will fund my eventual system.

In the wine world there is an impor-

tant common language that allows us to articulate in precise detail a range of sensory perceptions (sight, smell, texture, taste) and emotional response to describe a wine. I believe that such a language has evolved in the audiophile community but I have no understanding of it yet. I feel hampered without this language as I can't communicate accurately with others and, more importantly, I can't articulate to myself. Describing a component as "good", "very good" or "very, very good" is rather limiting.

Another important aspect of language is that it tends to develop from the experts in the field - they are the ones who are pushing at the boundaries of perception. For the rest of us, therefore, understanding the language will improve our knowledge of the subject

and, ultimately, our appreciation.

Could you answer the following questions for me? How developed is the audiophile's language, do you think? How can I gain fluency in it reasonably quickly? And can you give me some examples describing 'speakers, amplifiers and (say) an analogue tape deck'?

I am now working my way up through hardware to an eventual system for which I've earmarked £15000. At the moment, I've got some Sixties KEF cabinets (70lbs. each) with Scan-speak and Coles drivers and Wilmslow passive crossovers bi-amped with Quad 303s and driven by an Arcam pre. Sources are a Marantz CD-63 mkII KI-S, an Aiwa ADS-950 and a Leak Troughline.

Jeremy Kidson
JeremyKidson@compuserve.com



In a system which has sharp imaging, instruments and vocalists are easy to locate within the sound stage because their outlines are clear.

Fuzzy imaging makes it very difficult to pinpoint the position of individual images within the sound stage.

WRITE & WIN WITH HI-FI WORLD!

Every letter we print wins a superb prize! On offer are The Chord Co. interconnects, Audio Electronics books, Ringmat Statmats, DNM Licon contact enhancer, DNM Reson 'speaker cable, and a FREE subscription to Hi-Fi World for the best letter of the month! Please write, fax or E-mail to Hi-Fi World Mail, Suite F29, Imex House, Kilburn Park Road, London NW6 5LF. Fax: 0171 328 1844 E-mail: edit@hi-fiworld.co.uk



Once you've become vaguely accustomed to it through reading magazines and visiting dealers, you'll realise the vocabulary used to describe the performance of a hi-fi system is really very easy to get to grips with. And in spite of the fact that there aren't actually that many terms, it's possible to describe a component's character in a manner which makes sense to other audiophiles.

Words often used to describe loudspeakers include "sound staging" (the width and depth of the recording venue reproduced by the loudspeakers) and "imaging" (the sharpness of focus to the individual performers portrayed within

the sound stage). Then there are more everyday words such as "boomy" (bass which concentrates on one frequency at the expense of accuracy), "up-front" (where a rise in output across the midrange and treble appears to push vocals and percussion out towards the listener) and "coloured" (again, a lack of tonal accuracy due to poor design where instruments sound obviously artificial).

When it comes to amplification, you'll find a well-engineered example is smooth, unfatiguing and convincingly natural. Bass should be "tight" (fast and detailed rather than sluggish and indistinct). Sound staging and

imaging crop up again here.

As well as sharing some of the language above, cassette has developed its own idiom: a "papery" presentation is one which suffers from excessive "flutter" (high-rate fluctuations in the speed of the tape travelling over the head) while a piano which sounds as if it has been recorded under water is a victim of "wow" (low-rate speed instability).

With £15000 to spend, the world of hi-fi is your oyster. You've obviously been happy to buy second-hand thus far and this is a habit which you could continue even with that much money to invest. JM

QUAD TO DO NEXT?

I've been meaning to ask your advice on upgrading my turntable and, now that I have acquired some new (old) bits, I really need some help.

My system sources include a Michell Hydraulic Reference turntable with Focus arm and Goldring G900 IGC cartridge alongside a Quad 67 CD player. Amplification is Quad too (34 pre, 405 MkII power) driving TDL RTL2 loudspeakers.

Overall I have no complaints about the results but I would value your comments on any improvements. I was thinking about doing something with the Focus arm, either rewiring it or replacing it with a Rega RB300. Then again, I could pass on the turntable and go for a GyroDec (this I'm not sure of as I am quite attached to my piece of modern art). What do you think?

Just recently I bought a Quad FM3 and with it came a Quad 33 and a pair of 303s, so I could also swap my 405 with the two 303s. Is it alright to have each phono out of the pre-amp wired to the two channels of the 4-pin DIN input to the power amp, and is it straightforward to use bi-wire 'speaker cable from the output of the 303s? With regard to the wiring, is it better to have long leads pre to power, or power amp to 'speakers?

Hugh Watson
Aberdeenshire.

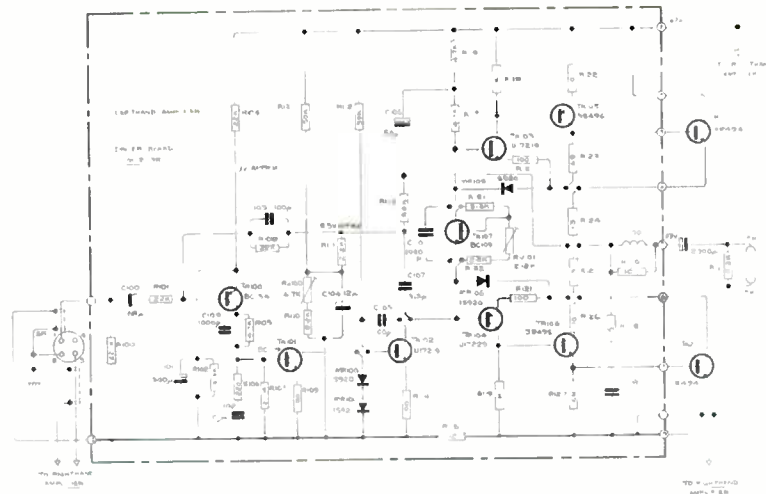

Above is the circuit for Quad's 303 amp. While the 50D monoblocs look similar, they have an output transformer and a choke input power supply.

Attractive though the Hydraulic Reference is, its performance compared to a modern deck like the Gyro lags quite badly. If you could bear to part with it, the latter would be a major improvement. Arm wiring is also best left to experts as it can be horrifyingly easy to turn a previously-functional piece of equipment into useless junk.

It's certainly worth trying a split pre-to-power lead. Connecting the two inputs of one 303 to a single output on whichever pre-amp you settle on will yield a net input impedance on the 303 of around 15kohms, lower

than the power amp's standard 22kohms but probably not so little it will cause problems.

As you're bi-amping, you won't actually need to bi-wire from the 303s - you could use, say, the right channel output to drive the tweeters and the left the mid/bass units.

Finally, long pre-to-power leads are normally better than miles of 'speaker cable, but ideally all cables should be kept as short as is practicable. JM

A free Ringmat Statmat should yield a purer, smoother sound from your digital front-end.

Are you getting the Maximum from your System

D102II Hybrid Interconnect cable

£99.99/0.8m pair

Best Interconnect Cable - What Hi-Fi? Award Winner 1998

★★★★★ "..."a wiry wonder" What Hi-Fi? May '98
 "..."this is pretty much as good as cable gets"
Best Buy Hi-Fi Choice March '98

CS122 Hybrid Loudspeaker Cable

£11.99/m

Highly Recommended - What Hi-Fi? Awards 1998

★★★★★ "Buy with confidence" What Hi-Fi? Oct '98

The Teatrack Hybrid Bi-Wire (£21.99/m)

Insist on Cables by
van den Hul

The Link Between Technique and Emotion
 For details of our extensive range of cables and cartridges please contact

van den Hul UK, Imex House, 6 Wadsworth Road, Greenford, Msex, U16 7JJ. Tel: 0181 997 4280

replay

Panton Road
 Hoole
 Chester
 CH2 3HX
 Tel: 01244 401290

- ALCHEMIST
- AUDIO ANALOGUE
- AUDIO PHYSIC
- AVI
- CREEK AUDIO
- CRIMSON
- DNM/RESON
- HEYBROOK
- JAMO
- LFD
- MERACUS
- MUSICAL FIDELITY
- NEAT
- ORIGIN LIVE
- PINK TRIANGLE
- PROJECT
- ROKSAN
- ROYD
- SONNETEER
- TEAC
- TRICHORD
- TRILOGY
- UKD
- YAKAMURA CHURCHILL

EMAIL replay@diat.pipex.com
 WEB SITE <http://diat.pipex.com/replay>
 TEL: 01244 401250

contact us for a copy of our product guide, newsletter or a list of our clearance items.

reson

the real sound experience

reson mica

MM Cartridge £85.00
 Trade in price *£135.00



reson etile

MC Cartridge £455.00
 Trade in price *£145.00



reson aciore

MC Cartridge £299.00
 Trade in price *£215.00



reson lexe

MC Cartridge £1300.00
 Trade in price *£295.00



reson reca

MM Cartridge £250.00
 Trade in price *£180.00



*Trade in any cartridge to qualify for the special offer price

Virtual Reality Audio Systems Ltd.

P.O. Box 383, Brentwood, Essex, CM14 4GR
 Tel 01277 227355 Fax 01277 224103
 E-mail: info@virtualrealdemon.co.uk

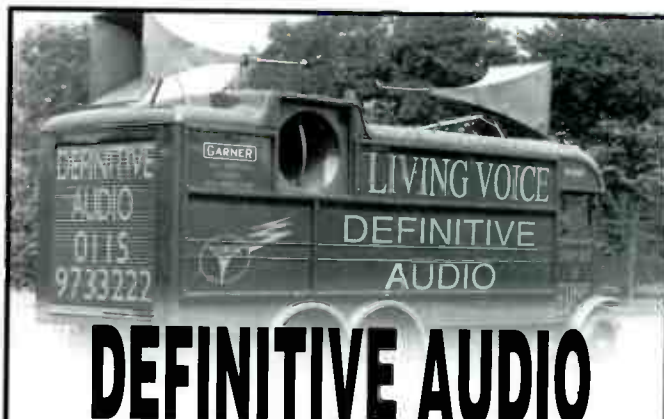

DEFINITIVE AUDIO

You may be a newcomer to Hi-Fi, bewildered by choice. You may be a seasoned audiophile, tired of hype and marketing. Perhaps you should give us a call.

Our range of equipment moves from modest to exotic, from mainstream to unusual. All of it serious. We have a system based approach that achieves results far greater than the sum of the parts. Our starter system, featured in 'Hi-Fi Choice' last year was praised as "One of the best systems I have heard. At any price."

If you share our passion for music and have the urge to hear something a little bit different, ring for an information pack or make an appointment to visit our new listening rooms. We are situated in a fabulous Victorian mill just off junction 25 M1., 10 minutes from East Midlands Airport.

Part exchanged items for sale:	Sale	New
2 x Vitavox RH330 mid range horns	£ 300 pair	
3 x N. Analogue Mentor Tonearms	£ 450 (£800 ea)	
1 x Hadcock special Tonearm	£ 400 (£ 600)	
Sugden SDT 1 CD Player	£ 400 (£1000)	
Carver Platinum loudspeakers	£ 650 (£2700)	
Ariston RD 80 Turntable (no arm)	£ 100	
Snell Type K & Huyden K4 stand	£ 400 (£ 900)	
AudioNote P4 Monos	£2700 (£4000)	
AudioNote Dac3 Sig	£1850 (£2850)	
AudioNote ANV i/connect 2m	£ 250 (£ 500)	
2 x M.O.D. 1-1 Isolation Transformers 3KVA	£ 200 each	
Kelly KT3 loudspeaker (new)	£1200 (£1850)	
Impulse H2 loudspeakers Mahogany	£1500 (£2500)	
Orchid Precision PLL 1 loudspeakers	£3900 (£7900)	
Naim 72 pre-amp	£ 400 (£ 745)	
Naim CD2	£1200 (£2000)	
Naim CDS	£1950 (£3940)	
Solatron SR 152 Valve regulator p/supply	£ 300	
Denon Transport and DAC	£7000 (£15000)	
Pass Labs X600 Monos	£15000 (£23000)	

AMEX - VISA - MASTERCARD

Tel 0115 973 3222 Fax 0115 973 3666

• Living Voice • Border Patrol • Art Audio • SJS Electroacoustics • Wadia • Vitavox • Lowther • Helios • MF • Kelly • Nott'm Analogue • Mystic Mat • SME • WB Ortofon •

124 TO GET READY

I recently found in a garage sale a Thorens TD124 Mk2 turntable in perfect condition. Everything is just like it was in 1968: original Thorens-EMT Swiss arm and original plinth. I equipped it with my old Linn K5 cartridge and it sounds wonderful, much better than my old Thorens TD160 Mk1.

I'm looking for advice on possible improvements - essentially a new plinth and SME 3012 arm mechanically isolated from the turntable (or other arm that could fit better). What about the quality of this kind of original Thorens arm in comparison with modern ones (in the £120 range)? Do you think the 12in. arm would be a significant improvement? Do you know of information about TD124 tweaking on the web? What about the material for the new plinth?

Didier Philippe
Paris.

The popularity of the 124 in its lifetime generally means that most have seen a lot of action before they descend to the garage-sale level.

I would not recommend the 3012 for this deck. Improvements in 9in. arms over the years have largely negated the superior geometry of longer arms. At the dearer end of the market an SME 300 series is a good bet, with its more rigid arm tube and precision gimbal bearings instead of the old-fashioned knife edge types.

In the £120 range there is always the Rega RB250. Whatever the merits or otherwise of this arm, it is cheap, and people are falling over themselves to upgrade it.



With its belt/idler drive, the 124 offers classic sound.

Plinth materials: the deader the better. Marble and aluminium are good but expensive, so wood looks like the choice of the handyman.

To be perfectly honest, where plinths are concerned there is more merit in design than in sheer density. An economical method adopted by many is to stack heavy sheets of MDF to make a thick block; this makes the cutting out much easier and in my experience it is possible to 'tune' the completed block by screwing it together more or less tightly. RMW

If you're after more from your system, try a free bottle of DNM's Licon contact enhancer.

A STATIC TECHNOLOGY

I am prompted to write having read Haden Boardman's article on the Quad Electrostatic 'speakers in your April issue.

I've always been interested in sound reproduction and, at around that time, I was busy constructing boxes of all shapes and sizes, using conventional cones, infinite baffles, ported cabinets, super-tweeters, etc in an attempt to simulate the 'electrostatic' sound. I decided long ago that the moving-coil cone wasn't the best thing to shift air. Nearly 40 years later, having recently invested in a complete upgrade, my opinion remains the same.

In a live concert hall, bass is an accumulation of frequencies produced by the instruments of the orchestra. Cones in boxes add their own coloration and, I fear, can never reproduce the original. Bass 'honked' out through horn loading and porting is miles away from the truth too. And yet, apart from the electrostatics, no one has yet come up with anything better than the box and cone. As Haden mentions, we do seem conditioned to listening to falsely-extended bass. I am still searching for something which gets near to the ESL57.

A.R. Thompson
Warwickshire.

When it comes to loudspeakers, there is something of 'survival of the fittest' in the mix, and the moving-coil transducer has many things in its favour; frequency range, robustness and efficiency for a start. I suppose ideally we could rule cost out of the equation but factor that in as well and the case for electrostatic loudspeakers is not so strong.

You comment that bass is an accumulation of frequencies, but which ones? It is true that losing the fundamental frequency of a note is not necessarily terminal as much of the timbre and the majority of the power will be in the harmonics. Unhappily, although our brains are happy to take a missing bass fundamental 'as read', I believe that for all that our ears are not fooled.

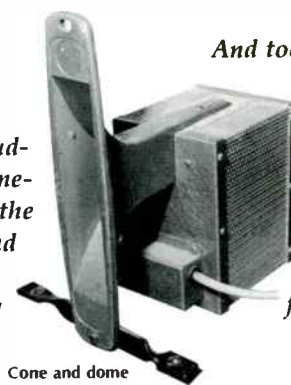

Cone and dome drivers may not be ideal, but they're cheaper and less poisonous than the Ionofane!

And too little bass is just as inaccurate as too much.

A well-designed horn does not "honk" any more than a well-designed electrostatic necessarily lacks bass.

Admittedly, there have been some poor endeavours in the field of reflex enclosures (I don't much like 'em myself) but this need not always be so.

As regards no one having come up with anything better than the box or the cone, it certainly isn't for want of trying. There have been numerous solutions to loudspeaker problems over the years, from ribbon tweeters and ortho-phase panels to ionophones. Trouble has always fallen under one of these heads: cost; efficiency; reliability. Had this not been the case, perhaps we should now be bemoaning the lack of an alternative to electrostatics! RMW

For more information on cone technology, have a look at John Linsley Hood's Audio Electronics.

e-mail

Visit our website at
<http://www.hi-fiworld.co.uk>
 or send your e-mails to
edit@hi-fiworld.co.uk

REFLECTIONS ON HI-FI

We would be grateful for your advice on the following system: Meridian 508 CD player, Audiolab 8000A acting as pre-amp (and driving a pair of remote loudspeakers in another room), a pair of Audiolab 8000Ms and bi-wired KEF 103/4 'speakers (sitting on ugly but effective paving slabs). Interconnects and loudspeaker cables are by Audioquest.

All the components were selected using our listening references of Pink Floyd, Joni Mitchell, Tom Waites and Simply Red, although our musical tastes are eclectic. Now for the problems:

1) The system achieves fine results on sparse recordings and excels on male and female vocals with light accompaniment, but on complex orchestral pieces and multi-layered Rock tracks there is a noticeable loss of detail and focus.

Some albums have a tendency to sibilance as well.

2) The listening room is approx 11ft. by 25ft., has a wood floor (with rugs) and is sparsely furnished. The 'speakers fire down the long length of the room (with surprisingly good results for most locations). I have noticed that if the 'speakers are more than 8ft. apart the sound stage is very large and detailed, but this spacing places the KEFs about 8in. from the side walls, thereby exciting a resonant (middle) bass mode which destroys the sound balance.

We would like to upgrade to gain detail and focus for all of our music without losing the clear sound we currently obtain on vocals and small-scale compositions. Spending up to £1000 is not unfeasible but the improvement would have to be dramatic. We would rather not spend more than £500.

We suspect the 8000A is the prime subject for replacement, but would an upgrade to the CD player achieve equally good results? Any upgrade to the pre-

amp would have to include a remote for volume control as well. As for the



Large floor standers like KEF's 103/4s need transparent electronics and plenty of space to give of their best.

'speaker placement? We have settled on a balanced sound albeit with a compressed sound stage. Do you have any tips as to how we could get a decent tonal balance and proper sound staging?

I enjoy reading Hi-Fi World for its eclectic mix of articles (and sometimes views) and the fact that the magazine has not been swamped by AV reviews. Keep up the good work.

Aaron and Marion Fentiman
aaron@igg1.demon.co.uk

Indeed, the 8000A is the weakest link in the chain at present. Since you're using it to drive another set of loudspeakers, why not use the 8000A purely as an integrated and go for a straight pre-amp in your main system?

A decent pre-amp which offers a genuine improvement over the 8000A and has remote control.

Hmm. That last part complicates matters considerably as handsets and receivers bite a large chunk out of budgets which would otherwise go on enhancing sound quality.

Spending only £500 on a remote pre wouldn't do much for sound quality. Creek's OBH-12 passive at £200 and Arcam's 9C at £400 are certainly deserving of audition, but you'd get vastly superior results if you could forego the remote. If by some chance you can, try Rothwell's Indus at £499. If the pre-to-power interconnects were around 50cms, you'd have no problems with the treble roll-off or sluggish bass which can afflict passives hooked up with long cables. And the tighter the bass, the less likely it is to excite room modes. Should remote operation prove indispensable, Musical Fidelity's X-P100 at £800 would be a prime candidate for purchase.

I think you'll find that a new pre will have a much larger impact on the sound than a CD player upgrade. Some fresh interconnects might help eliminate a little of the sibilance too - DNM's £36 Reson or the van den Hul D102 MkIII Hybrid at £70 are two to go for.

Seeing as the KEFs produce their best sound staging when well apart, why not have a go positioning them to fire across the width of the room instead? If you toe them in so that their axes cross in front of the listening spot you'll avoid strong, early reflections off the wall behind your head. JM

Another option for replacement interconnects in your system - a free pair of The Chord Company's Sirens.

If you do not want your e-mail address published, please let us know.

EXCITEMENT SEEKER

I have read your excellent magazine for several years and have relied upon your advice for upgrades and tweaks.

However, I now find that I am unhappy with the sound obtained from my current set-up; Rega Planar 3 with Rega Elys cartridge, Rotel RB-965BX LE Discrete CD player, Rogers T2 FM tuner (20+ years old), Trio KA-3700 amp (20+ years old, serviced a couple of years ago) and B&W 601 loudspeakers on Standesign twin-pillar stands (sand filled). Interconnects are from Monster, loudspeaker cable is Supra's 6mm. The listening room is large at 4m. by 11m.

Overall, the system performs well with a wide range of music from vinyl, CD and radio. Still, my LPs sound a little too bland and CD and radio are fine but not great. The music does not appear to have the spread or depth to the sound stage that I have heard elsewhere. The bass from the 601s is good but the treble is a little shut-in. I have my suspicions that the amplifier is at fault but would welcome your comments and recom-

mendations on how to recapture the excitement.

Fergus Taylor
fergus.taylor@
mpmadams.co.uk

Yup, the finger of blame is definitely swinging in the direction of your amplification. Some of Trio's older forays into this area have trundled past the ears of the World team and, while certain models have had their merits, the consensus was that they generally didn't set our ears on fire.

You don't mention what the budget for corrective purchasing is, but roughly £400 spent in the direction of either Audio Analogue's non-SE Puccini or Pioneer's A-300R Precision would be a wise decision. Both of these have fine



While most of Trio's Seventies amplifiers had bomb-proof build on the outside, what was on the inside generally wasn't quite so impressive by modern standards.

phono stages too, especially the Puccini, so you wouldn't have to bother sinking extra funds into an out-board device.

Future upgrades worth contemplating would be having your RB300 modified by Origin Live and replacing the Rotel. The first of these yields very major

gains in solidity, transparency and dynamics, turning the humble Rega into a veritable giant-killer. The second should bring with it obvious all-round improvements if you were to go for something like Cambridge's CD4SE at £200 or Marantz's CD-63mkII

KI-Signature at twice the price. JM

A free set of DNM's Reson loudspeaker cables should open out the sound from your hi-fi.

TALKING ITALIAN

My system at present is an Audio Analogue Puccini SE amplifier with Midiman's Flying Calf DAC and a Marantz CD-48 acting as transport. Other sources are a Yamaha KX-390 cassette deck and a Denon TU-260L tuner. The loudspeakers are B&W's DM601s on Atacama BD25 stands. Interconnects are van den Hul's D102 MkIII, QED's Digiflex, Cable Talk's Improved 2 and the same company's Talk 3.1 'speaker cable. The system is on an Alphason R17/17 component rack.

Because of the transparent, three-dimensional sound of the amplifier, the other equipment needs replacing to complement the sound of the Puccini. First to go will be the CD player. I have a budget of £500-£700. Do I go with Audio Analogue again or is there a better option?

The interconnects and 'speaker cable need upgrading along with the 'speakers, so where do I go from here? Budget is £200-300. Retailers around Hampshire seem only to stock one make each which complicates matters.

I have a vinyl collection but no turntable, arm or phono stage. I want to start small and build up but I'm not sure whether to go DIY or buy ready-made and upgrade. Do I need a phono stage with my amp? In this case I have £500-£600. Finally, the support section is going to get about £200 lavished on it.

Danny Barber
Danny.Barber@oxdgb.
.sprint.com

You have a couple of choices when it comes to CD replay. The first is to go for the Paganini CD to match the Puccini SE - this is a pairing literally made for each other. The alternative is to keep your Flying Calf, trade in or sell on your Marantz and pick up Teac's T-1 transport. It's difficult to say

which of the two choices would be best as the Teac/Midiman duo offers an upgrade path and the Paganini doesn't.

I wouldn't be in a hurry to change your vdH interconnects for the simple reason that they're very good. In fact, you could probably do with another set to replace the Improved 2.

It's a different matter when it comes to loudspeaker cable. The 3.1 is fine for the money, but it really is budget wire. At rough-

ly double the price is Ortofon's SPK200, and then for a little extra you could have DNM's Reson.

The Atacamas are decent stands, although the SE24s would probably be a step in the right direction for only £10 more. To be honest, unless you're going to



Audiophile Furniture's Base rack system has a sound to match its clean looks.



SOUNDS



PERFECTION

THE SOUTHWESTS PREMIER RETAILER

CONTACT NIGEL ON:- 01326 221372
OR MOBILE 0498 554357
e-mail:- soundsp perfection@mailscity.com

AUDITION THE FOLLOWING PRODUCTS HERE:-

AMPLIFIERS:- ALCHEMIST * AUDIO ANALOGUE * AUDIO NOTE * BORDER PATROL * ELECTROCOMPANET * GRAFF * MUSICAL FIDELITY * PARASOUND * PRIMARE * SONIC FRONTIERS * SUGDEN * UNISON RESEARCH

SPEAKERS:- AUDIO NOTE * AUDIO SPECTRUM * BOSTON ACOUSTICS * J.M LABS * KELLY * MAGNAT * MONITOR AUDIO * REL SUBWOOFERS * TOTEM * TRIANGLE * TSUNAMI * VIENNA ACOUSTICS

C.D. PLAYERS:- ALCHEMIST * AUDIO ANALOGUE * AUDIO NOTE * MUSICAL FIDELITY * PARASOUND * SONIC FRONTIERS * TEAC * TRICHORD

ANALOGUE:- AUDIO NOTE * HENLEY DESIGNS * MICHELL * MUSICAL FIDELITY * ORTOFON * PROJECT * SME * THORENS * VOYD

ANCILLARIES:- ATACAMA * AUDIOQUEST CABLES * CABLE TALK * ELEMENTAL AUDIO * PHILOSOPHY CABLES * SONIC LINK * STANDS UNIQUE * STRAIGHT WIRE * TARA LABS CABLES * TARGET

WE HAVE THESE SECOND HAND PRODUCTS

	SALE
Kef Reference 4 spks mint Rosette	£2350
Monitor Audio 20 Ann Piano black new	£1895
Pink Triangle ANNV/PSU/SME 309/MC10Supreme	£1395
Electrocompaniet EC 4.6 pre-amp ex-dem	£1349
Parasound CBP 2000 boxed	£695
Audio Note OTO SE phono ex-dem (new valves)	£995
Rel Stadium II (upgrade) black	£895
TDL Monitor Speakers black	£695
Pink Triangle Tarantula/Rega RB300/MC1 Turbo	£495
Parasound PLD 1500 pre-amp	£425
Quad 606 Power Amps Russ Andrews modified	£425
EPOS ES14 Speakers ex-con with stands	£375
MK 125 Sub-woofer black 2yr's old	£375
Sugden Optima CD player Trichord PSU/CLK 3	£375
Monitor Audio 3 speakers rose with plinths	£275
Kinshaw Perception DAC (2 units) each	£249
JPW Ruby 2 speakers	£295
Magnat Victory 6 speakers new boxed	£139
Sound Style X 100 4 tier stand signal red	£100
Nordost blue heaven 1M	£75

**CONTACT US FOR
UP TO THE MINUTE PRICES OF
SECOND-USER EQUIPMENT
AND SPECIAL OFFERS**

****FULL WEB SITE SOON AVAILABLE ON GLOBAL ****

**FOR FRIENDLY ADVICE AND 7 DAYS A WEEK
8AM to 10 PM**

MAIL ORDER THROUGHOUT UK

VISA/ACCESS/SWITCH



campaign audio design

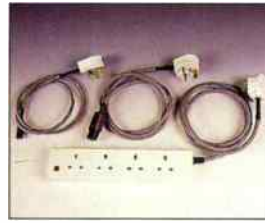

Getting a better, more involving sound often means spending a lot of hard earned money. It's such a waste, because every system can benefit from our cables and accessories, at a fraction of the cost of some new "black box". Here are some of the ways we can help.

We have Linear Crystal Oxygen Free Copper interconnects (£12.48) up to High Purity Silver cables (£89.00) and high definition loudspeaker cables in Silver Plated Copper or Pure Silver. Our mains cables add weight, power and scale,

and with non-inductive RF filtering (£10.00) and over-voltage protection (£3.00) enhance performance still further. Gold plated AV cables, both RF (£17.95) and OFC Scart (£19.21), help bring picture quality in line with NICAM sound resolution. Valves, capacitors and transistors are all microphonic. They cannot perform optimally if vibrated. Our set of three brass isolation cones are worth their weight in gold - revealing low level resolution and dynamics hitherto hidden beneath electronic noise. We also have a cure for your noisy fridge or central heating motor (£3.50), enabling you to throw away your big mains noise suppressor, which has been giving you that "sat upon sound" for years. There's lots we can do to bring you closer to the emotion and energy of the performance. So confident are we, that we offer a 14 day money back guarantee.

Ring or write for details:-

CAMPAIGN AUDIO DESIGN
Llandudno Road (HW)
Cardiff CF3 8PG
Tel:- 01222 779401

Website: <http://business.virgin.net/cad.cables/>



Trade and International Enquiries Welcome.



SUPRA

Interconnects

- EFF-ISL analogue "Best Buy" - Hi-Fi Choice, 04/99
- EFF-IXLR balanced (XLR/XLR)
- EFF-ID co-ax digital (phono/phono)
- EFF-IV 75 ohm video (phono/phono)
- DAC-X analogue (phono/phono)
- DAC-XLR AES/EBU digital (XLR/XLR)
- ZAC Fibre optic (TosLink) NEW for 1999

Speaker Cables

Classic Series: 2.5mm, 4mm, 6mm (NEW) & Quattro 4 (bi-wire), Ply Series: 2.0, 3.4 (low inductance) & 3.4S (shielded - NEW) LINC Series: 2.5mm and 4mm (shielded)



AUDIOVECTOR

Loudspeakers for 1999

Entry level C Series

- C1 bookshelf "over-riding musicality" - Hi-Fi News 05/99)
- C2 floorstander "Recommended" - Hi-Fi Choice 05/99) (finishes: Beechwood, Black Ash, Cherry & Rosewood)

And the UPGRADEABLE M Series

- M1 (from £759/pr - "worth consideration" - Hi-Fi World 08/98)
- M2 (from £1399/pr - "Recommended" - Hi-Fi Choice 07/98)
- M3 Signature (from £2499/pr) - Active upgrades (from £1495) (veneers: Beechwood, Birds-eye Maple, Black Ash, Cherry & Rosewood)

5 year transferable guarantee on all Audiovector speakers

Post to: Glave Limited, Unit 7, Wren Industrial Estate, Coldred Road, Maidstone, ME15 9YT. Tel/Fax: 01622 66 40 70. Web: www.glave.co.uk
Please send me info on: Supra cables Audiovector

Name:
Address:
Post code: HFW9907

spend a lot more money on a new set of 'speakers soon, it's not worth going beyond this sort of level for stands. If you do splash out on 'speakers, try to audition Castle's Edens at £470 as these would work a treat with the Puccini SE. And

for racks, have a look at Audiophile Furniture's Base system even if it might be a bit beyond your current price range.

Since the Puccini SE has an excellent MM/MC phono stage, you won't need to buy an outboard one.

There are still plenty of budget turntable packages around too, like Project's 1.2 at £200 (reviewed in June 1997). JM

A dose of DNM's Licon contact enhancer will smooth the signal path.

SEEKING DIRECTIONS

I recently acquired a Technics SP-10 MkII direct-drive turntable for what seems a bargain price compared to what you guys say they fetch over there. Surplus to a local TV station, it is in excellent condition and came mounted to a 30mm-thick plinth and fitted with a Denon DL-305 arm. I am currently using it with a Denon DL-103 cartridge mounted in an Audio Technica MG10 magnesium headshell.

I would like to keep the turntable and arm as they are for historical reasons. The trouble is, even though they seem to work well together, the lack of bias adjustment on the arm worries me a little. What do you think of this and can you tell me anything about the arm? I would appreciate your comments.

Ethan Buranyi
ethan_buranyi@yahoo.com

The 30mm plinth you mention is almost certainly the chunk of plywood most broadcast SP-10 MkIIPs were bolted to so that they could then be screwed into a console. Using the deck in this sort of mounting is hardly going to reveal its full potential.

As with common valve amps (and the SP-10 MkIIP isn't that hard to come by), keeping something in original condition for "historical reasons" normally means sub-optimal sound unless the item in question is in genuinely



Mass is the word when it comes to housing Technics' SP-10 MkIIP direct-drive motor unit.

mint condition. Your deck will be around 20 years old and quite a few of the electrolytic caps will be going wonky. As well as a wash and brush up, the SP-10 MkII really cries out to be mounted in a very solid plinth - think of 100mm-thick laminated MDF as a minimum. Anything less and you won't

be enjoying the impact and transparency this excellent motor unit is capable of.

Licon your cartridge pins for more detail and dynamics from LP.

SOURCY SHAKE-UP

My current system consists of a Marantz CD-67 CD player, Garrard DD75 direct-drive turntable with Ortofon 510 cartridge, Rogers Cadet III valve amplifier, Sony KC-600 cassette deck and Wharfedale Laser 100 'speakers.

I am fairly happy with the sound of the above equipment but it is time to replace a two-year-old stylus and I am thinking about upgrading at the same time. I am looking at spending about £100 on a replacement stylus or cartridge. Is the Ortofon 540 worth using on my turntable? I would also appreciate any suggestions as to future upgrades. Finally, is it normal to hear a slight hum during pauses between songs with the Rogers amplifier?

Nigel Feltham
nigel-f@realmail.co.uk

Hmm, the Garrard is hardly a top-

spec deck so £100 on a new stylus or cartridge seems somewhat ambitious. I would be sorely tempted to sell the Garrard and put the proceeds towards getting a new turntable. Rega Planar 2s and 3s aren't too expensive as used buys and it's very easy to upgrade either the arms or the decks themselves with a number of after-market mods. Once you've picked up the Garrard's successor, £100 on a cartridge would be fine.

The Rogers is a reasonable budget valve amp but it isn't in the same league as Leak or Radford's efforts. The humming is probably the electrolytics letting you know

they're on their last legs - they should be replaced.



When it comes to sub-£150 loudspeakers, Tannoy's Mercury m1s are strong contenders.

Whether you keep the Rogers or go for a Leak, a change of loudspeakers would also be in order. Tannoy's Mercury m1s at about £120 would out-perform your Wharfedales and not need vast amounts of power to go fairly loud.

You don't mention interconnects but if you're using the sort given away with new components you'd be well advised to invest in some Tandy Golds (reviewed last month) or SonicLink's Bonus. JM

Move up in the wire world with a free pair of Sirens from The Chord Company.



Sounds Of Music

- ◆ The best range of Hi Fi separates anywhere ◆
- ◆ 1 months home trial exchange system ◆
- ◆ Free delivery and installation ◆
- ◆ 6 demonstration rooms and easy parking ◆
- ◆ Interest free credit & most credit cards ◆

FOR SERVICE AND ADVICE - WE CAN'T BE BEATEN !

Agencies include:

Avantgarde, Argento, Audio Synthesis, Advantage, Audio Physics, Apollo, Audion, Audio Note, Audio Research, Audio Analogue, Anthem, Altis, AVI, ATC, Alon, Acoustic Energy, Atacama, Artemis, BCD, Base, Balanced Audio Technology, Bow, Bose, Convergent Audio Technology, Chord, Copland, Cadence, Cable-Talk, Churchill, Copulare, Dunlavy, DAC, Eggleston-Works, Electrocompanient, Eikos, FM Acoustics, Genesis, Graham, Graff, Goertz, Goldring, Gershman, Hales, Harbeth, Helios, Hovland, Jamo, J M Labs, Koetsu, Krell, KEF, Klipsch, Lumley, Lyra, L.A.T, Lavardin, Musical Technology, MIT, Magnum, Magnum Dynalab, Micromega, Marantz, Martin Logan, Mitchell, Musical Fidelity, Neat, Nordost, Nottingham Analogue, Opera, Optimum, Ortofon, Orelle, Orchid, Osborn, Plinius, Promenade, PAD, Passlabs, Pro-ac, Pink Triangle, Primare, QED, Quad, Reference 3A, Rockport, Ruark, Rel, Roland, SME, Shure, Sequerra, Sennheiser, Sonic Link, Soundstyle, Sonic Frontiers, Spondor, Sonus-Faber, Stands Unique, Target, Trilogy, Tannoy, Totem, Talk, Transparent, Transfiguration, Triangle, Unison Research, VAC, Woodside, Wisdom, Wilson, Wilson Benesch, Wadia, XTC, XLO, YBA, Zingali.

10-12 Chapel Place, Tunbridge Wells, Kent TN1 1YQ

Tel: 01892 547003 / 616383 Fax: 01892 616517

Web site: <http://www.sounds-of-music.co.uk>

Column

One of the reservations people in hi-fi have about Digital Audio Broadcasting, or DAB, is that it will offer no improvement in sound quality over analogue VHF/FM. In spite of this, the UK will be seeded with a whole new network of transmitters and, ultimately, we will all be forced to scrap our traditional radios and hi-fi tuners and buy new DAB equivalents. A lot of money will be changing hands.

"People will not be happy!" an industry public relations man told me some time ago. Since he was involved in DAB during its early days, when it was being developed in mainland Europe, he was

speaking from experience. "DAB will offer little benefit in Britain" I was told. "It was designed originally for the mountainous regions of Germany, Austria and Switzerland where there are

some peculiar reception problems. Yet it is being marketed on the basis of sound quality".

Imaginatively described as possessing "CD sound quality", DAB looks suspicious even if you only glance at its specification. The audio is sampled at 48kHz and 24kHz, giving an upper response limit of 24kHz and 12kHz respectively, the former little different from CD's 22.05kHz. Data reduction is then applied to lower the bit-rate between six and twelve times compared to CD, which is a source of sonic degradation. DAB cannot therefore be described as having "CD sound quality" without stretching that description in a major way.

It's ironic that DAB's specification is little different to that of VHF/FM radio. Any half-decent analogue tuner nowadays has an audio response that reaches 15kHz, distortion levels of 0.1% or so and -72dB hiss level. But VHF/FM does not use data reduction, so arguably it has better sound quality than DAB on

paper. This specification was laid down in the Fifties. We are now moving on to 24-bit audio sampled at 96kHz. DAB is being sold on a promise of better sound quality that can hardly be justified when you look at the facts.

DAB is with us for many reasons, not all of which benefit users. DAB transmitters work at one frequency and can overlap - lots of them can be deployed around the country so each can be of modest power. The biggest are rated at a modest 10kW, far lower than the 250kW of VHF/FM produced by masts like London's Wrotham or Sutton Coldfield, which must cover very large areas of the country.

” DAB is being sold on a promise of better sound quality that can hardly be justified when you look at the facts.

These big masts, usually located on remote, windswept hills, cost a lot in up-keep, and each one must be supported by hosts of low-power fill-ins to eliminate dead spots. Running and looking after this transmitter network is expensive. One of the attractions of DAB to broadcasters is its use of smaller, lower-powered transmitters that are more accessible and cost less to maintain. I guess this is the only way of providing radio coverage in mountainous areas.

A network of many low-powered transmitters gives a more even field strength and here it looks as if DAB will offer benefits. I live in North West London, far away from Wrotham which serves London yet lies 20 miles or so to the South East, in Kent. Although I am near to Central London, with millions of potential listeners, field strength on VHF/FM is weak and reception with a dipole noisy. I have just hooked up an Arcam DAB receiver

and found a small wire dipole gave enough signal to provide decent reception with a low error-correction rate. In terms of hiss, DAB will give better results for millions of Londoners, especially those with portables.

I have to use a large, roof-mounted VHF/FM aerial pointing South East to Wrotham to get hiss-free reception. DAB eliminates the need for such an installation, but sound quality is no better than current technology (in fact, it's slightly worse). The benefits of DAB are more mundane than those advertised and will exist more for those in poor reception areas than good ones. If you live in South or South East London, for example, as more than a few people do, DAB is likely to offer little or no benefit whatsoever.

In the same way CD provided better sound quality to anyone struggling with a cheap record player, DAB will provide better results for those with cheap radios. It will also be a boon to flat dwellers who can't put up an aerial. And motorists need not re-tune on motorways. Anyone who has invested in a proper VHF/FM set-up needn't get too excited though. DAB offers nothing over decent analogue equipment in terms of sound quality. The truth is it was conceived for mountain goats.



Noel Keywood

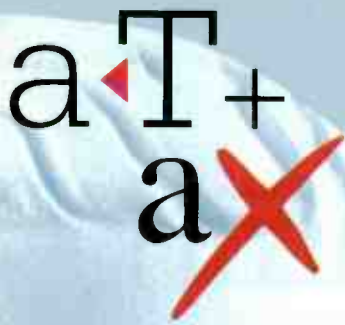

AT BASINGSTOKE

4 Feathers Lane
Tel: 01256 324311
Tues - Sat 9am - 5.30pm
Eve dems by appointment

AT BRENTWOOD

30 Crown Street
Tel: 01277 264730
Tues - Sat 9.30am - 5.30pm
Thurs eve open late until 8

AX BRISTOL

65 Park Street
Tel: 0117 926 4975
Tues - Sat 10am - 6pm
Thurs eve open late until 8

AT CAMDENLEY

173-175 London Road
Tel: 01276 685597
Tues - Satur 10am - 6pm
Thurs eve open late until 8

AX CARDIFF

134/136 Crwys Road
Tel: 01222 228565
Tues - Sat 9am - 5.30pm
Eve dems by appointment

AT CHELTENHAM

40/42 Albion Street
Tel: 01242 583960
Tues - Fri 9.30am - 6pm
Sat 9.30am - 5.30pm
Eve dems by appointment

AX CHESTER

88/90 Boughton
Tel: 01244 345576
Tuesday - Friday 10am - 6pm
Saturday 9am - 5pm
Thurs eve open late until 8

AT ENFIELD

159a Chase Side
Tel: 0181 367 3132
Tues - Fri 9.30am - 6pm
Sat 9.30am - 5.30pm
Eve dems by appointment

AT EPSOM

15 Upper High Street
Tel: 01372 748888
Tues - Sat 10am - 6pm
Thurs eve open late until 8

AX EXETER

156 Sidwell Street
Tel: 01392 491194
Tues - Sat 9am - 5.30pm
Eve dems by appointment

All shops are closed on
Mondays.

For the very latest information
please check our web sites:
www.audio-t.co.uk
www.audio-excellence.co.uk
www.music-at-home.co.uk

AX GLOUCESTER

58 Bristol Road
Tel: 01452 300046
Tues - Sat 9am - 5.30pm
Eve dems by appointment

AT HIGH WYCOMBE

30-32 Castle Street
Tel: 01494 558585
Tues - Sat 10am - 6pm
Thurs eve open late until 8

AT LONDON WEST HAMPSTEAD

190 West End Lane
Tel: 0171 794 7848
Tues - Sat 10am - 6pm
Thurs eve open late until 8

AT OXFORD

19 Old High Street,
Headington
Tel: 01865 765961
Tues - Sat 10am - 6pm
Thurs eve open late until 8

AX PRESTON

131 Friargate
Tel: 01772 253057
Tues - Sat 9am - 5.30pm
Eve dems by appointment

AT READING

4 Queens Walk,
Broad Street Mall
Tel: 0118 958 5463
Tues - Sat 9am - 5.30pm
Eve dems by appointment

AT SOUTHAMPTON

2-12 Hursley Road
Chandlers Ford
Tel: 01703 252827
Tues - Sat 9am - 5.30pm
Thurs eve open late until 8

AX SWANSEA

9 High Street
Tel: 01792 474608
Tues - Sat 9.30am - 5.30pm
Wed eve open late until 8

AT SWINDON

60 Fleet Street
Tel: 01793 538222
Tues - Sat 9.30am - 6pm
Thurs eve open late until 8

AX WORCESTER

Independence House
The Trinity
Tel: 01905 619059
Tues - Sat 9am - 5.30pm
Eve dems by appointment

MAIN BRANDS STOCKED:

- ACOUSTIC ENERGY
- ALCHEMIST
- ALPHASON
- APOLLO
- ARCAM
- ATACAMA
- AUDIO
- TECHNICA
- AUDIOPHILE
- FURNITURE
- AUDIOQUEST
- AVI
- B&W
- CABLE TALK
- CASTLE
- CELESTION
- CHORD
- CHORD ELECTRONICS
- CREEK
- CYRUS
- DENON
- DENSEN
- DYNAUDIO
- DYNAVECTOR
- EPOS
- GOLDRING
- GRADO
- HEYBROOK
- KEF
- LINN
- LOEWE
- MARANTZ
- MAXELL
- MERIDIAN
- MICHELL
- MILLER & KREISEL
- MISSION
- MIT
- NAD
- NAIM
- NAKAMICHI
- NORDOST
- ONKYO
- ORTOFON
- PANASONIC
- PARTINGTON
- PIONEER
- PRIMARE
- PROAC
- PRO-JECT
- QED
- QUAD
- QUADRASPIRE
- REGA
- REL
- ROTEL
- RUARK
- SENNHEISER
- SHAHINIAN
- SONANCE
- SONIC LINK
- SOUND STYLE
- STANDS UNIQUE
- SYSTEMLINE
- TAG McLAREN
- TALK ELECTRONICS
- TANNOY
- TARGET
- TDK
- TEAC
- TECHNICS
- THORENS
- VAN DEN HUL
- YAMAHA

Not all products are stocked by every shop so please check with your local branch before travelling



AUDIO T & AUDIO EXCELLENCE - probably the two best specialist retailers of hi fi and home cinema equipment - give independent advice, excellent deals and a level of after sales service that keeps customers returning year after year. We select products which offer high quality performance and value for money whatever your budget. We back this up with staff who have the knowledge that only comes from being genuine enthusiasts. We are not just the same as other dealers, so why not test our claims for yourselves soon at a town near you.

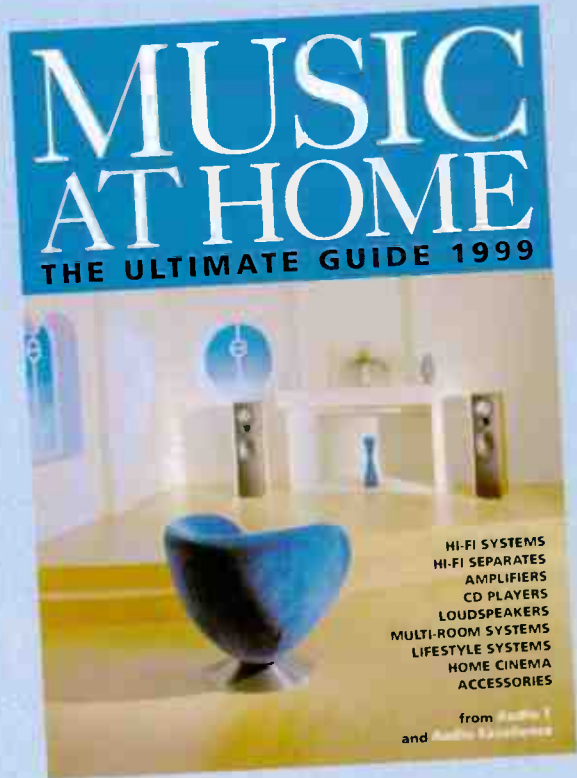

FOR THE ULTIMATE IN SOUND ADVICE

GET YOUR FREE COPY OF OUR 48 PAGE GUIDE NOW!

FREEPHONE 0500 101501

8am - 10pm 7 days a week

(UK only. Please quote HFW3)

Or complete and return the coupon

www.music-at-home.co.uk

PRICE PROMISE

- * We know you won't find better service.
- * We know you won't find better sound.
- * But if you find a better deal, let us know and as long as we can verify it we'll be happy to match it.

Please send me my FREE copy of
MUSIC AT HOME - The Ultimate Guide 1999 (UK only)

NAME

ADDRESS

POST CODE

Music at Home HFW3, Freepost LV1747, Abingdon, OX14 4YQ



Great Value Sound & Vision



WHERE THE MUSIC MATTERS

Working together to bring you the Best

NAD SilverLine

A stunning new range of true audiophile separate components which are setting new standards. At first glance the new SilverLine might appear to be a

departure for NAD, but look more closely and you will see this isn't really the case.

First and foremost, the SilverLine series remains faithful to the traditional NAD philosophy of high performance and sound quality combined with excellent value for money and ease of use.

With the SilverLine Series NAD delivers a statement: High End doesn't need to be outrageously expensive. This is precisely the same NAD philosophy as in the past - simply applied at a higher level.

The range consists of:

- S100 Stereo Pre-Amplifier £800
- S200 Stereo Power Amplifier £1600
- S300 Stereo Integrated Amplifier £1900
- S400 Tuner £750
- S500 CD Player £1100
- S70 System remote control £100



PRODUCT OF THE MONTH

Look out for more SilverLine products appearing in these stores soon

"... a big-boned, full scale sound with plenty of bass weight on tap, but with a smooth, even rounded treble." S500 CD Player WHF? May 1999

"An easy going sound that packs a great punch." S100/S200 Pre/Power Amplifier WHF? April 1999

"... there was no disguising the ease, power and breadth of dynamics on tap." "The S300 has a very agile and expressive midband, voices are more captivating than usual and instruments take on a colour and depth that are often denied them." S300 Integrated Amplifier Hi-Fi Choice April 1999

Product available from Audio T in West Hampstead and Brentwood and Audio Excellence in Cardiff and Worcester.

www.audio-t.co.uk

www.audio-excellence.co.uk

- 49 years of experience • fully authorised dealers
- full demonstration facilities • 10 day exchanges
- 30 day no penalty upgrades • interest free option on all sales over £250 (Subject to status. Written details on request)
- 3 year guarantee on hi-fi separates and systems • home loans and home dems • custom installation



World Radio History

INTEREST FREE OPTION

Available on all sales over £250. (Subject to status. Written details on request.)

A Lease Is Life

Designed for the studio but happy in the home, Alesis' M1 active monitors woo Jon Marks' ears.

Domestic and professional audio equipment normally moves in two separate orbits. After all, the one is designed to optimise musical enjoyment whereas the other's main aim in life is to dissect the recording coming through it in the search for any sonic gaffes. Every once in a while, however, along comes a component which crosses the border between living room and studio. Two such were Midiman's Flying Cow ADC/DAC and Flying Calf convertor. Number three is Alesis' M1 active monitors.

Intended for near-field monitoring, these American two-ways have a range of unusual features. The first is an active crossover with frighteningly steep 48dB, 8th-order roll-offs "which minimises the interaction between woofer and tweeter near the crossover point" (to quote the lucid and thorough manual). Electronic time alignment in the tweeter's circuitry also reduces phase differences between drivers, a fact which our measurement confirmed; the M1s' response on and off-axis was pretty much identical, a very impressive result. And as the crossovers have been tailored to suit the silk-dome tweeter and 6.5in. non-woven carbon-fibre mid/bass, the Alesis' response is astonishingly flat (+/- 1dB over most of their output).

Keeping the drivers on the move are four power amplifiers, a pair in each cabinet. The tweeter gets a 25watt and the mid/bass a 75watt, which will clip at roughly the same level as a single 200watt amp driving passive loudspeakers. A cun-



much depth as I'd hoped for after the Harbeth DPM1 Xpression! Actives (now HHB Circle 5s), but detail remained commendably high on the list of talents, the Alesis confirming their lack of a passive crossover by digging deep into recordings. More proof came in the plucked double-bass at the intro to 'Don't Ever Let Nobody Drag Your Spirit Down', where the leading edges were faster, crisper and better defined than through passive 'speaker/amp combos at a similar price.

So far, so good. Where the majority of the pro actives we've tested have tended to

possess a rather hard, insistent presentation which is perfect for uncovering any problems in a mix, the Alesis were more mellow. Still, on cymbals in particular they could be a bit brasher than strictly domestic transducers, and they couldn't equal the power and focus of a well-engineered ribbon. Putting things back in perspective, though, said ribbons normally appear on 'speakers at nowhere near the M1s' price (the ELAC Jets are the exception), and they certainly don't come fitted with their own amplification.

Alesis M1s' are extremely transparent loudspeakers which won't take kindly to mismatched pre-amps. Unfortunately, while the best sonic match would be a valve amp, the 10kohm unbalanced input impedance on the XLR/0.25in. socket is too low for most thermionic gear. If you can match the M1s with a sweet transistor pre and warmish cabling, they'll reward with a fast, open sound at an extremely reasonable price.

On paper at least, Alesis' M1s are some of the most competent loudspeakers we've ever come across. To find out if they could fulfil this promise in use, I wired them up to Musical Fidelity's X-P100 pre-amp and Teac's P-30 transport in conjunction with Alchemist's TS-D-1 DAC. Cabling came from Purist Audio Design and Roksan. With the M1s fired up, I plied them with our favourite Eric Bibb CD, Good Stuff. The opening track which gives this album its name was bread and butter to these actives, as their precision imaging made telling apart the various instrumental lines easy. Sound staging might not have had as

Alesis M1 £549

Sound Technology
Letchworth Point,
Letchworth,
Herts. SG6 1ND
Tel: 01462 480000

WORLD VERDICT



Almost worthy of domestic bargain status, the M1s lack just a little smoothness and finesse.

Measured Performance see p135

Ortofon Pilot

Ortofon's 510 MkII MM cartridge bids for budget gold in the first-time buyers' race. Richard White adjudicates.

As is well known, all the team at World Towers dine off gold plates and sleep under quilts stuffed with fivers. This pampered existence has not, however, blinded us to seeking value for money where hi-fi components are concerned. Once the ruby-encrusted waistcoats are off, we're as keen on a bargain as the next man. Happily, there are manufacturers willing to plug the gaps in the market for the impecunious, curious or plain 'just getting into vinyl'.

Ortofon's 510 MkII might be thought of as the company's 'starter pack' for hi-fi. They do make cheaper cartridges but these are mainly for disco use. The keen £39.95 price is about right for the new-comer and won't put off the seasoned vinylite who feels the need to maintain a turntable for old times' sake.

Fitting the new 510 to a Rega arm was a breeze. A quick alignment check proved similarly breezy since there are, thank goodness, enough 90° angles to the cartridge to save on unnecessary eye strain. Using a Black Plastic-improved counter-weight fitted to the Rega, I set the tracking force at the recommended 1.5gms and prepared to spin.

Elgar's Cockaigne Overture (digitally recorded) proved to be a very bright listen at times, to the extent that the undoubted power of the bass department could be a touch overwhelmed by the decidedly crisp treble presentation. Considering this piece's ingrained chirpiness, there was no audible trace of mistracking despite some heavy modulation on the sforzandi in the middle section.

Overall woodwind fared best with this cartridge; strings stopped a long way short of comb-and-paper



but lacked full body. On the other hand, there was a glorious moment of recognition when I realized that the organ had crept in and was growling away underneath, binding the orchestral parts into a noble whole. Now there's bass!

Following the clue given by the woodwind in the Elgar and wishing to play to the 510's strengths, I headed for the Shepherds' Pastorale from the Christmas Oratorio on Archiv. For a start, the wholly analogue recording put a lot of the gold-top back into the strings. For a next, the massed oboes of the Munich ensemble were in a fair way to charm the birds off the trees. Unable to tear myself away, I sat out the side to the 'Schlafe, Mein Leiben' lullaby, sung here by Christa Ludwig. The exquisite way in which the flute delicately shadows the vocal line proved a double-pointer to the 510's fortes.

In search of a triple-pointer, I tried the slow movement of the Fourth Brandenburg Concerto. A phenomenon noticeable with top-class diamonds, whereby the surface noise is 'played' separately and distinctly from the musical content, does not occur with lesser equip-

ment like the 510. As a consequence, this rather worn record showed a tendency to stereo muddle and a hint of tracing distortion on the more forceful recorder notes. Mark you, this sort of performance would have cost somebody a week's wages not so many years ago.

It's scarcely fair to put a budget cartridge through a Shure obstacle course but the 'Mais Que Nada' track on Side 2 has more uses than sibilance testing. In addition to 's' sounds which most cartridges play like a box of matches all being struck at once, there is a very broad sound stage to be accommodated. With the piano apparently firmly ensconced in the sideboard and the percussion in the kitchen, I knew that the 510 was safe in terms of separation at any rate.

Ortofon's budget babe doesn't cut the ground from under their more expensive offerings. All things considered, the 510 MkII has a forward slant which can be unforgiving with trebly records. A warm amplifier is best, if things are not to get too glossy, not to say gritty. Be that as it may, it is certainly sure-footed and won't damage your records ●

Ortofon 510 MkII
£39.95
Henley Designs
The Old Coach
House,
Crowmarsh Gifford,
Wallingford,
Oxon. OX10 8EH
Tel: 01491 834700

WORLD VERDICT



Excellent tracker at a good price. Warm amplification is needed to tame this sure-footed budget entry.

Measured Performance see p135

7 WONDERS OF THE HI-FI WORLD COMPETITION GIVE-AWAY!!

Come and enter our phone-in competition.

Dial the number under your chosen component and answer our multiple choice questions. It really is that simple.



Marantz MR2020 Layla - £500

This superb piece of equipment with its radical styling seeks to break the mould of conventional black-box hi-fi. Making up the package are a CD player and three-band RDS tuner accompanied by a pair of petite loudspeakers.

Q. What does the acronym RDS stand for?

- A1. Really Dire Souffle
- A2. Radio Data System
- A3. Rather Darling Sweetie

To leave your answer dial:- 0906 7340291

Denon TU-260L MkII - £129.99

Received a four globe World verdict June '99 issue. With its smooth, inoffensive sound and abundance of facilities the MkII is a worthy addition to the tuner line-up.

Q. In radio what do the initials FM stand for?

- A1. Ferrite matrix
- A2. Frequency Modulation
- A3. Frequently Modified

To tune in to the question dial:- 0906 7340295



Use the following guide for your chance to win any of the 7 prizes. All calls are charged at £1 per minute maximum call length 2 minutes:-

- A. Dial the telephone number under the product of your choice. B. Listen to the question:
- C. Press the corresponding button on your phone to select the answer you believe is correct
- D. Give your name, address and day-time telephone number, shortly after which the call will end.

3



Cura CA10 speakers - £699

British-made quality speakers. According to some retailers they sound superb with jazz, acoustic and classical music. So if mellow is your style, ring the digits on your dial and answer the following question:-

Q. Loudspeakers and pick-up cartridges are examples of?

- A1. Seducer
- A2. Transformer
- A3. Transducer

To leave your answer dial:- 0906 7340290



Harmon Kardon TC1000 remote control - £300

The remote control which has and does everything! This device can be programmed from its own screen or a PC and has the added benefit of being designed by none other than Microsoft! Try and interact with this remote!

Q. Who is the founder of Microsoft?

- A1. Bill Gates
- A2. Bill Clinton
- A3. Pearly Gates

To leave your answer dial:- 0906 7340292



5

4

Musical Fidelity X-24K DAC - £300

Another four-globe review for MF. This converter is crisp, detailed and dynamic and is a definite music maker!

Q. What does DAC stand for?

- A1. Digital to Analogue Converter
- A2. Digital Analogue Clock
- A3. Digital Audio Converts

To leave your answer dial:- 0906 7340296



6

Nordost Blue Heaven Cable - £149.95

This cable takes all the best attributes of the Super Flatline and manages to improve on them! Not a budget cable but definitely worth every penny.

Q. Which cables join hi-fi separates together?

- A1. Internet
- A2. Interconnect
- A3. Integrate

To leave your answer dial:- 0906 7340293



QED Qnect Silver Spiral (1m) speaker cable £90.00 & Genesis Silver Spiral (5m) speaker cable - £300.00

From the off-set the Genesis proved to be something special, especially when retrieving low-level detail; The Silver Spiral has fine transparency, grip and speed, and gives the competition at two or three times the money a very tough time.

Q. What is the name of QED's hit budget cable?

- A1. Connect 3
- A2. Queue net 5
- A3. Qnect 2

To leave your answer dial:- 0906 7340294



7

Rules & Regulations

The promoter is Audio Publishing Limited. The competition is open to all except the employees of AUDIO PUBLISHING Ltd, the manufacturers whose products feature in the competition and their families. The winners will be randomly selected from entries received by 29th June 1999 (closing date of competition). By entering this competition, entrants will be deemed to have accepted the rules stated herein. Entries may also be submitted by post and should be sent to Hi-Fi World, F21, Imex House, Kilburn Park Road, London NW6 5LF. No cash alternatives will be offered and no correspondence will be entered into. The telephone lines will be open from Saturday May 29th until midnight on Tuesday June 29th. Calls will be charged at £1 per minute. Maximum call length 2 minutes.

LONDON

SPECIALIST HI-FI DEALERS * SPECIALIST HI-FI DEALERS * SPECIALIST HI-FI DEALERS



think audio think...
Auditorium

0171 384 3030

THE HI-FI SHOP 112 NEW KINGS ROAD LONDON SW6



INSTANT 0% FINANCE AVAILABLE SERVING LONDON FROM BATTERSEA

ORANGES & LEMONS

Juicy fruit from London's newest, freshest hi-fi/home cinema retailer. Telephone demonstrations or just pop in. All the usual, i.e. friendly and efficient service, free home installation + credit cards.

THE INNOVATIVE AUDIO/VISUAL HI-FI RETAILER: ARCAM, CABLETALK, CHORD CO, DENON, EPOS, MARANTZ, NAD, NAIM, REGA, ROKSAN, ROTEL, ROYD, RUARK, SOUNDSTYLE, STANDS UNIQUE, YAMAHA.

NOW IN OUR FIFTH FLAMBOYANT YEAR.
0171-924 2040
61/63 WEBBS ROAD, SW11

O'Brien Hi-Fi



ARCAM • ANTHEM • AUDIOGRAM • AUDIO RESEARCH • AUDIO TECHNICA • BEYER • CABLETALK • CHORD • CREEK • DENON • DENISEN • JADIS • JEKLIN • MICHELL • MUSICAL FIDELITY • NAD • NAIM • OPERA • PRECIOUS METALS • QEO • REGA • ROGERS • ROYD • SENNHEISER • SILTECH CABLES • SME • SONNETEER • SONUS FABER • TEAC • THORENS • TRANSPARENT CABLES • UNISON RESEARCH • WILSON

MARLEN TORGAN COPI LAND

Clearance • Second Hand • Ex Dem Equipment • Details on request

0% Instant Finance Available
Written as a guide only

New Demonstration Rooms • Free car parking • Major Credit Cards
Personal Export • Mail Order • Installation Service • Repair facilities
5 mins walk Raynes Park BR • 20 mins Waterloo
5 mins from A3 (Raynes Park B282exit) • 25 mins M25 Junc 10

60 Durham Rd, West Wimbledon, London SW20 0TW
Est 1966
Tel: (0181) 946-1528 Fax (0181) 946-0331

AUDIO CONCEPTS

27 BOND STREET, EALING
LONDON W5 5AS
TEL. 081 - 567 8703

Audio Analogue, Art Glass, Ash Designs, Avik, B&O, B&W, Cabletalk, Chord Company, Creek, Denon, Epos, Harman Kardon, Infinity, KEF, Lat, Marantz, Musical Fidelity, NAD, Nakamichi, Nordost, Orelle, Onkyo, Primare, Quad, Roksan, Rotel, Ruark, Sennheiser, SonicLink, Sound Style, Stands Unique, Straightwire, Supra, Tag McLaren, Target, Teac, Thorens, van den Hul.

10 - 6 pm Mon., Tues., Friday, & Sat.
Late night Thur., closed Wed.

Two demonstration rooms.
Free local delivery and installation.
Repairs and Services

**TO ADVERTISE IN
SPECIALIST HI-FI DEALERS
PLEASE CALL
AMANDA or SARAH ON
0171 328 2213/0171 328 4892**

SOUTH

SPALDINGS
THE SOUTH EAST'S LEADING HI-FI COMPANY

3 DEM ROOMS A.V.
HOME DEMS., 0% CREDIT
FREE INSTALLATION

**LINN • NAIM • MISSION • KEF
DENON • TAG MCLAREN
MARANTZ • MUSICAL FIDELITY
CASTLE**

MON TO SAT 9.00 to 6.00, TUE 9.00 to 8.00 Closed
WEDNESDAYS

SEVICE DEPT
325-354 Lower Addiscombe Road, Croydon, Surrey CRO
7AF
Telephone: 0181 654 1231/2040 Facsimile: 0181 655 3922

WORTHING AUDIO
20 Treville Gate W.Sussex BN11 1UA
(01903) 212133

The friendly shop with the best sound system in the South.
Talk Electronics - Friendly Advice - 3 Year Guarantees
Easy Parking - Open Mon-Sat. 10am-6pm.
Late Night Wed 7.30pm.

Agencies include: Arcam, Exposure, Kinshaw, Naim, Audio, Marantz, Ruark, Audio Technica, Target, Tripod, JPW, TDL, Orelle, and many more.....

UNILET
Sound & Vision

Best place in town for Hi Fi and Home Cinema

- * Three demonstration rooms
- * All leading brands
- * Interest Free Credit
- * Good parking facilities

UNILET SOUND & VISION
24-26 UNION STREET, MAIDSTONE ME14 1ED
Tel: 01622 676703 Fax: 01622 676723

MIDDLESEX & SURREY

Front End Problem?
contact
The Cartridge Man

It doesn't have to cost an arm and a leg to get the best - listen to my Koetsu - and Decca - eater.

Also agents for Croft, Hadcock, Real Music Co, Michell & Moth.

plus cartridge re-tipping service

0181 - 688 6565

Stockists of: ARCAM • CREEK • EPOS • LINN • MERIDIAN • NAIM AUDIO • NAUTILUS 800 • NEAT • REGA • ROTEL • ROYD • SHAHINIEN • STAX • YAMAHA •

Infidelity
indecently good hi-fi

9 High Street, Hampton Wick, Kingston upon Thames, Surrey KT1 4DA. Tel: 081-943 3530
Open Tues - Sat 10.30am - 7.00pm.

UNILET
Sound & Vision

Best place in town for Hi Fi and Home Cinema

- * Six demonstration rooms
- * All leading brands
- * Interest Free Credit
- * Free Parking
- * Open 10-4 every Sunday

UNILET SOUND & VISION
35 HIGH STREET, NEW MALDEN, SURREY, KT3 4BY
Tel: 0181 942 9567 Fax: 0181 336 0820

AudioVenue
Respect Audio Visual Consultants
- ONCE IS NOT ENOUGH -



Nakamichi REIO Receiver Ortophon S10 Cartridge
X-PI00 & X-AS100 pre/power amplifier

- Export Orders Welcome
- Home Demonstrations
- Multi-Room Design & Installation Service

We at AudioVenue are committed to providing an unrivalled service together with state of the art equipment to achieve the ultimate in home entertainment, so whether you are buying, selling, exchanging or just looking for unbiased advice, ensure your first call is to AudioVenue.

Components from £120 - £72,000
0% Credit available. Written quotations on request. Subject to status.

NORTH

THE hi-fi ROOM

50 BRIDGE STREET, MANCHESTER M3 3BN. TELEPHONE: 0161-832 0883/0161-835 1366

An Oasis of Sound

EXCLUSIVE HI-FI AND AUDI VISUAL SYSTEMS

GLASGOW 0141 248 2857 EDINBURGH 0131 220 0909 NEWCASTLE 0191 230 3600 LEEDS 0113 242 7777

audio excellence

WHERE THE MUSIC MATTERS

CHESTER 68-90 Boughton, Chester CH3 5AQ (01244) 345576
PRESTON 131 Friargate Preston, PR1 2EE (01772) 253057

TUESDAY - SATURDAY 9.00 - 5.30
CLOSED MONDAY

Demonstrating some of the worlds finest HI-FI Home Demonstrations a speciality (see Dial-A-Dealer for complete product range)

Tel/Fax 0161 304 7494 Mobile: 07801 498934
Evening calls welcome

Input for the Pleasure of Music

SERIOUS KIT

The finest range of Hi-Fi in the north. Stockists of Audionote, Sugden, Impulse, Pro-Ac, Harbeth, Stempf, Target, Neat, Trichord, Systemdek, Lyra, Proceed, SME, Michell, Heart, Keswick etc etc

Open 10-6pm Mon-Fri
10-5pm Sat
10-2pm Sun

Phone: 0161 793 6742
Fax: 0161 727 7042

Soundcraft

INSTALLATIONS

VISIT THE LEADING HI-FI DEALER IN THE SOUTH EAST "SEE & HEAR THE DIFFERENCE REAL HI-FI MAKES"

LINN NAIM ARCAM REGA
HELPLINE: 01233 624441

Basically Sound

NORWICH • NORFOLK

Arcam, Audio Analogue, Cabletalk, Chario, Chord Co., Denon, Epos, Naim Audio, ProAc, Rega, Royd, stax, Talk Electronics, Teac, UKD Opera, Audio Note and many others

The Old School
School road, Bracon Ash
Nr Norwich, Norfolk, NR14 8HG
Tel (01508) 570829

Soundcraft

The best in sound advice from Kents premier audio dealer

Telephone our Customer Orderline: 01233 624441

Take advantage of our ex-demonstration clearance stock this month. Now is the time to buy that system you always dreamed of. All items listed are individuals sold with warranty, so you'll need to be quick!

We are even selling our reference Linn Keltik Aktiv system to make way for the new Climax power amplifiers. To guarantee your complete enjoyment some of our equipment may need to be delivered by our qualified installers. There may be a small additional charge for this service, but we will discuss that fully when you call.

Remember you can try before you buy in our period style listening and cinema rooms which are the perfect places to enjoy the delights of quality audio and video entertainment with your favourite recordings. Sit down, relax, trust your own ears and eyes, and our 50 years of experience.

Ex-display stock Loewe TV's: Calida 33inch (silver) £1195, Calida 21 (blue) £485 & Profil (black) 28 £985 + Sony KV28 WF1 widescreen £540 & Sony KV14 Portable £149

Ex-dem Summer Madness Clearance Sale ! July 1999

AE 120 Loudspeakers	£375	Musical Fidelity X-DAC	£199
Castla Avons (Birch)	£650	Musical Fidelity X-Pre&2 X-A50	£500
Derion AVC 2800 amp	£400	Musical Fidelity KT3 Spks	£950
Linn Majik	£450	Musical Technology Hawks	£950
Linn Kabers (black)	£1000	Musical Technology Condors	£800
Linn AV 5140 Speakers	£1400	Naim IXO Cross over	£250
Linn AV 5120 Centre	£495	Naim SBL Speakers	£1450
Linn LK100	£485	Naim Intro Speakers (black)	£499
Linn LP12/LV/Cirkus/K9	£900	Naim Cædo Spkrs (black)	£800
Linn Isobaniks (Walnut)	£1200	Naim NAP 180 Pwr amp	£850
Linn Keltik Aktiv System:		Rega Brio amplifiers	£199
3Clouts, Kaim + Keltiks:	£7500	Sony S315 DVD with free discs	£399
Linn Karik III CD	£1350	Sony DBR-925 AV amp	£450
Linn Numerik DAC	£1000	Shahinian Arc Loud speakers	£850
Linn Sara 9s (walnut)	£400	TDL T-Line 2 speakers (cherry)	£399

At 40 High Street, Ashford, Kent. TN24 8TE. Our exciting range includes: Arcam, Ruark, Linn (CD12 in stock), Loewe TV, Naim, Rega, Rotel & Musical Fidelity. We're open 9.5-30 Mon-Sat. Tel: 01253 624441 Fax: 01233 640333. All items come with a warranty for your security & peace of mind. Why not check out our web site <http://www.soundcraft-kent.ltd.uk>

MIDLANDS

CYMBIOSIS

AUDIO & VISUAL SOLUTIONS

WE MAKE IT HARD TO GET ON THIS LIST...

ARCAM · ACOUSTIC ENERGY · CASTLE · CHARIO · CURA
CHORD CO. · DENON · LINN HI-FI & KNEKT · LOEWE
LUTRON · MUSICAL TECHNOLOGY · NAIM · NORDOST
REGA · REVOX · ROTEL · TAG McLAREN · WADIA

6 HOTEL STREET
LEICESTER

TEL: 0116 262 3754
e-mail: shop@cymbiosis.com

...TO MAKE YOUR
CHOICE EASIER!

www.cymbiosis.com



THE LEAMINGTON HI-FI COMPANY THE LEADING HI-FI SPECIALIST

ARCAM AUDIOLAB QUAD MERIDIAN MARANTZ DENON PIONEER
YAMAHA MAD MICROMEGIA MISSION KEF CELESTION ATACAMA
TECHNICS TRICHORD TDL REL BKOS

SINGLE SPEAKER DEM ROOM WE DO NOT USE ANY COMPARETORS
WE ALSO HAVE FULL DEMONSTRATION OF PROJECTION TV WITH
LASERDISC AND FULL PRO LOGIC SYSTEMS

PART EXCHANGE WELCOME
PLEASE PHONE OR E-MAIL FOR PRICES
WE HAVE IN STOCK OVER 200 LASERDISCS
CALL FOR OUR LATEST CATALOGUE

THE LEAMINGTON HI-FI COMPANY
23a The Royal Street, Leamington Spa, Warwickshire CV31 5BJ
Phone: 01925 816644 Fax: 01925 817488 E-mail: l.brown@hbcoca.org.uk

FRANK HARVEY HI FI EXCELLENCE

The Midlands Largest Choice
of Specialist Hi Fi & Home Cinema

163 Spon Street, Coventry
Tel: 01203 525200
Web: <http://frankharvey.co.uk>

For real choice and the largest range of Hi Fi & Home Cinema products in the Midlands

Acoustic Energy - Atacama - Arcam - Audio Quest - Alphason - Apollo - Bang & Olufsen - B & W - Castle - Cable Talk - Celestion - Chord - Cyrus - Definitive Technology - Denon - IXOS - Kef - Marantz - Meridian - Monitor Audio - Miller & Kressel - Mission - Michell Gyrodec - Musical Fidelity - NAD - Optimum - Panasonic - Pioneer - Quad - QED - REL - Rega - Rotel - Sennheiser - Sharp - Tag McLaren - Target - Teac - Tannoy - Thorens - Van Den Hul - Yamaha

Much more in store on 3 Floors with 3 dedicated Hi Fi demonstration rooms of the very best Hi Fi
Plus our new Home Cinema Room. Very nice Staff and excellent coffee. Appts Req
Opening Hours 9-30 to 5-30, Tues to Sat. Closed all day Monday



INVEST IN OUR EXPERIENCE

SPECIALIST HI-FI DEALERS * SPECIALIST HI-FI DEALERS

REPAIR & DIY

TECHNICAL & GENERAL

THE ORIGINAL TURNTABLE SPECIALIST

for the Great Classical Turntable, Arms, Cartridges, Styli
 CONNOISSEUR • GARRARD • GOLDRING •
 Lenco • ORTOFON • SHURE • S.M.E •
 THORENS • WATTS

All available Genuine spares and our own
 re-manufacture of obsolete parts

NO ILLUSORY 'IMPROVEMENT' NO
 DUBIOUS OR HARMFUL 'MODIFICATIONS'

Cartridges and styli, correct radius diamonds, for early
 recordings - 78s & Lps

TECHNICAL & GENERAL

P.O.Box 53 Crowborough, East Sussex TN6 2BY
 Tel: 01892 65 45 34

VALVES & TUBES



Chelmer Valve Company
for audio valves

Buy CVC PREMIUM HI FI valves direct from us.
 All valves processed for improved performance.
 We also have stock of MAJOR BRAND types inc
 MULLARD, GEC, BRIMAR, RCA, GE, PHILIPS, etc.

130, New London Road, Chelmsford, Essex, CM2 0RG
 Tel. 01245 265865/355296 Fax. 01245 490064
 e-mail :- sales@chelmervalue.com

VINYL

MUSONIC STYLI

SPECIALIST MANUFACTURER &
 SUPPLIER FOR MORE THAN 40 YEARS
 REPLACEMENTS & ORIGINALS
 MANY OBSOLETE/78 VERSIONS
 PICK-UP CARTRIDGES
 & RECORD ACCESSORIES

For prices tel/fax/e-mail to:-

MUSONIC (UK) LIMITED

Unit 13 The Wentia Business Centre Colne Way
 Watford Hertfordshire WD2 4ND
 e-mail: musonic@compuserve.com
 Tel: 01923 213344 Fax: 01923 213355



WEST & WALES

audio excellence

WHERE THE MUSIC MATTERS

Bristol

65 Park Street
 Bristol BS1 5PB
 (01179) 264975

Gloucester

58 Bristol Road
 Gloucester GL1 5SD
 (01452) 300046

Exeter

156 Sidwell Street, Exeter, EX4 6RT
 (01392) 491194

TUESDAY - SATURDAY 9.00 - 5.30
 CLOSED MONDAY

Cardiff

134/6 Crwys Road
 Cardiff CF2 4NR
 (01222) 228565

Swansea

9 High Street
 Swansea SA1 1LE
 (01792) 474608

EIRE

Hearing is Believing

CLONEY
Audio
 10 years of Excellence

55 Main Street,
 Blackrock,
 Dublin.

Tel: (01) 2889449/2888477
 Open Tues - Sat 10 am to 6 pm.
 Thur - Fri 10 am to 6 pm.

Arcam
 B&W
 Tag McLaren
 Castle
 Meridian
 Classé
 Copland
 Marantz
 Jadis
 Naim Audio
 Sony
 REL

TO ADVERTISE IN

SPECIALIST HI-FI

DEALERS

PLEASE CALL

AMANDA or SARAH ON

0171 328 2213

0171 328 4892

SERVICES & CONSULTANTS

STUDER REVOX

SALES, SERVICE, SPARES

SERVICE & REPAIR OF

A77, B77, A700, PR99 &
 36 SERIES

HI-FI SPARES TO ORDER
 SERVICED MACHINES IN
 STOCK

APPROVED CONVERSIONS

E.M.A.S.

TEL: 01246-275479
 FAX: 01246 550421

atv

- Service & Repairs
- Valve & transistor amplifiers
- Vintage valve Radios
- Hi-Fi VCR's
- Valves Tested

ATV SERVICES
 LEATHERHEAD
 01372 456921

MAIL ORDER

*Russ
 Andrews*



KIMBER POWERKORDS

FROM £65

"By far the most cost effective
 upgrade ever, I wish I had done
 this years and thousands of
 pounds sooner."

Mr J Sealey, Southampton.

Call now for your free brochure
 quoting ref: ABHW0799

0800 373467 VH ONLY

Russ Andrews Accessories Ltd., Kendal, Cumbria, LA8 9AS
 Tel: +44 (0)1539 823247 www.russandrews.com
 E-mail: abhw0799@russandrews.com

TO ADVERTISE IN
 SPECIALIST HI-FI DEALERS
 PLEASE CALL
 AMANDA or SARAH ON
 0171 328 2213/0171 328 4892

The Jet Set

Little bigger than a shoebox, ELAC's Jet 310i 'speaker with its folded ribbon tweeter claims to have solved the perennial problem of small box, big sound.

When the Germans decide to pull out all the stops to make something look good, the results can be classic.

ELAC's Jet 310i has a Bauhausian air of top-grade industrial design to it which is a tonic after the totally unimaginative and tedious black boxes of most transducers. Equally refreshing is the technology which has gone into this tiny stand mounter.

Where common-or-garden loudspeakers are housed in MDF or chipboard enclosures, ELAC have gone the way of Celestion with their C series (and Musical Fidelity with their X range of electronics) and plumped for an extruded aluminium enclosure 208mm by 123mm by 282mm with walls 6.5mm thick. Tap this with your knuckles and you'll discover just how much more rigid it is than wood-based alternatives.

Bolted to the front of the extrusion (which ELAC are offering in black, white, silver and a limited-edition blue) are two unusual drivers. Uppermost is the JET ribbon tweeter constructed from a folded lamellar foil working against Neodymium magnets and hidden behind a slotted face plate.

Below this lies the TT115 KST long-throw woofer with its silver cone. Whilst this may look like most other metal-diaphragm units, it differs in having a paper pulp backing bonded to it to enhance its self-damping properties and lacking a dustcap.

To obtain a decent amount of bass from the cabinet, which is very deep front-to-back, a long port is fixed to the rear where you'll find the

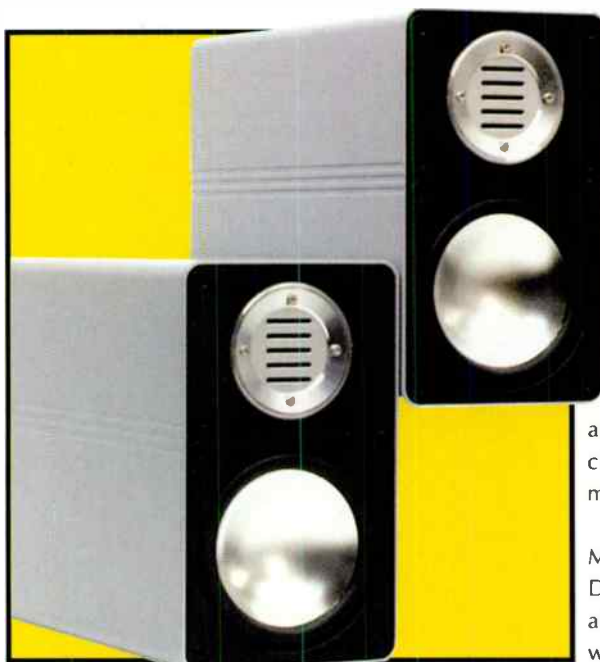

bi-wire terminals as well. On our review samples, these weren't linked in any way - ELAC obviously intend owners to bi-wire or bust.

To ensure that the innate 'snazziness' of the 310is isn't compromised by welded scaffold eye-sores, matching stands are available. The loudspeakers actually bolt to these instead of perching on spikes for the closest coupling.

Suitably set up, the ELACs were run in over the course of a weekend before being scrutinised through a Trio L-07D/SME V/Cartridge Man Music Maker and clocked Kenwood DP-X9010/Pink Triangle Cordinal connected to one of MVL's A2+ integrated amplifiers. Loudspeaker cable was QED's Profile Silver 12.

As you might expect from a be-ribboned loudspeaker with a small front baffle, the 310is had great clarity and detailing. Unfortunately, this

talent for delving into recordings proved just how many of my charity-shop special LPs have suffered groove damage, particularly on sibilants. Where soft-domes and even the superb Magneplanar SMGas had given these tired discs the benefit of the doubt, the JETs approached them from a 'warts and all' angle, but without sounding clinical or compromising on musicality.

Swapping to CD with Moloko's I Am Not A Doctor, I grilled that alloy/pulp driver. In keeping with its low mass, this packed plenty of genuine

punch in the upper bass where dynamics and finesse were the watch words. Lower down, there was decent extension for the size of cone and box, even if it wouldn't have subwoofer designers running for cover.

The JETs are extremely transparent devices capable of top-notch image focus and sound staging with minimal coloration (although, if you push them hard, they do start to 'thicken' in the bass). The midrange is every bit as open as the treble thanks to a happy marriage between tweeter and mid/bass, but the bottom-end doesn't have quite the same lucidity. Still, they head the stand mounter pack at under £1000 in sound as well as style.

ELAC Jet 310i
£799.90

Sennheiser
3 Century Point,
Halifax Road,
High Wycombe,
Bucks. HP12 3SL
Tel: 01494 551551

WORLD VERDICT



Lovely fast, clear sound majors on musicality. 10-year guarantee too.

Measured Performance
see p135

A REFERENCE GUIDE TO BRITAIN'S MANUFACTURERS AND DISTRIBUTORS.

ALCHEMIST PRODUCTS Call us and allow us to transform your life with products from an acclaimed range of Amplifiers, CD's and Pre-amp...

ALEMA LTD 103 South Street, Lancing, BN15 8AS. Tel. 01903 750755/6. "AUDIOPHILE" "EDISON" "DAC" "AMP" Europe's Leading Brands...

APOLLO The UK based designers and manufacturers of high quality speaker stands and equipment racks have now added to their comprehensive range...

ARCAM Pembroke Ave, Denny Industrial Centre, Waterbeach, Cambridge, CB5 9PB. Tel. 01223 440964...

AUDIOPHILE FURNITURE LTD The Square, Forest Road, East Sussex RH18 5ES Tel. 01342 826262. Fax: 01342 824845.

AUDIO SYNTHESIS Manufacturers of the the outstanding DA Converter, Logog converter, comes DAx-2, a new Hi-End reference convertible...

BORDER PATROL 63 Berriedale Avenue Hove BN3 4JD Tel/Fax 01273 276716. Manufacturers of Power Supply Units for valve amplifiers...

CABLE TALK Unit 12, Farnborough Business Centre, Elmour Road, Farnborough, Hampshire GU14 7XA. Tel: (44) (0)1252 37334.

CAMPAIGN AUDIO DESIGN Llandudno Road, Cardiff CF3 8PG. Tel: 01222 779 401. Suppliers / manufacturers mailorder...

CANFORD AUDIO PLC Crowther Road, Washington, Tyne & Wear, NE38 0BV. UK Sales 0191 415 0205. Fax: 0191-416-0392

CHORD ELECTRONICS LIMITED 3 Bower Mount Road, Maidstone, Kent ME16 8AX. Telephone: 01622-764874. Fax: 01622-688480.

CREEK AUDIO LTD 2 Bellevue Road, Friars Barnet, London N11 3ER Tel: (0181) 361 4133. Fax: (0181) 361 4136.

DAC. See our home page for further details or call us for leaflets.

DBS AUDIO P.O.Box 91 Bury St Edmunds, Suffolk, IP28 6RY. Phone: 01284 811891. Fax: 01284 811791.

EMINENT AUDIO Distributor of Croft Valve Amplification. Tel: 01902 656517. Fax: 0121 818177.

FALCON ACOUSTICS LTD Tabor House, Norwich Road, Mulbarton, Norwich, Norfolk, NR14 8JT. Tel. (01508) 578272.

FULLERS AUDIO 20 Tunbridge Road, Southend on Sea, Essex S52 6LT. Tel: 01702 612116.

IAN EDWARDS The Old Chapel, 282 Skipton Road, Harrogate, Yorks. Tel. 01422 500442.

IPL ACOUSTICS are a long established supplier of high quality speaker kits, components and PTFE Silver cables.

JAMO UK LTD Jamo House, 5 Faraday Close, Drayton Field, Daventry, Northants. Tel: 01327 301300

JEM DISTRIBUTION (FI RAX) Springfield Mills, Spa Street, Osssett, Wakefield, WFS DHW. Tel: 01924 277626.

JORDAN WATTS ACOUSTICS LTD Cyntia Place, 201 Mare Street, Hackney, London E8 3QE. Tel. 0181 985 1646.

KESWICK AUDIO RESEARCH 54 Coach Road, Outwood, Wakefield, W Yorks, WF1 6XJ. Tel/Fax: 01924 870606.

KRONOS DISTRIBUTION 7 Scotch Street Centre, Dungannon BT70 1AR Tel: 01868 753606.

LANGREX SUPPLIES LTD 1 Mayo Road, Croxall, Fenner, CRO 2QP. Tel: 0181 684 1166.

LORICRAFT AUDIO "Vintage DIY" 4 Big Lane, Gooose Green, Lambourne, Berks. RG17 8XQ. Tel. 01488 72627.

MARSTON AUDIO 17, Queens Avenue, King's Lynn, Norfolk, PE30 5LR. Tel: 01553 772875.

MAY AUDIO MARKETING U.K. LTD Areside Mills, Cononley, Keighley, West Yorkshire, BD20 8LW. Tel: 01535 632700.

MICROMEGA distributed by Surrey Sounds. 32-33 Enterprise House, Terrace Road, Walton On Thames, Middlesex, KT12 2SD. Tel: 01932 234297.

MORGAN AUDIO SYSTEMS LTD A range of equipment hand built in the UK, consisting of a CD player / D.A. converter / integrated & pre/amp amplifiers.

NORTON TECHNOLOGIES LTD Manufacturers of the acclaimed AirPower LP12 power supply. 14 Rochester Avenue, Chelmsford CM2 9BU. (01245) 283125

NOTTINGHAM ANALOGUE STUDIO Tel: 01773 762947. Design and manufacture of quality analogue audio. We're in the business because we realise how important music is.

OPUS3/PENTACONE. Natural Acoustical music recorded on CD & LP. Three Dimensional, Dynamic and Live. SYSTEM HARMONISING. A service to extract the full potential of your hi-fi equipment.

PLATFORM 7 High density marble ISOLATION RACKS/STANDS. An elegant way to UPGRADE. Improves clarity, better BASS control.

P.M. COMPONENTS LTD Are the specialist component company for high end audio enthusiasts. Also carbon tubes/audio valves.

PREMIER MARBLE LTD Uncover the true sound quality and potential of your system. Use the natural benefits of granite and marble.

REL ACOUSTICS North Road, Bridgend Ind Est. Bridgend, Mid Glamorgan, CF31 3TP, UK. Tel. 01656 768 777.

RDE TANDBERG HI-FI SERVICES Holly Rise House, Tuffness, Full Sutton, YORK YO26 1HW. Tel: 01759 372795.

ROTHWELL ELECTRONICS Specialist amplification for discerning audiophiles. Pure power amps and pre-amps with stepped attenuator volume controls.

SHEARNE AUDIO P O BOX 22, Stevenage, Herts SG2 0HF, England. Tel: 01438 740953.

SONIC LINK The Derwent Business Centre, Clarke Street, Derby, DE1 2BU Tel: 01332 361390. Fax: 01332 206098.

SOUND BYTES 72 Navar Drive, Hyndland, Glasgow, G12 9JY. Tel: 011 339 7595. Fax: 0141 339 7592.

SOUND IMAGE UK LTD, 52 Milton Road, London SW14 8JL. Tel: 0181 -255-6868.

JE SUGDEN & CO LTD Valley Works, Station Lane, Heckmondwike, West Yorkshire, WF16 0NF. Tel: 01924 713108.

TALK ELECTRONICS Unit 12, Farnborough Business Centre, Elmour Road, Farnborough, Hampshire, GU14 7XA. Tel: 01252 378383.

TAG McLaren AUDIO Cambridge Systems Technology Ltd, Spitfire Close, Ermine Park, Huntingdon, Cambs. PE18 6XU. Tel +44 (0)1480 415600.

TARGET AUDIO PRODUCTS PLC Britannia House, Leagrave Road, Luton, LU3 1BJ. The Audio equipment, rack and speaker stand specialist.

TECH-LINK distributes some of the best performing hi-fi and a/v accessories currently available in the UK.

TEAC 5 Marlin House, The Croxley Centre, Watford, WD1 8YA. Tel: 01923 819630.

TRICHORD RESEARCH LTD Following on from the highly acclaimed CD clock oscillator modifications the Pulsar Series One digital to analogue converter.

VADIS AMPLIFIERS Kirkland, 32 Head Street, Beth, Ayrshire KA15 2EU Tel: 01505 504128.

WILMSLOW AUDIO, 50 Main Street, Broughton Astley, Leicestershire LE9 6RO. Tel: (01455) 286603.

SERVICES & CONSULTANTS

RJF AUDIO VISUAL tel 01209 612260/010777 Fax 01209 711939. A.K.G., Atacama, Audioquest, Audio Technica, Beyer, Chario, Denon, Goldring...

STYLI

MUSONIC UK LTD Specialist manufacturer & supplier of replacement & original styli for more than 40 years.

To advertise in Meet Your Maker call Amanda or Sarah on 0171 328 2213/ 0171 328 4892

HI-FI WORLD

Buying Guide

Our comprehensive new guide contains over 1000 hi-fi components, all tried and tested by Hi-Fi World's listening team. Backing up each one is our performance verdict to help you select the perfect upgrade or first purchase. Happy reading!

Contents

Loudspeakers	68
Integrated amps	71
Pre-amps	73
Power amps	74
CD players	75
Turntables	77
Phono stages	78
Cartridges	79
Tone arms	79
Tuners	81
Cassette decks	81
DVD players	82
Headphones	82
CD transports	82
Classics	147

Loudspeakers £ Year Verdict

Under £300

Acoustic Energy AE100	£200	Jan 96	Reasonably neutral but ultimately lacklustre. Control of treble and mid-range poor.
Audio Gem Opals	£240	Dec 97	Partner the Opals with warm ancillaries and you get an involving sound. Avoid bright amps and sources.
Aura LSB-627M	£230	Aug 98	Energetic, bold and highly detailed, the Aura is one to consider for the budget-conscious.
Aura LST-627	£299	Oct 98	Like Aura's matching stand mounters, the 627Ms are lucid and controlled. Treble is brightish.
B&W 601	£200	Jan 96	Unrestricted and clean sound with satisfying musicality. An engaging subtlety not common at the price.
B&W DM302	£130	Apr 96	Clear open and detailed sound but balance too forward and weak bass.
B&W DM602	£250	Nov 96	Excel with taut hard-hitting bass with dynamic and uncoloured midrange. Metal dome tweeter bleaches out the treble.
Boston CR6	£150	Sep 98	With simple music, the CR6s work well, but not quite as well as the best of the competition.
Castle Isis	£230	Jan 96	A lively little animal, well worth the money.
Celestion 12i	£119	Feb 98	The 12is' powerful, confident sound belies a rather poor measured performance.
Celestion Impact 15	£200	Jan 96	Big presentation but a rather distant quality. Could sound boomy and confined.
Celestion Impact 23	£299	Nov 96	Sterling performance in the bass with speed and control. Good midrange projection.
Charlo Hiper 1000	£299	Feb 99	Quality construction and sound marry to produce a very capable 'speaker. Open treble and firm bass for the size.
Eitax Liberty 3+	£150	Jan 98	A lot of loudspeaker for the money. Punch and slam in the bass but sometimes thin in the treble.
Eitax Symphony 6	£240	Nov 96	Although bright, the Symphony 6s score for clarity and power. Bass is fast and accurate.
Gale 2i	£140	Feb 97	Smooth, balanced performers that do a good job on any genre. Free from the nasties that afflict many at the price.
Gale Mini Monitor	£50	Apr 97	Not the last word in midrange or bass clarity, but gives real hi-fi results for a paltry £50.
GLL ICT100	£170	Nov 95	For their size and price they offer some super qualities, especially stable imaging.
Heybrook Heylette	£270	Jun 98	A mini monitor with more precision and dynamism than the size and price tag would suggest.
Heybrook Optima	£259	Oct 98	Capable all-rounders, the Optimas combine smoothness, insight and control to great effect.
Heybrooks HB1 S3	£269	Nov 96	Excellent imaging with clear treble and midrange. Bass slightly dry and boxy but would suit a smaller room.
Jamo CS5 Actives	£200	Oct 98	In spite of a few colorations, the Jamos are fine examples of budget active operation.
JPW ML510	£130	Jan 98	With greater transparency and a bit more get-up-and-go, the 510s could be leaders of the budget pack.
Kef 60S	£200	May 96	The 60S is open and detailed but coloured too.
Kef Coda 7	£129	Apr 95	Rhythmic push and tuneful bass are the plus points of these small standmounts.
Kef Coda 8	£200	Jan 96	Breezy presence, good dynamics and a sense of fullness. Not the utmost in clarity, some box colouration.
Kef Coda 9	£299	Jul 96	Strong bass can get out of control, as can treble. This tends to overpower the midrange.
Kef Q15	£199	Feb 97	Impressive bass and a sweet clarity make the Q15s 'speakers that'll put a smile on any audiophile's face.
Kenwood LS90UK	£129	Jul 98	The LS90UKs have dry bass and limited tonal colour, but staging and imaging are superb.
Linn Sekrit	£298	Apr 96	Well-behaved and with a decent tonal quality.
Mission 700	£130	May 98	The 700s are easily outclassed by Mission's own superb 731 Pros at a £10 premium.
Mission 731	£129	Apr 95	An initially impressive, upfront sound but ultimately a little uninvolved.
Mission 731 Pro	£139	Jul 97	Music makers with a clean, punchy sound. Real value for money.
Mission 731i	£130	Nov 96	Mission's babies are a truly worthwhile improvement on the original 731s.
Mission 731LE	£150	Nov 95	Excellent sound puts the competitors in the shade. Well built and pretty too!
Mission 732i	£200	Aug 97	If you've got £200 with 'loudspeaker' written on it, then the 732i should be on your shopping list.
Mission 771	£170	Jul 98	Superb stand mounters of real refinement and musicality. A touch bass light.
Mission 772	£230	Apr 99	Civilised standmounters which lack nothing in control, finesse or transparency.
Monsoon MM-1000	£200	May 99	A novel multi-media two-satellites-and-sub which nevertheless demands to be taken quite seriously.
Mordaunt-Short MS20i	£200	Jan 96	Very tight bass and an all-round big sound. Some sharpness in the treble but assertive and clear.
Nad 801	£100	Jun 97	Impressive bass with midrange clarity are pluses. Prominent treble stops the 801 from challenging the best.
Paradigm Mini Monitors	£230	Aug 97	The Paradigms have a generally enjoyable sound but treble is sharp and midrange recessed.
QLN 122	£270	Jun 96	Solid bottom end will drive a large room well, but they're a bit bright too.
RDL RA Labs Mini Ref	£99	Jul 95	Engineering is not tip-top, but with a smooth system they will produce a clear and open, if bright, sound.
Revolver Purdey	£200	Jan 96	Rather small sound for a big cabinet. Absence of deep bass hard to forgive.
Rogers LS1	£149	Feb 96	Clear, bright and open but with weak bass. Best used close to or against a wall.
Rogers LS33	£250	Nov 96	Detailed and clear with a forward midrange. Could be a little rough on vocals; bass extension is limited.
System Audio 1005	£299	Aug 96	Excellent all-rounder that provides a real open window into almost every genre of music.
Tangent Monitor 11	£200	Nov 97	The Tangents' bass has attractive speed and impact, matched with smooth treble and open midband.
Tangent Monitor 2	£60	Jul 96	Good imaging as well as control. Tweets a bit too much but more than fine for the money.
Tannoy Mercury m1	£120	Jun 98	The best at the price and capable of embarrassing many more expensive 'speakers.
Tannoy Mercury m2	£140	May 97	For £140, you get a 'speaker with transparency and enjoyability unmatched at the price.
Tannoy Mercury m3	£240	Nov 97	Even overall balance and taut secure bass, if not the deepest ever. Slightly lightweight and uninvolved.
Tannoy R1	£199	Nov 98	Worth an audition if you need to balance a bright source and amp, but treble lacks clarity.
TDL NFM 1	£120	May 97	Bright treble is partially balanced by taut, well integrated bass, but outclassed by the competition.
TDL Nucleus 1	£60	Apr 97	Clean, incisive, detailed and revealing, especially in the bass.
W'dale Active Diamond	£180	Mar 99	Great value introduction to active. The sound is deep and powerful but could be a little coloured for some.
Wharfedale Valdis 300	£150	Jul 96	Can work well if partnered to give weighty bass and smooth treble.



Blue Room Mini Pod.



Aura Speakers.

Loudspeakers £ Year Verdict

£300-£799

B&W CDM1SE	£600	Apr 98	Tuneful and confident, these 'speakers are well suited to Pop and Dance music.
B&W DM305	£350	Mar 97	All the ingredients for listening fun are mixed into the DM305. Overall presentation could be more cohesive though.
B&W P4	£600	Mar 95	Good-looking solid 'speakers with great spirit and tenacity but with a dry treble. Not fans of classical music.
Blue Room Minipod	£400	Jan 97	Arresting style allied to an engaging sound makes the Minipods attractive. Best with smooth amps and source.

AUDIO ANALOGUE

In just a short while, Audio Analogue has won plenty of admirers. When Hi Fi World tested the *Puccini* Special Edition, they gave it their top star rating with the words

"Excellent sound quality ensures the *Puccini* S.E. outstrips the competition at up to £1,000". And the influential USA magazine *Stereophile* (Dec 98) praised its "harmonic richness, stunning purity of tone and sheer musicality". To top that,

the basic £475 *Puccini* won Hi Fi Choice's Best Buy for amplifiers in an up-to £1,000 group test (Feb. '98). In their words: "This is a first-rate budget amplifier that looks and sounds like an altogether more costly model. Check it out". The *Bellini* preamp and *Donizetti* power amp fared equally well. Ken Kessler in Hi Fi News (Jan. '98) had this to say. "A new benchmark in the value for money stakes". Now, we're proud to introduce you to the

latest member of the family: the *Paganini*. It's a real music-lover's CD-player. For more details contact:

UKD

23 Richings Way, Iver, Buckinghamshire SL0 9DA, England
 Telephone: 01753 652669 - Telephone: 07000 UKD HIFI (853 443) - Fax: 01753 654531
 Or visit our website: www.uk.co.uk

Loudspeakers £ Year Verdict

£300-£799

Carlsson OA 50.2	£585	Dec 98	Acoustic music gels nicely. More artificial pieces sometimes don't work so well.
Castle Avon	£699	Dec 96	Taut, dry bass and lucid midrange but need matching to warm ancillaries to avoid sounding bright. Castle
Hartech	£799	Aug 96	Bass power and extension will impress but overall sound is uneven and rather sterile.
Castle Kendal	£450	Mar 98	The Kendals have great clarity but need coupling to warm ancillaries.
Castle Severn II	£579	Jul 98	Apart from some harshness in the tweeters, the Severn 2s are accomplished all-rounders.
Chario Hiper 1	£399	May 95	Music makers through and through with a great feel for rhythm and dynamics.
Charlo Lynx	£549	Apr 99	The Lynxes are superbly built but their rising bass and treble suit home cinema more than hi-fi.
Dali 450	£700	Feb 96	A powerful and rich sound from these competitively priced floorstanders makes them worth a recommendation.
Epos ES12	£495	Oct 96	Strong, punchy bass allied to detailed and articulate midrange and treble.
Heybrook Heylios	£339	Mar 97	The Heylios stand out for their bass depth, dynamics and sound staging. Overall balance prefers Classical to Rock.
Heybrook Heylo	£389	Oct 95	Posses a neutral, fast and dry sound. A good match for soft sounding systems.
Jamo 307	£300	Apr 95	Delicate, detailed sound, albeit with rather imprecise imaging. Will work well on a bookshelf.
JPW ML910	£300	Nov 97	The 910s aren't perfect but they make music fun. Quality, power and extension, the Milleniums are worth a listen.
JPW Ruby 2	£395	Oct 98	Once allied to warm electronics, the Ruby 2s mix insight with plenty of involvement.
Kef LS3/5A	£599	Jul 95	Partnered with the Rogers AB1, this is a substantial marriage.
Kef Q35	£350	Nov 97	Very accomplished midrange and treble but the dry in the bass. For Rock fans the upper bass speed is appealing.
Kef Q55	£499	Aug 97	The Q55s look rather expensive at £500 with their 'boom and tizz' presentation.
Kef RDM1	£499	Oct 97	The RDM1s soundstage well thanks to their Uni-Q drivers. Can be uninvolving because of a lack of scale and impact.
Linn Tukan	£389	Dec 95	Highly musical standmounters that give similarly priced floorstanders a great deal to worry about.
Meridian A500	£750	May 95	Very polite and many will appreciate their civility. Deep powerful bass.
Mission 733	£300	Apr 95	Captivating floorstanders that bring music to life - what good hi-fi should do.
Mission 734	£430	Sep 95	Engineered for low price and showroom appeal rather than absolute sound quality.
Mission 751 Freedom	£350	Apr 97	Charming little stand-mounters with a sweet, warm, musical sound.
Mission 752 Freedom	£578	Jan 97	Dynamic, punchy, and musical yet refined like few at the price. Bass lacks a little depth.
Mission 774	£500	Feb 99	With the right ancillaries, the 774s have a clarity and lack of colouration still rare at the price.
Mordaunt-Short MS25i	£300	Nov 96	Sweet sounding metal dome tweeter although the dry bass and rather plasticky midrange work against it.
Musical Technology PM15	£474	Jan 99	Sophisticated, neutral sound and fine musicality put the PM15s near the head of the class.
Near 10M	£500	Jan 96	A thin and hard sound but precise with it!
Neat Critique II	£445	Jan 99	Deserving 'speakers with good looks and build. Can fail to shine with over-polite equipment.
NHT 1.3	£389	Aug 95	Very crisp sounding 'speakers best suited to smaller rooms.
Opera Prima	£495	Feb 99	The Primas offer a taste of the high-end at a sensible price. They are more fans of Classical than Rock though.
Ortofon ConCorde 6	£329	Oct 95	Good value floorstanders with clean enjoyable sound - not quite supersonic, though.
Polk PSW150	£500	Jul 97	The PSW150 adds depth to a system but can sound obvious at times.
Proac Tablette	£600	Aug 98	Amp-sensitive and slightly boxy in the lower treble, the ProAcs are still highly musical.
Rel Q Bass	£350	May 96	Needs care in setting up but this subwoofer offers serious quality bass for not a lot of money.
REL Q100E	£500	Apr 98	Another capable sub from REL that boosts bass and improves sound staging.
Rogers AB 1	£499	Jul 95	When used with the Kef LS3/5a this sub delivers the goods, beyond a doubt.
Roksan RokOne	£595	Feb 97	Musically involving 'speakers that many will enjoy, but a little unrefined at times.
Sequence 400	£329	Apr 96	Good at orchestral scale but coloured in the midband.
Soundcraft Absolute 4P	£799	Oct 97	The Absolute 4Ps excel in all areas except for the rather bright, hard treble. Bass is exceptional.
Spendor 2030	£599	Jun 96	Smooth, focussed and coherent in their delivery with deep and taut bass extension. Not the most spacious sound.
Systemdek 165	£400	Feb 96	Dry and clean sound, but can become hard and confused when pushed.
Tannoy Precision P10	£300	May 98	Though very even in their performance, the P10s lack ultimate clarity and punch.
Tannoy Profile 633 plus	£300	Nov 96	Weighty bass and rhythmic detail work well on dance. Less satisfying with classical music. Firm imaging.
TDL RTL 4	£650	Feb 95	Easy going with plenty of detail and timbral richness. Better with classical fare.
TDL T-line 2	£550	Jan 97	Midrange and treble have good tonal colour, detail and speed. Bass is slow and blurred.
Technics SB-M300	£350	Nov 95	A great sound with solid bass from a compact and well priced 'speaker.
Technics SB-M500	£450	May 96	Clean, dry and taut with good imaging and sound staging. More neutral than Mission's 752s but less euphonic.
Triangle Comete TZXe	£475	Jan 95	Quite pleasant, inoffensive sound but others costing less can offer more.
Wharfedale Valdis 500	£300	Oct 95	Good for adding scale and power to a weak system of budget separates.



JPW Ruby 2.



Soundcraft Absolute 4P.

Loudspeakers £ Year Verdict

£800-£1499

Audionote E	£1450	Mar 95	Big, bulky and ultra-sensitive with quick pace and a well balanced sound, but not without flaws.
Audiovector M1 Sig.	£1479	Aug 98	The M1 Sigs may be a little laid-back, but they have a pleasant and involving sound.
Audiovector M2	£1499	Jun 98	The M2s are marred by a boom 'n' tizz presentation that suits Heavy Metal but not much else.
B&W CDM7	£999	Feb 98	With warm ancillaries the CDM7s produce a weighty, open sound. Bass could be faster.
Castle Howard S2	£1099	Mar 96	Fantastically deep and tight bass but some treble sharpness requires careful matching.
Celestion A2	£1499	Jun 98	Focus is not a strength, but bass extension and even tonality are. Metal tweeter can be bright.
Chario Academy One	£1199	Dec 95	Musical realism and a great real-wood finish make these 'speakers enjoyable, if not perfect.
Dipason Karis	£1250	May 99	Small cabinet precludes the deepest bass, but a sweet little act for all that. Seriously imaging abilities.
Epos ES22	£1185	Jun 98	Aside from a slightly cool balance, the ES22s shine. Dynamics, bass depth and control are tops.
Event 20/20BAS	£829	Sep 98	Warm, detailed and well-endowed in the bass, the Events lack only a touch of overall control.
Harbeth DPM1 Active	£849	Sep 98	Now HHB's Circle Actives, these loudspeakers mix the best of pro and domestic to produce first-class results.

Total customer care

1. Expert, impartial advice on all aspects of audio & video, given by trained staff
2. Products specially selected for quality, performance and value
3. Personal demonstrations - Listen before you buy!
4. A home delivery and installation option - for optimum performance

Total peace of mind

1. A 10-day purchase exchange programme (returns as new & excluding special orders)
2. BADA's Free extended 2-year Guarantee on all new hi-fi and home cinema separates
3. The option to transfer the Guarantee to any one of 120 BADA members nationwide
4. Deposits safeguarded by the BADA Bonding Scheme



BADA
BRITISH AUDIO DEALERS ASSOCIATION
the symbol of security

BRITISH AUDIO DEALERS ASSOCIATION

P.O. Box 229 London N1 7UU Phone: 0171 226 4044

Fax: 0171 359 7620 E-mail: bada1@compuserve.com

For further information please see our web site: <http://www.bada.co.uk> or ring for our information pack

BADA acknowledges the support of the following Associate Members: Alphasound, The Chord Company, Dolby Labs, Heybrook, Jamo, KEF, Kenwood, Meridian, NAD, Pioneer, Polk, Sennheiser, Sony, Vivanco

- Integrated CD player
- Integrated amplifier
- Tuner
- Power amplifier
- DSP Surround sound processor
- 5 Channel AV amplifier

Finish: silver or matt black

MODE CD TUNER VIDEO LINE 1 LINE 2 TAPE

ROKSAN

Caspian
whichever way you look at it...

...its award-winning

Roksan Caspian system – January '99
Best Buy
CD player/amplifier/speakers



Caspian – '98 winner
Best Buy
Integrated/Power amp
from £1000



Caspian – '97 winner
Best amplification
component up to £1000



Roksan was formed in 1985 to offer sound reproduction systems of the highest quality for the most discerning of music lovers.

Today... nothing has changed, except of course the products... same standards – but now more affordable.

ROKSAN

ROKSAN Audio Limited
15B Atlas Business Centre
Oxgate Lane London NW2 7HJ
Tel: +44 (0)181 830 7722 / 7733
Fax: +44 (0)181 830 7744
Email: info@roksan.co.uk
www.roksan.co.uk

Loudspeakers £ Year Verdict

£800-£1499

Harbeth HL Compact 7	£1329	Jun 96	Dry and analytical but truthful with it. A first class monitor ideally suited to acoustic or classical music.
Harbeth HL K6	£975	Dec 96	Clean, musical and classy - Harbeth have done themselves proud again!
KAR Torino	£895	Jan 97	The Torinos' stylish sound won't shame any system. That powerful bass does need space to breathe properly though.
Kef Reference 1	£995	May 95	Beautifully fluid and integrated mid band and treble but can be slow, with a little loss of bass control.
KEF Reference 2	£1499	Jan 95	Handles rock and classical with equal aplomb, with the ability to reproduce detail that flummoxes many other models.
Kelly KT3	£1199	Apr 98	The KT3s go very loud very easily but they don't possess the most even response.
Klipsch Heresy II	£1150	May 99	Horn and infinite-baffle hybrid with power to spare. Phasing and frequency accurate beyond belief.
KRK V8	£995	Sep 98	Ultra-detailed and revealing, the V8s are true pro more than domestic transducers.
Magneplanar MG 0.6 SE	£1370	Mar 95	Very clear detail and separation, but just fails to produce a fully 3-dimensional sound.
Magneplanar MG12/QR	£1200	May 99	Lightness of touch, dynamics and clarity in trumps. Needs powerful amplification for 77dB/W/m. Not a valve 'speaker.
Mirage 890i	£1075	Oct 95	An easy going, open and natural sound makes the mirages an attractive proposition.
Mitsun 754 F5	£1299	Sep 96	Articulate and informative sound with fine imaging and tight, deep bass.
Mordaunt Short 860	£1450	Dec 95	Fast, tight and informative, but a poor tweeter casts a grey shadow.
Musical-Tech Falcon	£955	May 96	Give a big sense of scale on rock and jazz but not subtle and even enough for the critical classical listener.
NEAR Soundmast	£1199	Aug 95	An interesting, musical floorstander that's good value even at this price.
Origin Live Sovereign	£1225	Jun 98	The OLs have transparency and detail in considerable amounts. Bass can be loose though.
PT Ventricle	£896	Aug 95	Smooth and refined floorstanders that some listeners will find captivating.
QLN Signature	£1499	Mar 96	Super sound staging, openness and detail. Well worth seeking out.
REL Stadium 2	£995	Aug 95	Excellent bass performance means that this subwoofer is no toy.
Roksan Ojan 3	£1000	Jan 98	Unusual 'speakers with great rhythmic capabilities and bass. Could be more transparent.
Ruark Paladin	£1099	May 95	The Paladins possess a detailed and expansive soundstage but also a rather dry character
Spendor 2040	£899	Oct 96	The tweeter works well but a recessed midband and one-note bass are the Achilles heels.
Spendor FL8	£1275	Jun 98	The FL8s are warm, mellow performers which prefer Classical to Rock.
Tannoy D300	£1000	Apr 97	Impressive bass extension and control go hand in hand with precise imaging to make the D300s a snip at £1000.
Totem Model 1 Sig.	£1250	Sep 97	Good but the move from standard to Signature has taken speed and punch out of the Model 1s
UKD Callas Gold	£995	Jun 96	A rich and open sound, extremely musical if not strictly accurate. Great bass extension for their size.
UKD Divina	£1390	Jun 95	Not the most neutral 'speakers but they are extremely smooth with an overall coherence to the sound.



Jamo Concert 8.

Loudspeakers £ Year Verdict

£1500-

Audiovector 6	£4600	Jun 95	If you have enough room and money the 6s are capable of a highly musical, involving performance.
BKS 107 MkII	£1500	Dec 98	The 107 Mk2s may look slim but they have a solid sound and are fabulously revealing.
Cadence ES	£3500	Sep 95	Interesting design that incorporates an electrostatic tweeter. An impressive sound but an inconsistent performer.
Carlsson 52.2	£1500	May 99	Unusual design which is placed back against a wall for optimum performance.
Celestion A3	£1800	May 97	The A3s are quite simply superb. All you'll need to enjoy them is a large enough listening room.
Epos ES25	£1505	May 95	An extremely coherent and focussed sound; these are true audiophile speakers. Captivating with classical music.
Harbeth HLS8	£1999	Mar 97	Glassy clarity, bright treble, with bass that comes alive when given welly. Expensive though.
Heybrook Octet	£1800	Jul 98	The Octets are smooth, laid-back floor standers. Lack speed and transparency.
Jamo Concert 11	£2000	Dec 97	A worthy bigger brother for the Concert 8s, with a fast, transparent and even sound.
Jamo Concert 8	£1500	Jun 97	The Concert 8s are superbly clean and transparent. Their nature will show up any source shortcomings.
JBL S2600	£3500	Jul 96	Smooth, detailed and spacious with great scale, dynamics and imaging. Capable of producing a real performance.
Kef Reference 3	£2000	Nov 95	For superb reproduction within large rooms, the 3s are a force to be reckoned with.
Kef Reference 4	£3099	Oct 96	Superb bass and near-electrostatic soundstaging make these involving 'speakers a bargain.
LivingVoice Auditorium	£1500	May 99	Their strengths suggest a Classical 'speaker but they suit electronic compositions better. Rich tone but loose bass.
Proac Studio 150	£1500	Mar 99	They may be musically engaging but the tall ProAc's brightness suits them best for smooth valve amplification.
State Audio Stormforce	£8000	Feb 99	The best home for a reflex-loaded Tannoy dual-concentric, but they don't come cheap!
Spendor SP7/1	£1970	Jan 95	Gorgeous looking. Listening becomes an enjoyable experience, full of surprises from subtleties.
Spendor SP9/1	£3400	Apr 96	One of the clearest and most expressive loudspeakers you'll ever find for a large room. Easy to drive, too.
Tannoy AMS8	£2702	Aug 96	Bold and powerful sound with solid bass, clearly focussed midrange and delicious treble. Well worth tracking down.
Tannoy D900	£3999	Sep 97	£4000 may be a lot to pay for a pair of 'speakers, but the Tannoys deliver to great effect in all areas.
Technics SB-M1000	£1500	Nov 96	Materially excellent value. Sound clean and extended but can lack involvement.
Thomas Transducers Brio	£4750	Feb 95	Capable of producing a captivating performance of lifelike proportions with a great air of naturalness.
Thomas Virtuoso Gold	£3395	May 98	Impressive horns that combine lightness of touch with power and clarity.



Magneplanar MG12/QR.

Integrated £ Year Verdict

Under £300

Alchemist Mixim	£299	Mar 96	Fluid and musical but upper bass is a little dry. Useful phono stage with but with a little sibilance and ringing.
AMC 3025	£150	Nov 96	A lot for very little money - sweet sound and good build make the AMC 3025 a great starter amp.
AMC 3050A	£170	Feb 98	Offers plenty of power for the money but sound quality is not class leading.
Arcam Alpha 5 plus	£250	Oct 96	Good with efficient loudspeakers but generally needs more power and control.

Are you making the right connections?

Send for Britain's biggest catalogue of specialist cable and connections.

All available by mail order.

Phone 0181-942 9124 or clip the coupon for your Free copy

CUSTOM CABLE SERVICE

PO Box 4007, London SW17 8XG

Please send me your FREE Custom Cable Catalogue

Name _____

Address _____

Postcode _____

NO FURTHER INFORMATION REQUIRED

Send to: Custom Cable Service
PO Box 4007
London SW17 8XG

HFV 07/99



Integrated £ Year Verdict

Under £300

Arcam Alpha One	£230	Jan 99	In a smooth system with a warmish bias the Alpha One makes a strong case for itself.
Aura VA80	£279	Apr 95	Excellent value for money and will get the best from any component. Needs a separate phono stage.
Aura VA80 SE	£250	Mar 96	The Aura has a smooth, civilized sound with fine detail. Bass punch really rolls along. Good phono stage.
Cambridge A1 MkIII integ	£100	Jul 98	Involving and finely detailed, the Cambridge pushes forward the boundaries for inexpensive amps.
Denon PMA 750SE	£160	Feb 97	A mix of control, delicacy and detail allows it to excel with any music.
Denon PMA 425R	£230	Sep 96	Good drive, punch and an open soundstage, but suffers from confusion plus a thin midrange and treble.
Denon PMA 430GE	£280	Oct 96	Big and brutish but unfortunately bland with it. Something of a blast from the 1970s-80s past!
Harmon Kardon HK610	£180	Jun 95	Thorough-going down to earth liveliness. Bright but clean which gives appealing vivacity.
Harmon Kardon HK620	£280	Oct 95	Not quite a giant killer, the Harman is nevertheless a good solid budget buy.
Musical Fidelity E11	£299	Feb 98	A very capable integrated with a smoothness and warmth predisposed to classical rather than rock.
NAD 304	£239	Apr 95	Fine quality bass but rather lackadaisical as regards timing. Phono stage moderate. Needs careful matching.
NAD 310	£130	Jan 95	Good detail and a spacious open sound gives acoustic music and the majority of rock superb clarity.
NAD C320	£200	Apr 99	Younger sibling of the famous 3020 with many of its virtues to boot. Pre-eminently balanced and natural.
Pioneer A103	£130	Mar 95	Luxuriant presentation doesn't compensate for the tendency to un-rhythmic effects. MM phono stage.
Pioneer A300X	£230	Apr 95	Another highly capable all-rounder although a touch sterile sounding for some tastes.
Pro-ject 7	£259	Apr 95	On a budget, the Pro-ject has strong merit, including an excellent phono stage. Not for all systems.
Rotel RA 970BX	£250	Oct 96	Fresh sound with sharp attack. A slight midrange emphasis can make certain music sound rather forward.
Rotel RA 931	£150	Dec 98	For the money there's no faulting such a gifted performer.
Sony TAF44E	£250	Aug 95	bright clear and detailed, but needs a touch more refinement to prevail.
Technics SU A700 mk3	£250	Jan 97	A smooth unassuming sound misses out on the subtlety which brings music to life.



MVL A2+.

Integrated £ Year Verdict

£300-£799

Alchemist Axiom	£300	Sep 95	Musically rewarding; deserves serious audition. Great British hi-fi on a budget.
AMC 3150A	£329	Nov 98	Not the most musical amp ever but good value. The tone controls and balance adjustment will appeal to some.
Arcam Alpha 6+	£350	Jan 96	Full and smooth sound, unfortunately with loose bass.
Arcam Alpha 9	£500	Dec 96	Excellent value. A detailed and open sound gives great atmosphere to all types of music
A. A. Puccini SE	£595	Dec 97	All the main ingredients like rhythm and dynamics present and correct. Natural smoothness and transparency.
Audio Anal. Puccini SE	£595	Sep 97	Excellent sound quality gives the competition under £800 a lot to worry about.
Armitolab 8000A	£500	May 95	Manages the rare feat of sounding powerful and lithe at the same time. Bass taut but not the last word.
Audiolab 8000S	£700	Dec 97	Powerful hefty sound which doesn't blench when driving awkward loads.
Benchmark Royton SIA 1	£680	Aug 96	Too thin and crisp which makes prolonged listening fatiguing.
Cyrus 3	£500	Oct 96	Highly refined and detailed performance with a clear well-proportioned soundstage.
Cyrus Straight Line	£398	Nov 98	A good, honest bit of kit with a fine musical sound and no glaring vices.
Densen Beat	£650	Dec 97	If a musical adrenaline rush is what you seek, fine. Listening in bulk, rather clinical and cold sounding.
Edmund ES1 10	£400	Apr 99	Solid build and a big sound make the ES1 10 worthy of audition. Not perhaps the transparent at the price.
Hoffi Audis	£750	Jun 98	Powerful and refreshingly pure; a sound investment.
Kenwood KA 700R	£400	Apr 98	Excels with sound staging but lacks subtlety and tonal colour.
LFD Minimal	£499	Jun 97	An extremely enjoyable, lucid little amplifier that really gets to the heart of the music.
Morantz PM-66 KI-S	£400	Nov 97	An enjoyable and rhythmic sound but may be too lean for some bass-light 'speakers.
Monroe MJ	£695	Jan 97	An engaging musical performance; sweet overall sound. Doesn't cope with difficult loads so well.
Moth 30 Integrated	£320	Jul 95	A big open sound sets the Moth apart at this price. Low powered, though. Distinctly amateurish looks.
Musical Fidelity X-A1	£480	Dec 98	Two boxes don't form a pre and power in the X-A1 but the result is nevertheless a winning combination.
Myrydd T-40	£399	Nov 98	Couple the Myrydd with a warm system and enjoy. Possibly a little lightweight on the Reggae & Rap side.
Nad 317	£470	May 97	With 80 watts on tap, the NAD has power aplenty but is rather dynamically limited and ultimately uninviting.
Naim Nat	£500	May 95	Rather monochromatic with midband emphasis and slightly dry bass. Good imaging but smallish soundstage.
Orelle SA 100	£449	Jul 96	Clean, open, active sound. Smooth and detailed with good punch too. One of the best at the price.
Pioneer A-300R Precision	£400	Aug 97	A bargain at £400 pure and simple. Outdasses the competition in every area.
Pioneer A400X	£300	Oct 96	Complements all sorts of music with power and confidence. Outstanding value for money.
Quad 77	£595	Feb 95	Although classically orientated, the Quad will rock too. Precise and stable imagery and fidelity to tonal values.
Roksan Campton	£695	Jun 97	Mixes the best of solid state and valve worlds (without valves!) to produce a seductive sound.
Roku Scion	£615	May 97	Great packaging and super sound make the Scion a winner.
Sonneteer Campton	£579	Jan 96	Highly detailed and smooth sound. Worth searching out.
Sony TA-FB100R	£300	Feb 99	Partnered correctly to counterbalance its forwardness, the Sony offers a fast, rhythmic presentation.
Teac ABX7R	£700	Jun 96	Big and powerful sound, but a little unsubtle with it.
Technics SE A900 MNI	£300	Mar 99	Nominally a separate pre and power, but the pre can't work alone. Exciting but unsubtle.



Audio Analogue Puccini.

Integrated £ Year Verdict

£800-

Audionote Soro Se	£1099	Mar 95	Needs the right loudspeaker but a good musical presentation is in there somewhere.
Capitol CSA 14	£1099	Apr 96	A sweet and subtle sound. Fine midrange; transparent and open with vocals.
Densen DM 10	£1299	Jun 95	Dual mono construction gives strong stereo separation. Brutal resolution of detail but not the clearest ever.
Gannett Rhythm	£2499	Jul 96	Partnered with sensible loudspeakers of good bass depth, the Rhythm is capable of impressive performance.



HEATHERDALE AUDIO LTD.



202 FINDON ROAD, WORTHING, WEST SUSSEX, BN14 0EJ
TEL. 01903-872288 OR (AFTER HOURS) 0860 660001 FAX. 01903-872234
e-mail: heatherdale@hifi-stereo.com http://www.hifi-stereo.com

HEATHERDALE PRE-OWNED GUARANTEED EQUIPMENT EXPORT FACILITIES AVAILABLE

SPEAKERS

RENTAL ACUSTICS (Piano Black) £3995
AUDIONOTE ANESE (Rosewood) F/veneer £3995
B & W DM20's (Teak) £150
CELESTION Kingston speakers with stands £1395
IMPULSE H5 Speakers £895
KEF 104 loudspeakers £450
KINERGETIC subwoofers BOXED/MANUALS £2195
KLH Research speakers £250
MARTIN LOGAN CLS II BOXED/MANUALS £2895
MILLER & KREISEL MK100 SUBWOOFER £795
MIRAGE M-110 (paneback) MINT/BOXED £3995
MISSION 782 J/speaker with stands £250
MONITOR AUDIO Subwoofer rosewood £295
MONITOR AUDIO Studio 50 (rosewood) MINT £250
ORCHID F.L1 with stands 3 yrs old (36389) £1995
RUARK T-11 (magohany) 4 yrs old £395
SOLSTICE AAD speakers with stands £495
THEIL 7.2s (BIRDS EYE MAPLE) EX DEM QUAD ESL 63 Speakers £1995

JADIS JA80 Monoblocks £3295
JVC 7050 Power Amp £695
LUXMAN MQ 3600 K788 Stereo Power Amp £1295
LUXMAN M200 Power Amp £495
MARK LEVINSON MNL3 Power Amp £2450
PRIMARE 201 Pre-amp with 202 monoblocks/MINT/BOXED (£13000) £4995
TECHNIQUES Suv85A Stereo Integrated Amp £95

PRE AMPS

ARAGON Aurium Pre-amp £895
AUDIO RESEARCH SP15 Pre-amp £2495
AUDIO RESEARCH AP15 Revision A (black) £2350
BURMESTER 917 Pre-amp £1495
EXPOSURE 21 Pre-amp NEW (with remote) £890
FINESTRA Pre-amp & PSU £595
MARK LEVINSON 28 Pre-amp £1495
MARK LEVINSON 380s Pre-amp EX DEMO £4995
NAIM 32.5 Pre-amp with Hi-Cap £450

DACS

MARK LEVINSON 35 Dac EX DEM £5795
MERIDIAN 203 Dac £195
VAC Dac 22 1 (HCCD) £895

CD PLAYERS & TRANSPORT

ECOPHASE 0707 CD Player (MINT/BOXED) £1995
ALTIM CDT III CD Transport EX DEM (£3000) £3500
AUDIOMECA Cd Transport £595
Californian Audiolabs DAC with AES/EBU & AT7 £995
MARK LEVINSON 30.5/31.5 Transport & DAC £12995

MISCELLANEOUS

MARK LEVINSON 25s Phonostage & PSU £3495
MIT 750 Plus speaker cable 5 metre pair £495
MIT M15 24TR interconnect £230
NAKAMICHI 1000ZL Gold LTD Edition MINT/BOXED/MANUAL £3995
REVOX PR99 MK2 Tapedeck (Trolley Mounted) £1495
SYNERGISTIC Research resolution reference MK2 blue 1.5 balanced interconnect £695
TARA LABS RS2 Master interconnect 2m balanced £495
TEAC A-3340S Tape recorder £595

TUNERS

ROTEL RT850 AL Tuner £95

WE NOW OFFER 0% FINANCE (subject to status)
FEEL FREE TO ARRANGE AN ADDITION OF OUR PRODUCTS
MAIN UK DEALERS FOR THEIL SPEAKERS
MARK LEVINSON, ABSOLUTE SOUNDS PRODUCTS
AND MUCH MORE

ALL USED CARTRIDGES ARE CHECKED UNDER A MICROSCOPE BEFORE BEING OFFERED FOR SALE.

VISA - SWITCH - MASTER CARD - AMEX - DINERS CLUB WELCOME.
WE TAKE PART EXCHANGE ON NEW & USED STOCK AND BUY IN FOR CASH

Integrated £ Year Verdict

£800-

Lawson IT	£3200	Apr 99	Has clarity in spades and an extremely rare tonal purity. Outclasses many transistor alternatives with ease.
Melnicoff MA6000	£3735	Sep 95	A mighty confection of power, facilities and style, and it sounds good to boot.
Musical Fidelity A1001	£2499	Jun 98	Awesome power and seismic bass. A very good all-rounder with super-clean sound.
MVL Integral A2	£850	May 99	An excellent performer with any music. Adept at handling subtle details. Difficult to beat at the price.
MVL A2+	£1250	Jun 98	Seamless, natural and very open, the A2+ sets the pace at the price.
Sharma Phase 2	£800	Apr 97	Even-handed performer deals confidently with music regardless of genre. Not as smooth as the best.
Sonic Frontiers Amphib	£1295	May 98	A characteristically competent and musical integrated. Prefers fairly efficient loudspeakers though.
Sonn-Tone Ambassador	£900	Oct 97	Excellent high-end integrated with a real love of music and plenty of poke.
Tear AB 810	£1000	Sep 95	Very strong all round performer with excellent build and finish. Verging on the expensive though.
Unison Res Simply 845	£2950	Mar 98	Allied to all the right 'speakers will handle all musical genres with smoothness and power.

Pre-amps £ Year Verdict

Under £300

AMC 1100	£150	Mar 99	Tone controls cannot be defeated and the sum total is a little metallic but value in spades.
Creek OBH-11SE	£199	Apr 99	A very lucid, natural headphone amp which scores as highly on acoustic and Classical as it does on Rock.
Creek OH-12	£200	Jul 98	Only poor cosmetics mar the Creek. Sonically it's a gem.
Moth 10 Passive	£149	Mar 99	Won't win prizes for best build but a flexible effort for a passive. Somewhat dry presentation overall.
Musical Fidelity X-Cans	£130	Mar 98	If you haven't yet experienced the world of quality headphone listening, the X-Cans is the way to start.
Musical Fidelity X-Pre	£200	Jan 98	A smooth, sweet and musical performer.
Musical Fidelity X-Tone	£120	Mar 99	Easy-to-use stand-alone modern tone control with subtle effect. Rather a bargain.
Project 7	£259	Feb 95	Immensely enjoyable and listenable, a rare mixture of sophistication and fun.
Real IC 871	£150	Mar 95	Five line-level inputs and tone controls make for a flexible unit. Partnered by the RB-971 power amp, very good value.
Technics SU-C1000MkII	£299	Apr 98	Needs slightly more taut bass and a less grainy midrange to bring it up with the best.



Chord CPA-1800.

Pre-amps £ Year Verdict

£300-£799

Koda Annapole Dallas	£475	Apr 98	Organic and transparent. Free from transistor hardness.
Auris CA200	£749	Mar 97	A smooth and sweet sound devoid of roughness.
Orson GS100C	£440	Nov 98	The phono stage is the main area of weakness. Can sound a touch muddled at times.
Craft Epoch	£600	Jun 96	A fine sounding preamp, but the phono stage is weak in the bass.
Cyns Pre	£650	Feb 96	Pre-amplifier has plenty of facilities, but sounds a little unexciting and 'conventional'.
Hybrosk Signature II	£549	May 97	Impressive smoothness and tonal colour, transparent as well.
PM Audio Lab L15	£650	Dec 95	This valve pre-amp is very good value indeed.
Northall Indus	£499	May 99	Passive pre of box-of-switches, whichever way you look at it the Indu is stylishly finished and well conceived.
Sump Africa 8	£767	May 95	More valve-like than transistor in sound; highly competent if not spectacular.
Talk Hurricane 1	£500	Jun 97	Flexible with a strong controlled sound, but won't suit all tastes.
Technics SU-C1000	£350	Feb 97	Good when mains powered, even better running on its batteries. One to consider at the price.
Thornes TTA 2000	£550	Jul 95	Poor sound quality and engineering let this pre-amp down. Pricey too.
Unison Res Feather 1	£795	Aug 98	Warm but still exciting, it is only let down by a slightly recessed midrange.



Monarchy SM-70.

Pre amps £ Year Verdict

£800-£1499

Etalon Preampl	£1095	Feb 98	Smooth, even and transparent. Well worth the outlay.
John Shadmire Phase 6	£895	Sep 95	Matched with a smooth amp and 'speakers the Phase 6 is capable of a transparent and rewarding performance.
Linn Wallenda	£900	Apr 98	In terms of musicality and involvement it falls short.
Mendon 502	£1295	Dec 95	Transparent, detailed sound with good tonal range and very natural presentation.
Musical Fld. Nu-Vista	£1200	Sep 98	A truly competent pre-amp whose high-end sound comes with a very reasonable price tag.
Naim NAC102	£999	Apr 97	This even-handed performer images well and deals confidently with music regardless of genre.
Quad 7741	£850	Jul 96	Bright and detailed, but phono stage is inadequate at this price.
TAG McLaren PA10	£850	Nov 93	Justifies its price with a very musical and revealing performance.
XTC Pre-1	£1000	Nov 96	This pre-amp is highly detailed and spacious.

Pre amps £ Year Verdict

£1500

Kudrower PPF30	£1995	Mar 95	A bright and lean approach to the valve sound.
----------------	-------	--------	--

WORLD'S BEST AMPLIFIER UNDER £1,000?

MVL

WORLD VERDICT

An excellent performer with any music. At present, it would be hard to imagine the A2 being beaten at the price.

HI-FI WORLD MAY 1999

MVL

For more information ring 01953 850800 (See our main ad)

MVL Technology Limited, Northfield Mill, Wymondham, Norfolk NR18 0DF. Tel: +44 (0) 1953 850800 Fax: +44 (0) 1953 851022
Sound Sentinel® manufactured under licence from Sound Sentinel Systems. Sound Sentinel® is a registered trade mark.



Pre amps £ Year Verdict

£1500

Canary 601 MkII	£1600	Apr 99	Very musical, very revealing. A credit to the valve tradition with considerable kick in reserve.
Chord CPA 1000	£1774	Mar 98	Has it all - detail, transparency, slam and rhythm. In a word excellent.
Final Music 5	£1500	Feb 99	Partner for the Final Music-6 power amp. Battery powered.
Focusrite Red 4	£2345	Feb 96	Smooth and detailed sound. Not as clinical as some professional amps can be.
Galactron Pre	£1630	Nov 95	Smooth, but dull balance makes it suitable for bright systems.
Mirantz 7	£3500	Mar 97	Superb, combines delicacy and power, especially with a vinyl source.
Michel Orca	£1650	Oct 98	With its Panasonic pot, the Orca reaches new standards of transparency and involvement.
Unison Res. Mystery 2	£1750	May 98	Offers finesse, control and clarity for a very reasonable outlay.

Power amps £ Year Verdict

Under £300



Final Music-6.

AMC 2200	£150	Mar 99	Super value separate with first-rate sound staging. Midrange subtleties sometimes suffer but at this price...
Arctium 9P	£400	Dec 96	A detailed and open sound gives great atmosphere to all types of music.
Arctium Alpha 10P	£600	Jul 98	This power amp lags behind the best of the competition, and the build is flimsy.
Audio Analogue Donizetti	£575	Apr 98	As smart as an Armani suit, they sound powerful in a natural, organic manner.
Aura PA100	£749	Mar 97	A smooth, sweet powerful sound free from the rough brightness that afflicts many solid-states.
Creek A43	£399	Mar 99	Shows what a skilled designer can do, even when hooked up with a passive pre. A very realistic approach.
Cyrus Power	£449	Feb 96	The Cyrus Power is simply impressive in all respects.
Linn LK100	£650	Apr 98	Well built, but judged purely on a musical basis they fall short.
Linn LK240	£750	Aug 97	The LK240 plays tunes exceptionally well, tonal colour and image precision are not its fortes though.
Meridian 505	£795	Aug 97	Crisp, clear images are set in a broad spread between the 'speakers but the 505 lacks stage depth and grunt.
Monarchy SM-70	£595	Jan 99	The Monarchy is a smooth, warm amp most at home with 'speakers that are easily driveable.
Moth 30 Power	£249	Mar 99	Refined approach with the lighter acoustic music but lacking a little in overall clout.
Moth Stereo 60	£549	Dec 95	This power amp unfortunately suffers from sharp sounding treble and poor depth.
Musical Fidelity X-A50	£500	Jan 98	Very smooth, sweet and musical performers, not over-analytical but very involving.
Quad 77/67	£600	Jul 96	With good punch, speed and attack its not bad all but can be a little uninspiring.
Rotel RB-971	£225	Mar 99	70 Watts a channel helps give lucid presentation with deep sound staging. Perhaps on the bright side.
Shiame Phase 3	£689	Apr 97	The Phase 3 possesses impressive clarity, detail and dynamics.
Talk Tornado 1	£500	Jun 97	A flexible power amp with a strong, controlled sound, but won't suit all tastes.
Technics SE A1000	£400	Feb 97	Smooth, warm sound has plenty of grunt when needed and is very enjoyable to listen to.
Thorens TTP 2000	£500	Jul 95	Its best feature is the key on/off switch, otherwise its a case of poor sound quality and engineering.

Power amps £ Year Verdict

£800-£1499



Cambridge CD4SE.

Audiolab 8060Q	£999	Jun 95	Highly recommended for its blend of operational sophistication, build and sound quality.
Chameleon Ruby	£995	Jan 96	Well specified and powerful, but dry and short of life. Suits Rock on bass-heavy 'speakers.
Chord SPM 400	£1325	Mar 98	This amp has it all - detail, transparency, slam and rhythm. In a word, excellent.
Common CS620C	£800	Nov 98	These monoblocs have a tonal richness and bass speed rare amongst powerful amps.
Croft Series V	£800	Jun 96	Fast, clear and detailed sound will win friends in both the transistor and valve camps.
Delph Da Capo	£1469	May 95	Quality bass and a clear midband but the treble can be harsh at high volume.
DPA 200S	£1245	Jul 93	Serious audiophile product at an affordable price. Well constructed, pleasant to use and fine sounding.
Galactron Power	£1200	Nov 95	Smooth sound but dull balance make the Galactron suitable for bright systems.
HD Audio Duo	£1185	May 95	Not dissimilar to the Audiolab monoblocs, the sound has a sweet top and amazing clarity.
Haybrook Signature II	£1051	May 97	Not quite as transparent as it could be but impresses with its smoothness and tonal colour.
Meridian 557	£1400	Dec 96	Great control and dynamics allied to seductive smoothness. A rare combination of power and delicacy.
Musical Fidelity X-A200	£1000	Aug 98	Hugely powerful and controlled, the X-A200s are still superbly musical.
Myryad MA120	£1000	Apr 96	The sound is a somewhat acquired taste and a little rough in places.
Ormik Jewel One	£899	Jul 95	A lot of amplifier for the money. Big, warm, sweet sound places it ahead of most.
Quad 707	£800	Jul 97	The 707 embodies a rare blend of grace and power in its sleek grey casework.
Rubicon Rubicon	£949	May 99	Low on power at 8 watts but fairly musical for all that. Good resolution of detail and texture.
Sumo Polaris III	£898	May 96	More valve-like than transistor in sound; highly competent if not spectacular.
TAG McLaren 60P	£850	Nov 98	Fully justifies the cost with a very musical and revealing performance.
VRR Adur	£1495	Jun 95	Lovers of light piano-based fare and Baroque music will appreciate this amp's delicacy.

Power amps £ Year Verdict

£800-£1499

Autovox LC8	£1995	Mar 95	Eschews the traditional lavish tube sound for a brighter and leaner approach.
-------------	-------	--------	---

Sound Investment

If you have invested expertise and money in building up a sound system to your own unique specifications, then why compromise with indifferent housing units?

Fi-Rax offers a new dimension in audio visual racking - from a range of standard designs to the flexibility to custom create a unit to suit your particular sound system and lifestyle.

- *High quality aluminium construction.
- *Finishes available to your choice.
- *Fully adjustable 6mm glass shelving.
- *Sound isolation on shelving/feet.
- *Custom created to suit your system.
- *Free delivery throughout the UK.

Fi-Rax - a sound investment for those who want the best from their equipment.

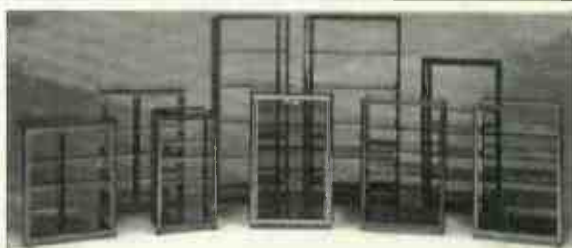

Audio Visual Furniture

For further information or a free brochure contact: JEM Distribution, Springfield Mills, Spa Street, Ossett Wakefield WF5 0HW. Tel: 01924 277626 Fax: 01924 270759

Power Amps £ Year Verdict

£1500-

Canary 301	£3055	Nov 98	The 301 puts the 300B's traditional virtues to good use in a push-pull design that will drive most loudspeakers.
Cary 300B SE	£3975	Feb 95	Cary have a winning amplifier that is a prime example of how a 300B can sound.
Etalon Ampli	£2925	Feb 98	Very natural, substantial presentation with lots of power on tap.
Final Music 6	£1500	Feb 99	Battery powered amp puts convincing scale and three-dimensionality into suitably sensitive loudspeakers.
Focusrite Red 5	£2057	Feb 96	Powerful, smooth and detailed sound. Not as clinical as some professional amplifiers can be.
Gamma Aeons	£4999	Apr 97	Sound quality of these monoblocs is impressive but marred by a rather obvious hum. Build could be better.
Marantz 9	£8000	Mar 97	These monoblocs are superb, producing a beguiling performance of great control and verve.
Mitchell Alecto	£1989	Oct 98	The new Alecto is crisper, cleaner and more controlled than earlier incarnations.
Orchid RC750	£6600	Aug 96	A powerful grip on usic, but articulate and detailed too. A rare combination.
Shearne Phase 1	£1999	Oct 94	Good sound quality and an impressive tonal balance.
Sugden Symetra	£1550	Oct 96	The Symetra monoblocs impress with their grip. They run hot and sound warm.
Tube Technology Genesis	£2599	Jun 94	Valve monoblocs that produce explosive bass, midrange as clear as a bell and shimmering treble.
Unison Res. Smart 300B	£4250	May 98	Powerful, neutral sounding amps thanks to their modified 300B valves, but a little expensive for the same reason.
Unison Res. Power 35	£1525	Aug 98	A great compromise between delicacy, power and practicality. Very musically satisfying, too.
Vadis S15	£2350	Jul 98	The S15's purity and clarity are impossible to beat for the money. Bass is not brilliant, but still better than most.
XTC POW-1	£2000	Nov 96	This power amplifier is smooth and seductive, although a little pricey.

CD Players £ Year Verdict

Under £300

AMC CD8	£150	Oct 97	The CD8 is free from grain but can sound too polished at times.
Cambridge CD45E	£200	Feb 98	Natural and very life-like, the CD45E embarrasses many pricier players.
Denon DCD-425	£150	Apr 97	Crisp, up-beat player which is inconsistent in its overall presentation.
Denon DCD-635	£180	Feb 98	Rhythmically slick and dynamic, the Denon errs to the cool side of neutral.
Denon DCD-835	£280	Nov 98	Warm and smooth, the 835 is laid-back rather than in-your-face.
Grundig CD3	£240	Sep 94	Great for simple Jazz and Folk, but soft bass slows things down.
JVC XL-V230	£157	Jan 99	Slightly muddled in the bass, the '230 isn't the most rhythmic of players.
Kenwood DP-3080/II	£180	Feb 98	One of the best budget all-rounders there is. A shade treble-heavy.
Kenwood DP-5050	£250	Aug 93	Waffly bass and enthusiastic treble mean the Kenwood prefers Classical to Rock.
Kenwood DPF-3010	£180	Jan 99	A fine performer. Lacks only some of the spirit of its predecessors.
Marantz CD-63	£249	Jun 94	Upholds the Marantz tradition of lively CD players.
Marantz CD-67	£270	Nov 96	Fine vocal projection and treble. Bass is deep if not that tight.
NAD 510	£200	Oct 95	Hard to criticise at the price, with a typically smooth, fluid NAD sound.
NAD 522	£170	Jan 99	Warm and smooth, this is a cultured player. Can be over-civilised at times.
Philips CD721	£130	Feb 96	Not the most accurate machine, but holds its own at the price.
Pioneer PD-103	£140	Feb 95	Rolled-off treble limits detail. Light bass retains foot-tapping ability.
Quad 67	£?	May 93	One of the top players at the price with great speed and grip.
Rotel RCD-940BX	£230	Oct 94	Controlled and invigorating player albeit a touch sterile.
Teac CD-P3450SE	£200	May 97	Refuses to become flustered. Can lack emotion as a result, though.
Teac CD-P4500	£249	Nov 92	Like many of its contemporaries, the Teac is too smooth to shine.
Technics SL-PG490A	£100	Jan 99	In spite of a bias towards bass and treble, this machine remains a bargain.
Technics SL-PS570D	£200	Feb 98	Typical Technics' bright and bassy sound. Prefers Dance and Rock.
Yamaha CDX-480	£200	Mar 95	Mature, laid-back machine drops points for inferior timing and imaging.
Yamaha CDX-590	£230	Feb 98	Detailed, refined but not particularly engaging or exciting.
Yamaha CDX-533	£180	Jan 99	Lean and up-front, the Yamaha is involving on Rock but can sound rough.



Sony CDP-XE300ES.

CD Players £ Year Verdict

£300-£799

AMC CDM7	£340	Jun 96	Very musical outfit which gains sweetness with optional valve output stage.
AR-07	£300	Jan 92	The '07 is even-handed but has no real fortes.
Arcam Alpha 7	£320	Jan 97	Superbly-designed, instinctively musical player destined for success.
Arcam Alpha 8SE	£599	Jun 98	The 8SE builds on the strengths of the standard 8 with HDCD filtering.
Arcam Alpha 9	£799	Dec 98	Apart from its tonal brightness, the Alpha 9 is a very capable machine.
Audio Analogue Paganini	£749	Apr 99	Effortless, wholly musical delivery. The Paganini does for CD replay what its stablemate Puccini does for amplification.
Audio Innovations Alto	£449	May 96	Grainless treble is detailed but the Alto misses that vital emotional spark.
Aura CD50	£450	Jul 93	High measured distortion mars the treble and bass is dry.
Creek CD43	£499	Oct 98	A competent player with a musicality that will seduce any music-lover.
Cyrus dAD 1.5	£398	May 99	Great detail and imaging with intimate music. Classical and Jazz suit the 1.5 down to the ground but Rock can sound harsh.
Cyrus dAD3	£598	Dec 96	Lacklustre with Classical, dramatic and lively on Dance and Rock.
Denon DCD-1550AR	£350	Jul 98	Clean and precise, the Denon lags only in warmth and openness.
Harman/Kardon HD730	£300	Aug 96	Strong on dynamics and drive, but lifeless treble can dampen music.



Marantz CD-63 K1-S.

Gershman Acoustics

Avante Garde RX20 - a mere 36" tall and 12" x 12" at the base - Absolute Sound review - "a true torture test with a bass line that's big, super fast and continuous - the Gershman's handled it beautifully, servo driven Infinity RS1 towers have more power but are way too slow. The Magnepan MG3.5R's, can't match the low bass impact of the Avant Gardes, only the Thiel 3.6 can handle this track with aplomb and even they don't sound quite as fast. Unquestionably, the Avant Gardes are a tremendously musical loudspeakers".
X-1, Specter, Enigma 500-X, GAP-520X

Sunfire Corporation

frankford & sullivan Co.

TUBE PRE AMP, POWER AMPS 300 & 600 wpc.
FIVE CHANNEL AMP 200 wpc x 5.
2700 watt TRUE SUB-WOOFER 11 INCH CUBE 18 HZ
2700 watt SIGNATURE SUB-WOOFER 13 INCH CUBE 16 HZ

AUDUSA & Co

4 Arundel Road Kingston Upon Thames
Surrey KT1 3RZ
Tel: 44 (0) 181 241 9826
Mobile: 0956 230056
Fax: 44 (0) 181 241 0999
E-Mail: cweere @mcm.com



L A T INTERNATIONAL

World Class Cables Made in USA

AC-2 Power cable - Silver clad, Teflon insulated at 10awg; this is the largest gauge of power cord we know of. The design of our shielding system effectively eliminates interferences from RF and EMI sources. Fitted with a MK Tough plug and IEC or Fig of eight connector. European connectors also available. Solder connections with Wonder Solder. 2ft £49, 3ft



£59, 4ft £69, 6ft £89. Other lengths to order. 4, 6 and 8 way all steel distribution boxes with 3 ft of cable & MK Tough plug £149, £179, £209. Analogue Interconnects, IC-50, IC-80, IC 100, IC, 200. Speaker cables - SS800, BIWIRE, SS1000

New Straits Times Presents the

Malaysia Audio Show '99



Organised By:



Official magazine:

AUDIO VIDEO
T O D A Y

Venue: The Legend Hotel, Kuala Lumpur

Date: 23-25 July 1999, Friday-Sunday (10.00am-7.30p.m)

For booking call : Tanway Sdn. Bhd. Tel : 603-795 1301 Fax : 603-795 1299

CD Players £ Year Verdict

£300-£799

Linn Mimik	£798	Apr 95	Tonally hard but possesses many, if not all, of the Linn rhythmic strengths.
Marantz CD-33 KI-Sig	£500	Sep 96	This is a rare player, greater than the sum of its parts.
Marantz CD-3SE	£350	May 95	Taken as a whole, the CD-3SE is one hell of a CD player. No digital nasties.
Myriad T30	£600	Dec 98	With its brightness balanced by warm ancillaries the T20 will win friends.
Orelle CD106a	£650	Mar 97	Clean and tidy on electronic music. Not so good with acoustic material.
Pioneer PD-8804	£400	Sep 96	Fluid midrange leads a dry bass and tonally-limited treble.
Rotel RCD-965BX Discrete	£375	Dec 94	Fast, clean sound verges on the clinical at times.
Rotel RCD-971	£350	Sep 98	Refinement is a plus point, but lack of vitality holds the Rotel back.
Rotel RCD-975	£450	Sep 96	Tuneful, pungent bass are the pros, flat sound staging and tone the cons.
Sony CDP-X200ES	£500	Mar 98	Neutral, dynamic and stylish but not quite up with the best.
Sony COP-XE900E	£300	Mar 97	In spite of fine sound staging and clarity, the Sony fails to involve.
Teac CD-5	£350	Jan 96	Clean and dry, the Teac is rather sterile compared to the competition.
Technics SL-PS840	£450	Sep 95	Not the last word in bass control. Midrange is more persuasive.
Thorens CD100	£600	Apr 99	A very smooth and refined player with the added bonus of good detailing. Can lack rhythmic bite at times.
Trichord Genesis	£549	Sep 96	Warm and bassy, but extremely natural. Not the most consistent player.
Trichord Revelation	£799	May 97	When it's good, it's very good indeed. Can get confused on dense mixes.



Roksan Caspian CD.

CD Players £ Year Verdict

£800-£1499

Audiolab 8000	£1000	Dec 96	Sweet treble and full midrange give the 8000CD a lucid sound.
Goldmund CDA 200	£1199	Feb 99	Perhaps lacks the last ounce of strength on Rock, nonetheless has winning all-round ability.
Symbol CDP12	£1279	Dec 97	Its warm, musical sound plus HDCD compatibility are a strong combination.
Cyrus iAD-2	£899	Jan 95	Up with the best at the money, the Cyrus simply sounds 'right'.
DPA Renaissance	£895	Jun 95	Breathtaking imagery and dynamics. Not strictly accurate, but who cares?
Harmin/Karson HD7725	£800	Jan 94	Construction is price-correct, but not the excessively relaxed sound.
Heybrook Signature	£989	Oct 97	The Heybrook loses out because of its rough treble and lack of clarity.
Holl Xara	£950	May 98	It's not cheap but the Xara scores for firm bass and exciting presentation.
LFD Mistral	£999	Nov 97	The Mistral is outclassed in areas like pace and bass depth.
Marantz CD-17	£800	Mar 96	The CD-17 has a presentation which excels in musicality and lucidity.
Marantz CD-17 KI-S	£1300	Sep 97	The KI-S has a valve-like smoothness and clarity.
Meridian 506	£875	May 95	Characteristically dry Meridian balance which could do with more emotion.
Musical Fidelity X-Ray	£800	Feb 99	Bright, clear and well-built, the X-Ray's transparency can be hard on poor recordings.
Pink Triangle Numerical	£1099	Apr 98	This very natural one-box fully justifies its £1000 price tag.
Quad 77	£850	Nov 95	Competent, entertaining machine with neat styling and remote.
Roksan Caspian	£895	Aug 97	The Caspian is a gifted player well worth its asking price.
Sugden SDT-1	£850	Mar 93	A superb all-rounder with particularly convincing rhythms.
Teac VRDS 10SE	£850	Apr 96	Draws you into the music. Soundstaging fine but treble is a little bright.
Teac VRDS-25	£1300	Aug 96	Solid build doesn't make up for sound which lags in integration and detail.
XTC CDP 1	£1250	Dec 97	Rhythmically satisfying, but can sound hard in the wrong system.



Pink Triangle Tarantella.

CD Players £ Year Verdict

£1500+

Anthem CD1	£1600	Mar 98	Sweet sound and numerous features make the Anthem fine value for money.
Burmester 932	£5460	Sep 94	Amongst the best with its belt-drive transport.
McIntosh CDM-7009	£2635	Dec 95	Unmatched quality from CD at a high but fair price.
Meridian 508.24	£1995	Jul 98	The 508.24 is one of the top performers at its price.
Naim CD2	£1998	Apr 97	CD2 excites at the expense of subtlety. More at home in a Naim system.
Pink Triangle Litaural	£2099	Feb 98	One-box player with sound capable of mixing it with the best.
Teac CD-X1	£2300	Jun 92	You'll either love or hate this machine's great flair and confidence.

Turntables £ Year Verdict

Under £300

NAD 300	£200	Nov 94	Based on a Rega Planar 2. Both pleasant to use and look at with a mature sound, all for £200.
Project 1.2	£200	Jun 97	A bargain at £200 with its substantial and involving sound.
Thorens TD180	£180	Feb 95	A good, basic budget bargain.
Thorens TD280 Mk4	£199	Jun 93	Superbly lucid and clear midrange, but lower reaches are a little lightweight.



Nu-Vista 300
power amplifier



X-P100
X-AS100
pre/power amplifier



X-A50
also available
X-A200
monoblock power amplifiers



X-A1
also available
X-A100R
integrated amplifiers



X-RAY
24 bit integrated
cd player



X-24K
digital analogue
converter



X-UP
phono stage

Hi-End Audio & Home Theatre

Home Demonstrations

Unbiased Advice & Support

Multi-Room Design & Installation

Export Orders Welcome

Part-Exchange Available

0% credit available. Written quotations on request. Subject to status.

Tel/Fax: +44 (0)181 707 4849 • Mobile: +44 (0)973 471 426 • email: info@audiovenue.co.uk

Other ranges available... Audio Analogue • Boston • Bow Technologies • Chario • Diapason • Graaf • Michell • Monitor Audio • MRS • Opera • Procead • Project • QED • Straight Wire • Stax • Target • Unison Research & other leading components & accessories

MUSICAL FIDELITY

X SERIES
at

AudioVenue
Bespoke Audio Visual Consultants

Turntables £ Year Verdict

£300-£799



van den Hul Grasshopper.

Model	Price (£)	Year	Verdict
Classmate Solution	£750	Feb 99	If you seek a powerful presentation where musicality takes precedence over absolute finesse, this could be the answer.
Linn Baikk	£400	Sep 94	Definitely a turntable for devotees of attack and strong bass lines. Not strong on imaging.
Michell Gyrodec SE	£775	Apr 99	Great sound, superb build and excellent upgradability make the 'spider' a wonder at the price.
Michell Mycro	£539	Jan 94	Silent and beautifully made, with transparent reproduction.
Opus 3 Continuo/Cantus	£900	Oct 95	Solid as a rock and almost as heavy, it's a satisfying performer, but not quite the best.
Pink Triangle Tarantella	£575	Oct 97	Simply the best at the money. Combines PT's customary transparency with real authority.
Project 6	£350	Dec 93	Involvement and rhythm are priorities. Highly recommended.
Project 6.1	£435	Sep 94	The 6.1 gives a very full, strong sound. A very exciting deck.
Systemdek 2X2	£500	Aug 96	Clear and precise sound through midrange and treble puts it up with more expensive rivals.
Systemdek IIX900	£415	Sep 94	Detailed sound stage and broad imaging with a good, even range of tonal colour.
Systemdek IIXE	£450	Jan 93	Combined with an SME 309 it achieves great results, with a massive sound stage.
Thorens TD166 Mk6	£405	Sep 94	Totally smooth with a warm midrange, but a little too laid back.
Virtual Reality Reson rs1	£600	Nov 95	With fine detail resolution, transparency and a neutral balance the Reson rs1 represents super value.
VPI Junior	£500	Oct 97	The Junior is a very good deck indeed, with an assured and involving sound.

Turntables £ Year Verdict

£800-£1499

Model	Price (£)	Year	Verdict
Origin Live Oasis-A	£950	Dec 98	Nice looks and a good sound, but can be bettered on price.
Pro-ject Perspective	£900	Aug 98	Aesthetically, the Perspective is a winner, but better sound can be had from cheaper decks.
Roksan X-traxs X	£1295	Jan 97	An undoubted bargain and class leader in all areas with a precise, confident and well-balanced sound.
Technics SL-1200 LTD	£1000	Apr 97	Looks expensive at £1000, but don't let that put you off the capable standard version.

Turntables £ Year Verdict

£800-£1499

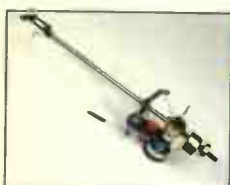

Hadcock 228 SE.

Model	Price (£)	Year	Verdict
Alphason Symphony	£1860	Nov 92	The Symphony has to be one of the best the British can offer. It's expensive, but a true sophisticate.
Michell Orbe	£1950	Apr 95	Fast and detailed with crisp sheer treble and clean, deep bass.
Origin Live Oasis-S	£2250	Oct 98	The Oasis-S is a cool, lean but very transparent performer thanks to battery power. Up against strong competition.
PT Anniversary	£2390	Oct 96	With its battery supply and ultra-quiet DC motor, the Pink displays great accuracy and neutrality. A top-flight deck.
SME Model 20	£2500	Oct 92	This is a deck for those with a substantial record collection who demand the best. Exemplary sound.
Wilson Benesch	£1775	Jul 96	Gives a technically excellent rendition but fails to really communicate the emotion in music.
Wilson Benesch Full Circle	£2000	Mar 98	Offers clarity in abundance with a natural ease. Looks gorgeous too.

Phono Stages £ Year Verdict

Under £300

Model	Price (£)	Year	Verdict
Creek OBH-8SE/OBH-2	£160	Nov 97	One of the best MC phono stages on the market at the price
Creek OBH-9/OBH-1	£110	Nov 97	Smooth and truly musical, exceedingly worthy entry-level phono stage.
LFD Mistral	£299	Sep 97	The most lucid and musical budget phono stage around - a true audiophile bargain.
Musical Fidelity X-LP	£130	May 99	First-class inexpensive phono stage. MM and MC inputs catered for. Low on distortion, high on clarity, build legendary.
NAD PP1	£40	Sep 98	At this price the NAD is an accomplished all-rounder. Slowish bass will suit leaner systems though.
QED Discsaver	£35	Jan 97	A bargain. Beguilingly musical presentation, with more than enough detail and power for a mere £35.
Rotel RQ-970BX	£130	Nov 94	Combine with a good cheap line level integrated and it will show you how good vinyl can be.

Phono Stages £ Year Verdict

£300-799

Model	Price (£)	Year	Verdict
Audio Innovation P2	£749	Feb 96	Fantastic bass and super insight make this one of the best phono stages around.
Densen DP Drive/DP-02	£350	Sep 97	A beautifully made, fine sounding device that looks great too.
DPA DSP 200SD	£495	Oct 94	Could be too forceful for some, but with excellent detail and extremely powerful bass.
EAR 834P	£340	Oct 94	Very fine phono stage with precise imagery and a bargain at the price.
Kinshasa Perception	£525	Oct 94	Extremely impressive results, especially with MM cartridges.
Lehmann Black Cube	£395	Oct 98	Capable of involvement, neutrality and insight usually the preserve of stages three or four times the price.
Michell Iso	£528	Oct 94	Gives a thoroughly cohesive picture of a recording with a very light and rhythmical bass.
Sonneteer Sedley MC/MM	£399	May 98	The Sedley combines transparency and fine dynamics with excellent rhythmic ability.
Union Simply Phono	£495	Mar 96	Liquid sound with great dynamics, but a little hissy and muddled too. Beguiling, but not perfect.

BEFORE YOU INVEST
IN HI-FI
MAY WE SUGGEST
YOU INVEST
IN ONE OF THESE?



At Arcam we believe that buying hi-fi is a serious business. Before splashing out, we believe that you should sit back and consider just what you expect for your money. Quality of sound, reliability, value for money, technical excellence...these are standards by which Arcam hi-fi is judged...and is found to excel.

But don't just take our word for it. A glance through any hi-fi magazine will reveal that our efforts are applauded more than

almost any other manufacturer. To find out why, complete the coupon opposite and tell us which products you're considering. We'll send you independent reviews of suitable Arcam equipment. (We'll give you our own views by including a colour brochure with details of our whole range).

But neither we nor the critics are the final judges. You are.

So we'll also send you a list of dealers where you can sample the Arcam experience for yourself.

ARCAM

Simply complete the coupon and post it to:
Arcam, Pembroke Avenue, Waterbeach, Cambridge CB5 9BP. Or telephone: (01 223) 203203

Please send me independent reviews of: (please tick box)

- Arcam Amplifiers
- Arcam CD players & DACs
- Arcam Tuners
- Arcam Home Cinema
- AudioQuest cables

Title _____ First Name _____

Surname _____

Address _____

Postcode _____

STAMP HW 499

Phono Stages £ Year Verdict

£800-

Anthem Phono 1	£899	Aug 98	Despite a sizeable price tag the Anthem offers a smooth, lucid sound and superb build quality.
Audiolab 8000PPA	£800	Oct 94	Instruments can have a somewhat flat perspective, but excellent clarity
Linn Linn	£850	Oct 97	Marries beautifully into the Linn family, but not too hot with other components.
Michell Iso HR	£850	May 93	Perhaps too good for some record collections. Extremely revealing.
Fluxion Audio Systems DS5	£945	Oct 97	Doesn't worry about genre, it just gets on with the job of making music in an enjoyable way.
Sonic Frontiers Phono 1	£2000	Apr 98	Expensive, yes, overpriced, no. The Phono 1 is a superb all-round phono stage.

Cartridges £ Year Verdict

Under £200

Clearaudio Alpha	£130	Apr 99	Tends to sound quite hard at the top but imaging and detail are good. Best in a warm system.
Denon DL103M	£110	Aug 97	First manufactured in 1963, it sounds mature and sure-footed rather than over the hill.
Denon DL110	£?	Mar 94	May be a little soft-natured for some. Splendid dynamics and an even tonal balance.
DNM Mica	£185	Feb 98	Better Goldring's 1042 without difficulty. MC quality from an MM.
Goldring 1042	£90	Jan 93	One of the best MMs at the price with stainless delivery.
Goldring 1012GX	£60	Jul 93	Great with Rock music, the 1012GX is the best value low-price MM.
Goldring Phosphate Silver	£119	Apr 97	Good tracking and inoffensive sound, but somehow lacks sparkle in any department.
Linn K9	£?	Sep 94	Rhythmic bite compensates for a lack of vibrancy in music (MM).
Ortofon S41	£100	Jan 93	Smooth operator and very good value for money (MM).
Ortofon MC15 Super II	£110	Mar 95	In the right system, can be masterful with its dry and accurate response.
Ortofon MC15F	£170	Sep 95	A considerable achievement that adds true verve a pizzazz to the MC15 Super II
Roksan Corus Black	£120	Jan 93	Light and dry presentation with good presentation (MM).
Sony Biazon MM	£185	Sep 97	If you like the V15 you'll love the Brazen. Works well with an SME 3009.
Sumiko Blue Point	£100	Oct 92	Excellent value for money. It does its job of transcribing the information on the disc without fuss or bother.



SME Model 20.

Cartridges £ Year Verdict

£200-

Cartridge Man Moving Magnet	£549	Feb 99	Good price, high output and a winning musicality make this Moving Iron cartridge the one to beat.
DNM Lexa	£1300	Jan 99	A Goldring make-over that tracks well and sounds good. Pricey, though.
DNM Phono MM Cartridge	£255	Jun 98	This betters the Mica, has super-MM virtues.
Dynavector DV20X-H	£299	May 99	Delightfully musical sound makes the Dynavector a very strong contender in the budget MC stakes.
EMT HC III	£850	Oct 96	Solid bass and smooth, musical sound make this rare MC cartridge worth the money.
Goldring Excel VX	£495	May 97	Has fine midrange clarity, but is bettered in other areas by cheaper competitors.
Linn Ares	£1200	Dec 97	Linn fans will love it but it's up against strong competition.
Linn Klyde	£489	Jun 95	Sumptuous sounding cartridge that borders on the bass heavy but has a good feel for music.
Lyra Lydian	£649	Jun 95	Extremely smooth, civilised MC with no obvious weaknesses.
Ortofon Jubilee	£1250	Mar 99	Detailed, musical and sure-footed, the Jubilee goes a long way towards justifying its elevated price tag.
Ortofon MC15F	£225	Sep 95	Delightfully sweet, musical sound with added refinement on FL that takes some beating.
Ortofon MC30 Supreme	£450	Jun 95	Involving yet refined presentation but some could feel it's slightly coloured.
Ortofon MC1500	£2000	May 94	Conveys the full gamut of emotion from A-Z with the fervour of a live concert. Expensive, but the business.
Ortofon Rohmann	£1000	Apr 96	A top quality MC with superb tonal quality and excellent imagery.
Ortofon V15	£295	Mar 97	Warm, dynamic rendition of music with great detail and impact (MM).
Transfiguration Spirit	£1000	Jul 98	A balanced all-rounder that misses out only on the last ounce of detail and bass weight.
Van Den Hul MC10	£840	Jun 95	The MC10 is very hard to fault. A honey, pure and simple.
VDH Grasshopper IV	£3750	Dec 95	Allows music to flow with superb fluidity and reveal things which were previously unheard - at a price!



Sonic Frontiers Phono 1.

Tone-arms £ Year Verdict

Hadcock GH 228 SE	£595	Dec 98	Construction won't worry SME but its sound quality will unsettle a lot of the competition.
Ortofon Live RB250 RB100	varies	Nov 97	These modified arms are a considerable improvement on the originals
SME 309	£689	Jan 93	Tight, neutral sound with good tonality, but lacks the IVs pace and precision.
SME IV	£828	Mar 92	Sexy chassis and staggering engineering along with potent performance earn it a place in audio history.

RELEASE the **FULL POTENTIAL** of YOUR SYSTEM



Russ Andrews

WHAT HI-FI?

★★★★★

"What's more, a mains block of this quality is for life!"

Dec '98

STEP 1: YOUR MAINS

Start at the beginning! The truth is that poor mains quality ruins the sound of even the best equipment. The better the equipment, the bigger the difference. Kimber PowerKords and Distribution PowerBlocks remove mains pollution so effectively that they can more than double the performance of your system.

Call NOW for your free brochure.

MAIL ORDER direct 0800 373467 (UK ONLY)

Russ Andrews Accessories Ltd., Edge Bank House, Kendal, LA8 8AS
Tel: +44 (0)1529 822247 Fax: +44 (0)1529 822317 www.russandrews.com E-mail: rtw@aol.com

Zouch Audio Ltd

WORLD CLASS HIGH FIDELITY



 SWEDEN

ADVANTAGE *'Simply irresistible'*

THE USA 

PASS LABS *'The king of Class A amplification'*.

HALES DESIGN GROUP *'Redefining the concept'*

BALANCED AUDIO TECHNOLOGY

'Value and solid state at its best'.

THE UK 

MUSICAL FIDELITY

'When music matters most'

BE A WINNER WITH ZOUCH
AUDIO

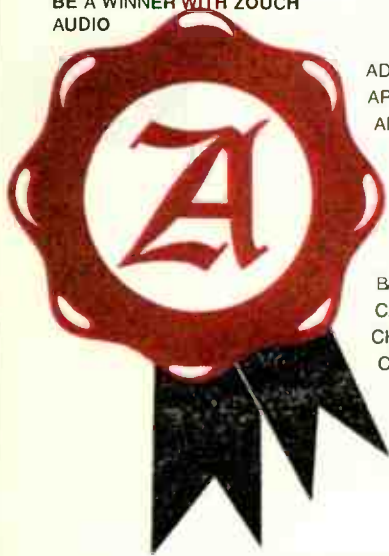

AGENCIES

ADVANTAGE
APOLLO
ARGENTO
ATACAMA
AUDIO ANALOGUE
AUDIO QUEST
AUDIO VECTOR
AVI
BALANCED AUDIOTECHNOLOGY
CAT
CHORD
COPULARE
CREEK
EGGLESTON WORKS
HALES
HOVLAND
JAMO
LUMLEY
MAGNUM DYNALAB

MIT, MUSICAL FIDELITY, MUSICAL TECHNOLOGY,
NAD, NEAT, OPERA, ORCHID, ORTOFON, PASS LABS, PROCEED,
PROJECT, PROMENADE, PURESONIC, REFERENCE 3A, SME,
SOUNDSTYLE, SUPRA, WILSON BENESCH, TARGET AUDIO, TEAC,
UNISON RESEARCH, WISDOM

Zouch Audio Ltd

The Old Coach House, off South Street,
Ashby de la Zouch, Leicestershire LE65 1AN

TELEPHONE 01530 414128

Mobile 0976 571875

<http://www.adyx.co.uk/ashby>

email: zaudio@ashb.adyx.co.uk



100% value

A supremely elegant, neat and
complete, CD music system combining
power, performance and style.

a classik by Linn®



LINN
the only sound®

Linn is available from the very best hi-fi retailers and
Linn at Harrods. For further information simply see our
website on www.linn.co.uk or call 0500 888909

Tuners £ Year Verdict

Under £300

AMC T7	£130	Jul 97	Although it has a tempting price, its sound quality is poor compared with its rivals.
Arson Alpha 7	£230	Ma 97	An attractive, smooth sounding tuner that won't break the bank.
Cambridge T300	£180	Feb 99	The T500 is one of the most gifted tuners under £500; a very accomplished all-round performer.
Harris/Radson TU 950	£200	Jul 96	Sound quality is generally impressive. Let down by a rather constricted sound stage, but still good value.
Kenwood KT-2080	£130	Feb 97	Smooth, even balance allows the KT-2080 to convince with whatever it's receiving. £130 well spent.
Mitsubishi ST-57	£150	Oct 97	The ST-57 is a smooth, warm tuner but lacks a little clarity and transparency.
Mission Cyrus FM7	£299	Apr 94	Musical, communicative and extremely detailed and a steal at the price.
NAD 412	£190	Jun 96	A remarkably musical and natural sounding tuner. Unbeatable at the price, or even twice the price for that matter.
Onkyo T401	£160	May 94	A competent machine, but time has taken its toll on the sound quality.
Pioneer F-34RDS	£300	Dec 98	One sole mark against the class-leading transparency is its slightly dry character.
Raga Radio	£230	Jan 95	Sounds on the whole more than its price, but in other respects it isn't especially competitive.
Real RT-930AX	£175	Aug 94	The RT-930AX is a glowing little bargain, real quality at a very realistic price.
Sony ST-S43E5	£250	Apr 97	The Sony is worth every penny of its asking price. If you're a fan of radio this is one to go for.
Sony ST-SE700	£180	Aug 97	The ST-SE700 is one of the best at this price. LW reception is a welcome bonus.
Technics ST-G1-350L	£140	Jun 95	Not a bad buy at all and a very good fit for budget and mid-price systems.
Yamaha T500 RDS	£200	Feb 95	If you want something for casual listening with superior aesthetics, this might be the one for you.



Rotel Michi Tuner.

Tuners £ Year Verdict

£300-£799

Adcom GFT 555-2	£399	May 93	Quite musical but does not rejuvenate the waves! Good solid performance but less than luxurious.
Crack T43	£399	May 98	A great little tuner. This is the one in the price bracket.
Denon TU-510	£400	Mar 98	A stylish, well-built tuner which has a detailed sound but needs careful partnering
Kenwood KT-6206L	£300	Oct 95	A good value, excellent sounding rds tuner, but lacks full EON facilities
Magnat Dynamic ET101A	£749	Apr 92	Worth auditioning but bass rather dry and light.
Marantz ST-17	£600	May 99	Knock-out build quality and rich velvety sound. Poor-signal mute a bit too enthusiastic.
Meridian 504	£660	Ma 96	A clear, natural sound with good punch. Has strong rivals at the price, but acquits itself well.
Micromega Tuner	£700	Jul 95	An unusual design from Micromega that's well built but sonically unrewarding and expensive.
NAD 702	£330	Jul 94	Well worth auditioning, even if you've never previously considered a receiver.
Naim NAT 03	£499	Sep 93	Soft and pure, especially across the midband. Speech very well reproduced plus solid weighty bass.
Nakamichi ST33	£350	Dec 94	Looks good, but the sound quality isn't really worth the asking price.
Pioneer F-34RDS	£350	Nov 95	Well engineered and competent tuner, but a little uninspiring.
Real RT 930AX	£500	Apr 95	The price of twenty concert tickets, and for that you can listen as if you were there. A bargain.
Thorn TRT-2000	£500	Dec 97	An otherwise competent tuner is let down by a rather processed character.



Nakamichi DR1.

Tuners £ Year Verdict

£800-

Cambridge T511	£4347	Nov 94	This is not a cheap tuner, but its cheaper than buying a radio station, which is the only possible alternative.
Fanfare FT 1	£1350	Mar 95	Whether it's sweaty disco or symphony hall, the Fanfare comes up to scratch.
John Koss	£1645	Mar 92	Commendable basic performance but, considering the price there are limitations.
Rotel Michi RH110	£895	Mar 94	This classy looking tuner can hold its head up high amongst the best tuners at the price.
TAC M-Len T20	£1100	Mar 99	Extremely well built with a lucid if slightly dry sound. The only real drawback is the high price.

Cassette £ Year Verdict

Under £300

Aiwa AD-F500	£150	Apr 98	No Dolby S, but three heads and two capstans make the Aiwa a bargain.
Denon DRM 500	£160	May 96	Good enough for the price and no worse than the competition.
Denon DRM-650S	£230	Aug 96	Top sound quality with ferric and chrome makes this deck a steal.
Grundig CPA	£250	Jan 95	Fair on pre-recordeds, OK when recording, but speed stability isn't great.
JVC TD-V651	£300	Sep 98	Only the lack of Dolby S conspires against the otherwise excellent JVC.
Kenwood KX-50009	£200	Jan 97	Stable transport gives fine results on metal and chrome. Rough on ferrics.
NAD 513	£230	Jan 96	Decent playback and good recording when used carefully.
NAD 514	£270	Sep 95	Excellent electronics are let down by a low-grade transport.
Rotel RD-9611A	£230	Oct 95	A solid, competent machine which is reasonable value for money.
Sanyo TC-K311	£150	Dec 93	Auto-tuning is mediocre and the general results are unexceptional.
Sony TC-K100	£170	Jan 93	A mix of average heads and electronics doesn't make for happy taping.
Teco V-610	£100	Apr 97	The V-610's performance matches its price well, but audiophile it isn't.
Teco V-600	£150	Sep 94	Satisfactory for in-car recordings, but the low price shows.
Yamaha KX-580 SE	£250	Sep 97	The '580 lives up to its SE tag with a fine performance in all areas.

Wide range of popular, classic, vintage, rare Electron Tubes from STOCK.

E.T.O.L.S
Electronic Tube On Line Shopping

Division of HALFIN
50 years of experience.
We ship worldwide

VISA



Web site

37/39
Quai aux
Pierres de Taille
B-1000 Brussels
BELGIUM

Free membership gives access to the gateway of the world.

www.halfin.com/shop

Phone: +32 2 218 10 11 Fax: +32 2 218 69 98
E-Mail: etols@halfin.com

Cassette £ Year Verdict

£300-

Arms AD-S950	£300	Feb 95	Vice-free playback is mirrored by impressive recording.
Denon DRS-810	£300	Jan 92	On the right tapes, the Denon repays with delightful sound quality.
JVC TD-V1011	£400	Sep 92	Disappointing on replay but recording is another kettle of fish altogether.
Kenwood KX-7060S	£330	Dec 94	Convincing all-rounder except for heavy-handed noise reduction.
Nakamichi 1.5	£500	Jan 92	The Cassette Deck 1.5 has no rivals in its ability to recreate a realistic performance.
Nakamichi DR-1	£780	Jun 93	Not perfect but as close as you can get for the money.
Nakamichi DR-3	£300	Mar 93	Unfortunately keeping the price down keeps performance below Nak's norm.
Onkyo TA250	£350	Oct 94	Top transport but the electronics aren't on a par.
Pioneer CT-95	£1000	Mar 97	On chrome and ferric, the '95 is smooth and natural. Not so good with metals.
Pioneer CT-S550S Precision	£340	Feb 99	Three heads, ease of use and high quality make the Dolby S equipped Precision a strong contender
Pioneer CT-S740S	£430	Jun 96	Complex but superb in every important area.
Sony TC-K611S	£330	Feb 94	Muffled on pre-recordeds but pulls out all the stops on recordings.
Teac V-6095	£550	Nov 97	Solid build and solid sounds. Top-notch at the price.
Teac V-8030S	£650	Aug 95	One of the highest quality Dolby S decks available.
Technic RS-AZ7	£300	Jul 96	Excellent bass but mid and treble lack dynamics. Auto-tunes poorly on metal.



Panasonic DVD.

DVD £ Year Verdict

Denon DVD-3000	£700	Aug 98	The Denon is a fine performer with CD and better still with 24/96.
Denon DVD-5000	£1500	Mar 99	Build is second to none. Sound is very solid convincing, but not as musical as the 3000.
Panasonic DVD-A350	£700	Jul 98	The A350 wipes out the CD-only competition at the price and threatens players up to £2000.
Panasonic DVD-L10	£1000	Nov 98	Isn't cheap, but it's an outstanding portable and a capable domestic device.
Sony DVP-S715	£700	Aug 98	The Sony is warm and smooth but lacks clarity and precision.

Headphones £ Year Verdict

Ergo Model 2	£140	Mar 99	Wonderfully lucid and transparent panel-like sound.
Jacklin Flight 2	£100	Mar 99	Clarity and openness are their traits, rather than slamming bass, but still good value.
Sennheiser HD-580	£200	Nov 98	In the company of a smooth, warm system the 580s can shine.
Smith-Morris HEV10 V70	£1000	Feb 95	Electrostatic that set a class standard and can put a case for chucking out your power amp and 'speakers.
Vivanco FMH-6800	£80	May 98	Have a lot of potential but basic operating problems have to be cleaned up first.
Vivanco SP550	£50	Nov 95	Excitement that is rarely heard in headphones, but have a little trouble with heavy orchestral loads.



Sonic Frontiers 3.

CD Transports £ Year Verdict

Under £800

DEA Enlightenment	£695	Mar 95	Solid and lifelike sound with Rock music and full bodied on Classical.
Kenwood DP-X9010	£530	Feb 92	Superb build for the money and a very musical sound. Benefits greatly from clocking.
Robi RD0-980	£450	Jul 96	Good, clean dynamic sound with a neutral and pure midrange tone.
Teac VRDS T1	£499	Feb 95	Enjoyable player with good insight. Good finish and keen pricing make it a thoroughly good buy.
Audiolab 8000 CDM	£1249	Aug 94	Distinguished by a wide array of facilities, thoughtfully designed and high quality.
Cyrus Disc Master	£1800	Jul 94	Smooth and cohesive. The Disc Master looks good and comes with the Dac Master within the price.

CD Transports £ Year Verdict

£800-

Micromega Duo	£3435	Apr 93	Excellent build quality and a sound quality to match.
Monarchy DT-40A	£1595	Jun 94	Isn't cheap but has a solid dependable sound with a big, powerful presentation.
Parasound C/BD 2000	£1695	Jun 97	The belt drive is an interesting idea but the Parasound is bettered by cheaper transports.
PT Cardinal	£1440	Feb 95	Heart-stopping speed and impact contribute to what is an exceptionally good machine.
Sonic Frontiers SFT-1	£2295	Aug 96	Top flight machine with an easy, musical and enjoyable sound, for those that can afford it.
Sonic Frontiers 3	£6999	Sep 98	A handsome machine both sonically and aesthetically. We love the camera aperture-style loading system.
Teac P-30	£2500	Jun 97	Costs a lot of money and sounds nothing short of superb.
Thorens TCD 2000	£900	Jun 96	A soft and warm sound will please vinyl lovers, but it's not the last word in detail.
XTC CDT1	£1200	Apr 96	A warm and musical sound with a taste of high-end refinement and detail.

SUPERCLOCK....a new concept in digital master clock design

Simply the Ultimate CD upgrade

The latest in CD master clock development, using a completely new unique design resulting in a much greater accuracy in data retrieval and conversion processes. Features comprehensive circuit topology using push-pull techniques and series mode oscillation, and the sine-square converter utilises a very high speed IC to provide a precision square wave clock signal.

- ⇒ Greatly improved resolution and detail
- ⇒ Extended accurate bass with real weight, control and presence
- ⇒ High frequencies have less glare and hardness at all listening levels.
- ⇒ Greater dynamics, and detail at all frequencies.
- ⇒ Spacious & clear presentation of vocals and instruments

The SUPERCLOCK is available *exclusively* from AudioCom (UK) and can be fitted to any CD player's transports using the following frequencies: 11.2896MHz, 16.934MHz & 22.5792MHz. Modifications are carried out at AudioCom (UK). A kit is also available with instructions for the technically competent.

Specialist Upgrade Service

Professional modifications using leading edge components. Modifications are carried out by engineer with 30 years experience in the field of analogue and digital electronics. Upgrades available to all types of audio equipment.

- CD Players/Transports • D-A converters
- Analogue stage, digital filter, master clock, power supplies.
- Pre & Post Power amplifiers,
- Power supplies, signal de-coupling, volume control

For further information on SUPERCLOCK and other products request a copy of our FREE catalogue. (Overseas: £3.50)
Tel 01834 842803 Tel/Fax 01834 842804 E-Mail audiocom@scotnet.co.uk



Ma Cherry Amour

Can Pro-ject's Classic Cherry turntable seduce Jon Marks's ears as well as his eyes?

Not everybody might agree, but to my eyes anyway turntables just seem naturally more attractive components than CD players. Amplifiers suffer from the same problem of what to do stylistically with a box full mainly of air - the purposeful black look is obviously the choice of many. Record decks offer more room for manoeuvre, and something as simple as a layer of veneer can work wonders for the aesthetics of vinyl replay.

Pro-ject have evidently cottoned on to this fact to judge from their Classic Cherry. A slab of MDF wrapped up in a fetching Cherry veneer, it's so much more appealing than bog-standard black Ash alternatives. The bottle green of the glass platter sets it off a treat too, although the felt mat hides it most of the time. Sitting under the platter is a plastic sub-platter on a bearing of decent tolerance. Drive comes from an AC synchronous motor mounted in a rubber-band cradle to minimise vibration transmission.

Included in the £450 asking price are an Ortofon 510 MkII MM cartridge (reviewed on p59 of this very issue), a record clamp and Pro-ject's own tone-arm, its chunky arm-tube supported on gimbal bearings. Bias is by the traditional weight-and-string method, and the 510's output reaches the rest of the system via a basic phono-to-phono cable that plugs into the sockets on the deck's rear, which at least enables easy experimentation. Finally, hopping between 33 and 45rpm is accomplished by moving the belt from the smaller pulley diameter to the larger.

Set-up should be a piece of cake - provide a level, low-vibration surface for the Classic to reside on, remove the motor's transit screws, put on the



belt and away you go (assuming the arm and cartridge have been pre-aligned by your dealer). I use the word "should" because our review sample hadn't been correctly assembled when it left the factory - the arm's gimbal bearings had not been tightened at all, rendering it unusable. Sample No2 duly arrived and was set up alongside an MVL A2+ integrated and Quad 57 electrostatics.

Just out of curiosity I tried the Classic with its motor transit screws in place. The deck turned out to be a surprisingly classy performer, with a punchy, rhythmic presentation of the first disc on the platter, The Thompson Twins' *Into The Gap* (well, everyone's got the odd musical skeleton in their cupboard!) OK, there was some top-end emphasis attributable to the 510 MkII cartridge, but overall, the Classic showed promise.

After removing the motor screws and pressing the Twins in place with the supplied clamp, I set the needle down once more. Immediately noticeable were better detail and

clarity, especially in the sound stage which had considerably greater depth than before. The midrange and treble were smoother too, which produced a more even tonal match between deck and cartridge.

Having finished with the Twins, I headed for some Bartok instead. The Pro-ject kept its cool in the face of a full orchestral onslaught, maintaining its transparency and precision imaging. Bass avoided the common pitfall of budget boom and displayed good articulation in spite of background noise being slightly more prominent than I had hoped.

The numbers of people wanting to get into vinyl at this late stage in the LP's life may be dwindling, but with turntables such as the Classic Cherry there are still good reasons to do so. With its tasty looks and solid build quality (including a main bearing free from play), it makes the black disc an attractive proposition. The only fly in the ointment is the somewhat doubtful consistency of the factory adjustment - check yours has a correctly assembled tone-arm before parting with your cash●

Pro-ject Classic Cherry £450

Henley Designs
The Old Coach House,
Crowmarsh Gifford,
Wallingford,
Oxon. OX10 8EH
Tel: 01491 834700

WORLD VERDICT

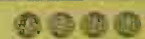

Eminently capable player that can be upgraded with superior cartridges.

Measured Performance see p135

WORLD LIBRARY

OVER 40 TITLES ON OFFER!!!

LOUDSPEAKERS



Theory and Design of Loudspeaker Enclosures
J. E. Benson
Covers infinite baffle, reflex, passive radiator etc. in great detail with a highly mathematical approach making it unsuitable for beginners but highly authoritative to experienced designers.
244pp 6" x 9"
Paperback Code: 1140
£23.95 + £2.50 P&P (UK)

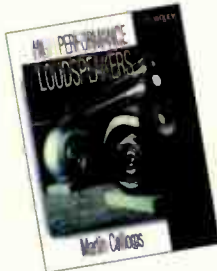

High Performance Loudspeakers 5th Edition
by Martin Colloms
An up to date high performance reference book. Ideal for professionals and students. Covering reviews of CAD packages, digital loudspeaker design, new results in loudspeaker distortion, new developments in short path, low order crossover network design, bending wave panel speaker technology, hybrid loudspeakers and more.
478pp 7 1/8" x 9 1/2"
Paperback Code No 1350
£27.50 + £3.50 P&P (UK)



The Loudspeaker Design Cookbook, 5th edition
Vance Dickason
This best seller offers up-to-date design information for the home constructor. It uses modern Thiele-Small theory and parameters.
185pp 8 1/2" x 11 1/8"
Paperback
Code No. 1090
£22.95 + £3.25 P&P



Electrostatic Loudspeaker Design and Construction
Ronald Wagner
Step by step guide to the design and construction of a full range electrostatic loudspeaker, including basic operating principles. Strongly recommended for those wanting to either build, repair and/or restore or who are just interested in electrostatics.
243pp 7" x 9 5/8"
Paperback Code No. 1080
£16.95 + £3.25 P&P (UK)

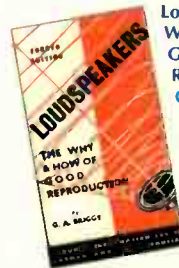

Loudspeakers: The Why and How of Good Reproduction
G.A. Briggs
An easy to understand book on building loudspeakers, using empirical techniques that pre-date computer analysis. Strong recommendation for beginners.

88pp 5 1/2" x 8 1/2"
Paperback Code: 1070
£10.95 + £1.50 P&P (UK)

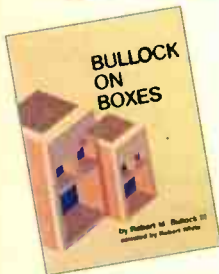

Bullock On Boxes
Robert M. Bullock III
Using Thiele-Small parameters clearly, it offers lots of helpful tables and graphs to get to grips with the sizing of the box and port of a reflex loudspeaker.
72pp 8 1/2" x 11"
Paperback Code No. 1100
£12.95 + £2.00 P&P (UK)

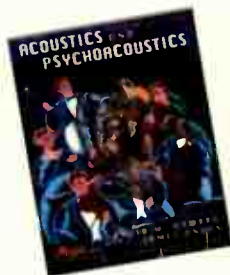

Acoustics & Psychoacoustics
by David M. Howard & James Angus
This book provides an introduction to acoustics, including the principles of human perception of sound, notes and harmony, musical dynamics, timbre of musical instruments, acoustic model for musical instruments, hearing music in different environments, deceiving the ear and processing sound electronically
224pp 244 x 189mm
Paperback Code No. 1370
£25.00 + £3.25 P&P (UK)



Testing Loudspeakers+
by Joe D'Appolito
The authoritative book on the subject of loudspeaker testing! Joe D'Appolito, loudspeaker designer and consultants, has written the definitive text on testing loud-

speakers. Dr. D'Appolito brings his expertise to the subject and provides you with a hands-on discussion of testing drivers and systems. He brings you the theory and physics behind loudspeaker testing in this volume.
Paperback Code No. 1580
£24.95 + £2.50 P&P (UK)

Loudspeaker and Headphone Handbook

Second Edition
by John Borwich

This book brings together in a single volume every aspect and practice in sufficient depth to equip students and professionals alike with a solid working knowledge of the subject.
592pp 234 x 156mm Paperback
Code No. 1360
£50.00 + £4.25 P&P (UK)

Electronic Circuits Student Handbook

by Michael Tooley

This book provides the knowledge necessary to appreciate the operation of a wide range of basic electronic circuits including amplifiers, logic gates, power supplies, timers and pulse generators. The coverage is ideal for students following formal courses.
240pp Paperback Code No.1450
£14.99 + £2.75 P&P (UK)

AUDIO ELECTRONIC THEORY BOOKS

Scroggie's Foundation of Wireless and Electronics

Roger Amos B.Sc. B.D., M.I.T.S.C. & S.W., Amos

Scroggie's Foundations is a classic text for anyone working with electronics, who needs to know the art and craft of the subject. Based on experience since the dawn of the electronic age, and updated in regular editions over 60 years, it covers both the theory and practical aspects of a huge range of

topics from valve and tube technology, and the application of cathode ray tubes to radar, to digital tape systems and optical recording techniques.

400pp 234 x 156mm Paperback
Code No. 1590 £19.99 + £3.00 P&P (UK)

Electronics made Simple

by Ian Sinclair

This books covers the basic theory and principles of electronics. A good read for the beginner.
Code No 1420 £12.99 + £2.00 P&P (UK)

Build your own High-end Audio Equipment

by Elektor

Build your own High-end equipment contains construction projects for solid state and valve preamplifiers and power amplifiers, active cross-over filters, and active subwoofer, a mono/stereo compressor and a headphone amplifier.

Code No. 1390 £14.95 + £2.25 P&P (UK)



High Performance Audio Power Amplifiers

by Ben Duncan

Power Amplifiers and their performance lie at the heart of audio engineering. This handbook is the distillation of the state of the art. Linking analog electronics, acoustics, heat and music technology; high-end hi-fi and professional PA and recording studio

use; theory, modelling and real-world practice; design and repair; the old and the new, the mainstream and the specialised.

288pp, 234x156mm,
Hardback Code No.1460
£40.00 + £3.25 P&P (UK)

Build your own Electronic Test Instruments

by Elektor

This book contains designs for 17 measuring instruments, seven generators and analysers; ten miscellaneous instruments and a number of test ancillaries and auxiliaries. The designs range from a simple multicore cable designs contain a special printed circuit, drawing of which are given in an appendix.

Code No. 1400
£15.95 + £3.25 P&P (UK)



Understand Amplifiers

by Owen Bishop

This is a readable introduction for those with little previous knowledge of the subject. The theme of amplification is central to many branches of electronics. Consequently there is a large and confusing array of amplifier types intended for a wide range of applications. This book describes amplifier types, how

they work, their properties, advantages and disadvantages, and applications. Amplifiers are treated with the minimum of mathematics and lots of illustrations.

Paperback Code No. 1560
£16.99 + £2.50 P&P (UK)

Practical Electronic fault-Finding and Troubleshooting

by Robin Pain

This book explains the basic techniques needed to be a troubleshooter, using only the basic equipment: a digital multimeter and an oscilloscope. Simple circuit examples are used to illustrate principles and concepts fundamental to the process of fault finding.

240pp 2 1/4 x 156mm
Paperback Code No. 1430
£19.95 + £2.25 P&P (UK)

VALVE BOOKS



The Beginner's Guide to Tube Design

by **Bruce Rozenblit**
The best beginner's guide on vacuum tube audio is now available. This book takes a comprehensive look at tube audio design. For the beginner, the author starts by explaining how vacuum tubes work and how to design with them. For the more experienced constructor,

Rozenblit has provided chapters on subjects including stabilisation and testing, a description of 13 famous and classic amps and preamps and how to work effectively as a designer. A hands-on guide to construction techniques, tools and choosing components and tubes is provided. 1997, 132pp., 8" x 11"
Paper back Code No. 1340
£15.50 + £2.25 P&P (UK)



Mullard Tube Circuits for Audio Amplifiers

Includes full designs for eleven power and control amps, including 5-20, using valves. Begins with a four chapter tutorial on getting the best sound from valve amplifiers. 142pp 8" x 10"
Paperback Code 1030
£13.95 + £1.50 P&P (UK)



70 Years of Radio Tubes and Valves

by **John W. Stokes**
Outlines the evolution of radio receiving tubes and the part they played in the domestic radio receiver. A reference for those interested in the history and development, and collectors alike. 256pp "8" x 11" Paper back
Code: 1050
£24.95 + £3.50 P&P (UK)

An Approach to Audio Frequency Amplifier Design

Seventeen circuits from 5 to 1100watts - General Electric Co. High quality amp. designs using KT66s, KT88s, DA100s etc. Includes two valve pre-amps complete with phono stages. 126pp 6" x 9" Paper back
Code No. 1020
£19.95 + £1.75 P&P (UK)

RADIO DESIGNER'S HANDBOOK

4th Edition Fritz Langford-Smith

This is a classic, comprehensive reference handbook for all who are interested in the design and application of audio amplifiers and radio receivers, and deals with basic principles and the practical design of all types of classic audio amplifiers, radio receivers and record-producing equipment up to the invention of the transistor.

This reprint of the classic fourth edition, first published by Iliffe in 1953 and revised in this edition in 1967, provides information that is not available from any other source. It will therefore be invaluable to anyone working with valves, and provides a definitive guide to the valve and other components, audio and radio frequency technology, rectification, regulation, filtering, hum, complete receivers and sundry data.

This book is the work of 10 authors and 23 collaborating engineers, under the editorship of F Langford-Smith. The enormous amount of data included in the book has been made readily accessible by means of a fully detailed list of contents and a very complete index. The main subjects are: valves, valve testing, general theory and components; audio and radio frequencies; power supplies, design of complete AM and FM receivers, and reference information.

1498pp 216mm x 138mm **Hard back Code No. 1600**
£35.00 + £6.00 P&P (UK)



Saga of the Vacuum Tube

by **Gerald E.J. Tyne**
This book covers the history of the evolution of the thermionic vacuum tube, tracing its complex genealogy, and presenting essential facts to assist in the identification of sub tubes made prior to 1930. Bell Labs News, March 29, 1974, "Today Tyne probably knows more about the history of tubes than anyone else in the world". As reviewed in

August Supplement 1998
Paperback 494pp, 5 1/2" x 8"
Code No. 1540
£16.95 + £2.50 P&P (UK)

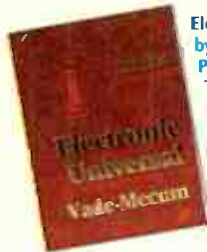

Electronic Universal Vade-Mecum

by **Piotr Mikolajczyk & Bohdan Paszkowski**
This Data book comprises 5693 valves divided into 442 groups. A comprehensive book which contains connection details, operating parameters, load lines and example circuits.
Hard back Code 1060
£49.95 + £ 8.50 P&P (UK)

Build your own Audio Valve Amplifiers

by **Rainer Zur Linde**
This book is intended for a broad cross-section of the public: apart from construction projects for preamplifiers, power amplifiers and two amplifiers for musical instruments aimed at the practical audio/hi-fi enthusiast, it offers much information on the operation of electron tubes, while the first chapter gives a short history of the thermionic valve.
Code No. 1320
£14.95 + 2.25 P&P (UK)

Valve Amplifiers

by **Morgan Jones, Audio Engineer**
This book allows those with a limited knowledge of the field to understand both the theory and the practice of valve audio amplifier design, such that they can analyse and modify circuits, and rebuild an amplifier. Constructional techniques are also provided so readers can build from scratch designs that actually work. 374pp 6" x 9"
Paperback Code No. 1330
£25.00 + 2.75 P&P (UK)



Tube Amplifiers

by **Kavsek & Kavsek**
The most beautiful tube amp book in the world. No specs. no test. just 215 gorgeous four colour photos of 65+ amps with a short description of each. Including a 12 page explanation of the history of tubes and tubeamps. Appendix with addresses with tech. data.
167pp 9" x 12"
Hard back Code No. 1310
£47.95 + £5.50 P7P (UK)



The Williamson Amplifier
by **D.T.N. Williamson**.
Offers practical advice on how to build and set up the amplifier for best results. 40pp 8" x 11"
Paper back Code No. 1040
£9.95 + £1.50 P&P (UK)

Electronic Valves in Audio Frequency Amplifiers

by **E. Rodenhuis**
Originally published in 1954 by Philips, this book encourages amp. builders to experiment with design elements. Discussing the use of valve data, the function of different amplifier stages and includes detailed descriptions of eight designs. A wealth of practical data, measurements and interesting features will be found. A very good read.
Paperback 147pp Code No. 1520
Price £12.95 + £2.00 P&P (UK)

Audio Amateur Power Amp Projects

by the editors of **Audio Amateur**
This profusely illustrated handbook features 26 of the best articles on power amps published in Audio Amateur from 1970-89. Authors from six countries offer an array of designs to provide almost any level of high quality audio power needed by the resourceful amateur who prefers the pleasure of building his or her own equipment. 205pp., 8" x 11"
Paper back Code No. 1300
£14.95 + £2.25 P&P (UK)

Principles of Electron Tubes

by **Herbert J. Reich**.
A textbook for beginners starting with the basics of how a vacuum tube actually works. Shows how a simple circuit is designed including amplifiers, transformers and power supplies. A must for both enthusiasts and hobbyists. 398 pp 6" x 9" Paper back
Code No. 1010
£27.95 + £3.00 P&P (UK)

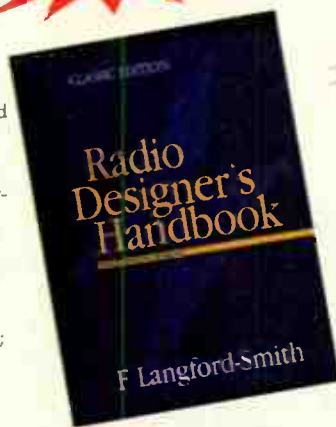

Valve and Transistor Audio Amplifiers
by **J.L. Hood**
This is J.L. Hood's greatest work yet, describing the milestones that have marked the development of audio amplifiers, from the earliest valve amps to the latest solid state design. This book is the complete world guide to audio amp design. Other contents: active & passive components, amplifiers, pre-amplifiers and power supplies.
As reviewed in June 98 Supplement
Paperback 250pp., 156mm x 232mm
Code No. 1530 £19.99 + £2.50 P&P (UK)

ORDER FORM

Please send (Code No.) _____ (enter codes clearly)

Pay: World Audio Publishing Ltd. £ _____ or debit my Mastercard/Visa card (Card No): _____

Expiry date: _____ Name: _____ Signed: _____

Delivery Address: _____

Tel: (Day) _____ Please return to: W.A.P.Ltd, Suite G4, Imex House, The Park Business Centre, Kilburn Park Road,

London NW6 5LF ENGLAND TEL/FAX: 0171 625 8032 OR 24 HOUR ANSWERING MACHINE: 0171 226 0461 E-Mail: wad@hi-fiworld.co.uk Tick if you do not want to be added to our mailing list

Please contact us for overseas P&P charges. Allow 28 days for delivery. All orders subject to availability. If further space is required please attach separate sheet.

pear audio

presents

Shahinian DYNAVECTOR Well Tempered

Stockists and Information from
**Pear Audio Ltd. 7 Prospect Place,
Alnmouth, Northumberland, NE66 2RL**
Tel: 01665 830862 Fax: 01665 830051

SONIC LINK

Make The World's Finest HiFi Cables
From The Highest Quality Materials



Good design improves your hi-fi
Good interconnect improves your music
Good music improves your life.

Derwent Business Centre, Clarke Steet Derby DE1 2BU
Sales Office Hot Line 07000 SONIC LINK
Tel: + 44 (0) 1332 361 390
Fax: + 44 (0) 1332 298 836

Two Epos Acoustics speakers, one large and one small, with a dark wood finish. The large speaker is on the left and the smaller one is on the right. Both have a black grille and a visible tweeter and woofer. The Epos logo is visible on the bottom of the large speaker.

epos

*HAPPY
BIRTHDAY
SWEET 16!*

*16 YEARS OF:
TECHNOLOGY...
BEAUTY...
MUSICALITY...*

Under new management:
EPOS ACOUSTICS
2 Bellevue Road, Friern Barnet
London N11 3ER, England
Tel: 00 44 + (0)181 361 8864
Fax: 00 44 + (0)181 361 4136
E-mail: epos-acoustics@ibm.net
Internet: www.epos-acoustics.com

Still Got The Nak?

Cassette deck legend Nakamichi have returned with a new range of components including the RE-10 receiver. Simon Pope welcomes them back.

The history of the Nakamichi name is as long and varied as any in the audio industry. Started in 1948 by Etsuro Nakamichi, the company produced its first tape recorder in 1950. However, it was almost 20 years later that their output started to gain audiophile popularity. 1973 saw the launch of the first cassette machine (the 1000) and the rest, as they say, is history, culminating in their classic three-head, auto-reverse Dragon. Basically, no self-respecting cassette user would have been found dead without one of their machines.

The Eighties saw Nakamichi branching out into other audio fields such as amplifiers, tuners, receivers and even the huge TTX-1000 direct-drive turntable with a built-in computer to auto-centre eccentric records. After the death of Etsuro Nakamichi in 1982, things foundered a little and they stopped producing components for the UK market. However, thanks to BBG Distribution, we now have a brace of fresh bits like the RE-10 receiver to look forward to.

Cosmetically, the RE-10 is a bit of a beast, its chunky dimensions and solidity hinting at the quality end of Japanese manufacturing. With a Nakamichi DVD player in the pipeline, it's no surprise that there's a dedicated input next to those for CD, Aux and Video. Oh, and don't forget the Tape and VCR loops, a sub-woofer out and sufficient binding posts for two pairs of loudspeakers! On the fascia reside the defeatable Bass and Treble controls as well as



Balance, Loudness, Mute and Volume.

As far as the amplification goes, the RE-10 certainly has plenty of clout - 100watts per channel, to be precise. When I first hooked it up to a Denon DCD-1650AR and Magneplanar SMGas, this much was

obvious. Relaying a Chandos recording of Tchaikovsky's 4th Symphony, the Nakamichi showed its mettle from the very start.

The opening brass calls were so pronounced you could probably

have heard them in Kiev! Subtle, no, but very exciting. The following silky string phrases highlighted the hefty bass of this receiver - double-basses and 'cellos, although quite metallic tonally, were very strong and powerful, bringing real depth to the orchestra.

Orbital's new Middle Of Nowhere was next in line. As the album's momentum grew, so did the RE-10's involvement with the music. While the excitement and precision of this sort of presentation were

bonuses, the sound was also very solid-state - warmth and smoothness weren't fortes; rhythmic attack and punch took that honour. One other disappointment was the lack of real depth in the sound stage; even through the Magneplanars, the sound was 'left to right' more than 'front to back'.

The tuner side of the operation performed in a manner similar to the amplification. With a Radio 4 broadcast, the result was clean and crisp, voices centred between the 'speakers. Again, depth perspectives were limited and there was some sibilance present which could make longer listening sessions tiring.

Receivers are invariably a compromise where compactness and cost are more important than outright sonic performance. For those who specifically require a combined tuner and amp with loads of power and an up-front way with music, the RE-10 has its merits - its radio section holds its ground well against tuners in the £120-£150 bracket. On the other hand, if it's purely high-grade sound you're after, Cambridge's T500 tuner and A1 MkIII integrated offer a more transparent and cohesive performance that's marginally lighter on the wallet.

Nakamichi RE-10

£399.99

BBG Distribution

Unit 3, Barratt Way,
Tudor Road,
Harrow,
Middx. HA3 5QS



The RE-10 comes with tone controls and a natty display.

WORLD VERDICT



A big, powerful performer and a competent package that is good value for money. Bettered by good separates though.

Measured Performance see p135

KITS HAVE NEVER



KEL34 E&I VALVE INTEGRATED AMPLIFIER KIT

The KEL34 E&I version is our second generation budget stereo integrated valve amplifier, utilising E&I output transformers, providing a massive 40 watts of pure valve sound. With 4 line level inputs and one tape output, fully controllable from the front panel, the KEL34 E&I is a simple and elegant circuit design using a 6AU6 pentode input valve, an ECC82 double-triode phase splitter and a push-pull pair of Tesla, JJ branded EL34s. The result is a typically sweet, open valve sound with atypical bass control and power. The KEL34 E&I will work its magic into 'speakers of average sensitivity too. Jon Marks says, "tonally the KEL34 E&I is a bit of a smoothie compared with the original toroidal version, a major upgrade in every area of performance. It has a fast, dynamic sound, plucked guitar strings and bass drum enjoy crisp leading edges and great impact. Clear imaging and spacious sound staging meant voices and instruments really jumped out of the loudspeaker boxes. Overall the KEL34 E&I is a beautiful power amp." At the price, this kit is second to none and will open up the benefits of valve amplification to a whole new class of audio nuts! Weight 12kg. External dimensions with valves: 33cm(w) x 27.5cm(d) x 18cm(h).

£315

HD83 VALVE HEADPHONE AMPLIFIER KIT

The HD83 is our new headphone amplifier, a beautifully simplistic design using Mullard ECL83 valves, a triode and power pentode housed in the same envelope. It works directly from any source be it a CD, tape, tuner etc., or from an amplifier's tape out or pre-amp sockets. The circuit utilises high specification output E and I output transformers that will drive any headphone load from 16 ohms to over 300 ohms depending on how the secondaries are wired up. The HD83 is a single ended design with the power pentode wired up in triode configuration for that added purity and is as quiet as a mouse. For sound quality Jon Marks says, "The bass is punchy and controlled without becoming artificial, while treble has the crispness of the best solid-state, with the tonal purity, delicacy and speed associated with valves. External dimensions 18cm(w) x 30cm(d) x 8cm(h) weight 4kg.



£175

KLPP1 VALVE PHONO PREAMPLIFIER

KLPP1 has five line inputs, a tape input with monitor, and a unique low noise valve MM/MC phono stage. There is a switchable subsonic filter to prevent output transformers of valve amplifiers saturating. The line stage has gain, so it will drive any power amplifier. Audio grade components are used and many parts are custom made for highest quality. KLPP1 has a super clear sound, sweet and detailed through line and phono inputs. Weight 6.5kg external dimensions 28.5cm(w) x 23cm(d) x 8cm(h).



KLPP1 & KLP1 use the same chassis

KLP1 VALVE LINE PREAMP

The KLP1 line level preamp uses one elegant cathode follower line drive circuit to give a sound of remarkable clarity and detail. The components are all high quality and include Alps volume control, Sovtek valves, silver plated wire etc. With a gain off x1, it matches our sensitive power amplifiers. Beautifully built, with solid machined alloy fascia and gold anodised knobs, it looks compact and elegant in the home. Weight 5kg external dimensions 28.5cm(w) x 23cm(d) x 8cm(h).

£345

K5881PSE VALVE AMPLIFIER KIT

An audiophile parallel-single-ended valve amplifier at an affordable price. K5881PSE uses the reliable Russian 5881 output valve. Its 17watts is enough to drive most loudspeakers, making high-end sound quality and design available to everyone. Can be easily monoblocked to give 32watts. Weight 17kg external dimensions with valves 40cm(w) x 32.5cm(d) x 17cm(h).



£650

K5881 MkII VALVE AMPLIFIER KIT

A 20watt, Class A power amplifier that uses reliable Russian 5881 output valves, a military version of the American 6L6, designed for low distortion audio work. Now with a super shunt regulated push-pull (SRPP) input stage K5881 offers amazing sound quality. It can be used with a simple passive pre-amp or one of our own pre-amplifiers, and it matches modern loudspeakers well. Weight 15kg external dimensions with valves 40cm(w) x 32.5cm(d) x 17cm(h).



MkII with SRPP input stage!

£35

300B VALVE AMPLIFIER KIT

This is a specialised 28watt amplifier based on the highly linear 300B triode valve.

Our 300B runs in Class A, giving one of the most sweet, open and neutral sounds possible today. Matched with good loudspeakers, it is unsurpassed. All parts are included in the kit, except valves since different 300B makes are available. Weight 26kg, external dimensions with valves 44cm(w) x 35cm(d) x 20cm(h).



£850

K5881 MkII Upgrade kit

Upgrade your pre Newer 1996 K5881 amplifier to MkII status. The kit converts your amplifier to the new 7025 double triode input stage in place of the original EF86 pentode input.

BEEN SO GOOD!

KLS10 HIGH TECHNOLOGY COMPACT MONITOR



£394

Want high technology loudspeakers, without a high cabinet high price? You couldn't do better than build KLS10, our latest mini-marvel. Using an Audax carbon fibre bass/midrange unit, married to the world's most advanced tweeter, the piezo-electric gold dome HD3P from Audax, KLS10 offers high performance from a small package. The main 'speakers are designed to work alone, or with a dedicated subwoofer to extend their bass. Alone, they are suited to near-wall mounting and can be tuned by port adjustment to suit personal taste and location. They are easy to drive and need just 30-60watts. Those who want the bass of a big loudspeaker can build our inexpensive dedicated subwoofer at a little extra cost or intrusion into the room, this custom designed addition offers big loudspeaker performance. KLS10 is unique. Technically advanced, yet compact and relatively inexpensive. There is little to match it. Sensitivity 89dB 1W/1m, 15mm MDF, internal volume 9Ltrs, external dimensions 19cm(w) x 31cm(h) x 23cm(d).

DRIVE UNITS & CROSSOVER KIT
DRIVE UNITS ONLY

£394.00
£358.00

KLS10 GOLD SUBWOOFER

Our new KLS10 Gold subwoofer was designed to compliment KLS10 Gold stand mounters by providing a deep and open bass. The subwoofer is inexpensive, easy to build, comprising a simple crossover network to a high quality 8 inch Aerogel, dual voice coil bass unit. A must for all KLS10 Gold customers. Sensitivity 89dB, volujme 25 litres, external dimensions 28cm(w) x 43cm(h) x 34cm(d).



£149.95

DRIVE UNIT & CROSSOVER KIT
DRIVE UNIT ONLY

£149.95
£71.00

KLS9 TWO WAY FLOORSTANDER



£230

Here's a storm for you - KLS9, with its BB4 alignment bass cabinet and Audax High Definition Aerogel 8in bass/midrange unit. Designed by Noel Keywood to possess optimal bass damping and a clean step response. Aided by a teensy bit of bass lift, KLS9 really thunders; it will re-arrange your furniture. But it does not waffle, falling silent when there's no bass in the music. Aided by a high power 1in fabric dome tweeter, KLS9 is detailed, evenly balanced and images superbly. It is an easy 12ohm load and is 88dB sensitive. For amps up to 60W. Easy to build and great for beginners. Internal volume 70l trs, 18m MDF external dimensions 25cm(w) x 93cm(h) x 40cm(d).

DRIVE UNITS &
CROSSOVER KIT
DRIVE UNIT PACK

£230.00
£160.00

KLS3 GOLD MK II



£575

ADVANCED TECHNOLOGY THREE WAY LOUDSPEAKER

KLS3 Gold uses the latest version of Audax's innovative oval gold dome piezo electric tweeter, giving it the sweetest and most extended treble. Married to a 4in. carbon fibre cone midrange driver for neutral and clear reproduction, and a powerful 8in. bass driver for superb depth, this is our top-of-the-line reference 'speaker. Sensitivity 90dB at 1W/1m, 25mm MDF, internal volume 60Ltrs, external dimensions 26cm(w) x 100cm(h) x 35cm(d).

DRIVE UNIT & CROSSOVER KIT
DRIVE UNIT PACK

£575.00
£450.00

Upgrade your KLS3s to Gold status. Includes latest oval gold dome piezo tweeter and all components.

£330

KLS3 3 WAY CARBON-FIBRE DRIVER LOUDSPEAKER



£350

KLS3 uses extremely light and stiff carbon-fibre cone drive units for a fast, accurate sound. A dedicated 4inch carbon-fibre midrange drive unit provides the clean, smooth and detailed midrange characterised by superb projection. Its high 90dB sensitivity and near flat 8ohm impedance make it one of the easiest loudspeakers to drive. An ideal loudspeaker for high-end valve amplifiers. 25mm MDF, internal volume 60Ltrs, external dimensions 26cm(w) x 100cm(h) x 35cm(d).

DRIVE UNIT &
CROSSOVER KIT
DRIVE UNIT PACK

£350.00
£230.00

KLS11 3 WAY DESIGN



NEW!

£595

Our newest design is a wonderful three way bass reflex enclosure stand mounter. Another star performer, featuring the superb gold dome tweeter, the HD3P. This, married perfectly to a HM100ZO midrange unit and utilising the deep full sound of the 10 inch PR24OZO bass unit. All units are from Audax. As both these units use high definition Aerogel cones they have similar sonic signatures, providing a deliciously gelled sound. Our KLS11 is a quality three way, with powerfull bass and midrange driver that ensures vocals are handled with high fidelity. The treble is both smooth and sweet. Sensitivity 88dB

Volume 45.5 litres External dimensions 31cms (w) x 37.3cms (d) x 64cms (h)

DRIVE UNIT &
CROSSOVER KIT
DRIVE UNIT KIT

£595.00
£470.00

KLS4 2 WAY CARBON-FIBRE DRIVER LOUDSPEAKER

A two way standmounter using stagger-tuned reflex loading for good bass, plus light and fast carbon-fibre drivers. Sensitivity 86dB at 1W/1m, 18mm MDF, internal volume 15.3 Ltrs, external dimensions 21.6cm(w) x 42cm(h) x 25.8cm (d).

DRIVE UNIT & CROSSOVER KIT
DRIVE UNIT PACK

£230.00
£120.00

KLS8 TWO WAY HIGH SENSITIVITY

With a sensitivity of 94dB, KLS8 needs very little power. Its 10in. professional bass driver and horn loaded tweeter give it a BIG sound. Ideal for low power amplifiers. Internal volume 50.5ltrs, external dimensions 29cm(w) x 65cm(h) x 36cm(d).

DRIVE UNIT & CROSSOVER KIT
DRIVE UNIT PACK

£260.00
£175.00

KLS7 2 WAY CARBON-FIBRE DRIVER FLOORSTANDER

Compact and affordable two way reflex loudspeaker. KLS7's slim dimensions make it easy to accommodate, but it uses top quality carbon-fibre drivers, so performance isn't compromised. An audiophile bargain. Sensitivity 86dB at 1W/1m 12mm MDF, internal volume 18Ltrs, external dimensions 15cm(w) x 80cm(h) x 22cm(d).

DRIVE UNIT & CROSSOVER KIT
DRIVE UNIT PACK

£195.00
£110.00

WAP SURPLUS VALVE TOROIDAL MAINS TRANSFORMER

For 230V/240V operation: join windings in series, join black & white together and amials. Brown is 230V/240V and blue is 0V.

For 110V/ 120V operation: join windings in parallel, join brown & white together, becoming 110V/120V and join black & orange together, becoming 0V.

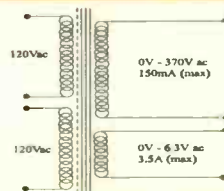

Perfect for kit valve amp builders, a quiet 77VA mains transformer, versatile use, will provide @ 500Vdc HT line, can be used for Mullard 5-20 and many others. Price includes 1 x 70mm fixing metal washer, 2 x 70mm rubber washer and M3 x 50 fixing screw. Physical size 95mm diameter, 50mm height, weight 1.5kg, 220mm leadouts.

Order code - TRANS1
Price-25.00GBP + 6.00GBP

SUBSCRIPTIONS

**GET TO THOSE CLASSIFIED ADS EARLY AND GRAB A BARGAIN !!!
SUBSCRIBE TO HI-FI WORLD !!!**

UK SUBSCRIPTION £27

- ★ Get to our amazing classified ads first and grab a bargain.
- ★ Run by dedicated hi-fi engineers and enthusiasts, Hi-Fi World has become famous for its informative reviews and radical kit designs.

MISSED AN ISSUE?

Back issues also available at a cost of £3.50 only (includes P&P), | payment by cheque only - overseas please contact for details.

Send cheque to Suite F21, Imex House, The Park Business Centre, Kilburn Park Road, London NW6 5LF

OVERSEAS SUBS RATES

Surface Mail	£40
Airmail Europe	£50
Airmail Middle East & South-East Asia	£60
Airmail USA, Canada, Australia, Japan, Korea and China	£70

Airmail Surface mail

NEWS;

DIY; VALVE AMPS/PRE-AMPS; SPEAKER KITS; REVIEWS

+ lots more information not published in the magazine.

VISIT OUR WEBSITE:

WEBSITE: www.hi-fiworld.co.uk

Credit card hotline 9.30AM - 12.00 NOON: (44) 0171 625 8033

Fax: (44) 0171 328 1844 (Please fax form below)

By post: Make cheque or postal order payable to Audio Publishing Ltd, sent in an envelope marked Hi-Fi World, FREEPOST LON3478, LONDON, W9 1BR

HI-FI WORLD SUBSCRIPTION CARD

PLEASE REGISTER ONE YEAR'S SUBSCRIPTION FOR HI-FI WORLD

I WOULD LIKE TO PAY BY CHEQUE MADE PAYABLE TO AUDIO PUBLISHING LTD CREDIT CARD

DEBIT MY MASTERCARD/ACCESS/VISA ACCOUNT NO:

EXPIRY DATE: SIGNATURE _____ DELIVERY ADDRESS IF DIFFERENT _____

NAME _____

ADDRESS _____

DAYTIME TEL NO _____

START ISSUE _____

WARNING

THESE ARE EXPERT KITS, NOT FOR THE INEXPERIENCED. YOU MUST BE ABLE TO SOLDER AND READ A CIRCUIT DIAGRAM. THE VALVE KITS CONTAIN LETHAL VOLTAGES. WE CANNOT BE HELD RESPONSIBLE FOR ANY ERRORS ARISING FROM THE CONSTRUCTION OF THESE KITS.

ORDER FORM

Please send your completed order form to: **WORLD AUDIO PUBLISHING LTD, Suite G4, Imex House, The Park Business Centre, Kilburn Park Road, London, NW6 5LF Tel/Fax: 0171 625 8032 e-mail: wad@hi-fiworld.co.uk**
240/120 option - delete the voltage NOT required. If you wish for a built item, please phone for a quote.

Valves included except where otherwise stated.

IF YOU WOULD LIKE A DATA SHEET ON ANY OF THE KITS, PLEASE WRITE A 'D' IN THE QTY BOX

WARNING - World Audio Publishing Ltd accept no responsibility for kits, parts or modifications made or supplied by third parties.

DESCRIPTION	ORDER No.	QTY	UK	OVERSEAS
			(inc VAT & carriage)	(exc. VAT)

AMPLIFIER KITS

HD83 Valve headphone amplifier kit.....	HD83-K240/120.....	<input type="checkbox"/>	£175	£150
HD83 Transformer set.....	HD83-K240/120(T.set).....	<input type="checkbox"/>	£105	90
KEL34 Upgrade Kit.....	KEL34 Upgrade Kit.....	<input type="checkbox"/>	£150	£125
KEL34 E&I 40W push-pull integrated amplifier.....	KEL34 E&I -K240/120(withvalves).....	<input type="checkbox"/>	£315	£270
KEL34 E&I (without valves).....	KEL34 E&I -K240/120(No valves).....	<input type="checkbox"/>	£270	£230
KEL34 E&I Transformer set (1 main & 2 outputs).....	KEL34 E&I -K240/120(T. set).....	<input type="checkbox"/>	£130	£110
KEL34 E&I Output Transformer (pair).....	KEL34 E&I -K240/120(OPT).....	<input type="checkbox"/>	£80	£68
K5881 MkII 20W push-pull valve amplifier.....	K5881-K240/120.....	<input type="checkbox"/>	£395	£350
K5881PSE 17W single-ended amplifier.....	K5881PSE-K240/120.....	<input type="checkbox"/>	£650	£555
300B 28W valve power amplifier (Not inc. Valves).....	300B-K240/120.....	<input type="checkbox"/>	£850	£725
KLP1 line level pre-amplifier.....	KLP1-K240/120.....	<input type="checkbox"/>	£345	£295
KLPP1 valve phono pre-amplifier.....	KLPP1-K240/120.....	<input type="checkbox"/>	£495	£425
WAP surplus toroidal valve mains transformer.....	TRANS1.....	<input type="checkbox"/>	£31	£21

LOUDSPEAKER KITS

KLS11 3-way aerogel standmounter loudspeaker with piezo gold tweeter				
Drive Units + Crossover kit etc.....	KLS11-C.....	<input type="checkbox"/>	£595	£505
Drive Units.....	KLS11-D.....	<input type="checkbox"/>	£470	£400
KLS10 2-way carbon-fibre standmounter loudspeaker with piezo gold tweeter				
Drive Units + Crossover kit etc.....	KLS10-C.....	<input type="checkbox"/>	£394	£343
Drive Units.....	KLS10-D.....	<input type="checkbox"/>	£358	£311
KLS10 SUBWOOFER Drive Unit + Crossover Kit etc.....	KLS10-SubC.....	<input type="checkbox"/>	£149.95	£130
KLS10 SUBWOOFER Drive Unit.....	KLS10-SubD (1 x HM210Z2).....	<input type="checkbox"/>	£71	£61
KLS3 3-way carbon-fibre driver floorstanding loudspeaker				
Drive Units + Crossover kit etc.....	KLS3-C.....	<input type="checkbox"/>	£350	£300
Drive Units.....	KLS3-D.....	<input type="checkbox"/>	£230	£200
KLS3 Gold 3-way carbon-fibre driver floorstanding loudspeaker with piezo tweeter				
Drive Units + Crossover kit etc.....	KLS3-C.....	<input type="checkbox"/>	£575	£500
Drive Units.....	KLS3-D.....	<input type="checkbox"/>	£450	£392
KLS4 2-way carbon fibre driver standmounting loudspeaker				
Drive Units + Crossover kit etc.....	KLS4-C.....	<input type="checkbox"/>	£230	£200
Drive Units.....	KLS4-D.....	<input type="checkbox"/>	£120	£105
KLS7 2-way carbon fibre driver floorstanding loudspeaker				
Drive Units + Crossover kit etc.....	KLS7-C.....	<input type="checkbox"/>	£195	£170
Drive Units.....	KLS7-D.....	<input type="checkbox"/>	£110	£95
KLS8 2-way high sensitivity standmounting loudspeaker				
Drive Units + Crossover kit etc.....	KLS8-C.....	<input type="checkbox"/>	£260	£225
Drive Units.....	KLS8-D.....	<input type="checkbox"/>	£175	£150
KLS9 2-way HDA driver floorstanding loudspeaker				
Drive Units + Crossover kit etc.....	KLS9-C.....	<input type="checkbox"/>	£230	£200
Drive Units.....	KLS9-D.....	<input type="checkbox"/>	£160	£140

AUDAX DRIVE UNITS

Carriage and packaging please add £6.00 for one unit or a tweeter pair, otherwise add £15.00 for 2-6 units * Not applicable to overseas prices

High Definition Aerogel Drivers

3inch midrange, 93dB.....	HM100ZO.....	<input type="checkbox"/>	£35	£30
4inch midrange, 92dB.....	HM130ZO.....	<input type="checkbox"/>	£47	£40
6.5inch bass/mid, 91dB.....	HM170ZO.....	<input type="checkbox"/>	£53	£45
8inch bass, 91dB.....	HM210ZO.....	<input type="checkbox"/>	£64	£55
10inch bass, 90dB.....	PR240ZO.....	<input type="checkbox"/>	£76	£65

Carbon Fibre Drivers

4inch midrange, 90dB.....	HM130C0.....	<input type="checkbox"/>	£41	£35
6.5inch bass/mid, 90dB.....	HM170C0.....	<input type="checkbox"/>	£47	£40
8inch bass, 90dB.....	HM210C0.....	<input type="checkbox"/>	£58	£50

Paper Cone Drivers

10inch paper cone bass, 95dB.....	PR240M0.....	<input type="checkbox"/>	£67	£55
13inch paper cone bass, 97dB.....	PR330M0.....	<input type="checkbox"/>	£147	£125

Fabric Dome Tweeters

25mm 92dB for 2 way systems.....	TW025M0.....	<input type="checkbox"/>	£15	£13
25mm 92dB for 3 way systems.....	TW025M1.....	<input type="checkbox"/>	£16	£14
25mm horn loaded 97dB.....	PR125T1.....	<input type="checkbox"/>	£25	£21
34mm 93dB - powerful sound.....	TW034X0.....	<input type="checkbox"/>	£26	£22
Oval Gold Piezo electric dome tweeter, 89dB.....	HD-3P.....	<input type="checkbox"/>	£130	£110

NAME: _____
ADDRESS: _____

POST CODE: _____
COUNTRY: _____
TEL. (DAY): _____

CREDIT CARD ORDERS TEL: 0171 266 0461 (24 hours)

I enclose cheque/postal order for £_____ made payable
to World Audio Publishing Ltd. I wish to pay by Mastercard / Visa /Switch/ Solo.
Please debit my account no:

<input type="checkbox"/> <input type="checkbox"/> <input type="checkbox"/> <input type="checkbox"/> <input type="checkbox"/> <input type="checkbox"/> <input type="checkbox"/> <input type="checkbox"/> <input type="checkbox"/> <input type="checkbox"/> <input type="checkbox"/> <input type="checkbox"/> <input type="checkbox"/> <input type="checkbox"/> <input type="checkbox"/> <input type="checkbox"/> <input type="checkbox"/> <input type="checkbox"/> <input type="checkbox"/> <input type="checkbox"/> <input type="checkbox"/>
--

Expiry Date: _____ Signature: _____



OVERSEAS PRICES & DETAILS

Please allow for your own local import taxes (customs duties) and for carriage charges, which must be added to the net price
METHODS OF PAYMENT
International money order in Sterling, Mastercard or Visa

Audio Direct (UK)

GOERTZ interconnect and speaker cable - "...Why play with firecrackers when someone hands you dynamite"... (Audiophile Voice) - the best price-v-performance ratio cables available anywhere! Special introductory offers. 30-50% off normal UK prices!
 Goertz HT "Home Theater" speaker cable - £5.95/meter unterminated.
 Goertz M1 "Centre Stage" speaker cable - £9.95/meter unterminated.
 Goertz "Tourmaline OFC. Interconnect," (RCA, 1 meter pair) - £64.95
 Goertz "Quartz Silver Triode Interconnect," (RCA, 1 meter pair) - £99.95
 Note:- Full termination and custom service available - cables are available on a 21 day trial basis. Please enquire for details.

PANASONIC Potentiometers:- probably the best audiophile pot. on the market! 10K and 100K dual log - £34.95, Motorised 20K and 100K dual log - £39.95

TESLA (JJ) Valves:- now widely recognised as the finest of their type available.
 New 300B - £59.95, XT88 - £19.95, EL34L - £5.95, ECC88 - £4.95 etc.
 Matching & burn-in service available, 0.80p/valve.
 Note:- Many other makes and types available, please enquire.

InfiniCaps:- ultra performance audiophile P.P capacitors as used by some of the worlds leading manufacturers in their reference products! Best prices offered for new "Signature" range - superb! Available in a range of values from 0.01 to 10 uF.- Please enquire.

Valve output & mains Transformers:- produced from the finest materials in one of the most advanced facilities in Europe.
 Typical examples:- 3.0K and 6.6K P/P opts. - £34.95, 1.25K and 2.5K S/P E Opts. - £44.95. Many others available - please enquire.

Valve Kit Amplifiers:- now upgraded and further improved!
 "Adonis 25" - 25 watt class A integrated amp. using Sovtek 6L6WXT output valves. A totally professional product in a superbly finished chassis. Now at a very special lower price of £395.00.
 "Adonis 35" - 35 watt class A integrated amp. using Tesla EL34L output valves. Chassis as above. Special new price of £495.00. "a real winner in the Adonis"... Glass Audio - USA.
 "The Adonis is the bargain of the decade"... Andre Jute, Audio Reviewer - see "Jute on Amplifiers" website for full review.

Please note - all our prices include Vat @ 17.5%, non EC. customers please deduct 17.5%. Insured carriage extra at cost. Please enquire for further information to:- Audio Direct (UK), 2 Crnigs Road, Carlisle park, Ballymahinch, Co. Down, BT24 8PQ - UK, Tel 01238.561348 Fax 01238.564063 Email-johnbarrie2@compuserve.com

The Truth Is Out There CANARY AUDIO



Hi-Fi News

"Impressively built, classically styled. Canary products are understated and seem bomb proof"
KEN KESSLER

Hi-Fi World

"Canary can hammer out basslines with speed and power"
 "Internal construction is the best"
JON MARKS

Hi-Fi World

"Canary's strengths, vocals which had a warmth and sensuality which solid state could not capture"
TIM LAU

Audiophile Magazine

"Canary Audio CA301 is excellence in craftsmanship. The only power amplifier you will need for the rest of your life"

Distributed by Audio Connoisseurs Phone / Fax 0151 343 0007

STOCKISTS:

Doug Brady Hi-Fi, Sounds Perfection, Better Hi-Fi, River Crossing Audio

Hear what you've been missing!

AE
 Atacama
 Audiolab
 B&W
 Cable Talk
 Copland
 Cyrus
 Epos
 Harman-Kardon
 JBL
 KEF
 Kenwood
 Krell
 Marantz
 Martin-Logan
 Mendian
 Michell
 Mission
 Monitor Audio
 Musical-Fidelity
 Pickering
 Pink Triangle
 Pioneer
 Quad
 REL
 Rogers
 SME
 Sonus-Faber
 Sponder
 Tannoy
 TDL
 Thorens
 Yamaha
 & lots more...

York... a great place for...

- Widest choice in the area
- Independent advice
- Qualified staff
- Comfortable dem rooms
- Superb showrooms
- Main road location
- Major car parks nearby
- Insurance estimates
- Over 30yrs experience.
- Service Dept.
- Delivery & installation
- Part Exchange
- Open 10.30-5.30 6 days

Up to 3 yrs. Interest Free Credit

deposit only 20% of
 £500+ for 12 months
 £1500+ for 24 months
 £3000+ for 36 months
 subject to status

PS if you're making a special trip...
 it's best to book, weekdays.



24 Gillygate, York
Tel. 01904 629659
 High Fidelity Specialists est. 1967

Cyrus



Audiolab



The very best
 in Hi-Fi and
 Home Cinema...

Martin-
 Logan



Krell

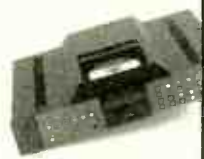

Monitor-
 Audio



X Dem. Sale...

	Was	Now
Acoustic Energy AE1 r/w	£995	£745
AE2 II r/wood inc stands	£2090	£1400
Audiolab 8000C	£580	£475
8000LX	£470	£395
8000CDM+DAC	£2300	£1725
8000DAC	£900	£650
8000MX pair	£1800	£1495
B&W CDM2 r/wood	£400	£320
Copland CDA288	£1999	£1599
Cyrus 111i	£598	£475
Commander remote	£100	£50
PSX-R	£328	£275
Power	£498	£395
SL integrated amp	£398	£325
JBL Aquarius S119 LSs	£1250	£625
KEF LS3/5a piano bk. LE	£1800	£895
Krell 250 Pre+power	£5195	£4650
KAV300 cd	£3550	£3195
Marantz CD17 bk.	£800	£650
PM17 gold	£900	£695
Meridian A500 r/wood	£875	£650
M60 r/wood	£2500	£1875
566.20	£1095	£750
500 CDT +566.20 DAC	£2420	£1795
Michell Argo pre.+Hera	£885	£595
ISO phono stage	£420	£320
Mission 753f oak	£898	£750
754f oak	£1498	£1125
Monitor Audio Studio 50SE		
r/wood piano laq.	£5000	£2995
Studio 12 r/wood	£1100	£825
Pink Triangle Litaural CD	£2099	£1675
Tarantella+RB+XLZ	£1054	£750
Pioneer CLD-D925	£800	£595
A300 Precision	£400	£300
PDS505 Precision	£460	£350
Quad 77 Power amp	£600	£450
77 Pre-Amp	£700	£525
77 Remote	£300	£150
77 CD bus (all carbon)	£700	£595
REL Q100E bk.	£495	£395
Yamaha DSP-A3090	£1500	£1125

Classic second-hand...

Acoustic Energy AE1 r/w	£495
Audiolab 8000C pre-amp	£375
8000A integrated amp	£350
Audio Innovations Series 1000 monoblox (were £1799)	£750
2nd Audio (was £3000)	£1000
Gale 401 chrome/black	£250
HK Citation 11/12 pre-power & 15 tuner the very first models, in walnut cases	£300
KEF 104/2 r/w (£2000)	£850
Marantz CD63 II K1-S	£275
CD85 (built like a tank)	£250
Mission 776/777 batt pre amp & 2 x 100w power amp	£950
Argonaut bk., big, tv in bass	£325
Quad 22 pre & powers	£600
ESL57 pair bk latest spec.	£750
34 pre-amp	£150
44 pre (din)	£185
405 power amp	£200
FM4 tuner (din)	£150
Revox G36 1/2 track 10"	£195
B77 reel-reel 1/4 track, 7.5ips pro-nabs, op cover	£850
Rogers LS6 teak	£175
Ruark Sabre bk.	£250
SME original 3012	£175
3009 mk1 original box	£75
Tandberg TD20A	
1/4 track 7.5ips 10" reel	£650
Tannoy Cheviot 10"	
Dual Concentrics, walnut	£350
609 marble effect inc. stands	£195
Thorens TD124 mk2 +3012	£150
TD125 mk2 +3009	£200
TD150+3012 in SME plinth	£300
Vortexion Series 4 recorder	£100

VINTAGE VIRTUES

By Haden Boardman

Three issues back, *Vintage Virtues* covered the Decca-Kelly ribbon tweeter story, and as a kind of part two, this month, we are looking at the Decca pick-up cartridges and arms.

As mentioned before in this column, Decca introduced the world's first high-fidelity system, Full Frequency Range Recording (FFRR), back in 1946. The 'flagship' audio set-up was the Decola, an extremely heavy radiogram with a record player. We have to remember that in 1946 raw materials, especially woods, were heavily rationed - a wood license was needed even to buy the stuff. The Decola must have been considered pretty much state of the art to be allowed to use so much of it! With a retail price of 200 guineas, this was as expensive as a small car.

Loudspeakers in the Decola ranged from full-range Goodmans to dual-concentric Tannoys (three of them, all 12in., in an efficient horizontal array). The amplifier was an all-triode, Class A design working in push-pull from input to output and producing five watts from a pair of PX25s, with less than 0.5% distortion. These valves run with 500V across them and 55mA of current each; I feel Decca may be a little conservative in their output figures.

Some commentators have called the Decola's amplifier "unsophisticated"; nothing is further from the truth. Yes, the PX25 was an established valve, but to quote from the Osram Valve Company's literature for a moment: "Where power supplies are not restricted, triodes are

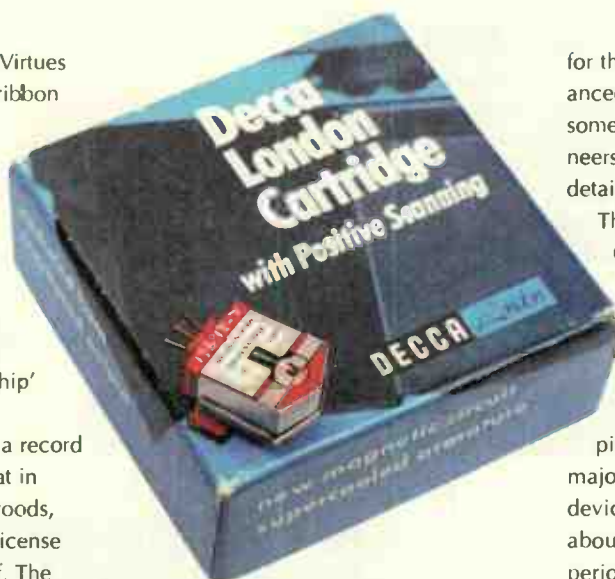

One to polarise opinion - Decca's London cartridge has both its fans and detractors.

preferable because their lower impedance is conducive to high fidelity... An amplifier for sound reproduction of the highest possible fidelity should centre around a push-pull triode stage" (Osram TP1, Jan. 1949).

The amp was clearly designed at the end of the 1930s and then 'put on hold'



Whereas most cartridges screw onto a headshell, the Decca slides down onto a mounting plate.

for the duration of the war. With its balanced topology from input to output, it is something a lot of modern valve engineers could do with studying in closer detail.

The turntable was based around a Garrard RC series autochanger or a single-play mechanism. However, the jewel in the crown was the cartridge with its sapphire tip.

The creation of Arthur Haddy, in its construction Decca's FFRR pick-up was hardly different from the majority of the pre-war, moving-iron devices which could be found on just about every electric gramophone of the period. It was the attention to detail that set the FFRR apart. As it was made to much tighter tolerances and fitted with a lower-mass, replaceable stylus assembly, the Decca was less suited to playing normal, abrasive 10in. 78rpm recordings than Decca's own soft-compound discs.

In some ways, it could be argued that Decca merely gathered together several existing new ideas and refinements to make the FFRR system. Whatever the basis for it, it was undeniably the world's first complete high-fidelity system.

By the mid-Fifties, massive progress was being made in record technology in the home, the studio and disc cutting. In 1958, Decca demonstrated their variation on stereophonic sound, introducing the Full Frequency Stereophonic Sound system (FFSS).

FFSS was the result of an exclusive technique which offered the highest "definition" of sound achieved thus far

EINSTEIN

'the octopus'
An 8 way mains
block...
with a difference



- △ Input filter feeds:-
 - 4 analog outputs
 - 4 digital outputs
- △ Line conditioner for the 4 digital outputs
- △ Mains overload protection on all outputs

"Amazing scale and position of instruments"
"Any grain or aggressive sound is lost"

available from:-

Audio T - High Wycombe 01494 558585
 Audio T - Oxford 01865 765961
 Oxford Audio Consultants 01865 790879
 The Right Note - Bath 01225 874728
 MAX - Kidderminster 01562 822236
 Doug Brady Hi-Fi - Warrington 01925 828009

A MANTRA AUDIO

CARTRIDGE SELECTION	STYLUS	REPLACEMENT STYLI
Audio Technica		Swiss Copy Diamond Styli
AT 95 E	£22 £14	ADC XLM Mk III £14.00
AT 110 E	£27 £14	Akai AN 5, AN 60 £10.00
AT OC 9	£300 £226 EX	AN2, AN 70 £12.00
Denon		Dual DN 145 E, DN 165 E £14.00
DL 110	£75 £59 EX	Goldring G800 Super E £14.00
DL 304	£200 £170 EX	JVC DT 55, DT 60 £10.00
Goldring		National EPS 24 CS, P 30 D, P 33 D £10.00
1012 GX	£76 £50	Ortofon FF 15 E II, VMS 20 E H, OM 20 £14.00
1022 GX	£94 £62	Pioneer PN 210, PN 220, PN 240 £10.00
1042	£115 £76	Shure N 75 C, SC 35 C, £10.00
Eroica (LX or H)	£108 £78 EX	N 75 ED T2, N 75 EJ T2 £12.00
Elite	£212 £153 EX	N 95 ED, N 95 EJ, N 75 3 (78) £14.00
Excel VX	£468 £342 EX	VN 35 E £16.50
Grado		N 95 HE, N 97 HE, VN 35 HE £22
Prestige Black	£44 £24	Sony ND 142 G, ND 150 G, ND 155 G £10.00
Prestige Gold	£134 £74	CN234 £12.00
Ortofon		*** OVER 500 STYLI TYPES STOCKED ***
510	£34 £22	ORTOFON DJ PACKS (CARTRIDGE + 2 STYLI)
MC 15 Super II	£120 £102 EX	Concorde Pro SSS Pack £52
MC 25 FL	£226 £190 EX	Concorde Nightclub SSS Pack £74
MC 10 Supreme	£283 £240 EX	Concorde Nightclub EEE Pack £85
MC 20 Supreme	£355 £300 EX	Concorde DJ SSS Pack £57
MC 30 Supreme	£420 £358 EX	
Rohmann	£779 £690 EX	HEADPHONE SELECTION
Jubilee	POA POA EX	
Shure		GRADO Prestige Series
V 15 V XMR	£265 £178	SR-40 £45
SC 35 X	£32 £24	SR-60 £75
		SR-80 £90
		SR-125 £135
		SR-225 £180
		SR-325 £270
		Reference Series
		RS-1 £590
		RS-2 (new) £425
		RECORD/DISC CLEANER
		KIT REFILL
		Milly Permaclean Record Cleaner £13.00 £9.00
		Permastal Anti-static Spray £13.00 £9.00
		Dishwasher CD Cleaner £15.00 £6.00

EX - Exchange price any Audio Technica, Denon, Goldring, Ortofon MC Cartridge

Order direct from the full selection as shown on our Website
<http://www.mantra-audio.co.uk>

MAIL ORDER (1-10 DAYS) PRICES (INC P&P) ARE BEST WE CAN OFFER THROUGH COMPETITIVE SOURCING UK & MAINLAND EUROPE - ALL ITEMS CARRY FULL MANUFACTURERS GUARANTEE - OVERSEAS CUSTOMERS PLEASE ADD £5.00 TO ORDERS OVER £50 IN VALUE TO COVER INSURANCE

Tel/Fax (01757) 288652 e-mail: enquiry@mantra-audio.co.uk
 MANTRA AUDIO (HFW), 22 GARTH AVENUE, NORTH DUFFIELD, SELBY, NORTH YORKS YO8 5RP



CURA (UK) LTD
 Authorised Stockists

- AUDIO T Basingstoke 01256 324311
- SEVENDAKS HiFi Birmingham 0121 233 2977
- AUDIO T Brentwood 01277 264730
- AUDIO T Cambridge 01276 685597
- AUDIO EXCELLENCE Cardiff 01222 228565
- AUDIO EXCELLENCE Gloucester 01454 300046
- AUDIO T High Wycombe 01494 558585
- CYMBIOSIS Leicester 0116 262 3754
- AUDITORIUM London-Fulham 0171 384 3030
- HiFi EXPERIENCE London-West End 0171 580 3535
- B&B HiFi Newbury 01635 32474
- AUDIO T Reading 0118 958 5463
- AUDIO IMAGES Sheffield 0114 273 7893
- ADAMS & JARRETT Hastings 01424 437165
- MIKE MANNING Taunton 01823 326688
- MIKE MANNING Yeovil 01935 479361
- MOORES HiFi Belfast 01247 612417
- SOUND ACADEMY Bloxwich 01922 493499
- AUDIO EXCELLENCE Bristol 0117 926 4975
- THE AUDIO FILE Cambridge 01223 368305
- AUDIO EXCELLENCE Chester 01244 345576
- ENGLISH AUDIO Hereford 01432 355081
- ZEN AUDIO Hull 01482 587397
- THOMAS HEINITZ London-Bayswater 0171 229 2077
- BARTLETTS London-Islington 0171 607 2148
- AUDIO T London-Happstead 0171 794 7848
- AUDIO EXCELLENCE Preston 01772 253057
- PHONOGRAPHY Ringwood 01425 461230
- CREATIVE AUDIO Shrewsbury 01743 241924
- AUDIO EXCELLENCE Swansea 01792 474608
- BARTLETTS Woking 01483 771175

CURA (UK) Limited

Unit 11, Arrow Industrial Estate, Eelmoor Road,
 Farnborough, Hants GU14 7QN.

Telephone: +44 (0)1252 401401 Facsimile: +44 (0)1252 401301

CURA HIGH QUALITY
 SPEAKER SYSTEMS

in recording. In addition to reproducing each musical instrument in its Full Frequency Range, FFSS recreated them so that where the string section, say, was located to the left side of the orchestra, in your room it would also appear to be on the left. The overall effect was to recreate in your room a "live" orchestra with all its sections in the proper place.

"FFSS brings you the highest definition in recorded sound, whether it be orchestral, chamber, instrumental or vocal music, opera, drama. . . in fact, any sound." This text is taken from the sleeve notes of Decca's first commercially-available stereo recording, a Journey Into Stereo Sound, Decca number SKL 4001.

In line with the hyperbole, this is one of the most hilarious records ever produced, one which single-handedly introduced the notion of 'ping-pong stereo'. There are steam trains crashing through front rooms, racing cars from Goodwood, the Ceremony Of The Keys at the Tower of London and, of course, the sampler's delight otherwise known as Geoffrey Sumner intoning: "This is a journey into sound, stereophonic sound." The musical interludes never stood a chance.

Find a copy of SKL 4001 and it should still be like new - once the novelty had worn off, I can't imagine anyone sitting down and listening to this nonsense. In defence of Decca, the cost of going stereo has to be considered; two large loudspeakers, twin power amplifiers and a complex stereo pick-up didn't come cheap. The public needed some convincing, which is what all the above was about, novelty or not.

Decca's FFSS pick-up was developed



Selling stereo to the public was left to Decca's classic SKL 4001 LP above. Subtle it wasn't!

by a BBC engineer called R.W. Bayliff and then presented to Arthur Haddy some time in the mid-Fifties. Even today they are sought after for their unique, up-front sound; with their high output, these beasts can really belt out a tune. The problem with them is that they have a habit of ploughing up the record groove, destroying it slowly over the course of a number of playings.

In this respect, the later London cartridge can be seen as a refinement of the FFSS principle.

Along with SKL 4001, Decca launched a new Stereo Decola. In contrast to the rather plain Mark I, the Stereo version was a heavily-ornamented, Regency-style effort with pre-amplifi-

er and tuner hidden behind false drawers, a Garrard turntable under the lid (301 or AP series autochanger with Decca FFSS) and power amps (triode-connected EL34s) and power supplies in the back. 12 EMI tweeters and two 9in. by 13in. bass units occupied the cabinets ends, and a record cabinet lived in its belly. The result was huge, and incredibly heavy - two people can just about pick it up!

Complete, and in good condition, stereo Decolas still command a premium price; despite the drop in overseas demand, a pristine example can fetch £500-£1000. From an audio perspective, unless the cabinet tickles your fancy, this is a very large curiosity.

The most important part of the Decca Stereophonic story is the development of the company's own stereo recording system, referred to by studio engineers as the Decca Tree. In this arrangement, Decca engineers located three Neumann



A little light pressure (!) will slip the pick-up head onto the end of the arm.

M49c condenser microphones above the conductor's head. One pointed straight forward while the other two pointed to the left and right so that the three had an inverted 'T' profile.

Anyone who has heard a classic Sixties Decca recording can

vouch for the incredible sound staging and detail this provided.

When it comes to the rest of the line-up, good as the pick-ups are, I cannot recommend anything that actually damages your records as you play them. On the other hand, a Decola (usually to be found in antique shops) would make a great talking point if you have the right room (ie, large Regency hall). The Decca Stereo records are awesome, though, as most Classical music fans will already know. The rarer box sets did fetch high prices, if in mint condition, but prices have fallen recently and copies can be had for as little as a fiver. And did I tell you the one about the early-morning bargain hunter who picked up eight Decca box sets from a car boot sale for £4? These things turn up everywhere. . .



You couldn't really call Decca's arm "complex" in its construction.

Column

“ They don't make 'em like they used to”: a hackneyed phrase and yet, in the case of much hi-fi on sale today, one which rings very true. Even the most passive of hi-fi consumers can hardly have failed to notice a more lightweight build quality to contemporary hi-fi. With electronics, this process began in the Eighties, whereas it's been this decade that's seen the 'speaker market economized.

In the hi-fi market as a whole, it's been the price-sensitive budget market that's suffered most - hardly surprising when you consider that price points simply aren't shifting. Hence there are still £100 amps and 'speakers just as there were 15 years ago. Taking inflation into account, the real cost of budget hi-fi has plummeted.

Whether this is a good thing or not depends upon the final product. Certainly when it comes to the budget amp and 'speaker market I'm not so sure. It's not hard to see where corners have been cut these days, and I'm not convinced that any sonic advances have been made in the budget 'speaker or amplifier market over the last 10 years. Without a doubt, budget 'speakers from Tannoy, Mission, Celestion, Wharfedale and the like would have been far more solidly built then than they are now. In strong contrast, the progress made on £200 CD players is indisputable. The best easily rival players of £1000 from 10 years ago, even if they aren't built like the proverbial battleship.

Perhaps the reason they don't make hi-fi like they used to is because they don't make it where they used to. A trip around a budget/mid-price hi-fi dealer's stockroom can be an enlightening experience. 'Guess The COO (Country Of Origin)' used to be easy - a British brand would have been built in the UK and you could equally rely on Sony, Technics/Panasonic, Pioneer, JVC et al starting life in Japan. And if a Philips unit wasn't assembled in Holland, you

could be sure it was somewhere close.

These days things are very different. For example, did you know that Tannoy build their Mercury range of 'speakers in Hungary? Wharfedales come from Poland and Gales from China. Pretty much all the loudspeaker manufacturers are at it with JPW being the budget 'speaker exception. Personally I don't have a problem with this: if something is properly and consistently built, then it doesn't matter where the factory is. Yet I do find it galling when manufacturers won't even own up to exactly where they've produced a component. Fearing

” Perhaps the reason they don't make hi-fi like they used to is because they don't make it where they used to.

snobbery or damage to their image as a UK manufacturer, 'Made In The EU' becomes their cover. Of course, 99% of the time this means the former Eastern bloc, but why not just say so?

In the electronics market, NAD are widely seen as having changed the way (and place) hi-fi is manufactured. Although designed and engineered in the UK, New Acoustic Dimension choose to build in Taiwan (not that this harmed sales of the NAD 3020, or failed to give the budget amp market a shot in the arm all those years ago). In the Nineties you'll find Cambridge and Ariston built in China.

Breaking that mould are Arcam and Musical Fidelity, who both still build in the UK despite manufacturing (comparatively) mass-volume products. In the future, however, it wouldn't be surprising to see either company move production from their home base. After all, Sony build their budget CD players in Hungary, Yamaha in Malaysia and Technics in Germany. Philips chose the former Dutch colony of Indonesia.

It's in this instance we also see the

most excruciating product labelling. Marantz, Philips' hi-fi specialist subsidiary, sees fit to print the following on the rear of their CD-67 OSE: "Produced under the supervision of Marantz Japan in Indonesia". How reassuring that the work-force is being supervised!

There is always an exception, and here it's when a hi-fi manufacturer produces a new format. Then the work will definitely not be farmed out but built at home, by hand if need be. Witness the Dutch-built DCC machines, or the fact that Sony still build MiniDisc players in Japan, despite the fact that the format is now five years old. Likewise, Panasonic and Pioneer DVD players are Japanese built. This makes perfect sense. When getting behind a new product, everything must perform perfectly first time, so the most skilled labour force is needed. And with constant running changes, it helps if they're near the R & D dept.

Without the public even really being aware of the change, hi-fi has become a truly global product. Let's hope that it's enjoyed world-wide. But to all you manufacturers out there, could you please be a little more precise with your labelling? Nobody's being fooled and there's already far too much PC-speak in this world as it is.



Dominic Todd

ROCK & POP

by Jon Clarke & Stuart Lenz



SKUNK ANANSIE
POST ORGASMIC CHILL

The feminist mantle and cloak of Heavy Metal might not be one of the world's natural pairings, but **Skunk Anansie's** controversial vocalist **Skin** doesn't let that bother her. If anything, her band's third album following on from *Stoosh* and *Paranoid And Sunburnt* merely confirms her unwavering ability to keep her mind focused; there's no sell-out here.

Post Orgasmic Chill kicks off in typically outrageous Skunk-style with a banging little track entitled *Charlie Big Potato*, a hard-edged Drum 'n' Bass number which brilliantly complements **Skin's** strong vocals. Many of the subsequent songs then revert to type; in-yer-face, guitar-based numbers, which alternate between mellow verses and angry refrains. At its best there's the politically-inspired *We Don't Need Who You Think You Are*; at its worst there's the shrill and bad tempered *The Skank Heads*. "Calm down, calm down," as **Harry Enfield's** scousers would say.

With nothing in the league

of, for instance, *Yes It's F***ing Political*, the 'issues' which **Skin** tends to tout somehow get lost in the noise here. On the plus side, there is no doubt that a tremendous amount of effort has gone into the recording, particularly in moulding the band's newer soft side - the ballads *Tracy's Flow* and *Lately* are among perhaps the best things they've ever done.

Post Orgasmic Chill, despite the anti-climactic name, incorporates just about everything from raw Soul and agit-Rock to chilled out grooves and ballads and is a big plus for fans of **Skin's** particular blend of Rock revolt.

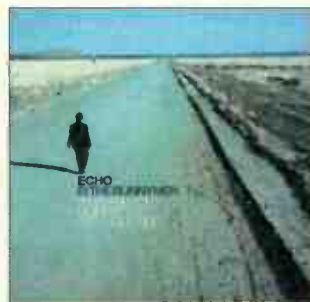

ECHO & THE BUNNYMEN
WHAT ARE YOU GOING TO DO WITH YOUR LIFE?

Much to everyone's surprise, **The Bunnymen** ended a decade in the wilderness two years ago with the release of their album *Evergreen*. Although it came out riding the crest of a wave of Brit Pop, it proved itself a commercially effective if patchy

venture for the group.

Evergreen was an achievement for another reason - the band had not played together for years and were also sadly minus their long-term drummer, **Pete de Freitas**. Now, with bass player **Les Pattinson** (who had featured on *Evergreen*) missing too, are they really up against it? Well, *What Are You Going To Do With Your Life* may not be the greatest album of all time but it has its moments.

It seems that the entire focus of **Ian McCulloch's** life since the **Bunnymen** in their prime has been to single-handedly mastermind his own smooth transition from hip Rock star to full-blown velvet lounge crooner. There's no denying that he is, indeed, fixated on both **Sinatra** and **Bacharach** from the evidence here. This is anything but Rock 'n' Roll as we know it - you hardly notice the once violent, edgy presence of **Will Sergeant**.

The psychedelic, corrosive thrills of early **Bunnymen** tracks are all but lost here as **McCulloch** croons away like his life depended upon it. You may warble along merrily to the many "La la las" herein contained and be moved heavenward by references to stars and satellites, but **Mac's** grandiose game plan flatters to deceive. The violin signatures are all quite nice, but tend to fall flat once it becomes apparent that they lack winning melody, and the songs are generally snail-paced,

reflective and world weary.

Then there are the high points, the top-spot a collaboration with friends **The Fun Lovin' Criminals** on *Get In The Car*. *Lost On You* and *Fools Like Us*, which first featured on last year's *Martha Meet Frank, Daniel And Laurence* soundtrack, also rise above the tedium.

Elder statesmen they may be, but this album just ain't what it should be. Unless something dramatic happens soon, the only **Sinatra** song **Mac** is likely to be chewing over is *One More For The Road*, and I fear it may be a long road.



VARIOUS
SOURCE ROCKS

Viva La Revolution! Painfully hip Parisian record label **Source** has done it again. Following its three-part *SourceLab* series, which brought us - for the first time - the likes of France's very excellent **Daft Punk**, **La Funk Mob** and **Air**, the label marks a new addition to the 'I can't believe the French can make cool music' school.

There's no denying it. Not

ROCK & POP

RECORD OF THE MONTH

BLUR
13

Forget *Nothing Hill: The Movie*, it's been more *Nothing Hill: The Soap Opera* for **Damon Albarn** over the last two years. The poor, misunderstood Essex lad has been living his life under the microscope, with every cough and spit of his hip West London residence pictured, debated and analysed for the masses. In particular, his long-term relationship with *Rock* critic, par excellence, the academically-esteemed but sadly wasted **Justine Frischmann** (of *Elastica*) came to a painfully drawn-out and amid-scurrying and largely unprintable climax.

The wild party house the couple had shared in the heart of the capital's trendy, Notting Hill became the grimey, loudest, spid, artzily, the quietest in the street. **Damon** decamped to a flat nearby, but spent most of his time in Iceland, or, on tour. **Justine** milled about, supposedly attempting to finish her band's *Stone Roses*-esque second album (it's still not out after two years).

Throughout this mess, **Damon** and friends **Graham**

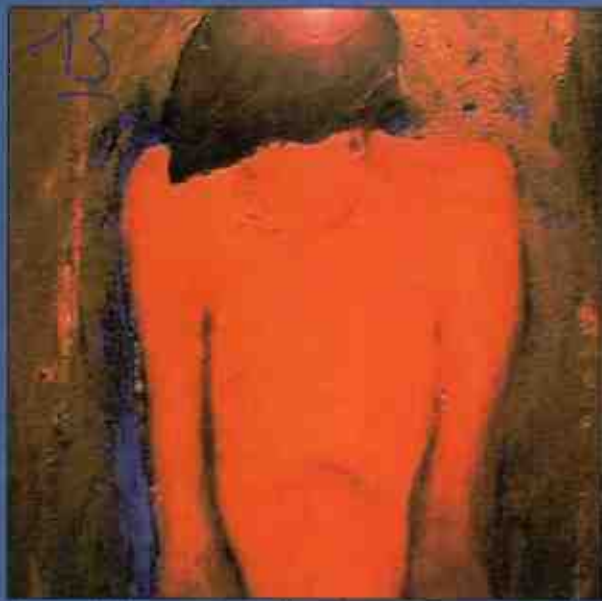

Dave and **Alex** recorded the album. It's as purple and patchy as any album can be: experimental, scary and sometimes unlistenable. *13* is nonetheless a major achievement. Following on from the heavier and commercially successful *Blur* of 1997, and the suspect and considerably Popper *Great Escape* of the previous year, this is a great return even if it takes a while to get going.

After the brilliant Gospel-inspired opener *Tender* (now a worthy hit single with its slow build-up, inspired guitar plucking and full choir), the album goes round the houses for 13 minutes. *Inhuman* and

Swamp Song (to name the two main offenders) are *loopy* and should have been created from the album, which at 66 minutes is already too long. Both are loud, lazy and unaccomplished, suggestive only of a confused and angry hotel *Cat* & *TV*, sandwiched between them, is welcome to stay, though I'm not so sure about the *burial* but highly original *Battle*.

1992, the year **Damon** apparently started dating **Justine**, is the first of the 'split' songs and really quite upsetting. Building up repetitively with swirling, gnarly guitar screeches, it has a nasty feel that smacks of bitterness, the

words: "You'd love my bed/You took the other instead" speak volumes. Later, in the brilliant *Triffidpark*, he laments how he lost his soul to "the Rolling Stones," a clever pun (not to be). Then the mood changes to, "Got to get over, got to get better" on *Caramel*.

13's best is saved for last. *No Distance Left to Run*, with the sad but inevitable words, "It's over", is a gem of a tune, all slow and painful. Actually, there's nothing even vaguely up-beat on the whole album. While there's nothing here as depressing as *Tricky*, God forbid, it's about as moody as it gets, and for a band who, after three hit albums, could easily be going for the poppy commercial glitz, that's great news. And in spite of the fact that they're apparently not as close as they once were, the four members still seem to gel as a musical unit.

A good deal of *13* is hit and miss, but there is much to suggest that *Blur* will yet, like *Radiohead*, carry on producing important music well into the millennium. And who knows, there might be a happy ending: the tabloids are already reporting a baby on the way for **Damon** and his new flame.

only have they won the World Cup and stuffed us at Wembley, now the French are teaching us about Dance music as well. Featuring 13 as-yet-unreleased demos from a range of unknown French Dance and Hip-Hop acts, including

Phoenix and **Sebastian Tellier**, *Source Rocks* has a slightly more electronic feel to it; think of it as a sort of modern day take on **Kraftwerk**.

Experimental, highly addictive and incredibly stylish, these tunes are going to

be tying up the airwaves throughout the long, hot summer. OK, some of it sounds like porn film material, but all in all it's as tasty as the ripest *Golden Delicious*. Me, I'm emigrating to Paris before **Petit** and **Viera** lift another cup for Arsenal.

CLASSICAL

by Stephen Priest and Frank Blake



Parry
Job
Toby Spence Peter Coleman-Wright Neal Davies Royal Philharmonic Hilary Davan Wetton
HYPERION CDA67025

Charles Hubert Hastings
Parry was, by conviction, a Darwinian rationalist and was thus strongly disinclined to write music on sacred subjects. (By a nice irony, he is best remembered now for *Jerusalem* and sundry church anthems!) Commissioned by the Birmingham Festival to write an Oratorio, Parry fixed on the Old Testament Book of Job as providing the least 'religious' biblical text, and cast it for a baritone narrator, bass (Job), tenor (Satan) and a boy treble for the uncanonical character of 'Shepherd Boy'. In addition, betraying its Festival origins, the work calls for full chorus and orchestra.

It would be stretching the truth to say that I was expecting a lot from Parry's end of the court. Time after time, bar after bar, the composer falls just short of originality. In places, especially the moody bits, there are phrases which seem to pre-empt Elgar's *Gerontius*. Unfortunately, whereas Elgar mastered the art

of sequencing endless unresolved cadences into an intricate musical knot, begging to be untied, Parry opts for tidying up as he goes along. The effect is, at times, as incongruous as those heavy-handed Messiahs we've all heard, where the delicate recitative 'resolves' are treated as epoch-endingly final 'Boom!-Booms'!

This is all a greater pity because the Royal Philharmonic plays throughout with considerable strength. The soloists (with the exception of the Shepherd Boy who appears to be sight-singing) give good value, particularly Toby Spence as Satan; then again, the devil gets all the best tunes. . .

We should not be in England if singers did not mispronounce 'the' as 'thaar' at the drop of a hat, possibly as a reminder of our nautical heritage. Mercifully, this isn't a New Testament oratorio or doubtless we'd have references to the elusive character G. Zarse as well.

Let's hope that the convention whereby 'good choral society standard' implies 'too poor to issue on record' isn't a purely English phenomenon too. I'd love to be more charitable to Guildford Choral Society, but as things wore on I found the catalogue of poor diction, hesitant entries (why not retake?), imbalance between the parts and the standard amateur soprano sotto on uncertain high notes impossible to overlook.

As a reference recording of this work, there is little truly

against it even though the overall performance is hardly sparkling. If there happens to come along a recording with professional-standard chorus, it might be worth waiting for. After all, if a *Job's* worth doing. . .



Francesco Guerrero
Missa de la Batalla Escoutez (Battle Mass)
Westminster Cathedral Choir/His Majesty's Sagbutts and Cornetts
James O'Donnell, The Master of Music
HYPERION CDA67075

The choir of Westminster Cathedral have long been champions of Spanish 16th and 17th-century sacred music. This is their second recording dedicated solely to the music of Guerrero. Born in 1528, he spent most of his musical career at Seville Cathedral and was as revered as both Morales and Victoria.

During the mid-16th-century, the cathedrals of both Toledo and Seville employed wind bands (so-called ministriles) on a permanent basis. The instruments on this disc, playing throughout the Mass and most of the six remaining pieces, consist of cornetts,

recorders, shawms (double-reeded, oboe-like instruments), sackbuts, dulcian and a chamber organ.

Whilst still using words of the Latin Mass, the thematic origin of *Battle Mass* itself (one of 19 composed by Guerrero) has, in essence, a secular theme (based on Jannequin's chanson *La Guerre* after the battle at Martignano of 1515). However, the setting of the Mass isn't especially battle-like. Instead of musical spectaculars and fireworks, we have a detailed and dignified piece with a fair spattering of ethereal grandness.

The instruments 'augment' the vocal lines and add richness and body to an already substantial sound. While this particular approach can result in a veiling of detail, All Hallows, Gospel Oak copes admirably with the intricate polyphony of the Gloria, for example. Of the other pieces on the disc, *In Exitu Israel* stands out as an interesting oddity, with the mix of instrumental and choral passages curiously bringing to mind the choral anthems of Bruckner, in which trombones accompany the voices.

The Westminster choristers have always had a very distinctive sound. The trebles possess an exciting edge and the gentlemen are well-supported and powerful - all refreshingly different to the Anglican choral tradition. Combine this with the organic drift of the accompanying musicians and you have what adds up to a wonderful presentation.

JAZZ

by Ian Nicolson

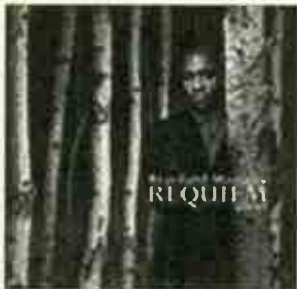

BRANFORD MARSALIS QUARTET
REQUIEM
COLUMBIA 069655

For 10 years, **Branford Marsalis** has steered well clear of the definitive in Jazz. He's played sax with **Sting**, **Tina Turner** and **Gangstarr**; led **Jay Leno's Tonight Show** band; made movies with **Danny De Vito**; even dep'd for **David Murray** in the **World Saxophone Quartet**. What he has steadfastly refused to do is go back and revisit the piano-and saxophone led quartet that formed his first solo outfit after leaving brother **Wynton's** band in the mid-Eighties. Now, after re-uniting with pianist **Kenneth D. Kirkland**, we have a glimpse into a future that might have been.

Kirkland's untimely death earlier this year came just weeks after these sessions were recorded (at the very end of 1998), and before the mixing process could begin. As a result, there's an audible directness and unity of purpose in their co-leadership of the Quartet that leaves me yearning for more. They are **Kirkland's** last recorded dates, and they do him proud.

Kenny always played like

a fountain - throwing music up into the wind, defying gravity or melancholy - and from the very first rhythm statement on *Requiem* his spirit swaggers across the sound stage. Written by **Marsalis** to elaborate one of **Kirkland's** signature sounds, his swinging comping behind singers and soloists from Pop to Classical, *Doctone* also sets out the Quartet's stall: liquid, effortless technique set free over charts that encompass Bop, post-Bop, Fusion, Pop and Swing.

From this seductive beginning the warm tone **Kirkland** and **Marsalis** adopt leaves room for bassist **Eric Revis** to double-time his way into the limelight without ever sounding forced or frantic.

As the instrumentalists slide into the post-**Jarrett** interpretation of **Paul Motian's Trieste**, their undoc-tored versatility shines through. The call to prayer, the call to arms and the call of love-for-sale are all in here. **Kirkland's** sizzling technique in an extended solo tempts drummer **Jeff Watts** into one of his kitchen-sink, bravura work-outs as **Branford** slips smoothly in alongside. Then a lyrical, complex and spacious reworking of *A Thousand Autumns* carries enough mood changes to soundtrack a short film.

British ears will then be delighted by the astonishing *Lykief*, a sly **Abdullah Ibrahim**-style fusion of Township and Modern Jazz that lets the band's voices chase an irresistible melody around three or four distinct

rhythms based on the same tempo.

This is where **Marsalis** says he most wants his music to stand - a living, growing fusion that builds empathy with the audience while challenging and re-inventing forms at the same time. Take his rock-steady approach on *Bullworth*: from a distance, listen out for the **Joe Sample** simple infectiousness of the melody, and the lick or tow of high-style technique over a four-square Fusion groove.

Three more originals from **Marsalis** flesh out a Spring must-buy. **Branford** has stepped two back to go three forward, and brother **Delfeayo's** practised, supportive production has pulled together a fitting last statement from **Kirkland**. There is no early warning of his death on these tracks, just the sound of a hot, creative musician flourishing in a hot, creative environment, captured largely live on analogue 24-track.



GLENN MILLER
MILLER PLAYS MERCER
RCA VICTOR 68717

This release finds the **Miller** band at the height of their powers playing 16 lyrical gems from **Porter's** equal,

Johnny Mercer, recorded when both were flying. And although **Mercer's** albums with **Benny Goodman** are better celebrated, **Miller's** respect for the man he called "The Best" matches **Mercer** smile for smile.

Miller's band's witty, stylish charts, cushioned by the insouciant confidence of a nation not at war, slink and slide like cats' tails through the singers' legs to mimic **Mercer's** phrasing. Yet because this is a movie-show tunes compilation, Rumbas, Standards, Dialogue songs, Vamps and **Mercer's** own indomitable brand of *Sunny Side Of The Street* optimism supply plenty of bells and whistles over his immaculate songwriting.

There's no end to the hokey harmonies plundered by generations of jingle writers ever since. Which is why it matters that it's **Mercer**. You get sympathetically and musically remastered definitive performances of *Skylark*, *Fools Rush In*, *And The Angels Sing*, a whole pocket-book full of sure-fire, hold-my-hand pitches and never a phrase that isn't original, inventive and plain, old class. Jeeves, really, when it comes to the words business, and not forgetting **Miller** and **Mercer's** Broadway-sequined but never-the-one-you-hear-on-the-radio, Barbershop-to-Gospel version of *Black Magic*.

If you haven't got these tunes, this era, this sound on a digital carrier already, *Miller Plays Mercer* is a bargain and a belter.

DANCE & AMBIENT

by Sara Davis

RECORD OF THE MONTH

SEB FONTAINE
PROTOTYPE
GLOBAL UNDERGROUND
PRODIGISPIN

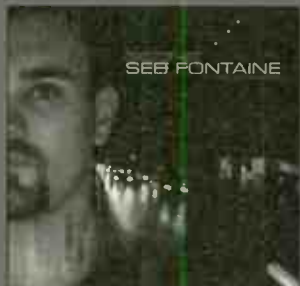

of full House mixes what should not be missed.

Producers Bessed Records have signed Seb to three

albums for 1999 and given him full artistic licence. The result is a double-CD of deep, hard and funky House with a mesmerising flavour. Prototype will appeal to anyone with an ear for a choon as it's one of those mix CDs that will suit all manner of activity - on-club, post-club and in-club too.

Starwurt fans will hear favourites such as Club Killer from X-Press. Follows

Universal Nation and anthemic crowd-pleasers like Woody McBride's Basketball Games. With an unrelenting, solid pace and long, misty mixes, Prototype delivers hard and fast House like only Seb Fontaine can. The classicism of this pair of discs comes from one man's genuine musical tastes and an understanding of how to build a set properly - the mark of a master at work.

Seb Fontaine is still one of the leading figures in clubland after eight years of chunky beats and an unfaltering sense of danceable House. With over 10 compilation albums under his belt, this Global Underground release is next in a long line



INCREDIBLE
INCREDIBLE SOUND OF DRUM 'N' BASS, MIXED BY GOLDIE

marketing talents mean he's the perfect choice to design the definitive desert island disc of Drum 'n' Bass.

So what's Goldie's pick? In there are old classics such as Alex Reece's groove-ridden smooch *Pulp Fiction* for one - not exactly a new cut but one which still sounds good. Then there are darker cases like the dusty *The Warning* via Code Name John and Doc Scott's *Unofficial Guest*.

Dipping illogically into hard-core beats of the Ram Trilogy variety as well as Jazzed-up rhythms like *Grooverider's*, it's certainly a diverse collection, even if it lacks direction. The number of tracks taken from Goldie's own Metalheadz label may explain the choice of music better than anything else, and you can't help but notice a track of his own squeezed on at the end.

Unmixed and running to 70 minutes, this is a good introduction to a range of quality Drum 'n' Bass, but

bear Goldie's influences in mind before drawing conclusions on the genre as a whole - the man's about to become the new Bond villain, which says it all really.



PETE TONG
ESSENTIAL COLLECTION - HUMAN TRAFFIC
FFRR/LONDON

Despite the hype, it remains to be seen whether *Human Traffic* can set the precedent for club film culture. The word on the street is that here, at last, is an accurate portrayal of clubbing on celluloid. It's a crafty compilation of current classics like System F's *Out Of*

The Blue and CJ Bolland's *It Ain't Gonna Be Me* alongside anthems such as Age Of Love's *Age Of Love*.

Human Traffic isn't all hands in the air - the more chilled-out side of club culture gets a mention too. Tracks such as *Orbital's Belfast* will appeal to anyone who has spent the early hours coming down with a bunch of mates.

As for the movie, it's set over a lost weekend in Cardiff and charts the ups and inevitable downs of a posse of mates out to get over the drudgery of their McJobs. It features a cast of up-and-coming talent accompanied by the altogether more established Carl Cox. Kids the world over will be further attracted by the promise of Howard Marks in a cameo role - respect. Pete Tong is a house-hold name and rather nifty when it comes to spotting talent; as a representative slice of club culture his line-up can't be faulted. In short, *Essential Selection* is just that.

**CLASSIQUE SOUNDS. (LEICESTER)
VINTAGE HI-FI & VALVE SPECIALIST**

Sugden A21A pure class A integrated £799 Sugden Audition CD player £649

**Now appointed agents for Sugden for the East Mids
FOR SALE. PRE/POWER AMPLIFIERS**

Sony TAF 3000S Int amplifier Mint. Boxed	£ 299	Sound Design S12 pre-amplifier Valve Amazing	£ 495
Tri-Vac line level valve pre-amplifier Excellent condition	£ 349	Arcam D1460 integrated amplifier Mint. Boxed	£ 149
Sugden AL5IC pre-amp Mint. Boxed Cost £1800	£ 550	Reel970BX pre-amplifier Mint. Boxed	£ 100
Pye HF53 integrated valve amplifier As new/Minor	£ 195	Quad 606 power amplifier excellent condition	£ 450
Armstrong A10 mono valve power and pre-amp	£ 195	Audio Innovations series 500 integrated valve amp	£ 300
Audio innovations Alto integrated amplifier Mint	£ 180	Sugden CS1 pre-amplifier. Excellent condition	£ 99
Sugden A48 integrated amplifier Good condition	£ 100	Luxman L81 integrated amplifier Mint	£ 125
Creek 4040 Mk1 amplifier Excellent condition	£ 75	Demon PMA350 amplifier	£ 75
Naim NA42 Mk2 pre-amplifier with MC board	£ 195	Musical Fidelity pre 8 pre-amplifier Boxed Mint	£ 199
Concordant modified Quad22 pre-amplifier	£ 75	Tri-Vac Model T4011 Int valve amp 50W Cost £1800/695	£ 100
Harman Kardian HK610 integrated amplifier	£ 99	O.A.C Mistrals int amp 55W C11 Cost £450	£ 180
Fisher X100A integrated valve amplifier GIC	£ 250	Rogers Cadet 2 prepower amplifier Ex condition	£ 150
Hickor 400 valve tuner amplifier With manual	£ 195	Connoisseur/Sugden stereo pre/power amp very rare	£ 195
Musical Fidelity L200 pre-amp with remote	£ 299	Sugden P51 power amplifier excellent condition	£ 200
Quad 11s various conditions from £150 pair	£ 350+	Richard Allen class A integrated amplifier serviced	£ 150
Quad 33 pre-amplifiers. Various from	£ 75	Rogers cadet 2 stereo valve power amplifier Reduced	£ 60
Leak Stereo 3D power amps Various condition from	£ 200	Leak TL25 mono valve power amplifiers From	£ 150
BTH Stereo valve amplifier and pre-very rare	£ 200	Conrad Johnson PV4 valve pre amplifier	£ 350
Lanley M100 monoblocks excellent condition serviced	£ 200		

TURNTABLES

Carand 301 & 401 motor units from	£ 125	Thorens 124 motor units from	£ 200
Lim LP12 with Akita tone arm Good condition	£ 450	Roel RP 90D turntable Good condition	£ 75
Lim LP12 with black Truak LV2 tone arm	£ 550	Thorens TD150 chassis only	£ 30
Lim LP12 with Rasko tone arm Good condition	£ 450	Thorens TD125 chassis mint boxed	£ 150
Thorens TD160 and Thorens arm No lid.	£ 65	Thorens TD160 and Thorens arm Good condition	£ 95

SPEAKERS

Linn Sekent loudspeakers Ex condition. Boxed	£ 225	Cade 301 speakers in black Mint Boxed	£ 150
Pair Dynanone electrostatic hybrid speakers	£ 100	Pair B&W DM3 speakers. Amazing sound	£ 125
Pair JRI50 speakers. Ex Condition	£ 200	Pair large corner speakers using tweeters drivers	£ 99
Heybrooks BB1 speakers. Black	£ 75	Rogers DB101 speakers Mint. Boxed	£ 75
Kel 105 speakers. Boxed. Ex condition	£ 495	Pair Whitley stentorian corner speakers	£ 75
Pair Rogers audio 5 speakers Ex condition	£ 350	Bose 901 with equaliser. Ex working order	£ 250
TDI RTL2 speakers. Mint. Boxed	£ 160	Cyros 781 speakers. Excellent condition	£ 99
Pair Lowline PMA6 line amps Ex model	£ 250	Mordant Short MS200 with Decca Kelly ribbon	£ 175
Kel 1022 speakers. Cost £700 Ex condition. Boxed	£ 295	Richard Allan Monitor 80 speakers Ex condition	£ 175
Miyospeaker SMC6B loudspeakers Mint. Boxed	£ 550	Pair 16wether Acousto speakers	£ 250
Simplex Leather acoustically treated PMA6 Early style sub	£ 150	Mordant Short MS400 with Decca Kelly Ribbons	£ 195
Quad ESL57 fully serviced	£ 400		

OTHER ITEMS

Revox A77 RRW. Cw Nab adaptors. Built in amplifier and speakers 4 track. 3.75 x 7.5. Excellent condition	£ 299
Pink Triangle Daraps and Pink Triangle Cardinal Transport & dc Both items in mint condition and boxed.	£ 1199
Arcam Alpha 3 cd player. Mint. Boxed. Reduced	£ 199
Pair original DB33 loudspeaker stands. Black	£ 75
Manantz CD80. Mint Boxed. A real heavy weight	£ 249
Revox A77 2 track 3.75x7.5 good condition	£ 225
Quad FM3 tuner. Excellent condition.	£ 75
Technica AT1005 2 tone arm New Boxed	£ 35
Arcam Alpha CD player. Boxed with remote	£ 150
Leak Tranchire 7 & 3 Mmm Series From	£ 75
SME 3019 servomotor 19. 20. 21	£ 80
Sony CDP 5050 CD player	£ 99

QUAD ESL57 PANELS/SERVICING ETC

Rebuilt & soak tested treble panels. Fitted new dustcovers. Exchange	£ 100
Rebuilt and soak tested bass panels. Fitted new dustcovers. Exchange	£ 120
New high spec rectifier boards. Excellent quality and long lasting	£ 40
Clamp boards. (price per pair)	£ 45
New dust covers bass or treble panels. Fitted	£ 25
Treble protection boards (before S/N 16800) price each	£ 15
Returbish Grille with fabric overcover. Black or brown. Each	£ 30
NEW. Stands for Quad ESL speakers (Flatpack). Black or wood finish	£ 139

Full servicing facilities available. 12 months warranty on all panels/parts

One Thing stereo decoder.

(lets a tuner speak for itself). Awarded 4 globes. Hifi World, June 1999. Only £150.00
Traughline tuner service & realignment £55.00. (excludes valves. Rarely needed)

TRANSLUCENT. (somewhat of a bargain) Hifi World. Jan 1999

PURE SILVER INTERCONNECT CABLE

99.99% pure silver conductors. Quality gold plated RCA phono plugs.

Half Metre terminated £60.00 One metre terminated £80.00

NEW..... Translucent Digital. 1M £40.00 Half metre. £30.00

Please add £20.00 per additional Half metre. £10.00 per half metre (digital)

7 day money back guarantee if not better than existing cable. Regardless of price or quality

99.99% pure silver wire .5mm (unsleeved). Only £4.95M

NEW EAR/YOSHINO EQUIPMENT

Pair £34P MM/MC phono stage with/without volume	Brand new. Boxed at only £499
Pair £34P MM phono stage. No volume control	Brand new. Boxed at only £350
Pair R34L Line only valve pre amplifier Amazing	Brand new. Boxed at only £450

301/401/124 PLINTHS

Plinths @ only £199 unfinished or £299 finished (venered) Awarded 4 Globes October 98 (HIFI WORLD)
Choice of veneers available. Extra for special finishes

WANTED VINTAGE & MODERN HI-FI EOPT.

Tel/Fax 0116 2835821 or 0802 213740 (Mobile). Callers by appt only
Opening times 10.00am-6.00pm Mon-Friday. 10.00am-2.00pm Saturday.
Classique House, 61 Aylestone Dreive, Aylestone, Leicester, LE2 8QE

cartridges

- denon
- dnm
- goldring
- lyra
- ortofon
- sumiko

cables

- audioquest
- cable talk
- chord company
- dnm
- heybrook
- ixos
- kontak
- lfd
- nordost flatline
- ortofon
- qed
- sonic link
- trichord
- van den hul
- xlo

headphones

- beyer
- ergo
- grado
- jecklin
- senneiser
- stax

stands

- alphason
- frameworks
- sound org'n
- something solid
- soundstyle
- stands unique
- target

accessories

- audioquest
- creek
- densen demagic
- discwasher
- earmax
- goldring
- ixos
- kontak
- michell
- milty
- monarchy
- moth
- musical fidelity
- nordost
- pixall
- qed
- rms
- shure
- trichord
- zerostat

hardware

- atc
- audiomeca
- audio physic
- audio synthesis
- densen
- harbeth
- jm labs
- michell
- nva
- nordost
- qln
- royd
- sequence
- sugden
- teac
- thorens
- totem
- trichord

**audio,
cables and
accessories
available
by post**

(post haste)

phone, fax or

write for latest

price list / newsletter



**Second hand &
ex dem deals**

Arcam Alpha 7 CD player. 18 months old, boxed, as new s/h (£325) **£185**
Arcam Alpha 8 r/control amplifier 2 years old, boxed, as new s/h (£349) **£195**

ATC A7 small stand - mount loudspeakers, Cherry veneer, ex display, Full warranty, boxed etc (£749) **£619**

Audiomeca Damnation "SE" CD transport. Fitted with trichord DOB board, AES/EBU phono + BNC digital outputs, unmarked, dinky and novel x/d (£1395) **£895**

Graaf 50-50 valve power amplifier As new, (extremely pretty!) boxed s/h (£2300) **£1195**

Monarchy 18 DAC Balanced digital input, volume control s/h very good condition (£800) **£399**

NVA cube 2 compact (cubic) stand - mount loudspeakers. Very interesting design, exceptional imaging, x/d (£750) **£600**

Quantum Minstrel hybrid amplifier S/H Boxed, (£999) **£349**

That's all folks!



hi-fi for grown-ups



ipswich (01473) 622866
signals martlesham heath
ipswich suffolk IP5 3UA
fax (01473) 631588
email: enq@signals.uk.com
www: signals.uk.com

RETRO REPRODUCTION

Exclusive Scottish distributor for
E.A.R./Yoshino Equipment and Nottingham Analogue Turntables
V20 & MC3 and spacedecks now in stock.



The Outstanding V20 Integrated Amp

V20
Introducing Tim De Paravicini's latest masterpiece, the outstanding V20. Using no less than 20 ECC83 triodes operating in Class A with no overall feedback, the result is the most natural and uncoloured sound available today.

HI-FI NEWS: Ken Kessler: 'What I think we're witnessing here is Tim De Paravicini's finest moment and that's scary, when you consider that even his disasters are better than most designer's triumphs!'

WHAT HI-FI: Verdict *****

Leading French magazine Diapason voted the V20 Amplifier of the year. To hear what all the fuss is about phone now for a personal home demonstration

Used Equipment For Sale

Audio Research Classic 30 power amp mint	£995.00
Audio Research D250 power amp 20x 6550 Awesome	£1995.00
E.A.R. V20 integrated amp 4 months old still under guarantee BARGAIN	£1995.00
JR 149 Spkrs original GRILL mint condition	£175.00
Rega Planar 3 with RB250 arm 4 yrs old	£175.00
Musical Fidelity XLP valve phono stage	££95.00
Concordant Excelsior valve pre with valve P.S.U. rosewood case superb sound	£495.00
SondeX integrated amp	£75.00
SME 309 tone arm	£495.00
Musical Fidelity Doctor Thomas power amp	£195.00
Tannoy III LZ 10" Monitor golds	£350.00
Meridian 100 series tuner, power amp & PSU	£350.00
Rodgers SL6 speakers	£125.00
Thorens TD150 turntable with thorens tone arm	£75.00
Michel QC P.S.U. unit as new boxed	£295.00
Mission DAD5 DAC boxed	£75.00
Meridian 506CD player 18bit	£595.00

SPECIAL OFFER
E.A.R. Clear Kit comprising of MM stage 5 passive line stages housed in the E.A.R. 834 case work.
Simply stunning. £299.00

Marantz SM10 class A monoblocks	£595.00
Meridian 605 monoblocks 200 watt	£895.00
Tube Technology Genesis 100 watt monoblocks with 2 box pre as new	£2750.00
Fisher x 100 Integrated valve amp	£145.00
Rodgers Cadet III valve amp mint	£145.00
Leak stereo 20 with Pre very good condition	£225.00
RB 300 tone arm	£89.00
Rodgers LS 35A BBC Monitors 15 ohm Walnut Boxed	£350.00
DNM Floor Stand For Turntables/Pre Amps /	£75.00
Denon DP 60 D/Drive Turntable Built Like A Tank	£295.00
Pioneer PL 12 D/Drive Turntable	£75.00
Garrard 401 Turntable	£95.00
Audio Innovations S200 Valve Pre with MC	£195.00
B & O Beolab 5000 Amp	£95.00
Revox A78 Amp MK II	£95.00
Meridian 500 Transport	£625.00
Musical Fidelity F22 valve pre amp, remote, class A balanced outputs, phono board. cost £1100.00	£495.00
Suniko Tone Arm	£125.00
QLN signature spks yew finish with outboard crossover and matching yew stands. 2years old mint	£1600.00
Pro Ac response 1S Burr walnut finish as new	£1400.00
EAR 834 L valve line stage	£275.00
Quad FM3 tuner with quality interconnect	£125.00
Revolver turntable blue marble finish new AT95E cart.	£95.00
Arcam Alpha 8 CD player 12 months old	£250.00
Arcam Alpha 9 remote int amp	£275.00
B&W 603 floorstanders boxed	£275.00
Meridian 205 monoblocks 100 watt	£450.00
Leak TL 10 monoblocks with spare valve	£395.00
Quad 10l speaker spks as new	£395.00
Quad II pair various	£300.00
Leak TL12+ pair	£300.00
EAR 834P	£235.00



Small but perfectly formed MC3

MC3
Producing the very best from vinyl has long been a black art and it's no wonder with so many permutations involved. Most people agree that Moving Coil cartridge design is technically superior than the Moving magnet but demands much more from it's ancillaries, especially the phono stage.

E.A.R./Yoshino have just launched the MC3 Cartridge Transformer with a band width of 31Hz-100kHz, facilities for a wide range of quality cartridge outputs and twin isolated earth terminals for maximum noise reduction.

The MC3 captures all the subtleties from the most complex recording without resorting to thrusting or spitting it out. Its extreme clarity and grainless presentation makes for a superb vinyl experience.

ART DUDLEY: Leading American hi-fidelity critic.

'I'm impressed with the MC3, and from a musical point of view, I think it's worth every penny of the price. Those of you who have tube-based systems & can afford it should pester your local dealer until he lets you take one home and try out Value/Quality *****'

Meridian 206 Delta Sigma CD	£295.00
Michel Argo pre with Hera	£295.00
Audio Innovations L1 Pre	£195.00
Revox B77 Open Reel mint	£495.00
Leak Troughline 3 Tuner	£95.00
Leak Troughline Tuner with studio 12 decoder full rebuild	£150.00
STD Turntable	£145.00
Cary 300b kit amp professional build	£450.00
Stax head phones and energisers various models	(phone)
Due in:	
Leak TL 50 + bronze & black, Quad 77 System, Leak Stereo 60, Meridian 601, 602, 604, PX 25, KT 61, KT88 (valves new boxed), Quad boxed ESL57 mint, Thorens 124, Garrard 301, Revox G36, Radford STA15, SME 12" Tonearms (various models)	

NOW DEMONSTRATING

CARY CAD 572 SE 20 WATT CLASS A MONOBLOCKS
SUPERB BUILD QUALITY AT A VERY COMPETITIVE PRICE

NEW SHOWROOM NOW OPEN

Phone / Fax 0131 553 4126 or 07801/288686
We will be closed from the 23rd May to 6th June

VALVE FRIENDLY SPEAKERS

NOW IN STOCK FROM BC ACOUSTIQUE & TRIANGLE 90
DB SENSITIVITY AND ABOVE PRICES START AT £199.00

SUSSEX SURPLUS

13 Station Road Horsham W. Sussex RH13 5EZ
Telephone: 01403 240257 Fax: 01403 270339

VALVES		T.C.C. AXIAL OIL FILLED PAPER CAPACITORS BRASS CASED				
KT66	GEC	£65	.1 µF	1000V	£10	
KT61	GEC	£25	.25 µF	350V	£5	
EZ80	Mullard	£8	.25 µF	500V	£6	
EZ81	Mullard	£10	5 µF	350V	£5	
			5 µF	500V	£8	
ECC33	Mullard	£25	OIL-FILLED CHOKES			
ECC35	Mullard	£25	45H	5mA	£10	
ECC81	Mullard	£6	2H	300mA	£15	
ECC82	Mullard	£10	16H	30mA	£10	
ECC83	Mullard	£12	6H	250mA	£20	
			10H	250mA	£30	
EF86	Mullard	£12	OIL FILLED TRANSFORMERS			
EL84	Mullard	£12	PARMEKO		PLESSEY	
E88CC	Mullard	£15	Primary 200-250V SCR		Primary 105-240V SCR	
M8137	Mullard	£15	Secondaries		Secondary	
EF37A	Mullard	£10	COM 4V 5V 3A		400-0-400 180MA £25ea	
EL84	RCA	£12	COM 4V 6.3V 3A		PLESSEY	
A2900	GEC	£20	COM 4V 6.3V 4A		Primary 105-240V SCR	
EL37	Mullard	£40	COM 4V 6.3V 4A		Secondary 1185-0-1185V	
ML6	Marconi	£25	COM 4V 6.3V 4A		200MA £50ea	
KT88	GEC	£125	350-300-0-300-350V		6.5V 3A 6.5V 3A, 6.5V 2.2A 6.5V 400MA,	
6SL7	STC	£8	250MA £70ea		57-0-57 60MA, 365-0-365V 215MA £35ea	
6SN7	STC	£15	OIL-FILLED BLOCK PAPER CAPACITORS			
6SN7	USA	£5	8 µF	600V	£10	
EF86	Brimar	£6	8 µF	1000V	£15	
8D8	Brimar	£15	12 µF	350V	£8	
6SN7	Brimar	£6	4 µF	600V	£6	
5Y3GT	Haltron	£5	4 µF	800V	£8	
5R4GY	USA	£8	4 µF	1500V	£15	
5R4GY	STC	£15	VALVE SOCKETS			PLUGS AND SOCKETS
3A/110A	STC	£20	Mc Murdo Octal	£1 each	Quad 2 pin mains	£4 each
3A/110B	STC	£20	Mc Murdo B7g	£1 each	Quad 6 pin output	£4 each
6072A	USA	£5	Cinch Skirted B9A	£1 each	Bulgin Octal plug	£3 each
5751	USA	£5	P.T.F.E. Skirted B9A	£1 each	Bulgin Free Octal SKT	£3 each
6B4G	USA	£35	P.T.F.E. Skirted B7G	£1 each	Bulgin Free 3 pin mains	£3 each
5U4G	USA	£12	USA Ceramic Octal	£1 each	Bulgin FXD 3 pin plug	£3 each
			Mc Murdo Ceramic Octal	£3 each	Bulgin Free 2 pin Spkr plug used for leak spkr output	£3 each
			Marconi Ceramic Octal	£3 each		
			Marconi Ceramic B4	£5 each		
			Chinese 807 Ceramic	£2 each		
			Chinese Twist Loc Ux4	£3 each		
			Chinese Twist Loc 211	£6 each		
			R.C.A. Twist Loc 211	£15 each		
			R.C.A. Twist Loc Ux4	£8 each		
			Marconi Bacolite DA100	£30 each		

Silver plated P.T.F.E. wire various sizes and colours several different voltage ratings all 50p per mtr (ring for details)

P & P £5 per order, overseas carriage at cost.

Men! Do You **JITTER**?

Are domestic earthquakes the plague of your life? Does the needle on your turntable skip like a spring lamb every time a sparrow lands on the roof? If so, then Davies Odell's Anti-Vibration Feet are for you!

Cunningly disguised as a Swamp Monster make-up kit, these little green blobs from Outer Northants. will mop up trembles from a variety of sources.

As all of you know, when you're working with a pneumatic drill, the frequent impacts can damage your hands, giving you what doctors call the dreaded White Finger disease.

Davies Odell developed their green compound for making safety gloves to protect the digits. Now the self-same

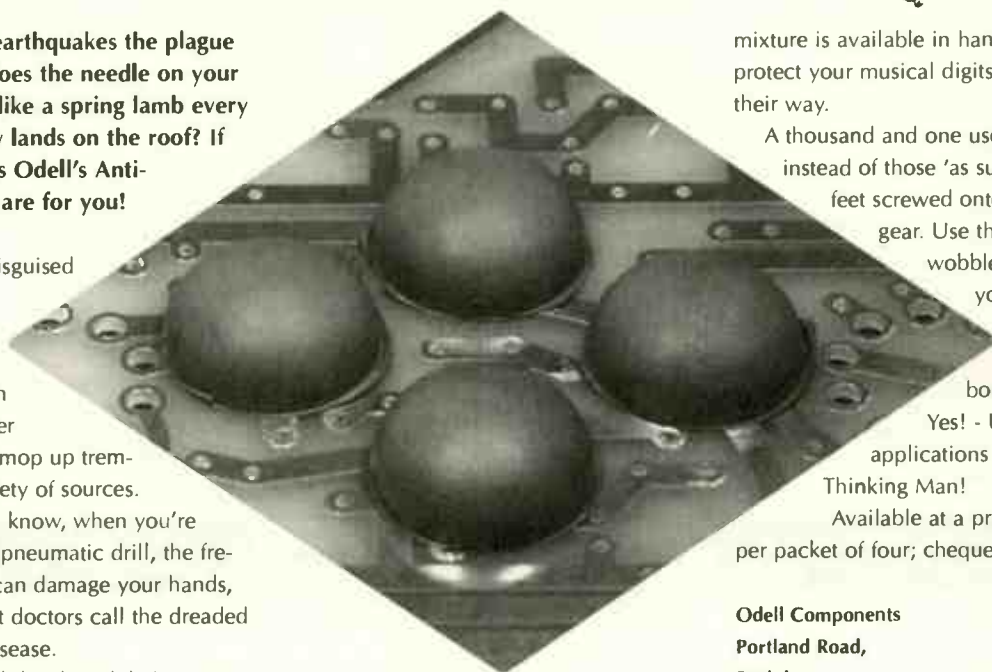

mixture is available in handy little feet, to protect your musical digits from losing their way.

A thousand and one uses! Use them instead of those 'as supplied' plastic feet screwed onto your hi-fi gear. Use them as extra wobble protection for your turntable, or for damping circuit boards...

Yes! - Unlimited applications for the Thinking Man!

Available at a price of £9.99 per packet of four; cheques payable to:

Odell Components
Portland Road,
Rushden,
Northants. NN10 0DJ
Tel: 01933 410818

Making a Miele of it

Is the man in your life tired of the Same Old Thing, ladies? Do you long for the days when you and he seemed to have a little more sparkle; a happy time before the dust settled on the knobs and cobwebs appeared under the chassis?

Now those days can be yours again. You too can show off a home hi-fi that'll be the envy of your friends. . . No more grime on the grids! No more fluff on your FETs!

Yes, you're never alone with a MIELE MICROSET!

Carefully packed, Especially For You, in a moulded case measuring a chic 9in. by 6.5in. by 2in., the MIELE MICROSET is chock full of tools that'll make your friends gasp "How does she do it?"

That'll be your secret, but we don't mind giving you just a peek into the little box of wonders! But remember - Mum's the word!

At the heart of the matter is an adorable

little suction-reducing attachment which fits straight on to your Miele vacuum cleaner, turning the everyday drudgery of hi-fi cleaning from a chore to a luxurious pleasure. The attachment has three feet of flexible hose ending in a versatile angled tube with retractable bristles.

For all those special hard-to-get-at places, there's another three - yes, three! - tools in the box which simply slip onto the fixed brush-tube.

Mrs Blake of Penge writes: "I thought I'd have to give up work



and sell the children just to find time to clean the hi-fi! I talked it over with my Ernie, and he said he could manage without the kids, but we needed my three mornings a week because he was saving up for some 'speakers! I was at my wits' end!

"Then a close friend told me about the new MIELE MICROSET, and imagine my surprise! Now I can work AND clean the hi-fi - and if we ever manage to get the children back, I could look after them as well, I shouldn't wonder."

Yes, for all those awkward moments which can beset the modern working girl, try a Miele Microset. . .

Remember - For awkward dust, it's a MUST!!!

Miele Microset around £30 from all good department stores.

FLAT PACK

David Price tells the tale of Naim's long lost Flat Loudspeaker

Back in the mid-Eighties, French audiophile Guy Lamotte found himself increasingly frustrated with the sound of his Linn/Naim 'six pack' system. The collective talents of his Naim NAC32 pre and six NAP135 power amps driving Linn Isobarik PMS loudspeakers through Naim's active NAXO crossover just weren't enough. Yearning for the lucidity of Quad's classic ELS loudspeakers, Guy nevertheless found that when he switched over to the Quads, he started wanting the 'Bariks back. In short, he desired the best of both worlds - something with tremendous clarity and imaging plus some serious welly

to get the earth moving in his listening room.

Sadly, in Guy's opinion, there was nothing around that could pull off this trick. Being au fait with the theory and practice of audio engineering - he was after all a Naim R&D engineer at the time - he decided to have a go and lash something up on his kitchen table.

As Linn and Naim were still officially best friends at the time - Linn would recommend Naim amplification and Naim insisted on Linn turntables and 'speakers - the time to launch a Naim loudspeaker wasn't quite right. So Guy duly persevered by him-

self, with no plans to put his new baby into production. But then came the famous 'falling out' between the two companies, a product of which was Linn launching the LK1/LK2 pre/power amplifier combination.

Guy's new loudspeaker duly went official. In March 1986 the project was transferred to Naim's Southampton Road headquarters and Guy was given the brief to design "a loudspeaker with as few compromises as possible". Like the Isobarik, this was to be a cost-no-object design. Legend has it that Naim told him, "build it and we'll work out the price when you're finished". And so the Naim FL1 was born.

THE BARE ESSENTIALS

Unlike the Quads, the FL1 was a three-way electrostatic/ribbon hybrid. The bass and midrange electrostatic panels were Guy's own design, and these were mated to a ribbon tweeter. Two large bass panels worked from around 22Hz up to 325Hz, between which a single panel handled the midrange up to 5.6kHz. From then on the ribbon took over. Below the drivers was an integral stand, inside which the passive crossovers and electrostatic transformers and electronics were housed.

The electrostatic panels themselves were a particularly interesting design. They comprised three 5-micron Mylar panels and two alloy electrodes housed in a rigid aluminium frame. The central panel between the electrodes used a semi-conductive coating to carry the high voltages. In front of and behind this were Mylar panels which moved in and out in sympathy with the central charged panel, thanks to the driver's air-tight construction.

By giving the central diaphragm panel as much room to move in and out as possible, and carefully insulating it from the outer panels, these electrostatic 'cells' had several advantages over other 'statics'. Guy made great claims for the robustness of his design. Whereas Quad electrostatics could let go in a spectacular way at

high volumes if clamp boards weren't fitted, Guy's design was said to be able to tolerate being driven flat out for half a day with no adverse effects!

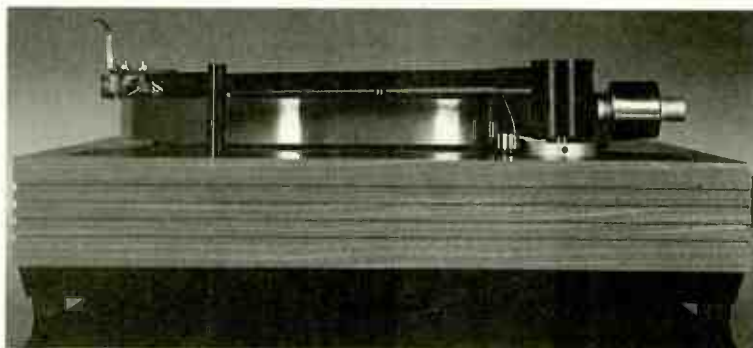

One of Guy's other designs, here in prototype form, is the classic Naim Aro tone-arm.

Another boon was the FL1's claimed insensitivity to room placement. By damping and acoustically loading the bass and midrange panels, Guy was able to optimise the loudspeakers' response characteristics to work in real-world conditions better than other electrostatics.

The FL1s were a pain to drive, thanks in part to some of their internals carrying around 4000volts and the fact that electrostatics generally are a reactive load (meaning that as the frequency of the music varies their impedance characteristics change quite dramatically). Indeed, with a load that ranged from 12ohms to 35ohms, even some Naim amps (famous for their muscular power delivery) struggled. The 40 watt NAP110 was the minimum you could get away with, but six 75watt NAP135s and a NAXO active crossover were preferable. Assuming you already had a NAXO, going active was simply a matter of snipping the wires in the loudspeakers' internal crossovers.

By 1987 the FL1s were in advanced pre-production form and Naim even let a couple of journalists in to have a listen. Guy was on hand to explain things and gave no hints about what was then to ensue. Indeed, Naim seemed about to invest in the clean room necessary to assemble the electrostatic panels.

Unfortunately, the FL1s were not to be. According to Naim's Paul Stephenson, making one or two units wasn't a problem but gearing up for volume production was. Difficulties centred around machining the central aluminium

electrodes in the electrostatic panels. British Aerospace were sub-contracted to do the work but couldn't produce absolutely flat panels with the required holes in. This, plus problems with glues, sample variability, durability, reliability and domestic safety finally sealed the Flat Loudspeaker's fate. "We were 100% behind Guy. We put a lot of money and time into the project. We had to assess whether it could go into production and finally had to say enough is enough," Paul confessed.

Guy wasn't so sanguine and, disappointed that the project had been shelved, decided to leave Naim. This is undoubtedly a great shame as Guy was a talented engineer - anyone wanting concrete proof need only look at another of his creations, the Naim ARO tone-arm. To their credit Naim invested vast sums of money and three years of R&D into the project.

To this day, people who've heard FL1 prototypes wax lyrical about how great they sounded. Hi-Fi Review editor Chris Frankland described them as "bloody amazing" and "frighteningly real and vivid" when he heard them. Naim's Paul Stephenson desperately wanted a pair for himself, telling me of their "fantastic bass and transients". Indeed, Naim demo'd them at several hi-fi shows and were overwhelmed by their public reception.

By all accounts the FL1 really did come close to the best of both worlds. It's a shame that Naim's production engineering problems were so severe that they didn't even get to pricing them, although Paul's guess is that they'd have sold for about £10000 in today's money. Meanwhile Guy Lamotte has returned to his native France and, sad about what could have been but never was, declined to comment. No fairy-tale ending then, but all credit to both Guy and Naim for investing so much time, money and effort in trying. If they'd succeeded, they could well have changed the face of high-end hi-fi for good ●

D.I.Y. SUPPLEMENT

No.46



Contents

109... DIY NEWS

Bring yourself up to date with recent arrivals on the DIY news scene.

112... KLS12 KIT LOUDSPEAKER

Hi-Fi World's range of 'speakers expands with the arrival of a new budget two-way using a large, soft-dome tweeter and fibre-glass mid/bass.

119... MAKING A 'B' LINE

In his search for the best 300B valves, Jon Marks auditions candidates from Western Electric.

BOOK REVIEW:

121... DICTIONARY OF ELECTRONICS

By S.W. and R.S. Amos.

123... DIY LETTERS

This month's audiophile advice covers topics like designing the perfect valve amp and optimising the sound of your CD player.

All rights to the designs are reserved by World Audio Design Ltd. They are published for single use by private individuals. They are not to be used for commercial gain without prior permission from World Audio Design Ltd.
 Audio Publishing Ltd and World Audio Design Ltd accept no responsibility for accident or injury arising from the construction or use of any of the designs published. All of the projects in this supplement have gone through rigorous listening and test procedures. The performance and specification of these projects can only be guaranteed on kits bought directly from World Audio Design Ltd.

PRICE VALIDITY TO END JUNE 1999 - ASK ABOUT ANY TYPES NOT ON THIS LIST



CHELMER VALVE COMPANY

for High Quality Audio Tubes

Everybody in the tube business knows that the justly famous Brand names of yesteryear like BRIMAR, GEC, MULLARD, RCA & TELEFUNKEN Etc. Etc. are scarce and often very expensive.

Although we supply all major brands when available (and have many in stock) our policy is to offer a range of tubes, mostly of current manufacture, the best we can find from factories around the world, which we process specially to suit audio applications. The result - CVC PREMIUM BRAND.

Our special processing includes selection for LOW NOISE, HUM & MICROPHONY and controlled BURN-IN on all power tubes to improve STABILITY and select out tubes with weaknesses Etc.

A selection of CVC PREMIUM Audio Tubes

PRE-AMP TUBES	POWER TUBES	POWER TUBES	SOCKETS ETC.
ECC81 5.20	EL34G 7.70	(continued)	B9A (Chassis or PCB) 1.60
ECC82 5.20	EL34 (TESLA) 8.20	6336A 46.00	B9A (Ch or PCB) G/Plated 3.00
ECC83 5.20	EL34/6CA7 (Large Dia.) 10.70	6550A 11.00	Octal (Ch. or PCB) 1.80
ECC85 6.00	EL84/6BQ5 4.80	6550WA or WB 13.50	Octal (Ch. or PCB) G/Plated 4.20
ECC88 5.00	EL509/519 13.00	7581A 11.00	4 Pin (For 2A3, 300B etc.) 3.30
ECF82 5.00	E84L/7189A 6.50	807 9.00	4 Pin (For 2A3, 300B etc) 5.00
ECL82 5.20	KT66 9.50	811A 11.00	G/ Plated 11.00
ECL86 5.20	KT66R 22.00	812A 34.00	4 Pin Jumbo (For 211 etc.) 11.00
EF86 5.60	KT77 12.00	845 30.00	4 Pin Jumbo (For 211 etc.) 15.00
E80F Gold Pin 10.00	KT88 (Standard) 12.50		Gold Plated 3.00
E81CC Gold Pin 6.80	KT88 (Gold Special) 21.00	RECTIFIER TUBES	5 Pin (For 807) 4.50
E82CC Gold Pin 8.00	KT88 (GL Type) 30.00	EZ80 4.20	7 Pin (For 6C33C-B) 5.00
E83CC Gold Pin 7.50	PL509/519 9.00	EZ81 4.70	9 Pin (For EL, PL509, Ch. or PCB) 5.00
E88CC Gold Pin 8.00	2A3 (4 or 8 Pin) 14.50	GZ32 12.00	Screening Can (For ECC83 etc.) 2.00
6EU7 6.00	211 22.00	GZ33 10.00	Anode Connector (For 807 etc.) 1.50
6SL7GT 8.50	300B 50.00	GZ34 6.70	Anode Connector (For EL509 etc.) 1.70
6SN7GT 4.60	6C33C-B 27.00	GZ37 8.70	Retainer (For 6L6WGC etc.) 2.00
6922 5.50	6L6GC 6.50	5U4G 5.50	
7025 6.50	6L6WGC/5881 8.00	5V4GT 4.70	
	6V6GT 5.00	5Y3GT 4.20	
	6080 11.50	5Z4GT 4.70	
	6146B 10.50		

and a few "Other Brands" (inc. Scarce types).

5R4GY FIVRE 7.00	6B4G / SYLVANIA 27.00	6SN7GT BRIMAR 10.00	13E1 STC 110.00
5R4WGY CHATHAM USA 10.00	6BW6 BRIMAR 5.00	12AT7WA MULLARD 5.00	805 CETRON 50.00
5U4GB RCA or GE 12.00	6BX7 GT GE 8.50	12AY7 GE-SYLVANIA 7.75	5842A GEC 15.00
5Y3WGT SYLVANIA 5.00	6CG7/6FQ7 SYLVANIA 7.50	12AZ7 GE 7.50	6080W TUNGSTOL 12.50
6AS7G RCA or SEIMENS 12.00	6CL6 RCA or GE 5.00	12BH7A GE or RCA 13.00	6550A GE 23.00
6AU6WC SYLVANIA 3.50	6CW4 RCA 11.00	12BY7A GE 9.00	6146B GE 17.00
	6SL7GT STC 8.50	12E1 STC 12.50	

ALL PRICES IN U.K. POUNDS £

Please note carriage charge extra + VAT (EEC Only) - When ordering state if matching required (add £1.00 per tube).

Payment by CREDIT CARD (ACCESS, VISA, MASTERCARD) or BANKERS DRAFT, TRANSFER or CHEQUE (UK ONLY).

FAX or POST your ORDER - We shall send PROFORMA INVOICE if necessary.

Valve Amplifiers sound better still fitted with CVC PREMIUM Valves!

Chelmer Valve Company, 130 New London Road,
Chelmsford, Essex CM2 0RG. England.

☎ 44 (0)1245 355296 Fax: 44 (0)1245 490064

TO ARMS! TO ARMS!

This world being imperfect, nobody has yet come up with tone-arm wires you can swing an elephant from. If you've ever tried persuading a loose connection to re-solder itself to the tag, you'll be aware of the problems. Ultimately, once you've melted all the insulation, the troublesome wire becomes too short (I see you're all wearing the tee-shirts).

Recognizing this problem, GFC Hadcock (of unipivot tone-arm fame) are offering handy hanks of replacement colour-coded, copper-cored cable. Prices for these are £14.69 inc VAT for four colours and £16.21 inc VAT for five colours, the extra colour being for arm earthing, etc. Each piece is 18ins. long, sufficient for the most extravagant arm length.

To finish the job, gold-plated cartridge tags are available at £1.47 inc VAT for a set of four.

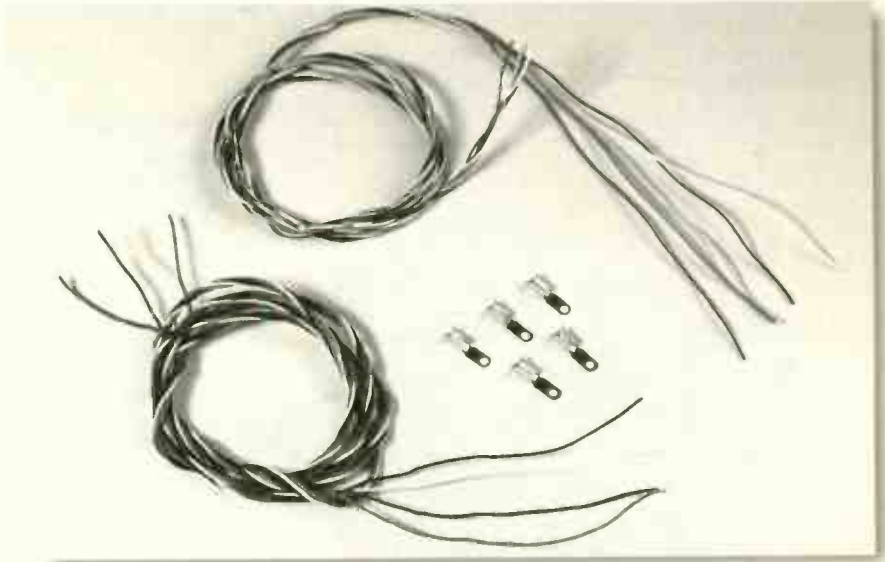

GFC Hadcock
Langley House,
11 Highwood Road,

Uttoxeter,
Staffs. ST14 8BQ
Tel: 01889 569166

HUNTSVILLE'S CLASSIC

Valve manufacturers Svetlana have announced a 'classic' version of the 300B triode. Starting from scratch, their designers sought to recreate the original specification but with the advantages of up-to-date vacuum processing plus a

more robust glass envelope.

Among other features, the Svetlana SV300B's grid is gold-plated to minimize grid emission and the finished valve is 'aged' to optimize stability when finally plugged in at home.

Svetlana Electron Devices
8200 S. Memorial Parkway,
Huntsville,
AL 35802
USA
Tel: (001) 205 882 1344

TO CAP IT ALL

Specialist parts suppliers AudioCom UK have just been appointed the sole European distributor of Reliable Capacitors, manufacturers of MultiCap, AudioCap and Exotica film capacitors.

The MultiCap PPMFX, PPFXS and RTX stocked by AudioCom benefit from a patented construction where a number of small caps are wound co-axially on each other and then connected in parallel to form a single component with minimal inductance and an Equivalent Series Resistance five to 10 times lower than normal. In addition, slow winding techniques and dielectrics such as polypropylene and polystyrene reduce the Multicap's dissipation factor and dielectric absorption.

Next up is the AudioCap RT. With its

gold-plated OFHC leads and polystyrene dielectric, this series is available in values from .01uF up to .68uF and voltages from 100VDC to 600VDC.

And finally, the Exotica TFT is one of Reliable's flagship caps. With its Teflon dielectric and tin foil construction, these .01uF to 1uF devices are said to offer outstanding sound quality.

AudioCom
Units 4/6 Tindle Centre,
Warren Street,
Tenby,
Pembs. SA70 7JY
Tel: 01834 842803



Audio Note Kit Amplifiers -

Power-Amp Kit

The Audio Note Kit One *(illustrated)*

Based around the justly famous 300B directly heated triode, we see this kit as the introduction to real Audio Amplification, as it covers all the important aspects of design necessary, Single Ended, No-Feedback, Class A, Directly Heated Triode, to become a member of this exclusive club of amplifiers

Kit One has one 300B per channel running at 420 volts with 75mA current giving 8-9 watts of the cleanest power you will ever hear, the Input stage consists of a 6SN7GT with a 5687 double triode driver stage running in SRPP. The power supply is capacitor-choke-capacitor configuration with a 5U4G HT rectifier, the 300B's have a DC filament supply for hum-free operation whilst the other valves are AC heated. Component quality is similar to our Level 2 finished products, **Audio Note** paper in oil signal capacitors, Beyschlag 1 watt 1% metal film resistors, good quality electrolytics (*sorry NO Black Gates!*) and a simple, attractive stereo chassis in black paintwork. We have several component and cosmetic upgrades available for **Kit One**, please ask for details.

The Kit One has recently been awarded the title "The Greatest Audio Bargain of the Twentieth Century" by Dick Olsher (ex-Stereophile) in a review on the Internet - this is just one of many rave reviews, copies of which we can supply on request.

Price: £799 Incl. VAT, which includes ALL parts & valves (yes, also the 2 x 300B's needed) but not postage/packing which to UK customers is £12.00.

KIT ONE ORDER CODE: AN-KIT-001

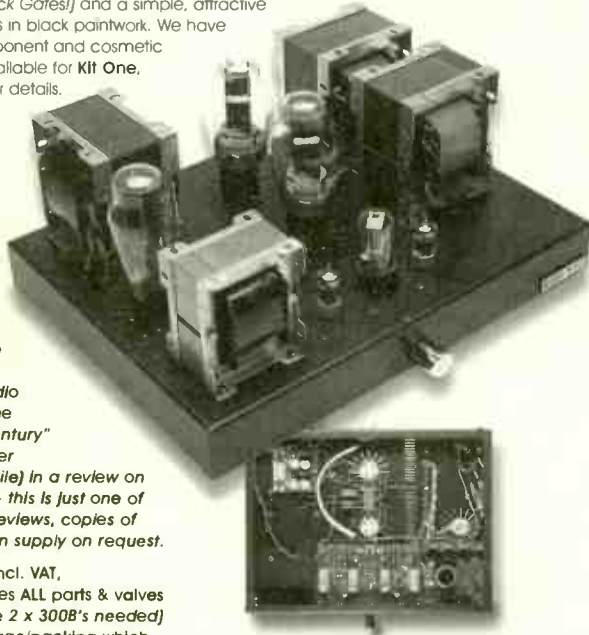

Audio Note is happy to provide a wide range of complete kits, output and mains transformers, chokes, paper in oil, aluminium, tin, copper or silver foil signal capacitors, Black Gate, Cerafine or standard electrolytic capacitors, tantalum, carbon and metal film resistors, silver wires, interstage and driver transformers, switches, balance controls, potentiometers, attenuators, chossis's and fittings for the quality oriented DIY'er, whether you are a beginner or hardened experimenter, male or female, we have the best (*and not always most expensive*) parts for most projects.

Audio Note Loudspeaker Drivers & Kits

We shall be offering the speaker drivers that we use in our own loudspeakers for general sale from now on. You can buy the drivers individually or together with matched and tested cross-overs, cabinet drawings and reflex ports.

Audio Note Circuits, Valvedata & Basic Technical Information

If you would like some suggestions which to base a future project around, then we shall be happy to provide you with a circuit pack containing good circuits like ONGAKU, KEGON/KASSAI, NEIRO, GAKU-ON plus several other power amplifier circuits and the M7tube & M10 pre-amplifiers, which are the best sounding pre-amplifier circuits we have come across.

Audio Note Quality Output Transformers

We are in the process of building up four separate ranges of Audio Note output transformers, in order to offer the best possible outputs at different pricepoints, they will fall into four categories.

Economy range Selected to ensure quality audio in a price efficient package.

Mid-price range Top quality with specially selected components.

High Quality range Double C-core outputs for single-ended circuits exclusively.

Super High Quality range All-silver wired outputs of the best possible quality.

Audio Note offer a design, prototyping and production service, where we can supply for almost any requirement. Please telephone for details.

Audio Note Mains Transformers

Available for most popular designs. We shall continue to expand the range as opportunities become available.

The Audio Note Kit Two

Kit Two features a single 6550 tetrode running in Single-Ended mode, yielding some 12 watts of pure Class A. With a valve rectified HT for the output stage, stereo chassis, and 6SN7GT input and 12AX7/ECC83 SRPP driver stage, componentry and chassis as Kit One.

Kit Two costs £599 Incl. VAT, includes valves, but not postage/packing.

KIT TWO ORDER CODE: AN-KIT-002

The Audio Note Kit Three

Kit Three features 2 x 300B's per channel running in single-ended parallel yielding 16/17 watts in pure Class A. This kit is on two mono chassis with valve rectified HT supplies, no signal feedback, it uses a 6SN7GT double triode as input valve and a pair of 5687 double triodes running in SRPP as drivers. The **Kit Three** is essentially a mono version of the Kit One with double the power, the same component choices and on two chassis' instead of one.

The Kit Three costs £1,550 Incl. VAT but excluding delivery.

KIT THREE ORDER CODE: AN-KIT-003

The Audio Note Kit Four

The **Kit Four** is really our introduction to valve amplifier kit building, the circuit and power supply being mounted on a single printed circuit board. The high-quality push-pull output and mains transformers are all mounted in a small aluminium chassis covering everything so nobody will be able to see that you have succumb to the lure of the valve amplifier which is sweeping the world. The circuit consists of two 6V6GT tetrodes running in Push-Pull class A, yielding about 10 watts, driven by a 6SN7GT and a 12AX7/ECC83 input stage. Easy to build, even for the beginner. Visually **Kit Four** matches the Audio Note Pre-amplifier shown here but with a single chrome-plated volume control. As with all Audio Note kits everything (*except solder*) is included.

The Kit Four costs: £299 Incl. VAT but not delivery.

KIT FOUR ORDER CODE: AN-KIT-004

Audio Note Driver, Interstage & Pre-Amplifier Output Transformers

Here is a product group that you do not see advertised every day! As usual we start small with the intention to grow quickly.

Audio Note Paper In Oil Signal Capacitors

These handmade signal capacitors are sonically superior to any of the plastic or other paper types we have come across. If you have never experienced the difference that a really good paper / oil capacitor can make in a valve amplifier, then you really should try.

Audio Note Paper In Oil Tin Foil Signal Capacitors

The tin foil is better than alu-foil for most applications, we recommend you try them.

Audio Note Paper In Oil Copper & Silver Foil Signal Capacitors

These copperfoil paper signal capacitors are considerably better than both the standard offerings and the tin foils. To start with there will be a few values / voltages of each available and we shall expend as fast as we can to cover all the popular values.

Audio Note Acid & Chloride Free Silver Solder

The best solder available, used in all our amplifiers from OTO to the mighty GAKU-ON.

Audio Note Cables & Wires

Audio Note manufacture a range of high quality copper and silver coax, speaker and wiring cables, which, depending on the overall price of the project, will do justice to any hifi system, regardless of price. Please call for prices and details.

Audio Note High Quality Stepped Attenuators & Switches

These handmade attenuators and switches are manufactured by a friend of Mr Kondo of Audio Note. They are the best you can buy.

Audio Note High Quality Valve Bases

All of our valve bases are of the highest possible quality materials. Ceramic, Teflon and gold and silver plated. If you want the best look no further - they are the ultimate!

Audio Note Resistors

Audio Note endeavour to stock the entire E12 range of all the different makes of resistor, since most are used in our products stock is generally available within four weeks.

BEYSCHLAG - HOLCO - SHINKOH Tantalum Film Resistors

AUDIO NOTE 1/2 Watt Tantalum Resistors

AUDIO NOTE 1 Watt Tantalum Resistors

AUDIO NOTE 2 Watt 1% Tantalum Resistors

AUDIO NOTE Precision Carbon Film Resistors

ALLEN BRADLEY 1 Watt 5% Carbon Film Resistors

Components & Valves

Pre-Amp Kit

The Audio Note Pre-Amplifier Kit *(illustrated)*

A complete kit loosely based on the Audio Note M7Tube pre-amplifier circuit is now available. The moving-magnet compatible phono stage consists of a cascode input, with passive RIAA equalisation and anode-follower output using the 12AX7/ECC83. Line buffer/amplification for the four line inputs consists of an ECC82 configured in parallel anode-follower mode. For the power supply a valve rectifier and choke-input filtering are employed. All circuitry is housed in a non-magnetic aluminium chassis, giving the very best sound quality.

Both phono and line stages are built on 'track-less' pcbs allowing easy construction but with the sonic benefits of hard-wiring.

The standard-quality version of the pre-amp kit includes Roederstein polyester film capacitors, Beyschlag 1 watt 1% metal film resistors, Noble open-frame style potentiometers and all pcbs, valves, wire etc. Various component upgrades are available, details upon request.

Cost of The Pre-Amplifier Kit is: **£349**
incl. VAT but not delivery.



Audio Note Black Gate Electron Transfer, High Performance, Graphite Foil Capacitors

Audio Note is currently the sole source in Europe that holds any significant range of values in stock, we use literally 1000's in production, as we were the first company to realise the tremendous benefits that Black Gate capacitors offer, and we are to date the only high-end audio company in the world to incorporate Black Gate capacitors consistently in our finished products.

There are very few audio parts that promise a guaranteed improvement when replacing practically any other part, but this is what the BLACK GATE capacitors actually do. Exchanging any electrolytic capacitor anywhere in the circuit of an amplifier or in the crossover of a speaker will greatly improve sound quality. We are working on some guidelines as to where, how and which types of Black Gates to use in different circuits, the first such technical guideline is available now and is called "Improving your CD-Player" and can be obtained by sending a stamped addressed envelope to us requesting this leaflet. All AUDIO NOTE Level 2 Signature products use Black Gate Electron Transfer in critical signal / power supply junctions.

Audio Note Cerafine Powdered Ceramic Electrolytic Capacitors

We have at long last secured a reliable source for these fine power supply filter capacitors, a must in any single-ended project. The Cerafines really cover many of the Black Gates values and where the prices for the BG's are prohibitive the Cerafine is a fine sounding alternative. We have increased the range of Cerafines we stock quite recently, and strongly recommend all the Cerafines as a far superior replacement or substitute for ordinary electrolytics, and at the prices offered that should be within most budgets. All power supply Cerafines are supplied with a capacitor clamp and are upright mounting.

Audio Note Potentiometers

The best available from a sound quality / price viewpoint, made by Noble in Japan, utilising high quality conductive plastic film. However a better alternative is the KO-ON volume controls which are used in pre-amplifiers like the M7 Tube, M7line, and in a mono version on the Input in the NEIRO, KASSAI, KEGON and GAKU-ON, these are very good sounding pots by any standard.

Audio Note also carry large quantities of STANDARD TYPE SWITCHES, STANDARD ELECTROLYTIC CAPACITORS (good quality industrial types), RCA, BNC, BANANA, PLUGS, RCA SOCKETS, SPEAKER & GROUND TERMINALS & LOUDSPEAKER SPADES.

Audio Note Moving Coil, CD Line & Input Matching Transformers

Audio Note now offer moving coil, CD and Input matching transformers for general sale. Common to all of these small signal transformers is that they come in a mumetal screening can with a threaded spindle with a nut for mounting

Stock Clearance SALE

In anticipation of the arrival of the new in-house made Audio Note copper foil paper in oil signal capacitors, we are pleased to offer a **60% discount on current list price** on all Tobias Jensen made paper in oil aluminium, tin and copper foil signal capacitors.

Offer strictly limited to availability, while stocks last.

Minimum Order
4 pcs single or mixed values or £20.00.

Audio Note Selected Audio Valves

Our valves are selected from the best available sources and are tested to the same stringent standards that we apply in the production of our own amplifiers. They fall into two categories, standard production items and rare, mostly NOS (New Old Stock) valves which are no longer in production. We have compiled a special list of the NOS items, which is available against a stamped self addressed envelope, if you live outside the UK, send US \$2. You should be aware that the valves on this list are NOT cheap, but we have stock of original GE, RCA and United Electronics 211, both standard versions and reinforced anode type for the US airforce, 845 Westinghouse, VT25/10/10Y, VT62/801A, WE300B, STC430CA, Mullard GZ34/Cv1377, Tungsol 5U4G (best sounding 5U4G we have ever heard!), Chatham 5R4WGY and many others.

Audio Note Recommended Magazines

Listener

Review based music & hi-fi magazine that contains some of the best considered & well written articles in print. A very good read £4 per copy.

The Audio Adventure

Glossy, well produced publication that provides a good alternative to the established magazines. Not afraid to be controversial. £4 per copy.

A full list of available issues on request.

FOUNDING SPONSOR
masterprize

Call us today for more information.
Ask for a full components catalogue or see our web page.

Audio Note now has a dedicated division to keep pace with the growing demand for amplifier kits and specialist components. **Music's Finest Conductor Limited** will now be able to provide a specialist service to DIY enthusiasts and record collectors.

Please direct all enquiries to the contact numbers below:

An
Audio Note

Music's Finest Conductor

Music's Finest Conductor Limited
25 Montefiore Road, Hove, East Sussex BN3 1RD

Tel: +44 (0)1273 770778

Web: www.audionote.co.uk

BUDGET STAR

Noel Keywood pulls the wraps off our new sub-£200 kit loudspeaker, KLS12, with fibreglass driver.

Our inexpensive kits, like the KEL34 valve integrated amp, are very popular. Designing a good budget product like KEL34 is a judicious balancing act that's definitely worthwhile if it can be pulled off. We decided to have a go with KLS12, featured here, looking for a budget loudspeaker able to deliver fine sound quality, but at a low price.

I'll be honest: the "we" I use above is royal. In the past I have preferred to do all design work in-house, so I know what Hi-Fi World DIYers are getting. We measure to industry standards and know what UK manufacturers are doing, which is important. Amateur designers tend to go off at tangents, coming up with idiosyncratic designs that might perform well in one area, but are hopeless in others. I'm not too keen on this sort of thing. Professionals must get every parameter right and move at least one ahead at a time to gain an advance, which has been our approach. This way you get a balanced design which has no weaknesses and at least one special strength.

Gary Hollands is a professional who designs for UK manufacturers and he designed KLS12, hence the royal "we". I did nothing this time around, other than measure the design he conceived.

I came across Gary's designs some time ago. "This guy knows what he is doing," I thought to myself. Experience, knowledge and test equipment give him an edge over cloistered in-house designers, less exposed to the outside world. So the performance of KLS12 is no accident. It's quite a specification for a loudspeaker costing £175 as a kit, not including the cabinet.

IN THE DRIVING SEAT

KLS12 uses a 210mm (8in.) Audax HT210FO woven-fibreglass cone



mid/bass unit. It has high sensitivity and needs only limited box volume for good downward extension. In a cabinet volume of 34litres, forward radiation from the cone reaches down to 50Hz, rolling off fast below this frequency as the port kicks in. The port tunes radiation from the rear of the cone, which is 180 degrees out of phase. It extends output from 50Hz down to 20Hz. That's good going for a cabinet of this size.

Fibreglass is very light but its response does not run up as high as carbon fibre or High Definition Aerogel, due to lower internal cone damping. Gary has used a larger 34mm dome tweeter, an Audax TWO34XO, to accommodate this, crossover at 2kHz.

To attain a flat response and good electrical load characteristics, the crossover is more complex than usual, with damped notch filters in each section, plus Zobel impedance-equalising networks. This raises the component count, but because electronic components are inexpensive, there's no great rise in cost. At a practical level, there's a few more items to solder, but this is not difficult.

It is the judicious selection of components and the way they have been integrated into a final design that marks out KLS12. It isn't possible to do this unless you design loudspeakers for a living, know what drive units are available, know their properties and know how to exploit them whilst at the same time

KLS12 PANEL DIMENSIONS

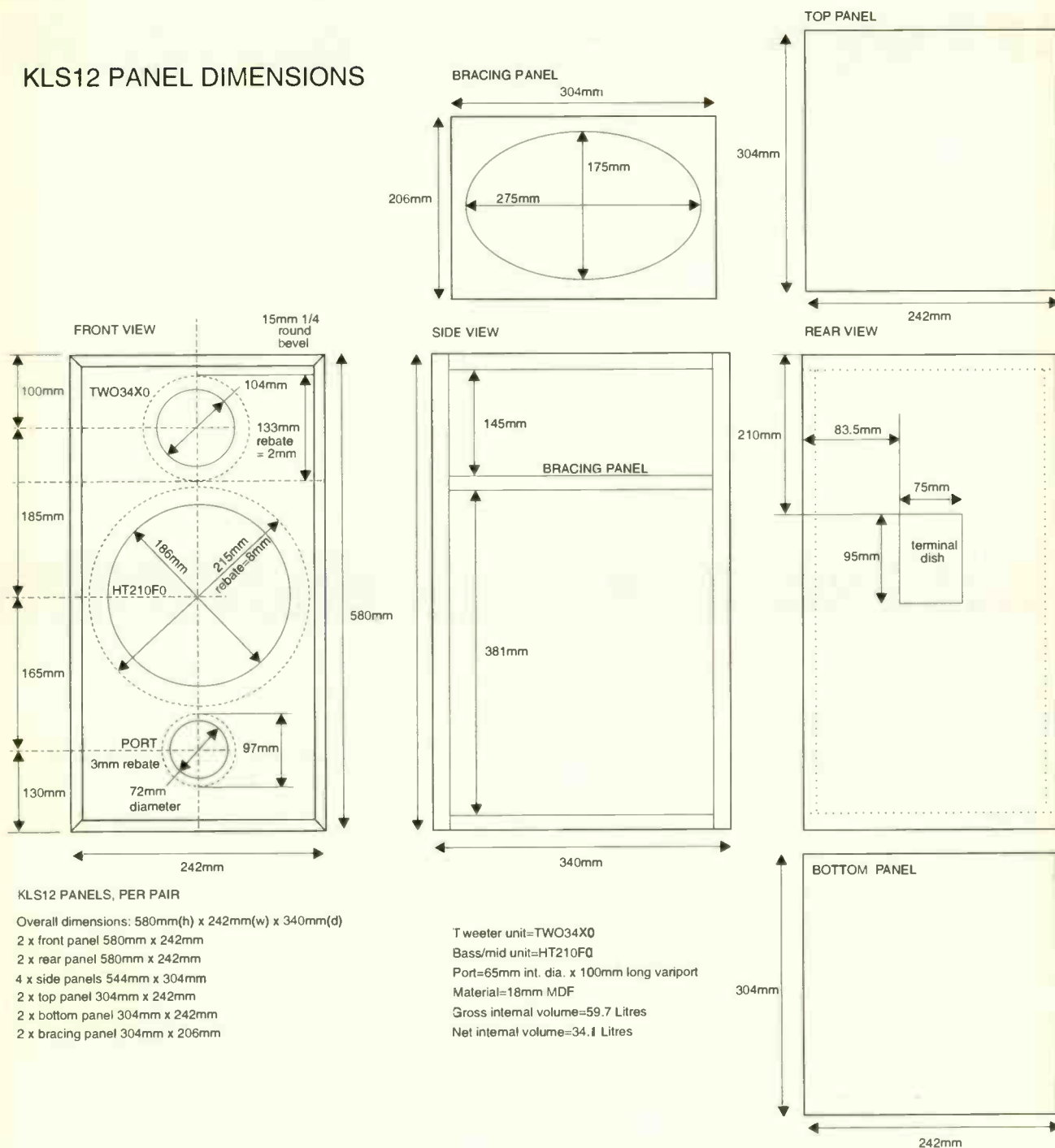

KLS12 PANELS, PER PAIR

- Overall dimensions: 580mm(h) x 242mm(w) x 340mm(d)
- 2 x front panel 580mm x 242mm
- 2 x rear panel 580mm x 242mm
- 4 x side panels 544mm x 304mm
- 2 x top panel 304mm x 242mm
- 2 x bottom panel 304mm x 242mm
- 2 x bracing panel 304mm x 206mm

- Tweeter unit=TWO34X0
- Bass/mid unit=HT210F0
- Port=65mm int. dia. x 100mm long variport
- Material=18mm MDF
- Gross internal volume=59.7 Litres
- Net internal volume=34.1 Litres

ensuring any problems are controlled. This is natty work!

TIMBER!

Regular readers will know that the key parameter determining bass behaviour is box volume. So in theory, the box surrounding the HT210FO could take on any set of dimensions providing it has an internal volume of 34 litres. However, I strongly advise using the dimensions we

propose, because it is easy to run into problems otherwise.

A narrow baffle with rounded edges is used for best stereo imaging. Box dimensional ratios have been chosen to avoid additive resonances that induce boom. The material used for the box is 18mm MDF (Medium Density Fibreboard). This is common, inexpensive and easy to glue and work. It is also fairly "dead" acoustically as it's a composite material.

There are fears that MDF dust is carcinogenic, so be careful not to breathe it in. Ideally, you should use a dust extractor whilst sawing, plus a face mask.

BOXING CLEVER

It is possible to use woods other than MDF. Plywood is lighter but more expensive. There's nothing wrong with light weight per se; mass is a reactive element that stores energy, so low mass equals



**COMPETITIVE WHOLESALE PRICES
BILLINGTON EXPORT LTD**

The minimum order requirement is £400.00 for all prices in this advertisement.

Orders under £400.00 are welcomed, please enquire for prices.

To qualify for the "100 pieces" price, please ensure your order is both over £400.00 and for 100 pieces.

	Unit Price For 01 piece	Unit Price For 100 piece		Unit Price For 01 piece	Unit Price For 100 pieces
4HA7/PC900 Russia/East European	£1.15 each	£0.90 each	85A2 Mullard	£3.00 each	£1.00 each
5Z4GT Russia	£2.30 each	£1.60 each	5670W GE USA	£1.50 each	£1.00 each
6AL5 Mullard UK/CV4025	£1.00 each	£0.75 each	5751 GE/JAN USA	£4.00 each	£2.80 each
6AU6WC USA	£0.95 each	£0.66 each	5965 GE USA	£0.99 each	£0.99 each
6BQ5 (EL84 Billington Gold Russian Extended guarantee. NFD)	£2.40 each	£2.00 each	6550B Russia	£8.00 each	£6.00 each
6BQ5/6CH6 Brimar UK - these 6CH6 are similar to 6BQ5 but have different pin out. Data on request	£1.95 each	£1.40 each	E88CC Tesla, gold pin 1962. OB	£5.90 each	£4.20 each
6DJ8/ECC88 Tesla 1962, OB, NFD	£2.00 each	£1.45 each	EB91 - SEE 6AL5		
6DJ8/ECC88 Tesla 1962, Unboxed, NFD	£1.75 each	£1.20 each	ECC81/83 - SEE 12AT7/12AX7		
6SG7 GE USA	£1.60 each	£1.40 each	ECL86 - SEE PCL86 similar item - data on request		
6SL7GT Russia, Unbranded	£1.60 each	£1.40 each	EL34 Tesla, clear glass	£5.40 each	£4.80 each
6V6GT Russia	£2.95 each	£2.10 each	KT88 - SEE 6550B		
12AT7/12AT7WC Phillips	£1.65 each	£1.65 each	PCL86 Russia	£0.37 each	£0.37 each
12AT7 Tungsol	£2.80 each	£2.80 each	PL509/19 Tungram	£5.60 each	£3.95 each
12AU7 Thermionic. NFD	£2.40 each	£2.00 each	SV572-30 Svetlana	£32.00 each	-
12AX7/12AX7WA Sylvania USA	£4.50 each	£3.20 each	SV811-10 Svetlana	£15.16 each	-

1 million valves in stock, please enquire for retail or wholesale prices including Billington Gold, Mullard, GEC and many others.
Major Credit Cards, Switch and Delta accepted.

**BILLINGTON EXPORT LTD IE GILLMANS INDUSTRIAL ESTATE
BILLINGSHURST SUSSEX RH14 9EZ**

TEL: (0)1403 784961 FAX: (0)1403 783519 email: billingtonexportltd@btinternet.com
VISITORS BY APPOINTMENT ONLY PLEASE

LOUDSPEAKER and ROOM MEASUREMENT PACKAGES

LIBERTY AUDIOSUITE v 3 visit <http://www.libinst.com>

Loudspeaker (and Electronic) Measurement System with

- * **HIGHEST CAPABILITY**
- * **STRAIGHTFORWARD OPERATION**
With built-in, expanded, EASY SCRIPTS
- * **NEW LOWER PRICE ***** £591.00 plus VAT**
Plus £16 next day delivery

ETF4 (WINDOWS95/NT) visit <http://www.etfacoustic.com>

Room Measurement and Analysis System

- * **ROOM ACOUSTIC MEASUREMENTS**
presented in simple graphical form, easy to understand
- * **DESIGN ROUTINES for HELMHOLTZ RESONATORS and QRD DIFFUSERS**
for you to correct room acoustic problems
- * uses your existing soundcard, and an omni mic **£125.00 plus VAT**

LspCADv3 visit <http://hem1.passagen.se/ijdata>

Combined Room / Loudspeaker Box / Crossover program

- * imports data from LAUD, LEAP and MILSA **£68.00 plus VAT**

Tony Scaford at MARTON MUSIC
Phone 01282-773198 or Fax 01282-776413
e-mail 106505.251@compuserve.com

Falcon Acoustics Ltd

Falcon Electronics, Basically Sound

<http://www.falcon-acoustics.co.uk>

DRIVE UNITS: by FOCAL & seas, and a pick of the best from other manufacturers.

100+ CROSSOVER NETWORKS: - Active & Passive. Components, Accessories.

COMPONENTS

SOLEN Polypropylene capacitors. 0.1mFd. to 100mFd.

Polyester and Polycarbonate Film Capacitors. 0.1mFd. to 10mFd.

ALCAP Reversible Electrolytic Capacitors (Non-Polar); 50v. 100v & Low Loss. 2mfd. to 600mFd

FALCON Custom-wound Inductors.

FERRITE:- Standard, High Power, Super Power, Super Super Power + **AIRCORED** 0.56 - 1.25mm wire

NEW IRON DUST. 1mm wire

TAPPED INDUCTORS:- 0-10mH in 1mH steps & 0-1mH in 0.1mH steps

AUDIO AMATEUR PUBLICATIONS

NEW- Valves for Audio Frequency Amplifiers from Philips Technical Library plus lots in P/L.

Back year sets of Speaker Builder, Audio Amateur & Glass Audio, plus the Audio Anthology Set.

Altogether 50+ books and 50+ Audio Amateurs magazine year sets. 1998 sets available.

FOCAL® 'State of the Art' Units & Kit Designs

Units in PolyKevlar, PolyGlass, NeoGlass, Paper and Neoflex.
Tweeters in Tioxid & Kevlar using Focal's inverted dome design.



A wide range of High-Tech
Loudspeaker units.
Unit Spec Booklet available 30p.

Please send A4 SAE with 40p stamp (61p with PL) +30p extra stamps.
SUPPLIERS TO THE TRADE SINCE 1972

Send for our **FREE** price list **PL28:** Just send a large S.A.E. (40p stamp) or US\$2 bill overseas.
Europe US\$1 bill or 3 International Reply Coupons (IRC) to:- (Dept HFW) Tablor House,
Norwich Road, MULBARTON, Norwich, Norfolk, NR14 8JT Tel (0)1508 578272

KLS12 CROSSOVER

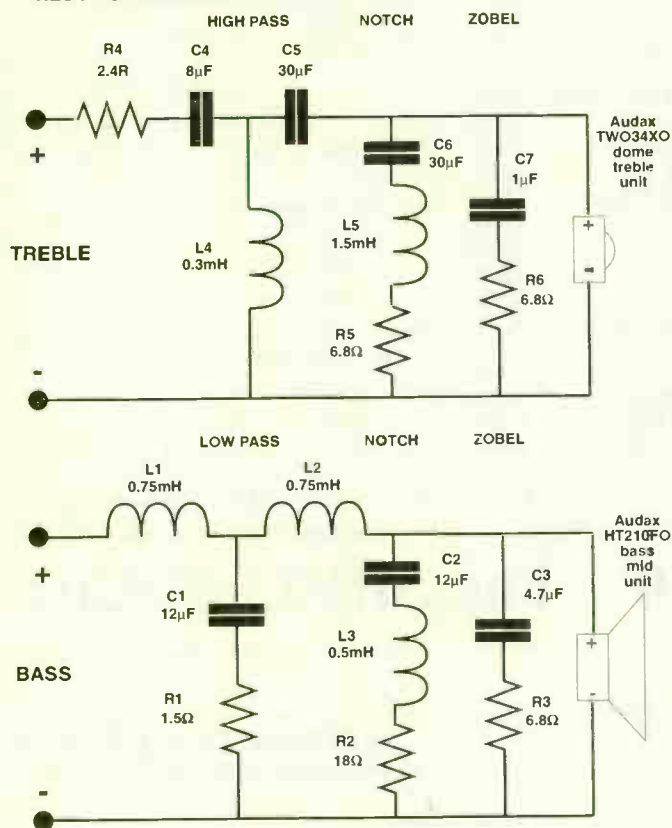

low energy storage and is, in fact, desirable. However, resistive damping must be present to dissipate energy and usually there isn't much of this in light panels. Plywood has glue layers between different woods, though, which is just about ideal. Additional bracing might be needed to stiffen large side panels, and it should be placed asymmetrically to distribute modes. Note that we use a bracing panel between the bass unit and tweeter.

Do not be tempted to use a lot of cabinet damping material - it will compromise reflex behaviour, sucking the life out of bass. The best place to apply it is on the rear panel, directly behind the HT210FO bass/midrange unit, to prevent rear-wall reflections returning back through the cone - modern, lightweight cones are more transparent to reflections than old, heavily-damped quackers.

You can opt for absorption, in the form of a roll of natural carpet felt, or dis-

persion to scatter high-frequency rear waves (with irregular blocks of wood or similar). BAF wadding isn't absorptive enough, by the way.

CONSTRUCTION

A timber merchant is usually able to cut panels, if you want to avoid having to do this yourself. They may be more accurately sawn than your own, if a good industrial circular saw with measuring bench is used.

The 15mm quarter-round specified for front panel edges is best done as Ramin hardwood set into rebates made with a router, meaning you will need a router of course. Hardwood edges are protective and light Ramin looks good against a darker veneer on the panel faces.

The drivers sit in rebates 2mm deep for the tweeter and 8mm for the woofer. These have to be routed as well. Then there's the port, which is also routed in.

Mounting the drivers flush and rounding the front panel edges contributes greatly toward obtaining clean stereo images. It is worth the effort and makes the final loudspeaker look professional.

It is usual to build the box first, gluing panels with Evode Resin W. When the glue is dry, the front and back can be stuck in place. The crossover is installed through the bass cut-out, or it can be boxed in a plastic case with terminals and located externally to avoid vibration. This can sit on the floor or be attached to the outside of the rear panel. It is common for DIYers to hard wire all crossover components to tags on a thin board.

SOUND QUALITY

KLS12 gives vocalists a clean outline and pushes them forward from the loudspeaker. Its slightly raised midrange is responsible for this strong sense of projection. At the start of Jackie Leven's 'Farm Boy' the "ooh, aah" of the chorus jumped out, with plenty of atmosphere around it. On vocal clarity, the KLS12s score highly.

These 'speakers also have rich detailing, highlighting the hand drums at the start of Angelique Kidjo's The Sound Of Drums. When the deep, walking bassline on this track kicks in, KLS12 shows it is tight and firm right across the bass spectrum. There's no waffle, so it can be placed close to a rear wall without sounding bloated or lumpy, ideally on short stands about one foot high.

At the other end of the range, the tweeter works well with violins. It kept individual instruments nicely separated but vivid and clear in Rimsky-Korsakov's Scheherazade. By handling more of the treble than normal, this 34mm tweeter manages to sound cohesive and resolve instrumental timbre effectively; the fruity rasp of a cello was quite different from the thinner tones of a violin, for instance.

In a nutshell, KLS12 is a transparent, vividly detailed transducer with fine projection. It has tight, well-defined bass which means it is best positioned close to a rear wall. On top of that, high sensitivity means it can be used with low-power amplifiers of around 20watts to 60watts.

Watford Valves

7 DAYS A WEEK 9AM - 9PM THE AUDIOPHILES CHOICE

All output valves multi-tested and digitally matched

Full no quibble guarantee. Expert advice on all valve amps

ECC81	Philips	4.50	EL519	E.I	12.00
ECC82	RFT	4.50	EM84	R.F.T.	4.50
ECC82	R.T.	7.00	EZ80	Mullard	5.00
ECC83	Philips	6.00	EZ81	Tesla	6.00
ECC83	G.E.	7.00	GZ32	Harma	9.00
ECC84	R.F.T.	4.50	GZ34	Harma	6.00
ECC85	R.F.T.	4.50	KT66	G.E.C.	80.00
E88CC	Tesla	6.00	KT88	Sovtek	20.00
ECC807	Brimar	28.00	KT88	Tesla	25.00
ECF80	Mullard	3.50	PL509	Tungstram	8.50
E182CC	Mullard	12.00	5687WB	Philips	5.00
E188CC	Philips	8.00	5881	Sovtek	5.00
ECL82	Siem/Telefun	14.00	6072	R.C.A.	9.00
ECL83	Mullard	6.00	6550C	Svetlana	16.00
ECL85	Polam	4.00	6550WE	Sovtek	16.00
ECL86	Harma	5.00	6CG7	G.E.	12.00
EF804S	Siemens	24.00	6CZ5	USA	10.00
EF86	Siemens	7.00	6GK5	USA	7.00
EL34WXT	Sovtek	6.00	6SL7WGT	Sylvania	8.00
EL34	Svetlana	8.50	6SN7GTB	G.E.	8.00
E34L	Tesla	8.50	7044	G.E.	8.00
EL84M	Sovtek	5.00	7591A	Harma	16.00
EL84	Philips	12.00	12AY7	Mixed	9.00
EL86	Siemens	7.00	12BH7A	Brimar	9.00



300B JJ/Tesla

This superb 300B features 24 carat gold plated control grids. The core is made from nife alloy and is copper coated which improves plate dissipation and sonic performance. The W.E. style grey coated plates are housed in a heavy grade glass envelope with structure supports, which results in less microphony than other types. The base is glazed ceramic with finely finished pins. Jon Marks commented 'The upper registers are cleaner and less fizzy and the bass is faster and meatier. Image, precision and sound stage are of the warehouse variety'. The valve is covered by a unique warranty and comes with its own test report. It will be the best upgrade you will ever make at only £68.00 each.

WATFORD VALVES 3 RYALL CLOSE,
BRICKET WOOD, ST ALBANS, HERTS AL2 3TS

Fast mail order/next day delivery/World Wide shipping
1000's more valves stocked. Prices exclude VAT and carriage.



01923 893270

Fax: 01923 679207



The Tube Preamp Cookbook

30 years of hi tech valve preamp development and philosophy discussed in depth—phono, line and P/Supply stages, overall topologies, balanced and SE schematics, and two complete state of the art designs for you to build.

"I was delighted to see that there is something more than just the same old schematics and principles over and over again" EW

"SOUNDS FABULOUS! More "grins per spin" than I dared to hope for.

Thank you so much for making your design available. It has been a positively uplifting experience to build and listen through this stellar device" WG

The SuperCables Cookbook

As it suggests: DIY super cables—analogue & digital interconnects, speaker and AC cables, theory and practice. Super sonics at some very un-super prices...

"Transcendence in interconnects" CJ (Positive Feedback Magazine)

"I tried the AC cord and the result was really good. I used it on my pre-amp. The music has more energy and is more lively" AC

"More music, more sense that the performers were living breathing humans—less hifi. No spit, grain nor fizz...rave rave!" RF

Precious Metal-Beautiful Music...

Four 9's pure silver foil to make the very best interconnect & speaker cables. Or use for superb low impedance, wide bandwidth internal wiring in electronics and speakers.

3mm x 0.05mm DM 12/\$8 per linear meter
25mm x 0.05mm DM 72/\$48 per linear meter

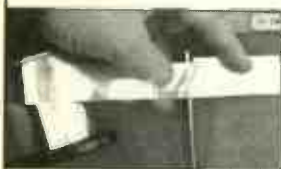

Prices

Silver foil and Teflon I/C kit: 1st meter pair DM 177/\$100—extra meter pairs for DM158/\$90 This is the best I/C anywhere! The books are DM60 (approx £23) or \$US40 each. P&P for a book or kit is DM14 in EU, \$5 in USA—worldwide it's DM26/\$US10.

Special offer: Both books for DM130/\$80 including p&p in EU or USA—elsewhere please add a extra DM12/\$8

VISA/MC welcome

USA: Ph (415) 492 0728 Fax (415) 499 8441 (FSpiritEd@aol.com)

Asia: Octave Ph + 60 3 793 7939 Fax ...7929 (octavele@tm.net.my)

Australia: Joe Rasmussen Ph+ 61 (0) 417 414475 (joeras@acay.com.au)

Europe and all other areas, please contact Allen Wright:

Einsteinstr.129, 81675 Munich, Germany. Ph/Fax: + 49 89 477415

(vacuumstate@compuserve.com) www.acay.com.au/~joeras/vacuum.htm

VACUUM STATE ELECTRONICS

TECHNICAL & GENERAL

SOME NECESSITIES - FROM THE ORIGINAL CLASSIC TURNTABLE SPECIALISTS

CONNOISSEUR			P&P
BD1/2 Drive Belt		£10.55	£1.85
BD1/2 Motor Suspension kit		£13.95	£2.45
SAU.2 Headshell		£16.75	£2.55
SAU.2 Connecting Lead		£15.95	£3.55
GARRARD Standard Models			
Wired arm tubes	from	£12.75	£2.50
Cartridge carriers (sliders)		£10.55	£1.85
Idler wheels		£9.85	£2.25
301/401 Transcription models			
Original Thrust pad assembly		£10.85	£2.25
Original Idler tension spring		£2.95	£1.85
Original Brake pad		£2.20	£1.85
Xeroxcopy Owners Manual 301 incl. full size mounting template		£8.85	£1.85
" " " " 401 " " " " " " " " " " " "		£6.70	£1.85
Replacement 301 control knobs On-Off/Speed select	pair	£20.25	£2.55
Replacement 301 suppressor unit		£5.65	£2.25
Replacement 301 motor pulley (-2%), (-1%), (Std), (+1%)	each	£15.65	£2.25
Replacement 301 Chrome plated mounting bolts	set	£6.60	£2.25
Recommended Lubrication set - early 301 or 301/401	(specify)	£5.60	£1.85

GOLDRING/LENCO			
Idler wheel (lock-nut or clip fixing)		£19.95	£2.85
Arm pivot bearings with instructions		£8.55	£1.85
Spindle/Main bearing assembly complete		£24.85	£3.85
Headshells	from	£21.95	£2.55
Instruction books	from	£4.20	£1.85

THORENS			
TD.124 series			
Idler wheel	original	£27.50	£2.85
Idler wheel	our redesigned replacement	£15.35	£2.55
Drive belt		£15.25	£1.85
Chassis spring suspension (replaces 'mushrooms')		£15.85	£2.55
TD.150/160			
Drive Belt		£12.50	£1.85
Suspension springs (-1%), (Std), (+1%)	set	£12.85	£2.55
Suspension bushes	(set of 3)	£12.50	£2.55
Armboards for most models	from	£16.90	£2.55

CECIL WATTS Dustbugs/Parastats/Spares - incl. Preener wicks

Cartridges and styli for 78s and Mono LPs in addition to current Stereo LPs

TECHNICAL & GENERAL
PO BOX 53, CROWBOROUGH, EAST SUSSEX, TN6 2BY
TELEPHONE: (01892) 654 534

MEASURED PERFORMANCE

The World Audio Design KLS12 was designed to deliver high quality at low cost from a compact cabinet.

It might not seem logical but big loudspeakers are the most sensitive. The smaller a loudspeaker gets, the less sensitive it becomes. Small bookshelf monitors deliver around 85dB nowadays, if they are good; stand mounters produce around 87dB, and floor standers typically 90dB.

Providing sensitivity is not gained by dropping impedance, this is good: the 'speaker is innately more efficient, which means a driver with a lightweight cone, powerful magnet and small voice-coil gaps. The crossover must be low-loss too.

KLS12 offers 89dB from a stand mount cabinet, making it sensitive for its size. This means it needs little more than 40watts to go very loud.

The impedance curve lies almost exactly on 8ohms from DC up to 20kHz except where it rises to the characteristic twin bass peaks that come from reflex loading. This gives KLS12 an overall measured impedance of 8.75ohms. A flat impedance trace means low reactance and energy storage, which in turn minimises unwanted signals entering an amplifier's feedback loop. A loudspeaker like this is very easy to drive, gets the best from all amplifiers and minimises amplifier differences. It's also optimal for valve amplifiers which need a precise 8ohms

for best power transfer.

Frequency response measured flat from 50Hz up to 20kHz, as our analysis shows. Absence of a crossover dip around 2kHz - the crossover frequency - ensures good detailing. The large tweeter runs smoothly up to 20kHz, so treble should sound even and free of brightness.

There's no bass lift, this level of damping tending to suit near-wall mounting. A damped response gives a slower roll-off, allowing KLS12 to reach 50Hz before the port takes over. This is quite low for the cabinet size. The port is tuned to 33Hz and takes output down to 25Hz.

KLS12 is a sensitive and accurate loudspeaker that should give fine sound quality at a low price. NK

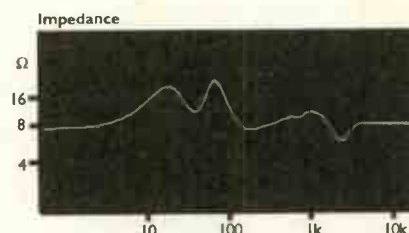

Use of impedance-compensating Zobel networks helps give KLS12 an unusually flat impedance characteristic, centred precisely on 8ohms. High impedance plus low reactance (low rates of impedance slope) make the loudspeaker an easy load for any amplifier and optimum power transfer is achieved with valve amplifiers.

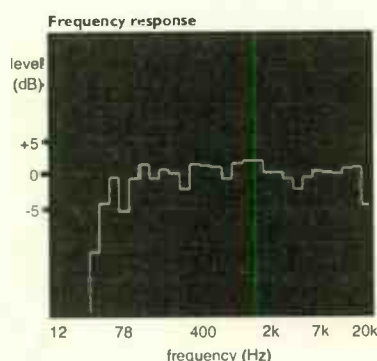

Frequency response stays within 2dB right up to 16kHz. This forward response plot does not show the contribution of the port, which extends bass down below 40Hz.

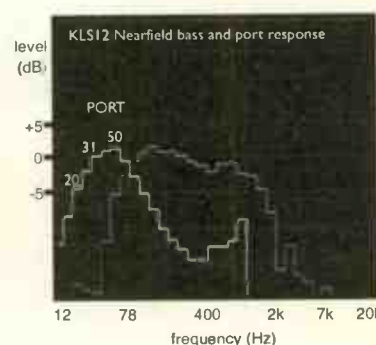

Nearfield responses of port and bass driver show how the two combine at low frequencies. The port takes over below 50Hz, reducing cone excursion, which helps power handling. The port is tuned to 32Hz and its output reaches down to 20Hz (-4dB).

KLS12 PARTS LIST

Drivers

Bass Audax HT210FO 210mm woven-fibre/glass cone, stamped chassis, large 550µm magnet
 Treble Audax TWO34XO 34mm high-efficiency tweeter

Crossover

L1 0.75mH, 0.18ohm, ferrite cored, 1mm wire

L2 0.75mH, 0.18ohm, ferrite cored, 1mm wire
 L3 0.5mH, 0.12ohm, ferrite cored, 1mm wire
 L4 0.3mH, 0.1ohm, ferrite cored, 1mm wire
 L5 1.5mH, 0.36ohm, ferrite cored, 1mm wire

C1 12µF, ALCAPS

C2 12µF, ALCAPS
 C3 5µF, ALCAPS
 C4 8µF, ALCAPS
 C5 30µF, ALCAPS
 C6 30µF, ALCAPS
 C7 1µF, two off 2µF (in series), ALCAPS

R1 1.5ohm resistor, 9W
 R2 18ohm resistor, 9W
 R3 6.8ohm resistor, 9W

R4 2.4ohm resistor, 9W
 R5 6.8ohm resistor, 9W
 R6 6.8ohm resistor, 9W

Hardware

Input 2 off - bi-wire terminal panel
 Damping a long-haired wool (0.5lb)
 Port 4.5mm int. D, 100mm Varioport
 Wire CFC multi-strand

KLS12 is available as a kit from HI-FI WORLD

UK (inc. vat & p+p)

Overseas (exc. vat & p+p)

Drive unit, crossover components, input dish, wool, etc (no wood)

£175.00

£150.00

Drive units only

£100.00

£85.00

Call or fax Nick Lucas on:
 e-mail:

+44 (0)171-625 8032 (9am - 5pm, Monday-Friday)
wad@hi-fiworld.co.uk

For overseas freight charges, please call, fax or e-mail.

Taking The Tube

Part 2

Jon Marks samples another pair of 300B valves from the originators Western Electric themselves.

Of all the many bottles in the thermionic bottle bank, Western Electric's 300B is probably the greatest classic of all. Particularly dear to American and Japanese valveheads (the latter group paying some frightening prices for originals), this power triode has been produced by many manufacturers. In the last Supplement, we examined the wares of two brands, Chinese Valve Art and Tesla from the Slovak Republic; this month we return to the source with Western Electric's very own 300B.

The test bed this time round was one of AudioNote's single-ended Meishu integrateds rather than our own push-pull power amp.

GO WEST

Our Western Electric 300Bs were supplied by Audio Connoisseurs (tel: 0151 343 0007) and came packed in individual boxes within a wooden case. Full marks for presentation then, but you'd expect this much given that the WEs sell for £600 per pair! In addition to the above, you get a full set of specs for each valve, and a manual (!)

Going a long way towards justifying the cost of these 300Bs is the five-year guarantee which covers any faults due to defects in their production (but not, unfortunately, dropping them accidentally on a concrete floor). If a WE goes phut, you can return it to Audio Connoisseurs who will ship it out to the factory in Kansas City for checking prior to a new

set being despatched. Owners are liable only for shipping costs.

Bearing in mind that price tag, it was a slightly shaky hand that pressed the



WEs home into the Meishu's sockets and flicked the On switch.

After an hour to settle down and become acquainted with their new surroundings, the WEs were making some very sweet sounds indeed. On acoustic recordings, plucked strings were very fast but extremely smooth, their complex harmonic character undisturbed. The Meishu has a weighty, solid sound which these 300Bs enhanced with a highly controlled but fluid bottom-end that worked a treat on electric bass as well as double-bass.

The velvet glove covering the iron fist turned out to be superb resolution of low-level detail, a talent for vividly recreating a sense of the recording venue and precision imaging. Overall, the WEs had an easy, mellow presentation which allowed music to ebb and flow without strain.

Swapping back to Valve Art's 300Bs (which come in at about a quarter of the WEs' cost), I heard an immediate change in the sound as music slowed down and lost a lot of its subtlety and musicality. Bass was less well defined and controlled, the midrange lacked projection and the treble had a rather hard, one-note quality to it.

Western Electric's 300B is not one of those low-cost purchases you can make without prior pondering. Counting against it is the high price, but in its favour are excellent sound and that five-year guarantee.

When you consider that in the same period you'd probably get through two or three sets of less esoteric 300Bs, the WE doesn't look quite so expensive.

Audio Connoisseurs

Unit 7,
Claremont Buildings,
Old Clatterbridge Road,
Bebington,
Wirral,
Merseyside L63 4JB
Tel: 0151 343 0007

KIT & COMPONENT SUPPLIERS

LOUDSPEAKER KIT SUPPLIERS

**Wllmslow Audio, 50 Main Street,
Broughton Astley, Leicester LE9 6RO
Tel: (01455) 286603
Fax: (01455) 286605**

UK distributors of Drive Units from ATC, COLES, DYNAUDIO, KEF, MOREL, PEERLESS, RCL, SEAS, SCANSPEAK AND VOLT. Comprehensive range of high quality crossover components, acoustic damping products, connectors and veneers. Over 20 different D.I.Y. loudspeaker kits on demonstration, including ATC S0 & 100.

**Audio Note (UK Ltd)
Unit C, Peacock Ind. Est.
125-127 Davigdor Road
Hove, East Sussex BN13 1SG
Tel: 01273 220511
Fax: 01273 731298**

Suppliers of a large amount of components for the Audiophile Kit builder. Valve amplification data and vintage circuits also available. See the double page spread in the back section of the main issue for extra & more detailed information.

**European Precision Mouldings Ltd
Highwyh, Sawbridgeworth,
Herts, CM21 0JS
Tel: 01279 600428
Fax: 01279 723846**

Manufacturers of the Red Scorpion range of loudspeaker terminals and binding posts.

**Falcon DIY Speakers
Falcon Acoustics Ltd, Tabor House,
Norwich Road, Mulbarton,
Norfolk NR14 8JT.
Tel: 01508 578272**

UK distributors of FOCAL drive units & Kits, plus SOLEN (SCR - Chateauroux) polypropylene capacitors and the largest specialist Audio inductor manufacturer in the UK. Stocking Audio Amateur Publications and Audio Computer Software. Comprehensive range of D.I.Y. Speaker kits, Parts, Accessories and Books. Please send large SAE (38p) for free price list. "Everything but the wood"

**IPL Acoustics, Chelsea Villa, Torrs Park
Ilfracombe, N.Devon EX34 8AY.
Tel: 01271 867439**

IPL supply a range of eight speaker kits using drive units from SEAS, Morel, Audax, Visaton etc. including four transmission lines to suit all room sizes. We also supply a full range of drive units, capacitors, and cabinet accessories as well as silver plated P.T.F.E. insulated cables.

**South Coast Speakers Ltd
326 Portwood Road,
Southampton, Hampshire.
Tel: 01703 559312**

UK suppliers for High-Quality Driver Units from: SEAS VOLT VISION SCAN-SPEAK also MOREL RCL & many more. Accessories/Components all of the Highest Quality inc. ProAudio MKT Capacitors, Inductors wound to order for any values. Many DIY Kits always on demonstration in our comfortable listening area. Custom design services & friendly advice!

VALVE AND OUTPUT TRANSFORMER SUPPLIERS

**Wilson Valves, 28 Banks Avenue,
Golcar, Huddersfield,
West Yorks HD7 4LZ.
Tel: 01484 654650
Fax: 01484 655699**

E-mail: wilsonvalves@surfink.co.uk
We stock over 2,500 different types of valves, N.O.S. and New. Please send a S.A.E. for full list. No charge for matching. Most major credit cards accepted

**Chelmer Valve Company
130 New London Road,
Chelmsford, Essex CM2 0RG.
Tel: 01245 265865 Fax: 01245 490064.**

Supplier of premium range of audio valves, other valves and components also available. (Please see our main advertisement in this supplement).

**Billington Export Ltd.
1E Gillmans Trading Estate,
Billingshurst,
West Sussex RH14 9EZ
Tel: 01403 784961
Fax: 01403 783519**

Billington Export Ltd. holds large stocks of audio valves including many obsolete brands such as Mullard, GEC, Brimar etc. as well as Sovtek, Thermionic Gold Brand and the recently introduced Billington Gold range. Also Cathode Ray Tubes (eg. used in Marantz tuner 10B). 50 page catalogue available, tel or fax for a quotation. Minimum order £50.00 UK, £100 export

**Langrex Supplies Ltd
1 Mayo Road, Croydon,
Surrey CRO 2QP
Tel: 0181 684 1166
Fax: 0181 684 3056**

One of the largest distributors of electronic valves, tubes and semi-conductors in the UK by original UK and USA manufacturers. Obsolete types are a speciality. Telephone or fax for an immediate quotation.

**Watford Valves
3 Ryall Close, Bricket Wood,
St. Albans, Herts AL2 3TS
Tel: 01923 893270
Fax: 01923 679207**

Specialist in new old stock and current production valves. Sole UK distributor of the Harma Diamond range selected for their superior performance. Huge range held, stockists of Mullard, GE, Phillips, National, Brimar, Sylvania, Telefunken, RCA, MOV and many more. All valves are new boxed and guaranteed. For free price list and specialist advice call or fax Derek Rocco, Watford Valves.

**PM Components
Springhead Enterprise Park,
Springhead Road, Gravesend,
Kent DA11 3HD
Tel: 0474 560521**

P.M. Components Ltd are the specialist component company for High End Audio enthusiasts. We have a design and manufacturing base for audio valves and associated products and have a capability to produce custom tubes for major manufacturers. Our 70 page catalogue is available at £2.50 including U.K. postage. P.M. Components are major stockists for Golden Dragon, Mullard, GEC and Teonex valves and have a vast archive of vintage tubes gathered from every manufacturer in the world.

**Woodside Sound Engineering,
Arfryn, Llanboidy, Whitland. SA34 0EY
Tel: 01994 448271 Fax: 01994 448665
E-Mail: woodside@tesco.net**

As well as producing transformers for our own products, we can now offer an expanding range of audio transformers for new ventures and Renovations. We can wind transformers for most RADFORD amplifiers to original specification. Contact us with your requirements or a list of standard items is available on request.

CLASSIC TURNTABLES

**Technical & General
P.O. Box 53, Crowborough,
East Sussex TN6 2BY.
Tel: 01892 65 45 34.**

The original specialist source of spares, replacements and expertise for the classic turntables. Years of actual experience and comprehensive range of parts (originals and re-manufactures), manuals, ancillaries, No dubious 'improvements' - no harmful 'modifications'. Our specialities: Connoisseur; Garrard; Goldring; Lenco; S.M.E.; Thorens; Watts; Ortofon; Shure: Cartridges and styli for 78s, Mono LPs, Stereo LPs.

COMPONENT SUPPLIERS

**PV Tubes, 108 Abbey Street, Accrington,
Lancs BB5 1EE. Tel: 01254 872500. Fax:
01254 872166.** Large range of electronic and TV components, satellite and aerial equipment. Call today for efficient service.

**Avondale Audio,
The Hollis, Avondale Road
Chesterfield S40 4TF
Tel: 01246 200096
Fax: 01246 207240**

Audio Engineers; upgrades, Improvements & servicing to both static and moving parts of the hi-fi chain. (amps as well as turntables). Also bespoke range of own equipment and an extensive range of parts & components available.

**Audio-Links
7 Fairmont Crescent, Scunthorpe,
North Lincolnshire DN16 1EL
Tel: 01724 870432 Fax: 01724 875340**

Large range of specialist audiophile components for solid state and valve enthusiasts. Mail order and a friendly service. Monday to Saturday, 9am - 6pm. 30 Page Catalogue - £2.00.

**AudioCom (UK),
Unit 4 & 6, Tindle Centre
Warren Street, Tenby
Pembrokeshire, SA70 7JY
Tel: 01834 842803
Fax: 01834 842804**

E-Mail: audiocom@scotnet.co.uk
Audiocom are international suppliers of premium grade components. We stock a large range of specialist parts which include; ALPS, Black Gate, Elna SLIMIC & CERAFINE, Danish Audio Connect CTI, Holco, REL-CAP, Sanyo OS-CON, MIT MultiCap, Semicon, Vishay, plus top grade OFC Inductors & RCA connectors. Our full colour 1999 catalogue is available at £250 (UK), & £3.50 overseas.

**Hart Electronic Kits Ltd
Penylan Mill, Oswestry,
Shropshire SY10 9AF
24 Hr sales/enquiries Tel: 01691 652894**

A range of Audiophile kits for 80 watt Power Amplifiers, Tuners, Pre-Amps and Moving Coil/Moving Magnet RIAA Pickup Preamps. All kits are fully engineered, with our thirty years design experience, for easy constructions from circuits by John Lindsey Hood, the most respected designer in the field. Send for lists.

**AP Electronics
20 Derwent Centre, Clarke Street,
Derby, DE1 2BUT
Check out the AP ELECTRONICS catalogue. It's free with every order of over £40.00 or can be purchased for a £4.95 cheque payable to 'AUDIOKITS'. Over 80 pages include pre and power amplifier kits, high grade audiophile resistors, capacitors and semiconductors, audio and mains cables, gold and rhodium plated connectors and COMPONENT NOTES on using high grade parts. A quarterly newsletter 'AP PERFORMANCE AUDIO' has been recently launched and your first issue is free.**

**Cambridge Scientific Supplies
12 Willow Walk,
Cambridge CB1 1LA.
Tel: 01223 811 716
Fax: 01223 501 833**

Specialist wire products for the knowledgeable audiophile including:- Silver wire (>99.99% purity, stress free) unique quadruple PTFE insulated Silver wire, Silver loaded solder, PTFE sleeving and Nylon braid sleeving, premium Gold plated connectors and plugs. Custom assembly available. Call Peter Bullock for a catalogue and application note.

**Kopperae
PO Box 6884, Dundee, DD5 1YB
Tel: 07970 - 654356
Email: wkopp@taynet.co.uk**

Kopperae manufacture unique anti-resonance and anti-interference hi-fi accessories that dramatically cut transistor harshness and background noise. These products include the highly effective anti-RF, anti-resonance CD Roof: an attractive medite-copper-damping pad slab that sits on TOP of your CD player. For the DIY enthusiast, we have the Cu Pad, a copper backed self-adhesive damping pad that can be used in a variety of applications, including cutting panel vibrations and lining chassis. We also supply plain 0.6mm sheet copper. Build chip, transformer and DAC shields, or clad casings, and get the significant

benefits that RF shielding brings. ALL products are available custom sized. Contact us now for a free brochure

RESTORATION

**Audio Laboratories (Leeds)
3, Kildare Terrace, Whitehall Road,
Leeds, LS12 1DB
Tel: 0113 244 0378**

Have your pet hi-fi project professionally done. With over 20 years experience in factory-grade kitbuilds and overhauls, to both valve and solidstate equipment, our good reputation stems from meticulous engineering coupled with superb measurement facilities.

**White Noise
11 Station Road, Bearsden
Glasgow G61 4AW
Tel: 0141 942 2460**

Specialist supplier of the highest quality, solder masked, silkscreened, PCBs and kits for audiophile grade, solid state power amplifiers, power supplies, MM/MC phono stages, and active crossovers, with many more to come. We also supply a wide range of top quality audiophile passive and active components, specialising in the latest high performance Japanese transistors and UK lateral power mosfets. Write for a free catalogue. Mail order only.

VINTAGE DIY

**Loricraft Audio
4 Big Lane, Goose Green,
Lambourn, Berks RG16 7SQ.
Tel: 01488 72267**

Specialist restoration of 301's and 401's using genuine spares and re-manufactured parts to original pristine standards in our newly built workshops designed primarily for these purposes.

WELDING

**N.Clark Welding & Fabrications
14 Redhills Road
Easton Industrial Estate
Southwoodham Ferrers
Essex CM3 5UP
Tel: 01245 323336**

Precision welding and sheet metal work TIG/MIG welding, CNE Punch and Press Milling and Turning Fine Limit and General Engineering Prototype work and batch work undertaken.

SPECIALIST UPGRADE SERVICES

**AudioCom (UK),
Unit 4 & 6, Tindle Centre
Warren Street, Tenby
Pembrokeshire, SA70 7JY
Tel: 01834 842803
Fax: 01834 842804
E-Mail: audiocom@scotnet.co.uk**
Professional modifications using leading edge components. Modifications are carried out by engineer with 30 years experience in the field of analogue and digital electronics. Upgrades available to all types of audio equipment including CD players, Transports, D-A converters, Pre & Power Amplifiers. Call us today for more information.

**TO ADVERTISE IN
KIT & COMPONENT
SUPPLIES
CALL AMANDA OR
SARAH ON
0171 328 2213 &
0171 328 4892**

NEWNES DICTIONARY OF ELECTRONICS

by SW & RS Amos.

Reviewed by Richard White.

Newnes Dictionary Of Electronics is, as the back says, "intended primarily to be of benefit to engineers and technicians... students... or amateurs who are interested in it". As I should judge that the vast majority of HFW readers come into the last category, my beady gaze has kept an amateur slant to it.

Let's face it, it's unlikely in 363 printed pages that anybody from any one electronic discipline will find all he or she wants to know. As a dictionary, the Newnes is chiefly concerned with what the words mean, rather than what the fullest explanation of the concepts implies.

This seems reasonable; the sketchiest encyclopædia of electronics these days would have to be a pretty substantial volume to hope to cover aspects of the mushrooming subject thoroughly. Naturally, this can mean that Newnes' Dictionary can seem sketchy - "Is that all they have to say?" is a remark which the approach invites. Nevertheless, where Messrs. Amos have scored rather highly is in breadth of coverage, and perhaps even more importantly, clarity of language.

To select a few instances at random, the Amoses succinctly define "information superhighway" as "a vague term" - and so it is! - "denoting any network over which information in a variety of formats is available to a wide public." Quite. And yet the way the term is used, particularly by media types, you'd think the superhighway was a Thing, not merely a phrase. Well, now we know.

This is all an indication of the de-mythification which a good dictionary should foster. Even in private life, there is a vocabulary in which insult cannot be distinguished from praise - unless you happen to know. Still more in an increasingly acronym-ridden branch of science, the uninitiated are cut off from knowledge simply by not knowing the terms in the first place. "Transistor" we all know;

"FET?" "MOSFET?" Seek and ye shall find.

Of course, in a work of this nature there is not room for everything and there seem to have been either some ruthless excisions or else certain features were never included in the first place. I was truly surprised to find that not only was Gauss not defined, but neither was Tesla. Max wasn't well either. These are quite major omissions. It is not at all unusual in a book of this type to include the derivation of units in tabular form somewhere, but even if this is omitted, to leave out a common measure on which you'll stub your toe on the merest stray from the amp-ohm-watt path is not good sense. In the immortal words of Dr Irving Gardner: "You can't make what you can't measure because you don't know when you've got it made."

Having griped a little, I found that on the whole the dictionary covered both concepts and their practical applications rather well. Cross-referencing is by means of italicization, so it is easy to pursue a line of enquiry through the pages without the annoyance of footnotes and appendices. At the conclusion of such a path, although perhaps not fitted for the Brain of Britain final, you have at least a grasp of the processes involved and will have picked up a smattering of the vocabulary on the way.

For example, picking on ion implantation quite by chance, I was gently led by way of diffusion, graded-base transistor and transit time to bask in the gentle glow of electron tubes. Having established that the US usage has a wider application than the English 'valve', it was a little easier to forgive the opinion

that the term valve "has been replaced by electron tube". Oh really?

Actually, valve-based electronics is very well served by this book. Having grumbled about the lack of unit definitions, I am forced to admit that valve types are covered with a thoroughness which would not disgrace a far more specialized publication. It's not that often that a casual enquirer wants to know what a nonode is (a failed limerick, maybe?); nevertheless, there it is, with a handy diagram and explanations of its function and typical uses.

Common circuit symbols are shown throughout the text, a useful feature in days when, as ever, the derivation of some of these is far from obvious. Unhappily, there is not a general chart of some of the more fundamental examples, nor is the from-time-immemorial symbol for a resistor given, the 'empty oblong' being favoured throughout. In similar carping vein, anyone whose eyes have been out on stalks trying to read a five or six-band resistor code (as commonly supplied by Maplin) will regret the lack of a guide beyond four-band and body-tip-dot types.

When all's said and done this Newnes Dictionary is a distinctly well-paced guide. As with any work of this sort, there are places where it ambles when you want to run, but for a hard-backed basic reference written in crystal-clear English and, what's more, plainly illustrated, it represents fine value●

See page 84, World Library, for order form.

Code 1610.

Price: £30.00 plus £2.00 p+p.

ISBN: 0 7506 2405 1

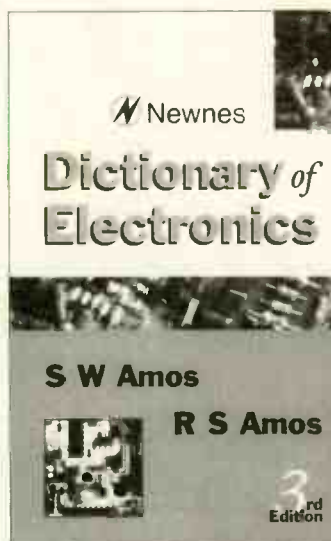

SPEAKER KITS FROM IPL ACOUSTICS

Over a 10 year period I.P.L. ACOUSTICS have developed a range of high quality speaker kits, using the best units from SEAS, MOREL, AUDAX, and I.P.L. and have produced a comprehensive range of speakers which will compete with the most expensive of commercial designs.

All speakers have biwired crossover kits containing high quality components and terminals.

**S5TL
TRANSMISSION LINE**



PLUS KIT£382.00
TOTAL KIT£506.00

**FIVE
TRANSMISSION
LINE KITS**

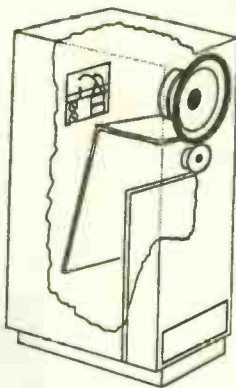

TRANSMISSION LINE
PLUS KITS£177.00 -
.....£382.00

**M3TL
TRANSMISSION LINE**



PLUS KITS£177.00
TOTAL KIT£241.00

**A2 H.D.A.
AEROGEL KIT**



PLUS KIT£187.50
TOTAL KIT£259.00

**S3TLM METAL
TRANSMISSION LINE**



PLUS KIT£233.00
TOTAL KIT£311.50

PRE-VENEERED CABINET KITS NOW AVAILABLE. Carriage charge extra on all kits.

If you would like further details please send large SAE with 38p stamp for SPEAKER BUILDING CATALOGUE, comprising VALUABLE ADVICE on DESIGNING, BUILDING, and TESTING speakers and full technical specifications including response curves of eight kits, drive units, and details of SPECIALIST CABLES and ACCESSORIES. KITS FOR A.V. USE NOW AVAILABLE.

I.P.L. Acoustics, Chelsea Villa, Torrs Park, Ilfracombe, N.Devon, EX34 8AY Tel:01271 867439

Pro-Cap

Silver Foil Paper in Oil Capacitors

*Precision Engineered Professional Grade Audio
Signal Capacitors*

MADE IN UK

These capacitors are the very best available anywhere in the world and are sonically superior to all others irrespective of price.

Silver Foil Paper in Oil Pro-Caps are perfect for single end triode amplifiers, push-pull power amplifiers, tube preamp, power supplies and premium loudspeaker designs. You will hear superior detail in your music, but none of the harshness, only deliciously liquid, sweet and rich music.

Available in the following values

Silver Foil Paper in Oil Capacitors (650 V)

0.005µF - 0.01µF - 0.02µF - 0.05µF - 0.1µF - 0.22µF - 0.47µF
1µF - 2µF - 4µF - 8µF - 16µF - 32µF

Low Voltage Speaker Crossover Silver Foil Paper in Oil Capacitors

1µF - 2µF - 4µF - 8µF - 16µF - 32µF

Contact Audiolamp for further information and pricing.
Audiolamp is the sole distributor for Pro-Cap capacitors for all countries that are members of the European Community (excluding Germany).

Fax: +39 0974 984477

E-Mail: audiolamp@pisacane.edinet-gdp.com
<http://www.edinet-gdp.com/audiolamp>

Audiolamp

Audiolamp, via Nazionale 41, 84067 Policastro B., Sa. Italy



SERVICE
FOR
ENTHUSIASTS

High quality Push-Pull or single ended
Output, Mains, Chokes, Interstage, Input and
Cartridge Transformers



Choose from our catalogue or specify a custom design at no extra charge. Range of package options: full or half shrouded or open frame. Encapsulation, as illustrated for our popular size "P+" for output or mains. All transformers built to order by our craftsmen. Usually 3-4 weeks delivery. Free technical support for all our products (Phone, Fax or internet). Free catalogue. Visa, Mastercard, JCB etc.

E A Sowter Ltd
PO Box 36 IPSWICH
IP1 2EI England
Tel: (+44) (0) 1473 252794
Fax: (+44) (0) 1473 236188

E-Mail: sales@sowter.co.uk
techsupport@sowter.co.uk
Catalogue and overseas
agents on our Website:
<http://www.sowter.co.uk>

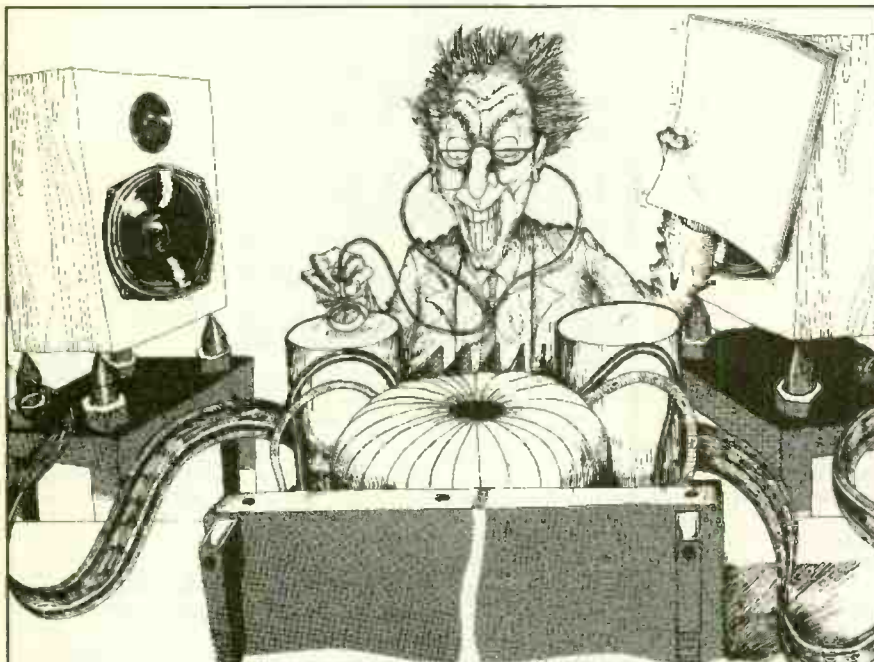

DIY

Letters

BRIDGING THE GAP

I recently had a brainwave while listening to my hi-fi. I was wondering how to improve my set-up, which consists of a Meridian 500 transport, 201 pre-amp (soon to be 501), 203 DAC and Pioneer A-400 GTE amps (pair thereof) bi-amping Origin Live OL2 'speakers.

I am very happy with the sound but I think I could get an improvement if the amps had more control over the 'speakers. I do not want to change the A-400 GTE as I have found nothing under £3000 that has the magical qualities of this amp.

This led me to think about bridging. In non-bridged operation one side of the 'speaker is grounded and the signal applied to the other. In bridged operation, one amplifier applies the signal to each side of the 'speaker but the two signals are out of phase.

If two stereo amps are used in conjunction with a balanced pre-amp then you can construct a cable which splits the balanced output into two phono plugs, one carrying the positive signal and the other the negative. These can then be plugged into the left and right inputs on the amp and the speaker connected between the two positive output terminals. Will this work? I can not try this as I do not have a balanced pre-amp at present.

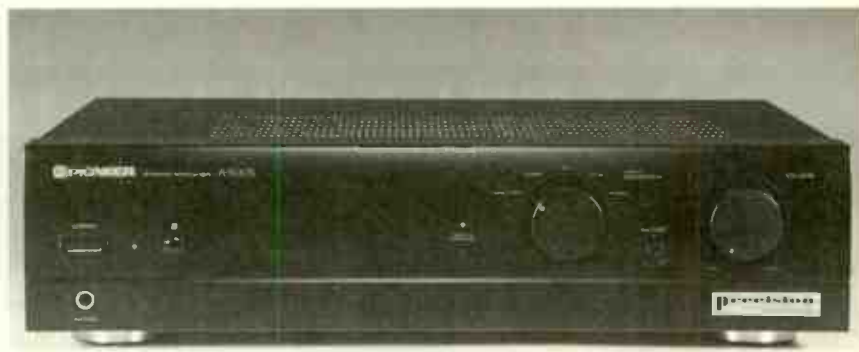

When tweaking goes overground, the result is amplifiers like Pioneer's A-300R Precision.

This arrangement could easily be achieved in a digital-only hi-fi using a Dacmagic as this has balanced outputs, and a passive pre could be built easily.

Is there a circuit to turn an unbalanced input into a balanced one without upsetting the sound quality? This could be incorporated into an active crossover (valve of course), so how about a DIY article on it?

George Bullimore
Grog@BTinternet.com

We asked Tom Evans, the designer of the GTE modifications, to comment: I agree the A-400GTE does have some interesting attributes

and in its day was an entry into real hi-fi. However, in my opinion you should sell the GTEs and upgrade to A-300R Precisions bi-amping your loudspeakers. The same remote operates both volume pots together, making life easy.

The A-300R Precision has so much more resolution and low-end control than the GTE. There is also a further upgrade for the Precision which turns the amp into a high-end contender with real grunt. Pioneer may at a later date incorporate these mods into the next batch of amps. Until that time, I am able to offer them separately (tel: 01443 816856). TE



**M. WALTHER
AUDIO ELECTRONICS**
HIGH GRADE AUDIOPHILE COMPONENTS
APPLIED AND TESTED PERFORMANCE

ALPS AUDAX FOCAL WIMA SCR RELCAP BHC-
AEROVOX ELNA RUBICON EVOX-RIFA NIPPON-
CHEMICON SICOCEL SANYO PANASONIC ICEL
SIEMENS SVETLANA BARR BROWN (OPA ICS)
HARRIS IR (FAST RECT-MOSFETS) TOSHIBA BC
(HIGH BETA) DALE VITROHM ROEDERSTEIN BI

TOROIDAL transformers wound to our spec using top grade big
cores and copper wire, CE approved, give fast & dynamic sound:
Power (VA): 50-100-200-300-400-500-630-800-1000-1500-2000.
Prices in EURO: 15-20-31-41-65-88-76-118-154-164-224.

ELNA STARGET electrolytics (microfarad/Volt): 2200/16-1000/16-
470/16-470/35-100/35-47/35-22/35-10/35-100/50-22/50-10/50-4,7/50.
Prices in EURO: 6,3-4,4-2,5-4,4-1,9-1,3-0,8-0,7-2,1-1,1-0,7-0,7.

ALPS special order conductive plastic pots, close tolerance 1,6%
gang error, 46Vac, 100mw (blue) and 150 mw (black), specified to
avoid overload from digital sources with 30,000 cycles rotational
life and specially positioned brushes to our spec again. BLUE
VELVET logs: 10K-50K-100K for 21,2 EURO. 10K motorized for
36,4 EURO. BLACK BEAUTY logs: 10K-50K-100K for 36,4 EURO.

GOLD plated TEFLON insulated female chassis mount RCAs are
2 EURO each. GOLD plated serious RCA males are 4,3 EURO
each. SILVER plated isophase ribbon double speaker wire is 3,8
EURO per 1 metre. You won't believe its sound at the price.

SVETLANA 6550C latest model valves are 36 EURO each, 33 for
5 pieces+, 31 for 10 pieces+. — The above are just a sample
of our complete list of thoroughly auditioned and logically priced
components. All prices include 18% taxes. Cheques payable to
"M.WALTHER", MASTERCARD and VISA are accepted. For orders,
complete price list and info about upgrading standard
equipment or building new audio projects please contact us at:

M. WALTHER AUDIO ELECTRONICS, 98 KOLOKOTRONI STREET,
18836, PIRAEUS, GREECE. TEL: +30-1-4134234, +30-1-4133905,
FAX: +30-1-4129842, (prefer) E-MAIL: walther@otenet.gr

50 WATT STUDIO

Loudspeaker Amplifier

Panel. PP50

FEATURES:-

- ★ 50W R.M.S. into 8 ohm
- ★ 775mV I/P for rated O/P
- ★ Toroidal Transformer
- ★ Short Circuit Protection
- ★ D.C. Speaker Protection
- ★ Balanced I/P (readily unbalanced)
- ★ Link through XLR sockets for daisy chaining more than one Speaker
- ★ Indented gain control
- ★ I.E.C. fused mains inlet
- ★ Compatible with HiFi Amps CD Players, Studio Mixers and Computers etc.

The PP50 Studio Loudspeaker Amplifier is designed to meet the exacting demands of the professional market but has the quality of sound reproduction normally associated with Highend Audio. Although having a small footprint, it has a full 50W R.M.S. output that makes a useful addition to an existing loudspeaker cabinet or custom made loudspeaker enclosure. The panel is designed to fit flush through a cutout approximately 170mm x 150mm in the rear of a Loudspeaker cabinet. Individual artwork available for OEM users.

SPECIFICATION: ★Power 50W R.M.S. @ 8 ohms ★B/W 20-25KHz -1dB
★Damping Factor >200 ★Distortion 0.05% ★S/N A Weighted >100dB
★Supply 230V. A.C. 50-60Hz ★Weight 1.4Kg ★Size H205 W165 D85mm

The above item may be ordered by post, fax, e-mail or phone and payment is welcome by cheque or credit card. **PRICE: £59.00 + £5.00 P&P Incl VAT**

B.K.ELECTRONICS
UNIT 1 COMET WAY
SOUTHEND-ON-SEA
ESSEX SS2 6TR

Web: <http://www.bkelec.com>
E-mail: Sales@bkelec.com
TEL: 01702-527572
FAX: 01702-420243

LANGREX SUPPLIES LTD

DISTRIBUTORS OF ELECTRONIC VALVES, TUBES AND SEMI-CONDUCTORS AND I.C.S.

1 MAYO ROAD • CROYDON • SURREY CR0 2QP

24 HOURS EXPRESS MAIL ORDER SERVICE ON STOCK ITEMS

E-MAIL: LANGREX@AOL.COM

PHONE
0181 684 1166

FAX
0181 684 3056

A selection of our stocks of **New Original Valves / Tubes.**
Many other brands available

STANDARD TYPES			SPECIAL QUALITY TYPES			AMERICAN TYPES			OTHER TYPES		
ECC88	BRIMAR	4.50	A2900/CV6091	GEC	17.50	6L6GC	GE	15.00	ECC81	RFT	3.00
ECC88	MULLARD	6.00	E88CC/CV2492	BRIMAR	4.50	6L6WGB	SYL	10.00	ECC82	RFT	3.50
ECH81	MULLARD	3.00	E88CC/CV2492	MULLARD	8.50	12AX7WA	SYLVANIA	6.00	ECC83	RFT	5.00
ECL82	MULLARD	5.00	ECC81/CV4024	MULLARD	6.00	12BY7A	GE	7.00	EF86	USSR	5.00
ECL86	SIEMENS	5.00	ECC81/M8162	MULLARD	7.50	5687WB	ECG	6.00	EL84	USSR	2.25
EL36	MULLARD	5.00	ECC81/6201	MULLARD	8.50	6072A	GE	6.00	EL34G	SOVTEK	6.00
EL84	RCA	5.00	ECC82/CV4003	MULLARD	6.00	6146B	GE	15.00	E34L	TESLA	8.00
EZ81	MULLARD	3.50	ECC82/M8136	MULLARD	7.50	6336A	RCA	35.00	6SL7GT	USA	5.00
EZ80	MULLARD	3.50	ECC83/CV4004	BRIMAR	6.50	6550A	JAN GE	25.00	6SN7GT	USA	5.00
GZ33/37	MULLARD	6.00	ECC83/M8137	MULLAD	15.00	7027A	GE	25.00			
5Z4G	BRIMAR	5.00				7581A	SYL	15.00			
6V6GT	BRIMAR	4.25									
12E1	STC	10.00									
13E1	STC	85.00									
807	HYTRON	7.50									
811A	RCA	25.00									
6080	MULLARD	10.00									

THESE ARE A SELECTION FROM OUR STOCK OF OVER 6000 TYPES. PLEASE CALL OR FAX FOR AN IMMEDIATE QUOTATION ON ANY TYPES NOT LISTED. WE ARE ONE OF THE LARGEST DISTRIBUTORS OF VALVES IN THE UK.

SAME DAY DESPATCH VISA/ACCESS ACCEPTABLE. OBSOLETE TYPES A SPECIALITY.

CREDIT CARD MIN ORDER £10.00.

OPEN TO CALLERS MON.-FRI. 9AM - 4PM. CLOSED SATURDAY

U.K. P&P 1-3 VALVES £2.00, 4-6 VALVES £3.00 ADD 17.5% VAT TO TOTAL INC P+P. O'SEAS P & P PLEASE ENQUIRE



A CLASSY ACT

I am, as most of us who write to you are, an avid reader of your magazine. Being an enthusiastic tweaker, I look forward to your DIY Supplements and letters. I have unfortunately not been able to obtain the Oct 1997 edition of your mag where you describe mods to the DAC-2. I am very interested in this as I have modded my CD players (a Marantz CD-52MkII and an Arcam Alpha) substantially.

Would it be at all possible to provide me with succinct details of the mod? I am more interested in the general details: ie, what is the ratio between the value of the power supply caps and the polypropylene bypass caps? Where specifically did you use the Os-Cons? Does one have to use SG-grade Os-Cons or will any do? Did you replace the output op amps?

By the way, here's one tweak that blew my socks off. It is possible to bias the output op amps into Class A operation by connecting a (say) 4kohm resistor between the output of the op amp and the -15V supply. I found this one on the Net and believe me, it works! The greatest impact in my case was in the midrange, which stood out more from the mix. A friend found that everything appeared more clearly imaged.

Ryan Hill
ryan.hill@hsbcib.com

One of the main mods for any gear is replacing the cheap electrolytics fitted to most components with higher quality alternatives.

CIRCUIT SORTING

I have read your magazine for many years with great pleasure, especially the Supplement. Your article describing KEL34 appeared at the same time as I was putting together a push-pull valve amplifier myself. I find design goals and considerations interesting as it is essential to consider the circuit as a whole, avoiding the eternal discussions as to which valves, transformers, etc are the best.

In my studies I ran across an article by Jean Hiraga on the design of the Lectron JH50 from 1988. This amplifier is very similar in circuit design to the KEL34 (and

However, the more caps I try out, the less I like electrolytics.

The idea of an amplifier (as an example) virtually free of electrolytics has been put into practice already by designers like Rob Watts and Tom Evans to name but two. The only area where electrolytics are pretty much unavoidable is in the main PSU, where values between 1000uF and 6800uF are almost impossible to obtain economically (in terms of money and space) in any other form of cap.

The problem with about 95% of electrolytics is that, compared to a good (and I do mean good, as there are some stinkers out there) tantalum or multi-layer ceramic, for instance, they have a horribly thick, sludgy, lifeless sound that squashes all the pace and power out of music. Os-Cons are far better than most, but wherever I've soldered them in, they've always robbed the music of its musicality, regardless of how long they've been burning in (about 400 hours and counting in one case).

Farnell (tel: 0113 363 6311, 24hours a day) do some very nice multi-layer ceramics (part number 578-400 is 10uF at 25V and costs about £6 a hit - not cheap but worth it!) and I've had excellent results from tubular, metal-cased tantalums. Because these caps have superior characteristics at high frequencies they work extremely well in digital gear (like Pioneer's DV-505

Mullard 5-20). The driver is a 6SJ7 while a 6SN7 provides the differential phase splitter. There are no screen taps on the output transformer either.

The design goal in the Lectron was to let even-order harmonics dominate in the basic design since they are cancelled out by push-pull whereas odd-order harmonics are not. This article and other experiences raise some questions and ideas concerning KEL34:

1) The combination of auto-biasing with fixed bias is not recommended. In terms of distortion I thought that fixed bias produced more third-order than auto-biasing.



One component that responds well to modification is DPA's 50S pre-amp.

DVD player), although analogue benefits considerably too (in my case a DPA 50S. In Michell's case, it's the HR series pre-amplification).

As to where to use these goodies, it's rarely wise to use a single brand of part throughout a component - mixing and matching is better. In my experience, the tantalums can be a bit dry across the midrange and treble while the multi-layers are sweeter and more natural in that area.

From what I've heard, there's a bit of a following for re-biasing output stages. I haven't tried it myself but I hope to soon. JM

2) I can't see how C17 in this feedback arrangement is an improvement over a high value of C17 in the regular circuit. A large C17 is always preferable since it has a lower ESR. Maybe the arrangement with the cathode over the output is what creates the extra tautness of the bass.

Whether to use a triode or a pentode as a driver has been hotly debated. Hiraga claims that a pentode improves the definition of the sound. Single-ended triode amplifiers are claimed to produce lower distortion when properly matched with a suitable pentode. At low anode voltages, a larger screen voltage than

anode voltage can be used, which can result in lower distortion of predominantly second order. This is due to an enlargement of the anode characteristics. I myself use a 6SL7GT SRPP connected.

3) Using 12AU7, 6SN7GT or other low- μ triodes results in a low output impedance to drive the output tubes. However, this usually leads to different values of Ra (anode resistance), as in KEL34. This in turn leads to different phase shifts on each anode in combination with Ca (anode capacitance). Normally, this requires some sort of compensation, if the amplifier uses overall feedback. Does KEL34 not need this compensation?

4) The description of KEL34 does not specify the primary impedance of the transformer. An oft-quoted value is 5kohms. However, this seems to generate more odd-order distortion than a lower value like 3kohms, where even-order harmonics dominate.

5) You have chosen to use a fairly low value of screen voltage in order to ensure safe operation of the output valves. The arrangement of the supply provides additional stabilization. However, an increase in the screen voltage would again enhance the characteristics of the output valves. This improves linearity and favours even harmonics over odd ones. Hiraga chooses $V_{g2}=410V$ at $V_a=435V$.

My design goals are to obtain the midrange of an SE amplifier combined with the force of a push-pull.

As I mentioned above, my driver is a 6SL7GT in Shunt-Regulated Push-Pull mode. A 6SN7GTA is the phase-splitter. The output consists of KT66 (Golden Dragon Teonex brand) with surplus Quad II transformers. I use no, or extremely little, overall feedback taken from the output winding rather than the 'speaker. This requires that the 'speakers are an easy load - I use Castle Avons.

The transformers have cathode feedback. This seems to linearize the already very linear KT66. Careful design of the phase splitters is needed to ensure a high enough output swing, since the gain in the output valves is lower than normal in this configuration. In this topology, the sound seems to be strongly influenced by the driver, which is single-ended. I changed from JAN Philips to GE, which

gave a highly-defined and vibrant sound. The bass depth also improved vastly, going almost an octave deeper. It might be worthwhile to try another brand of 6AU6 in KEL34. Since you use PCBs, your noval tubes can't be exchanged for their octal counterparts, which is a pity.

To summarize, I think that I very closely achieved what I was aiming for. As comparison I rely on a 300B SE amplifier and a couple of other SE amps.

David Rapp

David.C.Rapp@telia.se

Your query is very involved so I will try to answer your questions one by one. In general, however, I would like to emphasize a point which seems to be totally missed by a lot of people, including engineers: even harmonics are generated by asymmetries about the x axis (zero-crossing axis). This means that the positive half of the wave has a different amplitude to the negative half due to gain modulation. A perfectly-balanced push-pull amplifier generates ZERO even-order harmonics. If there were any present, it would not be perfectly balanced. It doesn't matter whether it's valve or transistor; if there are even-order components, there is asymmetry about the x axis. Also, if there is an unbalanced (for example, single-ended) stage before the push-pull stage, the push-pull part does not cancel the even harmonics generated there.

1) As with everything, there are advantages and disadvantages with auto and fixed bias schemes. With fixed bias, the instant benefit is that there is no need for set-up - the inherent DC feedback mechanism keeps the idle current about right. The disadvantage is that the even-order distortion produced by the valve (which becomes extreme when the valve is being cut off for part of a cycle in Class B and AB) results in the DC bias being modulated.

The distorted signal current causes the voltage across the cathode resistor to rise and the valve comes out of Class A or goes further

into Class B, giving rise to far greater crossover distortion - your bias point varies with the music. On top of that, the two cathode bypass caps form a resonant circuit with the output transformer, which can destabilise the amplifier at LF and, in general, produce a much more sloppy bass than fixed bias.

With fixed bias the above disadvantages are avoided. For a given set of operating conditions (HT voltage, anode dissipation, etc), you will get more power and lower distortion. The disadvantage with fixed bias is that, when the amplifier is driven into clipping, the grid of the output valve rectifies the drive signal, thereby producing a negative voltage at the grid. This rapidly cuts the valve off, causing a lot of distortion. Worse, the distortion continues for some time after the overloaded condition has passed, the grid resistor and coupling cap forming a time constant which must discharge before everything returns to normal. The same thing happens with auto bias but the feedback mechanism of the cathode resistor combats it to a certain degree.

If simple RC coupling is used, auto bias produces a softer, less drastic clip. If the fixed-bias valves are driven with a DC-coupled driver such as a cathode-follower or a transformer, the rectification does not take place and everything's hunky-dory again. The mixed bias scheme shares the greater power/lower distortion of fixed bias (due to the smaller cathode resistor) and a large portion of auto-bias's softer clipping.

2) All of the LF time constants in a feedback amplifier contribute, more or less, to the LF stability of an amp. I have heard and measured so many amplifiers which are only marginally stable at very low frequencies. This shows itself most readily as the usual 'valve bass', which is bloated and has poor timing. Another sign is, when playing percussive music on reflex 'speakers, the cones flap on snare drums. This

can be measured on a storage oscilloscope, too; if a large-amplitude 10kHz toneburst is applied, a decaying LF waveform is displayed after the burst has stopped.

Dogma has it that the ear is not sensitive at low frequencies, but that's just not true - phase and, more importantly, time effects are very audible. If the amplifier has a garbled phase and transient response at 'sub-sonic' frequencies, then the bass quality will suffer. This problem can even spread up into the low midrange.

Quite a few people claim that, if you roll off the bass higher up, it 'speeds up'. This is actually caused by the first-order dominant phase shift of the much higher roll-off. Transistor amplifiers generally have very dry, controlled bass not because of their damping factor, or their current delivery, but due to their low, first-order, LF phase shift. In KEL34, the LF stability, transient response and phase response is tidied up by the input-valve cathode cap - its effect is to increase feedback with lowering frequency. If you've built your own amplifier, why not try it to see how it sounds?

3) There are many debates amongst amp builders: the pentode driver versus the triode driver, second-harmonic versus third-harmonic distortion - on and on it goes.

Pentodes can be set up to produce very little distortion at all. Using a higher screen voltage generally opens up the characteristic, as you say, but it also moves the characteristic's 'knee' further up in voltage and makes it more rounded, which can result in higher, not lower, odd-order products. If you check the curves, you will see that, at a given anode current and voltage, varying the screen voltage does not have much of an impact apart from requiring a larger negative grid bias to get that current.

SRPP can be good - the feedback in the partial cathode-follower in the top portion gives a low output impedance at small signals, plus

KEL 34 CIRCUIT DIAGRAM

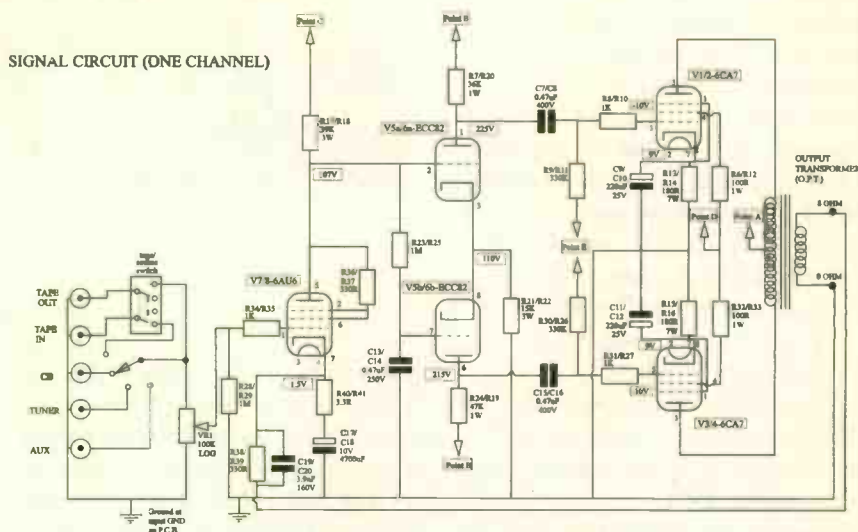

KEL34's mixed bias seeks to offer the best of both worlds.

there is some cancellation of even harmonics. The lowered output impedance can help with HF stability, moving the phase shift to a higher frequency, but it can, for the same reason, make the amp unstable.

A word of advice on this topic. SRPP stages can become very microphonic and noisy due to the heater cathode insulation of the upper valve degrading. For some reason the ECC82 always goes this way whereas the ECC83 and 6SL7 seem to be OK.

With the cathode-coupled phase splitter à la Mullard 5-20, the output impedance is very much higher than you might first assume. This is due to the influence of the cathodes of the valves on each other, the very mechanism on which the circuit relies for operation.

Each valve has the quite high impedance of its partner in its cathode, causing current feedback, which raises the output impedance many times. Even output pentodes have a highly capacitive input impedance, which naturally puts another phase shift into the stability equation. The differing output impedances show themselves as an increase in even-order distortion at high frequencies over and above that caused by the reducing feedback.

4) The optimum output transformer impedance depends on the valve operating conditions. So often I have heard it said, "A 300B requires a 2K5 transformer" or "EL34s require an XYZ impedance". I think this comes from merely looking at the example operating conditions given in the manufacturer's short-form data or 'at a glance' selection book and taking it as gospel.

Regarding the odd-order versus even-order trade-off; if the valves are driven with a well-balanced signal, the majority of the even-order products created by the output valves will disappear. Most of the distortion measured in valve amps of this sort is created by the input and driver stages (I have built amps with 0.1% THD with only 15dB of feedback. This was achieved with a special drive circuit, which maintains extremely good balance and low distortion).

With a lower anode impedance there is a greater current swing, resulting in greater even-order distortion. With a pentode, you start to approach the characteristic knee, which increases odd-order distortion as well. Even-order may dominate but, if impedance A produces 5% second and 1% third harmonic distortion while condition B had

15% and 2% respectively, which is better? The primary impedance of KEL34's output transformer is 8kohms, by the way.

5) To increase the screen-grid voltage of the EL34s a bit (maybe going to 350V) would be an improvement, but that would have required another supply, increasing cost without a commensurate increase in performance. Connecting EL34 screens to 500V is not recommended due to reliability problems.

The Quad II transformer has 10% cathode taps, which not only add cathode-injected feedback but also modulate the screen voltage to give some ultra-linear operation as well, a very elegant solution. Tango Transformers in Japan produce some transformers with similar taps. The ultimate is perhaps a transformer manufactured by Pearl in the US. The problem, as you say, is that the swing required to drive the output valve is increased. This usually results in the driver stage's distortion being higher than the output valves', and rather more complex circuitry is required.

The Quad II was spec'd at 0.1% distortion at 15W, but they actually come out at more like 0.05% when

POWER SUPPLY UNIT

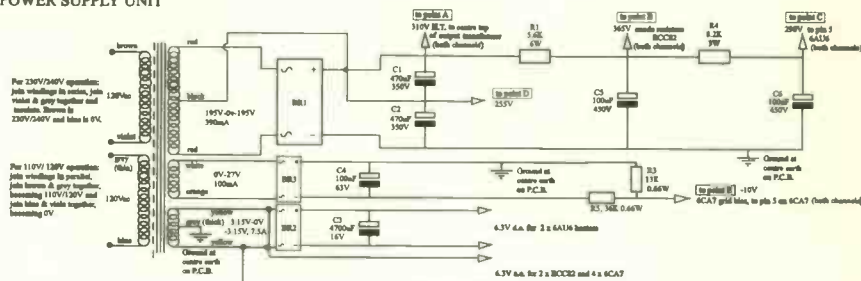

KEL34's power supply with bias voltages.

properly tuned and there's only one amplification stage in there - two pentodes! Taking the feedback from a tertiary winding is a nice idea too as it isolates the feedback from the loudspeaker load to a greater or lesser degree. There needs to be good coupling from the tertiary to the primary and from the primary to the load for it to work without causing an HF roll-off, though.

Owners of the KEL34 can try replacing the valves in their amps with ones from different manufacturers. The 6AU6 is a very common and cheap valve because usually everybody goes for the regular 'audio' types (ECC82, ECC83, 6SN7 and 6SL7), in the process inflating the price of NOS units.

If the KT66s you are using are

the little ones with a straight-sided bottle, bin them. I built a guitar amp which used original KT66s (at the time they weren't that valuable). I tried some of those little Teonex suckers in there and the anodes glowed red!

As alternatives you could try the new Golden Dragon KT66R, which is quite expensive and, since it's new, it may show up problems down the line. Then again, there are the US 7581s, which offer really superb quality for not much money. Even the common-or-garden, US-manufactured 6L6GC (and it must be the 'GC' suffix) would be a good choice if you want NOS valves. For the 6SN7, you could try the STC ones, or a Sylvania "Red Base". Gary Devon

RIGHTING RECTIFIERS

Can you please advise me on how I might incorporate a valve rectifier (EZ80 or EZ81) into your KLP1 pre-amplifier. I suspect it's only a matter of higher voltage secondary transformer windings and additional resistor/s, but I am unsure as to how to calculate all of this.

Chris Seymour
Melbourne, Australia.

The EZ80 and EZ81 are very good valves but are seriously overrated for use in the KLP1. The best bet would be a 6X4, which should fit in the box if you make a bracket for it. You would have to get another mains transformer wound with a centre-tapped HT secondary. If you don't know a friendly transformer

manufacturer, this could be your greatest hurdle.

Valve rectifiers don't like to be connected to too great a reservoir capacitor, but as the current drawn by KLP1 is so small you could use 100µF without running into problems. Valve rectifiers give a far more relaxed presentation when compared to solid-state diodes. However, there are some better sounding diodes on the market than the regular ones used in KLP1. You might like to try some of those first.

One I often use is the BV96E. All you would have to do is directly replace the ones you have now. Have you already upgraded the component quality? You could try changing to a better grade of electrolytic capacitor such as Black



Altering equipment to run from a valve rather than solid-state rectifier is not the simplest of jobs.

Gates and some audio-grade coupling capacitors like Solens. Different brands of valves are worth investigating as well - the Sovtek is good, but you could try a Telefunken if you've got the cash! GD



WELCOME TO OUR MARKET PLACE



Here you will find a variety of stalls offering you a wide range of products.

Look out for our regulars, some of which have sales in this issue with some real bargains.

So if your looking for a great deal this summer then look no further.

HAPPY HUNTING!!!



THE EMPORIUM

28 St Nicholas Street, Diss, Norfolk
IP22 3LB Tel/Fax: 01379 650744
emporium@dircon.co.uk

CD & DAC

	Cost	Price		
ALTIS CD transport + DAC NEW	5500	1750	TANBERG TCD	330 100
AUDIO NOTE DAC 1 signature		600	REVOX A77 just serviced 2 available	250
DPA little bit DAC		125	NAKAMICHI DRAGON	900
DPA 1024 three box top fitted dac	6000	2000		
PINK TRIANGLE ORDINAL DAC	500		SOLID STATE AMPS	
PS AUDIO LAMBDA CD Transport	2700	1000	ALBARRY DMP1 pre with M408 monoblocks	650
ROKSAN CASPIAN 3 months old	900	630	ALCHEMIST FREYVODIN pre/power original	
SUGDEN audition cd ex dem	650	490	budget high end designs	1100 1000
ARCAM 8se cd player	600	425	CHORD SPM 800B power amp	2200 1500
HELIOS stargate ex dem	2500	1875	COPLAND CSA 28 integrated amp	1300 900
MUSICAL FIDELITY x-24 dac		240	CYRUS straight line	400 275
PRIMARE D20 cd player ex dem	700	525	DENSEN DM 10 INTEGRATED	1250 875
MERIDIAN 203 DAC	500	150	HIFI NEWS headcase headphone amp	40
MERIDIAN 207 with phono board & remote			LAVERDIN IT	1700 2500
boxed	500		LFD PA1 power amp	900 450
MICROMEGA DUO B5	650	200	LINN INTEK	200
MARANTZ CD94 mill	850	375	McINTOSH C28 PRE / MC2105 power amp	
TEAC P500/T500 transport & dac	1200		Enormous beauties with wooden sleeves and they	
550			light up in blue!	900
			McINTOSH MC250 classic early transistor power	
			amp with output transformers	400
			MOTH 60 watt stereo power amp	
			with PSU	600 350

VALVE AMPS

AUDIO RESEARCH ip6		750	NAIM AUDIO ECLAT PSU	200
AUDIO NOTE M2 RIA phono stage			NVA 50 watt stereo power amp old style	200
NEW	1050	750	NVA P50 pre with mc input and two FSU	
AUDIO NOTE MEISHU phono			old style	250
NEW	3250	2400	PS AUDIO PLUS C power amps pair bridgeable for	
AUDIO NOTE CONQUEST MONOBLOCKS			150 watts per channel pair	500
NEW	4500	3250	QUAD 33FM2/303	250
ART AUDIO CONCERTO			QUAD 66 PRE 66FM remote & 306	1900 1000
monoblocks	2000	1200	SUGDEN OPTIMA 200 line integrated	450
BEARD BBA100 line integrated	1500	600	DENSEN best b-200/b-300 pre/power ex	
BEARD P500A valve pre with phono		400	dem	2000 1500
COUNTERPOINT SAI11 enormous line level			ELECTROCOMPANET pre/power class a	
valve pre his 7 valves!	9000	2500	500	
GAMMA SPACE REFERENCE 300B single ended			DENSEN d20/d30 pre/power ex dem	500 1850
line integrated	4000	1500	SUGDEN audition T remote integrated	700 525
HEATHKIT MA 12 valve monoblocks 12 watts per		250	OEM1500 250watts per channel massive	
MORE FIDELITY German 300B amp 2000		900	heatinks, stereophile class b recommendation	2500
ORANGE pre mm/line very smooth sound		300	1200	
concordant exhilarant line pre		500	MARANTZ mu24 class a monoblocks mint	
LUMLEY M75 MONOBLOCKS big black and			boxed	2700 1500
beautiful pair	1200		EXPOSURE vii pre with custom built pi u	
UDION silver night	2200	1350	250	
VTL 50 watt monoblocks			SUGDEN p28 power amp	
700			250	

LOUDSPEAKERS

ALIANTE MOD SPAZIO		300	MUSICAL FIDELITY the preamp/ptphono	
AUDIO TECHNICA ATH9000 electrostat			power amp	300
headphones	200	100	REGA masscursa pre power ex dem	675
CADENCE E5 hybrid electrostatic	3500	1500	HITACHI hma 7500 100 watt mosfet	
CADENCE arca amazing looks and sound			power amp	175
	10000	3000	ARCAM1 alpha 9 integrated amp	600 400
CASTLE SEVERN MK1		325	PRIMARE a20 integrated ex dem	700 525
DYNAUDIO AUDIENCE 5		200	AUDIOLAB 8000A	500 275
EPOS ES 111 biwire		350	MUSICAL FIDELITY x-a100R ex dem	1000 750
JR 149 round version of ls3/5a		175	MUSICAL FIDELITY x-p100x-as100	
ROGERS STUDIO 1		275	pre/power	1600 1200
ROYD MINSTREL pair		120	MICHEL ALECTO MONOBLOCKS latest	
RUARK SABRE		200	version	2100 1400
RUARK EQUINOX	2250	1000	QUAD 34 brown	150
SENNHEISER 580 JUBILEE HEADPHONES				
250	150		TURNABLES/ARMS/CARTRIDGES	
SONUS FABER MINIMA FM2			CLEARAUDIO with parallel arm and BETA car-	
600			tridge	1400
SPENDOR S100	1650	600	GARRARD 401 in slate plinth	300
TANNOY little gold monitor		700	LINN LP12 EARLY MODEL no arm	250
AUDIO physic tempos with essex			LINN LP12 with avondale psu	350
equalizer	4000	1750	LINN LINGO	700 350
DYNAUDIO contour 1.1 cherry ex dem	878	650	MICHEL FOCUS no arm crack in lid	90
DYNAUDIO contour 1.3 cherry ex dem	1198		ORTOFON MC3000 light use since	
900			rebuilt	1000 350
DALI grand coupe jr, vintage stand mounter ex			ROKSAN XERXES with XPS II	
dem	2500	1750	(SME cutout)	895 400
ORIGIN LIVE resolution with dedicated stands			SLATE AUDIO PLINTH FOR	
	1250	650	THORENSTD	124 300
ORIGIN LIVE sovereign floorstanders ex dem			GOLDRING ELITE MC boxed	100
	1200	800	SUMIKO blue point special unused boxed	200
SPENDOR sp1, bi wire	1000	500	SYSTEMDECK IIX/900	225
MONITOR AUDIO 1200 gold	800	400	VPI TMT MK III with base and jmw memorial arm	
REGA ELA8 ex dem		375	cost 7000 mint and boxed for only	3500
SONUS FABER MINNETTOS	800	450	THORENSTD 124 MKII excellent	225
SONUS FABER SIGNUM	1250	1000	WELL TEMPERED ARM	1500 500
PROAC TABLETTE 50 SE in ebony with target R1			SME 312(6 months old)	7000
stands mint	1168	800	1200	
he-brook quartets	550	300	THORENSTD 124 ml2 in green marble plinth	
tannoy chatsworths 12" gold			with silver wired	
500			technics sp10 ex bbc with dedicated rad mount	
TANNOY WESTMINSTERTWW latest			psu	300
spec 1 year old	4500			

CASSETTE DECKS & TUNERS

DYNACO FM3 valve stereo FM Tuner	120		JORDAN WATTS 4" Full range speaker modules	
LEAK STEREO FETIC FM Tuner	40		par	75
MERIDIAN 104 FM tuner	120		LEAK TL12+ pair	350
QUAD FM 2 stereo valve tuner	100		LOWTHER PM4A with new silver vice	
QUAD FM 66	400		coil pair	800
REVOX B77 high speed one owner from new	600		DECCA left ribbon tweeters	Pair 150
with service history	100		SHACKMAN electrostatic tweeters	Pair 150
NAKAMICHI 600				
			CLASSICAL LPS	
			ask for our latest list	

ANNOUNCEMENT

Available soon

The UK's first totally
dedicated classified
'in-house'
Hi-Fi Journal

'The Audio Trading Mart'

Whether buying, selling
or exchanging we will
offer you a better way

For advanced
information please
write or call us
now on

(01733) 555621

FAX (01733) 358141

TRADING STATION

The Hi-Fi Company

35-42 COWGATE PETERBOROUGH PE1 1Z

THE FINEST SELECTION OF PREVIOUSLY OWNED HI-FI IN THE COUNTRY - AND ALL GUARANTEED!

TURNTABLES / ARMS

AR Legend No arm	£148
MRM Source (Linn cut) +PSU	£450
Garrard 401 + SME 3009 + V15 (3 speed)	£228
Fons CQ30 + SME 3009 (3 speed)	£135
Garrard 401 (chassis only)	£165
Garrard 301 (chassis only)	£220
Revolver BX-Helius	£320
Rega Planar 2	£175
Pink Triangle LPT + Roksan Tabriz + High Spec PSU	£1095
Thorens TD126 Mk III (3 speed)	£230
Goldring Lenco 85 - white	£75
Goldring/Leak GL75	£70
Ortofon T30 Transformer	£150
Linn LP12 + Grace + AT (MM)	£425
Linn LP12 (Ex dem)	£1750 £993
Linn LP12 (black) + Ekos - Valhalla	£2600 £1198
Linn LP12 + Lingo + Ittok LVII + K9	£2300 £1150
Linn LP12 + Basic Plus	£1600 £595
Linn LP12 + Ittok LVII + ATOC9	£2500 £795
Linn LP12 + Ittok LVII + Sumiko Blue Point Special	£2250 £950
Luxman PD300 + SME III (Vacuum platter) Belt Drive - Accepts 2 arms - 33/45/78	£1468
Lyra Parnasus	£878
Michell Focus One/Hadcock 228/Dynavecator 20a	£220
Nottingham Analogue Hyperspace with mentor arm	£2300 £1298
Oracle Delphi II/Linn Ittok LVII	£1395
Oracle Alexandra MKIII (cut for SME)	£748
Ortofon T-300 Transformer	£900 £495
Pink Triangle PT2 Teak (SME cut)	£348
Revolver / Helius Scorpio / P77	£249
Roksan Xerxes + Artemiz + AT OC5	£1700 £758
Roksan Xerxes + Air Tangent 1B	£3500 £1995

AMPLIFIERS - SOLID STATE

Technics SL150 + SME3009 + Shure V151	£228
Adcom GTP500Mk2 + GFA545Mk2 Pre/Pwr	£695
Arcam Zeta 1 (Ex-dem)	£999 £597
Arcam Alpha 9 Power	£400 £295
Arcam delta 110 Pre	£700 £195
Audiogram MB1 (Integrated) Ex-dem	£495 £359
Audiogram MB2 (Integrated) ex-dem	£599 £429
Audiolab 8000A	£500 £365
Audiolab 8000 LX	£470 £378
Metaaxs Charisma Pre	£1800 £895
Audio Synthesis Passion (passive pre)	£POA
Cyrus Pre-amp	£600 £425
Cyrus III (Integrated)	£500 £375
Rotel RC850 (pre)	£95
Rotel RC970BX (pre)	£110
Lesson AC1 (pre)	£85
Sumo Athena III (balanced pre)	£POA
Sumo Andromeda III (balanced pre)	£POA
Sumo Polaris III power amp	£950 £695
Chameleon 900S 2 x 300w pwr	£1000 £495
Copland CTA301 Pre (Ex-dem)	£1249 £849
Copland CTA401 Integrated (Ex-dem)	£1698 £1069
Copland CTA501 Power (Ex-dem)	£1420 £999
Copland CTA504 Power (Ex-dem)	£1999 £1389
Cyrus Straight Line (Integrated)	£398 £298
DPA DSP200 Line Pre (Ex Dem)	£499 £397
DPA Renaissance (Ex-dem)	£595 £447
Dynaco ST120 (Classic circa '76)	£278
Pioneer A300 (Integrated)	£120
Pioneer A400X (Integrated)	£150
Exposure X (Int)	£195
Exposure XXI RC (Pre)	£999 £625
FM Acoustics A800 (2,500 watt)	£12,000 £4298
Goldmund 6B (Ex-dem)	£3124 £1799
Harmon Kardon AVP1a Processor	£2000 £495
Cyrus PSX-R (PSU)	£800 £525
Sony F440E (Integrated)	£120
Cambridge Audio C75 Pre	£780
Heybrook Signature pre/power + PSU	£998
Meridian 605 mono amps 150 wpc - bal	£2000 £1345
Quad 306 power amp	£220
Leak Delta 30	£75
LF LSB + PA2 (Pre/Pwr)	£3800 £1498

JUST IN

Linn Kairn Phono Pre	£1198
Cyrus 2 (Integrated)	£150
Linsley Hood '75' (integrated) needs attention	£85
Linn LK1 Pre	£250
Marantz SC22 (pre) + 4 MA22 (mono's)	£2800 £1795
Meridian 201 Pre	£760 £395
Meridian 501 Pre (ex-dem)	£740 £597
Michell Argo + Hera	£900 £595
Michell Engineering Alecto (mono power amp)	£2000 £1295
Musical Fidelity Elektra E100 (Int)	£750 £475
Musical Fidelity Elektra £20+E30	£900 £550
Musical Fidelity A100 (integrated)	£225
Musical Fidelity 3a Pre	£379 £248
Musical Fidelity 2a Pre	£299 £178
Myryad MP100 Power (EX-dem)	£599 £443
NAD 2700 HX Power 140WPC	£449 £295
Naim NAC12	£165
Naim NAC32.5	£195
Naim NAC42.5	£220
Naim NAC62	£150
Naim NAC22	£145
Naim NAC42	£195
Naim NAC92	£POA
Naim NAP90 (new Style)	£460 £370
Naim NAP110	£200
Naim NAP140 (Old Style)	£750 £450
Naim NAIT 2	£298
Nakamichi 1 A-3 (Int)	£150
Nakamichi 603 Pwr	£290
NVA P50 (Passive Pre)	£250 £150
NVA A70 (Mono's)	£448



NVA

EX-FACTORY SPECIAL PURCHASE

TDS Second State Mono Power amps - pair	£6400 £3200
Probably the most beautiful solid state amplifiers we have ever seen!	
TSS Second State Stereo Pwr	£3700 £1800
TSS Second State Stereo Pre amp	£1000 £500
TSS Integrated State Int-amp	£1500 £800
EMOTIVE STATEMENT integrated CD player	
NVA A60 Power - As New - old style case	£495 £325
NVA AP20 Power - As New	£210 £150
NVA old style AP30 integrated - chrome - new	£460 £275
NVA P90 pre-amplifier	£460 £275
NVA AP50 integrated amp - New - old style case	£610 £360
NVA AP40-P50 Pre-power s/h	£449 £150
NVA A80 Mono amps (new) 1 pair	£1460 £950

EX-FACTORY STOCK DUE TO DOWNTURN IN FAR-EAST EXPORT MARKETS - SO STRICTLY LIMITED AVAILABILITY

Onex A30 Series 2 mm Integrated	£170
Pink Triangle PIP Pre (3 box)	£2400 £1398
Pioneer C-90 Pre	£295
PS Audio PS IV (Pre)	£298
PS Audio 6.1 Pre (Ex-dem)	£799 £499
PS Audio 6.2 Pre (Ex-dem)	£899 £599
PS Audio 4.6 Pre (Ex-dem)	£998 £649
PS Audio 5.6 Pre (Ex-dem)	£998 £649
PS Audio Delta Power (Ex-dem)	£1499 £999
QED A270 Integrated	£225
Leak variscope pre-amp (cracked perspex)	£60
Quad 33/303 Pre/Power	£POA
Quad 405 Power-amp	£195
Quad 33 Pre	£65
Quad 34 (Grey & Beige)	£220
Quad 44 Pre (Beige)	£265
Rappaport Pre 1 (pre)	£275
Rappaport Amp 1 (Pwr)	£550
Musical Fidelity P173 pre + PSU	£800 £425
Naim Nait 3 amp	£580 £415

Roksan L1 Pre + PSU	£1100 £758
Rotel RC972 Pre	£225 £173
Rotel RB971 Power	£225 £173
Rotel RB981 Power	£325 £273
Sonograph SC1 Pre	£1250 £450
Sugden Optima 10 (2X70w Intgd)	£770 £448
Thorens TTP2000 Mk1 Pre (Ex Dem)	£499 £397
Thorens TTA2000 Pwr (Ex Dem)	£599 £497
Primare series 928 - pre	£4700 £1900

AMPLIFIERS - VALVE

Thule PR200 (pre) + 2 x PA200 (power)	£2700 £1398
Arion Tycho Power + Passive Pre	£1895 £1095
Audio Innovations Classic Stereo 25 int	£538
Audio Innovations Second Audio Monos	£3299 £1500
Audio Innovations Series 800 10th Anniversary Edition	£898
Audio Note P3 (300B Power)	£1298
Audio Note Meishu	£2750 £1500
Audio Research V140 (Mono-blocks)	£9000 £3998
Audio Research D200 Power (Ex dem) Solid State	£3248 £1997
Audio Research D250 power	£7000 £2498
Unison Research Simply 4P Int	£1595 £1095
Beard BB100 integrated amp	£695
EAR 859 integrated amp	£1295
Audion Sterling Integrated	£595 £398
Avantic SPA II Vintage Valves	£168
Beard P505 MkII (pre amp)	£495
Croft Series 5 (Power)	£495
Conrad Johnson PVII	£2000 £1398
EAR 549 (mono block power amps)	£6220 £3998
Grant G100AS (Pwr) + G100PB (Pre)	£2000 £650
Jadis DA30 DeLuxe Int (Black) Ex dem	£3490 £2699
Jadis DA60 Int (Black) Ex-dem	£4483 £3759
Jadis JJP200VT Pre Ex-dem	£4778 £3759
Luxman LX33 (Integrated)	£698
Luxman CL32 (Pre) + 3600 (Pwr) 50+50 watts	£1498
Muse Model 300 (Mono powers)	£4400 £2898
Papworth Audio M100 monoblocks	£3600 £2600
Tube Technology Prophet/Genesis	£4800 £2398

WE'LL SELL ON COMMISSION

So that you get the Best Price without any of the hassle!

TAPES AND TUNERS

A & R Cambridge Alpha Tuner	£75
Arcam Alpha Tuner	£75
Avantic BM611 Valve Tuner Circa 1960 (no dec)	£148
Leak Delta FM Tuner	£65
Leak Delta AM/FM Tuner	£75
Magnum Dynalab FT11	£550 £328
Myryad T/40 (ex demo)	£399 £294
Nakamichi 630 Tuner/Pre-amp	£500 £295
Pioneer RTU11 1/4 & 1/2 track 10" R to R	£595
Quad FM3	Choice from £95
Revox A77 1/2 track	£POA
Revox B77 Mk's 1 & 2 (Call for details)	£POA
Sony TCK 611S	£330 £218
Tandberg 3034 (silver)	£278
Technics RS-BX404 (cassette)	£90
Theta Lynx Tuner	£500 £324
Yamaha 800 AM/FM Tuner	£175

URGENTLY REQUIRED
ALL TYPES OF QUALITY HI-FI
WE BUY OR PARTEXCHANGE

After twentyfive years, and with three specialist stores, we know that thousands of satisfied customers prefer to shop this way!

CD PLAYERS - DACS

Accuphase DP75 CD Player	£5995	£3998
Accuphase DP65 CD Player	£4700	£2998
Alchemist Nexus APD32A Cd Player	£600	£425
Arcam Delta Black Box (DAC)		£148
Arcam Delta Black Box 5 (DAC)		£248
Arcam Delta 170 (Trans)		£198
Audiolab 8000DAC	£1000	£300
Audio Alchemy Drive 3	£695	£498
Audio Alchemy DACMAN (Ex dem)	£149	£117
Audio Alchemy DAC-IN-BOX (EX dem)	£229	£177
Audio Alchemy V1 DAC		£238
Audio Research DAC1 20 bit (Ex-dem)	£3740	£2199
Audio Research DAC3 Mk2 (As new!)	£3999	£3269
Audio Research DAC5 (ex-dem)	£2335	£1999
AVI S2000 DAC		£225
California Audiolabs Delta DAC (Ex-dem)	£1100	£859
California Audiolabs Sigma 2 DAC (EX-d)	£995	£789
California Audiolabs Alpha CD Trans	£1800	£1359
California Audiolabs Aria 3 CD Player XDE	£2489	£1599
California Audiolabs Icon 2 CD Player X	£1197	£899
DPA Little Bit 2 (DAC)	£250	£148
Denon DCD1560		£195
Denon DCD1650 (CD Player)	£600	£295
Denon DCD1500 Mk 2 CD Player	£500	£195
Jadis JD2 CD Trans (Ex-dem)	£4490	£3299
Kinergetics KCD30 CD Player (EX-dem)	£1900	£1059
Linn Mimik CD Player	£875	£555
Marantz CD50		£125
Marantz CD63 MkII Ki Signature	£400	£295
Marantz CD80		£230
Marantz CD17		£538
Marantz CD95 Transport	£1500	£845
Mark Levinson No.39	£5000	£3998
Meridian 200	£818	£425
Meridian 203 DAC	£560	£295
Meridian 206	£995	£495
Meridian 263DAC	£650	£395
Meridian 500 Transport (Old Style)	£1025	£793
Meridian 506 CD Player	£1100	£650
Meridian 508 20 Bit (Ex-dem)	£1650	£1293
Meridian 206 Delta Sigma CD		£595
Meridian 563 DAC	£865	£468
Meridian 606 DAC	£1500	£795
Meridian 207 CD Player-pre	£1400	£495
MicroSeiki CD-M2	£2800	£1445
Micromega Microdrive (transport)	£800	£398
Micromega Microdac (Dac)	£350	£225
Micromega Stage 2 CD player		£395
Mission PCM II CD		£150
Monarch DIP Jitter Buster	£345	£188
Musical Fidelity Digilog DAC		£98
Nakamichi OMS-7EII		£1100
Nakamichi DR3 cassette		£348
Naim CD1 CD player	£2000	£1298
Pioneer PD703	£300	£175
Pink Triangle Da Capo	£1500	£975
Pink Triangle Digital Package - Cardinal transport de Capo DAC + battery psu	£4500	£call
PS Audio Digital Link 2 DAC (Ex-dem)	£599	£399

CALL THE 'FI' FINDERS

Can't find what you want?
Rare, Classic, Special...even New!
Whatever you want, we'll find it
for you...and at the best price!

PS Audio DC 3 DAC (Ex-dem)	£777	£499
PS Audio SL 3 DAC (Ex-dem)	£1449	£899
PS Audio Reference Link PRF/DAC Balanced (Ex-dem)	£4500	£2899
PS Audio Lambada CD Trans (ex-dem)	£2250	£1439
QED Digit Reference	£450	£284
Quad 66 CD Player		£440
Rega EXS (Ex-dem)	£599	£444
Roksan DAC1		£250
Sony DVD 715 inc.5 titles AS NEW	£700	£485
Sony CDP970		£198
Sugden SDA-1	£800	£528
Yamaha CDX-390A CD Player		£85
Technics RS-TR232 cassette		£90
Technics SL-PG 200A		£100
Theta TLC	£230	£178
Theta Data Basic - Transport	£2397	£1398
Theta Gen III Dac		£2795
Theta Cobalt 307 DAC (New!)	£699	£539
Theta ProPrime DAC (Ex-dem!)	£1449	£1249
Theta Basic 11 CD Trans (Ex-dem)	£2307	£1689

A FEAST OF APOGEE

Apogee Centaur Minor	£1345	£847
Apogee Centaur (Ex-dem)	£2300	£1399
Apogee Column (As new)	£1900	£1199
Apogee Mini Grand (Mint)	£7598	£4499
Apogee On Wall (Mint)	£3000	£1999

Apogee Full Range (Ex-dem)	£17,000	£8999
----------------------------	---------	-------

QUITE LITERALLY A 'WALL' OF SOUND

LOUDSPEAKERS

Audiostatics ES100	£2400	£1698
B & W 2000IFS Centre	£220	£1080
B & W CC6 Centre speaker	£225	£148
B & W Silver Signature Fabulous!	£6000	£2498
Cambridge Auto R50 (Trans Line)		£495
Castle Chester (Yew)	£770	£495
Castle Durham (Inc stands - R/wood)		£245
Castle Howard (Rosewood)	£1399	£878
Castle Pembroke (Black Ash)		£200
Celestion CS7		£195
Celestion 3000 (black)(ribbon hybrid)		£495
Diesis Solitaire		£150
DCM Time Windows		£245
Duntech PCL500	£5250	£2699
Epos ES11 Rosewood		£368
Epos ES14 Ex-dem	£675	£474
Epos ES14 Black + stands		£428
Epos ES11 Black (vge)		£248
Epos ES30 Rosenuit NEW	£2700	£1697
Epos ES11 Black		£298
Gale 301 (Black)	£250	£159
Heybrook Quartet speakers + stands		£498
Heybrook HB200 (teak)		£140
Horning Aganthan bronze	£3500	£1650
IMF Professional Monitor MKIV (Teak)		£798
KEF 107 speakers + cube		£1200
KEF Q70 (Black)	£750	£498
KEF Q50 (Black)	£349	£195
KEF 105 (Walnut)		£378
KEF Coda (black)	£130	£80
Linn Tukan (black) mint	£650	£468
Linn Kaber (black)	£2200	£1098
Linn Kan (black)		CALL - Various available

MAIL ORDER

All items Fully Insured
and Guaranteed

Magna Planar MG2.5 (New)	£1998	£1199
Meridian DSP5000 Rosewood		£2498
M & K VX-7 subwoofer	£450	£375
Mission 707 (Walnut)		£100
Mission 733 (Black)		£155
Mission 770 (Mahogany + stands)		£228
Mission Argonauts (black)		£395
Monitor Audio Studio 60SE New/Blk/Rose	£5000	£2995
Naim SBL - Cherry (Latest)	£2030	£1378
Note Perfect Virtuoso (Ex-dem)	£2750	£1497
ProAc Tablette 50 Signature (Ex -dem)	£899	£POA
ProAc Response 3.5 (Ex-dem)	£4250	£2997
ProAc Response 3.5 (Cherry)	£4250	£2800
ProAc Response Two (black)	£1700	£995
Quad ESL57		from £395
Quad ESL63	£3449	£1698
Quad ESL63 (Ex-dem)	£3449	£1997
REL Strata	£550	£395
Rega Ela (walnut)	£299	£198
Rogers LS33/AB33 (Black Ash)		£1428
Rogers Studio 1a (Teak)	£600	£348
Rogers LS1 (Black)		£120
Royd Minstrel (Walnut/Black)	£240	£168
Snell K II		£288
Sonus Faber Electa (Black) Ex-dem	£1790	£1299
Spendor PS2/3	£1195	£775
Tangent RS2 + Stands	£400	£225
Tangent Monitor 2 (Rosewood)	£200	£140
Tangent 607 MkII		£185
Tannoy 638 Plus (Rosewood)	£750	£498
Tannoy 605 (black) + stands		£185
TDL Nucleus 1 (black)		£85
TDL RTL2 (black)	£300	£175
Thomas Transducers Virtuoso Gold with silver wired Lowther drive units	£3400	£1998
Wharfedale Harewood + stands		£POA
Wilson Witt Mk1 (Ex-dem)	£8888	£6497

MISCELLANEOUS

Audio Alchemy Clearstream digital Lead	£200	£128
DBX228		£98
Essex Digital Correction for Celestion SL700	£750	£250
Helios Orion arm		£548
Siltech 560 Balanced cables 1 mtr pr	£1600	£600
Stax SR Lambada SIG+SRMI Mk2		£1695
Electrostatic Headphones	£1695	£895
XLO Signature 2.1 Balanced Interconnects 1.0m pair: (£675) £448 0.5m pair £485		£398
Rotel RN560 Dolby Noise Reduction System		£75
Cogan Hall cables - digital. speaker. interconnects		£POA
Mana 3 layer reference stand - Superb	£500	£350

PART EXCHANGE EVALUATION

Ask about the best Trade-In
price against any NEW product

Note: All previous prices as shown are either the former manufacturers' list price when new; prices customers paid for their equipment (receipted) at the time of purchase; or the estimated price of comparable equipment/models at today's value

BUSINESS HOURS: TUESDAY - SATURDAY 9.30am - 5.30pm

CLOSED MONDAYS

VISITORS WELCOME AND DEMONSTRATIONS BY APPOINTMENT

35-42 COWGATE
PETERBOROUGH PE1 1LZ
(01733) 555514
FAX(01733) 358141

TRADING STATION

The HiFi Company

ESTABLISHED 1974

ALL MAJOR CREDIT/DEBIT CARDS ACCEPTED

ALWAYS
a Large Selection of
Budget Hi-Fi Bargains!
HERE ARE JUST A FEW EXAMPLES

NEW

Ex-demonstration

Denon DM03 system	£459	£389
Denon DM5 system	£279	£239
Denon DM7 system	£429	£369
Marantz Venus system	£700	£475
Teac 500 system	£799	£649
Audiolab 8000A amplifier	£500	£375
Audiolab 8000LX amplifier	£470	£350
Cyrus Pre-amplifier	£648	£548
Cyrus aPA7 mono blocks	£2000	£1600
NAD 208 HX power amplifier	£1200	£850
Pink Triangle Litaural CD Player	£2200	£1700
Copland CDA 288 CD Player	£1998	£1698
Quad 77 (Bus) CD Player	£699	£499
Monitor Audio PMC 700 loudspeakers	£500	£400
Pro-ac Tablette 50 (cherry) loudspeakers	£600	£450
Castle Severn II (walnut) loudspeakers	£580	£475
Mission 773 (cherry) loudspeakers	£350	£280
Meridian DSP6000	£10000	£7500
Pass Aleph 5 (class A amplifier)	£3150	£2500
Wilson Benesch Orator cherry no grilles	£2900	£1900
Naim CDX CD Player	£2265	£1800
Naim Credo loudspeakers ebony	£1250	£950
M + K MX150 Subwoofer	£1500	£1150

AMPLIFIERS-S/H

A & R Cambridge A60	£75
A & R Cambridge C200/SA150 Pre/Pwr	£250
Audiolab 8000A (DNIN)	
Fully upgraded to current spec	£295
Aura VA80SE-X	£198
Beard P100 100wpe Pwr amp	£695
Cyrus 1 and 2 amps	Several from £145
Kenwood KA540R	£320 £175
NAD 3020A integrated	£85
NAD 1000pre	£145
NAD 3240 Power Envelope Integrated	£145
Naim Nait 1	£138
Nytech CPA602/CP122 Pre/pwr	£300
PS Audio Elite	£450
Rotel BX935	£170
Yamaha DSPE200 Processor	£149

CD PLAYERS - DACS S/H

Arcam Delta Alpha CD	£250	£125
Arcam Delta Black Box		£175
Kenwood DP7060 CD	£360	£175
Marantz CD36		£110
Marantz CD52		£120
Marantz CD56		£70
Marantz CD65		£85
Mission daD 7000		£199
Mission PCM11		£140
Philips CD1 210		£95
Philips CD850 Mk2 (Trichord clock upgrade)		£195
Rotel RCD865	£300	£120
Rotel RCD965BX		£165
Yamaha CD3050		£178

LOUDSPEAKERS - S/H

B&W 2000IFS Centre Speaker	£95
Mission Argonauts	£240
Musical Fidelity MC2	£195
Gale 301	£125

**INSTANT CASH LOAN SCHEME
AGAINST QUALITY S/H EQUIPMENT
- ASK FOR DETAILS-**

The HiFi Company
**TRADING
STATION 2**

**22a LINCOLN ROAD
PETERBOROUGH
Tel: 01733 343469**

TESTING, TESTING

Simon Pope and Richard White reveal two more of their favourite recordings for grilling hi-fi components.



Edward Elgar
Violin Concerto
**Pinchas Zukerman, London
Philharmonic**

Pinchas Zukerman has recently turned 50, not quite an elder statesman but a senior all the same. One of my more up-to-date music dictionaries gives him as "Intl. rep as soloist esp. Elgar" and this 1976 CBS recording is probably the one which gave rise to the "esp. Elgar"!

Zukerman is in no mood to fool about here. From the first entry, the soloist stamps his mark, his approach more gypsy-ish than the earlier Sammons/Menhuin school. Whereas they had 'the composer's intentions' in their minds, Zukerman has the Concerto to mould anew.

You can almost see the clouds of rosin be-fogging the air as the glories of the first rhapsodic phrases get under way. The London Philharmonic under Barenboim occasionally seem a little hard-pressed to keep up; small wonder when the solo part is played with such thrilling urgency. Almost better than the exciting chunks are the moments of delighted heartbreak, where it seems that nothing in the world is sad enough to give such joy.

If you detest Elgar, there's not much for you here! If, on the other hand, you only think you do, let me play you something that could make you change your mind! RMW



Gustav Mahler
Symphony No5
Vienna Philharmonic

Of my eight or so desert-island choices, this is the one I genuinely couldn't be marooned without. One September evening in 1987, I joined the loyal throng of prom-goers to hear this work, with these performers, in the Royal Albert Hall. It turned out to be one of the all-time great proms - the critics raved and I don't think anyone who was there will ever forget the experience.

This recording was made on the same tour in the Alte Oper in Frankfurt and, whilst it doesn't have quite the fervour of the London performance, it's still awesome in its emotional power and sheer musicality.

It was Bernstein - a Jewish conductor-cum-composer like Mahler - who re-introduced an unenthusiastic VPO to Mahler (whose music was banned under the Nazis) back in the 1960s. He simply lived and breathed this music.

This is music-making at its very best. The exquisite playing (listen to the sweet tone of the Vienna strings) and communication between conductor and players is outstanding. The DG engineering also happens to be exceptional. Barbirolli's classic recording with the Berlin Philharmonic comes close, but for me this takes top honours. Forget capacitors and resistors, this is what really matters! SP

MEASURED PERFORMANCE

AMPLIFIERS

MUSICAL FIDELITY X-P100 AND X-AS100

The X-AS100 power amplifier delivered ample power, producing 128watts into an 8ohm load and a massive 225watts into 4ohms. That's more than enough to handle any loudspeaker and there was little voltage loss as current draw increased, so bass transients will be solidly delivered. The power amplifier will have no trouble driving any loudspeaker loud.

Frequency response was flat from 8Hz right up to 63kHz, from CD through to output. That is wide enough to reproduce CD properly and means the MF is able to

deliver deep low frequencies.

Distortion was low, measuring 0.004% at 1kHz and little more at 10kHz. The amp was very linear at all output levels and frequencies so it is likely to offer a clean, open sound. With good sensitivity, low noise in spite of high gain and wide channel separation, the Musical Fidelity combination measured very well. **NK**

Power	162watts
CD/tuner/aux.	
Frequency response	8Hz-63kHz
Separation	74dB

Noise	-83dB
Distortion	0.004%
Sensitivity	200mV
DC off-set	-33mV/1.9mV

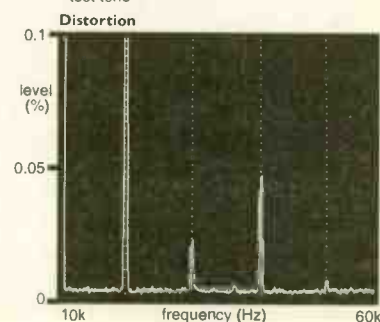
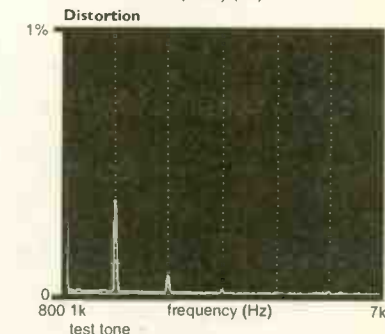
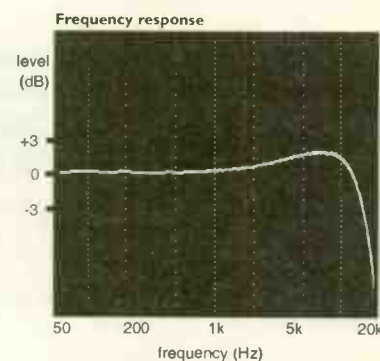
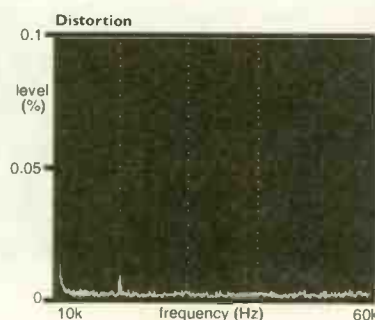

NAKAMICHI RE-10 RECEIVER

Nakamichi's RE-10 is very powerful, producing 153watts into 8ohms and 240watts into 4ohms. It has a beefy power supply which holds up well under load and should deliver solid bass.

Bass response reached down to 26Hz, which is a little curtailed. These days 5Hz-10Hz is more common. Treble distortion was on the high side too, but since it was primarily second harmonic it will probably be inaudible.

Unfortunately, the receiver has buffered inputs and the one for CD overloaded at 2V. Since many players these days produce more than 2V and CDs are often compressed up to the top, distortion is likely. This is not clever.

The tuner had +2dB treble lift at 8kHz in its audio response, which will give it a bright sound. Channel separation was adequate at 29dB but not up to modern standards set by budget separates. Hiss was adequately low at -70dB but sensitivity poor at 80uV for 50dB hiss on stereo.

The signal strength meter appears to have many segments but in fact has just two: one which will always be lit as it needs just 6uV, and one which will almost never light because it requires 1250uV. Although this is sensible,

because the tuner needs a lot of signal (1600uV) to reach full limiting, only those with a large aerial will get the upper two thirds of the display to light.

The RE-10 is powerful, but the tuner section is mediocre in quality and some CD players may well cause input overload distortion. It isn't very well engineered in truth. **NK**

AMPLIFIER	
Power	153watts
CD/tuner/aux.	
Frequency response	26Hz-48kHz
Separation	58dB
Noise	-97dB
Distortion	0.04%
Sensitivity	180mV
DC off-set	39mV/32mV
TUNER	
Frequency response	50Hz-13kHz
Stereo separation	29dB
Distortion (50% mod.)	0.7%
Hiss (CCIR)	-70dB
Signal for minimum hiss	1.6mV
Selectivity (at 0.4MHz)	74dB
Sensitivity	
mono	6uV
stereo	1250uV
signal strength meter:	6uV, 1250uV

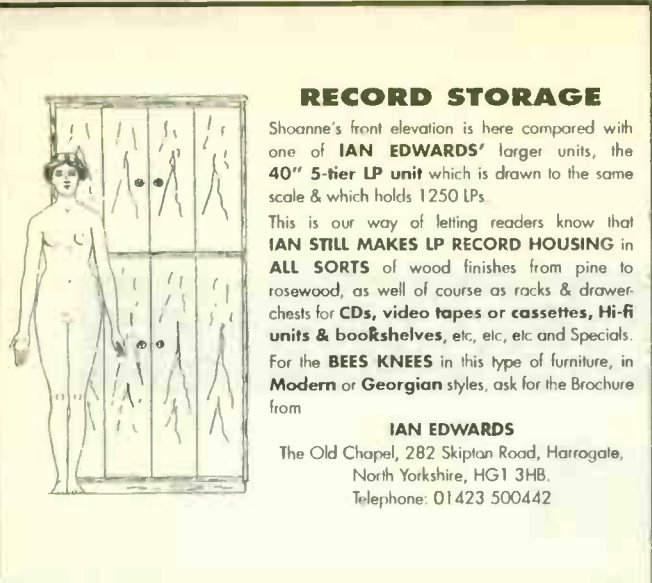

RECORD STORAGE

Shoanne's front elevation is here compared with one of **IAN EDWARDS'** larger units, the 40" 5-tier LP unit which is drawn to the same scale & which holds 1250 LPs

This is our way of letting readers know that **IAN STILL MAKES LP RECORD HOUSING** in ALL SORTS of wood finishes from pine to rosewood, as well of course as racks & drawer-chests for **CDs, video tapes or cassettes, Hi-fi units & bookshelves**, etc, etc and Specials. For the **BEE'S KNEES** in this type of furniture, in **Modern or Georgian** styles, ask for the Brochure from

IAN EDWARDS

The Old Chapel, 282 Skipton Road, Harrogate,
North Yorkshire, HG1 3HB.
Telephone: 01423 500442

Note Ian Edwards

SALE

of many superb items.

Reduced Prices & Quick
end-of-month delivery

Write or phone now for brochure
& sale notice

DO YOU WANT THE BEST
VINYL SOUND YOU CAN GET?
YES? WELL DID YOU KNOW
THAT GENUINE GARRARD
301, 401 & 501 IDLER DRIVE
TURNTABLES ARE STILL
AVAILABLE?

FOR FURTHER INFORMATION ON OUR PRODUCTS SEND A LARGE S.A.E. TO LORICRAFT AUDIO, UNIT N, WAGON YARD, LONDON ROAD, MARLBOROUGH, WILTSHIRE, SN8 2LH., CALL OUR PRODUCT HOTLINE 01672 511401, E-MAIL US AT LORICRAFT@GARRARD.NDO.CO.UK OR CHECK OUR WEBSITE: WWW.GARRARD.NDO.CO.UK GARRARD AND LORICRAFT PRODUCTS ARE ON SHOW AT BYWORTH AUDIO, FARNHAM, SURREY +44(0)1252 717 784 AUDIBLE ELLAGANCE, WEST MERSEA, ESSEX +44(0)1206 384 247

LORICRAFT AUDIO we make music

VINTAGE AND MODERN HI-FI SOLD, BOUGHT.
Lto TEL: 0790 1976 441 FAX: 0171 713 6722

Idelity £ 550, SME 3009 £ 80, SME 3012 £ 150, ORTOFON Rohmann still boxed £ 600, MC10 super, MC 20, MC30 POA, **AUDIO NOTE** IO-V £ 1000, IQ I £ 90, Soara £ 600, **SIMIRO** Blue Point New as new £ 100, Blue Point £ 199

VINTAGE/MODERN AMPS
LEAK TL 10 POA, TL12 £ 350 (pair), TL12 I £ 1000-1250 (pair), TL25+ POA, Stereo 20 £ 300, TL 50 POA, TL60 (pair) POA, Throughline Stereo Tuner £100, **QUAD** I early model POA, **QUAD** II + preamp + tuner from £ 450, **QUAD** 405 mint £ 200, **QUAD** 606 POA, also available **RADFORD** various model including STA 25, **DYNATRON** amp (pair) with PX4's, other brands available on request, **AUDIO NOTE** SHINRI 300B still boxed with original set of 300B valves, great sound (£ 23 000 new) £ 9500, P4 £ 1900, P3 £ 1300, M2 preamplifier phono £ 1000, M3 preamplifier phono £ 2500, **CONQUIST** used few hours £ 3800, M7 preamplifier phono £ 5000, **GRAAF** GM100 VTA £ 3800, GM20 £ 2700, GM 200 (UTL) £ 5800, Venti-cinque £ 900, **UNISON RESEARCH POWER** 35 £ 1450, **SMART** 300H £ 3900, **SMART** 845 £ 3600, 845 ABSOLUTE dual mono £ 9800, **PENTODE** 35 stereo £ 3500, **SIMPLY** 845 new, boxed £ 2200, **SIMPLY** FOUR Pentode £ 3000, Triode £ 3200, **NIGHTINGALE** ADM 20 POA, ADM 30 WLST £ 2000, **SYNTHESIS ART IN MUSIC** one of the best Italian integrated amps in period made only £ 800, ST1-WOOD £ 800, ST2-WOOD £ 1000

TURNTABLES/CARTRIDGES/AMPS
GARRARD 301 POA, 401 £ 150, **MICHELL** Gyrodisk MKII ex-demo £ 600, MicroGyro Arm £ 500, **AUDIO NOTE** TT1, TT3, **NOTTINGHAM MENTOR REFERENCE** (one of the best in the market) bargain £ 1500, **SME** 309

URGENTLY WANTED: AUDIO VALVES PX4, PX2E, PP3/250, P850/P16/250, P12 250, AC044, PP3/400, R8241, 300BWE, HT61, KT66, 8850A GE, EL34, EL84 (Mullard), LEAK, RADFORD, QUAD I and II, REVOX G36 F36 B77, ALL TYPES OF TANNOY & GARRARD...

Billy Vee Sound Systems

Selected list of Pre-Owned and Ex-Dem Units

All with minimum 1 year warranty. Interest Free Option Available
We are authorised agents offering genuine reductions - call now

AVI S2000 Pre amp/phono stage E/D	(1199.00)	£799.00
AVI S2000 Mono power amps E/D	(1399.00)	£899.00
B&O Avant 28" inc Video Ex-Display	(3700.00)	£2495.00
B&O AV5 TV/Hi-Fi/CD Ex-Display	(4650.00)	£3249.00
B&O MX4002 21" T.V. Ex-Display	(1290.00)	£879.00
B&W P4 Speakers - Black E/D	(675.00)	£499.00
Linn Kudos (Sneaky) Module Tuner	(1570.00)	£695.00
Linn Wakonda Phono Preamp S/H	(500.00)	£295.00
Linn Kan/2 Speakers S/H	(900.00)	£599.00
Linn Majik phono amplifier S/H	(579.00)	£199.00
Linn Karik/2 CD Player S/H	(800.00)	£479.00
Linn Numerik DAC S/H	(1498.00)	£999.00
Linn Kairn Preamp - Line E/D	(1500.00)	£899.00
Linn Kairn Preamp - Line E/D	(1400.00)	£1095.00
Naim Nait 3 Amplifier S/H	(585.00)	£395.00
Naim 92/90 Pre/Power Combo S/H	(1110.00)	£849.00
Naim CDi Player S/H	(1800.00)	£995.00
Naim CDS Player S/H	(3900.00)	£2595.00
Pioneer PDR04 CD Recorder As New	(449.00)	£349.00
Pioneer PWR555 Re-Writable (NEW)	(449.00)	£349.00
ProAc Super Tablette S/H	(599.00)	299.00
Pioneer CLD 2950 Laser Player S/H	(600.00)	£229.00
Rega XEL Monitor Speakers (blk) E/D	(1040.00)	£699.00
Yamaha CDX890 CD Player E/D	(349.00)	£199.00

Call (0181) 318 5755 or 852 1321

248 Lee High Road, Lewisham London SE13 5PL
10am-6.30pm Monday-Saturday (closed Thursday)

CYRUS aPA7 MONOBLOCS

The Cyrus aPA7 amp produces 162watts into 8ohms and 240watts into 4ohms. A cooling fan and protection circuits ensure the unit can cope.

Even though global negative feedback is not used, the unit was linear, producing little distortion across the audio band at all outputs. The worst figure was produced with the amp at full power at high frequencies, measuring a low 0.04%. Our analysis shows the distortion was odd-order only, which can have a minor sharpening effect but it

does not result in roughness or coarseness. The Cyrus does not suffer in measurement terms as a result of abandoning global feedback. However, transistors are so inherently non-linear and variable in gain they must be linearised through feedback one way or another, so the aPA7 uses local feedback.

With adequate sensitivity and very low noise, the Cyrus measured well. **NK**

Power 162watts
CD/tuner/aux.
Frequency response 10Hz-45kHz

Separation 98dB
Noise -104dB
Distortion 0.02%
Sensitivity 320mV
DC off-set 3mV/4.2mV

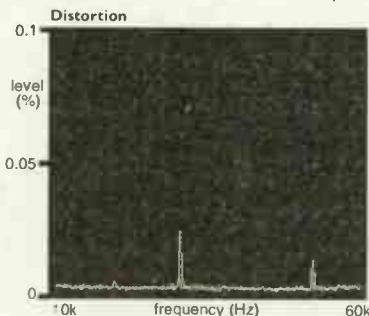

CD PLAYERS

ALCHEMIST NEXUS

The Nexus CD player has a wavy frequency response. There's a little roll-off in treble energy above 2kHz and a roll-off in upper treble above 10kHz. I would expect these traits to add body and warmth to the sound.

Distortion performance was a little disappointing. At low levels and at peak level (0dB) there was more distortion than usual. This wasn't an especially linear player. It was also the noisiest player I have ever measured, with a noise figure of -82dB. Although still low enough not to make the Nexus overtly hissy, this is extremely unimpressive.

The Nexus did not measure well but it will may well have some distinctive properties that give it character. It is a player that needs careful audition. **NK**

Frequency response 4Hz-20kHz

	left	right
Distortion (%)		
-6dB	0.05	0.05
-30dB	0.02	0.02
-60dB	2.6	2.3
-90dB	72	64

	left	right
Separation (dB)		
1kHz	90	88
20kHz	78	79

Noise -82dB
with emphasis -82dB

Dynamic range 92dB
Output 2.3V

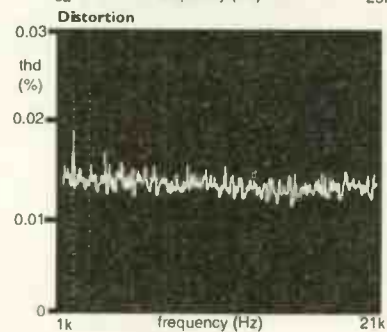
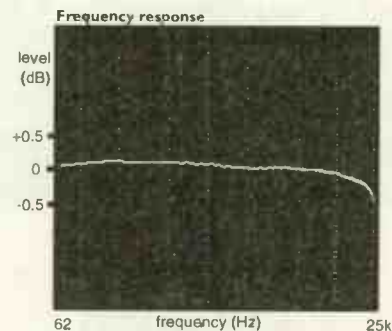

	122	124
1kHz		
20kHz	92	95

Noise -107dB
with emphasis -107dB
Dynamic range 104dB
Output 2.3V

MARANTZ CD-17

The CD-17 produces very little distortion. Our analysis at -30dB shows a smooth noise floor free from quantisation spikes and distortion harmonics. Although it cannot match Denon's Alpha Processing players below -60dB, this is otherwise the best possible result from CD.

Frequency response measured ruler flat, a characteristic likely to give the sound a hard edge at times.

Channel separation was high, noise very low and output normal at 2.3V. The Marantz measured well in all areas. **NK**

Frequency response 4Hz-21kHz

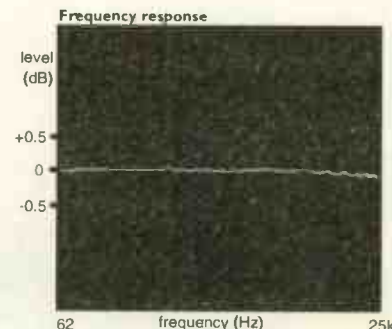
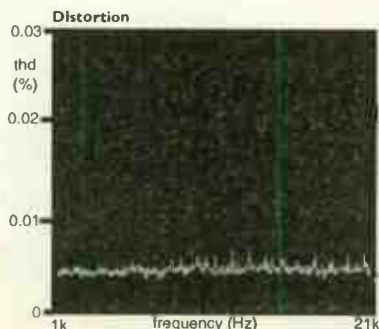



BorderPatrol

Valve Amplifier Power Supply Upgrade £595.00

Off board valve rectified, choke input filter power supply for Valve Amplifiers. This upgrade reduces distortion, increases resolution and strengthens bass performance and dynamics. If you like the sound of your valve amplifier but would like to tighten the bass and strengthen the overall dynamics this is what you need. Versions available to suit everything from vintage Leaks to modern Audio Innovations, Audio Note and Art Audio designs. If you are unsure about the suitability for your amp please telephone us.

'In every instance the Border Patrol effect was nothing short of a transformation. Bass solidified, imaging became significantly more three-dimensional and substantial, and the power supplied amp made the regular version sound, quite literally, a mess.'

'With the Border Patrol back on the music regained its composure: instruments not only sounded more natural and realistic, but seemed much more musically coherent. In many respects it was like taking the good things about transistor amps and adding them to the natural strengths of valves - a remarkable blend.'

... Jason Kennedy Hi-Fi Choice April 97

Check out the full range of BorderPatrol activities: power supplies, power amps, components, used equipment etc at www.borderpatrol.demon.co.uk

BorderPatrol Tel/Fax Brighton 01273 276716

Rothwell



Valve Amps of Distinction

This pre/power combo has been winning admiration and praise from satisfied customers throughout Britain and abroad for over five years. Many are so impressed with the performance that they have invested in a second Rubicon, running the two amps as monoblocks. To find out for yourself why these music lovers are so dedicated to Rothwell, contact your nearest dealer for a dem.

The Rubicon is a stereo valve power amp using triode configured EL84s to give a remarkably delicate sound, guaranteed to captivate. Bridgeable for monoblock operation. **£949**

The Indus is the ultimate passive pre-amp, based on Rothwell's unique stepped attenuator. This precision device has fine and coarse volume controls to give 132 volume settings and unbeatable sonic accuracy. **£499**

Audio Images Lowestoft, Suffolk 01502 582853
 Kronos Hi-Fi Dungannon, N.Ireland 01868 753606
 Serious Kit Prestwich, Manchester 0161 798 9649
 Sounds Perfection Helston, Cornwall 01326 221372
 Shadwell Hi-Fi Studios Leeds, Yorkshire 0113 237 1019
 Input Audio Dukinfield, Cheshire 0161 3047494
 Kevin Galloway Audio Killmarnock, Ayrshire 01563 574185
 Romers Hi-Fi Rishton, Lancashire 01254 887799
 Hazlemere Audio Consultants High Wycombe, Bucks 01494 437892
 Audio Illusion Langley, Berkshire 01753 542761
 Mid Shropshire Audio Telford, Shropshire 01952 502097
 Rothwell Electronics 60 Pennington Road, Great Lever, Bolton BL3 3BR
 Tel/Fax 01204 654614

HICAM

GOOD QUALITY PRE OWNED HI-FI EQUIPMENT PLUS PHOTOGRAPHIC EQUIPMENT - NIKON. CANNON A.F. BOUGHT SOLD PX (SOLD ON COMMISSION)

Cable Talk Concert 4 2x5 metres	£80
Cable Talk Improved 2, 1 metre	£20
Castle Chester Mahogany marked hence	£295
Chord Rumour 2x4 metres	£60
Denson Beat 100 amp	£395
Exposure 15 Int Amp/MM Phono	£395
Kef Q55 black (ideal for home cinema)	£350
Linn Basik plus arm	£50
Linn Index/Stands	£125
Linn Kairn pro/phono	£695
Linn Majik/phono	£475
Linn Wakonda/phono	£425
LP12 Valhalla Basic plus K9	£425
M+K 125 THX active sub	£495
Mark Levinson 28/29 + psu, balanced	£2500
Meridian 563 uprated to 566 spec	£425
Mission 753 black	£350
Musical Fidelity 3A pre/phono	£150
Musical Fidelity E200 pre/phono/E300 power	£795
Musical Fidelity E624 CD player latest 24 bit	£395
Musical Fidelity MVT pre/270 Mk2 power	£1200
Naim 250 power amp	£795
Naim 42.5 pre amp	£150
Naim 90 old style (recased)	£175
Naim 90.3/92 pre/power	£675
Naim cables various	
Naim Nait 2	£250
Naim Nait 3	£375
Naim phono boards	£40
Naim SBL black latest	£795
Revolver T/T complete	£70
Roksan Rok1 transport	£250
Sonic Link Violet 1 metre	£40
Sony 540 int. amp	£80
Soundstyle 4 shelf rack blue	£125
Technics SUA 900 Mk2 amp	£175

5 miles from either J6/8A M40

Mon Sun 10am - 8pm VISA Switch - Mastercard

For further details Phone/FAX 01844 260182

Mobile: 0973 233380 E-mail: HICAM@GLOBALNET.CO.UK

DANISH AUDIO CONNECT

Made in Denmark



CTI Audio Attenuator / Volume Control

Improve the sound quality of your amplifiers by changing to the CTI volume control.

CTI offers you a more effortless sound, more details, better dynamics, lower distortion and improved bandwidth. CTI has the ability to "disappear" and not influence the enjoyment of the music. The tracking between stereo channels and the attenuation is within the range of professional equipment. Besides, CTI is very compact for easy build-in.

How do we obtain this?

- 24 step precision switch
- contacts and conductors are gold plated
- Use of low noise, non-inductive, non-magnetic SMD resistors.
- Five times shorter signal path than conventional designs.

Key CTI specifications

Bandwidth: 50 kHz
 Attenuation accuracy: ± 0.05dB
 Tracking between channels: ± 0.05dB
 THD: < 0.0001%
 Dimensions: 32mm diameter, 45mm length

CTI versions

Standard impedances: 10, 20, 50, 100 and 250 kOhm
 Available with:
 • 1 wafers (single ended stereo or balanced mono)
 • 2 wafers (single ended stereo or balanced mono)
 • 4 wafers (balanced stereo)

Danish Audio Connect (Thailand) Ltd. 4m 150/3 Ban Chang Gas Heat Bldg. 1 Sampran Road, 25 Bangkok 10172, Thailand. Tel: (+66 2) 260 6072 Fax: (+66 2) 260 6071 E-mail: info@danishconnect.com

UK distributor: Audio Cam (UK) Unit 6 Tindle Interprint Centre, Warrim, Street, Northamptonshire, NN4 0Y Tel: (+44) 1832 818200 Fax: (+44) 1832 818204 E-mail: AudioCam@compuserve.com

DENON DCD-1650AR

Denon's Alpha processor has some distinctive characteristics that affect measured performance. We measure frequency response by convolving a pulse test signal in an FFT signal analyser. It's interesting to see that Alpha processing cur

tails treble energy with a pulsive signal: the upper limit measured just 8kHz instead of a normal 21kHz. This ties in fairly well with an innate warmth displayed by Alpha processing players. However, they aren't dull sounding either

and, not unsurprisingly, normal steady test tones are fully reproduced right up to 20kHz. So Alpha processing effectively slides bandwidth, according to the nature of the signal being processed, and I would guess that some 'warmth' will result. In practice it usually does.

The other feature of Alpha processing is superb linearity at low signal levels. Fewer and fewer digital bits become available to describe a signal as its level decreases, so distortion goes up. A -90dB

signal on CD typically suffers 30% distortion. The Denon DCD-1650AR produces just 6% at this level - a large improvement. In fact, the player is very linear right down the audio range, producing little distortion at all levels. This will help keep the sound smooth and free from harshness.

In all other areas, such as noise, channel separation and dynamic range, the Denon measured very well, right up with the best of them. Denon know what they are doing. This player's performance is a little unconventional but it has been carefully engineered, is typical of Alpha processing and, although arguably a little contrived, this usually results in fine sound quality. **NK**

Frequency response 4Hz-8kHz

	left	right
Distortion (%)		
-6dB	0.005	0.005
-30dB	0.009	0.016
-60dB	0.46	0.49
-90dB	7	5

Separation (dB)	left	right
1kHz	105	105
20kHz	80	80

Noise	-116dB
with emphasis	-116dB
Dynamic range	109dB
Output	2.3V

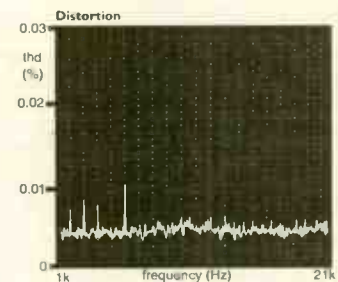
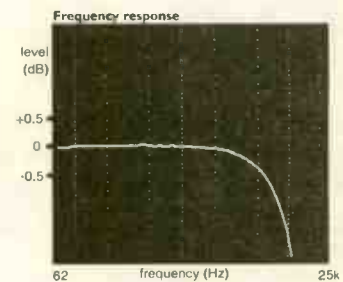

HELIOS MODEL 3

The Helios has a ruler-flat frequency response - so flat it may have been a prime design goal. Unfortunately, in my experience this offers no particular subjective benefits. It is an entirely theoretical design goal that with CD more often than not gives a slightly bright and hard edge to the sound.

Linearity was not up to current standards, distortion at -30dB measuring 0.04% against 0.02% for better converters. Further down the range, distortion was even higher than normal, hitting 2.4% at -60dB against around 0.5% for a good modern player. This reduced the EIAJ dynamic range figure to 95dB.

Output was unusually high at 5.1V. Philips specify 2V as the reference output level for CD. At +6dB above this, the Helios will be unusually loud against others in any shop demo and may even overload some active input stages. Noise was low without de-emphasis, but jumped to a poor -82dB with emphasis switched in. Although emphasis is rarely

used and hiss will not be a problem at -82dB, this is still unusual. Players usually measure much the same at infinity zero, emphasis or no emphasis.

The Helios was a little peculiar in many areas and not overly impressive in measured terms. **NK**

Frequency response 4Hz-21.5kHz

	left	right
Distortion (%)		
-6dB	0.005	0.005
-30dB	0.044	0.03
-60dB	2.42	2.28
-90dB	72	66

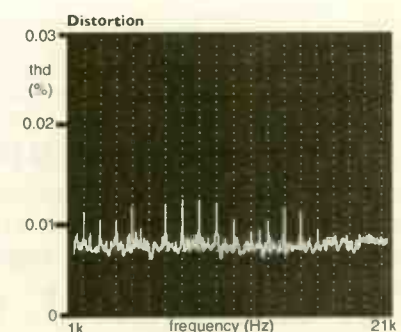
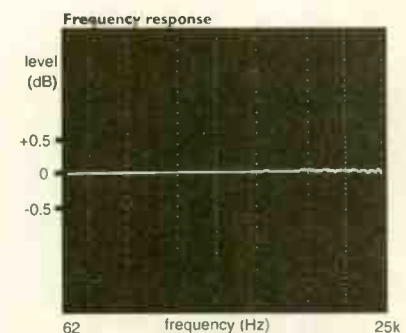

Separation (dB)	left	right
1kHz	112	109
20kHz	91	88

Noise	-104dB
with emphasis	-82dB
Dynamic range	94dB
Output	5.1V

SLATE AUDIO



Linking The Past, Present & Future



THE SPEAKERSTAND®

The best speaker supports in the world.

State of the art in performance and design, custom made to suit any loudspeaker. Solid slate, supremely rigid and totally neutral" ("One specific Slate was chosen after extensive testing on all other stones)

SPEAKER PLATFORMS ISOLATION PLATFORMS TURNTABLE PLATFORMS SHELVING SYSTEMS

"Immaculately finished, sublimely rigid, on a par with the best stands I've used." Ken Kessler, Hi-Fi News R/R. "An astonishing degree of instrumental separation, stable and holographic, with great precision and remarkable poise. The ultimate in high fidelity supports." David Praker, Hi-Fi Answers. "Superbly finished, the sound quality was considered to be first rate." Martin Colloms, Hi-Fi News R/R. "The sound quality when using the Slate Audio stands proved to be a revelation, something special." Paul Messenger, Hi-Fi Choice. "The finish is excellent, the sound quality magnificent and breathtaking." Tom Bryant, The Telegraph. "The Slate stand is unusual and expensive, but if you are after an exceedingly neutral stand it's the leading contender. This stand offers an exceptionally neutral platform for speakers; highly transparent sound leads to musical performances with real insight." SOUND QUALITY: ■■■■■ Malcolm Steward Hi-Fi Choice.



SLATE AUDIO GARRARD 301 and 401

The best & most musical record players in the world.

Our researched Solid Marble Plinth System® brings the Garrards into the 21st century. All wooden Plinths produce unacceptably levels of coloration and feedback. No other Plinth system can claim to improve the performance of these superb players.

THE REVIEWERS

"The Slate deck defines what real instrument solidity should be, it's in a class of its own." Alan Sircom, Hi-Fi Choice. "The build and performance of the Slate Audio 401 are the audio equivalent of the E type Jaguar." Audiophile. "I have never used a system like this one, it gets everything right. Peter Soper insists Garrards are best mounted on Marble or stone, and from my experience with this plinth I wouldn't disagree." Noel Keywood, Hi-Fi World. "The Garrards main problems are dealt with most effectively by three cures; correct set up, heavy plinth and appropriate mat. Peter Soper has mastered them all, the results are close to miraculous." Ken Kessler, Hi-Fi News R/R. "I have been using the fantastic Slate plinthed Garrard, the sound was nothing short of breathtaking. The basic Garrard without the Slate plinth is well engineered and pleasant sounding, but they only give exceptional results with the right kind of treatment." Dominic Baker, Hi-Fi World.

OUR CLIENTS "I have tested your 301, the sound quality as you know is excellent!" G. Pyne. "The results I get are really unbelievable and I have tried some of the best turntable around, (Linn LP12 Roksan Xerxes). "Thanks again for a marvellous piece of art." Mr Teilinger. "I am delighted with my Slate Audio Garrard 301, it sounds fantastic. Well worth all the detailed work that went into the design." R. Newham. "When I first put up the Slate Audio 301 I must admit to having quite a shock, forever converted." K. Van Green, Electric Eel Studios. "I'm over the moon, the plinth looks and sounds superb, stunningly beautiful!! I would very highly recommend any of your customers to seriously consider this great combination." J. Marsh.



Nothing sings like a diamond

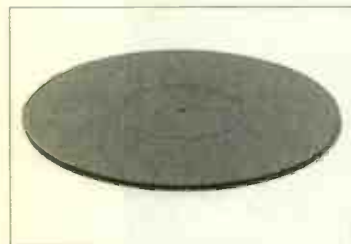

THE GLASSMAT®

The finest platter mat in the world.

The Glassmat® was developed to improve the performance of the Garrard 301 and 401 record players. However it also gives astonishing results when used on other turntables. So effective is its performance, we have now made it available as a universal replacement mat. In all cases other mats introduce colorations of their own, robbing the music of large amounts of detail and ambience. In order to achieve maximum information retrieval with optimum damping, a hard and unyielding material is required. Glass is ideal in every respect, damping is complete, the playing surface being quite simply sublime. In terms of detail resolution and sheer three dimensional ability, no other mat comes close. But then you still have to consider the absolute clarity, precision and solidity of the presentation. This is the ultimate platter mat.



THE POWERHOUSE OUR QUARTZ REFERENCED GARRARD 301/401 TD124 AND UNIVERSAL POWER SUPPLY. "KILLER" K.K.
THE TABLESTROBE & HANDSTROBE DEADLY ACCURATE QUARTZ REFERENCED STROBE GUNS, WITH STROBE DISC. PERFECTLY PITCHED? QUAD ESL 57s NOT WORKING? ALLOW OUR ELCTROSTATIC SPECIALISTS TO BRING YOUR QUADS BACK TO LIFE.
STORMFORCE MY ULTIMATE STATEMENT ON THE CLASSIC TANNOY DUAL CONCENTRICS. HOUSED IN SOLID MARBLE, THEY ARE DEVASTATING!
HUMDINGER ELEVATE YOUR EARLY SME 3009S2 TO 1999 STATUS. BREATHES NEW LIFE INTO A GREAT CLASSIC.
BACKLASH SUPERB SME 3009 & 3012 GOLD PHONO SOCKET CONVERSION, INCLUDING OFC LEADS; BRILLIANT? YES.
BRAZEN UPGRADE YOUR V15III WITH OUR ALLOY RE-BODY AND MICRO RIDGE STYLUS; INSANE? NO.
SOLID MARBLE PLINTH SYSTEMS® ALSO FOR EMT AND THORENS TD124.

SLATE AUDIO GARRARD 301 AND 401 ARE AVAILABLE COMPLETE OR MARBLE PLINTH SYSTEM® ONLY.
SME CELEBRATION ARMS WITH SPECIAL GRAPHICS "SLATE AUDIO 301 OR 401 CELEBRATION" AND "SLATE AUDIO TD124 CELEBRATION" 309 • 312 • IV • V.
THE TONEARM OUR SPECIAL VERSION OF THE FAMOUS REGA RB300, FITTED WITH GOLD PHONOS.
SME 3009S2 (1999 VERSION) A PERFECT MATCH FOR OUR V15III BRAZEN AND THE NEW SHURE V15V x MR. "STILL CRAZY AFTER ALL THESE YEARS".
THE SPIKEKIT SPECIALLY DEVELOPED TO FIT DIRECTLY TO FLOOR STANDING LOUDSPEAKERS OR ANY WOODEN SUPPORT ADJUSTABLE AND VERY SIMPLE TO FIT.

"THERE ARE NO PROBLEMS, ONLY SOLUTIONS"

SHURE STYLUS PRESSURE GAUGE • GARRARD 301 SWITCH SUPPRESSOR • TURNTABLE SERVICING • GARRARD 301 LEVER SET • GARRARD 301 FIXING BOLT SET
STROBE DISC • GARRARD 401 CONTROL PANEL SET • GARRARD 301 MOTOR PULLEY • FULL RESTORATION OF GARRARDS TO ORIGINAL CONDITION
ALWAYS WANTED, GARRARD 401, GARRARD 301 AND THORENS TD124 RECORD PLAYERS, PLEASE PHONE

47 GEMINI CLOSE, LEIGHTON BUZZARD, BEDS, LU7 8UD.

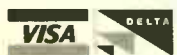

TEL/FAX: 01525 384174 MOBILE: 0956 471601



CASSETTE

DENON DRM-555

Denon adhere closely to the replay standards laid down for cassette. As a result, a recording made on their decks will transfer to a personal stereo, car player or any other player and work properly, providing the other player meets the standards too. The DRM-555 was no exception in terms of replay frequency response, meaning head azimuth and replay equalisation were both correct. Replay speed was +1.5% fast, but this is no disaster - most people will barely notice the error. Noise from the head and in the replay amps was low too.

Recording performance was adequate, if not wonderful. The head is a budget design and overloaded severely with metal tape and strong bass. Although decks like this work with metal tape, record levels must be kept to 0dB absolute maximum on the level indicator (set at Dolby flux). Trouble is, even then bass distortion hits 16%, measurement showed. Most users will probably find good ferric tapes like TDK AR best value, especially when there is a lot of bass, because the lower bias flux allows +4dB more signal level to be used. However, bass response was uneven due

to head contour effects so the DRM-555 will never excel in this region. Variable bias allowed flat frequency response to 18kHz or so, although there was little variation (2dB at 20kHz) with metals.

Similarly, the transport suffered erratic cyclic drift (low-rate wow) as the width of the peak in our speed stability analysis shows. This will make sustained piano notes seem unsteady and also dirty the sound with the paperiness of flutter.

The DRM-555 is a budget deck well designed and adjusted for its purpose. It does the best possible at the price. **NK**

REPLAY (pre-recorded tapes)

Frequency response (-2dB)	50Hz-18kHz
Speed accuracy	1.5% fast
Hiss (70uS, Dolby out)	-61dB

RECORDING (blank tapes)

Frequency response (IEC Primary Refs.)	
ferric (IECI)	55Hz-17kHz
chrome (IECII)	55Hz-18.6kHz
metal (IECIV)	55Hz-20kHz
Separation (1kHz)	51dB
Distortion (315Hz)	2.3%
Hiss (70uS, Dolby out)	-55dB
Speed variations (DIN total)	0.14%

Flutter energy (3-3.13kHz)	-17dB
MOL/SAT (IEC Refs)	315Hz/10kHz
ferric (IECI)	3.5dB/-4dB
chrome (IECII)	0dB/-2dB
metal (IECIV)	0dB/+2dB

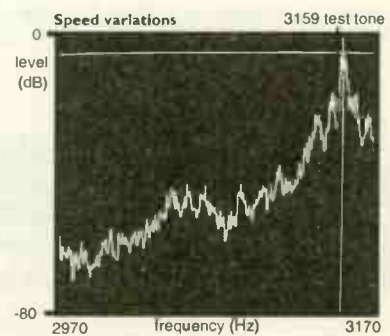
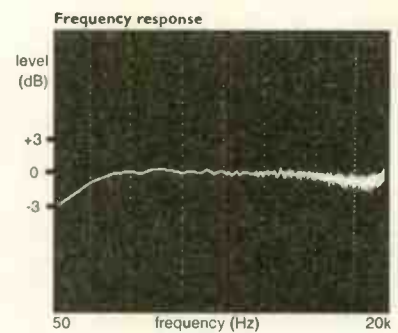

CARTRIDGE

ORTOFON 510 MKII

The original 510 had a rising response and a coarse-ish sound. The new MkII still has a treble rise of +5dB at 20kHz when tracking outside grooves and will sound bright. On inner grooves tracing losses, dependent upon stylus dimensions, measured -3dB at 20kHz. So the stylus is quite lossy and the 510 will change as it tracks in, sounding bright most of the time but slowly sounding more even toward inner grooves.

The cartridge is light at 5gms, meaning arm effective mass will be low and warp riding good. Tracking performance was exceptional at all frequencies; in this area the 510 was very impressive. It had correct vertical tracking angle too, and low overall distortion as a result. Channel separation was low at 22dB, as it always

is with Ortofon, but this is still adequate.

Another strong point was the enormous output of 6mV at 5cms/sec rms. This will ensure hiss is inaudible and help toward a clean, punchy sound.

The 510 MkII measured very well in most areas. It will still sound bright, except on inner grooves, and the stylus is likely to miss fine detail, but it will give sharply-defined images and preserve valuable records thanks to its superb tracking performance. As always, a nice piece of engineering from Ortofon. **NK**

Tracking force	1.5gms
Weight	5gms
Vertical tracking angle	22degrees
Frequency response	20Hz-20kHz
Channel separation	22dB

Tracking ability (300Hz)

lateral	90um
vertical	45um
lateral (1kHz)	25cms/sec.

Distortion (45um)

lateral	1%
vertical	1.5%

Output (5cms/sec rms)

6mV

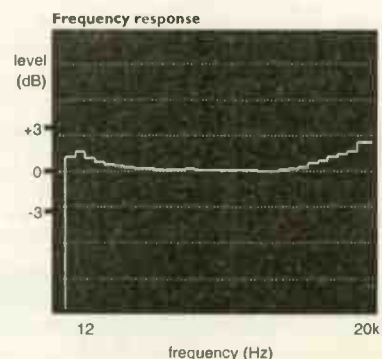

**THE MIDLANDS
BEST USED EQUIP-
MENT
SPECIALIST**

TEL/FAX 0121 783 8227



**QUALITY USED
EQUIPMENT,
BOUGHT, SOLD, PART
EXCHANGE**

**URGENTLY REQUIRED
LINN, NAIM,
MERIDIAN, QUAD
CASH WAITING**

	RRP£	NOW£
Audio Alchemy DDS3	700	250
Audio Research LS7	1700	850
Conrad Johnson PV10AL	1200	695
DPA Renaissance CD (Brand New Sealed in Box)	1000	650
EAR 509's Mk1 (full recent service)	3699	895
Epos ES14 & Stands	900	295
JBL L80T	1250	395
Jeff Rowland Model 1	3000	995
Linn LP12 Valhalla no arm	n/a	295
Linn Kan Stands MkII	n/a	50
Linn Kans Mk1 plus stands	n/a	195
Linn Karik/Numerik	3350	995
Linn LP12 Valhala Basik + K9	n/a	450
Linn Valhala Power Supply	200	95
Meridian 203 DAC	450	150
Meridian 557	1600	895
Meridian 601	2750	995
Meridian 602	1750	595
Micro Seiki CDM 2	2800	795
Micromega Duo B/S	500	195
Mission Cyrus Tuner MK1	n/a	95
Mission PSX Mk1	n/a	150
Musical Fidelity X10-D	130	70
Naim 02 Tuner	1130	695
Naim 135's	3410	1595
Naim 140 old style x2	770	350
Naim 32.5	n/a	250
Naim 82 plus phono	2307	1350
Naim 92	485	295
Naim Aro	1070	695
Naim CDI	1800	1095
Naim Nait 3	590	395
Naim SBL Black latest	2200	1095
Naim SBL Walnut	2200	895
Nuance Plenitude pre amp	n/a	295
Orlofon MC5000 boxed 25hrs	1500	495
Pink Triangle Export Rega RB300	1070	395
Pioneer PD95	2500	795
Revox A77 MK3 3 1/2" 7 1/2"	n/a	195
Roksan Xerxes Artemiz piano black	2500	795
Rotel RB 981	300	195
Rotel RC-970BX Phono Stage	130	70
Syrinx PU3	n/a	150

OPEN MON-SUN 10.00 TO 8.00 RING FOR FURTHER DETAILS TEL/FAX 0121 783 8227



**PROGRESSIVE
AUDIO**



2 Maryland Court, Rainham, Kent, ME8 8QY
Telephone / Fax No. 01634 389004
WEBSITE: www.progressiveaudio.co.uk
E-MAIL: dave@progressiveaudio.co.uk

We now have on permanent demonstration the following new products: PROAC Response 3.8 loudspeakers, the whole range of AUDIO SYNTHESIS products, the GRAAF GM 20 amplifier, the MUSIC FIDELITY NU-VISTA pre amp, the CADENCEARCA and latest CADENCE ES loudspeakers, DIAPASON loudspeakers, GOERTZ cables and TICE power conditioners and enhancers, the amazing INNERSOUND hybrids, PATHOS twin tower amp (stunning), PROAC Tablette 2000 and Studio 125 loudspeakers, AUDIONOTE Zero system, TUBE TECHNOLOGY CD players DNM pre and power amplifiers, Sugden MASTERCLASS CLASS A amplifiers and of course all our usual equipment. For any more information please call.

- Conrad Johnson NV55 Power amp £1,500.
- Proac Studio 150 Loudspeakers. Yew. Boxed. Mint. £1,025.
- Proac Response 2 Loudspeakers (Black) with Target R2 stands. Boxed. Mint. £995.
- Audionote SN 3 (Silver) MC transformer. Mint. £1,100.
- Mirage M3Si Loudspeakers. Boxed. Mint. £1,950.
- Pioneer Exclusive M6 300 Watt Class A mono blocks. Very rare. Boxed. Mint. Cost £8000 nine years ago. The pair £2,995.
- Tube Technology Prophet Pre amp and Genesis 100 Watt mono blocks. Boxed. Mint. £2,750.
- Genesis Digital Lens. Mint. £995.
- Monarchy 22 B DAC. 20 Bit Burr Brown. Mint. £475.
- SD Acoustics SD 1E Loudspeakers £1,995.
- Naim 72/Hicap/180 Newcase £1,550.
- Proac Response 3 Loudspeakers. (Mahogany) Boxed. Mint. £1,550.
- Proac Response 3.5 Loudspeakers. (Burnt Oak) Boxed. Mint. £2,850.
- Voyd Vald Turntable (Ash). RB300 Tonearm. Genz Micro Glider Cartridge. Absolutely Mint. £850
- Audionote CD 2 CD Player (One Year Old). £725
- Audio Innovations Series 1000 M/C Transformer. £185
- Audionote Level 5 E's. Ebony. Cost new £9,600. £2,995
- Densen DM10 Int. Amp. Boxed. mint. £750
- Audio Synthesis Desire Power Amp. Boxed. Mint. £1,295
- Audion Golden Knights 9W 300B. Boxed. Mint. £2,495
- Tube Technology Synergy 150W Integrated Amp (New) £5,250
- Harbeth HLP3ES (ExDem). Boxed. Mint. (Teak) £550
- Harbeth K6 (ExDem). Boxed. Mint. (Walnut) £725
- Acoustic Solutions "Eight" Loudspeakers (ExDem) Boxed. Mint. £795
- Muse Model 18 Active Sub Woofer (oak) mint condition £2250
- Gamma Aeon Mono Blocks very very latest specification. Mint Boxed 3 months old £3250 (new) £6000

TEL: 01428-651554

P.G. Hi-Fi

FAX: 01428-654592

**Buying & Selling Vintage HiFi, Valves,
Classical LP Records & Spare Parts.**

Quad

QA12P Amplifiers (Pair)	£0ffers
QCII Pre-Amps (x8) for spares or repair - the lot	£100
33/303	£120
QUAD 33	£50

Leak

TL12+ (Pair)	£300
Stereo 20	£250
TL12.1 (Pair)	£1300
TL25+ (single) Black	£150
Troughline 3 Mono	£30
Troughline 3 Stereo	£75
Stereofetic FM + Wooden Sleeve	£30
Stereo 30+ Amp' + Wooden Sleeve	£30

Valves (G E C Mullard etc.)

PX25, KT66, ECC81/84, EF80
Many Others.
Please Phone For Details.
CV378 (GZ37) Mullard £10 each

Most Models Of Leak Mono + Stereo Pre-Amps In Stock.

Garrard 401 (mint)	£120
Garrard 301/Goldring Arm + Plinth and cover	£275
Thorens TD135 II with Plinth + Cover (mint)	£200
UHER 4000 report IC automatic with mic' + mains adaptor/battery charger	£100
Radford SC2 pre amp	£70
Shure V15 III cartridge	£25
Nakamichi CR1E (mint)	£150

VALVE ALERT

**ORIGINAL MULLARD ECC83
LAST BATCH MADE IN UK
BLUE BOX - N.O.S.
£10 EACH INC P&P
FOREIGN ORDERS WELCOME
MINIMUM ORDER 10 VALVES**

servicing for Quad II + Leak Amplifiers
Photocopies Of Circuit Diagrams +
Vintage Hi-Fi Literature
Spare Parts For Quad +
Leak - Transformers etc.
Garrard 301 spares

AKG D190E MIC'	£20
Quad II mains transformer	£100
Quad II output transformer	£100
Quad II choke	£25

Please phone for details of other Quad/Leak/Garrard spares

Speakers

Leak sandwich speakers early type 15 ohms (pair) £75
Goodmans Axielle 8 drive units (pair) £25
Tannoy 12" direct radiator (single) £70
Tannoy 3LZ (cabinets only) very good condition £30
Tannoy 12" Monitor red drive units and crossover's (pair) £600
Sonab OA4 speakers (pair) £50
Tannoy 3838 15" professional drive units and crossover's £250
HPD 15" M/Golds (pair) £100
Tannoy speakers + drive units for sale please phone for details

Wanted

**Tannoy Speakers - Lancaster,
York, G.R.F. and Autograph.**

We specialise in natural sounding **dynamic audio systems** which use **valve**

amplifiers & high efficiency loudspeakers.

If dynamic effortless sound appeals to you give us a ring. If you prefer small, strained, wearing transistor sound don't bother...

Selected products from

Arcadia Audio Note BorderPatrol
Goldring Horning Living Voice SME

Used and Ex-demonstration equipment for sale	Offer	List
Audio Note DAC4 Signature	£2995	(£9,995)
Teac P500	£650	(£995)
Voyd The Voyd split phase, light ash	£659	(£2,195)
Audion Golden Night Single-ended 300B mono-blocks	£2200	(£4,500)
Border Patrol 300B SE 10W single-ended power amp	£1,700	(£2,500)
Helius Cyalene tonearm (Audio Note silver wired)	£800	(£1,799)
Helius Aureus	£125	(£375)
Selection of cables (Audio Note AN-B, AN-SPX, AN-V)	(please enquire for more details)	

Services

Audio innovations valve amplifier **repair, service and spare parts** (most parts available including replacement mains and output transformers) We can repair and service most makes of valve amplifier both vintage and modern, please call and enquire.

definitive audio

Telephone/Fax Brighton: 01273 276716
e-mail: definitive.audio@borderpatrol.demon.co.uk

SPEAKERS

ELAC 310i JET

Ribbon tweeters, when properly engineered, produce a ruler-flat frequency response. The JET's ribbon was properly engineered: apart from one small, narrow peak, it measured flat within 1dB to 20kHz - an exceptional result. It will almost certainly give smooth, clear treble free from artificialities or unpleasantness. It should also possess a sonority uncommon amongst conventional loudspeakers.

The mid/bass unit also measured flat and blends seamlessly into the tweeter without phasing problems. It has just a little bit of bass boost to add speed and oomph. Just as well, because downward extension was poor, the -6dB point being

a high 80Hz, so this loudspeaker does not produce low bass, even if it does look effective in this respect. It should be used close to a rear wall to raise bass output.

Sensitivity measured a reasonable 86dB sound pressure level from 2.8V input, but since impedance was low at 5ohms overall the ELAC was not especially efficient, drawing current to go

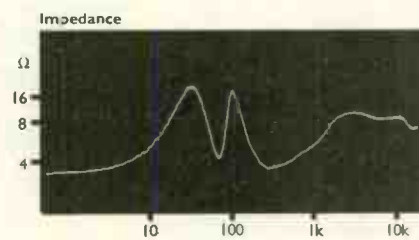

loud. It needs a good solid-state amplifier of around 60watts.

This unusual loudspeaker turned in a neat measured performance and is likely to display some interesting properties. NK

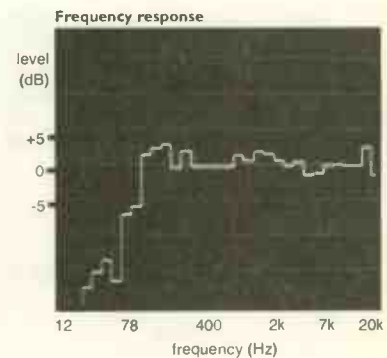

REL STRATA III

The Strata III can be adjusted to suit virtually any satellite loudspeaker and room. We used it with Diapason Karis loudspeakers. Measurement showed it extended response right down to 10Hz (-6dB), as our analysis shows. In practice we could get a flatter response through monitoring adjustments with our spectrum analyser, but we decided to publish instead the response dialled up subjectively. Not unsurprisingly, a little bass lift was chosen, which compensates for the

ear's falling sensitivity at very low frequencies, but all the same this is a very flat in-room averaged result.

Frequency response of the system ran flat (+/-3dB or so) down to 16Hz, so this combo would properly reproduce church organ and other ultra-low frequency effects. Conventional passive loudspeakers of any acceptable size cannot manage this. Since the subwoofer is not large and could easily be hidden, this is impressive. The REL offers true sub-bass. NK

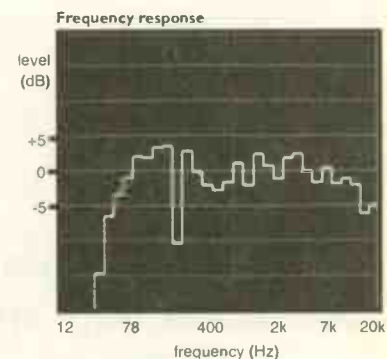

ALESIS M1

The M1 actives measured unusually well. Frequency response was academically flat, as our analysis shows, reaching 16kHz within 1dB, except at bass frequencies. There was no midrange crossover suck-out, nor any sign of one across a range of forward listening angles. This was a result of excellent driver integration from the active crossover.

The M1 was considerably better than a conventional passive loudspeaker in this area and, subjectively, the tight phase match adds weight and solidity to high-frequency transients like cymbals. Lack of a suck-out ensures good detail without the artificiality of treble lift, another good feature. Flat treble to 16kHz can result in treble hardness I have found, but this depends upon room acoustics and tweeter quality. Such a 'speaker will sound bright in a lightly-furnished, reflective

room, but normal in a heavily-furnished room with heavy curtains. If the tweeter is of high quality, as it seems to be in the Alesis (ie, not a peaky metal dome!) then bright treble is survivable.

Small-ish loudspeakers must have some bass lift for body and warmth; Alesis have used just the right amount, lifting output by +2dB down to 63Hz. Below this, bass output rolls off rapidly, measuring -6dB at 40Hz. Below this the ports take over, so the M1s go low from driver forward radiation, probably relying on a little active bass EQ to do so. So the M1s are unusually phase coherent, from low bass fundamentals up to high treble.

Sensitivity was high enough at full volume to deliver 110dB SPL at 1m from the peak output of a CD player. This is very loud, but below driver damage level and strikes me as very judiciously chosen.

Since the volume control would go to zero, the M1s can work direct from a CD player, but would need a pre-amp with a little gain (x7 for 300mV) for other sources.

With a silk-dome tweeter and carbon-fibre woofer, the M1s look very serious in every respect. Their measured performance was exceptional. NK

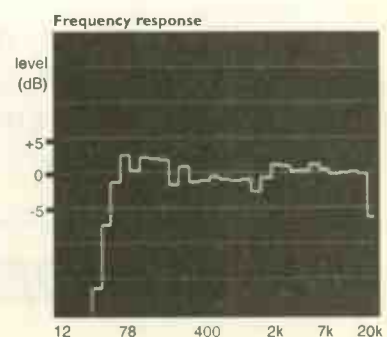

5 Rocks Lane Barnes
London SW13 0DB
Tel: 0181 876 3355
Fax: 0181 876 3399

THE
Hi-End



**Roksan Caspian Integrated
Amp + CD**

**£795 + £895 = £1690 or
£430 deposit and 9 x £140
(total payable £1690)**

**Sonic Frontiers
Anthem Integrated 2
£1799 or
£449 deposit and 9 x £150
(total payable £1799)**



AVI, ALCHEMIST, ANTHEM, BAYER, BOSE, BOULDER, CABLETALK, CASTLE, CHARIO, CITATION, ELECTROCOMPANIET, EXPOSURE, FINAL, GAMMA ACOUSTICS, GENESIS, HEYBROOK, JAMO, KEF, LINN, LUMLEY, MAGNUM DYNALAB, MARANTZ, MARSTON, MCINTOSH, MERIDIAN, MICHELL, MICROMEGA, MONARCHY, MYRYAD,

MAIL ORDER HOTLINE 0181 878 0066

0%

- ▼ Interest Free Credit
- ▼ On Selected items
- ▼ Subject to status
- ▼ UK only



Hi-End

We specialise in:

- Audio visual interior design.
- Multi-room installations.
- 'Life-style' systems.
- Systems from £300 to over £30,000.

For your convenience:

- All Major Credit Cards Accepted.
- Finance Arranged.
- 2 Demonstration Rooms.
- Open 9.00 to 6.00 Mon to Sat.
- 10.00 to 5.00 Sundays

CLEARANCE BARGAINS EX DEMO

Hotline: 0181 878 0066

	<u>Was</u>	<u>NOW</u>
Thorens TD180	£199	£145
Micromega Microdac	£499	£199
Monarchy Audio D18B	£595	£399
Marston Silhouette	£899	£649
Linn Classic	£995	£849
Gamma Rhythm	£2500	£2300
Michell Gyrodec RB300/OC3/Gyropower	£1320	£1099
Michell ISO	£420	£299
Michell Argo	£730	£549
Meridian		huge savings

STANDS

	<u>Was</u>	<u>NOW</u>
Alphason (5 shelf, black)	£470	£250
	£205	£185

SPEAKERS

	<u>Was</u>	<u>NOW</u>
Ruark Epilogues (cherry)	£280	£235
Lumley Monitor LM 2.5 (L. Oak)	£1750	£1500
Lumley Monitor LM 3.5 (Walnut)	£1050	£900
Totem mite 'T' (Mahogany)	£600	£550
Totem Rock (Mahogany)	£700	£650
AVI Bigatrons	£600	£560

PRECIOUS METALS, PRIMARE, PROJECT, ORTOFON, QED, QUAD, RESTEK, REVOX, ROKSAN, RUARK, SEQUENCE, SOUNDSTYLE, SONNETEER, SONICLINK, SENNHEISER, SONIC FRONTIERS, SME, STAX, TDL, TEAC, TOTEM, TRICHORD, TANNOY, TARGET, XANTEK.

WORLDWIDE MAIL ORDER + 44 181 878 0066

HI-FI WORLD

Classic Buying Guide

Cassette

Verdict

Yamaha TC-800GL

Early classic in serious cassette. It's ski-slope looks got it a cult following once it had ceased to be simply ugly.

CD Players

Verdict

Meridian 207
Pioneer PD-91

Beautifully-built two-box with pre-amp stage. Very musical although not as refined as modern Bitstream gear. No digital output. Built-to-last player with easy upgrade routes for the modifier. Not knockout as it stands but get one cheap and have a go!

Amplifiers

Verdict

Leak Point One TL12 & TL10
Leak Pre-amps
Leak Stereo 20
Leak TL12+
NAD 3020
Quad 33
Quad II
Sugden A21
PA Technics SE-A5 Mk2

Ancestors of Hi-Fi, consequently expensive nowadays. As with all vintage stuff, overhauling is de rigueur before use. Line of 'good for their time' pre-amps. Use of EF86 pentode for high gain rules out ultra performance. Not the highest-fi. Excellent workaday classic. In good order the 20 will not disgrace itself. Various upgrades are available from specialist repairers. Plentiful monobloc equivalent of Stereo 20. Reasonably inexpensive and a tweakers' dream. Genuine hi-fi on a budget. You can't argue with success! NAD's budget integrated gave thousands their first taste of hi-fi and remains great value. By no means a bad job and value for money. With its matching 303 pre-amp makes a good introduction to audio classics. One of the all-time classic mono amplifiers. Unusual circuit but it works beautifully. 22 pre-amp not up to today's standards. Seventies transistor integrated has an eminently likeable smoothness and musicality. Limited inputs via DIN sockets. Nice transformer and electronics, shame about the casework. With tweaking, this 150watter can sound sweet.



Leak TL12.

Loudspeakers

Verdict

Klipschorn
Leak Sandwich
Lowther PM6A
Magneplanar SMGa
Mission 770
Quad ESL57
Tannoy GRF & Autograph
Wharfedale Super 8 RS DD
Yamaha NS1000M
TannoyYork, Lancaster etc.

Not exactly plentiful or cheap but a splendid beast. For efficiency they have seldom been equalled. Space hungry! Rather warm sounding big infinite baffle but cheap with it. With reasonably powerful amp can sound quite satisfying. High quality full-range driver; still manufactured. High sensitivity, as fitted to many classic horn designs. Touch dry in the bass but a technological 'speaker with genuinely musical abilities. Usual warnings re: dipoles apply. Father of the 77 range which continues to this day. Well mannered with a warm sound and a kind load to amplifiers. Unrivaled. Properly serviced there is nothing like 'em. Their natural presentation may make them caviar to the general. Folded horn monsters which certainly sound good if you have the space. For Tannoy vintage see HFW November 1998. Ideal experimenters' driver. High sensitivity - 14,000 Gauss magnet and extended frequency range. Inexpensive too! Hi-tech favourites of the Japanese and Americans. Viewed more warily in the UK but can give excellent results. Many similar models of infinite baffle or reflex design. Not the last word in loudness but the drivers work well in modern cabinet.

Vinyl

Verdict

Acos Lustre
Alphason HR100S
Arlston RD11
Garrard 301 & 401
Goldring Lenco 88 & 99
Haddock 228
Linn Axis
Michell Focus One
Shure M75
SME 3009 IIS
Thorens TD124
Thorens TD150
Trio L-07D

Very honest piece of kit, well made and easily adjusted. Vinyl beginners could do very much worse. First class arm, up to present-day standards. Buy carefully, though, as there's no service available now. A one-time king of turntables very similar to the Linn LP12. Now deposited but worth a look at the right price. Legendary and fairly plentiful. Excellent back-up available; many different custom plinths available. High quality. Great deck for the kitchen table enthusiast. Garrard fans won't look at 'em but cheap and capable. Servicing available. Recently out-classed by Haddock's updated 228 Special Edition but a proper hi-fi arm for all that. Makers still service. Uncomplicated, lower-price version of the famous Sondek. Considerably less expensive than some of its stablemates. 20 years and still going strong. Early runner in the 'modern' turntable cycle with a first class arm. Factory servicing available. Recent line-contact improvements have left the M75 behind but the wide range of needles make it a handy tool. Everlasting classic tone-arm. Spares permanently available from SME. No longer the last word but peanuts second-hand. Best classic deck ever? Judging by the prices they fetch it's possible - 78rpm too! Mid-price deck with a keen following. No real difficulty with servicing - novices may find the suspension system unnerving. Knockout heavyweight from 1980 with stainless bearing and 11lb platter! Not a give-away and beware! - spares scarce.



Thorens TD124.

Tuners

Verdict

Leak Troughline (original)
Leak Troughline II & III mono
Leak Troughline III Stereo
Marantz ST-8

Interesting ornament but no longer hi-fi. Bandwidth limited to 88MHz to 100MHz only. Arguably the best-sounding tuners ever. Adaptation for stereo easy via phono multiplex socket. Excellent tuner with indifferent stereo decoding circuit. Best when adapted to use modern outboard decoder. Possibly the ultimate Tardis console, including an oscilloscope for checking the strength of signal. Expensive even now.

To advertise in the Buying Guide

Please contact Amanda Sweeney on 0171-328 2213
or Sarah Wrenn on 0171-328 4892

Or email us on edit@hi-fiworld.co.uk

SONNETEER

A · U · D · I · O · P · H · I · L · E

Campion
Byron Dryden
Sedley
Alabaster

It's time for a change...

p.o.box 163c, esher, surrey, kt10 0yh, england.

tel: +44 (0) 1372 468676

fax: +44 (0) 1372 470053

www.sonneteer.co.uk

- amplifiers - CD player - phono stage - dac -

R.J.F.

84 PENDARVES ST,
TUCKINGMILL
CAMBORNE
CORNWALL
TR14 8NJ
TEL: 01209 710777

AUDIO-VISUAL

NEW ITEMS

Denon AVD-2000, best buy for home cinema	£380.00
Denon DVD-3000, best buy for home cinema	£650.00
Denon - full range available	£POA
Neat Acoustics - full range available	£POA
Ortofon cartridges - full range available	£POA
Seleco SVP 350, AWARD WINNING CRT PROJECTOR	£3,500.00
Sharp XV-C20E LCD projector	£1,350.00
SME 20/2 precision turntable	£POA
SME 20/2A as above with series V arm	£POA
SME series II model 3009 pick-up arm	£POA
SME series 300 model 309 pick-up arm	£POA
SME series IV pick-up arm	£POA
SME series V pick-up arm	£POA
TDL Loudspeakers - full range available	£POA

We are Dealers for a good number of audio brands including PA and studio equipment. Please contact us with your requirements.

DVD, LASER DISC AND PROJECTION SYSTEMS NOW AVAILABLE

Consult us for your high (or low) end repairs/mods, CD re-clocking, LASER DISC AC3 UPGRADES - PIONEER, SONY, PHILIPS, DENON. We are valve and transistor specialists. Specialist cables supplied and made to order.

DUE TO THE ADVENT OF TRICHORD CLOCK III WE NOW HAVE A NUMBER OF CLOCK II UNITS FOR DISPOSAL. WE CAN OFFER THESE FITTED TO YOUR CD PLAYER OR TRANSPORT AT £110.00 INCLUDING RETURN CARRIAGE.

ORIGIN LIVE TURNTABLE KITS Standard & Ultra

Now you can save money and build your own high performance deck. The standard kit version is offered at £145, and the ultra version at £279. Both decks come with a full set of drawings and guidance instructions. The kit allows for your creativity or there are optional parts that will enable you to assemble a tried and tested design within 1-4 hours. This is probably the easiest kit you will ever make.

"this Vinyl font end had my jaw heading towards the floor with the solidity and transparency of the music it was making"...
"the standard came up with crystal clear images set in a broad sound stage"...
"With all these goodies in place, the standard would give turntables at the £1200-£1400 mark a hard time."
HI-FI WORLD SUPPLEMENT NOV 97

"is exceptionally easy to build and professional in both sound quality and appearance"
HI-FI NEWS SUPPLEMENT NOV 97

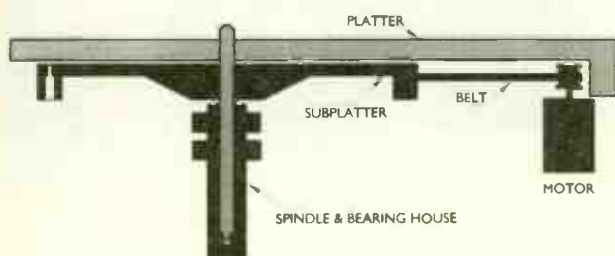

TURBOCHARGING YOUR REGA ARM

"Nothing less than total dynamite!"

HI-FI WORLD, FEB 1999

If you are the proud owner of any Rega arm, why not utterly transform it into the league of super arms with the Origin live structural modification: - £75 inc post & packing. This modification will enable your Rega to perform at a level exceeding that of arms costing over £1200. Internal rewiring with high grade litz cable is also offered at an additional £70.

"I have to say the Rega modifications turn this humble arm into a real Giant killer. Gone is the rather grey, sterile sound of the cooking Rega. Instead, tonal colour is fresh, dynamics have great speed and impact, and the sound stage is huge." HI-FI WORLD SUPPLEMENT NOV 97 (structural modification only to a RB250) WHAT HI-FI Sept 98 gave this modification a 5 star rating.

For arm modifications we normally return your arm in 2-3 days

CROSS SECTION OF ARM END

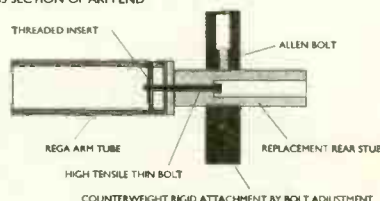

For further information contact:-
Origin Live, 87 Chessel Crescent, Bitterne,
Southampton, SO19 4BT
Tel: 01703 578877 / 442183 Fax: 01703 398905
Email: origin.live@virgin.net
web site: <http://www.originlive.com>

Cable Talk

Interconnects & Speaker Cables

1994



Best Speaker Cable

1995



Best Interconnect & Highly Recommended Speaker Cable

1996



Best Interconnect & Best Speaker Cable

1997



Best Speaker Cable & Highly Recommended Interconnect

Interconnects Speaker Cables

Doesn't Your System Deserve The Best?

FOR FURTHER INFORMATION

Please telephone, fax or write to

Cable Talk,

Unit J, Albany Park, Camberley, Surrey, GU15 2PL

Tel (UK ONLY): FREEPHONE 0808 - 100 - 6868

TEL: (+44) (0) 1276 686717. FAX: (+44) (0) 1276 686353

(CT HFW 07/99)

Audio Designs of East Grinstead

Mail Order and Export Service

PRODUCT	STATUS	WAS	NOW	PRODUCT	STATUS	WAS	NOW
Arcam Xeta 2	XD	399.90	299.00	Linn Majik Phono	SH	800.00	399.00
Arcam Alpha 8 CD	XD	499.00	339.00	Linn Tune Box	XD	-	689.00
Arcam AV50	XD	699.00	549.00	Linn Kudos module	SH	500.00	300.00
ArcamMCD	XD	449.00	379.00	Linn AV5103 Processor	XD	4850.00	3250.00
Castle Eden	XD	499.00	399.00	Linn AV-5105 Amp	XD	1200.00	960.00
Castle Avon	XD	729.90	579.00	Mission 754F	XD	1298.00	699.00
Cyrus DAD1	New	398.00	299.00	Naim Intro	XD	680.00	565.00
Cyrus PSXR	XD	328.00	289.00	Naim AV1	XD	1730.00	999.00
Cyrus AV Master	New	698.00	299.00	Naim32.5	SH	-	199.00
Epos ES12	New	550.00	465.00	Naim 92/90	XD	945.00	805.00
Epos ES22	XD	1350.00	1080.00	Naim 92/90	SH	945.00	499.00
Epos ES30	XD	2550.00	1899.00	Pioneer VSA E06	XD	999.00	779.00
Linn Arkiv	XD	1000.00	499.00	Quad 77 Remote	XD	299.90	149.00
Linn Ekos	SH	1500.00	900.00	Rel Storm	XD	695.00	595.00
Linn LK240	XD	750.00	525.00	Sennheiser Lucas Processor	XD	160.00	129.00
Linn Kaim (phono/brilliant)	SH	1750.00	825.00	TDL Studio 1	SH	-	199.00
Linn Kaim (phono)	SH	1750.00	699.00	TAG McLaren CD20R	XD	1250.00	999.00
Linn Karik III	XD	1850.00	1200.00	TAG McLaren 601	XD	799.00	649.00
Linn Karik III	SH	1850.00	1099.00	TAG McLaren PA10	XD	849.00	679.00
Linn Numeric (brilliant)	SH	1500.00	950.00	TAG McLaren 601RV	XD	999.00	799.00
Linn Mimik	XD	875.00	599.00	TAG McLaren 60P	XD	849.00	679.00
Linn KaberActive(inc. active cards)	XD	2375.00	1399.00	TAG McLaren 100P	XD	1099.00	879.00
Linn Kaber Passive	XD	2150.00	1299.00	Yamaha DSP-A1	NEW	1599.00	1299.00
Linn Klout	SH	2400.00	1299.00	Yamaha DSP-A2	NEW	999.00	745.00
Linn Kudos	SH	775.00	399.00				
Linn Kudos	XD	775.00	465.00				

Constantly changing stocks
please call with your requirements

Authorised Stockists of: ARCAM, AUDIOLAB, CASTLE, CHORD CO, CYRUS, EPOS, LINN, MARANTZ, MERIDIAN, MISSION, NAIM, PIONEER, PROAC, QUAD, REL, ROTEL, RUARK, SOUNDSTYLE, STANDS UNIQUE, TAGMCLAREN, TARGET, YAMAHA & MORE

26 High Street, East Grinstead, West Sussex, RH19 3AS
Open Mon-Sat 9.30 - 6.00 Tel: 01342 314569/328065

Oxford Audio Consultants HI-FI SPECIALISTS

WE'VE MOVED RIGHT NEXT DOOR TO
MUCH BIGGER PREMISES WITH SUPERB
PURPOSE BUILT DEM ROOMS



NOW DEMONSTRATING

SONUS FABER AMATI HOMAGE - a sensational world-beating product from our favourite Italian company - a full scale floor standing GUARNERI that we've prayed for for ages - we've actually got them now and wow!!!

KRELL KPS25 CD PLAYER - THE NEW REFERENCE - we become more and more impressed as each day goes past; it is just outrageously good!

B&W NAUTILUS 800 SERIES - WE ARE VERY PROUD TO BE A PREMIER RETAILER OF THIS MOULD-BREAKING RANGE FROM £1400 TO £8500

NAIM AUDIO CDS MK 2 - a sensationally good CD PLAYER for the money - audition an absolute must!

KRELL FPB POWER AMPS - the new range is out - audition a must!

VIDIKRON HELIOS PROJECTOR - PINAFARINNA LOOKS & PICTURE

DAVIS DL450 LITEBEAM PROJECTOR - fantastic value for money!!!

MUSICAL FIDELITY NUVISTA POWER AMP - a perfect match for the preamp

NAIM 82/250 - a top quality British products both in terms of build and sound

SONUS FABER SIGNUM - a replacement for the wonderful MINIMA AMATOR at £1249

MUSICAL FIDELITY X RAY CD, X-A1 AMP & ALL OTHER X SERIES - superb value for money

PIONEER 717 DVD PLAYER - SETS THE DVD STANDARD AT THIS PRICE POINT

THETA 'DAVID' & 'VOYGER' - STATE OF THE ART PRODUCTS

AUDIO ANALOGUE PAGANINI CD PLAYER - staggering build quality and unrivalled sound; on dem at last after a long wait

YAMAHA DSP A1 - a stunningly good home theatre package

MARANTZ CD17/P17/ST17 TUNER K.L. SIGNATURE SERIES - hear how good it is.

KRELL 250P PREAMP & 250A POWER AMP - incredible value for money

- just ask for a dem

CABLES & ACCESSORIES FROM TRANSPARENT, SILTECH, CABLE TALK, NORDOST, SOUNDSTYLE, TARGET, KONTAK etc.

GM AUDIO EQUIPMENT TABLES - THE ELITE - now even better looking and superb value

COPLAND CD266/271/288 CD PLAYERS - all superb value for money from this very

impressive company; now joined by the CSA28 amplifier

MAIL ORDER INTEREST FREE CREDIT NOW AVAILABLE

EX DEM & P/EX BARGAINS

PASS LABS X150 POWER AMPLIFIER	£5995	SH
NAIM 102 PREAMPLIFIER/N.A. PSC PSU	£895	SH
KRELL KRC 3 PREAMPLIFIER	£2250	SH
NAIM 180 POWER AMPLIFIER	£850	SH
WILSON SYSTEM FIVE EX DEM	£10995	XD
AUDIO RESEARCH SP14 PREAMP BLACK	£995	SH
MUSICAL FIDELITY F16 POWER AMP	£1395	XD
LEXICON DC1 AC3/DTS - LATEST VERSION	£1500	SH
AUDIO ALCHEMY DDS 3	£295	SH
UNISON RESEARCH SMART 845 - our demonstrators	£2595	XD
MICHELLE ARGO HR PREAMP	£795	SH
MERIDIAN 500 CD TRANSPORT	£695	SH
DCS ELGAR DAC	P.O.A	
EXPOSURE 17/18	£685	SH
COUNTERPOINT SA100 POWER AMP	£295	SH
MICROMEGA STAGE 1	£200	SH
KRELL FPB600 POWER AMP	£9995	XD
CASTLE HOWARD SPEAKERS LIGHT OAK EX DEM	£695	XD
EPOS ES14 SPEAKERS	£250	SH
KRELL REFERENCE 64	P.O.A	
LINN LP12	P.O.A	SH
NAIM CDI CD PLAYER	£1095	SH
NAIM 92R PREAMPLIFIER	£495	SH
NAIM 22 PREAMPLIFIER	£95	SH
ORELLE XTC PRE 1 PREAMP	£495	SH
THORENS PRE/POWER	£595	SH
YAMAHA DSPA590	£100	SH

0% INTEREST FREE CREDIT

Licensed Credit Broker

Agencies include: Audio Analogue, Air Tangent, Audiogram, Audio Research, Audio Technica, B&W, Cable Talk, Castle, Copland, Denon, Goldring, Harmonix, Heybrook, Jamo, Jadis, Koetsu, Krell, Lexicon, Lyr, Marantz, Martin Logan, Michell, Musical Fidelity, NAD, Naim, Onkyo, Ortolon, Opera, Pioneer, Proac, Proceed, Projekt, QED, QUAD, REL Subwoolers, Rotel, Sennheiser, SME, Sonus Faber, Stax, Target, TEAC, Theta, Thorens, Transparent Cables, Unison Research, van den Hul, Vidikron, Wilson, Yamaha.

TAX FREE EXPORT SERVICE
MAIL ORDER AVAILABLE ON MANY ITEMS

Open Mon-Sat 10am-6pm

Oxford Audio Consultants

Oxford Audio Consultants, Cantay House, Park End Street Oxford OX1 1JD

Telephone: Oxford (01865) 790879 Facsimile: Oxford (01865) 791665

E-MAIL: Oxford.Audio@btinternet.com

AUDIO ILLUSION

23 Langley Broom

Langley

Berks SL3 8NB

TEL: (01753) 542761 FAX: (01753) 772532

OPENING HOURS:

10am - 8pm Monday - Saturday (By appointment)



SUMMER SALE

*Mail Order Service * Export Facilities: * All Major Credit Cards Accepted

★ MASSIVE REDUCTIONS!!! ★

		NEW SALE
ACURUS DIA 100 Integrated Amplifier	Mint Ex. Demo	£1100 £599
ACURUS A100 100w Stereo Power Amplifier	Mint Ex. Demo	£650 £399
CLASSÉ CP-50 including Phono. Fully Balanced Remote Preamplifier (Black)	Mint Ex. Demo	£3190 £1995
CLASSÉ CAP-151 150w Integrated Power Amplifier Balanced. Remote (Silver)	Mint Ex. Demo	£2080 £1295
CLASSÉ CA-200 200w/500w Balanced Stereo/Mono Switchable Power Amplifier (Black)	Mint Ex. Demo	£3000 £1995
CLASSÉ CA-300 300w/1100w Balanced Stereo/Mono Switchable Power Amplifier (Silver)	Mint Ex. Demo	£4250 £2750
CLASSÉ CDP5 CD Player, Balanced with HDCD (Silver)	Mint Ex. Demo	£2000 £1275
COUNTERPOINT SA 20 220w Valve Hybrid Power Amplifier	Mint. S/Hand	£3080+ £995
EAD CD 1000 20 Bit HDCD CD Player	Mint S/Hand	£2000 £1095
KORA D30 30w Pure Class A Integrated Line Tube Amplifier	Mint Ex. Demo	£1850 £1150
KORA D50 50w Pure Class A Integrated Line Tube Amplifier	Mint Ex. Demo	£2700 £1795
KORA 100SB Pure Triode Monoblocks + Bal & S/E Inputs & Resonance Tuned Chassis	Min Ex. Demo	£5350 £3795
LINN INTEK Integrated Amplifier	VGC S/Hand	£175
MARK LEVINSON no. 27.5 Power Amplifier	Mint S/Hand	£5400 £2595
MIRAGE:-		
M-290 2-Way Audiophile Compact Monitors	Mint Ex. Demo	£400 £225
M-390is 2 Way Tuned Vent Floorstander (Black Ash)	Mint Ex. Demo	£550 £295
M-490is 2-Way Tuned Vent Magnetically Shielded Floorstander (Piano Black)	Mint Ex. Demo	£650 £375
REGA Planet CD Player with Remote Control	Unused	£500 £399
TEAC VRDS 10 CD Player	Mint S/Hand	£770 £399
HOME CINEMA		
CLASSE CAV-150 Multi Channel Switchable Power Amplifier, 3,4,5 or 6 Channels (6x150w - 3x300w) Balanced and S/E Inputs (Silver)	Mint Ex. Demo	£3600 £2495
EAD Theater Master Encore AC-3 & DTS Processor/ Preamplifier (Silver)	Mint Ex. Demo	£3000 £1995
EAD Theater Vision Ultimate NTSC Laserdisc Player, AC-3 Output Finished in 2ert Gold. *No 1 of only 5 ever made in Gold - Unique*	Mint Ex. Demo	£6100 £2800
RCE 3001 CRT Projector	Mint Ex. Demo	£4000 £2650

Information available on the following:-

acurus: AERIAL ACOUSTICS

Barclay : Cairn : Classé Audio

EUPHONIA ISOLATION DEVICES

RENAISSANCE AUDIO

KORA MIRAGE

For your nearest stockist contact AUDIO ILLUSION

Sound of Music

93/95 Nantwich Road, Crewe, Cheshire, CW2 6BA
Open Mon-Sat 10am-5.30pm Tel: (01270) 214143

Products:

LINN, KEF, Musical Fidelity, PRIMARE, Roksan, J A Michell, Pro-ject, AVI, TEAC, Onkyo, NAD, Boston, REL., Ortofon, Dynavector, Nordost, IXOS, Straight Wire, Stands Unique, Aavik Furniture, Projekt Furniture, Quadraspire, Target Audio, Tannoy, LOEWE!

For a full Demonstration of any of these products please contact Steve at our showrooms!

The products listed below are all Ex-Demonstration. A small charge will be incurred for Mail Order.

	WERE	NOW
TEAC DRIVE/DAC	£1,050.00	£750.00
J.A. MICHELL MYCRO TURNTABLE + RB300 ARM	£601.00	£450.00
MUS FID A2 INTEGRATED AMP	£500.00	£385.00
MUS FID E10 INTEGRATED AMP	£300.00	£180.00
BOSTON SOUNDBAR HOME CINEMA	£600.00	£300.00
BOSTON CR6 LOUDSPEAKERS	£150.00	£90.00
JOHN SHEARNE PHASE 2.5 INTERGRATED	£500.00	£295.00
JOHN SHEARNE PHASE 3.5 POWER AMP	£500.00	£295.00
KEF RDM 2 LOUDSPEAKERS	£700.00	£450.00
ALCHEMIST CDP CD PLAYER	£580.00	£235.00
ALCHEMIST KRACKEN POWER AMP	£550.00	£235.00
T&A RECEIVER	£1,400.00	£825.00
ROKSAN ROK ONE SPEAKERS	£500.00	£355.00
BLUEPRINT POINT ONE SPEAKERS	£1,000.00	£600.00
RMS WALL SUPPORT	£550.00	£430.00
NORDOST RED DAWN SPEAKER CABLE 4M PAIR	£969.95	£640.00
SYSTEM AUDIO 1150 SPEAKERS	£750.00	£495.03
LOEWE CALIDA 33" 4:3 100Hz TV	£1,500.00	£1,075.00

AUDIO MATTERS

NEW EX-DEM & PART EXCHANGE EQUIPMENT FOR SALE

	LIST	SALE
Alchemist Forsetti pre + power	£2398	£POA
Alchemist Kraken Anniversary MkII	£579	£POA
Anthem CD player (5 star What Hi-Fi)(ex/d)	£1699	£1250
Apogees ribbon monitors (new & ex/d)	£999	£699
Audiomeca Mephisto CD transport	£2400	£1250
Audio Research SP14 pre (boxed)	£3300	£1095
Audion Black Shadows 845 valve monoblocks	£4000	£POA
Audion Silvernight 300B monoblocks	£2250	£POA
Chario Academy 1 solid walnut (ex/d)	£1299	£800
Chario Academy 2 solid walnut (ex/d)	£1649	£1100
Chario Academy 3J (ex/d) floor standing solid walnut speakers	£5999	£2699
Conrad Johnson MV55 valve amp	£1995	£1195
Ear 859 pwr	£1700	£750
Ear 834L pre	£449	£235
Genesis Gen 500 spks in built active bass (ex/d) SUPERB	£11000	£6499
Genesis Amp1 spk (ex/d)	£9000	£3999
Krell Kav 3001	£2495	£POA
Krell Kav 250A	£3149	£2149
Macintosh C26 pre	-	£395
Macintosh 2100 (looks like 275)	-	£450
Micromega T drive & T DAC & XLO cable	£2150	£999
Nakamichi 1.5 cassette	-	£200
Nakamichi LX5 cassette	-	£350
Quad 77 Int. Carbon	£700	£450
Restek 6ch pwr amp	£900	£595
Revoe H1 cassette	£1150	£650

Wazoo integrated amp from Bow Technologies now on Dem

A NEW RANGE OF AUDION AMPS ON DEM - THE BLACK SHADOWS 845 TO THE GOLDEN DREAMS - WITH CADENCE ES MK II'S - LISTEN & BE PERSUADED

ON DEM - Alchemist, Anthem, Audiomeca, Audion Valve Amps, Cadence Spks., Chario, D.P.A., Monarchy, Ortofon, Pink Triangle, Project T-T, Sonic Frontiers, Triangle Spks., Trilogy Valve Amps, Vand den Hul.

VISA/MASTERCARD ACCEPTED

HI-FI WORLD CLASSIFIED ADS PRIVATE

Dealers must not advertise in the Private Classified section. Monthly consecutive insertions will be considered Trade advertising. The Publisher reserves the right to judge submissions.

SPECIAL
INTERNET
OFFER SEE
PAGE 162 FOR
DETAILS

QUAD ESL 63's £950, CD67, £450. 33 pre & 303 amps conv. Academy Sound £300, Garrard 401 & Decca MkII arm & two heads, £250. Two Leak Troughline tuners & one decoder (Tim de Paravacini) £400. Tel: 01274 667 347 (Jul/I)

AUDIO RESEARCH LS2B, boxed, as new £1300 ovno. Rotel Michi RCM-10 preamp £200. Audio Research DI25 new valves etc £1200. Krell KSA 100S, 1994 £2700. Audio Research SP9 MkII, as new £900. Audio Research Classic 60, ex. condition £1350. Marston Silhouette DAC/PSU, brand new £700 ono. Marston Silhouette CD player, new £450. Nakamichi CR7E cassette deck, as new £850. Audio Research LS7 preamp, as new £850. Tel: Jules 01792 280 061 (Jul/I)

MERIDIAN 551 preamp £450. Meridian poweramp 555 £400. Meridian 206B CD player £300. All mint condition. Tel: 01506 412 808 before 3pm (mobile after 5pm 0468 894 167 (Jul/I)

MARANTZ CD17-KI £850, Exposure 21 preamp £690, Exposure 18 super monoblocks £1350, Studio 2 SE 'piano lacquer' £450, REL Stentor II subwoofer 'Rosenut' £1390, Meridian 541 Analogue surround sound processor £450, all have boxes, manuals, guarantees. Tel: 0973 899 651 or 01622 844 556 (Aug/I)

NAIM HI-CAP New style, Dec 96, boxed, excellent condition £500. Tel: 01473 785 659 (Jul/I)

MARK LEVINSON ML-3 power amplifier(s) x 2 available. Late model (& damping circuits) consecutive serial numbers, 'matched pair' for bi-amping. Enormous power reserves. True TAS super amps. Either £2500 each or £4000 the pair. Tel: Dave Burton 01895 274 001 (daytime & evenings) (Jul/I)

AERIAL 10T speakers plus stands, plus Audio-Point 'footers', plus hoods, plus piano-lacquer black finish. Stereophile 'product of the year'. 'Fi' 4-star rated. £3000 ono (over £7000 new). Tel: Dave Burton 01895 274 001 (daytime or evening) (Jul/I)

STRATOSPHERE Turntable upgrade, Standalone Reference power supply, plus independent motor unit. Make 'the best' better. £560. Tel: Dave Burton 01895 274 001 (daytime or evening) (Jul/I)

ELECTROMANIET ECI-2 integrated amplifier, high end bargain. Bold and fluid, near mint. Nordic beauty. Any trial. £550. (£1000 new). Tel: 01308 868 044 (Jul/I)

TARA LABS Master Gen2 1m RCA £250, Wadia 21 CD player, digital volume control, £1995 (£5500 new), Wilson Watt 5/Puppy 2, gloss black, accessories, £6995, all equipment mint. Tel: 01449 676 335 (Jul/I)

NAIM SYSTEM CD CD player, NAC82/NAP180 pre/power, 2 Hi-Caps, SBL speakers (latest bass/midrange units). Half cost of units new £4200 ovno. Genuine reason for reluctant sale. Tel: David Freeman 01256 328 117 (Jul/I)

CAT SLI Mk2 phono valve pre, plus Counterpoint SA4 valve power amps (120W). Beautiful sounding combination, only £3500 all together. Tel: 01784 458 176 (Staines) or 0468 476 315 (Aug/I)

MERIDIAN 200 CD transport, 203 DAC, remote control 201 pre/amp. 1 pair Meridian M60 active speakers, 1 pair M60C active centre speaker. Too large for new house, sounds fab, £2300 ovno. Tel: daytime 0171 281 6155, evenings after 6pm 0181 352 1740 (Jul)

CASTLE CHESTER loudspeakers, mahogany, £285. Denon DCD1700 CD player, heavyweight build, would make good transport (£650 when new) £200. Monarchy Audio DAC £300. CD and DAC together £450. All excellent condition, boxes, manuals. Tel: 0171 473 3818 weekday evenings, 01844 216 706 weekends (Jul/I)

LEAK POINT One stereo amplifier (bronze), matching pre amplifier Varislope Stereo Plus. Troughline II tuner (mono) all refurbished to the highest standard (including transformer rewind £385. Nakamichi 680 mint (yes, mint!) hardly used with owners manual £360. Technics ST3500 classic tuner £40 mint. Hi-Fi magazines 600+, late 1960s to 1999 vgc. Weight 240kg bulk 10cf. Offers please. Tel: 01392 860 182 evenings (Jul/I)

LINN VALHALLA power supply £50, Naim 5 pin Snaic £15. Naim 72 variable input boards £25, Quad FM3 £65, Rotel 820L tuner £30, AR 18s speakers £30, Technics SUV3 amp £20. Tel: 01722 334 694 (Jul/I)

LOWTHER PM7A drive units, excellent condition UKP250/pair. c/w 2 Acousta cabinets (not exact pair). Tel: 0181 541 0337 hifi@morf.demon.co.uk (Jul/I)

QUAD ESL63 electrostatic speakers. natural ash/brown excellent condition £995. Gradient active crossover, £250. REL Srata II subwoofer, as new, boxed, £325. Leak Troughline 3 Stereo tuner, excellent condition £125. Tel: 01978 780 580 (Jul/I)

AUDION 300B Silver Knight valve monoblock power amps. Mint. Boxed £1000 ovno. Individually designed folded horn pair. (Black) PM6A's slot super tweeters. Offers invited. Volt, Skanspeak drivers. Offers. Tel: 01922 402 320 (Jul/I)

QUAD ELECTROSTATIC ESL 57 speakers. Bronze mid 70s. light domestic use only. Hardly marked £300. Tel: 01654 781 246 (mid-wales) (Jul/I)

SD1 ('really successful, big speaker performance' HFA) 3 way floorstanding speakers £375 (£1200); Early AR turntable £50; part-exchange Snell J, top pre amp, Stad S, Edison 12, SME 309? Tel: 01273 773 546 (Jul/I)

WANTED: VAN Den Hul The First and/or The Second interconnects. Tel: Paul 01603 410 828 (Jul/I)

AUDIO TECHNICA AT0C9, brand new and unused. Bought for spare, but progressive disability has compelled change to CD. Last RRP about £300. Sensible offers please. (superb cartridge). Tel: 01425 276 671 (Jul/I)

MUSICAL FIDELITY MVX pre-amp. Musical Fidelity A370 power amp £1200 combination only. Apogee Centaur Minor speakers with matching stands £650. Tel: Graham 0181 423 0900 (Jul/I)

STAX NOVA Basic electrostatic phones with SRM-XH energiser /amplifier (latest excellently reviewed models) as new and boxed £225 (ie 1/2 original price). Tel: 01923 821 204 (Middx) or email: c@2reedfreeserve.co.uk (Jul/I)

QUAD ELECTROSTATIC ESL 57 speakers. Bronze. Mid 70s. Light domestic use only. Hardly marked £300. Tel: 01654 781 246 (Mid Wales) (Jul/I)

MICHELL MYCRO. Rega 300 £270. Naim 140 power £300. Naim 62 pre MM phono £125. Naim Nait 2 MM phono £199. Rega Ela II black £199. Naim NAC A5 cable 2X5 metres £30. Buyers collects. Tel: 01634 363 374 (Kent) (Jul/I)

SMALL CAN BE THE BEST

As a small independent dealer we are able to give a more personal, honest approach to customers. But equally we mainly search for those pieces of equipment which are out of the ordinary and offer something that the more mass produced products that shops sell can't match. Invariably this means the smaller British firms such as AVI, whose range of electronics including integrated amp, Pre-amp, Monoblocks, CD Players and Tuners have recently been supplemented by an exciting range of speakers - The 'Trons', starting with the diminutive Nu-Neutron to the Bigatron, Positron and Gravitron. Can any new range of speaker's have received such a rave reviews in so many magazines in such a short time? All the AVI products are realistically priced and make superb complete systems, so do call if you would like a demonstration. Another British amp that has also recently impressed us is the new Michell Orca/Alecto plus the replacement for the ISO, namely the Delphini, which includes an outboard power supply plus ability to switch gain, impedance and capacitance. While the Alecto Monoblocks are excellent, they do cost £1989, while the stereo amp at only £1150, produces less power but never seems short of real impact, and makes an excellent buy.

SALE ITEMS - SEE MAY ISSUE - SOME ITEMS STILL AVAILABLE

Selco SVP350 Video Projector (Ex-Demo) £3300 (inc. fitting)
Selco SVT195 Video Projector (S/H) £2000 (inc. fitting)
Mission 767s (Out Board X-over) New £2600, (S/H) £1400

V'audio Hi-Fi Consultants
36 Druid Hill, Stoke Bishop, Bristol BS9 1EJ
Tel / Fax: 0117 968 6005

WANTED

HI-FI & accessories any make, any age

BUY · SELL · TRADE

NOTHING LEGAL REFUSED!

Please bring official ID with address & signature when selling or exchanging

MUSIC & VIDEO EXCHANGE

56 Notting Hill Gate, London W11
☎ 0171 792 3474

480 Fulham Rd (Broadway), London SW6
☎ 0171 385 5350

95 Berwick St, Soho, London W1
☎ 0171 434 2939

MVE, Manchester Arndale Centre (near High St entrance) ☎ 0161 839 0677
OPEN 7 DAYS

LARGE SELECTION ON SALE

ALSO BUY, SELL, TRADE MUSICAL & PHOTOGRAPHIC EQUIPMENT

UNIVERSITY AUDIO

SALE 3 Peas Hill Cambridge CB2 3PP **SALE**
01223 354 237

	WAS	NOW
AVI S2000 DAC	449.00	299.00
AVI S2000 Pre/Phono	1199.00	599.00
Arcam Xeta 2	499.00	299.00
Arcam Xeta 1	499.00	299.00
ATC SCA 2 Pre	2599.00	1999.00
ATC SPA-150 POW	2699.00	1999.00
ATC SC1A2/150	1984.00	1595.00
ATC SCM 10	999.00	799.00
ATC 20SL Tower Active	4249.00	3799.00
ATC 50SL Active	5875.00	4499.00
ATC Stands	350.00	249.00
Cyrus AV Master	698.00	299.00
Cyrus Disc/DAC Master	1790.00	950.00
Linn Kairn Line	1400.00	799.00
Linn Kairn Phono	1700.00	999.00
Linn Majik Phono	800.00	499.00
Mission Active Sub	299.00	249.00
Monitor Audio Act Sub	499.00	299.00
Monitor Audio CC900	499.00	249.00
Yamaha DSP E1000	699.00	349.00
Yamaha DSPA 592	330.00	249.00

ALL ITEMS ARE EX-DEMONSTRATION
MAIL ORDER ADD £10.00

Used and Ex-Demonstration Equipment

Equipment	Description		New	Sale
Micromega Stage 1	Integrated CD Player	Used	£550	£250
Micromega Drive3	CD Transport	Used	£1000	£650
Micromega DAC 2	DAC	Used	£750	£300
Martin Logan QuestZ	Loudspeakers	Used	£5500	£2050
Linn LK100	Power Amplifier	Ex-D	£650	£450
Linn Karik	CD Player	Ex-D	£1850	£1650
Linn Mimik	CD Player	Ex-D	£875	£700
Cyrus 3i	Integrated Amplifier	Ex-D	£598	£450
Cyrus Pre	Pre Amplifier	Ex-D	£648	£350
Epos ES22	Loudspeakers	Ex-D	£1350	£695
Epos ES30	Loudspeakers	Ex-D	£2550	£1995
Audiolab 8000Q	Pre Amplifier	Used	£1200	£995
Project 6+MC15	Turntable inc MC15	Ex-D	£500	£325
Krell PAM3	Pre Amplifier	Used	£1900	£500
Krell KSA100MK2	Power Amplifier	Used	£3847	£1200
Nakamichi Dragon	Cassette Player	Used	£1200	£600
Roksan Radius/Tabnz	Turntable	Used	£500	£250

THE powerplant

66-67 Upper North Street, Brighton
Tele: 01273 775978 Fax: 01273 748419
email@powerplant.co.uk

hi fi home cinema & multi room systems

Arcam. ATC B&W B&O Cyrus Epos. M&K Mission Mark Levinson. Linn. Lutron. Pro Ac. Rega. Rotel. Ruark. Tag McLaren. XLO. Yamaha and more

CLASSIFIED ADS

6 PAGES OF BARGAIN HI-FI

SPECIAL
INTERNET
OFFER SEE
PAGE 162 FOR
DETAILS

PAIR KLS10s (gold) mahogany veneered £350. Pair KLS3's (not gold) £300. Lumley ST40 power amp (chrome) £350. KLPP1 valve phono preamp (built by Nick Lucas) £425. Creek T43 tuner, remote control £250. Creek OBH-11 SE headphone amp with external supply £130. Sony DVD/CD Gold S715 £300. Garrard 301 with SME 12" arm, Ortofon FT25 moving coil cartridge £225. Yamaha cassette deck KX580 SE £125. All in mint condition with boxes and manuals. Tel: 0115 975 4070 (evenings) (Jul/I)

AUDIO INNOVATIONS 300 amp - great phono stage - boxed. excellent condition. Hi-Fi Choice/Answers rave. Original & new valves - matched CVC. Price £185. Tel: 0113 252 2820 (Jul/I)

WANTED: CELESTION SL6000 subwoofer system. With or without SL600S. Tel: 01782 535 652 (Jul/I)

GARRAD 401 turntable, Slate Audio plinth, RB300, Goldring 1042, Glassmat £475 no offers. Pair of Quad II amplifiers professionally renovated with audiophile components including new set of KT66R £620. Tel: 01834 860 681 (Jul/I)

TURNTABLES: ORACLE Premier with new suspension and power supply plus Oracle/SME 345 arm £2000. Koetsu 80th Anniversary, low hours £1300. Well Tempered Signature with arm. One of 29 made, beautifully engineered £2800. Clearaudio Insider £1400. Tel: 01483 407 624 (work) (Jul/I)

AUDIONOTE OTO SE phono amp, excellent condition and superb amp. £800. Dali 104MS speakers, very efficient £250 (£680 new). Tel: 01592 265 096 (Scot) (Jul/I)

NAIM 62/140 pre-power, new style vgc £400. Sonus Faber Concertino speakers c/w adjustable ironwood stands vgc £500. Tel: R. Burton 01403 250 570 after 6pm and weekends (W.Sussex) (Jul/I)

EXPOSURE 21RC remote preamp & Exposure/Neutr-x XLR i/c (1m) £575. Exposure 18 super regulatec monoblocks & 4x5m terminated Exposure spkr cable (bi-wired) £1175. Fabulous open window presentation. Gramophone magazine 'classic' status. All mint/as new condition (2 yrs) boxed, demonstration a pleasure. DPA Enlightenment DAC (marked @ rear) £275. Tel: 0131 538 9073 (eves) (Jul/I)

QUAD ESL 63s black with stands, mint £1250. Acoustic Precision Eikos CD player £950. Cyrus power/PSXR £525. Avondale 3 channel power supply/Naim 32.5 preamp, stunning £395. Tel: 0118 981 5681 (Jul)

PASS ALEPH 3, mint condition, original packing £1500. Tel: 0141 427 3219 (Jul/I)

MUSICAL FIDELITY X10D £65, X-PSU £75, A1 Final Edition 40wpc Class A amplifier with external psu £185. Tel: 01293 786 453 eves/weekends (Horley) (Jul/I)

LEXICON CP2 American digital surround processor, Dolby ProLogic (£750) £290. Sugden AU41 pre & power amplifiers 100w Hi-Fi World Favourite (£1000) £560. Linn LP12, Ittok LVII, Linn K9 £420. Quad IIs, QCII pre's, FM1 & AM1 tuners, boxes, manuals & spare valves £400. Rega ELAs black floorstanders (£500) £140. Tel: 0161 764 8888 (day), 0161 762 9884 (eves) (Jul/I)

PROAC STUDIO 100s, Mahogany £375 (£699). HNE Granite Cableway speaker stands for above or similar, stunning £275 (£460) £600 for pair. LFD LSI preamplifier £275 (£1000). Croft moving coil stage £100 (£250). Thorens TD160BCII/Mayware IV/ AT OCS £200. All items mint/boxed. Tel: 01780 764 149 (Jun/I)

AUDIO ANALOGUE Bellini pre-amp, Donizetti power amp. One year old, perfect, £725, will split. Linn Kairn preamp, pre Brilliant, hence £600. Ruark Sabres £330. Tel: 01530 831 357 or 0831 565 010 mobile (Jul/I)

NAIM SBL Mk2 speakers, excellent condition £750. Naim CD3 £575. Toshiba SD-3006 Region One DVD £275. Audionote CD2 (new) £750. Marantz CD63 Ki Signature £250. Totem Staff (new) £800. Tel: 01952 502 097 (Telford) (Jul/I)

HEYBROOK SEXTET speaker (yew) £400. Quad FM4 tuner (DIN) £200. Walker CJ58 turntable/Mission arm £80. Goldring 1042 cartridge £40. All in excellent condition. Tel: 01727 855 036 (St Albans) (Jul)

KEF CUBE 200 loudspeaker tone control equaliser. Cost £200. Suitable for any loudspeaker. Bypass switch and sensitivity control. Black and measures h6xw15xd22 centimetres. Connections supplied for phono and DIN. £60. Tel: 0161 445 8366 between 2-6pm (Jul)

HEYBROOK SEXTETS, Walnut £575 ono. Meridian 201 preamp (incl. remote) £280 ono. Technics SL 120 direct drive turntable £120. Harbeth HL extenders (bass speakers/stands) £195 ono. Tel: 01892 536 919 W.Kent (Jul/I)

CYRUS DAD 3 CD Player, only 10 hours use, mint, £375 or swap Meridian 200 transport. Tel: Phil 0116 284 9634 (Jul/I)

ELECTROCOMPANIET EC1-2 integrated amplifier, one year old £600 (mint). ECPI phono stage also available £350 (mint). Tel: 01661 844 177 email: Ernie@deer99.freereserve.co.uk (Jul/I)

AUDIONOTE OTO SE with phono stage. 12 month guarantee from Audionote. £900 (£1500 new). Copland CSA 14 in superb condition. Very well reviewed amp. £700 (£1200 new). Tel: 0141 571 3596 (Jul/I)

PIONEER A400X amplifier, boxed, £95. Pioneer SA7800 battleship integrated amplifier (£300 in 1980), £125. Sony ST-J60 high end digital FM tuner, £55. Sony SS86e mini monitors, boxed. £30. WANTED: Naim NAIT1, Meridian MCD. Tel: 07899 816 120 (Brighton) (Jul/I)

TEAC P30 CD transport. Boxed, immaculate, registration papers. HFV's reference. £1300 ono (£2500). Audio Synthesis DAX, balanced version. Boxed, mint. £950 ono (£2800). Tel: Salman: 0131 535 4307 (day); 0131 556 7545 (eves); Email: s.hussain@ed.sac.ac.uk (Jul/I)

LINN LP12 Cirkus, Valhalla, Ittok LV2 new Sumiko Blue Point Special, absolutely mint £850 ovo. STD 305M turntable - flagship model - Mayware Mk4 arm ex cond. £200. Tel: Brian 0181 952 2044 (Jul/I)

LP12 VALHALLA Zeta arm VDH wired Karma cartridge Mana sound frame £495. Plus record collection for sale. Tel: 01708 760 571 (Jul/I)

KLIPSCH CHORUS Mk1 speakers high and mid horns. 15in bass. Medium oak great sound. £650 - no time wasters. Tel: 0171 790 3404 (Jul/I)

NAIM 135s just returned from Naim, fitted with new latest issue amplifier and regulator boards. New PSU capacitors, new XLRs, new sleeves, absolute bargain £1995. Leave message Tel/Fax: 01642 649 702 (Jul/I)

BEST SOUNDING, looking Quad IIs existing, rebuilt, resprayed £595, Beard P505 valve preamp £295, Custom M7 line, looks, sounds amazing, Musical Fidelity B200, bi. Leave message Tel: 01642 649 702 (Jul/I)

NAKAMICHI 410 preamp £220, Nakamichi 420 power amp £220, Nakamichi 480 tape deck £220, Sony ST JX 444 tuner £60. Tel: 01243 830 443 (evenings) (Jun/I)

AUDIO NOTE Meishu 300B with phono stage. £3500 new mint condition want £2000. Tel: 0181 239 0409 (Jul/I)

MUSICAL IMAGES

PRODUCT LIST NOW

PRODUCT	LIST	NOW
ACOUSTIC PRECISION EIKOS CD	EX/DEMO £2,150	£1,500
ACOUSTIC PRECISION FRI green speakers	EX/DEMO £800	£500
AUDIOLAB 8000LX Int amp	NEW £450	£300
AUDIOLAB 8000Q pre amp	NEW/EX DEMO £1,250	£800
ANTHEM INTEGRATED AMP 1	EX/DEMO £1,300	£800
ANTHEM CD 1	EX/DEMO £1,700	£1,000
B&W CDM1 speakers	S/H £600	£300
CABASSE FARELLA 400 beech speakers	EX/DEMO £1,000	£700
CASTLE HOWARD S2 oak speakers	EX/DEMO £1,450	£1,000
CHORD SPM 2000 6 channel power amp	S/H £5,540	£4,000
DENON- PMA Q5 10W amp	EX/DEMO £1,800	£1,100
DENON DF07 mini system	EX/DEMO £650	£400
LINN LK100	EX/DEMO £650	£450
LINN CLASSIK	S/H £1,000	£700
MARANTZ MM 500THX (pair) mono power amp	S/H £500	£300
MERIDIAN-501V av pre amp	S/H £875	£400
MICHELL BRONZ GYRODEC	EX/DEMO £960	£725
MICROMEGA AMP power amp	EX/DEMO £1,250	£600
MICROMEGA PREMIUM 20 cd player	EX/DEMO £850	£550
MICROMEGA TEMPO P pre amp	EX/DEMO £1,250	£600
MISSION 754 r/wood speakers	EX/DEMO £1,500	£900
MONITOR AUDIO STUDIO50 r/wood speakers	EX/DEMO £3,300	£2,600
MUSICAL FIDELITY-3B pre amp	S/H £380	£150
MUSICAL FIDELITY A1001 amp	EX/DEMO £2,500	£2,000
NAIM NAIT 3R	S/H £850	£550
PINK TRIANGLE TARATELLA (no arm) T/Table	EX/DEMO £680	£475
PROAC-STUDIO150 cherry/walnut speakers	EX/DEMO £1,400	£950
ROGERS- GS5 black speakers	EX/DEMO £380	£190
ROGERS- GS6 black speakers	EX/DEMO £430	£215
ROKSAN-S1.5 silver power amp	EX/DEMO £1,495	£1,150
ROKSAN ROK1 black/r/wood speakers	NEW £600	£250
SOUNDLAB-PRISTINE electrostatics speaker	S/H £8,000	£2,000
TUBE TECHNOLOGY- PROPHET pre amp	EX/DEMO £1,970	£850
TUBE TECHNOLOGY- SEER phono pre amp	EX/DEMO £1,000	£600
XTC POW 2 power amp	EX/DEMO £1,450	£1,000

PLEASE VISIT OUR SHOWROOMS OR CALL OUR HOTLINE NUMBER FOR DETAILS. HURRY, THESE ARE ONE-OFF ITEMS!!

SEE IT! HEAR IT! BUY IT!

HOTLINE NUMBER:
0171 497 1346

14-18 Monmouth Street, Covent Garden, London WC2H 9HB
E-Mail: sales@musical-images.co.uk

Beckenham Edgware Hounslow

0181 663 3777 0181 952 5535 0181 569 5802

NOT VALID WITH ANY OTHER OFFERS OR PROMOTIONS E&OE



MUSONIC STYLI

SPECIALIST MANUFACTURER & SUPPLIER FOR MORE THAN 40 YEARS

REPLACEMENTS & ORIGINALS

MANY OBSOLETE/78 VERSIONS

PICK-UP CARTRIDGES

RECORD/TAPE/CD ACCESSORIES

WHY NOT TRY US AND HEAR THE DIFFERENCE !!

For prices tel/fax/e-mail to:-

MUSONIC (UK) LIMITED
Unit 13 Wenta Business Centre Colne Way
Watford Hertfordshire WD2 4ND
Tel: 01923 213344 Fax: 01923 213355
e-mail:musonic@compuserve.com

VISA

Trade and Export enquiries welcome



IAN HARRISON HI-FI

TEL: 01283 702875

9am-9pm

INCLUDING SUNDAYS

HI-FI AT DISCOUNT PRICES. FREE NATIONWIDE DELIVERY

TRADE IN YOUR OLD MOVING COIL CARTRIDGE & SAVE UP TO 45% OFF THE RRP.

CARTRIDGES & STYLI	TO NEARMS	CASSETTE DECKS	COMPACT DISC
DENON SHURE AUDIO TECHNICA GOLDRING AUDIOQUEST TRANSGURATION LONDON (DECCA) ARCAM GRADO ROKSAN VAN DEN HUL ORTOFON AUDIO NOTE DNM CLEAR AUDIO	ROKSAN SME MOTH TURNTABLES SME TECHNICS MICHELL CLEAR AUDIO HIFI FURNITURE APOLLO SOUND STYLE	PIONEER TEAC SONY DENON YAMAHA MARANTZ TASCAM D7AT PIONEER TEAC TASCAM SONY FOSTEX MINI DISC SONY DENON	PIONEER TEAC SONY DENON YAMAHA MARANTZ PHILIPS CREEK TUNERS SONY DENON PIONEER YAMAHA MARANTZ PHILIPS AMPLIFIERS DENON MARANTZ PIONEER YAMAHA MARANTZ PHILIPS & OTHERS
HARBETH ATC SONY ROYD	PROJECT SOUND ORGANISATION	SONY DENON	
HEADPHONES SENNHEISER BEYER SONY AKG GRADO AUDIO-TECHNICA	SONIC LINK AUDIOQUEST AUDIO-TECHNICA VAN DEN HUL GOLDRING OED ORTOFON NORDOST	PIONEER REEL-REEL STUDER TASCAM	
TEST CASSETTES TEST CD'S TEST RECORD DEMO CD'S *PHONE OR WRITE FOR DETAILS	BLANK TAPES / DISCS TDK AMPEX JVC SCOTCH FUJI	ACCESSORIES DISCOMASHER HULTY OED GOLDRING TDK	MAXELL SONY ANTEORANCE MAXVIEW PIVOTELLI

*ALL GOODS ARE BRAND NEW & BOXED WITH FULL U.K. GUARANTEES. NO EX/DEM OR EX DISPLAY GOODS. NO GREY IMPORTS.

PLEASE PHONE TO CONFIRM PRICE & AVAILABILITY PRIOR TO ORDERING GOODS ARE NOT SUPPLIED ON APPROVAL. SORRY, NO GENERAL CATALOGUES. PLEASE PHONE OR WRITE FOR SPECIFIC REVIEWS, BROCHURES OR PRICES.

MAIL ORDER ONLY FROM: IAN HARRISON, 7 MILL HILL, REPTON, DERBY, DE65 6GQ. TEL: 01283 702875. 9am - 9pm INCLUDING SUNDAYS.

CLASSIFIED ADS

6 PAGES OF BARGAIN HI-FI

SPECIAL
INTERNET
OFFER SEE
PAGE 162 FOR
DETAILS

NAIM 62K old style, good condition £150. Linn Sara IX speakers (black) with stands £375. NAD 3020i amplifier £60. Yamaha DSR-70PRO Dolby Prologic Surround Decoder £70. Arcam Black Box 3 £125. Tel: 01489 891 925 (Jul/I)

SPENDOR BC1 loudspeakers, teak & stands £175. Yamaha CT610 tuner £30, Sugden A48II £50, all boxed. Tel: 01704 531 526 (evenings) (Merseyside) (Jul/I)

MINT CONDITION Audio Analogue Bellini preamp £350. Financial reasons for sale. Tel: 0116 267 5113, Email: panda@onet.co.uk (Jul/I)

MISSION 772 speakers, unwanted gift. Mint £227, sell £185. Boxed. Pioneer PD506 champagne, mint, boxed. £550 sell £399. NAD 524 CD 1 month old, mint, boxed. £250, sell £185. Tel: Steve 01865 559 737 anytime (Jul/I)

QUAD 44/405-2 pre/power amp £350, Millennium 25w monoblock valve amplifiers £200 pair. Maplin active crossover £25. B&W DM2 loudspeakers £75. Philips 104B CD £60. Tel: Steve 0181 391 0229 (8am-10.30pm mon-sat) (Jul/I)

QUAD IIS & 22 control unit & mono tuner £395. Garrard 401 chassis £125. SME 9" fixed headshell arm £75. Leak Troughline III mono tuner £75. Tel: 0161 973 9229 (Jul/I)

LINN SONDEK, Ekos, K9, Manticore MB51 PSU £850. Arcam Alpha 3 amp £85. Mission 761i speakers £85, Technics SLPG200 CD player £65. All mint, boxed etc. Tel: 01444 410 445 (Sussex) (Jul/I)

LINN KABERS, black ash tri-wired 9 years old vgc £500 ovno: also 6m run Linn LK20 cable tri-wired - needs re-terminating £50. Tel: 0181 995 4312 (Jul/I)

CARY 805c amps. Mint condition, 18 months old, with granite plinths, spare 845s and all boxes £4950 ovno. Tel: Philip 01960 396 607 after 6pm (Jul/I)

CABASSE (FARELLA 400) 93dB floorstanding loudspeaker, 1997 £420 ono. Nordost (Silver Shadow) 1.5m digital interconnect (£385) £195. Audio Innovations (Series 1000 monoblocks Mk3) £725 ono. Audio Innovations (Series 200 preamp mc/mm) £175 ono. Tel: 016625 48623 (Jul/I)

NAIM NAC 52 & PS. Immaculate condition, boxed. £2400 ono. Tel: Colin 01293 416 022 (Jul/I)

SD ACOUSTIC SD1 speakers 3-way tri-wireable, very efficient, 90dB+ vgc £450. Cyrus 2 tuner mint boxed remote £150 ono. Leak Troughline Stereo teak sleeve vgc £95. Tel: Mike 01246 209 578 day/ 280 755 eves (Jul/I)

TEAC REF 500 amp, CD, tuner, RC vgc £349. Michell banana plugs, 3 sets £21. Linn K20 biwired 2x3.5m £15. WANTED: Sony Discman D-E905. Tel: 01493 851 296 (Great Yarmouth) (Jul/I)

AUDIOLAB 8000C 1989 vgc £150, Linn Mimik Anniversary 1998 £440, Linn Majik phono 1995 £365, Linn Keilidhs 1998 black £395, Monitor Audio 3s in oak 1998 £225, NAD 533 - RB250 arm and Rega cartridge £90. Tel: 01475 719 976 or 07801 587 407 (Jul/I)

EPOS ES22 speakers (new) £700, Myrrad T40 amp £190, Rogers Avanti 625 speakers (new) £225. Rogers home cinema receiver £175, Audio Synthesis DSM DAC with power module £400. Tel: 01344 872 568 (Jul/I)

REVOX B77 MkII, variable speed, half track, 7.5 and 15 ips. As new £475. Spendor SP2 MkIII, boxed as new, £490. Stax Lambda SR 84 pro headphones, boxed as new £135. Studer A725 CD player, as new £375. Tel: 0191 281 260 (Jul/I)

MERIDIAN M2 active speakers & stands £375. M101 MC preamp £95. M104 tuner £85. Diesel power amp inc passive volume £125. All vgc. Little Bit DAC - repair/spares £25. Tel: 0181 948 0899 (Jul/I)

LEAK 12.1 open transformer, mint condition, sensible offers, Audiolab 8000A £200, NVA P50 pre amp & P60 power amp £200. Tel: 01424 439 723 after 6pm (Jul/I)

SONY 228 ESD CD player. Good as transport £150. DPA Little Bit digital convertor £100. Will sell as pair at £200. Happy to demonstrate. Tel: 01746 710 356 (Jul/I)

MUSICAL FIDELITY X-A50s, X-Pre, X-PSU £600. Linn Keilidhs, black with granite stands £500. Atacama 24 in stands £40. Electrofluidic 20/20 speaker cables £180. All mint. Tel: 01977 620 558 (Jul/I)

B&W DM23 monitor loudspeakers, teak cabinets, excellent condition, well looked after, boxed £85. Buyer collects. Tel: 01962 885 714 (Jul/I)

NAIM CREDO speakers, cherry veneer, new x-overs, excellent condition, boxed with receipts £650 ono. Naim CDI CD player with CDM4 transport recently upgraded, excellent condition, boxed, Naim's finest one box player, £850 ono. Tel: 07970 163 314 (Jul/I)

LINN SONDEK LPI2, Valhalla Cirkus, Ittok LV2, Sumiko Blue Point Special £850 - mint condition. Rega Planar 3, no arm £65. Ex cond. Tel: 0181 952 2044 (Jul/I)

LUMLEY ST70 power amp, switch for pentode or triode use. 6 yrs old £800 ono. Tel: 01724 862 476 (Jul/I)

MARTIN LOGAN SL3 Electrostatic speakers (black) £2200. 2x30mm cream marble plinths £70. 2x6ft Kimber 8TCM powerkords £160. 0.5m pair Madrigal CZ Gel balanced interconnects £160. 1m pair transparent Musiclink Plus SE interconnects £110. Tel: 0831 623 725 day, 01483 282 537 eves (Jul/I)

ROGERS LS3/5As walnut veneer, boxed, good condition £250 ono. Tel: 0181 244 4164 (Jul/I)

LUMLEY REFERENCE M120 monoblocks, black chrome £1200. LVI preamp, black/chrome £450. LM2 speakers, mahogany £950. Restek concret CD player £750. All items boxed and excellent condition. Tel: 0116 281 1736 (Leicester) (Jul/I)

ROKSAN DARIUS speakers, black, MkI with box stands & separate crossover & cables. Use good source and material, they sound superb. £450. Tel: 01395 275 698 (eves or ansaphone) (Devon) (Jul/I)

PAIR DECCA DK30 ribbons, Volt BM 250.1 bass/mid. Deccavolt crossovers £120. Morel MDM 55 mid and Maplin 3 way electronic crossover £50. Tel/Fax: 01207 545 006 (Jul/I)

HELIOS ONE, new £1000, Densen Beat B100, new £450. Stax Lambda Nova classic system £450. Snell J11s, pirate stands, 92dB £500. Roksan Xerxes/RB300/ATOC5/XPS3/DS U £450. Tel: 01902 892 613 (Jul/I)

KEF 105.3 black ash £895, KEF 104.2 teak £375, KEF 105.4 teak £325, Marantz CD 65 £75, Quad 44 preamp £175. Tel: 01580 291 668 (Jul/I)

AVI 2000MM 150-watt monoblock power amps. Excellent condition, only a few months old, still under warranty £850. DPA PDM I DAC good condition £225. Tel: 01450 860 676 delivery can be arranged (Jul/I)

MUSICAL FIDELITY B1 integrated amplifier, as new £85. Sugden A21 series Z, class A integrated amplifier, excellent condition £85. Tel: 01209 212 270 (Jul/I)

MISSION 770 horn loaded tweeter grey facia, excellent £195. Rare Jordan Watts speakers £195. Sony CD 101 £25 (needs work), Pickering cartridge 7500S £140, Audio Technica arm, Linn board £35. Tel: 01273 727 476 (Jul/I)

Midland Audio X-change

Suppliers and installers of High Quality Audio Systems

Audio Note • Basis • BAT • Densen • Dpa • Electrocompaniet • Mark Levinson • Michell • Nagra
Pass • Primare • ProAc • Rega • Revel • Roksan • SPM • Sugden • UKD • Unison Research • Wadia

S/hand and ex-demo clearance items - June '99

	Was	Now		1650	1195
Arcam Alpha 8 CD Player	450	325	Michell Engineering Orca Pre amplifier (4 months old)	1650	1195
Audio Alchemy DDE 1.0V	399	149	Musical Fidelity P140 Power Amplifier	N/A	149
Audio Innovations 1000 Passive Controller	199	99	Naim Audio 2/4 X-Over New Style	650	350
Audio Innovations 200 Power Amplifier	N/A	195	Naim Audio 72 Preamplifier M/C Boards	689	375
Audio Innovations 400 Integrated Valve Amplifier	1099	450	Naim Audio Hi-Cap New Style	780	450
Audio Innovations 800 Series III Power Amplifier	999	499	Naim Audio NAC 32mm/MC Pre-amplifier	N/A	149
Audio Note ANCD2 Valve CD Player (new boxed)	1000	695	Orelle SA 100 Amplifier	449	299
Audio Note AN-VZ 1M Silver Interconnect	1520	750	Pink Triangle Cardinal/Decapo 1307/HDCD	2500	1295
Audio Note IO 1v Moving Coil Ex-Demo	1295	650	ProAc Tablette 50 Signatures Ebony Loudspeakers	900	695
Audio Note M3RIAA Phono Stage	3950	1750	ProAc Tablette 50 Yew	680	375
Audio Note TTL/RB250/IQ1	750	495	Radford/Woodside WS2 CD Player	1200	399
Audio Research LS3b (volume remote / black)	2750	1395	Rega ELA Cherry (latest spec)	535	399
Audion Premier 2.0 2 Box Pre-amp inc. Phono stage	1700	995	Rega HAL Pre Amp MM/MC Remote	998	599
Basis 2000 series Turntable /Air tangent 1B Tonearm	4000	2500	Rel Storm SubWoofer Black 3months old	695	575
Celestion SL6S Walnut	N/A	99	Revox A77fi Track 3fl 7fi MK3 Reel to reel	N/A	250
Cogan Hall Intermezzo REF 0.5M	375	95	Revox B77fi Track 3fl 7fi MK1 Reel to reel	1600	595
Conrad Johnson PV10 AL SE	1299	750	Roksan Artrexxes MK1 MC	599	195
Decca London cartridge Re built	N/A	199	Roksan Attezza DP3T Transport	1295	699
DPA Little Bit III 4 months old	300	195	Roksan Caspian CD Player	895	650
Elemental Audio SCZ Custom Loudspeaker Stands	1399	750	Roksan Caspian Power Amplifier	595	479
Epos ES 11 Loudspeakers Black	485	249	Roksan DA1 Converter	495	169
GM Audio Heavy Speaker Stands 24"	599	250	Roksan DA2 DAC	595	449
Harbeth HL-K6 Cherry	1049	599	Roksan DP1 Transport	995	399
Heybrook TT2 Turntable Black	N/A	175	Roksan DS 5 Power Supply	549	429
Heybrook TT2 Turntable Walnut/SME 3009/V15	N/A	249	Roksan ROK-1	650	279
Impulse Lali Cherry Loudspeaker	1750	1295	Roksan Shiraz 350hrs use	1000	375
Impulse Maya Loudspeaker	695	459	Roksan Xerxes SME cut/XPS2 Black (needs a paint job)	N/A	185
Impulse Moskito/RB300 Turntable (new & boxed)	695	399	Roksan Xerxes Syrinx PU2 Supex 900 MkII	N/A	499
Krell KPS 20i/L CD/Pre	11,000	5999	Roksan Xerxes Tabrizi XPS 3.5/DSU	1650	699
Krell KRC HR Remote Preamp	6950	3999	Roksan Xerxes XPS3.5/DSU/Tabrizi/Corus Black	1799	795
Linn Ekos MK1 (boxed immaculate)	1500	650	Rotel RC 970 BX Pre Amp (new)	175	99
Madrigal HPC Digital 0.5M RCA/RCA	N/A	50	Ruark Equinox Black Ash Loudspeakers	1750	950
Meridian 200 Transport	895	395	Ruark Talisman II Dark Oak	750	599
Meridian 201 Preamplifier	695	250	Sugden SDT-1 Special Edition CD Player	1499	895
Meridian 203 DAC 7	499	169	Transparent Music Wave Plus 2x 2.44m	428	295
Meridian 205 Mono block Amplifiers	1100	499	Transparent Reference Balanced Music Link 1.5m	2895	1495
Meridian 263 D/A Converter	495	225	Unison Research Smart 845 mono single ended valve	3450	2099
Meridian System Remote	N/A	50	Yamaha DSP A1 Amplifier (3 weeks old)	1600	1295
Michaelson Audio Chronos 2 Box Valve Preamplifier	4700	1250			

Midland Audio X-change is looking for good used British & American Hi-fi, cash paid call John Roberts on 01562 822236

Nagra

Nagra PLP Valve Preamplifier uses a battery & fully rechargeable power supply thus making it one of the quietest phono stages around in the vinyl domain. The price is £6995.00



Also the new VPA 845 valve monoblock amplifier and the MPA transistor available upon request.

ProAc Loudspeakers

Two new models are now available for your listening pleasure. A worthy successor to the Tablette 50 is the new Tablette 2000 built to take us into the new millennium, a two way design with over 50% greater volumetric capacity than the 50, made of high quality MDF then coated with bitumous damping to absorb any internal sound. An impedance of 8 ohms and a sensitivity of 87db this speaker can grace any of today's hi-end systems. Available in a range of finishes at £649.00.

The Studio 125 is a welcome addition to the range, a very attractive and sleek design with all the attributes of the 2000 we are sure that this will be the one to beat in the £1000.00 floorstander stakes.

Analogue lives

The growth of Analogue source material has seen a massive increase at Midland Audio X-change, over the last 12 months we have seen huge amounts of Hi-Fi enthusiasts wanting to buy high quality vinyl playing systems, or upgrading their existing record playing system.

Our Top-Ten Analogue Best Buys

1. Roksan Xerxes X Package £1200
2. Lehmann Audio Black Qube Phono Stage £395
3. Rega Planar 25 turntable £598
4. Michell Gyrodeck SE £775
5. Rega RB 600 Tonearm £350
6. Densen DP02 Drive Phono stage £350
7. Lyra Lydian Beta M/C £599
8. Ortofon MC 30 Supreme £549
9. Ringmat Developments Support System £160
10. Electrocompaniet ECP-1 Phono Stage £499

These products are just a selection of the popular Vinyl based products which Midland Audio X-change stocks and recommends.

Data Conversion Systems (Dcs)

At last the arrival of the most innovative digital product of all time, The Dcs Purcell Upsampler allows the user to take a 44.1 kHz signal and upsample to 24 bit 96 kHz or even 24 bit 192 kHz. Then, depending on the digital to analogue converter, it will reveal digital sound, like you have never heard before. No more nasty top end, no more 2-dimensional sound stage. For a truly magnificent duo, partner with the excellent Elgar DAC, to give transparency and smooth listenable sound. The Purcell costs £3450.00 and the Elgar is £8500.00.

Ring John Roberts • 181 Franche Road • KIDDERMINSTER • Worcs • DY11 5AD
Tel/Fax 01562 822236 • Mobile 0421 605966 • www.sales@midlandaudiox-change.co.uk

CLASSIFIED ADS

6 PAGES OF BARGAIN HI-FI

SPECIAL
INTERNET
OFFER SEE
PAGE 162 FOR
DETAILS

ACOUSTIC ENERGY 109 speakers month old £195, Arcam Alpha Plus CD player £135, Denon remote control stereo receiver £135, Project 7 amplifier £130, Marantz CD 52 Mk2 SE £130, Armstrong 521 amplifier £35, Rogers LS4A speakers £100 vgc. Tel: 0181 680 1341 (Croydon) (Jul/I)

PROAC STUDIO Three speakers, immaculate, black with stands cost £1250, one of the finest loudspeakers, three way ATC drive units, 300watts. No obligation demonstration £525. Tel: 0161 445 8366 between 2-6pm (Jul)

MONITOR AUDIO Silver 3, cherrywood finish, 3 months old, perfect condition. Cost £300, will sell for £150. Tel: 0171 713 6874 (EC1) (Jul/I)

ARCAM DELTA 290 amp. Fitted phono board with full remote control. Boxed with instructions. For sale due to upgrading. £250 or near offer. Tel: 01482 881 561 (East Yorks) (Jul/I)

CONCORDANT EXHILARANT Line level preamp, Groove Tubed, wooden case £375. Audiolab 8000C preamp £250. Rotel RT850AL tuner £75. Yamaha DSP300 Dolby surround-sound processor £100. All boxed, excellent condition. Tel: 01502 724 835 (Aug/I)

TDL NUCLEUS 4, floor standing speakers. Rosewood finish, latest model, brand new, unused, still sealed and boxed. Unwanted prize. List £300, accept £225. Tel: 0151 342 8463 (Jul/I)

HI-FI WORLD mags 1993-1998 inc. £12 per year. Other mags 50's on, Hi-Fi Answers, Practical Wireless, Radio Constructor etc. Buyer collects. Manchester area. Tel: 0161 790 9059 (Jul/I)

GOERTZ SUPERB M2 loudspeakers cable, 8ft terminated £120. MIT MH 750, 8ft terminated £150. Goertz Silver Sapphire interconnect, balanced 0.5m £100. Tel: 0171 937 7935 (Jul/I)

QUAD 34 (brown) £95, Quad 306 (grey) £120, both vgc. WANTED: Rogers A100 amp or A75, working or spares. Tel: 01938 553 559 (Jul/I)

SOURCE ODYSSEY RPI-XG tonearm, excellent condition, some parts gold plated. 'VDH' silver wired with new spare wire. Fits any SME armboard. Looks fantastic, sounds the same (£700) £275 Tel: 0121 476 7608 (Jul/I)

SHAHINIAN OBELISK speakers £1550. Shahinian Super Elf speakers £400. Shahinian Hawk mono subwoofers £1380. All mint and boxed in walnut. Tel: 01626 352 682 (Jul/I)

PINK TRIANGLE DaCapo DAC with 1307 filter, cost £1650, accept £495. Musical Fidelity P270.2 poweramp, boxed, as new, cost £1500, accept £595. F16 poweramp (£2500) accept £995. Tel: 01634 268 660 (Jul/I)

CYRUS DAD 3Q CD player plus PSX power supply. Brand new, unused £750 (originally £1200) Tel: Tom 0181 838 2432 (Jul/I)

LINN MIMIK £450. Linn Majik I phono £450. Linn Axis/Akito/K9 £250. Arcam Delta 280 tuner £150. All perfect. Tel: 01628 782 040 (Berkshire) (Jul/I)

SONDEK LINGO Ekos MC5000 £1000. Naim SBLs £650 (or both £1500) Nakamichi I.5 cassette player £175. Sony DAT DTC 55ES £250. Tel: 01905 640 422 (Jul/I)

ELEMENTAL AUDIO Monoplinth, reference equipment support platform. Brand new and still in manufacturers sealed packaging. Unwanted competition prize. Price new £499. Will accept £250. Tel: 01278 789 232 (Somerset) (Jul/I)

KEF Q35 Floorstanding speakers. Absolutely mint condition. Black finish. Complete with 2x2.5m biwire cable £200. Tel: 01923 671 984 (Jul/I)

LUXMAN PD300 Vacuum turntable belt £25. Tel: Steve 0181 850 0585 (Jul/I)

ARCAM 290 Integrated and 290P poweramps. £400 spent on modifications, now stunning sound. £500 ono for both. Pair Silver & Teflon 0.5 interconnects £50 ono. Nordost Flatline Biwire 2x3m £50 ono. 4x5m Teflon 'Deltron' OFC terminated speaker cable £60 ono. Trio KD2055 turntable and Arcam P77 cartridge £80 ono. Tel: 01325 320 988 (Jul/I)

SPRING CLEAROUT! Theta TLC Jitter Buster £95. Goliath PSU £85. Headphones: Sony MDRD77 Collapsible £50. Sennheiser HD250 Mk2 £75. DPA The Power RF Filter £55. Versalabs Red Rollers £45. Meridian MSR remote £35. Interconnects: Digital; half metre: Siltech HF8Si £50. AudioQuest Video Two £30. Pairs: 0.8m: vdH D102II Hybrid £38. Thunderline Hybrid £60. 1m: Kimber PJB.CD Ultraplate £48. Nordost Blue Heaven £80. No offers! Tel: 0181 871 2345 (evenings) (Jul)

CYRUS SL amp £200. XPA poweramp £150. Micromega Leader CD player £200. NAD 533 turntable & NAD PP phono stage £160. All pristine condition & boxed. Tel: 01923 829 140 (Jul/I)

IMPULSE TAUS horn loudspeakers in maple, mint condition £1500. Sugden Symetra Class A monoblocks £890 mint. Naim CD3, mint £600. Can deliver. Tel: 01482 445 090 or 0961 386 721 (mobile) (Jul/I)

DELTEC 50s pre power phono inc all cables £1500 ono. Deltec Little Bit £50. NAD 402 tuner £50. All mint condition. Tel: 0151 339 0268 (Jul/I)

JVC QL-G90 Linear tracking turntable. Fully programmable Ortofon OMP10 cartridge. Small scratch on case otherwise perfect. Instruction manual. Buyer collects £120. JVC TD-X202 cassette deck, Dolby B&C plus metal. Instruction manual £50. WANTED: NAD 912 poweramp. Tel: 0802 593 954 (day) 0191 242 1391 (evening) (Jul)

MERIDIAN 506.20 CD player £930. Meridian 501.2 control unit £540. Meridian 556 power amplifier £750. Epos ES12 loudspeakers inc stands £360. (all brand new) Quad FM4 tuner £250. Quac 34 control unit £210. Quad 306 power amplifier £210 (mint & boxed). Move abroad forces sale. Tel: 0181 741 5262 or 0956 136 421 (Aug/I)

HART ELECTRONICS, John Lindsley Hood designed, pre, power and phono amplifiers with DC power supply (all built) £500. IPL S4TL loudspeakers with mahogany veneer £250. Tel: 01249 444 946 (Jul/I)

AUDIONOTE MEISHU Amplifier, upgraded valves worth £375. AN V Silverwire upgrade plus latest front panel. Excellent sound quality (£2750 plus upgrades) £1950 ono. Tel: Terry 01384 359 273, mobile 0370 641 056 (after 6pm) (Jul/I)

CASTLE HARLECH floorstanding 'speakers. Natural oak, boxed, still under warranty. £580 (£880). Can demonstrate. Replaced them for Concert 8 Jubilees. QED 4 x 4 'speaker cable 2 x 3.5m £50. Tel: Lee 0181 361 8823 (Jul/I)

NAIM NATO2 tuner, Naim interconnect, boxed + manuals, perfect condition £700. Linn Axis turntable, K9 cartridge, Basik Plus arm, boxed + manuals, perfect condition £275. Tel: 07775 515 189 (Jul/I)

SUGDEN 51 pre-amp and 51 power amp £1300. ATC 20 'speakers with stands £900. AVI stereo power amp £425. Rotel 6 channel Pro-Logic pre/power £325. B & W CC6 centre channel 'speaker £140. Tel: 01977 643 629 (Jul/I)

THETA PEARL CD transport 6 months old, mint condition, boxed £995. Audiolab 8000 CD 2 years old, mint condition £675 ono. Tel: Steve 01423 881 260 Harrogate (Jul/I)

NAIM AUDIO CD2 £1000. Tel: Quentin 01865 438 488 evenings only. (Jul/I)



DENYS TRICKETT'S HI-FI CURIOSITY SHOP



Wanted all vintage and modern valve amps any condition any age. Repair service for all models Quad + Quad ELS57's!!

WE BUY & SELL VALVES!

For all valve amp repairs; overhauls, rebuilds. The best workmanship at the fairest prices

Buy: Sell: Exchange:
Tannoys: Garrard 301/401
Thorens 124/224: Quad: Leak:
Radford: Williamson W.H.Y.

We ship abroad:-
Tel/Fax for a quote, No destination too far
0171 328 3281

Visit us at:
Unit 231-2
Webheath Community Workshop
London NW6 2JX

5 mins Brondesbury + Kilburn Stn.
On-site parking!!

Tel/Fax 0171 328 3281

AMPLIFIERS

Radford K25 pair + SC22	£1500
Leak TL12 Point one pair	£1200
Quad II + 22 set	£550
Leak TL12 Plus & Pre	£350
Leak ST20 + Pre	£350
Fisher X100	£140
Scott 222C	£140
B.B.C. Amp/4 pair	£800
Radford STA25 + SC2	£650
Avantic 35watt pair	£600
McIntosh 626 Pre amp	£240

TUNERS

Leak Troughline St.	£140
Leak Troughline Mono	£60
Chapman valve AM/FM/SW	£120
Technics 9.800 FM	£195
We fit F.M. Decoders	£75

TAPE RECORDERS ALL G.W.O

Revox B77	£650
Akai 4000	£95
Sony 755	£325
Teac 3440 4ch	£450
Akai 1750	£75
Sony Valve St.	£120

LOUDSPEAKERS

ELS57 (pair) overhauled	£450
Lowter Acousta pair	£375
Tannoy 3LZ (pair)	£450
Tannoy H.P.D. 12" pair	
W Xovers	£295
Chassis	

CAPACITORS

0.47µ400V	0.47µ400V	0.27 400V
0.02 600V	0.012 2000V	.40p each
8µ350 paper block		£5.00 each

OPENING HOURS

TUES:THURS: SAT:10.30AM - 5.30 PM

WED: FRI: 10.30 AM - 2.00 PM

Closed all day Monday

Sunday by appointment demonstration
of valve amps and Quad ELS57

E-MAIL: denystrickett@yahoo.com



CODE KEY:- N = NEW X = EX DEM S = SECOND HAND

Make	Model	Description	Code	Stock	R.R.P.	Now
ARCAM	ALPHA 9	AMPLIFIER	X	1	£550.00	£350.00
BANG & OLUFSEN	BEOCENTRE 9000	CD/RADIO AND CASSETTE	X	1	£1,650.00	£1200.00
BANG & OLUFSEN	BEOLAB 2000	ACTIVE LOUDSPEAKER	X	1	£550.00	£350.00
BANG & OLUFSEN	BEOLAB 3500	HORIZONTAL ACTIVE LOUDSPEAKER	X	1	£900.00	£600.00
CASTLE	AVGN	LOUDSPEAKERS - BIRCH	N	1	£730.00	£475.00
CASTLE	SEVERN	LOUDSPEAKERS - NATURAL OAK	X	1	£580.00	£450.00
CASTLE	HOWARD	LOUDSPEAKERS - WALNUT	N	1	£1,200.00	£800.00
CASTLE	KENDAL	LOUDSPEAKERS - WALNUT	N	1	£400.00	£325.00
CELESTION	A-1	LOUDSPEAKERS - STANDS	X	1	£1,150.00	
CELESTION	100	LOUDSPEAKERS - MAHOGANY	N	1	£540.00	£300.00
CELESTION	SL 6 SI	LOUDSPEAKER - WALNUT	N	1	£450.00	£200.00
CELESTION	251	FLOORSTANDING LOUDSPEAKERS	N	1	£450.00	£250.00
KEF	CODA 9	FLOORSTANDING LOUDSPEAKERS	X	2	£300.00	£200.00
LINK	QUASAR	AMPLIFIER	S	1	£500.00	£200.00
MERIDIAN	500 & 566 DAC	CD TRANSPORT & 20-BIT DAC	S	1	£2425.00	£1400.00
MERIDIAN	565 7.1 AC-3	AC-3 DOLBY DIGITAL PROCESSOR	S	2	£2850.00	£1850.00
MERIDIAN	566	POWER AMP	X	1	£950.00	£760.00
MERIDIAN	567	POWER AMP	X	1	£1,525.00	£1,220.00
QUAD	77 AMP	AMPLIFIER - NEXTEL	N	3	£700.00	£300.00
QUAD	77 CD	CD PLAYER - MAINS + BUS POWERED	N	2	£900.00	£420.00
QUAD	ESL 57S	ELECTROSTATIC LOUDSPEAKERS	S	1		£300.00
REL	STRATA 2	SUBWOOFER	X	1	£600.00	£450.00
REGA	PLANNER 3	TURNTABLE	S	1		£120.00
ROTEL	RB 956	SIX CHANNEL POWERAMP	S	1	£350.00	£225.00
ROTEL	RB 976	FIVE CHANNEL THX POWERAMP	X	1	£750.00	£650.00
SPENDOR	2040	FLOORSTANDING LOUDSPEAKERS	S	1	£900.00	£400.00
YAMAHA	AV 1	PROLOGIC SYSTEM	N	2	£650.00	£500.00
YAMAHA	DSPA 492	AV AMPLIFIER	N	3	£250.00	£140.00
YAMAHA	DSPA 592	AV AMPLIFIER	N	3	£330.00	£200.00
YAMAHA	DSPA 1	DOLBY DIGITAL/DTS AMPLIFIER-GOLD	N		£1,700.00	£1,300.00
YAMAHA	DSPA 2	DOLBY DIGITAL/DTS AMPLIFIER	N		£1,000.00	£850.00
YAMAHA	DSPE 492	AV PROCESSOR	X	1	£250.00	£175.00
YAMAHA	RXV 582 RDS	AV RECEIVER	N	3	£400.00	£275.00

SPECIAL PRICES - DVD PLAYERS

YAMAHA	DVDS 700	DVD PLAYER MULTI REGION	N		£600.00	£425.00
PIONEER	DV 717	DVD PLAYER MULTI REGION	N			£550.00
PIONEER	DV 515	DVD PLAYER MULTI REGION	N			£400.00

RING FOR CASH PRICES!

ALL HI-FI WANTED
PLEASE RING FOR CASH PRICES

12 Regent Street, Rugby, Warwickshire, CV22 5LP
Tel: 01788 540772 Fax 01788 542170



listening rooms

RRP SALE
AMPS/PRE-AMPS/A.V.CONTROLLERS

ARCAM ALPHA7	249.00	199.00	D
ARCAM ALPHA 9 INC. PH. ST AS NEW		395.00	SH
ARCAM ALPHA 9P AS NEW		250.00	SH
AUDIO RESEARCH LS 3 PRE AMP	1895.00	995.00	D
AUDIOLAB 8000LX	469.90	299.00	D+N
AUDIOLAB 8000A	499.90	379.90	D
AUDIOLAB 8000Q	1,249.90	799.00	D
KRELL KRC3	2,998.00	1,999.00	D
KRELL KSA 200S		3,499.00	S/H
LINN 5105 POWER	1,200.00	779.00	D
LINN 5103 AV Controller	4,850.00	2,999.00	D
MERIDIAN 555 POWER	695.00	449.00	D
MERIDIAN 501 PRE	695.00	489.00	D
MICHELL, J.A. ALECTO stereo	1,150.00	849.00	D
MICROMEGA TEMPO2 int	899.90	599.00	D
QUAD 77 int	650.00	449.00	D+N

CD PLAYERS/TRANSPORTS/DACS

AUDIOLAB 8000CDM	1,399.00	899.00	D
AUDIOLAB 8000CD	999.90	699.00	D
AUDIOLAB DAC	899.90	449.00	D
MARANTZ CD67	269.90	189.00	D
MARANTZ CD67 SE	349.90	269.00	D
MICROMEGA DAC 1	699.90	379.00	D
MICROMEGA STAGE 2	549.00	299.00	D
MICROMEGA STAGE 1	499.00	279.00	D
QUAD MODEL 77	595.00	359.00	D+N
TRICHORD RESEARCH PULSAR	1,400.00	599.00	S/H
TRICHORD GENESIS	549.00	349.00	D
TRICHORD REVELATION	799.00	479.00	D

SPEAKERS

EPOS ES12	500.00	350.00	D
KEF CODA 7		59.00	D
KEF CODA 8	189.00	95.00	D
LINN KABER	2,000.00	995.00	D
MERIDIAN M1500 SUB	895.00	679.00	D
MISSION 753		349.00	D
NEATE PETITE 3	800.00	519.99	Mint

D = EX DEMONSTRATION, N = NEW, S/H = SECOND HAND

THE LISTENING ROOMS LTD

161 OLD BROMPTON ROAD LONDON SW5 0LJ

TEL: 0171 - 244 7750/59 FAX: 0171 - 370 0192

E-mail: thr@dial.pipex.com

Mon-Sat 10-6pm

CLASSIFIED ADS

6 PAGES OF BARGAIN HI-FI

SPECIAL
INTERNET
OFFER SEE
PAGE 162 FOR
DETAILS

WANTED: KIMBER 6-way block and Powerkords, Mana Soundbases, quality interconnects (vdH, Chord Co., Audioquest). FOR SALE: KEF 104/2 teak £450, Arcam Alpha 6CD and 6+ amp (remote & boxed £950 new) £450, Linn Kaber (black, mint) £575. Tel: 0113 2 824 428 (Leeds) (Jul/I)

PS AUDIO Lambda CD transport £1275. PS Audio Ultralink DAC £1475. Theta Timebase Linque conditioner £100. Siltech HF6, 2 x 1m interconnects £135. Space and Time Quantum III, 8 x 2m 'speaker cables £250. All vgc. Tel: 01954 719 495 (Cambridge evenings) E-mail BMorley870@aol.com (Jul)

LEAK CLEARANCE TL12+ refurbished pair £275. Troughline tuner + Studio 12 decoder £85. Stereo 20 refurbished, gold, original specs £225. Stereo 60 refurbished by GT Audio, black, rare £425 Tel: 01279 629 708 E-mail alex@apostolakos.freeseerve.co.uk (Jul/I)

MONARCHY DIP Jitterbuster £120. Croft Supermicro A pre-amp £150. Croft Epoch silver wired pre-amp £395. Croft Series 5 stereo amp £295. Croft OTL 3 SA special build monoblock/stereo amps 75 w/channel £1450 (pair). Tel: 01279 629 708 E-mail alex@apostolakos.freeseerve.co.uk (Jul/I)

DENON DRM 800 3-head cassette deck £130. Rotel 865 cassette deck £90. Luxman T-111 stereo tuner £60. Wharfedale Airdale corner 'speakers, updated crossover, silver wired, very rare £395. Tel: 01279 629 708 E-mail alex@apostolakos.freeseerve.co.uk (Jul/I)

LEAK STEREO 20 and pre-amp, recent new valves, bargain at £185. Goldring 1012 unguised and boxed £25 may swap PX. Tel: 01228 674 537 (Jul/I)

CHORD CPA 3200 Enhanced pre-amplifier, 5 months old as new £1900 half-price bargain. Tel: 01355 264 586 (Jul/I)

ACOUSTIC ENERGY AE1 speakers, black, mint condition. Fabulous small monitor. Excellent detailing and imagery. New speakers force sale £375 ovno. Tel: 01302 786 006 after 6pm (Jul/I)

SANSUI 707 amp (1500) £650. Sony 920 CD £190. AR R/C Tuner £75. Celestion 100 speakers £175. MF MC2 £75. Exchange for Denon system WHY. Tel: 0121 246 0486 (Jul/I)

PAIR QUAD II & 22 control unit, excellent original condition £400. Garrard 301 vgc £150. SME 3009 II arm & F200 damper, boxed £70. Audio Synthesis DSM-X DAC £400. Tel: 01827 261 082 (Tamworth) (Jul)

QUAD 33/303 and FM3 excellent condition. All boxed with instructions £250 ono. Also Leak Sandwich 'speakers £50 ono. Tel: 01438 239 526 Stevenage (Jul/I)

NAIM ARMAGEDDON with manual and power leads £375 boxed, mint condition. Tel: 01372 452 529 evenings after 7.30p.m. (Jul/I)

NAIM CDi £1295. Naim CD2 £1495. Shahinian ARC oak £1195. ATCSCM20 teak £995. Micromega TDrive 2/TDAC £1095. Denon DCDS10 gold £795. Micromega Stage 6 £595. Roksan Xerxes £495. Michell Hydraulic Reference £295. Tel: 01376 521 132 (Jul/I)

SME MODEL 20/IV/AT-OC9 £3250. Krell KAV300CD £2750. Marantz CP430 portable cassette £300. All boxed, one month's use. Target RS stands, unopened £250. Origin Live Skyline turntable support £20. Tel: 01924 290 749 (Jul/I)

IMF TLS80 Mk II. Kef 105/4. Celestion Ditton 66 mint. Meridian 200/203. Deltac PDM II DAC. Revox A77 High Speed. Teac A3340. Musical Fidelity F22 remote pre. All boxed and as new. Marantz Model 7T pre/15 power amps. Very rare: Michaelson & Austin TVA1 power amp KT88s Tel: 01992 718 265 (Aug/I)

EXCHANGE IMMACULATE Proac Response 2.5s for quality monitors plus £1000. Want Dynaudio Contour 1.3s, Totem Model I or Proac ISC with good stands. Need space and cash. Tel: 0114 235 2095 evenings. (Jul/I)

VINTAGE HI-FI separates:
Yamaha CA 600 amplifier. 2 x superb Celestion 44 'speakers. Sony PS4750 direct-drive turntable. All in good condition, sensible offers only. Tel: 01494 765 226 (Jul/I)

EPOS II. loudspeakers with stands. Perfect £250. Pioneer A400X amplifier and Aiwa AD F850 cassette deck. Both only 18 months old. Boxed, as new £120 and £110. (Huddersfield) Tel: 01484 862 487 (Jul/I)

PM COMPONENTS MP-L15 Mk2 pre-amp with MP211A monoblocks single-ended valve amplifiers, cost £5000, asking £1750 boxed. Will P/ef for Albarry AP4 M1008II grey finish plus cash difference. Tel: 01904 763 157 (Jul/I)

LINN LP12 (Affro), Trampoline, Cirkus, Ittok, OC9. excellent condition £595 ono. Sony Walkman Pro W11 DC6 without headphones hence £75. Tel: 0113 266 3749 (Leeds) eves. (Jul/I)

SONIC FRONTIERS SFD1 DAC (balanced option) HDCD compatible, boxed as new with two year warranty £1000 - no offers at this price. Theta Data Basic also available. Tel: 01623 871 950 (Jul/I)

LINN KARIK (brillianted) £850. Numeric £495. Kairn £995. LP12 Valhalla, Ekos, Klyde, would possibly split £995. AT OC9 cartridge boxed unused £195. Tel: 01582 456 137 (Jul/I)

PAIR OF ACOUSTAT electrostatic 'speakers better than Quad 57. asking £500. Altec Lansing Dual Concentrics horn units 604H/604G extremely rare asking £150 each. Luxman tuner T1 mint asking £100. Yamaha TC-800GGL rare cassette deck asking £100. Tel: 01342 850 652 (Jul/I)

REL STENTOR Mk 2 one year old, rosewood finish exc cond £875 (£1900 new). Tel: 01604 645 590 (Aug/I)

PAPER IN Oil reservoir capacitor clear out. NOS Dubilier 0.5µF at 2500V £3 each. Ferrograph S1 monitors with stands, immaculate, £200. John Bowers Active One loudspeakers. 3-way active floorstanders, cost £1500 in 1985, will accept £550 ono. Aurex System vgc, pre/pwr/tuner/tape £125. Small Sony amp 30watts/ch £25. WANTED: Trio L Series separates, working or not. Tel: Jon 0181 904 8023 (Jul/I)

WILSON BENESCH WB Turntable, PSU, Act Two arm, Cardas arm cable, Triptych stand £2000. Marantz CD12 DAC £400. Tannoy Mayfair 10" Dual Concentric & 10" ABR units £100. Tel: 0181 672 4319 (Jul/I)

MUSICAL FIDELITY F18/F22 power/pre amp. MF's greatest amplifier combination to date? Awesome power, sound stage and bass slam. Pristine condition. Boxed, manuals, remote, as new £2250 ono (cost £5000). STD 305M turntable + SME Series III's titanium nitride arm Shure V15IV VN45MR boxed, manuals complete with all original accessories, pristine £150. Demo will convince. Tel/Fax 0113 284 3770 (Leeds)(Jul/I)

KRELL KSA80 mint condition £1250. Art Audio VPI £450 mint condition. Buyer collects. Tel: Darren 0116 240 3437 after 6pm (Jul/I)

WANTED: TECHNICS EPS-P205 ED3 stylus assembly + Technics P205 CMK3 cartridge. Tel: 01752 266 753 anytime (Jul/I)

REGA RB250 Full Origin Live modifications. Few hours use only from new. Perfect condition. Boxed with full instructions, accessories and all receipts. Cost £254. Sell £154. Tel: 01803 868 869 (Jul/I)

NAIM 32.5 pre/110 power amp, good condition £495. Tel: Steve 01323 898 051 (Jul/I)

diverse vinyl

12 Upper Dock Street Newport Gwent NP20 1DF 9am-5 30pm Mon - Sat.
 internet site htt //www.diverse-music.co.uk
 phone/fax 01633 256261 / 259661 E Mail sales@diverse-music.co.uk
 -Mastercard - Visa- Catalogues available -Amex-Switch-JCB-

New Simply Vinyl Titles

Alan Parsons Project	I Robot		£17.90
Billy Joel	The Stranger		£17.90
Bob Dylan	Another Side/Nashville	Each	£17.90
Boz Scaggs	Silk Degrees		£16.90
Byrds	Dr Byrds And Mr Hyde		£16.90
Cowboy Junkies	Trinity Sessions		£16.90
Jeff Buckley	Grace		£17.90
Pearl Jam	Ten		£19.90
Soundtrack	Dirty Harry		£16.90
Soundtrack	Man From U.N.C.L.E.		£19.90

Forthcoming Releases

Bruce Springsteen	18 Tracks	18/5	£TBC
Captain Beelheart	Grow Fins Volume 1	18/5	£16.90
Cassandra Wilson	Travelling Miles - 2LP		£24.90
Tom Petty	Echo	18/5	£TBC

New & Recent Releases

Aranbee pop symphony	Today's Pop symphony		£14.90
Beck	Mutations (plus 7")		£12.90
Ben And Jason	Hello		£6.50
Beverley Knight	Prodigal Sista	2LP	£15.90
Dark Star	Twenty Twenty Sound		£11.90
Eminem	The Slim Shady	2LP	£18.50
Fall	Marshall Suite		£12.50
Fela Anikulapo Kuti	Box Sets(6LP's + Book)	Each	£55.00
Fu Manchu	Daredevil/No one Rides	Each	£10.90
Fugazi	Instrument Soundtrack		£6.90
Herbaliser	Mercenary		£11.90
Hurricane #1	Only The Strongest		£10.90
Incognito	No Time Like The	2LP	£15.90
James Hardway	A Positive Sweat		£11.90
Jefferson Airplane	Thru The Looking glass	2LP	£16.90
Olivia Tremor Control	Black Foliage		£12.90
Pink Floyd	Pulse - Back In Stock	Box	£43.00
Small Faces	Small Faces (plus 7")	180gm	£16.50
Suede	Head Music	2LP	£15.90
Tom Waits	Mule Variations	2LP	£10.90
Wings/McCartney	Band on the run-25th	2LP	£16.50

Japanese Blue Note 10" LP's Extremely Limited - £24.90
 Titles by Bud Powell, Clifford Brown, Elmo Hope, Fats Navarro,
 Howard McGhee, James Moody, Kenny Drew, Lou Donaldson,
 Miles, Milt Jackson, Thelonious Monk etc - Ring For Details
ALL PRICES SUBJECT TO CHANGE

P and P £1.00 1st LP additional LP's 50p each (max £4.00)

English Analogue

Supplier of quality second hand classical records
 Reasonable prices for truly collectable original vinyl from
 the 1950s to the 1970s. Labels include:

DECCA -SXL, SDD, SET, RCS, SPA, PFS
HMV - ALP, ASD, SAN, SLS
COLUMBIA - 33CX, SAX
RCA - SB - 2000/6000, VICS, SER
DEUTSCHE GRAMMOPHON, PHILIPS
 etc, also available

If you are unfamiliar with classical music,
 recommendations are available of great recordings to
 enhance the enjoyment of your Hi-Fi and enter you into
 the vast world of Classical Music. Just as there are good
 recordings or Rock, Pop or Jazz, the same applies to
 Classical.

To increase your satisfaction, all the records sold are
 cleaned and audibly checked before being sold, free of
 charge, as well as a guarantee. The records are also
 supplied with a new innersleeve, as well as the old, to
 insure a high standard. In addition, if you have any
 Classical LPs or CDs you wish to sell or want a free
 catalogue, please write, phone or fax to:

3 Naseby Rise, Newbury, Berks, RG14 2SF, England
 Tel: 44 - (0) 1635 40242 Fax: 44 (0) 1635 524239
[www.multiplex.co.uk /Records](http://www.multiplex.co.uk/Records)

audio *edge*

visual *edge*

174 Central Road,
 Worcester Park, Surrey
 0181 337 4455



*For the ultimate in
 Sound & Vision*

HELIUS • LOWEW SYSTEMS • AUDIO AND TV'S PLINIUS •
 AUDIO PHYSICS • JAMO • SONIC FRONTIERS • ROCKPORT •
 SPEAKERS & TURNTABLE • ORACLE CD PLAYERS & TURNABLE •

§ KITS-

DESIGNS ENGINEERED FOR
 EXCELLENCE WITH:-
 POLYPROP CAPS
 AIR CORED COILS
 HI-TEC DRIVERS
 TOP GRADE
 COMPONENTS

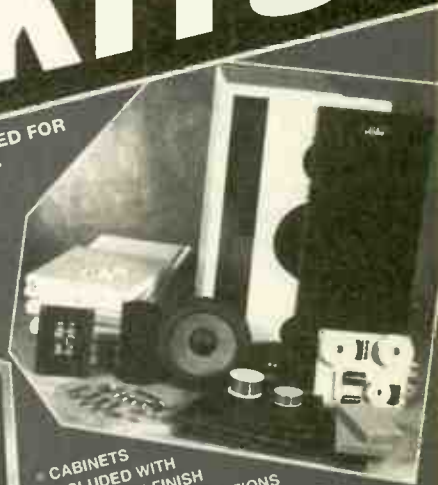

CABINETS
 INCLUDED WITH
 OPTIONS ON FINISH
 NOTES AND SPECIFICATIONS
 COMPREHENSIVE INSTRUCTIONS
 AVAILABLE AS COMPLETED UNITS
 WITH STANDARD OR EXOTIC VENEERS
 DISCRETE COMPONENTS
 CUSTOM MACHINING SMALL PANELS,
 JOINTS & CUT-OUTS
FOR FURTHER DETAILS:-

Q.T.A. Systems
 2 Wheatsheaf Way
 Linton • Cambs CB1 6XB
 Tel: 01223 891091

HI-FI WORLD CLASSIFIED ADS

Dealers must not advertise in the Private Classified section. Monthly consecutive insertions will be considered Trade advertising. The Publisher reserves the right to judge submissions.

SPECIAL
INTERNET
OFFER SEE
PAGE 162 FOR
DETAILS

WANTED - EARLY HI-FI LOUDSPEAKERS
Tannoy, Lowther, Parmeko, Voigt, Vitavox, RCA WE etc
TURNTABLES
Garrard, BBC301, EMT SME, Ortofon, Decca, etc.
VALVE AMPLIFIERS
AEI, EMI, Leak, Rogers, PYE- Quad, WE etc
AUDIO VALVES
DA30, KT66, KT88, PX4, PX25, PP3/350, WE300
CLEAR CRYSTAL SYSTEMS
John Petrie-Baker
Tel: 0171 328 9275

OFFICIAL SUGDEN Service, repairs, and upgrades. Sales of new and reconditioned SUGDEN audio products. Prices from £150 including carriage for recons with guarantee. Full details available. Tel: Audio Synergy 01924 406 016 (Jul99/1)

BUY-SELL-EXCHANGE. Vintage wireless and classical audio. Repairs, spares, restoration, modification to all valve equipment. Quad II, Leaks etc, shipped worldwide, best prices, call us at 17 Bell Street, NW1 5BY. Tel: 0171 258 3448 Fax 0171 258 3449 (Jul00/1)

SUPERB KEF home cinema loudspeaker package. Kef Q35/100c REF/Q15 all mint, boxed and under warranty for £657. Tel: Audio Visual Concepts on 01628 440 873 (Jul/1)

NO VINTAGE! No New! But lots inbetween, 70's and onwards hi-fi. Phone for stock information: 0181 590 2890. Essex Sound & Vision, 762 High Road, Goodmayes, Ilford, Essex IG3 8SY. Mail Order Available. (Jul/1)

ACTIVE CROSSOVERS. DESIGNED AND BUILT TO YOUR EXACT REQUIREMENTS. QUALITY UNITS WITH NO SILLY PRICES. SPEAKER MODIFICATIONS FOR ACTIVE OPERATION UNDERTAKEN. CONTACT
Paul: 01271 323 850 (Jul/1)

AUDIO RESEARCH LS8 preamp £900 (£1450), Krell KSA150 power £2000 (£5500) MIT Terminator 2 interconnect 1m £50 (£130) van den Hul CS122 biwire speaker cable 2.5m £50 (£120). All perfect with manuals and boxes. Upgrading again. Tel: Bill 01993 851 508 home, 01865 792 020 work (Oxford) (Jul/1)

IMF PROFESSIONAL monitors, Tannoy Berkeleys, Technics SP10, SL 110, SL 1510, RSB-905 cassette, Revox B77, Sony TC 399s, TC 458, Pioneer - PL12D's Lenco L55/GL75, Teac 3340S, Rotel RX-1203. Tel: Bay Electronics (Sales and Servicing) Leeds 0113 270 1954 (Jul/1)

BUY-SELL-EXCHANGE. Vintage wireless and classical audio. Repairs, spares, restoration, modification to all valve equipment. Quad II, Leaks etc, shipped worldwide, best prices, call us at 17 Bell Street, NW1 5BY. Tel: 0171 258 3448 Fax 0171 258 3449 (Jul00)

ROGERS SPEAKERS (new and ex-demo) still for sale, massive discounts. Studio 9 £550. Studio 7 £350, Studio 5 £250. BBC, Gold and LS ranges available. E40A valve amps £1000. Spares and servicing. Mitcham Loudspeakers Tel: 0181 648 6743 or 01344 872 568 (Jun/1)

ROGERS LS66 stand mounting and LS88 floor standing speakers, brand new and boxed, last versions of classic LS6 and LS8 designs in black and rosewood, LS66 priced £150 pair LS88 £200 pair. Save around 60% on list! Don't wait, call Mitcham Speakers 0181 648 0743 (Jul/1)

THE AUDIOFILE OBJECTIVE has 20% off existing Mission/Castle stock. Plus a selection of new, X display and s/h stock. Other major brands available. Hi-fi purchased. Free parking. 37 Tower Centre, Hoddesdon, Herts. Tel: 01992 478 666. Email: audiofileobjective@cwcom.net (Jul/1)

REVOX E36 £500. Revox G36 £600. Studer B62 £500. Studer B67 £600. Revox B77 £700. EMT 948 £550. EMT 950 £750. Technics SP10 £250. Studer A80 £1200. Studer A710 £550. Studer A810 £800. Tel: 01246 235 024. Fax: 01246 550 421 (Jul/1)

CASTLE LOUDSPEAKERS New. Discounts available. Deliver Anywhere UK. Please telephone for details. Five Ways Hi-Fidelity Ltd (Est 1972), 12 Islington Row, Edgbaston, Birmingham B15 1LD Tel: 0121 455 0667. Tues-Sat 10.30-6.00 (Jul/1)

SINGLE ENDED. Build a Mullard 3-3 type valve amplifier. No capacitors in the signal path. Output transformer is three times larger than original spec. Monoblock construction. Customers report 'unbelievable natural sound'. Finished chassis and transformer set £195 delivered UK. Tel/Fax F&S transformers (+44) 0121 686 2939 (Aug/1)

ANALOGUE ELECTRONICS Design Engineer Bsc (Hons) valve/transistor audio equipment designed, built to specification; stereo/monoblock amps, line and phono stages, power supplies. Also, repair, modification, restoration, technical writing. Tel: Theo 0181 881 1623 (Jul/1)

HI-FI WORLD CLASSIFIED ADS ORDER FORM

Dealers must not advertise in the Private Classified section. Monthly consecutive insertions will be considered Trade advertising. The Publisher reserves the right to judge submissions

Hi-Fi WORLD CLASSIFIED ADS ORDER FORM

Please type or write your advertisement copy in block capitals on a separate sheet of paper and return with this completed form.

SPECIAL OFFER
BOOK A PRIVATE OR TRADE CLASSIFIED AD. AND GET ONE MONTH'S FREE INTERNET AD.

RATES

Maximum length per advert is 30 words, each additional word is 50p extra. Telephone and model numbers are treated as one word.

MAGAZINE & INTERNET

- Private - Free Internet £10.00 per month
 Private, Boxed - Free Internet £15.00 per month
 Trade - Free Internet £10.00 per month
 Trade, Boxed - Free Internet £15.00 per month

PLEASE TICK HERE IF YOU DO NOT WANT YOUR FREE INTERNET ADVERT

Name

Address

Post Code Daytime Tel. No

I enclose cheque/postal order for £ Made payable to:-

Audio Publishing Ltd.

Please debit my VISA/MASTERCARD card No. Expiry Date



Send this form together with your payment to:



**Hi-Fi World Classified Ads.,
 Audio Publishing Ltd., Suite F21,
 Imex House, The Park Business
 Centre, Kilburn Park Road,
 London, NW6 5LF**

DEADLINE FOR AUGUST 1999 ISSUE IS FRIDAY 4TH JUNE 1999

ADVERTISERS INDEX

Affordable Audio	146	Henley Designs	6	RJF	148
Alto Fidelity	136	Hi-Fi Company	8	Roksan	70
Arcam	78	Hi-Fi Curiosity	154	Rothwell	138
Audio Lamp	122	Hicam	138	Russ Andrews	40, 79
Audio Design	149	Howard Dawson	118	Sevenoaks	20,21,22,23
Audio Note	110,111	Ian Edwards	136	Signals	102
Audio Links	118	Ian Harrison	154	Slate Audio	140
Audio T	56,57	IPL Acoustics	122	Soneteeer	148
Audio Direct	82	J E Sugden	10	Sonic Link	86
Audio Connoisseurs	92	Jem Distribution	74	Sound Management Consultants	10
Audio Illusion	40,150	KEF	25,27	Sound of Music (Crewe)	150
Audio Matters	150	Kit Suppliers	120	Sound Image	IBC
Audiocom	16, 138	Langrex Supplies	124	Sounds of Music Kent	54
Audusa	75	Linn Products	80	Sounds Perfection	48
B K Electronics	124	Listening Rooms	154	Sounds Expensive	154
BADA	69	Loricraft	136	Sowter Transformers	122
Billington Export	114	M.A.X.	94, 156	Sussex Surplus	103
Billy Vee	136	Malaysia Audio Show	76	Technical & General	116
Cable Talk	149	Mantra	94	The Right Note	38
CAD	48	Marton Music	114	Trading Station	131,132,133,134
Central Audio	142	Mission	BC	Try Me & See	144,145
Chelmer Valve	108	Music Video Exchange	152	UKD	68
Choice Hi-Fi	130	Musical Fidelity	30, 77	University Audio	152
Classique Sounds	102	Musical Images	154	Vacuum State Electronics	116
Cricklewood	118	Musonic	154	Van Den Hul	44
Custom Cable Svcs	71	MVL Technology	IFC, 73	Vickers	92
Definitive Audio	44	Origin Live	148	Virtual Reality	16,32,44
Definitive Audio (Brighton)	138, 12	Oxford Audio	149	Visual Edge	160
Diverse Vinyl	160	P G Hi-Fi	142	Vivante	32
Emporium	131	Paul Hynes	10	V Audio	152
English Analogue	160	Pear Audio	86	Walrus Systems	36
Epos	86	Powerplant	152	Walther Electronics	124
Falcon	114	Progressive Audio	142	Watford Valves	116
Glaive	48	QTA	160	Wire & Installation	36
Grandix	146	Replay Audio	44	Zentek	32
Halfin	81	Retro	103	Zouch Audio	80
Heatherdale	72	Ringmat	38		

classified ads form

advertisers index

STANDING OVATION

"For me, this is truly the ultimate desert island loudspeaker..."
Jack English, *Stereophile*, volume 19 no. 5.

"I am comfortable in saying that, to this point,
these are the best speakers I have ever heard. I love them..."
Johnathan Scull, *Stereophile*, volume 21 no. 4.



Sound Image UK Ltd ■ 52 Milton Road ■ East sheen ■ London ■ SW14 8JR
Tel 0181 255 6868 ■ Fax 0181 255 6869 ■ <http://www.focal.tm.fr>

Behind beauty...



...lies technological elegance.



Real wood veneers:-

From sustainable european forests



Spring loaded tweeter:-

Ensuring clarity through isolation.



Sculptured 35mm Medite baffle:-

Maximum rigidity without reflective surfaces



Aerogel:-

Lightness with carbon fibre rigidity.

