

Still
£2.00

Hi-Fi WORLD

DECEMBER 1994 £2.00

5 QUALITY CD PLAYERS
Arcam Alpha One
Yamaha CDX-980
Rotel RCD-965BX Discrete
Kenwood DP-7000
Onkyo DX-750

SCOOP!

**NEW DPA DIGITAL
RENAISSANCE
AMPLIFIER**

**NEW PRO-JECT 6.1S -
BEST TURNTABLE
UNDER £1000?**

**DIY SUPPLEMENT No. 12
banded to this issue**

**LOUDSPEAKERS FROM:
MISSION
TANNOY
SD ACOUSTICS
MUSICAL TECHNOLOGY**

**COMPETITION - WIN A COMPLETE VINYL
SYSTEM WORTH £1300**



The most complex DAC in the World



The PDM ten twenty-four - packed full of dpa innovations that redefine CD performance.

is also the simplest.

It has long been held as a tenet of audiophile wisdom that the simpler the analogue circuitry, the better the sound quality. We have spent many years developing our own DAC technology that results in an order of magnitude improvement in analogue simplicity. This is achieved by the use of our patent pending DX processor DAC that employs up to 128 times digital filtering. This gives a very simple analogue topology - just our op-amp and four passive components in the direct signal path.

This is some ten times simpler than conventional DAC's - and the sonic result it gives is extraordinary. Words cannot convey the sense of excitement when listening to music through it. Instruments sound much more tangible with better focus and separation. Sound stage and detail resolution are remarkable. Indeed, we are convinced our DX DAC technology completely redefines the capability of digital music.

However, this performance comes at a price - one being the complexity of the digital domain. An amazing one billion single bit additions are performed each second. The PDM ten twenty-four also features nearly 2,000 discrete components, 4,000 gates, 8 noiseshapers, 8 digital filters, 8 programmable dither sources and gold plated solid copper construction throughout - to name but some of the features. It is modular in construction, thus allowing future upgrades.

Moreover, the DX processor technology can be applied to more affordable DAC's. The PDM two fifty-six (our replacement for the highly regarded PDM two) is available. We are currently developing the PDM sixty-four that features a scaled down version of this technology for only £1250. For more information please telephone or write to:

dpa Digital Ltd.,
7&8 Willowbrook Lab Units,
Crickhowell Rd., St Melons,
Cardiff, Wales CF3 0EF
Tel: (0222) 795621
Fax: (0222) 794267

The logo for dpa Digital Ltd., consisting of the lowercase letters 'dpa' in a stylized, white, sans-serif font.

A logo for the 'dx 128 processor' featuring the text 'dx 128 processor' in a white, sans-serif font, enclosed within a white oval border with horizontal lines.



EXPERIENCE MUSICAL TRUTH

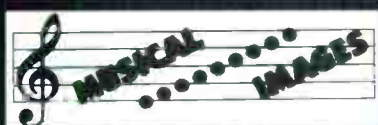

45 High Street, Hounslow, Middx.
TW3 1RH

Tel: 081 569 5802

(Also at Edgware, Middx,
Tel. 081 952 5535)

(Also at Covent Garden, London,
Tel: 071-497 1346)



NEW 200S PRE POWER
£1250



93 Hobs Moat Road,
Solihull,
W. Midlands
Tel: 021 742 0254

Zen Audio

35 George Street,
Hull HU1 3RE
Tel: 0482 587397

audible difference

Scole, Diss, Norfolk.
IP21 4DX.
Tel: 0379 740227

Doug Brady Hi-Fi

Kingsway Studios,
Kingsway North,
Warrington.
Tel: 0925 828009



34, Buckingham palace
Road, London SW1W 0RE
Tel: 071 - 233 0774
Fax: 071 - 233 7226

Oxford Audio Consultants

Cantay House,
Park End Street,
Oxford OX1 1JE
Tel: 0865 790879
Fax: 0865 791665



Chantry Walk,
16/18A Eldon Street,
Tuxford, Nr Newark,
Notts NG22 0LH.
Tel: 0777 870372

Audio Suite

42 St. Andrews Street,
Aberdeen AB1 1JA.
Tel: 0224 625 635



152A High Street,
Bloxwich,
West Midlands.
Tel: 0922 493499



3 Bridge Street,
Guildford,
Surrey.
Tel: 0483 504801

SHROPSHIRE HI-FI

St Michael's Street
Shrewsbury
Shropshire SY1 2ES.
Tel: 0743 232317



41 Victoria Road,
Cambridge.
CB4 3BW.
Tel: 0223 68305

ZEUS AUDIO

2/4 Great Victoria Street
Belfast BT2 7BA
Northern Ireland.
Tel: 0232 332522



KJ WEST ONE

26 New Cavendish
Street,
London W1M 7LH.
Tel: 071 486 8262

AT OUR KEY DEALERS

dpa digital ltd

Unit 7, Willowbrook Technical Units,
Crickhowell Road, St. Mellons, Cardiff CF3 0EF, Wales, UK
Phone: 0222 795621 Fax: 0222 794267

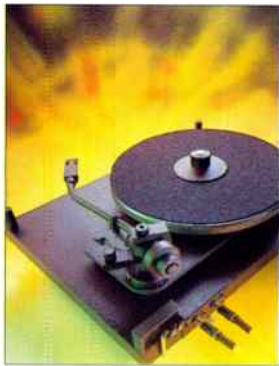

Cover Photograph by
Paul Hartley Studio 071- 482 3768

THIS MONTH'S REVIEWS

AMPLIFIERS

DPA DIGITAL RENAISSANCE 16
Yet another entry into the mid-price integrated amplifier market. DPA have included a phono-stage, tone controls and headphone socket to their surface mount electronics to produce an attractive package.



LINN KAIRN & KLOUT 33
You may remember these from October's group test. We thought they deserved a more in-depth review.

ROGERS CADET III 34 & Supp.
An introduction to this classic affordable valve amplifier, by Haden Boardman.

COMPACT DISC

AUDIOPHILE CD PLAYERS 21
We test a group of £300-400 CD players in a search for the best mid-priced sound around. Included in this test is the cheapest British built CD player available, the new Arcam Alpha One.



ARCAM ALPHA ONE
ROTEL RCD-965BX DISCRETE
YAMAHA CDX-880
KENWOOD DP-7060
ONKYO DX-750

LOUDSPEAKERS

MISSION 731 18
Mission's latest mass market mini-monitor, the 731, is part of an all-new range of loudspeakers. Dominic Todd takes a listen.

MUSICAL TECHNOLOGY KESTREL 30
An affordable metal cone floor-stander from newly formed Musical Technology catches Dominic Baker's attention.

TANNOY 632 41
Tannoy have a whole new range of loudspeakers. The 632 replaces the popular 605s. Dominic Todd and Eric Braithwaite air their views.

SD ACOUSTICS SD3-R 49
A high-tech, mineral-loaded polymer cabinet, custom bass unit and ribbon tweeter come together in SD Acoustics' £399 SD-3R loudspeaker package. Auditioned by Dominic Baker and Peter Downs.

TURNTABLES

PRO-JECT 6.1S 57
This amazing package of Pro-ject 6.1 turntable, Sumiko tonearm and Ortofon MC30 Supreme moving coil cartridge costs just below £1000. Eric Braithwaite frantically works through his vinyl.

CASSETTE

KENWOOD KX-7060S 64
Kenwood have just introduced Dolby S to some of their cassette decks. We take the KX-7060S for a spin.

TUNERS

NAKAMICHI ST3s 36
Part of a new range of products from Nakamichi is the ST3s tuner. We scan the air waves to test its abilities.



REGULARS

NEWS 8
Following Live '94 we take a look at the flurry of new equipment that has recently appeared.

LETTERS 38
Readers' views on all things hi-fi, with comments from our editorial team.



AMERICAN
and
CANADIAN
SUBSCRIPTIONS
- see page 68

Editor
Noel Keywood

Assistant Editor
Dominic Baker

Editorial Assistant
Simon Warsap

Production Editor
Ferewini T. Michael

General Manager
Mark Winfield

Marketing Manager
Richard Johnson

Advertising Executive
Amanda Sweeney
Advertising Tel: 071-266 0969

Design Engineer
Andy Grove

Technical Assistant
Nick Lucas

Contributors
Eric Braithwaite
Richard Brice
Giovanni Dadomo
Peter Herring
Simon Hopkins
Dominic Todd

Cartoonist
Freddy Ahmet

Distributed by:
COMAG, Tavistock Road, West
Drayton, Middlesex, UB7 7QE
Tel: 0895 444055

Origination by:
Ashford Scanning
2 Norfolk Drive,
Fairwood Industrial Park,
Asford, Kent TN23 2FB
Tel: 0233 622042

Printed by:
Southernprint, Poole, Dorset.
Tel: 0202 622226

AUDIO PUBLISHING LTD.,
64 Castellain Road, Maida Vale,
London W9 1EX.
Tel: 071-289 3533
10 am. - 6pm.
Fax: 071-289 5620
Queries cannot be answered
by telephone.

MAIL ORDER
Tel: 071-266 0461 (24 hours)

Subscription Rates:
UK: £22,
Overseas Surface: £29, Airmail:
£42 (Europe) £52 (USA, Middle
East), £62 (Australia, Japan).

No material may be reproduced
from this magazine without
the publisher's written
permission.
© Audio Publishing Ltd



Q&A	115
What is it? How do I get it to sound better? What should I do next? Our team of experts have the answers.	
COLUMNS	61, 63, 69, 73
Opinions and views from our team of hi-fi gurus.	
NEXT ISSUE	60
What will next month bring? Well, another issue of Hi-Fi World for a start, packed full of reviews, music, features, letters and much, much more.	
SUBSCRIPTIONS	68
Worried about missing out on all of the new products, technology and music? Subscribe to Hi-Fi World and keep up to date with the world of hi-fi.	
ACCESSORIES	97
One of those people who likes to have Christmas under control? Our accessories pages are packed full of super present ideas.	
HI-FI WORLD LIBRARY	101
Educational, entertaining and affordable. A whole range of books for enthusiasts and budding audiophiles.	
DIAL-A-DEALER	89
Who sells what and how to get in touch.	
WORLD AUDIO DESIGN	81
Our in-house designed range of valve amplifier kits and high technology drive units from Audax offer superb value to the home constructor.	
MEET YOUR MAKER	84
The manufacturers' directory.	

WORLD FAVOURITES	110
Looking to buy a hi-fi? See our listing for the best sounding and best value equipment we've tested.	
CLASSIFIEDS	123
SPECIALIST HI-FI DEALERS	77
Need a specialist, look no further.	
ADVERTISERS' INDEX	130

FEATURES

DCC IMPROVED TO 18-BIT STANDARD	11
Decca are now recording DCC tapes at 18-bit resolution and true 18-bit machines will be available from Philips soon. We report on the advances made.	
LIVE '94	12
The UK's biggest consumer electronics show held at Earls Court. We report on the show and all of the new products that were launched.	

DIY SUPPLEMENT

In this month's FREE DIY hi-fi supplement, you'll find extensive application notes on two new High Definition Aerogel drive units from Audax, a super quality kit CD convertor from Audio Technology, a restoration article on the Rogers Cadet III valve amplifier plus book reviews, news, letters and more.

MUSIC

Our guide to some of the best new releases.

ROCK RECORD OF THE MONTH:
R.E.M.: Monster

CLASSICAL RECORD OF THE MONTH:
The Tallis Scholars: Live In Rome

ROCK AND POP	73
CLASSICAL	85
JAZZ	93

COMPETITION

A chance to win a top-flight vinyl playing system worth over £1300. The system comprises: Systemdek IIX900 turntable complete with Rega RB250 tonearm and Goldring 1022GX cartridge, DPA Digital Renaissance integrated amplifier and Systemdek Systym 931 loudspeakers. 66



CONTENTS

PHILIPS INVENTS

The Digital Compact Cassette

When it comes to sound quality, for Sting "good" just isn't good enough. He demands that his music is reproduced perfectly. That's why he is so impressed with Philips latest invention. DCC.



A digital cassette with the pure sound quality of a compact disc and the convenience of a compact cassette. There's a complete range of equipment, so you can play your DCC anywhere, in the home, in the car or on the street. And don't worry

about your collection of ordinary compact cassettes, the beauty of the DCC system is that it will play them too. DCC is already a big hit with the major record companies with hundreds of titles already available. So don't make a mistake, choose DCC. For details of stockists and further information telephone 081-665 6350.



DCC 600 Player/Recorder



FW 91 DCC System



DCC 130 Portable



DCC 811 In-car



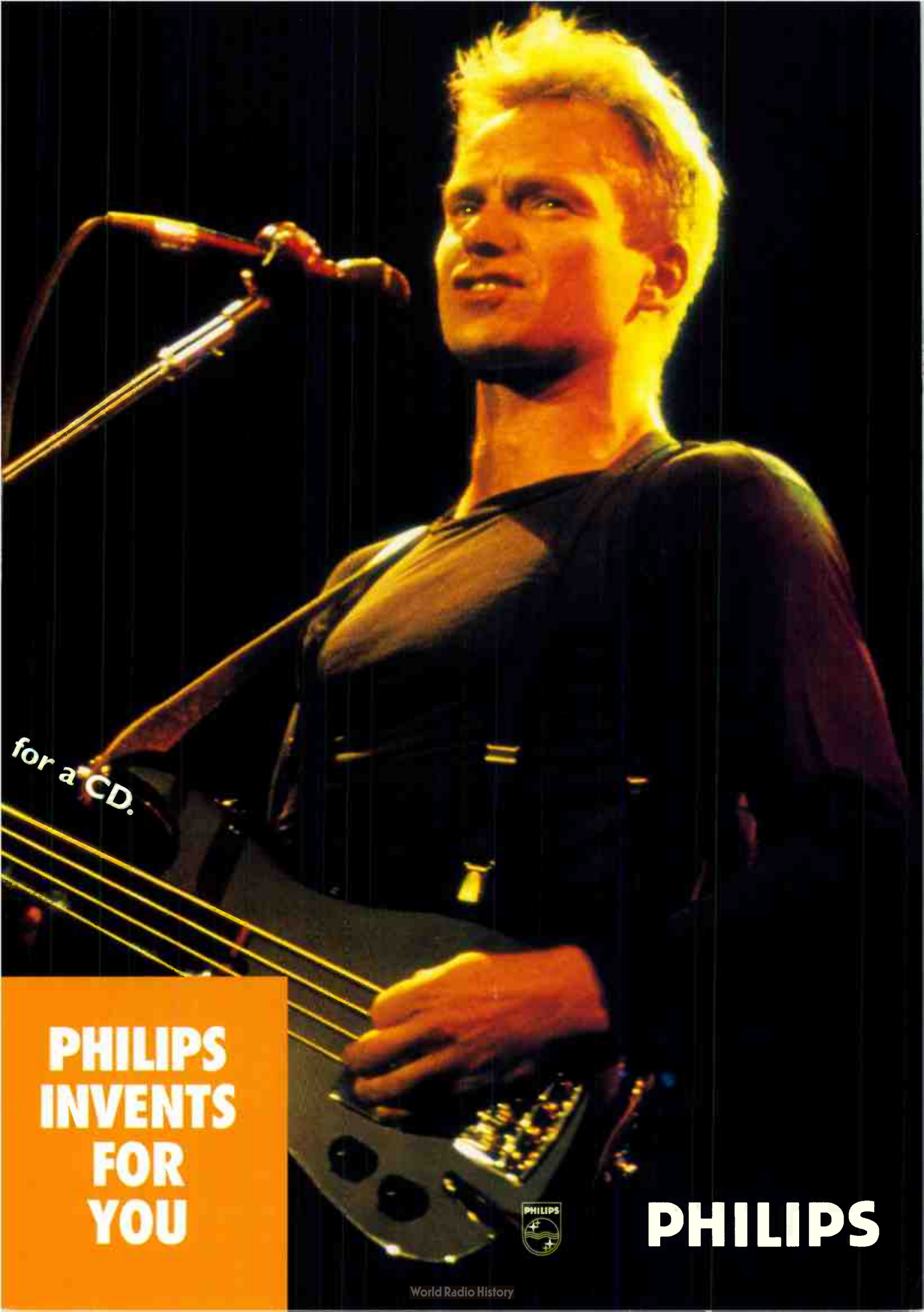

for a CD.

**PHILIPS
INVENTS
FOR
YOU**



PHILIPS

QUAD LAUNCH INTEGRATED AMP

Quad will shortly launch the Quad 77, an integrated amp it hopes will become the essential core for hi-fi systems of the future. It is the first in a planned series of products which link up through a data bus which carries analogue, digital and control signals, Quad said, removing debates about interconnects.

Two systems are linked to the Quad 77: Quadlink and Quadremote. Quadlink is the system bus, enabling the amp to grow in any direction, carrying analogue, digital, system protocol, system commands and HT for lower powered units. Quadremote is a two-way, infra-red remote control system. The amp will retail at around £595 and the remote panel at £250.

The handset has just ten buttons, a rotary knob and a display for system information, defining the function of the six 'soft' buttons. The remote also receives information from any future equipment linked to the Quad 77.

Quad Electroacoustics
St Peters Road, Huntingdon,
Cambs. PE18 7DB. Tel: 0480 52561



NEW NFM2 FROM TDL

Two new TDL 'speakers are now available. Complementing their established TDL Near Field Monitor (NFM) is a new NFM2 which uses two bass units in a taller cabinet to improve power handling. A soft dome tweeter is positioned between the bass/mid. 'speakers, to resemble a point source.

A pair of NFM2s in Rosewood or a Black finish retail at £179.95.

Another newcomer is the TDL RTL4 which is an up-rated version of the TDL RTL3. It uses larger bass units and a 25mm soft dome tweeter for higher power handling and greater sound pressure levels, making it ideal for larger rooms. It offers all the detail and extended bass of the RTL3, even at low volumes, TDL claim.

At £649.95 retail, TDL RTL4s have a Black or Rosewood finish.

TDL Electronics
PO Box 98, High Wycombe
Bucks HP12 3AD Tel: 0494 441191



PHILIPS 18-BIT DCC RECORDER

Due for release early next Spring - probably February Philips told us - is Philips' new DCC-730 18-bit DCC recorder. Capable of playing normal 16-bit tapes, but also tapes recorded with higher resolution and, therefore, better sound quality, this new domestic recorder could well look interesting for audiophiles. The only caveat at present is lack of availability of 18-bit pre-recorded tapes. Curiously, by default, Philips have managed to upgrade DCC's resolution to exceed that of CD, whilst tape prices remain the same (we hope) - now pegged at CD prices. At present, only Decca Records, who have collaborated in the development of DCC, have the necessary duplicating equipment to achieve the 18-bit standard on commercial cassettes, but if wise minds prevail at Philips, they'll push this development through as quickly as possible to give DCC the advantage it so desperately needs.

FAST RESPONSE FROM PROAC



A new loudspeaker has been launched by ProAc to complement its Response range. The new Response Three Point Five is a replacement for the Three, ProAc said. Designed by Stewart Tyler, the Response 3.5 uses a new polypropylene bass driver possessing a lighter, thinner and stiffer cone, whilst retaining good damping qualities. The aim was to get faster, more powerful bass, whilst maintaining clarity and detail in the mid-range area. Like the Response Four, the new speaker's tweeter has a super-light diaphragm, exclusive to ProAc, with a hand applied coating. Driver arrangement into mirror image pairs gives the Three Point Fives a "wonderfully large sound stage, but with pin point imagery", ProAc said.

Prices start at £4250, moving up to £4975 for Signature finishes.

ProAc
130-132 Thirsk Road, Borehamwood,
Herts. WD6 5BA
Tel: 081 207 1150

CZECH PRO-JECT 7

Czech turntable manufacturer Pro-Ject has just announced a new integrated amplifier. Named the Pro-ject: 7, it will retail in the UK for around £259. Designed by Prague university professor, Dr Sykora, the amp has line and phono stages and is dual-mono in design, with the exception of the mains transformer. The phono stage can be adjusted to match the cartridge. It also has inputs for two tape decks, tuner, aux and CD. All sockets are gold-plated and all components used are hand built in a Czech plant familiar with the production of military specification electronics.

Pro-ject is also launching a high end version of the award winning Pro-ject 6 turntable, which now features a tonearm produced by Sumiko. This Pro-ject 6.1S will retail at £699. Current Pro-ject 6 owners can fit the arm, which involves buying a plinth too. These are expected to cost around £425. See review in this issue.

Ortofon UK
Chiltern Hill, Chalfont St Peter,
Bucks. SL9 9UG Tel: 0753 889949

UNO & DIVA DUO

Encouraged by the success of its Callas model, UKD has introduced a further two models to the Opera range of solid-wood loudspeakers.

New are the Opera Uno and the Diva. At £450 the Opera Uno is made of solid walnut and described by UKD as "an

affordable luxury miniature 'speaker'. Sharing many of the characteristics of the existing Callas model, the Diva has twice the internal volume and offers "outstanding depth and weight to musical presentation" UKD said. The price of this 17kg solid walnut heavyweight is £1,300.

Two other members of the Opera range have been updated. Both the SuperPavarotti and the Caruso have new drive units and crossovers to give deeper and tighter bass.

U.K Distribution
23 Richings Way, Iver,
Bucks. SLO 9DA Tel: 0753 652669

NEW-LOOK CHESTERS

Castle Acoustics have made several modifications to their popular Chester loudspeaker, adding new finishes, repositioning the drivers and adding a new curved grill.

Matching wood plinths, once an extra, are now included on the Chester, and the drivers have been repositioned on the front baffle to form mirror image pairs for improved stereo.

The revised Chester is available now and a choice of nine real wood veneers are on offer. Prices start from £699.

Castle Acoustics
Park Mill, Shortbank Road, Skipton,
North Yorkshire BD23 2TT Tel: 0756 795335

DENON LAUNCH NEW MODELS

Replacing Denon's well-received DRM-710 cassette deck is the DRM-740, which with a retail price of £259.99 offers a three-head, three-motor, dual-capstan arrangement, plus contemporary styling.

Both record and playback heads contain Super Permalloy cores for wide frequency response and the head coils are wound from high purity, oxygen-free copper wire.

Denon also have a new remote control RDS receiver, the DRA-365 RD, costing £249.99. With a 13 segment display, giving the station name or frequency, up to 40 stations can be manually or automatically stored in the memory. Functions on the '365 include: full remote control, traffic information service, an accurate clock and programme type for selecting news, rock or classical.

Aimed at the budget CD market is the new DCD-615 (£179.99). Denon say the 615 is a replacement for the DCD 595 to keep company competitive in a "fast changing market". The new machine employs 18-bit Burr-Brown DACs and Denon's own 20-bit/8x oversampling Lambda digital filters, plus a host of other features.

Denon has also launched a refinement of its PMA-450 amplifier, the PMA-450SE priced at £269.99. It boasts a number of improvements, including revised track layout on its output board and a gas-filled output relay with silver contacts for the 'speaker switching circuit. Denon said this model, giving 60w per channel, had proved in listening tests to "deliver tremendous levels of dynamic punch, detail and transparency along with improved sound staging."

Denon
Hayden Laboratories
Chiltern Hill, Chalfont St Peter
Gerrards Cross, SL9 9UG Tel: 0753 888447



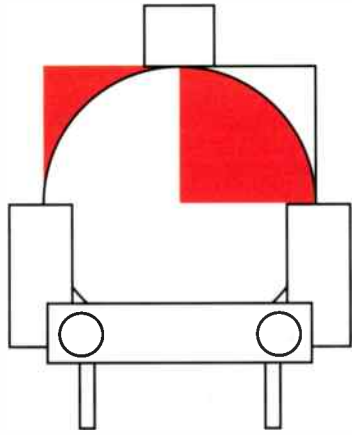

STEAM

OUT AND BUY A NAKAMICHI

For details of products and stockists, 'phone B&W UK on 01903-750750



ORANGES & LEMONS
THE INNOVATIVE
AUDIO/VISUAL RETAILER

O&L

SERVING LONDON FROM BATTERSEA

071-924 2040/3665

61/63 WEBBS ROAD, SW11

Don't trip up on your speaker cable!



When you invest in good quality hi-fi equipment, why skimp on the cable?

Especially now that Ortofon can offer 3 types of top-quality cable for under £10.

Each cable is made up of very fine core copper strands rated at 6-Nines (that's a copper purity of 99.9999% - it doesn't come much better), is flat and flexible for easy installation and features a 'tack-rack' for panel-pin fixing.

Cable Type	Description
SPK 100	Twin-core white cable, each core with 130 copper strands (total 260 strands).
SPK 200	Triple-core grey cable for bi-wiring with twin-core treble (260 strands) and 3-core bass (390 strands).
SPK 300	7-core blue cable having 13 strands per core (each strand laminated). Requires soldering.

You'd better hound us for the name of your nearest stockist.

ortofon

Ortofon (UK) Limited, Chiltern Hill, Chalfont St Peter, Bucks SL9 9UG. Tel: 0753 889949.



KENWOOD DEPTH CHARGE

Tackling criticism that CD reproduction lacks depth, Kenwood has launched two new CD players. Both models feature 'DRIVE' (Dynamic Resolution Intensive Vector Enhancement), a new development from the company that, they claim, improves sound quality by ensuring that players hold on to the lower level information from a disc. DRIVE works by ensuring a correlation between input and output signals is maintained, which helps resolve fine detail.

With a retail price of £249.95, the new DP-5060 CD player also carries a fourth order, zero-shifted noise shaping 1 bit digital-to-analogue converter for greater harmonic detail. It also has a high precision master clock system to prevent CD jitter and Optimum Linear Cascode Drive to ensure a pure signal, Kenwood tell us.

At the top of Kenwood's range is the DP-7060 (£399.95) carrying even higher sound quality specifications. It has a switched capacitor one-bit convertor, based on Philips' DAC-7 chip. See review in this issue.

Trio-Kenwood

**Kenwood House, Dwight Road, Watford
WD1 8EB Tel: 0923 816444**

KINSHAW GO FOR POWER

Kinshaw recently unveiled a new Perception range of three power amplifiers. The line-up comprises a 150w RMS (8Ω) stereo power amplifier priced at £975, monoblock power amplifiers priced at £1435 (pair) and bridged monoblocks that give 500w RMS (8Ω) at £2,499 (pair).

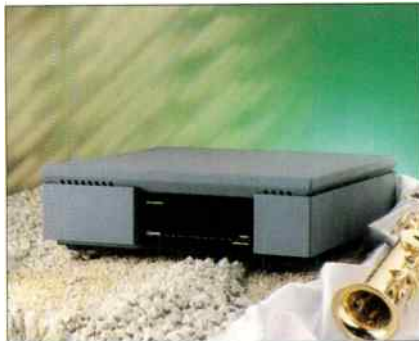

Anthracite finish Nextel cases as well as gold-plated inputs and outputs are used throughout, along with true balanced line XLR inputs allowing the use of balanced cables.

Kinshaw Electronics

**84 Pendarves Street, Tuckingmill, Camborne,
Cornwall. TR14 8RE Tel: 0209 715878**

NAKAMICHI'S 'S' GENERATION

Nakamichi has launched four 'S' models - an amplifier, a tuner and two CD players.

In the face of what the company described as "tough competition in the UK amplifier market", a new 1A-4s integrated amplifier has been launched. Priced at £199.95 the amp. has an output of 30w.

At £349.95, the new ST-3s VHF-FM tuner features multi-regulated power supplies along with a special circuit that disables the tuner data circuitry to improve performance. See review in this issue.

The new CD players incorporate the upgraded generation of Music Bank 7-CD changer mechanisms, first featured in the MB-4. With a 18 bit D/A convertors, the new MB-3 has a price of £499.95. At £699.95, the new MB-2 has individually matched D/A convertors, a digital output socket and full remote control.

B&W Nakamichi

**Marlborough Road, Churchill
Industrial Estate, Lancing, West
Sussex. BN15 8TR Tel: 0903 750750**

PHILIPS TO PUSH DCC

In a press conference held at Decca Records' famous Kilburn Studios, Philips told journalists that they'll be righting wrongs in the marketing of DCC, in order to give the medium a new push into the marketplace. Potential buyers might be interested to know that a reduction in tape prices is on the agenda in this new campaign.

Pre-recorded tapes will be priced identically to CDs in future and many more new releases will be put onto DCC, giving this medium parity with the silver disc. A Philips representative said this should bring DCC pre-recorded tapes from £14.99 down to £10.99 or so.

Blank tape prices are unlikely to change much though, even though a DCC tape is basically cheap to manufacture. Keeping the price of blanks high might be a gesture of goodwill to the music business though, who are convinced recorders exist only to deprive them of income through loss of sales of pre-recorded material due to copying.

The number of retailers stocking DCC recorders will be reduced from 1000 to around 300, in order to provide better understanding and advice at the point of sale.

Philips and Marantz are actively and effectively bringing recorder costs down and widening their scope. The new range is to possess car players, inexpensive portables, high quality 18-bit domestic machines and hybrid recorders that can record to DCC or normal analogue cassettes for car or portable use. The new line up includes the DCC730 domestic 18-bit recorder priced at £249, a DCC mini-system with analogue and digital recording for £499, the DCC740 twin deck with analogue and digital recorders priced at £300, the DCC134 personal stereo (playback only) for £149.99, the

DCC170 personal with recording as well for £249.99 and the DCC821 car player for £399.

Another interesting advance is the move to 18-bit digital-to-analogue conversion in domestic recorders. Decca claim to be able to supply 18-bit pre-recorded tapes now and others may shortly follow. Were this to become widespread, then DCC could well offer an improvement in quality over CD for no extra cost. This would usefully buff-up its somewhat lack-lustre current image. With the promise of shorter access times due to Turbo Drive, which gives higher tape reeling speeds, Philips may well be able to give DCC the appeal it currently appears to lack.

With Sony targeting MD at young buyers only and refusing to engage in any form of quality contest, it looks as if DCC has occupied the high ground unchallenged. Whether Philips have either the will or the ability to make the most of this, only time will tell.

Philips

**City House, 420-430 London Road,
Croydon, Surrey. CR9 3QR**

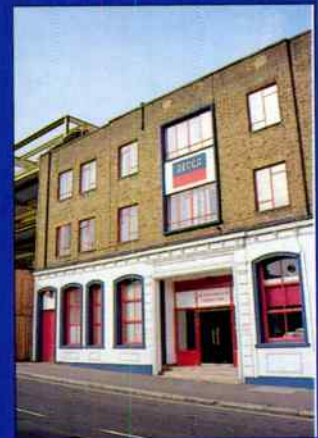

Decca Studios - Kilburn



LIVE!

Noel Keywood imbibes the colour, commotion and plentitude of this year's successful Live '94 show at Earls Court.



Our stand at one of those brief moments when things were quiet.

Love it or hate it - and some did - Live '94 at the Earls Court 1 exhibition centre was a great extravaganza of an exhibition this year. It attracted a massive and impressive showing from the world's major manufacturers and although officially a 'consumer electronics' show, it was strongly attended by Britain's specialist hi-fi manufacturers.

For some, the noise and commotion was too much, but it simply reflected the level of activity in the vast display hall, with live shows, demonstrations, Karaoke, competitions and such like, not to mention the 30,000 people or so who attended daily, totaling 186,484 over six days. Serving their needs were a variety of restaurants and bars around the perimeter of the hall. We contributed to the din by irreverently running our KLS3 carbon fibre cone kit 'speakers from a World Audio Design 300B valve amplifier, assailing passers by with a variety of music from Snoop Doggy Dog to Carlos Santana. Meridian and B&W Loudspeakers - our high technology neighbours - occasionally looked bemused,

either at our music/girls/valves.

Someone was handing out free lollipops - Richer Sounds we suspect - and there seemed to be a great affinity between them and our carbon fibre cones. Teenage reprobates who wanted to know what the "jamjars" were for on our valve amps were invited to try touching them, but sadly they knew more than they were letting on; none did! A large number of dedicated World readers turned up to chat about their

homes, music and systems - and very interesting it was too. Although Live '94 had more than its fair share of camcorders, home theatres, computers and musical instruments, it also had plenty of real hi-fi and plenty of real hi-fi enthusiasts: thanks for attending.

Quad's Ross Walker, son of founder Peter Walker, looked permanently happy to be back in the middle of a big show - Quad have always been great exhibitors -



Richer Sounds were handing out lollipops, many of which ended up stuck to other exhibitors' products.



Quad's Ross Walker - enjoying the razzmatazz of a big show.

and they had their new Quad 77 integrated amplifier on display. Also, there was a cut-away ESL63 electrostatic and an attractively lit Quad 22/II valve amplifier, amongst other things.



KEF's new Coda 7s claim 90dB sensitivity for a modest £129.

KEF had a big stand with a variety of new models on display. Especially interesting were the new baby Coda 7s which, they claim, has 90dB sensitivity (6Ω) and costs £129. A new Coda series above this is expected. There's a new Reference range and we heard a demo of the revised Reference Model 2 with its improved Uni-Q drive unit. It sounded very smooth and revealing, projecting fine stereo images.



Linn's log cabin housed a solid sound, supplied by Activ powered Keltik loudspeakers.

Linn built a bigger log cabin this year which, no matter how much Amanda Sweeney (she's our advertising girl) huffed and puffed, she couldn't blow down - see picture. Mind you, Linnies inside looked pretty scared. But perhaps that was because they were playing Keltiks, on the end of an Activ system comprising Karik transport, Numerik converter, Kaim pre-amp with new switched mode power supply and Klout power amplifiers - price £23,000 in all!



Naim's Paul Stephenson and our Ad sales girl Amanda.

Amanda had more luck with Paul Stephenson of Naim; her Black Belt in Judo made the right impression. So did their Flat Cap power supply, which she thought went on the head. In fact, Naim told Amanda, you connect this new £299 power supply to your 92/90 pre/power amplifier combination to upgrade it. Also there was their awesome DBL loudspeaker costing £6900 and the new Slimline Series CD3 CD player at £898.



NAD's new super simple, super budget 310 amplifier - watch out a review soon.

NAD were showing a number of new models, the budget NAD310 amplifier taking pride of place. It offers 30watts per channel, but will deliver no less than 80watts into 2Ω loads.



Marantz are due to launch this high end CD23 CD player in 1995.

Marantz had a squat, purposeful looking dedicated CD player in the new CD23. It uses a full floating CDM-9 Pro transport and Philips' DAC-7 converter configured in differential mode for minimum distortion, due out in 1995, price £3990. There was a new CD15 Reference CD player with CDM-4 diecast transport and copper-plated chassis at £3499 and a new CD63SE CD player with CDM-12 transport and copper-screened HDAM output stage, plus chassis bracing. This is a budget audiophile special, a player Marantz have traditionally done well with.

Retailers Richer Sounds and Musical Images were in friendly rivalry, both trying to outstage each other in razzmatazz. Whilst Richer had a mock shop stocked to the ceiling, plus plenty of Richer girls outside to make sure everyone got a brochure of models and prices, plus a damn lolly, Musical Images made sure they kept a continuous disco/dance/singing show going; my camera went off accidentally as two sturdy looking



Musical Images dancing girls attracted a good audience.

'Images' girls were dancing - must teach it some manners.

Heybrook were showing a new loudspeaker, the Heystak, which despite its name is an attractively proportioned floorstander. Priced at £499 they use twin bass/midrange units and a passive bass radiator for real punch and impact. Other new loudspeakers on the scene came from



Heybrook's Heystaks use a passive bass radiator for real punch and impact.

Mission, with their new 73' series. The range starts with the 731s, reviewed in this issue, and goes right up through the 733 two-way floorstander at £299 up to the massive 735s using four drive units in a tall tower enclosure. All of the 73' series use a clever modular construction approach which allows Mission to offer them at very competitive prices.



Mission's new 735s look impressive for £599

The organisers told us it went "wonderfully well" and people are signing up already for next year, Grundig and Hitachi being new recruits. Live '95 will be bigger again, spilling over into Earls Court 2 hall from Earls Court 1. We hope to see you there ●

Pure and Precise

In sound and design

In 1994 Jamo celebrates its 25th Anniversary and to celebrate we bring you leading edge technology combined with an exceptional loudspeaker design synonymous with Danish styling and excellence. The 07 series combines fascinating design with transparent and authentic sounds meeting all the demands of the eyes and ears.

The 07 series - The Total Listening Experience



Jamo

"The Sound of Excellence"

Pure and Precise

Dealer

Adams & Jarrett
Brighton Audio
Canterbury Hi-Fi
Dawson's
Howes of South Borough
Kimberley's Hi-Fi
Tru-Fi
Universal Hi-Fi
Weybridge Audio
Alphabec
Ask Electronics
Atlantic Electronics
Babbler Electronics
Galaxy Audio
Hi Spek Electronics
Hi Way Hi-Fi
Kamla
Laysyl Ltd
MCQ Entertainments
Musical Images
Musical Images
Myers Audio
Rightway
Selfridges
Time & Tune
Hi-Fi Corner
Cas. Sac
Clearstone Hi-Fi
D Eckersley
D Eckersley
Geoff Jackson
J R Gough
Riley Electronics
Scratch Music
Westgate Audio Visual
Westside Music Centre
Amadeus Sound & Vision
Car & Home Stereo
Chris Pettitt
Peter Martin
Snellings
A N Audio
Carvells of Rugby
Discount Hi-Fi
Fenway
Hi-Fi City
PJ's Hi-Fi & Video
Pounds Limited
Select TV
Sound Stage
Techno Sound
The Hi-Fi Exchange
The Videofactor
Fortuna Ltd
Excel Venture Trad. Co.
Jamo Hi-Fi USA Inc.
Pan International Company
Scan Audio
Taiwan Audio Trad. Co.
Jamo UK Ltd

Town

St Leonards on Sea
Brighton
Canterbury
Bournemouth
Tunbridge Wells
Bexley Heath
Redhill
Croydon
Weybridge
London NW2
London W1
London NW10
London W13
London W1
London NW3
London W2
London W1
London SW14
London SE17
Edgware
Hounslow
Walthamstow
London
London
London E1
Dublin (Eire)
Bradford
Bolton
Bury
Leigh
Leeds
South Shields
York
Doncaster
Bradford
Sheffield
Sutton Coldfield
Macclesfield
Grantham
Congleton
Norwich
St Neots
Rugby
Potters Bar
Newmarket
Wattford
Centre Banbury
Hoddeston
Bristol
Broxbourne
Luton
Bristol
Gerrards Cross
Jersey
Singapore
USA
Hong Kong
Australia
Taiwan
Daventry

Telephone

0424 437165
0273 622871
0227 765315
0202 764965
0892 28682
081 304 3272
0737 766128
081 654 1919
0932 851121
071 431 9133
071 637 0590
081 451 0302
081 579 6315
071 637 2624
081 349 1166
071 723 5251
071 323 2747
081 876 7632
071 701 3204
081 952 5535
081 569 5802
081 520 7277
W2 071 723 7565
W1 071 629 1234
071 247 0567
01 714343
0274 626211
0204 31423
061 797 5979
0942 673371
0532 781513
091 455 3663
0904 679859
0302 850030
0274 732947
0742 670718
021 354 2311
0625 432707
0476 593464
0260 273206
0603 712202
0480 472071
0788 541341
0707 643593
0636 663166
0923 226169
0285 263222
0992 465531
0275 833135
0992 440549
0582 471078
0272 664930
0753 884552
0534 32549
65-3832200
1-7884984648
852-8891989
61-38195352
886-42237609
8327 301300

Jamo



JUMP

OUT AND BUY A NAKAMICHI

For details of products and stockists, phone B&W UK on 01903-750750

Great tracking

Ortofon is famed the world over for the tracking capability of its cartridges. Cartridges which will breathe new life into a cherished LP collection, divulging detail as never before.

The cartridge is always the key factor in the reproduction of music from records and Ortofon has dedicated nearly 50 years to the manufacture of the finest pick-ups possible. Enjoying constant critical acclaim along the way.

So if you want to bring more out of your records than ever imagined, an Ortofon Cartridge will have you hot on the scent.



500 Series
Moving magnet cartridges from £30-£100



MC Series
Moving coil cartridges from £80-£110



Q Series
Moving coil cartridges from £140-£500



1000 Series
Moving coil cartridges from £600-£1500

ortofon

Ortofon (UK) Limited, Chiltern Hill, Chalfont St Peter, Bucks SL9 9UG.
Tel: 0753 889949.



GENTLE RENAISSANCE

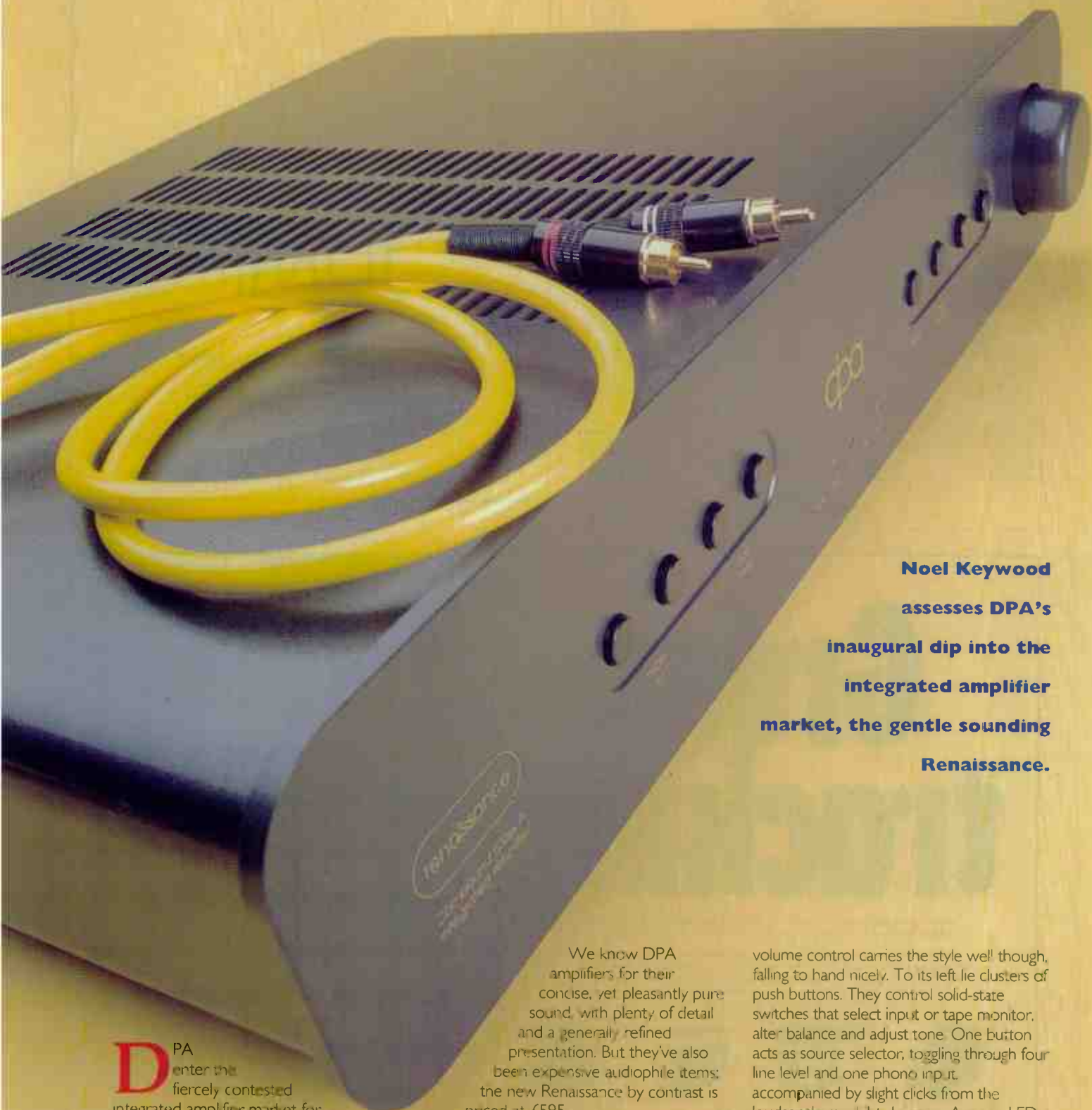

**Noel Keyword
assesses DPA's
inaugural dip into the
integrated amplifier
market, the gentle sounding
Renaissance.**

DPA enter the fiercely contested integrated amplifier market for the first time with their new Renaissance amplifier. It brings an interesting extra dimension offering buyers the special surface-mount components and unusual circuitry normally found in the company's top-end designs - albeit with some differences.

We know DPA amplifiers for their concise, yet pleasantly pure sound, with plenty of detail and a generally refined presentation. But they've also been expensive audiophile items; the new Renaissance by contrast is priced at £595.

The slate grey casework, with its large radiuses, is very much in house-style, even if the company have been forced to drop their deeply curved and distinctive cast front panels in favour of more controllable machined panels that look a little slab like unhappy conscripts to the idiom. The

volume control carries the style well though, falling to hand nicely. To its left lie clusters of push buttons. They control solid-state switches that select input or tape monitor, alter balance and adjust tone. One button acts as source selector, toggling through four line level and one phono input, accompanied by slight clicks from the loudspeakers whilst doing so. A green LED identifies the input selected.

The tone controls offer only bass lift (no cut) and treble cut (no lift), which they apply in sparing but useful amounts, I found. Adjustment is carried out by 'up' and 'down' buttons. Unfortunately, there's no way of knowing how much boost or cut is available

or has been applied, except by counting, which is a little disconcerting. I found there were seven boost/cut steps.

For better or for worse, all adjustments default to zero at switch on, so flat response and normal balance can be set by switching the Renaissance off then back on. And, of course, whenever the amp is switched on any preferred settings will have to be re-programmed in. It's not a convenient system, nor one that is transparent to understand.

The rear panel carries a set of gold-plated 4mm screw/plug 'speaker terminals, a line of phono socket inputs and a switched mains IEC power input socket. To switch on, you have to reach over to the back of the amplifier to flick this hidden switch - fine in some situations, but not so easy in a rack.

SOUND QUALITY

The rich tones of Eddie Reader's voice and the gentle tinkle of percussion on *Patience of Angels* showed clearly enough that the Renaissance reflects DPA's abilities in amplifier design well. Clearly outlined between the 'speakers, full bodied and timbrally rich, her voice came over as engagingly clear and natural. The sweet nature and gentle ring of the percussion was testament to the amplifier's handling of high

frequencies, imposing little if anything in the way of hardness or coarseness. In fact, the Renaissance has to be one of the sweetest sounding amplifiers around, matched or exceeded only by esoterica like Audionote's single-ended valve OTO.

Steve Earle's resonant guitar strings on *Guitar Town* sang crisply too, evoking no hint of nastiness or incision. His guttural voice perhaps lacked a little push, some bite, a little viscerality and, perhaps, the Renaissance could be accused of seeming a little too euphonic and cutely manicured for hard rockers. It's probably one of the smoothest and most refined sounding amplifiers I've come across, dynamically fast and lively, and of just-so imaging, but it doesn't seek to offend - ever. Having recently had my throat gripped by an awesome twin-211 triode single-ended power amplifier, and my ears cuffed at the same time by this thermionic hooligan, the Renaissance struck me as a Beau Brummel by contrast.

Refinement and delightfully concise imaging are properties strong on this amplifier's agenda. It possesses good bass drive too, if not bass power of the earth shaking variety. The gentle yet tactile bass performance was entirely in keeping with - and helped form - the overall character of the Renaissance. It plays for you, honestly,

openly and with great poise, yet it just could not offend.

Even with its unusual bass lift, the disc stage sounded light in bass drive, but it was exceptionally clear across the midband and treble, giving superb sense of insight, again aided by precise imaging. A cartridge with plenty of bass drive - a good Goldring is my recommendation - is needed, plus speakers with some bass too.

If this amp is lacking, it is only in ultimates: ultimate detail and retrieval, ultimate power. As a solid-state amplifier to sit in front of and enjoy most types of music, especially with violin and strings, the new Renaissance is difficult to beat in its composure, clarity and openness. It has a gentleness born of refinement, with superb stereo staging and imaging. I'd rate it very, very highly for serious listeners, since as with all DPA amplifiers, what they do well they do so very well few can come close. Listeners seeking richness of timbre, purity of sound, sweet treble and impressively concise imaging need look no further. ●

Renaissance Integrated £595
DPA Digital Ltd.,
Unit 7, Willowbrook Technical Units,
Crickhowell Road, St. Mellons,
Cardiff, CF3 0E1
Tel: 0222 795621

MEASURED PERFORMANCE

The Renaissance was unusual in its performance. It delivers a modest 32watts, limited by asymmetric clipping, not a good sign, but DPA told me that the asymmetry was a function of the circuit topology and couldn't simply be balanced out by adjustment. The problem became worse into 4ohms, limiting power to just 36watts. The Renaissance should ideally be paired with sensitive speakers of 88dB SPL/watt or more.

In contrast to this, DPA power amplifiers have traditionally clipped cleanly and have doubled power when load is halved, as a good amp. can, so the Renaissance doesn't match up in this respect.

Bandwidth via CD/tuner/aux measured a satisfactory 17Hz-30kHz, being curtailed at both spectrum extremes, an approach that helps to give a clean sound. Sensitivity was low at 450mV, a more common figure these days being 220mV or so. Some older cassette recorders and tuners that developed 300mV will not drive the amplifier to full output even at maximum volume.

The bass boost control gives a maximum of +5dB boost below 500Hz, a useful amount, and the treble control -5dB cut above 1kHz. Both offer a useful 'fine trim' facility.

The distortion characteristic was very unusual - in fact it was one of the most unusual I have ever measured, possessing

more fifth harmonic than anything else, as our analysis shows. Usually, second or third dominate. High order components, characteristic of hard switching (crossover) distortion, were present, but happily in small quantities. The highest figure was 0.07%, produced at 1W/10kHz. Otherwise, levels hovered around 0.02%, a satisfactorily low figure.

The Renaissance comes in line level only form or with an MM disc stage; ours had the latter. It has an unusual equalisation characteristic, displaying slight (+0.4dB) bass lift and slow treble fall (-0.5dB at 20kHz), contrary to that of most amplifiers. As a result, the DPA will have better apparent bass drive and less brightness.

Disc noise was very low and sensitivity low too at 3.8mV. Input overload was unusually low at 23mV; a common minimum is around 30-40mV. My measurements show that to get 25mV from a cartridge on occasional musical peaks is rare, so although the Renaissance does not measure well in this respect, in practice it will pass muster. It is best used with low output MMs all the same.

The Renaissance has a peculiar measured performance. Were it to be from a new company with no track record I'd probably be a bit scathing, but DPA are more knowledgeable and innovative than most, making judgement best left to listening tests. **NK**

TEST RESULTS

Power	32watts
CD/tuner/aux.	
Frequency response	17Hz-30kHz
Separation	47dB
Noise	-96dB
Distortion	0.006%
Sensitivity	450mV
dc offset	0/2mV
Disc	
Frequency response	30Hz-71kHz
Separation	41dB
Noise	-80dB
Distortion	0.004%
Sensitivity	3.8mV
Overload	23mV

Distortion

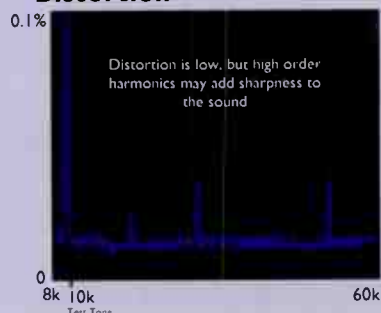

CANDID SUCCESSOR



**Can Mission's
new compact 73 I
loudspeakers match the
success of their top selling
760s? Dominic Todd listens
carefully.**

The trouble with products that turn out to be run away successes, is what to do when it comes to replacement time. Pioneer faced such a dilemma when it came to replacing the A-400, which it didn't overcome entirely successfully with the A-400X. Mission now face a similar dilemma in replacing the high selling, highly praised 760. As Pioneer did with the A-400, Mission are wisely keeping certain 760 models (and spin off varieties) going in case the new model isn't so well received. Mission have also had the good sense to completely rename the new model, establishing it as an entirely different speaker.

Different the 731 most certainly is, at least in terms of construction. The new model makes extensive use of injection mouldings, which are used for both front and rear baffles, pushing together to sandwich the thin MDF cabinet wall carcass. Even more unusual is the way the entire front baffle lifts out exposing the bass unit, which is actually connected to the rear baffle by integral plastic stalks. The plastic dome tweeter is bayonet mounted to the front baffle, next to the port. The bass unit is similar to the 760s, but feels lighter and more responsive. Although it does smack of cost-cutting somewhat, it's thoroughly serviceable and the bass unit is rigidly mounted. The wiring and crossover components are nothing special and there's only a single tiny piece of wadding. This, however, is no doubt something to do with the way Mission wanted the 731s to sound. A deliberate fast and clean balance has been sought which, bearing in mind likely partnering equipment, is probably no bad thing.

The styling is a matter of taste. They certainly look more hi-tech than the 760s, but are rather too similar to the "organic" look favoured by the Japanese, for my liking.

A sensitivity of 88dB means the Missions shouldn't prove difficult for most amplifiers, with a budget Rotel system, and my own A-400, having little trouble driving the 731s. You could even consider a low-cost valve amp.

The little Missions were initially very impressive. But as is often the case with first impressions, the they weren't faultless, yet neither were they without ability. Elvis Costello's 'Mighty like a Rose' album showed up a slightly exaggerated edge to vocals, although imaging always remained precise and consistent. Mission have certainly succeeded in producing a fast and clean sounding 'speaker. Bass quality, in particular, was superbly judged with none of the artificial boominess of other rivals (present to a degree with the TDL NFM's).

It wasn't really surprising to find the 'speakers worked better with simpler music, and could become confused with

more complex pieces. No 'speaker at this price possesses an iron grip on the music. However, it would be wrong to call the 731s muddled, quite the opposite in fact. Transients were handled very cleanly, and the baby Missions were quite capable of high levels without showing signs of stress. Because of their well tuned bass quality they never sounded tinny, managing an overall balance akin to a 'speaker a size or two larger. Certain drum beats could occasionally sound boxy, but in general the 731s sounded impressively articulate. Cymbals infrequently caused a degree of splashiness in the treble, and its bright, clean nature could make the treble units sound slightly detached from the mid-range.

“Imaging always remained precise and consistent. Mission have certainly succeeded in producing a fast and clean sounding 'speaker.”

With Prefab Sprout the crisp treble was in evidence once again. Although there was no unwanted sibilance, I did detect an unnatural sheen to the sound which spoiled an otherwise impressive performance. Despite the occasional boxiness I'd noticed on drums before, with a good quality, sparse, pop recording the Missions sounded pleasantly open and clear as you'd expect (but don't always find) from compact, narrow 'speakers.

Fine so far, but the flip side of the

731s' jollity was a forwardness that could become tiring, especially with unsympathetic equipment. Listening further revealed that although the bass was fast and articulate, it did lack extension compared to rivals.

If this review seems a little critical it's only because the 731s' forebears and (many) rivals have led us to expect high standards from small 'speakers these days. Although I felt the 760s were often over rated, there's no doubting their widespread appeal from mid-system upgrade to audiophile on a tight budget. They managed to pull it off too, sounding just as impressive on the end of a mid-system as they did on a top valve amp.

In summary though, although they are

an impressive small 'speaker, they lack the refinement of the 760s, or better still the Celestion 3s, meaning they don't quite sound at home on a high quality system. Having said that, used in context with similarly priced equipment, or on the end

of a dull sounding hi-fi (perhaps even a vintage valve unit), they deserve recommendation, and should be auditioned alongside competitors from Celestion and Goodmans ●

Mission 731 £129.90
Mission Electronics,
Stonehill, Huntingdon,
Cambs. PE18 6ED
Tel: 0480 451777

MEASURED PERFORMANCE

Whilst the 760s are an affordable audiophile loudspeaker aimed at the UK, the new 731s look to be a Euro-speaker preened for success overseas. They have treble lift and a bass peak, to give a more exciting balance, with sparkling treble and punchy bass. These speakers won't necessarily be the last word in refinement or neutrality, but they could certainly add some useful speed and excitement to budget hi-fi systems possessing limited dynamic ability.

Mission's 731s are easy to drive. They have a high overall impedance and just above average sensitivity, exactly the kind of easy load that is needed for budget amplifiers. The impedance curve holds no nasty surprises either, staying high over the audio band and never dipping below 6Ω at any point.

The 731s are an interesting loudspeaker. They have been boosted up at frequency extremes for a lively and exciting balance and are an easy load for low-power amplifiers. They could well bring a pleasant injection of energy to budget systems. **DB**

Frequency Response

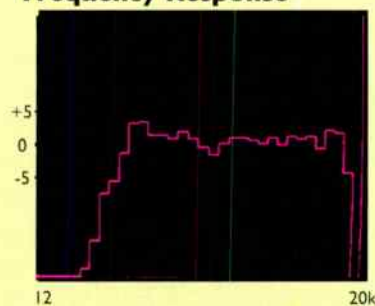

Smooth response, but treble rise and bass peak will give an exciting sound

Impedance

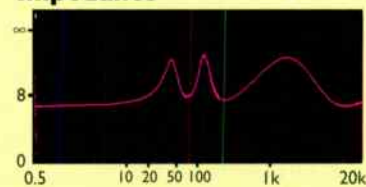

The high overall impedance makes the 731s an easy load



Just what you've always wanted. Speakers that don't make a sound.

And so it was written that the advanced "silent" cabinet design of Tannoy Profile speakers should offer a purity of sound and absence of distortion that other manufacturers could only

dream of. Allowing the powerful drive units to produce a volume of music sufficient to bring down the walls of Jericho. And the people heard this, and there was great rejoicing.

TANNOY PROFILE

RING THE PROFILE HOTLINE ON 0236-425407. OR WRITE TO TANNOY LTD., ROSEHALL INDUSTRIAL ESTATE, COATBRIDGE, STRATHCLYDE ML5 4TF.

World Radio History

AUDIOPHILE ASPIRATIONS

Five manufacturers auditioned a group of 12 players in the £100-400 price bracket, all claiming audiophile status.

Make it slick, sensible or sassy. Those are the rules for designing CD players at around £300. Below that price, buyers are assumed by and large to

be going for widgets. Above, it is sonic performance – or more widgets. Onkyo and Yamaha have gone for a sassy

approach, button-happy. Arcam opt for a stripped down, performance-based design with a Delta-Sigma converter and slim-line looks; Rotel, as always, keep their eyes firmly fixed on the audiophile with a stripped down purse. Kenwood have adopted a half-way house approach, with a medium range of facilities but a sleek curvature to the drawer, fascia and controls.

It should be no surprise then – though it was to one of my tame listening panel –

CD players group test



that the sound of each is totally different. This time, I mention a listening panel because, playing the suspense game again, the conclusion on one CD player is quite different to what you will read in another magazine. Both listeners heard the CD players in random order, unaware of which was which, with a 'spoiler' not tested here thrown in. Fortunately, for the peace of mind of all of us, it's worth pointing out that the reference Arcam 170 transport and Sugden SDD 1 DAC came out top every time.



ARCAM ALPHA ONE

£299.90

The Alpha One is neatly styled, having smooth lines and gentle curves to break the harsh appearance of a rectangular box. Built like its competitors, the Alpha One nevertheless feels sturdier if, unfortunately, it clanks more resonantly than them. Arcam have yet to stick bituminous pads to the casework to prevent this and convey a better impression, as the Japanese commonly do.

Never mind, the Alpha One works plenty well enough in practical terms. It moves quickly and quietly, giving any user a good impression in this respect. The display offers track number and time in soft green numerals, a Remain button switching the display to show track time remaining (rather than elapsed) and dsc time remaining - useful for tapers.

There's no keypad on the machine itself, but the remote control has one. It also has a volume control function but, teasingly, this is not available on the Alpha One. There's one set of analogue outputs (fixed level) and one electrical digital output. Up to 21 tracks can be programmed in, with Shuffle play an option for those who like surprises.

Sound Quality

At first hearing, this was a very bright, crisp breezy player with a very full bass. On the plus side it was very exciting to listen to, but doubts, alas, crept in quickly. While on blues or simple rock tracks the bass line thundered along and vocals and

rhythm guitars projected sharply, the performers were uniformly placed in a triangle with its base well inside the centre point of each 'speaker.

Tonally, there was a question mark on classical music. Authentic strings, for example, were barely recognisable as such, all with a warmer Romantic tinge. Orchestral dynamics too, were less good than expected, there being something of a curtailment evident when things became busy. The Alpha One had a knack of rhythmically being in the right place at the right time, but not entirely respecting nuances in a score. It was noticeable how, when a panel of friends heard other players in this group, they observed how the musical subtleties some displayed just weren't in balance on the Arcam: some practically squeezed out or subdued in favour of the general picture.

Conclusion

This is certainly an exciting player, but it has its own view of how music should be performed, and that is not necessarily what the producer intended. It was very reminiscent of a certain type of turntable: you'll either love it or hate it.

**A&R Cambridge Ltd.,
Pembroke Avenue,
Denny Ind. Centre,
Waterbeach,
Cambridge CB5 9PB
Tel: 0223 440964**

MEASURED PERFORMANCE

In similar style to the older Alpha + CD player, the new Alpha One has a rolled-off high frequency response. This gave the old Alpha + smooth, 'warm' treble, which went down well with many audiophiles. Our frequency response analysis also shows that the Alpha One has falling bass, which may give it a slightly lightweight bottom-end.

The new Alpha One has much lower distortion than the Alpha +. The plot below, taken at -30dB to represent typical music level, shows that third harmonic distortion predominates. Even at a low level such as this, I would expect this to add a little sharpness to the sound, but this may trade nicely against the rolled off treble.

Distortion is a little higher than average at -60dB, with a corresponding lower than average 102dB measured dynamic range (EIAJ). Output is high too; at 2.44V, making the Alpha One sound louder than its competitors in a demonstration. **DB**

TEST RESULTS

Frequency response	4Hz-20.75kHz	
Distortion %		
-6dB	0.004	0.004
-30dB	0.032	0.026
-60dB	0.93	0.89
-90dB	32.1	31.6
-90dB dithered	12	16
Separation dB	left	right
1kHz	106	105
20kHz	85	84
Noise	-95dB	
with emphasis	-95dB	
Dynamic range	102dB	
Output	2.45V	

Frequency Response

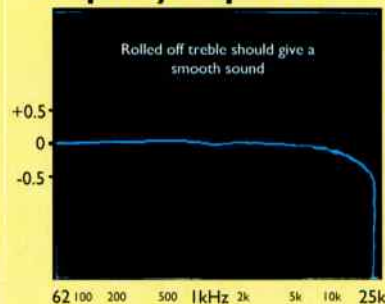

62 100 200 500 1kHz 2k 5k 10k 25k

Distortion

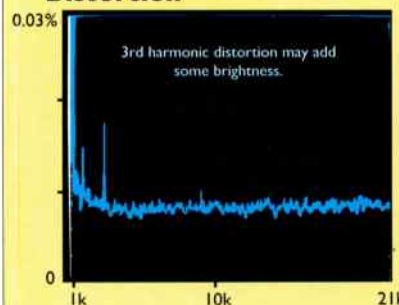

MEASURED PERFORMANCE

The frequency response of the Rotel RCD 965BX Discrete shows the characteristic ripple of Philips' SAA 7323 bitstream convertor in its high frequency performance. However this ripple isn't normally audible, and good 7323 based players can sound extremely clean and powerful in their presentation. The bass has a slight lift towards lower frequencies, which should give the '965 a solid bottom end.

Distortion was low on both channels in this sample, an earlier machine having fared more badly. Our distortion analysis at -30dB signal level from disc shows little in the way of harmonics, a performance repeated on both channels. At low levels though, performance deteriorated in this respect, distortion rising past that of competitors like the Kenwood, the -60dB figure giving a poor dynamic range figure.

Channel separation was satisfactory and output normal at 2.2V. There was a little more noise than usual these days, but it was so low in any case as to be inaudible. Generally, the '965BX measured well. **NK**

TEST RESULTS

Frequency response	4Hz-20.8kHz	
Distortion %		
-6dB	0.004	0.003
-30dB	0.009	0.009
-60dB	0.7	0.7
-90dB	51	50
-90dB dithered	37	38
Separation	left	right
1kHz	98	97
20kHz	98	98
Noise	-97dB	
with emphasis	-98.5dB	
Dynamic range	-102.5dB	
Output	2.2V	

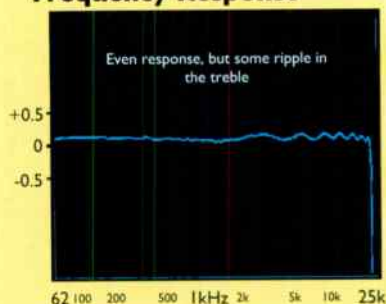
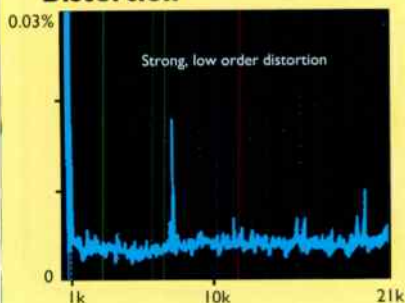
Frequency Response**Distortion**

ROTEL RCD-965BX DISCRETE £374.95

The Rotel has a fuss free front panel and remote control; both are clearly marked and easy to use. This isn't solely due to lack of facilities - necessary or unnecessary - since a good number are provided. The player can be programmed with up to 20 tracks, a high enough number for most people, and there is an allied repeat function. The remote has a 0-9 keypad, a very useful facility, but the player itself does not. Rotel do, however, provide comprehensive Index search facilities, which classical music enthusiasts may appreciate, although this function isn't much in use these days.

The display panel lights a peculiar blue/green, giving track number and elapsed time simultaneously, as well as disc size, in large, pin-sharp numerals. This player is built well, the large Discrete logo referring to the audio output stage, which uses discrete transistors rather than silicon chips. Whether this is consequential depends solely upon the effectiveness of its design.

The rear panel carries an electrical digital output as well as normal analogue outputs. Remote control of volume is not provided.

Sound Quality

Here is a player that deserves its 'audiophile' tag. A little laid back in presentation compared with the others, it makes use of precise internal sound stage focusing that lays recording techniques unusually bare. The RCD-965 was the only

player in this group to entirely separate single instruments or orchestral sections with fly-on-the-wall clarity. A crisp delivery, on-the-ball timing and bass that was only around when it had to be, produced a very lively performance. Unusually for this group, the Rotel also managed the 'infill' in the sound stage, with a clear perspective all the way from left through centre to right. Tonal variety of colour was exemplary at this price. Its only drawbacks were a touch of hardness to strings, with a degree of hollowness in the mid-range that tended to give an impression of depth while also adding a touch more reverberation than was entirely truthful and tending to give a mild degree of lightness to male vocals. All the same, when a sax let rip it sounded nearly as big as a real sax would.

Conclusion

Apart from a desire to be a little over-atmospheric on orchestral recordings, the Rotel was placed next to the reference for overall accuracy and clarity. Its sound had a clinical aspect which would prove disconcerting to some, but it responded to changes in musical dynamics very fast and kept tempo perfectly in time.

**Gamepath Ltd.,
25 Heathfields,
Stacey Bushes,
Milton Keynes,
Bucks. MK12 6HR
Tel: 0908 317707**

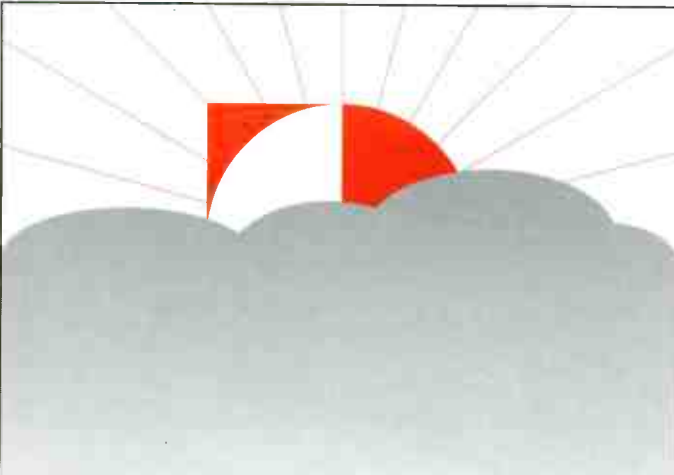

SUN

ET LUMIERE

For details of products and stockists, phone B&W UK on 01903-750750

CLASSIQUE SOUNDS

Leicester's leading vintage valve hi-fi specialist.
Are looking for vintage valve Hi-Fi equipment

AMPLIFIERS/TUNERS

Leak, Quad, Radford, RCA, Rogers, Fisher, Marantz, Pye Avantic, Dynatron, Western Electric ETC. (working or not)

TURNTABLES/ARMS.

Garrard 301/401, Thorens 124/224/125. Emt, Sme, Decca, ffs
ETC

SPEAKERS

Lowther, Quad Electrstatic, Voigt, Tannoy (dual concentric)
ETC

AUDIO VALVES

MUllard, Osram, Bimar, Gec ETC

ITEMS FOR SALE INCLUDE

Leak TL10, TL12, Stereo 20, Troughline 2/3, Quad11, Radford STA25/SC22, Quad Electrostatics, RCA new orthothonic (mono) Lowther (mono), Revox G36 (slight fault)

Garrard 301/401. Thorens 124, Thorens TD150. Sme arms, Decca arms heads ETC

REBUILDS (including same day service) for vintage valve amps.
From £100.00 complete.

Handcrafted plinths for 301/401 ETC From £200

Power supplies for 301/401 (100v) £95.00

Cork mats for 301/401 £15.00

Merdian M1 active loudspeakers £495.00

Townsend Avalon/Moth £225.00

I ALSO OFFER:

Home visits (within 40 miles) radius.

Dedicated listening room.

Part exchange service.

FOR MORE DETAILS PLEASE CONTACT:

CLASSIQUE SOUNDS

61 Aylestone Drive, Aylestone, Leicester LE2 8QE

Telephone/Fax (0533) 835821

EXPORT ENQUIRIES WELCOME

Steve Boxshall **AUDIO**

OFFERS YOU THE BEST HI-FI IN CAMBRIDGE



Use our expertise to invite real music into your home

- BEST CHOICE IN HI-FI
- INTEREST FREE CREDIT
- THREE DEMONSTRATION ROOMS
- VISITING CAMBRIDGE...?... VISIT US

41 VICTORIA ROAD

CAMBRIDGE

(0223) 68305

MEASURED PERFORMANCE

The new Yamaha CDX-880 has an interesting frequency response. Rather than the usual ruler-flat line, Yamaha have chosen to engineer the response to give a slight lift in both bass and treble. This, although appearing to be only minor from the plot, should give the CDX-880 good bass weight and bright, clear treble in subjective tests.

This treble lift can turn to harshness if combined with high distortion, but the CDX-880 behaves well in this area. Although wide-spread across the band, all of the distortion harmonics are low, so the Yamaha should remain reasonably sweet in the treble.

Elsewhere, as is commonly the case with mid-priced players these days, the CDX-880 performs well. Separation is wide, noise low enough to be inaudible, dynamic range good thanks to low distortion, and output dead on the Philips standard at 2V. **DB**

TEST RESULTS

Frequency response	4Hz-21.4kHz	
Distortion %		
-6dB	0.004	0.002
-30dB	0.025	0.022
-60dB	0.67	0.54
-90dB	24	17
-90dB dithered	11	10
Separation dB	left	right
1kHz	99	96
20kHz	74	75
Noise	-103dB	
with emphasis	-103dB	
Dynamic range	105.5dB	
Output	2.0V	

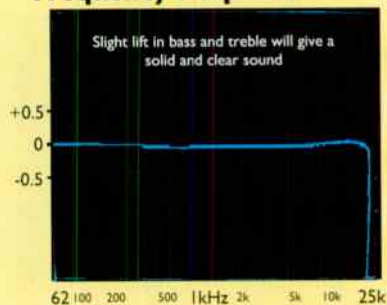
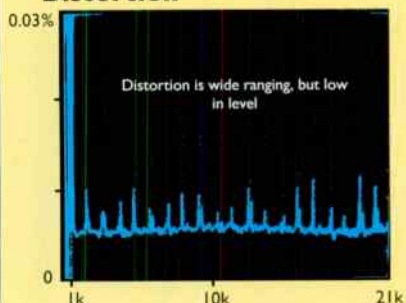
Frequency Response**Distortion**

YAMAHA CDX-880

£339.95

Another player with an urge to fit in facilities, but this time locating the secondary controls on a flip-down panel. When this is closed, the CDX-880 could be mistaken for a minimalist audiophile machine, should anyone feel shy of admitting a need for taping facilities like the Onkyo, Repeat, Random play and all the other CD replay options reviewers often despise, but come in handy. The player itself has a 0-9 keypad and this is repeated on the remote control. Exclusive to the remote is control of volume, variable output being available from a set of sockets on the rear panel. There's a fixed output avoiding the internal volume control chip for those who want the highest quality. Yamaha also fit electrical and optical outputs for those who might want to use an outboard converter at a later date. The remote control sender has been fitted with every facility possible it appears, including all the taping functions, display dimmer and open/close.

The Yamaha has a clean profile and a clear orange display showing track number and elapsed playing time; it was easy enough to use.

Sound Quality

Thanks to its 'Pro-Bit' DAC, the Yamaha was the most 'analogue-sounding' of all this group. Nothing in this world being entirely equal, this had unexpected results, its ranking changing depending on the music played. While a Purcell overture failed, since the normally dry strings

sounded distinctly nineteenth century, other orchestral material blossomed into a warm, rich and undeniably enjoyable experience. While full-scale orchestral dynamics were a little restrained, at least the effect was even throughout, no melody or rhythm gaining undue prominence. Rock music too was lively, detailed and very believable, if somewhat studio-bound, never quite powering out into a tough performance. Tonal colour tended to be gently sketched in rather than reproducing the whole spectrum, while the sound stage was a spot lacking in focus in the centre. One curiosity was that it was difficult to follow a beat: I noticed one listener, heavily involved in the music, nonetheless tapping her foot in the wrong time-signature.

Conclusion

Without being condemnatory, Yamaha has produced an easy-listening player in the best sense. This is a player with just enough analogue warmth to take the sting out of the nastier digital recordings, only a little too easy-going to produce that essential shock factor when music is intended to startle.

**Yamaha Electronics UK Ltd.,
Yamaha House,
200 Rickmansworth Road,
Watford,
Herts. WD1 7JS
Tel: 0923 233166**



KENWOOD DP-7060

£379.95

The Kenwood possesses a wide range of facilities, including peak search for aiding home-taping, but less the Onkyo's FTS-equivalent or the Yamaha's array. The display can be switched off, a nice touch, even though it is among the cleanest and most legible of this group, possessing large blue numerals. They show track, time, emphasis if on, and even output level in dB, which all looks pretty impressive. The styling is as curvaceous as any Page 3 model too, and the cabinet equally well built.

This player has a 0-10 keypad on its front panel as well as on the remote control and it also has remote control of volume, with 'fixed' output in addition to variable for those who want optimum sound quality. There's just one digital output though, which uses an optical transmitter.

Lack of time and a manual prevented me from discovering precisely what the legend "Dynamic Resolution Intensive Vector Enhancement" meant, but it sounds like something the USS Enterprise would use for chasing Klingons.

Sound Quality

By and large, a refined and listenable player, safely playing at Warp Factor Three. Kenwood's DP-7060 has one of the most lucid mid-ranges of any of these players and catches fine detail like the slightest breath of players or the dunk of music stands.

However, frequency extremes are a little restricted. Bass trombones and flutes were lacking some body to them, with horns tending to be very hom-like but without that control over dynamics that allowed muted instruments to diminish their volume naturally. Although adept at reproducing a melody, the '7060 did sound a little slow by comparison with the other players, which made it less sure-footed by catching a beat or sudden time-signature changes. Although tonally on the thin side, the DP-7060 made up for the lack of thick-blood in the musical stream with a compensating aura of clarity which spread instruments across a fairly wide stage without them being clotted together, producing a very good impression of individual sections, vocalists or players with the proper amount of space between them.

Conclusion

Not the niftiest of this group in timing, but a very lucid and clean-sounding player. Had there been a little more 'body' and roundness to strings and vocals to add to a splendid definition of detail, this would have been a winner.

**Trio Kenwood,
Kenwood House,
Dwight Road,
Watford,
Herts. WD1 8EB
Tel: 0923 816444**

MEASURED PERFORMANCE

Contrary to U.K. tastes, Kenwood continue to give their CD players a treble peak, including this one. This characteristic invariably produces a bright, sometimes sharp sound that on some systems may be unacceptable. On others, it could well provide a welcome tonic, but experience shows that, generally, players with mildly falling treble (e.g. Arcam, Pioneer) find favour with audiophiles, not vice versa.

That was the (qualified) bad news. The good news with this player is a remarkable absence of distortion, quantisation noise, and spurious outputs, both in-band and above 21kHz. The distortion analysis shows this quite clearly as a lack of spikes across the noise floor. No matter what test I applied, the Kenwood produced nothing nasty or unwanted; it is an unusually 'clean' player - always a good sign with CD.

Output measured a normal 2.12V and channel separation was high. Dynamic range, at 112dB, was higher than that of most players, due mainly to low distortion. **NK**

TEST RESULTS

Frequency response	3Hz-21.4kHz	
Distortion %		
-6dB	0.005	0.005
-30dB	0.006	0.006
-60dB	0.2	0.2
-90dB	4	4
-90dB dithered	11	11
Separation dB	left	right
1kHz	110	110
20kHz	83	88
Noise	-106dB	
with emphasis	-106dB	
Dynamic range	-112dB	
Output	2.13V	

Frequency Response

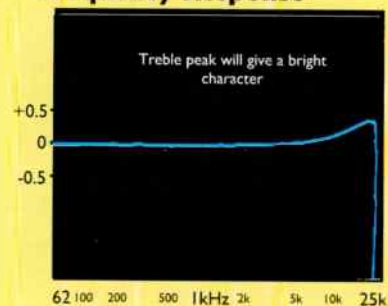

Distortion

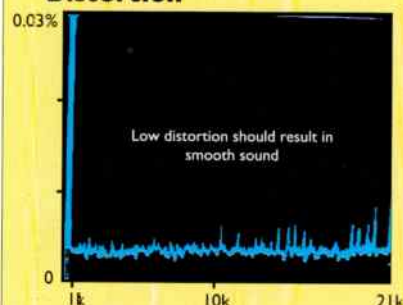

MEASURED PERFORMANCE

The frequency response of the Onkyo DX-750 is an interesting one. The whole response has a tilt to it, favouring bass, which I would expect to result in subjectively solid and weighty bass. There's a peak in the treble too, which may add some brightness, but the peak is sharp and above 10kHz where its effect will be less audible than a slow rise starting from lower down.

Distortion is reasonably low, as can be seen from the plot below, taken at -30dB to represent a typical music level. Second harmonic predominates, which is a good sign as this form of distortion is mainly innocuous and there is only a very small amount of 3rd or higher order distortion. However, at -60dB the DX-750 has higher than average distortion which limits dynamic range to a mediocre 100dB.

Elsewhere, the DX-750 measures well, with output just a touch higher than normal at 2.15V. **DB**

TEST RESULTS

Frequency response	4Hz-20kHz	
Distortion %		
-6dB	0.003	0.003
-30dB	0.035	0.036
-60dB	0.94	1.03
-90dB	43	37.6
-90dB dithered	14.3	13.9
Separation dB	left	right
1kHz	101	98
20kHz	76	77
Noise	-109dB	
with emphasis	-109dB	
Dynamic range	100dB	
Output	2.15V	

Frequency Response

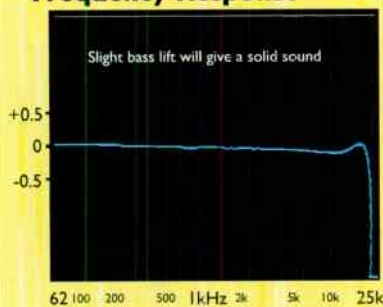

Distortion

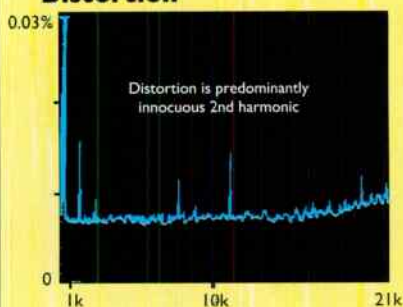

ONKYO DX 750

£349.95

After some years' absence, Onkyo, once a mainstream brand here, is back. The DX-750 is by far the bulkiest, with an intimidating array of buttons left and right of the central tray. These control all the usual functions, but also include 'Peak Search' and 'Time Edit' for (still illegal) home taping and 'Music File' which allows selected tracks from up to 204 discs to be memorised. The complex display has a track calendar, in addition to track number and, in smaller numerals, track elapsed playing time. A 0-10 keypad for quick track selection has been provided on both player and remote control and remote control of volume has been included too. As usual with this facility, those who want top quality can use a pair of 'fixed' output sockets on the rear panel. There's a digital output too, but optical only - an unusual choice. These days, electrical digital outputs are more common, optical coming under suspicion for the dubious quality of the transmitter system commonly used. Yet it does invariably offer an amenable sound.

The Onkyo was reasonably well built and finished. Inevitably, a box of this size has large surfaces and rings more than smaller, sturdier constructions, making it seem less substantial than competitors. This is a problem Aiwa face too, with their penchant for large, unfillable boxes.

Sound Quality

A very harmonious player, this one,

smooth and extremely enjoyable. With rock music, rhythm and bass guitars came forth and multiplied, while orchestral music had strong dynamics. If there was anything missing, it was only the perception of depth, the Onkyo having a perspective that was forward of the plane of the speakers plus a layer just behind. Consistently, however, the DX-750 reproduced instrumental and vocal colour with a kind of gleefulness that ensured listeners could always be certain that a band was playing authentic instruments or romantic ones. Its sense of timing was totally consistent, too; listeners never failed to match a beat or keep to a rhythm. A small degree of coarseness in the upper mid-range would have said 'multi-bit' a few years ago, but this is a bitstream player.

Conclusion

Consistent in playing music, the Onkyo constantly came out top of the bunch, not for accuracy, but for a strong balance of virtues. My panel of friends tended to mutter more about the quality of performance than recording quality, always a good sign at this price level, though noting a slightly dry, lean tonal quality in the mid-range.

NAD Marketing Ltd.,
NAD Building,
401-405 Nether Street,
London N3 1QG
Tel: 081 3433240

Here's what the UK's leading publications have to say about the new Q Series.

Q10

"ALL ROUND THE USER-FRIENDLY Q10s LOOK LIKE WINNERS FOR KEF - AND MUSIC LOVERS SHORT ON SPACE."

What Hi Fi?, February 1994

Q30

"WHERE THE KEFs REALLY SCORE IS IN THEIR ABILITY TO BRING EVERY SEGMENT OF THE MUSIC TOGETHER IN A HIGHLY INVOLVING MANNER."

What Hi Fi?, February 1994

Q50

"THE OPENESS, CLARITY AND SPEED OF THE Q50... MAKE IT PRE-EMINENT OF ITS TYPE."

Alvin Gold, Audiophile, June 1994

Q70

"...THE Q70s WILL DELIGHT YOU WITH THE SHEER TOGETHERNESS OF THEIR MUSIC MAKING."

What Hi Fi?, June 1994

SEE YOUR NEAREST DEALER FOR A DEMONSTRATION.

ABERDEEN	
HOLBURN HI FI	0224 585713
ALLOA	
McMICHAEL BROTHERS	0259 724230
BIRMINGHAM	
MUSIC MATTERS	021 429 2811
(3 BRANCHES IN WEST MIDLANDS)	
BLOXWICH	
SOUND ACADEMY	0922 473499
BRISTOL	
RADFORD HI FI	0272 428247/8
(7 BRANCHES IN THE SOUTH WEST)	
CARDIFF	
AUDIO EXCELLENCE	0222 228565
(4 BRANCHES IN THE SOUTH WEST)	
CHELTENHAM	
SEVENOAKS	0242 241171
(12 BRANCHES IN THE STH & MIDLANDS)	
COLWYN BAY	
ELECTRO TRADER	0492 548932
CREWE	
NORMAN AUDIO	0270 211091
(ALSO IN LANCASHIRE)	
CROYDON	
ZEBRA	081 688 2491
EDGWARE	
MUSICAL IMAGES	081 952 5535
(ALSO IN MIDDLESEX)	
EDINBURGH	
IN HI FI	031 225 8854
GLASGOW	
BILL HUTCHINSON HI FI	041 204 4433
(8 BRANCHES IN THE NORTH)	
GUERNSY	
MELODIA	0481 56647
GUILDFORD	
P J HI FI	0483 304801
HUDDERSFIELD	
REDAVISION	0484 532294
JERSEY	
BASE HI FI	0534 58518
KNUYSFORD	
WILMSLOW AUDIO	0565 650605
LEEDS	
AUDIO PROJECTS	0532 304565
LEICESTER	
LEICESTER HI FI	0533 539753
LONDON	
HI FI EXPERIENCE	071 580 3535
K J LEISURESOUND	071 486 8262/3
AUDIO CONCEPT	081 567 8703
MANCHESTER	
D & T ELECTRONICS	061 445 2694
NEWCASTLE	
J G WINDOWS	091 232 1356
NEW MALDEN	
UNILET	081 942 9567
NOTTINGHAM	
NOTTINGHAM HI FI	0602 786919
OTLEY	
DOUG BRADY HI FI	0943 467689
PETERBOROUGH	
THE HI FI COMPANY	0733 892231
(ALSO IN LEAMINGTON SPA)	
READING	
B & B HI FI	0734 583730
(5 BRANCHES IN BERKS/BUCKS)	
SHEFFIELD	
SOUND WITH STYLE	0742 737893
(ALSO IN DONCASTER)	
SHREWSBURY	
CREATIVE AUDIO	0743 241924
SWINDON	
AUDIO T	0793 538222
(7 BRANCHES IN THE SOUTH)	
ROCHDALE	
JOE KOCZUR	0706 42107
THAME	
THAME AUDIO	0844 215431
TWICKENHAM	
RIVERSIDE HI FI	081 892 7613
WILMSLOW	
SWIFTS OF WILMSLOW	0625 526213
WORTHING	
PHASE 3	0903 245577

THIS DOES NOT CONSTITUTE A FULL DEALER LIST. FOR A COMPLETE DEALER LIST PLEASE CONTACT KEF ON 0622 672261.



The experience of sound

KEF and Uni-Q are registered trade marks. Uni-Q is protected under GB Patent 2 236929 - worldwide patents pending.

It's that

KEF
feeling

The
NEW Q series



Q10



Q30



Q50



Q70

World Radio History

CONCLUSION



first Onkyo's DX-750. Certainly the best all-rounder, with the widest variety of colour, ripping dynamics and a firm grip on rhythm. It was by far the most adept at consistently playing music rather than recordings, a small degree of grain only obscuring the upper midband. With the exception of the Rotel, followed a couple of paces after by the Kenwood, this player also produced the widest and

soundstage. A slight constriction of tonal colour put it somewhat behind the Onkyo, while a too-refined dynamic smoothness added to its long-term overall listenability, while making it perhaps rather too bland for up-beat rock listeners.

The Yamaha unexpectedly caused a guinea-pigs' revolt, having been praised for the nearest-to-vinyl vocal and tonal quality of any of the players. An LP was produced to test the claim, whereupon three grands' worth of vinyl replay system turned out to have such a superior range of tonal colour and dynamics that the guinea-pigs refused to go back to digital at all and the fourth listening session came to a sticky end. However, despite a rather flat sonic perspective and restrained dynamics compared to the other CD players in the group, the CDX-880's overall just-on-the-right-side of rosy glow brought praise.

Distinctly the odd one out, Arcam's Alpha One turned out to be, well, odd. Alone, it would be likely to score highly, since its strengths are immediately obvious. Very tight, very sharply focused, superficially it tightens up a listener's picture of a rock or blues band, so it sounds 'live' between the speakers with, always, a deep rich 'thrum' from the bass,

All CD players sound the same, do they? Not on your Nelly. For amusement value only, there are two rankings this time. First for facilities: joint winners are Yamaha and Onkyo, though the Onkyo's optical-only digital output puts it one pace behind the Yamaha.

Least facility-bound and therefore bottom of this list, is the Rotel, though of course its simplicity puts it top for audiophile credibility. Only winner of the upgradeability prize is the Rotel RCD-965BX, since it can be transformed into an RCD-965BX LE, where an added UK-designed board addresses what few sound-quality criticisms can be made of it and puts it decidedly two rungs up on the ability scale.

Sonically, each of these players has a quite different character. In order of bulk,

clearest defined lateral soundstage.

Supreme on depth and coherence, soundstaging was where the Rotel scored. While a certain 'hollow' mid-range quality tended to thin tonal colour, for insight into recording quality the RCD-965BX came second only to the reference. It clearly displayed a 'wet' (liquid) quality, as one listener described it, to one recording which is a consequence of the way that particular recording was mastered.

Concomitantly, if perhaps a little artificially,

the Rotel was better than any of the others at giving an impression of air and space between and around performers.

With a broad array of controls, Kenwood's DP-7060 also produced a well-rounded performance for those who like clarity and refinement, rather than punchiness. Lacking the Rotel's surprising capabilities in portraying the depth (classical) or layers (rock) of a recording, it still had a very tidily defined



more impressive than that from any other player. Only in comparison does it become obvious that the whole tonal balance is slightly skewed, with the emphasis on rhythm and sharpness of projection rather than all the internally-defining subtleties of attack and decay in notes that define a coherent musical performance. Exciting, no doubt, but less than accurate. The benefit is on the side of rock listeners who would be dismayed at the technical inadequacy of some current recordings: the Arcam would still let them spark and sparkle, whereas, at the other end of the scale, the Rotel, especially, or the Kenwood would strip them so bare the result could be dismaying.

Over to you, Nelly ●



Polite Predators



The name is new, although former TDL designer Clive Gibson is no stranger to loudspeakers. Dominic Baker listens to Clive's latest design, the small floor-standing Kestrel.

Although Musical Technology are new to the loudspeaker market, the people behind this venture are certainly not. The Kestrel's impressive paper spec. includes in-house built metal cone bass units and an attractively proportioned triangular floor-standing cabinet, all for a mere £250. This is the work of designer Clive Gibson, until recently with TDL and before that IMF and Acoustic Energy amongst others.

The Kestrels are slim, narrow floor-stander's. This kind of cabinet makes a lot of sense, taking up less room than a standmounter plus stand, but allowing better bass from the increased cabinet volume available to the designer. A spiked metal plate stand is available for an extra £29.95 which gives them a solid footing.

The Musical Technology Kestrels benefit strongly from near-wall placement. Further out into the room bass became light, lacking power and clearly showing the metallic character of the bass unit. Even when pushed right back so that they were virtually touching the rear wall, bass couldn't be described as weighty or strong. They did have enough lower down to establish a reasonable balance, displaying good definition and an ability to play a tune. They coped well with Frank Black's Sir Rockaby, the deep underlying bass line strong enough to make its presence known, whilst upper bass followed the beat of the music well.

Listening to several tracks on the same album also demonstrated their civilised and polite nature. Even with screaming

guitars, crashing cymbals and punchy bass lines they sounded comfortably soft. This can be seen in two lights. On the one hand they won't offend, and are particularly suited to relaxing background music. But personally I'd rather have a little more get up and go. From an audiophile point of view, they're not really captivating enough to encourage you to listen deeper and deeper into the music.

A violent drum roll didn't get much louder as the drummer worked harder, and no part of the music ever really made it out of the plane of the loudspeakers and into the room. It's on dynamic contrasts like this that the Kestrels don't really convince. Pink Floyd's The Wall goes from an almost inaudible whisper to super, loud, guitar riffs with moments, but the contrast between loud and soft was compressed down to reduce dynamics and impact.

In other areas though, the Kestrels do extremely well for their price. Their midrange was exceptionally smooth. The Cranberries' Dolores O'Riordan showed this to full advantage with her rich, full-bodied voice. Their clarity across the midrange is no doubt due to a well-engineered crossover integrating the drive units smoothly together. The triangular section cabinet will help to prevent standing waves setting up, which can introduce a hard and boxy effect.

The metal drivers gave The Cranberries a brighter tone than normal, which was quite a pleasant effect with this album, if not the most accurate. This brightening of tone gives the 'speakers an open and clear

sound that certainly seems impressive to start with. After a few hours though, I found myself struggling to hear the finer points of the music. Low level detail such as the ambience surrounding the instruments and the way they decayed were rarely fully exposed, making it difficult to gain much insight into a recording, I found.

“ The Kestrels do extremely well for their price. Their midrange was exceptionally smooth. The Cranberries' Dolores O'Riordan showed this to full advantage with her rich, full-bodied voice. ”

Partly for this reason, the Musical Technology Kestrels have a fairly limited repertoire. Their metal dome tweeter handled cymbals well, giving them the sharply etched zing necessary to become believable, the midrange coped smoothly with most vocals and the upper bass played a tune well. But if percussion became too complicated and laced with high treble energy, the Kestrels quickly became splashy and vague. Counting Crows' acoustic guitars sounded like they were stuffed with foam and the string bass intro to Lou Reed's Walk on the Wild Side was coming from a cupboard at the back of the stage.

I'm not against metal cone loudspeakers; JPV's Ruby 1s and Townshend's Glastonburys are among two that I rate highly. I suspect that the larger magnet assemblies needed to drive the heavy cones properly cost a lot and that a compromise has to be made for more affordable designs such as this. Unfortunately, this results in a weak sound, one that at this price level others can beat.

For the money you do get a lot of technology. Metal cone drivers and a triangular-shaped floor-standing cabinet together make the Kestrels look good value. Sadly, for £50 less the standmounting Harman Kardon LS0200s put more effort into the music and if you really want a floor-stander with good bass, then TDL's RTL2s have it sewn up. The Kestrels are a lot more civilised than either of these two though, so if that's what you're looking for, they're worth auditioning ●

Kestrel £249.95
Stands £29.95
Musical Technology
Unit 10, Howard Industrial Estate,
Chilton Road, Chesham,
Bucks. HP5 2AU
Tel: 01494 793137

MEASURED PERFORMANCE

Musical Technology are a newly formed loudspeaker manufacturer, but their designer has had plenty of experience, working for TDL and drive unit manufacturers Elac amongst others. This shows through in the measurements of the Kestrel: they have a well mannered, smooth response and an extremely even impedance curve.

Although the response is smooth, there is an upward trend that will give the Kestrels a light and airy sound. Midrange output droops a little, which will remove some projection and bass was visibly weak. Although this characteristic will impart a light and fast sound to the speaker, the sound will also lack bottom end weight.

As I mentioned above, the impedance curve is one of the smoothest I've measured, making it a candidate for low or zero feedback amplifiers. Unfortunately they'll also have to be powerful; I measured just 84dB SPL at 1m for a nominal watt (2.83V) pink noise signal. This, and the low overall impedance figure of 7Ω means that a powerful amplifier will be needed for best results from the Kestrels. I'd recommend at least 60watts.

The Kestrels measure well enough, with a smooth frequency response and

impedance curve. They are insensitive by today's standards, but that's the price you pay for metal cone drivers. **DB**

Frequency Response

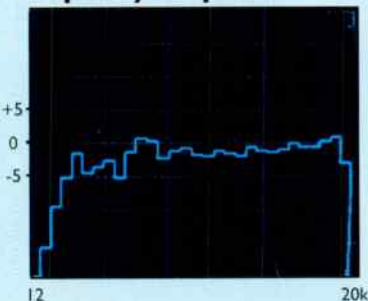

Rising response will give a light sound.

Impedance

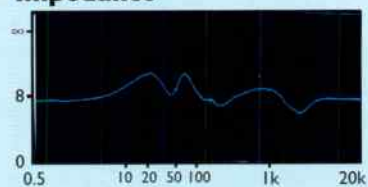

Very smooth impedance.



NEW... Diamond shaped crystal clear Big sound deep bass line... Bright and life like sound... Even from the smallest one... Home trial or no trial this must be done... Better price better design. 1994..... For free full colour brochure
Phone 081 986 8455
Elvins Acoustic Technology, 12 Brett Road, London E8 1JP England.

PRICE STUDIO MONITOR

- * Direct from manufacturer
- * Why pay more?



Each Price Studio Monitor is **individually** calibrated.

By using the very best drive units available coupled to ceramic-resin bonded cabinet of immense rigidity, the result is a loudspeaker with an incredible dynamic range and extremely flat frequency response extended from **28Hz to 20KHZ.**

Loudspeakers of this quality normally cost £2,500

The price Studio Monitor is available direct from the manufacturer for **only £1,500** (VAT is included and there's no charge for delivery!)

For a free home trial or further information simply phone:

0443 - 480258

The Sound Company)))

23 Whiterock Drive, Pontypridd, Mid Glam., CF37 2HA

Proprietor: D. Price

campaign audio design

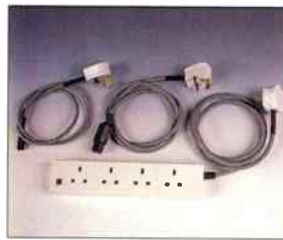

Getting a better, more involving, sound often means spending a lot of hard earned money. It's such a waste, because every system can benefit from our cables and accessories, at a fraction of the cost of some new "black box". Here are some of the ways we can help.

We have Oxygen Free Copper interconnects (£12.48) up to Pure Silver cables (£120.00) and high definition loudspeaker cables in Silver plated Copper or Pure Silver. Our main cables add weight, power and scale. Non inductive RF filtering (£10.00) and over voltage protection (£3.00) enhance performance still further. Gold plated AV cables, both RF (£19.95) and Scart (£23.52), help bring picture quality in line with NICAM sound resolution.

Valves, capacitors and transistors are all microphonic, they cannot perform optimally if vibrated. Our set of three Brass Isolation cones (£6.50) are worth their weight in gold - revealing low level resolution and dynamics hither to hidden beneath electronic noise. We also have a cure for your noisy fridge or central heating motor (£3.50), enabling you to throw away your big mains noise suppressor, which has been giving you that "sat upon sound" for years.

There's lots we can do to bring you closer to the emotion and energy of the performance. So confident are we, that we offer a 14 day money back guarantee.

Ring or write for details:-

CAMPAIGN AUDIO DESIGN
Llandudno Road (HW)
Cardiff CF3 8PG
Tel:- 0222 779401

Trade and International Enquiries Welcome.

Tesseract Audio.

If you've never heard of it, you should hear it.

For an appointment call 081 568 8808.

For full details of the Tesseract range of head amplifiers, pre-amplifiers, power amplifiers, Gyrodec power supplies and dealer list contact: Choice Audio Marketing, Butter Field House, Church Street, Old Isleworth, Middlesex TW7 6BE.

Tel/Fax: 081 568 8808



TESSERAC AUDIO
 The Best of British High End



KING KLOUT

Is Linn's Kairn and Klout pre/power amplifier the king of slam and dynamics, or is there something more subtle about this top-end combination? Noel Keywood listens closely.

Although the days of blind Linn/Naim religion are over, other beliefs being given some freedom of expression, it's still the case that what Linn and Naim do well, they do very well. If you want to hear grippingly dramatic solid-state amplifiers, all punch, power, control and revelation - ask for a Linn or Naim demo. Many 'World readers do, and many also ask us how we rate top Linn and Naim models. In the October issue I listened to Linn's top Kairn pre-amp and Klout power amp, driving TDL Reference Transmission lines. Here's a longer view, based on listening with other, more conventional loudspeakers.

In use, I have two criticisms to make of the Klout. In spite of on/off mute circuits it comes on with a squeal from both channels. And the input impedance is unusually low at 5kohms, causing a potential matching problem with quality pre-amps, especially those without feedback infested, silicon chip line drivers. I saw the relevance in Linn's comment about the Kairn that "most importantly, (it) correctly matches the impedance between source and power amplifier". The Klout is best used with a Kairn.

The Kairn Pro pre-amplifier I reviewed was line-only and, ironically, phono is not now available (I used an EAR834P valve

phono stage for LP). The Pro has a switch mode power supply, a complex way of obtaining mains energy, albeit with practical benefits. Linn were very enthusiastic about this, saying it greatly improved sound quality. The Kairn is remotely controlled and can be used in a multi-room system. It can be manually controlled, but this isn't especially easy. There are seven inputs, three outputs and a very wide range of functions, including balance, volume, muting, input level equalisation, record/listen selection, buffered tape output, mono, etc. In terms of sound quality, the Kairn did deliver. Unlike the Klout, it could be easily matched with items from other manufacturers.

Partnered with Linn Kabers and then the TDL Reference Transmission line loudspeakers I detected some interesting properties in the Linn Klout power amplifier. There were so many other items in the chain, however, that I couldn't distil the sound of the Klout from the rest with any confidence - and it's always dangerous to base firm views on anything other than comprehensive experience in this game. I had to get a Klout home and into a known system before becoming more certain about its qualities.

The property that originally captured my attention made itself clearly known straight away: the Klout projects strongly across the midband and lower treble regions, throwing out a wealth of fine detail. This gave a captivating stereo stage with simple recordings possessing well separated instruments and performers, strongly outlining castanets, vocals and strings, for example, on Manuel de Falla's 'The Three Cornered Hat', from a delicious analogue 35mm film soundtrack recording (on CD) of the L.S.O., from Everest records. In this area the Klout possesses a master-tape type of presentation, forward, dry and detailed: impressive.

With the Kairn preamplifier especially, and with loudspeakers possessing strong bass, our own KLS3s and Heybrook Quartets, I was impressed by the powerful metronomic beat on Carol Kenyon's Dance With Me (12in single); it's meant to move you almost physically and it punched out from the 'speakers. The Klout has grip and power; it can also reproduce delicacies whilst supporting strong driving bass lines - impressive stuff.

Some of the dryness and in-your-face drama of this combination may be a little overwhelming for some listeners. Depth perspectives and a certain sense of liquidity in the sound are less evident than with good valve amplifiers (or DPA). However, to some extent this is the trade-off you make between good solid-state and valves; some like one, some the other. The Kairn preamplifier survived being hooked up to our revealing 300B amplifier. So often, solid-state pre-amps are revealed as sounding grainy and flat by a lucid valve power amplifier, but in this case the Kairn shone, coming over as clear, cohesive and highly detailed, with scant sign of unpleasant colouration.

Ultimately, I was deeply impressed by the Kairn/Klout. It's a forceful combination that images superbly left-to-right, has pile-driving power (I measured 78 watts) yet a vividly detailed midrange. Full marks for viscerality - it's a system that's especially fine for hard driving rock yet it is neither hard nor fatiguing ●

Kairn Pro £998
Klout £1895
Linn Products, Floors Road, Waterfoot, Eaglesham, Glasgow. G76 0EP
Tel: 041 644 5111



Cadet Force

Haden Boardman explores a classic affordable valve amplifier, the Rogers Cadet.



The ECL86 valves are hidden behind a metal heat screening plate to protect the smoothing capacitors.

Altogether there are four versions of this classic little valve amp. The MkI introduced around 1958 was initially called the 'Minor' and used a pair of ECL83 triode/pentode valves to give a claimed 5watts output - quite reasonable in those days. The chassis was very small and neat, with the matching four-knob pre-amp; they 'aint that common though as monoblocks and if you have just one, finding another for stereo sound may take some time.

The MkII arrived in 1961 as a Stereo pre/power combination. This time it used ECL86 valves for a more powerful 10watts per channel. If you already have one of these be warned, the pick-up input on the preamp does not accept MM cartridges.

The later MkIII from 1964 was much more modern looking. Usually, it was supplied in a little wooden case and early versions were split into pre/power sections. The circuit was not that different from the MkII, but the pre-amp was significantly better and with a suitable adapter most moving magnets will work very well. Later MkIIIs were built as pure integrated amplifiers, and tend not to be as popular as the pre/power item, especially if the case has gone astray.

One fly in the ointment with the

MkIII is the Brimar ECC 807 tube used in the preamp. Supplies of these have long since dried up. Fortunately an ECC 83 is basically the same valve, and will work if you alter the wires on the base of the socket. (The two are not pin compatible). In theory an '807 is an up-rated '83, in reality, though, the two measure near enough the same.

The ECC 83 heater does have a centre tap, whilst the ECC 807 heater

doubler power supply, these capacitors each carry half of the full HT voltage on them. Be careful.

Price of Cadets is pretty low, and supply of MkIIIs very good. Anyone after an introduction to valves on a very tight budget should certainly consider a good second-hand Cadet with confidence. Sonically they are surprisingly open through the midband, with the extreme frequencies rolled off gently (thanks to a

rather average output transformer). I think this can be a good thing with some budget CD players, taming the bright and sterile treble quality they tend to exhibit.

Power isn't exactly in the Cadet's dictionary either. Unless you own a pair of Klipsch horns or something with 90dB or higher sensitivity, head bangers should look elsewhere ●

FOR CIRCUIT, SEE SUPPLEMENT, P.19

Rogers Cadet £120 Approx.
Mellotone Acoustics
PO Box 67 Wigan,
Lancs WN2 3AG
Tel: 0194 57525

Valve Pin Connections

The ECC83 and 807 are both twin triodes, i.e. two valves in one glass envelope.

Pin	ECC83	ECC807
1	Anode I	N/C
2	Grid I	Grid II
3	Cathode I	Anode II
4	Heater	Heater
5	Heater	Heater
6	Anode II	Cathode I
7	Grid II	Cathode II
8	Cathode II	Anode I
9	Heater centre tap	Grid I

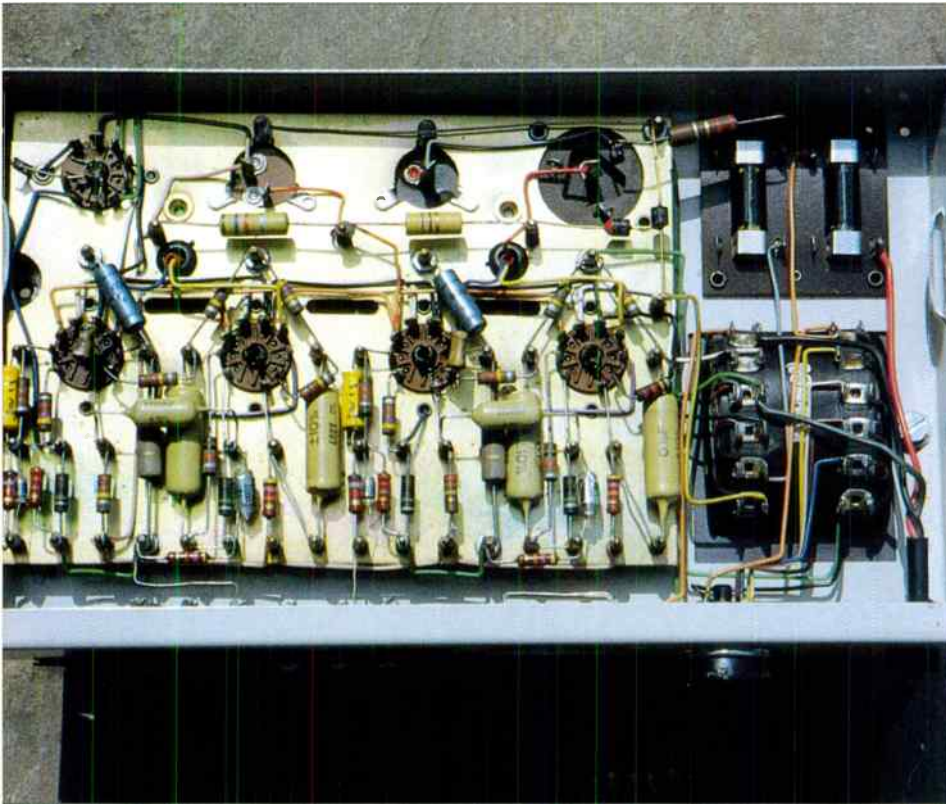

The underside of the Cadet III power amplifier is easily accessible making servicing and restoration simple.

does not. Connect one side of the heater supply to strapped pins 4 and 5, and the other connection to pin 9. Watch the earthed screen on the 807. When swapping leads about remember not to mix the two halves of each valve up. If in doubt leave this job to a professional.

Another problem that can be usefully solved is the joint cathode resistor for the output valves. As with the QUAD IIs these should be split. Components that give the most aggravation are usually the aforementioned cathode resistors, bypass capacitors and *all* of the anode load resistors in the amplifier. Around 99% of faults on Cadets are caused by these components. Coupling capacitors and power supply electrolytics are usually very reliable, surprising for an amplifier of this period. Make sure the insulation is good on these electrolytics. Because the Cadet uses a voltage -



The matching Cadet III pre-amplifier and Variable tuner complete with wooden cases.

SEEKING SIMPLICITY

Does the amount of features and functions of Nakamichi's new ST-35

mean more or less than you'd expect of the manufacturer?

By Robert Greig, Editor at Large



Part of the new 's' series from Nakamichi, the ST3s tuner is attractively styled. The front panel is clean and uncluttered, having only what is necessary and no more. For £350, this Japanese tuner is surprisingly minimalist; FM only and no RDS - something becoming standard even on £150 tuners these days.

Tuning can be controlled in two different ways. There is the, nowadays, more common push-button scan-up and down, or a nicely weighted rotary control. Rather than being a free-wheeling control though, it turns in 5/100th MHz steps with a positive click for each step. However, this is all a bit academic; the push-button scan controls make tuning fast and accurate, and once you've stored your favourite thirty stations, the rotary control is redundant. The only other controls worth mentioning are for mono and auto-muting off-station.

Throughout the listening tests, the ST3s stayed admirably clean and clear of birdies or whistles, as you'd expect from a modern tuner. Even from a modest three-element aerial in Central London the signal proved strong enough for good stereo and low noise from a large range of stations. The ST3s appears to be very sensitive, but be careful of overkill when selecting an aerial: on a couple of stations it came close to being overloaded, and a touch of distortion set in. The signal level meter doesn't seem to be too discriminatory either; if I could get a squeak out of a station it showed four or even five bars - maximum.

On Peter Cirkin's interpretation of a Beethoven piano concerto in C minor on BBC Radio 3, the firmly played notes of the piano took on two characters, depending upon where they were. Above middle C they had an annoying tendency to fizzle out with a phasey, slightly sibilant character rather than smoothly decaying away into the low level hiss. This effect got worse as the notes scaled the keyboard. Lower notes however, were dealt with with more aplomb, having good weight and definition. They still didn't have quite the same atmosphere and three-dimensional scale as on the reference Leak Troughline, but they remained smooth and focused all the same.

The next part of the programme comprised the Chrysler string Orchestra playing Sibelius. The strings were impressively pure and clean, the upper harmonics only suffering a slight brightening in tone. The sound-stage wasn't especially deep though, and when

cello came in, the woody reverberant character was compressed into a two-dimensional plane between the loudspeakers. The space around individual instruments was conveyed well, but the overall sound-stage stood inwards from its boundaries. This was also noticeable on announcements, where the ST3s lacked the ability to draw me into the close-miked atmosphere of the studio.

Initially, the ST3s sounded surprisingly clear and open in the top after the Troughline reference. However, on mainstream rock from Capital Radio and BBC Radio 1, the splashiness of the treble made itself known, clearly. Admittedly, transmission quality also took a step backwards from the solid and rich character conveyed by Radio 3, but the Nakamichi struggled to play cymbals with any power, the papery texture of the upper registers removing body and weight from each strike. Bass lines too, on Kiss FM, weren't given enough presence and attack to really define the beat, although individual notes seemed well constructed.

These days, when a lot of transmissions sound thin and sibilant to start with, Nakamichi would do well to engineer for a warmer, sweeter balance in the treble than they have here. With light bass and treble that could become a touch sharp, a gritty and weak overall balance was provided. Here, tuners like the Aura TU-50, shortly to be replaced by the TU-80, have a sweeter balance that manages to bring body and warmth to rock, yet stay neutral enough to do justice to better quality signals from BBC stations.

The Nakamichi ST3s is attractively styled, quick and simple to initially program and then use in everyday life. But although minimalist in design, the quality of its sound wasn't quite up to what you'd expect from a £350 tuner. There are cheaper designs around, the Aura TU-50 for example, that gives a smoother and sweeter sound with better body, yet they lose little in terms of clarity to the ST3s.

And there are even more tuners around that can offer a far wider range of facilities, RDS, medium wave etc. for less than half the price. The ST3s looks like it's been aimed at the audiophile with its 'less is more' design approach, but it falls too short in sound quality to gain any appreciation in this market ●

Nakamichi ST3s £350
Nakamichi B&W
Marlborough Road,
Churchill Ind. Estate,
Lancing,
W. Sussex. BN15 8TR
Tel: 0903 750 750

“Nakamichi would do well to engineer for a warmer, sweeter balance in the treble than they have here.”

MEASURED PERFORMANCE

The ST3s has a small upper midband lift - enough to add a little sheen or brightness into its sound. Our frequency response shows this clearly, as well as the sudden drop in output above 16kHz due to the 19kHz pilot tone notch filter. This did a good job in suppressing all unwanted outputs above 16kHz, reducing pilot to -75dB and sub-carrier to -100dB. Bass output extended down below 10Hz.

Distortion was a trifle higher than that of some tuners, hovering around the 0.2% mark, with both second and third harmonics present; this may tinge the sound slightly.

At -71dB, hiss was satisfactorily low, but this performance was no better than that of most rivals. For Radio 3 in particular, which has extended silences, a tuner must offer better than -70dB, so the ST3s just scrapes in here.

Sensitivity was high: just 0.5mV was needed for minimum hiss (full quieting), a level any two or three element aerial can usually provide. Selectivity, the ability to separate closely grouped stations, was also high. Nakamichi have also fitted a useful signal strength meter: all five segments must be lit for full quieting. **NK**

TEST RESULTS

Frequency response	42Hz-13kHz			
Stereo separation	42dB			
Distortion (50% mod.)	0.2%			
Hiss (CCIR)	-71dB			
Signal for minimum hiss	0.5mV			
Selectivity (at 0.4MHz)	80dB			
Sensitivity				
mono	4µV			
stereo	25µV			
signal strength meter				
1	2	3	4	5
4µV	16	40	200	500µV

Frequency Response

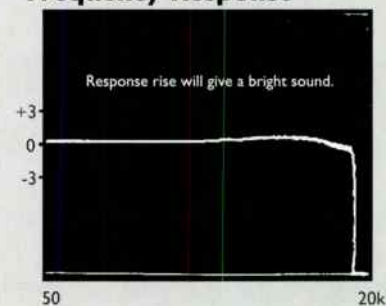

Distortion

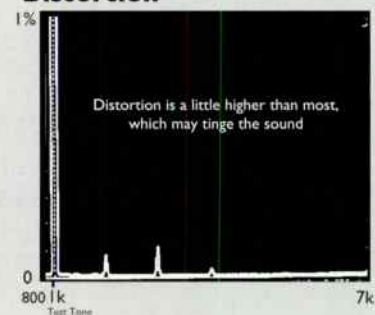



World

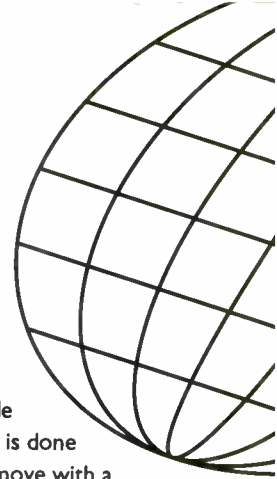

VINYL STAND

I have been reading hi-fi magazines for 25 years now. I am 47 years-old and have a large collection of LP records. I have been reading Hi-Fi World for several months and have placed a regular order with my newsagent.

I am completely satisfied with my system which doesn't have a CD player. I remember when they first came out and someone said they had a quiet background. So, Ivor Tiefenbrun of Linn took a lemon to some hi-fi shops, saying that didn't make a noise either.

Although the technology has advanced, I was really pleased to see in a recent issue of Hi-Fi World the advice that readers with large LP collections shouldn't ditch them, but get a really good turntable and enjoy the result. Well, I have just such a turntable; it wasn't expensive and it certainly has a fine sound. It is an Acoustic Research EB101, recently fitted with a Goldring 1012GX cartridge, which I can confirm to your readers as excellent value.

Amplification is provided by an Arcam Delta 60 which has a superb sounding phono-stage. This then drives Tannoy floor-standing 611 Mark One 'speakers.

Ancillaries are an Arcam Alpha 2 tuner - excellent FM sound, the MW and LW bands can be useful too - and an Arcam Delta 150 Nicam tuner for excellent TV sound. Try putting your television between the 'speakers and place the rack with your hi-fi behind, to the left or right; a little trouble making the wiring neat doesn't take long.

In my Target rack there is room for just one more item, a NAD6325 cassette deck. Using TDK AR90 tapes, superb

results can be obtained. 'Speaker cable, I forgot to mention, is the tried and trusted QED 79 strand with gold-plated banana plugs. One other famous make of plug made the sound tinny and the bass guitar wouldn't play properly on my Grace Jones LPs.

Finally, the amp, two tuners and my Nicam VCR each stand on a Mission Isoplat; these really do help.

So why all the funny stares from staff at the High End of hi-fi shops when I say I haven't got a CD player? One feels ostracised. I daren't ask them to order a stylus from Goldring - I might be thrown out of the shop. I got the 1012 GX direct from Goldring because of the attitude I mentioned with vinyl. And yet CDs are expensive, they can skip or jump, they can rust even. As far as I'm concerned they are also boring. There's nothing like seeing the marvel of a pick-up in its arm and that platter revolving; one can hardly believe it would make the sound it does, or contribute towards it.

Readers who need convincing can visit my home, if they are true enthusiasts. I guarantee some of them will be going away and ditching whatever it is they've got. Look at the letter from Joe Hagan of Thomton Heath, Surrey in your September issue, headed Stunners and Crap. Although you did make a fair point regarding his room and furnishings, how the hell did he house it in the first place?

So keep it up; yours is the best hi-fi magazine I've read to date.

**Brian Walker
Stratford on Avon
Warwickshire.**

Just because CD is the latest

medium, it doesn't mean that you can't have musical enjoyment from vinyl or compact cassette. I cringe at the thought of the thousands of records that were ditched in favour of CD when it was first introduced. Even cassette can sound superb, some of my

most enjoyable listening is done on the move with a Walkman Pro.

Let me assure you though, that the attitude you experienced at that particular hi-fi dealer is not

Letter of

Two of your letters in the October edition, and one in particular, brought waves of nostalgia back to me from many years ago.

Your Letter of the Month espoused the cause of quality hi-fi and not simply the latest is always the best, but the letter about the Voigt Tractrix horn loudspeaker was the one which really struck home. I thought you may wish to hear the following true story.

As a preamble my Father, who died in 1980, was always a keen lover of good quality reproduction. His interest was more than academic and he built much of his own equipment in the early days. By the early days I mean the late nineteen twenties and thirties. My mother still holds the third broadcast/receiving licence to be issued in Nottingham, to my father. In the thirties he built a Beard-type television to receive the early transmissions from Alexander Palace. The resolution was so good, he

said, that a pair of 'drop' earrings could just be made out on a female announcer during one of these early broadcasts. I believe the standard in those days was thirty lines!

To get on to the story I intended to tell, my father had a great friend, also a lover of reproduced music, who at the time owned a Magnavox Model 66 12" mains energised drive unit. This was a most handsome unit with a beautiful, black enamel case and cone basket and a chrome carrying handle. With its curvilinear cone and conservatively rated at 20 Watts, it was the apple of his eye. He had this unit mounted on a large baffle and fed it via a DC powered amplifier - I said it was the early days! They had both discussed for some time the merits of the Voigt approach and had both cast covetous eyes over a Voigt unit. At a cost of £17.10 Shillings per unit however, in the nineteen thirties the cost was just too much.

Send your letters to Hi-Fi World Letter Page,

writes

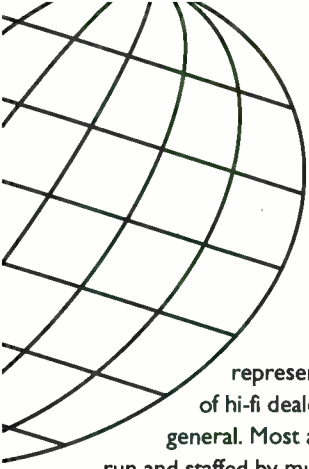

representative of hi-fi dealers in general. Most are run and staffed by music lovers, who either use vinyl as a prime source themselves or respect it as a medium even if they do use CD, like myself, because of the availability of

new releases etc.

As for hearing differences between plugs and Isoplats, pat yourself on the back and ignore their ignorance and inferior hearing abilities. In short, it sounds like you need to find a better dealer - there are plenty out there. **DB**

ANOTHER GOLDEN AGE BECKONS

Following at least a couple of references in recent issues of Hi-Fi World to the book 'Setmakers' by Keith Geddes and Gordon Bussey, I decided to buy a copy. It is an excellent book, telling as it does the history of the British radio and television industry - it even provided me with the answer to something I've been curious about for some time, namely why so many cycle shops branched out into the radio supply business.

However, what aroused me most in 'Setmakers' was the foreword to the book written by Lord Chapple of Hoxton. In the last paragraph, Lord Chapple expresses his hope that 'Setmakers' will be followed someday by a similar history of the hi-fi industry, adding that there is a "mass of relevant documentation to draw upon," at Landseer House (headquarters of BREMA which includes the Federation of British Audio).

The success of Hi-Fi World is evidence in part of the continued interest in many of the glorious names of the past, such as Leak and Radford, who were part of the history of the British hi-fi industry. Is it too much to hope that at sometime in the near future we will see a definitive history of the British hi-fi industry, similar to that now provided by 'Setmakers'? Who knows, perhaps some hi-fi journalist at a loose end will take up the challenge (maybe from the now defunct Audiophile magazine or even Hi-Fi World - not that I'm suggesting anyone at Hi-Fi World is ever really at a loose end!)

Michael Winnington Belfast.

It should be done - and soon. Sadly, many of the great audio engineers of our past are passing away, taking their knowledge and experiences with them. At the moment there is still a massive amount

continued on page 45...

the Month

One day, much to my father's surprise, his friend announced that he was going to buy a Voigt unit, and sure enough several weeks later he turned up at my father's house saying that the unit had arrived with an enclosure. He was looking glum however and my father naturally enquired about his long face in view of his new acquisition. 'It doesn't look much' came the reply.

With re-assurances from my father, they both went to see and hear the new buy. The Magnavox was taken down with its baffle and the new Voigt mounted into its relatively crude horn, i.e. no bass chamber, and wired up to the DC powered amplifier and switched on. My father said the look on his friend's face when he heard the Voigt with its, for those days, wonderful high frequency response, and natural presentation of sound at head height, was a joy to behold. Within five minutes he had given my father his Magnavox - he wasn't interested in that any more.

I still have the original leaflets on the Voigt loudspeaker and the beautiful Birch ply corner horn incorporating the Tractrix curve. Where this Voigt unit went to, I don't know, but my father, who was never able to purchase a Voigt unit, always spoke in glowing terms about the Voigt. Only in the nineteen sixties when he heard a single Quad ELS, which I had purchased, did he ever admit to being equally impressed.

I hope this ancient story has been of some interest. It is ample proof, if any is needed, that the joys of hi-fi are not new, but were being enjoyed over sixty years ago.

Graham Vickers Arnold, Nottingham.

What a wonderful story, I bet your father would be amazed to see us talking about Voigt and his Tractrix over sixty years later. DB

Yes, the joys of hi-fi certainly aren't new, but perhaps they need a little re-discovering. NK

64, Castellain Road, Maida Vale, London W9 1EX.

WIN HI-FI WORLD INTERCONNECT CABLES

OR PERFECT PITCH'S FRANCINSTIEN CD

ENHANCER

The writer of the most interesting or funniest letter will receive a choice of either: a free set of Hi-Fi World's silver plated copper interconnect cables, worth £69.95, or a Francinstien CD convertor enhancer worth £150.



close your eyes and see



the new improved Arcam Alpha 5 system

Close your eyes and see the difference between Arcam's new Alpha 5 system of hi-fi components and anything else in its price range.

Ignore the fact that the Alpha 5 amplifier is our best 'budget audiophile' amplifier ever, outselling all others in the UK for the past year. Don't be tempted by its attractive styling or a price tag which looks too good to be true. Just listen, and discover for yourself a quality of sound that can only be described as exceptional.

Next, try the Alpha 5 FM tuner. Again, don't let its surprising affordability seduce you. Instead, listen to broadcast sound that is natural, clear and dynamic - qualities which gained it a class leading

Recommendation in the 1994 What Hi-Fi? Awards.

Finally, feast your ears on the new Alpha 5 Plus CD player - quite simply, the best value high performance CD player ever produced by a UK manufacturer. Over the past year the critics have heaped praise on its predecessor, the Alpha 5 CD player, calling it "the player to beat" (What Hi-Fi?) and "standing head and shoulders above the rest" (Hi-Fi News)*. Now, thanks to new master clock circuitry, the 5 Plus sounds even better and once again sets the standards for other CD players to match.

Just listen. Close your eyes, open your mind, and see the light.

*If you already own an Alpha 5 CD player, we'd be happy to update it to full 5 Plus specification. Please call our service department at the number below during office hours for full details and prices.



For more information, including the nearest place you can listen to Arcam, complete the coupon and post it to:
 Arcam, Pembroke Avenue, Waterbeach, Cambridge CB5 9PB, England. Or telephone: (01223) 440964 (24 hours). Fax: (01223) 863384

In Canada: Avalon Audio Ltd, 101 Hanlan Rd., Woodbridge, Ontario L4L 3P5 Tel: (905) 507 7581 In New Zealand: Avalon Audio, 587 Mount Eden Rd., Auckland Tel: (09) 639 9000 In the USA: Audio Influx Corporation, PO Box 381 Highland Lakes, New Jersey 07422-0381 Tel: (301) 764 8958

Please send me information and reviews on (please tick boxes):

Arcam CD players
 Arcam tuners
 Arcam amplifiers
 Arcam's cassette deck
 Arcam speakers
 AudioQuest cables

Please send me a brochure with details of all your products

Title _____ First Name _____ Surname _____

Address _____ Postcode _____

NOW HEAR THIS!

review

**Dominic Todd and
Eric Braithwaite listen
attentively for that 'big box
sound' from Tannoy's new
632 loudspeakers.**

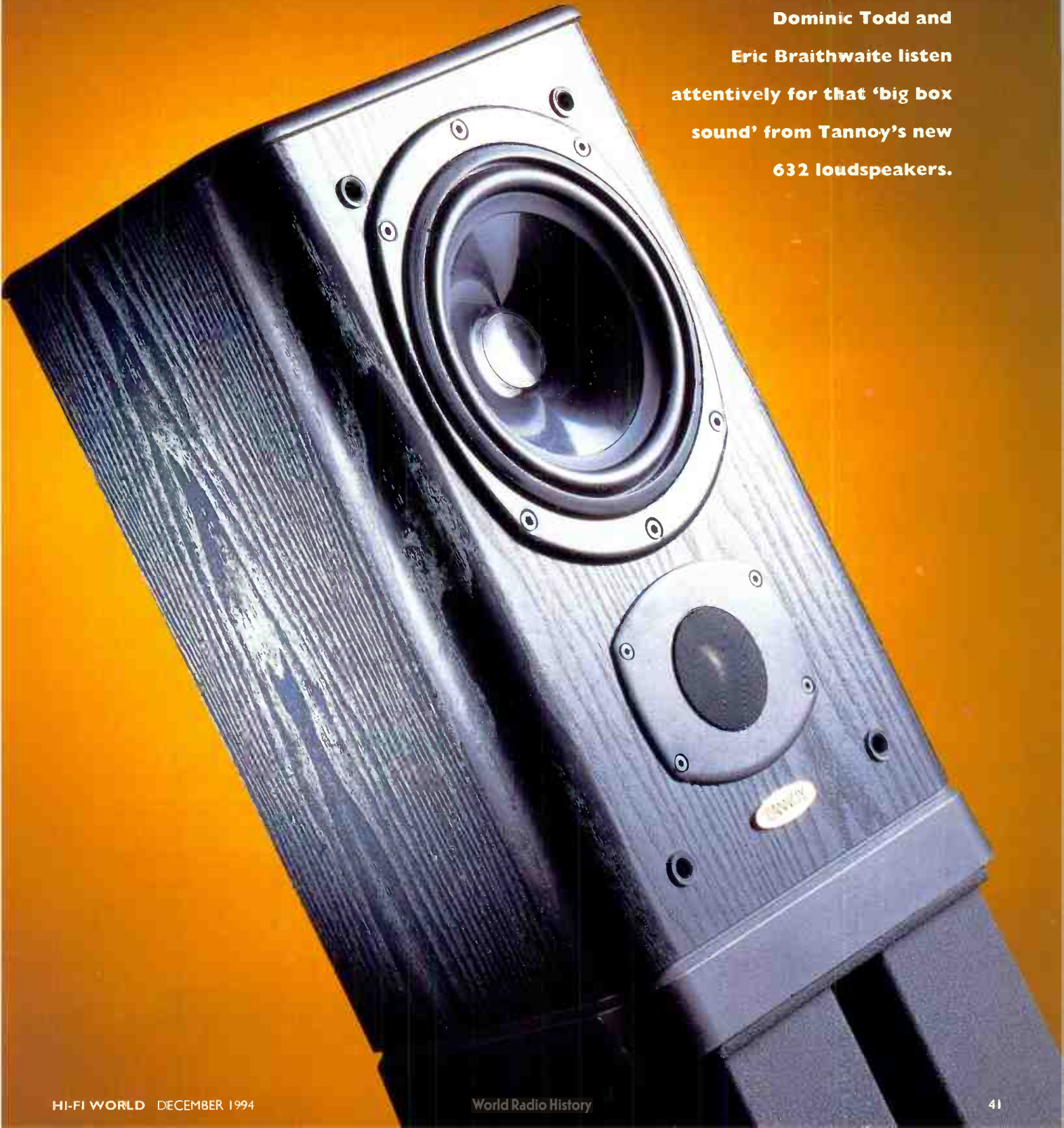



Listening

THE HI-FI  SPECIALISTS

STOCKISTS OF

- ARCAM
- AUDIOLAB
- CHORD COMPANY
- CREEK
- CYRUS
- DENON
- EPOS
- HEYBROOK
- LINN
- MARANTZ
- MISSION
- NAD
- NAIM
- NEAT
- NAKAMICHI
- ONIX
- REGA
- ROTEL
- ROYD
- TDL

...and she thought she was getting a new washing machine

6 HOTEL ST. LEICESTER
TEL: 0533 623754

32 GOLD ST. NORTHAMPTON
TEL: 0604 37871



Full range of Denon equipment on demonstration.
Including the new Denon DCD 825



Come and experience Denon Audio Visual in our
dedicated studio.

Stockists:-

Adcom, Apogee, Audiolab, Audio Innovations, Audio Research, B&W, Castle, Celestion, Copland, Denon, Jadis, Koetsu, Kef, Krell, Magneplanar, Marantz, Martin Logan, Michell, Micromega, Orelle, Professional Monitor Co., PS Audio, Rel, Revox, Roksan, Sequence, SME, Sonic Link, Sonus Faber, Target, TDL, Theta, Thorens, UDH, Wilson Audio.

Acoustic Arts Limited

101 St Albans Road, Watford, Herts. WD1 1RD
Tel:- 0923 245250/233011 Fax:- 0923 230798

Opening hours 10 am - 6 pm Tues to Sat

fuller's audio



The new high sensitivity
SULTAN H.E. Loudspeakers
from Fuller's Audio are rated
at 98dB 1w/1m

This has been achieved
without sacrificing sound
quality and imaging. An
ideal partner for low
powered amplification, you
can now attain realistic
music levels without having

to put up with the resulting distortion. The
matching, optional sub woofer can be added to give
truly extended bass, without boom or drag.

For a demonstration visit your dealer or contact us
direct

SULTAN H.E. - £439 Sub Woffer - £559

Fuller's Audio 20 Tunbridge Road
Southend-on-Sea Essex SS2 6LT

Telephone - 0702 612116



Ruark Crusader II Loudspeakers
"One of the best 3 ways designs around"

Hi-Fi Choice May '94

BRENTWOOD HI FIDELITY

Aura • Audio Innovation • Castle • Chord • Crimson •
Denon • DNM • E.A.R. • Impulse • Lumley • Marantz • Mission •
Micromega • Musical Fidelity • NAD • Pink Triangle • Project •
Quad • Ruark • Shearne Audio • Systemdek • Tannoy •
TDL • Thule Audio

Tel: 0277 221 210

2 INGRAVE ROAD, BRENTWOOD
Near corner of Brentwood High St. Closed Tuesday

Tannoy's new 632 is arguably their best looking affordable model so far. The rather blunt hexagonal cabinet from the previous range has been rounded off and is tapered less towards the rear. In the case of the 632, it creates a stance not dissimilar to that of Tannoy's more expensive D100. The squarer footprint also allows it to fit conventional stands, unlike its forebears.

The drive units are similar to the previous Tannoy 605, using a gold anodised metal dome tweeter and variable thickness plastic 6.5inch woofer. What is new, though, is that the drive units are now inverted. Previously, this arrangement was exclusive to limited edition derivatives. The oxygen-free copper cabling remains, but the actual terminals have been tweaked. The old bi-wiring terminals were great in principal, with no chance of losing the linking pins, but proved fiddly in practice. The new terminals have greatly improved cable access, although finger space is still a bit tight, despite Tannoy's claims to the contrary.

Unfortunately, the finish proved to be unexpectedly dodgy on my pair, with large gaps around the top cap and cabinet, and an ill fitting top panel. My examples weren't pre-production either, but knowing Tannoy's previously good reputation I'd expect things to improve.

Tannoy have deliberately sought a 'big box sound' from the ported 632 and, with this in mind, it was interesting to see how they compared with Mission's 731s which are designed to have a similar balance. The new Tannoys left me in no doubt of their big box pretensions with Bob James' 'Restless'. Although reasonably compact, the bass depth was equivalent to a compact floor-stander. Yet, even over a foot out from the rear wall, it always seemed underdamped and woolly.

It seems Tannoy's engineers have gone all out to squeeze the most bass out of the 632 whilst neglecting control and integration. A good balance could be achieved, but it involved the 'speakers being pulled at least two feet away from the wall; something which a prospective purchaser of

this type of speaker is unlikely to tolerate. The balance would also suit a lean amplifier, although the loose bass may still remain. It's a shame, because the rest of the 'speaker isn't that bad. It showed the customary Tannoy strength of being able to image well, and is more tolerant of room variations than many competitors.

Music with a less prominent bass fared better, although I still felt there was a slight cloudiness to the sound that could make all the difference to the presence and believability of a flute, for example. The shut-in upper midrange also took its toll on pianos, sounding distant and boxy. Female vocals, such as Michell Shocked didn't prove a problem though. The treble was never intrusive and struck a good balance between smoothness and detail retrieval. It also has the edge on most of its rivals in being clean and free from sibilance.

One advantage brought about by the ample bass was decent scale. I could see how this could appeal to some listeners, with music such as Gershwin's Fanfare For The Common Man sounding expressive and powerful. Equally, the overbearing nature of the bass could irritate.

To sum up, I feel Tannoy have achieved their ambition in creating a big box sound. However, whilst this may appeal to lovers of dance or even organ music, anyone else is left with a compromise. The combination of a lack of bass integration and solidity with a nasal mid range spoils an otherwise fine 'speaker. As a student's boom box it would do just fine (and I know many who'd adore the sound) but, unfortunately, the 632 is no audiophile bargain and cheaper Missions (731s included), Celestions and even Tannoy's own 631 model offer a better balanced sound. These represent superior value for the audiophile on a tight budget, or you could save up for Tannoy's excellent D100s, but that's a different ball game altogether. **DT**

Second Opinion

By far the best aspect of the 632 is an openness that does wonders for its clarity of perspective on classical music. In one choral

recording the positions of the members of the BBC Chorus were quite remarkably obvious for a speaker this price. So was a twittering sparrow on one track, definably up in the rafters. It was a delight to hear the relative perspective of orchestra and piano in one of the Mozart Piano Concertos. Just as good, too, was the enveloping ambience, which adds a great deal to the atmosphere and often somehow separates itself from the music. Through the 632s, this was all a homogeneous whole, a wee bit on the small side of full scale, but that is inescapable. A Sony SBM recording of Haydn had Tafelmusik's gritty, authentic strings and the empty studio space around them down to a T: the T in Studio Monitor, almost.

With this as a serious benefit, a certain lack of weight and definition in the lower registers was acceptable, left hand on piano being there, but needing a bit more power. The 632 wasn't too clear about distinguishing the upper notes of double basses from the lower ones of cellos for example, and timps were a little perfunctory. The Tannoys did, however, offer up a whole orchestra with a very wide range of tonal colour.

While woodwinds, especially oboe and bassoon were splendidly rounded, flute, piccolo and violins missed out on middle notes, resulting in a mildly quacking effect when they happened to be playing at the same time. Harp arpeggios, rich at one end, suddenly 'pinged' at one point, which was mildly disconcerting. Colour rather washed out of boys' and sopranos' voices, too, giving a mildly pinched effect on some notes.

Overall though, Tannoy have produced a relatively affordable speaker which makes a serious attempt to reproduce a full chorus or orchestra. One of the few speakers under £250 I would risk opera, Bruckner or Mahler on **EB**

Tannoy 632 **£189.99**
Tannoy Ltd
Rosehall Ind. Est., Coatbridge,
Strathclyde. ML5 4FT
Tel: 0236 420199

MEASURED PERFORMANCE

Tannoy's new 632 loudspeakers have an unusual response characteristic. Across the midband output is generally lower than that of bass and treble, which tends to limit projection of vocals and lead instruments. There are a couple of dips in the response too, at 1kHz and again at 5-6kHz; they are almost certainly phase cancellations; moving my ear up and down the plane of the baffle I could hear phase lobes as the tweeter added to the midrange output at one point, then subtracted at another.

In the far field (listening position) however these response dips filled in to give a flatter result, so the 632 should sound balanced, but critical listeners may detect a slight loss of coherence or focus.

As far as driving the 632s is concerned,

most modern solid state designs shouldn't run into difficulty. Although only of average sensitivity, measuring 85dB at 1m for a nominal watt (2.83V) pink noise signal, impedance was high overall at 11.5Ω. So although they will require a healthy dose of volts to go loud, not much current is required. This makes them ideal for many Japanese integrated amplifiers, which can do just that.

Overall the Tannoy 632s aren't quite as polished as we'd expect from one of the most reputable loudspeaker manufacturers in Britain. It looks like a little fine tuning to the crossover may be necessary to make this a more consistent performer. **DB**

Frequency Response

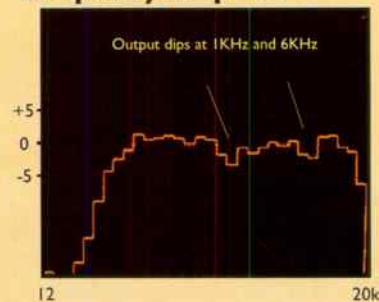

Connections



Tel: 081 348 5676 (2.00-7.00pm)
Fax: 081 341 9368

Esoteric High Fidelity CABLES

Dealers in: Absolute, Audio Note, Audioquest, Deltec, Harmonix, Kimber, Mandrake, MIT, Siltech, Symo, Van den Hul, WBT, and others

...the RIGHT cable
...in YOUR system
...for YOUR ears
...in YOUR home

Contact us by phone, fax, or letter and we'll do our best to help you achieve your goal.

(Auditions may be subject to a handling charge)

CONNECTIONS 13 John Prince's St, London W1M 9AH (A division of Connection 90' Travel Ltd.)

Analogue lovers... **SME**



Our world renowned precision pick-up arms and turntables await you. Sales and service enquiries to:

MODEL 20

SME LTD • STEYNING • SUSSEX • BN44 3GY • ENGLAND
☎(0) 903 814321 Fx(0) 903 814269

Art Audio MAESTRO

"They are just so stunningly gorgeous and open to listen to, I can barely imagine anything more alluring"

NK Hi-Fi World, June '91

Valve amplifiers from £750 to £4150 Cables from £27 to £1700

Select Audio
Glasgow (041) 226 4268
Doncaster Hi-Fi Studios
Sunnyfields (0302) 781387

Paul Green Hi-Fi
Bath, Avon
(0225) 316197
Hazelmere Audio
High Wycombe, Bucks
(0494) 437892

Audio Venture
Banbury, Oxon (0295) 261863
The Hi-Fi Consultants
London (071) 380 0866
Evenings (071) 482 0003

Audible Difference
Diss, Norfolk
(0850) 983233 or
(0379) 740227

K.A.L. (UK) Ltd
Folkstone (0303) 245005

The Hi-Fi Consultants
Nottingham (0602) 232450

Impulse Audio Consultants
Westcliff-on-sea, Essex
(0831) 616426 or 0374 277336

Sound Academy
Bloxwich, West Midlands
(0922) 473499

New A4 brochure containing full details of our amplifier and silver cable range contact

Art Audio (UK) Ltd., 130 Main Street, Calverton, Nottingham, NG14 6LU
England UK
Tel. 0602 - 653604
Fax 0602 - 637795

SPALDINGS

The South East's Leading Hi-Fi Specialists

352-354 Lower Addiscombe Road, Croydon, Surrey. CR0 7AF

081 654 1231/2040

Arcam, Audiolab, Linn, Meridian, Naim, Mission, Quad, Denon, Marantz, Ruark



"SIMPLY STUNNING"

Alvin Gold (Hi-Fi Choice) December 1993

★ Phone or write for review reprints and details of the full range of Opera loudspeakers, including the Superb new Solid Walnut Operetta

CALLAS from UKD

UK Distribution
23 Richings Way
Iver, Bucks SL0 9DA
Tel: 0753 652669 Fax: 0753 654531

.... continued from page 39

of detailed information upon which to draw. **DB**

That very same remark caught my eye too and I remember thinking I'd very much look forward to such a book. As Dominic says, the first wave of engineers, like Voigt, Leak, Briggs (Wharfedale), Barlow, and others have passed away. However, Walker (Quad), Cooke/Fincham (KEF) and others are alive and able to contribute invaluable information to such a book. **NK**

SACKED AND LOOTED

"That Quad don't often get recommended is part of the same problem, one of limited outlook. There's been far too much concentration on some forms of musical presentation to the exclusion of all others."

Hear, hear!. My experience exactly! As a relative newcomer to hi-fi a couple of years ago I went down the 'Naim route' at the recommendation of several dealers. Why Naim? because I was looking for a 'live' sound.

Whilst I enjoyed some aspects of the system (I ended up with CD1/72/HI-CAP/140), it ultimately proved not as enjoyable as I had hoped. Dealers seemed unaware that this would be the case, and attempted to sell me increasingly expensive upgrades to further my listening enjoyment.

Earlier this year I made a bold decision and advertised my entire Naim system in Loot, a London free ad newspaper, and sold the whole lot to a guy who only owns ten CDs and claims to only own CDs at all so he can "listen to the equipment". Funnily enough, this reinforced my opinion that a music lover like me, who is not really interested in electronic components per se, would be better to switch to Quad.

Once I had sold the Naim set-up I went out and ordered the top of the range Quad system: 67 CD player, 66 pre-

amplifier and 606 power amplifier. I then made an inspired choice and bought a pair of B&W's fabulous Matrix 805V monitor loudspeakers.

These are mounted on Sound Organisation stands - although the finishing touch, the dedicated Slate Audio 805V solid slate loudspeaker stands are now on order.

Noel, I think that you will know what I'm talking about when I describe the many nights of enraptured, totally happy listening that I have enjoyed since changing to the Quad/B&W system. The Quad sounds to me like *music*; it does all the hi-fi things as well, like imaging and so on, but any type of CD that I care to put on sounds musically rewarding and delightful to listen to.

I have a sneaking suspicion that, if dealers sold Quad more enthusiastically, (a typical dealer comment is "Quad. It's not really competitive any more. We only keep it for old times sake") the hi-fi industry in Britain would be in a far healthier state. Many people are sold a middle-of-the-range Linn or Naim system and after a while find that they are not really happy; that's why there's so much of this equipment advertised in the columns of publications like Loot.

People like myself, who have spent a few thousand pounds, but are completely happy and satisfied with their purchases, are becoming increasingly rare. Hi-fi dealers, tempting customers along these 'upgrade paths', in the hope of gaining bigger profits, could be unwittingly killing the goose that, in the past, has lain golden eggs.

PS: can we have the B&W Matrix 805Vs back in World Favourites please? And what about the Quad 66 pre-amplifier (which I would rate on a par with the Naim 82 with two HI-CAPS - yes, honestly!)

**Anthony Edwards
Chislehurst,
Kent.**

Hi-fi is all about finding what is right for yourself. Many people swear by Naim, it's dynamic,

forthright and exciting presentation is just what they are looking for. You have found the more laid back and richer sound of Quad suits your music and taste far better than Naim. Others would say that a record deck and a valve amplifier driving horn loudspeakers is far more effortless, smoother and sweeter. Andy Grove loves horn loudspeakers. I find them coloured, unacceptably so in some cases, but Andy says he can ignore this because they are fantastic in other areas. So be it.

As reviewers we have to appreciate this 'personal taste' factor. When something is not to our liking, we must be able to pull back and listen for what is good about a product, and what may appeal to different listeners' tastes. The attitude of reviewers in the 80s, telling readers that Linn/Naim were the only answer and everything else was wrong was naive. Sure a Linn/Naim system is fantastic, but it's not everyone's cup of tea, as you've found. Nothing comes close to reproducing a live event, it just produces a different interpretation of music that will appeal to some listeners, but not to others.
DB

SOURCING YOUR SOUND

Remember when some people said "A turntable cannot possibly have an affect on the sound" - even though they hadn't checked for themselves? In practice, it only took a short audition to hear completely unsubtle differences in sound from systems differing only in the choice of turntable. Later, some people said that 'CD' was vastly superior to 'LP' (they had compared a £200 CD-player with a Dansette-clone) and others said that 'CD' was aurally offensive (they had compared a £200 CD-player with their £2000 analogue front-end).

Having got used to the idea that 'the source' is fundamentally significant, perhaps reviews of loudspeakers should consist only

of technical specifications (among the most important being physical dimension, colour range and price) with instructions to audition them with various 'speaker cables, various interconnects and various mains leads with the desired front-end/amplifier in the intended listening environment.

If the above seems jaundiced, it's because I have just replaced my mains distribution lead with a RATA Distribution Powerkord (incorporating a RATA Superclamp, Olson distribution block and Kimberkable mains lead) and the sound from my loudspeakers (IMF ALS40s) is so enhanced (not just changed) that I would certainly want to experiment with all types of lead/interconnects before considering a change of loudspeakers.

Prior to the new mains lead I tried a pack of Harmonix tuning sheets which, for a cost of around £2 per disc, improve CD sound dramatically. Is their effect merely to bring the disc to the standard which the manufacturer should have supplied in the first place, or is it that they modify the disc physically, allowing an above £200 CD-player to operate optimally? Incidentally, does anyone know of any catastrophic problems with the Harmonix RFI CD treatment? For example, does the adhesive end up distributed inside the CD-player?

In the June issue, two of my future letters have been pre-empted (possibly) by your article on CD quality and G A Jolly's letter on 'stereo'. While my predilection is for Jazz, Blues and Old-Time Country Music (mostly mono), I find myself buying CDs of classical music (probably recorded in a hall with a crossed pair of microphones) in preference to the pan-potting (fake stereo?) and multiple miking used in a lot of pop recordings. Also, close miking seems a bit of a curse. What about TV

continued on page 47

The new Audiolab 8000CDM Compact Disc Transport



The Audiolab product range:
8000A Integrated Amplifier
8000C Pre-amplifier
8000PPA Phono Pre-amplifier
8000P Stereo Power Amplifier
8000T FM/AM Tuner
8000M Monobloc Power Amplifier
8000DAC Digital-Analogue Converter
8000CDM Compact Disc Transport



Audiolab 8000A
Best Integrated Amplifier
over £300

Audiolab 8000T
Best Tuner

Audiolab 8000DAC
Best Digital product

AUDIOLAB

Cambridge Systems Technology Limited, Spitfire Close, Ermine Business Park, Huntingdon, Cambs. PE18 6XY. Tel 01480 52521

.... continued from page 45

announcer sound? Are they in cupboards? My mother's favourite programme is 'Top Gear' - she is not interested in cars, but she can hear every word that Jeremy et al say.

M Collins
Benfleet,
Essex.

SOUND COLLECTIVE

It was with great interest that I read your column in the September issue of Hi-Fi World, and your comments on hi-fi clubs.

I belong to a hi-fi club based in New Ash Green in Kent. We meet each month with members taking turns to hold each meeting.

This means you get to hear a wide range of systems and a wide range of music.

We have members who have CD - only collections (myself) or are dedicated to vinyl - one member - who has just succumbed to getting a CD - player; the rest are a combination of both.

The club was formed in the late seventies. I joined in 1981 and it's proved to be very successful. At each meeting there is usually four to eight members. This can increase to quite a few more when we ask various manufacturers to come and demonstrate. Pink Triangle, B&W, Audiophile Furniture, Trichord Research and NVA have all visited.

We also organise trips to manufacturers such as Rega, Naim and DNM.

If you are interested, perhaps Noel or Dominic would like to visit us. As yet we haven't had any hi-fi journalists (apart from Jimmy Hughes, a personal friend) pay a visit. I'm sure the politics of hi-fi magazines would be very enlightening. You would be very welcome to visit; the meetings are very informal. Then after the visit a possible plug for the club in the mag would be very much appreciated? You can contact

either myself on 0732 883950 (after 7pm) or the present club chairman, Mike Blackmore on 0732 461561

Ron Bosio
Borough Green,
Kent.

NETWORK NORTH EAST

Just a note to let you know of a hi-fi club that's been on the go for some time. It works simply by introducing our customers to each other. They then visit each other and become friends, it's as simple as that! The biggest problem with hi-fi clubs is one of security. If you have a healthy few thousand pounds invested in a system, the last thing you want to do is let people know. Our club gets around that problem as we get to know personally all members before we introduce them to others

The benefits are countless and the atmosphere in the shop fantastic. It does, however, prevent you making some sales when busy, but then again if I were in this business for the money I would be a most misguided individual

Derek Keith
Hi-Fi Excellence,
Union Grove,
Aberdeen AB1 6TD

SCRATCH FILTER QUEST

Congratulations for providing us with the best hi-fi magazine blend of news, views, reviews, and DIY projects. All without losing sight of the original intention - the enjoyment of music!

After years of listening to classical music LPs and (more recently) CDs on undistinguished equipment, I treated myself to a better budget system. The Pro-ject 6 turntable, Rotel RT-950BX tuner, Marantz CD-52MkII SE CD player and PM40SE amplifier, Sony TCK590 tape deck, Mission 760i 'speakers, stands and decent interconnects. It all proved very satisfying, and a tribute to the

numerous reviews which I read before purchasing. Thanks!

Nearing retirement, I intend to use some time to build even better kit, including valve amplifiers and pre-amps which you have published. My last valve amp I built in 1957! First I need something else from you. For my collection of LPs (most now irreplaceable) I want a really good scratch filter

I do look after my records, am very careful to clean them before playing, and try to avoid static build-up. Even after that, still I want to minimise those faint pops, clicks, and scratching of surface noise. It breaks concentration and reduces my enjoyment during LP listening. Even so, I've decided I prefer LP to CD.

Obviously, I do not want to sacrifice any more hi-fi than necessary by reducing high strings or attack, which presumably is a risk. At the same time I recognise that at my relatively advanced age, my hearing does not extend to very high frequencies. So I'm sure there must be some benefit to be had.

I've seen a unit advertised from Marantz (and dismissively reviewed) but I would rather build something myself. Since there must be many of your readers in a similar position to me, how about this for a DIY supplement project, soon?

Mr. L.A. Saunders
Longfield,
Kent

I've heard every scratch filter going (try buying a Quad 33 preamp) - and I'd prefer to stick with the scratches. The only system that works is a complex digital one used by studios. Filters remove much of the music all of the time; scratches occur only now and then. Generally, as reproduction quality improves, the music becomes more captivating and noises less apparently intrusive; the brain can learn to ignore fleeting noises. I suggest you try either an Ortofon VMS2E cartridge for its warmth and lack of high treble, or you try covering the

tweeters of your 'speakers, either partially with tissues, or completely. Or perhaps you should upgrade to a Goldring 1012GX cartridge.

If you still insist on making a scratch filter, buy the Active Filter Cookbook, by Don Lancaster (Sams/ISBN 0-672-21168-8; the Modern Book Co., Praed Street, London W2., tel: 071-402-9176, stock it). This gives you all the info necessary to build high-order (fast cut-off) filters around silicon chips.

Publish details of a music removing device? Geroff! NK

FAREWELL TO MIDI SYSTEMS

I am a newcomer to the purchase of hi-fi, but not to listening to it. About three weeks ago I decided (rather my wallet did) it was time to dump my midi-system in favour of a more realistic sound. To start with I looked through the usual hi-fi mags and went around some dealers in Leeds and Wakefield. The results of this tentative survey were frightening. The first obstacle was a sneering and a less than helpful manager at the Sony Centre in Leeds, the next were prices that made my mortgage look like dinner money. Finally, after many hours of searching for a sympathetic dealer I found Richard Sounds in Leeds.

I was received with courtesy and shown that although I would not get the best sound from a budget system I could be sure of a reasonable sound and the option to upgrade in easy stages at a latter date. The system I settled on comprised of: a NAD 3020i amplifier, an Aiwa XC-750 CD player, a Cambridge CT200 twin cassette deck and a pair of JPW mini monitors with 79 strand 'speaker cable. The total cost of this was £410! This may not win any awards but it has provided me with a more than passable sound for less money than I would expect to pay for a midi system.

continued on page 53

Bury Audio. Chosen by hand appreciated by ears.

For the best in Hi-End hi-fi Bury Audio is a must. All the names stocked are individually chosen to complement one another to give the best sound in their class. Whether you're after an upgrade or a full system, we can offer advice and experience together with full demonstration facilities to ensure you make the right choice. Naturally we offer a full installation and set-up service

Analogue CD Replay. Replay.

Denon,
Goldring,
Kinshaw,
Lyra,
Michell,
Ortofon,
Pink Triangle,
Project,
Rega,
SME,
Sumiko
Tesseract.

Arcam,
Audio Alchemy,
Counterpoint,
Marantz,
Meridian,
Musical Fidelity,
Orelle,
Pink Triangle,
Quad,
Rotel
Teac.

Amplification Speakers.

Arcam,
Albany,
Audio Innovations,
Aura,
Heybrook,
Marantz,
Meridian,
Michell,
Musical Fidelity,
Quad,
Rotel,
Shearne,
Tesseract
Tube Technology.

Arcam,
Castle,
Heybrook,
Keswick Audio,
Monitor Audio,
ProAc,
Royd,
Ruark
Spendor.

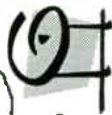

BURY AUDIO

47 CHURCHGATE STREET,
BURY ST. EDMUNDS, SUFFOLK IP33 1RG.
TEL/FAX: 0284 724337

Mon-Sat. 9.30am - 6.00pm. Closed Wed.
Mail Order and Export enquires welcome.

The WIZARD



**Hand made
Adjustable Shelf
Rotary Unit.**
Can hold 1536 CDs
or 1440 Cassettes
or 384 Videotapes
or 575 Penguin
Books; or any
mixture. Books up
to 6 1/4" deep.

Revolves on Ball
Bearings in 30·4"
turning circle
21 1/2 x 21 1/2 x 75" high.

Teak, oak, pine
mahogany, ash,
£1550 inc.
VAT & Delivery.

**FOR OUR BROCHURE
of
CD/Video Drawer Chests
CD racks
Bookshelves
LP, music · Hi-Fi
Cabinets &
the Budget Line
—Specials made to
order—**

Please send 3 x 2nd
class stamps to:

Ian Edwards The Old Chapel
282 Skipton Road, Harrogate
HG1 3HB. Tel: 0423 500442



TRIANGLE

ELECTROACOUSTIC

FRENCH SPEAKERS

...as reviewed by English speakers...

"The Alicante's big, fluid, wide-ranging and open presentation lets the music speak for itself."

Jonathan Kettle. AUDIOPHILE, November 1993

"The Titus E has an absolutely riveting sound with openness and rhythmic drive."

WHAT HI-FI?, March 1993

"The Icares are fast and enthusiastic; there's nothing twee or laid-back about their presentation of music - whether reserved classical or high energy rock."

WHAT HI-FI, October 1992

AND AS FOR THE AMPLIFIER...

"The Triangle TE60...has very clean treble...separation is first class...bass is outstanding...an excellent product. A super little amplifier, nicely styled and beautifully finished."

Jimmy Hughes. AUDIOPHILE, March 1994

T H E R O M A N C E O F F R E N C H H I - F I

Berks
THE AUDIO ROOM
3 Little brook Avenue
Burnham, Slough, Berks
0628 - 668112

Cornwall
RJF AUDIOVISUAL
84 Pendarves Street
Tuckingmill, Camborne
0209-710777

Dublin
ACOUSTIC DIMENSION
16 Idrone Mews, Idrone Lane
Black Rock, Co. Dublin
0103531 - 2884612

Norwich
SOUND APPROACH
161 Unthank Road
Norwich
0603 - 622833

London
DOUG BRADY HI-FI
(See Dial-A-Dealer)
071 - 379 4010

Liverpool
DOUG BRADY HI-FI
(See Dial-A-Dealer)
051 - 7336859

Warrington
DOUG BRADY HI-FI
(See Dial-A-Dealer)
0925 - 828009

London
DIVA
Workshop 30, Royal Victoria
Patriotic Bdg., Wandsworth
081-875 9593

Greater Manchester
ORPHEUS AUDIO
Wigan WN6 0PD
0257 - 428100

Scotland
HI-FI EXCELLENCE
293 Union Grove
Aberdeen
0224-322520

Triangle loudspeakers cost from as little as £265; TE60 Integrated Amplifier £549 - for more details phone Ortofon UK (0753-889949) or Kronos (08687-48632)

TYING RIBBONS

SD Acoustics have tied together a ribbon tweeter and custom made bass unit into the new £399 SD3-R loudspeakers. Dominic Baker and Peter Downs take a close listen.

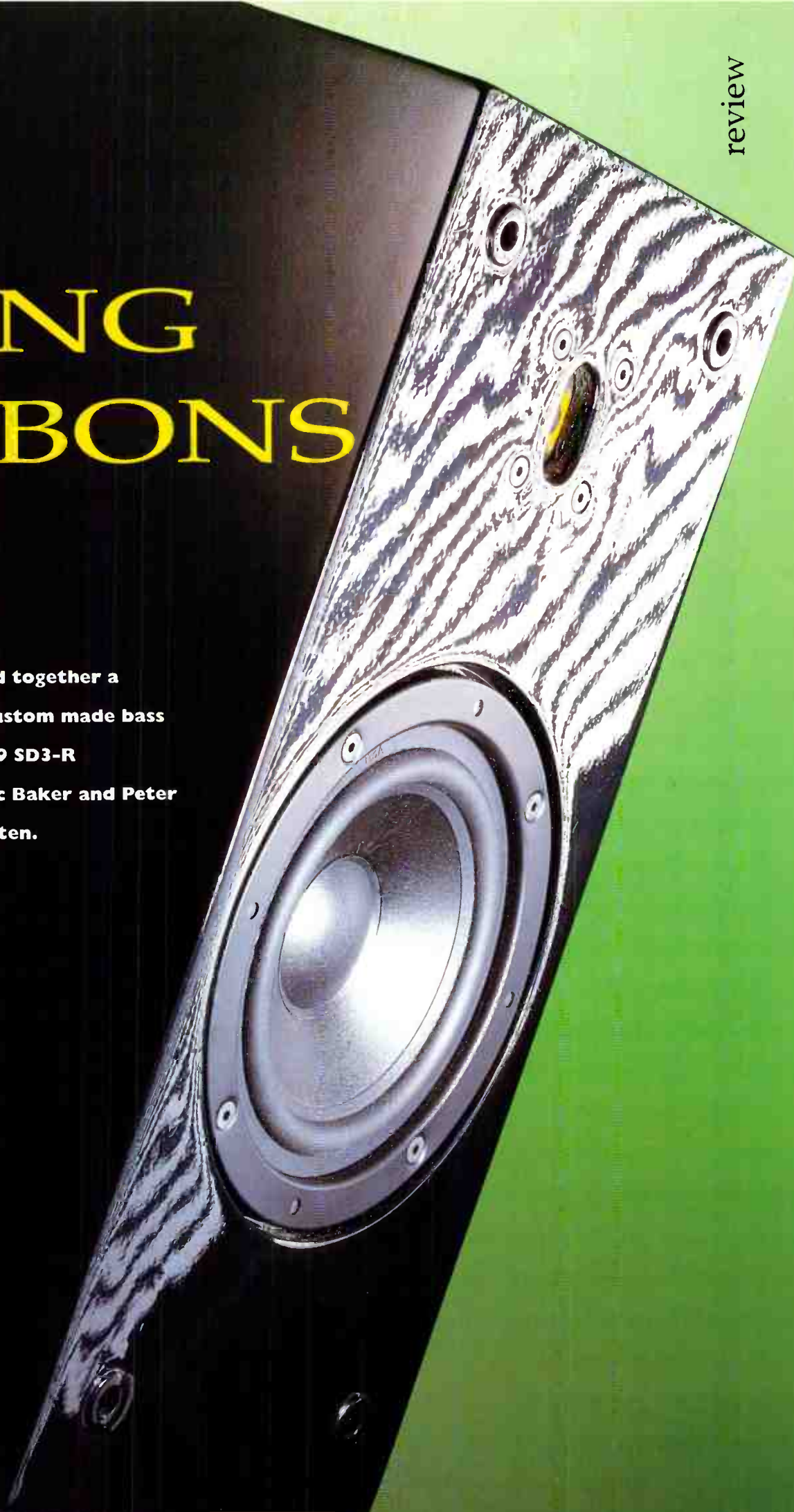



World Audio
design
300B



Listen to the enticing sound of a modern valve amplifier.

NOW ON DEMONSTRATION AT

HI-FI CONFIDENTIAL LTD
34 Buckingham Palace Road
London SW1 W0RE
Tel: 071 233 0774

HI-FI CORNER
1 Haddington Place
Edinburgh EH7 4AF
Tel: 031 556 7701

FOR MAIL ORDER AND FURTHER INFORMATION SEE PAGES 89 - 91
Class A, 28 watt Stereo Power Amplifier
or 60watt Monoblock

FI - RAX

ADJUSTABLE AUDIO FURNITURE

High quality
Aluminium
Construction
Various Finishes
available.

Adjustable
Glass Shelves
sitting on
Isolating Rings.



Tel: 0924 277626

FAX: 0924 270759

Any size or
shape custom
made on request.

JEM DISTRIBUTION
SPRINGFIELD MILLS SPA ST.,
OSSETT, WAKEFIELD,
WEST YORKS WF5 0HW

SONOLITH® LOUDSPEAKERS

No Wood

No Veneer

No Contest

MINERAL-POLYMER ENCLOSURES

CONTROLLED-FLEXURE ALLOY CONES

27 Fournier Street, London E1 6QE
Telephone: 071 247 0813



ELECTROFLUIDICS
THE SOUND FOUNDATION

A loudspeaker using a custom made ribbon tweeter and bass unit in an attractive, gloss black, polymer cabinet sounds like the recipe for a unique top-end model. SD Acoustics are aiming to bring this level of technology to the hi-fi market, with the new, very affordable SD3-Rs, priced at £399.

The cabinet itself is made from polybimin (PBM), a mineral loaded polymer that SD Acoustics claim results in far lower cabinet colouration. The liquid PBM is poured into a mould and then baked hard, a process that allows SD to make the cabinet slightly wedge-shaped to prevent standing waves between parallel cabinet walls. It also allows the high quality gloss piano black style finish pictured to be offered at no extra cost. A matching pair of stands in a similar finish are available for £299.

The circular ribbon tweeter may look familiar to those acquainted with Infinity loudspeakers, but in fact the only common part is the diaphragm. SD Acoustics choose to fit their own high power magnet assembly and they mould the face plate into the PBM baffle, a neat and effective method of attachment.

Internally, quality hasn't been compromised either. The crossover uses high quality components and is finished off with silver-plated copper internal wiring.

So, with all this going for them, as well as an increasingly appetising price tag, I was eager to listen. Wired up to a trusty DPA 50S power amplifier, the SD3-Rs instantly gave me a taste of what they had to offer. Bass was solid and dynamic, midrange clear and detailed and treble bright, fast and tactile in a way that only ribbons seem able to manage.

As with the Heybrook Sextets, the ribbon tweeter is subjectively quite obvious at first, sounding detached in character from the bass/mid unit. Ribbons generally sound so much cleaner and less coloured than any form of dome tweeter that they draw attention to themselves, but after a few hours of listening you become accustomed to their clarity and everything else sounds vague and spitty in comparison.

The use of a ribbon tweeter helps to give the SD3-Rs an exceptionally open and transparent sound, able to convey atmosphere and sound stage detail with a delicate and focused touch. The upper harmonics that provide these acoustic qualities were handled beautifully.

Lower down in the midrange the SD3-Rs don't give up trying. Whether it's the choice of the PBM cabinet, a good quality drive unit, high quality crossover components and internal wiring or a combination of all of these, the result is superb. The midrange is forward and projects detail well, but without becoming too forced. If I were looking to be

extremely critical, it does suffer a little plasticky colouration and lower midrange could do with a touch more punch and drive, but the 'speakers are certainly no worse in this respect than any other £400 design.

“One side of The Rippingtons was enough and I had to chicken out and turn down the volume, I felt I had gone nine rounds with Mike Tyson.”

One other thing to bear in mind before I hand over to Peter, is that the SD3-Rs are likely to reveal bright or harsh systems for what they are. The tweeter is exceptionally clean, and any hint of grit or grain will be passed directly to the listener. Otherwise, if your system needs a little opening up or an injection of space, the SD3-Rs could be just the tonic.

Second Opinion

This 'speaker is amazingly clean, so forget your rose-tinted glasses. The lack of colouration, due to the polymer cabinet, is quite outstanding, leaving me free to crank up the volume. In fact, I didn't realise how loud I was playing them until I tried to speak to someone. Bi-wiring is a must as the image suffers otherwise.

The bass is forceful and punchy, but doesn't suffer overhang or boom. One

side of The Rippingtons was enough and I had to chicken out and turn down the volume, I felt I had gone nine rounds with Mike Tyson. That is not say that they lack finesse: the opening moment of Rachmaninov's Second Symphony had me watery eyed, the delicate strings just exude emotion. Turning up the volume was a mistake, the sudden bass punch had me diving for cover.

Vocals were produced clearly, without chestiness. Piano was played with a solid and three dimensional feel, which Harry Connick Jr's first album showed well.

The treble I have left to last as it was undoubtedly the best. I am used to ribbon tweeters, but the speed and presence was stunning. Percussion has a clarity that was uncanny, bringing them clear of the mix.

The only down side I found was that it could be a little clinical at times but, being used to cabinet colouration from my normal box loudspeakers, this is to be expected. Also, you need to bear your neighbours in mind; the temptation to keep upping the volume is ever present. In my opinion, the SD3-R is a resounding success ● PD

SD Acoustics
The Factory,
Alpha Road,
Surbiton,
Surrey. KT5 8RP
Tel: 081 399 6308

£399

MEASURED PERFORMANCE

The SD Acoustics SD3-Rs took quite some effort to get meaningful test results from. The ribbon tweeter is extremely directional, good for stereo imaging, but a nightmare to measure and combine with the output from the bass/mid unit, as well as the rear firing port, which handles most of the lower bass.

The response shown is built up from measurements taken from in front of the tweeter, bass/mid unit and at rear from the port. It shows that the three are reasonably well integrated, but that between midband and treble there is a dip and that bass needs to be enhanced by near wall placement. This dip in the upper midrange will remove some projection, but because of the rigid PBM cabinet used I wouldn't expect it to become boxy or closed in.

The SD3-Rs don't present the kindest load to partnering amplifiers. Impedance hovers around 6Ω from bass right up to 1kHz. Above this frequency it dives downwards, falling through 3Ω at 10kHz and still further to around 1.5Ω by 20kHz. For this reason, treble quality will vary from amplifier to amplifier. Those capable of driving this kind of load will produce a bright and clear sound, whilst those that can't - which may be the majority - will sound dull or muddled to differing extents, depending

on their drive characteristics.

Sensitivity was quite a reasonable 86dB, a touch above average, which is good for a compact design like this.

Overall, the SD3-Rs are a bit of an oddball. I used them on a powerful DPA solid state amplifier to good effect, but because the strongly falling impedance will give variable results, I'd recommend a demonstration with your own partnering equipment first. DB

Frequency Response

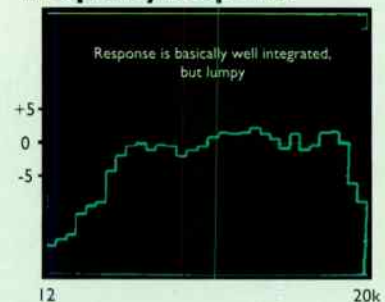

Impedance

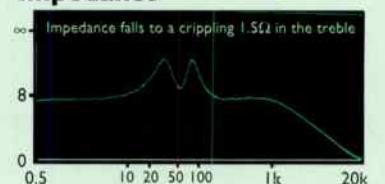

AUDIO ILLUSION

23 Langley Broom
Langley Berkshire SL3 8NB
(Near Slough, 2 mins Junc 5, M4)
TEL: (0753) 542761

Mirage™
MIRAGE LOUDSPEAKERS
THE ORIGINAL BIPOLAR LOUDSPEAKER

*Where the search ends
and the pleasure begins*

To experience BIPOLAR magic come to one of four Musical Evenings where we will be demonstrating some of the new Mirage® range. Demonstrations:-
5th, 6th and 7th December 1994 : 7.30pm for 8.00pm
Call JOHN or LYNDIA to reserve your seat



WISHING YOU A HAPPY CHRISTMAS



..... See the Music



SECONDHAND BARGAINS

CELESTION 7000 Ribbon Hybrid £695
MIRAGE M-1s Bipolar £2495

"Opening Hours
10.00am - 10.00pm
Mon-Sat"
Sunday by arrangement

- * Home Demos
- * Free Delivery
- * Free Installation
- * Part Exchange
- * All major credit cards and switch accepted

Air Tangent: Apogee: Audio Research: Classe:
Copland: Davidson Roth: Jadis: Koetsu: Krell:
Lineaum: Magnepan: Martin Logan: Micro Seiki:
Mirage: Musical Fidelity: PS Audio: Sonus Faber:
Theta: Wilson: Siltech and Transparent Cables: WBT

Studio One

117-119 HAMMERSMITH ROAD
LONDON, W14 0QH.
Tel: 071 371 3037
Fax: 071 371 1790
We are Mon-Sat 9.30 -6.30



Presents:
"AUDIOLAB"
Audio Specialists
Classical and Jazz Vinyl
on Sale



*We offer home demos on
Hi-Fi equipment and
cables.
So you can make
your choice.*



- * Home Installations*
- * Free Local Deliveries*

"Introducing to the U.K."
Valve amps from L.A. Audio exclusive

"Call Joseph or Ossie now for Free advice"
"Unique Offer" - The Last Musical Fidelity A1 F.E.
"Final Edition" Hurry Now!!

"Records cleaned and sleeved on Nagaoka antistatic for £1.50 per album"
Pay us a visit, we are near Olympia

.... continued from page 53

The reason I am writing is firstly to let other first time buyers know that there is life after a listless midi and to ask if you could recommend a pair of 'speakers that will improve my system as the JPWs are a little bit inadequate for Black Sabbath. I do not intend to upgrade my amp for some time as I am more than pleased with it, as well as my CD and cassette deck. So I need 'speakers that are sensitive enough to work with my 3020i NAD, whilst being of a high enough quality to see me through a complete upgrade in the future.

By the way I am very impressed with your mag even if I don't understand much of the technical details. I am learning and the reviews of products and music sections are excellent.

**Iain Barclay
Knottingley,
North Yorkshire.**

As you have found, it is possible to put together a budget system that costs a similar amount to a midi-system, but sounds far better. The items you have selected are excellent value for money, and you should enjoy many years of listening to music on your new system.

Many potential purchasers of separates hi-fi are put off by the initial treatment from dealers that you too experienced. The outcome is usually the purchase of an inferior midi-system. By not being dissuaded by the attitudes of those dealers you were eventually able to purchase a sensibly priced system with good sound. Well done Richer Sounds for sensibly showing you the way into separates hi-fi. **DB**

And try listening to TDK NFM's, RTL2's or Mission 751's, or the new Tannoy's. **NK**

SINGLE-ENDED MANIA

Thank you for your interesting projects. I find them both

enjoyable to read and tempting to try.

Intentionally or otherwise, two single-ended amplifiers were introduced in the August issue of HFW. One of them is a valve unit from Audio Note and the other a transistor headphone unit from yourselves.

I would have normally concluded your editorial arrangement as a special issue on single-ended amplifiers and simply get on with life. After-all, solid-state or even tube amps have been providing the world (forgive the generalisation) with good music via the push-pull topology.

However, one simply cannot overlook the recent crop of single-ended tube amplifiers that are winning overwhelming acclaims; dare I say a resurrection not seen in the amp world for a long time.

As an absolute amateur not content with merely the marketing impact of these single-ended amps, and with enough physics to know roughly what an amp is, but far from adequate to handle audio electronics, I have to burden you with the following questions:

1. Is it possible (and feasible), from a hobbyist point of view, to make a solid state single-ended amplifier?
2. If single-ended Class A amps can be built to excellent results from valves, can the same be done with FETs?
3. If so to 1 & 2, can you recommend where I can learn about such circuits?
4. Is a single-ended unit necessarily Class A, or is Class A/B also possible?
5. Conventional push-pull designers take pride in their strictly resistive signal path - a claim I more or less understand - whereas most single-ended units I have seen have capacitors and transformers in the signal path. Who's right? What's going on?

I was not even born when transistors became more common and valves less

common, so naturally I felt obliged to defend the inventions of my generation. I would like to know, for example, if similar wonders like the Audio Note OTO can be had using a simple FET circuit. Knowing that there is nothing factual or rational behind my sentiment, I would very much appreciate your expert advice before I go on singing my stupid song.

I shall look forward to your reply.

**Vincent Kan
Philips Hong Kong
Limited.**

It is in fact quite easy to build single-ended amplifiers using solid state devices. Most transistor amplifiers, including our own solid state amp, employ mainly single-ended amplification stages with only the output buffer operating in push-pull. It would be possible to modify our kit to operate with a single-ended output stage, but power would drop to around 18W with 90W heat dissipation in the output stage.

F.E.T.s could be used in a single-ended design in exactly the same way as Bipolar transistors, but I'm not sure if there is any sonic benefit in this. There is a group of "F.E.T. Followers" who maintain that the F.E.T. is the best thing since sliced silicon, but the rest of the audio world is realising that a simple, well-designed valve amplifier can sonically outperform the most expensive of heatsink wielding transistor Titans-Bipolar, or F.E.T.

Single-ended audio circuits are, by their nature, Class A. In a Class AB or B push-pull circuit one of the valves is cut off, (non conducting) over part of the audio cycle, its partner supplying the output signal. In a single-ended amplifier if the valve were to cut off it would have no partner to take over the operation so the output would be severely distorted.

In an ideal world we could do without interstage transformers and coupling capacitors, but in order to

operate the valves optimally it is necessary to use them. Many transistor amplifiers use no coupling devices, but usually have five or six times the amount of active devices in them when compared to a valve amplifier, especially a single-ended one.

I think that if you are going to attempt to build an amplifier you should investigate the theory first. We recommend *The Art Of Electronics* by Horowitz and Hill. It's quite expensive but is a very worthwhile investment. It is available from us or from good technical bookshops. **AG**

SPIRIT OF THE AGE

Your September editorials imply the death knell for hi-fi if we continue to regard 16 bit digital as a medium, believing that we are very close to the limit of reproduction available from CDs. DACs are still improving in leaps and bounds, with units like DPA's 1024 and PT's Da Capo revealing nuances and information that really had been on the little silver disc all along, (if 16-bit is the limiting factor, why does that battery supply make such a difference?) Of course CDs carry only a finite amount of information, but ultimately so does vinyl.

Pioneering implementations of digital technology like the above have convinced me that there is still plenty of life in 16-bit. I certainly agree that we should be discussing a replacement, but 20 or 22 bit is far too low, (in 10 years time I shall be reading that these were inadequate!), but whatever system is implemented, it will most certainly be digital, not as you wish, analogue vinyl.

CD was viewed by many hi-fi nuts (myself included) as a welcome alternative to the constant stream of expensive inferior pressings that we had endured for years. Some felt, that the hardware had actually surpassed the performance

continued on page 55....

Distributor clears stock, export-discount **50%** or more

HIGH END SALE

WELL TEMPERED



Record Player, Classic, Signature **£590**
export price from

AUDIO RESEARCH

DAC1, SP9, SP15, D250 MkIIS, M300 MkII, Classic150

KOETSU Black, Rosewood Signature, Onyx Signature

MARK LEVINSON

MLC1, JC1, ML6, HQD-system (2xML6A, 2xLNC2, 6xML2, 2xHartley/Quad/Decca-array)

Also: **Berning, Bruer, Cotter, Eureka, Fidelity Research, Linn, Moersch...**

Call for catalogue!

Glotta AB, phone +46 8345251, fax +46 8346533

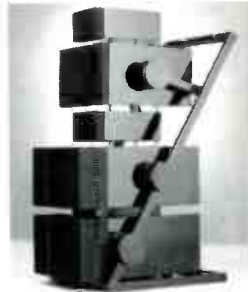

GOLDMUND

Studietto, ST4, T5, Cartridge, Mimesis amplifier series, Super-Dialogue, Apologue (picture)

SINGLE ENDED

Single ended valve mono block power amplifiers

KT66£350.00/pair

KT88£528.75/pair

Valve phono stage MM£179.00
- variable output -

MC step up transformers.....£42.00

The Garrard 301/401 power supply
100/130 volt setting£64.45

All units are fully assembled and tested.

Prices include Delivery and VAT

2 week money back guarantee

SAE for data sheet

F&S Trading

31 Brooks Road, Sutton Coldfield

West Midlands B72 1HP

Tel: 021 321 3357

synergy
(sin' ə r jə)

definition; simultaneous action of separate instances which, together, have a greater total effect than the sum of their individual accomplishments.

Dual Mono 150W per Channel, Remote Controlled All Tube Line Level Integrated Amplifier.

Also available as a Stereo Power Amplifier.

For further details on the Synergy and our complete range, including a UK dealer list, please call or write to:-

Tube Technology, Foxhills Farm Longcross Road Ottershaw, Surrey KT16 0DN, England

Tel: 01932 873444
Fax: 01932 873012



...Mesmerizing



.... continued from page 53

limit of available software. Sound familiar?

Many CD player sales were in the budget-mid price range, as owners of Thorens, Regas, Heybrooks et al like myself, realised that for less than their planned upgrade to Linn, Logic or PT, they could buy a CD player, with no precision engineering or intensive assembly labour costs to hike up the price, that gave a substantial upgrade. Sure, first generation machines sounded artificial and harsh, but so did a lot of hardware then. CDs also had the secondary advantage of convenience. Of course the downside was actually finding a disc to buy! Initially, CD availability lent heavily towards the more mature and discriminate classical buyers, who surely were most likely to have serious systems. If it was as inferior as you now believe, it would not have become as popular.

I am certainly not anti-vinyl. I strive to reproduce a live performance in my lounge, and I do not care whether it is played on CD, vinyl or wax cylinder. What does concern me is the quality of reproduction - as should all hi-fi enthusiasts by definition.

Judge each piece of equipment on its merits, be it IC transistor or valve. Promoting the opinion that the only good hi-fi is vinyl and retro valve will leave you only with readers who are proud owners of SP25s and Bush stereograms from car boot sales.

**David Carter
Trowbridge,
Wiltshire.**

We are not anti-CD, all of us own players and listen to silver discs daily. The view we do have though, is that if you own a lot of records, tapes, a vintage valve amplifier, old horn loudspeakers etc and enjoy your music, it is not wrong to carry on enjoying it. Good sound is good sound, and it doesn't matter how it's produced.

I am a little upset, justifiably so, I feel, that after spending thousands of pounds on CDs after deciding at the age I got into hi-fi, it was going to be the medium of the future, that it has already been announced that a replacement system using different lasers and disc pressing processes is to be launched in the very near future. I bought into CD hoping that quality would improve and that some day it would overtake vinyl. It never has, comprehensively, and I could have had a fabulous record collection by now rather than an outdated CD format. But that's life, I still enjoy my music. **DB**

Analogue systems are open ended to development; digital systems are not. I wrote that we were running out of development potential with CD some time ago and that it was basically an old and now inadequate seventies technology, rushed into commercial production by Philips and Sony to capitalise on the wonder of "digital sound", which was no wonder at all. CD suffers 0.5% of the most horrid digital distortion at -60dB; in my view it has a distortion-limited 50dB dynamic range - not 90dB as claimed.

I have actually never promoted vinyl as an analogue carrier; I did suggest Laservision, with its FM carrier might do, or some equivalent. If we have to stay with digital, it must be considerably more future-proof.

Now we learn that CD sales are slowing and that, with the emergence of 18 and 20-bit professional recorders for studio use, the music business has finally accepted that 16-bit does have audible limitations and is, therefore, not perfect (phew, it took them long enough!).

I suspect that the marketing men already fear that CD has peaked as a consumer medium and may well go into decline over the next few years (they insist

media have "lifetimes"). Consequently, the race is now on to replace CD, with something that sounds more "analogue like", I'm told. Last month we heard that HDCD will be announced soon, meaning that CD has now been accepted as inadequate - just as I and thousands of others have always said. Oh, and how long did perfection last - 12 years. Hah! **NK**

LONE LOWTHER

Back in the early '40s I wanted a Radio but couldn't afford to buy one. So, armed with a little knowledge I set about building one. I was pleased with the result for about a fortnight and then I started musing "I wonder if I can make it sound better?" If only I'd rested content I would have saved a lot of money - but also missed out on an enduring hobby!

It was in my early days that I concluded (and still believe) that the major problems of record reproduction lie in getting the "music" off the record and into the amplifier and then getting it out of the amplifier into the room as sound. In my early days I made my own moving coil pick-ups with coil connections that broke about every three months! My wife got used to holding very fine wire that she couldn't see whilst I soldered it. My liking for MC cartridges continued, culminating in various Dynavector products.

I converted to CD during their first year of production - they may not be perfect but they do have some major advantages. They don't pop, crackle and hiss, masking important low level ambient sounds like vinyl, and any fool can put a CD in a player without having to apply laboratory standards to ensure proper pick-up tracking and stylus tracing.

I first got interested in horn loaded loudspeakers when I encountered a pre-war Voigt Corner Horn. I also became enchanted with a Voigt derivative made by a man called Enock - but his studio was an

old wooden Gymnasium in Ealing and I could never make up my mind whether it was the 'speaker or the room acoustics that sounded so nice. I flirted with Klipshorn, Decca folded organ-type pipes and have suffered a number of various conventional resonant boxes.

I like Quad Electrostatics but they give my wife apoplexy because of their appearance. I am currently using a couple of the original Lowther Bi-Cor cabinets fitted with the latest and superb PM2C/Hi Ferric drive units: these are the first reasonably sized horn derived 'speakers that I have encountered that will reproduce at 40Hz. For my personal taste the bass generally is a bit light, but this is easily overcome with a gentle bottom end boost.

Mention of Lowther brings me to the main point of my letter. Hi-Fi World is the only magazine where, in recent years, I've even seen the name Lowther mentioned, let alone run a technical review of any of their products. Lowther are now producing a couple of new 'speakers and I enclose for you the blurb they have sent me. As the bass level/room acoustic adjustment appears innovative what is the chance of you testing them?

**Noel Parks
Brockenhurst,
Hampshire.**

Yes, there is a chance of us testing the new Lowther loudspeakers. I have contacted Lowther and hopefully a review will appear in the coming months. The model we hope to be receiving is the Bel Canto at £1799, using a single PM2C/Hi-Ferric drive such as the ones in your Bi-Cor cabinets. Sadly though, Lowther specialise in export only nowadays, so their new loudspeakers are unavailable in the UK. However, if a review creates enough interest, I'm sure they will re-think this strategy. **DB**

And any man that winds his own moving coil cartridge has my utmost admiration! **NK**

THE RECORD SHOP

66 FIFE ROAD
KINGSTON-UPON-THAMES
SURREY
KT1 1SP
TEL: 0181-546 3880
FAX: 01372 360996
EST. 1968

SPECIALIST IN NEW VINYL RECORDS

MAJOR STOCKIST OF ECM, LINN, ORIGINAL JAZZ CLASSICS, BLUE NOTE & ACID JAZZ. WE ARE NOT TIED TO ANY PARTICULAR TYPE OF MUSIC. WE LIKE EVERYTHING ON VINYL. HEAVY TO AMBIENT!

!CAPITAL RECORDS IN U.S.A. REPRESS BEACH BOYS CATALOGUE!
ALL TITLES £11.95

LITTLE DEUCE COUPE/TODAY/69 LIVE IN LONDON/PARTY/20:20/WILD HONEY SMILEY SMILE/FRIENDS/SUMMER DAYS SURFIN' SAFARI/STACK O' TRACKS/CONCERT SURFIN' USA/SHUT DOWN VOL.2/PET SOUNDS

BLACK CROWES - AMERICA £9.49
BON JOVI - CROSSROAD, BEST OF (DOUBLE) £10.49
REM - MONSTER £9.99
CHRISTY MOORE - SMOKE AND STRONG WHISKEY £7.99
SHANE MCCOWEN - THE SNAKE £9.99
VARIOUS - TRIBUTE TO VICTORIA WILLIAMS £9.99
(FEATURES JAY HAWKES, WATERBOYS, LUCINDA WILLIAMS, PEARL JAM)
TOM PETTY - WILD FLOWERS (DOUBLE) £12.95
KENNY G - BREATHLESS £9.95
KINKS - TO THE BONE (PART CONCERT & PART STUDIO UNPLUGGED) £8.49
CRANBERRIES - NO NEED TO ARGUE £8.95

MOBILE FIDELITY 200G U.S.A. VINYL, PHONE FOR DETAILS, TITLES AND PRICE

BUCKSHOT LE FONGUE (DOUBLE) £13.95
(BRANFORD MARSALIS LATEST PROJECT - TIM'S FAVOURITE VINYL AT PRESENT AND WELDED TO THE DECK! A COLLABORATION OF POPULAR MUSIC IN THE 90'S - JAZZ, HIP-HOP, BLUES, ROCK AND A LOVE SONG - A MUST)

BACK IN STOCK

JOHNNY CASH - AMERICAN RECORDING £9.95
(MASTERPIECE FROM THE MAN IN BLACK)
ALI FARKE TOURE AND RY COODER - TALKING TIMBUKTU £8.49

BARGAIN SECTION - ACE LABEL

B.B. KING - BEST OF £4.99
B.B. KING - MEMPHIS MASTERS £3.99
LITTLE RICHARD - HIS GREATEST RECORDINGS £4.99
EVERLY BROTHERS - GREATEST RECORDINGS £4.99
VARIOUS - KING OF THE BLUES £4.99
JIMMY WITHERSPOON - BLOWIN' IN FROM KANSAS CITY £3.99
B.B. KING - MY SWEET LITTLE ANGEL £3.99
CREEDENCE CLEARWATER - PENDULUM £3.99
CREEDENCE CLEARWATER - LIVE IN EUROPE £3.99
VARIOUS - FLAIR LABEL, R&B CONFIDENTIAL £3.99

POSTAGE & PACKING £2.00 +50P PER ALBUM THEREAFTER. WE DON'T SKIMP ON THE PACKING - AND ALL LPS ARE POSTED WITH POLY-LINED INNER SLEEVES

SO PICK UP THE PHONE AND ASK FOR TIM OR MARTIN
(SECOND HAND VINYL ALSO AVAILABLE)

ACCESS/VISA WELCOME

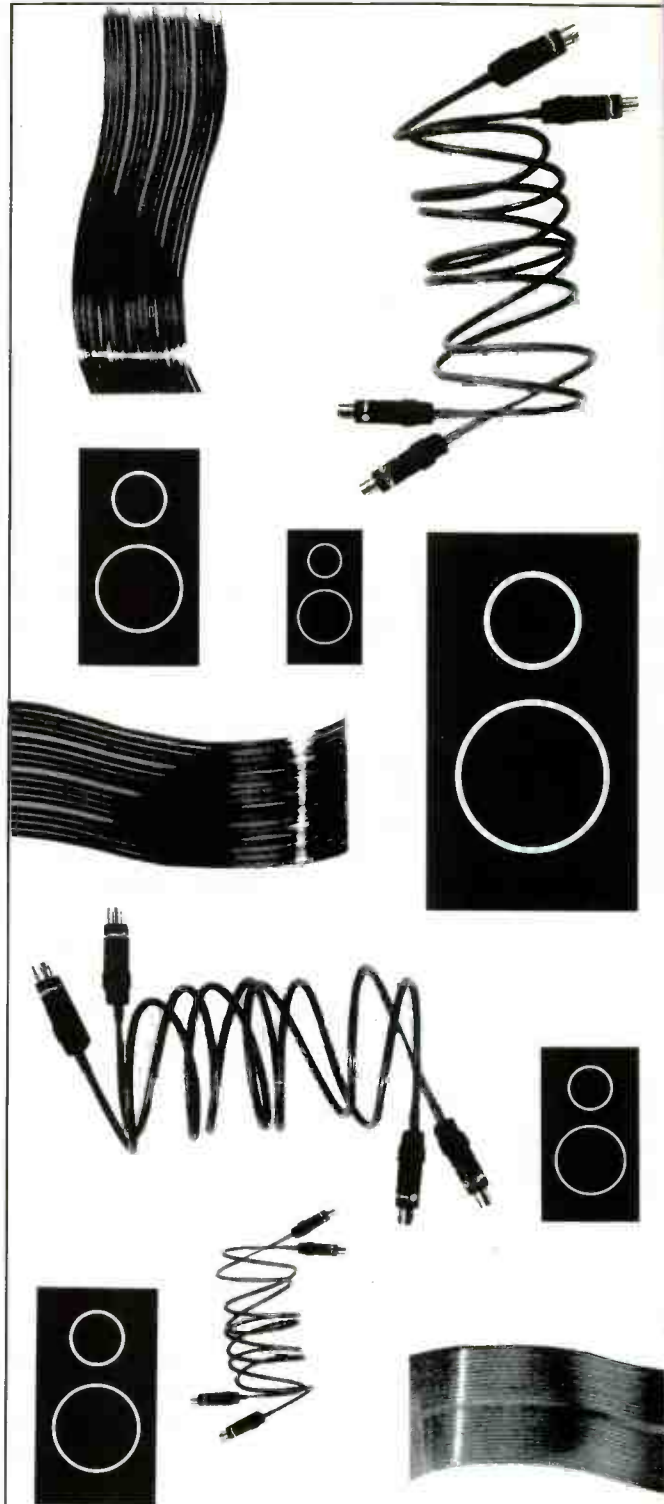

INTERCONNECTS SPEAKER CABLE LOUDSPEAKERS BY

30a Sarum
Business Park,
Portway,
Salisbury,
Wiltshire
SP4 6EA



Telephone
(0722) 331674

Fax
(0722) 411388

For advice, sales and service or simply a brochure - call, fax or send the coupon

NAME _____

ADDRESS _____

Interconnects Speaker Cables Speakers Please tick required box



GRAND BOHEMIAN

The combination of Pro-Ject's 6.1S turntable, a Sumiko arm and Ortofon's MC30 Supreme has Eric Braithwaite enraptured.

Not long ago a reader wrote to Hi-Fi World wondering how a Pro-Ject 6.1 could be improved. As it happened, Ortofon were thinking on similar lines, wondering how far a very good basic turntable design could be pushed. The 6.1S is the result. I'd hate to

project the Pro-Ject's sales trajectory, but the omens are good. Very good. No, let's be brave. How about excellent?

Mind you, Pro-Ject has certain advantages. In this case, one of them is the fact that Ortofon imports the company's products into the UK.

Therefore, the 6.1S now comes with an Ortofon MC30 Supreme, well-named at that, for that is what it is, thrown in for the grand this set-up costs. The other is that Pro-Ject now fits a Sumiko arm, addressing the one disadvantage the 6 had: an arm that simply wasn't as good as

TECHNICAL & GENERAL

Some Necessities - From the Original Classic Turntable Specialists

		P&P	
Connoisseur	BD1/2 Drive Belt	9.85	1.85
	BD1/2 Motor Suspension kit	13.75	2.25
	SAU.2 Headshell	16.75	2.55
Garrard	SAU.2 Connecting lead	15.95	3.55
	<u>Standard Models</u>		
	Wired arm tubes	from 12.75	2.55
	Cartridge carriers (sliders)	9.25	1.85
	Idler Wheels	9.85	2.25
	<u>301/401 Transcription Models</u>		
	Original Thrust pad assembly	9.80	2.25
	Original Idler tension spring	2.95	1.85
	Original Speed control disc - 401	13.75	2.20
	Xeroxcopy Owners Manual 301 incl. full size mounting template	7.35	1.85
	Xeroxcopy Owners Manual 401 incl. full size mounting template	5.20	1.85
	Replacement Intermediate drive wheel	19.95	2.85
	Replacement 301 control knobs On-Off/Speed select	pair 20.25	2.55
	Replacement 301 suppressor unit	5.65	2.25
	Replacement 301 motor pulley (-2%), (-1%), (Std), (+1%)	each 12.65	2.25
Replacement 301 Chrome plated mounting bolts	set 3.70	1.85	
Recommended Lubrication set - early 301 or 301/401 (specify)	5.20	1.85	
Goldring/Lenco	Idler wheel (lock-nut or clip fixing)	19.95	2.85
	Arm Pivot bearings with instructions	7.85	1.85
	Spindle/Main bearing assembly complete	22.85	3.85
	Headshells	from 21.95	2.55
Thorens	Instruction books	from 4.20	1.85
	<u>TD 124 series</u>		
	Idler wheel	19.95	2.85
	Drive belt	9.85	1.85
	Chassis spring suspension (replaces 'mushrooms')	13.85	2.55
	<u>150/160 series</u>		
	Drive belt	9.85	1.85
	Suspension springs (-1%), (Std),(+1%)	set 10.85	2.55
	Suspension bushes	set 12.50	2.25
	Armboards for most models	from 16.90	2.55

Cecil Watts Dustbags/Parastats/ (spares incl. Preener wicks)
Cartridges and styli for 78s & Mono LPs in addition to current Stereo LP

TECHNICAL & GENERAL PO Box 53, Crowborough,
E.Sussex. TN6 2BY Tel:- 0892 654534

Loricraft Audio

Specialists in Garrard, Thorens and SME.

Loricraft exhibited a Garrard 401 with an SME Series IV arm, complete with electronic power supply which gave stunning results at the RCA Living Stereo Records launch.

Many thanks to Impulse Loudspeakers for their generosity and glorious sounds.

Manufacturer of dedicated power supplies for Garrard 301/401 and Thorens TD124 (review copies available). Supply and service of Garrard, Thorens and other high quality turntables using genuine and manufactured parts to original specifications. Also manufacturers of high quality plinths for Garrard 301/401 and Thorens TD124.

We are happy to quote on any aspect of high quality equipment, electronic, electrical and mechanical.

Loricraft high quality record cleaning machines as used by the professionals. Please send for details

High quality Audiophile Records stocked including, RCA, Living Stereo, Decca SXL with many more titles to follow, also good conditioned cleaned second hand list in preparation.

•New 1995 catalogue in preparation•

Loricraft Audio

4 Big Lane, Goose Green

Lambourn, Berks RG16 7XQ

Fax/Tel: 0488 72267

Garrard, Thorens Goldring, SME, Decca (London)

WOLLATON A•U•D•I•O

presents



The Audio valve Assistant-S valve
integrated amplifier

Phone for further information
and current dealer list

Wollaton Audio

134 Parkside, Wollaton, Nottingham, NG8 2NP

Tel (0115) 9284147 Fax (0115) 9280625

“Excellence amongst mediocrity”



Linn Naim Rega Arcam Quad Audiolab
Royd Kef Epos Mission Nakamichi Denon
Rotel Teac Micromega

Access & Visa
% Finance
BADA

Real Hi Fi

Hear the difference

Demonstration
Installation
Service

BETTER HI-FI

The Essence of Music
16 COOK STREET, LIVERPOOL L2 9RF ☎ 051-227 5007

the turntable deserved. The result is - doing the Carlsberg thing in case somebody is in sving mood - probably the best turntable for the price in existence.

Last time round, I praised the '6 for its dynamics.

This time round, believe me, this aspect is astounding. Checking out the new RCA stereo re-pressing of Also Sprach the way the strings and then brass arrive on your doorstep with heart-stopping vitality was enough to provoke a cardiac arrest. Not just that, but the low thunder of the organ note at the beginning was positively stomach-shivering as well. The reason we all praise these early stereo recordings up to the skies after forty years is that they recreate a profound and exciting musical moment, with all the tingle of a live experience. And that is what the new Pro-ject amplifies. Shivers down your spine; tingles in your toes; ears at attention. And the emphasis is on the musical part of the equation.

Only top-rate turntables, as the Pro-ject did, allow a listener to say during the Strauss "Ah, that phrase is more reminiscent of Till Eulenspiegel than I thought", realising the intentions of both conductor and composer without the thought disrupting the flow. This turntable/arm and cartridge combination is a musical experience projector.

Now that phrase is not entirely metaphorical. Apart from an orchestral tutti burgeoning full tilt and gung-no out of the 'speakers, the overall presentation of these RCA's was just enough more forward than normal to add five per cent more excitement without destroying the perspective. While not in the high-end league for Pacific Trench depth, the Pro-ject's abilities in this direction rate Alpha. In Bartok's Concerto for Orchestra (another classic RCA), the depth of space the simple miking arrangement put down on tape was obvious.

The top end on these LPs is not exactly up to modern recording standards, being a bit thin and shrill, but the Ortofon/Pro-ject combination erred on the side of good taste rather than cruelty. The upper strings had a small degree of richness and smoothness added that took the bitterness and edginess away, while adding a bright clean edge to the attack, if that doesn't sound

paradoxical. Adding an MC30 into the equation must also be responsible for a superlatively wide soundstage, expanded on these RCA's even more than I recall from the originals.

When it comes down to rock music, it's another case of well, 'shiver mi' timbers, me hearties'. The bass power is breathtaking, and the speed and timing that of a stop-watch. Yet again, it pulled off the trick of making a recording near-transparent so the lead singers of The Beautiful South were practically visibly wearing cans and in sound booths. Not quite as analytical as my Gyrodecz/SME IV in showing up the minutiae of mixing, the Pro-ject placed the listener in the best seat in the

control room rather than precisely behind the desk.

If this sounds a subtle difference, it was meant to be. It's illustrated by shading like one backing vocalist being 'breathier' than his counterpart, or the absolute certainty that you could mime the engineer's fingers on the faders. Or, the oh-so-subtle difference between hearing the different force of one palm on a bongo to that of another. Considering the Pro-ject was up against a QC-powered Gyrodec, if this is now a '6 with a Sumiko and an MC30 can perform on its lonesome from the grubby mains we are now afflicted with, then, the possibility of an add-on power supply had better become a probability.

With such a tight control of all the essentials - rhythm, a metronomically tight beat, almost outrageous dynamics, a superbly wide dynamic range and punchy, seriously heavy bass - the 6.1S is the brightest set of fireworks you'll ever see on November the Fifth. Or, if I have my publication dates wrong, the sparkler at the top of the Christmas tree.

A 'thou' is not exactly small change, but ask any actuary what a Pro-ject plus a Sumiko plus an MC30 Supreme really adds up to and it would be a bargain at twice the price. It will definitely have some other manufacturers getting their drive belts in a twist. Let's hope Ortofon, Pro-ject and Sumiko stay one big happy family. Meanwhile, my vinyl collection is wearing a big grin and saying "Play me". I'm hanging the "No visitors" sign on the front door for the first time in quite a while ●

Pro-ject 6.1S £999
Ortofon UK Ltd.,
Chiltern Hill,
Chalfont St. Peter,
Bucks. SL9 9UG
Tel: 0753 889949



IN THE JANUARY ISSUE

Don't miss the bumper Christmas issue of Hi-Fi World complete with a FREE supplement full of puzzles and games to keep you amused over Christmas as well as gift ideas and much more. Of course we'll still be bringing you news from the world of hi-fi, features, a fabulous competition, and lots of new products. Here's just some of what we hope to bring you in the January Christmas issue.

DENON D-F10



We review Denon's latest high quality component system for those who like a little style in their lives.

HEYBROOK HEYSTAK

A new floorstanding loudspeaker from Heybrook featuring a passive bass radiator for deep and powerful lows.

B&W P4

Using high tech. Kevlar drive units, B&W hope to find success with their new 'P' range of loudspeakers. We test the 2-way floorstanding P4s.

AURA TU-80

Replacing one of our old favourites, the TU-50, is the new Aura TU-80 tuner. Does it still offer the sweet and clear sound that we liked so much from its predecessor?

ORTOFON MC15 SUPER II

This £100 affordable moving coil cartridge from Ortofon is a bit of a shocker. Find out why in the January issue.



TRIANGLE COMETE TZXe

Triangle have made major revisions to their whole range of sensitive loudspeakers. We listen to the popular standmounting Comete, now in TZXe guise.

COMPETITION - WIN THE PRODUCTS FEATURED IN THE JANUARY ISSUE.

That's right, to celebrate Christmas we're going to try and give away everything reviewed in the January issue as a prize. Just pick which product you'd like to win and if your name is picked - it's yours.

Hi-Fi World is still only £2, but with more editorial than most rivals. With the most enthusiastic and expert editorial team in hi-fi journalism, can you afford to miss it? Make sure you don't by filling in this order form and handing it to your newsagent.



Please reserve/deliver* Hi-Fi World on a regular basis, commencing with the next issue, until further notice.

Name: _____

Address _____

Signed: _____ Date: _____

• Delete as appropriate

Distributed to the news
trade by

COMAG

MAGAZINE MARKETING

CHRISTMAS SUPPLEMENT

FREE with the January issue of Hi-Fi World, the Christmas supplement is packed with games and puzzles to keep you amused over the festive period. They'll also be great ideas for Christmas gifts for audiophiles, music lovers and enthusiasts.

It must be down to a conjunction of the planets. Suddenly, it's all good news, so much of it in fact that people in the hi-fi business are wandering around looking a little bewildered, wearing fragile smiles of half belief. Live '94, the Consumer Electronics Show, was the major reason: it was one hell of a show in size and razzmatazz. Held at Earls Court 1, an enormous display hall, and organised by News International, it was heavily publicised and strongly attended by manufacturers and public alike. No fewer than 186,484 people made it through the doors, compared with 15,000 or so for a typical, specialist hi-fi show, like Bristol or Penta (in its heyday). And as if Live wasn't big enough this year, it will be bigger next year - proving that Britain can support a great Consumer Electronics show, one in which hi-fi still plays a major role.

This, everyone agreed in the hi-fi business, was what we need - one yearly mega event, no argument, something everyone can look forward to, a real focus for the year. Why? Well, sales of proper hi-fi are in steady, if gentle, decline in Britain, large companies relying heavily - sometimes almost entirely (e.g. B&W, Lowther) - on export. Yet separates have never been so inexpensive, rivalling cost cut mini/midi systems. It seems that an increasing proportion of the British public now believe 'hi-fi' is something you get for £500 from Rumbelows, when better is available for little more. There's widespread agreement amongst specialist manufacturers that this impression needs to be countered, and one large show with everyone in attendance is a good way of going about it.

So many people, including myself, remember with affection coming to London to visit the Audio Fair at Olympia back in the late sixties/early seventies, as well as other mega-events like the Motor Show at Earls Court. These shows were galactic events it seemed to me at the time, coming 'up' from the West Country.

London I remember for the curious but intriguing smell of the tube trains - and when you emerged from that experience, large aircraft lazied through the skies overhead. The exhibitions themselves seemed to distil out the city's life and excitement, concentrating it into a frenzy of vivid displays, hordes of beaming sales girls, a cacophony of noise and more goodies than you could see in Hamley's in half-a-dozen Christmases. It wasn't an experience to forget, yet it disappeared for many reasons.



Reflections from Noel Keywood kaleidoscope

The seventies degenerated into a decade of strikes, it seems in retrospect, and they put paid to Olympia and Britain's only major hi-fi show. The audio industry has seen a lot since then and although not exactly out of the woods commercially as yet, it is larger than ever and needs a major exhibition of international stature to display its goods not only to a wide buying public in Britain, who seem to have forgotten about the delights of good music reproduction, but to those overseas who still value British hi-fi.

I was delighted to see Quad in the thick of things at Live '94, loving every minute of it and, still, displaying a cutaway electrostatic loudspeaker. How that cutaway used to intrigue me when I was barely out of my teens, wide-eyed and eager to learn about such mysterious things. This year KEF joined them with cutaways of their Reference 2 loudspeaker, showing its internal chambers and drive units. Linn have taken to showing internal bits too, especially the impressive Klout amplifier one-piece chassis extrusion. Audio is - or should be - about super

quality specialist engineering, serving us by increasing our pleasure in music. This sort of display emphasises the point.

Really successful products possess many attractions: great visual appeal, novel yet superlative engineering and, last but certainly not least, a really thrilling sound. Add to this unquestionable reliability and long, long service and you find a quintessential good hi-fi product.

A dreamer? Not entirely. Many companies strive hard to reach such a goal, recognising that is how it must be if hi-fi products are worthy of the quality tag they claim.

I have to say that, debates about sound quality apart, Quad have been something of a long term torch holder in this area. But Arcam, Audiolab, SME, KEF and others have all in their time claimed, to some degree justifiably, to offer the same sort of exceptional product quality and customer service that Quad have, through years of consistency in this area. And product longevity effectively makes a quality hi-fi system better value than a midi that needs

replacement after a few years.

The organisers told me that this year's show was a great success and that Live '95 will be bigger, spilling over into Earls Court 2, next door. Many exhibitors judged it a success too, although sadly one or two saw it only in terms of whether their own, specific customers had turned up and were, inevitably, a bit disappointed. Such a narrow view was rare, luckily. Most were pretty pleased about the whole shebang. Linn had a bigger log cabin than last year, immaculately built by a Finnish company who assemble such things for

ordinary domestic use in their home market. It took five days to build and, I reckon, cost around £100,000; Linn wouldn't divulge the figure, but said it was a great success. Everyone was awed by Sony's stand, reputedly the most expensive at around £1.2million, but Sony reckoned it was worth it too. That's how much goes into these things.

The only people missing - an omission the organisers are aware of - were the smaller UK specialist companies. There was plenty of room for them upstairs, but the cost of exhibiting is a little high for most. The show would be a lot more varied if they were accommodated. We then wouldn't be the only ones with valve amps on display, a dubious honour amongst a sea of lollipops, camcorders and the other electronic paraphernalia of modern living. Only our regular readers knew what they were. In a few years time, as a result of a few more shows, perhaps this will change. If everyone's optimism is justified, many more people in Britain will become aware of the sheer variety of products available in our vigorous audio market ●

OUR FAVOURITE PAIR

ARE OUT FOR A WALK-TAE *James Kerr*

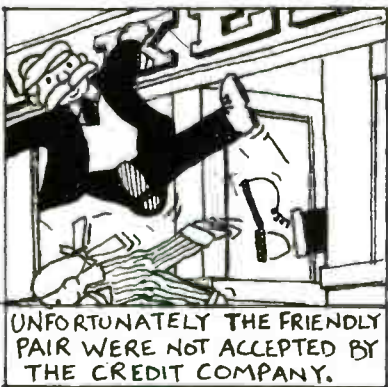
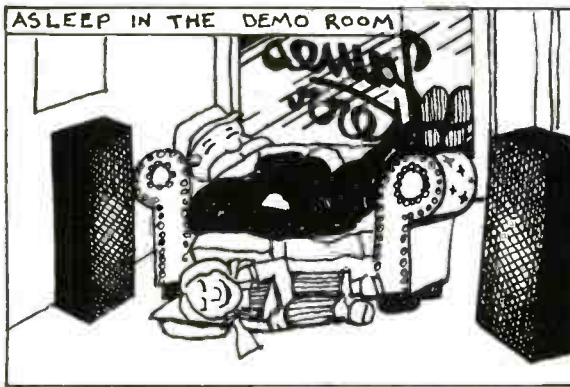

ANY SIMILARITY TO CUSTOMERS OR OTHER CHARACTERS IS ENTIRELY COINCIDENTAL.

James Kerr 100 WOODLANDS RD., GLASGOW
 RENTAL OF HOME THEATRE AND HI-FI
 CLOSED TUESDAYS - TEL. 041 332 0988

It's probably about ten years ago that I read a letter in *Wireless World* magazine from the late, and great, M.G. Scroggie deploring the term "current dumping" to describe the amplifier topology invented and exploited by the Acoustical Manufacturing Company in the Quad 405.

Scroggie acknowledged that the term pertained to the relatively straightforward task undertaken by the output transistors in such an amplifier. However, he argued, since the current that the output transistors passed was used directly to energise the loudspeaker and thus produce sound, the role these transistors played could hardly be considered "dumping", suggesting - as the word does - that they were involved in disposing of a useless commodity.

Now dumping is an everyday word for storing precious computer data. Perhaps it is only the ever-Victorian, scatological British who could regard responsible "dumping" as the hallmark of an accountable professional life.

Not that Scroggie was criticising the development of the Quad 405. I've owned a Quad 405 as a studio amplifier for many years and it's a wonderful product. I choose to ignore the engineers and academics who consign it to the waste-paper basket of history. They - blinded by mathematics - prefer their own (faulty) reasoning to the evidence of their own senses.

Technically, current-dumping does work - believe me. It works well and it goes on working. But how exactly does it work?

In Fig. 1, I've drawn a simple power amplifier with a voltage amplification stage (A) and a complementary bipolar transistor output-stage. In many ways this looks like any other complementary power amplifier, except that there is no static bias applied to the output transistors. Negative feedback encloses the whole and attempts to maintain linearity despite the large transfer-characteristic discontinuity

introduced by the unbiased output stage.

If you breadboard something like my Fig. 1, I guarantee you'll be surprised. It doesn't sound that bad. Provided the gain/bandwidth of A1 is large enough, the output signal is remarkably undistorted, especially at low frequencies.

Essentially this arrangement would be acceptable were it possible to construct the amplifier A perfectly, so that it "slewed" infinitely quickly across the crossover "deadband". I've



recorded message

Left by Richard Brice

tried to show the way A1 behaves by sketching the signal waveform at the bases of the two transistors.

Of course, it isn't possible to construct a perfect amplifier for A1 and, in practice, as frequency increases, crossover distortion starts to make itself heard. The essence of the idea behind current-dumping is illustrated by the inclusion of R_d (shown with dotted connections in Fig. 1). R_d feeds current directly to the load during the proportion of the output cycle when both the output transistors are off. In effect, R_d reduces the "gap" A1 is required to slew across and permits a practical amplifier to be used instead of a mythological, perfect amplifier.

Stripped of their duty during the essential and fragile crossover region, the

output transistors are only called upon to deliver drive into the load at powers above about 100mW whilst A1 does all the clever bit in between - hence the term "current-dumping" to describe the uncomplicated job they perform. In Quad's final circuit, the resistor is augmented by a capacitor and inductor which act in a reactance-bridge arrangement to enhance the effect of R_t across the whole audio bandwidth.

Despite the undeniable engineering ingenuity displayed in the 405 amplifier, Quad never seem to have earned *creme-de-la-creme* audiophile status for this product, nor indeed its heirs. However, comments that amplifiers of this stable lack "slam" or "punch", probably derive from Quad's prudent decision to employ extensive current-protection

and sub-bass roll-off (features which have many times saved my 405's life). It is almost certainly not the action of the amplifier topology itself which accounts for this apparent lack of subjective impact, but the effect of these other ancillary features and design decisions.

Is it, perhaps, because of this poor subjective reaction to Quad amplifiers that other manufacturers have not trodden the current-dumping route? Unlikely, more probable is that Quad's patents have prevented a

flood of carbon-copy, current-dumping amplifiers.

Granted, Quad have kept the technology to themselves, but have they sold more amplifiers, I doubt it. Quad's undoubted reputation for reliability and solid engineering would hardly have fallen apart if they had (like everybody else) built upon their success with the 303 and continued with the development of the class A/B audio power amplifier.

True, the designers, freed of their usual commercially-rooted secrecy by the sanctions of the law, were able to write articles explaining the technique in full. But, did Quad really hope that other manufacturers, wowed by the brilliance of their idea, would opt to pay Quad a royalty for every power amplifier sold? Surely not. It's not as if they invented an amplifier without the need for a mains transformer! Interestingly, Quad's patents for current-dumping were published in 1975 which means the protection expires next year. So current dumping could yet become household bywords for high-quality amplification. Sorry Mr. Scroggie ●

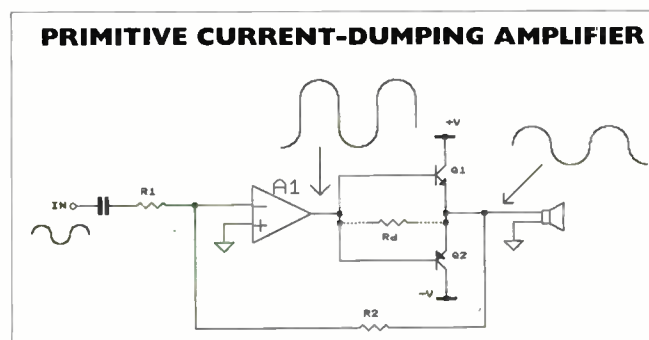

~ S ~ EXPRESS

**Noel Keywood scrutinises Kenwood's new three-head,
KX-7060S, cassette deck with a host of features
including Dolby S.**

Sony started something with their marauding TC-K611S cassette deck. Launched as a DCC spoiler - and Philips recently admitted it has had some impact - this £330 deck has sold in container loads. Immediately, of course, clones have appeared. Here's one - the new Kenwood KX-7060S Dolby S cassette deck, priced at £329.95.

Kenwood offer a package very similar to that from Sony, a deck that is at heart very sophisticated, but comparatively easy to use. To gain advantage, they've incorporated a dual-capstan transport, against Sony's single-capstan unit, which should give less flutter. An automatic tape tuning system has been included too, as well as a powered door, both useful

convenience factors. Trouble is, the door on our first sample never worked properly and that on our second sample proved temperamental. Sometimes it refused to budge, no matter how many times the open/close button was pressed. Dolby selection was similarly blighted - sometimes a long switching delay occurred.

The KX-7060S is a three-head deck, like the Sony, so recording quality can be judged whilst a recording is being made - a very useful feature. I would have preferred tape tuning to be manual (adjustable bias), since it's a doddle with three-heads and the final balance can be adjusted to suit preferences. Kenwood's

MEASURED PERFORMANCE

Replay response, which determines performance with tapes recorded on other machines, including commercial pre-recordeds, measured flat to 20kHz and high frequency output from the head was relatively stable, indicative of good tape guidance and head surface finish. Noise in the replay amplifiers was low at -60dB and replay speed absolutely correct. So the KX-7060S will make a good job of replaying pre-recorded tapes.

The head has, in essence, a superbly flat frequency response, but tape tuning put in treble lift with metals, but flat response with chromes and treble roll-off with ferrics.

Maximum recording levels weren't so high with metal tape - this is no Nakamichi - but they were very good with ferrics and chromes. With 0VU set high, above Dolby but below IEC reference fluxes, record levels will not go much past +3 on the display before overload compression and muddle sets in, and wallowy bass too, since bass distortion was high at 5%. Hiss levels were low, especially with Dolby S.

The dual-capstan transport suffered some flutter and a little capstan wow, seen respectively as a minor peak in the speed stability analysis and as 'shoulders' each side of the main test tone peak, at right in the analysis. Overall though, it held speed tightly and will provide a stable sense of pitch.

Input sensitivity was high at 100mV and output level also healthy at 800mV, so the deck will be broadly compatible.

At heart the KX-7060S is a well engineered product, but it would benefit from more attention to detail to eradicate niggling faults. **NK**

TEST RESULTS

REPLAY (pre-recorded tapes)
 Frequency response (-2dB) 30Hz-20kHz
 Speed accuracy 0%
 Hiss (70uS, Dolby out) -60dB

RECORDING (blank tapes)
 Frequency response (IEC Primary Refs.)
 ferric (IECI) 10Hz-20kHz
 chrome (IECII) 10Hz-16kHz
 metal (IECIV) 10Hz-20kHz
 Separation (1kHz) -60dB
 Distortion (315Hz) 0.8%
 Hiss (70uS, Dolby out) -56dB
 Speed variations (DIN total) 0.06%
 Flutter energy (3-3.13kHz) -44dB
 MOL/SAT (IEC Refs) 315/10k
 IEC I (ferric) 4dB/-4dB
 IECII (chrome) 3dB/-4dB
 IECIV (metal) 3.6dB/+1dB

Frequency Response

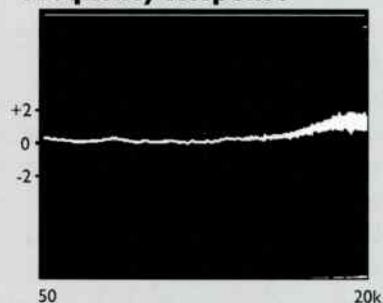

Rising treble with metal tape.

Speed Stability

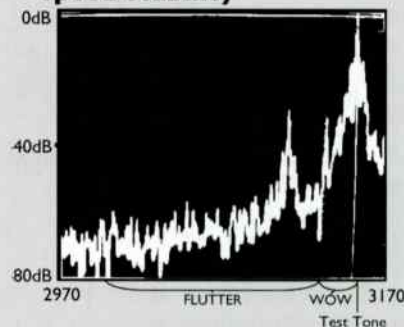

Some flutter, but stable speed.

auto-tune system was slow and whatever it decided couldn't be altered. So, for example, whilst TDK AR tape consistently tuned-in sounding a little dull and warm, TDK MA metal tape always ended up sounding bright and brittle. Consequently, I preferred AR - something of a cock-eyed result.

The KX-7060S has been fitted with a host of convenience features, such as Index Scan and A-B Repeat. It also has the usual tape/monitor button with autosetting and automatic tape type selection too. The display panel has pale blue graphics, with red to indicate peaks exceeding 0VU. Kenwood set 0VU high-ish, meaning it is wise to record up to +3 or so. Going much further introduces muddle with chromes and ferrics, even with Dolby S.

The deck is built and styled in a conventional manner. It worked smoothly, albeit erratically at times, not always obeying commands first time, possibly due to faulty switches. This was a little disconcerting; whether it will happen commonly we cannot tell. This is a question for the dealer and cause to scan the after-sales guarantee.

Sound Quality

The tightly held beat of a Tina Turner track suggested straight away that the Kenwood's transport keeps good control - and so it does. Timing was right on the nail; this deck gave tightly timed bass lines and clean, fast transients, free from slurring and splash. Piano notes decayed naturally and there was little sign of pitch 'wateriness' to notes; they sounded solid and well defined in the time domain. A superb sense of clarity brought tapes to life - the Kenwood's head seemed surprisingly good in this respect, and I suspect the replay electronics helped too.

Although dull tapes remained dull - a Nakamichi can get more out of apparent duffers - they also came over as entertainingly clear and dynamic. Bass quality was better than usual I fancied. In all, this deck played pre-recorded tapes extremely well.

Recording raised some minor peculiarities. The tape tuning system worked well enough but the Dolby systems seemed far more obvious in their companding than usual, which was odd.

“The KX-7060S is, at heart, a good deck. I got fine recordings from it with all tape types and superb results with pre-recorded tapes.”

Dolby B cut off decays noticeably and pumped, Dolby C pumped so badly it was beyond serious use and whilst Dolby S was good, it wasn't transparent, coarsening treble. I settled on Dolby B with high-ish recording levels to hold it off, my usual preference. I feel I've heard Dolby S sounding better though.

Most users would fancy that TDK AR ferric tape was as good as anything with Dolby S engaged; it gave a very even balance, if slightly ragged treble. TDK AD

was no better on this deck, but hissed.

TDK MA metal tape tuned in sounding a trifle brittle, but with Dolby B gave fine results. Again, although S suppressed hiss more it didn't sound convincingly better, just a trifle different due to glassy treble. TDK SA chrome tape matched it well, but produced a softer, easier treble delivery.

I don't recall ever being so aware of Dolby B/C action; I strongly suspect the Dolby system of this deck was operating incorrectly. The selector switch sometimes had a time delay and stuttered. The door close button was occasionally not of a mind to work first time either, so perhaps the deck had a switch problem. Our first sample had a door problem too.

The KX-7060S is, at heart, a good deck. I got fine recordings from it with all tape types and superb results with pre-recorded tapes. Whilst Dolby S worked well and would be fine for all but the most picky, I was suspicious about the obvious failings of B and C. Being a bit picky myself, and being used to recording on a Nakamichi ZX-9, which has superb Dolby B - all that's needed these days - I was a little disappointed by the Kenwood. However, there's no denying that with Dolby S engaged it offered excellent recording quality on all tape types and this is perhaps enough ●

Kenwood KX-7060S £329.95
Trio Kenwood,
Kenwood House,
Dwight Road,
Watford,
Herts. WD1 8EB
Tel: 0923 816444



WIN A COMPLETE SYSTEM WORTH

One for the vinyl lovers this month: a complete top-end system to get the very best from your records. The system is built around the

Systemdek IIX900 record deck, reviewed in our September '94 issue and set up with the same Rega RB250 tonearm and Goldring 1022GX cartridge. This feeds

the new DPA Digital Renaissance integrated amplifier which in turn drives a pair of Systemdek Systym 931 loudspeakers.

The Systemdek IIX900, complete with RB250 tonearm and Goldring 1022GX cartridge, represents one of the best vinyl front-ends available. When we reviewed this combination we found it had marvellous definition, laying out a whole band between the loudspeakers. Vocals were clear and intelligible, the record deck possessing fine detail and tonal shading in this area. In summary Eric Braithwaite wrote "A very detailed sound stage, with a good broad image, was allied with a wider and more even range of tonal colour . . . always producing a lively and entertaining performance".

The DPA Digital Renaissance integrated amplifier comes complete with a phono-stage to resolve the very best from the vinyl front-end. It produces 32watts of clean, smooth power, enough to drive sensitive loudspeakers to high levels without trouble. It also has four line-level inputs where a CD player, cassette deck and tuner or any other line level source can be connected.

Although the Renaissance integrated amplifier has been designed for a good sound first and foremost, it doesn't lack useful features either. There are bass lift and treble cut controls, a tape monitor, balance and even a headphone socket.

The Renaissance integrated feeds the talented little Systemdek Systym 931 loudspeakers. These are compact mini-monitors, but there is nothing small about their sound. They have an expansive, detailed and open sound that will give you hour after hour of listening pleasure. They also have a polite and balanced nature with good bass impact and definition for their size, which helps to produce a realistic, full scale performance.

To enter this fabulous competition simply complete the questions opposite, sending your entry on a POSTCARD or the back of a SEALED ENVELOPE and completed in block capitals, to arrive no later than Friday 4th December 1994 to:

SYSTEMDEK/DPA DIGITAL Competition
Hi-Fi World Magazine,
64 Castellain Road,
Maida Vale,
London, W9 1EX.

COMPETITION ENTRY QUESTIONS

1) What is the finish on the Systemdek IIX900 turntable and Systym 931 loudspeakers?

- | | |
|----------------|--------------|
| A. Natural Ash | B. Oak |
| C. Walnut | D. Black Ash |

2) What is the arm and cartridge combination fitted to the Systemdek IIX900?

- | | |
|---------------------------------|---------------------------------|
| A. Rega RB250 + Goldring 1012GX | B. Rega RB250 + Goldring 1022GX |
| C. Rega RB300 + Goldring 1022GX | D. Rega RB300 + Goldring 1042GX |

3) Select one of the following features that the DPA Digital Renaissance integrated amplifier possesses?

- | | |
|-------------------------|---------------------|
| A. Dolby Surround Sound | B. Tape Monitor |
| C. THX | D. Headphone Socket |

4) What kind of loudspeakers are the Systemdek Systym 931s?

- | | |
|------------------|-----------------|
| A. Electrostatic | B. Mini-Monitor |
| C. Floorstander | D. Disco |

TIEBREAKER

The sound of vinyl is still superb after all these years of CD blurb why change when music sounds so sweet making our enjoyment so complete instead just fill in the forms to win a system above todays norms

(Complete poem with another four lines).

.....

Don't forget to include your name, address and a telephone number so we can contact the winner promptly.

In the event of more than one entrant submitting all the correct answers, the winner will be picked by the Editor from the tiebreaker. We will endeavour to publish the results in the February 1995 issue. Purchase of the magazine is not a pre-condition to entry.

No correspondence about this competition will be entered into and the Editor's decision is final.

No employees of Audio Publishing Ltd. or any of the companies associated with production or distribution of the prizes may enter.

Your name and address may be added to our mailing list only. If you would prefer not to receive details of new products or special offers from us alone please state so on your competition reply form. Hi-Fi World magazine is published by Audio Publishing Ltd.

VINYL PLAYING OVER £1300.

competition



OCTOBER ISSUE COMPETITION - A COMPLETE MISSION CYRUS SYSTEM

It's not fair, there's a fabulous system on offer and we're not allowed to enter. You did though, we received masses of competition entry forms this month, and no wonder - the Mission Cyrus system on offer is a fantastic prize. Included in the prize is a top flight, two-box CD player, superb tuner, powerful amplifier and the latest high technology 752 loudspeakers. Sadly the time has come to give it all away, but the happy winner is:

Ms. R. Wallace of Chiswick in London

Congratulations, this system should put a smile on your face for the rest of the year.

Subscriptions

12 ISSUES FOR ONLY £22 (UK only)

HI-FI WORLD SUBSCRIPTION FORM

Please send me the next 12 issues of Hi-Fi World, starting with the _____ issue.
I enclose my cheque/postal order for £22 (UK only) made payable to **Audio Publishing Ltd.**

Name _____
Address _____
Daytime Tel No: _____

Please debit my VISA/ACCESS Card No:

--	--	--	--	--	--	--	--	--	--	--	--	--	--	--	--

Expiry Date: _____ Tel: 071-266 0461

Send to: **Audio Publishing Ltd.**, 64 Castellain Road, Maida Vale, London W9 1EX.

Overseas subscription rates.

Surface Mail: £29.
Airmail: £42 Europe, £52 Middle East, Hong Kong, Singapore & Malaysia, £62 Australia, Japan, Korea & China.

Airmail
 Surface Mail (tick as appropriate)



8/94 E&OE

U.S. & Canadian Subscriptions



Hi-Fi World
U.S. & Canadian Subscriptions

P.O. Box 754, Manhasset, N.Y. 11030 - 0754
Telephone: 516 627 3836 Fax: 516 627 1972

I wish to subscribe right now - and receive monthly copies of Hi-Fi World Air Speeded direct from the Publisher in London U.K. to the N.Y. Office

I enclose my payment to :- FRJ/Hi-Fi as checked below
1 Year - 12 Issues \$66 (U.S.)

U.S. FUNDS ONLY PLEASE - Add \$10 U.S. for Canada.

OR
Please charge my Credit Card with the amount indicated.
(All major Credit Cards accepted)

No:

--	--	--	--	--	--	--	--	--	--	--	--	--	--	--	--

Expiry Date:

--	--	--	--

Signature: _____ Name: _____

Address: _____

City: _____ State: _____ Zip: _____

Or Telephone:

516 627 3836

Or Fax:

516 627 1972

8/94

Back Issues

Unfortunately, all issues prior to December 1991 are completely sold out, but subsequent issues, as listed below are available for £2.00 excluding postage and packing.

HI-FI WORLD BACK ISSUES ORDER FORM

Please tick the box next to the issue(s) you wish to order

- | | |
|---------------------------------------------------|----------------------------------------------------|
| <input type="checkbox"/> December 1991 £2.00 | <input type="checkbox"/> September 1993 £2.00 |
| <input type="checkbox"/> January 1992 £2.00 | <input type="checkbox"/> October 1993 £2.00 |
| <input type="checkbox"/> October 1992 £2.00 | <input type="checkbox"/> November 1993 £2.00 |
| <input type="checkbox"/> January 1993 £2.00 | <input type="checkbox"/> January 1994 £2.00 |
| <input type="checkbox"/> February 1993 £2.00 | <input type="checkbox"/> February 1994 £2.00 |
| <input type="checkbox"/> March 1993 £2.00 | <input type="checkbox"/> March 1994 £2.00 |
| <input type="checkbox"/> May 1993 £2.00 | <input type="checkbox"/> April 1994 £2.00 |
| <input type="checkbox"/> June 1993 £2.00 | <input type="checkbox"/> May 1994 £2.00 |
| <input type="checkbox"/> July 1993 £2.00 | <input type="checkbox"/> June 1994 £2.00 |
| <input type="checkbox"/> August 1993 £2.00 | <input type="checkbox"/> July 1994 £2.00 |

Total no of issues ordered.....Total price.....

(Overseas add £1.00 p+p for every issue UK p+p £0.50 inc)

I enclose cheque/PO for £made payable to **Audio Publishing Ltd.**
I wish to pay by Visa/Access (orders for 3 copies or more only), please debit my account no:

--	--	--	--	--	--	--	--	--	--	--	--	--	--	--

Expiry date:

--	--	--	--

Name.....

Address.....

Post Code..... Tel:.....

Please send completed order form together with your cheque/PO to:
HI-FI WORLD, 64 Castellain Road, Maida Vale, London W9 1EX.

8/94

Please allow 28 days for delivery

Since we started the DIY Supplements, designing loudspeakers for the home constructor and more recently selling Audax high technology drive units, there have been an increasing number of you contacting us regarding loudspeaker design. I'm not going to get too technical here though, it is more of an introductory level that needs to be addressed. The apparent simplicity of a DIY loudspeaker has encouraged many to have a go, and it is for these first time builders that this column is devoted.

One area which receives numerous queries is that of reflex ports. Tracking back a few paces, the quality of bass and depth of bass you get is determined by the box volume, the size of the port and the parameters of the drive unit you are using. As far as bass reproduction is concerned, the shape of the box is not important, neither is the position of the port. It is the ratio of box volume against port size that matters here, so the port can be mounted on the back, side, front or top of the cabinet, which itself can be tall and thin, short and fat, round etc.

For practical reasons, we decide to configure our DIY loudspeakers in a particular way. Take KLS3 as an example. We made the box tall and thin, partly to get the drive units off the ground where they would drive a room's resonant modes most effectively (undesirable for clean, dry bass) and to place the drivers close to ear level (the on-axis response of the loudspeaker being the most truthful). This last point is especially important if you are constructing a two-way design, since the mid-range output from the bass driver is directional and will need to face the listener, along with the tweeter, for the clearest sound.

We also choose to place the reflex ports on the front baffle, facing in the same direction as the drive units. This isn't really critical and is a decision based on what we want the loudspeaker to look like, and the gut feeling that if the port is

venting sound, it ought to do it towards the listener. In theory, it doesn't matter which direction it is facing at the frequencies concerned, since they are normally well below 100Hz and non-directional.

Another reason for making our designs tall and slim is to improve the ability of the loudspeaker to produce a good stereo image, something we are particularly keen on, having spent a lot of time with Quad electrostatics, which are masters in this area. A drive unit still produces a considerable amount of



Dominic Baker

dB on the level

sound energy from the side, and it is these sound waves travelling across the front of the baffle that disturb the main frontal sound and produce a reduction in image focus. A thin cabinet has less frontal surface area, so will produce less of these harmful reflections.

Another practical consideration concerns the powerful rear sound wave produced by the drive unit inside the box. This will reflect strongly off the rear face of the cabinet, so it is useful to keep the rear baffle of the loudspeaker a good distance away from the driver and to damp it well with carpet felt or other similar acoustic treatments that will help absorb as much of this energy as possible.

'Handing' the loudspeakers, with the drivers offset toward the inside wall of the baffle, is a further refinement based along similar lines. When you sit between the loudspeakers, the majority of the treble energy you hear comes from the inside half of the tweeter dome which is facing you. By

moving the tweeters to the inside edges of the cabinet, this half of the dome 'sees' less baffle area from which to produce destructive reflections. It only makes a small difference, but a worthwhile one in my view, and as you're building the things yourself it takes little extra effort to implement.

Another query concerns where to put the crossover. We place them inside the cabinet for obvious practical reasons. However, for home constructors who aren't going to shift their loudspeakers around quite so much, there's a better way. Getting the crossover out of the cabinet and away from the strong vibration produced by the drive units is certainly a step in the right direction. But if you're going to go to this effort, you may as well take one step further.

Mount the crossover right next to your power amplifier. This has two advantages. Firstly, the power amplifier can drive the crossover more effectively than it can if it were at the end of a long piece of wire. Secondly, the

cables from the crossover to each drive unit are only carrying the signal that particular driver requires. So for the tweeter, the wires from the crossover are only carrying treble energy, not bass as well, and the cabling becomes that much more efficient.

At the end of the day though, it's *your* loudspeaker. We design our loudspeakers in a particular way according to those areas which we feel are most critical. Every designer has their own idea of what is important in a loudspeaker and this can be seen in the

wide variety of designs on the market today. DIY loudspeakers give you the chance to decide what is the most important aspect for yourself, and then implement those ideas in a design of your own.

One last thing I would like to mention concerns the Audax drive units we sell. Although we have only published two designs using these drivers to date, if you want to design a loudspeaker using a different line up of drivers, we offer a service which gives workable box volume and crossover designs for anyone purchasing Audax drivers from us. So if you want to create a six way, triple bass unit, floorstander with open baffle mid range and line source tweeter arrangement, we can give you a box volume, port size and basic crossover design that will get you into the right ballpark first time. A little fine tuning will almost certainly be necessary for perfect results, but we can offer advice here too. Have a go, I'm sure you'll be amazed by what you can create ●

TRUE MUSICAL

quality hi fi products with style and value for

roksan



attessa dp2 mkII

Following the success of their first CD Transport - the highly acclaimed Rok DP1 - Roksan has introduced the Attesa Series.

Incorporating technology developed over many years of audiophile turntable production, the new **Attesa DP2 MkII** features a unique 4 layer isolation system, a highly stable master clocking circuit and striking good looks.

Thus providing one of the finest CD Transports available in the world today. (To audition the Superb Roksan range contact our branches in Sevenoaks, Guildford or Tunbridge Wells).

marantz



cd63

Marantz are another of the audio pioneers with a passion for making recorded sound as enjoyable as the real thing. They call it a dedication to pure hifidelity, and over the years it has led the audio press to bestow awards on numerous products in their extensive range.

Since it's launch earlier this year the **CD63** has been heralded as a player with outstanding performance and exceptional value for money.

mission



752

Featured here is the **752** the latest addition to the award winning Mission 75 Series.

Featuring elegant wood cabinets in real wood finishes this exciting range of loudspeakers has

already won numerous awards worldwide.

Audition their fine products in our demonstration rooms - and treat yourself to a unique sound experience.

pioneer



pds703

It's here, the new star of the CD world at an outstanding price. With Pioneer's unique Stable Platter Mechanism and their revolutionary Legato Link DAC, is this the one to judge the others by? Audition this exciting new player, along with front runners from Arcam, Marantz and Rotel.

Oh, and by the way, Pioneer have generous cash back offers available on selected CD Players at any of our branches listed below.

Sevenoaks, Tunbridge Wells, Watford, Chelsea, Leicester, Guildford, Oxford, Croydon, Hanley, Nottingham, Leeds, Derby, Sheffield, Lincoln, Camden, Hull and Birmingham.

Yet more reasons to check out the award winning range at Sevenoaks Superfi.

Pioneer offer valid from October 17th - December 3rd, 1994.

kef reference



model 3

Heralding the new Kef Reference Series of loudspeakers, this comprehensive new range of floor standers feature Kef's fourth generation Uni-Q driver providing high output, good sensitivity and low distortion.

The **Model 3** has all the hallmarks of quality you associate with Kef products - a Dual Coupled Cavity Configuration and superb cosmetic appeal. You will find the new range, **Models 1, 2, 3, 4** at Sevenoaks Superfi.

There are many other quality loudspeakers including Ruark, Castle, ProAc, TDL, Mission and Monitor Audio.

sounds outstanding

0%
0% FINANCE
AVAILABLE ON A
WIDE RANGE OF
HI FI SEPARATES

BRANCHES THROUGHOUT

authorised dealers for most brands of quality Hi Fi. For a competitive quote please



SEVENOAKS
109-113 London Road
0732 459555
Sevenoaks Hi Fi



CHELSEA
403 Kings Road, SW10
071 352 9466
Sevenoaks Hi Fi



ESSEX
1 The Grove Centre, Witham
0376 501733
Sevenoaks Hi Fi



TUNBRIDGE WELLS
28-30 St Johns Road
0892 531543
Sevenoaks Hi Fi



BRIGHTON
55 Preston Street
0273 733338
Sevenoaks Hi Fi



CHELTHENHAM
24 Pittville Street
0242 241171
Sevenoaks Hi Fi

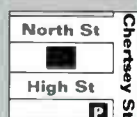

GUILDFORD
73b North Street
0483 36666
Sevenoaks Hi Fi



WATFORD
478 St Albans Road
0923 213533
Open Sunday
Sevenoaks Hi Fi



CANTERBURY
20a Lower Bridge Street
0227 462787
Sevenoaks Hi Fi



CROYDON
373 London Road
081 665 1203
Sevenoaks Hi Fi

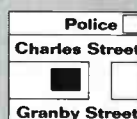

LEICESTER
94 Granby Street
0533 557518
Sevenoaks Hi Fi



WOOLWICH
162 Powis Street
081 855 8016
Sevenoaks Hi Fi



CHATHAM
4 Railway Street
0634 846859
Sevenoaks Hi Fi



ENFIELD
7 Genotin Road
081 342 1973
Sevenoaks Hi Fi



OXFORD
41 St Clements
0865 241773
Sevenoaks Hi Fi



WORCESTER
2 Reindeer Court
0905 612929
Sevenoaks Hi Fi

EXPRESSION

hi fi connoisseurs and music lovers



For over 50 years the name Quad has meant quality. Throughout the world, hundreds of thousands of satisfied customers have endorsed this statement.

The secret of Quads success is their constant search for improved musical reproduction and original style. True to their ideals the 67CD incorporates the latest technology and innovative looks.

To audition other audiophile CD players, Transports and DAC's from Audiolab, Teac, Pink Triangle, Arcam, Musical Fidelity and Cyrus, contact your local branch.



Renowned, almost from its inception, the 'original' 3020

amplifier has become a hi fi classic.

Many variations on a theme followed, until the introduction of the 302. This latest version has continued to impress, collecting the award for European Amplifier of the year.

For affordable, quality hi fi components, that present the music faithfully - look for the New Acoustic Dimension.



The original Project 6 was the winner of the 1993 What Hi Fi Award for the best turntable, and acclaimed throughout the Hi Fi Press. Subtle improvements have inevitably led to the new Project 6.1, helping to make a good turntable even better.

Included within the price is an Ortofon cartridge (option without cartridge) and two different platters - one metal, one glass - thus enabling the most determined audiophile to 'tweak'!

Our other audiophile turntables include Pink Triangle and Michell. Picture courtesy of WHAT HI FI?

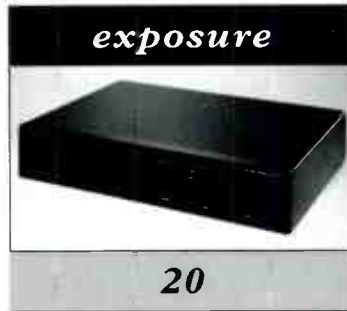

For the past fifteen years Exposure has been one of the small group of companies which made its presence felt more by reputation than promotion.

Many of John Farlowes designs, like the 15, 20, 17 & 18 have been acclaimed both in the UK and abroad for their striking musical performance, and excellent build quality.

That's not all - we also have top quality amplification from Audiolab, John Shearne, Cyrus, Musical Fidelity and Quad for you to consider.



WHO ARE WE?

Sevenoaks Superfi are at the forefront of Hi Fi retail in the UK. For over 21 years our companies have been selling quality Hi Fi products to discerning customers, and our enthusiasm is undiminished.

AFTER SALES

All our products can be installed in your home. If you wish to use this service please ask your local branch for details.

PEACE OF MIND

All the products we sell are brand new, fully guaranteed and maintained in our own service departments. We also offer our own 'no quibble' extended warranty. Ask for details.

PRICE PROMISE

We always try to ensure our prices are competitive. In the unlikely event of an identical product being available from an authorised dealer at a lower price, we will beat that price by £ 10.

SALE VALUE:

UP TO £120 =
PRICE MATCH

£121 + = £10
PRICE BEAT

SOME USEFUL NUMBERS:

Sevenoaks Central Service Department
0732 459105

Superfi Central Service Department
0602 420414

Mail Order Hotline
0732 458985

THE COUNTRY...

ring any one of our branches ~ we are always pleased to hear from you.

BIRMINGHAM
67 Smallbrook, Queensway
021 631 2675
Superfi

COVENTRY
16 Spon Street
0203 223254
Superfi

DERBY
56 London Road
0332 360303
Superfi

HULL
4 Dock Street
0482 24051
Superfi

LEEDS
7 King Edward Street
0532 449075
Superfi

LINCOLN
271a High Street
0522 520265
Superfi

LONDON
2-4 Camden High Street
071 388 1300
Superfi

NOTTINGHAM
15 Market Street
0602 412137
Superfi

SHEFFIELD
1 Rockingham Gate, The Moor
0742 723768
Superfi

STOKE ON TRENT
51 Picadilly, Hanley
0782 265010
Superfi

Prices include VAT and were correct at time of going to press, but are subject to change without prior notice. E&OE. Most, but not all, of the offers displayed are also available from our associates Superfi. Sevenoaks Hi Fi and Superfi are not legally related and are separate commercial undertakings.
All prices are valid until at least November 30th, 1994



SEVENOAKS
SUPERFI

An invitation from Bill Wilson



**Cut the cost
of your CD
buying by
as much as
50%**

Buy your CDs the easy way and save £££'s
at the same time with Bill Wilson's

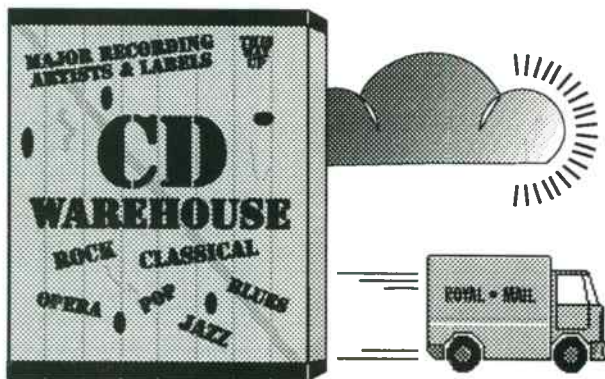

Join the ultimate service for discriminating CD collectors who demand the greatest range and the widest choice of top quality CDs at lowest ever cost.



1,000's of CDs
at give-away
prices from
Britain's totally
reliable mail
order service
— established
since 1961

It's just part of the WSL CD service which includes...

- A unique library 'try before you buy' service.
- The CD Index — the only book that tells you all you want to know about CDs.

If you want the kind of service no other CD club can offer you, contact me now for full details of the Wilson Stereo Library CD service — I'll reply personally and make you a very special offer of membership.

OK Bill Wilson! Tell me about the WSL CD Service and the benefits I can get from it. Including the New CD Warehouse. Without obligation (I enclose two first class stamps for speedy reply).

Name: _____

Address: _____

Postcode: _____



Est. 1961

To: Bill Wilson Wilson Stereo Library PO Box 32
St. Leonards-on-Sea East Sussex TN38 0UZ
Telephone: (0424) 718254 Fax: (0424) 718262

HW12/94

V'audio

Hi-Fi Consultants

Hype N° 2

Last month we talked about 'front & back ends', so now it's hype N° 2, the single speaker demo room. Now I'm not implying that other speakers in the room don't affect the sound, but then everything in the room does. The demo room won't sound exactly like your room at home anyway, so all you can try and do is to determine if a particular speaker comes close to what you require. When you are reasonably happy, then a home demo is vital to make sure it works in your home. That is where my personal involvement also helps, I will give you the benefit of my experience as well, ad if it's not right we start again

Customers regularly comment on the superb sound in my demo room in spite of 6 or more sets of speakers being present! Why not come and enjoy yourself and hear the new Lyra Clavis DC (£999), (cheaper but better than the old Clavis), in the SME 20A Turntable, through some of the speakers cluttering up my demo room!

By the time this advert appears the demo room should sound even better as sound treatment will have been applied. Don't forget also that we can always demonstrate 'Home Cinema' with results not achieved by anyone at 'Live '94' - Terrible!

Ian C. Vaudin
36 Druid Hill, Stoke Bishop,
Bristol BS9 1EJ
Tel/Fax: Bristol (0272) 686005

Recital

A SELECTION OF COMPELLING SYSTEMS:

CD PLAYER	MICROMEGA STAGE 1	£450
PRE AMP	MUSICAL FIDELITY E200	£599
PWR AMP	MUSICAL FIDELITY E300	£699
SPEAKERS	RUARK BROADSWORD	£850

CD PLAYER	AVI S2000MC	£999
PRE AMP	AVI S2000MP	£699
PWR AMP	AVI S2000MM	£999
SPEAKERS	ATC SCM20	£1499

CD PLAYER	AUDIOMECA KREATURA	£1199
PRE AMP	CR DEVS CARMENTA	£659
PWR AMP	CR DEVS AMPHION	£1799
SPEAKERS	AUDIOPHYSIC VIRGO	£3199

CD TRANS	DPA ENLIGHTENMENT	£795
CD DAC	DPA TWO FIFTY SIX	£3500
PRE AMP	TRIOLOGY 918	£2775
PWR AMP	TRIOLOGY 958 MONOS	£2995
SPEAKERS	CABASSE PACIFIC	£4600

R E C I T A L

289 NEW KINGS ROAD
FULHAM
LONDON SW6 4RE

TELEPHONE REX ON: 071-731 0340
10 TIL 6, MONDAY TO SATURDAY

It's been that time of year again. The time when the usually comatose British hi-fi industry leaps into action with a flurry of trade shows and then strong sales up to the Christmas period (well that's the theory at least).

This year the focus was very much on Live '94. It could hardly fail to have been a success for the audio manufacturers after last year's results, and a massive advertising campaign. This time round, I didn't make the same mistake as last year by going on a Sunday; by mid afternoon the gates had to be closed and I understand it was similarly packed this time round.

The venue itself was new too. Earls Court provided the desperately needed extra square feet, and a far more logical layout. The most obvious change from the layout at Olympia last year was the abandonment of the 'Real Hi-Fi Village'. This meant that rather than the specialist hi-fi companies all being bundled together, they were spread out throughout the venue. I had mixed feelings about the new arrangement. At first I found it rather confusing, having to weave my way through budding Beadles on camcorders and spotty faced youths gawping at the latest 'beat 'em up' computer game, in order to locate the hi-fi stands. But most of the companies were happy with the new layout, and I could see why.

This year companies such as Tannoy, Mission, B&W, Naim, Linn etc. had just as equal prominence as the big Japanese players. Whilst their stands may not have been quite as flash, I think they were perceived by the public at large, on level terms with the majors. This has to be a good thing, because it not only promotes brand and therefore hi-fi awareness, but it also does a lot to destroy the cliquish elitism

that the real hi-fi industry is often thought of as possessing by the general public. A Real Hi-Fi Village tucked away in the corner of the building simply promotes such a stereo-type (pun definitely not intended!).

As well as the presence of the hi-fi companies, the sheer razzmatazz of the whole event couldn't fail to impress. The glamorous girls (on around £100 per day I was reliably informed), were out in force. It could have easily been the Motor Show rather than an

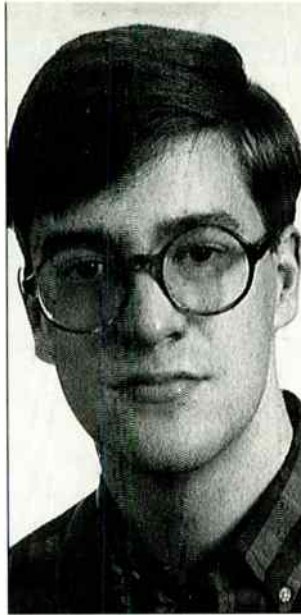

mouth, brat fashion, that I came across the Hi-Fi World stand. Thinking that going to say, "Hi", to those brave souls on the stand with a lolly in my mouth would look a wee bit immature, I ducked round the Meridian stand and quickly crunched it up. Only, when I arrived at the HFW stand I was to find the crew completely disregarding their personal vanity munching on Richer Sounds' lollies; apparently their staple diet for the entire event!

So where does all this

Fair Views

- from Dominic Todd, our man in Scarborough

electronics show in only its second year, such was the hype and excitement surrounding everything.

There were some pretty hard-hitting publicity stunts going on too. One such promotion that I was aware

cunning eh? Unfortunately I wasn't picked, but it was possibly for the best as I don't think I could go through the process of some patronising PR man telling me that Bose really did sound better than the other 'speakers. Of course they did. The Boses in question were the £1700 901s on stands with the conventional sound coming from little more than some old Videotones situated on the floor! Still, two of my friends won pairs, so going home with £140 worth of trainers made the nine hours

of travelling worthwhile after all. Other bribes were rather more mundane, usually sweets, although Richer Sounds would only give its lolly pops away to the over - 18s!

It was whilst sucking on such a lolly, complete with sucked in cheeks and the stick hanging out of my

glamour and triviality leave Penta (or Ramada as it's since been renamed). The fact that during its entire duration this year Ramada hosted around 7500 visitors, compared with 25,000 on Wednesday alone at Live, and a staggering total of over 185,000, must weigh heavily on Ramada's future. Especially as most of the large British and Japanese companies have since pulled out of Ramada.

I see no reason, though, why Ramada shouldn't continue as a specialist show, although why on earth can't they be on at the same time? Better still, if the organisers got their heads together, the specialist hi-fi could be moved into some of the rooms around Earls Court, or a nearby hotel. This would make it so much easier for those who don't live in London, and would also help to increase public awareness of hi-fi still further. So how about it News International - a consumer electronics show akin to America's CES for Live 95? Fingers crossed ●

“The fact that during its entire duration this year Ramada hosted around 7500 visitors, compared with 25,000 on Wednesday alone at Live, must weigh heavily on Ramada's future.”

of even before I'd set foot in London, was Bose's expensive sounding claim in giving away £50,000 worth of trainers, if you were prepared to nail your old shoes to the floor! I had it sussed. Not wanting to nail any of my own shoes to the floor, I took some tacky BMW flip flops to slip into;

The Music of Lyle Lovett

Ms. R. He is, after all, one of the most engagingly witty and talented songwriters to have come out of the USA in some time. Equally unjust is the fact that, as a result of his general style, and by virtue of the fact that he first

came to prominence during the latest so-called Country renaissance, Lovett should be lumped in with the likes of Dwight Yoakam and that maybe bald-headed geezer what wears the stetsons. In fact, and as those with long memories and/or extensive "Hi Fi World" back number collections will perhaps recall, I slipped LL's name into a review of the latest record by – you got it – that geezer who might be bald and wears the XL stetsons.

But today's hair – if you'll allow me the one Gump-ism – is tomorrow's fall-out. Any similarity between Lyle and people who don't need to go to the barber's is purely coincidental. In short, what Lovett does is craft songs of great wit and imagination, and if his material tends towards Country and Western in feel, that's far from all he does, did, or will and can do. Items such as 'Skinny Legs', 'Penguins' or 'Creeps Like Me' evince a lyrical wit and an even rarer sense of irony you'll be hard pushed to find this side of Randy Newman, and Lovett's words are inevitably matched by an equally broad vocabulary in the music department. On 'I Love Everybody', the singer-songwriter's fifth album, the instrumentation is predominantly sparse, Lovett's vocals and guitar assisted by a simple, classic bass and drums format (John Leftwich and Russ Kenkel respectively) – names, ask anyone who studies their sleeve notes with both eyes open, which are hardy to be dropped lightly or heard without gasps of respect and admiration. Aided and abetted where Lovett sees fit, and primarily by the sensitive violin of Mark O'Connor, Lovett and friends produce music of much breadth, warmth and, frequently, heart-lifting inspiration. Add a spot of cello or violin here, the occasional gospel-flavoured vocal expansion there, and you wind up with a collection of songs filled out with considerable colour, charm and breadth of vision. Lovett's powers as a song-writer of considerable merit and elegance are never in doubt. On this instrument, and as with previous forays, I Love Everybody is brim full of evidence that this is a pan-American musical talent of the first order.

Giovanni Dadomo

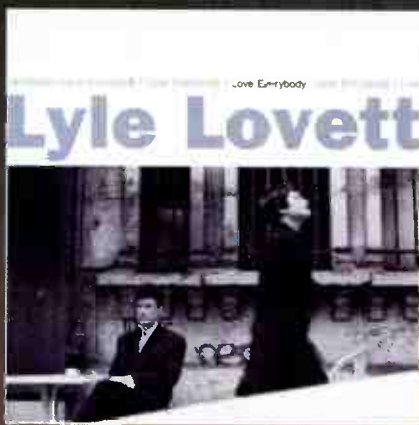

LYLE LOVETT
I Love Everybody
MCA MCD 16808

INDEX

RECORD REVIEWS

ROCK & POP73
Giovanni Dadomo

CLASSICAL85
Peter Herring

JAZZ93
Simon Hopkins
Simon Cooke

● What do you get if you take John Cooper Clark, guillotine his head off and replace it with a huge wedge of Parmesan cheese, topped off with a mess of used Brillo pads? Easy you got yourself Lyle Lovett, that's what. But the eye can be a big deceiver, don't you think? Superficially, this gent's about as geeky as they come, but if seeing were believing then how come this seemingly haphazard hunk of skin and bone should end up being partnered with Julia Roberts, a woman who – if she were French – would most definitely be called Le Renard

That said, it's somewhat sad, not to mention unjust, that Lovett's name should only be brought up primarily by virtue of his relationship with the divine

RECORD OF THE MONTH

**R.E.M.
Monster**
WARNERS 9362-45740

● Monsters - ask any of Christopher Lee's short-lived co-stars - ought to be approached with at least a modicum of care. So it was with said necessary trepidation that I set myself to lock horns with the latest offering from Athens, Georgia's most famous sons. After all, had not Michael Stipe, bless his pointy little head, not warned us that this latest offering would see R.E.M. at their most basic, stripped down, carnal, whatever...a disc conceived and delivered if not in the garage, then at least in a rough contemporary approximation of the same. Like, uh, out the orchestra, choke the cellos, vilify the violins...in short, elbow all the embellishments of recent products and be prepared to meet a re-born R.E.M. - one whose heroes, primary sources reported, were Iggy and The Stooges re-incarnated. Now, like U2 before them, R.E.M.'s back catalogue was, or is, fast approaching double figures - my, my, don't time fly? So you can't blame them, let alone us, for maybe thinking an, erm, re-think might not be in order.

Aforementioned trepidation well and truly in hand, I gave this monster the once over. And true, this really is just R.E.M., frugal not merely in instrumentation but also in terms of arrangement and melody. In short, if this record were a shirt it would be a plain white St. Michael first-day-of-school cotton/polyester mix, no frilly collar or cuffs, Paisley patterns or fancy tab or button-down collar included.

But hey, as anyone who wasn't born yesterday will happily tell you, there always was more - and less - to

R.E.M. than the fancy pageantries of 'Automatic For The People' or its audience-expandingly catchy predecessor.

So sure, you do get the occasional heads-down, brains-out, gloriously void, straight-ahead "rock'n'roll" snite a la prime time Stooges ('I Took Your



Name') but then it doesn't take a Big Brain or, come to that, even a fair-sized record collection, to suss that even Mr. Pop and Co. couldn't have done it without having first being pummelled into love eterna by exposure to those blessed early concoctions delivered by The Kinks and producer Shel Talmy.

But of course, R.E.M. - bless their pointed little brains - know all this, because, if not, why bother to give the aforementioned Iggy a namecheck within the lyrics of the, ahem, aforementioned song? Iggy's shade pops up in another guise in the ironically titled 'King of Comedy', both in the lyrics - "I'm not the King of Comedy/ I'm not your magazine/ I'm not your television..." et cetera - as well as in a dense, smoothly mechanical

arrangement and whispered Machiavellian vocals that carry echoes not only the of Ig of The Idiot but also of U2's only recent saving grace, that well-known Edge cut off the predominantly dismal Zooropa effort.

But R.E.M.'s palette has always been nothing if not broad, and without a painful amount of patience and reflection it quickly becomes obvious that, far from having lost it, R.E.M. are as hot as ever they were. From the opening 'What's The Frequency Kenneth' - all wideawake, happy-to-greet-the-day vocals, snappy back-ups and brilliantly resurrected backwards guitar drones - through to the languorously spaced out 'You', where Stipe recalls the Lennon of 'Strawberry Fields' and 'Tomorrow Never Knows', the instruments just sound like they've been abandoned and are drawing an exhausted, if contented, tired last breath. This is a great band proving once again that pop music can be a cure-all of considerable potency and longevity.

In between we have glories such as 'Let Me In', Stipe's suitably heartfelt adieu to the late Mr. Cobain, all agonisingly pure vocals set against the most evocatively restrained guitar and keyboards you'll hear this side of paradise. Place this beside the ensuing 'Circus Envy', an item as engagingly primal and froth-at-mouth energetic as anything put down by everyone from the Kinks to the MC5 and anyone in between or since. Just compare these two cuts and it's immediately and lastingly obvious that Monster is a disc of broad contrasts, wild imagination, the result of considerable thought, much feeling and - for a combo who've been in the saddle so long - admirable power. Thank God, Satan and all the little angels and demons for that.



SUEDE
Dog Man Star
NUDE 3CD

● Now perhaps it's a question of how old you are and/or how deep your record collection is, but it seems to this old fart at least that we have to draw the line somewhere; and it also seems to me that Suede are what we call in the Smoke, "Having a laugh". I mean, does the fact that I happen to be circa 437 years old give me the right to say this record is a piece of pure, unadulterated

crap or not? Or does it mean that it's me that's the piece of crap?

Success does indeed breed strange bedfellows. I've just been glancing at a bunch of reviews of Dog Man Star and it is rather amazing how many people who used to think Suede were a bunch of uninspired and derivative dolts reckon they've now, with this second LP, somehow come into their own.

Ho, ho and another ho, don't make me laugh, John. I don't buy that for one second or division thereof. So I sit here looking at a picture of Brett Anderson in

a bomber jacket I wouldn't be cremated in and I ask myself, as I listen to his laughably derivative new record ("screaming my name through the astral plane...shaking around in the underground..." et al), did Sid Vicious die for nothing, so that we could all go back to platform shoes and too-tight bombers and eye-liner and lord knows what other rubbish? I may be embarking on a 'wild, southern Rab C. Nesbitt-meets-Hunter S. Thompson trip here, but, to quote one of my favourite poets E.E. Cummings – "there is some shit I will not eat".

So either I've lost my marbles or there's something wrong here. And I say to myself, would Brett Anderson have got a band together, let alone a record contract, if he looked like the Hunchback of Notre Dame. Well, the answer to that one's easy – yes on both counts. But it'd be a Heavy Metal band on some Death Rock label or other.

But, strangely enough, none of these thoughts seem to have crossed the minds of one's newsprint brothers, they being too busy instead pondering on the dreadful dilemma of will Anderson and Suede survive the departure of guitarist Bernard Butler, to all intents and purposes the "new" Mick Ronson to Anderson's "new" David Bowie?

There's a short answer to this particular poser: Who gives a toss about Suede? They have all the substance and quality of Bauhaus, of Gary Neuman, of Nelson Slaughter. Of who, you say? Exactly.

And me, I'm left with the age-old question: Is this a record that desperately wants to be an ashtray? Or is it an ashtray dreaming that it's a record? Both.

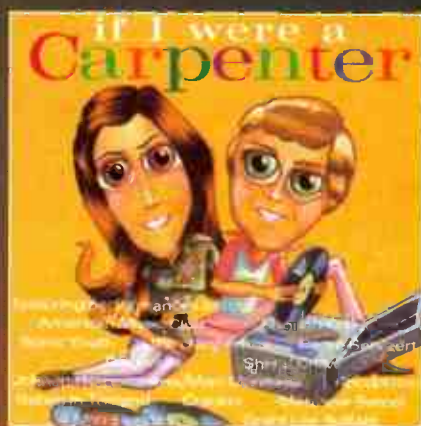

VARIOUS ARTISTS
If I Were A Carpenter
A&M 540 258 – 2

● She had a great voice, he had great hair, they were brother and sister and Karen thought square meals were square. Mama Cass should've given her that sandwich but she didn't, end of story. Most of the songs were naff except the one ("Calling Occupants Of Interplanetary Craft") where they pretended – maybe – to be on drugs. The family back catalogue goes through

the mincer c/o the likes of Sonic Youth, 4 Non-Blondes, The Cranberries, Babes In Toyland and other laff riot acts. I laughed. I cried etc.

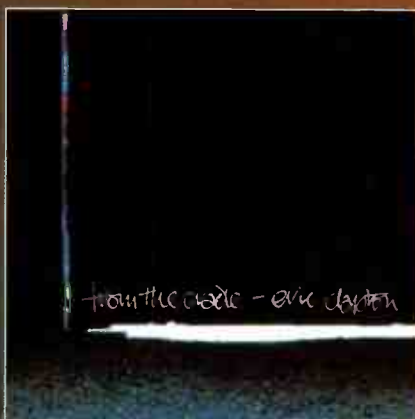

ERIC CLAPTON
From The Cradle
REPRISE 9362 45735 – 2

● New Blues boom? Okay, let's wheel out Eric Clapton and let him run through The Songs That Made Him God. In point of fact, the old bloke acquires himself extremely well, thundering through sixteen Blues classics with all the verve, style and precision his reputation requires. The big surprise is the vocals – always his weakest point, age appears to have given the big E that work-weary texture this classic music demands. And if it goes on a tad too long, well you can always switch off.

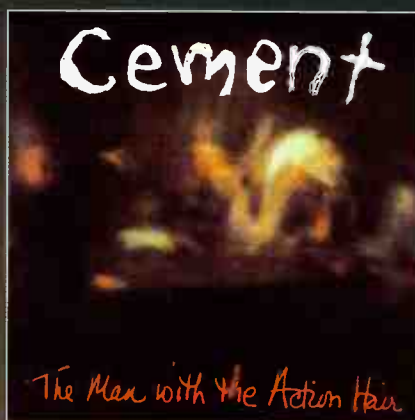

CEMENT
The Man With The Action Hair
WORLD SERVICE RTD 157.1745.2

● Second LP from the new band fronted by the original vocalist with Faith No More (viz. circa It's A Dirty Job... etc.). Chuck Mosley, as he be called, spends more time muttering and mumbling than he ought. Caught in full flow – 'Magic Number' is a good example – he has tonsils to kill for. But the man can also spit venom with the best of 'em; on the self-explanatory

'Hotel Diab o', to name but one, Chuck sounds like PM Dawn on a wicked mix of speed and testosterone. No bad thing

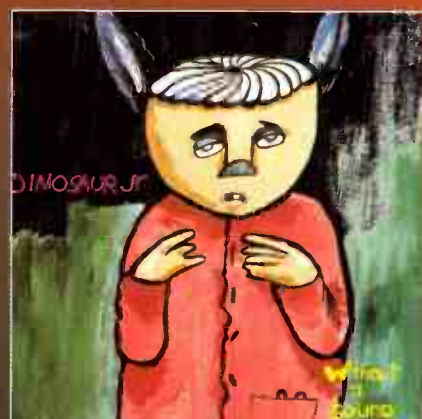

DINOSAUR JR.
Without A Sound
BLANCO Y NEGRO 4509 96933 2

● Pal of mine – fema e as it happens, but these things do happen – recently gave up the so-called crusty life. This entailed not only bathing more regularly but stopping her aural subscription to the likes of Dino Jr. I find all this a trifle unfair, not only to the laws of hygiene, but also to Dinosaur Jr's mainman, J. Mascis, a musician and writer of considerable talent and ability – as usual, he played and produced the bulk of this record, but – as usual again – he's too imaginative an artist by far to be locked in anyone's stylistic or fashionable straight-jacket. Good record...goodnight.

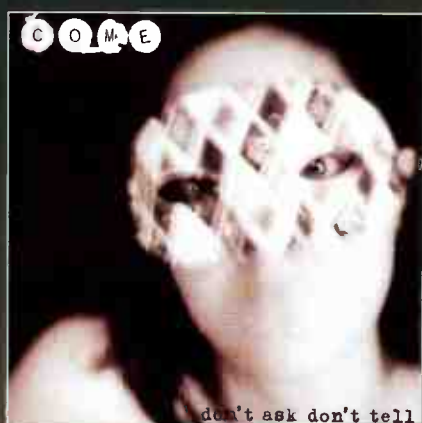

COME
Don't Ask Don't Tell
BEGGARS BANQUET BBQCD 260

● If P J Harvey has any serious competition then it's Thalia Zadek, singer/guitarist with Boston quartet Come. This, their second album, is a tour de force of awesome power and majesty. Listen to 'yr reign', easily one of the most breathtakingly impressive performances laid down anywhere, by anyone in 1994. Class 'A' rock'n'roll petro.

Specialist Hi-Fi Dealers

BADA DEALERS COME HIGHLY RECOMMENDED



Hear the difference.

VOX MAGAZINE:
"You can be confident that BADA members are reputable, financially sound businesses which will sell you hi-fi in a professional manner."

HOMES & GARDENS:
"A tried and tested way of finding trustworthy dealers... BADA whose members are specialist Hi-Fi Dealers."

GRAMOPHONE:
"Over 100 member shops... from Aberdeen to Plymouth... Helping customers to identify, clarify and satisfy their needs through the demonstration of suitable hi-fi products."



LOOK FOR THE BADA LOGO WHEN YOU CHOOSE YOUR REAL HI-FI DEALER

Write for a FREE Fact Sheet, BADA benefits and full members list to P.O. Box 229, London N1 7UU. Tel: 0171 226 4044 Fax: 0171 359 7620

SOUTH



BUCKINGHAMSHIRE'S PREMIER HI-FI DEALER

Arcam, Denon, Linn Products, Naim Audio, Meridian, Rotel, Yamaha, NAD, Quad, Tripod, Nakamichi, Rega, Creek, Epos, Mordaunt Short, Celestion, Marantz, Mission, Cyrus, etc. ...

65 Castle Street, High Wycombe, Buckinghamshire.
Open Monday - Saturday
0494 531682 / 464670

INHAUS AUDIO



Tel. (0702) 465892 or Mobile (0831) 616426
Viewing & demonstrations strictly by appointment only



ROKSAN J NAIM J REGA J MICROMEGA J ARCAM J CREEK
J ROTEL J MARANTZ J DENON J RUARK J EPOS J
SYSTEMDEK J AUDIOLAB J NEAT J SHAHINIEN J SOUND
ORGANISATION J SOUND FACTORY J CHORD COMPANY J
AUDIO TECHNICA J MANA ACOUSTICS J

Records also available
PRO MUSICA
6 Vineyard St., Colchester, Essex
0206 977519



SPECIALIST HI-FI OUTLET
DEMONSTRATION ROOM - PARKING

- QUAD • AUDIOLAB • REL • TUBE TECHNOLOGY •
- TDL • TANNOY • KEF • DENON • NAKAMICHI • THORENS •
- TARGET • MAGNUM • ROTEL • MARANTZ • MICHELL •
- SENNHEISER • BEYER HEADPHONES • JPW •
- SOUND ORGANISATION • SOUNDSTYLE TRIPODS •
- VAN DEN HUL CABLES • BOSE • MUSICAL FIDELITY •
- SEISMIC SINK •

'HOME CINEMA NOW ON DEMONSTRATION'

Just 2 minutes off Junc. 6 M25, (A25)

GODSTONE 0883 744755
45 High St., Godstone, Surrey RH9 8LS



7 ST. PANCRAS,
CHICHESTER,
WEST SUSSEX
CLOSED ALL DAY
MONDAY
Tel: (0243) 776402

Appointed stockists of: A+R Cambridge, Castle Acoustic, Creek, Dual, Goldring, Linn Products, Monitor Audio, Naim, Nakamichi, Quad, Rega, Rogers, Royd Audio, Spendor

LONDON & SOUTH EAST

"One of the 5
best hi-fi shops
in the world"

GRAHAMS HI-FI

Canonbury Yard, 190a New North Road
London N1 7BS, ☎ 071-226 5500
Ring for a chat, an appointment and a map!

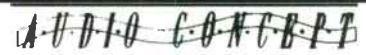

27 BOND STREET, EALING
LONDON W5 5AS
TEL. 081 - 567 8703

AMC, Acoustic Energy, Aura, Audiolab, Audio Innovations, B&O, B&W, Cannon, Castle, Cyrus, Denon, Dual, Evolution, JPW, KEF, Marantz, Micromega, Mission, Monitor audio, Musical Fidelity, NAD, Nakamichi, Onix, Onkyo, Quad, REL, Rogers, Rotel, Systemdek, Target, Teac, Thorens, Van den Hul.

10 - 6 pm Mon., Tues., Friday, & Sat.
Late night Thur., closed Wed.

Two demonstration rooms.
Free local delivery and installation.
Repairs and Services



BRIGHTON'S LEADING HI-FI SHOP

Cyrus, Roksan, Micromega, Audionote, Audiolab, Rega, Arcam, Exposure, Aura, Epos, Thiel, Ruark, Rotel, Marantz and other fine equipment.

66 Upper North Street, Brighton
Telephone 0273 775978

WORTHING AUDIO

20 Treville Gate, W.Sussex. BN11 1UA
(0903) 212133

The friendly shop with the best sound system in the South. Friendly advice

• 3yr guarantees • easy parking

Open Mon.-Sat. 10am-6pm Late night Wed. 7.30pm
Agencies include: Arcam, Exposure, Kinshaw, Naim Audio, Marantz, Ruark, Audio Technica, Target, Tripod, IPW, TDL, Orelle, and many more.....

Stockists of: ARCAM • CREEK • EPOS
HEYBROOK • MICROMEGA • NAIM AUDIO
NEAT • REGA • ROKSAN • ROTEL • ROYD
TEAC • YAMAHA

Infidelity
indecently good hi-fi

9 High Street, Hampton Wick, Kingston upon Thames, Surrey KT1 4DA. Tel: 081-943 3530
Open Tues - Sat 10.30am - 7.00pm.

FRANKIE IS BACK!

Ex-Luxman, Carver & Hafler chief engineer with his own back up team can custom-modify, rebuild, up-grade or repair any high-end equipment. Japanese spares, speaker bi-wiring service. To restore the best sound for modern & old classics, call Francis Wong on:-

專音家响

Tel: (0582) 411480 or Fax (0582) 451957

The Hi-Fi Shop

GUILDFORD'S SPECIALIST SINCE 1950

We are at:
3 BRIDGE STREET, GUILDFORD
(By the traffic lights - next door to Alfred Marks)
0483 504801 • 0483 304756

Access • Visa • Switch
Open Monday-Saturday 9am-6pm (later by appointment)



Spaldings
ESTABLISHED IN SOUND

☎ 081-654 1231/2040
352/4 LOWER ADDISCOMBE RD.,
CROYDON, SURREY



79/81 Fairfax Road
Swiss Cottage
London NW6 4DY
071 624 8855/6
Mon-Fri 10-7 Sat 10-6

alphason apollo audio innovations audio note audiolab denon
fuller helus heybrook impulse issos kar lyra michell micromega morel
ortofon pierre lurne project projekt qed royd sonic
tink sound organisation soundstyle sterling sughden sumiko
townshend trichard van den hul voyd home demonstrations, wide range
valve/transistor/analogue/digital, nice people, peculiar adverts.....

hifi for grown-ups
Signals
martlesham heath ipswich (0473) 622866

The Audio File



27 HOCKERILL
STREET, BISHOP'S
STORTFORD,
HERTS.
TEL: 0279 50576

Specialist Hi-Fi Dealers

♦ Open 9-5.30
 ♦ Demo Room
 ♦ Free Parking
 ♦ 0% Finance
 ♦ Closed Wed.

**A + R + C
AUDIO**
 QUALITY HI-FI

Denon, Harman Kardon, JPW, Monitor Audio, Micromega, Rogers, Rotel, Ruark

0344 762201

Peter Dand & Company Ltd
 Established 1963
 Bang & Olufsen, Quad, KEF, Thorens, TEAC, and many more!
 2 Demonstration Rooms
 2 Year Guarantee
 111 Clonskeagh Road, Dublin 6
 Tel. 01035 31 269 4433

MIDLANDS

MUSIC MATTERS

THE AUDIO SPECIALISTS

for the most exciting range of equipment available in the Midlands which includes:

Aiwa, AKG, Alchemist, Alphason, Apollo, Arcam, Audiolab, Audioquest, Audio Technica, Aura, Beyer, B+W, Cabletalk, Cambridge Audio, Canon, Celestion, Chord, Cyrus, Deltac, Denon, DPA, Dual, Epos, Exposure, Harman, Heybrook, Impulse, Infinity, KEF, Kenwood, Kinshaw, Lexicon, Lumley, Marantz, Meridian, Michell, Micromega, Mission, Mordaunt-Short, Monitor Audio, Monster, Musical Fidelity, NAD, Nakamichi, NVA, Onkyo, Panasonic, Pink Triangle, Pioneer, Polk, Pro-Ac, Pro-ject, REL, Revox, Rogers, Roksan, Rotel, Royd, Ruark, Sansui, SD Acoustics, Sennheiser, SME, Straitwire, Systemdek, Systym, Tannoy, Target, Thorens, Wharfedale, Yamaha etc...

OPENING TIMES:
 Tues - Thurs 10.30 - 6.00
 Friday 10.30 - 8.00
 Saturday 10.00 - 5.00
 Demonstration by Appointment

351 HAGLEY ROAD, EGOBASTON, BIRMINGHAM B17 8OL
 Tel: 021-429 2811

156/7 LOWER HIGH STREET STOURBRIDGE, WEST MIDLANDS OY8 1TS
 Tel: 0384 444 184

93-95 HOBSMOAT RO, SOLIHULL, WEST MIDLANDS B92 8JL
 Tel: 021-742 0254

"We are a BADA dealer" and "full service facilities"
 INTEREST FREE (for Ltd Period) APR 0%
 Written details on request. Licensed Credit Broker
 Switch card accepted



STOCKIST OF: HEYBROOK, NAD ROTEL, PHILIPS, MARANTZ, QUAD, PINK TRIANGLE, ACOUSTIC ENERGY, JPW, CELESTION, MUSICAL FIDELITY, TANNOY, TDL, NAKAMICHI, YAMAHA, KEF, SONY, AURA, PIONEER, ALBARRY AND MANY MORE...

38 WALNUT ROAD, CHELSTON, TORQUAY, DEVON TQ2 6HS
 TELEPHONE: (0803) 606863

Come to us for the largest selection of surround sound systems in the South West

CREATIVE AUDIO
 9 DOGPOLE, SHREWSBURY, SHROPSHIRE
 Tel: (0743) 241924
 Closed Mondays

- Comfortable listening rooms
- Home demonstrations available
- Part exchange welcome
- Free home installation
- Interest Free credit

Authorised retailer for:
 A & R ARCAM, AUDIOLAB, CELESTION, CYRUS, DENON, DUAL, MERIDIAN, MISSION, MONITOR, AUDIO, QUAD, REVOLVER, ROKSAN, ROTEL, YAMAHA, EPOS, NAIM, KEF, RUARK

STATION SOUNDS
 W O R T H I N G
 FOR A SELECTION OF VALVE AMPLIFIERS AND OTHER OLDER QUALITY EQUIPMENT

Valve amplifiers (combos and hi-fi) overhauled at sensible rates.
 Audio Note speakers and used Audio Innovations amplifiers stocked
 Valve and other equipment always wanted.

Mike Pointer 0903 239980 (including Fax)
 DOWN PLATFORM WORTHING STATION SUSSEX

Moorgate Acoustics Hi-Fi



Frustrated and confused?
 Call in and get some help and advice from a company that cares enough about its customers to put them first.
 184 Fitzwilliam St., Sheffield. Tel: (0742) 756048
 8 Westgate Chambers, Rotherham. Tel: (0709) 370666

W. OWEN EST 1900
Audio/Video Specialists
 Pioneer • Reference Point • Kenwood
 Sony • Akai • B&W
 Free Installation and Home Delivery

58 Market Street, Oakengates Telford, Shropshire Tel: (0952) 613818
 2A Stratford Street Newport, Shropshire Telford Tel: (0952) 810876

EIRE



"How can I buy the best HiFi?
 Phone us to find out!
 Choose from: AVI • Audio Innovations • LFD • Albarr • Heybrook • Triangle • Amrita • Proac • TDL • ATC • Micromega • Pierre Lurné • AMC • Rotel • Marantz • Kinshaw.
 We can help you choose wisely!
 Part exchange • Credit Card accepted • 3 demo rooms.
 Acoustic Dimension 16, Idrone mews, Idrone Lane, Black Rock, Co Dublin Fax/Tel: 01-2884612

We Never Compromise On Quality



55 Main St Blackrock Co Dublin
 Tel 2889449/2888477 Fax 2834887
 Open Tue/Sat 10AM-6PM, Thur/Fri 'till 9pm - Closed Monday

FRANK HARVEY
Hi-Fi EXCELLENCE

163 Spa Street, Coventry, CV1 3BB Tel : 0203 525200.
 Mon to Sat 9.30 till 5.30. Closed Thursday

MUCH MORE THAN HI-FI
 WE ARE A BADA DEALER

Audiolab • Audio Alchemy • Arcam • Alphason • Bose • Bang & Olufsen • Celestion • Cyrus • Denon • Dual • Foundation • Kef • Marantz • Monitor Audio • Mission • Musical Fidelity • Nakamichi • Nad • Quad • Rega • Rogers • Rotel • Target • Wipod • Tannoy • Thorens • Van Den Hul • Yamaha
MAILORDER • EXPORT • HOME TRIALS

3 Floors, 3 Dem rooms, 3000 sq feet in the pursuit of Hi-Fi Excellence



AUDIO EQUIPMENT FROM LEADING AND SPECIALIST BRANDS ON TWO FLOORS FOR YOU TO LISTEN AND CHOOSE FROM

- 3 Demonstration Rooms
- Home Trials
- Home Cinema - Instore Demonstration Theatre
- Audio Visual Equipment
- Evening Demonstrations by appointment
- Inhouse Service Department
- Mail Order Available
- Interest Free Credit on Selected Items (Apr. 0% - Written details on request)



Hi-Fi for the Beginner, the Enthusiast and the Audiophile Telephone (0922) 493499/473499

ACUSTIC ENERGY • ARCAM • ALEMA • AUDIO LAB • APOLLO • A.T. • AUDIO ALCHEMY • AUDIO QUEST • BAW • BOSE • BEYER • CABLE TALK • CHORD COMPANY • CHORD • CYRUS • CELESTION • DPA • EPOS • EXPOSURE • INFINITY • JPW • KEF REFERENCE • KENWOOD • MARANTZ • MICHELL • MONITOR AUDIO • MONSTER • MORDAUNT SHORT • MERIDIAN • MICROMEGA • MISSION • MOTH • MUSICAL FIDELITY • NAKAMICHI • ORTOFON • PROJECT • QUAD • ROKSAN • ROGERS • ROTEL • SENNHEISER • SONY • SPENDOR • SUMIKO • SYSTEMDEK • TARGET • TDL • THORENS • TRIANGLE • TUBE TECHNOLOGY • VAN DEN HUL • VANDERSTEEN • YAMAHA • YBA

Sharing the ASDA Carpark with ample free parking. Off High Street, Bloxwich, Nr. Walsall, West Midlands Near M6 Jnc. 10 & 11
 Open 6 Days, 9am - 6pm Late night Friday

Bloxwich: M6 Jnc 10
 Walsall: M6 Jnc 10
 M5 Jnc 11

Quality, Clarity, Expertise... and that's just the service!

Specialist Hi-Fi Dealers

Peter Ellis Audio

A wide range of audio products always in stock including:
Quad, Denon, Stax, Marantz, Arcam, Creek, Sugden, QED,
Castle, Rogers, Celestion, Tannoy, Nakamichi, Yamaha

- * Home Cinema available *
- * Demonstration Room *



29, Kirkgate, Newark,
Nottinghamshire NG24 1AD
0636 704571



Well engineered products for accurate sound reproduction from: Arcam, ATC, Audioquest, Audio Technica, AVI, Beyer, Cable Talk, Castle, Chord, Denon, Dual, Klipsch, Michell, Nakamichi, Ortofon, QED, Quad, Revox, Sennheiser, Sequence Design, SME, Spondor, Target, TDK, TDL, Thorens, etc., Keith Monks Record Cleaning Machine.

Five Ways Hi-Fidelity Ltd., (Est. 1972)
12 Islington Row
Edgbaston, Birmingham B15 1LD



You can come and visit us at:
**25 HENLEY STREET,
STRATFORD CV37 6GW**
Contact Dirk or Jamie on:
Tel/fax No. 0789 414533
We are stockists of the leading
Hi-Fi brands including:

ARCAM, SONY, PANASONIC, NAKAMICHI, B&W, PIONEER, TECHNICS, DENON, NAD, KEF, MARANTZ, ROTEL, MUSICAL FIDELITY, MONITOR AUDIO, MISSION, TANNY, QUAD, TDA & SENNHEISER, YAMAHA, CELESTION, ACOUSTIC RESEARCH, AUDIOQUEST, MONSTER, TARGET, BEYER, SYSTEMDEK.

2% Finance is available on selected products and all major credit cards accepted. We also have a Demonstration Room and Service Facilities.
Monday to Saturday 9.30-5.30. Late night Wednesday
"WHERE FRIENDLY SERVICE STILL COUNTS!"

WEST & WALES

ENGLISH

audio

EADE

CYRUS CENTRE

PINK TRIANGLE-AUDION-SYSTEMDEK-HEYBROOK-
MICH-KEF-REFERENCE-MICROMEGA-NAKAMICHI-CHORD-
ARCAM-MUSICAL FIDELITY-ROGERS-NAD-ROTEL-DENON-
TANNY-MARANTZ-MISSION-STAX-DUAL-TDL-ALBARRY-JPW-
CELESTION-IAOS-SME-RUARK-MOTH-AUDIO TECHNICA-
EXPOSURE-AND OTHERS.

Free installations. Credit Facilities. Service Department

Mon. Sat. 10.0-6.0

95 Whitecross Road, Hereford HR10 1EG, 01432 35081

NORLOSTONE

MARBLE - GRANITE - STONE SPECIALISTS

GRANITE AUDIO STANDS. The ultimate solution to problems of resonance and tonal accuracy. For 'bespoke' designs consult **NORLOSTONE**, West Dean Road, West Tisbury, Salisbury. SP5 1QG. Tel: 0980 862253

V AUDIO

Tel: 0272 686005

36 Druid Hill
Stoke Bishop

ATC, AVI, Acoustic Energy, Audio Innovations, Alon, Audiomeca, Audio Technica, AMC, Analogue Electronics, Cadence Valve, Chord AMPS, ElectroCompaniet, Exposure, Goldring, Harman Kardon, Heybrook, Jamo, LFD, Lyra, Ortofon, Perception, Pink Triangle, Ruark, Michell, REL, Sansui, SME (inc. 20A), Sonic Link, Stax, Sugden, Sumiko, Townshend, Triangle, Wadia.

Demos by appointment only. Home trial facilities. Free installations. Servicing facilities. We are not a shop

NORTH



ARCAM • MERIDIAN • MISSION • CYRUS • AUDIOCAB • B & W • NAKAMICHI • AURA • DENON • QUAD • YAMAHA • KEF • MARANTZ •

ROKSAN • NAD • MF • AIWA • DUAL • CELESTION • ROGERS • AUDIOQUEST • TECHNICS •

WEST STREET • ALDERLEY EDGE • PLUS HOME CINEMA • CHESHIRE • TEL: 0625 582704 • INTEREST FREE CREDIT • DISCOUNT CD & TAPE • BADA •

Audio Reflections

DISCOVER ACCURACY IN FIDELITY

On permanent demonstration exclusively in Yorkshire and the North East of England - ATC: SCM10, SCM20, SCM20 Tower, SCM50A and SCM100A, ATC, AV International, Bryston Amplifiers, Castle York, Chester & Howard, Concordant, Chord SPH Power Amplifiers, Equinox, Harbeth Acoustics, JPW, Sequence Loudspeakers, Marantz, Michell Gyrodec, Mech, Ortofon premier range, Rotel, Sansui, reference grade fully balanced CO players and integrated amplifiers, SME, Spondor, Target, TEAC, Townshend Sessme Sirk, Q.E.O., van den Hul, The First & The Second Cables. Demonstrations by arrangement in LEEDS, or in your own home without obligation. For further details contact JOHN BLEAKLEY, Phone/Fax LEEDS (0532) 528850 (evening calls welcome) Part Exchange and Second Hand Equipment available.

TEAC® Perfectly Balanced Sound

MICHI

spondor

CASTLE

AVI

ORFON

ROTEL

SANSUI VINTAGE LINE



Near Norwich
Norfolk
Tel. (0508) 570829

Basically Sound of Norfolk

STOCKISTS OF LEADING HI-FI

Arcam, Naim, Audiolab, Epos, Denon, Nakamichi, Acoustic Energy, Heybrook, Micromega, Rotel, TDL, The Chord Company, Sound Style etc...

Swift

THE hi-fi SPECIALISTS

57 ANN'S PARADE (ON A34) WILMSLOW, CHESHIRE

☎ (0625) 526213

• 2 YEAR GUARANTEE • EASY PARKING
• DEMO ROOM • PART EXCHANGE



AIWA • Audio Lab • Aura • B & W • Castle • Denon • Cyrus • Celestion • JPW • Kenwood • Marantz • Mission • NAD • Pioneer • Rotel • Systemdek • Tannoy • Technics

Retailers of Fine Audio Equipment

Compton

- ▶▶ EPOS
- ▶▶ ONIX
- ▶▶ DENON
- ▶▶ LINN
- ▶▶ AUDIO ALCHEMY
- ▶▶ ARCAM
- ▶▶ B&W
- ▶▶ NAKAMICHI
- ▶▶ ROYD
- ▶▶ TARGET
- ▶▶ TRIPPOD
- ▶▶ LOUSY COFFEE

▶▶ SUPERB DEMO FACILITIES

▶▶ FULL INSTALLATION & HOME DEMO SERVICE

OPEN 6 DAYS A WEEK
OTHER TIMES BY APPOINTMENT

0260
297544

1/7A Duke St Compton Cheshire CW12 1AP

REPAIRS/DIY



Chelmer Valve Company
for
Audio Valves

Buy CVC PREMIUM Hi-Fi valves direct from us. All valves processed for improved performance. We also have Stock of MAJOR BRAND types including: MULLARD, GEC, BRIMAR, RCA, GE, etc
130, New London Road, Chelmsford, Essex, CM2 0RG
Tel: 0245 265865 Fax: 0245 490064

TECHNICAL & GENERAL

THE ORIGINAL TURNTABLE SPECIALIST for the Great Classical Turntable, Arms, Cartridges, Styli
CONNOISSEUR • GARRARD • GOLDRING • Lenco • ORTOFON • SHURE • S.M.E. • THORENS • WATTS

All available Genuine spares and our own re-manufacture obsolete parts Servicing and Overhuls, to original technical specifications.

NO ILLUSORY 'IMPROVEMENT' NO DUBIOUS OR HARMFUL 'MODIFICATIONS' Remedial Services available

Cartridge and styli, correct radius diamond, for early recording - 78s & Lps

TECHNICAL & GENERAL

P.O.Box 53 Crowborough, East Sussex TN6 2BY
Tel: 0892 65 45 34

SOUNDS AROUND

NEW & USED HIFI

Professional Service Repairs and Accessories

146A Clarendon Park Road, Leicester
Telephone : 0533 702442

Sussex Surplus

Original Mullard GEC Valves for sale & wanted for cash

Sussex Surplus
13 Station Road, Horsham, West Sussex.
Tel: 0403 251302

Sowter Transformers
EA Sowters Ltd
PO Box 36
Ipswich IP1 2EL
0473 219390/252794

Output and mains transformers for GEC KT88 circuits. Can also make any other transformer to order. Send SA for lists and data.

SOVTEK VALVES

6550WA. 6L6WG/C/5881. EL34G.
12AX7WB/7025. EF86/6267

(Over 1000 different types of valves stocked S.A.E. for list DEPT. HIFW)

Wilson Valves, 28 Banks Ave, Golcar, Huddersfield, West Yorks, HD7 4LZ

Tel: 0484 654650/420774 Fax: 0484 655699

Mail order only, Visa etc.

HI-FI YOU CAN'T AFFORD not to listen to

EQUIPMENT BY ABSOLUTE SOUNDS, AUDIO INNOVATIONS, SUGDEN, IMPULSE, MICHELL, ROKSAN, PINK TRIANGLE, ACCUPHASE, THIEL, COUNTERPOINT, SONIC FRONTIERS, TRICHORD RESEARCH ETC.
By appointment only

SERIOUS KIT
061-707 4823

Specialist Hi-Fi Dealers

Lockwood Audio

Tel: 081-207 4472 Fax: 081-207 5283

WE BUY AND SELL
NEW, USED AND VINTAGE
SPEAKERS, DRIVERS, CABINETS, PARTS.

SPEAKER REPAIRS

THE

Authorised **TANNOY** Specialist

MAJOR CREDIT CARDS WELCOME



IMPERIAL STUDIOS,
MAXWELL ROAD,



BOREHAMWOOD, HERTS. WD6 1WE

GT AUDIO

Specialises in the repair of all types of
audio equipment (including valve). All
work is guaranteed and carried out to
the highest standard.

Tel: 0895 833099

AUDIO COUNSEL HI-FI SPECIALISTS

LINN, NAIM, REGA, ARCAM, ROTEL, ROYD,
SHAHINIAN, DYNAVECTOR, EPOS, MARANTZ,
NAKAMICHI, MICROMEGA and many more....
"Time spent with staff may prove to be a particularly wise investment"

Audiophile

12/14 Shaw Road, Oldham OL1 3LQ
Tel. 061 633 2602

MUSIC

CD SELECTIONS

The UK's leading suppliers of bargain CDs and music
for your free catalogue contact

CD SELECTIONS
PO BOX 1011

DORCHESTER DORSET D12 7YG
Tel. 0305 848 725

THE Music Station

• MISSION • DENON • ROTEL • PIONEER • SONY • KEF • TEAC •
• WHARFEDALE • CELESTON • JAMO • MUSICAL FIDELITY •
• MARANTZ •

LISTENING FACILITIES AVAILABLE
FOR ALL THE BEST IN HI-FI

Contact

THE MUSIC STATION
49 Church Street, Inverness. Tel: (0463) 225523

SERVICES & CONSULTANTS

service and repairs

maintenance to almost all brands of hi-fi.
in guarantee repairs to Kenwood,
pioneer, Aiwa, Panasonic, Technics,
Teac, Yamaha and others.
All repairs guaranteed for 3 months.

mwes electronic services.

5, King St. Delph, Oldham.

Tel/fax 0457 820862

REVOX SERVICE

A77, B77 PR99

For fully guaranteed professional service and
repairs, call RamTek.

Tel: (081) 207 6159. Fax: (081) 953 1118
Suite 33, Kinetic Centre, Theobald Street,
Borehamwood, Herts WD6 4SE

L.G.S AUDIO SERVICES.

Quality Audio Equipment and Hi-Fi Systems
Repaired and Serviced at Reasonable Cost

2nd Floor, Forest Mills, 133 Alfreton Road,
Radford, Nottingham NG7 3JL

Tel:- 0602 24443

STAFFS & DERBY

HOW TO SAVE £100 ON YOUR HI-FI

Choosing the right Hi-fi and saving money is a difficult
task, make it easy on yourself.

To get your copy of "Guide to Buying Hi-fi"
just telephone

FREEPHONE 0800 373039

We will send you one Free of Charge together with our
Fact Pack and see how you can save £100 on
recommended Hi-fi Systems.

Active Audio

12 Osmaston Rd. 29 Market Street. 95 Stafford Street.
The Spot, L'arnworth, Hanley.
Derby Staffs. Stoke-on-Trent.
Tel: 0332 380385 Tel: (0827) 53355 Tel: 0782 214994

SCOTLAND

ANCURUM ELECTRONICS

YOUR LOCAL HI-FI SHOP

PIONEER, TECHNICS, PROLOGIC AMPS + LASER

DISC FOR HOME ENTERTAINMENT

TEL: (0382) 480030

39 GRAY ST., BROUGHTY FERRY DUNDEE
Dedicated Dolby, Pro-logic listening rooms

Silver Sounds and Sonic Link cables tailor-made to your
requirements.

Check out the latest impedance matched Goertz cable
from Townsend Audio. Cogan-Hall Cables.

Contact Mike Gilmore for professional advice and friendly
service.



Linnore, Avoch, Ross-shire IV9 9RP
TEL/FAX 0381 620655

THE AERIAL SHOP

188 Halfway St, Sidcup, Kent. (London SE & Kent areas covered)
Tel:- 081 300 5588/8990/7454

GET THE BEST FROM YOUR HI-FI

100's of Aerials, 100's of fittings for Hi-Fi Aerials, TV
Aerials & Satellite Dishes DIY or fitted by our Engineers.

Quality equipment stocked e.g.

ANTIFERRENCE, TRIAX, LAB GEAR ETC.....

T.V.M. Audio Visual

The Antenna Specialists

52 St Andrews Street
Northampton NN1 2HY

Tel:- (0604) 37769

Fax:- (0604) 601845

High quality FM Radio and T.V. Aerials. Mail Order
Please phone for more details

OVERSEAS

Sum of the parts.

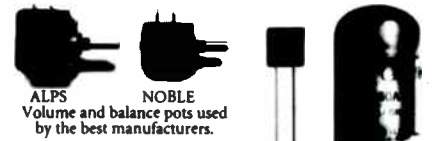

ALPS NOBLE
Volume and balance pots used
by the best manufacturers.

KIMBER KABLE
Precision crafted wire,
connectors and caps.



VISHAY
A resistor
without equal.



GOLD AERO
Selected, tested,
guaranteed.



MIT MULTICAP
World's finest film capacitor!

The very best in audio grade parts,
upgrade/mod kits and complete kit products.
Call, write or fax for our catalogue.

SONIC FRONTIERS INCORPORATED

2790 Brighton Road, Oakville, Ontario, Canada L6H 5T4
Telephone (905) 847-3245 - Fax (905) 847-5471

MIT MultiCap • Wonder Cap • Kimber Kap • Solen • Siemens
Hovland MusiCap • Wima • Holco • Draloric • Vishay • Caddock
Mills • Matsushita • Noble • Kimber Kable • Cardas • Discovery
Audioquest • Alps • Bourns • Shalco Attenuators • Electroswitch
Elma • CTS • Elna • Nichicon • Gold Aero • RAM • N.O.S. Tubes
Linear Technology • Burr Brown • Analog Devices/PMI • Motorola
Edison Price • Pearl • Tube Sockets • WBT • Neutrik • Kits

Hi-Fi World Specialist Dealer Directory Order

Book 12 Months For A 30% Discount!!
Or 6 Months For A 20% Discount.

I wish to be included in Hi-Fi
World's Specialist Dealer Directory
starting the _____ issue for a
total of _____ insertions.

Please find enclosed my
artwork/copy details.

I wish to book _____ column
centimetres at £12.50 per col. cm.

Name _____
Company _____
Address _____

Postcode _____
Telephone No. _____

Please return to **Amanda Sweeney**
Hi-Fi World, 64 Castellain Road,
London W9 1EX

WORLD DESIGNS

by Mail Order

world audio design mail order

K5881 KIT

£395 ▼



A superb, Class A, 20watt stereo power amplifier that uses the Russian 5881 output valve, a military version of the American 6L6, designed for low distortion audio work. It has super-quality output transformers (4/8/16Ω selected internally) to minimise distortion and the input stage uses triode working. A rugged, sixteen-gauge, all-welded steel chassis is provided, together with protective bottom plate for safety.

Designed for long life, low running costs and excellent sound quality, K5881 is sensitive enough to be used with a simple passive pre-amp. or our own line-drive pre-amp, and it matches modern loudspeakers well. There is a choke-regulated power supply and the channels can be paralleled to turn it into a 40W monoblock if desired.

SPECIFICATION		Noise (CCIR)	-103dB
Power	20watts/ch.	Sensitivity	240mV
Frequency resp.	16Hz-40kHz	Weight	16kgs(34lbs)
Distortion	0.02%	Dim. (mm)	300x400x180
Separation	60dB		

The kit comprises a strong 16-gauge mild steel chassis, fully punched, welded and ground smooth. Finish is a durable 'powder coat' black. A protective bottom plate is provided for safety. Output terminals (one pair) take 4mm plugs axially and radially for bi-wiring, or heavy gauge bare cable. Output options of 4/8/16Ω are selected internally at the transformer. A small circuit board carries most of the components. Can be monoblocked for 60watts.

All parts are included in the kit, except valves since different 300B makes are available.

SPECIFICATION		Separation	54dB
Power	28watts	Noise (hiss/hum)-100dB/-72dB	
Frequency resp.	5-18k-nfb	Sensitivity	240mV
	50k-fb	Weight	20kgs(44lbs)
Distortion	0.2%	Dim. (mm)	405x295x175

4W SINGLE-ENDED VALVE AMP KIT £385 ▼



The 4W Single-Ended amplifier kit is a line level integrated amplifier. It comes with three line level inputs and a tape output. High quality components are used throughout, including polypropylene signal capacitors, Alps volume control, custom C&K gold plated selector switch etc. Valves are included.

SPECIFICATION			
Power	4watts	(hum)	0.7mV
Freq. Response	9Hz-64kHz	Sensitivity	180mV
Distortion	1.3%	Weight	10Kgs (22lbs)
Separation	74dB	Dim. (mm)	260x200x180
Noise (hiss)	-100dB		

DEMONSTRATIONS!!

Most of our products are on demonstration at Hi-Fi Confidential, 34 Buckingham Palace Road, Victoria, London. Phone the patient and understanding Luigi on 071-233-0774 to check availability. He's a valve aficionado, and stocks plenty of good products - including World Audio Design.

300B VALVE AMP KIT

£850 ▼



This is a specialised amplifier based on the highly linear 300B triode valve. Our 300B runs in Class A, giving one of the most sweet, open and neutral sounds possible today. Matched with good loudspeakers, it is unsurpassed.

See page 83 for order form...

WORLD DESIGNS

by Mail Order

VALVE LINE LEVEL PRE-AMPLIFIER £295

Constructed from heavy gauge steel with an aluminium anodised and polished front panel. This new chassis comes with the complete kit of parts necessary to build the valve line level pre-amp.

The components are all high quality and include a special screened toroidal transformer, Military Spec. Russian valves, Alps potentiometer, polypropylene signal capacitors, silver plated copper wire etc. Dimensions (mm) 290x200x80



HIGH DEFINITION LOUDSPEAKER

The High Definition loudspeaker is ideal for low power, high quality amplifiers, transistor or valve. It goes very loud with just 1-5watts, having an enormous sensitivity of 94dB - that's 8dB more than most other speakers. It is also a very easy load for valve amps (8ohms) and it gives a terrifically dynamic and fast sound. This speaker is also unusually suited to low powered vintage amplifiers, such as Quad IIs, Radfords, Pye Mozarts and such like.

The High Definition loudspeaker is available in two forms; as a drive unit pack containing two bass units and two tweeters modified and tested, or complete with all crossover components, gold plated bi-wire terminal dishes, silver plated copper wiring and long haired wool.

Drive Unit & Crossover kit etc

£195

Drive Unit Pack £145



HIGH TECH AUDAX DRIVE UNITS

The 1994 range of Audax drive units sees many modern high tech materials and technologies that would normally be unavailable to the home constructor. We offer a small range of the highest quality drivers, including High Definition Aerogel (HDA) units, carbon fibre and three superb soft dome tweeters. Sadly there isn't enough room to print the specs, but if you are interested in any of the following drivers, please ask us for a detailed spec sheet.

Audax Drive Units:

CAST CHASSIS UNITS ▶

	4 inch mid	6.5inch bass/mid	8inch bass
HDA.....	HM130Z0.....	HM170Z0.....	HM210Z0
CARBON FIBRE.....	HM130C0.....	HM170C0.....	HM210C0
NEW 3inch HDA mid,	HM100Z0		

NEW

CLASS A 36W SOLID STATE MONOBLOCKS

£580/pr.

A pure Class A transistor design offering superb clarity and transparency. The Class A monoblocks use special new super grade audio transistors. They are extremely fast and linear, giving a super measured performance without the need of high levels for feedback.

We can supply a parts pack containing only those specialised parts not widely available: eight output transistors (4 per channel) and two circuit boards cost £129.40 inc P&P and VAT. Individual output transistors cost £9.80 each, the 2SC2240 and the 2SA970 are 80p each.

SPECIFICATION

Power (8Ω)	36watts	Distortion (%)		
Frequency Resp.	1Hz-50kHz	1W		Full O/P
Noise	-104dB	1kHz	0.003	0.005
d.c. offset	3mV max	10kHz	0.008	0.04

NEW

THREE WAY CARBON-FIBRE DRIVER LOUDSPEAKER

This is our third loudspeaker design and the most advanced to date. KLS3 uses extremely light and stiff carbon fibre cone drive units for a fast and accurate sound. A dedicated 4inch carbon fibre midrange drive unit provides the cleanest, smoothest and most detailed midrange characterised by superb projection. The treble is handled by a sweet sounding fabric dome tweeter and for real bass power and articulation a light and stiff 8inch carbon fibre bass driver is employed.

KLS3 has been engineered to get the best from your amplifier, be it valve, solid state, single-ended or zero feedback. Its High 90dB sensitivity and near flat 8Ω impedance make it one of the easiest loudspeakers to drive.

KLS3 is available in three forms: Drive unit pack £230; Drive units + crossover etc (just about everything but the wood) £350; fully built, tested and finished in high quality, real wood veneer for £1500.



FABRIC DOME TWEETERS

- TW025M0 (25mm 92dB suitable for 2-way systems)
- TW025M1 (25mm 92dB suitable for 3-way systems)
- TW034X0 (34mm 93dB a large dome with powerful sound)

Classical

Peter Herring



BELA BARTOK
Rhapsody No2 for violin and piano/Hungarian Folk Songs/Sonatina/Hungarian Folk Tunes/ Sonata No I for Violin and Piano
 Susanne Stanzeleit, violin; Gusztav Fenyó, piano
 ASV CD DCA883 (DDD/68.41)

Violin Sonata of 1921 came at a critical time in the composer's development. Within the formal, three-movement structure, Bartok gives his imagination and his technique free rein and the result is compelling and exciting, not least in the rondo finale, with its clear debt to Romanian folk music.

Romanian folk dances and, for that matter, several aspects of folk dancing's performing style, are distilled into the exhilarating Second Rhapsody, which inspires Susanne Stanzeleit and Gusztav Fenyó to some breathtaking playing. And the same can be said of the Sonatina, another set of transcriptions for violin and piano, this time by Andre Gertler. Above all, the programme here provides a revealing insight into the way that classical disciplines were fused so effectively with eastern European folk music and performing styles in Bartok's music. If, like me, you enjoyed the first CD in this series, you'll love this one.

CARL NIELSEN
Prelude to Act II of Saul and David Op25/Clarinet Concerto Op57/An Imaginary Journey to the Faroe Islands/Flute Concerto/ Springtime on Funen-Lyric Humoresque Op42

Asa Baverstam, soprano; Kjell Magnus Sandve, tenor; Per Hoyer, baritone; Linnea Ekdahl, girl soprano; Andreas Thors, boy soprano; Swedish Radio Choir; Stockholm Boys' Choir; Swedish Radio Symphony Orchestra; conductor, Esa-Pekka Salonen
 SONY CLASSICAL SK 53276 (DDD/75.02)

● An all-Scandinavian production: Swedish performers, Finnish conductor, and music by Denmark's greatest composer. Not, for once, one of the six symphonies which are the cornerstone of Nielsen's output, but two of his concertos and three less-well known orchestral pieces.

A pan-European selection with music from Renaissance Italy, twentieth-century Denmark, by a Pole whose finest work was created in Britain, and work from a Hungarian for whom east European folk music proved an endless source of inspiration.

● This is the second collaboration between these musicians in the music of Bela Bartok and the partnership once again produces highly enjoyable results (the previous release was on ASV CD DCA852). As the booklet note points out, although Bartok was a virtuoso pianist, it is not at all surprising that he also made a substantial contribution to the violin canon. During his years in Hungary, he partnered some of the finest violinists of the age. And then there was the long tradition of violin playing at the heart of Hungarian and Romanian folk music.

The Magyar flavour permeates much of the music here, although the folk element is explicit in only two works, both transcriptions for violin and piano from the piano original. In the Hungarian Folk Songs of 1908-09, Bartok collaborated with Tivadar Orszagh and, in the Hungarian Folk Tunes of the same period, but to a lesser extent, with the legendary Jozse Szigeti. It's infectious stuff, played with great elan and evident enjoyment.

Of the other works here, the First

Continue on page 87 ... ▶▶

NA
AD

POST
CREF

OVER
All our
tax (VAT)
carriage
Surface
expenses
We pay

RECORD OF THE MONTH

Should there have been any lingering question about the international status and appeal of Britain's Tallis Scholars, here surely is the ultimate recognition. It was they who were invited to Rome last February to celebrate the four hundredth anniversary of the death of Giovanni Pierluigi da Palestrina, arguably the greatest composer of the High Renaissance and, for Italians, the musical equivalent of Michelangelo, Raphael or Leonardo. By any measure, quite an accolade.

There were concerts over three days in the splendid setting of the Basilica of Santa Maria Maggiore, one of four religious foundations in Rome in which Palestrina is known to have been employed. The Basilica was chosen for both its splendid acoustic and because it has little changed since Palestrina's time. (of the other locations, the Church of

St John Lateran has been extensively rebuilt, St Peter's was impractical and, if you have heard recordings made in the Sistine Chapel, you will know that the adjective 'atmospheric' barely begins to describe the amorphous clouds of sound it produces!)

Palestrina's position at the apex of Renaissance music remains unassailable, not only through the matchless body of work which he produced, but because he stands at one of music's great crossroads. By the mid-sixteenth century, the development of the Franco-Flemish style of composition had reached such a level of elaboration and technical effect that the Church was coming to the conclusion that composers had completely lost sight of the original purpose - music was intended to enhance understanding of liturgical texts, not obscure them in a

web of sound.

Discussion of the problem which - difficult as it may be to accept these days - could have altered the whole course of the development of western music, was instigated by Pope Marcellus II in 1555 and discussed by his cardinals at the ensuing Council of Trent. It is probably a mixture of fact and fiction, but the story goes that Palestrina wrote his *Missa Papae Marcelli* to demonstrate to the Pope and his clerics that it was possible to combine liturgical demands and musical aspirations to the satisfaction of both parties, with a style of polyphony, fusing clarity and concision with beauty and splendour. Given the historical importance of this work, it was only fitting that it should become the centrepiece of the Tallis Scholars' commemorative concerts, 'Live in Rome'.

GIOVANNI PIERLUIGI DA PALESTRINA

Missa Papae Marcelli/ Stabat Mater/Motets: Surge illuminare; Alma Redemptoris Mater/Magnificat and Numc dimittis

GREGORIO ALLEGRI

Miserere
The Tallis Scholars, director Peter Phillips

GIMELL CDGIM994 (DDD/73.19)

Scholars' finely-shaped performance demonstrates, three of the five movements remain rooted in the 'old' polyphonic style. Was this Palestrina's way of making the change evident in the other two movements all the more emphatic? Certainly, the double-choir motets reflect the new approach, with the music quite clearly the servant of the words

Peter Phillips unashamedly admits that the opportunity to perform the famous *Miserere* by Gregorio Allegri in

this moment of self-indulgence.

Originally, this setting of the *Miserere* (Psalm No5) was the exclusive property of the Sistine Chapel Choir and sung by them just once a year, during Holy Week. Anyone caught trying to smuggle out a copy of the piece was liable to nothing less than excommunication (and you thought today's record contracts were draconian!). But copies did reach the outside world and a certain Wolfgang Amadeus Mozart, having heard the work just once, promptly wrote it out from memory.

Allegri's *Miserere* shares, along with the rest of the music here, fine recorded sound, engineered by Philip Hobbs with the assistance of Ben Turner. But those accustomed to listening to the Tallis Scholars in a kind of spiritual quietude will have to adjust to the applause which follows each work. Somehow, applause doesn't seem to equate with the celestial, contemplative nature of this music but it would be churlish to deny the choir the appreciation it has so richly earned. In his usual lucid notes, Peter Phillips reveals: "I felt that we had touched the spirit of this unsurpassed master as never before."

I couldn't have put it better.

The Tallis Scholars' 'Live in Rome' is also available on VHS videocassette - GIM VP994 - and Laserdisc - GIM LD994 - both highly recommended if you want to combine the visual experience with the aural.

● It is not just the uniqueness of the occasion which makes this recording so reasonable, or the fact that one is simply swept away by the performances. Equally commendable is the attempt to represent the full range of Palestrina's art, from the brilliance of the double-choir motets to the profound, deeply-moving setting of the *Stabat Mater* (*Stabat Mater dolorosa, iuxta crucem lacrimosa* - The grieving mother stood, weeping by the Cross), one of the supreme achievements of the late Renaissance, and of the composer's last years (it dates from around 1589-90). What a contrast with the bright exultation of the *Magnificat*, which of course presents a very different depiction of the Virgin.

As mentioned in the introduction above, the *Missa Papae Marcelli* marked a turning point in music yet, as the Tallis

the glorious acoustic of Santa Maria Maggiore was irresistible. Hearing the end result, with Deborah Roberts' soprano hitting those spine-tingling high Cs and the thrilling antiphonal interplay between the voices, you can forgive him

The Tallis Scholars LIVE IN ROME



*Peter Phillips
directs the
Palestrina 400 Concert
including
Allegri's Miserere*



Gimell

Classical



Nielsen had planned to write concertos for all the wind instruments of the orchestra but, in the event, only completed those for clarinet and flute. Neither is especially virtuosic, the emphasis being more on simplicity and lyricism. But both are attractive, idiomatic works and the Clarinet Concerto evokes echoes of the notorious Fifth Symphony with its 'disruptive' role for the side-drum. Both soloists here are impeccable, Per Flemstrom the flautist and Hakan Rosengren the clarinetist, and both are recorded with a fullness and firm focus, if perhaps a little too closely.

The Imaginary Journey to the Faroe Islands is a kind of orchestral narrative, not unlike Nielsen's magnificent Helios Overture which, I believe, has yet to appear on CD. It begins slowly, broodingly, evolving into a glorious orchestral tutti. Nielsen derived some of the thematic material from a Faroese folksong, Easter bells chime softly, and it is used most effectively.

Saul and David is a fine opera which, sadly, has never become established in the repertoire. However, the colourful Prelude to Act II with its 'pomp and circumstance' opening, has justly become a concert showpiece and makes a stirring opener here. It is splendidly played, too. The programme concludes with Nielsen's 'folk cantata' Springtime on Funen. The island of Funen was Nielsen's birthplace and his love for it never diminished. Here, in a simple, joyful, tuneful fashion, the people of Funen celebrate the coming of spring. At its heart is a sequence where an old, blind musician plays the clarinet while the young people of the island dance around him. It is difficult not to imagine that Nielsen was recalling his own father here, an itinerant country

musician. Though written in the style of Danish folk music, Nielsen made no specific use of folk melodies and this charming work ends with an ecstatic proclamation of spring's arrival.

Delightful performances throughout, and the recording - made using Sony's 20-bit Super Bit Mapping system - is strikingly truthful.



ANDRZEJ PANUFNIK **Sinfonia Concertante for** **Flute, Harp and Strings*/** **Concertino for Timpani,** **Percussion and** **Strings/Harmony**

Karen Jones, flute*; Rachel Masters, harp*; Richard Benjafield, percussion; Graham Cole, timpani; London Musici; conductor, Mark Stephenson

CONIFER CLASSICS CDCF 217
(DDD/54.48)

● From first to last, an enriching musical experience. What a distinctive and appealing voice, Andrzej Panufnik possessed, and how the earlier neglect of his work now seems so misguided and unfair. I had not read the booklet note before playing the first piece here, the Sinfonia Concertante. Beguiling, enchanting, magical, mysterious were the adjectives that sprang to mind, as I was mesmerised by its poetic utterances on the flute and the glittering droplets of sound cascading from the harp. It was only later that I discovered that the composer had dedicated the work to his wife, Camilla, beginning and ending it with a C to represent her initial, and placing another C at the very centre. Now its warm, gently lyrical nature was explained.

But it is not an exclusive pleasure: anyone can share in and enjoy this richly expressive, highly inventive music, and I feel sure the composer would have appreciated Mark Stephenson's finely-judged and clearly sympathetic direction. The playing of both soloists and orchestra in what Panufnik considered his 'Fourth Symphony' is first-class.

The Concertino for Timpani, Percussion and Strings is a more extravert piece. As with so much of Panufnik's music, the music grows organically from a 'cell' or motif, in this case made up of the four notes F-G-B-C. Its development is then governed by both musical and extra-musical considerations (Panufnik was fascinated by geometric patterns, especially those occurring in nature).

Equally apparent here, though, is the composer's mastery of instrumental colour: sample the eeriness of the pedal timpani played glissando in the fourth movement, Canto II. The work opens with a dialogue between the tubular chimes and strings, punctuated by a dazzling solo on the vibraphone, then continues to explore the potential of the last instrument, along with the timpani, in music of vivid originality. The Intermezzo finds four unpitched drums, three triangles and three cymbals having a splendid time against a backcloth of chordal strings in quintuple time, while the finale is an explosion of triple rhythms and cross-accented culminating in an exhilarating quasi-cadenza for timpani and unpitched drums. The Concertino was composed in 1979-80 and received its first concert performance in 1981. Quite why no recording company has seized upon its sonic potential before is quite beyond me, so all credit to Conifer, and to Technics Hi-Fi who - as with a number of other Panufnik recordings - have provided the finance to allow this recording to be made.

The final work here, Harmony, dates from 1989, just two years before the composer's death. No diminution of creative power or energy is evident from the intensity and craftsmanship of the writing; quite the reverse. Andrzej Panufnik's creative spirit was as fertile as ever, producing a haunting dialogue between strings and woodwind groups and enlarging the normally vertical notion of harmony into other planes. The playing here, as throughout this recording, is wholly committed and the recorded balance is exemplary. Andrzej Panufnik, for so long denied proper exposure for his music, could wish for no more eloquent exponents.



GT AUDIO

CROFT "EPOCH"



THE NEW CROFT EPOCH VALVE PRE-AMPLIFIER SETS NEW STANDARDS OF PERFORMANCE AT A VERY AFFORDABLE PRICE. IT IS THE IDEAL PRE-AMPLIFIER FOR DRIVING ANY OF TODAY'S POWER AMPLIFIERS INCLUDING SINGLE ENDED/TRIODE DESIGNS. SEE KEN KESSLER'S REVIEW IN THE OCTOBER ISSUE OF HI-FI NEWS. IT IS ALSO A PERFECT MATCH FOR DRIVING CLASSIC AMPLIFIERS SUCH AS LEAK, RADFORD, RCA, BEAM ECHO, AND ALL MULLARD 5-10/20 DESIGNS.

(THE CROFT EPOCH NOW REPLACES THE MICRO)

AGENTS FOR CROFT, NOTTINGHAM ANALOGUE, POSSELT, UKD CALLAS, MONARCHY AUDIO, XLO, GROOVE TUBES, GOLD AERO, TOWNSHEND, CLEMENTS, METAXUS, UNISON RESEARCH

TELEPHONE 0895 833099

DEMONSTRATIONS STRICTLY BY APPOINTMENT ONLY

 **naim your price!**



The new **naim audio NA CD3** now on demonstration at

The Hi-Fi Showrooms

12a West Street, Congleton, Cheshire, CW12 1JR
Telephone (0260) 280017.

RINGMAT

FOR RECORD LOVERS

First record support to be properly designed

Hear what reviewers say:

"A carefully researched and innovative product which genuinely transforms analogue replay at nominal cost. The string bass was more dynamic, the separation cleaner and, more importantly, the phrasing of the music was more fluid - you heard the vocal line arch fall." **Christopher Breunig (Hi-Fi News, September '93)**

"I found I preferred the RINGMAT and will carry on using it. The results were wholly positive..." **Jason Kennedy (Hi-Fi Choice, April '93)**

"RINGMAT gave a sharper, cleaner, more solid sound, with better fine detail and clarity. On complex material the improvement in stability and focus was remarkable; easily comparable to an expensive tonearm, cartridge or power supply upgrade... Any drawbacks? None I could detect..." **Jimmy Hughes (Audiophile, October '93)**

"I found the sound of my LPs improved significantly, reminding me of the experience of listening to records on a Goldmund reference turntable with a van den Hul Grasshopper cartridge with its nude stylus. All of a sudden, much more of the music, and the space in which it was performed, was evident. I'm sure that the legions of Linn and Rega owners out there who still play their LPs will want to make the modest investment required for major improvement in vinyl play." **Andrew Marshall (Audio Ideas Guide, Winter '94)**

Hear what your fellow music lovers say:

"I would agree with everything you claim for this product. The music is more natural, more musical, and with a loss of a certain rawness which persisted, no matter what, beforehand." **Mr. C.R., Northants**

"RINGMAT goes on my very short list of things that make differences I care about." **Mr. P.F., Washington D.C.**

"This product must be one of the most cost-effective accessories ever to be offered to music lovers." **Mr. R.A., Norway Can RINGMAT really be that good?**

Yes, it is, but there is only one way for you to find out - try it yourself. But be warned: if you let your best friend borrow it, you will finish up buying another!



Prices

Different versions to suit turntable or budget from £25 for RINGMAT 200 to £40 for RINGMAT 330 MKI. They can be obtained through good Hi-Fi retailer or on mail order direct from:

RINGMAT DEVELOPMENTS

PO BOX 200 BRENTWOOD ESSEX CM15 8QG

Tel.: 0277 200 210 Fax: 0277 201 225

(p&p: additional £2.50 UK, £5.50 outside)

USA: Something Worth Hearing, Rochester, N.Y.

Tel.: 716 461 1295

TAIWAN: Taifu Electronic Corporation, Taipei,

Tel.: 8862 341 9137

GERMANY: Fortissimo, Düsseldorf, Tel.: 211 482 372

Hi-Fi World Dial-a-Dealer

AUDIO EXCELLENCE 'Where the music matters', 65 Park Street, Bristol BS1 5PB Tel. 0272 264975 Fax 0272 251327 Great Hi-Fi carefully selected and demonstrated by friendly enthusiastic staff. Home installations and check-ups Two year warranty from our own service department Open 9.00-5.30 Tuesday - Saturday closed Monday

PAUL GREEN HI-FI LTD. Kensington Showrooms, London Road Bath. Tel. (0225) 316197. Musical Fidelity, Krell, Creek Rogers, Quad, Cust car park Best selection in the West!

V'AUDIO. 36 Druid Hill, Stoke Bishop, Bristol BS9 1EJ Tel. 0272 686005 ATC, Acoustic Energy, Ruark, AVI, Exposure, Pink Triangle, Wadia, Audio Innovations, SME (incl 20A), Chord Amps, Micron, AMC, Analog Electronics, Cadence Valve, Jamo, LFD, REL, Sansui, Sonic Link, Stax, Townsend, Audio Technica, Goldring, Utra, Ortofon, Sumiko. Demos by appt only, home trial facilities, free install, service facilities.

WILTSHIRE

WENTWORTH AUDIO. 83 High Street North, Dunstable, Beds, NUG 1J, Tel. 0582 6633 83 Marantz Pioneer, Rotel, Audioblab Mission, Cyrus, Sony, HK, NAD, Pink Triangle, Yamaha, Systemdek, Albury etc. Free installation & delivery Home dems. Part exchange, interest free credit - 6, 9, 12, 18 & 24 month terms. Free car parking at rear of shop. Free refreshments (alcoholic or otherwise!) Open 10-6pm Tues-Sat

TECHNOSOUND LTD, 79 West Street, Dunstable, Beds. Tel. 0582 663297 - See our main entry under Bucks.

WILTSHIRE

NEWBURY AUDIO. 2 Weavers Walk, Northbrook Street, Newbury, Berks, RG13 1A1 Tel. 0635 33929 Linn, Creek Epos, Denon, Nakamichi, Shahman, Marantz, Micromega, JPW Ruark Single speaker dem. room. Appt. necessary. Home trial facilities. Free install. service dept. late appts. Access/Visa. interest free credit subject to status. 6 days 9.30am - 6.00pm

ARC AUDIO. 9 Dukes Ride, Crowthorne, Berks, RG1 16L2 (0344) 762201. Denon, Harman, Kardon, JPW, Marantz, Monitor Audio, Onyx, Rogers, Tannoy, Thorens, Yamaha. Demonstration facilities, no appointments necessary, home trial facilities, free installation, access, Visa, Diners, Open Mon-Sat 9-6pm (closed Wed at 1pm)

READING HI-FI CENTRE, 4 Queen's Walk, Reading RG1 7DF Tel. 0734 585463 "The best equipment advice and service from Berkshire's premier Hi-Fi emporium". Products include: Arcam, exposure, Audioblab, Meridian, Rotel, Sony, sennheiser, Top Tape Centre, and many more.

ASTLEY AUDIO, Wallingford, 0491 839305. See our entry under OXFORDSHIRE

BUCKS

D.L. CHITTENDEN LIMITED 59-61 The Broadway, Chisham, Bucks, HP5 1BX (Opposite Boots) Tel; 0494 764441. Philips, Denon, Kenwood, Canon Audio, Koss, Wharfedale, Mitsubishi, Target, Grundig, OED, Mordaunt-Short, Toshiba, Dolby, Prolog Systems, Nicam TV and Video, Surround Sound, AV Systems, Showroom Demonstrations from expert and friendly staff. No appointments necessary, Service Department, Credit facilities available. Open 8.30 to 5.30 Mon-Sat

AUDIO INSIGHT- 53 Wolerton Rd, Stony Stratford, Milton Keynes, Bucks - 0908 561551 - See our main entry under Technosound

DEJAC HI-FI Consultants, 21 the Broadway, Old Amersham, Bucks, HP7 0HL. Tel. (0494) 433173. AMC, Arcam, Bosh, Meridian, Quad, Denon, NAD, Tannoy, Mission, TDL, 2 dem rooms. Appts necessary. Free installation. Trufty finance. Instant credit, open 9.30-5.30 pm including Saturdays

NORTHWOOD AUDIO II, 98 Cambridge St, Aylesbury, Bucks NP23 1BA. Tel. 0296 28790 (A/P). Selected sounds from Alchemist, Aura, Boston, B & W, Cabletak, Castle, Celestion, Denon, Exposure, Gyrodec, Harman Kardon, Heybrook, Marantz, Micromega, Monitor Audio, Moth, NAD, Nakamichi, Rotel, Rotel, Ruark, Systemdek, Tannoy, TDL, Thorens etc. ect. Export orders welcome. 2 Dem rooms. Credit facilities available.

TECHNOSOUND LTD, 7 Granville Square, Wilton, Milton Keynes, MK15 9JL Tel: 0908 604949. Audiophile HI-Fi Specialists. All major brands stocked from Arcam to Yamaha. Demonstration facilities and expert advice. Mon-Sat 9.30 - 5.30 late night Friday. Credit Cards accepted. Finance available.

CAMBRIDGE

CAMBRIDGE HI-FI, 1-3 Hawthorne Way, Chesterton, Cambs. CB4 1AT. Tel. 0223 67773. Kenwood, Pioneer, Arison, Krell, Technics, Yamaha, Marantz, B&W, AR, Mordaunt-Short, Bose. Single speaker dem room. Tues-Sat 9.30-5.30pm. Closed Monday. Free install, service dept. Vis/Access credit facilities.

STEVE BOXSHALL AUDIO, 41 Victoria Road, Cambs. CB4 3BW. Tel. 0223 68305. 10.00-6.00pm 6 days. 3 dem rooms. Denon, Rotel, Yamaha, Mission, Nakamichi, Tannoy, Audioblab, Marantz, Krell, Martin Logan, Magneplanar, Wadia. Home trial

facilities. Appointments preferred. Free install. and service dept. Access/Visa

FENWAY, 5 High St. Ely. Tel 0353 664421. Contact Gary Holland. For Sony Technics, Rotel, Tannoy, Pioneer, OED, equipment and accessories. Demonstration facility. In-House Service Dept

CHESHIRE

SWIFT HI-FI, St. Annes Parade, Wilmslow. 0625 526213. Aura, B&W, Denon, Kenwood, Marantz, NAD, Pioneer, Rotel, Systemdek, Tannoy, Revolver, J.P.W., M. Short, Mission, Celestion Technics, Audioblab, Castle. Open 9.30-6. Dem room. No pressure. BADA member

THE HI-FI SHOWROOMS 12A West Str. Congleton Cheshire (0260)280017, 1 Stanley St. Leek (0533)383780. Celestion, Creek, Exposure, Marantz, Musical Fidelity, Pink Triangle, Project, Rotel, Ruark, Systemdek, Tannoy, Technics 5 Dem rooms. Noapts nec. Home trial. Free install. Service dept. Access, Visa, Lombard Tricity. Open 9-5.30, Closed Wed

HALE HI-FI, 2 Bold St. Hale Road, Altringham, Cheshire WA14 2ER Tel 061 929 0834. Open Mon - Sat 10am-6pm & later by appointment. Specialising in equipment by: Nam, Quad, Royd, Wad. Denon plus selected others. Large range of quality accessories. On site service department. Installation & delivery. Home demonstrations a pleasure

ASTON AUDIO, 4 West Street, Alderley Edge, Cheshire. Tel. 0625 582704. Products include: Bang & Olufsen, Arcam, Audioblab, B&W, Cyrus, Denon, Epos, Meridian, Micromega, MF Mission, Nakamichi, Quad, Rotel, TDL & other leading brands. Demonstration Rooms. Installation Service. Interest Free Credit. Access. Visa. Open Mon-Sat

CHRIS BROOKS AUDIO, 29 Gaskell Street, Stockton Heath, Warrington, Cheshire, WA4 2UN Tel (0925) 261212. Tues-Sat 10.00-6.00. 2 dem-rooms. credit facilities. All credit cards. Established 1978. Total absence of bulls***

CONGLETON HI-FI, 11a Duke St, Congleton, Cheshire, CW12 1AP (0260) 297544. Acoustic Energy, Arcam, B&W, Denon, Epos, Kef, Linn, NAD, Nakamichi, Onix, Royd, Target, Yamaha etc. Superbly appointed single speaker demo facilities. No appointments necessary, home trial facilities, free installation 2 year guarantee on all equipment. Access. Visa. Open Mon-Sat, closed Weds

DOUG BRADY HI-FI, Kingsway Studios, Kingsway North, Warrington, Cheshire, WA1 3JA, (0925) 828009. Largest choice of specialist Hi-Fi in NW. All credit cards. 3 dem rooms. Fair demonstrations and home trial facilities. Open 6 days

PRACTICAL HI-FI. 88 Bridge Street, Warrington, WA1 2RF Tel: 0925 632179. See our main entry under Preston, Lancs

CLEVELAND

GILSON AUDIO LTD, 172 Borough Rd, Middlesbrough, 0642 248793. Linn, Exposure, Arcam, Mission, Cyrus, Denon, Marantz, Rotel, Pioneer, Audioblab, Tannoy. Demonstration facilities in main shop and one demonstration room. Appointments necessary. Home trial facilities. Free installation on request. Service department. Access Visa, H.P. 10-5-6 days

ACTION ACOUTICS, 155-157 High Street, Redcar, Cleveland, TS10 3AN. 0642 480723. Audio Innovations, Denon, Harman, Kardon, JBL, Musical Fidelity, Pink Triangle, RMX, Rogers, Sugden, Sonic Link, Townsend, TDL, Thorens etc. Dem room. Appointments nec. Home trial facilities. free installation, service dept. Access. Visa & HP. Open 9.15-5.30

CORNWALL

RJF AUDIO VISUAL, 84 Pendarves Street, Tucking Mill, Camborne, Cornwall TR14 8NJ. 0209 71077/612260. Audio Analysis, Audio Innovations, JBL, Teac, TDL, Monitor Audio, Musical Fidelity, NAD, Nakamichi, B&W, SME, Micromega, Pink Triangle, Project, Perception, Sugden, Harman Kardon, Triangle, Integral dem/showroom and special home dems. Appts nec. home trial, free install, service dept. All cards. Switch and Transax. Open Mon-Sat 9.30-5.30.

COUNTY DURHAM

HI-FI EXCHANGE DARLINGTON, 30a Larchfield Street, Darlington, County Durham. The north's only used Hi-Fi Specialists. Hear our Quad, Naim, Ortofon, Neal, Thorens etc. Separate Dem Room. 3 months warranty on all systems. Full range of leading Japanese makes Technics, Sony etc. Tel. 0325 463007

MISONS SOUND & VISION, 11 Warwick Road, Carlisle CA1 10H Tel (0228) 22620. Bang & Olufsen, B & W, Castle, Sonic Link, Quad, NAD, Yamaha, Sony, Rotel. Demo Suite. No appts nec. Home trial facilities. Free installation. Service Department 9 - 5.30 Mon - Frid, Thurs 9-1, Sat 9-5.

PETER TYSON, 6 Abbey Street, Carlisle, Cumbria, CA3 8TX. 'Cumbria's premiere hi-fi centre'. Part exchange welcome. (0228) 46756. Linn, Musical Fidelity, Cyrus, Marantz, Denon, Philips, Nakamichi, Technics, Pioneer, Creek and more. Dem

rooms. Demos without obligation. Home trial. Free installation. In-house service dept. Access. Visa. HP. 9-5.30pm

PRACTICAL HI-FI, 106 English Street, Carlisle, CA3 8ND Tel: 0228 44792. See our main entry under Lancaster.

DEVON

THE HI-FI ATTIC, 58 New George St., Plymouth, Devon PL1 1RR. 0752 689511. We stock most leading brands including Linn, Arcam, Denon, Pioneer, Musical Fidelity amongst others, and have an expert enthusiastic staff. Premises include attractive hi-fi and home cinema demonstration rooms. We offer free installation and credit facilities (written details on request) also a fully equipped service department. We can also provide a mail order service for all your LaserDisc requirements. We accept Visa, Access, Amex

CHELSTON HI-FI, 38 Walnut Road, Chelston, Torquay, Devon TQ2 6HS Tel (0803) 606863. Denon, Marantz, Rotel, Musical Fidelity, Acoustic Energy, NAD, Castle, Heybrook, Celestion, JPW etc. Two dem rooms. Home trial. Free installation. Access, Visa. Amex. Credit facilities 9.00 - 5.30, 9.00 - 1.00 Wed

UPTON ELECTRONICS, 31 Torquay Road, Paignton, Devon TQ3 3DT Tel. 0803 551329. Pioneer Reference Point Dealer, Denon, Sony Technics, Harmon-Kardon, Orelle, Kinshaw, Creek, Quad, Audio-Innovations, Target, Tannoy, Mordaunt-Short, Castle, TDL, Ruark, JPW, Royd, Project, Monitor-Audio, Micromega, Chord, van den Hul, Jamo, Full range of accessories etc. Demonstration room. Home dems. free delivery and installation, own in-house service dept. AAccess, Visa, Amex. Credit facilities 9.00 - 5.30, 9.00 - 1.00 Wed

DURBY

STRAD TRADITIONAL AUDIO, 29 Meadowfield, Whaleybridge, nr Buxton, Derbyshire, SK12 7AX. Tel. 0663 733383. We construct custom made reproductions of classic 1950's loudspeaker enclosure designs using authentic blueprints. These have never been bettered for valve amplification. Request for specific designs considered and researched. Superb new speaker units from Richard Allan and Lovthar are used

ACTIVE AUDIO, 12 Osmaston Street, The Spot, Derby. Tel. 0332 380385 Fax. 0332 385185. We have three studios including a dedicated Audio Visual studio for the demonstration of quality equipment from the largest range in the Midlands. Open six days per week. Dwn service department. Free local delivery, home trial facility. Current special offers and buyers fact pack and quotation on request

DORSET

DAWSONS, 23 Seamoor Road, Westbourne, Bournemouth, Dorset. 0202 764965. B&O, Castle, Canon, Jamo, JBL, Pioneer, Sony, Target, TDL, Technics. No appts necessary. Free installation. Service dept. Various credit facilities available. Open 9-5.30 6 days a week

SUTTONS HI-FI, 18 Westover Road, Bournemouth, Hants. Tel. 0202655512. Linn, Arcam, Mission, Quad, Audioblab, Rotel, Yamaha, Denon, etc. 2 single speaker listening rooms. Home demonstrations and free installation. Mon-Sat 9.00-5.30. Call for details

ESSEX

AUDIO T, 442-444 Cranbrook Road, Gants Hill, Ilford, (0181) 519 02915. Great Hi-Fi from Arcam, Audioblab, Cyrus, Denon, Marantz, Meridian, Mission, Micromega, Nakamichi, Rotel, Technics, Yamaha and many more. Mon-Sat 10-6. 3 Year Hi-Fi guarantee. Free delivery & installation. 30 day free upgrades. Home demonstrations. Part X Selected Interest Free Credit. 2 Listening Rooms. Home Cinema specialists. BADA Bonded.

BRENTWOOD HI FIDELITY, 2 Ingrave Road, Brentwood, Essex CM15 8AT Tel. 0277 221210. Aura, Audio Innovations, Castle, Chord, Crimson, Denon, DNM, E.A.R., Impulse, Marantz, Mission, Micromega, NAD, Pink Triangle, Project, QUAD, Ruark, Rehdero, Shemaer Audio, Systemdek, Tannoy, TDL. Thule Audio Single speaker dem rooms, home trials, dems and installations. Mon-Sat 9.30-5.30. Access, Visa, service facilities. Simply THE place to visit if you're serious about music.

TWENTY 20 AUDIO VISUAL LTD Unit 205 Lakeside Shopping Centre, West Thurrock, Grays, Essex OM16. Tel. 0708 891818 Fax. 0708891300. For your total home entertainment requirements. From a 2" Cassio to a 50" Pioneer screen. Dolby surround specialists with three dem rooms dedicated to prologic, laser disc software in stock, from Harman Kardon, Pro Logic from Yamaha, Marantz, Pioneer, Technics, Kenwood & B&O.

RAYLEIGH HI-FI, Chelmsford, 216 Moulsham St. 0245 265245. RAYLEIGH HI-FI, Rayleigh, 44a High Street. 0268 779762. RAYLEIGH HI-FI, Southend, 132/4 London Rd. 0702 435255.

Over 21 years experience of supplying the best. "The best dealer, the best hi-fi equipment, the best service" Carefully selected Hi-Fi from: Arcam, Audioblab, Cyrus, Denon, Epos, Linn, Meridian, Mission, Naim, Nakamichi, Quad, Rega, Roksan, etc.etc.... 3 years guarantee on hi-fi systems. 0% credit facilities.

AUDIO T, 442444 Cranbrook Road, Gants Hill, Ilford, Essex. IG2 6LL (081) 518 0915. Fax (081) 554 8463. Great Hi-Fi from Arcam, Audioblab, B&O, Bose, Cyrus, Denon, KEF, Marantz, Meridian, Mission, Micromega, Nakamichi, Rotel, Sony, Yamaha & many more. Mon-Sat 10-6. 3 year guarantee on Hi-Fi. Free delivery & installation. 30 day free upgrade scheme. Home demonstrations. Part exchange. 2 listening rooms. Home Cinema specialists. BADA Bonded.

GLoucestershire

AUDIO EXCELLENCE - WHERE THE MUSIC MATTERS', 58 Bristol Road, Gloucester, GL1 5SD. Tel. 0452 300046 Fax. 0452 310680. Great Hi-Fi carefully selected and demonstrated by friendly enthusiastic staff. Home installations and check-ups. Two year warranty from our own service department. Open 9.00-5.30 Tuesday - Saturday closed Monday.

AUDIO T, 40-42 Albion Street, Cheltenham, Gloucestershire, GL52 2RQ (01242) 583960. Great Hi-Fi from Arcam, Audioblab, Aura, Denon, Epos, Linn, Marantz, Meridian, Mission, Quad, Rotel, Technics, Yamaha & many more. Mon-Fri 10-6. Sat 9.30-5.30. 3 year Hi-Fi guarantee. Free delivery & installation. 30 day free upgrades. Home demonstrations. Part exchange. Selected Interest Free Credit Listening Room. BADA Bonded.

HAMPSHIRE

AUDIO GALLERY Near Petersfield, Hampshire, Mana Castle, Alchemist, Albany, Audio Innovations, Wadia, Deltac Tech Technology, Denon, Pioneer, Alphasound, Tripod, NAD, Teac, Audio Alchemy, Klipsch, AACC, Proac, JPW, Moth, Pink Triangle. Mail order cabinets supplied to order in any size, wood & hand painted finishes, stone-granite-marble shelving. For a demonstration with home comforts call us for an appointment on 0730 895194

HOPKINS HI FI, FOR THE BEST SEAT IN THE HOUSE experience home cinema sound with Technics, Denon and Kenwood. Award winning products. Now on demo at HOPKINS HI-FI, 38-40 Fratton Road, Portsmouth, Hants, PD1 5BX. Tel. 0705 822 155 Fax 0705 830 753

HAMPSHIRE AUDIO LTD., 2-12 Hursley Road, Chandlers Ford, Hants SO5 2FU (0703) 252827/265232. 3 hi-fi and 2 home cinema/surround sound dem studios. Thurs late evening. closed Mondays (except in December). Service dept on site 12 yr guarantee. Large free car park - junctions 4 (M27/M3) 5 (M27), 12 (M3) and 13 (M3) all within 3 miles. est. 1969

AUDIO T, 4 Feathers Lane, Basingstoke, Hampshire, RG21 1AS (01256) 24311. Great Hi-Fi from Arcam, Denon, Linn, Meridian, Mission, Naim, Rotel, Technics, Yamaha & many more. Mon-Sat 9.30-5.30. 3 year Hi-Fi guarantee. Free delivery & installation. 30 day free upgrades. Home demonstrations. Part exchange Listening room. BADA Bonded

HERTFORDSHIRE

ENGLISH AUDIO, 95 Whitecross Road, Hereford, HR4 0DG (0432) 355081. Musical Fidelity, Arcam, Castle, Ruark, Rogers, JPW, Micromega, Chord, Audio, Systemdek, Heybrook, Kef, Stax, Pink Triangle, Denon, Marantz, Mission, Cyrus, A.I., Rotel, NAD, Nakamichi, TDL and others. Single speaker dem room, home trial facilities. free installation, service dept. Access/Visa. Credit arranged. Open Mon-Sat, 10-6pm. BADA members

DAVID ORTON AUDIO VISUAL 6-8 Bancroft, Hitchin, Herts Tel - 0462 - 452248. Mission, Cyrus, Denon, Pioneer, Marantz, Aura, Kenwood, Rotel, Ruark, Celestion, JVC, Polk and many more. Open Mon-Sat 9.30-5.30. All major credit cards accepted. Finance available. (See our main advert pg 106)

DYNAMICS, Welwyn, Herts - Europe's largest stockist of ex-dem and second hand equipment. High End Audio - Bought, Sold or Exchanged. Many items in stock (see our main ad pg 128). Efficient servicing Dept. All items guaranteed. All major credit cards accepted. Please telephone 0438 - 714038 for appointment.

GOSPEL MUSIC AUDIO, 32a High Street, Kington, Hertfordshire, HR5 3BJ. (0544) 230254. Alphasound, Allison, Revolver, Luxman, Yamaha, OED Audio, Systemline

ACOUSTIC ARTS LTD, 101, St. Albans Rd., Watford, Herts. 0923 245250. Fax 0923 230798. Absolute Sounds, Adcom, Acoustic Energy, Audioblab, Chord, Denon, Marantz, Meridian, Orelle, S.M.E., T.D.L. 3 dem rooms, multi-room & home theatre. Expert installation. Credit facilities available, Tues-Sat 10-6.

STUDIO 82, 82 High Street, Harpenden, Herts, AL5 2SP. 0582 746246. Fax 0582 467022. ATC/AVI, Arcam, Aura, Audioblab, B&O, Denon, Epos, Mission, Cyrus, Naim Audio, Nakamichi, Quad, NAD etc. Quiet single speaker dem room. Appts nec. Home trial, free installation. Service dept. Visa, Access and finance terms. 9-5.30 (Mon-Sat) Closed Weds.

THE AUDIO FILE, 27 Hockerill St., Bishop's Stortford, Herts, CM23 2DH. Tel. 0279 506578. Fax 0279 506638. Linn, Naim, Roksan, Quad, Rega, Mission, Arcam, ProAc, Marantz, Sony, etc. 4 dem rooms, installation service. Min 3 year warranty, 0%, BADA.

HERTFORD MUSIC. We want you to feel good when choosing your system in our 3 demonstration rooms (and bar!). Systems from budget to £15,000. Products include: CR Developments, Micromega, REL Acoustics, Acoustic Energy, Michell, Magnum, Diamond Acoustics, Beard, Lumley, Renaissance, etc. AAccess, Visa, Mail Order. Please telephone: 0992 442425.

Hi-Fi World Dial-a-Dealer

RADLETT AUDIO, 141 Watling Street, Radlett, Herts, WD7 7ND Tel: 0923 856497 Mark Levinson, Procead, Proac, Magnepan, Martin Logan Tube Technology, Teac, Roksan, Audiobab, Stax, Systemdek, Jardis, Copland ATC, Audio Alchemy, AVI, EAR, Sumiko, Quad, Sonus Faber. Home trial facilities, free installation. Service Dept. Visa/Access 9-5:30 Mon-Fri 10-5:30 Sat

REVOX Service & Repairs, Suite 10, Smugook Business Centre, Lye Lane, Brickwood, Herts AL2 3JG Tel: 0923 893711 Seventeen years experience ex-Bauch Authorized agents for Revox products, sales and spares. All repairs carried out are guaranteed. Fast turnaround. Any enquiries telephone: 0923 893711

GLoucestershire

ZEN AUDIOLAB - George Street, Hull Tel: (0482) 587397 - Evening (0964) 670849. Audiobab, Audio Innovations, Aura, B&W, Cabletalk, DPA, Heybrook, JPW KAR, Micromega, Michell, Harmon Kardon, Impulse, Ruark, Rotel, Sugden. Comfortable Listening Room. Home Trial facilities. Free installations - personal friendly service

Kent

PROGRESSIVE AUDIO, 2 Maryland Court, Rainham, Nr Gillingham, Kent ME8 8QY. Tel: 0634 389004. Agencies include: Audio Innovations, Audio, Audiotech, Audiostatic, Audiotechnica, Chord amps, Cogan Hall, Conrad Johnson, Convergent DALI, Decca, Eminent Technology, Goldring, Impulse, Koetsu, Levinson, L.F.D., Lyra, Lumley Reference, Meridian, Michell, Micromega, Moth, Origin Live, Pink Triangle, Proac, Proceed, Ruark, Silversounds, SME, Sugden, Sumiko, Systemdek, Snell Target, T.D.L., Transfiguration, Townshend Tube Technology, Voyd V.P.I. etc. etc. Demonstrations by appointment please

JOHN MARLEY HI-FI CENTRES, 2 Station Road, West Canterbury (0227) 769329. Also at Dover - 0304 207562. Arcam, Audiobab, Aura, B&W, Heybrook, JPW, Proac, Pioneer, Rotel, Ruark, Tannoy, Technics, Dem rooms and home trial facilities. Mon-Sat, 9-5:30 clost Thurs. Free install. Credit to #1000. Access: Visa and credit charge Service Dept.

KIMBERLEY HIFI, 193 Broadway, Bexleyheath, Kent. Tel: 081 3043272 Pioneer, Technics, Kenwood, Marantz, Denon, NAD, Aiwa, Tannoy, Mission, Rotel, Wharfedale, Castle. Separate dem room no app necessary. Free installation service dept. instant credit facilities. no early closing

V.J. HIFI, 29 Guildhall Street, Folkestone, Tel: 0303 256860. Mon-Sat 9-6. NAD, Yamaha, Marantz, Sony, Tannoy, Denon, Kenwood, Rogers, Musical Fidelity, Quad, Aiwa, Aura, Heybrook, Castle, Mission, Yamaha, REL, JBL, Polk. Dem rooms in both stores. Free install. Credit facilities available. Specialists in home theatre. Amex, Diners, Visa, Access. Service Dept. We are BADA dealers.

THE WESTGATE HI-FI, 2 Station Road West, Canterbury, Kent. 0227 769329. Suppliers of quality hi-fi equipment including: Arcam, Akai, Aura, B&W, Denon, Jamo, JPW, Mordaunt Short, NAD, Panasonic, ProAc, Quad, Rotel, Ruark, TDL, Technics, Tannoy, Part exchange, Listening room. Service and repairs. Credit facilities. Access/Visa. Open 6 days 9-5:30

DOVER HI-FI, 43 High Street, Dover Tel: 0674 207562. Suppliers of quality hi-fi equipment including: Arcam, Akai, Aura, B&W, Denon, Jamo, JPW, Mordaunt Short, NAD, Panasonic, ProAc, Quad, Rotel, RuArc, TDL, Technics, Tannoy, Part exchange, Listening room. Service and repairs. Credit facilities. Access/Visa. Open 6 days 9-5:30

Lancashire

ROMERS HIFI CENTRE, 94-96 High Street, Rishton, Blackburn, Lancs. Tel: 0254 887799. Stockists of Sony, Esprit Hifi, Technics, Marantz, Musical Fidelity, Pioneer, Kenwood, Rotel, Tannoy, Mission, Ruark, B&W and many others. Dem room, service dept, free delivery and installation (local area). Access/Visa and Switch.

PRACTIAL HI-FI 43 Farngate, Preston Tel: 0772 883958. The audio visual specialist, expert advice, instant demonstrations, best prices, instant free credit, part exchange welcome. Extended warranty. Stockists of Yamaha, Kenwood, Denon, Sony, Technics, Onkyo, Marantz, Pioneer, Mission, Kef, Jamo, Celestion, B&W. Also stockists of LaserDiscs.

PRACTICAL HI-FI, 84 Penny Street, Lancaster, LA1 1XN Tel: 0524 39657. See our main entry under Lancaster.

PRACTICAL HI-FI, 33/35 Knowlesley Street, Bolton, Lancs Tel: 0204 395789. See our main entry under Lancaster.

PRACTICAL HI-FI, 10 Preston New Road, Blackburn, BB2 1AW Tel: 0254 691104. See our main entry under Lancaster

PRACTICAL HI-FI, 81 Whitegate Drive, Blackpool, FY3 9DA Tel: 0253 300599. See our main entry under Lancaster.

Leicester

LEICESTER HIFI COMPANY, 6 Silver Walk, St Martin's Square, Leics. LE1 5EW. Tel: (0533) 539753 Fax (0533) 626097. Acoustic Energy, Arcam, Marantz, Micromega, Mission/Cyrus, Musical Fidelity, Nakamichi, Meridian, Rogers, Roksan and "doodles more" 2 dem rooms, home trial arranged, free install. service dept. Credit facilities, Access/Visa/Diners/Amex 6 days 9.30-5.30

THE LISTENING ROOMS, 6 Hotel Street, Leicester. Tel: 0533 623754 fax 0533 623758. Linn, Audiobab, Arcam, Tannoy, Definition, Denon, Rotel, Nad, Heybrook, TDL etc. Open 10.00-5.30 (Six days)

STERED SHACK, 1-3 Guildhall Lane, Leicester. Tel: 0533 530330. Aiwa, A.R., Denon, Kenwood, Jamo, Mission, NAD, Philips, Pioneer, Home Cinema specialists. Free installation. Open 9.30-5.30 6 days. Credit available

Lincolnshire

BOSTON HI-FI CENTRE 65a Wide Bargate, John Adams Way Boston, Lincs PE21 6SG Tel: 0205 365477. Quad, Nakamichi, Arcam, Marantz, NAD, Castle, Tannoy, Rogers etc. Separate demonstration studio incl. home cinema. Free installation. Access: Visa. Tues-Sat 9-5 pm

COTTAGE AUDIO, 17 Bridge Street, Saxby, Nr Lincoln, LN1 2PZ Tel: (0522) 702834. Evenings: (0522) 696708. ATC, AVI, Chord amplifiers, Harbeth, LFD, Michell, Drigin Live, Kinshaw, QED, Royd, Sansui, Sequenced Something solid, Sonic Link, etc. Demonstration rooms. Home trial facilities. Free installations and above all a personal, friendly service

STAMFORD HIFI CENTRE - 9 Red Lion Square, Stamford, Lincs PE9 2AL (0708) 62128. Pioneer, Technics, Cyrus, Mission, Rotel, NAD, Yamaha, Kenwood, Marantz, Quad plus all major speaker manufacturers. Expert Advice. Comparator demonstrations part-exchange. HiFi purchased for cash. No appts necessary. Home trial facility, free installation. Service Dept: Mastercard, Visa and credit charge. Mon-Sat 9.5-5.30 pm. Closed Thursdays

Lincoln

ANALOG AUDIO, 849 High Road, Finchly N12 (081) 445 3267. For friendly service and advice: AR, AKG, Allison AT, Cerwin Vega, Denon, Dual, Harmon Kardon, Jamo, Infinity, Marantz, NAD, Pioneer, Rotel, Revolver, Sonab, Teac, Thorens, Tannoy, Wharfedale, Yamaha. Speaker cables and accessories. Free installation service

AUDIO CONCEPT, 27 Bond Street, Ealing, W5 5AS. Tel: (081) 567 8703. Acoustic Energy, Audiobab, Aura, B&W, B&W, Boston Acoustics, Canon, Castle, Denon, Dual, Evolution, Infinity, JPW, Kef, Marantz, Mission, Monitor Audio, Musical Fidelity, NAD, Nakamichi, Onix, Quad, Revex, Rogers, Rotel, Systemdek, Target, Teac, Thorens, Van den Hul. Two dem rooms. Interest free credit, free local delivery & installation. service department
Hi-Fi Specialists without the attitude

AUDIO T, 190 West End Lane, West Hampstead. (0171) 794-7848. Great Hi-Fi from Arcam, Audiobab, Aura, B&W, Denon, Epos, Linn, Marantz, Meridian, Mission, Rotel, Micromega, Nakamichi, Yamaha & many more. Mon-Sat 10-6. 3 Year Hi-Fi guarantee. Free Delivery & Installation. 30 Day Free upgrades. Home Demonstrations. PX. Selected Interest Free Credit. 2 Listening Rooms. BADA Bonded

BABBER ELECTRONICS, 158 Uxbridge Road, West Ealing, London. W13 8SB (081) 579 6315. Akai, Aiwa, A&R, Celestion, Dual, Goodmans, Harman Kardon, JBL, JVC, Kenwood, Marantz, Panasonic, Sennheiser, Sony ES range, Tannoy, Technics, Wharfedale, Yamaha

THE CARTRIDGE MAN - Front end problems? It doesn't have to cost an arm and a leg to get the best listen to my Koetsu - and - Decca - Eater. Also agents for Croft, Sugden, Thorens, Pentachord Speakers and Notts Analogue. (Plus a cartridge re-tipping service). Tel: 081 688 6565

GOLF ELECTRONICS 311 Kenish Town Road, NW5 2TJ Tel: 071 482 2518. Fax 071 284 3381. Authorised dealers for: Sony, Panasonic, Aiwa, Akai, Mitsubishi, Philips, Grundig, Bose. We carry an extensive range of hardware from Walkmans to camcorders, including a wide range of TV and video equipment. Free local delivery & installation on selected items. Open 10-6 Mon-Sat. We regularly have special offers on different products. A visit to GOLF ELECTRONICS could save you \$\$\$

HIFI & COMPONENTS, 84 Battersea Rise, London, SW11 1EH. (071) 223 1110. Denon, Tannoy, NAD, Rotel, Bose, Dual, QED, Wharfedale, Jamo, Celestion, Kenwood, Orton, Infinity, Shure, to name but a few! Established over 29 yrs. Appts necessary. Service dept. 10-6 (closed Weds)

HIFI EXPERIENCE, 227 Tottenham Court Road, London W11. 071 580 3535. Arcam, Audiobab, Mission, Cyrus, Quad, Celestion, Kef, Meridian, Rogers, Tannoy, Yamaha, TDL, Thorens, Marantz, Nakamichi, Musical Fidelity and many more. Open 10.00-7.00 Mon-Fri. 9-6 on Sat. Service dept. Credit facilities, delivery and free installation.

THE HIFI SURPLUS STORE, 62 Weymouth Street, W1 Tel: 071 486 9981/071 935 7582. Stock a full range of goods including: Aiwa, Akai, B&W, Bose, Dual, JVC, Jamo, Kenwood, Marantz, Mordaunt-Short, Mission, NAD, Pioneer, Rotel, Sony, Technics, Teac, Thorens, Tannoy, Wharfedale. Full range of "Target" speaker stands always on stock. All goods are brand new in sealed cartons with full 1 yr guarantee. We guarantee you can not buy cheaper elsewhere. Give us your genuine quote and we will beat that price by £10 (goods must be in stock). Access/Visa welcome. Open Mon-Sat 9.30-6pm. Late night till 6.30 Thurs.

KAMLA ELECTRONICS, 251 Tottenham Court Road, London W1P 9AD. Telephone: 071 323 2747. Fax: 071 637 2690. Acoustic Research, Aiwa, Akai, Albary, Alchemist, Alphason Audio Alchemy, Audio Innovations, Audio Technica, Audiogest, Aura, Audiostatic, B&W, Cerwin Vega, Conrad Johnson, Copenhagen, Furukawa, Goldring, Infinity, IKOS, JPW, JVC, Kef, Kenwood, Kuzma, Lynwood, Maxell, Micromega, Mitsubishi, Monster, Mordaunt Short, Moth, Nakamichi, Oracle, Ortofon, Panasonic, Pioneer Project, QED, Rotel, Ruark, Sansui, Stax, TDK, and many more!

K J WEST ONE, 26 New Cavendish St, London W1M 7LH. 071 486 8262/63. Fax 071 487 3452. Two hi-fi & dedicated home cinema dem studios. Appts pref. Home trial. Installation by arrangement. Service dept. Major credit cards. Interest free credit on selected items. Major brands stocked. Acoustic Energy, Arcam, Audio Innovations, Audion, Aura, Audiobab, Audio Research, B&W, Chord, DPA, Epos, Impulse, Krell, Martin Logan, Meridian, Michell, Musical Fidelity, Nakamichi, Nitty Gritty, Oreille, Pink, ProAc, Quad, Roksan, Sonus Faber, Stax, Tannoy, Theta. Open 6 days

BILLY VEE SOUND SYSTEMS, 248 Lee High Road, London SE13 (081) 318 5755. Arcam, Linn, Naim, Quad, Creek, Cyrus, Marantz, NAD, Rega, Denon, Yamaha, Tannoy, Mission, Micromega, Heybrook, etc., 2 dem rooms, instant free credit. Access/Visa. Closed Thursdays

CONNECTIONS, 13 John Prince's Street, London W1M 9AH. Tel: 081 348 5676. Dealers in: Absolute, Audio Note, Audioquest, Deltac, Harmanix, Kimber, Mandrake, MIT, Silech, Symo, Van den Hul, WBT and others

THE LISTENING ROOMS, 161 Old Brompton Road, London SW5 0LJ (071) 244 7750/59. Fax (071) 370 0192. Linn, Quad, Meridian, Nakamichi, Arcam, Audiobab, Acoustic Energy, SME, Audio Research, Krell, Wadia, Theta, Apogee, Martin Logan, Pioneer, Tannoy, Systemdek, Stax, Pink Triangle, Michell, Monitor Audio, Yamaha, Marantz, Kef, Bose, Celestion, Epos, Mission, Denon, Neat Petite. Mon-Sat 10-6pm

THE CORNFLAKE SHOP, 37 Windmill Street, London W1 (071) 631 0472 (domestic). (071) 323 4554 (multiroom). Fax (071) 436 7165. Tues-Sat 10-7 Rega, Roksan, Naim, Monitor Audio, Arcam, Nakamichi, Rotel, Epos, etc. 3 dem rooms (incl. home cinema). Friendly professional service. Home trial facilities. Appts preferred. Full delivery and repair service. Multiroom specialists. Access & Visa

MUSICAL IMAGES, 173 Station Road, Edgware, Middlesex. Tel: (081) 952 5535. See advert under Middlesex for more information

MUSICAL IMAGES, 45 High Street, Hounslow, Middlesex. Tel: (081) 569 5802. See advert under Middlesex for more information

AUDIO T, 190 West End Lane, West Hampstead, London, NW3 1SQ. (071) 794 7848. Fax (071) 431 3570. Great Hi-Fi from Arcam, Arcam, Audiobab, B&W, Denon, Epos, Marantz, Meridian, Michell, Mission, Philips, Rotel, Proac, Micromega, Nakamichi, Yamaha, & many more. Mon-Sat 10-6. 3 year guarantee on Hi-Fi. Free delivery & installation. 30 day free upgrade scheme. Home demonstrations. Part exchange 2 listening rooms. BADA Bonded

ORANGES & LEMONS 61-63 Webb's Road, Battersea, SW11. Tel: 071 924 2040/3665. Juicy fruit from London's newest, freshest Hi-Fi/Home Cinema retailer. Telephone demonstrations, or just pop in. All the usual i.e. friendly and efficient service, free home installation, credit cards, plus... all the very best from: Arcam, Chord Co., Meridian, Mission, NAD, NAIM, Roksan, Royd, Cable Talk, QUAD... with more to come. The innovative Audio/Visual retailer

ZEBRA, 18-24 Brighton Road, South Croydon. Tel: 081-688 2093. The UK's First and Finest Home Cinema Store, 3 Demonstration Rooms, Laser Disc, CRT and Projection TV Centre. Many brands stocked including Arcam, Audiobab, Meridian, Lexicon, Kef, Pioneer, Rotel, Yamaha, REL and Panasonic. Mon-Sat 9.30-6.00pm. All major credit cards accepted. Finance available. Evening demonstrations by appointment.

GREATER MANCHESTER

THE AUDIO COUNSEL, 12 Shaw Road, Didsbury, Manchester, M20 2JL. Tel: 061 633 2602. Linn, Arcam, Naim, Yamaha, Creek, Nakamichi, Denon, JPW, Marantz, Royd, Lexicon, 3 dem rooms, free install, Visa/Access. Licensed credit brokers up to £1,000 instant credit. Full multi-room & A.V. installation. 10.00-5.30pm Mon, Tues, Wed, Sat. 10.00-7.00pm Thurs & Fri

CENTRAL RADIO (Manchester) Ltd, 30-32 Shudehill, Manchester M4 1EZ. Tel: 061 834 6700. Est 1946 we have a wide range of Hi-Fi separates, systems, Pro-logic, TV, Video, Portable Audio, Tape, Decks and Accessories. In House Service Dept. Agents for Aiwa, Beyer, Bose, B&W, Cerwin-Vega, Canon, JBL, Kenwood, Marantz, Mission, Panasonic, Pioneer, Sennheiser, Sony, Technics, Thorens, Wharfedale, etc. We accept Access Visa Am/Ex. Switch Cheques upto £1500 & Finance subject to status. Open 9.00am to 5.30pm Mon to Sat. Easy Parking. Call for directions

ORPHEUS AUDIO (HOME DEMONSTRATION SPECIALIST) - for a Musical 'system' tailor-made (sonically and visually) to your Home requirements. Arion Acoustics (Valves), Audiomeca, Audio Synthesis, Audio Valve Amplification, Kinshaw, Lieder, Ortofon, Project, Teac, Triangle, YBA, Orpheus Audio, please Tel: 0257 426100 or Fax: 0257 473175 for appointment

HALE HI-FI, Tel: 061 929 0834. See our main entry under Cheshire.

BILL HUTCHINSON HIFI, 50-52 Deansgate, Manchester M3 2FE. (061) 8321600. For the largest selection of Hi-Fi and audio visual equipment in the North West. Specialist AV demonstrations of the highest quality. Best prices guaranteed. Minimum 2 year warranty and an optional 5 yr guarantee available. Instant credit and mail order service on offer throughout the U.K. Pioneer, Denon, Kenwood, Yamaha, Technics, Marantz, Mission, Tannoy plus many more

TO FIND YOUR AREA Use our COLOUR REFERENCE



To Advertise in this section, please contact Hi-Fi World Sales Dept on:

071 266 0969

Hi-Fi World Dial-a-Dealer

PRACTICAL HI-FI 65 Bridge Street, Manchester M3 2BO
Tel: 061 839 8699 See our main entry under Lancaster.

MERSEYSIDE

DOUG BRADY HI-FI, 401, Smithdown Road, Liverpool, L13 3JL. (051) 733 6859 Fair demonstrations and home trial facilities. All credit cards. Largest choice of specialist hi-fi in N.W. Closed Wednesdays and lunch 1-2.15pm.

HARROW AUDIO, 27, Springfield Rd., Harrow, Middlesex. Tel: 081 863 0938. Open Mon-Sat 9.30-5.30. Most brands available - see our regular advert for full range including Audiolab, Arcam, Audioquest, Apogee, Aura, B&W, Cyrus, Denon, Epos, Krell, Marantz, Mission, Nakamichi, Tannoy, Targit, Yamaha etc. AV Specialist including installation, Interest Free Credit - ask for details. The largest range of accessories for miles around. 2 dem rooms. Plus Carriage Free Mail Order.

AUDIOCRAFT, 18 Hillingdon Road, Uxbridge, Middlesex. UB10 0AD (0895) 253340. Unbelievable but true you can audition these brands here: Audion, Proac, Michell, Erlele, LFD, Lumley, Levison, Lurne, Triangle, Sentec, Mag Audio, Teac, VHD, Siwerssons, YBA, Sax, Theta, Monitor Audio, Fuller Audio, Trilog, Lyr, Sumiko, Ortofon, Decca, Target, Project, Moth, Kelvin, Townshend, Edison, Audio Alchemy, Kesirk, Musical Fidelity.

AUDIO T, 159A Chase Side, Enfield, (0181) 367-3132. Great Hi-Fi from Arcam, Audiolab, Cyrus, Denon, Linn, Marantz, Meridian, Micromega, Mission, Rotel, Yamaha and many more. Mon-Fri 10-6. Sat 9.30-5.30. 3 year Hi-Fi guarantee. Free delivery & installation. 30 day free upgrade. Home demonstrations. PX Selected Interest Free. 2 Listening Rooms. Home Cinema Specialists. BADA Bonded.

MUSICAL IMAGES, 45 High Street, Hounslow, Middlesex. Tel: (081) 569 5802. Fax: (081) 569 6353.

MUSICAL IMAGES, 173 Station Road, Edgware, Middlesex. Tel: (081) 952 5535. Fax: (081) 952 5535. Most brands available - see full page advert. Interest free credit, ask for details. Demo rooms. Repairs & Service. Sunday opening - Open all week A Home Cinema Specialist. Mail order. Part exchange

AUDIO T, 159A Chase Side, Enfield, Middlesex, EN2 0PW. (081) 367 3132. Fax: (081) 367 1638. Great Hi-Fi from Adcom, Arcam, Audiolab, Celestion, Denon, Marantz, Meridian, Micromega, Mission, Philips, Rotel, Yamaha, & many more. Mon-Fri 10-6. Sat 9.30-5.30. 3 year guarantee on Hi-Fi. Free delivery & installation. 30 day free upgrade scheme. Home demonstrations. Part exchange. 2 listening rooms. Home Cinema specialists. BADA Bonded.

NORFOLK

BASICALLY SOUND, The Old School, School Road, Bracon Ash, Norwich Norfolk NR14 8HG. Tel: (0508) 570829. Arcam, Heybrook, Chord Co. Rotel, Sound Style, TDL, Royd, Denon, Naim, Spondor, Sound Organisation, Audio Technica, Creek, Epos etc. 2 comprehensive dem rooms, home trial facilities. Free installations. Visa/Access. HP facilities. Tues-Fri 9.30-1.00pm, 2.00-5.30pm, Saturday 9.30-5.30pm.

PROTECT-A-DISC, Unit 4, Elvin Way, Sweetbriar Industrial Estate, Norwich, NR3 2BB. Tel: 0603 482193. Producers and suppliers of finest quality card record and CD sleeves with taped edges, poly-lined or unlined, mailers and crumchims etc. Please send SAE for full current price list. Trade enquiries welcomed. Tel: 0603 482193.

NORTHAMPTON

LISTEN INN, 32 Gold Street, Northants NN1 1RS. Tel: 0604 37871. Fax: 0604 601430. Naim, Linn, Rega, Audiolab, Arcam, Cyrus, Royd, Nakamichi, Mission, Denon, Rotel, NAD, Heybrook, Marantz, Chord Co. etc. Open 10.00 - 5.30 (Closed Thurs)

THE AUDIO SHOP, Hi-Fi Specialists. Appointed stockists of: Ariston, Creek, Denon, Dual, Goodmans, JPW, Mordaunt-Short, Rotel, Royd, Tannoy. 6 Hill Street, Raunds, Northamptonshire. Tel: 0933 622325

NOTTINGHAMSHIRE

DEFINITIVE AUDIO, Tel: (0602) 813562. For a carefully considered approach to building a true high fidelity audio system with components derived from the following manufacturers: Audio innovations, Wadia, Micromega, Deltac, E.M.T., Horning, Voyd, Systemdek, SME, Revox, Impulse, Ortofon, Pioneer. Also the remarkable Living Voice Air Partner loud speaker system. Demos by appt. Please phone for further details, install, free of charge. Mon-Sat 10.00-7pm. Closed Wed a.m.

PETER ELLIS AUDIO, 29 Kirkgate, Newark, Notts NG24 1AD. Tel: 0636 704571. QUAD, Castle, Arcam, QED, Sugden, Tannoy, Thorens, Marantz, Denon, Teac. Demo room, free install, Service dept. Access, Visa, American Express. Mon-Sat 9-5.30. Closed Thursdays PM.

CHANTRY AUDIO, 18-18a Eldon Street, Tuxford, Nr Newark, Notts, NG22 0LH. Tel: 0777 870372. Pink Triangle, DPA, Rotel/Michell, Micromega, NVA, Alchemist, Michell, Monitor Audio, Lumley, SME, Audion, and much more! 1 Three dem rooms, home trial, free installation, service department. Access & Visa, credit facilities, Mail order, Mon-Sat 9.30-6.00. Sun and evenings home dem by appointment.

NOTTINGHAM HI-FI CENTRE, 120-122 Alfreton Road, Nottingham. Tel: 0602 786919. Over 25 years experience, superb demo rooms, extensive range. Free parking. Mon-Sat 9-5.30

OXFORDSHIRE

AUDIO T, 19 Old High Street, Headington, Oxford, OX3 9HS (01865) 659611 Great Hi-Fi from Arcam, Cyrus, Denon, Marantz, Meridian, Mission, Rotel, Sony, Yamaha & many more. Mon-Fri 10-6. Sat 9.30-5.30. 3 year Hi-Fi guarantee. Free delivery & installation. 30 day free upgrade. Home demonstrations. PX. Selected Interest Free. 2 listening rooms. Home Cinema specialists. BADA Bonded.

WESTWOOD & MASON, 46 George Street, Oxford. Tel: 0865 247783, Creek, Marantz, Naim, Arcam, Rotel, Rega, Epos, Tannoy, Mission, Nakamichi, Denon, Aiwa, Quad, Yamaha. Monitor Audio. Open 9.30-5.00pm. VHM dem room. Closed Thursdays

ASTLEY AUDIO LTD, 3 Marketplace, Wallingford (3 miles from Berkshire border). 0491 839305. Aura, B&W, Technics, Panasonic, Pioneer, Kenwood, Sony, Yamaha, Denon, Dual, Marantz, Mission, Tannoy. 1 listening room. Home trial. Free installation. Service department. Access, Visa, Amex. Diners. Instant credit. Tues-Fri 9-5.30. Sat 9-5. Records & CDs stocked.

SHROPSHIRE

AVON HI-FI, 12 Barker Street, Shrewsbury, Shropshire, SY1 1QJ. Tel: 0743 355166. Aiwa, Beyer-Dynamic, NAO, Quad, B&W, Mordaunt-Short, Kenwood, Bose, Nakamichi Onkyo, Teac, Sennheiser. Dem room. Home trial. Free install. Service dept. Access/Visa £1000 instant credit. Mon, Tues, Wed, Fri, Sat 9-5.30.

SHROPSHIRE HI-FI, St Michael Street, Shrewsbury, Shrops. SY1 2ES. Tel: 0743 232065. Stockists of Musical Fidelity, Mordaunt Short, Sony, Kenwood, Pioneer, Rotel, Denon, B&W. Proac. Audio Visual Products available. Open 9.30 - 5.30pm Mon-Sat.

MID SHROPSHIRE AUDIO, 24 Peveril Bank, Dawley, Telford TF4 2BU (0952) 502097. Pink Triangle T.D.L., Marantz, Denon, JPW, Ortofon, Project, Yamaha, Ruark, Royd, Michell, Musical Fidelity, Yamaha, Targit (Tables, Speaker Stands, best prices) Free Delivery nationwide. Good Discounts with no p/sex. Surround sound specialist. Home demonstrations a pleasure. 0% finance.

SOMERSET

MIKE MANNING AUDIO, 110 Middle Street, Yeovil, Somerset. BA20 1NE. Tel: 0935 79361. Fax: 0935 32923. Mobile 0850 325965. Naim, Roksan, Pink Triangle, A&R (Arcam) ION, NAD, Pioneer, Rotel, Denon etc. Dedicated listening lounge, for relaxed and unpressured demos. Appts not necessary but best to telephone first. Home trial facilities on request, free installation and service dept. Instant credit, Access/Visa etc. 9-5.30. closed Mondays.

STAFFORDSHIRE

ACTIVE AUDIO, 95, Stafford Street, Hanley, Stoke-on-Trent, Staffs. Tel: 0782 214994. Fax: 0782 283346. We have four studios including a dedicated Audio Visual studio for the demonstration of quality equipment from the largest range in the Midlands. Open six days per week. Own service department. Free local delivery, home trial facility. Current special offers and buyers fact pack and quotation service on request.

MUSICAL APPROACH, Unit 7, Woodings Yard, Bailey Street, Stafford, Tel: 0785 55154. Also branch at 37 High Street, Aldridge, nr Walsall. Tel: 0922 57926. Linn, Rega, Arcam, Rotel, Royd, Heybrook, Marantz, Teac, Celestion, Apollon, Target. Mon-Sat 9.30-5.30. Home cinema equipment stocked. 2 single speaker dem rooms. Service dept and free install. Credit facilities. We are now agents for Rega products. Stafford branch only.

ACTIVE AUDIO, 29, Market Street, Tamworth, Staffs. Tel: 0827 53355. Fax: 0827 59513. We have two studios including a dedicated Audio Visual studio for the demonstration of quality equipment from the largest range in the Midlands. Open six days per week. Own service department. Free local delivery, home trial facility. Current special offers and buyers fact pack and quotation service on request.

SUFFOLK

AUDIO IMAGES, 7 All Saints Road, Pakefield, South Lowestoft, Suffolk, NR33 6JL. Tel/Fax: 0502 582853. Quad, Triangle, Arcam, Castle, Rotel, Moth, JPW, Sugden, Mission, Project, Denon, Yamaha surround sound. Audio

Innovations, plus the amazing ROTHWELL range. Separate dem room, no appts nec. 10.6.30 Tues-Thurs, 7pm Fri. 6pm Sat.

SIGNALS Martlesham Heath, Ipswich. Tel: (0473) 622866. See display advertisement for brands. Turntables, high end CD drives/DAC's as well as integrated players, valve and solid state amplification, wide range of cables and loudspeakers. Home demonstrations/equipment trial service. Please telephone for directions and to book appointment.

BURY AUDIO, 47 Churchgate Street, Bury St Edmunds, Suffolk, IP33 1RG. Tel: 0284 724337. Arcam, Audio Alchemy, Heybrook, Marantz, Michell, Meridian, Nakamichi, Pink Triangle, Quad, Rotel, Sonus Faber, Stax, Tube Technology, Single speaker dem room. Free install. Credit facilities. Mon-Sat 9.30-6.00, closed Wed. Evening dems by appointment.

EASTERN AUDIO, 41 Bramford Road, Ipswich, Tel: 0473 217 217. Fax 0473. 215705. Quad, Arcam, Audiolab, Meridian, Mission, Denon, Rotel, Marantz, NAD, Sony, Rogers, Nakamichi, Systemdek, Technics, Celestion, B&W, Tannoy, Morel Thorens and Top Tape. Also stock a wide range of accessories. usual credit facilities. A BADA dealer.

FENWAY, 71 The Rookery Centre, Newmarket. Tel: 0638 66166. Contact Mark Pearson. For Sony, Technics, Rotel, Tannoy, Pioneer. QED, equipment and accessories. Demonstration facility. In-House Service Dept. "FREE INSTALLATION BY EXPERTS"

HEREFORD

SPALDEN HI-FI, 352-4 Lower Addiscombe Rd., Croydon, Surrey. 081 654 1231/2040. 3 dem rooms and home dem. Free installation/credit.

Linn, Naim, Quad, Arcam, Audiolab, Cyrus, Marantz, Denon, Ruark. Mon-Sat 9-6, Tues 9-8, Closed Wed. Service dept.

PJ HI-FI, The HiFi Shop, 3 Bridge Street, Guildford, Surrey GU1 4RY. Tel: (0483) 504801. 9-6 Mon-Sat. Linn, Meridian, Rega, Arcam, Quad, Revox, Musical Fidelity, Rotel, NAD, Nakamichi, Marantz, KEF, Reference etc.

ROGERS HI-FI, 13 Bridge Street, Guildford, Surrey, (0483) 61049. Aiwa, Creek, Denon, Dual, JPW, Marantz, Onky, Pioneer, Systemdek, Ruark, Tannoy, Teac. Dem facilities available, no appts necessary, free installation, service dept. Access/Visa. Instant credit upto £1,000 subject to status. Monday-Saturday, 9.30-6pm, later by appt.

SURBITON PAPER AUDIO, 48 Surbiton Road, Kingston-upon-Thames, Surrey. (081) 546 5549. QUAD, Castle, Denon, Dual, Kenwood, Mordaunt-Short, JBL, Rotel, Pioneer, QED, B&W and Tannoy. Demo facil. Access. Visa and Switch. 9.30-5pm.

SURREY HI-FI, 45 High Street, Godstone, Surrey, RH9 8LS (0883) 74755. Specialist HiFi outlet, demonstration room and parking available. Quad, Audiolab, TDL, Tube Technology, Rel Acoustics, Nakamichi, Kel, Thorens, Musical Fidelity. Van Den Hul cables, Bose, Sennheiser, Beyer headphones, Marantz, Denon, Michell, Van den Hul, Musical Fidelity, Tannoy, Target, JPW Single speaker dem rooms. Free installation service dept. Access/Visa/Mastercard. Open 9-6pm. Closed all day Wednesday.

SUSSEX (EAST)

THE POWERPLANT "Brighton's Leading HiFi Shop" 66 North Street, Brighton, Tel: 0273 775978. Comfortable listening rooms. Knowledgeable and approachable staff. Roksan, Micromega, Exposure, Audiolab, Epos, Rotel, Marantz, Cyrus, Regal, Arcam, Mission and more. **WORTHING AUDIO**, 20 Treville Gate, W Sussex, BN11 1VA. Tel: 0903 212133 "The friendly shop with the best sound systems in the South". Friendly advice, 3 yr guarantees, easy parking, open Mon-Sat 9-6pm. Late night Wed. Arcam, Exposure, Naim Audio, Marantz, Ruark, Restek, Clear Audio, Audio Technica, Target, Tripod, Sennheiser, AR and many more.

CHURCHERS HI-FI, 154 Montague St. Worthing, Sussex. BN11 3HH. Tel: 0903 821595. All major well know brands of Hi-Fi stocked. Please call for details.

HEATHERDALE AUDIO LTD, 202 Findon Road, Worthing, Sussex. Tel: 0903 872288 or 0860 660001. eves. Three comfortable demonstration lounges where you can audition, Audionote, Krell, Audio Research, Klipsch, Martin Logan, Apogee, Sonus Faber, Theta, S.M.E. Copland, Voyd, Magnephan, E.M.F., Lumley Reference, Creek, Rotel, Heybrook, Clearaudio. Phone for used stock list. "We are the South Coast's Premier Hi-Fi Specialist"

SUSSEX (WEST)

BOWERS & WILKINS Ltd. (est. 1945). 1 Becket Buildings, Little Hampton Road, Worthing. Tel: (0903) 2 64141. Top names in HiFi and audio visual including B&W, Nakamichi, Castle, Denon, Philips, Quad, Technics, Aura Teac, Sugden, Mission Thorens and many more. 4 dem rooms (budget - high end) expert friendly advice, service dept, local installations free. one minute from A24 & A27, free

local parking, Access/Visa, Instant Credit up to £1,000 subject to status. Open 6 days.

CHICHESTER HI-FI, 7 St Pancras, Chichester, W Sussex. PO19 1SJ. Tel: 0243 776402. Linn, Naim, Rega, Creek, Nakamichi, A&R, Denon, Roksa, Epos, JPW, Ruark, Rotel, Quad, Spondor. Evening appts available.

CRAWLEY AUDIO, 1 Silkin, Dalton Close, Broadfield, Crawley, West Sussex. Tel: 01293 531190. Mob: 0860-911640. RCA "Living Voice" Recordings, Alchemist, Burmester, Manhattan Acustik, German Physiks, Chord Co, Cable Talk, Systemdek, Gravis Subwoofer, WAD, Apollo, CAD, Ortofon, Fullers Audio, Lorcraft (Garrard) SME, Denon cartridges, Polk Audio, Atacama, Magnephan. Purpose Built Dem Rooms, Home Dems available. Part Exchange, Credit Cards Accepted.

HORSHAM HI-FI, 28 Queensway, Horsham, WEST SUSSEX. Tel/Fax 01403 251589. Mobile: 0831-418619. RCA "Living Voice" Recordings, Alchemist, Burmester, Manhattan Acustik, German Physiks, Chord Co, Cable Talk, Systemdek, Gravis Subwoofer, WAD, Apollo, CAD, Ortofon, Fullers Audio, Lorcraft (Garrard) SME, Denon cartridges, Polk Audio, Atacama, Magnephan. Purpose Built Dem Rooms, Home Dems available. Part Exchange, Credit Cards Accepted.

TYNE & WEAR

BILL HUTCHINSON HI-FI, 87a, Castle Street, Newcastle-upon-Tyne, (091) 230 3600. For the largest selection of HiFi and audio visual equipment in the North East. Specialist AV demonstrations of the highest quality. Best prices guaranteed. Minimum 2 year warranty and an optional 5 yr guarantee available. Instant credit and mail order service on offer throughout the U.K. Pioneer, Denon, Kenwood, Yamaha, Technics, Marantz, Mission, Tannoy plus many more.

WARWICKSHIRE

STRATFORD HI-FI, 25 Henley Street, Stratford-upon-Avon, CV3 0W. Tel: 0789 414533. Pioneer, Technics, Denon, Marantz, NAD, Rotel, Musical Fidelity, Monitor Audio, Mission, Tannoy, Quad, TDL, Sennheiser, 0% finance is offered on selected products and all major credit cards accepted. Dem Rooms. Service facilities. open 9.30-5.30pm. Late night Thursday until 8.00pm.

WEST MIDLANDS

FRANK HARVEY HI-FI EXCELLENCE, 163, Spon Street, Coventry CV1 3BB. Tel: 0203 525200. The Midlands first hi-fi and audio specialist Hi-Fi. Audiolab, Audio Alchemy, Arcam, Audio Quest, Alphason, Bose, Bang & Olufsen, Celestion, Cyrus, Denon, Dual, Foundation, Kel, Reference, Marantz, Monitor, Audio Mission, Musical Fidelity, Nakamichi, NAD, Rega, Rogers, Rotel, Quad, Systemdek, Target, Tripod, Tannoy, Thorens, Van den Hul, Yamaha 3 floors, 3 demonstration rooms. Open 9.30 till 5.30. Closed Thursdays. All credit cards incl. Amex & Diners. Instant credit and interest free facilities. Home trials. Free installation, home cinema A/V floor. We are a BADA dealer.

MIDLAND VALVE HI-FI, Specialising in true fidelity systems built around valve amplification:- Audion 300B Silver Nights, Audio Innovations, Impulse, Audio Note, KAL, Townsend Audio, Ortofon, Voyd, Micromega, Edison, Stax, Apollo, Dynavector, Seismic Sink, Valves. Home demonstrations and part exchange. Also vintage: Leak, Quad, Croft, Radford, etc. Flexible opening 7 days. phone Gary 021 722 2317.

MUSIC MATTERS, 351 Hagley Road, Edgbaston, Birmingham. B17 8DL. Tel: 021 429 2811. Roksan, Nakamichi, Arcam, Audioab, Kenwood, DPA, Tannoy, Royd, Heybrook, Michell, Pansonic, Aura, Celestion, Musical Fidelity, Mission/Cyrus, Meridian, Kel, Monitor Audio, Pink Triangle, Ruark, Epos, Exposure, Pioneer and many, many more! 2 single speaker dem rooms. Appts necessary. Home trial facilities and free install. Service dept. Access/Visa/instant credit upto £1,000. Interest free credit available also. Tues - Thurs 10.30-6pm, Friday 10.30-8.00pm, Saturday 10.00-5.30pm. Check out the new branch in Solihull - Phil works there so it can't be bad! 021 742 0284.

COVENTRY HI-FI, 126, Church Lane (off Walsgrave Road), Coventry. CV2 4AJ. Tel: 0203 440529. Quad sales & service agent, Pioneer Reference Point, Kenwood, Aiwa, T.D.L., B&W, Tannoy etc. Private listening room. 2 year guarantee on all new hi-fi. Open 9.30-5.30 Mon-Sat. Closed Thursdays.

ELECTRO CENTRE, 244 Soho Road, Handsworth, Birmingham, Tel: 021 554 1878. Full range of HiFi, Pioneer, Technics, Kenwood, JVC, Sony, Aiwa, Akai, "Guaranteed the lowest price in the UK" 24 hour mail order facility available.

ELMDON AUDIO, Tel: 021 784 8765. Reference Imports Lumley, Alon etc. Esoteric Audio Research 834 integrated on demonstration. Home demonstration can be arranged, Top part exchange prices, lots of used bargains. Quad, Leak, etc. Valves and valve testers, new GEC KT66s available.

Hi-Fi World Dial-a-Dealer

FIVEWAYS HI-FIDELITY LTD., 12 Islington Row, Edgbaston, Birmingham, B15 1LD 021 4550667 Arcam, ATC, AAudiquest, Audio Technica, AVI, Beyer, Cable Talk, Castle, Chord, Denon, Dual, Klipsch, Michell, Nakamichi, Ortofon, QED, Quad, Revox, Sennheiser, Sequence Design, SME Spendor, Target, TDK, TDL, Thorens etc. Keith Monks Record Cleaning Machine. Closed Mondays.

MUSICAL APPROACH, 37 High Street, Aldridge, nr Walsall. Tel 0922 57926. Linn, Arcam, Rotel, Royd, Heybrook, Marantz, Teac, Celestion, Apollo, Target, and others. Mon-Sat 9.30 - 5.30 Closed Thursdays Home Cinema equipment stocked. Dem rooms, service dept. Free installation and credit facilities. Free parking at rear of shop.

SOUND ACADEMY, The ultimate experience for those seeking HiFi. Ac. En. Arcam, Audiolab, AudioQuest, B&W, Bose, Chord, Cyrus, Cable talk, DPA, Epos, Kef, ref. Marantz, Meridian, Mission, Mus. Fid, Nakamichi, Ortofon, Project, Quad, Roksan, Tube Tech, Rotel, Micromega, KAR, Kenwood, Lexicon, Cannon, Celestion, Beyer & more. 3 Single speaker dem room on two floors incl. A/V Cinema. Open 6 days a week Mon-Sat. All major credit cards taken. Part exchange, enquiries welcome. Just off the high Street. Blowich, Walsall W Midlands Tel: 0922 493499. (ample free parking)

AMADEUS SOUND & VISION, 10 Boldmere Road, Sutton Coldfield, West Midlands, Tel 021 354 2311 Audio Innovations, B&O, Castle, QED, Wharfedale. Single speaker demo appts preferred, service available. Installations B&O link install, home trials. Access/Visa interest free credit available subject to status. 9.30-6.00pm 6 days

GRIFFIN AUDIO, 34 Bristol St, Birmingham, Tel 021 622 2230/021 692 1359. Tues-Sat 10 a.m.-6 p.m. Enjoy music at home with a system from Griffin Audio. We demonstrate and install the very best hi-fi, with systems from £500 to £25,000. Ask for Bob, Tim or Alex. Linn, Nam, Shahman, Quad, Arcam, Rega, Denon, Marantz, Rotel.

WILTSHIRE

THE AUDIO EXCHANGE, 52 Morse Street, Swindon, Wiltshire SN1 5DP (0793) 539008. Acoustic Energy, Audio Innovations, Beard, Cerwin Vega, CR Developments, Impulse, Magnum, Micromega, Michell, REL, Sequence AV and single speaker demo room. Home trial facilities free installation, service dept. Mon-Sat 10-6.

AUDIO T, 60 Fleet St, Swindon, Wiltshire, SN1 1RA (01793) 538222. Great Hi-Fi from Arcam, Denon, Linn, Marantz, Meridian, Mission, Nam, Rotel, Technics, Yamaha & many more. Mon-Sat 9.30-5.30. 3 year Hi-Fi guarantee. Free delivery & installation. 30 day free upgrade Home demonstrations. Part exchange. 2 listening rooms. Home Cinema specialists. BADA Bonded.

P.R. SOUNDS, 58 Castle Street, Trowbridge, Wilts BA14 8AU Tel: 0225 777799. Authorised dealer for Pioneer, Technics, Marantz, Kenwood, Mission, Jaha and many more. Cinema Sound Specialists with Listening Room. For all trials best in Hi-Fi at a Price you can afford! Open Mon-Sat 9-6 Credit Cards accepted. Finance available.

WORCESTERSHIRE

SPAINS HI-FI, 2 +2a New Rd., Bromsgrove, Worcs Tel: 0527 872460. Aura, B&W, Beyer, Denon, Heco, JVC, Kenwood, Marantz, Mission, Monitor Audio, NAD, Nakamichi, Pioneer, Rotel, Sennheiser, Soundstyle, Sony, Systemdek, Tannoy, Target, Thorens. Integral demo room/showroom for instant comparisons on Hi-Fi & AV equipment. Free installation. Part exchange welcome. Service department. Access, Visa, 0% finance on selected products. Mon-Sat 9.00-5.30 pm. Closed Thursdays.

COLORAMA HI-FI, 27 Kingfisher Walk, Kingsfisher Centre, Redditch, Worcs B97 4EY (0527) 597260. Aura, NAD, Onkyo, Kenwood, Denon, TDL, Polk Audio, B&W, Tannoy. Full Pro-logic products. In-store integrated dem facilities. No appts required. service dept. Access, Visa. Open 9-5.30, closed Thursdays.

WEST MIDLANDS

WEST MIDLANDS AUDIO, 158 Oldembury Road, Worcester WR3 7HA. Tel 0905 458046. Fax 0905 457585. Nam, Rega, Rotel, Marantz, Nakamichi, NAD, Audiolab, Roksan, Meridian, B&W, Audio Research, Krell, Martin Logan, Arcam. 9-5.30 Mon-Sat, eves by appt only. Free.

YORKSHIRE (SOUTH)

HIFI STUDIO'S, Sunnyfields, Doncaster, Tel 0302 781387. TOL, Sugden, ProAc, Ruark, Teac, Impulse, Systemdek, Alphason, Target, Albany, Heybrook, Monitor Audio, JPW, Totem, Harbeth, Keswick Audio Research, Michell Engineering, AMC (CD and Valves), CR Developments (Valves), Art Audio (Valves), Rel Acoustics, Projekt, Origin Live, Dual, Yamaha plus home Cinema pro-logic dems. Listening room demo's. Home trial, free install, licensed credit broker, 2 yr guarantee on all equipment, service available. Access/Visa, 10-8pm 6 days. Phone for further information and free fact pack.

TRC HIFI, 3 Kings Cross Street, Halifax, HX1 (0422) 366832. Agents for Kenwood, Denon, Castle, Rotel. Demonstrations and advice a pleasure. Call at any time to audition some of the best HiFi and pro-logic systems. Delivering and installation free within 20 miles. "The family firm where the customer matters most."

YORKSHIRE (NORTH)

AUDIO CLINIC, 22 Lord Mayors Walk, York, YO3 7HA. Tel: (0904) 646309. Revox, QED, Audio Innovation, Allison, Celestion, Yamaha, Teac, Revolver, JPW, Kenwood, Bose, Thorens, Mission, Snell, B&W, Heco, Cannon, NAD, JVC, Musical Fidelity, Wharfedale, Micromega, Ruark, Heybrook. Surround sound and demo rooms. free installation. Service Dept. Credit facilities on request. Access, Visa. Open 10am - 5pm 6 days a week.

SCARBROUGH HIFI, 14 Northway, Scarborough, North Yorkshire YO11 1JL. Tel 0723 374547. Albarray, Aura B&W Matrix, Cyrus, Pioneer, Philips, Marantz, Cabasse, Bose, Tannoy, DCC wide screen and laser vision. Home trial facilities and free installation. service dept. Access/Visa. Credit charge £1,000 instant credit. Amex/Diners.

THE SOUND ORGANISATION (YORK), 2b Gillygate, York, YO3 1TE (0904 627 108). Linn, Meridian, Micromega, Nam, Rega, Arcam, Castle, Nakamichi, Mission, Denon, Epos, Royd, Rotel. 3 single speaker dem rooms. appts preferred. home trial facilities. free install, service dept. Credit facilities on request. Access/Visa. 10.00am-5.30pm Tues-Sat. Sony dealer award nominated '86, '87 and '88.

VICKERS HIFI, 24 Gildgate, York (0904) 629659. Audio Innovations, A. E. Audiolab, Beyer, Harmon Kardon, JBL, Kef, Kenwood, Marantz, Michell, Mission, Monitor Audio, Mordant, Short, Pickering, Pink Triangle, Pioneer, Quad, Rogers, Systemdek, Tannoy, Technics, Heybrook, TDL, Thorens, Dual and lots more. Dem Rooms 4 (3 by appointment). Superb showrooms. 2 yr guarantee on all nfi products. Appts. as above. Home trial facilities, free install, service dept. Qualified and experienced staff over 25 yrs experience. 12 mths interest free credit. 10.30-5.30 Mon-Sat.

YORKSHIRE (WEST)

BILL HUTCHINSON HIFI, 26-28 Woodhouse Lane, Leeds (0532) 427777. For the largest selection of HiFi and audio visual equipment in the Yorkshire. Specialist A/V demonstrations of the highest quality. Best prices guaranteed. Minimum 2 year warranty and an optional 5 yr guarantee available. Instant credit and mail order service on offer throughout the U.K. Pioneer, Denon, Kenwood, Yamaha, Technics, Marantz, Mission, Tannoy plus many more.

DOUG BRADY HIFI, The Forge Cottage, 19 Cross Gate, Otley, West Yorks, LS21 1AA. Tel: (0943) 467689. Nam, Arcam, Rotel, Pink Triangle, Meridian, Epos, Castle, 20 dem rooms, fair demonstrations and home trial facilities. Access/Visa. Open 10.00-6pm Tues-Sat.

HUDDERSFIELD HI-FI CENTRE, 4 Cross Church St, Huddersfield, (0484) 544668. B&W, Cyrus, Kenwood, Denon, Rotel, Arcam, Musical Fidelity, Quad, Audio Lab, Marantz, Mission, ect. Dem facilities - appointment reqd. Mon-Sat 9-5.30, Thurs 9-8. Closed Wed. Free installation, credit facilities. Access, Visa.

AUDIO PROJECTS, 45 Headingly Lane, Leeds. Tel: 0532 304565. A&R, Audiolab, Creek, Heybrook, Linn, Musical Fidelity, Nam, Quad, Rega etc. Free installation, home trial. 2 year warranty, appts preferred. Tues-Fri 9.30-6, Sat 2.30 - 5.30.

ASTON AUDIO, 19 Crossgates, Otley, Leeds LS21 1AA 0943 467689. Products, Nam, Arcam, Audiolab, B&W, Cyrus, Denon, Epos, Meridian, Micromega, MF, Mission, Nakamichi, Quad, Rotel, TDL & other leading brands. Demonstration Rooms. Installation Service. Interest Free Credit. Access, Visa, Open Tues - Sat.

SCOTLAND

EDINBURGH

BILL HUTCHINSON HIFI, 43 South Clark Street, Edinburgh (031) 667 2877. For the largest selection of HiFi and audio visual equipment in Lothian Specialist A/V demonstrations of the highest quality. Best prices guaranteed. Minimum 2 year warranty and an optional 5 yr guarantee available. Instant credit and mail order service on offer throughout the U.K. Pioneer, Denon, Kenwood, Yamaha, Technics, Marantz, Mission, Tannoy plus many more.

MUSIC MILL - 72 Newhaven Road, Edinburgh EH6 5QG. Tel: 031 555 3963. Stockists of Micromega, Proac, Audio Innovations, Lumley Reference, Tube Technology, DNM, B&W, Systemdek, Nottingham Analogue, Nakamichi, Rehdeko, Oak, Crimson, Harmon Kardon, Goldring, Mon-Sat 10-4.30 pm by appt. Closed Wednesdays. All Major Credit Cards Accepted. Contact Fraser or Mark.

ABERDEEN

HOLBURN HI-FI, 441 Holburn Street, Aberdeen Tel: 0224 585713. Arcam, Audiolab, B&W, Celestion, Denon, Dual, Epos, Heybrook, ION, Kenwood, Creek, Marantz, Meridian, Mission, Cyrus, M.S., NAD, Nakamichi, Pioneer, QED, Quad, Revox, Rotel, Ruark, Tannoy, Technics, Wharfedale, Yamaha. 9.30-5.30 Mon-Sat.

HI-FI EXCELLENCE, HI-FI innovators & product designers with 15 years experience. Very much in the business for the music. Musical Fidelity key dealer. Largest Rotel retailer in the area. Particularly keen to make the buying of Hi-Fi a fun experience. Situated in the West End away from the bustle of the City centre - the perfect environment to enjoy quality Hi-Fi. Full time service engineer. Open Mon-Tues 10-6, Wed 10-1, Thurs 10-7, Sat 10-5 or later by appointment. Hi-Fi Excellence, 293 Union Grove Aberdeen. Tel: 0224 322520.

AUDIO SUITE 42 St Andrews Street, Aberdeen Tel: 0224 625635. Single Room Demonstrations available. Full Service Department. Free Delivery and Installation anywhere in Scotland. Authorised dealer for Linn, Chord, Proac, Mordant, Short, Audio Research, Sonus Faber, All Major credit cards accepted.

AYRSHIRE

LASER AUDIO, Now at new premises, 1 St Marnock Place, Kilmarnock KA1 1OT. Tel: 0563 40292. Audiolab, Awa, Celestion, Cyrus, Denon, Dual, Marantz, Mission, Philips, Pioneer, Systemdek and Tannoy. 2 demonstration rooms. AV den room. Appointments preferred, home trial facilities. Free installation service facilities. Access, Visa and writers credit. Open Tues - Fri 10-5.30 Sat 9.30-5.30.

GLASGOW

STEREO STEREO, 278 St Vincent Street, Glasgow, Scotland. Tel: 041 248 4079. Closed Tuesdays. Installations throughout Scotland. Credit facilities available.

BILL HUTCHINSON HIFI, 43 Hope Street, Glasgow (041) 248 2857. For the largest selection of HiFi and audio visual equipment in South West Scotland. Specialist A/V demonstrations of the highest quality. Best prices guaranteed. Minimum 2 year warranty and an optional 5 year guarantee available. Instant credit and mail order service on offer throughout the U.K. Pioneer, Denon, Kenwood, Yamaha, Technics, Marantz, Mission, Tannoy plus many more.

INVERNESS

THE MUSIC STATION, 49 Church Street, Inverness, IV 1DR. Tel: 0463 225523. Beyer, Dynamic, Celestion, Denon, Jamo, Kef, Kenwood, Mission, Pioneer, Rotel, Sony. Listening room, service department, free local delivery, part exchange, full range of credit facilities.

TAYSIDE

J.D. BROWN, 28-36 Castle Street, Dundee DD1 9NZ. Tel: (0382) 26591. Rotel, Denon, Pioneer, Technics, Awa, Mission, Castle, Mordant-Short, Monitor Audio, Bose. Infnt nfc. Free installation service dept. Open 9.30-6pm six days a week. (close 5pm Sat).

IRELAND

DUBLIN

ACOUSTIC DIMENSION, 16 Idrome Lane, Rear of Main Street, Blackrock, Co. Dublin. Tel: 288449/288477. Fax: 2834887. Products include: Arcam, Classe, Philips, Rogers, Epos, B&W, Nam Audio, Meridian and others. Open Tues/Sat 10am-6pm, Thurs/Fri 11am-9pm. Closed Mondays.

LAFAYETTE HI-FI, 50 Wellington Quay - Dublin. Tel: 010 353 1677 0443. Dublin's Hi-Fi Separates Specialists. All leading brands, demonstrations available on request. Open Monday - Saturday 10 am - 6 pm.

CLONEY AUDIO, 55 Main Street, Blackrock, Co. Dublin. Tel: 288449/288477. Fax: 2834887. Products include: Arcam, Classe, Philips, Rogers, Epos, B&W, Nam Audio, Meridian and others. Open Tues/Sat 10am-6pm, Thurs/Fri 11am-9pm. Closed Mondays.

PETER OAND & CO LTD. 111 Clonskeagh Road, Dublin 6. Tel: 0103531 2694433. Products include: B&O, Quad, Kef, Thorens, TEAC & many more! 2 demonstration rooms and 2 year guarantee.

BELFAST

LYRIC HIFI, 163 Stanmills Road, Belfast (0232) 381296. Linn, Nam, Rega, Arcam, Denon, Rotel and more. Mon-Sat, 10.00-6.00pm. Late night Thurs.

ZEUS AUDIO, 6 Hope Street, Belfast (0232) 332522. Audio Innovations, Pink Triangle, Roksan, Marantz, Celestion, Meridian and more. Mon-Sat 10.00-5.30pm. Late night Thursdays.

COUNTY DOWN

ASTON AUDIO, Unit 8, Kings Road Shopping Centre, Kings Road, Belfast (0232) 402220. Akai, Technics, JVC, Samsung, Toshiba, Panasonic and many more. Demos. Open Mon-Fri 10.00-8pm. Sat 10-5pm.

LONDON DERRY

ZEUS AUDIO, 23a Kingsgate Street, Colraie, BT52 4LB. Tel: (0265) 56634. Marantz, Mission, Cyrus, Awa, Akai, Aphason, Sony, Pink Triangle, Celestion, Rotel. Mon-Sat 10.5-3.0pm. Closed Thurs.

WALES

ASTON AUDIO, 4 Ruabon Road, Wrexham, North Wales, Tel: 0978 364 500. Audio Visual Specialists. Awa, Arcam, AMC, Bose, B&W, Beard, Cannon, Celestion, Castle, Cyrus, Jamo, Marantz, Michell, Mission, Mordant, Short, Musical Fidelity, NAD, Nakamichi, Micromega, QUAD, Radford, Rotel, Rogers, Rega, Ruark, Spendor, Tannoy, Thorens, Wharfedale, UKD, Yamaha. DSP Club Member. Demo Room. Installation service. Easy Parking and Motorway access. All major credit cards accepted. 9.30 - 5.30 daily. Closed Weds pm.

ELECTRO TRADER, 19 Colwyn Crescent, Rhos on Sea, Colwyn Bay, Clwyd, Wales, LL28 4RN (0492) 548932. NOW APPOINTED SUGDEN DEALER FOR THE NORTH WEST. Rotel, Yamaha, NAD, Harman, Kardon, Teac, Alphason, Heco, Infinity, Kef, JBL, Sugden, Tannoy, Rotel, Michi, Haybrook, Acoustic Research, RUARC and Soundstyle. In-rod racks etc. Dem room appts. preferred. Home trial free. Free install. Access, Visa. Open 9.30 - 1.00, 2.00 - 5.30 Mon-Sat.

ELECTRO TRADER, 19 Colwyn Crescent, Rhos on Sea, Colwyn Bay, Clwyd, Wales, LL28 4RN (0492) 548932. NOW APPOINTED SUGDEN DEALER FOR THE NORTH WEST. Rotel, Yamaha, NAD, Harman, Kardon, Teac, Alphason, Heco, Infinity, Kef, JBL, Sugden, Tannoy, Rotel, Michi, Haybrook, Acoustic Research, RUARC and Soundstyle. In-rod racks etc. Dem room appts. preferred. Home trial free. Free install. Access, Visa. Open 9.30 - 1.00, 2.00 - 5.30 Mon-Sat.

AUDIO EXCELLENCE - WHERE THE MUSIC MATTERS 134-6 Cnys Road, Cardiff, CF2 4NR. Tel: 0222 226565. Fax: 0222 3398201. Great Hi-Fi carefully selected and demonstrated by friendly enthusiastic staff. Home installations and check-ups. Two year warranty from our own service department. Open 9.00-5.30 Tuesday - Saturday closed Monday.

AUDIO EXCELLENCE - WHERE THE MUSIC MATTERS 9 High Street, Swansea SA1 1LE. Tel: 0792 474608. Fax: 0792 645087. Great Hi-Fi carefully selected and demonstrated by friendly enthusiastic staff. Home installations and check-ups. Two year warranty from our own service department. Open 9.00-5.30 Tuesday - Saturday closed Monday.

AUDIO EXCELLENCE - WHERE THE MUSIC MATTERS 9 High Street, Swansea SA1 1LE. Tel: 0792 474608. Fax: 0792 645087. Great Hi-Fi carefully selected and demonstrated by friendly enthusiastic staff. Home installations and check-ups. Two year warranty from our own service department. Open 9.00-5.30 Tuesday - Saturday closed Monday.

I&H GRIFFITHS & SONS, 313 High Street, Bangor, LL57 1YA. 0248 370655. Yamaha, Tannoy, Teac, Sony, B&W, Wharfedale, Rotel, JVC. Home trial facilities. Free installation service dept. After hours dems by appointment. Access, Visa, Lombard credit charge. Mon-Sat 9-5.30, Wed 9-1. Audio Visual Specialists.

TOP TAPE, 1 Crystal Way, Elm Grove Road, Harrow, Middlesex, HA1 2RJ. Tel: 081 427 1404. The UK's oldest and largest Tape Mail Order Service. TDK, Maxell, Sony, Ampex audio cassettes plus Fuji, JVC, Columbia, Memorex, Scotch & TDK video tapes. Send for complete list of latest prices and offers including Video 8, VHS-C, S-VHS, DAT, MiniDisc and Open Reel and tape accessories including Alltop. Local Dealer Listing available. Telephone orders on 081 427 1404. Mastercard, Visa & Switch accepted.

TO ADVERTISE IN THIS SECTION PLEASE CALL THE HI-FI WORLD SALES DEPARTMENT ON 071 266 0969

Simon Hopkins

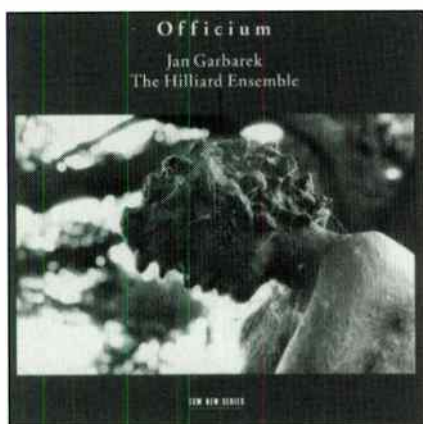

JAN GARBAREK/THE HILLIARD ENSEMBLE
Officium
ECM 445 369-2

● Last time I reviewed a bunch of reissues from the ECM label I made the point that while its reissue program was all fine and dandy, it at times rather showed up some of the new material being released on the label. I also made an observation that perhaps label main man Manfred Eicher's greatest energy had recently been reserved for the ECM New Series - the label's increasing output of "contemporary classical" (a term inherently oxymoronic but one we'll have

to live with within these pages). Anyhow, no sooner have I said all that than the label go and stick out three records which somehow at once underline and deny this criticism.

First up, a real masterpiece, and no mistake. There's a general tendency in the hyperbolic world of the music business to grant the status "classic" to any record which immediately captures enough critics', listeners' and music biz moguls' imaginations. This is ridiculous, of course, for the whole point about any creative endeavour being a "classic" is that this judgement must have some degree of hindsight. All that said, I find it difficult to believe that listeners ten or twenty years hence will regard *Officium* as anything but an honest-to-goodness, no-holds-barred classic.

The official story on how this record happened is this... While at work in Iceland in 1991 on his film "Holozan", an adaptation of Max Frisch's apocalyptic novella "Man in the Holocaust", Eicher found himself frequently listening to the *Officium Defunctorum* of the 16th century Spanish composer Crisobal Morales, the *Tenebrae Resposories* of Morales' Italian contemporary Carlo Gesualdo, and to the work of one of his label's stars, the Norwegian tenor and soprano saxophonist Jan Garbarek. Eicher had an initial impulse to marry the work of Garbarek and these 16th century masters to his film, and although he later dropped this idea, in his own words "The vision remained".

Two years later Eicher brought together Garbarek and the Hilliard Ensemble, a vocal quartet specializing in - perhaps perversely - early, pre-baroque European music and late 20th century work. The group have worked widely for the ECM New Series, recording work as diverse as that of the 13th century father of polyphony Perotin and the recent new work of genius composers like the Estonian Arvo Part and the Briton Gavin Bryars.

Together, Garbarek and the Hilliards take as a starting point excerpts from Morales' *Officium*, 15th century pieces by La Rue and Dufay, and even earlier anonymously-written chants. To this Garbarek adds soprano and tenor saxophone, with a combination of written and extemporised lines which seem to flow organically out of the singing. In his notes to the recording, one of the group's two tenors, John Potter, makes much of the fact that Garbarek's saxophone often seemed like an extension of their own voices. I would add to that that while much of his recent work with the Jan Garbarek Group - to all intents and purposes a jazz-rock group, albeit a very sophisticated one - has been increasingly reserved, the saxophonist's two outstanding albums of the last few years have been recorded with vocalists: 1992's collaboration with the Pakistani Ustad Fateh Ali Khan, *Ragas and Sagas*, and 1991's blissful *Rosensfole*, a collection of Norwegian mediaeval music recorded with the breathtaking Scandinavian singer Agnes Buen Gammas. There is quite simply something in the nature of the human voice which brings out the most lyrical and plangent side in Garbarek's playing.

There are already signs that the classical music establishment will turn *Officium* into this year's answer to Gorecki's *Symphony No 3*, but as with that piece, too much public attention will sell this record short. Like the Gorecki 3rd, this is a record which, while superficially gorgeous and highly accessible, only offers its real fruit on repeated and close listening. This is music of an emotional intensity at once bleak and lovely. It's certainly a record which will sit in the ECM canon alongside, say, Keith Jarrett's *Koln Concert* or Arvo Part's *Tabula Rasa* when it comes to weighing up the label's contribution to the music of the late 20th century. Buy it before everyone else on the block does.

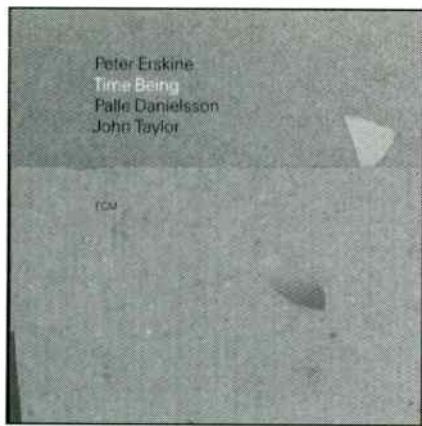

PETER ERSKINE
Time Being
 ECM 521 719-2

● While *Officium* is the kind of genre-straddling work of greatness for which ECM first gained its reputation, Peter Erskine's *Time Being* is one of two straight jazz records released by the label this month which, while undoubtedly fine sets, nonetheless do little to expand the music's horizons. But then, they hardly set out to, and any comparison with the Garbarek/Hilliard record is bound to be unfair.

Time Being is a follow-up to *You Never Know*, the ECM debut for a trio of British pianist John Taylor, Swedish double bassist Palle Danielsson and drummer-leader Erskine. That record established the trio's reputation for finely-crafted, fragile, exquisite improvisations which heavily recalled the work of one of the trio's collective heroes, the late American pianist Bill Evans. *Time Being* is again drenched in Evans' highly lyrical marriage of early 20th century French music to jazz improvising, but this time out the group are altogether tougher, the lyricism of songs like *Evansong* and *Liten Visa Till Karin* balanced here with the strident odd-meter work-out of Taylor's composition *Page 172* or the leader's



Eastern European folk music pastiche Bulgaria.

Through this easily accessible mix of the poetic and the hard, the trio improvise with a dexterity and ingenuity that you'd expect: Daniellson remains one of Europe's finest bassists; Taylor is one of contemporary jazz's most overlooked and underrated pianists, whose playing and composition deserve a much wider hearing than he'll ever get as the regular sideman choice of American stars visiting Europe; and Erskine is consistently one of the most inventive jazz drummers working today. To my mind only Paul Mórtian - Erskine's senior - is as outstanding a drummer-composer-bandleader, and that's no slim praise.

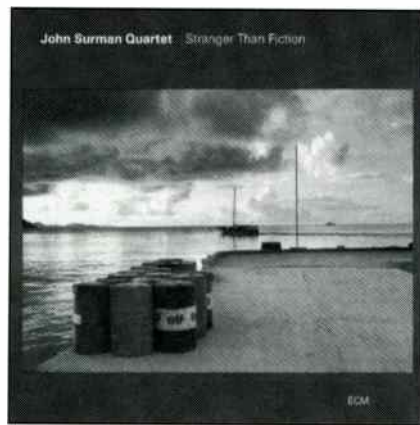

JOHN SURMAN QUARTET
Stranger Than Fiction
 ECM 521 850-2

● Although this group of musicians has played together in a huge variety of combinations over the last thirty years, *Stranger Than Fiction* is in fact a debut recording for this particular quartet: leader John Surman, the baritone and soprano saxophonist whose solo records - exquisite, highly pastoral, multi-tracked affairs using synthesizers and saxophones - have been one of the chief points of musical enjoyment for this hack over the last few years; once again, pianist John Taylor, adapting himself with ease and skill to yet another group; double bassist Chris Laurence, an alumnus of Surman's large group, the Brass Project, whose oblique lines underpin that music in a constantly surprising way; and the underused, but fiercely swinging drummer John Marshall (check out Marshall's 1970s work with bassist Eberhard Weber's jazz-rock group *Colours* for as fine a blending of drive and grace as you'll hear from any jazz-rock drummer).

Together the group rework seven Surman pieces which date from throughout the saxophonist's career, from 1973's *Promising Horizons* to 1992's *Across the Bridge*; it's a set which easily demonstrates this group's ability to swing from the urgent to the lyrical, from the abstract to the tangible. It's music at once highly accessible to the experienced

listener (and, indeed, certainly nothing new to him or her) and a strangely unique sound-world for the newcomer. And despite Surman's undoubtedly tremendous contribution to jazz composition, perhaps the piece I'd recommend most highly here is the closer, *Triptych*, a fifteen-minute group improvisation which develops from a Surman/Taylor duet and spontaneously suggests its own structure. This is highly developed group improvising at the outer limits of consonant, acoustic jazz and personally I could have taken a whole album of this alone.

Not earth-shattering stuff, then, but highly enjoyable for all that.



PIGPEN
V As In Victim
 AVANT AVAN-027

● There's been a plethora of hugely enjoyable recordings out on John Zorn's Japan-based label Avant lately; for space reasons, we've barely been able to touch on them here, a situation I hope to put right soon with an Avant round-up. Before then, however, a brief mention for one of the label's stand-out recent releases.

Pigpen is the latest in a series of fine groups led by Wayne Horvitz, the chameleonic keyboard wunderkind whose melding of cheesy B-movie organ, Lennie Tristano-inspired hard-bop piano and jazz-rock synth-abuse (a sort of Jan Hammer on serious psychedelics) made him the natural choice of keyboardist in Zorn's own freewheeling eclectic collagists *Naked City*.

In *Pigpen* he's joined by bassist Fred Chalenor, alto saxist Briggan Krauss and drummer Mike Stone, all new names to me. Together they tackle Horvitz's fantastic take on jazz-rock as play area for jazz heads with a serious penchant for garage-band enthusiasm, cocktail-lounge sleaze and prog-rock weirdness. Into the bargain, Horvitz throws in some of the best keyboard sounds heard since someone first stuck a Fender Rhodes through a fuzz box, and a desolate reworking of guitarist Bill Frisell's *Again* - which is as fine a piece of music as I've heard all year.

Highly recommended stuff.

Simon Cooke

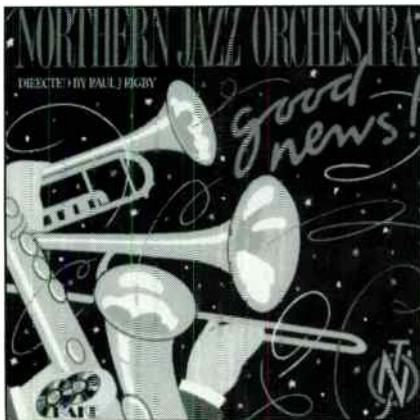

THE NORTHERN JAZZ ORCHESTRA
Good News
LAKE LACD38

● Roll over Glenn Miller; the band members' average age is 19, they recorded this in Blackburn College, and the recording sessions had to be timetabled around school exams. But, they breed 'em tough up north, and the band passes with flying colours, playing a set that ranges from the 'Starsky and Hutch' theme to 'Harlem Nocturne' and similar standards, which are acceptably well recorded.

This month's treat for big band fans.



BRUCE ADAMS/ALAN BARNES QUINTET
Side-Steppin'
BEAR CD38

● Soft bebop from two fine exponents of the style, supported by Brian Dee on piano, Len Skeat on double bass, and Bobby Orr on drums, playing tunes ranging from Horace Silver's 'Opus De Funk' to Berlin's 'The best thing for you is me'. Perhaps only acceptably well-recorded, but expert, impressive, energetic stuff.

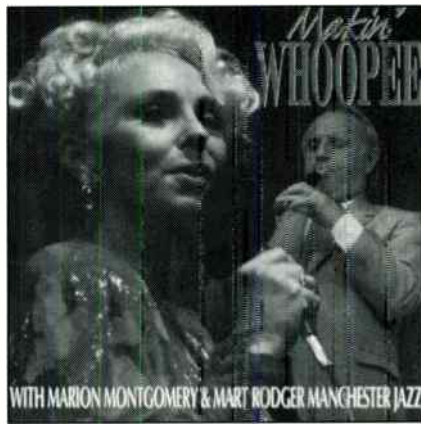

MARION MONTGOMERY
Makin' Whoopee
OWSCD 2602

● Like an eggshell, fragi'le, smooth and seamless, and without the glossy finish of many performers, Montgomery's voice is well suited to the slower Trad-based jazz offered here. Many tracks have more than a hint of torch-song about them ('The Inkspots' 'I get the blues when it rains', taken slow, for example) and the title track has a perfect knowing air about it which leaves most other versions standing. Basically, Marion Montgomery is a world-class jazz singer, and it shows.

Mart Rodger and his band make an excellent backdrop for Montgomery, all damped brass and shrilling clarinet, they bring out the elusive soul of Trad jazz in a way that the usual breakneck Trad treatments of tunes fail to. There is a depth and emotional palette worthy of the finest mainstream players here. Well-recorded, well played, and fronted by Marion Montgomery. What more do you want?



RUBY BRAFF
Cornet Chop Suey
CCD-4606

● Ruby Braff is more of a musician than a jazz player, using notes and phrases sparingly because every nuance overflows with emotion, and the kind of player who returns from a half-hour set break to find his last note still hanging in the air. For Ruby Braff to play a venue is

to spoil it for other players, as his sound hangs in the air long after the notes have died.

Here, the solid Braff-Alden-Tate trio supported by Ken Peplowski's clarinet and Ronnie Zito's drums - skips lightly through a range of the usual thirties and forties tunes, like the Satchmo title track and a 'High Society' medley, ending with Hammerstein/Romberg's 'Lover come back to me', a track that'll doubtless get the man swamped with Valentines in '95.

When Braff plays, any description becomes superfluous, suffice to say that Concorde have done their transcription to disc well enough for me to leave you with these words of advice; just buy it.

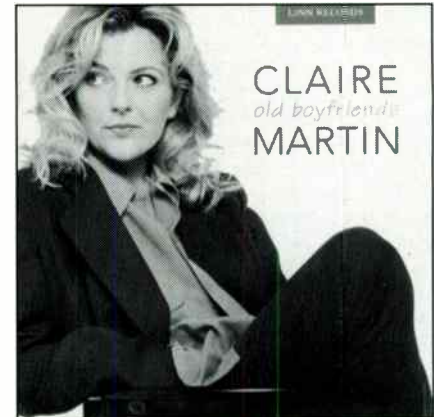

CLAIRE MARTIN
Old Boyfriends
LINN AKD 028

● The much publicised latest from this Linn stalwart although, for those who don't know her work, the next item may be preferable.

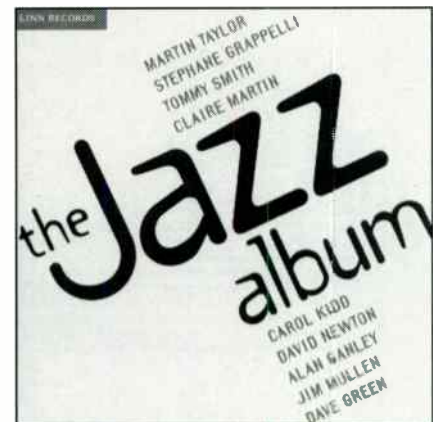

ANTHOLOGY
The Jazz Album
LINN AKD 038

● An anthology of jazz artists available on Linn; Claire Martin, David Newton, Carol Kidd, Tommy Smith (a personal favourite), Stefan Grappelli, and Martin Taylor.

An excellent chance to dip into the Linn jazz catalogue, and worth recommending as a sampler for Linn's recording quality alone.

CHORD

Chord Electronics Ltd
3 Bower Mount Road
Maidstone ME16 8AX

Tel. 0622 764874/692000 Fax. 0622 764506

Chord UK Dealers

Cottage Audio	0522 702834
KJ Leisuresound, London W1	071 486 8262
Acoustic Arts, Watford, Herts.	0923 245250
Brentwood Music Centre, Brentwood, Essex	0277 221210
Progressive Audio, Gillingham, Kent	0634 389004
Doug Brady Hi-Fi, London WC2	071 379 4010
Doug Brady Hi-Fi, Warrington, Cheshire	0925 828009
Doug Brady Hi-Fi, Liverpool, Mersyside	051 733 6859
Doug Brady Hi-Fi, Leeds, Yorkshire	094 346 7689
Photocraft Hi-Fi, Ashford, Kent	0233 624441
West Midlands Audio, Worcester, West Midlands	0905 58046
The Reference Studio, Heathfield, Sussex	0435 868004
Paul Green Hi-Fi, Bath, Avon	0225 316197
Eastbourne Audio, Eastbourne, Sussex	0323 25828
Surrey Hi-Fi, Godstone, Surrey	0883 744755
Sound Academy, Wallsall, West Midlands	0922 493499
English Audio, Hereford, HR4	0432 355081
Hi-Fi Experience, London W1	071 580 3535
London Hi-Fi Services, London	071 263 1015
Diva Audio Fidelity, London SW11	071 924 5286
Music Matters, Birmingham, West Midlands	021 429 2811
Music Matters, Dourbridge	0384 444184
V'audio, Stoke Bishop, Bristol	0272 686005
In Hi-Fi	031 225 8854
Audio Reflections	0532 528850
Audible Difference	0379 740227

The Troika



The Troika is a handsome piece of furniture for storing away CDs and cassettes.

The Troika has 3 drawers and a definitive, patented system for arranging any combination of CDs, and audio and video cassettes. It measures approx. 23" high x 20" wide x 17" deep, and can store away up to 306 CDs.

The Troika is available fully-assembled in light or dark oak finish £295 including delivery.

For details, write or fax:

Reflection Furniture
 Hill Cottage Workshop
 Moon Hall Road
 Ewhurst Surrey GU6 7NP

Fax 0483 277352

HARBETH® HL-P3

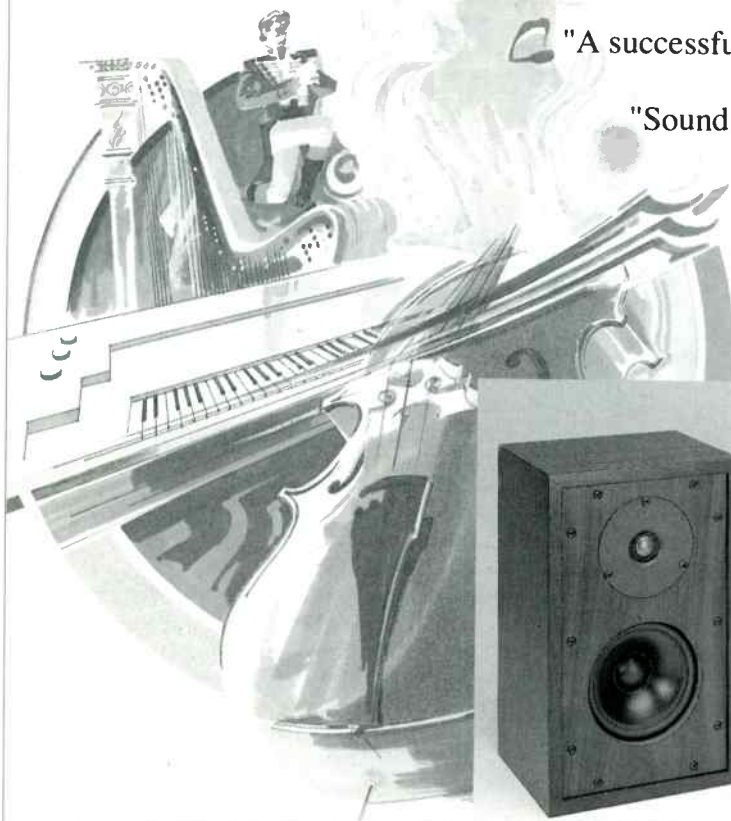

"Listening to the HL-P3, I found its mid-band clarity and life the most striking feature... Imagery is also clear and highly three-dimensional... I would be hard pressed to find a better, more neutral sounding, design anywhere near the price."

Hi-Fi World magazine - Alan Sircom - February 1993

"A successful hi-fi-oriented update on the revered LS3/5A."

Hi-Fi Choice magazine - Recommended - September 1993

"Sound - in a word, *stunning*. In another word, *clean*."

With "an astonishing amount of bass for such a small speaker."

Stereophile magazine (USA) - John Atkinson - December 1993

"Instruments had near perfect tonality; vocal colour and intonation is excellent."

Audiophile magazine - Eric Braithwaite - July 1993

HARBETH ACOUSTICS LTD.
 Unit 1, Bridge Road, Haywards Heath,
 West Sussex RH16 1UA, U.K.
 Tel. 01444 440955 Fax. 440688

Please send information on:

HL-P3 Full Range

Title _____

Name _____

Address _____

Postcode _____

HW/10/94

AUDIO ACCESSORIES



HI-FI WORLD SOLID SILVER INTERCONNECTS.

Constructed from solid strands of pure silver wire, and with a thick outer casing and screening braid, these interconnects offer the ultimate in transparency, openness and detail. Superb Neutrik Profi phono plugs are silver soldered to the cables in pseudo-balanced configuration for lowest noise/interference and extensive use of adhesive heat-shrink is used to strengthen the join between cable and plug for long life. Available exclusively through Hi-Fi World Mail Order.

.....£139.95/1M PAIR.

HI-FI WORLD SILVER PLATED COPPER INTERCONNECTS.

A similar construction to our solid silver cables, but using silver plated copper and standard Gold Phono plugs. Because the majority of the audio signal passes through the skin of a cable these can approach the quality of silver, but at the cost of normal high quality copper cable.

.....£69.95/1M PAIR.

HIGH QUALITY MAINS CABLES.

Supplied to Hi-Fi World by Campaign Audio Design these mains cables are screened to reduce Radio Frequency and Electromagnetic Noise. They also come

with a VDR fitted which protects equipment from mains spikes. The MK plugs have a silver plated fuse and holder for the cleanest supply. Available with IEC or Figure eight (Marantz/Philips CD players) equipment plugs or with a hard wired, soldered 4-way mains block.

1M WITH IEC PLUG£19.20
1M FIGURE 8 PLUG£15.75
1M 4-WAY BLOCK.....£31.95



4-WAY MAINS BLOCK WITH RF FILTER

Similar to the standard 4-way mains block featuring 2m screened mains cable, MK plug with silver plated fuse and holder and VDR to stop mains spikes reaching your equipment, A special RF filter has now been added which cuts out even more mains boume interference. Suitable for top-end systems

.....£45.50

EQUIPMENT SPIKES

Machined from solid brass these equipment spikes can be placed under equipment to help ground harmful vibration and enhance the visual appearance of your equipment. The spikes come in sets of three and will

support equipment weighing up to 10kg. We hope to introduce a larger spike suitable for heavier equipment and loudspeakers within the coming months.

.....£6.50

AFFORDABLE SILVER PLATED COPPER INTERCONNECT

A 'budget' interconnect featuring high quality silver plated copper co-axial cable and standard gold plated phono plugs is now available. The plugs are silver soldered to the cable for good electrical contact and high mechanical strength.

.....£28.00/1M PAIR



HIGH QUALITY AERIAL LEADS

If you've just spent a lot of money on a good tuner and aerial, then you'll want to connect the two together with the best cable possible to ensure the signal is preserved. We now have a high quality copper co-axial cable furnished with gold plated connectors which does just that. Because the length of cable required for different circumstances will vary greatly, we are offering a custom termination service for this cable.

.....£19.95/M +£2/EXTRA M



GARRARD 401 CELEBRATION SME IV TONEARM

A special version of the SME IV cast magnesium alloy tonearm, dedicated to the Garrard 401. The SME IV is precision engineered to be fully adjustable, making set-up easy and precise. If you want to get the best from your Garrard 401, this is a fantastic tonearm, sympathetically styled to form a perfect combination.

GARRARD 401 CELEBRATION SME IV TONEARM£820

AUDIO ACCESSORIES



LP together. Review in Hi-Fi World August 1994, these machines are a must for the dedicated Vinyl collector.

BASIC RECORD CLEANING SYSTEM

£199.90

RECORD MASTER RECORD CLEANING SYSTEM FOR ALL SIZES (7/10/12") WITHOUT ADAPTOR

£249.90

1.5 FI FULLY AUTOMATIC SINGLE SIDED RECORD CLEANING SYSTEM

£399.00

MINI-PRO I RECORD CLEANING CLEANING SYSTEM BOTH SIDES CLEANED SIMULTANEOUSLY

£599.00

For further details and cleaning fluid cost please contact the Mail Order Department on 071 - 266 0461

RECORD STORAGE CUBE

Designed to hold about a hundred LPs, with an internal width of 37cm, height of 32.5cm and depth of 32cm. The cubes can be stacked or placed alongside each other - and are even strong enough to be used as seats! Made from 15mm MDF (Medium Density Fibreboard) with a smart durable black paint finish, the cube is supplied in flat-pack

form ready for home assembly.

RECORD STORAGE CUBE

.....£45 EACH

SIX CUBES FOR THE PRICE OF FIVE

..... £225.00

EIGHT CUBES FOR THE PRICE OF SEVEN!

.....£315.00

NEW

NITTY GRITTY RECORD CLEANER

Bring a glossy shine to your LPs with the Nitty Gritty series of record cleaners. Several versions are available from the basic machine to the near fully-automated Mini-Pro (pictured) which cleans both sides of the



ANTI-STATIC RECORD SLEEVES

Translucent sleeves, treated to reduce static and dust attraction, supplied in packs of fifty.

They will fit inside ordinary printed inners.

LP SLEEVES (50) PRICE £8.15

BUG AUDIO

A fascinating little device no larger than a hand-held remote which allows the user to adjust bias on any cassette deck perfectly for any tape. You can check the state of your cables and connections with it, too! Supplied with a cassette test tape and full instructions. (See review, Nov. 1992 issue.)

BUG AUDIO£59.99



MICHELL ENGINEERING PLUGS

Craftsmanship marks out Michell Engineering's range of gold and rhodium plated plugs from the competition.

GOLD-PLATED SIDE ENTRY BANANA PLUGS (4)£10.00
GOLD-PLATED SURE-LOC



BANANA PLUGS (4)£14.95
RHODIUM-PLATED SURE-LOC BANANA PLUGS£18.95
GOLD-PLATED SPEAKER CABLE CONNECTORS...£10.00

GOLD PLATED 4MM BANANA PLUGS

Heavy-duty, gold-plated banana plug with a unique type of axial solderless connection for loudspeaker cables. The cable is stripped back and pushed into a clamping collar which is then screwed down tight, accepting cable up to 6mm external diameter and 4mm core diameter. Supplied in sets of four.

BANANA PLUGS (4)£8.00

SOUND SWIVEL

A rotating, upright, double-sided, storage cabinet with space for up to 160 Compact Discs, including 8 double jewel-cases. Mounted on an all-steel turntable, it swivels smoothly through 360 degrees giving easy access to the storage compartments either side. Manufactured in durable MDF with a Black Ash effect finish, the Sound swivel comes packed for self assembly with full instructions.

SOUND SWIVEL£49.95





Announcing . . . the
Elektra Integrated &
Eos Power Amplifiers

ELEKTRA INTEGRATED £999
EOS POWER AMP £899
TITAN MAINS FILTER £125
SILVER INTERCONNECT AND DIGITAL
CABLES FROM £75
SILVER SPEAKER CABLES FROM £25 per m

Arion
ACOUSTICS

MAKE THE LEAP
FROM AUDIO TO
. . . REALITY

Worldwide sales agents

KRONOS DISTRIBUTION

35 Farlough Road • Newmills

Dungannon • N. Ireland

Tel. 0868 748632

Fax. 0868 748281



KRONOS

Extraordinary hi-fi for ordinary people.

That would sum up our approach to how we choose the products that we import and distribute.

Pro-ject turntables. *Audiomeca* analogue and digital disc players. *Triangle* amps and speakers. *Lieder* cables. *YBA* and *Arion* amplifiers.

Style, character, top class performance and value for money: another way to sum

PUTTING THE GROOVE BACK INTO MUSIC

For more information, contact

Kronos on: 08687-48632

CABLE TALK

BRITISH
MADE

★★★★★ Rated interconnects and speaker cables are available from your local specialist dealer.

.....STOP PRESS.....STOP PRESSSTOP PRESS.

"Talk 3's great sound quality and value for money"
(Dec '92 WHAT HI-FI?)

Can now be obtained in a convenient bi-wire format at £4.50 per metre.

Please telephone 0483-750667 Fax 0344-360866
For Further Information

MARTIN LOGAN • ALCHEMIST • AUDIO RESEARCH • AUDIO INNOVATIONS

AUDIO GALLERY AS

NR PETERSFIELD HAMPSHIRE

MISSION, MUSICAL FIDELITY, KLIPSCH, DECAPOL, AEGIS SPEAKERS, LYRA CARTRIDGES, DPA 2008 HEYBROOK

FOR OPENING HOURS AND APPOINTMENTS PLEASE RING 9.30am - 7pm

HOME DEMO
AUDIO SYNTHESIS • ACOUSTIC ENERGY
WADIA 6, MICROMEGA STAGE, DAC-IN-A-BOX, TDL, SME, TEAC, VRDS 10, AUDIONOTE + AV

0730 - 895194

VALVE SPECIALISTS ON A SUPERIOR LEVEL

RE-STEEL • PRO-AC • JMW • MOTH • PINK TRIANGLE • WADIA DPA • TUBE TECHNOLOGY
AUDIO ALCHEMY • TEAC • SAE • TRIPOD • ALPHASON • PIONEER • DENON

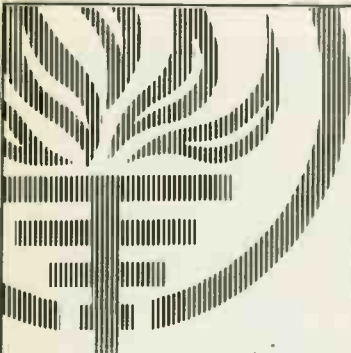

**AUDIOPHILE
5
Five Star
DEALER 92**

REFRESHINGLY DIFFERENT

the powerplant

CYRUS, REGA and ARCAM products now on demonstration

Roksan, Micromega, Audiolab., Rega, Arcam, Aura, ATC, Exposure, Marantz, Rvark, Epos, Thiel and other fine equipment

66 Upper North Street Brighton 0273 775978

HI-FI



HI-FI

LOUDSPEAKERS BOUGHT & SOLD

ACOUSTIC ENERGY • ATC •
B&W • CELESTION • LINN •
LINEAUM • MISSION • MONITOR •
AUDIO • NEAT • THIEL •
TANNOY • TDL • Etc.

- ALSO ACOUSTIC FOAM TILES -

DEMONSTRATION BY
APPOINTMENT ADVICE
ANYTIME ON:

WESTWOOD & MASON EX DEMONSTRATION BARGAINS

LOUDSPEAKERS	PAIRS	TUNERS	
TANNOY DEFINITION 700	£1300.00	QUAD FM66	£399.00
REGA XEL	£699.00	REGA 'THE RADIO'	£159.00
KEF Q50	£299.00		
ROYD MINSTREL	£199.00	<u>TURNTABLES</u>	
REGA ELA	£320.00	PROJECT POINT FIVE	£129.00
SOLID CENTRALE (single)	£99.00		
MA MONITOR ONE GOLD	£149.00	<u>SECOND HAND</u>	
TDL NEAR FIELD MONITOR	£79.00	QUAD 306	£250.00
MISSION 752	£425.00	NAKAMICHI BX125E	£250.00
		NAIM NAC 32 (old)	£100.00
<u>AMPLIFIERS</u>			
AURA VA100 EVOLUTION	£239.00		
AURA VA80	£199.00	<u>MISC</u>	
DENON PMA 450 SE	£175.00	SENNHEISER HD560II	£99.00
		SENNHEISER HD580	£139.00
<u>PRE AMPS</u>		GOLDRING EROICA (unused)	£69.00
NAIM NAC 52	£3495.00	LINN ISOBARIK stands s/h	£29.00
QUAD 66	£399.00		

WE STOCK: ARCAM, AURA, DENON, EPOS, KEF, MARANTZ, MISSION, NAIM, NAKAMICHI, QUAD, PROJECT, REGA, ROYD, TANNOY, TDL, YAMAHA.

WESTWOOD & MASON (OXFORD) LTD
46 GEORGE ST
OXFORD

OPEN 10.00AM TO 5.00PM
CLOSED THURSDAY
TEL 01865 247783

AMADEUS SOUND & VISION



Aura, Audio Innovations, Bang & Olufsen, Castle Acoustics, Micromega, Musical Fidelity, Nakamichi, NAD, Pioneer, Quad, Royd, Spondor, Technics.

**10 BOLDMERE ROAD
SUTTON COLDFIELD
WEST MIDLANDS**
Tel: 021 - 354 2311

Interest Free Credit Facilities

Demo room with A/V system set-up.

VISA



ABERDEEN



- Single Room Demonstrations available.
- Full Service Department
- Free Delivery and Installation anywhere in Scotland

Authorised dealer for:- Linn, Chord, Proac, Mordaunt Short, Audio Research, Sonus Faber



42 St Andrew Street, Aberdeen
Tel/Fax 0224 - 625635

•SALE•SALE•SALE•

IAN HARRISON HI-FI
TEL: 0283 702875

SENNHEISER		BEYER		AUDIO TECHNICA	
HEV70	£399	DT911	£170	ATH1000	EPOA
HEB3	£389	DT901	£155	ATH1111	EPOA
HCS80P	£180	IRS890	£155	ATH110P	EPOA
HCS80H	£109	IRS790	£140	ATH10811	EPOA
HQ1000	£173	DT811	£140	ATH10811	EPOA
HQ1000	£109	DT801	£119	ROSS	
DHPHEUS	EPOA	DT511	£77	ROSS	
IS80H	EPOA	DT431	£68	ESP-50	£650
IS50H	£140	DT411	£65	OTHER	
IS45H	£119	OTHER		MODELS	POA
OTHER		MODELS	EPOA	MODELS	POA
MICHELLS	EPOA	MODELS	EPOA	MODELS	POA
NAKAMICHI		TEAC		AIWA	
DRAGON	£150	V7010	EPOA	KDS1100	£750
CP7E	£1850	V8000S	£625	KS9000	EPOA
DP1	EPOA	R8000S	£450	KS7000	EPOA
DR2	EPOA	VRDS-7	£550		
DK3	EPOA	VRDS-10	£699	SONY	
OTHER		VRDS-20	£1110	DTC50ES	£699
MICHELLS	EPOA	X-1	EPOA	TCDD7	EPOA
		X-1S	EPOA	PC423DD	EPOA
				PC427DC	EPOA
QUAD		QED		MARANTZ	
C167	£725	DIGIT	£100	CD63	£199
66	£775	DIGIFLEX	£110	CD53	£160
63	£685	DAC PACK	£160	CD52	EPOA
34	£685	DIGIT REF	£160	SD11	£215
FR*	£990	POSTROM	£99	SD3	£189
FME*	£485	AMPS	EPOA	SD415	£169
ELL-83	£690	OPTIFLEX	£70	SD15	£130
				ST3	£115
				ST4DL	£115
DEMON		SHURE			
DL104	£180	VNSMR	£115	PM100AV	£375
DL110	£80	OTHER		PM13	£199
DL120	£75	STYL	EPOA	PM13	£185
DL120B	EPOA			PM12	£115
DL150	£70	ME97-E	EPOA		
		TTR117		SR12	£99
		TEST	£12.50	SR13	£99
		RECORD		SR-3	£215
				SR-3	£215

CARTRIDGES

I SUPPLY: AUDIO TECHNICA, ORTOFON, DENON, DYNAVECTOR, SHURE, GOLDRING ARCAM & STANTON. TRADE IN YOUR OLD MOVING COIL(S); ANY MAKE ANY CONDITION AND SAVE UP TO 45% OFF THE NORMAL SELLING PRICE!! NO OLD MOVING COIL? DON'T WORRY, JUST PHONE.

HI FI FURNITURE

I SUPPLY: APOLLO, SOUND ORGANISATION, SOUND FACTORY TRIPOD, SOUNDSTYLE PLEASE PHONE OR WRITE FOR BROCHURES & PRICES.

CABLES

I SUPPLY: AUDIOQUEST, SONIC LINK, QED & GOLDRING

TEST CASSETTES AND CDs

I SUPPLY MY OWN REAL TIME, INDIVIDUALLY MASTERED RANGE OF AUDIO TEST CASSETTES FROM £5-£20.

THE MULTI-PURPOSE TEST CASSETTE TESTS: DOLBY LEVEL, AZIMUTH, REPLAY FREQUENCY RESPONSE (30Hz-15KHz) DOLBY B/C TRACKING & TAPE SPEED AVAILABLE IN 120us & 70us eq VERSIONS. £20 POST FREE.

I ALSO SUPPLY DENON TEST CDs INCLUDING THE AUDIO TECHNICAL TEST CD, £12 POST FREE.

BLANK TAPES & ACCESSORIES

I SUPPLY TDK, MAXELL, SONY, JVC, SCOTCH, AMPEX, BASF, LONICA, PANASONIC, FUJI, DISCWASHER, AUDIOQUEST, GOLDRING

PLEASE NOTE:

ALL GOODS ARE BRAND NEW WITH FULL U.K. GUARANTEES.

NO EX-DEM EQUIPMENT. INSURED DELIVERY IS £5.

CARTRIDGES ARE POST FREE. PLEASE PHONE PRIOR TO ORDERING TO CONFIRM PRICE & AVAILABILITY.

MAIL ORDER FROM: IAN HARRISON HI FI,

7 MILL HILL, REPTON, DERBY, DE65 6GQ.

TEL: 0283 702875 9am-9pm.

Richard's Audio Visual

Stockists of

Arcam, Audio Innovations, Audioquest, Aura, Beyer, B&W, Bose, Celestion, Cyrus Denon, Marantz, Mission, Moth

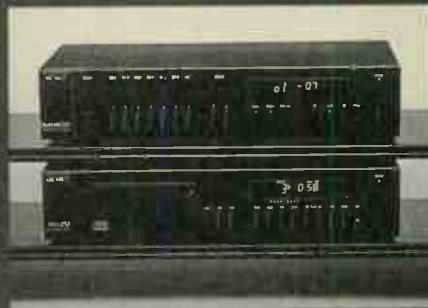

Musical Fidelity, Nakamichi, Ortofon Pioneer, Pro-ject, Rotel, Royd, Ruark Sennheiser, Systemdek, Target, Thorens Van den Hul & more!

Expert friendly service: Listening room Pioneer Reference Point

4 Greyfriars, Bedford

Tel: 0234 365165



HIGH END AUDIO BOUGHT/SOLD EXCHANGED

	SALE		LIST
MARK LEVINSON ML7A PREAMP MINT	2995	S/HAND	£6800
WELL TEMPERED WATT TURNTABLE & ARM MINT	£1,095	EX/DEMO	£1,995
MERIDIAN 602 TRANSPORT 608 DAC 7 LATEST MINT	£2250	EX/DEMO	£3,100
CAMBRIDGE CD1 CD PLAYER HEAVILY MODIFIED WITH MASSIVE POWER SUPPLY SUPERB	£1,295	PHONE	
METAXIUS ICARUS INTEGRATED AMPLIFIER CHROME. MINT	£595	EX/DEMO	£895
AUD/O RESEARCH SP15 REVISION A PREAMP BLACK	£3,495	S/HAND	£7,000
PINK TRIANGLE PIP 2 MK2 VISHAY MODIFIED PREAMP. MINT	£1,795	S/HAND	£4,500
CARY CAD 550GS PREAMP PHONO & PROCESSOR. MINT	£995	EX/DEMO	£2,250
COUNTERPOINT SAIL LINES/STAGE & SA9 PHONO STAGE GO BLOW YOUR MIND & WALLET MEGA. V.G.C.	£6,995	S/HAND	£12,600
BURMESTER 808 MK3 PREAMP BALANCED. MINT	£3,995	S/HAND	£8,000
AUDIO RESEARCH D70 MK2 POWER AMP. MINT	£895	S/HAND	£1,929
COUNTERPOINT SA4 OTL MONO AMPS V.G.C	£2,995	S/HAND	£8,000
MARK LEVINSON ML2 REFERENCE MONO POWER AMPS. BALANCED SUPERB V.G.C.	£3,995	S/HAND	£15,000
MARK LEVINSON ML3 POWER AMP. MINT	£3,995	S/HAND	£8,250
NRG 4201S POWER AMP BALANCED LATEST SPEC. MINT	£3,495	S/HAND	£6,600
NRG A 401 400 WATT CLASS A MONO POWER HOUSES. BALANCED HIGH POWER WITH SEDUCTION V.G.C	£5,500	S/HAND	£13,000
CONRAD JOHNSON MV75 VALUE POWER AMP. MINT	£1,295	S/HAND	£2,500
OCTAVE RESEARCH ORI POWER AMP. V.G.C.	£1,795	S/HAND	£4,500
MERIDIAN D6000 DIGITAL ACTIVE SPEAKERS STUNNING LOOKS AND SOUND TO MATCH. MINT	£5,750	EX/DEMO	£7,630
ACOUSTIC ENERGY AEI SPEAKERS & STANDS. MINT	£995	EX/DEMO	£2,000
CELLO AMATI SPEAKERS TWIN MOUNTED PAIR IN OAK ON GRANITE STANDS SUPERB V.G.C.	£5,500	S/HAND	£20,000
CANON ESO SPEAKERS & STANDS BLACK MINT	£250	S/HAND	£400
DYNAUDIO CONSEQUENCE SPEAKERS FLAGSHIP MODEL IN CHERRYWOOD DYNAMIC DRAMA. STUNNING MINT	£10,250	EX/DEMO	£15,275
GENESIS 8300 SPEAKERS & STANDS PIANO BLACK. MINT	£1,395	EX/DEMO	£1,895
MERIDIAN ARGENT 3 SPEAKERS ROSEWOOD MINT	£995	NEW	£1,495
SYNTHESIS REFERENCE ELECTROSTATIC SPEAKERS RARE V.G.C	£1,995	S/HAND	PHONE
AUDIOPLAN KOMTRAST 2 SPEAKERS ROSEWOOD MINT	£4,995	S/HAND	£6,995
SNELL A3 SPEAKERS WALNUT V.G.C.	£6,995	S/HAND	£15,000
APOGEE DIVA & DAX TAUPE SPEAKERS MINT	£895	EX/DEMO	£1,500
METAXIUS IRAKLIS MK2 POWER AMP CHROME MINT	£2,250	S/HAND £	4,650
AUDIO RESEARCH D125 KT90 VALVES AMP. MINT	£895	S/HAND	£1,500
MUSICAL FIDELITY P270 MK2 POWER AMP. MINT	£1,995	S/HAND	£3,998
APOGEE CALIPER SIGNATURE SPEAKERS GREY MINT	£3,995	S/HAND	£8,000
SYNTHESIS REFERENCE SPEAKER SYSTEM ASH MINT	£1,595	S/HAND	£2,800
AUDIOPLAN KOMTRAST 2 SPEAKERS ROSEWOOD MINT	£4,995	EX/DEMO	£11,500
METAXIUS CHARISMA PREAMP CHROME MINT	£2,495	S/HAND	£5,800
MARK LEVINSON ML7 PREAMP MINT	£1,295	S/HAND	£2,400
SONOGRAPHE AIRTIGHT ATMI AMPLIFIER MINT	£3,995	S/HAND	£8,500
DUNTECH CROWN PRINCE SPEAKERS PIANO BLACK MINT	£695	S/HAND	£1,400
EQUATION ZERO SPEAKERS PIANO BLACK MINT	£1,5495	S/HAND	£3,000
MARANTZ LEIZ CD PLAYER LTD EDITION BALANCED QUICKSILVER PRE AMP MINT	£1,250	NEW	£1,750
MERIDIAN 601 DSP PRE AMP BALANCED MINT	£1,995	EX/DEMO	£2,750
CARY 2A3 VALVE POWER AMP 15 WATT TRIODE MINT	£895	EX/DEMO	£1,400
CARY 300B VALVE MONO POWER AMPS 40 WATT TRIODE	£2,995	EX/DEMO	£4,800
APOGEE SCINTILLA SPEAKERS GREY 10TH V.G.C	£895	S/HAND	£1,345
SUMO ARIAS SPEAKERS OAK V.G.C.	£1,495	S/HAND	£2,995
ORACLE DELPHI MK3 URNTABLE SME IV SPECIAL WITH SILVER WIRE & SILICON TROUGH MINT.	£1,395	S/HAND	£2,800
GYRODEC EXPORT BLACK & GOLD GYROPOWER SME V MINT.	£1,295	S/HAND	£2,200
HELVIS CYALENE ARM MINT	£795	S/HAND	£1,400
MERIDIAN 200 MK2 CD TRANSPORT 263 SIGMA DAC MINT.	£895	EX/DEMO	£1,350
WADIA 6 CD PLAYER BALANCED OUTPUT MINT	£2,995	EX/DEMO	£3,995
BEARD BB100 MK2 VALVE INTEGRATED AMO MINT.	£895	EX/DEMO	£1,300
PINK TRIANGLE DECAPO DAC MINT.	£1,195	EX/DEMO	£1,500
AUDIO RESEARCH CLASSIC 60 POWER AMP MINT.	£2,250	S/HAND	£3,600
AUDIO RESEARCH M10 VALVE MONO AMPS MINT.	£2,995	S/HAND	£7,000
AUDIO RESEARCH M300 MK2 VALVE MONO AMPS MINT.	£4,995	S/HAND	£12,000
CHORD 1200 POWER AMP. MINT	£1,995	S/HAND	£3,000
CABSSE IROISE MC SPEAKERS CHERRYWOOD MINT.	£1,995	EX/DEMO	£2,700
CABSSE SKIFF SPEAKERS WALNUT MINT.	£1,200	EX/DEMO	£1,500
MERIDIAN M30 ACTIVE SPEAKERS STANDS MINT.	£595	S/HAND	£1,110

"ODDLES OF HIGH END CARTRIDGES AVAILABLE RING FOR DETAILS" MANY MORE ITEMS IN STOCK, EFFICIENT SERVICING DEPARTMENT. WE ARE LOCATED IN WELWYN, HERTS

ALL ITEMS GUARANTEED - ALL MAJOR CREDIT CARDS ACCEPTED RING FOR DETAILS AND DEMONSTRATION 0438 714038
10.00 AM - 7.00 PM MON - SAT 10.00 AM - 1.00 PM SUN

The NORFOLK/SUFFOLK High End Dealer audible difference near DISS, NORFOLK

- | | | |
|----------------|-------------------|--------------------|
| Audio Research | Audion (Alema) | ART Audio |
| ATC | Audio Innovations | Audio Note |
| AVI | CHORD | Copland |
| Croft | DAWN AUDIO | dpa |
| EAR | Impulse | Kinshaw Perception |
| Linaeum | Lyra | LFD Audio |
| Magnepan | Micromega | neat |
| Orelle | Pink Triangle | ROKSAN |
| Sumiko | SME | Sonus Faber |
| SUGDEN | Tube Technology | van den Hul |

At this level of equipment we believe that the highest level of service should be offered.

We will book only three demonstrations a day to ensure that you have ample time to evaluate the option YOU choose,

DEMONSTRATIONS IN OUR LISTENING ROOM OR
YOUR HOME
EQUIPMENT LOAN SERVICE AVAILABLE

Tuesday to Friday, 12 to 9 pm
Saturday 9 to 5 pm
PLEASE RING FOR AN APPOINTMENT

0379 740227 OR 0850 983233

AUDIO COUNSEL HI-FI SPECIALISTS

LINN, NAIM, CREEK,
YAMAHA, ROTEL,
NAKAMICHI,
MORDAUNT-SHORT,
A&R, DUAL,
REGA, NAD, JPW
SHAHINIAN,
DYNAVECTOR
and many more....

12 SHAW ROAD
OLDHAM

TEL: 061-633 2602

SLATE AUDIO

HI-FI Design & Cable Services



THE FINEST SPEAKER SUPPORTS IN THE WORLD

I found that, as it had done last year, the stand offered a sound that was characterised by its lack of intrusive character. On the Slate Stand, speakers seemed to shake off unmusical, unnatural qualities that were audible on other stands. I noticed this lack of added colour particularly with female vocal music. Voices had openness and a tangibility that reinforced their communicative qualities. Singers appeared more expressive and technically more impressive. Last year, I remarked upon the stand's "cleanliness and lack of clutter" and nowhere was this better demonstrated than on the Annie Golden and Frank Carillo CD, which can appear far less polished on a system whose set-up is below par. The Slate stand's ability to refine a speaker's presentation was evident even with the Mordaunt-Short MS10, for which it's not ideal. Golden's taxing voice and Carillo's acoustic guitar both sang out with striking verve yet never approached coarseness, nor did they fall short of refinement.

The stand's sonic transparency and musical fluency are partly a function of its excellent control at the frequency extremes. The Slate allows bass lines to thunder without wallowing, and treble to sing without zing. Having lived with, and appreciated, a pair for a year now I'm not going to do what I did last year and allow their cost to stop them obtaining a Recommended flag.

VERDICT: The Slate stand is unusual and expensive. But if you're after an exceedingly neutral stand it's the leading contender. This stand offers an exceptionally neutral platform for speakers: highly transparent sound leads to musical performances with real insight.

SOUND QUALITY: ■■■■■

47 GEMINI CLOSE, LEIGHTON BUZZARD, BEDS, LU7 8UD. TEL: 0525 384174

HI-FI EXCHANGE DARLINGTON

The North's only used Hi-Fi Specialists
Largest selection of used Hi-Fi

	List	S/H
Audio Innovations series 1000 preamp (german spec. with new Golden Dragon Valves)	£1800	offers
Audio Research D115 Valve Power Amp	£3500	1200
Snell JIII's ex-dem	£800	£550
Thorens 2001 ex-dem (boxed)	£700	£480
Quad 306/34	£750	£475
Mission 765 (thunder boxes) excellent	£700	£350
Musical Fidelity 3a Preamp & P140		
Power Amp excellent	£750	£350
Yamaha Pre Power combination (annoy the neighbours!!) - Awesome		£650
Garrard 401 Chassis excellent		£100
Garrard 301 Chassis excellent		£120
Neat Critique new	£335	£310
Marantz CD52 MKII excellent	£300	£150

All equipment guaranteed. Quality Hi-Fi separate wanted for cash.
Large stock of Japanese separates by Technics, Marantz, Sony etc.

All types of Hi-Fi bought and exchanged

Tel:- 0325 463007

Hi-Fi Exchange Darlington
30b Larchfield Street
Darlington
Co. Durham

Esoteric • Audio • Imports

Importers, Distributors and Purveyors of Fine
Quality Audio Equipment

Once again it is our pleasure to
announce a **NEW** range from the
highly acclaimed audio manufacturer
ELECTROCOMPANIET A/S

This range known as the "**SUPER-FIDELITY**" range, sport the superb Larvikit blue stone facia previously seen on the "20th Anniversary" Limited Edition which proved so popular.

FOR FULL DETAILS OF THESE, &
OTHER FINE MODELS FROM
ELECTROCOMPANIET.

Tel/Fax:- 0243 53 30 30

DAN DULEY HI-FI

AT GRAMEX
25 Lower Marsh
(By Waterloo Station)
London SE1 7AB.
Technical enquiries:
081 470 9795
Gramex: 071 401 3830

THE NEGUS SYSTEM, and other specialist units
including **PHONO HEAD AMP** and **HISS-KILLERS**,
is now on demonstration.

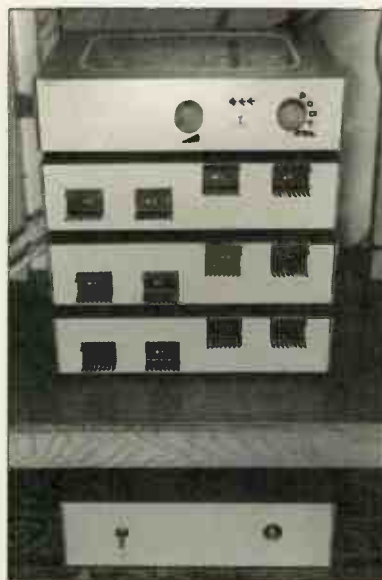

NEGUS
Electronics:-

COMBINED
PRE-AMP AND
CROSSOVER

THREE
MATCHED
50W_{RMS} PER
CHANNEL
AMPLIFIERS

POWER PAK:-
SUPPLIES ALL
UNITS

LEONARD BOOTH

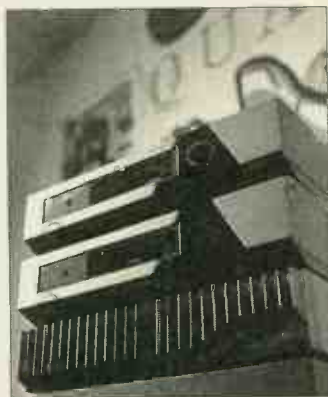

**WHY WAIT A LIFETIME
BEFORE YOU SEE & HEAR
..... AND BUY
YOUR QUAD EQUIPMENT
CALL IN NOW FOR YOUR
IMMEDIATE DEMONSTRATION**

**35 SOUTH STREET
EASTBOURNE
0323 731755**

MONOSTEM Audio Support System

hi-fi wall units speaker stands accessory stems
Designed by Ashley Miles Dennis

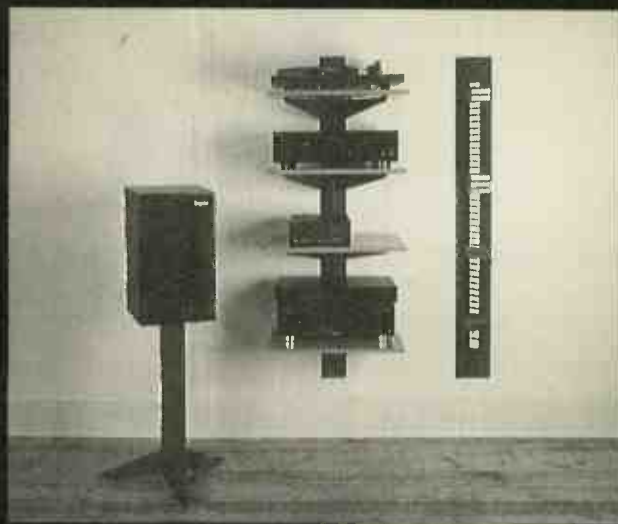

**tel or fax 0533 433233
for a full colour brochure**

innovative design the coach house school lane
houghton - on - the - hill leicestershire le7 9gd

PURE HIGH FIDELITY
Telephone: 0753 680868

marantz

WORTHING AUDIO

**20, Teville Gate Precinct,
West Sussex BN11 1UA**

The Friendly Shop With The Best Sound Systems In
The South

- Friendly Advice *Three Year Guarantees
- Easy Parking
- Open Monday To Saturday 10am to 6pm
- Late Night Wednesday, 7.30pm

Agencies include: Arcam, Audio Technica, Clear
Audio, Exposure, Kinshaw Electronics, Marantz,
Naim Audio, Orelle, Origin Live, Restek, Ruark,
Sennheiser, Target, TDL, Thorens, Tripod and many
more

Telephone (0903) 212133

JOIN CD EXPRESS MUSIC CLUB AND BUY ALL YOUR COMPACT DISCS AT TRADE PRICE !!!

NO COMMITMENTS NO RESTRICTIONS

TYPICAL FULL PRICE CD	CD EXPRESS	£9.30	Mail Order	£7.99
David Byrne/David Byrne	TYPICAL MID PRICE CD		CD EXPRESS	£5.70
High St	Undertones Rereleases		TYPICAL BOX SET PRICE	
Mail Order	High St	£9.99	Who/Maximum R&B (4CD)	

Why are we the Fastest Growing CD Club in Europe?

Run by Musicians who CARE about the price of CDs.

**All UK CDs (not just chart product) at
GENUINE TRADE PRICE.**

**We trace the titles you want -
FREE LISTS (24000 + Titles)**

**Access to our Trade Database of millions of titles
NO GIMMICKS, NO CATCHES -
Just a RADICALLY GOOD DEAL!**

☎ 0532 351865

**RING NOW FOR
FREE INFOPACK**

**OR FAX US ON
0532 359941**

CREATIVE AUDIO

Shropshire's Hi-Fi Specialists
-the best is now within easy reach

- ✓ Friendly, experienced staff
- ✓ Comfortable listening room
- ✓ Expert installation
- ✓ Interest Free credit
- ✓ Part exchange welcome
- ✓ Selected used and ex-demo equipment
- ✓ Home Cinema

Ring us for your free Creative Audio
Information Pack

Creative Audio,
9 Dogpole, Shrewsbury, SY1 1EN
Tel: (01743) 241924

Hi-Fi specialists

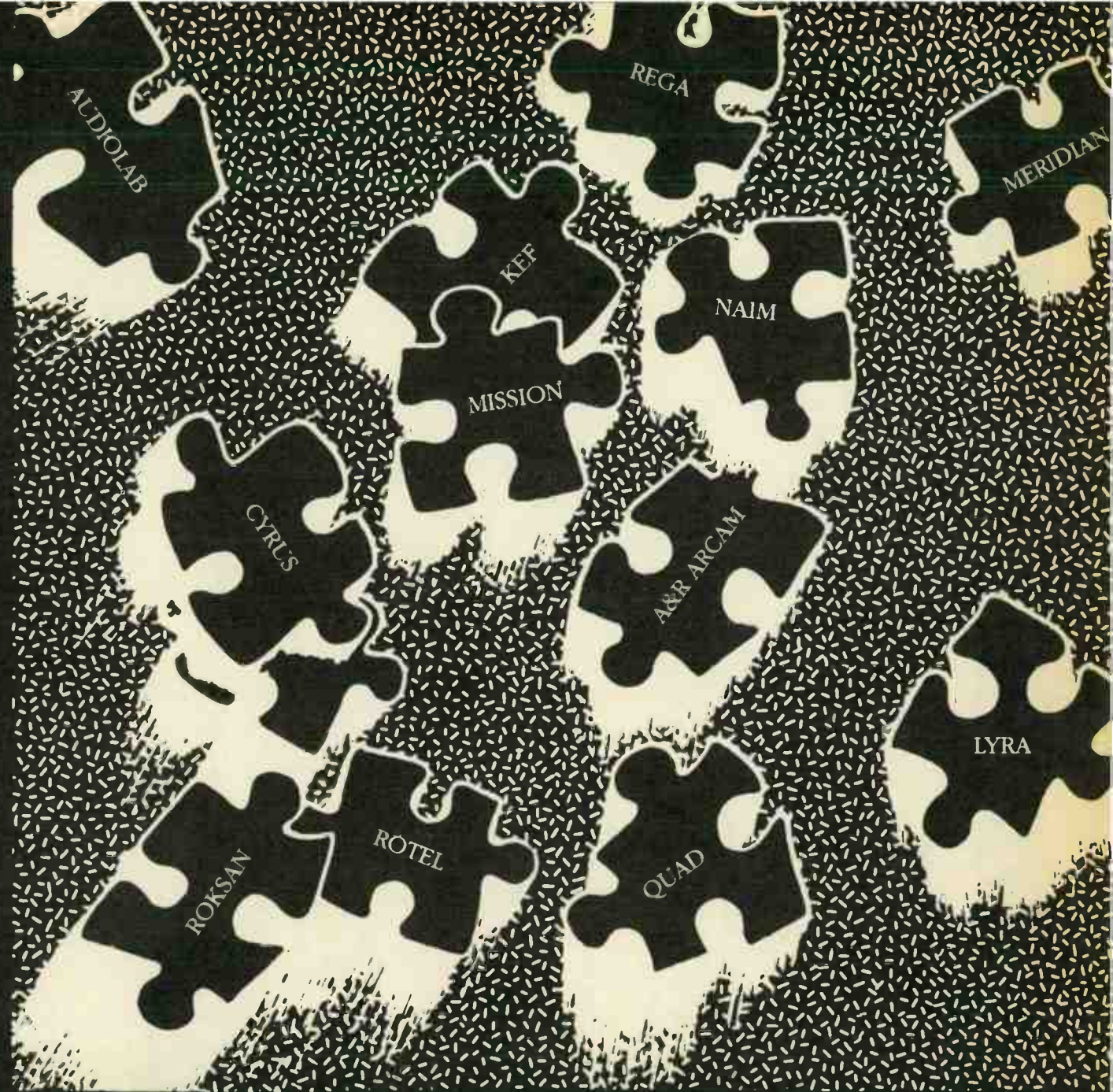

- PUTTING THE PIECES TOGETHER

World favourites

COMPACT DISC PLAYERS

NAD 501	£180	A break from the MASH tradition, the Philips powered 501 gives excellent results.	Apr'94
ROTEL RCD965 DIS	£350	A smooth and easy sound make this one of the best value players around.	Jan'94
QUAD 67	£790	A new breed of Quad. Lacking nothing in verve or excitement.	May'93
SUGDEN SDT 1	£850	Airy and spacious with a rare quality of ambience.	Mar'93
NAIM CDI	£1598	Single box, 16 bit player. Close to the two box CDS, has vital 'tingle factor'.	Apr'92

COMPACT DISC TRANSPORTS

ARCAM DELTA 250	£750	Transport with sync-lock facility. Good partner to BB50	May'94
DPA DIGITAL T-1	£795	Superbly detailed sounding transport when sync-locked to DPA's converters.	Jan'93
ORELLE CD10-T	£799	Very involving, unforced and natural when used with Orelle's DA-180 DAC.	Feb'94

DIGITAL TO ANALOGUE CONVERTERS

DACULA	£376	This little devil from Select Systems really gets its fangs into the music.	Dec'93
DPA LITTLE BIT II	£450	Clean and confident sound with good resolution and focus.	May'94
ORELLE DA-180	£599	'Analogue' sounding converter, best with matching transport.	Feb'94
P. T. ORDINAL	£695	Pure sound, smooth and free from harshness. One of the best at any price.	Jul'93
P. T. DA CAPO	£1450+	Pink Triangle's own one bit DAC reaches new standards in digital. One of the very best. Even better with DC supply and new filter options.	Mar'94
DPA 1024	£6000	A reference for all other converters. DPA's own discrete design.	July'94

TURNTABLES

SYSTEMDEK IIX900	£230	£330 with RB250 tonearm. A fine all-rounder and easy to upgrade. Neutral character.	Sep'94
PRO-JECT 6.1	£435	Complete with Ortofon MC15 Super and can even play 78s for an optional £10.	Sep'94
TOWNSHEND ROCK III	£799	The MkIII has a fabulously stable, solid image and terrific bass.	Feb'94
P. T. ANNIVERSARY	£1200	Very neutral turntable. Excellent imagery and detail.	May'92
SME MODEL 20	£2495	The last great turntable, bettered only by the £11,000 Model 30.	Oct'92

TO NEARMS

REGA RB 300	£139	Simple and superb; dynamic with solid bass.	Various
SME 309	£568	Based on IV and V: Aluminium armtube and detachable headshell.	Jan'93
SME IV	£850	Loses little to the fabulous V, possibly the best value for money SME.	Dec'93
SME SERIES V	£1232	A masterpiece of precision engineering, with a cohesive sound.	May'92

CARTRIDGES

ORTOFON VMS-2E	£10	Warm, full bodied, punchy, fast, good tracking - what else can you get for a tenner.	Nov'94
GOLDRING 1012 GX	£60	Rounded bass, slightly forward midband, clean transients. A bargain.	Jul'93
GOLDRING 1022GX	£80	Extra degree of dynamic range and speed over the 1012GX	Jul'93
GOLDRING 1042	£100	A reference to all other MMs regardless of price	May'92
ORTOFON SUPREMES	£225-450	The MC10, 20, & 30 Supremes offer superb sound and value for money.	July'94
LINN KLYDE	£450	Soft treble, but a stonkingly good cartridge.	June'94
ORTOFON MC2000	£650	We came across this one by accident; used on a Garrard 401 with an SMEIV it gave one of the best results we've ever heard.	Dec'93
ORTOFON MC7500	£2000	The best MC available? Produces real-life scale of music.	May'94

CASSETTE RECORDERS

AIWA AD-F850	£230	Fine recording quality and good playback. A real bargain.	July'94
NAKAMICHI DR2	£500	Worth every penny, pushes recordings to the limit and remains unflustered.	Feb'94
NAKAMICHI DR1	£780	Nakamichi sound quality, and manual head azimuth adjustment.	Jun'93
NAKAMICHI CR-7	£1500	No Dolby 'S', but auto tape tuning and motorised head. The Best!	Aug'92

TUNERS

NAD 402	£160	Stunning budget tuner, with a warm and open sound. Can compete with the best.	Jan'94
MISSION CYRUS FM7	£299	Clear and lucid sound. One of the best, regardless of price.	Apr'94
QUAD 66FM	£490	Among the very best in terms of tonal colour and imagery. Remote controllable.	Nov'92
NAIM NAT 03	£500	Warm and easy sound with a good sense of atmosphere. Good value.	Sep'93

World favourites

NAIM NAT 01	£1377	The best solid state tuner currently available. For better radio, live in the studio!	Mar'92
BURMESTER 931	£4,347	Super high-end tuner with a super high-end sound. Exceptional clarity and detail.	Nov'94

INTEGRATED AMPLIFIERS

NAD 302	£160	Lots of insight and detail, but could sound a little rough in the wrong system.	Jan 93
PIONEER A-300X	£200	Exceptionally sweet mid and treble, plus the superb dynamic range of the A400.	Dec'92
DENON PMA-350II	£220	Powerful and with deep rhythmic bass drive.	Sep'93
ARCAM ALPHA 5	£230	Lots of life and energy; a good phono stage too.	June'94
ROTEL RA960BXII	£325	Suits a wide range of music always sounding confident and open.	May'94
AUDIOLAB 8000A	£430	Very neutral and superbly built. Good bass, great imagery, but can be sterile.	Apr'92
MISSION CYRUS III	£499	Superb engineering, a solid cast chassis and a clear and spacious sound.	Sep'94
STEMFOORT SF60	£549	Excellent bass drive and fine midband presence, powerful too.	Sep'94
SUGDEN A21a	£639	Class A transistor amp. Sharp, crisp, deep, tight, and it images well too.	Feb'94
AUDIONOTE OTO SE	£1500	10watts of the sweetest sound around. Use sensitive speakers though	Aug'94

PRE-AMPLIFIERS

ROTEL RQ-970BX	£130	Audiophile quality components and sound with a bargain basement price tag.	Nov'94
EAR834P	£290	MM/MC phono stage. Uses valves to create a rich, sweet sound with tremendous depth.	Oct'94
A. Innovations. L1	£299	Valve line level preamplifier. Outstanding results with vdH carbon interconnect.	Feb'94
A. SYNTH. PASSION	£475	Or £275 for the kit version. Unrivalled transparency from a passive pre-amp.	Aug 93
ROSE RV23-S	£495	Valve/Transistor hybrid. Smooth and clean, rich and spacious.	Nov'93
DPA DSP 200S	£495	Not quite the 50S, but there's still nothing to match it at the price.	Jun'93
MICHELL ISO/HERA	£528	Fine midband and treble detail and taut bass from this MC only phono amplifier.	Oct'94
MICHELL ISO HR	£850	Impossible not to recommend. What more does your vinyl want?	May'93
NAIM NAC82	£1945	Remote control preamp. The NAC82 thrusts detail forwards in true Naim fashion.	Apr'94

POWER AMPLIFIERS

ROSE RP-190	£495	Used with the Rose pre-amp it gives 70 watts of smooth relaxing sound.	Nov'93
SUGDEN AU41P	£530	100 Watts of smooth, detailed, full bodied sound. And at a bargain price.	Apr'93
QUAD 606	£675	140W powerhouse. Smooth and civilized, with the legendary Quad back-up.	Aug'93
DPA DPA 200S	£750	Not as cold as the 50S. Better than anything else at the price.	July'93
NAIM NAP180	£898	Partner to NAC82. Has real drive and grip on loudspeakers.	Apr'94
MICHELL ALECTO (S)	£1300	Valve like transparency, big warm easy going sound.	Sep'93.
MICHELL ALECTOS	£1800	The Alectos have a lucidity and three dimensional realism that is rarely attained.	Dec'92
CHORD SPM 1200	£2995	Massively powerful, dynamic and detailed sound. Among the best of solid state.	Mar'93

LOUDSPEAKERS

GLL MAXIM	£120	Replacing the Maxim 3; not as tight in the bass but still one of the best at the price.	Aug'93
MISSION 760iSE	£150	One of the best miniatures around, very musically involving.	Jan'94
HARMAN LS 0300	£200	Glass fibre woofer gives a forward and open mid with good bass kick	Nov'93
TDL RTL 2	£250	Bass on a budget. Solid, vibrant and spacious sound.	Dec'93
SYSTEMDEK 931	£330	Coherent and involving, these little gems really sing. Super value mini monitor.	Nov'94
HARBETH HL-P3	£479	Neutral and revealing sound that produces a fine, cohesive performance.	Nov'94
ROGERS LS8a/2	£449	Big, enjoyable, room filling sound from this 2-way floorstander.	Feb'94
REL STRATA	£499	Rel's Strata offers excellent bass depth and power.	Mar'94
MISSION 752	£500	Using High Definition Aerogel drive units the 752s are clear, crisp and focused.	Oct'94
H'BROOK QUARTET	£555	Sensitive enough to work with low power valve amps. Fast and detailed sound.	Jul'93
CASTLE CHESTER	£600	Good solid sound and beautiful finish. 1/4 wave bass bading.	May'94
SYSTEMDEK 937	£600	Transmission line floorstander that won't offend.	May'94
TANNOY D100	£650	Believable 3D images produced by this small dual concentric speaker.	Jan'94
PROAC Studio 100	£699	Excellent monitors with detailed, natural sound and plenty of atmosphere	Feb'94
SPENDOR SP2/3	£769	Smooth sounding speaker with a superb mid-range. Very easy to listen to.	Feb'94
UKD CALLAS	£850	Powerful bass and high quality sound from a solid wood miniature.	Aug'94
SPENDOR SP3/1	£890	Beautifully built and finished. Superb midrange and treble detail and clarity.	Nov'94
TANNOY D700s	£1970	Dynamic and powerful. Needs a good clean power amplifier for best results.	Sep'93
QUAD ESL63	£3228	A reference to all others; superb imaging qualities and transparent sound.	Various

Hi-Fi Confidential Can Reveal All

Under our magnifying glass goes the fine range of audio equipment that we stock, ensuring you the customer, a purchase of the best value and best sounding products to match your given budget.

To make your important buying decision even easier, we offer Home Demonstrations, Part Exchange, Interest Free Credit, Home Installation and a Three Year Warranty on selected products. Relax in our demonstration room as experienced staff guide you through your individual requirements, be it digital, analogue, loudspeaker, amplification, or just plain old friendly advice. Jus. 1 minutes walk from Victoria mainline station, and open until 9 pm on Thursday Hi-Fi Confidential welcomes you.

Enjoy the Magic of Valves

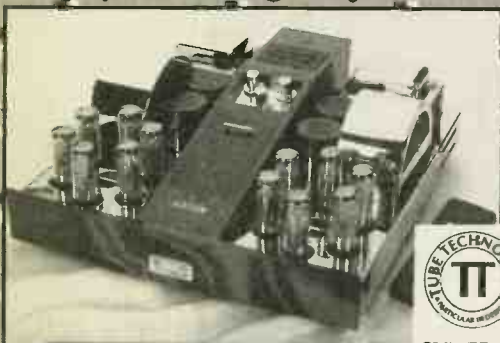

SYNERGY

HI-FI CONFIDENTIAL

34 Buckingham Palace
Road, London, SW1W

Products Include;
Valve Amplifiers by;
EAR, D.D. Audio,
Tube Technology, Conrad
Johnson, Lumley Reference,
Audio Innovations, *Amplifiers*
by; Musical Fidelity, Kinshaw,
Quad, Alchemist, Denon, Orelle,
Albary, Pioneer, John Shearne.
Loudspeakers by; Monitor
Audio, ProAc, System, Spendor,
Tannoy, Celestion, Castle,
Triangle, KEF, UKD *Digital by;*
Pink Triangle, Quad, Sony, DPA,
Audio Alchemy, Pioneer, Orelle.
Musical Fidelity, Micromega,
Kinshaw, QED, Marantz,
Sugden, TEAC *Analogue Replay*
by; Pink Triangle, Systemdek,
Alphason, Thorens, Townsend
Cassette Decks by; Yamaha,
Sony, Marantz, Nakamichi,
Aiwa, Denon *Accessories;* Gold
Aero Tubes, QED Audioquest.

0%

INTEREST FREE
CREDIT
ON SELECTED
ITEMS

NEW PRODUCTS

PINK Δ DAC
VENTRICLE
TUBE TECH SEER PRE
PEARL VALVE COOLERS
DYNAUDIO SPEAKERS
EAR 859

HI-FI CONFIDENTIAL LTD.
34 Buckingham Palace Road,
London, SW1W 0RE

Tel: 071 233 0774 ~ Fax: 071 233 7226

The Audio Room

&

Pure Sound



Hi-Fi Consultants

A Huge Range!

Come and listen to the following famous brand names of quality hi-fi equipment at our listening rooms:

Amplifiers

Arion Acoustics
Audio Innovations
Audio Note
C.A.T.
Credo
Kinshaw
Lumley Reference
Triangle
YBA

Loudspeakers

Audio Note
Impulse
Lumley Monitor
Townshend
Triangle
Credo

CD Players

Audio Note DACs
Counterpoint
Kinshaw DACs
Kreatura
Mephisto
Micromega

For example, the great new Lumley ST40 40 watt push-pull valve amp is here, as are the latest ST70 and M120s, together with the pre-amps, active line and phono, and passive line level. The brand new 300B triode single ended design from Audio Note, the Meishu is also with us, we think the only permanent demonstration one in the UK. - A fabulous addition to the Audio Note Range. The Lumley Monitor speakers are superb-accurate and dynamic and they're here too. Just phone to book your audition!

0784 458176 / 081 893 4485

We've also got heaps of ex-demo and used bargains - call us for details!

Pure Sound + The Audio Room, Whitton, Twickenham and Staines. Personal service, home demonstrations, excellent hi-fi

Valves Mostly UK. Oil Filled Chokes

Type	Price	Type	Price
DA100 GEC	POA	10H 25mA	£8
PX25 MARCONI	POA	10H 35mA	£10
KT61 GEC	£25	10H 170mA	£15
KT66 GEC	£65	10H 180mA	£15
KT88 GEC	£85	10H 250mA	£25
GZ34 MULL	£10	10H 75mA	£12
EL34 MULL	£25	10H 120mA	£12
EF86 MULL	£6	5H 200mA	£12
ECC81 MULL	£5	5H 400mA	£20
ECC82 MULL	£5	5H 120mA	£12
ECC83 MULL	£10	4.5H 220mA	£12
5R4GY	£4	20H 120mA	£15
6080	£10	6H 30mA	£10
GZ37	£3	6H 250mA	£15
EL84 MAZDA	£4	2H 300mA	£12
A2900 GEC	£20	16H 150mA	£20
6SN7 GT	£4	20H 100mA	£15
U19 RECT	£10	5H 500mA	£30
6X4 RECT	£3	40mH 3A	£30
6L6	£10		
4212E STC	£100		

Varnished Chokes

10H 75mA	£10
3H 40mA	£10
9H 240mA	£20
5H 430mA	£25
5H 350mA	£20

Oil Filled Paper Capacitors

1 MFD 600V	£6
2 MFD 600V	£6
4 MFD 600V	£6
8 MFD 600V	£8
8 MFD 800V	£10
8 MFD 1000V	£12
0.5 MFD 1000V	£6
0.5 MFD 5000V	£15
12 MFD 350V	£8
1 MFD 2500V	£15
0.25 MFD 1000V	£6
2 MFD 1500V	£15
8 MFD 1500V	£30
8 MFD 2500V	£40
4 MFD 1000V	£12
4 MFD 800V	£12

P.T.F.E. silver plated wire various colours and sizes 50p per mtr.
A.V.O CT160 Valve Tester EX M.O.D tested and supplied with data book £99 + £20p+p
Solartran varifiable H.T power supplies with meter 0-500V+DC 100MA/3-15-0-3-15 3A tested very good condition £75 + £20p+p
P+P add £5.00 +VAT per order UK only unless otherwise stated.
Overseas postage at cost
VAT at 17.5% to be added to all UK orders.
All items in this advert are made to mill spec

Oil Filled H.T Transformers

Primary	Secondary	
115/230V	1250-0-1250V	230V
	310MA	£35.00 725/700-0-725/700
	4.6V 100MA	385MA
		180-0-180 55MA
		6.3V 6A
115/230V	400-0-4-00	5V 6A £50.00
	250MA	6.3V1A
	30V 100MA	
115/230V	350-0-350 150MA	115/230V
	6.3V 1A	300/250-0-250/300
	6.3V 2A	£37.00 125MA
	6.3V 6A	£20.00

Oil Filled Heater Transformers

Primary	Secondary	
115/230V	6.4V 3A x2	
	2.5-5V-6.4x2	£15.00
115/230V	6.4V 10A	
	10V 650MA	
	26V 650MA	£15.00
115/230V	2-5V-5V-6.4V	
	2A x 4	£15.00
115/230V	6.4V 5A x 3	£20.00

All items in this advert are made to mill spec.

HORSHAM HIFI & CRAWLEY AUDIO PRESENT THE 300B VALVE AMPLIFIER

BURMESTER



MAGNEPLANAR

DEALERS FOR RCA "Living Voice" RECORDINGS, ALCHEMIST PRODUCTS, BURMESTER, MAINHATTAN ACUSTIK, GERMAN PHYSIKS, CHORD CO., CABLE TALK, SYSTEMDEK, GRAVIS SUBWOOFER, WAD, APOLLO, CAD, ORTOFON, FULLERS AUDIO, LORICRAFT (GARRARD), SME, DENON (CART), POLK AUDIO, ATACAMA, KONTAK, SENNHEISER

CONTACT
RICHARD DAWSON
CRAWLEY AUDIO
1 SILKIN
DALTON CLOSE
BROADFIELD
CRAWLEY
W. SUSSEX
TEL/FAX 01293 531190
MOB 0860 911640

* PURPOSE BUILT DEMONSTRATION ROOM BY APPOINTMENT ONLY
* HOME DEMONSTRATIONS AVAILABLE
* PART EXCHANGE
* CREDIT CARDS ACCEPTED

CONTACT
JEFF PAYNTER
Panel Speaker & Subwoofer
Specialist
HORSHAM HIFI
28 QUEENSWAY
HORSHAM
W. SUSSEX
TEL/FAX 01403 251587
MOB 0831 418619

Oxford Audio Consultants

HI-FI SPECIALISTS



Our superb service is the same, regardless of price.

AUDIO RESEARCH LS7/VT60

At last a combination at an affordable price! Quite sensational sound quality to boot!

NOW DEMONSTRATING

- AUDIO RESEARCH CD1/CDT 1
- AUDIO ALCHEMY DAC IN THE BOX - staggering sound for £199.95
- MICROMEGA STAGE - the new concept in upgradeability
- ORELLE CD480 - a serious British competitor to the ARCAM
- PINK TRIANGLE DA CAPO - NOW IN STOCK
- THETA DATA BASIC & GENERATION V - real high end
- TEAC VRDS 7/10/20 AND 700 2 BOX SYSTEM
- SME 20 - the finest engineering with superb sonics
- PROJECT TURNTABLES - value for money
- LYRA CLAVIS Mk 2 - even better and only £995
- KINSHAW PERCEPTION PHONO STAGE
- AUDIO INNOVATIONS ALTO - lovely sound and styling
- COPLAND CSA 14 - bargain of the century!!
- DPA 200 SERIES PRE/POWER
- KRELL KRC/KRC 2 preamps with the latest S SERIES power amps - seriously high end
- wait till you see the new KPS digital series
- MUSICAL FIDELITY F SERIES - very, very good value
- HEYBROOK SEXTET/QUARTET - very room friendly
- MARTIN LOGAN AERIUS - magic looks and sound
- QUAD ESL 63 - we are now main agents for the complete range of QUAD
- REL STRATA AND STADIUM SUBWOOFERS
- RUARK EQUINOX - furniture for the living room
- SONUS FABER - no apologies! these are our favourites
- DENON DF 10 - mini size components available separately
- BOSE LIFESTYLE SYSTEM - almost invisible hi-fi!

EX DEM & P/EX BARGAINS

- KRELL KSA200B POWER AMP £2495
- MAGNEPLANAR SMGA £395
- MAGNEPLANAR SMGA BX DEM £695
- APOGEE DUETTA SIGNATURES (TAUPE) MINT £1995
- LAMBDA SIGNATURE HEADPHONES ONLY £350
- AUDIO RESEARCH LS2B PREAMP BLACK £1795
- QUAD 66CD PLAYER £350
- REGA PLANAR 3 £150
- ROKSAN TABRIZ Z1 ARM/CORUS BLACK £195
- ACOUSTIC ENERGY AEI ROSEWOOD WITH STANDS £750
- ORACLE DELPHI MK3/SME V £1595
- AKG K1000 HEADPHONES £250
- PROCEED PCD 3 CD PLAYER EX DEM £2195
- PIONEER CLD 800 LASERDISC PLAYER £275
- NAIM 32.5/HICAP/250 £950
- KRELL KRC2 £3195
- MUSICAL FIDELITY PRE3A PREAMP £195
- AUDIO RESEARCH V70 EX DEM £2995
- KRELL CD DSP CD PLAYER EX DEM £2995
- THETA DS PRO PRIME £895



Please ask for details or our current list
Agencies include: Aura, Accuphase, Acoustic Energy, Air Tangent, Apogee, Audio Alchemy, Audio Research, Audio Technica, Basis, B&W, Casile, Classe, Copland, Denon, Denon Cartridges, DPA, Dual, Goldring, Harmonix, Heybrook, HPW, Kimber, Koetsu, Jadis, Kreil, Lyra, Magneplanar, Magnum, Mandrake, Marantz, Martin Logan, Michell, Micromega, Music Fidelity, NAD, Nakamichi, Onix, Orelle, Ortofon, Pink Triangle, Pioneer, Polk, Proceed, PS Audio, QED, Quad, REL Subwoofer, Revox, Rogers, Roksan, Rotel, Ruark, SD Acoustics, Seismic Sink, Sennheiser, Sequence, Sequerra, Slate Audio, SME, Sonus Faber, Stax, Target, TDL, Teac, Theta, Thorens, Van den Hul, Wadia, Wharfedale, Wilson

TAX-FREE EXPORT SERVICE
MAIL-ORDER AVAILABLE ON MANY ITEMS
Open Mon-Sat 10am-6pm

Oxford Audio Consultants

Oxford Audio Consultants, Cantay House, Park End Street OX1 1JE
Telephone: Oxford (0865) 790879 Facsimile: Oxford (0865) 791665

Billy Vee

SOUND SYSTEMS

Presents together with Blackheath Concert Halls

A MUSICAL EVENING



Monday, November 21st. 7.30 - 10.30pm.
at the Blackheath Concert Halls, Lee Rd.
This is your chance to experience some of the sounds that Naim are famous for, meet the Naim guys, hear some great music and, maybe take advantage of our special 0% offers. Tickets are limited, so telephone to reserve your place now!

248 Lee High Road
Lewisham, London, SE13 5PL
Tel: 081 318 5755 or 852 1321



"WHERE
FRIENDLY
SERVICE STILL
COUNTS!"

You can come and visit us at:
25 HENLEY STREET
STRATFORD ON AVON
Tel/Fax No. 0789 414533

We are stockists of the leading Hi-Fi brands
HOME CINEMA SPECIALISTS

ARCAM • AURA • B&W • DENON • KEF • KENWOOD •
MARANTZ • MISSION • MONITOR AUDIO • MORDAUNT-
SHORT • NAD • NAKAMICHI • ONKYO • PANASONIC •
PIONEER • TANNOY • TDL • TECHNICS • ROTEL • YAMAHA

INTEREST FREE (0% FINANCE)
ON EVERYTHING OVER £300
PLUS - We have a demonstration Room &
Full Service Facilities

All major credit cards accepted.
• MAIL ORDER • HOME TRIALS •
Monday to Saturday 9.30-5.30

readers'

queries

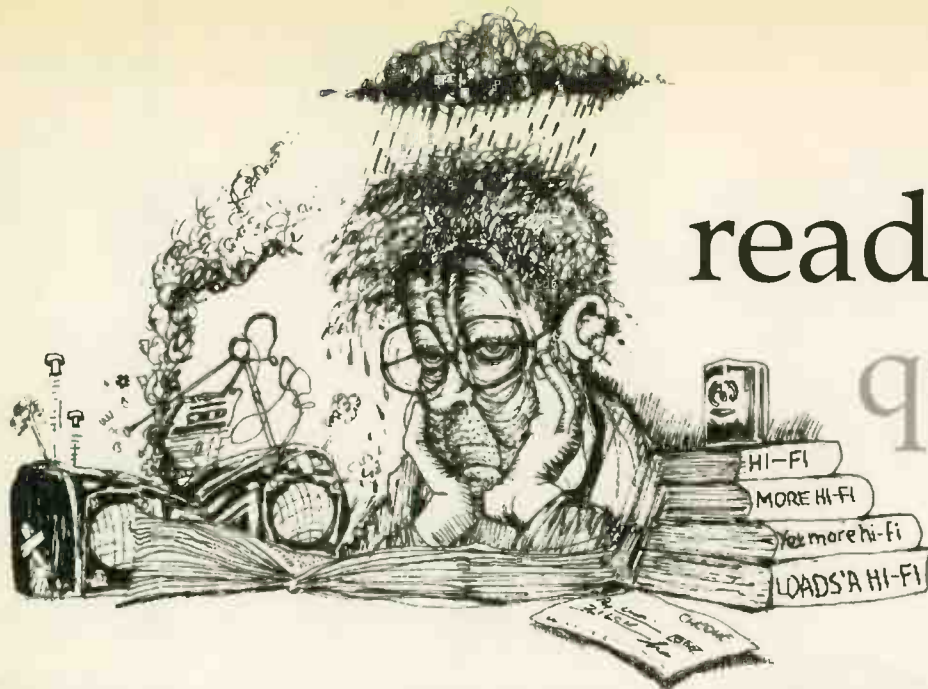

TRANSPORT AND CONVERT

I currently have a Denon DCD-1520 CD player, Croft Charisma pre-amp, Series X OTL power amp and custom-built 'speakers using Decca London ribbon horns and Volt eight inch bass units.

Interconnect is Kimber PSB with Audioquest F18 speaker cable.

I'm very happy with the overall balance which sounds very open and detailed, but I feel the Denon CD is letting the side down. What would be the best replacement for the CD player? I've short-listed the following: NVA, TES, Roksan, P.T. Da Capo (keeping the Denon as transport), Micromega T-Drive/T-DAC.

My budget is around £1,500-£2,000 and musical styles include jazz, female light rock and film sound-track music. The sound must be detailed with high resolution dynamics. If you have other ideas or advice I would be very grateful.

Marc Helliwell
Exeter,
Devon.

The one we use as a reference both for reviewing products and for developing designs for our DIY supplement is the Pink Triangle Da Capo. We have found it gives an exceptionally clear, clean and accurate sound, but conveys enough character to make

Write in with your problems to Hi-Fi World, 64 Castellain Road, Maida Vale, London W9 1EX.

Our panel of experts will endeavour to solve them, or at least offer some practical advice.

music involving. Whilst developing the solid state monoblocks and the carbon fibre drive unit KLS-3 loudspeakers we went through many convertors and players and all of them, apart from the Da Capo, imparted some character of their own to the sound which was undesirable as far as we were concerned.

The Da Capo has the ability to resolve amazing levels of detail and present it in a natural and informative manner, an ability that only a handful of the convertors we have come across possess. We use the Philips 1307 digital filter, finding it gives a bit more body to the sound than the Yamaha 22-bit filter, which has a cooler presentation. This ability to change filters also makes the Da Capo very

versatile, since when new filters are introduced, you can just upgrade, rather than buy a whole new model.

The Da Capo also has a re-clocking circuit, which reduces jitter from whatever transport it is connected to, making the DCD-1520 you have fine as a transport, although it would be worth upgrading to a dedicated transport at a later date. **DB**

DANCE-HALL DAYS

My query comprises two parts: firstly my system comprises Meridian 200/203 (DAC7), Pioneer A400, TDL Studio 1s, bi-wired with silver-plated copper multi-strand cable, with solid-silver multi-strand interconnect (both excellent value from the Maplin catalogue).

While I am essentially happy with the sound, I feel that the bass has perhaps more weight than actual definition and I suspect the amp may be the culprit. If so, would a change to a decent valve amp improve matters? How about one or two of your own K5881s, or would the TDLs be too much for a valve amp to handle? If so, perhaps you could recommend some compatible solid-state amplifiers at around £1,000.

My listening tastes cover most areas except opera and country and western.

The second part of my

query is somewhat more unusual, but I hope you can help. My partner (who teaches dance to school children) having experienced real hi-fi at home, would like to achieve a similar level of sound quality in the school hall!

The proposed system will comprise CD player, tape deck (both easily chosen from the budget end of the market), amplifier and 'speakers. It is the choice of 'speakers and amplifier which concerns me rather, given that they must provide enough music to fill the hall, not to rock concert SPLs, but to a level adequate to accompany a dance performance to an audience of around 150 people.

I'm of the opinion that the finer points of hi-fi may be safely ignored (particularly imaging and soundstage) but I would appreciate any thoughts you may have regarding the use of long 'speaker cables (20m) and the necessary physical size of the enclosures and power output of the amplifier. The size of the hall is approximately 25m long, 20m wide and 12m high.

Ian Jones
Market Harborough,
Leicestershire.

Firstly, as far your own system is concerned the Pioneer A400 amplifier, as good as it is, is not

Continued on page 117...



14 northway, scarborough, n. yorks yo11 1jl
 phone: (0723) 374547
 15 commercial street harrogate, n. yorks hg1 1ub
 phone: (0423) 504274



SALE SALE SALE SALE SALE SALE

	RSP	Now
SME Model 20A	3,750	2,600
Nott'm Analog Tracer	500	200
Ortofon MC7500	2000	1250
Con. Johnson Motif Phono	2250	1500
Kinshaw Perception DAC	745	575
Marantz CD10	1,199	899
Michell Iso	400	300
Quad ESL(Black)	2860	2100
Quad FM4	434	325
Mod Squad Preamp	500	250
Lexicon CP2	1,100	899
Oxford Mistrale	400	300
Ariston Maxim Amp		250
Celestion 300	1100	899
Celestion SL600 + DSP	1169	875
Equation 0 speakers	1099	750
Dahlquist DQ10 (s/h)		450
Bose 901 complete	1695	1200
Rotel Michi Power amp	1550	1200
Stax Lambda pro +energ	728	550

CARRIAGE FREE ANYWHERE UK. MAIL VISA/ACCESS

You should be looking for only one kind of Hi-Fi.
The Best!
Call me, it's the only kind I deal with.

For the Best...

**Apogee, Audio Research, Classé, Copland, Linnaeum,
 Magnepan, Martin Logan, PS Audio, Sonus Faber,
 Theta, Van den hul**

And the Best of British...

DPA, LFD, Michell, Orelle, Pink Triangle

Ex Demo equipment: All Guaranteed.

DPA T1 transport/Bigger Bit	was £1590	now £1250
DPA 200S pre/power	was £1250	now £1000
Orelle 10T transport/DAC180	was £1400	now £1100
Orelle 200 pre/power, mm, mc	was £1300	now £1050
Orelle Orator speakers	was £ 699	now £500
LFD PA2 power	was £1099	now £875
Sonus Faber Electa	was £1790	now £1300

All World Favourites

Phone or fax me:

0252 - 377952

Mobile:

0385 - 317952

Mike Harvey's



.... Continued from page 115

the best match for your Studio 1s. The A400 has a full sounding bass which gives small budget loudspeakers real punch and apparent bass depth, an area in which your Studio 1s certainly don't need any more help. To tame the strong bass of the TDs and get a taut and tuneful bass line you are going you need something with a little more power and grip. Having said this, I'm sure that you won't want to compromise the superb clarity in the midrange and treble of the A400, so something powerful and smooth is the order of the day.

If you want to stay on the safe side of £1000, then your options are limited. The Quad 606, at £675, has the power and is certainly smooth, but I suspect that it may be a little too laid back for your system. Have a listen anyway, it is a superb amp. If it sounds a little too soft for you, then Sugden's AU41P is much the same, but with a little more sparkle in the treble. It again has a lovely smooth and detailed sound, but is slightly less powerful, so may not be quite as good in the bass.

Both of these are power amplifiers, so you will need a pre-amp to drive them. If you are just using CD as a source, I'd recommend you invest in the Audio Synthesis Passion at £475. It's a lot of money for a passive pre-amp, but the stepped attenuator using high quality bulk foil resistors and a heavy duty selector switch are the next best thing to a piece of straight wire with attenuation.

Alternatively, as you're into building your own cables, use a high quality Alps volume potentiometer with a silver-plated wafer switch and silver cable from Maplin to make your own. Maplin also stock gold-plated phono sockets and a suitable case.

For your partner's school hall system, I had a quick discussion with John at the

Leicester hi-fi company (Tel: 0533 539753) and we decided that the best bet would be a pair of Klipsch horn loudspeakers driven by either a powerful integrated or a budget NAD pre-power combination. The Klipsch loudspeakers, being horn-loaded, are very sensitive and will drive a large hall with ease from few watts. Although the Leicester hi-fi company don't stock Klipsch, I spoke to the importers (Midland Radio Supplies Tel: 021 430 7817) and they would be prepared to discuss which of their range would be most suitable and then deliver them to the Leicester hi-fi company who could carry out the installation. I hope this is of some use. **DB**

Public Address (PA) work demands very high SPLs, although not necessarily high power in the case of horn speakers. Other speakers to consider are American Cerwin Vega for a big sound from little power. If the budget is limited then think about a big three-way (good power handling) bought secondhand from our Classified Ads section. There are a lot of bargains here and great variety too. But stick to big, multi-unit speakers from KEF, Celestion or Tannoy if possible, which are well made and can take continuous power without falling apart. Keep away from strictly domestic hi-fi two-way speakers; they are inappropriate. **NK**

MYSTERIOUS MC

I just thought I'd put to pen to paper to try and find out if you could answer a query of mine.

I have recently found a moving coil cartridge which I believe to be called an Entre I. I have hooked it up to my turntable, from which it gave out an excellent sound, far exceeding my previous cartridge (Nagaoka MP-11).

Could you please give me some background information on it, such as when it was built and how much it probably cost?

I also think that the stylus

may be on its way out. Is it possible to fit a new cantilever and stylus, as I seem to remember a previous reader's letter mentioned a man who re-built a cartridge for him. If this is the case, could you give me an address so that I can contact him about the cartridge.

I have included a list of the Entre's technical specifications for you to browse over. Your help would be much appreciated.

'Entre-1':

Frequency response - 10Hz-50,000Hz

Output voltage - 0.2mV (35.4mm/sec, 1000Hz 45 degrees)

Channel balance - within 1dB (1000 Hz)

Channel separation - better than 28dB (1000 Hz)

Compliance - 10x10⁻⁶ cm/Dyne

Impedance - 3.0 ohms
Tracking force - 1.8gm +/- 0.3gm

Vertical tracking - 20 degrees
Stylus - diamond, elliptical with a radius of 0.3mm x 0.8mm

Mass - 5.8gm

Mounting - half-inch or 12.7mm

**Adam Russell
Willenhall,
West Midlands.**

Two companies to contact are the Diamond Stylus Co. on 0492-860881 and The Cartridge Man on 081-688-6565. Both offer a re-tipping service and may be able to help with repairs, according to what is needed. **NK**

LACKING SPARKLE

I think I have wrecked my hi-fi system. The sound has certainly improved a lot in recent years, but who stole the sparkle? The overall presentation used to be a lot brighter than it is now - not as solid, but where has the snap gone out of my snare drum? Could it be that I have OD'd on valves?

As it stands, my system is as follows: Garrard 401, Slate plinth, SME IV, Denon DL-304, EAR 834P phono head amp, Concordant Excelsior pre-amp, Quad II power amps and Castle

Durham Mk 1s on Heybrook HBS1 stands.

I want to spend about £1,000 on sparkle, but where to start polishing?

I am convinced that there is no problem in the turntable department. This leaves the amplifiers and 'speakers. This is where my problems start. Do I rebuild the two pairs of Quad IIs I have and bi-amp with them, or replace the Quads completely? Alternatively, should I hang on to the Quads as they are and look to replace the 'speakers first?

The power amps and 'speakers are, by the way, the same items that used to sparkle when fed from a modified Michell Hydraulic Reference turntable, Keith Monks unipivot arm, A&R P77 cartridge, and Hafler DH101 pre amp. Sadly, none of these items are available for re-instatement as they have both expired. Your help in this matter would be very much appreciated. Best wishes for the future with your erudite publication.

**Alan Mildren
Ealing,
London.**

If you have made absolutely sure that the cartridge isn't worn out (get a good dealer to check it under a microscope) then I too will assume that the problem is elsewhere. The EAR head amplifier, Quad power amps. and Castle Durham loudspeakers all have a similarly soft and warm balance and the combination will be compounding this quality. If you spend £1000 on your system not only should you be looking to inject a bit of life back into it, but also upgrading the whole sound at the same time.

Your have some excellent core items - Garrard 401, SME IV, Quad IIs - and I would suggest you build around these for best result. The DL-304 is a lovely cartridge, but the combination of 401 + SME IV is worthy of far better MCs. I'd have a listen to Ortofon's

Continued on page 119...





EXTRACTS FROM RECENT REVIEWS

"It's diamond necklace in a world of plastic - but without a Tiffany price tag" **Eric Braithwaite, HiFi World, Sept 1992**

"Clearly the, these LFD components are of an outstanding quality" **Jimmy Hughes, Audiophile, Jan 1993**

"The placing and scale of each element was near perfect; Dynamics were also impressive" **Malcolm Steward, Audiophile, Sept 1993**

"The result was music making without the Hi-Fi intruding" **Peter J Comeaux, HiFi News, June 1994**

"Spirolink I, Spirolink II and Digilink Copper"

HiFi Choice Recommended, June 1994

"Airoflex, ***** Rating" **What Hi-Fi, Feb 1994.**

"Spiroflex I, Hi-Fi Choice Recommended, Aug 1994

**LFD Audio, 110 Oxford Crescent,
Clacton-on-sea, Essex, CO15 3PZ
Tel. (0255) 422533, Fax. (0255) 221069**

HALE HI FI



We stock:-

**ROYD, NAD, NAIM, LINN, CREEK, ARCAM,
QUAD, YAMAHA, AMC.**

A wide range of accessories always available.
Full demonstration facilities - no appointment
necessary - full service department.
Free delivery and installation

**2 Bold Street, Hale Road
Altrincham, Cheshire WA14 2ER**

Telephone: (061) 929 0834

Francis of Streatham

Established 1913

Hi-Fi Video Specialists



Appointed Stockists for:-

Panasonic/Technics, Hi-Fi + Video, Dolby Prologic
Come and listen to the new Technics SCCA1080
Dolby Prologic mini system and the range of
Technics separates

Large Stockists of Styli & Accessories

Own Service Department
Part Exchange available

081 - 769 0466/0192

169 Streatham High Road, London SW16 6EG

Audio Physics

CLEANLINE - Modification for the Naim HICAP

**Would you believe that the already excellent sound
of your Naim equipment could be improved?**

Replace the IC regulator in the HICAP with our easily
fitted very low noise regulator module, built with
selected discrete components. **Like our many satisfied
customers you too can gain a clearly demonstrable
improvement in clarity and enjoyment.**

The CleanLine module is £125 inc, with clear fitting instructions, a
help line and a full refund if not completely satisfied.

Phone Geoff Mead on 0895 637846 for full details



MANTRA AUDIO

• CARTRIDGES AND STYLI
• MAIL ORDER DIRECT 1-10 DAYS
• COMPETITIVE PRICE (inc P&P)

MAKE	MODEL	CARTRIDGE	STYLUS	MAKE	MODEL	CARTRIDGE	STYLUS
Audio Technica	AT 95 E	£21.00	£13.50	Ortolon	510	£29.00	£19.00
	AT 110 E	£26.00	£16.00		520, 520P (T4P)	£49.50	£36.00
	AT 450 E	£57.00	£33.00		MC 1 TURBO	£54.00	£45.00*
	AT420 E	£36.00	£22.00		MC 3 TURBO	£99.00	£82.50*
Denon	AT OC 3	£95.00	£64.00*	Shure	MC 18	£76.00	£65.00
	AT OC 5	£110.00*	£90.00*		MC15	£95.00	£82.00
	DL 110 MC	£65.00	£52.00*		MC 10 Superme	£208.00	£150.00*
	DL 160 MC	£75.00*	£58.00*		MC 20 Superme	£315.00	£236.00*
Goldring	DL 304 MC	£180.00	£155.00*	Ortolon	VN 35 MR	£63.00	£63.00
	ELECTRA	£24.00	£16.00		VN 45 MR	£90.00	£90.00
	1006	£44.00	£29.00		V 15 VMR	£225.00	£130.00
	1012 GX	£58.00	£38.00				
Nagaoka	1022 GX	£76.00	£49.00	SWISS QUALITY DIAMOND STYLI			
	1042	£94.00	£61.00	EDC	R20 XE, OLM 32/34/36, XLM III		£12.50
	Eroica (LX)(H)	£90.00	£65.00*	Alwa	AN 5/11/8745		£8.00
	MP 11 Boron	£25.00	£12.50	Akai	RS 33/3/33/84/85/90		£8.00
Ortolon	OM10, OMP10 (T4P)	£25.00	£18.00	Ortal	DN 145/155/165E, DN 149S		£12.50
	OM20, OMP20 (T4P)	£54.00	£31.50*	Ortolon	FF 15/MS 10/20 EIL, OMP/10/20		£12.50
	OM30, OMP30 (T4P)	£72.00	£58.00	Shure	N75 ED/EJ T2, N95 ED/EJ		£10.00
	OM N/CLUB S	£29.00	£18.00	Sony	ND 133/134/142/150/155/200 G		£8.00
				Technics	EPS 23/14/25/27/290, P 30/33 D		£8.00

* Exchange any Mk! *** Over 500 styli type stocked ***

Tel (0757) 288652

All above items UK supplied/UK guarantees - No grey imports

MANTRA AUDIO (HFW), 22 GARTH AVENUE, NORTH OUFFIELD, SELBY, NORTH YORKS YO8 7RP

... Continued from page 117

MC10 Supreme, I think you'll find this a lot more dynamic, open, cleaner and brighter. This will give you an absolutely superb front-end, in which case a top flight phono stage is in order. Again the EAR 834P is good, but with a front-end of this calibre you really should be aiming a little higher. Try Michell's Iso, which combines the smoothness and richness of the EAR with greater dynamics and better detail resolution.

The Quads are best left alone, i.e. unmodified, but get someone like Graham Tricker of GT Audio or Hayden Boardman of Audio Classics to make sure that they are in top condition, with no leaky capacitors or out-of-tolerance resistors, etc.

The last step I would make is to find some high sensitivity loudspeakers that will get the very best out of the Quads. Try auditioning the Cabasse Prao which are sensitive and have a forthright sound with lots of detail. Others to audition include Triangle's new Cometes, and the Heybrook Quartets. **DB**

Having owned Quad IIs I would be prepared to suspect they might be contributing to your dissatisfaction. Whilst these amplifiers are as sweet as can be, they are also a little mellifluous and too vague on the beat to be true rockers. Many people prefer this sort of presentation, which is unavailable in solid-state - no transistor amp could match the Quad II for sheer beauty of sound. But limited power output (8watts-12watts according to condition) and poor 'speaker matching can conspire to make the Quads struggle. Bearing this in mind, you could well try the IIs with a sensitive, 'fast' loudspeaker, the new Mission 752s being one possible option, Heybrook Quartets another. Ultimately though, I'm not sure that it is possible to get the best of solid state and the

best of valve perfectly combined. You might have to accept some slight compromise between the two. Our K5881 kit valve amp achieves this trick nicely, sounding clean, fast and lively, and so does the EAR834 integrated valve amplifier. **NK**

THE UPGRADE PATH

My present system comprises: a recently purchased Goldring 1012GX cartridge (upgraded from an Audio Technica AT95E) feeding a Revolver Rebel turntable, through the turntable's own interconnect into a Creek 4140 S2 amplifier. I have original wooden Sonata speakers on JPW stands and use DNM solid core speaker cable. Since the cartridge upgrade I have noticed an improvement, but it is not quite as breathtaking as I'd hoped.

I rarely use my cassette deck and have weaned myself off the few CDs I own as I vastly prefer records, especially since I buy mainly pop records from the '80s, at one third of the price of new CDs.

I have recently left student life (where my speaker cable was slightly gnawed by my housemate's rat) and have become a small cog in the financial machinery of the City. Unfortunately, I have yet to see a commensurate improvement in my bank balance. Further improvements to my system will have to wait a while.

When I do upgrade, what should I do? I could wait for a good turntable to be advertised second hand in your classified pages (I particularly have a Roksan Xerxes or a Pink Triangle in mind) or upgrade the speakers, possibly to your own KLS2 design. I am particularly keen on the second-hand market since I bought the Creek at a bargain price through your classified pages, from a gentleman halfway across the country who sent it to me to try before even glimpsing the colour of my money.

I am now considering a Garrard 401 with a high end arm; your articles have inspired

me to hear the sound of some of these antiquated beasts myself. However, I know production quality varies considerably and I was born after their heyday, so I am not confident of finding a good specimen to build on to. Perhaps an article on what to look for?

Before we fix it, what is wrong? Imaging, deep bass reproduction and ease of distinction between instruments and vocalist have improved since the cartridge upgrade. However, there is none of the startling realism, openness and sense of power I experienced several years ago during several visits to Oxford Audio Consultants. Admittedly, that was through such esoteric components such as Krell amplifiers and six-foot high electrostatic speakers whose manufacturer I have forgotten.

Finally, a tweaking question. I cannot decide whether adhering blocks of lead in the holes underneath my turntable platter would enhance or degrade pitch stability, without access to precise balancing. What do you think?

**William O Smith
Palmer's Green,
London.**

If you are not against buying second-hand, there are certainly some bargains to be had. With second-hand turntables there is little that can go wrong. In most cases all that will need replacing is a worn out drive belt. If you're unlucky the motor may be starting to wear, but these are relatively inexpensive to replace. Be a little wary of second-hand tonearms though. If they have been on several turntables and roughly treated the bearings can be damaged. Stick to Rega and SME. Both are strongly made and can deal with a little punishment.

Looking through our classifieds from last month, there is a Gyrodec with RB300 and K9 for £495, an RB300 on its own for £95 and numerous Garrard 301 and 401s for around £125. The

Gyrodec is beautifully engineered and stays 'in-tune' once it has been initially set-up, which makes life a whole lot easier. The Garrard 301 and 401 are both superb turntables, but be prepared to spend at least £200 on restoration etc before their full potential can be realised.

The Creek amplifier has a lovely sweet and gentle sound and for this reason I'd hold on to it for the time being. It may well be worth adding an external phono stage to get the very best from your front end - the EAR834P is excellent value. The Creek is fairly low-powered though, so a good pair of sensitive loudspeakers are in order. Models to try include Castle Durham 900s if you want good imaging, Heybrook Quartets for a bouncy and entertaining sound, TDL RTL3s for good bass power and ProAc Studio 100s for a refined and detailed sound.

Blocks of lead are not a good idea. They will stress the motor and belt on start up which may lead to premature failure. **DB**

If you are interested in a Garrard try contacting suppliers first to ascertain costs and potential problems. Spares are now available from various sources, some re-manufacture having started, such is demand. Loricraft (tel 0488-72267) are long-termers in this field, having workshops and plenty of experience. Slate Audio (0525-384174) are also experts and Technical & General (0892-654534) have a wide range of spares and parts, plus plenty of expertise. The Garrards are beautifully engineered and a pleasure to own and use. Get a Garrard 401 Celebration tone arm (SME IV) and fit an Ortofon MC cartridge when you make it big in the City, but in the meantime use a Rega RB250 with your Goldring 1012GX or a budget Ortofon MC like the new MC15 Super II.

Continued on page 121.... ▶▶

**H I - F I Y O U
C A N ' T A F F O R D
n o t t o l i s t e n t o**

EQUIPMENT BY ABSOLUTE SOUNDS, AUDIO INNOVATIONS,
SUGDEN, IMPULSE, MICHELL, ROKSAN, TRICHORD RESEARCH,
VOYD, LYRA, MICROMEGA, WILSON BENESCH, ORTOFON, TARGET,
KINSHAW.

By appointment only

SERIOUS KIT

061-707 4823

21, ALGERNON ST., MONTON, ECCLES, MANCHESTER, M30 9QA.
A STATE OF THE ART COMPANY

Are you making the right connections?

Send for Britain's biggest catalogue of
specialist cable and connections.

All available by mail order.

Phone 081-9429124 or clip
the coupon for your Free copy.

**CUSTOM CABLE
SERVICE**

PO Box 4007, London SW17 8XG

Please send me your FREE Custom Cable Catalogue

Name _____

Address _____

Postcode _____

NO FURTHER INFORMATION REQUIRED

Send to: Custom Cable Service
PO Box 4007
London SW17 8XG

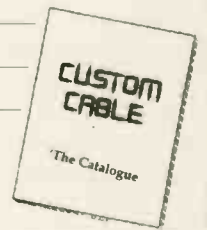

HF71794

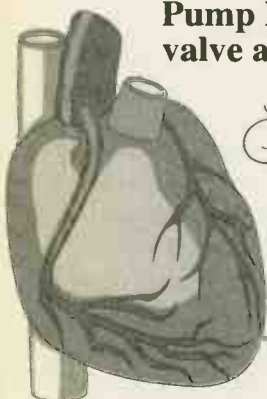

**Pump New Life back into your
valve amplifier, transplant with**

Gold Aero

**the worlds finest vacuum
tubes, selected and tested
in the USA for optimum
sonic performance. The
heart of your amplifier is
a valve, fit the best.**

Distributed in the UK by Tube Technology & their selected dealers; please
call or write for detailed literature to :- Tube Technology,
Foxhills Farm, Longcross Road, Ottershaw, Surrey, KT16 0DN, England.
Tel: 01932 873444 ~ Fax: 01932 873012



Home Cinema Consultants

Guiding you out of the maze of "home
theatre" hype; into the paradise of your own,
high end AV system.

"Elite" model Laserdisc player
Amplifiers and speakers (various)

Video monitor/Video projection.

061 773 6924. By appointment.

.... Continued from page 119

The electrostatic speakers you heard at Oxford Audio Consultants (0865-790879) were Martin Logan Arias, which are very impressive. Don't forget that a pair of early Quad Electrostatics properly positioned and, preferably, raised up off the floor (stick them on a cardboard box first and listen from below to check this out) offer superb results at a fraction of the price and may well be a satisfactory alternative until you get into The Sunday Times Top 100. **NK**

SOUND PROOF

I live in an end terraced cottage of stone construction, built as a pair of cottages with just a single brick party wall separating the two houses

I get on very well with my neighbours who are very quiet, unassuming people and I have on two or three occasions asked them to say, if at any time my hi-fi disturbs them. They have never complained, but I find it difficult to settle down to serious listening knowing that I might be disturbing them. Having said that, I do try to limit my listening to, at most, a couple of hours per evening before 10pm.

Having now definitely decided to stay in this cottage (a proposed move to a detached house having fallen through) and feel that my solution is to, attempt, as far as it is possible, to 'soundproof' the party wall.

I have taken some preliminary advice from a firm of sound and vibration consultants whose thoughts concurred with my own ideas, i.e. to construct a secondary wall of timber frame construction (say two inch by two inch, spaced half an inch) away from the main wall filled with high density sound absorbing fibreglass matting and faced with two layers of overlapping plasterboard.

I would be extremely grateful if you could advise me

whether or not the above is my best course of action, before I go to the expense of having the work done. I am sure that this is a common problem for fellow music freaks and perhaps an article on the subject might be welcomed. I look forward to hearing from you.

PS: just for the record I've just finished upgrading my system which now sounds glorious - it really makes music! It comprises: ProAc Studio 200s, Kenwood DPX 9010 Transport (Trichord modified 'Clock 2') Sugden SDA1 DAC, Audio Research SP9, Nakamichi BX300E, Denon TU2601 tuner, VDH First cables (including a digital link), VDH 122 single 'speaker cables and Denon POA 4400 monoblocks (to be replaced by valve amp(s) next month). I have heard it with an Audio Innovations First Audio and it sounded fabulous, or would you recommend any other valve amps - any other comments!

**Phil Willan
Mellor,
Blackburn.**

The first thing to do is to identify where the transmission occurs; this is of vital importance prior to any form of acoustic treatment. Ceiling voids and electrical conduits are known weak spots and may often contribute to poor sound insulation. These should be thoroughly assessed before embarking on any secondary wall construction as significant time and cost savings can be made.

Room Interaction

This is the relationship between the audio components and the room and their influence on the overall dynamics. Wall surfaces, furniture and room dimensions all play a large role in determining what happens to the musical energy after leaving the loudspeakers.

Two types of intrusive noise concerns us. a: airborne and b: impact. Floor-standing loudspeakers with large internal volumes are capable of

generating high sound pressure levels in the sub-sonic domain. Although inaudible, these frequencies can most definitely be felt, especially by your adjacent neighbours where the corresponding wavelength extends beyond your party wall and rebounds off their outer wall.

With respect to the ProAc Studio 200s, the manufacturers have made provision for fine tuning the bass response. By means of filling a small cavity with dry silver sand the low frequency response can be altered to compliment the room acoustically. An accurate measurement by an acoustician can identify whether this is necessary (in relation to the room's central resonant frequency) and at which point precisely this intuitive method is most effective.

Room Modes

These are the relationships between the wall, floor and ceiling dimensions. Certain ratios are preferable and are mathematically prescribed. These ratios have an important bearing on the final sound of the room and ultimately, its insular potential. A good acoustic consultant can help here (feel free to give me a call at European Acoustic Repertoire on 0732 763046) compiling a room mode analysis and report defining these relationships in relation to your equipment and furnishings.

Conclusion

In the November issue of HFV we discussed the effectiveness of diffusion in a domestic listening environment. There are a number of 'install yourself' packages available that can create an optimal and diffuse linear listening environment. This acoustical treatment uniformly affects the internal airborne energy thereby attenuating the actual transmitted sound. As a result of correct treatment, the psycho-acoustic perception is that the music is actually

greater in volume while the adjacent neighbour experiences a much reduced transmission level. **DFD**

LOOKING TO CD

My system consists of the following components: Rega Planar 3 with Rega RB300, Goldring Eroica LX (MC), Musical Fidelity A1, Rogers LS4a2 (bi-wire) on Target HJ20/2, Van den Hul CSI 22. Equipment supports are Target.

I'm happy with the sound of this system, moreover, I have set four cones of steel under the platform of the Rega Planar 3 and this has isolated perfectly any vibration problems. I must confess the result is fantastic.

I love vinyl records, but here in Spain, they're difficult to find. So, I wish to buy a good CD player. I seek a smooth sound with superb fidelity of tonal colour. Would the Marantz CD 52SE profit my system or perhaps the renowned Rotel RCD-965BX? Could you give ideas of price, say between £500 and £1,500. I would appreciate your information. Thank you.

**Jose Manuel Lis
Malaga,
Spain.**

To get the same level of enjoyment from CD as you do from vinyl, you will need to aim higher than the two models you have mentioned in your letter. If the CD player you buy is lacking, you will quickly discard it and revert back to vinyl in disgust. To get enjoyment from CD I'd suggest the Rotel RCD 965 Discrete as an absolute minimum, and more in line with your vinyl front-end would be the Quad 67 CD player.

The Quad is an especially good buy, having a sweet and fulsome sound, being well-built and having a high quality CDM-9 transport which could be upgraded with an outboard CD convertor at a later date. Audition carefully though, you may well decide to stick with the extra effort of searching out the black stuff. **DB**

LOUDSPEAKERS WHEN MUSIC MATTERS

FEATURING
ACTIVE/PASSIVE X-OVERS
REAL WOOD VENEERS
ALUMINIUM CONES
OFC CABLING · STANDS

Q.T.A. SYSTEMS
2 WHEATSHEAF WAY · LINTON
CAMBS · CB1 6XB · TEL: 01223 891091

FREE Audio Catalogue

**That Will Change
The Way You Buy Hifi**

**Inside the new RDL
catalogue you'll discover:**

- The secret to picking the right speakers.
- Why your home is the only place to test audio equipment.
- How to get more audio for your money.
- How to buy home theatre systems.
- Why the reviewers say RDL offers superior audio equipment at unbelievably low prices.



Buying from RDL is easy and risk free with our 100% "no strings attached" money back guarantee.

Roy Allison, President and Chief Designer of RDL Acoustics has put together two new, superb ranges of speakers to fit every situation at prices well below normal shop retails.

FREE
32 pg.
AUDIO
catalogue

Order your free catalogue, call:
0484 603333

or fax on 0484 607774

RDL
ACOUSTICS

20 Cleveland Way, Shelley
Huddersfield, HD8 8NQ

CLEARAUDIO, S.M.E, AUDIO RESEARCH, CREEK, E.M.F. GRAHAM

HEATHERDALE AUDIO LTD.
202, Findon Road, Findon Valley, Worthing, West Sussex.
Tel. 0903-872288. Fax 0903-872234

CLEARAUDIO
"In my introduction I described the Clearaudio Signature's performance as stunning. It's the only word that does this cartridge justice"
Chris Beeching. Hi-Fi News & RR. Aug. 94.

This months pre-owned bargains:

Magnum Reference 300 pre-amp	£325	Magneplanar Tympani IV speakers	£2495
Magnum Reference Int amp	£299	Musical Fidelity A100 Power Amp	£250
Audio Innovations 1st Audio	£995	Musical Fidelity T1 FM Tuner	£250
Audio Innovations 1000 pre-amp	£995	Audio Research SP 9 (Black)	£1895
Audio Innovations 200 pre-amp	£295	Linn LP12/SME/Ort. MC20 cartridge	£795
Audio Innovations 200 power amp	£295	Apogee Centaur Minor Speakers	£995
Audio Innovations 300 int. amp	£375	Naim 110 amplifier	£175
Linn LP12	£395	Naim Hi-Cap 32.5	£225
Wadia DigiMaster v32 DAC	£795	Naim 32.5 pre-amp	£225
Sony 702 DAC	£795	Linn Sara speakers	£275

THREE COMFORTABLE DEMONSTRATION LOUNGES.
VISA WELCOME.
PART EXCHANGE WELCOME

HEYBROOK, MAGNEPLANAR, MARTIN LOGAN, ROTEL, THETA, BASIS

VOYD, KLIPSCH, ARPEGGIO, COPLAND, SONUS FABER, ABBONORE, C.A.T

LUMLEY REFERENCE, KRELL, LUMLEY MONITOR, MAGNUMDYNALAB

World Audio design 300B



Listen to the enticing sound of a modern valve amplifier.

NOW ON DEMONSTRATION AT

HI-FI CONFIDENTIAL LTD
34 Buckingham Palace Road
London SW1 WORE
Tel: 071 233 0774

HI-FI CORNER
1 Haddington Place
Edinburgh EH7 4AE
Tel: 031 556 7701

FOR MAIL ORDER AND FURTHER INFORMATION SEE PAGES 89 - 91
Class A, 28 watt Stereo Power Amplifier
or 60watt Monoblock

PRIVATE

IPA T1 CD Transport, £575. DPA DM 2 two box converter, £1,350. Audio Innovations L2 pre-amp, £475. Audio Innovations 2nd Audio Monoblocks, £1,875. Impulse H2 horns, £1,475. DPA The Power filter £59.00. All as new, boxed, warranted. Canemo. Best offers. Tel: 0472 852240.

XPOSURE 17 pre-amplifier, mint, under warranty, boxed, £500. Audio Technica AT OC3 MC cartridge £50. Sennheiser Ovation HD560II headphones £60. All 16 months old. Tel: Guildford 0483 69443.

NAIM NAP 250 £625, NAP160 £275, HICAP £325, NAXO 3/6 £325. Snaps 135, NAC 325 £225, Arcam Alpha ID £225, Micromega Microdac £145, Mendian 101 pre-amp £75, JPN mini monitors £40 All VGC. WANTED Mendian 105 Mono Blocks. NAC 72, P12 & Armageddon. Tel: 0243 128555.

MAGNEPLANAR MG2.5 Panels, as new £850.00. Quad 33/303 Amp £160. Good working order. Tel: 081-657 141 after 7.00pm.

LINN ACTIVE SYSTEM, comprising P12 Lingo, Ittok, Asaka, Kaim, Aktiv (Kaber Crossover, 3 x LK280s, pair (Kabers, excellent condition, boxed, originally cost £8,500, will accept £4,500 or may split. Tel: 0978-780580.

PINK TRIANGLE GTI, RB300 arm, new. Audio Technica OC10, turntable shelf and brass cones. Boxed. £500. Colkestone Tel: 0303 244626.

MANTICORE MANTRA ELECTRONIC 1.8.6 Musician (S) tone arm just serviced by Manticore with new Roksan blue cartridge other upgrades included. Must sell £350 ono. Tel: 071 739 2397 after 7.00 pm. Excellent condition.

GARRARD 301 + SME 3009 £110 JVC T-V6 tuner £35 Lecson AC1 pre-AMPLIX power amp £190 Gale 401A pkrs £290 c.i. stands £45. Manuals, cartons. All g.w.o. Or £599 the lot. Tel: 0764 664 037.

BROKEN-HEAR 'ED last resort sale, bargains for good home. Mission 751, Arcam Alpha 5 Amp, Linn Basik+Akito+KS, Sennheiser HD 320 and Mission stands - £800 all immaculate condition. Tel: 0926 812496.

NAIM 72 Pre-amp plus HiCap with spare variable boards. Excellent condition £700 No offers. Tel: 0825 840279 (evenings) East Sussex, Lewes area.

LINN AKITO Tonearm, Rotel 820 BX amplifier £60. Both in mint condition and original packaging. Tel: 0709 547176.

SE-M100 Technics digital power amp. Optical fibre outputs cost new £611.00. Used twice as new including manual £299.00 O.N.O. Tel: 0706 343777.

EXPOSURE TWENTY, £325; Leak Stereo 20, Point One pre-amplifier £180; Leak Stereofetic FM tuner, £50; Ferrograph 4A and G33T, £100 each; Vortexion WVA £140, Hi-Fi Year Book 1959, £10. Tel: 081 686 3850.

MICHI AMPLIFIERS, Rotel Flagship comprising of passive pre-amp for CD, one phono pre, power amp 200 W.P.C. Excellent reviews, sale £2,300 New £3,340. All immaculate and boxed. Tel: 0276 858481.

TURNTABLE THORENS TD160 MKII, Mayware Formula4 MKIII tonearm, Denon DL-110 Cartridge, ADC XLM MKIII cartridge. Various great extras. Excellent condition, little used, one loving owner. £100 ono. Tel: 081-898 2872.

TOM EVANS Pioneer A400GTE Boxed £150. Tel: 0633-872998.

ORTOFON QUASAR moving coil cartridge. Boxed. Unused. With all accessories. Cost £350, will sell for £175.00 ono. Contact (0480) 468165 after 7 pm.

MERIDIAN 200/203 DAC 7-mint, (cost new £1,395) accept £650 inc. interconnects - IXOS + Audiquest. Audiotech turntable stand, (cost new £136) accept £50. Tel: 0204 29443 (Bolton).

SONUS FABER 'Minuetto' speakers, new with warranty, solid walnut with leather, bargain £750.00. LINN BASIK turntable, with Linn arm, immaculate, £180.00 (350.00). Hi-Fi Cabinet, mahogany, swivel top, swing doors, cost £169.00 quick sale at £50.00. Tel: 081 347 6077.

NAIM AMPLIFICATION, NAC72 (including moving-coil and variable level boards), Hi-CAP, NAP140. New style, mint, boxed. Bargain £999. Tel: 081 309 7589 (Sidcup).

MERIDIAN 200/263 CD Audiolab 8000C MKII pre-amp, Mendian 205 amps, Nakamichi DR2 cassette, KEF 104/2 speakers and Kuba 200, Rotel tuner, Dual CS505/4 turntable, 3. Two tier Target stand, Mission Isoplats and various Van Den Hul leads. Must be sold as complete system. All boxed, receipts, as new £2,995. No time wasters. Tel: 0181-502 5634.

BEREAVEMENT SALE of radio and amplifier components. Mainly valves, coils, transformers, etc. Some unused 8" 10" speakers. Most of these items have never been used and are either boxed or well wrapped in original packing. Phone for details 061-439 7007.

KRELL KSA150 power amplifier £2,500. Quad 34/306 £400. Gyrodec RB300 K9 £495. Tannoy York 15" Monitor Golds £600. IMF TLS-50s £175. KEF 104 Reference £150. Revox A77III HS 2T complete overhaul £550. Tel: 0403 251587.

AUDIOLAB DAC (latest) £550. Ortofon Quasar MC cartridge, unused £200. Musical Fidelity pre-amp 8 + pair MA65 power amps. New, £900. Project 6 turntable + MC15 cartridge, new £325. 10% off all Marantz, Denon, etc. Tel: Telford 0952 502097.

NVA P50 Passive/phono module/A300 power, £415. Leak Troughline 3, £125. Audio Innovations 300, £250. Linn Troika, £225. Monitor Audio 352s, £135. Stnxx PU2 arm, £80. Chns Tel: 0223 69245.

VALVE CHARACTERISTIC METER, AVO MK IV. Good Condition £250. Tel: 0483 68654.

NAIM 02 TUNER £550. Linn Lingo 1994 spec. Ekos Klyde £2,000. All as new, boxed. Tel: 0279 412902.

SEQUENCE SPEAKERS Model 40 £225, Model 30 £175, Model 20 £110. All black, new, unused, studio power satellite and sub-woofer speakers, silver grey £50, rear surround speakers £20. Tel: 081 875 0831.

TRANSMISSION Line Speakers - Quest Audio Designs K100s. 32 x 26 x 75cm with Sonus Faber drive units. £325 ono includes stands, cable (5mm dia. x 182 strands x 8m long) and gold plated bullion connectors. Tel: 081-514 5720.

J.P.W. MINI Monitors Gold. What Hi-Fi 5 star award winner. Used as rear surround speakers. Unmarked. Boxed. 15 months guarantee left. Can demo stunning little speakers £50. Tel: 081 402 1486. Martyn.

QUAD 606 power amplifier £375, Quad 34 pre amplifier £195, Sansui AU-G90X integrated amplifier, 350W per channel £195, Denon DR-M30HX, 3-head cassette deck £90. Tel: 0252 615545.

IDEAL WITH Valve amplification - Audio Note K/SP loudspeakers (silver-wired) with Huygens K4 stands £625. Telephone: (081) 572 2504.

AUDION 300B Signature Monoblock amps (1500). Audion active Valve Preamp with Dual PSU (1200). All significantly upgraded. Audio Innovations Nova Transformer (600). Audio Note Silver SP spk cable 4 x 1.5mtrs (400). Tel: 0635 36599.

MISSION DAD5 CD Player £200; Celestion DL3 II Speakers with stands £75. All boxed as new. Tel: 0703 328573.

LINN EQUIPMENT: Kaber £699. Kaim Pro £649. Arkiv £599. Basik/KS £199. Tune box £250. K9 £40. Nakamichi 700 TRI Tracer offers. Tel: 0585 373735 (days), 0628 782040 (eves/weekends) Berks.

GARRARD 401/SME 3009 S2 in heavy plinth. Unmarked and in perfect working order, £250. Tel: 081 747 4764 after 7pm.

NAIM SBL loudspeakers, black, passive crossovers, £900. Sony Walkman Pro WM-D6C £160. Pioneer car CD player/Tuner, removable fascia, remote control, four months old £175. Tel: 0635 869107.

SPENDOR BCII, custom stands and cables £600 ono. Demo possible Tel: 0689 874438 evenings. Near London (SE).

TDL MONITOR speakers. Mint condition, black Ash finish, incredible performance and clarity. Move forces reluctant sale. Cost £2,000.00 new, a bargain at £1,350.00. Tel: 0727 866384 (St. Albans).

CROFT INTEGRATED valve amp 35WPC mint £350. Michell ISO MC pre-amp, 8 months old, £250. Tel: 0706 869428.

MUSICAL FIDELITY A370 II with circuit diagram £995. Naim 135s, NAC72, Hi-Cap £2,095, EMT 928 with EMT arm EMT HSD15 M.C. (unused) £1,495, Silver interconnect £75. Lowther Acoustas, offers Exchanges Tel: 0642 559543.

ROTEL RCD-965 BX CD. sorbothene feet, good quality leads, £190. Rega RB-300 arm, £90. May purchase together for £260, or swop for Pioneer 1750 Laserdisc. Items in excellent condition. John Tel: 0256 20608.

QUAD II power amps (2), 22 pre-amps (2) F.M. tuners, early mode's (2), A.M. tuner, £350.00. Tel: 0722 (Salisbury) 339497

SPECIAL LFD LS2/PA2 integrated amplifier, new, excellent, boxed, cables/interconnects. £895. (£1,695). New Nottingham Analogue Spacedeck/silver wired, Mentor arm, marble base £895 (£1,495). Immaculate Myst TMA (amplifier), TMR (tuner) original, boxed, Myst Interconnects, manuals, rare, excellent £325 both. Nakamichi tapedeck, boxed, manuals £295. Excellent. Tel: Paul (0482) 842740.

LP12, LINGO, Ittok, Dynavector £850. Michell ISO/Hera £350. Both for £1,100. Michell Argo/Hera £600. Pair Albary 100 watt monoblocks £600. All pristine condition. Tel: 0223 (Cambridge) 322215.

JOHN LINSLEY-HOOD Discrete phono stage, plus power supply. Excellent design and sound £200. Tel: 0724 870432.

SD ACCOUSTICS OBS speakers, mint £349.00 (860). Leak Troughline Stereo FM3, £150.00. Sony D.A.T. portable, new £245.00 (459). Dual 505-3, slightly marked otherwise OK, hence £50.00. Tel: 081 347 6077.

REGA PLANAR 2 £125. Dual 505-4 £125. Toshiba SS45-GB speakers £50. Quality analogue tuner £30. Wharfedale Laser 100 Cabinets £25, Arcam Black Box-1 £75. 0274 572924 (Bradford).

MERIDIAN 206B CD player, barely used. Boxed as new £650 o.n.o. Tel: Nick 0737 222968 - daytime, Tel: 0737 761163 - evening (Surrey).

NAIM NAIT 3 Integrated amplifier with MM phono stage, mint condition, boxed £400.00. Naim IBL speakers passive black with 2 x 5 mtrs NAC5 cable £350.00. No offers. Tel: 081 699 1011.

LINN KANS (Black Ash) plus Kan stands, immaculate £220.00 ONO. Audiotech spiked sub-table, Italian elegance £45.00. Sound Organisation two - shelf table £20.00. Will dem/ deliver Londonish. Tel: 081 460 1124.

EQUINOX PRE-AMP cost £1,800, sell £650. Sugden A21 amp £120. Sumo tuner cost £700, sell £375. Mendian M3 active speakers £275. Musical Fidelity Studio 'T' amp £475. Tel: (0977) 643629.

SONUS FABER ELECTA speakers. Retail £1,790 selling for £950. Target R2 speaker stands one month old. Retail £287 selling for £150. All items boxed. Tel: 081 299 0075.

definitive audio nottingham

Tel/Fax (0602) 813562

Import/Export

DEFINITIVE AUDIO IS CONVENIENTLY SITUATED TWENTY MINUTES FROM EAST MIDLANDS INTERNATIONAL AIRPORT 15 MINUTES FROM JUNCTION 24, M1, BIRMINGHAM - 1HR LONDON 2HRS

LIVING VOICE, HORNING, VITAVOX, LOWTHER, WADIA, MICROMEGA, BORDER PATROL, VOYD, SYSTEDEK, IMPULSE, AUDIO INNOVATIONS, DALI, SNE, XLD, EIT, TOWNSHEND, SOLDERING, PIONEER, REVOLT

LIVING VOICE, VITAVOX, HORNING AND BORDER PATROL HAVE ALL APPOINTED DEFINITIVE AUDIO AS EITHER THEIR UK OR WORLDWIDE DISTRIBUTION AGENT - INDICATIVE THAT DEFINITIVE AUDIO IS MORE THAN SIMPLY A HI-FI RETAIL OUTLET. INDEED IF YOU ARE SERIOUS ABOUT THE QUALITY OF YOUR MUSICAL EXPERIENCE, YOU OWE IT TO YOURSELF TO DISCOVER WHAT HAS MADE DEFINITIVE AUDIO SYNONYMOUS WITH THE ABSOLUTE HIGHEST STANDARD IN SOUND REPRODUCTION SYSTEMS FROM £1,100 - £50,000

FOR ADVICE/APPTS/ENQUIRIES +44 (0) 602 813562

SECOND HAND ITEMS

*denotes full warranty

	SALE PRICE	RRP		
SNELL A11 MAHOG*	2000	5000	SILVER SOUND WHISPER	
ACOUSTIC ENERGY AE2 A1			1.5 METRE SET	175
ROSEWOOD - PERFECT*	700	1100	SILVER SOUND I/C 1M	100 1140
TANNOY 603II INC STANDS	100		ART AUDIO QUINTET*	400
AUDIO NOTE 10. 10HRS.	700	1500	REGA II + ARM	120
ORTOFON QUARTZ	100		SYSTEMDEK 11X900 DAK*	100 200
ORTOFON QUAZAR	150		BORDER PATROL CHARGE HAND	
NVA PHONO STAGE (MC)	150		300B SINGLE*	2000 2700
AUDIO INNOVATIONS 51000 PRE			LIVING VOICE TONE SCOUT	
PERFECT CONDITION			CHERRY (EX DEM)*	3000 6000
WITH SPARE VALVES*	700	1350	HORNING AGATHON OAK	
AUDIO INNOVATIONS			(EX-REVIEW)*	2500 3400
S.200 PRE (HM)	200	350		
AUDIO INNOVATIONS ALTD*200	330		VITAVOX AND LOWTHER DRIVE UNITS	
VOYD 5 REFERENCE - DAK*	2000	3000	IN STOCK	
LINN AXIS AKITO K9	330		FOR PHONE DIRECT 0602 813562	

CARRIAGE EXTRA
PHONE OR FAX DIRECT (0602) 813562



Don't let your
LISTENING ROOM
spoil his performance.

With the help of

Room Acoustics Services

you can achieve near concert hall realism,
in harmony with your home decor.

Full details, reviews etc, of our computerised postal
Hi-Fi room acoustics consultancy available from:-

ROOM ACOUSTICS SERVICES

3, Queen Elizabeth Way, BARTON-upon-HUMBER,
South Humberside, DN18 6AJ. Tel: (0652) 635523

hi Best prices for new, xdem & s/h equipment fi

Audio Innovations 1st Audi	mint s/h	£850	Magneplanar 2.3	mint s/h	£995
Audio Research D115	mint s/h	£995	Quad ESL 63	mint s/h	£1595
Audio Research D70 mkII	mint s/h	£795	Celestion SL600 si	mint s/h	£595
Nestorovic A1 150w valve monobkls	mint s/h	£1995	Mission 753 black	mint s/h	£550
Radis Defy 7	mint s/h	£3400	Impulse H2's	mint s/h	£1650
Naim NAP 135 monoblocks	mint s/h	£1800	JPW Minims	as new	£60
Audion 300b Silver Knights	mint s/h	£1695	Infinity IRS Beta	mint s/h	£4995
Quicksilver monoblocks	mint s/h	£1495	Epos ES 14 + stds	as new	£450
Conrad Johnson MF200	mint s/h	£795	Linn Sara + Stds	v.g.c.	£200
Krell KMA 100 mkII monobkls	mint s/h	£1895	Snell JII's and stds	mint s/h	£895
Krell KSA 100 mkII	mint s/h	£1495	Totem & Foundation stds	mint s/h	£895
Musical Fidelity P150	mint s/h	£295	Proac EBS + stds	mint s/h	£995
Tesseract Tamp 60 monobkls x-dem	£3995		SD Acoustics SD5	mint s/h	£850
Mark Levinson ML2 monobk mint s/h	£3995		Apogee Centaurs	mint s/h	£1195
Tube Technology Genesis monobkls	mint s/h	£1495	Meridian 200/203 dac 5	mint s/h	£650
Cadence Pre/Power 2/MA x-dem	£1995		Meridian 200/203 dac 7	mint s/h	£695
Denon 2500/4400 pre/pwr	mint s/h	£895	Meridian 200/263 Delta/Sigma	mint s/h	£795
Beard P35/C35 pre/pwr	mint s/h	£1095	Wadia 7+9 tran/dac	mint s/h	£14995
Exposure XI, IX, IV pre/pwr	mint s/h	£1295	Wadia 8 transport	mint s/h	£1995
Musical Fidelity P150/P3A	mint s/h	£450	Wadia 3200 transport	mint s/h	£1295
Audio Research SP9 mkII	mint s/h	£995	Meridian 206B	mint s/h	£595
Audio Research SP11 mkII	mint s/h	£1795	DPA T1/PDM 1 mkII tran/dac	£1895	
Audio Research SP14 black mint s/h	£1595		Audio Note DAC 3 sig	mint s/h	£1995
Audio Research SP15 mkII black mint s/h	£3500		Wadia 64.4 dac	mint s/h	£2250
LFSD LSI line only	mint s/h	£495	Roksan DA1 dac	mint s/h	£250
Trilogy 902 line	mint s/h	£695	DPA PDM1 series 2 dac	mint s/h	£195
Audio Research LS2B	mint s/h	£2250	Naim CDI	mint s/h	£1200
Tesseract TAP-A/TAPS/TAHA pr ex-dem	£3995		AVI S2000 c.d. player	mint s/h	£895
Audio Research SP8 mkII	mint s/h	£795	Meridian 606 dac (mkII)	mint s/h	£850
Audio Innovations L2	mint s/h	£450	Micromega Trio CD2	mint s/h	£1995
Audio Synthesis Passion	mint s/h	£695	VPI HW19 mkIII & psu	mint s/h	£995
Pega Elilit	mint s/h	£495	Alphason symphony/HR100 mcs + Atlas	mint s/h	£1495
Albary PP	mint s/h	£295	The Voyd, Helius Orion, psu	mint s/h	£995
Linn Majik	mint s/h	£395	Townsend Rock REF/Exgalibur	mint s/h	£1995
Sonus Faber Extrema + stds	mint s/h	£3995	Burmester 838 phono	mint s/h	£450
Sonus Faber Minima Amators + Stds	mint s/h	£1200	Audio Innovations s1000	mint s/h	£295
Sonus Faber Electa Amators	mint s/h	£1800	Glassic Valve Head Amp	mint s/h	£350
ATC SCM 100 A	mint s/h	£3500	Koetsu 80th Anniversary	mint s/h	£1495
			Van-Den-Hul MCI	mint s/h	£495
			Audio Note Type II	mint s/h	£495

MINT S/H - Second hand as good an example as we've seen anywhere

AS NEW - Typically less than 4 months old in new condition

X-DEM - Typically 'as new' but may be older

G.C/V.G.C - In perfect working condition but may be marked

hi **CHOICE** fi
(081) 568 8808

Equipment bought or part exchanged
Full demonstration facility - by appointment
Major credit cards accepted
9.30am - 8.00pm 7days

Can't Find What Your Looking For?

THE HI-FI EXCHANGE

Whether buying or selling Audiophile equipment register your requirements with us now. All enquiries are entered on our sophisticated database where equipment matching takes place. A complete catalogue of equipment wanted and for sale, available weekly, is free * to anyone both here and abroad. The Hi-Fi Exchange is continually updated and is the most comprehensive source of second hand and s-xdem equipment anywhere.

* 1st issue free to advertisers, subscriptions available.

Trade enquiries welcomed.

Choice Too
(081) 568 8808
9.30am - 8.00pm

PRIVATE

KEF 105/3 Rosewood, mint, boxed, latest spec, £1,550.00 ONO. Stax SR 34s £70.00 ONO boxed. Naim 32.5 NAP 90 £350 ONO. LP12, Val, Ittok LV2, 1991 spec, £800 ono. Tel: 0792 280061.

NAIM 250/32/Snaps, old style. £850 o.n.o. Kenwood DPX 9010 CD. transport/Arcam Black Box 5. £500 o.n.o. Will separate. Pye Mozart pre/power amps £250. All equipment in very good condition. Tel: 091 4877796 (Tyneside).

QUAD E.L.S. Full Quad service, 1993, £350, ono or swap for Quad FM4 or Quad 405 II.. Tel: 0904 626915, after 6.30pm.

NAKAMICHI OMS4E CD player "A major bench mark in CD sound" used every day, good condition, for sale £300. Tel: (0362) 858515.

QUAD II amplifiers, tuner and pre-amp £300. Rogers Cadet 3 amplifier £80. Troughline 3 in case with stereo 30 amp £150. Sugden T21 tuner £50 Linn Klyde, hardly used £200. Tel: 031 229 5020.

RUARK CRUSADER II speakers – £1,250 ONO. Meridian 208 CD player + remote control – £1,000. Michell Argo HR pre-amp £900 ono. Bang & Olufsen Beocord 8000 tape recorder £300 ono. Michell Alecto monoblocks £1,500 ono. Tel: 0602 672541 X5703 (day) 821785 (eves).

MISSION DAD5 CD Player £149. Meridian 203 DAC £195. Rothwell passive pre-amp £75. Tel: Roger 0270 625159.

LEAK TL12 + PAIR Audio Classic rebuild £250. Stereo 20 Holco resistors Poly caps £250. Troughline Stereo, mint £125. Wanted TL12 0.1 Gold enclosed transformers. Tel: 0524 423516.

MAGNEPAN SMGa Planar speakers, £350. Arcam Alpha CD player. £200. Arcam Alpha 2 tuner, £80. Thorens TD280 MK II turntable, £125. All boxed, good/excellent condition. Tel: 081 888 2537 eve 071 405 4377 x 2226 day.

GARRAD 401, SME Plinth, SME 3009 Arm £125. Elektor M/C head amp £75. Beard CA 506 valve pre-amp, boxed as new £475. Kit built reflex ported speakers, cost £225, accept £125. Tel: 0742 459698.

AMC 3030 amplifier valve/transistor hybrid, 18 months old, excellent condition. Sale due to up-grade. £280. Tel: Cambridge 0223 290619. (Day/Evening – answerphone).

WANTED. LEAK Stereo 70 amplifier in good condition. Please contact Mr. Snow Tel: 0273 583675.

SYSTEMDEK IIX 900. Roksan Tabriz, AT 110. Excellent condition. Boxed with receipts. Can demo. Sondek reason for sale. Bargain £300. Wanted Linn Ittok or Ekos, also Lingo. Castleford Tel: 0977 519454.

"AUDIOPHILE" COMPONENTS at realistic prices. Vast range of highest quality electronic components and accessories for the D.I.Y. builder. Tel: 0724 870432.

60 VALVE AMPLIFIER circuit diagrams for KT88, KT66, EL34, EL84, 6L6, 2A3, 300B, 211, 845 etc. and data sheets for 30 Audio Valves English Text 90 pages. Send £20 Cash or Bankers Cheque. Matjaz Seliskar, Riharjeva 3, Ljubljana 61000 Slovenia.

FOR SALE: Accuphase T100 FM/AM stereo tuner. One of the best analogue tuners. Sell/Exchange. Best offer secures. Further details. Tel: 0736 60367.

SONY CARBON FIBRE Monitors (94dB/IW) £195. Linn Ittok £195. Linn Kans and stands £230. Michell reference turntable £90. NVA AP30MC £95. Pioneer 4 head, DD, AR, open reel £195 ATOC9 unused £190. Tel: 06974 78537 or 0273 846290.

GARRARD 401, SME 3009 IMP, Shure V153, SME 2000 Teak Plinth, All excellent. £120. Garrard 401, Decca FFSS Arm, MK2 Head, good condition with spare new turntable control knobs. £75. Thorens TD124 MK1 Chassis Model with arm board (SME). Excellent, with new spare idlers and belts £50. Decca London cartndge £10. Decca MK3 head £10, both boxed. SME 3009R stainless steel arm, new, boxed, unused £60. 2 used PX4 valves £50. Tel: 0273 583675.

AUDIOLAB 8000All, mint, boxed £295 ono, RB300 tonearm, Ex condition £95 ono. S/Cables: Cyrus S/Core, 4 x 3M £15.00, Linn K20, 4 x 5m, £65.00. I/Connect: Silver Sounds 1/2 2 x 1m. £65.00, Chord mono's 2 x 1m £25.00. David Tel: 081 741 3119 (days), 081 348 0612 (eves).

FOR SALE. Studer Revox B77 MkII. Twin speed 7.5 / 15IPS. Immaculate condition. Very little use. Now almost £2,000 new. Will accept £600 ono. Tel: Paul (0831) 686927 or (0707) 322662 anytime.

GARRARD 301 £125, Leak Stereo 70 £50, Leak Stereofonic £30, Leak Vanislope 3, Mono Preamp £30, Ferroglyph Series 4 two track £50, Brenell Mono two track £25, Armstrong 626 £20, Metal Reels (8.25") for Ferroglyph £5 each (24). Tel: 0794 322782 (Hants).

ELITE ROCK MK II, Excalibur Arm, Goldring 1022 Avondale Taps Power Supply Seismic Sink £800. Linn Basik plus arm £40. Offers. Tel: 0902 762395. Evenings.

TECHNICS SV-DA10 DAT deck £275. Pioneer CLD 1750 PAL/NTSC laser disc with 13 movies £450. Sony TAE1000ES Digital pro-logic pre-amp £475. Sony TAN220 Four channel bridgeable power-amp £99.00. B/W Rock solids £125. Meridian M30s with stands £495. All mint condition with manuals, most boxed. Tel: 01661 822564.

JPW AP3s + Stands £135. Celestion 1s + stands, absolutely as new, packaging guarantee, £89 (£159). Naim IBLs (latest drivers) £459. Alpha CD £210. A1 amplifier £115. All excellent. carnage included. Tel: 091 4144221.

NEAT PETITE Loudspeakers, boxed as new £350, Quad 33/303 pre/power £150, Quad Racks for 66 series (£30) and 34/FM4/306 (£25), Empire MC1000 Cartridge recent re-tip £175. Tel: 0603 714528.

WANTED NAIM 82 Hi Cap and 250 power amp. Must be new shape + excellent condition. Cash waiting. Tel: 0333 424642 after 6pm.

FOR SALE. NAIM Nait 2 integrated amplifier. Lots of power from a little box! £200 ono. moving up to Hi-Fi World 300B. Nait sale buys values! Ring Guy Tel: 0923 262895 – Answerphone.

SD ACOUSTICS SD 5 floor standing speakers, new, unused, full manufacturers guarantee, Hi-Fi recommended, highly reviewed, £750 (new £1,250). Nakamichi 580 cassette deck, vgc, superb sound £300. Tel: 0494 721274, Bucks.

NAIM NAP 110 (£100), NAC 42.5K (£130) and Hi-Cap (£280) – No longer required due to recent up-grade. (All boxed). Also Yamaha K300 Cassette (£50). Tel: 0349 877243.

MUSICAL FIDELITY MVT pre-amp & P270 power amp. Excellent condition – can demo £1,250 ono. Tel: 031 661 6040 (anytime).

ORACLE ALEXANDRIA turntable, Oracle silver wired tone arm, Grado signature 8 cartridge, massive power supply by Mod Squad probably the best sound for £400 ono. Tel: 0908 502795 (Milton Keynes).

EARLY 60s LEAK STEREO Equipment. Lenco Goldring GL68 turntable, FM Troughline III, Leak Stereo 30 amp. Wharfedale Airdale speakers (4 corner units). Sensible offers. Tel: 0885 400312 after 6pm.

ROKSAN XERXES/Artemiz/Chorus Black. Latest spec power supply, matt black finish, ex demo condition, boxed £775. Tel: 0989 764396 Evenings.

SILVER SOUNDS 16/4 1 metre stereo pair bi-wired speaker cables fully terminated. Cost £400, accept £175. Hi-Fi Choice recommended. Tel: 0623 798210.

MUSICAL FIDELITY P270 MkII 150wpc power amplifier £745 Musical Fidelity Pre3a pre-amplifier £155 Alphason Sonata turntable HR100MCS arm Ortofon Quasar £675. Pair KEF C95 floorstanders Walnut £295 all boxed v.g.c. Paravicini "The Head" TX4 MC transformer £195. Tel: 0843 862603 (Kent).

KENWOOD DP5030 CD player £110, KRA5020 receiver £100, KXW6030 tape deck £50, HECO 220S speakers £110, Target AER5 equipment support £90, QED Cables £15. Or all for £450. Excellent condition. 2 years old. Mostly boxed. Tel: 0734 662620.

LINN LP12, VALHALLA, Ittok, new K5, spares, dealer serviced £595. Naim Nap 140 power amp £280. Epos ES 14 + dedicated stands £430. Receipts available for all items. Tel: 0423 863770.

PINK TRIANGLE LPT GTI, Manticore Musician tonearm, Goldring 1042. Cos new £1,000.00, asking price £400.00 o.n.o. Sale due to up-grade. Tel: Edenbridge 0732 866817.

SPEAKER CABLE, 2 x 4 metre lengths of silver sounds cost £280 (£35 per metre). Sell for £128 (£16 per metre). Tel: 0884 32465 (Devon).

CROFT SERIES 4 valve amplifier (KT88s) £375. Four Bando 50mm Speakers (instanter Pentachords!) £100. Pioneer tuner £50. Wilmslow Microbass sub-woofer £70. Stacked Quad Els frames, offers? Wrightman Tel: 0782 658114 evenings (Stoke)

SPENDOR SPI/2 + M.A.F. stands two months old £900. Leak Stereo 20 fully re-built £320. Trilogy 948 tube stereo amp 50 W.P.C. £550. Tel: 081 531 5979 any time.

GARRARD 401 – £150 SME 3009/2. Damper, spare head £50 Technics EPA500 Arm (unused) £75 Wharfedale RS12/DD £35. All mint and boxed. Lowther PM6C (four) need reconing £100 lot. Tel: 0423 868144 (Harrigate).

DUNLOP SYSTEMDEK/Helius arm/Ortofon MC20 vgc £200. Tresham DRI pre-amp + PS1 power supply £50. Tel: 0909 (Worksop) 475890 (evenings).

MUSICAL FIDELITY B1 £100. Denon DCD 1420 £100 QED T260 £100. Gale AS220s + stands £100 Sony ICF5W1 £80. Sony D99 £80. Audio Technica ATH911 £40. (0705) 753054 (Portsmouth).

ROGERS CADET III integrated valve amp £85. Rotel 965 BX CD player £180. Denon TU 260L tuner (rare gold version!) mint £85. Audio Alchemy DDE V.1. DAC (mint) £235. Power Station Two Up-grade for DDE (mint) £140. Furukawa PCOCC Interconnect £25. Tel: 0462 678158 (N.Herts).

DENON HEAVYWEIGHT CD player (14Kg) £245 Marantz CD63. Sony CDP.101 R/C £150 (£549) TD160B/Grace/P77 £150, Magnum MF250 Power-amp £275. Yamaha EX630 £150. Isobanks £795 PIX? Tel: 0206 861457 (6-7pm jim).

REGA RB300 Pick-up arm, brand new and unused, £105. Tel: 0403 254117.

AUDIONOTE VALVE system. Unwanted prize worth £6,000. Will sell unused £3,750. Comprises DAC 3 signature feeding PISE valve amp. Speakers & stands high quality cables & interconnects. Willing to split. Tel: 0303 840 303 anytime.

TDL STUDIO 1 Speakers with TDL stands, black ash veneer, perfect condition, boxed, £375. Tel: 0734 869789 (Berkshire).

TASCAM 32 2 TRACK recorder/reproducer, boxed as new (RRP £1,549) will accept £750 and include 10 Ampex tapes. Tel: 0480 464132.

VTL DELUXE valve pre amplifier cost £1,300 sell £650. Audio Research SP9 £950. Electro '25' Class A power amplifier with matching pre £350. Mission 737R £120. Wanted Nakamichi. Mick Tel: 0926 831388.

TO NEARM Alphason Xenon (Titanium) Linn fitting. (cartridge available). £95. Speaker/Crossover design package for your computer – many complete designs and data files. £30. Tel: Hinckley (0455) 619007 (evenings) 637765 (day).

EAR MOVING Coil step-up. the head. Brand new and unused, big saving. £365 (£590). Tel: 081 659 9538.

PRIVATE

ORTOFON/SME 30H cartndge in CAI type arm VGC £25. Two Fane 3" tweeters, two Fane 8" units, one Fane 12" unit in 4.5 cubic foot enclosure. Smaller units in their own enclosures £50. Radford amplifier type SCA 30 good condition, Teak case. £40. Tel: 0903 247779

MISSION 752 speakers, Rosewood, 1 month old, mint, boxes, £325 ono, London. Tel: 071 387 7189.

CABLES & BITS. Audioplan Super AF 1m. £60. 1/2m. £40. Type 4 1/2m. £25. XLO Pro.100 1m. £45. Siltech MC4.24 1m. £125. VdH. The First 0.6m. £65. All pairs. Siltech HF6 Digital 1/2m. £40. Audioquest Optlink X 1m. £20. Kimber 8TC Mains 1/2m. £15. DPA Power Slink 1m. £20. Fitted MK/IEC. Lynwood Mains Cleaners. Basic £25. Advanced £80. Meridian 209 Remote £30. Tel: 081 871 2345.

OLD VALVES FOR SALE: Osram PX 4; Marconi MHL 4; National 6D6; National 75; Cossor 10VG; Marconi U14; Raytheon 6A7; National 185/R8; Mazda AC/HL; Mullard 76; Osram VMP4G; National 12Z3; Bnmar 6D6; Mullard PCL86. Offers or swaps. Tel: 0956 362699.

MERIDIAN 203 DAC. £250. Kenwood DP X 9010 transport £250. Both £450 ono. Or exchange for SME IV arm. Tel: Marc 0392 498913 Exeter.

MONOBLOC ULTRALINEAR valve amplifiers, custom-built to high standard, 30 watt £325, 100 watt £525, or can supply complete build plans, parts lists, PCBs etc. Tel: 081 427 1378.

PAIR EARLY Quad ESLs, fitted black grilles, new treble units and clamp boards last year. £245. Tel: 081 742 1170 daytime or 081 940 7289 evenings till 9pm.

GARRARD 301 Senal No 26827 (grease bearing). White slight dust bug mark, but with new sealed Dust bug (collectors item) included. £120. Tel: 081 742 1140 daytime or 081 940 7289 evenings till 9pm.

LEAK STEREO Troughline tuner (black and silver) with matching Stereo 70 integrated amplifier. Both working perfectly. £220. Tel: 081 742 1140 daytime or 081 940 7289 evenings till 9pm.

AUDIO INNOVATIONS SERIES 500 amp, as new. £595 (999); Technics MC head amp, battery operated, superb sound £150; F+S MC transformer £20 (42) Tel: 0642 542395 (day) 0424 274638 (eve)

DENON POA4400 monoblock power amps 160 wpc. One of the best sounding transistor amps, still under guarantee. £495 ono. Meridian 204 DAC7, superb first upgrade £265 ono. Both boxed and in superb condition. Tel: 0254 81288 (eve) 061 773 9121 (x2945, day).

AUDIOLAB 8000A 7 months old, as new £350. Call Huw. Tel: 071 425 8557 (work hours)

LINN KAN MKII black superb, bi-wired with Atacama SE24 stands, superb condition £275 ono Linn Troika cartndge, good condition £150 ovno and Linn/ITTOK LV2 arm good condition £150 ovno or £280 for the pair. Tel: 071 606 0888 (day), 081 665 6183 (eve).

TECHNICS DIGITAL REFERENCE series SLZ1000 CD transport & SHX 1000 DSP brand new, was. £4,995, now only £1995. Also new Technics USV920 integrated amp at only £400. Tel: 081 742 1140 (day), 081 940 7289 (eve).

GARRARD 401, SME Senes II, SME series 2000 plinth, £180. Revolver, Linn LXV, Boron 11, £180. Revox A50 amp no sleeve, £80. 1961 EMI portable reel-to-reel (ex BBC?) absolutely mint. £350. Tel: 0604 37872 (N'ton).

PYE MOZART single-ended amp with matching pre-amplifier and tuner (fully restored). £225. Lowther twin Acoustas (4 PM6 drive units) £250. AVO valve tester, tatty but, working £45. Tel: 01903 715191.

SYSTEM FOR SALE Meridian 206 CD, Leak Troughline plus stereo decoder, Audio Research SP9 MkII, Krell KSA 50A MkII, Acoustic Energy AE1 +stands (piano black) including all cables etc. £3250 ono, may split. Call Enc. Tel: 051 722 291

AUDIO RESEARCH SP14 pre-amplifier black two years old, mint condition, £1595 (new £3000). Art Audio Tempo monoblocks £995 (new £2,150), Straightwire interconnect £50 (new £120). Phone Chns. Tel: 071 617 2109. (Mon-Fri 9.30-5.30).

PENTACHORD PENTACOLUMNS (active stereo crossover), £750 ono; Orelle CD10T Transport and DA 180 DAC £850 ono; XLO RS dedicated digital cable £50. Oxon/Berks border. Tel: 0235 850 393 (eves and w/e)

LEEK STEREO 60 Chromed, Groove tubes £650; mint Garrard 301, African Mahogany plinth, SME arm, Shure V15, £395; Harman Kardon Pro turntable, pivoted tangential arm, mint £120; Linn Theta tuner, analogue output stage, £175; Nakamichi LX5 3 head cassette deck, Nakamichi serviced, £295. Coventry. Tel: 0203 679165.

LINN KARIK/NUMERIK CD transport & DAC. £2575, new will accept £1600, still under warranty, mint condition, can demonstrate/deliver within reasonable distance. Call David. Tel: 0256 28117 or 0831 104253.

CHORD COMPANY INTERCONNECTS I have a number of Chord interconnects surplus to requirement, mainly one meter phono to phono leads, at £10 each. For full details: Tel: 0992 632777 (home) 071 382 4175.

TDL STUDIO 2 transmission line loudspeakers, walnut excellent condition and fine full-range sound. Too large for current location, £245, ono. QED headphone/speaker switch £5. Sage Digtaps £10. Tel: 0962 851802.

LINN LP12 (VALHALLA), Ittok, Karma. New arboard, 45 adaptor, Sound Organisation table, £430. Ortofon MC20 Super little use £25. Tandberg TCD 310 cassette deck, £15. 0728 747735.

HARBETH BBC LSS/12A speakers, black ash finish, £550. Call Plymouth. Tel: 0752 405052.

MOD SQUAD, passive line drive, 5 inputs +2 tapes, mint condition with instructions, £275 ovno. Wirral. Tel: 051 327 2436.

GRADIENT SUB-WOOFER for original Quad ESL (including £100 worth of interconnects), £600; Quad 44/405 £300; Decca London Super Gold, 5 hours use, £150. Wanted Leak 2060 or 2075 'speakers, Sinclair Neotenc 60 amp. Tel: 081 393 4265 (day), 081 393 4147 (eve).

ARISTON CD 3 CD player, transport modified by Trchord Research, £180. Ring after 6.00pm for details. Tel: 0634 221100.

ROKSAN/XP52 ARTEMIS Shiraz in black. Superb turntable. Lovingly cared for, but cartndge past its best. Will PX against TMS if unwanted by discerning music enthusiast, circa £925. Mike, Thanet. Tel: 0843 597822.

AUDIONOTE ONGAKU, Kegan, M7 phono, M7 pre-amp, Voyd reference, Snell E, will split. Ask for Steve. Tel: 0992 620905.

REVOX A77 REEL-TO-REEL (3.75/7.5 ips) two-track. Cased model with power amp and 'speakers, good condition, recent new head, £595 ono. Tel: 081 743 1140 (day). 081 940 7289 (eve)

PT TOO BLACK £250; Helius Orion 11, £150 (recently serviced); NVA AP30 (mc), £120. Unwanted prize Bando units 2X8" bass, 2X50mm modules + crossovers £175. Tel: 0603 665003.

NAIM ACTIVE SYSTEM Naim CDS, Naim SBL 'speakers, Naim NAC A5 cable, 2X250 amps, 2X Hi-Caps, Naim 72 pre-amp, Naxo 2-4 crossover, all in excellent condition, may split £6,250. Tel: 0628 38153.

ARCAM ALPHA 6 amplifier. As new £249. Philips AZ6815 portable/car CD player £70. Horsham, after 6.00pm and weekends. Tel: 0403 250570.

LINN NAIM EQUIPMENT black: LP12; Armageddon ARO Troika £1800; CDS £1900, NAC82 £1500; Old Style: NAT02 £600; Hi-Cap £250; NAP250 £650; black SPLs £950. All mint all boxed. tpods 3X25 X15, 2X1m £150. Shrewsbury. Tel 0743 709411.

VOYD TRIPLE MOTOR turntable, twin-belt, split phase, light ash; Helius Orion II; Audio Note silver wired; Miltek Aurora, totally mint, superb sound, £1150 ono, may p/ex CD. Tel: 0602 286710.

SONY CDPX77ES CD player as new boxed, £395; Celestion SL65i, black as new boxed, £250; Spondor BC1 full working order, £160, NAD 3020i as new boxed, £95. Lancs. Tel: 0257 263403.

QUAD II VALVE AMPLIFIERS control unit, FM tuner, £300; AM2 Tuner, £60; FM2 stereo tuner, £75; Leak TL12 + monoblocks, £225; TL10 monoblocks, £175; Stereo 20 and pre-amp £175; Radford STA15. All vgc. Tel: 0245 266027.

QUAD EQUIPMENT ESL-63 'speakers, £1250; 606 power amp, £350; 44 pre-amp, £175, complete set £1600. Very little used and in excellent condition. Tel: 071 725 8324 or 0474 703347.

PINK TRIANGLE, Mission 77+ AT37e, £295; SME plinth (401), 3009ND, Elite 700, £95; Crimson 1704 power amplifier, £135; Connoisseur BD2/SAU2, £35; IAS plinth (301), £20; Acos lustre, £25; ETI pre-amp mm/mc, £95; H/K T403 tuner, £65; Armstrong valve receiver £75. Tel: 0503 250679

GARRARD 301 on board with unusual pivot arm; Ortofon headshell and cartndge, £175; Arcam Alpha 3 amp, £115. Wanted: Shure V15v; Quad 67 CD. N. Herts. Tel 0462 678158.

B&W 803 LOUDSPEAKERS, brand new, but must see, hence only £1650, also Alphonson Sonata turntable with HR10 0 arm, mint condition, £500. Tel: 081 742 1140 (work), 081 940 7289 (eve).

MERIDIAN 208 CD player and pre-amp, plus 209 remote control, boxed, excellent condition will demonstrate, £550. Herts. Tel: 0923 282129.

CHORD SPM1000B power amp, factory-fitted grab handles, £1800; AV1 S2000mp pre-amp, £650, both six months old, stunning sound, mint, boxed, forced sale. Tel: 0222 499561.

SPENDOR SPI/2 + MAF stands 3 months old, £900; Leak Stereo 20 £320; Trilog 948 power amp 50wpc, £650. Tel: 081 531 5979.

AUDIO SYNTHESIS passion passive pre-amp (Vishay/Vernon), £300; London (Decca) Jubilee phono cartndge, £400 ono. Tel: 0403 733 055 (answerphone).

KEITH MONKS record cleaning machine, mint £350; serviced Bastin modified Garrard 301 with Rega RB300 arm, slate plinth, £300, mint. Leicester. Tel: 0533 553176.

EPOS ES14 with stands, black five years-old, immaculate; £285; Target 5-shelf rack, black, spiked feet and top shelf, £55; 5 mins M4/M5 junction. Tel: 0454 614883 (eve).

SNELL TYPE //II, black ash, good condition with 17" Target HJ stands (lead-filled and spiked), £325 for both. Call Geoff, (Surbiton). Tel: 081 390 9618 (eve).

PRIVATE

ALLISON 6 'speakers, £80; Apollo 24 inch 'speaker stands, £60; Audax tweeters TWQ25M1 2 off, £18. Tel: 0827 261082.

AUDIO ALCHEMY DDE v1.0 & separate power one PSU, three year warranty, £269 (479 new); Musical Fidelity A100, mint accept £239 ono; Linn Axis cartndge, suspended chassis, Sondek-like performance, mint £249 (599). Tel: 081 245 0970.

VOYD VALDI + Voyd arm + Goldnng 1040, mahogany as new cost £1200, sell for £399; Helius Anus tonearm, £99; Audio Technica OC7, £75; Audio Innovations Senes 500, £499. Tel: 0302 371464.

LINN SONDEK LP12 (Valhalla), lttok arm, Linn K9 cartndge vgc £435; also Tno KR-2090L receiver, £25; Audiomaster MLs2 'speakers, £45. St. Albans. Tel: 0727853600 (eve).

QED DIGIT CONVERTED for two power supplies, plus two Positron power supplies. Telephone weekends only. Tel: 08068 339

MUSICAL FIDELITY A100, £150; Pioneer A400 £150; Kenwood KT2010 digital tuner, £60. Wanted: 1 Quad I power amp, 1 Quad 303 power-amp. Call Steve. Tel: 0902 870101.

MUSICAL FIDELITY P270 Mk2 with P3B pre-amp; Earthquake + pre-amp with 5 inputs including moving coil/magnet. excellent condition no scratches, £900. Tel: 091 4174603 (eve).

DUE TO UPGRADING OF HFV transmission line 'speaker kit drve units. Pair of Mordaunt-Short MSB200 8" drve units with 1" metal dome tweeters and 2.2µf polypropylene coupling capacitors, £65. Tel: 081 697 6371.

AUDIO INNOVATIONS Second audio amps, £1200; Goodsell Williamson amps, £450; Mendian 263 DAC, £325; Naim 12 pre-amp, plus battery supply, £100; Tresham 75w power amp, £250. Tel: 0392 57202.

AUDIO ALCHEMY DDE V1 Dac with audioquest video Z interconnect, as new both boxed, £260. Milton Keynes. Tel: 0908 211691.

PROAC RESPONSE THREE loudspeakers (beautiful yew finish), £2000 only; one 8-foot pair of XLO type 5 Reference 'speaker cables (£980 retail) only £450 for the very best; Audio Synthesis Passion passive pre-amp (Vishay version), £300; London (Decca) Jubilee cartndge (little used), £400 ono. All must go. Tel: 0403 733055 (answerphone).

LINN LP12, £200, Zeta arm £200; Audio Technica OC7, £150; Gale GS401A 'speakers incl stands, £220; JVC KD-65 cassette deck £60; Technics ST7300 tuner, £60. call Steve. Tel: 0268 883178 (day), 0268 758395 (eve).

EPOS ES11 + foundation designer stands, detailed and revealing combined with punchy bass, will complement most systems, two years old, boxed, excellent condition, £450, won't split. Worcs. Tel: 0905 778174.

STEREO LEAK TROUGHLINE, £125; mono Troughline, modern external decoder, £145; six inch bass/midrange driver Mission £10 wanted for collection, any worn broken cartndge: all ono. Tel: 0209 219483.

AUDIOLAB 8000A amplifier. six months old, mint condition, £325 or part exchange for LFD amplifier Spendor BCI monitors, £100. Northampton, evenings/weekend. Tel: 0604 495181.

AUDIOLAB 8000A MK2 one week old, two-year guarantee, receipt, boxed, £375 ono. Tel: 081 346 8166 (day).

LINN SYSTEM LP12 (rosewood), Lingo, Ekos, K18s, Kaim, LK280, Kabers (walnut), cable, stands, table, remote, complete £3000. Also Kan: 1 (rosewood) available Call Steve. Tel: 0539 721304 (day), 0539 730625 (eve).

LINN LP12, plus lttok, £395; Sony PCM-F1 plus video, £450; PX quality headphones or CD transport or sell Wadia DAC, buyer collects. Tel: 0386 446756

GARRARD 401 3009 II, new plinth, mint £249; TD124/II RB300 solid teal plinth, superb, £275; Troughline II mono, prstine, £130; Arcam twos improved, £150, plus other items. Cal Paul. Tel: 0895 446713.

VOYD VALDI RB250 + Golding 1040, mint, £560 ono; Audio Innovations series 500 tnode coupled, just re-valved with Sovteks, 2 years-old, mint, £520, £1000 for the pair, Tel: 0323 841472.

AUDIO INNOVATIONS series 1000 (passive) silver-wired pre-amp, £165 ono; Leak Troughline mono valve tuner, re-aligned with v d Hul signal leads & phonos, £95 ono. Tel: 0423 712126 (after 7pm and weekends).

J F LE Tallec t/table-7 stone beast; Aragon 2004 100wpc (by Krell designer); Quad 520f Prof (19" rack) power amp; Linn Kans B&O 6000 Rec'r, all vgc; Wavter ARC pre/power, Hybrid spk. Tel: 0533 511815.

NAIM CDI very little use, boxed complete with remote control leads etc. As new, £1000. Tel: 081 248 2938.

CAMBRIDGE CD2 boxed with remote control, £225; Linn Basik plus arm, K9 cartndge and Linn armboard, £45; Target 3-shelf equipment stand, £30; Target wall shelf, £15. Tel: 0943 818752.

ARCAM DELTA 2 'speakers, £200' Mission DAD5 CD player, £150; Celestion DL3 II 'speakers with stands, £75; Marantz CD41 CD payer, £100. Call Chns, (Southampton). 0703 328573.

REVOX B77, 7.5/15 ips, excellent condition, £650; Tannoy Reds 12"d/cs in Lockwood cabs, £499, pair ono; Scully 8-track 1 inch tape recorder, ex Decca, £450 + 20 tapes; Quad 405, offers, (Northants). Tel: 0933 58304 after 6pm.

DPA LITTLE BIT DAC, cost effective upgrade for CD players with co-ax or optical digital input. Highly reviewed superb sound can demo, £190 boxed. Call Alan (Worcs) evenings. Tel: 0386 793319.

UKD CALLAS 'speakers mint condition, boxed, cost £700, sell £490; Arcam 70.3 CD player, cost £650, sell for £390; Arcam amp A60, £130. Call Dave. Tel: 0978 860 332.

300B/211/845 output transformer, outstanding tape wound core design (made in Germany), pott 16X21X12cm, "holographic sound" Contact: R Thores, Reiman Str. 20, D - 52070 Aachen, Germany.

KEF R102 'speakers with Kube, £180; Castle Clyde 'speakers, £80; Castle Tower equipment rack, £55; Rotel tape deck, £95, all excellent condition. Camberley after 6.00pm. Tel: 0252 870861.

FOR SALE: EXPOSURE dual regulated VII pre-amp, boxed, mint condition, £150 no offers. Tel: 0242 522169.

KEF 105/3 rosewood as new £1395 ono, may p/x; Denon DCD 3300 flagship CD, £1200 only, £495. Tel: 0225 480990.

ROKSAN ROK DPI transport, excellent condition, boxed £680; Naim pre-amp (new) £420 Hi-Cap power supply (old), £320. Tel: 0524 381389.

MICHELL SYNCRO turntable, Rega RB300 arm, Audio Technica AT-OC5 cartndge, 18 months old very little use, excellent condition boxed, full instructions + extras, £350 (Milton Keynes) Tel: 0908 696869.

CELESTION SL700, bi-wired, dedicated stands, £500 ono; Mendian component amp mc, tape, fm, CD, Aux, £150; part-worn OC9 £75. Tel: 0273 598952.

AUDIO RESEARCH CLASSIC 60 power-amp, £1100, less than one third of new price, Avon area. Tel: 0454 418997.

STEREO DECODERS module only £12.50 or complete boxed self-powered unit ready to use, £48.50. Works well with Troughline, Quad, Chapman, Anatic etc. all new & tested. Tel: 0736 798393.

NAIM CDI CD PLAYER mint condition, boxed, leads £970; Foundation Classic 'speaker stands, £50; equipment rack Apollo 4-tier, £40, Celestion One 'speakers, £40. Tel: 0742 846088.

ROGERS LS3/5A + pro Audio Active sub-woofer, £550; Audio type K 'speakers, £210; Equinox pre-amp, cost £1800, sell £600; Pro-ac studio 3s, £600. Tel: 0977 643629.

LINN LP12, ROSEWOOD, lttok P77 33rpm adaptor in maker's box with manuals. One careful owner from new, plus wall shelf, £950' Naim 42.5, £150 both ovno (Leicester). Tel 0533 892420.

SME 3009 Improved tone arm with Shure M97ED cartndge and stylus. 0892 532226.

ARCAM ALPHA 5 33 months warranty, £350; Sonic/ Violet 1M, £45, 2XDNM TCC75, £25 P/P, 2X3 Chord Flatline twin, £80. Call Philip after 6.00pm. 071 4034656.

LINN HI-FI FOR SALE, Majik-1 pre-integrated amp with mc phono input, £465; LK100 power amp £425, both 6 months, old, perfect (Stafford). 0785 715650.

LINN SARA 9 'speakers, rosewood excellent condition with stands, £375 ono. Tel: 0623 759264 after 6.00pm.

SUGDEN CS1/P51/R21 amps + tuner, £150; KEF drve units T27/B110/B139. £75. all as new, never been used, still boxed. Tel: 0484 854147.

GARRARD 401 turntable, Ortofon VMS30 MkII cartridge, Decca International arm, £150 or will split. All new unused in original boxes. Call Richard (Herts). Tel: 0763 244744.

LEAK STEREO 20 complete. 320; Akai GX77 reel/reel, £220; pair Wharfedale Airdales, £275; pair of Goodmans Axiom 400s, £60. Offers or part exchange any for top quality. 10.5 reel/reel, twin cassette and semi automatic turntable. Tel: 0392 860182.

PAIR OF LINN Isobank 'speakers with stands walnut finish, £940; pair of Naim 135 amps plus 32 Hi-Cap pre-amp £1790, al excellent condition (Bucks). Tel: 0494 837358.

MERIDIAN 605 monoblocks £1295; Quad ESL 63s on Arcici stands, £1400; Meridian 208 (DAC7), £875 all boxed. Absolutely mint superb system will split. retired owner. Tel: 0202 470789.

WANTED; PIONEER PL-7 turntable and F-9 tuner or similar. Sell Linear tracking PL-800 with Mayware cartndge, £100; Philips CD104, £50, both excellent. Tel: 0789 772137.

MERIDIAN 101B/ ALBARR' M408 monoblocks, £525 with free exposure interconnect, will split; Cambridge Audio CD3, £350; Sugden A48II, 3150; Wharfedale Active Diamonds, £75; Subwoofer, £40, part exchanges/swaps considered. Tel: 0621 772884

COMPACT DISCS

The Classical CD Specialist

H & R CLOAKE LTD

(Established 1946)

OVER 10,000 CD's IN STOCK
3,000 Cassettes
3,000 LP's (POP)
and Laserdiscs to order (list available)

SPECIAL OFFERS
each month

ALSO MAIL ORDER SERVICE AVAILABLE
CD'S SENT POST FREE (UK)
CASSETTES/LP'S AT COST

Access/Visa Accepted

29 High Street, Croydon CR0 1QB
081 - 681 - 3965 - Classical
081 - 686 - 1336 - Pop/Jazz

COMPACT DISCS

C
L
A
S
S
I
C
A
L

P
O
P
U
L
A
R

ATC, AVI CHORD, HARBETH, LFD, MICHELL,
ORIGIN LIVE, KINSHAW, QED, ROYD, SANSUI,
SEQUENCE, SONIC LINK, PROJECT, THORENS

EX-DEMONSTRATION & SECONDHAND SALE

LP12, Valhalla, Basik +	Garrard 401, Ortofon arm,	
MC10 super	£425 Ortofon mc10 Super cart	£195
Michell Gyrodee psu	£85 Quad 606 p/amp	£450
Quad 34 preamp	£220 Harbeth HL Compact Idskrs	£299
LFD Int "0" (phono) int amp	£529 Linn Kans	£175
Chord SPM 800 power amp	£1399 Sansui AV S/Sound amp	£499
Origin Live OL2 Idskrs	£450 Cambridge C70 preamp	£125
Acoustic Energy AE1 Idskrs	£400 Spondor S20 Idskrs	£399
DNM 3A6 preamp	£650	
Arcam Alpha 2 int amp	£100 ATC SCM 50A	£3995
Mordant Short NS50	Sony CDP 550 CD player	£60
(bi-wired)	£150	
ATC SCM 50A	£3995 Linn Kans	£175

Cottage Audio

17 Bridge Street, Saxilby, Nr. Lincoln. LN1 2PZ
Tel: (0522) 702834 eve: (0522) 696708

Esoteric • Audio • Imports

Importers, Distributors and Purveyors of Fine
Quality Audio Equipment

Are proud to announce yet another
V'Audio first.

V'Audio of BRISTOL are the U.K.'s
first retail dealer to have in stock
ELECTROCOMPANIET'S **NEW**
"Super Fidelity" range sporting the
magnificent blue stone facia last
seen on the 20th "Anniversary" sets.
Telephone Bristol **0272-686005**.

For product and market details contact:-
Esoteric Audio Imports
Tel/Fax:- **0243 53 30 30**

Inaccessible accessories by post.

If you can't get to us, we'll get our accessories to you.
CARTRIDGES: Arcam, Audio Technica, Denon, Dynavector, Goldring,
Lyra, Ortofon, Sumiko. CABLES: Audioquest, Cable Talk, Goertz,
Heybrook, Ixos, Kimber, Kontak, LFD, Monster, Ortofon, Precious
Metals, QED, Sonic Link, Van den Hull, XLO. STANDS: Alphason,
Apollo, Atacama, Sound Organisation, Sounds Style, Stands Unique,
Target. HEADPHONES: Beyer, Sennheiser, Stax. ACCESSORIES: Audio
Technica, Audioquest, BIB, Discwasher, Goldring, Hunt, Ixos,
Kontak, Last, Michell, Milty, Moth, Nagoaka, Pixall, QED, Shure,
Townshend. Plus a full range of quality equipment available.

PLUS A FULL RANGE OF QUALITY EQUIPMENT AVAILABLE. SEE OUR MAIN ADVERTISEMENT.



BURY AUDIO
TEL & FAX: 0284 724337
MOBILE: 0850 565693

47 CHURCHGATE STREET,
BURY ST. EDMUNDS,
SUFFOLK IP33 1RG.

SITUATIONS VACANT

Hi-Fi Loudspeaker Manufacturer requires
Freelance Representatives throughout the
U.K.

For further details please contact:-

Mr Elvins
Elvins Acoustic Technology
12 Brett Road
London E8
Telephone:- 081 - 986 8455

Advertisers Index

MAIN ISSUE

ACOUSTIC ARTS	42	G.T. AUDIO	88	SOUND ILLUSION	116
AMADEUS S&V	105	GLOTTA AB	54	SPALDINGS	44
ARCAM	40	H&R CLOAKE	128	STEVE BOXSHALL	24
ARION ACOUSTICS	103	HALE HI-FI	118	STRATFORD HI-FI	114
ART AUDIO	44	HARBETH ACOUSTICS	96	STUDIO ONE	52
ATTIC MUSIC	104	HEATHERDALE AUDIO	122	SUSSEX SURPLUS	113
AUDIBLE DIFFERENCE	106	HI-FI CONFIDENTIAL	112	TANNOY	20
AUDIO COUNSEL	106	HI-FI CORNER	62	TECHNICAL & GENERAL	58
AUDIO ILLUSION	52	HI-FI EXCHANGE DARLINGTON	107	TESSERAC	32
AUDIO PHYSICS	118	HI-FI SHOWROOMS	88	THE RECORD SHOP	56
AUDIO ROOM	112	HOME CINEMA	120	TRIANGLE	48
AUDIO SUITE	105	HORSHAM HI-FI/CRAWLEY		TRY ME & SEE	102
AUDIOLAB	46	AUDIO	113	TUBE TECHNOLOGY	54,120
B&W	10,15,24	IAN EDWARDS	48	V'AUDIO	72
BETTER HI-FI	58	IAN HARRISON	105	WESTWOOD	104
BILLY VEE	114	INNOVATIVE DESIGN	108	WILSON STEREO LIBRARY	72
BRENTWOOD MUSIC	42	J.E. SUGDEN	IBC	WOLLATON AUDIO	58
BURY AUDIO	48,128	JAMO	14,15	WORTHING AUDIO	108
C.A.D.	32	KEF	28		
CABLE TALK	104	KRONOS DISTRIBUTION	103	DIY SUPPLEMENT	
CD EXPRESS	108	LEONARD BOOTH	108	ANTIQUE ELECTRONICS	18
CHOICE HI-FI	124	LFD AUDIO	118	AUDIO CAB	6
CHORD COMPANY	56	LISTEN INN	42	AUDIO NOTE	10,11
CHORD ELECTRONICS	96	LORICRAFT	58	AUDIO TECHNOLOGY	4
CLASSIQUE SOUNDS	24	MANTRA AUDIO	118	BILLINGTON EXPORT	6
CONNECTIONS	44	NAD	BC	BORBELY AUDIO	18
COTTAGE AUDIO	128	ORANGES & LEMONS	10	CHELMER VALVE CO	BC
CREATIVE AUDIO	109	ORTOFON	10,15	CRICKLEWOOD ELECTRONICS	22
CUSTOM CABLE SERVICES	120	OXFORD AUDIO		EUROSONICS	18
DAN DULEY	107	CONSULTANTS	114	FALCON DIY	4
DCN ASSOCIATES	96	PHILIPS	6,7	GLASS AUDIO	4
DEFINITIVE AUDIO	124	POWER PLANT	104	HART ELECTRONICS	IFC
DIGITAL KONNECTIONS	50	QTA	122	KIT SUPPLIERS	14
DPA	IFC,3	RDL ALLISON ACOUSTIC	122	LANGREX SUPPLIES	20
DYNAMICS	106	RECITAL	72	LOCKWOOD AUDIO	6
ELECTROFLUIDICS	50	RICHARDS A.V.	105	LYNWOOD ELECTRONICS	
ELVINS ACOUSTIC		RINGMAT DEVELOPMENT	88	P.V. TUBES	22
TECHNOLOGY	32,128	ROOM ACOUSTIC SVCS	124	SJS	20
ESOTERIC AUDIO IMPORTS	107,128	SCARBOROUGH HI-FI	116	SONIC FRONTIERS	18,26
F&S TRADING	54	SERIOUS KIT	120	SOWTER	4,6
FRANCIS OF STREATHAM	118	SEVENOAKS HI-FI	70	SPEAKER CO.	24
FULLERS AUDIO	42	SLATE AUDIO	107	SPECTRA DYNAMICS	IBC
		SME	44	VINTAGE VALVES	22
		SOUND COMPANY	32	WOLLATON AUDIO	20



SUGDEN

HAND CRAFTED ■ FAIT À LA MAIN

DESIGNERS & MANUFACTURERS OF HI-FI & AUDIO EQUIPMENT

J. E. SUGDEN & CO. LTD.

Valley Works,

Station Lane, Heckmondwike,

West Yorkshire WF16 0NF

Tel. Heckmondwike 0924 404088/9

Fax No 0924 410069

World Radio History

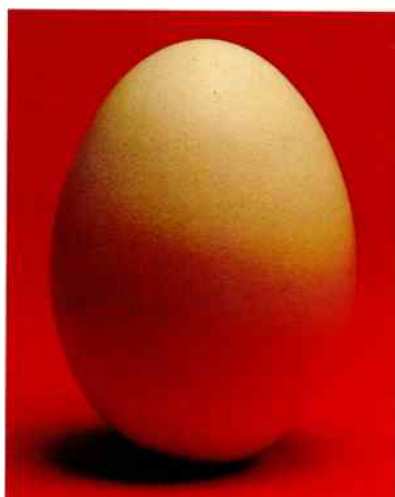

Can sound be this simple ?

- The answer is an audible Yes. Unlike many electronics companies, NAD specialises in delivering innovative, award-winning audio and home cinema products - and nothing else. Simplicity and symmetry. A free-ranging approach to design. Balancing acoustic excellence, ease of use, reliability and value. Principles which need for little else.

NAD MARKETING LIMITED NAD BUILDING 401-405 NETHER STREET LONDON N3 1QG. TELEPHONE 081 343 3240

NAD

pure. and simple.

