

Still
£2.00

Hi-Fi WORLD

SEPTEMBER 1994 £2.00

HI-FI WORLD'S
AMP. - THE
FOUR £400 T

SCOOP!

**BURMESTER
937 CD PLAYER
HIGH-END ELEGANCE**

SCOOP!

**NEW HDCD
FIRST DETAILS**



**LEAK TL12
RESTORATION - PART II**



**COMPETITION - AUDIONOTE OTO SE
VALVE AMPLIFIER AND UKD
CALLAS WALNUT SPEAKERS**

SEE US AT
LIVE US AT '94
THE CONSUMER ELECTRONICS SHOW
EARLS COURT
LONDON
20-25 SEP
1994



The most complex DAC in the World



The PDM ten twenty-four - packed full of dpa innovations that redefine CD performance.

is also the simplest.

It has long been held as a tenet of audiophile wisdom that the simpler the analogue circuitry, the better the sound quality. We have spent many years developing our own DAC technology that results in an order of magnitude improvement in analogue simplicity. This is achieved by the use of our patent pending DX processor DAC that employs up to 128 times digital filtering. This gives a very simple analogue topology - just our op-amp and four passive components in the direct signal path.

This is some ten times simpler than conventional DAC's - and the sonic result it gives is extraordinary. Words cannot convey the sense of excitement when listening to music through it. Instruments sound much more tangible with better focus and separation. Sound stage and detail resolution are remarkable. Indeed, we are convinced our DX DAC technology completely redefines the capability of digital music.

However, this performance comes at a price - one being the complexity of the digital domain. An amazing one billion single bit additions are performed each second. The PDM ten twenty-four also features nearly 2,000 discrete components, 4,000 gates, 8 noiseshapers, 8 digital filters, 8 programmable dither sources and gold plated solid copper construction throughout - to name but some of the features. It is modular in construction, thus allowing future upgrades.

Moreover, the DX processor technology can be applied to more affordable DAC's. The PDM two fifty-six (our replacement for the highly regarded PDM two) is available. We are currently developing the PDM sixty-four that features a scaled down version of this technology for only £1250. For more information please telephone or write to:

dpa Digital Ltd.,
7&8 Willowbrook Lab Units,
Crickhowell Rd., St Mellons,
Cardiff, Wales CF3 0EF
Tel: (0222) 795621
Fax: (0222) 794267

dpa

dx 128
processor



EXPERIENCE MUSICAL TRUTH



45 High Street, Hounslow, Middx.
TW3 1RH
Tel: 081 569 5802
(Also at Edgware, Middx,
Tel. 081 952 5535)

audible difference

Scale, Diss, Norfolk.
IP21 4DX.
Tel : 0379 740227

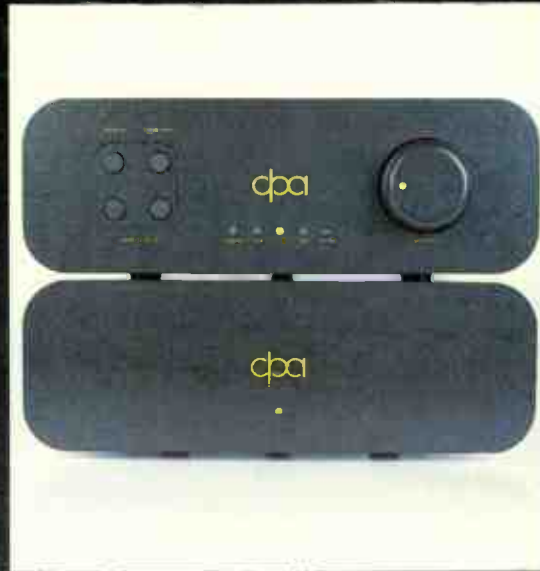

NEW 200S PRE POWER £1250



93 Hobs Moat Road,
Solihull,
W. Midlands
Tel: 021 742 0254



34, Buckingham palace
Road, London SW1W 0RE
Tel: 071 - 233 0774
Fax: 071 - 233 7226



Tel/Fax: 0252 377952

Doug Brady Hi-Fi

Kingsway Studios,
Kingsway North,
Warrington.

Tel: 0925 828009

(Also at Liverpool, London and Otley, Nr Leeds)

Oxford Audio Consultants

Carlay House,
Park End Street,
Oxford OX1 1JE
Tel: 0865 790879
Fax: 0865 791665



Chantry Walk,
16/18A Eldon Street,
Tuxford, Nr Newark,
Notts NG22 0LH,
Tel: 0777 870372

Audio Suite

42 St. Andrews Street,
Aberdeen AB1 1JA,
Tel: 0224 625 635



152A High Street,
Bloxwich,
West Midlands.
Tel: 0922 493499



3 Bridge Street,
Guildford,
Surrey.
Tel: 0483 504801

SHROPSHIRE HI-FI

St. Michael's Street
Shrewsbury,
Shropshire SY1 2ES.
Tel: 0743 232317



41 Victoria Road,
Cambridge.
CB4 3BW.
Tel: 0223 68305

ZEUS AUDIO

2/4 Great Victoria Street
Belfast BT2 7BA.
Northern Ireland.
Tel: 0232 332522



KJ WEST ONE

26 New Cavendish
Street,
London W1M 7LL.
Tel: 071 486 8262

AT OUR KEY DEALERS

dpa digital ltd

Unit 7, Willowbrook Technical Units,
Crickhowell Road, St. Mellons, Cardiff CF3 0EF, Wales, UK
Phone: 0222 795621 Fax: 0222 794267



Cover Photograph by Paul Hartley Studio 071-482 3768

THIS MONTH'S REVIEWS

AMPLIFIERS

AUDIO VALVE ASSISTENT-S 23
A compact integrated valve amplifier from Germany. Dominic Baker asks if size is everything.

WORLD AUDIO DESIGN 300B VALVE AMPLIFIER 40
World Audio Design's 300B power amp is finally ready for the outside world. Here's the story behind it.

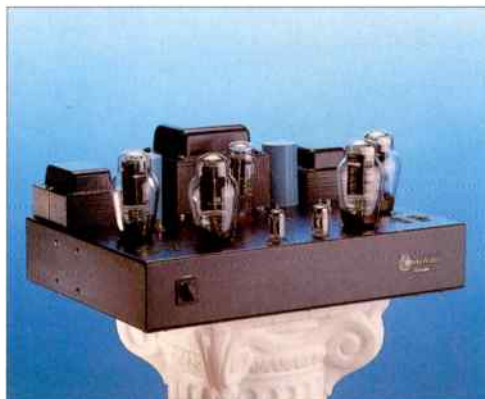

STEMFOORT SF60 58
A sixty watter from the Sugden stable. David Harris finds a warm heart inside.

COMPACT DISC

BURMESTER 937 14
The 937 CD player uses Burmester's unique belt drive CD transport mechanism. German engineering at its best.

KINSHAW OVERTURE 48
A budget DAC from newly established Kinshaw Electronics.

GRUNDIG CD3 56
A Philips CDM-9 transport and DAC-7 convertor in one box for £250. Dominic Todd investigates what could be the audiophile bargain of '94.



LOUDSPEAKERS

KAR VOLANTE 19
An elegant new floorstander from Keswick Audio Research, promising high sensitivity and quality sound.

HARMAN KARDON LS 0200 52
The smallest of the well received LS range from Harman Kardon. Eric Braithwaite finds these £150 stand mounters can disco with the best.



PENTACHORD 66
An active satellite and subwoofer system using Bando metal cone drive units. Dominic Baker lends an ear.

TURNTABLES

£400 TURNTABLES 31
Enjoying your vinyl. Eric Braithwaite listens carefully to four of the best turntable combinations available for around £400 in this month's group test.

THORENS TD166 MKVI/RB 250/GOLDRING 1042

LINN BASIK/AKITO ARM/K9

PROJECT 6.1/ORTOFON/MC15 SUPER

SYSTEMDEK IIX900/RB 250/GOLDRING 1022GX

CASSETTE

TEAC V600 28
Can Teac's latest budget cassette deck compete with the rest of the market? Eric Braithwaite investigates.

TUNERS

DENON TU-380RD 26
The latest to join Denon's range of RDS tuners is the budget TU-380RD. David Harris scans the airwaves to examine its abilities.

**AMERICAN and CANADIAN SUBSCRIPTIONS - see page 68**

Editor
Noel Keywood

Assistant Editor
Dominic Baker

Production Editor
Ferewini T. Michael

General Manager
Mark Winfield

Marketing Manager
Richard Johnson

Advertising Director
Caroline Knott
Advertising Tel: 071-266 0969

Advertising Executive
Amanda Sweeney

Design Engineer
Andy Grove

Technical Assistant
Nick Lucas

Contributors
**Eric Braithwaite
Richard Brice
Giovanni Dadomo
Peter Herring
Simon Hopkins
Dominic Todd**

Cartoonist
Freddy Ahmet

Distributed by:
COMAG, Tavistock Road, West
Drayton, Middlesex, UB7 7QE
Tel: 0895 444055

Origination by:
Ashford Scanning
2 Norfolk Drive,
Fairwood Industrial Park,
Ashford, Kent TN23 2FB
Tel: 0233 622042

Printed by:
Southernprint, Poole, Dorset.
Tel: 0202 622226

AUDIO PUBLISHING LTD.,
64 Castellain Road, Maida Vale,
London W9 1EX
Tel: 071-289 3533
Fax: 071-289 5620
Queries cannot be answered
by telephone.

MAIL ORDER
Tel: 071-266 0461 (24 hours)

Subscription Rates:
UK: £22,
Overseas Surface: £29, Airmail:
£42 (Europe) £52 (USA, Middle
East), £62 (Australia, Japan).

No material may be reproduced
from this magazine without
the publisher's written
permission.
© Audio Publishing Ltd

REGULARS

NEWS	7
We tell you what's new in the way of hi-fi from Britain and across the seas.	
LETTERS	38
Letters from around the world; your chance to speak your piece.	
Q&A	103
The Hi-Fi World team and other experts present helpful and authoritative answers to your queries.	
COLUMNS	61,63,69,71
Our regular team air their views on current hi-fi issues.	
NEXT ISSUE	60
What's in store for October? We give you a glimpse of next month's edition.	
SUBSCRIPTIONS	68
Make sure you don't miss out - order your copy now and avoid a trip to the newsagent.	
ACCESSORIES	97
Tweaks to get the most out of your system, available by Mail Order.	
HI-FI WORLD LIBRARY	101
A selection of books that won't send you to sleep!	
DIAL-A-DEALER	89
Who sells what and how to get in touch.	
WORLD AUDIO DESIGN	81
Valve amplifiers and loudspeakers for those with soldering irons.	

MEET YOUR MAKER	65
The manufacturers' directory.	
WORLD FAVOURITES	128
Our pick of the best in hi-fi.	
CLASSIFIEDS	139
Second-hand bargains for immediate sale and a new job section for the hi-fi industry.	
SPECIALIST HI-FI DEALERS	77
Need a specialist, look no further.	
ADVERTISERS' INDEX	146

FEATURES

THE FUTURE OF HI-FI	50
Have we come to a standstill with 16 bit CD. Where is hi-fi heading. Noel Keywood investigates what developments might be just around the corner.	
LEAK TL12 (Part II)	45
Part II of our restoration article on this classic valve power amplifier. Graham Tricker of GT Audio explains what to replace and what to replace it with.	



MUSIC

Our guide to some of the best new releases.

ROCK RECORD OF THE MONTH:

L7: Hungry For Stink

CLASSICAL RECORD OF THE MONTH:

Nielsen - Symphony No. 5
Shostakovich - Symphony No. 6

ROCK AND POP **74**

CLASSICAL **85**

JAZZ **93**

COMPETITION

A chance to win a fabulous Audionote OTO SE single-ended valve amplifier complete with solid Walnut UKD Callas loudspeakers, together worth over £2300. **72**



CONTENTS



"I've got a pretty good hi-fi system"



"Friends tell me all the time"

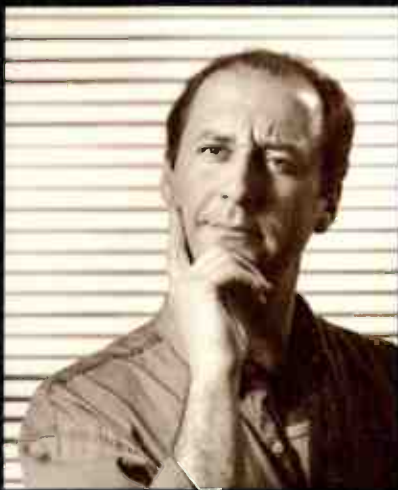

"Sure I'd like a Naim CD player"



"But it would cost me thousands to buy one"



"The CDI costs how much?"



"It'll look great over there!"

Put the expression back into your music with the Naim CDI. You can listen to our integrated CD player, incorporating all the technological innovation and expertise you'd expect from one of the world's leading hi-fi manufacturers, at any of the specialist retailers listed here.

What's more, it's so reasonably priced, you won't even need the brave face.

Now you know what's in a Naim



NA naim audio

Naim Audio, Southampton Road, Salisbury SP1 2LN, England, Tel: (0722) 332266

LONDON

Audio Venue
74 Church Rd. Crystal Palace, SE1. Tel: 081 771 9787
Billy Vee Sound Systems
248 (a) High Rd. Letchworth, SE13. Tel: 081 318 5755
Doug Brady Hi-Fi
10 Elmwood St. Colindale, WC2. Tel: 071 378 4010
The Cornflake Shop
31 Watney St. W1. Tel: 071 261 1676
Grahams Hi-Fi
Compassery Yard, 190a New North Rd. N4. Tel: 071 226 5500
Son of Lumina
67 Mansham Court Rd. W1. Tel: 071 501 9059
The Sound Organisation London
4 Poplars Wharf, Clith St. SE1. Tel: 071 403 2005
Studio 89
28 81 Farnham Road, W6. Tel: 071 624 8826
Uxbridge Audio
168 Chiswick High Rd. W4. Tel: 081 742 8444

NEAR LONDON

Infilicity Hi-Fi
9 High St. Harpenden, Herts. Tel: 0464 549001
Radford Hi-Fi
Te. 081 942 3500
Radford Hi-Fi
43 King Edward Court, Windsor, Bucks. Tel: 0753 698001
The Sound Gallery
85 Church St. High Wycombe, Bucks. Tel: 0494 021802
Spaldings
359 1/4 Loughborough Rd. Clarendon, Slough
Tel: 061 654 1931
Studio 89
82 High St. Harpenden, Herts. Tel: 0462 764246
Unitel Products
25 High St. New Bedford, Suffolk. Tel: 01473 807400
Uxbridge Audio
278 High St. Uxbridge, Middlesex. Tel: 0815 288644

SOUTH

Audio Designs
26 High St. East Grinstead, W Sussex. Tel: 0242 314500
Chichester Hi-Fidelity
7 St. Peter's, Chichester, Sussex. Tel: 0243 776402
Jeffries Hi-Fi
68 Liphook Road, Brighton, E Sussex. Tel: 0231 602431
Jeffries Hi-Fi
4 Allport Parade, Green St. Eastbourne, E Sussex
Tel: 0232 318700
Jeffries Hi-Fi
29 London Road, Portsmouth, Hampshire. Tel: 0705 667600
Sogedraft
45 High Street, Aylesbury, Bucks. Tel: 0293 624441
Sound Waves
1 Holbury Drive, Princes Hillbury, Hampshire
Tel: 0703 620113
Worthing Audio
20 The Old Gate, Princes Road, Worthing, W Sussex. Tel: 01243 272000

EAST

The Audio File
21 Newmarket St. Bedford, Bedfordshire. Tel: 0179 586576
The Audio File
No 2 Fidelity Walk, Seven Kings, Essex. Tel: 0206 050105
Basically Sound
The Old School, Kempston Rd. Barton, Beds. Tel: 0525 220000
Cam Audio
112 High Street, Cambridge. Tel: 0223 89440
Pro-Musica
6 Vennard St. Colchester, Essex. Tel: 0206 277519
Rayleigh Hi-Fi
214 Museum St. Chelmsford, Essex. Tel: 0245 265245
Rayleigh Hi-Fi
122 London Rd. Southminster, Essex. Tel: 0702 453200
Rayleigh Hi-Fi
44A High St. Rayleigh, Essex. Tel: 0268 779762

WEST

Audio Excellence
58 Bristol Rd. Gloucester. Tel: 0452 300049
Audio Excellence
66 Park St. Bristol, Avon. Tel: 0272 264975
Radford Hi-Fi
6 Fort St. St. Mary's Church, Torquay, Devon. Tel: 0800 097070
Radford Hi-Fi
28 Coward St. St. Thomas, Exeter, Devon. Tel: 0322 718880
Radford Hi-Fi
12 James Street, West. Bath, Avon. Tel: 0225 444245
Radford Hi-Fi
107 Gurney St. Plymouth, Devon. Tel: 0752 822011
Radford Hi-Fi
52 The Gables, Road, Bristol, Avon. Tel: 0272 428248
Mike Manning Audio
110 Highgate Street, Leeds, West Yorkshire. Tel: 0208 703651

WALES

Audio Excellence
134 Crwys Rd. Cardiff, South Glamorgan. Tel: 0292 278800
Audio Excellence
9 High St. Swansea, West Glamorgan. Tel: 0783 476600

MIDLANDS

Creative Audio
9 Doggale, Shrewsbury, Shropshire. Tel: 0743 241884
Griffin Audio
94 Billesley, Birmingham 5, West Midlands. Tel: 031 680 4000
Listen Inn
32 Gold St. Northampton. Tel: 0504 37871
Sound Advice
The Swan, Rectory Drive St. Loughton, Essex. Tel: 0206 18004
West Midlands Audio
158 Grafton Road, Worcester. Tel: 0953 53046
Overture
3 Church Lane, Blunbury, Oxfordshire. Tel: 0795 272150
Westwood & Mason (Oxford) Limited
46 George Street, Oxford. Tel: 0865 247783

NORTH

Audio Projects
45 Humberley Lane, Leeds, West Yorkshire. Tel: 0532 30451
Belter Hi-Fi
16 Clive Street, Liverpool 6, Merseyside. Tel: 051 477 8000
Doug Brady Hi-Fi
The Old Rectory, 10 Clarendon, Uxley, Leeds, West Yorkshire
Tel: 0534 447000
Doug Brady Hi-Fi
481 Symondson Rd. Loughborough, Leicestershire. Tel: 051 733 0000
Doug Brady Hi-Fi
Kingwell Street, Kingston, North Westmorland, Cheshire
Tel: 0928 222000
Linton Audio
8 The Arcade, Ewby, Gillingham, Tyne & Wear
Tel: 091 430 0800
Linton Audio
11 The Lane, Gillingham & Tyne & Wear. Tel: 091 477 4111
Linton Audio
10 1/2 Mansfield Road, Newcastle upon Tyne, Tyne & Wear
Tel: 091 332 2014
Linton Audio
142 Park View, Whitley Bay, Tyne & Wear. Tel: 061 352 4800
Moorgate Acoustics
84 Farnham St. Sheffield, S Yorkshire. Tel: 0742 750493
Moorgate Acoustics
8 Windgate, Clapham, Westgate, Rotherham, S Yorkshire
Tel: 0708 770500
Murray Hi-Fi
The Old Rectory, 10 Clarendon, Uxley, Leeds, West Yorkshire
Tel: 0534 447000
Murray Hi-Fi
Earl Agham Buildings, Pilsbury Dock St. Hill, Hibernia
Tel: 0482 927867
Sound with Style
87 Riverside Hill, St. Doncaster, S Yorkshire
Tel: 0332 31421
Sound with Style
87 Riverside Hill, St. Doncaster, S Yorkshire. Tel: 0742 757883
The Sound Organisation
25 Glydegate York. Tel: 0504 627108

SCOTLAND

Stereo Stereo
278 St. Vincent Street, Glasgow, West-Dunbarton. Tel: 041 848 6700
Robert Ritchie
102 Murray St. Memmore, Tayside. Tel: 0674 73700

NORTHERN IRELAND

Lyric Hi-Fi
168 Drogheda Road, Belfast. Tel: 0282 370000
Lyric Hi-Fi
84 Park Lane, Belfast, Co. Antrim. Tel: 0763 230000

DENON'S NEW CD PLAYER AIMS HIGH

Denon UK have recently developed the DCD-825, a high specification machine targeted at the 'hot' £250 class. Guided by Ray McLellan, Denon UK's audio technologist, each stage of the player's design process has been carefully auditioned to guarantee a competitive quality of sound.

Using audio-grade components at critical points in the circuit and Dual-Mono Burr Brown 18-bit DACS together with high grade NPC 8 x Oversampling 20-bit Digital Filters, Denon promise a player which will bring music 'alive' without any artificial edge in the midband or treble.

The DCD-825 is supplied with a full remote control, 20 track programming and even a Display-Off facility. It will be available in the UK in July '94, and is expected to retail at £219.99.



Denon (UK)
Hayden Laboratories Ltd, Hayden House,
Chiltern Hill, Chalfont St Peter, Bucks SL9 9UG.
Tel: 0753 888447

NEW 'BITCHECK' CD PLAYERS FROM PHILIPS

Five CD players have just been introduced by Philips incorporating their new 'continuous calibration technology'. Starting with the £119.99 CD710 and moving up to the £199.99 CD750, each player uses the latest CDM-12 linear tracking mechanism, three-beam laser and DSIC digital servo IC which controls all laser focusing and tracking digitally. The cheaper of the machines are the first to carry the new Bitcheck logo and utilise the latest 16-bit DAC - TDA1545A. At the top of the new range the CD750 has a selected version of Philips own Bitstream DAC, the SAA7350.

Also available is the CDC745 five disc changer at £199.99. All players come with a remote control.



Philips Consumer Electronics,
City House, 420-430 London Road,
Croydon,
Surrey CR9 3QR
Tel: 081 6892166

NEW AURA LINE-LEVEL AMPLIFIER

Building on the strengths of the VA-50, the VA-80 is a minimalist line-level only amplifier rated at 45wpc and carrying a £50 lower price tag than its bigger brother, the VA-100. As before, Aura have used a MOSFET power amp and a passive pre-amp, offering six line inputs, but as a 'CD era' amp there is no phono stage. The critical audio components have been carefully selected for their contribution to the sound quality and Aura claim a substantial increase in dynamic and rhythmic qualities over the VA-50 it replaces.

The VA-80 is available in a Black Mirror or a Chrome finish for £279.95 and £329.95 respectively to match existing Aura products.

Aura Designs Ltd.,
Marlborough Road, Churchill Ind. Estate, Lancing,
West Sussex. BN15 8TR
Tel: 0903 750750

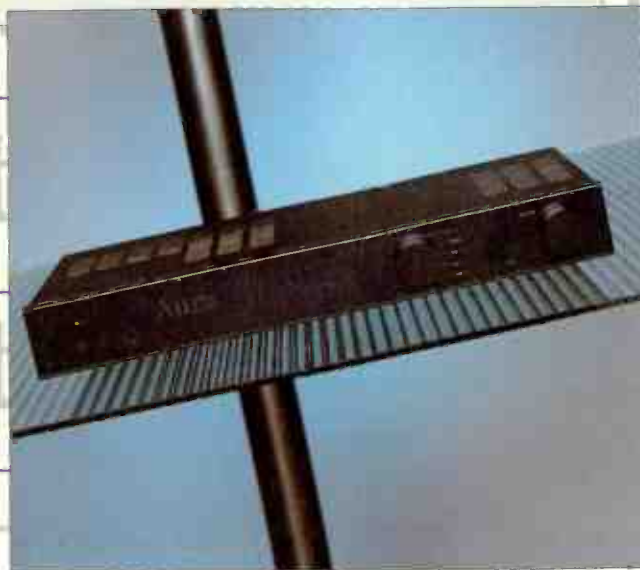

Here's what the UK's leading publications have to say about the new Q Series.

Q10

"ALL ROUND THE USER-FRIENDLY Q10: LOOK LIKE WINNERS FOR KEF - AND MUSIC LOVERS SHORT ON SPACE."

What Hi Fi?, February 1994

Q30

"WHERE THE KEFs REALLY SCORE IS IN THEIR ABILITY TO BRING EVERY SEGMENT OF THE MUSIC TOGETHER IN A HIGHLY INVOLVING MANNER."

What Hi Fi?, February 1994

Q50

"THE OPENESS, CLARITY AND SPEED OF THE Q50... MAKE IT PRE-EMINENT OF ITS TYPE."

Alvin Gold, Audiophile, June 1994

Q70

"...THE Q70s WILL DELIGHT YOU WITH THE SHEER TOGETHERNESS OF THEIR MUSIC MAKING."

What Hi Fi?, June 1994

SEE YOUR NEAREST DEALER FOR A DEMONSTRATION.

ABERDEEN	
HOLBURN HI FI	0224 585713
ALLOA	
McMICHAEL BROTHERS	0259 724230
BIRMINGHAM	
MUSIC MATTERS	021 429 2811
(3 BRANCHES IN WEST MIDLANDS)	
BLOXWICH	
SOUND ACADEMY	0922 473499
BRISTOL	
RADFORD HI FI	0272 428247/8
(7 BRANCHES IN THE SOUTH WEST)	
CARDIFF	
AUDIO EXCELLENCE	0222 220565
(4 BRANCHES IN THE SOUTH WEST)	
CHELTHAM	
SEVENOAKS	0242 241171
(12 BRANCHES IN THE STH & MIDLANDS)	
COLWYN BAY	
ELECTRO TRADFR	0492 548932
CREWE	
NORMAN AUDIO	0270 211091
(ALSO IN LANCASHIRE)	
CROYDON	
ZEBRA	081 688 2491
EDGWARE	
MUSICAL IMAGES	081 952 5535
(ALSO IN HOUNSLOW)	
EDINBURGH	
IN HI FI	031 225 8854
GLASGOW	
BILL HUTCHINSON HI FI	041 204 4433
(3 BRANCHES IN THE NORTH)	
GUERNSEY	
MELODONIA	0481 56647
GUILDFORD	
P J HI FI	0483 504801
HUDDERSFIELD	
READYVISION	0484 532294
JERSEY	
BASE HI FI	0534 58518
KNITSFORD	
WILMSLOW AUDIO	0565 650605
LEEDS	
AUDIO PROJECTS	0532 304565
LEICESTER	
LEICESTER HI FI	0533 539753
LONDON	
HI FI EXPERIENCE	071 580 3535
K J LEISURESOUND	071 486 8262/3
AUDIO CONCEPT	081 567 8703
MANCHESTER	
D & I ELECTRONICS	061 445 2694
NEWCASTLE	
J G WINDOWS	091 232 1356
NEW MALDEN	
UNINET	081 942 9567
NOTTINGHAM	
NOTTINGHAM HI FI	0602 786919
OTLEY	
DOUG BRADY HI FI	0943 467689
PETERBOROUGH	
THE HI FI COMPANY	0733 892231
(ALSO IN LEAMINGTON SPA)	
READING	
B & B HI FI	0734 583730
(5 BRANCHES IN BERKS/BUCKS)	
SHEFFIELD	
SOUND WITH STYLE	0742 737893
(ALSO IN DONCASTER)	
SHREWSBURY	
CREATIVE AUDIO	0743 241924
SWINDON	
AUDIO T	0793 538222
(7 BRANCHES IN THE SOUTH)	
ROCHDALE	
JOE KOCZUR	0706 42107
THAME	
THAME AUDIO	0844 215431
TWICKENHAM	
RIVERSIDE HI FI	081 892 7613
WILMSLOW	
SWIFTS OF WILMSLOW	0625 526213
WORTHING	
PHASE 3	0903 245577

THIS DOES NOT CONSTITUTE A FULL DEALER LIST. FOR A COMPLETE DEALER LIST PLEASE CONTACT KEF ON 0622 672261.



The experience of sound

KEF and Uni-Q are registered trade marks. Uni-Q is protected under GB Patent 2 236929 - worldwide patents pending.

It's that
KEF
feeling
The
NEW Qseries



Q10



World Radio History
Q30



Q50



Q70

BBC MINI-MONITOR BECOMES REALITY

Harbeth Acoustics have finally reproduced the BBC mini-monitor LS5/12a. It has benefitted from substantial improvements to the crossover since its debut at the London (Penta) Ramada show in September 1993, and electrical load regulation is now incorporated to make the LS5/12a an easy amplifier match, which is important because of the low sensitivity of 81.5 dB/w/metre.

The Harbeth LS5/12a is currently available through selected dealers. For further information contact:

Harbeth Acoustics Ltd.,
Unit 1, Bridge Road, Haywards Heath,
W. Sussex RH16 1UA,
Tel: 0444 440955 fax 0444 440688

HI-FI AT HARRODS

Harrods have opened a dedicated music and hi-fi department, called Sound and Vision on 3 (i.e. the third floor). Amongst a sea of major Japanese names like Sony and Toshiba, Linn have a concession in which, uniquely, two elegantly furnished listening

rooms each carry a system. Sized roughly 15ft by 12ft they fairly well represent normal domestic conditions, demonstrating accurately what a Linn system offers in the home. Glass fronted cabinet displays of parts, such as the massive extrusion used to form the structural frame of the Klout power amplifier, stand outside the rooms, illustrating the engineering processes and specialist nature of these hi-fi products. Linn have a number of their own dedicated salesmen on hand to help explain and demonstrate their equipment, bringing a helpful and knowledgeable response to this store-in-a-store.

Ivor Tiefenbrun, founder and managing director looked

pleased at this new retailing concession, situated right in the heart of one of London's glitziest areas. It brings substance to Linn's controversial move away from the dyed-in-the-wool enthusiast, with whom they built their reputation. However, with turnover rising 19% to £11.5 million last year, Linn is large by U.K. specialist standards. The need to expand into new, affluent market sectors is obviously seen as important to the company's future. Harrod's customers - the moneyed from around the world - are affluent beyond most hi-fi manufacturers dreams. No wonder Ivor was smiling!

SONY LAUNCH NEW AUDIO TAPES

Sony are currently introducing three new audio tapes - UX, UXS and Metal XR. The UX is aimed at the budget end of the market. The more costly UXS and Metal XR feature anti-vibration mechanisms and guide blocks to minimise distortion. All three tapes will be sold in twin or multipacks of 90 and 60 minute lengths.

Sony Consumer Products Ltd.,
Sony House, South Street,
Staines, Middlesex. TW18 4PF
Tel: 0784 467000 fax 0784 467296

SIX-WAY MAINS LEAD FROM LFD AUDIO

LFD Audio are now offering a dedicated six way mains distribution socket to complement their existing range of Gold plated mains accessories. PTFE insulated 30A Silver plated copper wire is used internally, and to avoid the detrimental effect of neon indicators a switch with visual indication has been utilised, capable of handling in-rush currents in excess of 125A.

The six way distribution socket comes with two metres of PVC mains cable for £150 or with LFD HiAmp mains lead for £240. For further information contact -

LFD Audio,
Micron House, 23 Coppins Road,
Clacton-on-sea, Essex, CO15 3HP.
Tel: (0255)422533, fax (0255)221069.

RICHER SOUNDS MOVE TO BIGGER PREMISES

Famous for their tiny stores stacked to the ceiling with cut-priced equipment, Richer Sounds have now decided that the time is right to expand. Opening on Monday July 4th, store manager Floyd Case said his Chelsea shop had moved next door to larger premises "to give us enough room to swing a cat". Featuring a demonstration room to allow relaxed listening to some of the more up-market equipment that Richer Sounds is now stocking, the shop promises to remain the cheapest and friendliest hi-fi store in Chelsea.

Richer Sounds (Chelsea)
258 Fulham Road,
Chelsea, SW10 9EL.
Tel: 071-352-8496

MORE EFFICIENCY FROM FULLER'S AUDIO

In addition to the current range of Sultan loudspeakers Fuller's Audio have announced the new Sultan H.E. Based on the same cabinet as the standard Sultan, the H.E. is claimed to achieve an extremely high 98dB for 1watt/metre, making it an ideal choice for lower powered amplifiers. An 8" paper coned bass/midrange driver and a fabric dome horn-loaded tweeter are used, together with a crossover which utilises air-cored inductors, high quality capacitors and o.f.c. cable for internal connections. The Sultan H.E. is available in Natural Oak, Mahogany and Black and will retail for £439.

Fuller's Audio,
20 Tunbridge Road,
Southend-on-Sea,
Essex SS2 6LT.
Tel: 0702 612116



Steve Boxshall **AUDIO**

OFFERS YOU THE BEST HI-FI IN CAMBRIDGE



Use our expertise to invite real music into your home

- **BEST CHOICE IN HI-FI**
- **INTEREST FREE CREDIT**
- **THREE DEMONSTRATION ROOMS**
- **VISITING CAMBRIDGE...?... VISIT US**

**41 VICTORIA ROAD
CAMBRIDGE
(0223) 68305**

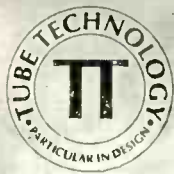

Prophet



Genesis



Unisis

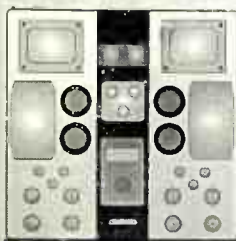

Synergy

*Explosive Bass dynamics, a midrange clear as a bell & shimmering treble.....
.....A tighter rendition of Music...*

In a world of black boxes, valve amplifiers like this are scene stealers.....

Hi-Fi World, June 1991

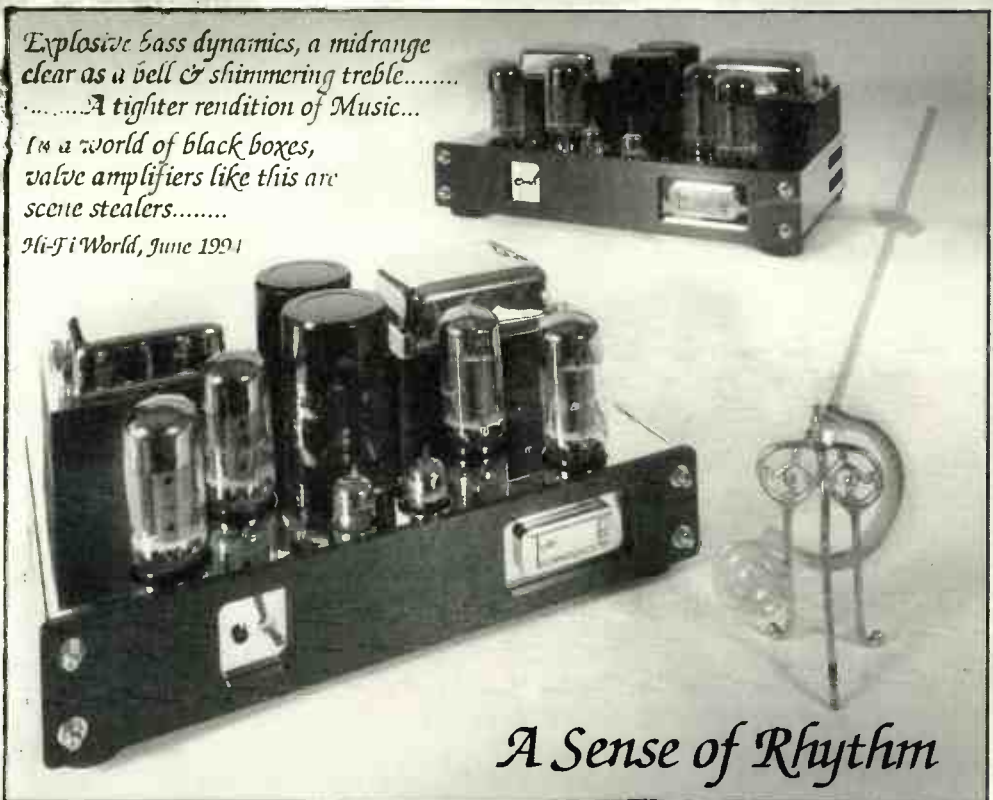

A Sense of Rhythm

Tube Technology, Design & Manufacturers of High Quality Tube Amplification & Distributors of Gold Aero Vacuum Tubes. Please enquire for further information on our range of amplifiers and Vacuum Tubes. ~ Foxhills Farm, Longcross Road, Ottershaw, Surrey, KT16 0DN, England.
Tel: 0932 873444 Fax: 0932 873012 ~ Pictured: *The Genesis 100 unit All Tube Monoblocs.*

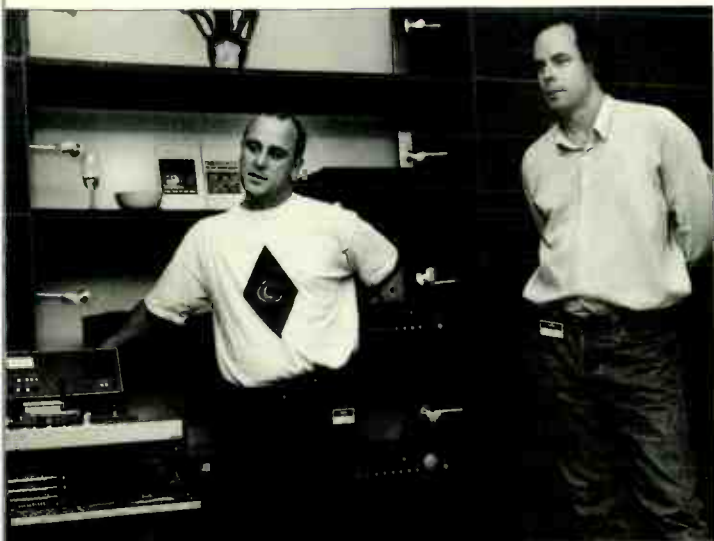

Murray Harris (left) and Simon Heyworth of West London CD mastering specialists Chop Em Out, demonstrate Sony's Super Bit Mapping process at Knightsbridge hi-fi dealer Kraft.

SONY DEMONSTRATE SUPER BIT MAPPING

At Knightsbridge hi-fi store Kraft, Sony recently demonstrated their latest Super Bit Mapping system, version 2.2, designed to improve the sound of CD. Because SBM is used in studios to improve the quality of digital master tapes, it's an innovation that comes free to end users. Sony demonstrated the system to the press (most of whom couldn't make it due to a rail strike), to prove that it works and show how it affects sound quality. Hi-Fi World fought its way through Hyde Park, an area free of trains - if not flashers - to attend.

It was lovely to hear the original analogue master tape of Roxy Music's Avalon; it was far less lovely to hear what a CD made of it in comparison. A hard upper midrange emphasis, loss of clear differentiation between instruments, compressed treble and bass dynamics were all evident. The overall effect could be called scratchy, hard and sterile - all adjectives commonly used by seasoned listeners to describe digital sound ever since its introduction. Sadly, besotted by the apparent wonder of digital, the professional side of the business has never agreed, so it's good to see, at last, the myth of perfection laid to rest by no less than Sony, who co-developed CD with Philips.

As beautiful as Avalon is, it proved to be less revealing than the massed strings of Haydn's Symphony 86, which really brought home just how much degradation can exist. Violin, with its rich harmonic structure that extends strongly up into the treble regions, presents a fierce test for any hi-fi component. In this case the natural stridency of the strings became a screech and separation between strings and between instruments was lost, congealing all into one. The effect was unpleasant; what we heard was a relatively poor representation of violins.

So what did Sony SBM do? Much as expected, because 16-bit is a 1970s coding system with constrictive and inviolable limitations, it did not wreak miracles. It did appear to soften and sweeten the sound, removing a goodly amount of the harshness or glare, restoring apparent tonal balance and generally improving the euphony of recordings. There was still a sense of overall constriction, in terms of dynamics and freedom of expression, but that's a function of the medium, as anyone with a good record player will be aware.

Super Bit Mapping provides a useful improvement in CD sound quality and, considering how much research and effort has gone into developing it, Sony are to be congratulated, since these days there seems to be little incentive to fund and pursue improvements in audio technology. Look out for CDs from Sony

Music and from Tring International plc, with an SBM logo on them. At present most titles are Classical, but in Rock look for Eno 1 & 2 box sets, Paul Young's *The Crossing*, re-mastered Aerosmith albums, S.E. Rogie, and imported U.S. Columbia albums (Tower Records) which are apparently premium grade 'collectors' classics of Brubeck, Springsteen, etc in 24carat gold. We hope to be bringing you reviews of some of this new material in the near future

The Royal Philharmonic Collection

DVORAK - BORODIN

String Quartet No.12 in F major
Op. 96, 'The American'

String Quartet No.2
in D major

Royal Philharmonic Chamber Ensemble
Directed by Jonathan Carney



TRING RELEASE SONY BIT MAPPED CDs for £3.99

Tring International plc, who have traditionally re-packaged recordings for sale at budget price through "non-traditional outlets" as they put it, meaning airports, petrol stations and what have you, are now offering a range of classical CDs recorded with Sony's Super Bit Mapping system for just £3.99 each. Many of you may well have bought budget digital recordings in the past and found they were of abysmal sound quality. Tring make much of the fact that their recordings are all recent and of top quality, relying on twenty-bit master tapes and Sony Super Bit Mapping. What's the snag, you may well ask (if you're as cynical as us!). We 'phoned them to find out.

Michael Infante, Head of Marketing for Tring told us they turn over £25-27 million, making them two-to-four times larger than most U.K. hi-fi companies. This allowed them to offer the Royal Philharmonic, when they had their Arts Council grant axed, a £2 million contract to record 125 albums over the next 18-24 months. It eliminated Copyright costs, but even though the unit pressing cost of a CD varies from 50p-£1.20 according to quantity, this still doesn't leave much margin for wholesalers and retailers, recording costs, promotional costs and the aforementioned £2 million, it seemed to us. "A classical performance from a respected name like the Royal Philharmonic, well recorded so that the performance has enduring appeal, will sell steadily for a long period. This allows us to recoup our costs without the need for a high unit price", Michael Infante told us. "That's how we can offer high quality classical performances for £3.99".

The CDs will be available from most leading record retailers.

SBM
Super Bit Mapping

Tring
INTERNATIONAL



GET YOUR FINGER ON THE PULSE

LOOK THEA



Take your senses for a trip to LIVE '94, the UK's most exciting consumer electronics event.



See the latest hi-fi. TV. Video. Computers. Games. Camcorders. In-car. Musical instruments. Cameras. Telecoms. Satellite. Home automation.



Experience Capital Radio Live at LIVE. TV Times Live Television Studio. Dolby Home Cinema Promenade. BPIA Future of Photography. Real Hi-Fi Village. Young Newspaper Feature. Yamaha/TES National Youth Rock & Pop Awards. Computer Shopper PC Village. Focus on Multimedia. Games Arena.



Get your hands on a ticket. Phone the LIVE hotline or return the coupon now.

LIVE '94
THE CONSUMER ELECTRONICS SHOW
EARLS COURT • LONDON
20-25 SEPTEMBER 1994

LIVE HOTLINE:
0 8 9 1 5 0 0 1 0 3

Calls cost 39p per minute cheap rate and 49p per minute at all other times.

Please tell me more about LIVE '94 and how I can get a ticket to the UK's most electrifying event.

Name.....

Address.....

.....

..... Postcode.....

HFW

Please return this coupon to:
LIVE '94, News International Exhibitions Ltd.
Europe House, World Trade Centre,
St Katharine-by-the-Tower, London E1 9AT.

CD GOES BELT-DRIVE !

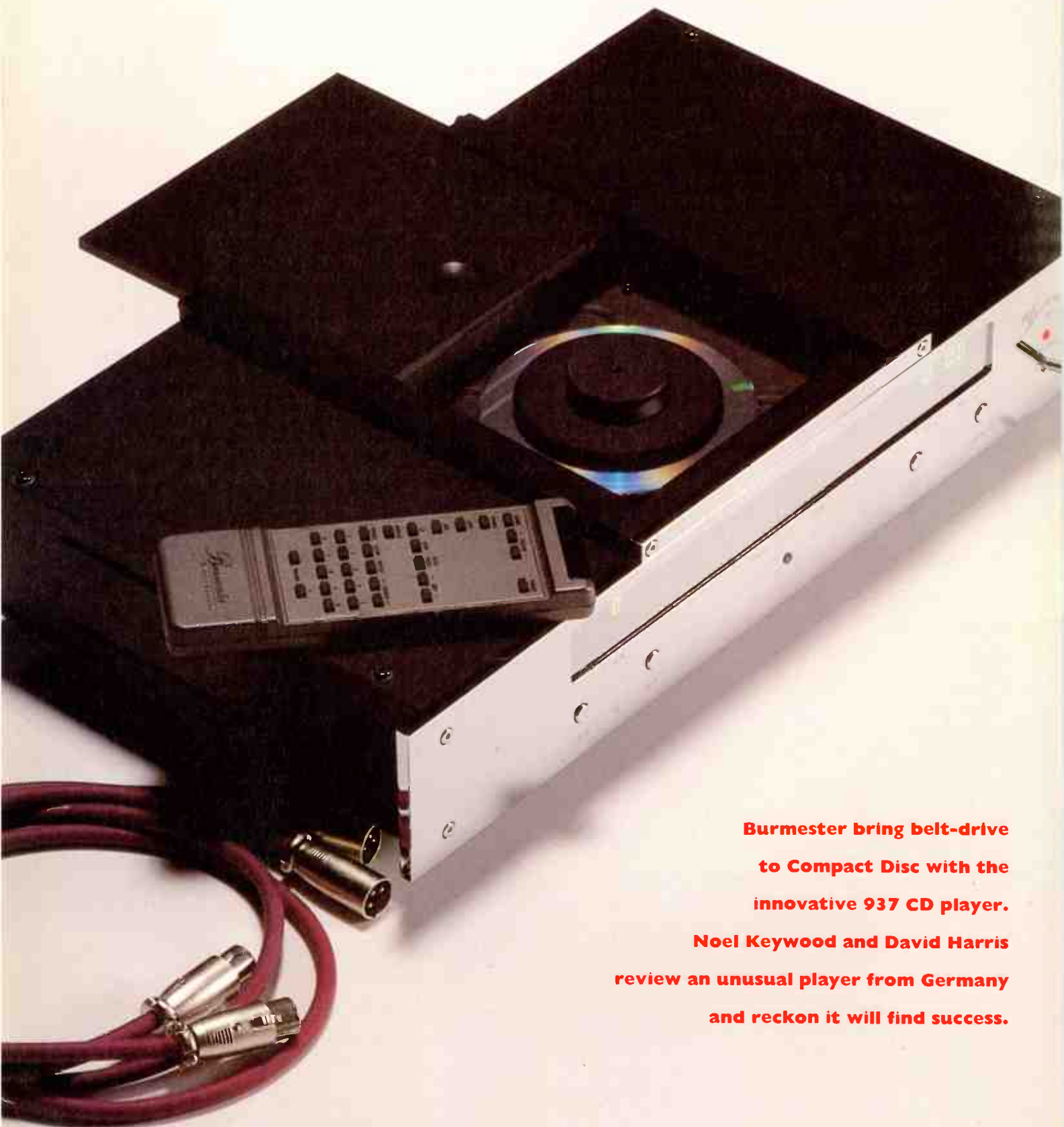

Burmester bring belt-drive to Compact Disc with the innovative 937 CD player. Noel Keywood and David Harris review an unusual player from Germany and reckon it will find success.

It was a few years back that I first stumbled across the Burmester belt-drive CD player. Not only wacky, but original too, it takes some dedication to engineer an unique transport drive system like this for CD. I was impressed, but I was also in Berlin visiting the vast Funkaustellung audio fair, so carrying one off for review wasn't a practical proposition. It wasn't a realistic one either, Dieter Burmester told me at the time, since their products were not sold in Britain any more. They did, once upon a time make a brief appearance, but it came to an early end with difficulties over distribution.

Now that Burmester is to become available again in the U.K. I jumped at the chance of reviewing their attractively styled 937 belt-drive CD player. As you'd expect from an expensive - £5460 - German product, its mechanical engineering is superb. But then, anyone who can engineer a belt drive transport should be able to do a good job with the rest of the player. This model is a top loader: a heavy cover slides back smoothly to reveal the hub onto which a CD is placed. It's held in place by a heavyweight puck that serves also to damp the CD. Slide the cover forward, press Play and the 937 starts quietly, green LED displays showing track number at left and elapsed time at right from behind a silvered window. Everyone who saw the 937 commented on the attractiveness of this feature; only once was it compromised when strong sunlight hitting it straight on overwhelmed its reflective properties, revealing a circuit board and components behind.

As standard, the usual TORX optical and phono electrical outputs are fitted, but high performance AT&T optical and BNC electrical are available as options. The 937 has basic controls on its front panel, but a full complement on the remote control handset, which includes programming. It uses a Japanese protocol, not Philips RC-5 so beloved by the British.

We similarly wondered about the origins of the convertor technology used, to be told only that the company doesn't feel it is important, implementation being the key to achieving good sound quality. Described as 18-bit with 8x oversampling, this could be one of a few Crystal convertors or a Burr Brown chip like the popular PCM64P. It's important for us to know of course, since we follow chip developments closely and compare effectiveness of implementation amongst manufacturers. It's no slight against Burmester when I note that a large majority of

manufacturers work from chip application notes and demonstration models. The 937 appears to be within this grouping rather than the next league up, occupied only by DPA (I024) and Pink Triangle (Da Capo) at present, where the critical one-bit convertor is a dedicated in-house design.

Not that these musings and views colour our assessment of sound quality. It has to be subjective in the end, the 937 being used fairly intensely as a CD source during the final development of our Class A solid-state monoblock amplifiers due to appear in next month's DIY Supplement. We found neither the Audiolab 8000DAC nor the Arcam Black Box 50 convertors good enough for this, which was a surprise, their treble possessing a little harshness through the brutally revealing Class As. We turned to Pink Triangle's Da Capo as one of the very few top convertors suitable for our purposes and it was against this unit that the Burmester was assessed by myself, Andy Groves and David Harris, who describes its sound below.

SOUND QUALITY

The first piece the Burmester played for me (with the emphasis on the word 'played'), was Patience by Guns and Roses. This is an acoustic track which has been exceptionally well recorded - good systems can really give the impression that

Axl Rose is singing in your room. And the Burmester did just this, unnervingly. It seems to 'play' the music adding a little of its own unique character, rather like a musician playing an instrument, which may not be considered very desirable in terms of true hi-fi, but it does provide very interesting and involving listening.

The 937 creates one of the most open and believable soundstages I have ever heard from CD. Every instrument is presented with crystalline clarity and definition. When listening to Puccini's Tosca on the Burmester it was the first time I had ever noticed that the chimes heard in the introduction were also present further on in the piece - previously swamped in a sea of sound, lesser players being unable to rescue them. An almost cavernous soundstage is set up, the full scale dynamics of the orchestra are thrown at you from all directions creating an amazing sense of realism.

The tuneful bass lines on Seal's first album came across very musically, clearly defined and well focussed. Many machines confuse deep, melodic bass lines such as these, making them sound jumbled and difficult to follow. The bass from the 937 could not be described as heavy or overpowering, but it definitely had absolute control and speed. The subtle variations in the tones produced by the plucked double bass on the track Free For All (The Sound of Jazz, Art Blakey CLCD

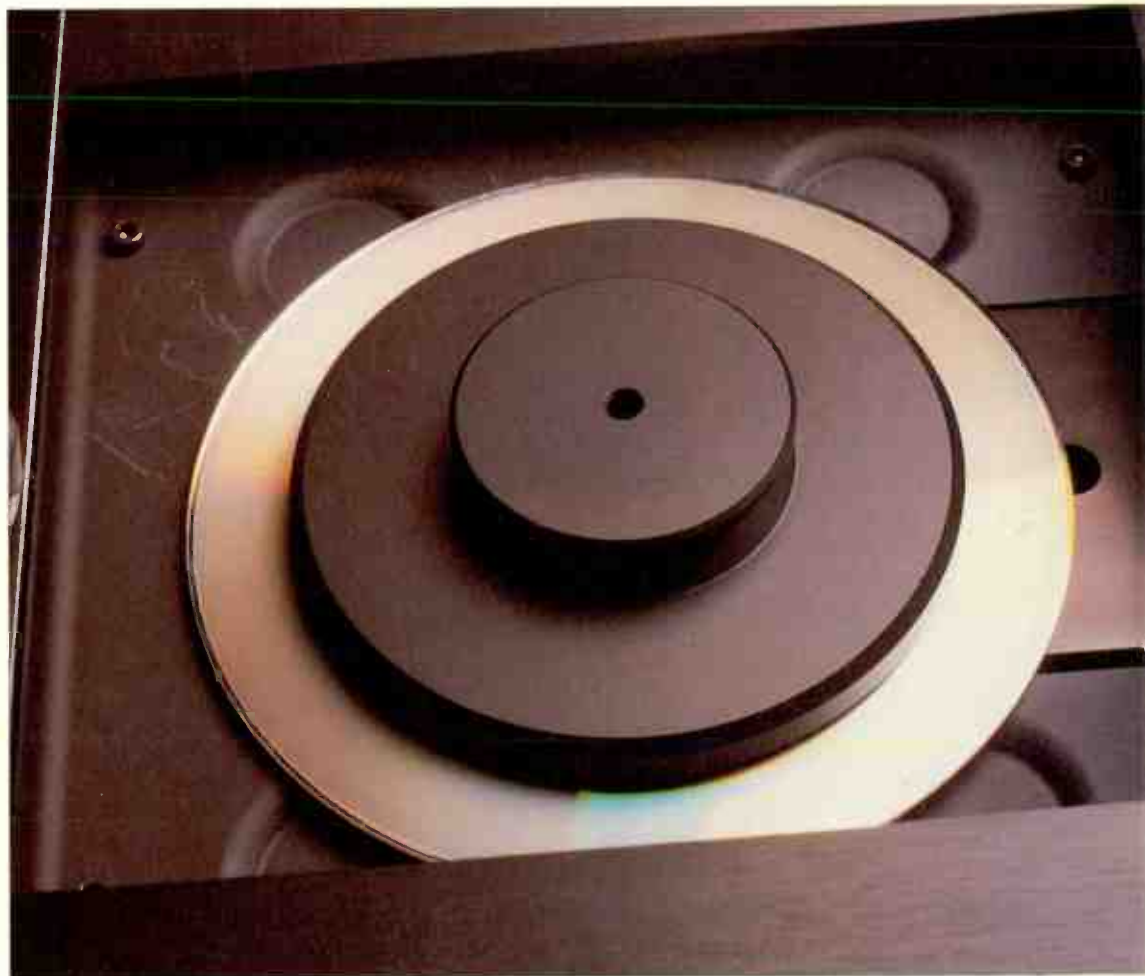

A heavy puck holds the disc firmly in place.

Great tracking

Ortofon is famed the world over for the tracking capability of its cartridges. Cartridges which will breathe new life into a cherished LP collection, divulging detail as never before.

The cartridge is always the key factor in the reproduction of music from records and Ortofon has dedicated nearly 50 years to the manufacture of the finest pick-ups possible. Enjoying constant critical acclaim along the way.

So if you want to bring more out of your records than ever imagined, an Ortofon Cartridge will have you hot on the scent.



500 Series
Moving magnet
cartridges from £30-£100



MC Series
Moving coil cartridges
from £60-£110



Q Series
Moving coil cartridges
from £140-£500



1000 Series
Moving coil cartridges
from £360-£1500

ortofon

Ortofon (UK) Limited, Chiltern Hill, Chalfont St Peter, Bucks SL9 9UG.

Tel: 0753 889949.



Infidelity

indecently good hi-fi



Buying hi-fi should be fun, we guarantee to make it so. Listen to a well chosen selection of quality hi-fi equipment in our comfortable and relaxed listening room. Bring along your own records or CDs, we'll provide the coffee, and hear the difference we can make to your enjoyment of music.

MICROMEGA's fantastic new STAGE CD players now on demonstration

ARCAM, EPOS, HEYBROOK, MICROMEGA, NAIM, NAKAMICHI, NEAT, REGA, ROKSAN, ROTEL, ROYD, TEAC and YAMAHA

9 High Street, Hampton Wick, Kingston upon Thames, Surrey KT1 4DA
Telephone: 081-943 3530. Open: Tues - Fri 10.30am - 7pm, Saturday 10am - 6pm.

Tesseract Audio.

We make them
the way they said
you just can't make
them anymore.

For full details of the Tesseract range of head amplifiers, pre-amplifiers, power amplifiers, turntable power supplies and dealer list contact: Tesseract Research Ltd, Sutton Business Centre, Restmor Way, Hackbridge Road, Wallington, Surrey, SM6 7AH Telephone: 081-669 0011 Fax: 081-773 0406



TESSERAC AUDIO
The Best of British High End

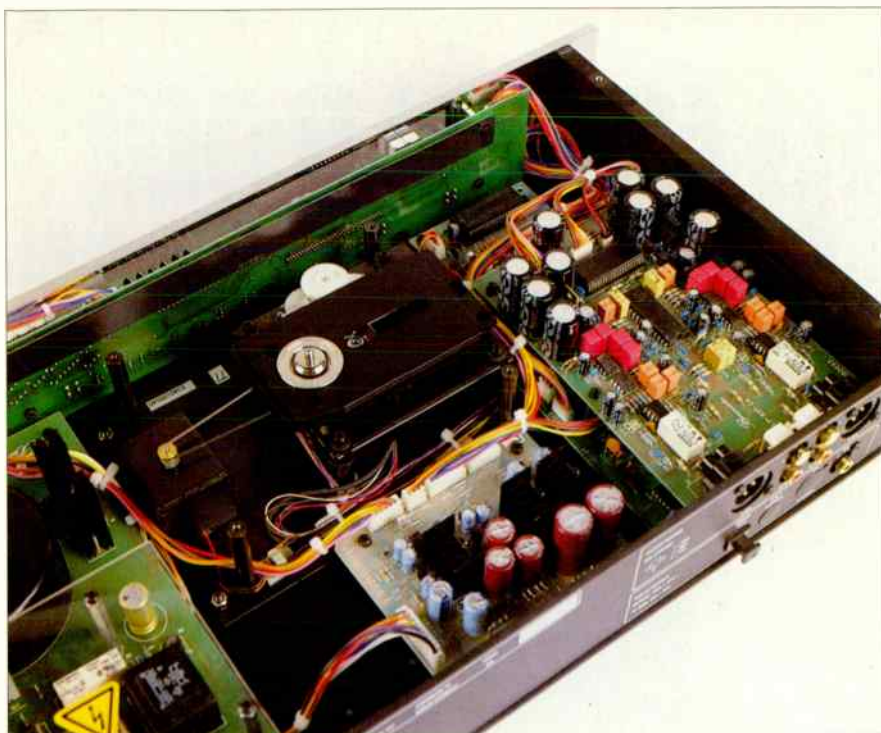

Burmester's unique belt drive transport.

5001) could be heard with astonishing precision, the Burmester easily differentiating them from the sound of the bass drum.

This CD player has the remarkable ability to precisely focus on vocal

performers regardless of the accompanying music. Combined with the natural ambience and pure transparency given from the Burmester, an astonishing feeling of presence was created in the performance.

The high frequency delivery from this machine could be described quite sufficiently in one word: realistic. Cymbals actually had mass and solidity, where some players simply represent them as a sort of lightweight 'tizz'. It is extremely informative and totally absent of grain, which, when combined with the articulate bass results in a sound that has difficulty sounding loud. I found this to be the 937's 'bad' point - I continually wanted to turn the volume up! Many players become too harsh on the ears at high listening levels. This is a CD player that doesn't hide anything, but at the same time it is easy to listen to.

Our conclusion is that the 937 is a fine player, up amongst the best. We would place it ahead of the Arcam Black Box 50 and Audiolab 8000DAC, but not on par with Pink Triangle's Da Capo, which costs less, nor DPA's 1024 which costs a little more. Anyone wanting a stylish, remote controlled player for which matching tuners and amplifiers exist would do well to audition it ●

Burmester 937
Tabula Rasa
No. 1 Silkin,
Dalton Close,
Crawley, West Sussex,
RH 11 9JD.
Tel: 0293 531 190

£5460

MEASURED PERFORMANCE

Like a lot of high-end equipment, the Burmester 937 is a little unusual in its measured performance. The convertor itself isn't very linear; distortion rises considerably as signal level decreases. At -30dB, a level that represents typical average music level on a CD, distortion was nearly ten times that of the best convertors. Convertors equipped with Philips DAC7 (TDA1547) one-bit chip typically measure between 0.006% and 0.008% distortion at this level compared to the 0.054% figure of the 937, but DPA's new 1024 offers similar measured results. The harmonic structure is mainly odd order too, so some brightness may creep into the sound.

At -60dB, distortion rises to an average 1.85%, which limits dynamic range (EIAJ test) to an unimpressive 90.8dB. Again, however, the 937 is no worse in this area than DPA's revolutionary 1024, even though it looks poor in performance against industry-standard chip sets.

Like most U.K. manufacturers Burmester have chosen to roll off upper treble, as seen on the frequency response below, which should help to suppress any CD sharpness, but only subjective tests will reveal the balance they have achieved.

The 937 has a low output level of 1.25V, nearly 40% lower than the Philips standard of 2V. Not only will potential customers have to be careful when assessing this player against higher output

players in the demonstration room, but they must also bear in mind that 1.25V doesn't leave much headroom for use with a passive pre-amplifier.

Elsewhere the 937 measures competently, with low noise and wide separation. As far as measurement goes it's a bit of an oddball, but at this price level a careful audition is essential, bearing in mind that whilst Burmester might be a new name in the U.K. it's a well established company with a fine reputation in Germany. **DB**

TEST RESULTS

Frequency response	4Hz-21.2kHz	
Distortion %		
-6dB	0.007	0.007
-30dB	0.054	0.054
-60dB	1.66	2.03
-90	63.9	61
-90dB dithered	19.4	17.9
Separation dB	left	right
1kHz	120	122
20kHz	96	97
Noise	-107dB	
with emphasis	-107dB	
Dynamic range	90.8dB	
Output	1.25V	

Frequency Response

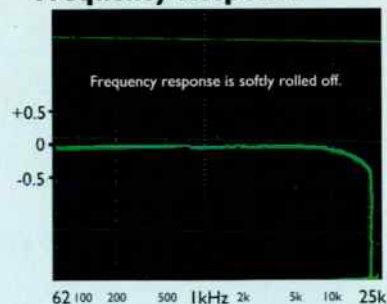

Distortion

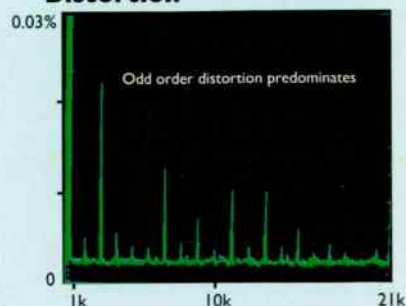

Don't trip up on your speaker cable!



When you invest in good quality hi-fi equipment, why skimp on the cable?

Especially now that Ortofon can offer 3 types of top-quality cable for under £10.

Each cable is made up of very fine core copper strands rated at 6-Nines (that's a copper purity of 99.9999% - it doesn't come much better), is flat and flexible for easy installation and features a 'tack-rack' for panel-pin fixing.

Cable Type	Description
SPK 100	Twin-core white cable, each core with 130 copper strands (total 260 strands).
SPK 200	Triple-core grey cable for bi-wiring with twin-core treble (260 strands) and 3-core bass (390 strands).
SPK 300	7-core blue cable having 13 strands per core (each strand laminated). Requires soldering.

You'd better hound us for the name of your nearest stockist.

ortofon

Ortofon (UK) Limited, Chiltern Hill, Chalfont St Peter, Bucks SL9 9UG. Tel: 0753 889949.



making the most of the music



PETITE



CRITIQUE

neat
acoustics

62 High Northgate
Darlington
Co Durham DL1 1UW
0325 460812

WOLLATON
A•U•D•I•O

The Monarchy



DIP



Digital Interface Processor

The DIP will improve your CD transport by banishing jitter

Guaranteed improvement in sound or your money back

See the review in the May issue of Hi-Fi World and the latest issue of HiFi Choice

£245 + P&P

Available exclusively from Wollaton Audio

WOLLATON AUDIO
TEL/FAX: 0602 284147

VIVA VOLANTE

**Dominic Baker celebrates the
arrival of a new loudspeaker
from Keswick Audio
Research, the £500
Volante.**

The new Volante loudspeaker from Keswick Audio Research looks like any other well engineered British design. It's a nicely finished two-way floorstander, using a custom made silicon-paper bass unit and the familiar SEAS 19mm polyamide soft dome tweeter that finds its way into so many quality loudspeakers. The Volantes come as a handed pair for improved stereo imaging. A choice of finishes is available: satin black, Mahogany and dark or light Cherry.

A good integrated can give you superb sound, avoiding the expense of a separate pre/power amplifier. They don't necessarily have the same power, but the sonic abilities are certainly there - try Sugden's AU2 1a or the Audiolab 8000A for example - and you may well wonder if it's worth spending any more.

Here's where the Volantes step in. Until now there's only really been the Heybrook Quartets that we could confidently recommend to owners of low power, high quality integrated amps. The Quartets are unusually sensitive, 89dB in



Golden Dragon

RETAIL PRICE LIST

Golden Dragon Pre-Amplifier Tubes	Singles
6AQ8/ECC85	£6.50
12AT7A/E81CC/ECC81	£6.95
12AU7A/E82CC/ECC82	£6.95
12AX7A/E88CC/ECC83	£6.95
6DJ8/E88CC/ECC88	£10.95
6SN7GT/ECC33	£8.95

Special Quality Golden Dragon Pre-Amplifier Tubes

Singles	Price
E81CC-01 Gold Pins Low Microphony Low Noise	£10.50
E82CC-01 Gold Pins Low Microphony Low Noise	£10.50
E83CC-01 Gold Pins Low Microphony Low Noise	£9.50
E88CC-01 Gold Pins Low Microphony Low Noise	£14.50

Golden Dragon Triodes

	Singles	Pairs	Quads
2A3 4PIN	£22.50	£50.00	£100.00
2A3 OCTAL	£22.50	£50.00	£100.00
211	£28.50	£60.00	£120.00
811A	£11.50	£25.00	£50.00
845	£36.50	£75.00	£150.00
805	£36.50	£75.00	£150.00

Golden Dragon 300B Range

	Singles	Pairs	Quads
300B Super	£79.00	£160.00	£320.00
4.300B	£84.00	£170.00	£340.00
4.300B Super	£124.00	£250.00	£500.00

Please enquire of any tube types not listed. We have an inventory of over 2,500 different types in stock.

Golden Dragon Power Tubes

	Pairs	Quads	Octets
EL34/6CA7	£25.00	£50.00	£100.00
EL34L (Laminated EL34)	£29.95	£60.00	£120.00
EL84 (Special Quality EL84)	£12.50	£25.00	£50.00
6L6WGB/5881	£25.00	£50.00	£100.00
KT66	£25.00	£52.00	£104.00
KT88 (New Design)	£57.95	£116.00	£232.00
KT88 Super (Laminated)	£67.95	£136.00	£272.00
*KT88 Special (Gold Plated)	£64.95	£136.00	£272.00
6L6GC	£19.95	£40.00	£80.00
6550A	£42.95	£86.00	£172.00
6550A Special (Gold Plated)	£64.95	£130.00	£260.00
50CA10	£84.95	£170.00	£340.00
807	£25.00	£50.00	£100.00

Ceramic Sockets and Hardware

	Standard	Gold Plated
Locking 4 Pin (300B etc.)	£6.95	£15.00
4 Pin UX4 (300B etc.)	£2.5	£3.50
Jumbo (211 etc.)	£14.50	£25.00
Octal Chassis (EL34 etc.)	£1.25	£3.50
Octal PCB (EL34 etc.)	£1.25	£3.50
B9A Chassis (pre amp)	£2.50	£2.50
B9A PCB (pre amp)	£0.95	£2.50
Screening Can & Skirt (pre amp)	£8.50	£8.50
Damping Can (pre amp)	£4.50	£4.50
Power Valve Retainer (EL34 etc.)	£5.50	£5.50

High Quality Plastic Sockets and Hardware

B9A Chassis (pre amp)	£1.15
B9A PCB (pre amp)	£0.95
Octal Chassis (EL34 etc.)	£1.25
B7G Chassis (85A2 etc.)	£0.95
B9A Skirted Chassis	
Socket & Can (pre amp)	£1.75
Power Valve Retainer (EL34 etc.)	£1.95

Carriage charge £2.50 on any U.K. order. Cash with order or Visa - Mastercard accepted. 24 Hour Answerphone Service.

We have a vast range of tubes available from manufacturers all over the world including rare and vintage types. A 50 page booklet of valves available is updated monthly and can be provided at a cost of £2.50 per copy including U.K. postage or you may telephone our Sales Desk for prompt a quotation. VAT at 17.5%.

A selection from our stock of over 2,500 different audio quality valves. Please enquire for items not listed

ECC81	BRIMAR	4.50	LS9B	COSSOR	6.95	6SL7GT	BRIMAR	4.50
ECH81	MULLARD	3.50	M8136	MULLARD	8.50	6SN7GT	BRIMAR	4.50
EC82	GE	4.50	M8162	MULLARD	8.50	6SN7GT	TEONEX	3.50
ECC82	RFT	4.50	M8137	MULLARD	15.00	6SQ7GT	TONEX	4.50
ECL82	TEONEX	3.50	MHLD6	MAZDA	5.50	6V6G	RCA	5.50
ECC83	TEONEX	3.50	OA2WA	TEONEX	3.50	6V6GT	TEONEX	4.50
ECC85	TEONEX	3.50	PCC88	SIEMENS	3.50	6X4	TEONEX	2.50
ECL86	TEONEX	3.50	PL36	MAZDA	3.50	6550A	TEONEX	12.50
ECC88	BRIMAR	4.50	PL504	MAZDA	2.50	12AT6	BRIMAR	2.50
ECC88	GE	5.50	PL509	MAZDA	5.50	12AV6	RCA	2.50
ECC88	TEONEX	4.50	PL519	THORN	5.95	12BA6	WESTINGHOUSE	3.50
EF86	TEONEX	4.50	PY32	MULLARD	2.50	12J5GT	RCA	3.95
EF804S	TELEFUNKEN	25.00	TT100	GEC	65.00	12E1	RCA	3.95
EL32	MULLARD	4.50	U19	GEC	8.50	12E1	STC	15.00
EL85	MULLARD	4.50	UCC85	MULLARD	3.50	13E1	STC	140.00
EL86	MULLARD	4.50	UU5	MAZDA	5.50	13D3	BRIMAR	6.50
EL504	TEONEX	3.50	UU6	MAZDA	6.50	85A2	MULLARD	6.50
EL509	TEONEX	5.50	2X2A	RCA	5.00	1625	RCA	6.50
EL519	TEONEX	5.50	3A/167M	ITT	10.00	5687WA	RCA	6.50
EM84	TEONEX	3.50	5Y3WGTA	SYLVANIA	4.50	5751	RCA	6.50
GZ32	MULLARD	8.50	5V4G	BRIMAR	3.50	5814A	GE	5.50
GZ33	MULLARD	5.50	6AG7	RCA	3.50	5881	USSR	4.95
GZ34	MULLARD	12.50	6A7G	RCA	8.50	6146B	TEONEX	8.50
GZ37	MULLARD	4.50	6BH6	BRIMAR	3.50	6158	BRIMAR	6.50
GZ34	TEONEX	5.50	6C8G	RCA	3.50	6189	SYLVANIA	6.50
KT66	TEONEX	6.00	6DQ6B	PHILIPS	3.50	6201	GE	6.50
KT66	GE	16.50	6K7G	RCA	3.50	6463	UNITED	7.50
						6870	BRIMAR	11.50

EXPORT WELCOME CARRIAGE AT COST

P.M. COMPONENTS LTD., Springhead Enterprise Park, Springhead Road, Gravesend, Kent DA11 8HD, England
Sales Desk Tel: 0474 560521. Fax: 0474 333762

fact, making them suitable for any amplifier capable of providing 10watts or more. But they don't have especially solid or deep bass and their image is rather diffuse. The Volantes, with their custom designed bass unit, handed-pair construction and floorstanding cabinets also have high sensitivity, as well as a focused image and deeper bass.

Their price is right too - £500..It makes them worth stretching to if you own the £460 8000A, but they'd be equally at home on the end of a £1400

Audio Note OTO. say. For my listening tests I used the 20W Sugden AU21a, which has an exceptionally detailed and clean sound, and the sweet and musical 8watt Audionote OTO.

My initial impressions of the Volantes were of

a clean and energetic vocal presentation with bright and unrelenting treble. Longer acquaintance confirmed their brightness, but I decided that the treble was also clean and well focussed - more forgivable than a sibilant harshness. All the same, I decided that this was going to be a 'grilles on' listening test.

On 'Parklife' from Blur's album of the same title, the Volantes gave a very cohesive and powerful presentation. Bass didn't plummet to the greatest depths, finding instead a firm ledge to stand on. From this ledge upwards bass quality was solid, perhaps a little rounded, but tuneful. Lack of deep bass gave the speakers a fast

and light subjective balance, but enough detail was resolved to keep my ears entertained.

The vocal harmonies of the Lemon Trees had a lovely presence and were spread wide across the front of the sound stage. The doped paper cones add just a slight colouration to the upper midband, but the lighter tonal shade of paper is certainly closer to the truth than the character imparted by heavy polypropylene.

Helped by the handed tweeters, the

almost forgotten about it, only noticing the unbalance upon returning to the Quads, which then seemed dull by contrast.

Classical violin on the fone label did reveal just a hint of papery thinness and treble sibilance; it seemed as if a loose peg was producing a sting in the treble. I suspect that this could have been tamed with a steeper order crossover, but at the expense of sensitivity. Personally I'd rather have the energy and delicately detailed presentation of a sensitive loudspeaker

and put up with this sort of slight colouration, but serious classical listeners may disagree.

The Volantes are best suited to light acoustic works with good ambience, or any music with atmosphere and detail in abundance. Here they thrive, giving an exciting and

cohesive performance that reveals information others would hide. Avoid cheap or badly recorded CDs and sharp sounding ancillaries and the results are first class. If you use vinyl, with its softer tone and stronger imaging abilities, the Volantes are definitely worth auditioning ●

“ With The The's Mind Bomb the recording engineer's intentions were clearly revealed. Vocals panned from side to side were smoothly and solidly reproduced, the focus staying true even in the centre of the stage. ”

Volantes image well; even with a multi-track pop mix like The The's Mind Bomb the recording engineer's intentions were clearly revealed. Vocals panned from side to side were smoothly and solidly reproduced, the focus staying true even in the centre of the stage. When the vocalist moved forward on the sound stage the effect was captured convincingly, providing a good perception of stage depth.

Initially, I thought the treble of the Volantes would become fatiguing after a few hours. But because of its clean and undistorted nature I quickly adjusted to their balance. After a day or two, I'd

VOLANTE £499.00
Keswick Audio Research,
54 Coach Road,
Outwood, Wakefield,
W. Yorks, WF1 3EX.
Tel: 0924 870606

MEASURED PERFORMANCE

Keswick Audio Research designed their own bass unit for the Volante, a doped paper cone with high sensitivity. To avoid losing this benefit a simple first order crossover is used to gently roll off the upper midband where the soft-dome tweeter comes in. I measured a healthy 88dB for a nominal watt of pink noise (2.83V) measured at 1m. This means that the Volantes will go louder than most speakers for the same volume control position.

Their response was essentially smooth, with the bass unit response aligned well to the tweeter on the axis of the bass unit. But on the tweeter axes frequency response displayed a treble lift, which will add a brightness to the sound. I'd recommend using the Volantes with the grilles on and sitting below the axis of the tweeter, perhaps toeing them in to cross a few feet in front the listening position.

There should be little difficulty driving the Volantes with a good 20watts. Although they are sensitive their overall impedance is high at 10.9Ω, so they will demand little current also. The impedance curve has quite a strong lift through the mid range and dips strongly in the treble, so high output impedance valve amplifiers will tend to push vocals forwards a little and soften treble.

Overall the Volantes look to be a promising loudspeaker. They are an easy amplifier load and with a little careful positioning should give a smooth and accurate sound, even from low power amplifiers.**DB**

Frequency Response



Impedance

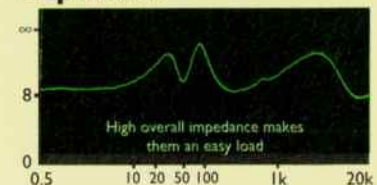

“At Lytte Er At Leve”

(as they say in Denmark)

Hearing is believing
(as we say in England)

It has been the dream of our engineers for 25 years to have a free hand in designing and developing a loudspeaker without constraints of production, price and time. The Oriel is a unique experience in sound, design and construction and represents a development process unsurpassed by any other manufacturer...

The result is stunning
The result is Oriel

Oriel

The Total Listening Experience



Jamo

"The Sound of Excellence"

World Radio History



VALVE ASSISTED

Dominic Baker auditions the Assistant-S, an interesting little valve amplifier from Audio Valve in Germany.

Here's the Assistant-S, a 10watt integrated valve amplifier from Germany where their fascination with gold, valves, glass and hi-fi all come together in one toaster-size amplifier imported by Wollaton Audio. For £875 you can buy the Assistant with a single line-level input. £995 gives the option of four such inputs, but not phono.

The Assistant uses an interesting and unusual valve line up. The output valves comprise two tetrodes in one envelope to give push-pull working. These are supplied from an unusual triple-triode valve amplifier/driver/phase splitter stage. The valves are circuit board mounted on view in the top half of the amplifier. To

avoid burnt fingers a glass top-plate and slatted side panels are fitted to make this essentially a closed chassis design.

The amplifier is nicely put together - there are no loose sockets, switches or panels, but it does feel just a little light-weight considering there are a mains and two output transformers on board.

For the listening tests I used the Audionote OTO SE amplifier as a reference, together with a suitable pair of sensitive loudspeakers having a smooth impedance characteristic to give as easy a load as possible.

The Audio Valve sounded spacious and airy, if a touch on the light side too. That legendary clear, smooth, sweet as

honey midrange associated with valve amplifiers showed true with the Assistant. Female vocals, such as Denise Johnson's on Primal Scream's 'free' or Sonic Youth's Kim Gordon came from the 'speakers with a silky smooth lucidity. They did lose just a little body becoming lighter in tone, but this was through a very revealing pair of 'speakers. On something a little more forgiving, like Heybrook Quartets, this effect was less noticeable.

Like the midrange, the treble offers all the hoped for benefits of valves, a sweet and pure tone free from grain or harshness. Ultimately, this amplifier does lack high treble, which removed some sparkle, resulting in a soft and inoffensive

Electrostatic speakers for the *love* of music

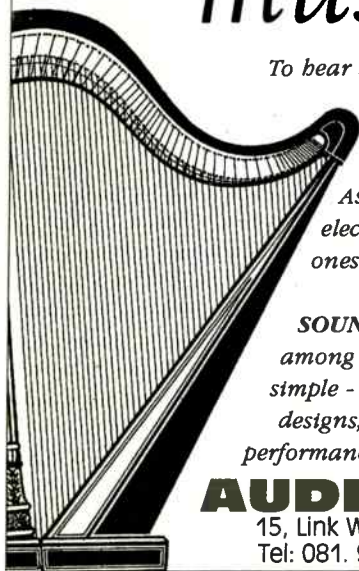

To hear the beauty and intimacy of Claude Debussy's 'Danse Sacree' your Hi-Fi system comes from Audiofreaks.

As it has been known for years, electrostatic speakers are the only ones to recreate the real and natural sounds of music.

SOUND-LAB (USA) is our choice among the very best. The reason is simple - they are the best. Different designs, different looks, first-class performance - all for the love of music.

AUDIOFREAKS

15, Link Way, Ham, Surrey TW10 7QT.
Tel: 081. 948 4153 Fax: 081. 948 4250.



BANDOR

Miniature Loudspeakers
The sound of excellence

BANDOLINE 20 and BANDOLINE 30



Transmission line kits designed to exploit the unique acoustical performance of BANDOR musical loudspeakers which are the product of 35 years experience humidity proof.

Anodised, curvilinear aluminium cones are assembled by hand into robust chassis fitted with powerful magnets. Long-throw, low distortion bass drivers for clean deep bass. THE ULTRA LINEAR DRIVER (see brochure for xmas). Complementary treble section with fast transient response and wide bandwidth, covers $\frac{2}{3}$ rd of spectrum frequency allowing low crossover point - below 200Hz.

Free technical details and prices from

Bandor
Design and Development Studio
11 Penfold Cottages
Penfold Lane
Holmer Green
Bucks HP15 6XR
Tel. & Fax (0494) 714058

Assembled
Bandoline 30
30Hz - 20KHz
size
48 x 13 x 8.5 in
122 x 33 x 21.16 cm

Adagio cantabile

VISIT US AT THE RAMADA HI-FI SHOW, Heathrow
ORTOFON/KINSHAW/PROJECT - FRIENDSHIP ROOM

- STOP - consider all the options
 - LOOK - at all the alternatives available
 - LISTEN - carefully to what is on offer
- With British reviews consistently awarding **** and **** ratings to our equipment, you will not be disappointed.

Overture Integrated Amplifier: "... it offers a quality of sound comparable with models priced at least twice as much and will suit those looking for something that is vibrant and alive, yet tonally neutral and absolutely natural." ... **AUDIOPHILE** June 1994.

Overture DAC: "It's terrific value and a good upgrade if you think your CD player is a bit lethargic or not injecting enough verve into the music" ... **WHAT HI-FI?** August 1994

New product launches every quarter. Ask your dealer for a demonstration of the Kinshaw range and redefine your reference.

Contact your nearest retailer for an audition or for more information ...

KINSHAW

Overseas agent:
Kinshaw Electronics Ltd.
84 Pendarves Street
Tuckingmill, Camborne
Cornwall TR14 8RE
Tel: +44 (0)209 715878
Fax: +44 (0)209 711939

U.K. agent:
Ortofon (UK) Ltd.
Chiltern Hill
Chalfont St. Peter
Bucks. SL9 9UG
Tel: 0753 889949
Fax: 0753 889636

Conceptual Design - Sound Engineering



Tannoy D 700 loudspeakers

"This design is the rare combination of explosive power and fine detailing." Audiophile (07/93)

BRENTWOOD HI FIDELITY

Aura • Audio Innovation • Castle • Chord • Crimson •
Denon • DNM • E.A.R. • Impulse • Marantz • Mission •
Micromega • NAD • Pink Triangle • Project • Quad • Ruark •
Rehdeko • Shearne Audio • Systemdek • Tannoy •
TDL • Thule Audio

Tel: 0277 221 210

2 INGRAVE ROAD, BRENTWOOD
Near corner of Brentwood High St.

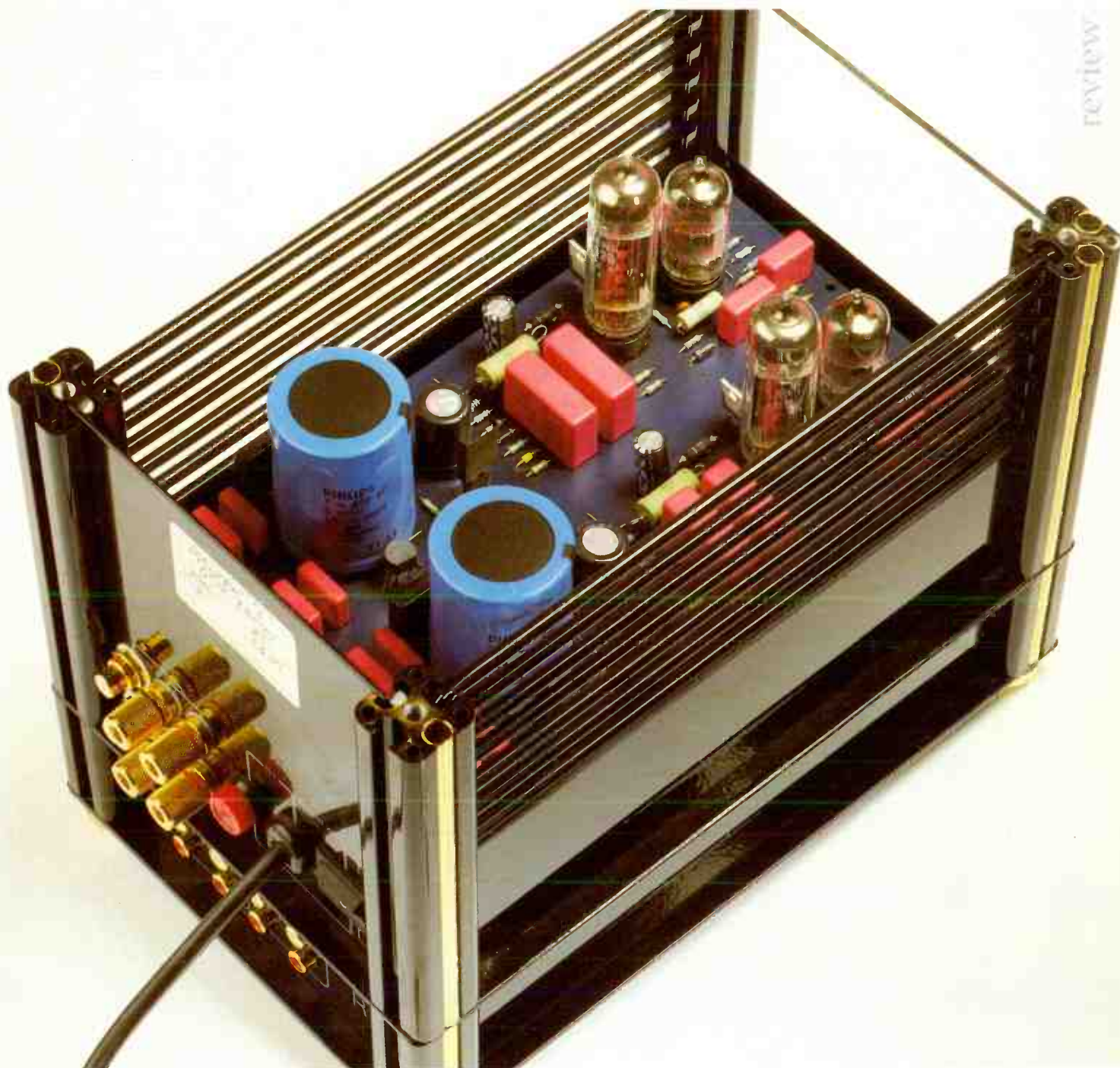

presentation which was certainly more acceptable than solid state harshness. The rattling cymbals on Primal Scream's 'Call on Me' took up a place somewhere in the background, failing to ever make it out past the midrange and into the room with any incisiveness. In fact this softness survives thanks to a little euphonic sibilance, heard on cymbals and vocal S's, which provided the illusion of bright tone very nicely.

Spinning Blur's new album in the CD player the track 'London Loves' punched out with real enthusiasm. Its up-beat pop tempo, electronic bass, vocal harmonies and crack from the snare drum gave the Audio Valve something to really get its teeth into, and for 10watts the result was surprisingly gutsy. Bass lines were followed promptly with reasonable slam, although in truth it's more a colourful bloom than a taut and powerful kick - but enjoyable all the same, keeping time with the swooping and diving melody hovering above.

Out of interest, I tried one of the *f*one classical recordings that we have recently received for review. These are painstakingly recorded with as much attention to detail as possible. For instance, wherever possible original instruments and locations are used for the performance. The recording is then made to a very high standard using valve mics. The disc I chose was "I violini di Cremona", containing simple violin and piano pieces. I must say that although I don't normally listen to classical music, the recording was fabulous. The violin had a superb tone to it, and was well forward of the 'speakers placed just a few feet in front of the listening position.

Although I did notice a slight loss of warmth and ambient detail when compared to the Audionote OTO SE, the Assistent was extremely smooth and had a wonderful tone. It doesn't demand quite the same degree of intense attention as the OTO; more involved listening did

reveal a loss of fine detail in comparison, but it is very easy to sit back and enjoy.

For a few hundred pounds less the Sugden A21a is more brutally clear, forward and defined, while a few hundred pounds more gains the silky fine texture and layered detail of OTO SE. The Audio Valve Assistent-S falls in between these designs, and in some ways can be seen as a compromise between both. When it comes to the crunch, I'd head up or down in price rather than stay in the middle, but that's my choice - yours may well be different ●

Audio Valve
CD only
4 line inputs
Wollaton Audio
134 Parkside,
Wollaton, Nottingham,
NG8 2NP
Tel: 0602 284147

£875
£995

RADIO - CONTROLLED

The new TU-380RD RDS tuner from Denon takes its instructions from the airwaves.

David Harris sits back and lets the radio do the talking.



The latest tuner from Denon arrives equipped with full RDS (Radio Data System) facilities, and costs a penny under £190.

RDS is becoming increasingly popular on recent Japanese budget tuners, which is not surprising as it delivers useful information and simplifies operation, without theoretically compromising sound quality. The RDS EON (Enhanced Other Network, giving emergency announcements priority) facility is particularly useful for the traveller, making it possible to receive local traffic info whilst listening to a national station. This maybe more appropriate for someone who is on the move, but it's a nice gadget for home users all the same.

Amongst other features of enhanced RDS are an accurate clock that receives

time signals direct from the broadcaster, programme search which allows the user to locate stations broadcasting a particular type of music and, of course, the Radio Text facility, which displays the name of the station and the type of music, or details about the programme currently being broadcast.

The Denon was easy to use; it was capable of automatically locating and presetting every receivable station in the area from the instant it was switched on and the RDS facility ensures that almost all of them are named.

The TU-380RD also offers 40 channel presets, a programmable RF attenuator

for regions where high signal strength may cause problems, and a MOS-FET RF input stage for increased sensitivity and selectivity in both AM and FM operation. It can also be operated by a Denon remote audio or AV amplifier handset, but a dedicated remote control unit is not supplied.

Although quite lightweight in build

the Denon looks smart and stylish in its black, slimline, aluminium faced case, but does its sound quality reflect the good looks and numerous facilities?

My first impressions about the Denon were of a light, pleasant, easy-on-the-ear sound, one that will not cause offence, whilst at the same time bringing life into almost any system. An unusually large and tuneful bass blended well with a polite, refined midrange, and when complemented with the sparkly, percussive treble a lively, if a little excited sound was created overall.

On closer listening I began to notice a slight lack of weight behind the music. Instruments such as pianos did not have quite the body given by the best of tuners, leaving the performance a bit empty and lacking in scale. When listening to Rock music however, this was much less noticeable and the TU380RD performed at its best, involving the listener in a lively and exciting portrayal of the music. Even though stereo stage depth and imagery were not in the same league as that of a Leak Troughline, a fairly open and believable soundstage was created all the same.

Speech came across particularly well, human voice sounding

natural and life-like with good focus, giving the listener that valuable feeling of involvement necessary to capture and hold attention.

Weak stations did not cause too much of a problem for the Denon, sounding less dynamic and a fraction more laid back than they would otherwise, and good selectivity was also demonstrated, the TU380RD proving able to receive a weak station's signal when close to a stronger local one with no interference and little change in sound quality.

The tuner achieved very reasonable AM reception, reasonably noise-free and with some bass content too. In fact, I found AM sound quality was well balanced overall and generally quite listenable.

In the TU-380RD Denon are offering an easy to operate tuner packed with facilities at an affordable price. The overall sound quality was essentially polite, light-weighted and lively, and although it may not have the finesse or midrange body found in some of the more expensive tuners on the market it does give a respectable, exciting sound that is good value for money ●

“Speech came across particularly well, human voice sounding natural and life-like with good focus, giving the listener that valuable feeling of involvement”

Denon TU-380RD
Hayden Labs,
Hayden House,
Chiltern Hill,
Chalfont St Peter,
Bucks, SL9 9UG
Tel: 0753 888447

£190



MEASURED PERFORMANCE

Denon engineer a very flat frequency response into all their tuners these days and the TU-380RD is not an exception, as our analysis shows. As a result it will have a basically even and correct tonal balance, free from unnatural emphases.

Measured distortion was very low, except above about 8mV from the aerial, where it started to increase significantly possibly due to front-end overload. The analysis shows low distortion of 0.08% with 1mV of aerial signal, a normal enough performance.

There was little spurious output at 19kHz or 38kHz and hiss was low too, measuring -74dB at full quieting, a little lower than usual and sufficiently low to be inaudible in practice. However, the Denon needed 1.6mV from the aerial to achieve this, making it less sensitive than usual, 1mV or so being a normal figure. Sensitivity figures all round were a trifle lower than usual in fact, not uncommon with RDS tuners.

Like most Denon tuners, the new TU-380RDS measures well, showing no significant weaknesses. **NK**

TEST RESULTS

Frequency response	10Hz-16kHz
Stereo separation	58dB
Distortion (50% mod.)	0.08%
Hiss (CCIR)	-74dB
Signal for minimum hiss	1.6mV
Selectivity (at 0.4MHz)	80dB
Sensitivity	
mono	2.5µV
stereo	30µV
signal strength meter	none

Distortion



Frequency Response

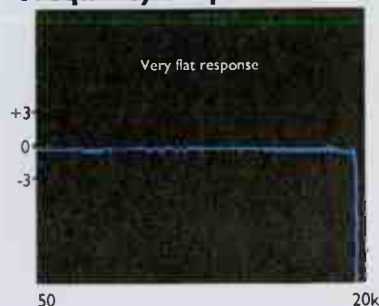

ECONOMY CLASS

Eric Braithwaite flies economy with TEAC's £150 V600 cassette deck.

Are we all fuddy-duddies, stuck in the mud of old-fashioned technology, or is it just that we Brits still have an awful lot of cassettes about still? I suspect a great many people use cassette as a preferred, compact medium for both in-car and personal stereo rather than as a primary source or for taping broadcasts off-air. For the many who do, a machine like Teac's new V-600 at just under £150 shares the virtues of convenience and cheapness. In fact it possesses a couple of convenience factors that used to be firmly

located two or three rungs up on the price ladder. My review sample also possessed a couple of mechanical quirks that belonged a couple of rungs down the price ladder, too, but, being a master of suspense, I'll save those for later.

Unlike one or two other manufacturers whose tape machines have been to slimming classes, Teac are not ashamed of bulk, the V-600 sitting fairly high-and-mighty on its now-traditional four circular feet, with a prow-shaped cassette compartment door that looks like the stem of a Mississippi paddle-steamer. For a relatively thin wedge of notes, the V-600 offers Dolby HX, B and C, automatic tape-type sensing, 'Intro Scan' (which is supposed to pick up and play the first fifteen seconds of each recorded track, shades of CD) and 'Computomatic Program Search'. This latter theoretically allows the user to go directly to a track before or after the one being played. Like the Intro Scan function, however, it relies on there being four seconds of silence between tracks, not something that is common on pre-recorded tapes.

It's unfair to expect miracles of a deck at this price, but the Teac replayed pre-recorded tapes with quite a fair degree of competence and enough flair not to make

direct comparison with my Nakamichi BX-2 too painful. On orchestral music, to be sure, the V-600 had a somewhat flat and under-developed soundstage, but not noticeably squeezed or squashed. With Frederica Von Stade's My Funny Valentine, an EMI chrome tape, there was a good simulacrum of orchestral colour, though a slight dry chestiness to her voice and the whole taking up a plane between the speakers. Observable on other recordings, too, was a lateral spreading and blurring of focus which took the place of fore-and-aft depth.

Comparing Erich Gruenberg and David Wilde's Beethoven violin sonatas on CRD between vinyl and tape showed that though the performance was lively, pleasant and detailed, the two opposite ends of the frequency range were restrained, with lower piano notes softened and the fairly sharp tone of Gruenberg's upper violin notes subdued. It would be unfair to call it dull, since the V-600 is quite a clean-sounding, unmuddied deck in the mid-range, and bass is subdued rather than soggy; 'restrained', but far from displeasing, would be more to the point. In fact, on pre-recorded tapes, the Teac overall was

pleasant and very respectable to listen to.

A slight tilt in the treble, using TDK ferric and chrome tapes, lent a welcome touch of sharpness when recording rock music. Bearing in mind the illegality of recording from copyright material (I wonder what all those blank tapes are used for?) I used one of my own master recordings of a live performance of a country rock band. Mandolin had a slightly steely sound, drums and six-string bass - correlating with the results from pre-recorded tapes - rolled off noticeably in the lowest registers, though without the mugginess and indistinctness on the way down that often spoils the listening pleasure. Vocals, too, were a little more laid back and less clear in the mix than the master, with a degree of uncertainty in their position. Switching back to the master, the lead guitarist was projected more forward and more clearly than on the V-600 recording, while there was more detail on lead guitar. The Teac's version wouldn't have convinced a listener that lead guitarist and singer were in the same position, but the overall effect was nonetheless convincing enough. The same was true for both ferric and chrome tapes, with Maxell varieties showing less



added sparkle.

Although its transport sounded smooth, the servo mechanisms clanked and whinged a bit; the first sample soon became unable to play or record on any of five different metal cassettes and began to falter with other types after a few days. The 'Eject' button also had its moments, for the first few days sticking in its slot.

A second sample, however,

performed better mechanically; recordings on metal tape reproducing a fair amount of detail with a slightly stronger bass and brighter and more detailed mid-range than chrome or ferric, though still subject to blurred resolution, getting a little muddled in the mix, putting backing tracks a little out of focus. All the same, this deck is well worth considering, especially for

those who want to make decent recordings for commuting in the car, but check out a sample first.

V600

£149.99

TEAC UK

5 Marlin house, The Croxley Centre,
Watford, Herts. WD1 8YA
Tel: 0923 819630



MEASURED PERFORMANCE

Teac's V600 suffers from random wow, measuring 0.18%. Speed stability in the long term was poor too; the deck wandered in speed. In my view Teac should go for a simpler, smaller case and spend more on the transport.

The head performed well however, even though bias settings were on the low side, especially with metal tape. The treble overload ceiling (SAT10k) was just -1dB below that for the midband (MOL315), whereas 4-6dB is more common. Had Teac used a higher bias, then midband MOL315 would have been usefully greater. As it stands, with 0VU peak record level set high at IEC0dB flux, recordings should be peaked at no more than +3 with metals, the same or a little less with ferrics and chromes.

The only area of weakness - a common one with budget decks - was head overload at low frequencies, coupled with an uneven frequency response. Together, these effects usually result in soft bass.

Noise was low at -56dB with quiet chrome tape (TDK SA-X) and Dolby out. Dolby B and C produced 10dB and 20dB improvement respectively and sensitivity

settings (record gain) were correct for correct Dolby tracking with modern tapes conforming to the IEC Primary Reference standards. This will allow the Teac to provide recordings of healthy dynamic range. **NK**

TEST RESULTS

REPLAY (pre-recorded tapes)
Frequency response (-2dB) 30Hz-15kHz
Speed accuracy +0.7%
Hiss (70uS, Dolby out) -59dB

RECORDING (blank tapes)
Frequency response (IEC Primary Refs.)
ferric (IECI) 60Hz-17kHz
chrome (IECII) 60Hz-14kHz
metal (IECIV) 60Hz-15kHz
Separation (1kHz) -45dB
Distortion (315H) 1%
Hiss (70uS, Dolby out) -56dB
Speed variations (DIN total) 0.18%
Flutter energy (3-3.13kHz) -25dB

MOL/SAT (IEC Refs) 315/10k
IEC I (ferric) 2dB/-4dB
IECII (chrome) 0dB/-2.5dB
IECIV (metal) 2.5dB/1.5dB

Frequency Response

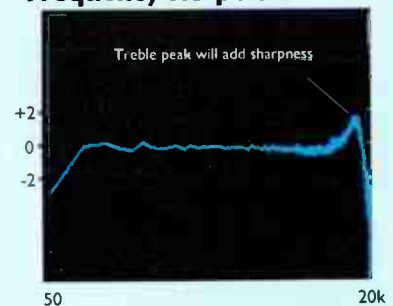

Speed Stability

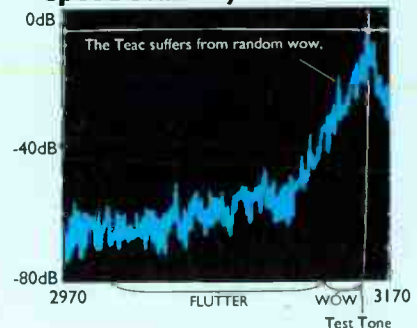

analogue replay

Project

Michell

Townsend

Wilson Benesch

Basis

Pink Triangle

SME

Sumiko

Lyra

Transfiguration

digital replay

TEAC

Pierre Lurine

Micromega

Counterpoint

Mark Levinson

Audio Alchemy

Pink Triangle

valve amplification

Audio Innovation

Trilogy

Audionote

Lectron

Conrad Johnson

Lumley Reference

C.A.T

Copland

Sonic Frontiers

solid state amplification

Rotel

Aura

Jeff Rowland

D I V A

a u d i o f i d e l i t y



The Michell Gyrodeck, a classic turntable now even better with John Michell's new QC Power Supply.

Always a firm favourite of ours with the inexpensive RB300 Tonearm, the Gyrodeck performs even better with SME's 309/IV/V tonearms any one of which forms a synergistic combination suiting a wide range of cartridges - particular favourites of ours being the Ortofon MC 15 II and the Sumiko Blue Point Special the latter is especially versatile due to its high output making it suitable for moving magnet phono stages.

You're welcome to audition the Gyrodeck at its best by phoning Simon, John or Paul at our new shop in Covent Garden - We look forward to seeing you.

18 Monmouth Street, Covent Gardent,
London WC2H 9HB

0 7 1 3 7 9 4 0 1 0

Counterpoint

Audiogram

Primare

Mark Levinson

loudspeakers

Charios

Monitor Audio

Proac

B & W

Martin Logan

Triangle

Audionote

SD Acoustics

Impulse

REL

Audiostatic

Thiel

Klipschorn

Sonus Faber

cables & accessories

XLO

Audioquest

Audionote

Cogan Hall

Silver Sounds

Seismic Sink

Tripod

Framworks

Leider

audio-visual

Harman

Lexicon

JBL



CUE THE MUSIC

Eric Braithwaite spins some vinyl to find what a £400 turntable's made of these days.

Even if you have just a hundred LPs, the cost of swapping colour from black to silver would be at least £1,000. For less than half of that, any of these four turntables would keep those LPs spinning not only for their lifetime, but probably for yours as well.

Thorens' TD166 derives from the '160 and has, structurally, changed little over twenty years. I have a Mk I and it's still going strong.

By comparison, Linn's Basik is a relative newcomer, as is the other Scottish deck, Systemdek's IX/900.

Pro-ject is the youngest of the bunch, imported from Austria via Ortofon UK, which explains why the superb MC15 Super high-output moving-coil is thrown in along with it for effectively a third of its normal price.

All, except for the Linn, possess a floating suspension system where platter and arm are isolated from vibration by three springs - a system devised by Ed Villchur of Acoustic Research thirty years ago. Linn's Basik is the odd one out here, being a basic MDF box that relies upon spongy feet to tune out unwanted vibrations.

Living in a city, I'm plagued by dust, so dust-covers I find essential. All four possessed decent ones, though the Pro-ject's rests on pillars, leaving a gap at the bottom. I wouldn't fuss about this except that while the company's advice to keep the lid off during use is sound enough, the '6 has its sub-chassis exposed above the plinth instead of hidden below, making it a devil to keep clean.

Arms can be upgraded easily on the Thorens and Systemdek, since the armboards can be replaced easily, though a modern SME is a bit too massy for the 900's suspension. Fixing another arm into the Pro-ject would need some care: the sub-chassis would have to be removed. Also, the arm lead is terminated at the plinth in a pair of phono-sockets, which at least allows for a spot of fun changing signal cable types.

Linn use their own arm-base (shared by Alphason) so that limits the range of arm-upgrades somewhat.

All four turntables used felt mats. I prefer rubber, but that's a case for experimentation.

On to the sound quality in a hurry, I think, before I get into deep water . . .



£405.00



The TD166 MKVI possesses a mechanical speed-change controlled by a knob on the top, giving 33/45rpm. There is little to frighten even a novice from putting the TD166 together. It's boxed with the arm and sub-platter already fitted, packed in the order it all goes together, like a live exploded drawing. Thorens provide a neat little cartridge-mounting kit, with screws and even a mirror to check the alignment with, along with a basic but good alignment protractor for the RB250 fitted.

The transformer that used to sit inside the plinth of the old '160 has migrated and is now external, a line version in the mains cable. The mat is made of felt for the UK

SOUND QUALITY

A spot of hollowness in the

mid-range, while it did wonders for adding to the impression of air and space in classical recordings, rather took away the atmosphere from Gary Moore's Live. The band was beautifully laid out and precisely spread between the speakers, every member plain to the view, but we're not talking Beautiful People here, we're talking seriously heavy guitar and power drumming, with some strong lung power in the saxes. Dynamically, the LP was more restrained on the TD166 than on any of the others, neither vocals nor saxes blasting out to the front of the stage. If the RB250 on the Systemdek lacked oomph on this LP, on the Thorens it was a sonic seven-stone weakling. It ain't necessarily so, since on a Townshend Rock it has plenty of power; I wonder if it is really so well-suited to some sprung suspensions.

For the more cerebral listener, the Thorens would come close to the top of the list on classical music. More adept at spatial positioning of instruments than the others, making the best stab at reproducing an acoustic surrounding the players, the TD166 MKVI also pulled off the neat trick of giving aural clues as to what a studio engineer was doing. Sustains lasted longer on the Thorens, particularly welcome in the Beautiful

South mixes; it was the only deck to plot the passage of a pan-potted ukelele (well, that's what it sounded like!) across from left to right. String tone was smooth and silky, along with the woodwind section, by far the most attractive and sweet of the group. It should have scored with the Capriccio, but slightly squashed dynamics made it pleasurable rather than powerful. It occurs to me that a friend with an early version loves it for the more intellectual varieties of jazz, where it has exactly the right tonal strengths.

SUMMARY

I confess to mild disappointment with the TD166 MkVI, having had many happy hours with a TD160 and a variety of arms - albeit pricier than the RB250. It is a worthy performer, but somewhat short on full-scale dynamics, never quite releasing the power of an orchestra in full flight. Tonally extremely smooth, on the verge of laid-back, with good warm timbre in the midrange, the TD166 MkVI subdued some of the sparkle in recordings while attaining a good presentation of fine detail and space. But it is a very reliable, long-lived workhorse, as well as a good platform for a better arm ●



The Basik lived up to its name - it came completely disassembled. The buyer must oil the bearing, install the belt and platter and even the tonearm. The plinth itself is a hollow box of MDF, finished in black with three chunky, flexible composition feet to provide some isolation from vibration. A worthy tool-kit of essential Hex keys is provided, but an irritating quirk, considering the K9 is recommended, was that the bolts supplied with the cartridge were shorter than necessary. I had to find longer ones from my stock of spares.

Like three of these four turntables, changing speed from 33 to 45 involves lifting the well-finished metal platter along with its felt mat and shifting the belt down or up on the pulley. Linn recommend the Basik is placed on a light coffee table; thuswise was the Basik used.

SOUND QUALITY

Linn's K9 cartridge turned out to have plenty of bite, with the raucous energy of Gary Moore Live, the 'young Eric Clapton' powering through the speakers and pounding into the room. Rhythmically tough, tight on the beat and giving little quarter, Linn's Basik set the

pace during this test. However, while its reluctance to image precisely didn't affect the riffs and speedy fretwork of Moore himself, some of the other band members didn't quite come into the limelight so strongly, the backing members - the saxes particularly - staying in the background. Very much an exciting performance, this, though the sense of the band being on stage in public was subsumed by the rhythm and beat, the audience applause and 'buzz' sounding rather dried out.

When it came to Tchaikovsky's 'Capriccio Italien' (an Alto re-pressing on heavy vinyl of Decca's famous SXL2001) it came up with a 'performance' rather than a reproduction of what I believe the engineers put on tape. And I've heard this recording on more turntables than I like to count for - ahem - thirty years. Individually, in respect of tonal quality, instruments couldn't really be faulted, but though melodic lines were eminently foot-tapping, the whole was rather incoherent, seeming to be a piece that was stitched together, one idea after another, rather than being a cohesive creation. It's difficult to explain, but my attention was always either on the cellos or the violins or the percussion, depending on which was rhythmically

strongest, with whatever else the rest of the orchestra was doing cursorily dismissed into the background. In other words, the Basik/K9 was strongest in the bass and mid-range, but a bit short on dynamics in-between, which suits strong melodic pieces.

SUMMARY

This is definitely the turntable for devotees of speed, attack and strong bass lines. While rock and heavily rhythmical recordings were supremely vivid and exciting, even (justifiably) brash, what the Basik did to contrapuntal melodies in classical music was sometimes odd compared to the other turntables in this group. It swung with some, and cold-shouldered others. Image-freaks also need to look elsewhere: rhythm is Linn's priority ●

£400.00

£435.00



Pro-ject's 6.1 has its own arm and can be levelled without resort to coins of the realm underneath, using adjustable feet and an integral spirit-level. Less attractive is the arm's use of thread-and-weight bias, a fiddly affair.

It has a flimsy instruction manual. A three-point suspended sub-chassis rides above the plinth, the arm mounting being integral with one of the three outriggers. The arm is the flimsiest of the three, with the least effective arm-rest and a cueing action that owes everything to gravity and nothing to damping (the stylus comes down with a bit of a wallop.) It performed well, all the same. A threaded spindle holds a record clamp. An add-on sleeve can be fitted to the pulley to play 78s.

SOUND QUALITY

By far the best with Gary Moore's Live album, the Pro-ject powered out the rasp of saxes and the guitar riffs with aplomb, making Moore sound more like Clapton than ever before. A tight, sharply defined soundstage put the band on a near-visible stage, with nothing missing, not even the drummer's occasional tinkles on triangle, set way back. It gave a very homogeneous performance, with a good smoky atmosphere and that sense that a live audience was driving the players along - something none of the other turntables attained. Saxes were tremendously brassy and large, while Moore's vocals were well out in front, as they should be. Fast and fierce, the 6.1 had the best dynamics of the lot on this recording, only tripping over its own feet when the rhythm got a little too speedy for it. Then, it hardened the guitar tone and came near - but just avoided - slurring some riffs. Of all four turntables, Moore's voice sounded most accurate on this one.

And on to Tchaikovsky, where, when it came to the brass section, the Capriccio blared out of the speakers with undiminished enthusiasm and pizzicato strings plonked with great

vigour. String tone, among the violins, was less satisfactory, rather on the cold and thin side, lacking fullness of colour. Woodwind was very respectable, though despite a competent breadth of image, with the orchestral sections well-placed, the Pro-ject couldn't quite pinpoint the fact that there were several individual instruments playing rather than just the woodwind. Horns and trumpets were superbly brassy, though in Gershwin's American in Paris slide trombone had a rather papery rasp. I'd have liked some of the sweeter string tone of the Thorens, but you can't have everything.

SUMMARY

Potentially the best of the bunch, the Pro-ject came nearest to portraying full-scale dynamics, with the tautest, deepest and most rhythmical bass of any bar the Linn Basik. A good tight soundstage and fine detail was marred only by a degree of thinness at the top end, and a slight loss of grip on complex mixes. The 6.1 gave a very full, strong sound, in itself the most exciting and lively of any model but the Linn. I suspect the arm needs to be just that bit better, or quality control on it a spot tighter ●

£415.00



Visually clean and uncluttered, neatly veneered in light ash, fresh out of the box the Systemdek IIX900 smelt wonderfully of sawdust and carpenter's shop. Mine had no instructions, which was odd, but it was simple to set up. A screw which holds the sub-chassis tight has to be unscrewed to let the suspension float; oil has to be induced into the bearing (Systemdek provide a small syringe) before the sub-platter is placed in position, but this takes only a matter of minutes.

Like all the other turntables in this group, except the Thorens, speed change is manual, performed by lifting off the felt mat and glass platter and shifting the belt on the pulley. The Rega arm has no tracking weight markings on its counterweight and counting the turns to set it seems imprecise; a tracking force gauge is best used.

SOUND QUALITY

In some ways, you couldn't have wished for more from Moore when his album was spinning on the Systemdek. Reproducing more individual notes than any of the others, quite impartially, the IIX900 laid out the whole band between

the speakers with marvellous definition. Unfortunately, the sense of excitement of a live performance failed to appear, since the guitar lacked that extra bite and attack that puts you on the edge of the seat.

The '900 wasn't really raucous enough; saxes, fine and fruity in tone though they were, dynamically sounded a touch restricted. And while there was a good sense of atmosphere, there wasn't really enough oomph behind the bass to power it along with the vigour it ought to have. On Beautiful South's 'The Rocking Chair', bass appeared tougher and tighter, while the girl's vocals were by far the most intelligible.

Few decks in this price bracket can really cope with the shading of timbre of orchestral instruments, particularly among the woodwind and strings. On the Systemdek, the darker-toned strings in the Capriccio were particularly good, with good definition among the woodwinds, which is something of a rarity. The brass section, compared to the Pro-Ject 6.1, had a firm overall quality, but more constricted dynamics.

For sheer even-ness, the Systemdek scored highest, performing very well on orchestral music, with the best individual instrumental differentiation of all four

models tested. A sweeter violin tone and warmer woodwind à la Thorens would have been a welcome bonus, the IIX900 being a little dry in this area.

SUMMARY

Deserving its high reputation, the Systemdek made full use of the RB250's capabilities. A very detailed soundstage, with a good broad image was allied with a wider and more even range of tonal colour than any of the other decks in this group. Although large-scale dynamics sometimes proved a struggle, the IIX900 didn't compromise on speed and attack, always producing a lively and entertaining performance, helped out by firmer bass than can usually be expected from this arm ●

SONIC INTEGRITY



Creek Audio Limited
2 Bellevue Road, Friern Barnet,
London N11 3ES

Telephone: 081 - 361 4133 Fax: 081 - 361 4136

CONCLUSION

To begin with all four turntables were checked out with the same cartridge, an Ortofon MC15 Super, to establish any fundamental differences. Surprisingly, with the cartridges supplied the same qualities were discerned.

Mechanically, none suffered any problems, though the three suspended-sub-chassis models needed care cueing the arm down and none were impervious to knocks. The Thorens, was the smoothest on start-up, the others juddering a little as the motor picked up speed.

All four arms (remember, the Thorens and Systemdek have a Rega RB250 in common) had a slight 'zing' in the treble, which constricted tone in the violin section. Of the two Rega-armed decks the Thorens was marginally better-controlled - or at least smoother - in this area, though the Systemdek produced a broader lateral image spread and somewhat deeper and tighter bass. Pro-Ject's arm suffered occasionally from run-away enthusiasm, which delivered taut and exciting performances, but muddled the strings in Stravinsky's *Petroushka* and made them fizz rather more than its rivals.

Where the Pro-Ject scored was on acoustic classical guitar. José Ferrer's 'Vals' has some very fast arpeggios, which the Pro-Ject handled with tremendous verve, just on the verge of falling off the edge, but with a precise central image and very good overall tone, with the pitch more believable than the other turntables, which tended to have some notes either a trifle sharp or a trifle flat. It was the only one of the four to place the instrument in a full surrounding recorded acoustic.

The Systemdek had equally good tone, but the instrument was less well integrated, the higher notes rather sharp, and it had just a fraction less punch, with the two hands seemingly separated by a longer guitar than it should have been.

The Thorens produced a slightly too resonant, but attractively guitar-like sound, like the Systemdek rather spread over the sound of the location as it were, and by comparison with the Pro-Ject it produced a somewhat mundane, even rather slow, portrayal.

Linn's Basik has strengths - and very

muscular, beefy strengths they are too - that are also its weakness. Gershwin's 'American in Paris' sounded by far the fastest, and punchiest of the lot on the Basik, but with a series of spotlights on the rhythm section rather than on overall subtleties. A complete sound picture of a carefully arranged and recorded orchestra there was not, the image's constituent



parts sat at left, centre and right with little in-fill, or they ballooned forwards, making it difficult to get a grip on the whole picture. The Basik is for people who like their music fast and furious, well-forward and rock-solid, rather than for subtle nuances.

Curiously, when it came to solo instruments, tonally the Basik/K9 suffered practically no disadvantages, passages being handled with real quality and splendid dynamics, woodwind as woody as the Thorens, the best of the four here, brass as bright as the Pro-Ject and strings with an element of real sweetness.

For all-round satisfaction, the 'other' Scottish turntable, the IIX900 from Systemdek gained top marks, displaying the most balanced sound. Inevitably there

were compromises: a decently extended though not too well-defined bass against the Pro-Ject's clean and taut one and the Linn's unmistakable and energetic power and solidity. Least satisfactory, however, was electric rock, the Systemdek requiring some of the zip of the Pro-Ject to bring Gary Moore's album to life. Despite being partnered with a cheaper Goldring cartridge than the Thorens, it gave a better sense of orchestral and musical dynamics, since the Thorens seemed to mildly compress on full-scale climaxes. On grounds of sheer overall clarity, both on *The Beautiful South* album and the classical material, the Systemdek nosed nicely ahead of the other three.

In brief, the winners are: best for exciting rock, or solo acoustic material, the Linn Basik/K9. Best all-rounder for a wide variety of rock and classical, the Pro-Ject. Best for jazz, the Thorens; best and most balanced compromise for everything, Systemdek's IIX900. And, looking to the future, most upgradeable, bearing in mind this can comprehend both power supply and arm, the Systemdek; most upgradeable arm-wise, the Thorens TD166 Mk VI. I'll leave it to you to decide on your priorities ●



NEXT MONTH - WE TEST
FIVE OF THE BEST
PHONO HEAD AMPLIFIERS
UNDER £1000.



World

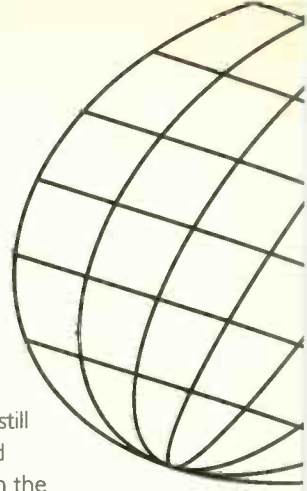

IMAGES DO EXIST WITH LINN

In the May '94 issue you kindly printed my views on imaging. A couple of days after the May issue hit the news stands I received a phone call from a chap who introduced himself as Mr Morgan from Linn Products and commented in a slightly menacing voice that he'd read my criticisms of Linn. Something wasn't quite right though. Our friend had a rather thinly disguised 'Scouse' accent, not an uncommon phenomenon in these parts. When I pressed Mr Morgan as to where he was based he cracked up and confessed to being another hi-fi nut, about half a mile away from my house. He was not at all connected to Linn!

A long conversation ensued during which my new found fellow enthusiast described how he had spent years trying to get his Linn based, but modified system to image. Then came the magic words "would you like to hear it?" Is the Pope a Catholic? A few days later I was welcomed into a dedicated listening room to die for. The large and beautifully furnished room contained a 'full spec' LPI2/Ekos/Arkiv turntable feeding a full active Isobarik system. The amps are LK2s all Sparked and controlled by a Kaim pre-amp. The turntable sits on a bizarre looking Dyer support comprising a triple glass and spike sandwich with some form of damping material around the spikes and sitting atop a sort of camera tripod arrangement. One wall was completely lined with Ku Stone panels, another with thousands of records. Perceptive as ever, I made a mental note. 'This guy is keen... and loaded!'

Before firing the system up, Ian (formerly Mr Morgan) gave me a guided tour. The whole system has been modified using Russ Andrews power supply components: mains cables, circuit breakers, power supply capacitors, the lot. Ian speaks in glowing terms of the Russ Andrews philosophy and how it has transformed his system. Like

any true hi-fi obsessive he hasn't finished yet and waxes lyrical about hoped for future upgrades to interconnects etc.

How does it sound? Well it certainly images. There's a deep, almost tunnel like and three dimensional sound stage which leaves you in no doubt as to the intentions of the recording engineer. A very minor quibble is that the

sound stage is still confined between the speakers, but the general topography of the room and the listening position means that this matters little.

Ian has tweaked the crossovers, resulting in what to me is a slightly bass heavy balance, but then I don't often

MATCH WITH CARE

I usually read equipment reviews with considerable scepticism and wish that editors could find more useful matter to fill the magazines, as was the practice before about 1980. In general, combinations of "Best Buys" sound horrible. I was impressed however by the enthusiastic review of the NAD 402 tuner (Jan 1994). I live at the limit of good reception from the North Hessary Tor transmitter in Devon and my aged Sony 3950 had become very difficult to tune, so I felt a change was justified.

I therefore set forth to find an NAD 402 at a dealer's who would let me try it at home before buying. This was surprisingly difficult, but I eventually tracked one down. My system is modest, but well-matched: a Musical Fidelity B200 amplifier driving Spendor BC1 speakers. The dealer did not have Spendors or even Rogers, which have a similar

sound, but produced a mid-priced, mid-sized pair from a well known British maker, likewise a well-reviewed British 50-watt amp. I listened in eager anticipation; the sound was awful, over-bright, oversibilant and brittle. So much, I thought for HFW reviews.

Another tuner was produced, again well-reviewed (not HFW) with RDS and a plethora of buttons. This sounded a little better - not good, but better. There was a trace of hiss, suggesting lower sensitivity. The obvious course was to take home this tuner to see if it was noisy at my location. It was, moreover with "birdies" on Radio 3. The sound was not much good either, far inferior to my old ST3950.

At this point I became worried. Was it necessary to spend a great deal more money to get acceptable results? Had the whole exercise to be aborted?

I returned the tuner to the shop and took home

the NAD. I plugged it into my set-up and switched to Radio 3, expecting the worst. The result was amazing; the sound was clear, sweet and above all musical, with a completely silent background. The system of presets was simple and sensible. To sum up - I was delighted.

The point of my letter is this. Careful matching of items of equipment is essential and so-called "qualified" staff should be aware of the characteristics of well-known items and be able to advise accordingly. NAD could have lost a sale here.

Last winter my wife and I attended a demo of well-known, costly, British amplifiers. They are known to be good, but played through the speakers provided (quite expensive) they were heavily criticised by most of the people there. Speakers in particular seem to fall into definite groups, eg. BBC (Spendor, ATC, Rogers), full-sounding

Letter of

Send your letters to Hi-Fi World Letter Page,

writes

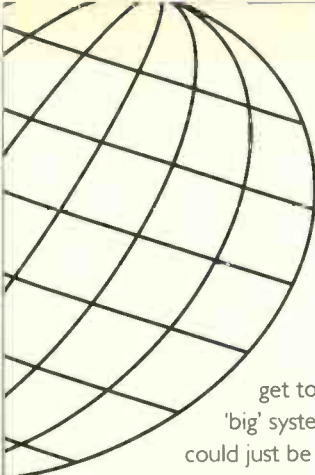

get to hear a 'big' system so it could just be a case

of what you get used to.

The real magic though is that this system has one of those sounds which are wonderful to hear, but difficult to describe. Sheer power and loudness capability is both overlain and interspersed with a sense of delicacy which

leaves you breathless and at the same time draws you into the music. All this is a million miles from what to my ears can be the dry and mechanical sound of Linn.

Conclusions? 1. Imaging does exist. 2. Linn stuff can image. 3. I need a bigger house!

**Colin Berresford
Lancs.**

Perhaps Linn ought to have a listen to Mr Morgan's system too. **DB**

ROTTING COMPACT DISCS

Having recently read your rotting CD article (June '94 issue) I was prompted to write to you today, having just purchased a rotting CD from W.H. Smith. The disc in question is The Best of Incantation purchased in a jewel case and manufactured in England (UK) by PDO! This disc is very discoloured. (NAGE 100CD)

This prompted me to go through my whole collection and to my horror all the discs listed below are showing advanced signs of rusting. All were purchased and kept in jewel case and all purchased within the last two years - some only a month or two ago as new releases! All by PDO UK.

Joe Cocker - The Legend

(Polygram TV SIS 411-2)
U2 - Rattle & Hum (Island CDI U27)

Elton John - 17-11-70 (DJM 512 854-2)

Mellissa Etheridge - Brave & Crazy (Island CID 9939 842 302-2)

Mellissa Etheridge - Mellissa Etheridge (Island CID 9879 842 303-2)

The following album has no reference to PDO, but is manufactured in the UK and is very discoloured.

Tangerine dream - Rubycon (Virgin CDV 2025)

Please advise.

**Robert Stares
Sawbridgeworth,
Herts.**

As you can see from the letters below, PDO are sticking to their word and promptly replacing any discs made by them that show discolouration. Thank you for sending in a detailed list of

continued on page 54...

the Month

(Tannoy, MA) etc, and dealers should have suitable ones available for demonstrating other items, even if they do not actually sell these speakers.

Finally, I now have a completely satisfactory tuner. Thank you HFW for guiding me in the right direction.

**Mr D Pearson
Dartmouth,
Devon.**

I'm surprised that the NAD 402 sounded so bad at the dealers. It seems as if there was something seriously wrong with either the system or the aerial. I can't understand the former, but for many dealers in town locations with masses of electrical equipment and lighting nearby, and jammed between other shops and what have you, getting good FM reception is a serious problem. It only goes to stress the importance of a home demonstration, especially with tuners which are so

dependent on the aerial and its location.

From our side of things, tuner testing is difficult, demanding experience in RF engineering, quantities of expensive test equipment and, of course, a very good aerial set up with defined signal levels that must exceed 1mV on major stations in order to ensure the tuner under test is being worked optimally, i.e. in full quieting. A Leak Troughline is used as a reference. Trouble is, whilst all this is laudable, it isn't necessarily representative of any one individual's situation - and nor can we devise anything that would be. We do our best not to misrepresent a manufacturer's efforts and products and mislead potential buyers, yet this isn't necessarily enough, showing yet again the need for home demos and the value of a co-operative dealer. **DB**

64, Castellain Road, Maida Vale, London W9 1EX.

WIN HI-FI WORLD INTERCONNECT CABLES

OR PERFECT PITCH'S FRANCINSTIEN CD

ENHANCER

The writer of the most interesting or funniest letter will receive a choice of either: a free set of Hi-Fi World's silver plated copper interconnect cables, worth £69.95, or a Francinstien CD converter enhancer worth £150.



We didn't know how our original DIY 300B valve amplifier design would be received. In the event we were swamped by interest. Rare and esoteric this amplifier may be, unpopular it was not, especially in the Far East and the States. The 300B valve has more of a reputation than we knew.

Our first prototype worked well, but production engineering a kit is another matter altogether. Long term reliability and safety have to be taken into account, which brings in a host of extra considerations. It took us roughly six months to overcome some of the most peculiar and intractable problems I have ever come across. Here's a brief history explaining the delays, why the design has changed and what our 300B kit, now in stock, has to offer.

I thought the original driver transformer screening cans were Russian surplus tank parts. Made from steel 3mm thick, I'd never seen such construction. "Why does 300B have to survive the next nuclear war?" I asked their designer facetiously. "Good driver transformers are very difficult to design" I was told. "Every so-and-so will try to copy mine so I want you to pot them in cans that are impossible to saw open. Put steel ball bearings in the potting compound so that if they get through, the balls will break the blade". It sounded like something from Raiders of the Lost Ark.

Andy was down on his luck. "Can you design driver transformers?" I asked. "Yes, I've done quite a few". "Then I've got a job for you".

All designers have their own ideas and Andy Groves had his. For the production version he felt things could, with benefit, be done differently. The ECC83 front-end

went out, replaced by a 6072 which is designed for low noise and microphony. "It's similar, but it has a clearer sound".

The ECC82 driver valve was replaced by a 5687 which disipates 4watts per channel. "It's dead linear, needs less drive

“The re-design and re-prototyping delayed 300B for six months. However, the final design is now so linear that feedback has been removed and made optional - it can be switched in and out on the back panel.”

and has a low output impedance”.

The all-important driver transformer posed some interesting and difficult problems. Getting a symmetrical square wave out of the thing was the crucial test and finally, with a particular winding arrangement, we got it, together with good audio bandwidth - without resorting to feedback. The use of driver transformers is a major difference between our 300B amplifier and most others.

We got the new prototype up and running, but with large amounts of heat being dissipated in a relatively compact

chassis, running tests showed that after 12 hours or so the chassis was getting hot. The chassis was redesigned.

The new chassis was fine, but during soak tests a GZ34 rectifier started arcing internally, making some fearful cracking sounds; then another went. Whilst original Mullard GZ34s, rated at 550V, had worked perfectly, Chinese and Russian versions, we found in these tests, had a short life of just weeks. The original Mullard GZ34 was a very precisely made rectifier with small clearances, in order to make it compact, minimise losses and reduce heat production. Modern versions do not match it, so we chose instead a bridge rectifier for reliability and to cut electrical losses and heat production. A GZ37 was employed as a slow start series diode. From that moment on, our power supply problems vanished. There are plenty of original GZ37s around, beautifully made to military spec. and priced at just £5 or so.

The first smoothing capacitors needed to be increased in value to reduce ripple on the H.T. line, so we resorted to electrolytics, retaining polypropylenes for use after the choke, where they were needed most to pull the H.T. line down to ground with respect to a.c. The polyprops are manufactured to our own specification using an audio grade metallised film.

Finally, we ran long listening tests on the new design to optimise subjective component balance. Here we found, for example, that although we all liked the sound of modern paper-and-oil capacitors, Solen audio grade polyprops got close but, by not being leaky, were potentially more reliable. Reliability and safety are both very important of course. Experimenters can substitute components of their choice at a later date.

The re-design and re-prototyping delayed 300B for six months. However, the final design is now so linear that feedback has been removed and made optional - it can be switched in and out on the back panel. I prefer it switched out, finding this gives greatest stage depth and most 'freedom' in the sound. But with loudspeakers having a strongly varying impedance characteristic it is best switched in, to reduce the amplifier's output impedance from around 6Ω to 2Ω or so.

This amplifier is a fine match for electrostatic loudspeakers, delivering a good 28watts per channel, or 60watts in monoblock form. With 280mV input sensitivity (feedback in) 300B needs no preamp, just a passive volume control, except with LP of course.

Although built like the Forth Bridge, possessing no fewer than seven transformers bolted down to a rigid welded steel chassis, this sort of amplifier is simple and elegant in its circuit topology. There are just four active devices and no feedback - how much simpler can an amplifier get? It capitalises on the innate strengths of the 300B

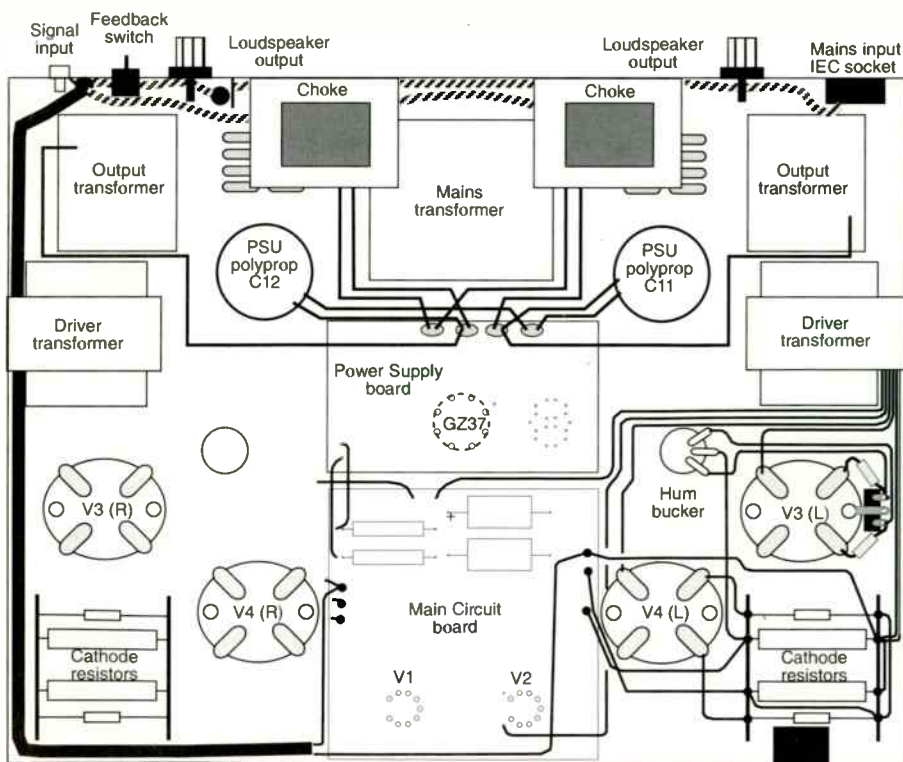

DEVELOPING 300B



Scott Kuykendall explores the development of our 300B six tube amplifier.



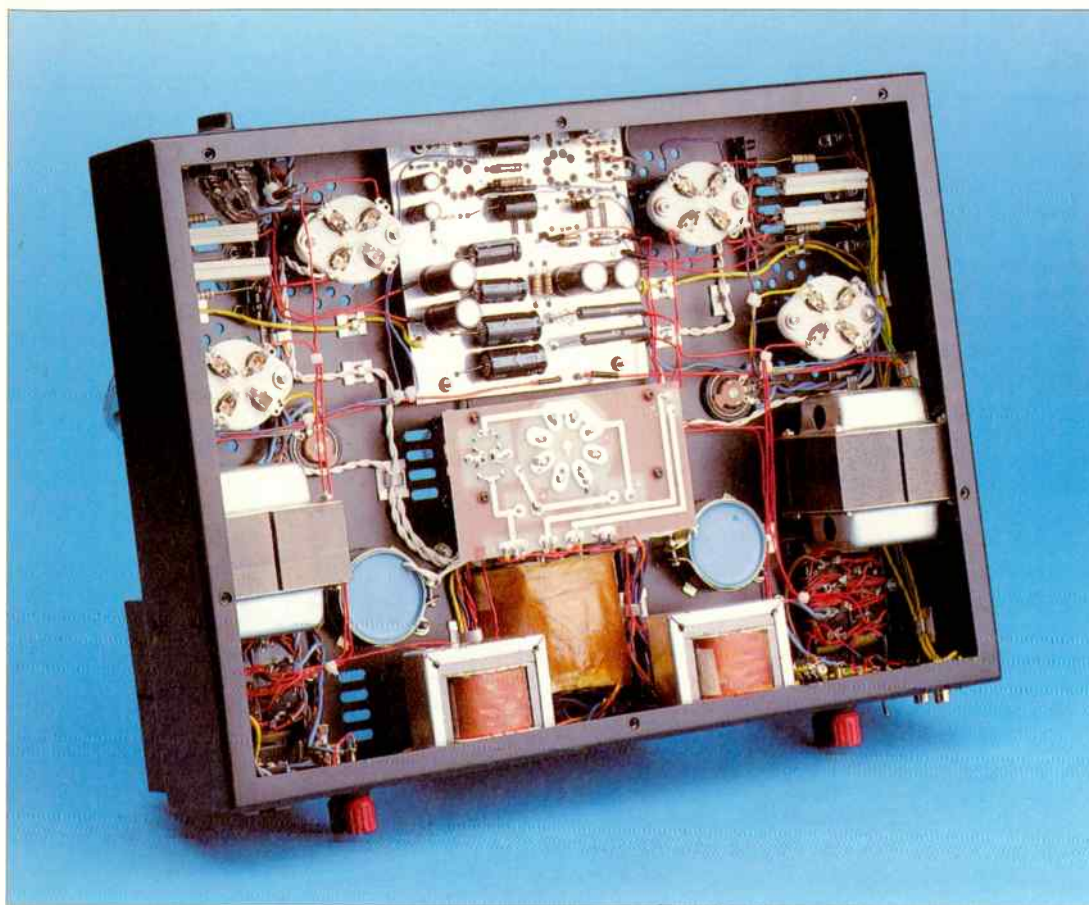

power triode to give a super smooth sound with superb sound stage dimensioning, offering a standard of reproduction not really available from today's overly complex, feedback-reliant solid state circuits.

Theory of operation

The signal input reaches V1 grid through stopper resistor R2, grid leak R1 setting input Z at 100k Ω . The first stage applies gain, developing the amplified signal across anode resistor R5. This is coupled through to the grid of the 5687 by C3 which passes a.c. but blocks d.c. from the H.T. line. This is a fairly critical component. Although paper-in-oil capacitor construction gives good sound quality, these capacitors can leak. Were this to happen, it would bias the grid of V2 positive and possibly burn out the phase splitter transformer, so C3 has been made a reliable, high voltage Solen audio grade polypropylene capacitor.

The 5687 driver valve applies gain and develops the audio signal across the primary of the phase-splitter transformer (T1). This supplies signals in anti-phase to the two 300B output valves (V3,4), so one pushes whilst the other pulls through their respective sections of the output transformer primary (T2).

The standing current passing through the output valves develops 95volts across cathode resistors R12,13 which effectively biases the grids negative by this amount, since they are held to ground at d.c. by secondary winding resistance of the driver transformer. This system is known as auto-bias. It has the advantage of providing automatic compensation of

valve characteristics, so valve matching and adjustment aren't necessary, although matched pairs of valves are still recommended. It also gives that sweet, easy sound valves possess. Fixed bias gives more power, but a harder sound.

Since with directly heated valves the heating filament is an electrode carrying 5V a.c. through it, to avoid hum the audio signal is applied in balanced fashion by the resistor networks R14,15,16,17,18, adjustment on one valve allowing any imbalance to be cancelled out by hum cancelling potentiometer R14.

Feedback is applied through R10,C8 from the output back to the input, by developing part of the output voltage across R4 to oppose (i.e. negative feedback) the signal through V1. R10 determines the amount of feedback and C8 the phase shift of high frequencies to avoid instability. The values chosen give a good stability margin and clean square wave response; we don't recommend they are changed.

Feedback has been made available to lower output impedance and improve speaker matching when speakers of strongly varying impedance are used (this is a speaker problem, not an amplifier problem). It isn't used to "improve" the amplifier in any way and, indeed, it doesn't do so. It can be switched off by a switch on the rear panel.

Sensitive valve amplifiers with high input impedance suffer from hum/induction loops more than solid state designs, meaning more care is required in certain respects. An earth lift resistor (R11) prevents hum occurring (from a hum loop) when other items such as a

prolonging the life of the relatively expensive 300B valves by running up H.T. after their heaters. The reservoir capacitors C11,12 are high voltage polypropylene types that hold the H.T. line to ground at all a.c. frequencies and are specially designed and manufactured for this amplifier. Chokes L1,2 provide smoothing and decoupling of the H.T. lines.

The 4 Ω /8 Ω output transformer has been carefully load matched for minimum distortion and to maintain matching (even though triodes are very load tolerant). The 16 Ω tap is for monoblock working. It allows the channels to be paralleled, increasing output from 28watts per channel to 60watts from one channel.

Separate 100/110/120volt and 220/240volt mains transformers are available for efficiency. For anyone wanting to build this amplifier in its entirety we offer a transformer set comprising mains transformer, two output transformers, two driver transformers and two chokes. We do not sell these items individually.

A full kit is also available with welded steel chassis having a special black 'powder coat' finish that is smooth and durable. All parts are provided, including bottom plate, safety gloves and mains test screwdriver. A top cover is not available and since 300B valves run hot and can burn, this amplifier may not be suitable where there are young children or pets. Since valve choice at this level is often personal, the kit comes without valves. We can supply a set of valves however. All the valves used are commonly available and are likely to remain so ●

preamplifier are also earthed and have their metalwork connected to 300B through signal cable screens. Input signal cables (L&R) must be run together and alongside their earths too, so twin-screened cables should be used.

The power supply uses high voltage diodes in bridge rectifier form feeding the smoothing capacitor C9,10 in series. They provide 160 μ F at 800V, giving plenty of safety margin in an H.T. line that runs at 565volts. The centre tap ensures that at no time during charge and discharge will the full H.T. voltage appear across either capacitor.

The GZ37 series diode acts as a slow start up device,

300B CIRCUIT DIAGRAM

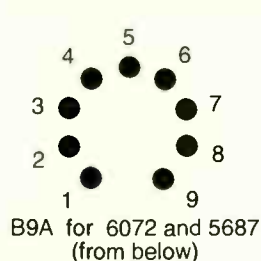
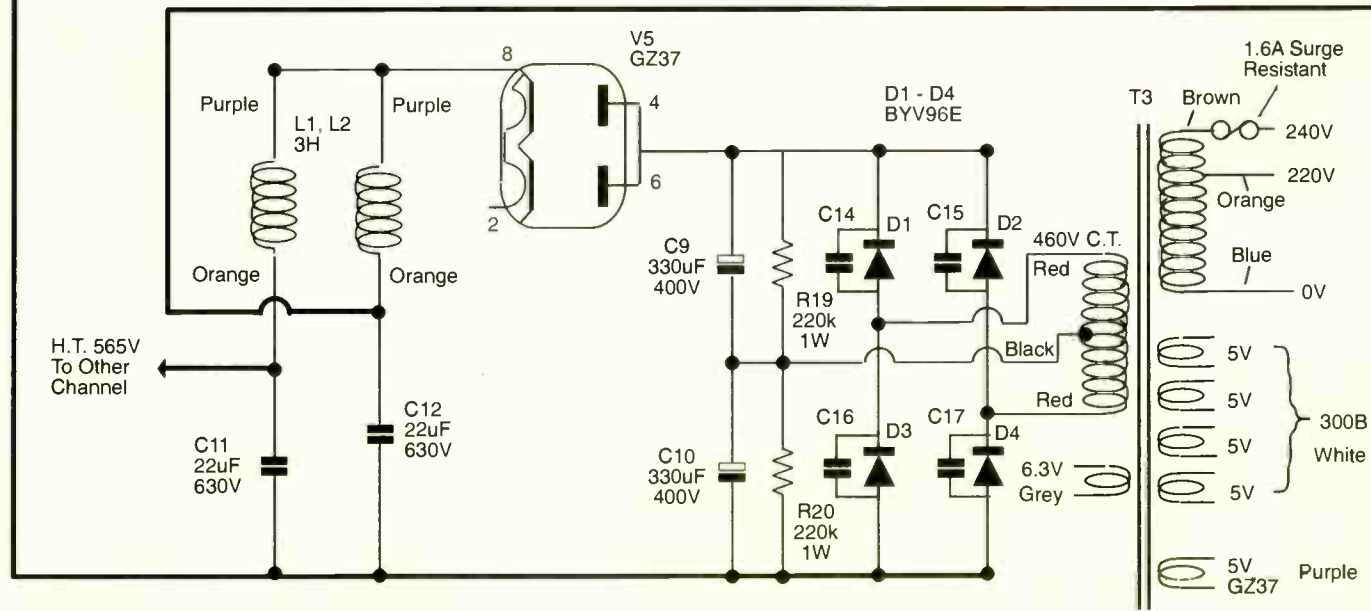
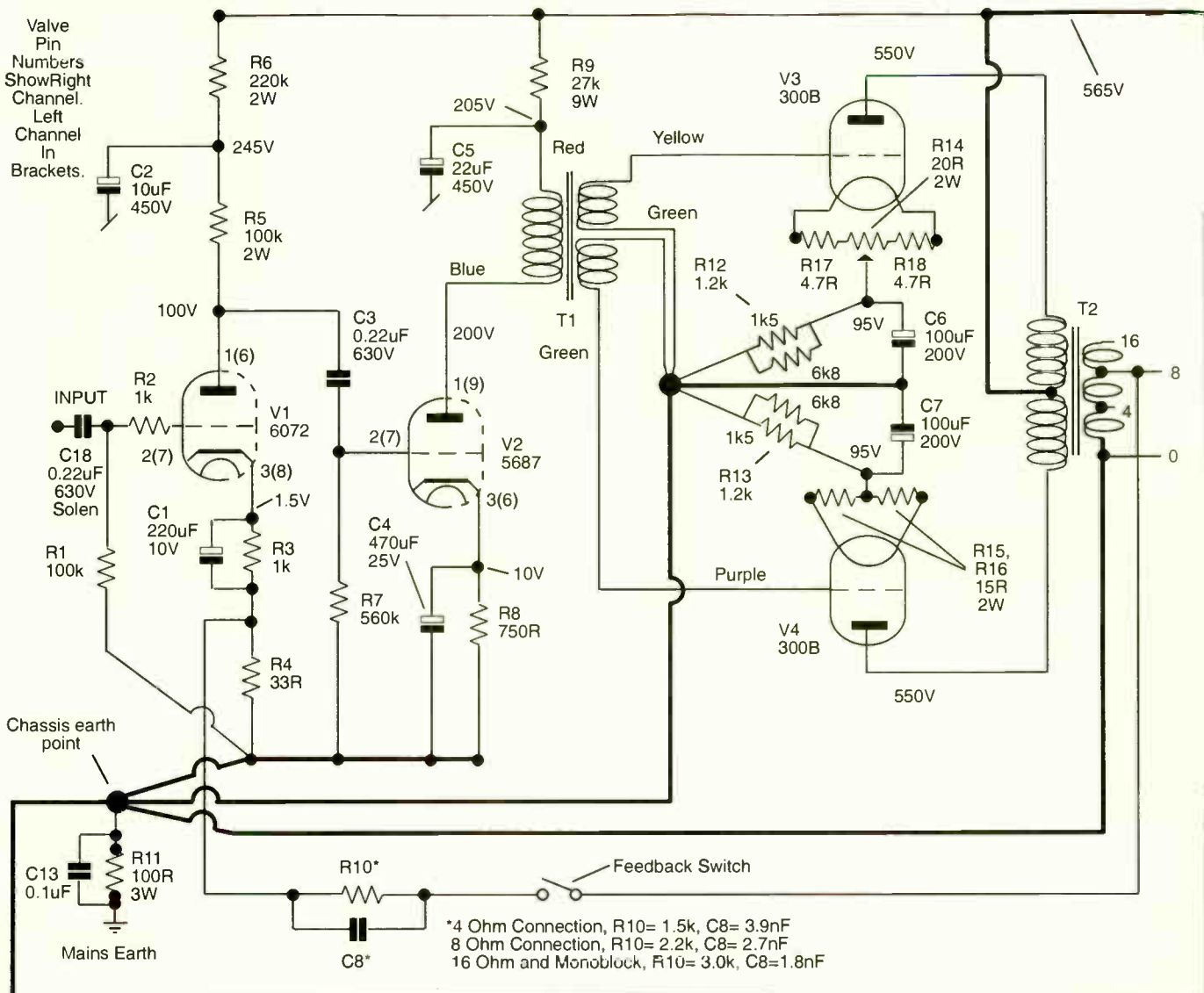

- | | |
|----------|----------|
| 6072 | 5687 |
| 1 - A'' | 1 - A'' |
| 2 - G'' | 2 - G'' |
| 3 - K'' | 3 - K'' |
| 4 - H | 4 - H |
| 5 - H | 5 - H |
| 6 - A' | 6 - K' |
| 7 - G' | 7 - G' |
| 8 - K' | 8 - Hct. |
| 9 - Hct. | 9 - A' |

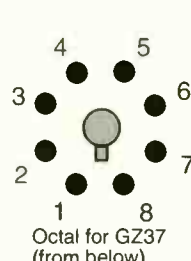

- | |
|----------|
| GZ37 |
| 1 - i.c. |
| 2 - H |
| 3 - n.c. |
| 4 - A' |
| 5 - n.c. |
| 6 - A'' |
| 7 - n.c. |
| 8 - H,K |

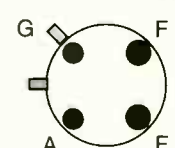

Wilmslow Audio

THE ULTIMATE HI-FI EXPERIENCE

Arcam Aiwa Audiolab B&W Castle
Denon Dual Heybrook Kef Marantz
Monitor Audio Mordaunt-Short
Nakamichi Qed Revolver Rogers
Tannoy Target Teac . . .
*Britain's leading loudspeaker kit
and drive unit suppliers*

Catalogue of our full range £2.00

Four demonstration rooms

Wellington Close, Parkgate Trading
Estate, Knutsford, Cheshire WA16 8DX
(Dpt HFW)

No appointment necessary Closed
Monday

Telephone (0565) 650605

Fax (0565) 650080

VINYL & CDs

FROM THE RECORD CONNOISSEUR

WE CARRY THE FOLLOWING GREAT LABELS:

ALTARUS.....LP	KING SUPER ANALOGUE.....LP
ALTO.....LP	KAMEI.....CD
ANALOGUE	MAPLESHADE.....CD
PRODUCTIONS.....LP/GOLD CD	MOBILE FIDELITY...LP/GOLD CD
ATHENA.....LP	ORIG. JAZZ CLASSICS.....LP
AUDIOQUEST.....LP/CD	POP/ROCK.....LP/CD
BLUE NOTE (JAPAN).....LP	PROPRIUS.....LP/CD
CHESKY.....LP/CD	REFERENCE.....LP/CD
CBS MASTERSOUND..GOLD CD	RYKO.....LP
CONCORD AUDIOPHILE.....LP	SHEFFIELD LAB.....LP/CD
DCC.....GOLD CD	VITAL.....LP/CD
DECCA (180 GM HQ).....LP	WATER LILLY.....LP/CD
ENJA (180 GM HQ).....LP	WILSON.....LP/GOLD CD
GRP JAZZ.....LP	SUMIKO & LYRA CARTRIDGES
JAPANESE PRESSINGS.....LP	NAGAOKA SLEEVES
JAZZ IMPORTS.....CD/LP	

For a Free 40-page Catalogue send 28p SAE to PO Box 132,
Wokingham, Berks, RG11 4NG.

Free to overseas customers

Tel:/Fax 0344 780262



RECORDS WANTED

Paying up to £100 each for Classical LPs on Decca SXL,
EMI ASD Columbia Sax, Mercury SR, RCA SB. **Top prices
paid for** Mobile Fidelity. Nimbus Supercuts, Nautilus, 1/2
Speed Master, Japanese Pressings, Rock, Pop, Jazz, Folk,
Blues & more.

PROGRESSIVE AUDIO



ACCESSORIES CABLES BY: QED, STRAIGHTWIRE, LOGAN
HALL, AUDIOQUEST, SILVER SOUNDS, AUDIONOTE, KIMBER,
L.F.D., AND VAN DEN HUL, STANDS BY: TARGET, TRIPOD,
FOUNDATION, GOLDRING, HEADPHONE BY STAX, SEISMIC
SINKS BY TOWNSHEND

HOME DEMONSTRATIONS A PLEASURE
PHONE DAVE ON MEDWAY 0634 389004

HOME DEMORECORD CLEANING SERVICE, SECOND HAND
EQUIPMENT AND RECORDS. PHONE DANNY ON: 0634 580763
DONS TRATIONS A PLEASURE
PHONE DAVE ON MEDWAY 0634 389004

DIGITAL BY: SUGDEN, MERIDIAN, MARANTZ, MICROMEGA,
PROCEED, AUDIO ALCHEMY, ORELLE AND AUDIOMECA

ANALOGUE BY: MICHELL, PINK TRIANGLE, SME, VPI, BASIS,
VOYD, PROJECT, SYSTEMDEK

ARMS AND CARTRIDGES BY: LYRA, MICROBENZ,
TRANSFIGURATION, KOETSU, SUMIKO, GOLDRING, AUDIO
TECHNICA, DECCA, SME, GRAHAM, REGA, EMINENT AND
KUZMA

AMPLIFICATION BY LFD,
AUDIO INNOVATIONS,
AUDION, SUGDEN, CHORD,
MOTH, LEVINSON, CONRAD
JOHNSON, CONVERGENT,
LUMLEY REFERENCE,
MICHELL, TUBE
TECHNOLOGY

SPEAKERS BY: PROAC,
AUDIONOTE, SNELL, IMPULSE
TDL, JPW, DALI, ORIGIN LIVE,
AUDIOSTATIC, RUARK,
SOUND LAB, DIAMOND
ACOUSTICS, TOWNSHEND,
MONITOR AUDIO, UKD,
ALCON

TREAT YOURSELF!

DEM ROOMS AT BOTH BRANCHES INSTANT CREDIT AVAILABLE

Selected sounds from Alchemist, Aura, Boston,
B&W, Cabletalk, Castle, Celestion, Denon,
Exposure, Gyrodek, Harman Kardon, Heybrook,
Marantz, Monitor Audio, Moth, NAD, Nakamichi,
Rose, Rotel, Royd, Ruark, Systemdeck, Tannoy,
TDL, Thorens, etc...



Export speciality
all major credit cards accepted



NORTHWOOD AUDIO HI-FI SPECIALISTS

126 Pinner Road
Northwood
Middx HA6 1BP
Tel: (0923) 820877

98 Cambridge Street
Aylesbury
Bucks HP20 1BA
Tel: (0296) 28790

RESTORING THE LEAK TL12 - PART II

Last month Graham Tricker of G.T. Audio explained the history of the Leak TL12 valve amplifier. This month he gives details on the circuit and renovations.

As mentioned in Part I, the TL12 Point One got its name from being the first amplifier to achieve 0.1% distortion. It was able to reach this excellent figure by use of Leak's triple-loop feedback circuit. The 'triple loop' took the form of local feedback applied to the first valve via C2, and to the phase splitter through R8/R14 going to R11 undecoupled, this forming two loops. The third loop was overall feedback conventionally applied from transformer secondary back to the input valve's cathode. In Britain, negative feedback was first used commercially by H. J. Leak & Co. Ltd (1945) and its effects were often demonstrated in front of technical audiences.

The amplifier, without feedback, has a sensitivity of 7.5mV rms to produce full power of 12watts. Once the overall feedback loop is closed the sensitivity decreases to 150mV rms. The first driver stage of the circuit consists of an EF36 pentode valve which has a rather unusual feature in the fact that it has a grid top cap, hence the need for a peculiar looking shielding cap fitted over this valve on the chassis. This driver stage is capacitor coupled to the grid of the first triode in the ECC33 phase splitter.

The second triode has its grid connected to the first via a common cathode connection (via R11-R8). This type of connection causes a slight imbalance in the phase splitter, compensated by using unequal resistor values in R12+R13 (68k&57k), the anode load resistors of the phase splitter.

This compensation provides an equal voltage swing of opposite phase via the coupling capacitors C5/6 to the grids of the KT66 output tetrodes. They are triode connected, run in class A-B and are biased via the cathode bias resistors R16,17 to a

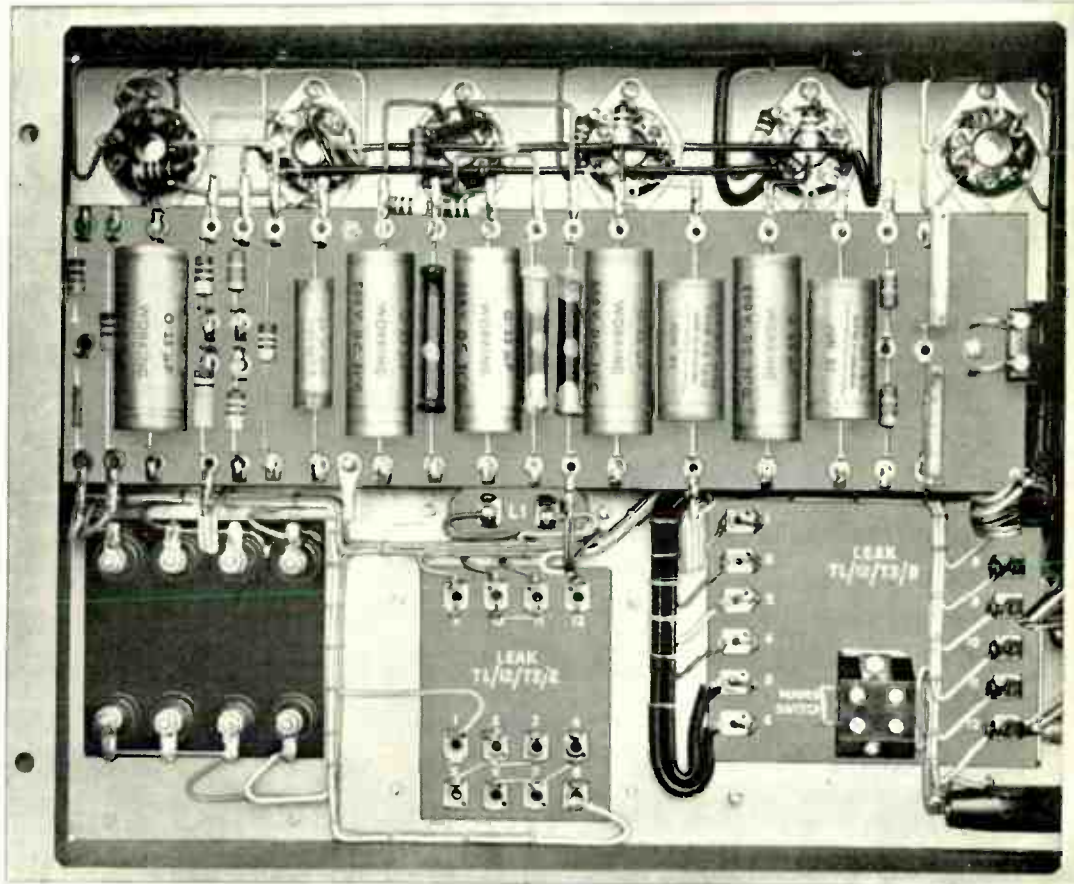

value of 62mA per valve. This arrangement provides self-biasing operation of the output valves, which limits power, but makes re-balancing unnecessary when changing valves.

The overall feedback connection has level/compensation components R18/C9 which must be selected according to the impedance setting chosen (2/8/16/32Ω) in the output stage from the output transformer secondary. This returns via the cathode of the EF36 input stage. Depending on the selected load impedance for the speaker, the feedback within the amplifier (R18+C9) must be adjusted via Leak's recommendations in their service sheet to prevent possible instability in the amplifier.

GETTING THE BEST FROM THE TL12

Due to the high sensitivity of the TL12, matching pre-amps can be problematic. The original pre-amp designed for the TL12 was mono and so two pre-amps would be required when using TL12s as an everyday stereo power amplifier. Although the matching pre-amp was very good in its day, you should really be looking for something a little bit more modern, with inputs suitable for today's tuners, tape decks, turntables and CD players.

Modern pre-amps possessing gain are not ideal for the TL12 because of its high sensitivity; the volume control will have to be kept right down, the gain and the amplifying devices

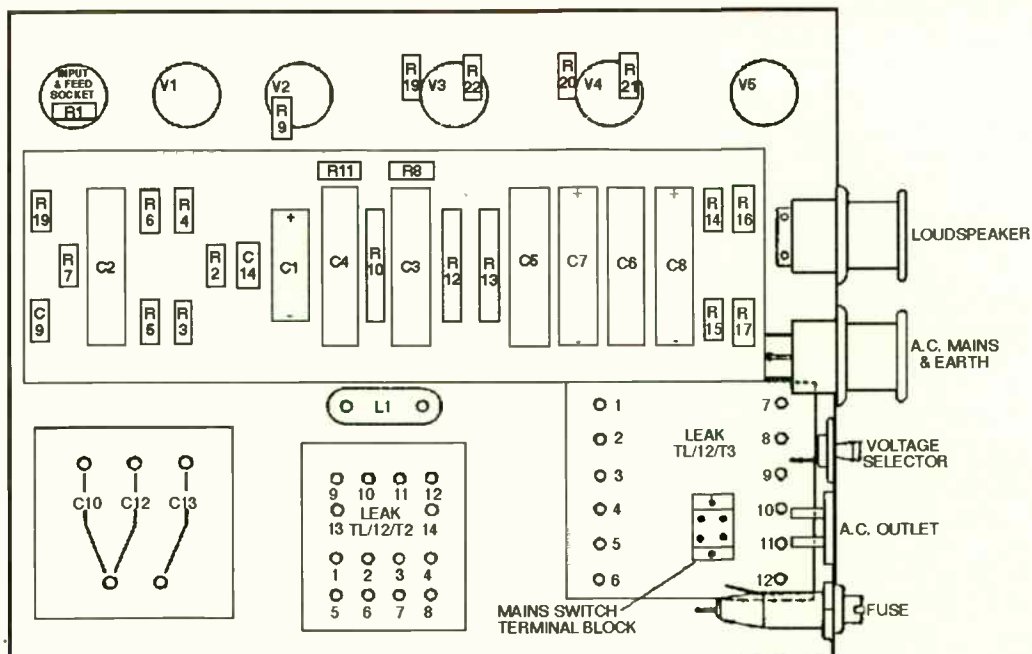

UNDER CHASSIS VIEW

output stage, R16 and 17 are of the wire wound variety and can be replaced with a high quality equivalent (3W min.).

Overall feedback components R18 and C9 must be set in accordance with the load setting on the output transformer. Failure to do this may result in instability and oscillation. Component selection for the rebuild is up to the choice of the restorer. The Leak amps were designed with particular detail surrounding the type and construction of the components in order to maintain maximum sound quality and reliability, so the amplifier will always sound at its best when using components of the original construction, i.e. carbon and wire wound resistors and paper capacitors.

Valves

A GZ32 rectifier tube gives the amplifier a soft start for the H.T. supply. The first stage uses an EF36 or EF37, the phase splitter uses a ECC33 driving two KT66s. The driver (V1), phase splitter (V2) and valve rectifier (V5) are ideally from Mullard and the KT66 originals made by GEC.

Leak do say that an EL37, 6L6 or 5881 can be used in the output stage. I have tried the Sovtek 5881, but it sounds out of character compared to the GEC valve in this particular circuit. KT66s are getting rare and very expensive and new old stock is practically impossible to find. All the other valves (V1, 2 & 5) are still available and can be obtained from Billington Export, P. M. Components or Langrex. However, the only supplier I know who has original GEC KT66s is Sussex Surplus.

Expect to pay between £5-10 each for the EF36/37, ECC33 and the GZ32s. However, an original GEC

KT66 will cost £65. I have heard from a friend in the States that these valves are fetching up to several hundred dollars each over there. P.M.

Components can supply a version of the KT66 for £25.95 per matched pair and the American 7581 is similar.

Suggested Suppliers

P M Components
Springfield Enterprise Park,
Springfield Road,
Gravesend,
Kent.
DA11 8HD
Tel: 0474 560521

▼
 (EF36s ECC33s and GZ32, plus version of KT66 from China)

Billington Export
1E Gillimans Industrial Estate,
Billingshurst,
West Sussex.
RW14 9EZ
Tel: 0403
784961

▼
 (EF36s, ECC33s, GZ32s and occasionally GEC KT66s).

Sussex Surplus
13 Station
Road,
Horsham,
West Sussex.
RH13 5EZ
Tel: 0403
251302

▼
 (GZ32 and GEC KT66s)

Langrex Supplies Ltd
1 Mayo Road,
Croydon,
Surrey.
CR0 2QP
Tel: 081 684 1166

▼
 (EF36, ECC33s + GZ32s)

G.T. Audio
5 Upper Road,
Higher Denham,
Bucks,
UB9 5EJ
Tel: 0895 833099

▼
 G.T. Audio supply all the components needed to restore Leak amplifiers, including capacitors and resistors. Restoration can also be undertaken on Leak amplifiers and all other classic equipment ●

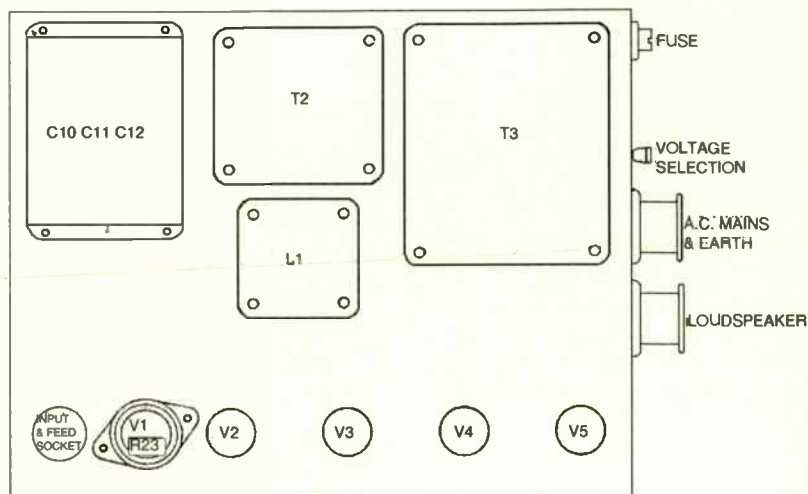

TOP CHASSIS VIEW

AFTER THE OVERTURE . . .

. . . David Harris judges the performance. Have Kinshaw been successful with their new £235 Overture CD convertor?

Inexpensive add-on DACs usually offer an improvement in sound quality for people wishing to upgrade dated or budget machines equipped with digital outputs. The Kinshaw Overture accepts electrical input signals via phono and BNC sockets and an optical input is available on request.

The black acrylic front printed with simple graphics is pretty much all that is on view with the Kinshaw - even the on/off switch is situated at the rear of the unit alongside the connection sockets. A small, green LED at the front informs the user that the converter is turned on, although the switch on the rear panel also lights.

Simplicity seems to have been the key aspect in the thinking behind the new range of Overture products from Kinshaw, both in the style and the technology. The 16-bit, 8x oversampled single-chip filter, DAC and simple analogue filter circuitry employ Burr-Brown PCM1710 chips; the converter retails for £235.

The Kinshaw was partnered with a high quality Audiolab 8000CDM transport to ensure that a digital signal reasonably free of error was received for conversion; I wanted to make certain the system would be capable of revealing the sound of the convertor. Our own valve pre-amp and 300B power amplifier were used to

drive the KLS3s.

Considering the level of the partnering equipment, the Overture did not seem too much out of its depth, presenting a fairly well balanced and moderately refined sound for the £235 asking price. Bass was particularly warm and fairly tuneful, although there did seem to be a slight lack of emphasis to the very lowest of notes. The kettle drums on Puccini's Toska sounded big and full, but lacked some of the definition that is present with better CD players; the resonances that follow the initial impact were not as well controlled as they could be, lending some degree of muddiness to the bass. Having said this, these resonances from the

MEASURED PERFORMANCE

This was the second sample of the Overture DAC that Kinshaw supplied. The first one measured so badly we suspected a fault. Unfortunately, the second sample wasn't much better.

Measuring frequency response I suspected that there were going to be problems. Rather than the usual ruler flat response of CD, sometimes rolled off at the top end, there is a slight peak around 300Hz below which bass level decreases. I'd expect the Overture to have weak bass as a result.

Distortion at all but the highest signal level was high, 25 times that of the best at -30dB music level on CD - a typical average level. At -30dB and below I had to re-scale the plots we normally show because the noise floor was so high that it was off the top of the analyser screen. At -60dB a distortion figure of 4.3% limits dynamic range (EIAJ test) down to an unusually low 84dB, and at -90dB distortion measured an alarming figure of around 150%.

The Overture often failed to lock onto the signal supplied by the transport and had to be switched on and off repeatedly until it

did. It would appear that the Overture needs more development. **DB**

TEST RESULTS

Frequency response 4Hz-20.7kHz

Distortion %		
-6dB	0.009	0.009
-30dB	0.154	0.151
-60dB	4.28	4.43
-90	146	156
-90dB dithered	Unmeasurable	

Separation dB	left	right
1kHz	93	93
20kHz	79	78

Noise	-101dB
with emphasis	-101dB

Dynamic range	84.3dB
Output	1.97V

Distortion

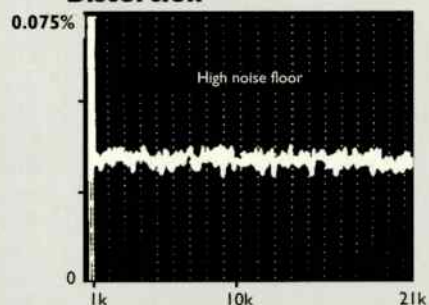

Frequency Response

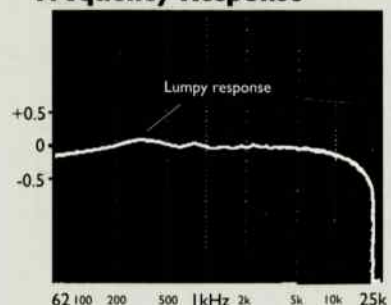



timpani prove a particularly revealing test which many CD players have difficulty in accommodating. The more usual sound of a bass guitar or drum was produced more accurately, the Kinshaw generally possessing a musically tuneful bass that could sometimes be a little too warm for my own personal taste.

The Overture DAC fared a little better in the midrange; although not displaying the openness of some CD players it did remain coherent and quite well focussed. Listening to *Patience* on the album *Lies*, by Guns and Roses, Axle's voice sounded slightly hollow and deprived of natural body. This is a common problem amongst budget CD players, but less so is the slight clouding effect that the Kinshaw could sometimes have on the human voice, occasionally giving the impression that a curtain had been drawn in front of the performer. This was also noticeable on the saxophone, which did not sound as though air was being blown through it, as

if the Overture was somehow removing the subtle pieces of information necessary to paint a believable picture. The effect was fairly minor, and on the plus side it made for a more laid back, smoother sound that many other more aggressive, harsher sounding machines could fail to achieve.

The Kinshaw's mellow midrange was quite well complemented by its unusually refined treble, which in my opinion was definitely the convertor's strong point. Listening to some jazz brought to my attention the fast, rhythmic, almost delicate portrayal of cymbals delivered by the Overture. Maybe lacking in absolute weight, they splashed around lightly, giving an immediate feeling of finesse to the music.

The upper midrange was by no means harsh; it had a certain amount of smoothness, which many people may prefer. For me it subdued some of the sparkle present in the higher frequencies and although the sound could not be

described as dull, it could neither be described as particularly clear or exciting. Having said this, the Kinshaw Overture may well bring about a new lease of life to ageing CD players that still manage to spin the silver disc by removing some of the brittleness sometimes associated with earlier machines.

For those wishing to upgrade, with a smooth, laid back, inoffensive sound in mind, the Kinshaw DAC may be worth an audition. For a little more money, however, it'd be worth listening to the Marantz CD63 (£249) or the latest Grundig Fine Arts CD3 (£240), to name but two of several highly competent one-box players that are available today ●

Kinshaw Overture £235
Kinshaw Electronics Ltd.,
84 Pendarves Street,
Tuckingmill,
Camborne,
Cornwall TR14 8RE.
Tel: 0753 889949



◀◀ **HDCD - is this the future for hi-fi?**

Where's hi-fi going?

What does the future hold for hi-fi? Will Philips and Sony run with new HDCD?

Noel Keywood investigates.

With sales around the world not so much in decline, but reportedly non-existent, with a recession in Japan and nosediving profits from all Japan's major audio manufacturers, I was going to say the future of audio was no future. That scenario has just been superseded. In a piece of perfect synchronicity, its future (possibly) arrived today, in the form of a new technology known as HDCD, or High Definition Compatible Digital.

New technology? You've surely all heard it and perhaps have suffered it before. I believe the much vaunted 'new technologies' of yesteryear, like Elcassette and Four Channel, have in part contributed to today's malaise in audio. There certainly seems to be little enthusiasm in Britain today for technologies such as DCC, digital cassette tape, and MD, the miniature recordable disc. There is no great perceived need for them and, in a recession, they represent too strong a purchase demand for most people I suspect. Tight funds are being channelled elsewhere, mobile phones in particular offering genuine lifestyle/business benefits, technology attraction, and bearable running costs it seems. Mobiles look to be today's technology purchase, not hi-fi.

Our casual acceptance of technology today, after two decades of constant exposure, places more emphasis on functionality than fashion. People are just not impressed by lights, buttons and displays anymore. So much so that new technologies cannot demand a price premium. A

spokesman for a major company moaned that RDS (Radio Data System) has had to be added to tuners 'at cost', helping only to bolster flagging sales. It seems doubtful that technological innovation in audio will ever have the appeal it once had; there are too many other demands vying for people's attention and spending power these days and we all expect tomorrow's widget to be considerably better than today's - that's progress.

Not only are new hi-fi technologies having a rough ride. Sales in budget audio - high-street hi-fi - have proven so weak in Europe and Japan in particular that fierce price competition has broken out just to maintain turnover. "They're desperate to keep the factories running in Japan" a spokesman for a Japanese major told us. Prices are being cut so far there's no profit left at all".

Whilst Japanese companies like Toshiba, Mitsubishi, Sanyo, Hitachi and Sansui have all but faded out of the U.K. marketplace, Technics/Panasonic, Sony and Pioneer continue to battle it out. But even these stayers have experienced precipitous declines in profit and JVC has been in loss for the last two years. Likewise, European Philips has been battling to maintain audio sales and profits, the latter amounting to a puny £15m last year. A central London retailer told us "I just can't move black boxes at the moment. People don't want to know". Mass market audio is in the doldrums and new technologies hold little attraction. So what does the future

hold? How will hi-fi move forward, if it moves at all?

Not all the indications are bad and where there is activity there is perhaps hope. Top end hi-fi manufacturers with attractive products continue to do well in spite of everything. Arcam are active players in the tough U.K. market, into which they sell 70% of their output. Like many of Britain's specialist companies, they see hi-fi in Britain as a niche market that is in slow contraction, yet in spite of this they managed to increase sales by around 18% in the last year to hit £7million, from which modest profits were earned. All the same, Managing Director John Dawson felt confident enough to invest in expansion, improved production facilities and new product development. The TGI Group, comprising Tannoy, Goodmans Loudspeakers, Mordaunt Short, Epos, Audix and Martin Audio similarly increased turnover 6% to £35.8m and made a net profit of £1.6m. Whilst these performances might, alone, be small beer to the big boys, it nevertheless demonstrates that whilst high street sales in downmarket audio are a basket case, the market for real hi-fi remains relatively resilient. With Mission, Linn, Tannoy and other specialists all reporting good sales for quality hi-fi products, this sector manages to perform well on aggregate in the U.K. and even more strongly overseas.

Marketing men believe the audio industry must offer new and exciting products to stimulate sales. But it now

looks as if the buying public has had enough of new and exciting products - at least, ones that bomb out after a few years. There are other 'new and exciting products', such as faxes, computers, mobile 'phones and video games that exert a stronger attraction. With audio now so discredited by past failure, it would be a brave company that attempted an introduction of a completely new technology, unless perhaps it was mind bogglingly radical.

This leaves hi-fi source development stuck in a peculiar position. We have a VHF FM stereo radio system (Zenith-GE) from 1961, an analogue recording medium inadequate for audio even when it was launched in 1963 (as a dictation medium) and a performance-limited digital replay technology from the late Seventies which has attracted criticism for its dubious sound quality. These sources desperately need upgrading; they're either archaic or inadequate. Neither DCC nor MD were launched as upgrades of course, nor are they good enough to become so, especially in light of what is happening elsewhere, mainly in the studios.

Digital audio has progressed a lot since the seventies, when CD was introduced, mainly through innovation in the computer world. Serious signal processing power is now available; recording studios routinely talk twenty-bit - which brings me to the next part of the story.

Whilst the appeal of new audio replay technologies might well have become dissipated by other attractions and past failures, the need and desire to listen to music remains. Thom-EMI recently announced a 25% increase in music sales, as did their HMV chain of record stores. The professional side of the industry, meaning the recording studios, production houses, pressing plants, and equipment manufacturers derive their business from these sales; they are not directly influenced by the travails of the audio hardware business.

The professional side of the business is, according to Richard Brice of Select Systems, quite bouyant at present. Re-mastering back catalogues is keeping the mastering houses going, studios are re-equipping with professional 20-bit recorders and there is talk of using 22-bit - perhaps more. Their outlook has changed too. Once upon a time, just a few years ago, every studio engineer knew that 16-bit digital (e.g. CD) was perfect, even if the hi-fi fraternity had doubts. Now 16-bit is deemed inadequate for good domestic replay by the professional world, including its developer Sony. Even Philips will be forced to admit this is the case soon, just so it doesn't get left behind in the

next battle looming - improved CD.

Because any attempt to launch a new consumer replay medium now looks very dangerous, pressure is on to improve the performance of CD as we know it from the recording end of the chain. By various re-coding schemes CDs can be made to sound better, at least up to a point. Sony are promoting their SBM re-coding system into mastering houses to improve sound quality. We've obtained Tring SBM discs and can confirm that they do offer superb quality.

I 'phoned Philips about SBM and was promptly told that they had a better system! Tony Griffiths of Decca Records, who works closely with Philips, insisted that SBM was inferior to their own triangular noise shaped dither technology which they have been using for the past two years (try the CD Decca 440281, Peter Jablonski playing various piano pieces). In fact, Tony told me that SBM is limited by not dithering the digital signal, thereby redistributing quantisation noise and distortion. Their own system, he claimed, by applying dither minimises noise and distortion as well as redistributing noise away from the ear's sensitive regions.

Needless to say others have been working on CD re-coding schemes and reckon they've got something better than Sony or Philips. Cheeky chappies in the U.S. of A, Pacific Microsonics Inc., are asking both companies to sign up for what they claim is an even more advanced re-coding system for CD, known as High Definition Compatible Digital. (HDCD). These discs will offer improved sound quality through standard players, it's claimed, but dramatically improved sound quality through special HDCD players. So whilst new hardware is needed to appreciate the full benefits of the system, it isn't essential.

If HDCD really offers all that is claimed of it, and if Philips, Sony, retailers and the music biz. don't allow avarice or mutually destructive competition to foul the waters, then the much maligned, long suffering and exploited listening public may well decide to spend a few pennies on this one.

But before jumping into the air and shouting "Hallelujah, we're saved", just remember that for such a system to take off, Sony must drop SBM, Philips must drop noise shaped dither and studios, including those owned by Sony and Philips, must buy HDCD re-coding gizmos, at whatever price their inventors wish to ask for them. Sony want around £16,000 for an SBM re-coder which, being a form of dedicated computer, is pricey. Hopefully, the U.S. inventors of HDCD won't try to price it too high.

If all these things were to come

about then a genuine advance in programme source quality for domestic hi-fi might be just around the corner ●

HOW SBM COMPARES

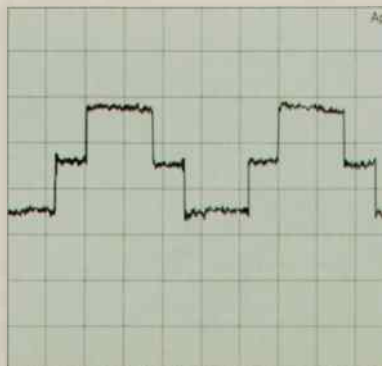

A 100Hz signal at -90dB in standard 16-bit .

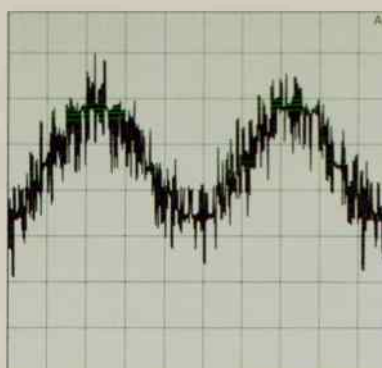

The waveform above, but with dither noise applied. The steps are removed, but noise is added.

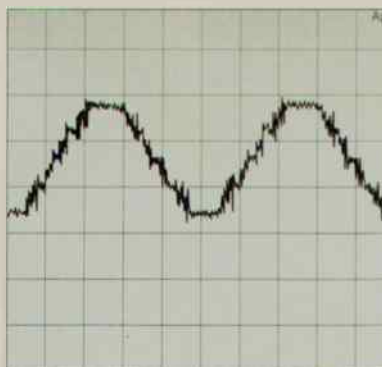

Sony's SBM gives a smooth waveform shape, but noise is greatly reduced.

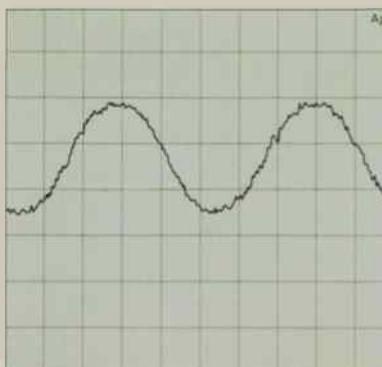

A 20-bit waveform shows how the signal should look.

review

KICKING BASS

Harman/Kardon's LS0200s put the bass in
what it comes to disco bass.

Eric Swartzwald goes on disco.



harman/kardon

World Radio History

HI-FI WORLD SEPTEMBER 1984

With the best will in the world, Harman-Kardon's LS0200 loudspeakers could not be described as elegant. In their proportions, they hark back to a different age, a little too tall for the 21 in Foundation sand-filled stands I used - it meant an extra cushion on the settee to lift the Braithwaite ears to tweeter level - and a little too deep to avoid a somewhat heavy appearance. When the grilles come off, as they should for best results, the great surround of the Audax tweeter looms large as well, the bulbous cloth dome looking almost menacing. These speakers mean business.

The business is hard-core rock business too, not any namby-pamby stuff. The LS0200s leave that for the lace and frills brigade. These Harman-Kardons are for people who like tough, hard bass and want to party. Horrid Americanism, that, but these speakers don't go along with you to the rave, they power it up and come to meet you. Yet they do this without the forwardness in the vocal range or mid-band that shoves a central image out into the middle of the room to impress. These speakers are a bit more refined than examples of the in-your-face brutality brigade. You may not have heard of Freaky Realistic, but their brand of electronic samples, metronomic beat and The Orb-type tracks came over with a sprightly clean and mind-numbing power, even if the sampling has left the digital resolution somewhere around 8-bit and it showed.

Turn to something with serious bass and a wider range, like Bill Bruford's live recording Earthworks, and the panoply of drums, electric and acoustic bass and saxes bloomed across a quite believably broad stage. True, when there was an alto sax, the instrument squawked a little, lacking the warmth and roundedness of brass in the lower registers, but the startling aspect of this recording was the way the Harmans handled some phasing trickery.

While the LS0200s couldn't generally quite release themselves from the outer edges of their boxes, reproducing a scaled soundstage rather than an expansive one, there were tracks on the Bruford album, thanks to in-built phase manipulation, which floated well out to either side, and, just as intended, behind or in front of the plane of the speakers, which suggested very decent coherence and bass/mid drivers of a greater quality than might usually be found under £200. The bass isn't the cleanest or the least coloured around, but the LS0200s provide a lot of it. Other speakers at this price sound distinctly emasculated by comparison. It manages to be forceful and firm, with a bloom that's neatly distributed over the lower regions rather than one which muddies some bass notes too much or turns to a boom.

Where there are snags is in the upper mid-range, affecting violins and vocalists most. Not so much, mind you, to detract from the listening pleasure, but a

reminder that compromises are made here. A notch 'twixt mid-range and treble nips vocalists, so that some notes are restricted. It made the girl's words on Beautiful South's 'The Rocking Chair' pretty well unintelligible, while running my master tape of The Nelson Brothers, the difference between the two male singers, one with a lighter tenor than the other, was glossed over, both voices thinner than they should be.

On classical music, this affected violins, which adopted a steely tone in stark contrast to the lush throatiness of horns

“ These speakers mean business. The business is hard-core rock business too, not any namby-pamby stuff. ”

and brass, for example. Mandolins, too, both on a Vivaldi piece and The Nelson Brothers Country-Rock tape, were distinctly metallic. When it came to acoustic guitar the warmer mid-band had the music blooming. On orchestral pieces, this produced a fullness of sound that was refreshing, even if not entirely accurate, cellos and woodwind having a very full and rounded tone. The bigger the orchestra, the more this overcame the air and space in a recording, however. Wagner's overture to Tannhäuser proved too much for the LS0200s, the Decca recording needing a portrayal of

considerable depth and more than the Harman's had on offer to avoid sounding earth-bound.

Nonetheless, at £150, the Harmans are distinctly good value. Fine detail isn't their strongest point - harpsichord continuo, like soprano voices, tends to be overwhelmed by other instruments - although the stereo image proved very stable. They don't need to overdose on watts, either; mostly I had sixty to hand, which was twice as much as was really necessary. In fact, more would be an unnecessary indulgence, since despite their apparent size, the bass/mid drivers will crack up if pushed too hard. Not ideal for the disco-deaf, then, who are catered for by Cerwin Vega, but a good compromise which will more than satisfy those who find smaller speakers (and some of the bigger ones) bass-light on rock music. The unusual bonus is that for once, a strong-ish bass hasn't knocked the truer hi-fi sonic balance out of the equation.

The LS0200s are even bi-wirable; while it makes 'notch' in the treble a little more obvious, does clarify the mid-range, too, refining the inner detail enough to be worthwhile, so what's lost on the swings is gained on the roundabout. At this price, anyone can afford a few quid for another pair of cables and it should extend these speakers' useful life through a couple of source and amplifier upgrades above their natural budget partners ●

HK LS0200 £149.99
Harman UK Ltd.,
Unit 2, Borehamwood Industrial Park,
Rowley Lane, Borehamwood,
Herts., WD6 5PZ
Tel: 081 207 5050

MEASURED PERFORMANCE

The LS0200s are an interesting piece of engineering. The bass/mid output has been angled downwards by use of a large value inductor to give bass lift, and the 93dB sensitive tweeter attenuated down to 84dB to line up with the mid-band. The result is a 'speaker which has rising bass level towards the lower end, so I'd expect large and powerful lows from this one.

However, the downside is that they could sound a bit closed in or muggy, because of the low midrange output. Remember that the response shown below is taken on a tall stand so that room reinforcement is at a minimum. In practice the bass will be emphasised even further.

As I mentioned above the LS0200s are insensitive, measuring just 84dB at 1m for a nominal watt of pink noise. However the overall impedance is high at 11Ω and the impedance curve is smooth, so they'll need relatively little current to drive and aren't reactive. I'd recommend amplifiers offering 40-50watts power for good levels. **DB**

Frequency Response

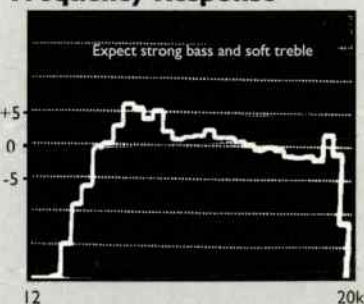

Impedance

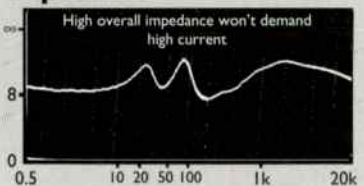

.... continued from page 39

CDs you have that have suffered from this fault. It shows that there most certainly is a problem with 'rusting', even if it hasn't reached catastrophic proportions. **DB**

MORE ROT

I continue to read and enjoy Hi-Fi World and the June '94 issue was no exception. The article on "Rotting CDs" caught my immediate attention and sent me rushing to my record cabinet to check out my collection. None of the normal recordings exhibited this problem, but to my alarm, the majority of recordings collected with BBC Music magazine, from Volume 1, Issue 8 onwards to be precise, do have this bronzed appearance. Indeed, I did have to return one CD to PDO last year as faulty, but at the time supposed it to be an isolated incident, which of course it may be.

My initial response has been to write to BBC Music magazine describing the problem and referencing your article, but some more investigative journalism on behalf of the BBC's readers may be in order!

Ian Haynes
West Sussex

PDO, being one of the largest pressing plants in the UK, are a likely choice for magazines wanting to press their own promotional CD. But because the discs are normally specially compiled and may contain tracks with a limited copyright agreement, it could be difficult for PDO to re-press for replacement. Perhaps when a disc comes free, replacement is a contentious issue in any case. **DB**

BEHIND CLOSED DOORS

I am sorry for this whining letter. However, I would initially like to point out that I

am a hi-fi and music enthusiast of several years standing.

Anyway on to the whine. Following reports in Hi-Fi World of the 1993 Chesterfield Show and after speaking with the organisers, my wife and I decided to visit the 1994 show. Fine I hear you say, but living in Southampton this necessitated a 400 mile round trip in a day and a 6am start, i.e. a major effort.

We arrived at the Chesterfield venue shortly after the advertised start and the show had been open for approximately one hour by the time we visited the upstairs demonstration rooms. However, several of the demonstration rooms were closed for no apparent reason. In one specific case I was told, in a brusque manner by the company, that their demonstration was not open! Obviously I accept that there are problems associated with attending an exhibition. However, surely at a hi-fi exhibition the manufacturers have a captive audience and should make every effort to ensure that their stand runs smoothly? If they cannot be bothered to make such an effort then what confidence do I have, as a customer, to buy equipment from them?

Over the past few months I have read with interest your editorial columns about the current state of the UK hi-fi industry. After my experiences at Chesterfield I can only conclude that several manufacturers deserve their fate.

On a more positive note I managed to buy a Leak Stereo 20 and a Varislope pre at Chesterfield, so the visit had some redeeming features! It is my intention to use the Leak with a TEAC VRDS-7, though I am unsure about appropriate speakers. I have auditioned Impulse H6s which I find musically appealing. Could you possibly suggest alternatives? I have no reservations about a second-hand purchase.

Finally, I would like to

thank you for all the effort you must put into the magazine, which in my opinion offers a significantly better read than your competitors. Suggestions for the future? What about a regular feature on re-appraising second-hand equipment? Also, how about broadening the appeal of the Supplements with practical articles on rebuilding classic equipment? I am willing to donate a Stereo 20 and a Troughline II for a free rebuild! **A. Winstanley,**
Southampton.

I'm sorry that you were treated in such a way at the Chesterfield Hi-Fi Show. I know what it is like to do a show as an exhibitor and the problems associated with it (we had to shut our room at the Ramada last year for several hours while I was still building the 'speakers we were supposed to be demonstrating), but turning a potential customer away in a brusque manner is unnecessary. A note on the door or verbal apology and explanation may have persuaded you to take the trouble to return later on in the day to view that manufacturers product, a more successful strategy. Anyway, let's hope that this was an isolated incident.

On to your happy purchase of a Leak Stereo 20. This amplifier, being both low powered and valve, will need careful matching to loudspeakers for best results. We don't know the H6s, but after reviewing the smaller H7s (see August '94 issue) I'd hesitate to recommend them. For small boxes try the ProAc Studio 100s and for good floorstanders the Castle Chesters. Both are sensitive enough to work well with the Stereo 20 and have high overall impedance, so they will not demand high current. Our new KLS3 is sensitive and designed to be suitable for valve amps. as well as transistor.

Restoration and historical

articles need research and pre-planning, much like our DIY projects, if they are to be more than a superficial skim over a subject. To get facts right, we like to have the final draft vetted or even written by someone who was there at the time. This takes time, but we do have a number in the pipeline. Like you, we hope to expand the Supplements in the near future too. Numerous projects are under development at this moment, most of them quite ambitious. **DB**

TRANSFORMING CD

I have seen a brief reference to CD matching transformers available (rather expensively) from Audio Note and perhaps others. The transformer goes between CD player/DAC and pre-amp and is reputed to impart a certain warmth and extra body to CD replay, bringing it agreeably closer to analogue.

I have never seen a review of such a CD matching transformer and dealers seem to have little knowledge of the device. How does it work? Is it really and truly effective? Perhaps someone at Hi-Fi World can answer from first-hand experience.

J.Hall
Tunbridge Wells

Unfortunately the only similar device we have come across is the Monarchy Audio Digital Interface Processor (DIP). This has such a transformer inside, but it also works as a jitter cleaner. They use the transformer to separate the grounds of the Transport and DAC, which may carry interference between the two. Here's what they had to say about how it works -

Like with many other products, we arrived at the CD interface or matching transformer by experimentation and observation. It has to be said that they give varying results in some installations but

generally improve the sound by reducing the 'tizz' from transients and the general sense of impact.

There are, in my modest opinion, three reasons for this -

1) The transformer's primary and secondary has separated ground planes, and this isolates the ground of the CD player/DAC from the pre-amplifier.

2) The CD interface improves the impedance matching, direct and reflected, between the output stage of the DAC and the input of the pre-amplifier.

3) Any transformer, no matter how good, has limited bandwidth, and as such the CD interface transformer acts as a filter preventing supersonic garbage from getting to the pre-amplifier.
Peter Qvortrup
Audionote.

VINYL JUNKIES DELIGHT

I feel I must tell you about a fantastic discovery I have made, which I fear could do severe damage to your bank account! It's called 'The Record Shop' in Kingston.

I saw their advert in your July edition, and a quick phone call to the very friendly and helpful Tim produced by post the very next day some great recordings on LP and even an excellent one on CD!

Tim's enthusiasm for black stuff comes across on the 'phone and I soon hope to make an effort to visit the shop to rummage through their stocks.

All the recordings I wanted, except one, were available on LP, and one of Tim's recommendations - Ali Tarka Toures, Talking Timbuktu - is a fantastic recording. The one CD was Ry Cooder & V.M Bhatt's "A Meeting by the River", which is a superb analogue recording.

I would therefore strongly recommend a phone call to The Record Shop on 081-

546-3880 to anyone looking for new (and also second-hand) releases on LP.

If I now qualify for your letter of the month, forget the free goodies, give me record token! Thanks for a great mag. and keep up the good work.
**John G. Hall,
Little Hampton,
West Sussex.**

As promised, we'll try and print all of your letters that recommend good vinyl outlets. After all, without music, where is hi-fi.

Whilst we're on the subject of record shops, the number we printed in the July issue for Gema Records was apparently wrong. Apologies to Mr Cook of Newbury who received numerous phone calls from excited vinyl enthusiasts. The correct number for Gema records is: 0635 867140, or you can write to: Gema Records, P.O. Box 54, Reading for a complete catalogue of records and CDs. **DB**

CROSSING OVER

I am a keen constructor and have been for several years now. A lot of my building has concentrated on amateur radio, where valves have always been commonplace. My first eye opener concerning valves was in my teens operating a force air cooled 4CX350F in a 300W VHF amp - this beast actually managed to stall a generator during portable operation! I was also fortunate to play with an old Pye Savage, a laboratory amplifier made in the late 50's (I think) and used a pair of STC 4212's in push-pull. Its particular strength was a varied selection of output taps which we used at work to drive a welding transformer with 240v primary to give us 200-300A at 40Hz to 40kHz. This allowed us to examine the frequency response of current transformers and the like. I loved firing it up, the anodes glowed a dull red and you really knew it meant

business. Sadly the output transformer failed and we scrapped it, but I did keep the valves, one valve's filament went open circuit and it now resides on a friend's mantle piece, the other is fine and I still have it - perhaps I may use it again one day.

Modernisation and site clearance at work (an old English Electric place) has produced some interesting finds, the best of which is an Ediswan 4334 still in the box and assorted KT66, 6L6 etc., some used and some boxed.

My main reason for writing is a plea for help. Having a limited budget I have always fancied getting into audio construction and have repaired several bits and pieces, but you finally persuaded me and I have built a Mullard 5-20 on my own stereo chassis with Sowter transformers. The rest of my system is Bang & Olufsen based, comprising 1702 speakers, 1202 turntable (seventies vintage) and a recently acquired Marantz CD72. The preamp is under construction and will incorporate your phono stage (PCB available yet?).

At present I am using the volume control in the CD player connected direct to the valve amp and can report that the sound is an order better than with the old Beocenter 1300 amp I was using. What I would like to do is to replace the old speaker cable and inspect the crossovers for upgrading, but I don't know how to get into the speakers. Can you help?

I would also, in the future, like an active crossover system. I have a design for a coupled-cavity sub-bass woofer and a Maplin Mosfet amp partially built. All I lack is an audiophile crossover design, can you oblige please.

Finally thanks for a great read and all the hard work on the DIY supplements, hope I am not asking too much.

**A. Burnett
Bradley,
Stafford.**

You'd be much better off building new speakers than trying to squeeze more out of your old ones. If you do want to hold on to the old B&O drivers, your best bet would be to butcher the B&O cabinets and try re-mounting the drivers and crossover in a new re-sized cabinet. You'll have to tune the new cabinet by experiment. Start out with as large a cabinet as practicable and reduce volume by putting bricks inside until you get the bass quality you like. Then experiment with improving crossover component quality. If a reversible electrolytic feeds the tweeter replace this with an audio grade polypropylene capacitor first. Wilmslow Audio and Falcon Components can supply.

This is a lot of work though, and you'd be much better off contacting one of the above companies who provide a range of kits that use modern high quality drive units and crossover components. Wilmslow in particular stock over thirty different kits, and most can be auditioned in their showroom before purchase.

A subwoofer needs to be fed from a low pass filter that allows through only bass frequencies. Unfortunately, we cannot offer a design because we do not have the details necessary to match it in and, even if we did, its design would take too long to contemplate. Crossovers have to be carefully designed to meet numerous requirements, they cannot be generalised to feed any subwoofer, for example.

I suggest you read up a bit on this subject. The Loudspeaker Design Cookbook by Vance Dickason is excellent (see our Library section, p101) or, for active filters, try The Active Filter Cookbook, by Don Lancaster, from the Modern Book Co., Praed Street, Paddington, London (Tel: 071-402-9176). **NK**

PRICED FOR SOUND

Could the Grundig CD3, equipped with Philips' CDM-9 transport and DAC-7 chipset, be the audiophile bargain of the year? Dominic Todd investigates.

Never mind the name, just look at the specification, and then gasp in amazement at the price! Grundig may not exactly be the world's most respected name in hi-fi, but if the recently introduced CD3 is anything to go by, they're about to shake it up at the "value" end of the market.

At the heart of the CD3 lies a DAC-7 convertor (as used in Meridian and top Marantz machines), and an up-to-date Philips CDM-9 transport complemented by an NPC digital filter and three fold noise shaper. All this comes at the

ridiculous price of just £239.95 (£10 less than the superb value Marantz CD63). Until now the cheapest DAC-7 player, to my knowledge, has been the £350 Philips CD950. The Grundig doesn't skimp when it comes to style, substance and features either, beating most of the competition on all three counts.

The CD3, whilst unlikely to vie for recognition amongst Frank Lloyd Wright's greats, is neatly styled and unobtrusive. The central CD mechanism is flanked by the major controls (with the track advance buttons being confusingly placed)

surrounded by a matt grey fascia. Detailing is clean and thoughtful, with touches like the power switch containing a tiny power LED. The plethora of minor controls are thankfully placed beneath a solid flap. From the smooth action of the draw and controls to the high quality finish, the general feel and weight of this machine is more in keeping with something costing half as much again.

As far as features go, there's enough to make most competitors look positively stingy. There are outputs for a remote BUS link, co-ax digital, variable headphone and main output, as well as the standard fixed output. The display is extinguishable (full marks to Grundig), and features a calendar display. Other than that there is a stylish remote control, FTS (Favourite Track Selection), A/B repeat and a comprehensive tape editing section including auto space and fade out.

How do they do it? Well, it's simple really. Grundig have taken a leaf from the motor industry by cutting dealer profits in comparison with other brands. This is likely to make it less popular with dealers, but on the other hand makes the range less susceptible to savage discounts; annoying when you've just paid top whack a few months earlier. The other penalty could of course be sound quality. To see if this was the case, I enrolled the aid of a Marantz CD63 to see how the Grundig would fare in this cut throat market.

Unsurprisingly, the Grundig sonically reminded me of its half brother, the Philips CD950. Ruby Blues' "Away from here" featured crisp clean vocals, produced in an unforced and almost laid back manner. The guitar was reproduced with impressive delicacy, with the notes decaying by just the right amount. The Marantz instantly had more body to the vocals, but after sustained listening the relaxed Grundig proved less fatiguing.

"Jump they say", from Bowie's "Black Tie White Noise" again had more presence when played on the Marantz. Yet ultimately, the Grundig proved less urgent in its delivery and made a better job of separating the entangled melange of percussion. The brass section didn't quite score with the same enthusiasm as the CD63, yet the layering of vocals was more noticeable. Overall, the CD3 was subtle in its performance; carefully

MEASURED PERFORMANCE

Grundig are owned by Philips, which probably explains why they can equip this player with a CDM-9 transport mechanism and DAC-7 convertor for such a low price.

Unfortunately, although DAC-7 is normally associated with low distortion, especially when implemented by a consumer electronics giant, in this player things weren't as good as they could have been. At all but the highest signal levels, distortion was several times higher than that expected.

As the distortion plot taken at -30dB level (normal music level) shows, distortion is widespread and rises towards the top end of the spectrum. I would expect this to add a degree of sharpness to the sound, especially as the frequency response stays flat right up to 20kHz. A little care may be needed when using hard or bright sounding transistor amplifiers and metal dome tweeters.

Elsewhere, the CD3 measures competently, as expected. Output level was just a touch over the Philips 2V standard, measuring 2.1V. Noise, as with all CD players, is so low you won't hear it, dynamic range is reasonable and separation wide. **DB**

TEST RESULTS

Frequency response	4Hz-21kHz	
Distortion %		
-6dB	0.006	0.005
-30dB	0.034	0.028

-60dB	1.3	1.1
-90	31	35
-90dB dithered	7.9	16
Separation dB	left	right
1kHz	110	105
20kHz	81	81
Noise	-109dB	
with emphasis	-109dB	
Dynamic range	100dB	
Output	2.1V	

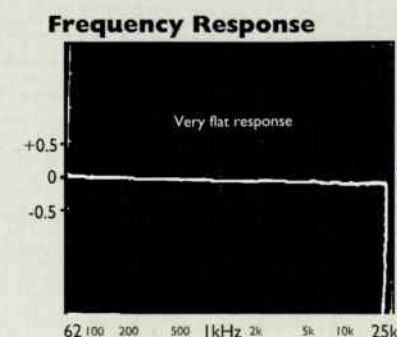
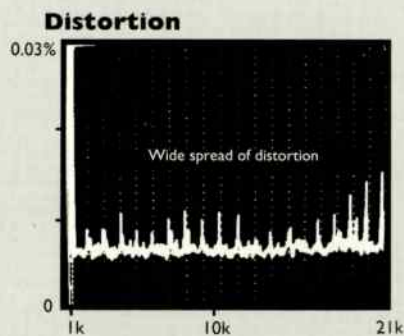



presenting the music to the listener. Obviously, this style of presentation will suit some systems more than others, with warmer sounding systems not so well suited.

I tried a compilation disc of various blues/jazz funk artists to see if the CD3 was perhaps too refined, or if it was able to get down and boogie with the best of them. Ronny Jordan's "Bad Brother" had a slightly soft bass line, with the brass section once again missing out on the raw edge of other machines. The Marantz proved generally preferable with this type of music, offering a degree more authority in the bass. The treble integrated better with the rest of the track in the Grundig's case, although both machines suffered from a somewhat "obvious" treble.

"Loud Minority" by the "United Future Organisation" provided a racy pace which could catch the Grundig out at times. In comparison to the precise and spacious mid and treble, the bass line could occasionally wallow and sound confused as it attempted to unravel the low frequency information in time.

Returning to something a little more natural and without a prominent bass line (Capercaillie) brought about a reinforcement, in my mind, of the CD3's

strong points. More detail than the, still fine, Marantz CD63 and a broad, clearly defined soundstage. Recalling my original comment about the CD3's sonic resemblance to the Philips, much is carried over in the spaciousness and depth to the sound. There's also an almost artificial sweetness to its presentation that is a trademark of the DAC-7 chipset.

Grundig's re-entry into the hi-fi separates market is a qualified success. The CD3, as with the rest of the range, offers styling that, whilst not to everyone's taste, is at least original and discrete. The build quality and general operation of the machine are way ahead of what you'd expect for the money, rivalling Rotel in this respect. Whether or not they can match Rotel's impressive reliability though, only time can tell. All the models, and the CD3 in particular, offer a high feature count. What's more, Grundig seem to have got it right in what to provide and what to leave out. The switchable display, FTS and digital output are all useful features to have, and a bonus in this class of machine. And if you're after a high value Philips based CD player to use as a transport how about the CD1, complete with a digital output for a ridiculous £140!

The qualification comes with the CD3's sound quality. It's very much a DAC-7 clone, with a sweet and articulate mid and top, let down by a rather soft and indistinguishable bass. The last of these is probably down to the machine's cost rather than the chipset's follies. At its best, with simple folk or jazz, the CD3 can sound incredibly refined and delicate for the price. Yet other musical tastes and softer sounding systems may have you wishing for a bit more of the Marantz CD63's "get up and go".

As an all round package I still rate it highly, and feel it should be given a hearing alongside the NAD 501 and Marantz CD63 ●

Grundig CD3
Grundig Int'l. Ltd.,
Mill Road, Rugby,
Warwicks,
CU21 1PR
Tel: 0788 577155

£239.95



Sugden have been manufacturing high-end Stemfoort amplifiers in Holland since 1987, most being sold outside Britain. Aiming to enter the more affordable end of the market, the Sugden Stemfoort SF60 is the forerunner of a new range of amplifiers soon to be released in Britain.

The Stemfoort looks and feels powerful; it has a weighty, solid construction, exemplified by its sturdy 6mm thick aluminium front panel, possessing a milled aperture that frames the controls - an interesting styling feature. Inside, build quality reaches a high standard, a decent toroidal transformer powering a neatly laid out circuit board containing many audio grade components.

The few controls decorating the front

of the SF60 were clearly marked and simple to use, although I did experience an initial difficulty in connecting the speaker cables to the gold plated binding posts located at the rear of the amplifier, due to them being labelled in a confusing manner.

The Stemfoort offers 72 watts per channel, working in conventional Class A-B mode. Five line level inputs are offered including one tape facility and the unit retails for £549.

SOUND QUALITY

The SF60 possesses most of the characteristics of a well constructed,

minimally designed solid-state amplifier. It has a sound quality that is generally dry, open and transparent, capable of revealing subtle characteristics of source components without colouration. At just under £550, one would expect a truthful insight into the music being played, and the Stemfoort is well able to do this, amiably involving the listener in an ocean of sound which flows along with remarkable ease.

The huge kettle drums heard on Puccini's Tosca filled the room completely

MEASURED PERFORMANCE

The Stemfoort is a wide bandwidth design that operates from a low 6Hz right up to a high 120kHz figure. The lower limit is sufficiently deep to enable the amplifier to reproduce CD subsonics cleanly, keeping phase shifts out of the audio band. These days amplifiers are being heavily band limited by designers, rarely making it up past 50kHz, so the Stemfoort's extension to 120kHz is surprising. However, in my experience, band limiting confers no certain advantages subjectively, in spite of the theory behind it, so I tend to keep an open mind about this practice. Since CD reaches 21kHz before dropping dead, however, gain is not needed above this frequency.

Distortion was low at all frequencies and levels, with a predominance of second harmonic, as our analysis shows. Since this harmonic is subjectively innocuous even in large quantities, it's a good sign, even if it is not proof of goodness.

Power output was high at 72watts into eight ohms and 100watts into four ohms. To deliver this, just 160mV of input signal is needed, making the amplifier sensitive.

One worrying feature was the amount of d.c. offset on the speaker outputs, which averaged 120mV. This is far too high, 10mV or so being a usual maximum and 3mV a norm. Sugden need to either adjust the Stemfoort more carefully, or improve the d.c. feedback behaviour. The offset that existed biased the speaker cones away from rest by about 1mm or so - not disastrous by any means we feel, but not wanted either. This was the only point of concern in an otherwise fine measured performance. **NK**

TEST RESULTS

Power	72watts
CD/tuner/aux.	
Frequency response	6Hz-120kHz
Separation	66dB
Noise	94dB
Distortion	0.007%
Sensitivity	160mV
dc offset	110/137mV

Distortion

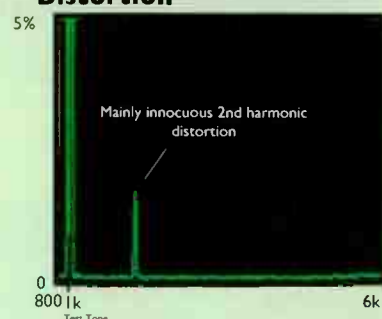

Influence

David Harris auditions the Stenfoort SF60, a powerful integrated amplifier manufactured in Holland under the watchful eye of Sugden.



with thunderous levels of bass, the natural resonances decaying with absolute control and power. The Stenfoort's ability to authoritatively control large amounts of low frequency energy was also displayed when listening to the opening of Stravinsky's Firebird Suite. The gigantic orchestral bass drum was reproduced with astonishing clarity, the initial contact between the beater and the skin, the explosive build up of bass within the room, then the massive resonances naturally rolling away were all held under the iron grip of the SF60.

Moving up to the midrange, the Stenfoort showed excellent transparency, allowing well recorded vocals to literally breathe through the loudspeakers (World Audio KLS3s were used for the purpose of this test as they present the amplifier with an controlled load and are extremely revealing). When listening to Seal's performance of Whirlpool through the respected Arcam Black Box 50 DAC/Delta 250 transport, a real air of naturalness was given to his voice. The openness of this amplifier provided good focus on vocals, projecting them out of the speakers, creating a well defined central image. A credible soundstage with good width and moderate depth was set up successfully. Instruments were well separated and accurately defined; only on highly complex orchestral passages could

detect a slight amount of confusion. The treble first struck me as very crisp and dry, yet at the same time it was reasonably delicate and refined. Listening more closely, however, revealed an occasional metallic ring, giving violins and other stringed instruments a slight edginess about them. This was less obvious with cymbals, perhaps because they have a metallic sound anyway, but it was noticeable on woodwind instruments, such as Ronnie Cuber's baritone saxophone. It didn't sound natural and added a small amount of colouration. Overall though, this effect didn't detract much from overall sound quality and generally the treble came across as delicate, adding an air of openness to the whole structure of the sound.

Art Blakey's drum solo at the beginning of the track Free For All (The Sound Of Jazz, Art Blakey CLCD 5001) was conveyed with dramatic power, cymbals crashed relentlessly whilst a volley of toms led down to gut-wrenching kicks from the bass drum. The Stenfoort handled this material well, allowing the full force of percussion to be felt as well as heard.

A strong sense of rhythm was

continually present when using this amplifier, very noticeable on Seal's track Killer where a tight, fast, pacey beat kept me on my toes throughout the song. The bass on this piece remained both deep and resonant, with a fullness only usually found in costly valve amplifiers.

Changing the Arcam CD combination to the latest Burmester 937 CD player cured this to some extent, showing that the Arcam source was partly responsible, but underlining also the revealing nature of the Stenfoort.

The SF60 is most at home with high quality source components, for which it rewards the listener with excellent bass reproduction and startling midband presence, making it in my book a fine amplifier for the money ●

Stenfoort SF60 £549
J. E. Sugden & Co. Ltd.,
Valley Works,
Station Lane,
Heckmondwike,
W. Yorks. WF16 0NF
Tel: 0924 404088

IN THE OCTOBER ISSUE



It may be the end of summer and getting dark and gloomy outside, but that's all the more reason to cheer yourself up with the next colourful issue of Hi-Fi World. Not only is there a massive new reference loudspeaker from TDL, but two group tests - high end amplifiers and phono head amplifiers. And our 10th DIY Supplement.

TDL REFERENCE STANDARD TRANSMISSION LINE SPEAKERS

A massive £6000, six-driver floorstander from TDL Electronics. This mighty beast crowns the top of TDL's range of transmission line loudspeakers. It promises awesome bass along with sweet and natural highs.

HIGH END AMPLIFIERS

Imagine you had enough money for the TDL References. Now, what amplifier would you choose to drive them with? We test a handful of the very best amplifiers available.

PHONO HEAD AMPLIFIERS

Following our group test of turntables in this issue, we test five of the best head amplifiers available for under £1000. With many modern amplifiers being supplied without a phono stage these days, a separate head amplifier could be the answer for a golden sound.

GRUNGE AUDIO

Not systems to play your latest Indie releases on, but hi-fi for the first time buyer. Grunge Audio comes in all shapes and sizes, from massive, silver fronted JVC receivers, to battered Celestion Ditton 'speakers. Grunge Audio is all about getting a reasonable sound for as little dosh as possible.

WORLD'S TOP MUSIC

Our record reviewers bring you their top albums of the past year. If you're looking for the definitive list of World reviews over the last year, don't miss the October issue.

DIY SUPPLEMENT No 10

Build superb monoblock solid-state Class A power amplifiers using super new audio output transistors, in development for many years and not yet in use elsewhere. This is a top quality, all-discrete design of advanced specification and performance. Of course there'll be all the usual features, such as DIY letters, Q&A, component suppliers etc.

Hi-Fi World is still only £2, but with more editorial than most rivals. With the most enthusiastic and expert editorial team in hi-fi journalism, can you afford to miss it? Make sure you don't by filling in this order form and handing it to your newsagent.



Please reserve/deliver* Hi-Fi World on a regular basis, commencing with the next issue, until further notice.

Name: _____

Address _____

Signed: _____ Date: _____

- Delete as appropriate

Distributed to the news
trade by

COMAG
MAGAZINE MARKETING

On this magazine the future of hi-fi is a Big Issue. Not as a nutty pastime where technology and mysticism meet to form a cosy enclave for dotty dufflebags, nor as a income source for Publishers, but more simply as a way that anyone and everyone may better enjoy music.

Our source technologies are poor and they're stuck in the past. Look at the Pro. side of the audio business for comparison. Recording studios are recording at ever higher digital resolutions, using 20-bit or more digital tape recorders. It's broadly accepted in the Pro world that, ideally, original performances should be captured with the highest fidelity. But in 1994 we are little closer to conveying much of that quality into the home. CD was never convincingly better in terms of sound quality than LP; it still isn't and nor can it be made so, except by serious upgrading such as, possibly, to HDCD. Except in so far as loudspeakers and amplifiers have improved, we're no further forward today in sound quality terms than we were in 1980, before CD arrived.

The reasons for this situation and the seeming impossibility of breaking the current technological impasse are, I believe, largely a result of flawed thinking by the major consumer electronics companies, especially the big players: Sony and Philips. Driven by commercial rivalry to be first to the marketplace, they've both launched audio technologies prematurely, ones that have offered little if any improvement in that most fundamental property: sound quality. These companies hold greatest scorn for anyone, like myself, who should ever dare say "but it doesn't sound any better!". Sound quality, they say, doesn't of itself sell; other properties are more important.

From my strictly personal point of view, this magazine, with its DIY Supplement/kit aspect, clearly and cogently informs me that people *do* want

better sound quality - and they want it to better enjoy music. It's as simple as that. This should be an inalienable pre-requisite; Philips and Sony are now finding to their cost that they should never have ignored it. It would have been better if hi-fi journalists - including myself - had shouted louder on behalf of readers that this is so. However, the armies of marketing men, whose job it is to know about these things, could make anyone believe otherwise. And they have done so.



either Philips or Sony to come to market with something truly advanced and exciting in terms of sound quality then our pleasures and their futures would be better assured.

How could they ever do this? This is the big one, the \$64,000 question. Firstly, the shibboleth of competition must be put to rest. It hasn't given us a better mousetrap, only too many wonky ones launched on a sea of hype. Sony and Philips must co-operate and in doing so should draw in other interested parties.

This could come about

Reflections from Noel Keywood

kaleidoscope

One of the problems here lies in disentangling prime from secondary requirements and judging their effects. Because Elcassette (I'm showing my age!) went down through lack of pre-recorded material does not mean its basic concept was flawed. It offered superb recording quality and would be serving us well now had this weakness been attended to.

Equally, because CD has been a success even though it was no better than LP in sound quality does not mean it was the right technology to fly with. The sniping at it and the dissatisfaction are already beginning to take their toll. I have a suspicion that CD is about to take a sudden and unexpected turn for the worse because, at heart, it isn't good enough. Sales of players are ominously flattening out, suggesting that full penetration has been reached - but at an incredibly low figure of 35% of total homes. LP reached a far wider audience. CD might offer convenience, but whether it offers value is another matter altogether. Were it

to provide a really superb musical experience then buyers may well value it more highly and be prepared to pay the price.

Curiously, this notion is not up for discussion in either Philips or Sony, even though they do carry out basic research of an expense and complexity that would appear to suggest quality was on the agenda. What goes on in their backrooms by and large stays there, which is one major problem of their corporate outlooks and abilities. They are unable to envision and successfully commercialise their better innovations.

Instead, they come to market with fundamentally duff gizmos aimed to appeal to everyone. They shouldn't be surprised to find that they appeal to few. If CD bombs now, it'll be because it was sold on secondary factors like convenience and lack of surface noise. Satisfying these secondary requirements is not enough; the prime requirement of good sound quality must be met if a hi-fi medium is to possess durability. Were

through an international body like the International Electrotechnical Commission. The IEC could, for example, suggest a specification and convene working parties from these companies to discuss how best to achieve it.

Perhaps they should abandon the Red Book which sets CD standards in stone and agree now on a CD with future expandability. This is what HDCD is doing. Alternatively, if Sony and Philips could agree upon a super-advanced professional mastering medium, say 22-bit recordable optical discs with high speed access, then these discs could possibly be commercialised as-is. In other words, copies would be pressed for direct commercial sale. This is a bit more radical, relying on the pull of offering 'masters' direct to the buying public. CD could remain, but the new discs would offer super-quality replay with future potential to record. Costly at first, but as a notion, buying the master tape just cannot be beaten ●

close your eyes and see

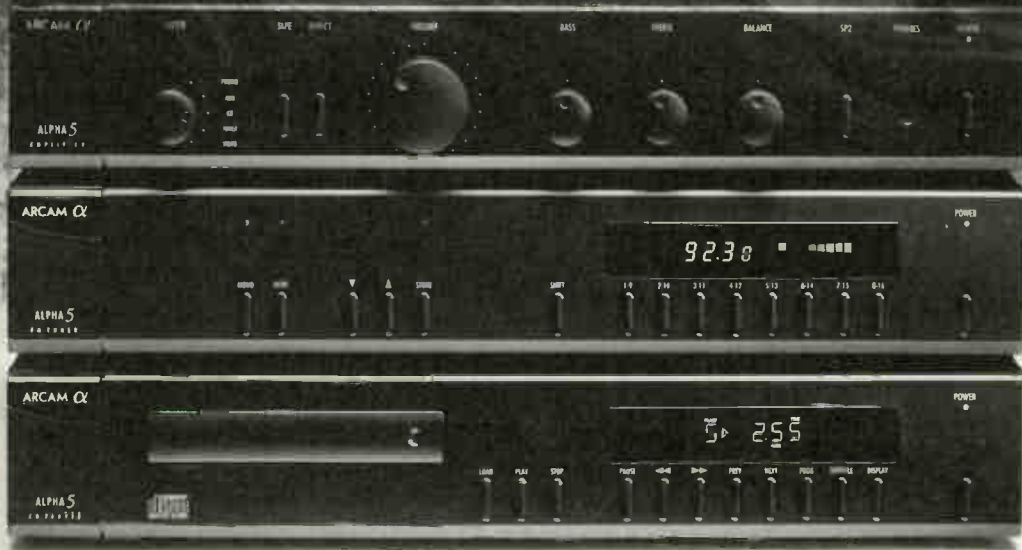

the new Arcam Alpha 5 system

Close your eyes and see the difference between Arcam's all new Alpha 5 system of hi-fi components and anything else in its price range.

Ignore the fact that the Alpha 5 amplifier is our best 'budget audiophile' amplifier ever. (No mean achievement as its predecessor, the Alpha 3, has outsold all competitors in the UK for more than 18 months.) Don't be tempted by its attractive styling or a price tag which looks too good to be true. Just listen, and discover for yourself a quality of sound that can only be described as exceptional.

Next, try the Alpha 5 tuner. Again, don't let its surprising

affordability seduce you. Instead, listen to broadcast sound that is natural, clear and dynamic, without annoying sibilance or harshness.

Finally, feast your ears on the Alpha 5 CD player - quite simply, the best value high performance CD player ever produced by a UK manufacturer. And, September's What Hi-Fi? agreed, calling it "the player to beat" and giving it a class leading 5 star rating. They concluded, "it's one remarkably transparent player, seeming to be at home with all genres of music, and equally enjoyable with all."

Just listen. Close your eyes, open your mind, and see the light.

ARCAM

For more information, including the nearest place you can listen to Arcam, complete the coupon and post it to:
Arcam, Pembroke Avenue, Waterbeach, Cambridge CB5 9PB. Or telephone: (0223) 440964 (24 hours)

In Australia: Silver Australis Pty Ltd., 4 Rushdell St., Streeby 3179, Victoria Tel: (613) 7630177. In Canada: Avalon Audio Ltd., Unit 17, 975 Frazer Drive, Burlington, Ontario L7L 4X8 Tel: (416) 333 4633. In New Zealand: Avalon Audio, PO Box 5373, 119 Wellesley St., Auckland Tel: (649) 779 351. In South Africa: Hi-Fi Installations, 134A Fox St., Johannesburg, 2001 Tel: (021) 3312011. In the USA: Audio Illusions Corporation, PO Box 381, Highland Lakes, New Jersey 07 422-0381 Tel: (201) 764 8098.

Please send me information about: (please tick box)

Please send me a brochure with details of all your products

Arcam CD players Arcam tuners AudioQuest Nicam TV tuner Arcam amplifiers Arcam speakers Arcam cassette deck

Title ----- First Name ----- Surname -----

Address ----- Postcode -----

This month a watershed has been reached, perhaps even a Rubicon crossed, with the publication of the new RS Components catalogue. This latest edition of the electronics engineers' *vade mecum* contains a section devoted to valves for the first time since the 1960s. Nestling between uni-junction transistors and MOSFETs are a selection of handsome tubes. Perhaps even more extraordinary, the appearance of valves in the catalogue is by no means an ignominious return, instead the New Products supplement contains a two-page article blazoning their re-appearance. Obviously these new additions are no strangers at the feast. The prodigals have returned!

And prodigal they are, wasteful of space, wasteful of heat, and wasteful of pound notes. Consider the 486 chip nestling inside the computer that I'm using to write this article. It's about the same size and gets about as hot as the ECC83 valve that sits inside the valve equalizer in my studio rack. The difference is that the 486 chip contains nearly one and-a-half million active devices and the ECC83 contains two! Yet it seems history has repeated itself and valves once again clearly have a place at the designer's table. Revealingly, the range of valves in the RS Catalogue does not contain any t.v. line output pentodes, r.f.

amplifiers or vari-mu devices. I don't anticipate power-supply designers, microprocessor engineers or telecoms technicians jumping for joy at seeing tubes back in the catalogue. No, valves are back for one reason and one reason alone - the way they sound. Of course, as a guitarist and hi-fi tube-freak I could have told them this years ago and I'm clearly not alone. Indeed my biblical metaphor doesn't hold up to close scrutiny. The original prodigal son went away and frittered away a fortune



however is that the ProMix 01 costs under £1800. At that price the ProMix 01 is cheap enough for the home and project studio meaning that DDD compact discs are within the reach of even modest production budgets. For once the marketing boy's slogan is entirely justified, "A revolution in mixing has (indeed) begun".

But if the ProMix 01 represents the digital reformer, the revolutionary electronic Bolshevik, then the analogue, thermionic Romanovs are not yet deposed. Creating no less

recorded message

Left by Richard Brice

whereas over the last few years valves have quietly been earning one. Currently world-wide business in valves is an estimated \$3 billion a year.

Now I'm not going to waste time and space arguing whether modern digital-audio recording technology is a step backwards or forwards. The truth is, to the modern musician, the computer and the valve are both indispensable. I use computer based hard-disc editing to edit singing recorded with valve mics! Where valves seem to have made their most vigorous comeback it is precisely in

this way, as a complement to the vast complexity of VLSI digital recording and signal processing techniques. Last week London's Olympia hosted the APRS (Association of Professional Recording Studios) exhibition in London. The event served as a debut for two remarkable products. The first, Yamaha's breakthrough in low-cost digital audio mixing, the ProMix 01. This mixer is entirely digital. All inputs are equipped with 20 bit analogue to digital converters and all the signal processing electronics inside is performed in the digital domain. A digital output is provided for recording directly to a DAT machine or hard-disc and analogue outputs are available (again via high-resolution 20 bit D/As). All channels have assignable equalization (EQ), compression and limiting. The mixer is controllable from MIDI and features motorised faders which "learn" the engineer's moves and then operate by themselves so that the engineer doesn't need to be an octopus (or even a 16-armed Hexadekapus!) in order to perform a complex mix. What's really remarkable

interest at the APRS show was a new mixer from Tony Larking Audio, the TL Audio Valve 8/2 Mixer. This minimalist valve design contains just 8 mic and line inputs with EQ on each channel, rotary channel faders (real retro-styling this!) and two long-throw linear faders for stereo output. In other words, considerably less than half the Yamaha mixer without the dynamics processing, the flying faders and the MIDI control and costing about tidy £1000 more than the digital alternative! Couple this with this month's re-introduction of the classic C12 valve mic from AKG at £3000 a shot, the re-introduction of the 1960 valve compressor from Drawmer and the handful of manufacturers lovingly recreating the classic Pultec valve-equalizer and it adds up to a very strong statement. In audio, just as in music itself, there's no sense in which tomorrow is always better and yesterday always worse. Aside from the vagaries of fashion, there's just good quality and bad quality and in the modern digital revolution, good valve circuits still make the best of comrades ●



The new Audiolab 8000CDM Compact Disc Transport



The Audiolab product range:
8000A Integrated Amplifier
8000C Pre-amplifier
8000PPA Phono Pre-amplifier
8000P Stereo Power Amplifier
8000T FM/AM Tuner
8000M Monobloc Power Amplifier
8000DAC Digital-analogue Converter
8000CDM Compact Disc Transport

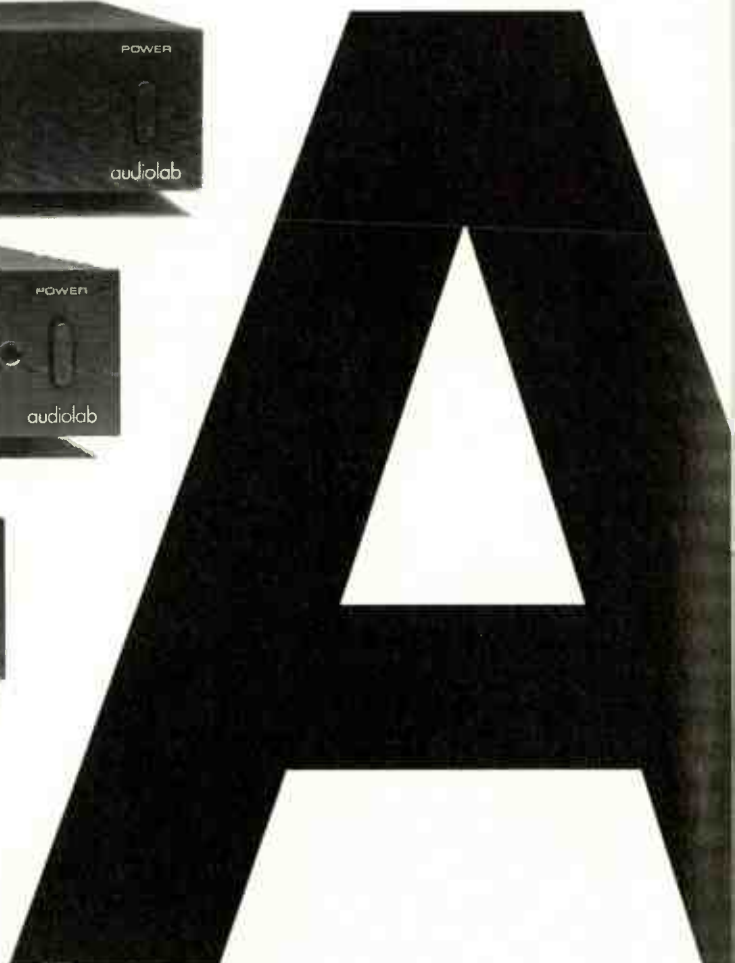

AUDIOLAB

Cambridge Systems Technology Limited, Spitfire Close, Ermine Business Park, Huntingdon, Cambs. PE18 6XY. Tel 0480 52521

Meet-Your-Maker

A reference guide to Britain's Manufacturers and Distributors.

ACOUSTIC ENERGY, 3a Alexandra Road, London W13 ONP. Tel. 081 840 6305. Acoustic Energy manufacture the award winning Reference Series AE1 and AE2 loudspeakers and the new Aegis Series Model 1, all of which feature the unique AE metal cone drive units. The AE distribution division offers superb high end products from WADIA, GRYPHON, ENSEMBLE and TARA LABS.

ALCHEMIST PRODUCTS, 4 Rosebury Mews, London N10 2LG. Call us for a list of our dealers in many areas including:- London, Kent, Hampshire, Wilts, Milton Keynes and N. Ireland and for product information on the Kraken, Freya, Bragi, Odin, Genesis and more. Tel: 081 883 3008

ALEMA UK LTD., 25 Montiflore Road, Hove, BN3 1RD. Tel. 0273 202637. Audion + Edison + Andersson + (Trade enquiries welcome for our newly extended range).

APPOLLO, The UK based designers and manufacturers of high quality speaker stands and equipment racks have now added to their comprehensive range a modular system ideal for housing audio visual products and CD storage. Please send us our free brochure to Zenith Crown Ltd, Tipton Rd, Dudley, West Midlands, DY14 Tel. 021 520 5070. Fax: 021 522 2055. - All export trade enquiries welcome.

ARCAM, Pembroke Ave, Denny Industrial Centre, Waterbeach, Cambridge, CB5 9PB. Tel. 0223 440964 or Fax: 0223 863384. Manufacturers of the Delta 290 Amplifier and the Delta 280 Digital FM Tuner. The two together produce a sound that has been described as 'subtle and intriguing' and that provide 'real clout' - discover this for yourself. For information on not only these products but also the Arcam CD Players, Speakers, Cassette Decks etc., Phone or write in to request a brochure - The pleasure is all yours!

AUDIOTONE CO. Unit 1, Block C, Hove Business Ctr, Fonthill Road, Hove BN3 6HA Tel. 0273 220511. Audiotope supply a range of very high quality and very expensive audiophile components including valve output transformers.

AUDIO SYNTHESIS, 99 Lapwing Lane, Manchester, M20 0UT. Tel. 061 434 0126. Audiophile design, development and distribution. Please contact us for details of: PASSION the passive controller everyone's talking about SILVERBLUE pure silver interconnect cable and the ultra analog based DAC - DSM.

BANDOR MINIATURE LOUSPEAKERS, Studio II, Pinfold Cottages, Penfold Lane, Holmer Green, Bucks. HP5 6XR. Tel. 0494 714058, Aluminium anodised cone drivers with only 1.8 gm moving mass giving full detail to sound covering 2/3 of the frequency spectrum.

BANORIOGE LTD are the premier suppliers of quality audio and video leads, connectors and speaker cables in the UK. In addition to probably the widest range available, including PROF GOLD, SUPER GOLD and SUPER +, offering a level of quality that meets the needs of the most exacting specification. Bandridge of London Ltd Premier House, Deer Park Road, Wimbledon SW19 081 543 3633.

CABLE TALK PO Box 413, Woking, Surrey, GU22 8YZ. Telephone 0483 750667. Fax 0344 360866. Designers and manufacturers of British made high quality, value for money, interconnect and speaker cables. Phone or fax for a free full colour brochure on our What Hi-Fi? 5 star rated products.

CAMPAIGN AUDIO DESIGN, Llandudno Road, Cardiff CF3 8PG. Tel. 0222 779 401. Supplies / manufactures mailorder high purity silver interconnects, loudspeaker cables, internal wires and bespoke mains cables. Generous two week trial period.

CHORO ELECTRONICS, 3 Bower Mount Road, Maidstone, Kent, Tel. 0622 764874. Audition the Chord SPM 1200 at any of the following branches: Doug Brady Hi-Fi - Liverpool / Leeds / London / Cheshire, Audio Reflections - Leeds, Music Matters - West Midlands and many others. Please call us for details.

CREEK AUDIO LTD, 2 Bellevue Road, Friar Barbet, London N11 3ES. Tel: 081 361 4133. Fax: 081 361 4136. Manufacturers of the 4240 Integrated Amp P42 and A42 Pre/Power Amps, CD42 CD Player. Please write for further details.

The Exultant Power Amp fitted to Quad II Hardware.
OBS AUDIO, PO Box 91, Bury St. Edmunds, Suffolk, IP3 0NF. Tel: 0284 828926. Fax: 0284 828026. The DBS6 loudspeaker kit, as designed by Dave Berman and featured in Hi-Fi News Feb/Mar 92, is still available - only from DBS Audio. To find out what these comprise, cost and how to order plus any other information on DBS products please telephone, fax or write in to the above address and numbers.

O H M DESIGN, BUNDEE CD REPAIR PROTECTION SYSTEM- Tried and tested on Tomorrow's World. Repairs and protects over 50 CD's, even those scrubbed with steel wool. Effective for all laserdisc formats including CD ROM, MiniDisc and CDi. RRP £14.95. Why buy a new one when you can clean, repair and protect fifty? Contact David Mather for details of your nearest stockist or distributor. Export enquiries welcome. DHM Design Ltd, Studio 6, Bentinck Court, Bentinck Road, West Drayton, Middlesex. UB7 7RG. Tel: 0895 449559 Fax: 0895 420540

IAN EDWARDS, The Old Chapel, 282 Skipton Road, Harrogate, Yorks. Tel. 0423 500442. Somebody Somewhere must make better storage units for CDs, Music, LPs, HiFi, Books, etc. than Ian Edwards. BUT until he appears, why not send for the brochure showing a selection of HAND MADE units. To do this please send 3 x 2nd class stamps

E J JORDAN DESIGNS, The Oak, Manor Bier, nr Tenby, S Pembrokeshire, SA70 8QR. Tel. 0834 871 209, or Fax: 0834 871 770. Curvilinear metal cones loud speakers were first developed by Ted Jordan in 1963.

EJ Jordan Designs are now World leaders in foil cone technology. First and foremost.

ELECTROMAIL, PO Box 33, Corby, Northants, NN17 9EL. Tel: 0536 204 555. The branch of the well known R S Components trade mail-order business that deals with the public. They have a huge range of components- and catalogues to match.

EMF, 2a Bellevue Road, Friern, Barnet, N11 3ES. Tel. 081 361 6734. Manufacturer of Sequel 50w integrated amplifier and the Crystal D2A converter. Amplifier and DAC. Please write in for details.

FALCON ACOUSTICS LTD., Tabor House, Norwich Road, Mulbarton, Norwich, Norfolk, NR14 8JT. Tel. (0508) 78272. U.K. distributors of FOCAL drive units and SOLEN (chateauroux) polypropylene capacitors and the largest inductor manufacturer in the U.K. Comprehensive range of DIY Speaker Parts and Kits. Sub-Bass and Electronic Filters.

Everything but the wood
FARADAY SOUND, 248 Hall Road, Norwich, NR1 2PW. Tel: 0603 762967. Loudspeakers in CONCRETE: the ultimate enclosure. Now you can build your own low density concrete cabinet enclosure Faraday FS1. Siren, FS5, FS10 or a design of your own choice. Stunning sound and reviews. Simple DIY skills only. Full instructions including cabinet construction for only £10. Includes reviews, photos etc and at least £10 discount off any further products purchased from us e.g. ready made cabinets. Also £25-£150 off any complete loudspeakers!!!

FOUNDATION AUDIO, 53 Beecroft Way, Dunstable, Beds. LU6 1EE. Tel. 0582 477550 or Fax: 0582 604001. We have long been acknowledged as the market leader in sonically superior stands and major in 'specials'. Send for our brochure and details of your nearest stockists.

FULLERS AUDIO, 20 Tunbridge Road, Southend on Sea, Essex SS2 6LT. Tel. 0702 612116. Fuller's audio produce a range of innovative products. Amplification - a10 a single ended class A semiconductor power amplifier - £1200. b70 a mosfet power amplifier of high standard - £599, pre1 and pre2 + matching pre-amplifiers - £599/£649, gen1 phono stage for mm and mc cartridges £299. Loudspeakers - Pharaoh system, upgradable from 1 pair of cabinets to 3 pairs for truly extended bass, passive/active options £649-£2499, Sphinx a 3 way floor standing unit £849, Sultan 2 way reflex, 91 5dB sensitivity £3099

J E SUGOEN & CO LTD., Valley Works, Station Lane, Heckmondwike, West Yorkshire, WF16 0NF. Tel. 0924 404088. Manufacturers of hand crafted audio products 'A world of Music'. Call or write in for information on our SDA-1 Digital to Analogue Converter, SDT-1 CD Player, A21a Class 'A' Amplifier, A25B Integrated Amplifier, A48 Integrated Amplifier, Au51c Pre Amplifier, Au51p Power Amplifier and more.

JORDAN WATTS ACOUSTICS LTD, Cyntra Place, 201 Mare Street, Hackney, London E8 3QE. Tel. 081 985 1646. Jordan Watts Acoustics for Sight AND Sound
KESWICK AUDIO RESEARCH, 54 Coach Road, Outwood, Wakefield, W. Yorks, WF1 3EX. Tel/Fax 0924 870606. 'I'd say that the Figaro is the best miniature speaker I have heard' Audiophile March 1993. Write in or call for details on our full product range and your nearest stockist.

KRONOS DISTRIBUTION, 35 Farlough Road, Dunganon, N. Ireland, BT714 DU. Tel: 0868 748632 Fax: 0868 448281. Kronos is the UK distributor of

some of the finest Hi Fi products in Europe. These include Audiomeca digital-products and turntables; Lieder silver speaker and interconnect cables; Project turn-tables and amplifiers; Triangle speakers and electronics; and YBA amplifiers. We also handle Frameworks equipment tables; Arion valve amplifiers and mains filters and Essex Audio digital products from the UK. Please telephone or write for product details and dealer lists.

LANGREX SUPPLIES LTD, 1, Mayo Road, Croydon, Surrey. CR0 2QP. Tel: 081 684 1166. Fax: 081 684 3056. We are one of the largest stockists and distributors of electronic valves, tubes and semiconductors in the UK. Over 6,000 types in stock. We specialise in obsolete types including original UK and USA made audio valves. Telephone or fax for an immediate quotation.

LECSON SYSTEMS LTD., Unit 19, Nuffield Rd. Ind. Est., St. Ives, Huntingdon, Cambs, PE17 4LD. Tel: 0480 498211. Call for info on our range of integrated and four channel integrated bi-amplifiers. Stereo, Quadra and Quattraplus analogue and digital interconnects and loudspeaker cables. As a compliment to the LFD range of accessories GOLD plated mains 13A plugs and sockets now available.

LOCKWOOD AUDIO, Imperial Studios, Maxwell Road, Borehamwood, Herts. WD6 1WE. Tel. 081 207 4472/ LORICRAFT AUDIO, 4 Big Lane, Goose Green, Lambour, Berks. RG16 7SQ. Tel. 0488 72267.

Specialist restoration of 301's and 401's using genuine spares and re-manufactured parts to original pristine standards in our newly built work shops designed primarily for these purposes.

LYNWOOD ELECTRONICS, Coley Lane Farm, Wentworth, Rotherham, S62 7SQ. Tel. 0709 873667. Lynwood Electronics is famous for manufacturing the only range of audio mains cleaners that really work. A complete range is now available to suit every system and every pocket

MAY AUDIO MARKETING U.K. LTD, 83 Main Street, Burley in Wharfedale, North Yorkshire. LS21 7BU. Tel: 0943 864930. Distributors of High Quality audio products from Duson Electronics, Totem Loudspeakers, Jeklin Float Headphones and quality recordings from Proprium, Prophone, Opus, MAP and Swedish Society. If ITS MUSIC YOU LOVE TELEPHONE OR WRITE FOR LITERATURE

MICHELL, 2 Theobald Street, Boreham Wood, Herts, WD6 4SE. For full information on our full range of excellent products including the Gyrodec, Aleco, Iso Argo and others please telephone us on 081 953 0771. Michell - Symbol of Precision

NORLOSTONE, Granite Audio Stands. The ultimate solution to problems of resonance and tonal accuracy. For 'bespoke' designs consult NORLOSTONE, West Dean Road, West Thyerley, Salisbury SP5 10G. Tel: 0980 862253

SELECT SYSTEMS (PERFECT PITCH MUSIC), Hanworth Trading Estate, Hampton Road West, Feltham, Middlesex, TW13 6DH. Tel: 081 893 8662. Fax: 081 893 4318

We manufacture the Francinstien CD enhancement system. The Dacula DAC and Perfect Digital and Analogue interconnects. Perfect Pitch also provide freelance design, manufacture, prototyping and test, also valve and solidstate specials. Trade enquiries welcome.

QUANTUM AUDIO LTD, PO Box 26, Kilmarnock, Ayrshire, Scotland, KA3 7JA. Tel. 0563 71122. Audiophile CD's & LP's. The UK's largest specialist: Minstrel ultra linear integrated tube amplifier. Last record and preservation products. Write or phone for full listings and prices

REL ACOUSTICS, Unit 2, New Street, Bridgend Ind Est, Bridgend, Mid Glamorgan, CF31 3UD. UK. Tel. 0656 768 777, international +44 656 768 777. Fax: 0656 766 093 international +44 656 766 093. The UK's only specialist sub-bass speaker manufacturer. 'The only one that works' Get your dealer to give you a home demo and find out what the fuss is all about.

REL, HARMAN AUDIO, Unit 2, Borehamwood Ind Park, Rowley Lane, Borehamwood, Herts. WD6 5PZ. Tel: 081 207 5050, Fax 081 207 4572. Sub Base Systems - Rel Strata, Stadium, Stentor, Studio
RICHARD ALLAN AUDIO, Bradford Road, Gomersal, Cleckheaton, W. Yorks. BD19 4AZ. Tel. 0274 872442. Fax 0274 869935. Manufacturers of very high quality loudspeaker enclosures and drive units. Examples being the E270 RA8 series 2 as supplied to the BBC and the S - reviewed Minette 2 at £120

SAMBELL ENGINEERING LTD, Winston Avenue, Croft, Leicestershire, LE9 6GQ. Tel. 0455 283251.

ATACAMA AUDIO SUPPORTS from Sambell Engineering Ltd. We are the sole manufacturers of the 'SE' range of speaker stands, consisting of an 8", 12", 16", 20" and the award winning 24" high stand. Also three specialist models for the Tannoy 'sixes' Loudspeakers.

SEQUENCE DESIGN LTD, 63 Main Street, Burley-in-Wharfedale, Yorkshire. LS29 7BU. Tel. 071 495 0775. Fax 071 495 0281. Slim loudspeakers which stand close to a wall or hang like pictures. 'Likely to cause a glint in the audiophile's eye' (Audiophile); 'the answer to a prayer....a bargain in the extreme' (HiFi News). Available with light or dark grilles and various solid wood finishes. From £199.95 a pair. Call or write in for an information kit and reviews re-prints.

SHEARNE AUDIO, PO Box 22, Stevenage, Herts. SG2 8HF. Tel. 0438740953. Following the success of John Shearn's Phase 1 pre-power combination, (reviewed in HiFi), is the phase2 reviewed earlier in HiFi and listed as a favourite. Having many of the design features of the phase 1 R.R.P. £549, 50 wpc and same finish as Phase 1 pre-power. Also, option of phono stage for phase 2 mm £65 mc £75

SLATE AUDIO, makers of THE FINEST SPEAKER SUPPORTS IN THE WORLD have never had a bad review, our reputation is legendary. Contact us now for details on our CUSTOM STANDS, as well as our solid marble GARRARD 301/401 PLINTH SYSTEM (Hi-Fi World Dec 93) THE GLASSMAT platter mat and the very special SME GARRARD 401 CELEBRATION ARMS. 47 Gemini Close, Leighton Buzzard, Bedfordshire. LU7 8UD. Tel: 0525 384174.

THE SPEAKER COMPANY, Unit 9, Waterside Mill, Waterside, Macclesfield, Cheshire, SK11 7HG. Tel. 0625 500507. The Speaker Company are a new company offering a wide range of loud speaker units from Audax, Celestion, KEF, Morel SEAS and many more. Also a wide range of speaker accessories the keen builders

THE TOI GROUP, Unit 1 Summerlea Court, Alton Road, Harriard, BASINGSTOKE, Hampshire. RG25 2PN. Tel: 0256 381 514. Fax: 0256 381 692. Electronic Components distributors specialising in: Mains Power Connectors, Jack Plugs and Sockets, 4mm Connectors, Din and Mini Din Connectors, Phono Connectors, DC Connectors, XLR Connectors, Rotary Potentiometers, D Type and IDC Type Connectors, Co Axial and BNC Connectors, Switches, LEDs, Diodes, Bridges and Rectifiers, Fuses and Thermal Tips. - Have you got one of our new 1994 General Product Catalogues?

TARGET AUDIO PRODUCTS PLC, Britannia House, Leagrave Road, Luton, LU3 1RJ. The Audio equipment, rack and speaker stand specialist. For information on our products please telephone or write

TRICHORO RESEARCH LIMITED Following on from the highly acclaimed CD clock oscillator modifications the Pulsar Series One digital to analogue converter. This unique design is part multibit and part bitstream to give absolute linearity over an extremely wide dynamic range. Switchable between 18 or 20 bit resolution this converter will become the standard for CD replay. For details telephone (0684)573524

WOLLATON AUDIO, 134 Parkside, Wollaton Notts. NG8 2NP. Tel/Fax: 0602 284147. Imported high end at low prices. XLO interconnects and loudspeaker cables - 'The Best In The World'. Clements loudspeakers - incorporating ribbon and transmission line technology to reproduce the finest sounds. Monarchy digital - transport, DAC, DAC + pre and DIP anti jitter module. Matches the best at a fraction of the price. 'NEW' Audio Valve amplifiers - Simply gorgeous. Call us for details.

WILMSLOW AUDIO LTD, Wellington Close, Parkgate Trading Est. Knutsford, Cheshire. WA16 8DX. Tel. 0565 650605. Extensive range of drive units and over 30 different designs of self-assembly kits. Everything required for the loudspeaker build and four dem rooms to listen to the kits in built-up form

To Advertise in this section, please contact Caroline Knott on: 071 266 0969

The distinctive Pentachord loudspeaker comprises two satellite that use 50mm metal-cone Bandor drive units in sealed pentagonal enclosures. The subwoofer also uses a Bandor driver in a sealed pentagonal box, but scaled up somewhat. Both are driven actively, needing a mono power amplifier for bass (a Moth was supplied for this purpose), and a stereo unit for the satellites, the signal being supplied from the pre-amp through an active crossover. As with nearly all subwoofer systems, bass level can be altered to suit taste and aid room matching.

We first reviewed the Pentachord loudspeaker a few years ago. In this latest incarnation, Oliver Brooke, Pentachord's founder and designer, claims to have made significant improvements.

As soon as I pressed play for the first time, I became aware of limitations within the satellites. Dynamic crescendos were suppressed, leaving little dynamic contrast, which in turn limited stage depth considerably. When a chord was struck hard on guitar it sounded little louder or further forward than a snare drum being hit at the back of the stage. Even close miked recordings such as John Lee Hooker's Boom Boom sounded more distant than it should, the sound seeming compressed and lacking fullness of tone.

Vocals suffer too, especially male vocals where a deep chesty growl was just too much for the

little satellites to cope with. Limited dynamic contrast and lack of power through the vocal range give the Pentachord system a small scale performance.

Another problem they face is lack of high treble, which makes them sound even more closed in. Sparkle from cymbals was virtually lost and what remained quickly decayed to leave a rather damped 'ting'. The treble that is there is quite clean and detailed, but against any other speaker that gets smoothly past 18kHz, these speakers sound sterile.

Upper bass sounded clean and smooth, but there was little punch to get

tracks like Blur's 'London Love' really moving. The satellites don't have enough energy to provide a strong beat, sounding lethargic, and the subwoofer, although it comes in quite high up, struggles to make up for them. The satellites ideally need to be pushed down a little lower, where the light and fast cones should be able to fill in this missing speed, but I suspect that this would severely limit power handling.

On the plus side, the two integrate together well, at least in terms of sonic character, as you'd expect from units

“Upper bass sounded clean and smooth, but there was little punch to get tracks like Blur's 'London Love' really moving.”

STRIKING

The new Pentachord loudspeaker system comprises two 50mm active satellites and a subwoofer.

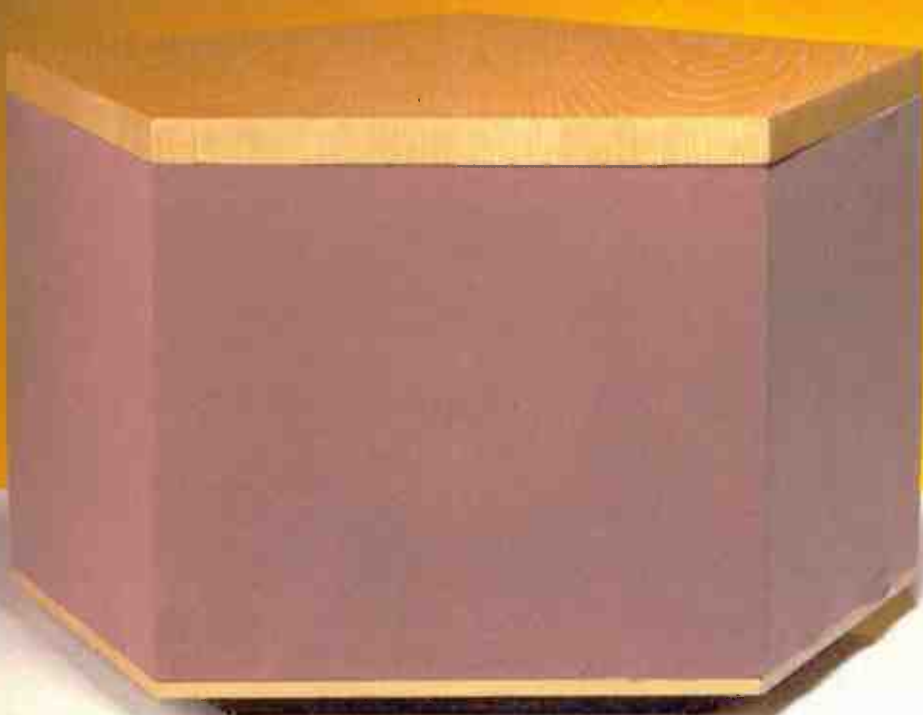

MEASURED PERFORMANCE

To measure the Pentachord system I used a different form of analysis to the 1/3 octave plots we normally favour. Periodic noise and near field measurement gave a higher resolution picture of the drive units where a subwoofer and satellite system is concerned; it shows how the two roll into each other at the crossover point more clearly.

The main plot is that of the satellites, covering a range from around 150Hz up to 10kHz. Above 10kHz the 50mm Bandor cones break up quite strongly due to their size, but treble is smooth enough up to 10kHz, and output still good enough above this for them to sound reasonably well balanced. I'd expect the Pentachords to sound clean, but slightly softened in the

using the same cone material. Bass lines can be followed smoothly up and down through the crossover point, and the result is pleasantly tuneful. But the Pentachord system is best suited to dry recordings, like The Breeders' Pod, where it follows bass lines well and disguises the lack of expression. Female vocals too are well represented, where the satellites sound clean and can project reasonably far forwards.

Dolores O'Riordan's Irish tones on The Cranberries album Everybody Else Is Doing It, So Why Can't We, were delivered with a smoothness you only get from full range speakers. On 'Pretty', as she reaches a crescendo, the little 50mm Bandor drivers became a touch too far forwards and hard, but otherwise turned in a tidy performance. This did reveal a little glare in the upper midrange, but it is only really noticeable when vocals are especially strong.

The imaging qualities of the Pentachords wasn't as precise as I'd expected. They create a wide enough

stage, but individual performers were spread wide too, giving them a diffuse, almost phasey quality. Something I also hadn't noticed before, was the way the subwoofer missed the seismic bass at the intro of this track, where the RELs, for example, go deep enough to catch its full impact.

I had to watch the volume quite carefully with this system. The small Bandor units of the satellites are quite insensitive and cover a wide frequency spectrum which places a heavy demand on them. A powerful amplifier is needed to get them going, but with a touch too much volume large cone excursions at low frequencies causes them to meet the end stops with a metallic crack. I don't listen at high levels, many play their music at higher levels and I suspect that they'd have problems with the Pentachords in this area.

The Pentachords are nicely finished and traditionally styled, but in my view their sonic quality just doesn't live up to the high price tag, especially when you

take into account the extra amplification needed ●

Satellites + Subwoofer £899
Including Moth Amplifier £1164
Pentachord
49 Rusholme Rd,
London.
SW15 3LF
Tel: 081 788 2228

A CHORD

uses metal cone Bandor drivers.

Dominic Baker asks if the replacement will help.

treble, which is no bad thing with CD.

Through the midrange their response is very smooth, a benefit of using one driver to cover the whole range. There is a notch around 1kHz, but the ear isn't especially sensitive to short, sharp discontinuities, more so to wider overall trends.

The satellites are smoothly rolled off around 150Hz where the subwoofer comes in, taking bass down to a healthy 30Hz or so. Again, a metal cone Bandor unit is used, so the two should integrate well having the same sonic character.

The 50mm Bandor units cover a reasonably wide range smoothly, albeit

breaking up in the extreme treble, and the subwoofer is able to extend bass down far enough to provide a deep and solid foundation to music. **DB**

Frequency Response

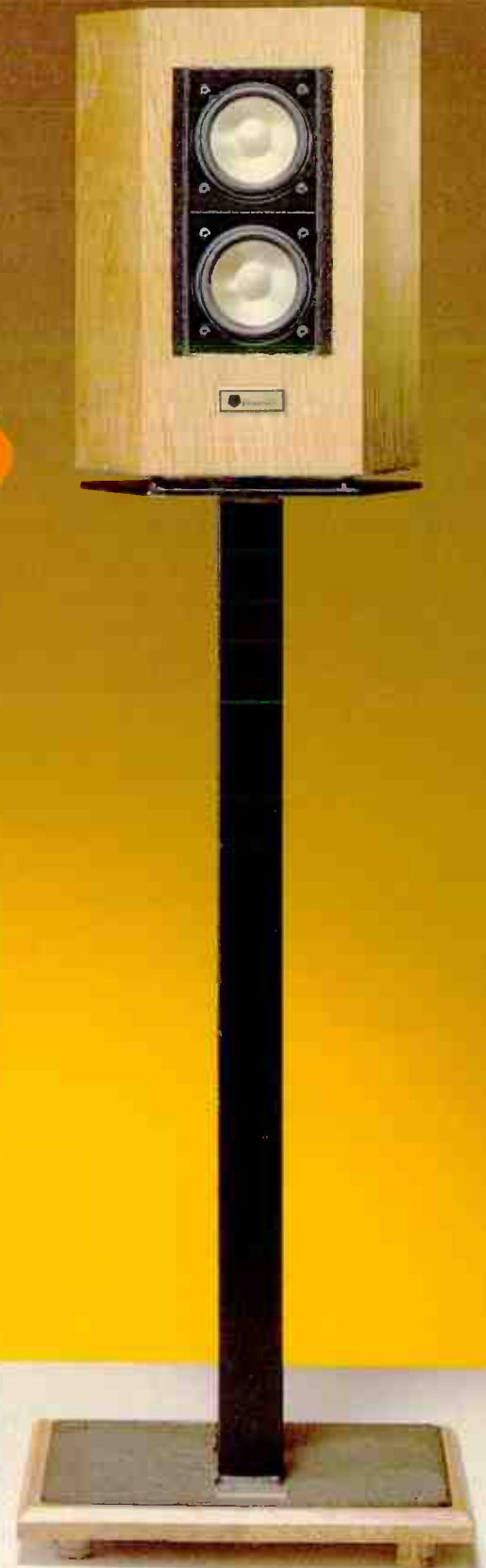
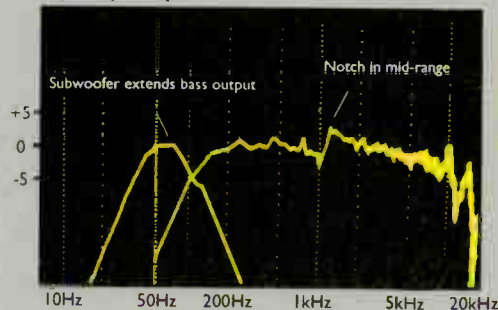

It has taken a long time, but I think that the hi-fi industry is slowly being forced to listen to what people want and meet their needs. Back in the early eighties hi-fi took a severe turn for the worse, not due to the arrival of the Compact Disc, but because of the attitude of major manufacturers to the buying public. We were told that CD was better than vinyl, that big, powerful and expensive amplifiers were better than little ones, that expensive cables were a necessity with them, etc, etc. The decisions were made in all confidence and were not questioned, giving buyers no options - it was pointless arguing.

A high end system comprised a convenient but harsh sounding CD player, a pre/power amplifier of gigantic proportions and enough current on the 'speaker terminals to weld with, plus a pair of 'speakers no bigger than a shoe box and of gruesome inefficiency. The black box CD player and amplifier, full of cheap, low tolerance, industrial grade components, were connected with interconnects and 'speaker cables resembling a hose pipe to prevent any detail that still survived from being lost before it entered the next box of electronics. It worked for a while: "Hey, look at my interconnects. They're thicker than a North Sea pipeline, bright yellow and cost £700 per metre! And the power-amp makes the lights dim when you turn it on - watch."

Faced with this sort of thing as the best hi-fi could offer, it's no wonder midi-systems became so popular. Both seem equally crass in their own way, yet one costs a lot less than the other. Why shouldn't they be a common choice? Those with little knowledge of hi-fi would have had no reason to doubt the promise of quality sound from a £500 all-in-one, complete with a light display complex enough to convince anyone that what was going on behind it was absolute state of the art. The impecunious audiophile was left with a

little 'starter' system, unable to afford a super-amp that could double up as an arc welder.

Ironically, Japanese consumers were less fooled by this aggressive marketing. Whilst Britons were buying the latest gadget stacked midi-system; they were stocking up on real hi-fi from Britain, Germany and the States. Garrard Leak, Quad and Tannoy, Thorens and EMT, Klipsch and Marantz. Being fastidious people by nature, they took good care of them though and in fact do more to preserve our hi-



Dominic Baker

dB on the level

fi heritage than ourselves.

Thankfully we've started to realise this, and manufacturers are beginning to cater more for the consumer and less for the simple paths charted by marketing men. Amplifiers are diversifying, some becoming smaller with more attention paid to component quality and circuit topology than outright power; loudspeaker sensitivities are on the rise too in order to accommodate such amplifiers. Turntable manufacturers are continuing production, 12 years after the introduction of CD, and companies like Ortofon have even managed to increase business in this area. We are seeing the revival of the valve amplifier too; we get more press releases about new models than the granting of THX licences (for the audiophiles out there, THX is something to do with home cinema).

DIY hi-fi is also making a strong re-appearance, increasing the amount of diversification. You can now build almost every part of your hi-fi, which puts the word 'Hobby' back into a

business that was degenerating into a box shifting operation.

And - best of all in some ways - some amazingly well engineered and built vintage equipment is gaining the recognition it deserved and still deserves today. Sadly, it's a little late for the likes of Leak and Garrard, to name but two.

All of this makes hi-fi more interesting, involving and even exciting than it has been for a long while. It's more affordable and therefore accessible too - a superb system can be put together for the same money as a reputable brand midi system.

So, happily it looks as if we're finally going in the right direction. But a lot of damage has been done on the way. The consumer has become more critical and discerning of sales 'hype' it seems to me, from the numerous letters we receive about the negative effect this has had on those who want to enjoy music, and not be fed commercial dogma. Trust has been lost to such an extent that innovations like MiniDisc, DCC and Home Cinema

systems are having a difficult time trying to convince the public of their worth. I missed out on vinyl; by the time I got seriously into hi-fi CD was the only option. But even I've bought a Garrard 401 and I'm starting to visit more second hand record shops than CD megastores, after discovering that CD offered no advance in sound quality.

This appears to be a phenomena of the nineties. Whereas before people were happy to believe and be led, now the consumer is more informed and wary and has a

wider choice. You can go out and choose what you want, the richness of variety being on the increase all the time.

Against this background, why are the overall circulations of the hi-fi magazines on the decline, suggesting a falling interest in hi-fi? Well, I reckon it's because the mainstream magazines cover such a small area of the wide range of hi-fi orientated subjects. I think we are seeing a revolt away from the mainstream, from rampant and dictatorial commercialism, towards smaller, more specialised groups. Clubs, swapmeets, shows, music evenings and underground magazines are taking over as places for audiophiles to communicate.

We recognise this and try to cover as many areas as possible. But this wouldn't be possible without the letters you send in, telling us about your clubs, meetings and so on. Write to us with details of your hi-fi club, however big or small, and we'll let people know. After all, isn't this where hi-fi is really at nowadays?

Hi-fi for as little as £50,000.

[And more. Or less.]

If you take your hi-fi seriously – and we do mean seriously – this should sound familiar.

One, you'd like totally unbiased advice on all the available options.

Two, you're not prepared to settle for less than the best your money will buy.

Three, you feel you deserve a professional to tailor a one-off system to your personal requirements.

Four, you expect to test drive equipment – at length – before you decide.

And last, but not least, you'd love to have your own expert on permanent call.

In short, you want Serious Kit.

Simply ring 061-707 4823 for access to all the above.

Plus, most of the world's finest names in top-end equipment. And all the experience of the UK's top talent in hi-fi system design.

Serious sound. Serious sense. Serious service.

Serious Kit.

Music to your ears.

SERIOUS KIT

SERIOUS KIT · 21 ALGERNON STREET · MONTON · ECCLES · MANCHESTER M30 9QA · TELEPHONE 061-707 4823.
THE TOP NAMES. THE TOP EQUIPMENT. ACCUPHASE · ALCHEMIST · APOGÉE · AUDIO INNOVATIONS · AUDIOLAB
AUDIO RESEARCH · COPLAND · COUNTERPOINT · EPOS ACOUSTICS · GROOVE TUBES · HEYBROOK LOUDSPEAKERS
IMPULSE LOUDSPEAKERS · JADIS · KRELL · LYRA · MAGNEPAN · MARTIN LOGAN · MICHEL · MICRO-MEGA
PINK TRIANGLE · P.S.AUDIO · ROKSAN · SONUS FABER · SUGDEN · SYSTEMDEK · TEAC · THETA · THIEL · WILSON AUDIO

The death of the Roksan Xerxes turntable came as a double edged blow to me. Not only was it, in my opinion, one of the most capable and satisfying turntables available, short of such esoterica as the SME 20, but its demise serves as an acute reminder of vinyl's unceremonious and terminal decline.

Roksan fans are now left with the thankless task of choosing between the competent but unexceptional Radius and the superb but pricey TMS. Some choice! For vinyl enthusiasts the only real choice is the TMS and at £2500 before extras, its price alone puts it well out of contention for many. So where does this leave vinyl enthusiasts who want a high quality deck, but can't afford, or aren't willing to pay the decent, second-hand car sums involved? Certainly not at Thorens' door, that's for sure.

Thorens now have a range of turntables, sold in the U.K. numbering just four. Admittedly, the TD180, 280 and 166VI are capable decks, but the newly crowned "top of the range" combination of the TD166VI with Rega 250 arm is hardly going to set the world alight. One of my points in last month's column was how important aspiration is to the hi-fi industry. Thorens' TD 2001, 3001, 320 and 520 models may not have quite made it to the top of their respective classes, but they offered superb build quality, German engineering precision and pretty decent styling and sound quality to boot. Without such models Thorens' image slips to that of maker of good budget turntables - hardly aspirational and certainly nothing to set the industry alight.

Life at the budget end of the turntable market is tough. This sector has been hit hardest by the rising standards and falling costs of CD players over the last few years. Casualties were inevitable, and one of the more recent is the loss of Revolver.

They shall be missed in the industry for producing turntables which didn't necessarily sound the best, but which offered a range of quality finishes at very reasonable prices.

Although the Revolver name is to be reincarnated, it's highly unlikely we'll see the return of their turntables and affiliated clutter such as the aptly named "Pig" record clamp. Instead, the Revolver name will be used on - surprise, surprise - budget loudspeakers.

They are not alone in



Fair Views

- from Dominic Todd, our man in Scarborough

having dropped out of the turntable market either (and, indeed, the market as a whole). Since 1990, AR, CEC, Heybrook, Kuzma, Opus, Oracle, Oxford, Vantage, Alphason and Revox have all pulled out of the turntable market, or have even been forced to cease trading altogether. Revox was struck a double blow with the demise of their open-reel tape recorder, accelerated by DAT, leaving only their tuners as a decent product with a market.

And what of the other vinyl greats, Linn, Rega, Townshend, Pink, Michell, SME and the like? Well, with the exception of SME, they have all (including Roksan) crept further and further into the electronic and loudspeaker domain, despite a number of them vehemently rubbishing digital technology as little as five years ago. Having said that, it's reassuring to see such companies sticking by vinyl (there's obviously still a bit of money in it), although new products are becoming thinner and

thinner on the ground. With a bit of head scratching, I can think of only a handful of new vinyl based products launched within the past 18 months or so from these manufacturers: Linn Klyde, Arkiv and Circus, Michell Mycro, the aforementioned Roksan TMS and Townshend Rock III spring to mind. It's pretty pitiful when one considers that in the mid-to-late eighties there was that much kit being launched almost every month.

Not everything is doom and gloom in the vinyl camp though. Newcomer Pro-ject helped to significantly boost flagging sales of record decks at the tail end of '93 up to the present day. This fledgling in the vinyl camp came at precisely the right time for the industry. The budget market received the highly acclaimed and immensely "tweakable" Pro-ject 1 and 2, whilst stalwarts such as Linn, Pink and Manticore face strong competition from the highly talented, mid-price-range Pro-ject 6.

It hasn't ended there, either. Several months after their launch, Ortofon decided to offer these decks with their own cartridges at discount prices - and the super-budget Project 0.5 was launched too. There are also plans to fit the '6 with a new arm designed by none other than Sumiko.

If my ruminations sound like the last utterances of a vinyl junkie, muleishly blind to CD, then they're not supposed to. I fully accept that any music lover has to

have a CD player these days simply to be able to obtain certain discs (particularly Classical). But what has startled me is the sheer speed of vinyl's decline. The way I see it, Compact Disc's dominance is an inevitability that has come upon us prematurely, since it is still very much in its development stages. If vinyl could just hold out until CD has reached such a stage where its sound quality justifies its market dominance, then fine.

We are only just starting to see such CD players reach the market. DPA's new PDM ten twenty-four CD convertor is such a machine, but at £6000 it's a high price to pay. How long is it going to be before a four hundred pound CD player offers the performance of a Pro-ject 6, for example, let alone a budget machine involving the listener in a way that a Pro-ject or Rega Planar 2 can? It probably won't be until the next century. In the meantime I'll just stick to my recently purchased Roksan Xerxes and Artemiz thank you!

COMPETITION - WIN AUDIONOTE OTO SE AMPLIFIER AND UKD CALLAS LOUDSPEAKERS

This month you could be the lucky winner of a superb amplifier / loudspeaker combination, ideal for those with small rooms and a taste for the finer qualities of music. The amplifier is the highly specialised Audionote OTO SE, a single-ended valve amplifier

producing one of the sweetest 8watts of power we've ever heard. The OTO SE uses super quality components in an elegant single-ended circuit with EL84 output valves to produce a level of sound far above its price.

When Noel listened to the OTO SE

for our August issue this is just one paragraph he wrote in its praise. "By conveying such low level delicacies with tactile clarity, crescendos sweep past with an unstrained majesty; there's no need to jump for the volume control. The OTO SE remained smooth and pure at these moments, keeping first and second strings clearly separate, for example. In fact, it handled every situation with aplomb, bringing a silkiness to strings, yet giving them fine delineation too, imparting seismic power to kettle drum, yet a sweet ring to triangle".

With an amplifier of such capabilities, a top quality loudspeaker is a necessity, so we've found just the thing. UK Distribution's Callas loudspeakers, reviewed in the same issue, use super drive units from specialist manufacturer Focal, along with solid Walnut cabinets to give a sound that belies their small proportions. With the OTO SE they'll be superb for small rooms, producing terrific bass quality for their size.

When auditioning the Callas, Dominic wrote: "The dry kick drum on Grant Lee Buffalo's country style acoustic set had plenty of atmosphere and detail to it; the initial impact triggered from the foot pedal and the following echo from the studio clearly evident. This album also highlighted the superb qualities of the treble unit. It is exceptionally clear, layers of fine detail appearing and accurately portraying the upper harmonic structure of steel strung acoustic guitar and the bright metallic chime of cymbals."

To enter this fabulous competition for an Audionote OTO SE and UKD Callas loudspeakers, simply complete the questions opposite.

Please send your entry on a POSTCARD, or the back of a SEALED ENVELOPE, and completed in block capitals, to arrive no later than Friday 7th September 1994 to:

**Audionote/UKD Callas Competition
Hi-Fi World Magazine,
64 Castellain Road,
Maida Vale,
London. W9 1EX.**

COMPETITION ENTRY QUESTIONS

- 1) Which valves does the Audionote OTO SE use in its output stage?

A. EL34	B. EL84
C. EF86	D. ECC88
- 2) What kind of circuit does the OTO SE use?

A. Push-pull transistor	B. Push-pull valve
C. Single-ended transistor	D. Single-ended valve
- 3) What are the cabinets of UKD's Callas loudspeakers made from?

A. MDF (medium density fibreboard)	B. Chipboard
C. Platerboard	D. Solid Walnut
- 4) Who makes the special drive units in the Callas loudspeakers?

A. Focal	B. Audax
C. RCF	D. SEAS

THE TIE BREAKER (OBLIGATORY)

SE is short for
 sweet and ethereal
 violins that sing
 a sound so beautiful.
 (complete poem with another four lines)

Don't forget to include your name, address and a telephone number so we can contact the winners promptly.

In the event of more than one entrant submitting all the correct answers, the winner will be decided by the tie breaker. We will endeavour to publish the results in the November 1994 issue. Purchase of the magazine is not a precondition to entry.

No correspondence about this competition will be entered into and the Editor's decision is final.

No employees of Audio Publishing Ltd. or any of the companies associated with production or distribution of the prizes may enter.

Your name and address may be added to our mailing list only. If you would prefer not to receive details of new products or special offers please state so on your competition reply form.
 Hi-Fi World magazine is published by Audio Publishing Ltd.

JULY ISSUE
COMPETITION - £2000
ORTOFON MC7500
CARTRIDGE

Possibly the best cartridge in the world and only one lucky winner. Congratulations to Mr. Sean Mitchell of Camden. We hope you've got a good record deck for it.

competition





as stylish and stylised as ever, whether echoing former glories like the country flavoured (as in Gram Parsons) 'New Faces', or the Faces/Stones riffing of 'Sparks will Fly', not to mention the Stax-Volt Horns that fill out 'Brand New Car'. And in 'Out of Tears' we have an example of what made the Stones great.

Darryl Jones proves himself a more than competent replacement for cradle-snatching Bill Wyman on bass, and producer Don Was - in collaboration with the Glimmer Twins - proves a more than adequate knob twiddler. Other highlights include Keith's 'Sweethearts Together' a sweet country and western item with a subtle Latino undertone (Flaco Jimenez, who else? You can just taste the burritos and tacos.). 'Suck on the Jugular' has a strong Crescent City feel thanks in no small part to Ivan Neville's organ.

And if it's true there are times that Jagger bends over backwards somewhat too far to be topical ('Did ya ever feel the pain/as a Semtex bomb goes off...?'). Then there are wild gems like Keith's wheezy 'Thru and Thru' or 'Mean Disposition' a neat up tempo boogie threaded with the sweetest Chuck Berry guitaring this side of Keith Richard!

A classic? Definitely not. But interesting none-the-less.



Giovanni Dadomo

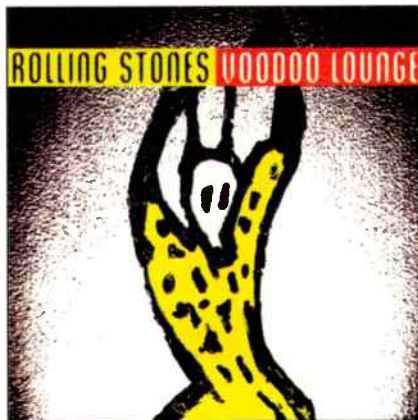

THE ROLLING STONES Voodoo Lounge VIRGIN CDV 2750

● The trouble with the Rolling Stones, and we all know it, so it's barely worth the mention, is they're somehow beyond discussion. Are they an event, a benchmark, the rock and roll equivalent of The Holy Bible? Once maybe, but on the basis of the last decade's releases at best they're a bunch of old crinkly-wrinkleys, struggling to retain a spot of credibility alongside heaps of Jagger and Keith come-latelies, most notably Primal Scream and the Black Crowes.

That said, this is a far more interesting, variegated and entertaining recording than the somewhat plod-hopping 'Wheels of Steel'. Overall, and on a few mere hearings, Voodoo Lounge is more than just run of the mill Rolling Stones, which is to say the band remains

INDEX

RECORD REVIEWS

ROCK & POP74
Giovanni Dadomo

CLASSICAL85
Peter Herring

JAZZ93
Simon Hopkins
Simon Cooke

L7
Hungry For Stink
 SLASH/LONDON 828 531-2

● L7 continue their role as the Grunge Queens of the Music World with this excessively heavy medley of anti-everything 'tunes'. The low slung guitars and an attitude wreaking of Courtney Love's twisted screams characterise this menacing second album from L7, *Hungry For Stink*, the follow up to their major label debut, *Bricks Are Heavy*. In fact if you could describe its style you could only say it lies somewhere in between the frenzied guitar attack of *Sonic Youth* circa *Daydream Nation*, and the sardonic wit of PJ Harvey.

That's not to say L7 are merely an amalgam of outside influences. They are most definitely at the forefront of the so called Riot Girl movement, but mention that to their faces and they are likely to take serious offence.

This long player carries on where the classic single 'Pretend That Were Dead' left off and then goes some.

Kicking off with the current single 'Andres', performing well in the charts and giving L7 the larger audience they



deserve, it roars along at a ferocious rate of knots.

Layers of searing guitar (with the obligatory feedback) underpins the majority of *Hungry For Stink*. From cuts like 'The Bomb' through to 'Stuck Here

Again', a cert for the next single in my mind, we are treated to an all consuming assault on the senses. L7

take you on a rollercoaster of a ride; ridiculously fast, thrashy guitars hammer out every number like there's no tomorrow. It's exhilarating to the last and hugely enjoyable. One thing you can be sure of is that these girls just want to have fun. 'Shirley', a song about Shirley Muldowney one of America's only female drag racing stars, sums up L7's view with the question: "What's a beautiful girl like you doing in place like this?" To which they retort "Winning".... and who would doubt them?

The closer, 'Talk Box', slows the pace down, but only slightly. A song full of wah wah and most memorably a gloriously sarcastic chorus: "Last night I had a dream / It scared the shit out of me" - I mean, one

listen to this and you will be left in no doubt that it would take a great deal to do anything of the sort.

This is an album to be played loud. So wind your amp up to ten, sit back, and enjoy.....or else!

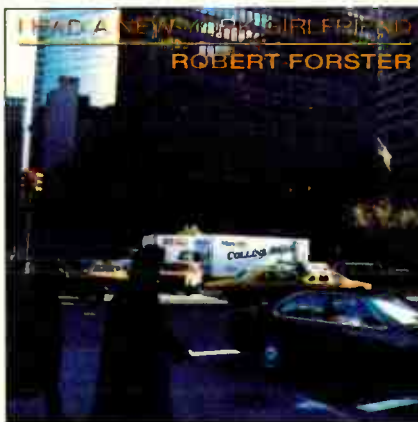

ROBERT FOSTER
I Had A New York Girlfriend
 BEGGARS BANQUET BBQCD 161

● A surprising and daring change of pace for Aussie maverick Robert Forster, late lynch pin of the departed Go Betweens, and much respected if little bought indie star. Utilising a bevy of local names (including Nick Cave's cohorts Mick Harvey and Conway Strange), Forster's third solo album is a novel and daring collection of cover versions.

Nature's Way, the opener, dates from Randy California's Spirit days and is definitely one of the first in a long line of eco-friendly pop classics not to mention boasting a refrain to die for. There's a rare Neil Diamond composition first recorded by the Monkey's, 'Look Out Here Comes Tomorrow' and Mickey Newbury's 'Frisco Depot' - a little known singer songwriter better known for writing the Presley anthem 'American Trilogy'. Needless to say there is the odd clinker; Martha and the Muffins 'Echo Beach' is.. well Marth and The Muffins 'Echo Beach! On the other hand Keith Richard's 'Locked Away' can only benefit from someone who can sing. Heart's 'Alone' is similarly served by being patently more subtle than its blatant AOR original. Dylan's 'Tell Me It Isn't True' and the previously obscure 'Bird' by the little noted Germans, King Candy, both benefit from Forster's distinctive interpretation.

Overall a very nice album from one of the lesser known members of the Rock and Roll Pantheon and one who deserves as much attention for his interpretive gifts as for the writing which he has previously only been known for.



BOOTSY COLLINS NEW
RUBBER-BAND
Blasters of the Universe
 RYKO RCD 90307/08

● A welcome return to form from one of the pioneers of funk. Bootsy Collins cut his bass-playing teeth in the classic James Brown line up that set the tone for generations to come with the likes of 'Sex Machine', and other "shall we take it to the bridge?" foundation funk classics before going on to become a pivotal

force in George Clinton's Parliament, P-Funk and various permutations thereof, prior to becoming a star in his own right with the inestimably influential Booty's Rubber Band.

His seemingly low profile of late still allowed him such various collaborations as work with Afrika Bambatta, Deee Lite, not to mention original mentor George 'funkadelic' Clinton. Collins is the man who made six inch platforms and silver lamé suits a byword for style when Gary Glitter was still looking for a wig to fit, let alone a style that wasn't vile. Like Clinton himself Booty is one of black music's true originals, in fact the only sin he could be accused of is dredging the depths for every obscene pun imaginable on the word funk. When he is playing bass however he is still an ace.

This double set comes with a free (in every sense) disc of re-mixes. Take it or leave it, he has no peer.

VELVET CRUSH
Teenage Symphonies To God
 CREATION CRECD 130



● Velvet Crush? I think if I ran Creation Records I would label this Stoned Roses and hope for the best. A friend of mine - a leading light in a major indie band himself (no name no pack drill) - recently described them as just another Creation pop band. And you have to admit anybody who calls their debut LP In The Presence Of Greatness and then follows it up with the current Teenage Symphonies To God is probably not too short in self-esteem, ego, humility etc.

And yes yes - it's true these Rhode Island boys owe more than a might of inspiration to the likes of The Nazz, Big Star, Teenage Fanclub and a hundred billion other sweet-voiced harmonizing popsters with an ear for a good hook and a nice line in jangling guitars. But what the hell is wrong with that? It was good enough for Peter and Gordon, it was good enough for Blondie, it was even good enough for the Beatles, so who are we to complain.

What more can you say about Velvet Crush except that Teenage Symphonies To God is a pretty aptly named title. 'My

Blank Pages' for example (no Byrds allusion intended) is as catchy as they come, although I'm a trifle stuck to find such supposed influences as Buck Owens and Chet Baker - unless it was in the hair styles. All quibbling aside, well worth listening to.

SWELL
41
 ARB CD 6



● Fourth long player from American indies, who put out an interesting, if a little self indulgent, fanzine - Swollen - the most interesting section being a find the word puzzle which includes no less than 72 bands they have been compared to.

To this particularly cloth eared reviewer they sound nothing so much like the bastard offspring of the Velvets' third long player and anything at all by Tindersticks. Obviously one of us is totally barmy. Or not.

VARIOUS ARTISTS
No Prima Donna - The Songs of Van Morrison
 POLYDOR 523368 2



● The astonishing thing about this 'Tribute' album is that Van the Man co-produced it alongside Phil Coulter. For a start this could hardly be said to be the finest collection of Morrison's songs by any standards. Likewise the selection of artists - Lisa Stansfield (?), Casandra

Wilson (who is she?) and, worst of all Liam Neeson (isn't he an actor?) can hardly be said to represent popular music's perihelium (pretentious? Moi, non!).

Sinead O' Connor with 'You Make Me Feel So Free' and Elvis Costello's relatively obscure 'Full Force Gale' almost save the day, while Marianne Faithfull could hardly go wrong with the classic 'Madame George'. Overall though, an artist of Morrison's stature deserves a great deal more.

CONSOLIDATED
Business of Punishment
 LONDON 828 514-2

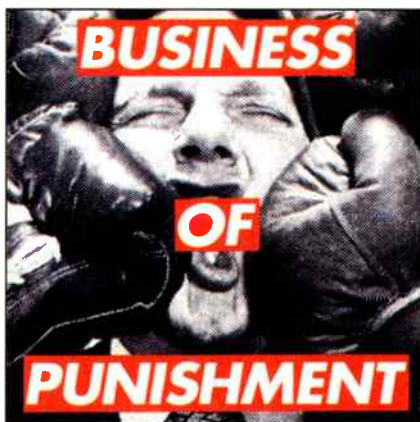

● Consolidated are a five year old principally rap-orientated trio from the USA. Surprisingly enough, Mark Pistel, Adam Sherburne and Philip Ster are in the vanguard of the politically committed rap movement producing music that is both imaginative and to-the-bone.

As before and with perhaps more eloquence and power they confront such patent world problems as female exploitation; 'No Answer For a Dancer' - a woman's right to choose, 'Born of a Woman, and the dread of AIDS on 'Today Is My Birthday'. Comrade spirits evoked include the late Frank Zappa and the ailing but none-the-less great Curtis Mayfield.

This is perhaps the band's most musical record yet, but that doesn't mean they have compromised their hard hitting political message one jot. Consolidated continue to put the bulk of rap to shame. They are essential, quintessential and live up to their name.



Specialist Hi-Fi Dealers

SOUTH

THE SOUND GALLERY

BUCKINGHAMSHIRE'S PREMIER HI-FI DEALER

Arcam, Denon, Linn Products, Naim Audio, Meridian, Rotel, Yamaha, NAD, Quad, Tripod, Nakamichi, Rega, Creek, Epos, Mordaunt Short, Celestion, Marantz, Mission, Cyrus, etc. ...

65 Castle Street, High Wycombe, Buckinghamshire.
Open Monday - Saturday
0494 531682 / 444670

WORTHING AUDIO

20 Treville Gate, W.Sussex. BN11 1UA
(0903) 212133

The friendly shop with the best sound system in the South, Friendly advice

• 3yr guarantees • easy parking

Open Mon-Sat. 10am-6pm Late night Wed. 7.30pm

Agencies include: Arcam, Exposure, Kinshaw, Naim Audio, Marantz, Ruark, Audio Technica, Target, Tripod, JPW, TDL, Orelle, and many more.....

the powerplant

BRIGHTON'S LEADING HI-FI SHOP

Cyrus, Roksan, Micromega, Audionote, Audiolab, Rega, Arcam, Exposure, Aura, Epos, Thiel, Ruark, Rotel, Marantz and other fine equipment.

66 Upper North Street, Brighton
Telephone 0273 775978

Stockists of: ARCAM • CREEK • EPOS
HEYBROOK • MICROMEGA • NAIM AUDIO
NEAT • REGA • ROKSAN • ROTEL • ROYD
TEAC • YAMAHA

Infidelity

indecently good hi-fi

9 High Street, Hampton Wick, Kingston upon Thames, Surrey KT1 4DA. Tel: 081-943 3530
Open Tues - Sat 10.30am - 7.00pm.

CHICHESTER HIGH FIDELITY

7 ST. PANCRAS,
CHICHESTER,
WEST SUSSEX
CLOSED ALL DAY
MONDAY
Tel: (0243) 776402

Appointed stockists of: A+R Cambridge, Castle Acoustic, Creek, Dual, Goldring, Linn Products, Monitor Audio, Naim, Nakamichi, Quad, Rega, Rogers, Royd Audio, Spendor

FRANKIE IS BACK!

Ex-Luxman, Carver & Hafler chief engineer with his own back up team can custom-modify, rebuild, up-grade or repair any high-end equipment. Japanese spares, speaker bi-wiring service. To restore the best sound for modern & old classics, call Francis Wong on-

Tel: (0582) 411480 or Fax (0582) 451957

粵音
專家响

LONDON & SOUTH EAST

"One of the 5 best hi-fi shops in the world"

GRAHAMS HI-FI

Canonbury Yard, 190A New North Road
London N1 7BS, ☎ 071-226 5500
Ring for a chat, an appointment and a map!

BADA

For the great sound of sound :

The Comflake Shop
37 Windmill Street London W1P 1HH
071 631 0472 Fax. 071 436 7165

We stock ATC, Arcam, Meridian, Naim, Rega, Royde, Roksan, AVI, Monitor Audio, DNM; as well as offering a marvellous mail-order worldwide service • Crunch •

The Hi-Fi Shop
GUILFORD'S SPECIALIST SINCE 1950

We are at:
3 BRIDGE STREET, GUILDFORD
(By the traffic lights - next door to Alfred Marks)
0483 504801 • 0483 304756

Access • Visa • Switch
Open Monday-Saturday 9am-6pm (later by appointment)

Front End Problems?
contact-

The Cartridge Man

It doesn't have to cost an arm and a leg to get the best - listen to my Koetsu - and - Decca - eater.

Also agents for Croft, Sugden, Thorens, Pentachord Speakers & Nottingham Analogue.

plus cartridge re-tipping service

081-688 6565

AUDIO CONCEPT

27 BOND STREET, EALING
LONDON W5 5AS
TEL. 081 - 567 8703

AMC, Acoustic Energy, Aura, Audiolab, Audio Innovations, B&O, B&W, Cannon, Castle, Cyrus, Denon, Dual, Evolution, JPW, KEF, Marantz, Micromega, Mission, Monitor audio, Musical Fidelity, NAD, Nakamichi, Onix, Onkyo, Quad, REL, Rogers, Rotel, Systemdek, Target, Teac, Thorens, Van den Hul.

10 - 6 pm Mon., Tues., Friday, & Sat.
Late night Thur., closed Wed.

Two demonstration rooms.
Free local delivery and installation.
Repairs and Services

studio 99

7981 Fairfax Road
Swiss Cottage
London NW6 4DY
071 624 8855/6
Mon-Fri 10.7-5at 10.6

SURREY HI-FI

SPECIALIST HI-FI OUTLET
DEMONSTRATION ROOM - PARKING

- QUAD • AUDIOLAB • REL • TUBE TECHNOLOGY •
- TDL • TANNAY • KEF • DENON • NAKAMICHI • THORENS •
- TARGET • MAGNUM • ROTEL • MARANTZ • MICHELL •
- SENNHEISER • BEYER HEADPHONES • JPW •
- SOUND ORGANISATION • SOUNDSTYLE TRIPODS •
- VAN DEN HUL CABLES • BOSE • MUSICAL FIDELITY •
- SEISMIC SINK •

'HOME CINEMA NOW ON DEMONSTRATION'

Just 2 minutes off Junc. 6 M25, (A25)

GODSTONE 0883 744755
45 High St., Godstone, Surrey RH9 8LS

Spaldings

ESTABLISHED IN SOUND

☎ 081-654 1231/2040

352/4 LOWER ADDISCOMBE RD.,
CROYDON, SURREY

EAST

alphason apollo audio innovations audion audio note audiquest dpa fuller helus heybrook impulse ixas kar lya michell micromega morel orafon pierre lurne pro-ject projekt qed royd sonic link sound organisation soundstyle sterling sugden sumiko townshend trichord van den hul voyd home demonstrations, wide range valve/transistor/analogue/digital, nice people, peculiar adverts.....

Signals hifi for grown-ups
0473) 622866
mantesham heath ipswich

EIRE

We Never Compromise On Quality



55 Main St Blackrock Co Dublin
Tel 2899449/2888477 Fax 2834887
Open Tue/Sat 10AM-6PM. Thur/Fri 'till 9pm - Closed Monday

Acoustic Dimension

"How can I buy the best HiFi?"

Phone us to find out!

Choose from: AVI • Audio Innovations • LFD • Albarré • Heybrook • Triangle • Amrita • Proac • TDL • ATC • Micromega • Pierre Lumé • AMC • Rotel • Marantz • Kinshaw.

We can help you choose wisely!

Part exchange • Credit Card accepted • 3 demo rooms.
Acoustic Dimension 16, Idrone mews, Idrone Lane,
Black Rock, Co Dublin Fax/Tel: 01-2884612

Specialist Hi-Fi Dealers

AUDIO EQUIPMENT FROM LEADING AND SPECIALIST BRANDS ON TWO FLOORS FOR YOU TO LISTEN AND CHOOSE FROM

- 3 Demonstration Rooms
- Home Trials
- Home Cinema - Instore Demonstration Theatre
- Audio Visual Equipment
- Evening Demonstrations by appointment
- Inhouse Service Department
- Mail Order Available
- Interest Free Credit on Selected Items (Apr. 0% - Written details on request)

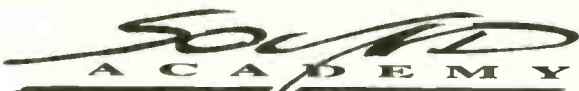

CINEMA
TEST

Quality, Clarity, Expertise...
and that's just the service!"

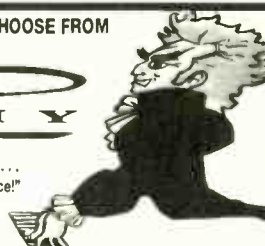

Sharing the ASDA
Carpark with ample
free parking
Off High Street,
Bloxwich,
Nr Walsall,
West Midlands
Near M6 Jnc. 10 & 11

Open 6 Days,
9am - 6pm
Late night Friday



Hi-Fi for the Beginner, the Enthusiast and the Audiophile Telephone (0922) 493499/473499

ACOUSTIC ENERGY • ARCAM • ALEVA • AUDIO LAB • IPO • D • A • ALPINO ALCHIMY • AUDIO QUEST • B&W • BOSE • BEYER • CABLE TALK • CHORD COMPANY • CHORD • CYRUS • CELESTION • IDEA • EPOS • EXPOSURE • INFINITY
JF • KEF REFERENCE • KENWOOD • MARANTZ • MICHELL • MONITOR AUDIO • MON TERA • MORDAUNT SHORT • MERIDIAN • MICROMEGA • MISSION • MOTH • MUSICAL FIDELITY • NAKAMICHI • ORTOFON • PROJECT • QUAD
ROKSAN • ROGERS • ROTEL • SENNHEISER • SÖN • S • ENDOR • S • UMIKO • SY-T • MDE • • TARGET • TDL • THORENS • TRIANGLE • TUBE TECHNOLOGY • VAN DEN HUL • VANDERSTEEN • YAMAHA • YBA

W. OWEN EST 1901
Audio/Video Specialists
Pioneer • Reference Point • Kenwood
Sony • Akai • B&W
Free Installation and Home Delivery

58 Staffin Street, Dakenegates Telford, Shropshire Tel: (0952) 613818
2A Stratford Street Newport, Shropshire Telford Tel: (0952) 810876

ARCAM, ROYDE, AUDIOTECH, CELESTION, APOLLO

Surround sound systems available for demonstration

STAFFORD WILKINSON ROAD 0785 55154
ALDRIDGE 37 HIGH STREET 0922 57926

LINN, ROTEL, MARANTZ, HEYBROOK, TARGET

Single speaker demo rooms free expert installation

Moorgate Acoustics Hi-Fi

Frustrated and confused?
Call in and get some help and advice from a company that cares enough about its customers to put them first.
184 Fitzwilliam St., Sheffield. Tel: (0742) 756048
8 Westgate Chambers, Rotherham. Tel: (0709) 370666

MIDLAND STUDIO

PHONE/FAX OR WRITE FOR OUR LATEST LIST OF EXHIBITION OR SECOND HAND EQUIPMENT FROM LEADING ESOTERIC MANUFACTURERS

MIDLANDS HI-FI STUDIO
WULFRUNA STREET
WOLVERHAMPTON WV1 1LX
TELEPHONE 0902 771774 FAX 0902 380083

MUSIC MATTERS

HI-FI THE AUDIO SPECIALISTS HI-FI

for the most exciting range of equipment available in the Midlands which includes:
Arcam, Aiwa, Alchemist, Alphason, Apollo, Arcam, Audiolab, Audioquest, Audio Innovations, Audio-Technica, Aura, Beyer, Cambridge Audio, Canon, Celestion, Chord, Cyrus, Deltec, Denon, Dual, Epos, Exposure, Heybrook, Impulse, Infinity KEF, Luxman, Marantz, Meridian, Michell, Micromega, Mission, B+W, Mordaunt-Short, Michaelson Audio, Monitor Audio, Monster, Musical Fidelity, Nakamichi, NVA, Panasonic, Pink Triangle, Pro-Ac, Revox, Rogers, Roksan, Rotel, Royd, Ruark, Sansui, Sennheiser, Straitwire, Systemdek, Target, Technics, Thorens, Wharfedale, Yamaha etc.

OPENING TIMES:
Tues-Thurs 10.30-6.00
Friday 10.30-8.00
Saturday 10.00-5.00
Demonstration by Appointment

351 HAGLEY ROAD, EDGBASTON, BIRMINGHAM B17 8DL
Tel: 021-429-2811

156/7 LOWER HIGH STREET
STOURBRIDGE, WEST MIDLANDS DY8 1TS
Tel: 0384 444 184

INTEREST FREE (for Ltd Period) APR 0%.
Written details on request.
Licensed Credit Broker.
Switch card accepted

THE STATE OF THE ART...

- EXPERT ADVICE
- CREDIT FACILITIES
- PART EXCHANGE WELCOME
- REPAIRS

Come and hear NAD+ B&W • NAKAMICHI • BOSE QUAD • BEYER-DYNAMIC • SENNHEISER • AURA - and lots more in our listening room.

Tel. 0743 - 355166

WON Hi-Fi Limited
12 Barker St. Shrewsbury
Plenty of parking - park and ride buses stop outside!

Peter Ellis Audio

A wide range of audio products always in stock including:-
Quad, Denon, Stax, Marantz, Arcam, Creek, Sugden, QED, Castle, Rogers, Celestion, Tannoy, Nakamichi, Yamaha

- * Home Cinema available *
- * Demonstration Room *

29, Kirkgate, Newark, Nottinghamshire NG24 1AD
0636 704571

Advent, Albarry, AKG, Alphason, AMC, AR, Arcam, Audioquest, Audio Technica, Beyer, Bose, Castle, Chard, Denon, Dual, Goldring, Meridian, Michell, Monitor Audio, Nagaoka, Nakamichi, Ortofon, QED, Quad, Rega, Rogers, Rotel, Sequence Design, Spondar, Target, TDK, TDL, Thorens, Wharfedale, K. Manks Record Cleaning Service.

Five Ways Hi-Fidelity., (Est. 1972)
12 Islington Row
Edgbaston, Birmingham B15 1LD
021-455 0667 (Closed Mondays)

FRANK HARVEY
Hi-Fi EXCELLENCE

163 Spon Street, Coventry, CV1 3BB Tel: (0203) 525200.
Mon to Sat 9.30 till 5.30. Closed Thursday

MUCH MORE THAN HI-FI
WE ARE A BADA DEALER MAILORDER - EXPORT - HOME TRIALS

Audiolab • Audio Alchemy • Arcam • Alphason • Bose • Bang & Olufsen • Celestion • Cyrus • Denon • Dual • Foundation • Kef • Marantz • Monitor Audio • Mission • Musical Fidelity • Nakamichi • Nad • Quad • Rega • Rogers • Rotel • Target • Tripod • Tannoy • Thorens • Van Den Hul • Yamaha

3 Floors, 3 Dem rooms, 3000 sq feet in the pursuit of Hi-Fi Excellence

World Radio History

CREATIVE AUDIO
9 DOGPOLE, SHREWSBURY, SHROPSHIRE
Tel: (0743) 241924
Closed Mondays

- Comfortable listening rooms
- Home demonstrations available
- Part exchange welcome
- Free home installation
- Interest Free credit

Authorised retailer for:
A & R ARCAM, AUDIOLAB, CELESTION, CYRUS, DENON, DUAL, MERIDIAN, MISSION, MONITOR, AUDIO, QUAD, REVOLVER, ROKSAN, ROTEL, YAMAHA, EPOS, NAIM, KEF, RUARK

WEST & WALES

ENGLISH audio BADA

CYRUS CENTRE
PINK TRIANGLE • AUDION • SYSTEMDEK • HEYBROOK
MICHI KEF REFERENCE • MICROMEGA • NAKAMICHI • CHORD
ARCAM • MUSICAL FIDELITY • ROGERS • NAD • ROTEL • DENON
TANNOY • MARANTZ • MISSION • STAX • DUAL • TDL • ALBARRY • JWC
CELESTION • IXOS • SMI • RE • ARK • MOTH • AUDIO • TECHNICA
EXPOSURE AND OTHERS

Free installations • Credit Facilities • Service Department
Mon - Sat 10 - 6
95 Whitcross Road, Hereford HR4 0JG (0432) 355481

audio excellence BADA

WHERE THE MUSIC MATTERS

Bristol
65 Park Street
Bristol BS1 5PB
(0272) 264975

Cardiff
134/6 crwys Road
Cardiff CF2 4NR
(0222) 228565

Gloucester
58 Bristol Road
Gloucester GL1 5SD
(0452) 300046

Swansea
9 High Street
Swansea SA11LE
(0792) 474608

TUESDAY - SATURDAY 9.00 - 5.30
CLOSED MONDAY

Specialist Hi-Fi Dealers

NORLOSTONE
MARBLE - GRANITE - STONE SPECIALISTS

GRANITE AUDIO STANDS. The ultimate solution to problems of resonance and tonal accuracy. For 'bespoke' designs consult **NORLOSTONE**, West Dean Road, West Tytherley, Salisbury. SP5 1QG. Tel: 0980 862253

Near Norwich
Norfolk
Tel. (0508) 570829



Basically Sound of Norfolk
STOCKISTS OF LEADING HI-FI

Arcam, Naim, Audiolab, Epos, Denon, Nakamichi, Acoustic Energy, Heybrook, Micromega, Rotel, TDL, The Chord Company, Sound Style etc...

SOVTEK VALVES

6550WA. 61.6WGC/5881. E1.34G.
12AX7WB/7025. EF86/6267

Over 1000 different types of valves stocked S.A.E. for list DEPT. HFV

Wilson Valves, 28 Banks Ave, Golcar, Huddersfield, West Yorks, HD7 4LZ.
Tel: 0484 654650/420774 Fax: 0484 655699

Mail order only, Visa etc.

NORTH WALES

ACTON GATE AUDIO
THE HI-FI CENTRE IN
WREXHAM

Aiwa, Albarry, Arcam, B&W, Canon, Celestion, Cyrus, Marantz, Michell, Micromega, Mission, Musical Fidelity, NAD, Nakamichi, Quad, Radford, Rega, Rogers, Rotel, Ruark, Spendor, Tannoy, Thorens, Wharfedale, Yamaha.

"Yamaha cinema DSP club authorised dealer"

4 RUABON ROAD, WREXHAM
TEL. 0978 3645000

Cheshire Music
Hi-fi systems for music lovers.

ATC Loudspeakers **AVI** Electronics.
Clearly the best at any price.

For further details or a demonstration contact
Roy Parrish on 061-439 0082

SOUNDS AROUND

Professional Service Repairs
and Accessories
Agent for Golden Dragon Valves

146 Clarendon Park Road, Leicester
Telephone : 0533 702442

NORTH



ARCAM • MERIDIAN • MISSION •
CYRUS • AUDIOCAB • B & W •
NAKAMICHI • AURA • DENON •
QUAD • YAMAHA •
KEF • MARANTZ •

ASTON AUDIO HI-FI SPECIALISTS

ROKSAN • NAD • MF • AIWA •
DUAL • CELESTION • ROGERS •
AUDIOQUEST • TECHNICS •

WEST STREET • ALDERLEY EDGE • PLUS HOME CINEMA •
CHESHIRE • TEL 0625 582704 •
INTEREST FREE CREDIT • DISCOUNT CD & TAPE • BADA •

Retailers of Fine Audio Equipment

Complete

- ▶▶ EPOS
- ▶▶ ONIX
- ▶▶ DENON
- ▶▶ LINN
- ▶▶ AUDIO ALCHEMY
- ▶▶ ARCAM
- ▶▶ B&W
- ▶▶ NAKAMICHI
- ▶▶ ROYD
- ▶▶ TARGET
- ▶▶ TRIPOD
- ▶▶ LOUSY COFFEE

- ▶▶ SUPERB OEMO FACILITIES
- ▶▶ FULL INSTALLATION & HOME OEMO SERVICE

OPEN 6 DAYS A WEEK
OTHER TIMES BY
APPOINTMENT





**0260
297544**

1/1A Duke St. Congleton Cheshire CW12 1AP

Lockwood Audio
Tel: 081-207 4472 Fax: 081-207 5283

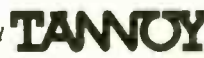
WE BUY AND SELL
NEW, USED AND VINTAGE
SPEAKERS, DRIVERS, CABINETS, PARTS.

SPEAKER REPAIRS
THE
TANNOY Specialist
MAJOR CREDIT CARDS WELCOME
IMPERIAL STUDIOS,
MAXWELL ROAD,
BOREHAMWOOD, HERTS. WD6 1WE

THE HI-FI STUDIOS

Sugden, ProAc, Ruark, Teac, Impulse, Systemdek, Alphaeon, Target, Albarry, Heybrook, Monitor Audio, JPW, Totem, Harbeth, Kenwood, Audio Research, Michell Engineering, AMG (CD and Valves), Art Audio (Valves), CR Development (Valves), Ral Acoustics, Project, Origin Live, Dual, Yam also plus home Cinema pro-logic decks; and others

FROM THE COMPANY THAT CARES FOR CUSTOMERS.
DEMONSTRATION IN OUR LISTENING ROOMS OR AT HOME

SUNNYFIELDS, DONCASTER
Tel: (0302) 781387

REPAIRS/DIY

CVC Chelmer Valve Company
for
Audio Valves

Buy CVC PREMIUM Hi-Fi valves direct from us. All valves processed for improved performance. We also have Stock of MAJOR BRAND types including: MULLARD, GEC, BRIMAR, RCA, GE, etc

130, New London Road, Chelmsford, Essex, CM2 0RG
Tel: 0245 265865 Fax: 0245 490064

AUDIO SOLUTIONS LIMITED

Manufacturers of amplifiers and speaker system with Differential Error Correction, the only amplifiers with virtually zero distortion and no output DC offset. Send for information Installation & Maintenance of Hi-Fi equipment. Acoustic measurement and design of listening environments. Recording studio design and installation. Sole concessionaires of service and spares for 3M professional recording equipment Contact: Clive Kavan.

Phone +44 (0)81 998 8127, (0)860 519 748,
or Fax +44 (0)81 997 0608
9b, Ashbourne Parade, Hanger Lane, Ealing,
London, W5 3GS.



Swift
THE hi-fi SPECIALISTS

ST ANN'S PARADE (ON A34) WILMSLOW, CHESHIRE
☎ (0625) 526213

- 2 YEAR GUARANTEE ● EASY PARKING
- DEM ROOM ● PART EXCHANGE

Aiwa Audio Lab Aura
B & W Castle Denon Cyrus
Celestion JPW Kenwood
Marantz Mission NAD
Pioneer Rotel Systemdek
Tannoy Technics

TECHNICAL & GENERAL

THE ORIGINAL TURNTABLE SPECIALISTS
for the Great Classic Turntable, Arms, Cartridges, Styli.

CONNOISSEUR • GARRARD • GOLDRING • Lenco •
ORTOPON • SHURE • S.M.E. • THORENS • WATTS

All available Genuine spares and our own re-manufacture of obsolete parts
Servicing and Overhauls, to original technical specifications.

NO ILLUSORY 'IMPROVEMENTS' NO DUBIOUS OR HARMFUL 'MODIFICATIONS'
Remedial Services available

Cartridges and stylis, correct radius diamonds, for early recordings - 78s & LPs

TECHNICAL & GENERAL
P.O. Box 53 Crowborough, East SusSex TN6 2BY
Tel: 08 32 65 45 34

BANDOR
MINIATURE LOUSPEAKERS
DESIGN AND MANUFACTURE OF MINIATURE LOUSPEAKERS AND SYSTEMS

TRANSMISSION LINE KITS exploits the unique performance of BANDOR 150mm (8") & 50mm (2") drivers. Humidity proof Ultra Linear Drivers (see Brochure for Xmax)

11 Penfold Cottages, Penfold Lane,
Halmer Green, Buck. HP15 6XR
(0494) 714058



AUDIO COUNSEL
HI-FI SPECIALISTS

LINN, NAIM, REGA, ARCAM, ROTEL, ROYD, SHAHINIEN, DYNAVECTOR, EPOS, MARANTZ, NAKAMICHI, MICROMEGA and many more....

"Time spent with staff may prove to be a particularly wise investment"

Audiophile
12/14 Shaw Road, Oldham OL1 3LO
Tel. 061 633 2602

LOOKING FOR REAL HI-FI or HOME CINEMA IN SWINDON

Audio Technica, Acoustic Energy, Audio Innovations (valve Amp), Beard (Valve Amp), Cerwin Vega, Impulse, Red/Acoustics, and many more....

We also stock quality ex demonstration and secondhand hi-fi Quality car Audio, new, used and secondhand, also available Repair and refurbishment classic equipment

52 Audio Exchange 52
52 Morse St, Swindon Tel. 539008
(Off Commercial Road, Swindon) Open 10am - 6pm, Mon - sat

Specialist Hi-Fi Dealers

BADGER BOARDS
Printed Circuit Boards
Prototype-Singles-Multiple runs.
Minimum charge £15.00
Artwork, Plotting from Schematic to final board layout.
Send S.A.E. now for Catalogue of Kits-Boards-Projects available. May magazine boards produced for individual customers.
Dept. HFW 87, Blackberry Lane, Four Oaks, Sutton Coldfield, B74 4JF
Tel: 021 353 9326

ANCURUM ELECTRONICS
YOUR LOCAL HI-FI SHOP
PIONEER, TECHNICS, PROLOGIC AMPS + LASER DISC FOR HOME ENTERTAINMENT
TEL: (0382) 480030
39 GRAY ST., BROUGHTY FERRY DUNDEE
Dedicated Dolby, Pro-logic listening rooms

FAST • CHEAP RATES • EXCELLENT SERVICE
THE REVOX MOBILE SERVICE
ALL MODELS
CALL US: UK (0850) 167955
24 HRS INCLUDING WEEKENDS
WHY CONTINUE TO ACCEPT OTHER INFERIOR SERVICE?
THERE IS ONLY ONE LIKE US
FREE TECHNICAL ADVICE FREE ESTIMATES

Sowter Transformers
EA Sowters Ltd
PO Box 36
Ipswich IP1 2EL
0473 219390/252794
Output and mains transformers for GEC KT88 circuits. Can also make any other transformer to order. Send SA for lists and data.

Silver Sounds and Sonio Link cables tailor-made to your requirements.
Check out the latest impedance matched Goertz cable from Townsend Audio. Cogan-Hall Cables.
Contact Mike Gilmour for professional advice and friendly service.
Lismore, Avoch, Ross-shire IV9 8RF
TEL/FAX 0381 620655

L.G.S. AUDIO SERVICES.
Quality Audio Equipment and Hi-Fi Systems Repaired and Serviced at Reasonable Cost
2nd Floor, Forest Mills, 133 Alfreton Road, Radford, Nottingham NG7 3JL
Tel: 244443

MUSIC ETC...

CD SELECTIONS
The UK's leading suppliers of bargain CDs and music for your free catalogue contact
CD SELECTIONS
PO BOX 1011
DORCHESTER DORSET D12 7YG
Tel. 0305 848 725

GOLDMINE RECORDS
(Behind M & S)
8 Shambles Square, Manchester M3 1RE
Telephone 061 839 3616
The best Oldies Shop in the North!
Fantastic Selection of 45s, from the 50's, 60's and 70's (US Re-issues) US and UK hits and Classic Rock 'n' Roll, R & B, Country, Doo-wop, etc. Plus superb range of re-issue CDs. Send large 42p S A E for our brilliant 45's catalogue (over 5000 titles)
Downstairs in The Soul Cellar - Killer Selection of Soul Originals + Latin, Funk, Etc....
Pay a visit to the shop, open from 10am - 6pm - Mon - Sat
Stay and find all the tunes you've been after for years
dept HFW

OVERSEAS

Sum of the parts.

ALPS Volume and balance pots used by the best manufacturers.
NOBLE
KIMBER KABLE Precision crafted wire, connectors and caps.
VISHAY A resistor without equal.
GOLD AERO Selected, tested, guaranteed.
MIT MULTICAP World's finest film capacitor!

The very best in audio grade parts, upgrade/mod kits and complete kit products. Call, write or fax for our catalogue.

SONIC FRONTIERS
INCORPORATED

2790 Brighton Road, Oakville, Ontario, Canada L6H 5T4
Telephone (905) 847-3245 - Fax (905) 847-5471

MIT MultiCap • Wonder Cap • Kimber Kap • Solen • Siemens Hovland MusiCap • Wima • Holco • Draloric • Vishay • Caddock Mills • Matsushita • Noble • Kimber Kable • Cardas • Discovery Audioquest • Alps • Bourns • Shallco Attenuators • Electroswitch Elma • CTS • Elna • Nichicon • Gold Aero • RAM • N.O.S. Tubes Linear Technology • Burr Brown • Analog Devices/PMI • Motorola Edison Price • Pearl • Tube Sockets • WBT • Neutrik • Kits

REVOX SERVICE & REPAIRS
"Authorised agent for Revox Products"
• 17 Years experience, ex-Bauch •
• All repairs carried out and guaranteed •
• Fast turnaround •
Tel: 0923 893711
Suite 10, Smugoak Business Centre, Lye Lane, Bricketwood, Herts. AL 23UG

STAFFS & DERBY

HOW TO **SAVE £100** ON YOUR **HI-FI**

Choosing the right Hi-fi and saving money is a difficult task, make it easy on yourself.

To get your copy of "Guide to Buying Hi-fi" just telephone

FREEPHONE 0800 373039

We will send you one Free of Charge together with our Fact Pack and see how you can save £100 on recommended Hi-fi Systems.

Active Audio

12 Osmaston Rd. 29 Market Street. 95 Stafford Street.
The Spot, Tamworth Hanley.
Derby Staffs. Stoke-on-Trent.
Tel 0332 380385 Tel: (0827) 53355 Tel: 0782 214994

SCOTLAND

RIVERSIDE AUDIO

South West Scotland Tel: 0475 631 066
Argyll and Bute Tel: 0700 504845

The mystique of valve amplification demonstrated in the comfort of your own home. Art Audio, Concordant Valve Amplification, Atacama Audio Supports, J.P.W. Speaker Systems, Fullers Audio Loudspeakers.

SERVICES & CONSULTATIONS

R. J. F. 84 Pendarves Street, Tuckingmill, Cambourne, Cornwall TR14 8NJ
Tel: (0209) 710777
AUDIO-VISUAL
Dealers for: Audio Technica, B & W, Beyer, Cennin Vega, Denon, Dynacolor, Foundation Audio, Goldring, Harman Karson, JBL, Marantz, Michel, Microsonic, Musical Fidelity, Nakamichi, Ortofon, Percepiton, Pink Triangle, Project, QED, Sansui, S.D. Acoustics, Sharp, SME, Targel, TDA, Townshend, Impulse, Audio Innovations, Audionote, Audiomach, New Firm, Suggden, TEAC, Triangle plus more!
Much second hand equipment available plus repairs to all brands.
retro
the old is the best

HI-FI WORLD SPECIALIST DEALER DIRECTORY ORDER
BOOK 12 MONTHS FOR A 30% DISCOUNT!!
OR 6 MONTHS FOR A 20% DISCOUNT.
I wish to be included in Hi-Fi World's Specialist Dealer Directory starting the _____ issue for a total of _____ insertions.
Please find enclosed my artwork/copy details.
I wish to book _____ column centimetres at £12.50 per col. Cm.
Name _____
Company _____
Address _____
Postcode _____ Telephone No. _____
Please return to Caroline Knott,
Hi-Fi World,
64 Castellain Road,
London W9 1EX

WORLD DESIGNS

by Mail Order

world audio design mail order

K5881 KIT

£395 ▼



Here's a superb, Class A, 20watt stereo power amplifier that uses the inexpensive Russian 5881 output valve, a military version of the regarded American 6L6, designed for low distortion audio work. It has super-quality output transformers (4/8/16Ω selected internally) to minimise distortion and the input stage uses triode working. A rugged, sixteen-gauge, all-welded steel chassis is provided, together with protective bottom plate for safety.

Designed for long life, low running costs and excellent sound quality, K5881 is sensitive enough to be used with a simple passive pre-amp. or our own line-drive pre-amp, and it matches modern loudspeakers well. There is a choke-regulated power supply and the channels can be paralleled to turn it into a 40W monoblock if desired.

K5881 costs just £395 as a kit of parts and £595 fully built from our own build service. The U.K./Europe version has a 240/220V transformer but 120/110V can be supplied as an alternative - see Overseas details on Order Form.

SPECIFICATION

Power	20watts/ch.
Frequency response	16Hz-40kHz
Distortion	0.02%
Separation	60dB
Noise (CCIR)	-103dB
Sensitivity	240mV
Dimensions (mm)	400w,300d,180h
Supply	110/120V or 220/240V, 220W
Weight	16kgs(34lbs)

VALVE LINE LEVEL PRE-AMPLIFIER

£295 ▶

Constructed from heavy gauge steel with an aluminium anodised and polished front panel. This new chassis comes with the complete kit of parts necessary to build the valve line level pre-amp.

The components are all high quality and include a special screened toroidal transformer, Military Spec. Russian valves, Alps potentiometer, metal film resistors, polypropylene signal capacitors, silver plated copper wire etc.



◀ HIGH DEFINITION LOUDSPEAKER

£295

The High Definition loudspeaker is ideal for low power, high quality amplifiers, transistor or valve. It goes very loud with just 1-5watts, having an enormous sensitivity of 94dB - that's 8dB more than most other speakers. It is also a very easy load for valve amps (8ohms) and it gives a terrifically dynamic and fast sound. This speaker is also unusually suited to low powered vintage amplifiers, such as Quad IIs, Radfords, Pye Mozarts and such like.

The High Definition loudspeaker is available in two forms; as a drive unit pack containing two bass units and two tweeters modified and tested, or complete with all crossover components, gold plated bi-wire terminal dishes, silver plated copper wiring and long haired wool.

KLS2 LOUDSPEAKER

Drive Unit & Crossover kit etc	£195
Drive Unit Pack	£145

See page 83 for order form...

WORLD DESIGNS

by Mail Order

300B VALVE AMP KIT

£850 ▼



This is a specialised amplifier based on the highly linear 300B triode valve. Our 300B runs in Class A, giving one of the most sweet, open and neutral sounds possible today. Matched with good loudspeakers, it is unsurpassed.

The kit comprises a strong 16-gauge mild steel chassis, fully

punched, welded and ground smooth. Finish is a durable 'powder coat' black. A protective bottom plate is provided for safety. Output terminals (one pair) take 4mm plugs axially and radially for bi-wiring, or heavy gauge bare cable. Output options of 4/8/16Ω are selected internally at the transformer. A small circuit board carries most of the components. 240/220V and 110/120V versions available. Can be monoblocked for 60watts.

All parts are included in the kit, except valves since different 300B makes are available.

A fully built version from an approved build service is also available.

SPECIFICATION

Power	28watts
Frequency response	5-18k-nfb/50k-fb
Distortion	0.2%
Separation	54dB
Noise (hiss/hum)	-100dB/-72dB
Sensitivity	240mV
Dimensions (mm)	405w,295d,175h
Supply	110/120V or 220/240V, 220W
Weight	20kgs(44lbs)

4W SINGLE-ENDED VALVE AMP KIT

£385 ▼



The 4W Single-Ended amplifier kit is a line level integrated amplifier. It comes with three line level inputs and a tape output. High quality components are used throughout, including polypropylene signal capacitors, Alps volume control, custom C&K gold plated selector switch etc. Valves are included.

SPECIFICATION

Power	4watts	Noise (hiss)	-100dB
Freq. Response	9Hz-64kHz	(hum)	0.7mV
Distortion	1.3%	Sensitivity	180mV
Separation	74dB		

DEMONSTRATIONS!!

By the time you read this we hope to have our K5881 20W valve power amplifier, KLP-1 valve pre-amplifier and 4W single-ended on demonstration at Hi-Fi Confidential, 34 Buckingham Palace Road, Victoria, London. Phone the patient and understanding Luigi on 071-233-0774 to check availability. He's a valve afficianado, knows Tim de Paravicini and is still sane, and stocks plenty of good products - including World Audio Design.

4W SINGLE-ENDED TRANSFORMERS £190

A set of transformers (8kgs) for our single-ended amplifier (December '93. Supplement No 6).

- 1) Mains (1 off) Secondary: 0-210V a.c. at 150mA, 6.3V centre tapped. Primary: 220/240V or 110/120V - please state which on order form. Drop through fixing.
- 2) Output (2 off) High quality transformers with grain orientated silicon steel laminations. Secondary tapped 4/8/16Ω. Drop through fixing.
- 3) Choke (1off) Compact 1.2H/150mA choke for under-chassis fixing. Frame mount.

6080 valves - double-triode power valve for the single-ended amplifier - **£15.00**

K5881 (20W CLASS A) TRANSFORMERS £220

There are four transformers in all, weighing 12kgs.

- 1) Mains (1 off) Secondary: 0-360, 1 x 6.3V centre tapped. Primary 220/240 or 110/120 - please state which on order form. Drop through fixing.
- 2) Output (2 off) These transformers use high quality materials, laminations of thin and best quality grain orientated silicon steel. Output tapped 4Ω, 8Ω and 16Ω. Drop through fixing.
- 3) Choke For smoothing of the H.T. line to provide best sound quality, a 5H choke that fixes under the chassis. Frame mounting.

300B (28W CLASS A) TRANSFORMERS £430

Seven transformers in all, weighing 16kgs (35lbs)

- 1) Mains (1 off) Secondary: 230V-0-230V, 5 x 5V, 1 x 6.3V. Primary 220/240 or 110/120 - please state which on order form. Drop through fixing.
- 2) Output (2 off) Designed for low distortion and broad load compatibility from the 300B. Cores with centre-hole fixing to avoid corner flux concentrations; laminations of grain orientated silicon steel. Output tapped 4/8/16Ω. Drop through fixing.
- 3) Intervale/phase splitter (2 off) frame mounting.
- 4) Chokes (2 off) For smoothing of the H.T. lines, two 3H chokes that fix under the chassis. Frame mounting.

WARNING

THESE ARE EXPERT KITS, NOT FOR THE INEXPERIENCED. YOU MUST BE ABLE TO SOLDER AND READ A CIRCUIT DIAGRAM. THE VALVE KITS CONTAIN LETHAL VOLTAGES. WE CANNOT BE HELD RESPONSIBLE FOR ANY ERRORS ARISING FROM THE CONSTRUCTION OF THE KITS.

world audio design mail order

ORDER FORM

Please send your completed order form to: WORLD AUDIO DESIGNS, 64 Castellain Road, Maida Vale, London W9 1EX
Tel: 071 266 0461 Fax: 071 289 5620

240/120 option - delete the voltage NOT required.

Valves included except where stated.

'BUILT' - we can supply the amplifiers built up and tested by an approved service, for safety and guaranteed performance to specification.

DESCRIPTION	ORDER No.	QTY	PRICES	
			UK (inc VAT & carriage)	OVERSEAS. (net)
4W single ended integrated				
KIT	4WSE-K240/120	<input type="text"/>	£385	£330
transformer set	4WSE-TR240/120	<input type="text"/>	£190	£150
K5881 20W budget valve amplifier				
KIT	K5881-K240/120	<input type="text"/>	£395	£350
BUILT	K5881-B240/120	<input type="text"/>	£595	£550
transformer set	K5881-TR240/120	<input type="text"/>	£220	£180
300B 28W specialised valve amplifier				
(prices do not include valves)				
KIT	300B-K240/120	<input type="text"/>	£850	£725
BUILT	300B-B240/120	<input type="text"/>	£1150	£950
transformer set	300B-TR240/120	<input type="text"/>	£430	£370
KLPI line level preamplifier				
KIT	KLPI-K240/120	<input type="text"/>	£295	£250
BUILT	KLPI-E240/120	<input type="text"/>	£395	£335
Phono Stage				
PCB only	RIAA-PCB	<input type="text"/>	£35	£30
Full kit including casework	RIAA-K	<input type="text"/>	£249	£215
KLS2 2-way, high definition, floorstanding speaker				
Drive Units + Crossover kit etc	KLS2-C	<input type="text"/>	£195	£165
Drive units	KLS2-D	<input type="text"/>	£145	£120
KLS3 3-way carbon fibre driver floorstanding loudspeaker				
Drive Units + Crossover kit etc	KLS3-C	<input type="text"/>	£350	£300
Drive Units	KLS3-D	<input type="text"/>	£230	£200
Loudspeaker measurement				
mic and preamp + test disc	3382B	<input type="text"/>	£440	£390

NAME: _____

I enclose cheque/postal order for £ _____
made payable to **World Audio design Ltd.**

ADDRESS: _____

I wish to pay by Access/Visa. Debit my account no:

<input type="text"/>	<input type="text"/>	<input type="text"/>	<input type="text"/>	<input type="text"/>	<input type="text"/>	<input type="text"/>	<input type="text"/>	<input type="text"/>	<input type="text"/>	<input type="text"/>	<input type="text"/>	<input type="text"/>	<input type="text"/>	<input type="text"/>	<input type="text"/>	<input type="text"/>	<input type="text"/>	<input type="text"/>	<input type="text"/>	<input type="text"/>
----------------------	----------------------	----------------------	----------------------	----------------------	----------------------	----------------------	----------------------	----------------------	----------------------	----------------------	----------------------	----------------------	----------------------	----------------------	----------------------	----------------------	----------------------	----------------------	----------------------	----------------------

Expiry date:

POST CODE: _____ TEL: _____

Signature

CREDIT CARD ORDERS TELEPHONE 071 - 266 0461 (24 HOURS)



OVERSEAS PRICES AND DETAILS

All our kits can be supplied overseas excluding the European Community, free of UK tax (VAT). However, allow for your own local import taxes (customs duties) and for carriage charges, which must be added to our net price.

Surface mail is slow (1-4 weeks) but inexpensive; airmail is fast (up to 7 days) but more expensive. Couriers like Amtrak we recommend for speed and door-to-door service. We package overseas orders strongly.

METHODS OF PAYMENT

International money order in Sterling, Visa, Mastercard/Access, Local Currency at agreed exchange rate by registered mail. Payment in advance. Contact us for details.

CONTACT: RICHARD JOHNSON

London, England.
PHONE (9.30am-6pm) 071-289-3533
ANSWERPHONE (24hrs) 071-266-0461
FAX (24hrs) 071-289-5620

SONOLITH® LOUDSPEAKERS

No Wood

No Veneer

No Contest



MINERAL-POLYMER ENCLOSURES

CONTROLLED-FLEXURE ALLOY CONES

27 Fournier Street, London E1 6QE
Telephone: 071 247 0813

ELECTROFLUIDICS
THE SOUND FOUNDATION



Tel: 081 348 5676 (2.00-7.00pm)
Fax: 081 341 9368

Esoteric High Fidelity CABLES

Dealers in: Absolute, Audio Note, Audioquest, Deltec, Harmonix, Kimber, Mandrake, MIT, Siltech, Symo, Van den Hul, WBT, and others

...the RIGHT cable
...in YOUR system
...for YOUR ears
...in YOUR home

Contact us by phone, fax, or letter and we'll do our best to help you achieve your goal.

(Auditions may be subject to a handling charge)

CONNECTIONS 13 John Prince's St, London W1M 9AH (A division of Connection 90' Travel Ltd.)

HORN LOUDSPEAKERS
Klipsch®
HIGH EFFICIENCY FOR FULL PERFORMANCE SOUND

Hear KLIPSCH for yourself at - Acton Gate Audio 0978 364500. Audio Excellence 0272 264975. Audio T 071 794 7848. Doug Brady 071 379 4010. Chantry Audio 0777 870372. Clearsound 0745 343060. Diva 081 875 9593. Five Ways Hi-Fi 021 455 0667. KJ West One 071 486 8262. Listen Inn 0604 601430. Music Matters 021 429 2811/742 0254/0384 444184. Heatherdale Audio 0903 261213. Radlett Audio 0923 856497. Riverside Hi-Fi 081 892 7613. The Audio Galley 0730 895194. The Hi-Fi Studio 0302 781387. Westwood & Mason 0865 247783.

Peter Herring

Sound that accurately conveys the notes; performances that get beyond those notes. The fundamentals of a memorable recording. Savour the collaboration between musician and engineer in the best of Britten, in symphonies by Nielsen and Shostakovich, and in the vocal music of Vaughan Williams, where the words - as well as the notes - are always worth hearing

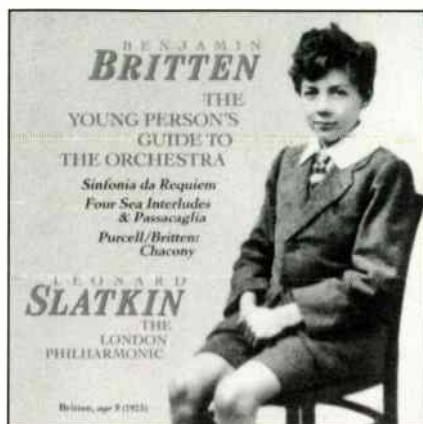

BENJAMIN BRITTEN
Sinfonia da requiem/Four
Sea Interludes and
Passacaglia from Peter
Grimes/Young Person's
Guide to the Orchestra
(Variations and Fugue on a
Theme of Purcell)
HENRY PURCELL (arranged
Britten)
Chacony for Strings in G
minor
 London Philharmonic Orchestra;
 conductor, Leonard Slatkin
RCA VICTOR RED SEAL 9026 61226 2
(ADD/68.05)

● Something of a Britten 'primer', this, at least as far as the orchestral music is concerned. It offers his most popular composition - the Young Person's Guide to the Orchestra - a work which, for me, never dulls on repeated hearing (unlike some 'orchestral showpieces' I could name). Then there are the only marginally less well known Sea Interludes from Britten's first operatic success, Peter Grimes, and what is arguably his greatest orchestral composition, the Sinfonia da requiem which, despite its title, relies entirely on instruments to make its point rather than words. The programme is nicely rounded off with one of Britten's arrangements of Purcell. Britten, along with Vaughan Williams did much to bring Henry Purcell's music deserved recognition in his native land. He was certainly indebted to Purcell for the theme to his Young Person's Guide, but savour in this superlative Walthamstow Town Hall recording, just how Britten develops that famous theme. And is there a finer apotheosis in music as the theme makes its reappearance at the end of the scintillating fugal section?

Leonard Slatkin's pedigree in twentieth century English music has been well established by his recordings of Elgar and Vaughan Williams. Now, in Britten, an authority and empathy are combined with an arresting freshness of approach. There is nothing routine here, either in the conducting or the playing, as the many imaginative

touches in each interpretation bear witness. In the Sinfonia da requiem, Slatkin is utterly compelling, whether in the grim utterance of the opening Lacrymosa, with its chilling declamations on brass and bass drum, or the more reflective, noble music of the concluding Requiem aeternam. The Sea Interludes find Slatkin at his most pictorial, pointing up the vivid colours of Britten's scoring and conveying the almost tangible atmosphere of each of these pieces.

He is well served by the recording team, which has used the brighter acoustic of Abbey Road for the Sinfonia and the Sea Interludes and the spacious warmth for the other works, and in each case achieving agreeably natural and detailed balances. This is contemporary orchestral recording at its best; the intriguing thing is that, if the code on the disc outer is to be believed (ADD), the original master was made in analogue.

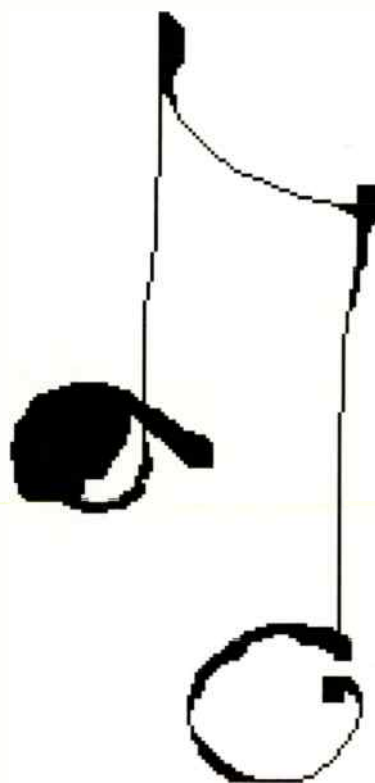

What are the benchmarks of a good performance? Fidelity to the score? Well, preferable to infidelity, if you see what I mean. Accuracy of playing? Desirable. Beauty of sound? A pleasing bonus. All components of the whole; all welcome qualities. But they count for nothing if the end result fails to move the listener. Above all, any performance should be an enriching and enlightening experience. If the work is new to you, then it should introduce it in the most interesting way; if the music is familiar, then it should broaden the appreciation. Either way, it should make an impact.

There are many conductors whose fidelity to the score and to the composer's instructions is beyond reproach. They obtain first-class playing and wrap it up in fine sound. But whether they understand what they're playing is quite another matter. And, assuming they do have some understanding, there is no guarantee that it can be communicated. How often have you heard a performance on record, radio or in the concert hall and felt unfulfilled by the experience? All the right pieces were there, but somehow they didn't fit together. The end result

was acceptable on all the technical counts, but ultimately unmemorable. If you are not left at least thinking about what you have just heard, it's a pretty poor show.

All of which leads me to two performances of symphonies which must count among the most enigmatic written this century. They're not 'difficult' in the accepted sense, nor especially demanding, but they do require a certain understanding and insight on the part of the interpreter. If the conductor loses the plot, then it will prove just as elusive for the audience.

CARL NIELSEN
Symphony No 5 Op 50
DMITRI SHOSTAKOVICH
Symphony No 6 in B minor
Op 54

Royal Concertgebouw Orchestra;
conductor, Kirill Kondrashin
PHILIPS 438 283-2 (ADD/57.17)

● This is one of a series of CDs issued by Philips in its 'limited edition' Collector series. The CD outer sternly warns that they will be available for a limited period only (what marketing wheeze will they come up with next, I wonder). Among the most desirable items in the series are the recordings made by the late Kirill Kondrashin, a Russian-born conductor who was granted political asylum in The Netherlands in 1978 but tragically died of a heart attack just three years later. Kondrashin's interpretations of Shostakovich are legendary: the composer entrusted him with the first performances of the Fourth and Thirteenth Symphonies, both among Shostakovich's most profound utterances. In contrast, the Sixth Symphony of 1939 is in a very different vein. For a start, it is unconventional in form, with an apparently lop-sided sequence of movements beginning with a gravely expansive Largo, moving into a cheery Allegro and ending with a

rumbustious, burlesquelike Presto.

What is Shostakovich's intention? The first movement is one of those great, timeless planes of mood-painting along the lines of the first and third movements of the Fifth Symphony, or the epic opening of the Seventh. Yet there are no heroic or dramatic gestures and the subsequent movements are brimful of quicksilver wit and earthy humour. In the wrong hands, it could be utterly unconvincing; but not with

they objected to continues to be one of the most contentious elements of Nielsen's music, his brutal, cacophonous use of the snare drum in the first part of the work. Nielsen wanted the drum to epitomise the destructive force of evil. In the score, he is unequivocal: he instructs the snare-drummer to improvise in any way possible to interrupt the flow of the music. It should be noisy, violent and wholly unmusical. Yet so many conductors still shy away from this head-on confrontation and the impact of the entire work is diminished as a result. Kondrashin, however, is rightly uncompromising and, as a result, Nielsen's purpose becomes clear and the symphony as a whole takes on a new cogency. The musical and intellectual struggle is magnificently resolved.

Two illuminating and enlightening performances, therefore, both taken from radio tapes (the Shostakovich from 1968, the Nielsen from 1980) and both remastered using the Bitstream process. The sound quality throughout is clear and clean and makes the most of the

generous Concertgebouw acoustic. There is some audience noise - the odd rustle, the occasional cough (why do people always choke in pianissimo passages) - but the power and conviction of these performances easily transcends it.

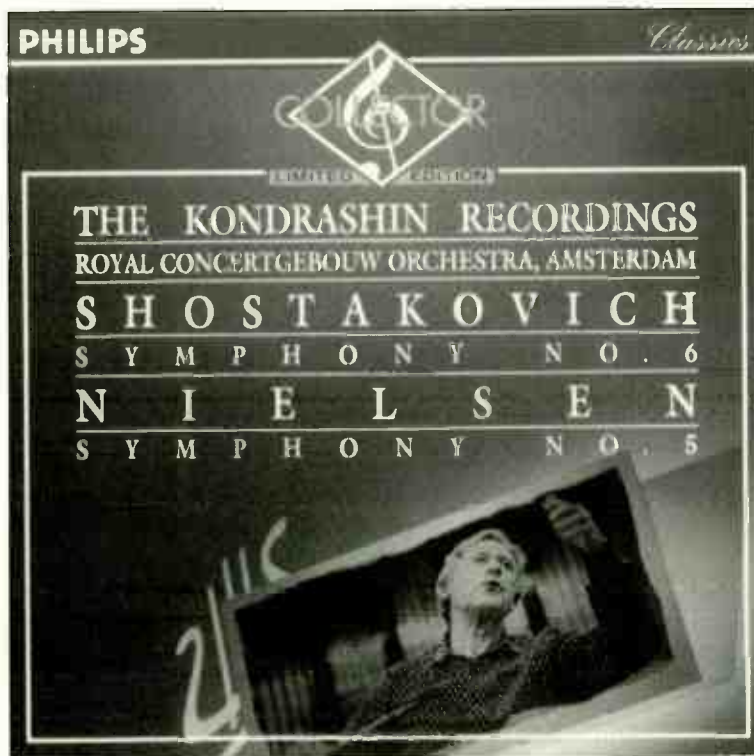

Kondrashin, who leaves you in no doubt about Shostakovich's intentions. The playing of the Concertgebouw is dazzling, as indeed it is in Nielsen's Fifth Symphony, the work that appalled the Copenhagen audience at the first performance in 1922. What



GEORGE FRIDERIC HANDEL Israel in Egypt

The Sixteen; Orchestra of the Sixteen;
conductor, Harry Christophers
COLLINS CLASSICS 70352 (2 CD SET)
(DDD/I41.39)

● Nowhere among Handel's oratorios - Messiah included - is the chorus given so many opportunities to shine as it is in this celebration of the Israelites' deliverance from captivity in Egypt. Unfortunately, London audiences of 1739 were more enamoured with the delights of the solo voice than with choral splendour and, commercially, *Israel in Egypt* was a flop. The genesis (if you'll forgive the Biblical pun) of this musical depiction of the Book of Exodus was typical of Handel. Never one to waste a good tune, or indeed an entire work, he fashioned the first part of the work, *The Lamentations of the Israelites for the Death of Joseph*, out of the funeral anthem he had composed in 1737 on the death of Queen Caroline. However, the poor reception accorded the first performance persuaded Handel to revise the oratorio, entirely omitting the first part and instead opening with an overture made up from two movements of an organ concerto (generally assumed to be the one in F Major known as the Cuckoo and the Nightingale). *Israel in Egypt* was now re-advertised as 'Shortened and intermix'd with songs'. The fickleness of West End audiences is clearly nothing new.

Until recently, it had been the practice to perform *Israel in Egypt* in its revised, truncated version, but contemporary recordings by Andrew Parrott, John Eliot Gardiner and now Harry Christophers have reinstated the first part - and quite rightly, too, for it contains some majestically grave and elegaic choral writing.

In the second part, entitled *Exodus*, Handel enjoys himself. The 'plague choruses' are a piece de resistance, unashamedly pictorial, with the orchestra imitating the hopping frogs, the swarming locusts and the lashing hailstones of God's wrath. While Harry Christophers doesn't let the

opportunity pass him by, I thought him less colourful and witty at this point than, say Gardiner. But it is in the grandeur of part three - Moses's Song - that Christophers and his choir, The Sixteen, come into their own. They tackle this mighty song of thanksgiving with impressive sureness and wholeheartedness. Again, though, Gardiner's Monteverdi Choir is better still and, for all its qualities - among which I would include more consistent solo singing - I feel Christophers's performance remains eclipsed by that of Gardiner on Erato. The sound is full and warm, but the focus is not always helped by the ripe acoustic of St-Jude-on-the-Hill in Hampstead. Not the perfect performance, perhaps, but a persuasive one nonetheless.



RALPH VAUGHAN WILLIAMS Dona Nobis Pacem - cantata for soprano and baritone soli, chorus and orchestra/Four Hymns for tenor, viola and strings/Toward the Unknown Region/O Clap Your Hands (Psalm 47)/Lord, Thou Hast been our Refuge (Psalm 90)

Judith Howarth, soprano; John Mark Ainsley, tenor; Thomas Allen, baritone; Matthew Souter, viola; Corydon Singers; Corydon Orchestra; conductor, Matthew Best
HYPERION CDA66655 (DDD/76.26)

● The excellence of Matthew Best's interpretations of Bruckner's choral music have tended to overshadow his achievements as an equally sympathetic interpreter of the vocal music of Vaughan Williams. The Hyperion catalogue boasts first-rate recordings of *the Mass in G Minor*, *the Five Mystical Songs*, *The Shepherds of the Delectable Mountains* and *The Pilgrim's Progress*, among other works, and there is much about this new recording that earns it a place in the list.

When it comes to choosing texts to set to music, some composers' literary judgement is decidedly suspect. Not so Vaughan Williams; whether setting A.E. Housman or George Herbert, or Shakespeare, VW's selection of words was unerringly successful. Yet, although steeped in the great tradition of English literature, at least two of VW's finest vocal compositions were inspired by the poetry of an American, Walt Whitman. Vaughan Williams was not alone in being moved by Whitman's verse - it had a similar effect on Delius, witness the superb *Sea Drift*.

Vaughan Williams employed three Whitman texts in the cantata he composed in the mid-1930s, *Dona Nobis Pacem* (Grant us Peace). Though not overtly political, its message would not have gone unrecognised by audiences at the time. Tragically, like every other plea from within Europe's artistic community, it did go unheeded elsewhere. But, *Dona Nobis Pacem* is not shackled to events; its resonance is undiminished. Matthew Best and his colleagues offer an accomplished and, at times, radiant account of the cantata, if a comparatively undramatic one. The recording, as throughout this CD, is exemplary, in terms of clarity, balance and presence. The combination of the Corydon Singers' precise diction and the well-focused sound ensures that none of Whitman's words or, for that matter, the Biblical texts which Vaughan Williams also employs in this 'prayer for peace' pass the listener by.

The other Whitman setting here is the much shorter but no less affecting *Toward the Unknown Region*, VW's first major choral piece. There are also two splendid psalm settings and, for the Vaughan Williams enthusiast, a true find in the *Four Hymns*, which are economically but beautifully scored for tenor, solo viola and strings. They were composed in the immediate aftermath of the *Four Mystical Songs* and share much of the quiet ecstasy of that work. It is difficult to imagine these performances, with Thomas Allen at his finest, being bettered; the same could be said of the two psalm settings. In other pieces, Best faces stronger competition, but the excellence of the recording may sway it for many.

Classical

Francinstien

STEREO ENHANCEMENT SYSTEM



The CD Filter with a difference

When we listen to music, both the high and low frequency sounds help our brains to paint a 3-dimensional stereo picture. But when we listen to CD, the high and low pictures do not perfectly realign. With their clinically clean electronics, CD players lack the beneficial, subtle signal handling of analogue equipment which can actually "re-converge" the two stereo images. So creating the convincing illusion that is the hallmark of good analogue systems.

Francinstien, originally developed for the recording industry, breathes life into digital stereo. By simulating the best aspects of analogue equipment, it restores the sense of depth – and even height – to digital recordings. And it does it without introducing any of analogue's vices!

Simply plug **Francinstien** between your CD player and pre-amplifier (or integrated amplifier) and you can

have your cake and eat it. Analogue imaging and "involvement" with the clarity and "bite" of digital.

"It's a gentle elegant effect – and a very even one ... One simply becomes more aware of the music."

— Eric Braithwaite – Hi-Fi World

"CDs sounded better defined, the soundstage having a more definite shape. It was as if there was more air around each strand in the mix, allowing you to hear it more distinctly, more separately... I didn't immediately want to switch the CD player off and relax with some LPs, instead I went on to make further explorations of my CD collection"

— Andrew Cartmel – Hi-Fi Choice



Perfect Pitch Music is a trademark of Select Systems TM

For further information please complete the coupon below and send it to:

Select Systems Ltd. Hanworth Trading Estate Hampton Road West Feltham Middx TW13 6DH Tel: 081 893 8662 Fax: 081 893 4318

Please send me further information on (please tick boxes):

Francinstien + CD enhancer

Dacula DAC

Light Metal Loudspeakers

isolat/jsolat pre-amp combination

Title: _____ First Name: _____ Surname: _____

Address: _____ Post Code: _____

Hi-Fi World Dial-a-Dealer

AUDIO EXCELLENCE 'Where the music matters', 65 Park Street, Bristol BS1 5PB. Tel. 0272 264975 Fax 0272 251327. Great Hi-Fi carefully selected and demonstrated by friendly enthusiastic staff. Home installations and check-ups. Two year warranty from our own service department. Open 9.00-5.30 Tuesday - Saturday closed Monday.

PAUL GREEN HI-FI LTD. Kensington Showrooms, London Road, Bath. Tel. (0225) 316197. Musical Fidelity, Krell, Creek Rogers, Quad, Cust. car park. Best selection in the West.

VAUDIO, 36 Druid Hill, Stoke Bishop, Bristol, BS9 1EJ. Tel. 0272 686005. ATC, Acoustic Energy, Ruark, AVI, Exposure, Pink Triangle, Wadia, Audio Innovations, SME (incl 20A), Chord Amps, Michell, AMC, Analogue Electronics, Cadence Valve, Jamo, LFD, REL, Sansui, Sonic Link, Stax, Townsend, Audio Technica, Goldring, Ltra, Ortofon, Sumiko. Demos by appt only, home trial facilities, free install. service facilities.

WILTSHIRE

WENTWORTH AUDIO, 83 High Street North, Dunstable, Beds. NU6 1JJ. Tel. 0582 6633 83. Marantz, Pioneer, Rotel, Audiolab, Mission Cyrus, Moth, Sony, HK, NAD, Pink Triangle, Yamaha, Systemdek, Albury, etc. Free installation & delivery. Home dems. Part exchange. Interest free credit - 6, 9, 12, 18 & 24 month terms. Free car parking at rear of shop. Free refreshments (alcoholic or otherwise!) Open 10-6pm Tues-Sat

GLoucestershire

NEWBURY AUDIO, 2 Weavers Walk, Northbrook Street, Newbury, Berks. RG13 1A1. Tel. 0635 33929. Linn, Creek, Epos, Denon, Nakamichi, Shaminan, Marantz, Micromega, JPW, Ruark. Single speaker dem room. Appt. necessary, Home trial facilities, free install. service dept. late appts. Access/Visa. interest free credit subject to status. 6 days 9.30am - 6.00pm.

BERKSHIRE

ARC AUDIO, 9 Dukas Ride, Crowthorne, Berks, RG1 16LZ. (0344) 762201. Denon, Harman Kardon, JPW, Marantz, Monitor Audio, Dynx, Rogers, Tannoy, Thorens, Yamaha. Demonstration facilities. No appointments necessary, home trial facilities, free installation. Access, Visa, Diners. Open Mon-Sat 9-6pm (closed Wed at 1pm)

READING HI-FI CENTRE, 4 Queen's Walk, Reading RG1 7QF. Tel. 0734 585463. "The best equipment, advice and service from Berkshire's premier HiFi emporium". Products include: Arcam, exposure, Audiolab, Meridian, Rotel, Sony, sennheiser, Top Tape Centre, and many more.

ASTLEY AUDIO, Wallingford, 0491 839305. See our entry under OXFORDSHIRE

BUCKS

J.L. CONTINENTAL LIMITED, 59-61 The Broadway, Chesham, Bucks. HP5 1BX. (Opposite Canon Audio). Tel: 0494 784441. Philips, Denon, Kenwood/Bonus Audio, Koss, Wharfedale, Mitsubushi, Target, Grundig, QED, Mordaunt-Short, Toshiba, Dolby Pro-logic Systems, Nicaam TV and Video, Surround Sound, AV Systems. Showroom Demonstrations from expert and friendly staff. No appointments necessary. Service Department. Credit facilities available. Open 8.30 to 5.30 Mon-Sat.

DEJAC HI-FI Consultants, 21 the Broadway, Old Amersham, Bucks, HP7 0HL. Tel. (0494) 433173. AMC, Arcam, Bose, Meridian, Quad, Denon, NAD, Tannoy, Mission, TDL, 2 dem rooms, Appts necessary, Free installation, Tricity finance, instant credit, open 9.30-5.30 pm, including Saturdays.

NORTHWOOD AUDIO II, 98 Cambridge St, Aylesbury, Bucks HP20 1BA. Tel. 0296 28790 (A/P). Selected sounds from Alchemist, Aura, Boston, B & W, Cabletalk, Castle, Celestion, Denon, Exposure, Gyrodec, Harman Kardon, Heybrook, Marantz, Micromega, Monitor Audio, Moth, NAD, Nakamichi, Rose, Rotel, Royal, Ruark, Systemdek, Tannoy, TDL, Thorens etc ect. Export orders welcome. 2 Dem rooms. Credit facilities available.

CAMBRIDGE

CAMBRIDGE HI-FI, 1-3 Hawthorne Way, Chesterton, Cambs CB4 1AT. Tel. 0223 67773. Kenwood, Pioneer, Ariston, Kef, Technics, Yamaha, Marantz, B&W, AR, Mordaunt-Short, Bose. Single speaker dem room. Tues-Sat 9.30-5.30pm. Closed Monday. Free install, service dept. Vis/Access credit facilities.

STEVE BOXSHALL AUDIO, 41 Victoria Road, Cambs. CB4 3BW. Tel. 0223 68305. 10.00-6.00pm 6 days. 3

dem rooms. Denon, Rotel, Yamaha, Mission, Nakamichi, Tannoy, Audiolab, Marantz, Krell, Martin Logan, Magneplanar, Wadia. Home trial facilities. Appointments preferred. Free install. and service dept. Access/Visa.

FENWAY, 5 High St. Ely. Tel 0353 664421. Contact Gary Holland. For Sony, Technics, Rotel, Tannoy, Pioneer, QED, equipment and accessories. Demonstration facility, In-House Service Dept.

SWIFT HI-FI, St. Annes Parade, Wilmslow. 0625 526213. Aura, B&W, Denon, Kenwood, Marantz, Nad, Pioneer, Rotel, Systemdek, Tannoy, Revolver, J.P.W., M. Short, Mission, Celestion, Technics, Audiolab, Castle. Open 9.30-6. Dem room. No pressure. BADA member.

THE HI-FI SHOWROOMS 12A West Str, Congleton, Cheshire (0260)280017, 1 Stanley St, Leek(0533)383780, Celestion, Creek, Exposure, Marantz, Musical Fidelity, Pink Triangle, Project, Rotel, Ruark, Systemdek, Tannoy, Technics. 5 Dem Rooms, Noapts nec, Home trial, Free install, Servicedept Access, Visa, Lombard Tricity. Open 9-5:30, Closed Wed.

HALE HI-FI, 2 Bold St. Hale Road, Altringham, Cheshire WA14 2ER. Tel:061 929 0834. Open Mon - Sat 10am-6pm & later by appointment. Specialising in equipment by: Naim, Quad, Royd, Nad, Denon plus selected others. Large range of quality accessories. On site service department. Installation & delivery. Home demonstrations a pleasure

ASTON AUDIO, 4 West Street, Alderley Edge, Cheshire. Tel. 0625 582704. Products include: Celestion, Creek, Yamaha, Monitor Audio, B&W, Awa, Aura, AKG, Musical Fidelity, Tannoy, Sennheiser, Marantz, Dual, Denon, Quad, Sansui, Technics, Spondor, Mission, SME, Nakamichi, Audiolab, Rogers, Audioquest, Mordaunt-short, Meridian, Deltec, Roksan, Arcam, Kef, NAD, Cyrus and others. Discount CD and tape. Extended guarantee, interest free credit and written details on request

CHRIS BROOKS AUDIO, 29 Gaskell Street, Stockton Heath, Warrington, Cheshire, WA4 2UN. Tel (0925) 261212. Tues-Sat 10.00-6.00. 2 dem-rooms. credit facilities. All credit cards. Established 1978. Total absence of bulls "t".

CONINGTON HI-FI 1/1a Duke St. Congleton, Cheshire, CW12 1AP. (0260) 297544. Acoustic Energy, Arcam, B&W, Denon, Epos, Linn, NAD, Nakamichi, Onix, Royd, Target, etc. Superbly appointed single speaker demo facilities. No appointments necessary, home trial facilities, free installation. 2 year guarantee on all equipment. Access, Visa. Open Mon-Sat, closed Weds.

DOUG BRADY HI-FI, Kingsway Studios, Kingsway North, Warrington, Cheshire, WA1 3NV. (0925) 828009. "Largest choice of specialist hi-fi in NW. All credit cards 3 dem rooms. Fair demonstrations and home trial facilities. Open 6 days.

CLEVELAND

GILSON AUDIO LTD, 172 Borough Rd., Middlesbrough. (0642) 248793. Linn, Exposure, Arcam, Mission, Cyrus, Denon, Marantz, Rotel, Pioneer, Audiolab, Tannoy. Demonstration facilities in main shop and one demonstration room. Appointments necessary. Home trial facilities. Free installation on request. Service department. Access, Visa, H.P. 10-5-6 days.

ACTION ACUSTICS, 155-157 High Street, Redcar, Cleveland. TS10 3AN. 0642 480723. Audio Innovations, Denon, Harman Kardon, JBL, Michell, Musical Fidelity, Pink Triangle, Revox, Rogers, Thorens, etc. Dem room. Appointments nec. Home trial facilities, free installation, service dept. Access, Visa & HP. Open 9.15-5.30.

CORNWALL

RJF AUDIO VISUAL, 84 Pendarves Street, Tucking Mill, Camborne, Cornwall. TR14 8NJ. 0209 710777/612260. TDL, Michell, Musical Fidelity, NAD, Nacacmichi, B&W, SME, Micromega, Pink Triangle, Pro-ject, Perception, Harman Kardon, Triangle, Intergral dem/showroom and special home dems. Appts nec, home trial, free install, service dept. All cards Switch and Transax. Open Mon-Sat 9.30-5.30.

CUMBRIA

MISONS SOUND & VISION, 11 Warwick Road, Carlisle CA1 1DH Tel (0228) 22620. Bang & Olufson, B & W, Castle, Sonic Link, Quad, NAD, Yamaha, Sony, Rotel. Demo Suite. No appts nec. Home trial facilities. Free installation. Service Department 9 - 5.30 Mon - Frid, Thurs 9-1, Sat 9 - 5.

DEVON

THE HI-FI ATTIC, 58 New George St., Plymouth, Devon. PL1 1RR. 0752 669511. We stock most leading brands including Linn, Arcam, Denon, Pioneer, Musical Fidelity amongst others, and have an expert enthusiastic staff. Premises include attractive hi-fi and home cinema demonstration rooms. We offer free installation and credit facilities (written details on request) also a fully equipped service department. We can also provide a mail order service for all your LaserDisc requirements. We accept Visa, Access, Amex.

HERBERTSON, 38 Walnut Road, Chelston, Torquay, Devon TQ2 6HS Tel.(0803) 606863. Denon, Marantz, Rotel, Musical Fidelity, Acoustic Energy, NAD, Castle, Heybrook, Celestion, JPW etc. Two dem rooms. Home trial. Free installation. Access, Visa, Amex. Diners. HiFi Markets Chargecard. Credit facilities. 9.30-7.30 Mon-Frid, 9.30-6.00 Sat.

DERBY

STRAD TRADITIONAL AUDIO, 29 Meadowfield, Whaleybridge, nr Buxton, Derbyshire. SK12 7AX. Tel. 0663 733383. We construct custom made reproductions of classic 1950's loudspeaker enclosure designs using authentic blueprints. These have never been bettered for valve amplification. Requests for specific designs considered and researched. Superb new speaker units from Richard Allan and Lowther are used.

ACTIVE AUDIO, 12, Osmaston Street, The Spot, Derby. Tel: 0332 380385. Fax: 0332 385185. We have three studios including a dedicated Audio Visual studio for the demonstration of quality equipment from the largest range in the Midlands. Open six days per week. Own service department. Free local delivery, home trial facility. Current special offers and buyers fact pack and quotation on request.

DORSET

BANBURN, 23 Seamoor Road, Westbourne, Bournemouth, Dorset. 0202 764965. B&O, Castle, Canon, Jamo, JBL, Pioneer, Sony, Target, TDL, Technics. No appts necessary. Free installation. Service dept. Various credit facilities available. Open 9-5.30 6 days a week.

SUTTONS HI-FI, 18 Westover Road, Bournemouth, Hants. Tel. 0202555512. Linn, Arcam, Mission, Quad, Audiolab, Rotel, Yamaha, Denon, etc. 2 single speaker listening rooms. Home demonstrations and free installation. Mon-Sat 9.00-5.30. Call for details.

ESSEX

BRENTWOOD HI FIDELITY, 2 Ingrave Road, Brentwood, Essex. CM15 8AT. Tel: 0277 221210. Audio Innovations, Aura, AVI, Castle, Chord Electronics, Denon, DNM, EAR, Impulse, John Shearman, Kenwood, Marantz, Micromega, Mission, NAD, Nacacmichi, Pink Triangle, Pioneer, Project, Quad, Rotel, RuArk, SME, Systemdek, Tannoy, TDL, Townshend Audio, Yamaha plus many more. Single speaker dem rooms, home trials, dems and installations. Mon-Sat 9.30-5.30. Access, Visa, service facilities. Simply THE place to visit if you're serious about music.

TWENTY 20 AUDIO VISUAL LTD. Unit 205 Lakeside Shopping Centre, West Thurrock, Grays, Essex. 0816 1. Tel. 0708 891818 Fax. 0708891300. For your total home entertainment requirements. From a 2" Casio to a 50" Pioneer screen, Dolby surround specialists with three dem rooms dedicated to pro-logic, laser disc software in stock, from Harman Kardon, Pro logic from Yamaha, Marantz, Pioneer, Technics, Kenwood and B&O.

RAYLEIGH HI-FI, Chelmsford, 216 Moulsham St. 0245 265245. RAYLEIGH HI-FI, Rayleigh, 44a High Street. 0268 779762. RAYLEIGH HI-FI, Southend, 132/4 London Rd. 0702 435255.

Over 21 years experience of supplying the best. "The best dealer, the best Hi-Fi equipment, the best service" Carefully selected Hi-Fi from : Arcam, Audiolab, Cyrus, Denon, Epos, Linn, Meridian, Mission, Naim, Nakamichi, Quad, Rega, Roksan, etc. etc..... 3 years guarantee on Hi-Fi systems. 0% credit facilities.

AUDIO T, 442-444 Cranbrook Road, Gants Hill, Ilford, Essex, IG2 6LL. (081) 518 0915. Fax (081) 554 8463. Great Hi-Fi from Arcam, Audiolab, B&O, Bose, Cyrus, Denon, KEF, Marantz, Meridian, Mission, Micromega, Nakamichi, Rotel, Sony, Yamaha & many more. Mon-Sat 10-6. 3 year guarantee on Hi-Fi. Free delivery & installation. 30 day free upgrade scheme. Home demonstrations. Part exchange. 2 listening rooms. Home Cinema specialists. BADA Bonded.

GLOUCESTERSHIRE

AUDIO EXCELLENCE 'WHERE THE MUSIC MATTERS', 58 Bristol Road, Gloucester, GL1 5SD. Tel. 0452 300046 Fax. 0452 310680. Great Hi Fi carefully selected and

demonstrated by friendly enthusiastic staff. Home installations and check-ups. Two year warranty from our own service department. Open 9.00-5.30 Tuesday - Saturday closed Monday.

AUDIO T, 40-42 Albion Street, Cheltenham, Gloucestershire, GL52 2RQ (0242)583960 Fax (0242) 226435. Great Hi-Fi from Arcam, Audiolab, Denon, Epos, Linn, Marantz, Meridian, Mission, Quad, Rogers, Rotel, Yamaha, & many more. Mon-Fri 10-6. Sat 9.30-5.30 3 year guarantee on Hi-Fi. Free delivery & installation. 30 day free upgrade scheme. Home demonstrations. Part exchange. Single speaker listening room. BADA Bonded.

HAMPSHIRE

ALPHA, Near Petersfield, Hampshire. Mana Castle, Alchemist, Albary, Audio Innovations, Wadia, Deltec, Tube Technology, Denon, Pioneer, Alphason, Tripod, Nad, Teac, Audio Alchemy, Klipsch, AMC, Proac, JPW, Moth, Pink Triangle. Mail order cabinets supplied to order in any size, wood & hand painted finishes, stone-granite-marble shelving. For a demonstration with home comforts call us for an appointment on: 0730 895194.

HOPKINS HI-FI, 'FOR THE BEST SEAT IN THE HOUSE' experience home cinema sound with Technics, Denon and Kenwood. Award winning products. Now on demo at HOPKINS HI-FI, 38-40 Fratton Road, Portsmouth. Hants, PO1 5BX. Tel. 0705 822 153. Fax. 0705 830 753

HAMPSHIRE AUDIO LTD., 2-12 Hursley Road, Chandlers Ford, Hants SO5 2FU. (0703) 252827/265232. 3 hi-fi and 2 home cinema/surround sound dem studio's. Thurs late evening, closed Mondays (except in December). Service dept on site (2 yr guarantee). Large free car park - junctions 4 (M27/M3), 5 (M27), 12 (M3) and 13 (M3) all within 3 miles, est. 1969.

AUDIO T, 4 Feathers Lane, Basingstoke, Hampshire, RG21 1AS. (0256) 24311. Fax (0256) 24430. Great Hi-Fi from Arcam, Audiolab, Denon, Linn, Meridian, Mission, Naim, Rotel, Sony, Yamaha & many more. Mon-Sat 9.30-5.30. 3 year guarantee on Hi-Fi. Free delivery & installation. 30 day free upgrade scheme. Home demonstrations. Part exchange. Single speaker listening room. BADA Bonded.

HERTFORDSHIRE

ENGLISH AUDIO, 95 Whitecross Road, Hereford, HR4 0DG. (0432) 24511. Fax (0256) 24430. Great Hi-Fi from Arcam, Audiolab, Denon, Linn, Meridian, Mission, Naim, Rotel, Sony, Yamaha & many more. Mon-Sat 9.30-5.30. 3 year guarantee on Hi-Fi. Free delivery & installation. 30 day free upgrade scheme. Home demonstrations. Part exchange. Single speaker listening room, home trial facilities, free installation, service dept. Access/Visa. Credit arranged. Open Mon-Sat, 10-6pm .BADA members.

FRANCE, - Welwyn, Herts - Europe's largest stockist of ex-dem and second hand equipment. High End Audio - Bought, Sold or Exchanged. Many items in stock. (see our main ad pg. 128). Efficient servicing Dept. All items guaranteed. All major credit cards accepted. Please telephone 0438 - 714038 for appointment.

GOSPEL MUSIC AUDIO, 32a High Street, Kington, Herefordshire, HR5 3BJ. (0544) 230254. Alphason, Allison, Revolver, Luxman, Yamaha, QED Audio, Systemline.

ACOUSTIC ANTS LTD, 101, St. Albans Rd., Watford, Herts. 0923 245250. Fax 0923 230798. Absolute Sounds, Adcom, Acoustic Energy, Audiolab, Chord, Denon, Marantz, Meridian, Orelle, S.M.E., T.D.L. 3 dem rooms, multi-room & home theatre. Expert installation. Credit facilities available. Tues-Sat 10-6.

STUDIO 82, 82 High Street, Harpenden, Herts AL5 2SP. 0582 764246. Fax 0582 467022. ATC/AVI, Arcam, Aura, Audiolab, B&D, Denon, Epos, Mission, Cyrus, Naim Audio, Nacacmichi, Quad, NAD etc. Quiet single speaker dem room. Appts nec. Home trial, free installation. Service dept. Visa, Access and finance terms. 9-5.30 (Mon-Sat) Closed Weds.

THE AUDIO FILE, 27 Hockerill St., Bishop's Cleeve, Herts, CM23 2DN. Tel 0279 506576. Fax 0279 506638. Linn, Naim, Roksan, Quad, Rega, Mission, Arcam, ProAc, Marantz, Sony etc. 4 dem rooms, installation service. Min 3 year warranty, 0% BADA.

HERTFORD MUSIC. We want you to feel good when choosing your system in our 3 demonstration rooms (and bar!) . Systems from budget to £15,000. Products include : CR Developments, Micromega, REL Acoustics, Acoustic Energy, Michell, Magnum, Diamond Acoustics, Beard, Lumley, Renaissance, etc. AAccess, Visa. Mail Order. Please telephone: 0992 442425.

RAOULET AUDIO, 141 Watling Street, Radlett, Herts, WD7 7NQ. Tel. 0923 856497. Mark Levinson, Procead, Proac, Magneplan, Martin Logan, Tube Technology,

Hi-Fi World Dial-a-Dealer

Teac, Roksan, Audiolab, Stax, Systemdek, Jarda, Copland, ATC, Audio Alchemy, AVI, EAR, Sumiko, Quad, Sonus Faber. Home trial facilities free installation. Service Dept. Visa/Access 9-5.30 Mon-Fri 10-5.30 Sat.

REVDX Service & Repairs, Suite 10, Smugook Business Centre, Lye Lane, Brighthelm, Herts AL2 3UG. Tel: 0923 893711. Seventeen years experience, ex-Bauch. Authorised agents for Revox products, sales and spares. All repairs carried out are guaranteed. Fast turnaround. Any enquiries telephone: 0923 893711.

WINDERSHIRE

ZEN AUDIO - George Street, Hull. Tel: (0482) 587397 - Evening (0964) 670849. Audiolab, Audio Innovations, Aura, B&W, Cabletalk, DPA, Heybrook, JPW, KAR, Micromega, Michell, Harmon Kardon, Impulse, Ruark, Rotel, Sugden. Comfortable Listening Room. Home Trial facilities free installations - personal friendly service.

YORKSHIRE

PROGRESSIVE AUDIO, 2 Maryland Court, Rainham, Nr Gillingham, Kent ME8 8QY. Tel: 0634 389004. Agencies include: Audio Innovations, Audion, Audionote, Audiostatic, Audiotechnica, Chord amps, Cogan Hall, Conrad Johnson, Convergent, DALL, Decca, Eminent Technology, Goldring, Impulse, Koetsu, Levinson, L.F.D., Lyra, Lumley Reference, Meridian, Michell, Micromega, Moth, Origin Live, Pink Triangle, Proac, Proced, Ruark, Silversounds, SME, Sugden, Sumiko, Systemdek, Sneli, Target, T.D.L., Transfiguration, Townshend, Tube Technology, Voyd, V.P.I. etc etc. Demonstrations by appointment please.

JOHN MARLEY HI-FI CENTRES, 2 Station Road, West Canterbury. (0227) 769329. Also at Dover - 0304 207562. Arcam, Aura, B&W, Heybrook, JPW, Proac, Pioneer, Rotel, Ruark, Tannoy, Technics. Dem rooms and home trial facilities. Mon-Sat, 9-5.30. Closes Thurs. Free install. Credit to £1000. Access, Visa and credit charge. Service Dept.

KIMBERLEY HI-FI, 193 Broadway, Bexleyheath, Kent. Tel: 081 3043272. Pioneer, Technics, Kenwood, Marantz, Denon, NAD, Aiwa, Tannoy, Mission, Rotel, Wharfedale, Castle. Separate dem room, no appt necessary. Free installation. Service dept. Instant credit facilities. No early closing.

V.J. HI-FI, 29 Guildhall Street, Folkestone. Tel: 0303 256860. Mon-Sat 9-6. NAD, Yamaha, Marantz, Sony, Tannoy, Denon, Kenwood, Rogers, Musical Fidelity, Quad, Aiwa, Aura, Heybrook, Castle, Mission, Yamaha, REL, JBL, Polk. Dem rooms in both stores. Free install. Credit facilities available. Specialists in home theatre, Amex, Diners, Visa, Access, Service Dept. We are BADA dealers.

THE WESTGATE HI-FI, 2 Station Road West, Canterbury, Kent. 0227 769329. Suppliers of quality hi-fi equipment including: Arcam, Akai, Aura, B&W, Denon, Jmo, JPW, Mordaunt Short, NAD, Panasonic, ProAc, Quad, Rotel, Ruark, TDL, Technics, Tannoy. Part exchange. Listening room. Service and repairs. Credit facilities. Access/Visa. Open 6 days 9-5.30.

DDVER HI-FI, 43 High Street, Dover. Tel: 0207 207562. Suppliers of quality hi-fi equipment including: Arcam, Akai, Aura, B&W, Denon, Jmo, JPW, Mordaunt Short, NAD, Panasonic, ProAc, Quad, Rotel, Ruark, TDL, Technics, Tannoy. Part exchange. Listening room. Service and repairs. Credit facilities. Access/Visa. Open 6 days 9-5.30.

LANCASHIRE

AUDIC CLASSICS, 8 Lowe Mill Lane, Hindley, Wigan, Lancs. WN2 3AF. Sorry but we are unable to answer queries in writing. I buy, sell, modify and repair all vintage and valve hi-fi equipment. Advice is free. New equipment by EAR, Croft, Ortofon and more soon. Phone if just for a chat. Credit cards accepted. Quick worldwide delivery, callers by appointment. Tel: 0942 57525 or Fax: 0942 525861. 7 days a week.

ROCKS HI-FI CENTRE, 94-96 High Street, Rishton, Blackburn, Lancs. Tel: 0254 887799. Stockists of: Sony, Esprit HiFi, Technics, Marantz, Musical Fidelity, Pioneer, Kenwood, Rotel, Tannoy, Mission, Ruark, B&W and many others. Dem room, service dept, free delivery and installation (local area). Access/Visa and Switch.

LEICESTER

LEICESTER HI-FI COMPANY, 6 Silver Walk, St

Martin's Square Leics LE1 5EW Tel: (0533) 539753 Fax: (0533) 626097. Acoustic Energy, Arcam, Marantz, Micromega, Mission/Cyrus, Musical Fidelity, Nakamichi, Meridian, Rogers, Rollsan and 'oddsies more'. 2 dem rooms. Home trial arranged. Free install service. Dept. Credit facilities. Access/Visa/Diners/Amex. 6 days. 9.30-5.30.

THE LISTENING ROOMS, 6 Hotel Street, Leicester. Tel: 0533 623754. Fax: 0533 623758. Linn, Audiolab, Arcam, Tannoy, Definition, Denon, Rotel, Nad, Heybrook, TDL etc. Open 10.00-5.30 (Six days.)

STERED SHACK, 1-3 Guildhall Lane, Leicester. Tel: 0533 530330. Aiwa, A.R. Denon, Kenwood, Jmo, Mission, NAD, Philips, Pioneer, Home Cinema specialists. Free installation. Open 9.30-5.30 6 days. Credit available.

LINCOLNSHIRE

WIMBORNE AUDIO, 65a Wide Bargate, John Adams Way, Boston, Lincs PE21 6SG. Tel: 0205 365477. Quad, Nakamichi, Arcam, Marantz, NAD, Castle, Tannoy, Rogers etc. Separate demonstration studio inc. home cinema. Free installation. Access, Visa, Tues-Sat 9-5 pm.

COTTAGE AUDIO, 17 Bridge Street, Saxilby, Nr Lincoln LN1 2PZ. Tel: (0522) 702834. Evenings: (0522) 696708. ATC, AVI, Chord amplifiers, Harbeth, LFD, Michell, Drigrin Live, Kinshaw, QED, Royd, Sansui, Sequence, Something solid, Sonic Link, etc. Demonstration rooms. Home trial facilities. Free installations and above all a personal, friendly service.

STAMFORD HI-FI CENTRE - 9 Red Lion Square, Stamford, Lincs. PE9 2AL (0708) 62128. Pioneer, Technics, Cyrus-Mission, Rotel, NAD, Yamaha, Kenwood, Marantz, Quad plus all major speaker manufacturers. Expert Advice, Comparator demonstrations, part-exchange HiFi purchased for cash. No appts necessary. Home trial facility free installation. Service Dept. Mastercard, Visa and credit charge. Mon-Sat 9.5-3.0 pm. Closed Thursdays.

ANALOG AUDIO, 849 High Road, Finchly, N12. (081) 445 3267. For friendly service and advice. AR, AKG, Allison, AT, Cerwin, Vega, Denon, Dual, Harmon Kardon, Jmo, Infinity, Marantz, NAD, Pioneer, Rotel, Revolver, Sonab, Teac, Thorens, Tannoy, Wharfedale, Yamaha. Speaker cables and accessories. Free installation service.

AUDIO CONCEPT, 27 Bond Street, Ealing, W5 5AS. Tel: (081) 567 8703. Acoustic Energy, Audiolab, Aura, B&O, B&W, Boston Acoustics, Canon, Castle, Denon, Dual, Evolution, Infinity, JPW, KEF, Marantz, Mission, Monitor Audio, Musical Fidelity, NAD, Nakamichi, Onix, Quad, Revox, Rogers, Rotel, Systemdek, Target, Teac, Thorens, Van den Hul. Two dem rooms. Interest free credit, free local delivery & installation service department. *Hi-Fi Specialists without the attitude.

BABBER ELECTRONICS, 158 Uxbridge Road, West Ealing, London, W13 8SB. (081) 579 6315. Akai, Aiwa, A&R, Celestion, Dual, Goodmans, Harman Kardon, JBL, JVC, Kenwood, Marantz, Panasonic, Sennheiser, Sony ES range, Tannoy, Technics, Wharfedale, Yamaha.

THE CARTRIDGE MAN - Front end problems? It doesn't have to cost an arm and a leg to get the best listen to my Koetsu - and - Decca - Eater. Also agents for Croft, Sugden, Thorens, Pentachord Speakers and Notts Analogue. (Plus a cartridge re-tipping service. Tel: 081 688 6555.

DIVA AUDIO FIDELITY: For the finest in real HiFi, AV and Multiroom systems. Accuphase, Audio Innovations, Audio Note, Audiostatic, Aura, Chord, Conrad Johnson, Impulse, Klipschorn, Levinson, Lumley, Lyra, Michell, Micromega, Monitor Audio, Pmcare, Rel, Rotel, SME, Triangle, Trilogy, XLO. Call us or pop in for a musical experience you'll never forget. Open 10-6, Mon-Sat at Workshop 30, Royal Victoria Patriotic Building, Fitzhugh Grove, Wandsworth Common, London SW18. Tel/Fax: (081) 875 9593. Also see our full page advertisement on page 18 of this issue.

GOLF ELECTRONICS, 311 Kentish Town Road, NW5 2TJ. Tel: 071 482 2518. Fax: 071 284 3381. Authorised dealers for: Sony, Panasonic, Aiwa, Akai, Mitsubishi, Philips, Grundig, Bose. We carry an extensive range of hardware from Walkmans to camcorders, including a wide range of TV and video equipment. Free local delivery & installation on selected items. Open 10-6 Mon-Sat. We regularly have special offers on different products. A visit to GOLF ELECTRONICS could save you £££.

HI-FI & COMPONENTS, 84 Battersea Rise, London,

SW11 1EH. (071) 223 1110. Denon, Tannoy, NAD, Rotel, Bose, Dual, QED, Wharfedale, Jmo, Celestion, Kenwood, Ortofon, Infinity, Shure, to name but a few! Established over 29 yrs. Appts necessary. Service dept 10-6 (closed Weds).

HIFI EXPERIENCE, 227 Tottenham Court Road, London W11. 071 580 3535. Arcam, Audiolab, Mission, Cyrus, Quad, Celestion, Kef, Meridian, Rogers, Tannoy, Yamaha, TDL, Thorens, Marantz, Nakamichi, Musical Fidelity and many more. Open 10.00-7.00 Mon-Fri, 9-6 on Sat. Service dept, Credit facilities, delivery and free installation.

THE HIFI SURPLUS STORE, 62 Weymouth Street, W1 Tel: 071 486 9981/071 935 7582. Stock a full range of goods including Aiwa, Akai, B&W, Bose, Dual, JVC, Jmo, Kenwood, Marantz, Mordaunt-Short, Mission, NAD, Pioneer, Rotel, Sony, Technics, Teac, Thorens, Tannoy, Wharfedale. Full range of "Target" speaker stands always on stock. All goods are brand new in sealed cartons with full 1 yr guarantee. We guarantee you can not buy cheaper elsewhere. Give us your genuine quote and we will beat that price by £10 (goods must be in stock). Access/Visa welcome. Open Mon-Sat 9.30-6pm. Late night 'till 6.30 Thurs.

KAMLA ELECTRONICS, 251 Tottenham Court Road, London W1P 9AD. Telephone: 071 323 2747. Fax: 071 637 2690. Acoustic Research, Aiwa, Akai, Albarry, Alchemest, Alphason, Audio Alchemy, Audio Innovations, Audio Technica, Audioquest, Aura, Audiostatic, B&W, Cerwin Vega, Conrad Johnson, CopenHagen, Furukawa, Goldring, Infinity, IXDS, JPW, JVC, KEF, Kenwood, Kuzma, Lynwood, Maxell, Micromega, Mitsubishi, Monster, Mordaunt Short, Moth, Nakamichi, Oracle, Ortofon, Panasonic, Pioneer, Project QED, Rotel, Ruark, Sansui, Stax, TDK, and many more!!!!

K J WEST ONE, 26 New Cavendish St., London W1M 7LH. 071 486 8262/63. Fax: 071 487 3452. Two hi-fi & dedicated home cinema dem studios. Appts pref. Home trial. Installation by arrangement. Service Dept. Major credit cards. Interest free credit on selected items. Major brands stocked: Acoustic Energy, Arcam, Audio Innovations, Audion, Aura, Audiolab, Audio Research, B&W, Chord, DPA, Epos, Impulse, Krell, Martin Logan, Meridian, Michell, Musical Fidelity, Nakamichi, Nitty Gritty, Oreille, Pink, ProAc, Quad, Roksan, Sonus Faber, Stax, Tannoy, Theta. Open 6 days.

BILLY VEE SOUND SYSTEMS, 248 Lee High Road, London SE13 (081) 318 5755. Arcam, Linn, Naim, Quad, Creek, Cyrus, Marantz, Nad, Rotel, Rega, Denon, Yamaha, Tannoy, Mission, Micromega, Heybrook etc. 2 dem rooms, instant free credit. Access/Visa, Closed Thursdays.

CONNECTIONS, 13 John Prince's Street, London W1M 9AH. Tel: 081 348 5676. Dealers in: Absolute, Audio Note, Audioquest, Deltec, Harmonix, Kimber, Mandrake, MIT, Siltech, Symo, Van den Hul, WBT and others.

THE LISTENING ROOMS, 161 Old Brompton Road, London SW5 0LJ. (071) 244 7750/59. Fax: (071) 370 0192. Linn, Quad, Meridian, Nakamichi, Arcam, Audiolab, Acoustic Energy, SME, Audio Research, Krell, Wadia, Theta, Apogee, Martin Logan, Pioneer, Tannoy, Systemdek, Stax, Pink Triangle, Michell, Monitor Audio, Yamaha, Marantz, Kef, Bose, Celestion, Epos, Mission, Denon, Neat Petite. Mon-Sat 10-6pm.

THE CORNFLAKE SHOP, 37 Windmill Street, London W1 (071) 631 0472 (domestic). (071) 323 4554 (multiroom). Fax: (071) 436 7165. Tues-Sat 10-7. Rega, Roksan, Naim, Monitor Audio, Arcam, Nakamichi, Rotel, Epos etc. 3 dem rooms (incl. home cinema). Friendly professional service. Home trial facilities, appts preferred. Full delivery and repair service. Multiroom specialists. Access & Visa.

MUSICAL IMAGES, 173 Station Road, Edgeware, Middlesex. Tel: (081) 952 5535. See advert under Middlesex for more information.

MUSICAL IMAGES, 45 High Street, Hounslow, Middlesex. Tel: (081) 569 5802. See advert under Middlesex for more information.

AUDIO T, 190 West End Lane, West Hampstead, London, NW3 1SQ. (071) 794 7848. Fax: (071) 431 3570. Great Hi-Fi from Adcom, Arcam, Audiolab, B&W, Denon, Epos, Marantz, Meridian, Michell, Mission, Philips, Rotel, Proac, Micromega, Nakamichi, Yamaha & many more. Mon-Sat 10-6. 3 year guarantee on Hi-Fi. Free delivery & installation 30 day free upgrade scheme. Home demonstrations. Part exchange 2 listening rooms. BADA Bonded.

GREATER MANCHESTER

THE AUDIO COUNSEL, 12 Shaw Road, Oldham, Manchester OL1 3LQ. Tel: 061 633 2602. Linn, Arcam, Naim, Yamaha, Creek, Nakamichi, Denon, JPW, Marantz, Royd, Lexicon 3 dem rooms, free install. Visa Access. Licensed credit brokers up to £1,000 instant credit. Full multi-room & A.V. installation. 10.00-5.30pm Mon, Tues, Wed, Sat, 10.00-7.00pm Thurs & Fri.

CENTRAL RADIO (Manchester) Ltd, 30-32 Shudehill, Manchester M4 1EZ. Tel: 061 834 6700. Est 1946. We have a wide range of Hi-Fi separates, systems, Prolog, TV, Video, Portable Audio, Tape, Stylus and Accessories. In House Service Dept. Agents for Aiwa, Beyer, Bose, B&W, Cerwin-Vega, Canon, JBL, Kenwood, Marantz, Mission, Panasonic, Pioneer, Sennheiser, Sony, Technics, Thorens, Wharfedale, etc. We accept Access, Visa, AmEx, Switch, Cheques up to £1500 & Finance subject to status. Open 9.00am to 5.30pm Mon to Sat. Easy Parking. Call for directions.

SPECIALIST (HOME DEMONSTRATION SPECIALIST) - for a Musical system tailor-made (sonically and visually) to your Home requirements. Arion Acoustics (Valves), Audiomeca, Audio Synthesis, Audio Valve Amplification, Kinshaw, Lieder,

TO FIND YOUR AREA Use our COLOUR REFERENCE



To Advertise in this section, please contact Caroline Knott on:

071 266 0969

Hi-Fi World Dial-a-Dealer

Drtofon, Pro-ject, Teac, Triangle, YBA, Drpheus Audio, please tel: 0257 426100 or Fax: 0257 473175 for appointment.

HALE HI-FI, Tel 061 929 0834.
See our main entry under Cheshire.

BILL HUTCHINSON HI-FI, 50-52 Deansgate, Manchester M3 2FE. (061) 6321600. For the largest selection of Hi-Fi and audio visual equipment in the North West. Specialist A.V. demonstrations of the highest quality. Best prices guaranteed. Minimum 2 year warranty and an optional 5 yr guarantee available. Instant credit and mail order service on offer throughout the U.K. Pioneer, Denon, Kenwood, Yamaha, Technics, Marantz, Mission, Tannoy plus many more.

MERSEYSIDE

DOUG BRADY HI-FI, 401, Smithdown Road, Liverpool, L13 3JJ. (051) 733 6859. fair demonstrations and home trial facilities. All credit cards. Largest choice of specialist hi-fi in N.W. Closed Wednesdays and lunch 1-2.15pm.

MIDDLESEX

HARROW AUDIO, 27, Springfield Rd., Harrow, Middlesex. Tel: 081 863 0938. Open Mon-Sat 9.30-5.30. Most brands available - see our regular advert for full range including Audioblab, Arcam, Audioquest, Apogee, Aura, B&W, Cyrus, Denon, Epos, Krell, Marantz, Mission, Nakamichi, Tannoy, Target, Yamaha etc. AV Specialist including installation, Interest Free Credit - ask for details. The largest range of accessories for miles around. 2 dem rooms. Plus Carriage Free Mail Order.

AUDIOCRAFT, 18 Hillingdon Road, Uxbridge, Middlesex, UB10 0AD. (0895) 253340. Unbelievable but true you can audition these brands here. Audion, Proac, Michell, Erelle, LFD, Lumley, Levison, Lurne, Triangle, Sentec, Mag Audio, Teac, VHD, Silversounds, YBA, Stax, Theta, Monitor Audio, Fuller Audio, Trilogi, Lyrá, Suriko, Ortofon, Decca, Target, Project, Moth, Kelvin, Townshend, Edison, Audio Alchemy, Kesiki, Musical Fidelity.

MUSICAL IMAGES, 45 High Street, Hounslow, Middlesex. Tel. (081) 569 5802. Fax. (081) 569 6353.

MUSICAL IMAGES, 173 Station Road, Edgware, Middlesex. Tel. (081) 952 5535. Fax. (081) 952 5535. Most brands available - see full page advert. Interest free credit. ask for details. Demo rooms. Repairs & Service Sunday opening - Open all week. A Home Cinema Specialist. Mail order. Part exchange.

AUDIO T, 159a Chase Side, Enfield, Middlesex, EN2 0PW. (081) 367 3132. Fax (081) 367 1638. Great Hi-Fi from Adcom, Arcam, Audioblab, Celestion, Denon, Marantz, Meridian, Micromega, Mission, Philips, Rotel, Yamaha, & many more. Mon-Fri 10-6. Sat 9.30-5.30. 3 year guarantee on Hi-Fi. Free delivery & installation. 30 day free upgrade scheme. Home demonstrations. Part exchange. 2 listening rooms. Home Cinema specialists. BADA Bonded.

NORFOLK

BASICALLY SOUND, The Old School, School Road, Bracon Ash, Norwich, Norfolk, NR14 8HG. Tel. (0508) 570829. Arcam, Heybrook, Chord Co. Rotel, Sound Style, TDL, Royd, Denon, Naim, Spondor, Sound Organisation, Audio Technica, Creek, Epos etc. 2 comprehensive dem rooms, home trial facilities, free installations, Visa/Access, HP facilities. Tues-Fri 9.30-1.00pm, 2.00-5.30pm. Saturday 9.30-5.30pm.

PROTECT-A-DISC, Unit 4, Elvin Way, Sweetbriar Industrial Estate, Norwich, NR3 2BB. Tel: 0603 482193. Producers and suppliers of finest quality car record and CD sleeves with taped edges, poly-lined or unlined, mailers and cruciforms etc. Please send SAE for full current price list. Trade enquiries welcomed. Tel. 0603 482193.

NORTHAMPTON

LISTEN INN, 32 Gold Street, Northants NN1 1RS. Tel. 0604 37871. Fax 0604 601430. Naim, Linn, Rega, Audiolab, Arcam, Cyrus, Royd, Nakamichi, Mission, Denon, Rotel, Nad, Heybrook, Marantz, Chord Co. etc. etc. Open 10.00 - 5.30 (Closed Thurs)

NOTTINGHAMSHIRE

DEFINITIVE AUDIO, Tel. (0602) 813562. For a carefully considered approach to building a true high

fidelity audio system with components derived from the following manufacturers: Audio innovations, Wadia, Micromega, Deltac, E.M.T., Horning, Voyd, Systemdek, SME, Revox, Impulse, Drtofon, Pioneer. Also the remarkable Living Voice Air Partner loud speaker system. Demos by appt. Please phone for further details, install. free of charge. Mon-Sat 10.00-7pm. Closed Wed a.m.

PETER ELLIS AUDIO, 29 Kirkgate, Newark, Notts NG24, 1AD. Tel. 0636 704571. QUAD, Castle, Arcam, QED, Sugden, Tannoy, Thorens, Marantz, Denon, Teac. Demo room, free install. Service dept. Access, Visa, American Express. Mon-Sat 9-5.30. Closed Thursdays PM.

CHANTRY AUDIO, 18-18a Eldon Street, Tuxford, Nr Newark, Notts, NG22 0LH. Tel. 0777 870372. Pink Triangle, DPA, Rotel/Michi, Micromega, NVA, Alchemist, Michell, Monitor Audio, Lumley, SME, Audion, and much more! Three dem rooms, home trial, free installation, service department. Access & Visa, credit facilities, Mail order, Mon-Sat 9.30-6.00, Sun and evenings home dem by appointment.

OXFORDSHIRE

AUDIO T, 19 Did High Street, Headington, Oxford, OX3 9HS (0865) 65961. Fax (0865) 60415. Great Hi-Fi from Arcam, Audioblab, Cyrus, Denon, Epos, KEF, Marantz, Meridian, Mission, Musical Fidelity, Rotel, Sony, Yamaha & many more. Mon-Fri 10-6. Sat 9.30-5.30. 3 year guarantee on Hi-Fi. Free delivery & installation. 30 day upgrade scheme. Home demonstrations. Part exchange. 2 listening rooms. Home Cinema specialists. BADA Bonded.

WESTWOOD & MASON, 46 George Street, Oxford. Tel. 0865 247783. Creek, Marantz, Naim, Arcam, Rotel, Rega, Epos, Tannoy, Mission, Nakamichi, Denon, Aiwa, Quad, Yamaha, Monitor Audio, Open 9.30-5.00pm. Dem room. Closed Thursdays.

ASTLEY AUDIO LTD, 3 Marketplace, Wallingford (3 miles from Berkshire border) 0491 839305. Aura, B&W Technics, Panasonic, Pioneer, Kenwood, Sony, Yamaha, Denon, Dual, Marantz, Mission, Tannoy, Yamaha. Home trial, free installation. Service department. Access, Visa, Amex, Diners. Instant credit. Tues-Fri 9-5.30, Sat 9-5. Records & CDs stocked.

SHROPSHIRE

AVON HI-FI, 12 Barker Street, Shrewsbury, Shropshire, SY1 1QJ. Tel. 0743 355166. Aiwa, Beyer-Dynamic, NAD, Quad, B&W, Mordaunt-Short, Kenwood, Bose, Nakamichi, Dnkyo, Teac, Sennheiser. Dem room. Home trial. Free install. Service dept. Access/Visa. £1,000 instant credit. Mon, Tues, Wed, Fri, Sat 9-5.30.

SHROPSHIRE HI-FI, St Michael Street, Shrewsbury, Shrops. SY1 2ES. Tel. 0743 232065. Stockists of Musical Fidelity, Mordaunt Short, Sony, Kenwood, Pioneer, Rotel, Denon, B&W, Proac. Audio Visual. Products available. Open 9.30 - 5.30pm Mon-Sat.

SOMERSET

MIKE MANNING AUDIO, 110 Middle Street, Yeovil, Somerset, BA20 1NE. Tel 0935 79361. Fax. 0935 32923. Mobile 0850 325965. Naim, Roksan, Pink Triangle, A&R (Arcam) ION, NAD, Pioneer, Rotel, Denon etc. Dedicated listening lounge, for relaxed and unpressured demos. Appls not necessary but best to telephone first. Home trial facilities on request, free installation and service dept, instant credit, Access/Visa etc. 9-5.30, closed Mondays.

STAFFORDSHIRE

ACTIVE AUDIO, 95, Stafford Street, Hanley, Stoke-on-Trent. Staffs. Tel: 0782 214994. Fax: 0782 283346. We have four studios including a dedicated Audio Visual studio for the demonstration of quality equipment from the largest range in the Midlands. Open six days per week. Own service department. Free local delivery, home trial facility. Current special offers and buyers fact pack and quotation service on request.

MUSICAL APPROACH, Unit 7, Woodings Yard, Bailey Street, Stafford, Tel. 0785 55154. Also branch at 37 High Street, Aldridge, nr Walsall. Tel 0922 57926. Linn, Rega, Arcam, Rotel, Royd, Heybrook, Marantz, Teac, Celestion, Appollo, Target. Mon-Sat 9.30-5.30. Home cinema equipment stocked. 2 single speaker dem rooms. Service dept and free install. Credit facilities. We are now agents for Rega products. Stafford branch only.

ACTIVE AUDIO, 29, Market Street, Tamworth, Staffs. Tel. 0827 53355. Fax. 0827 59513. We have two studios including a dedicated Audio Visual studio for the demonstration of quality equipment from the largest range in the Midlands. Open six days per week. Dwn service department. Free local delivery. home trial facility. Current special offers and buyers fact pack and quotation service on request.

SUSSEX

AUDIO IMAGES, 7 All Saints Road, Pakefield, South Lowestoft, Suffolk, NR33 6JL. Tel/fax: 0502 582853. Quad, Triangle, Arcam, Castle, Rotel, Moth, JPW, Finlux, Audio Innovations, plus the amazing ROTHWELL range. Separate dem room, no appts nec. 10-6.30 Tues-Thurs, 7pm Fri. 6pm Sat.

SIGNALS Martlesham Heath, Ipswich. Tel. (0473) 622866. See display advertisement for brands. Turntables, high end CD drives/DAC's as well as integrated players and solid state amplification, wide range of cables and loudspeakers. Home demonstrations/equipment trial service. Please telephone for directions and to book appointment.

BURY AUDIO, 47 Churchgate Street, Bury St Edmunds, Suffolk, IP33 1RG. Tel. 0284 724337. Arcam, Audio Alchemy, Heybrook, Marantz, Michell, Meridian, Nakamichi, Pink Triangle, Quad, Rotel, Sonus Faber, Stax, Tube Technology, Single speaker dem room. Free install. Credit facilities. Mon-Sat 9.30-6.00, closed Wed. Evening dems by appointment.

EASTERN AUDIO, 41 Bramford Road, Ipswich, Tel. 0473 217 217. Fax 0473. 215705. Quad, Arcam, Audioblab, Meridian, Mission, Denon, Rotel, Marantz, NAD, Sony, Rogers, Nakamichi, Systemdek, Technics, Celestion, B&W, Tannoy, Morel Thorens and Top Tape. Also stock a wide range of accessories. usual credit facilities. A BADA dealer.

FENWAY, 71 The Rookery Centre, Newmarket. Tel 0638 66166. Contact Mark Pearson. For Sony, Technics, Rotel, Tannoy, Pioneer, QED, equipment and accessories. Demonstration facility. In-House Service Dept.

"FREE INSTALLATION BY EXPERTS"

SURREY

SPRINGFIELD, 352-4 Lower Addiscombe Rd., Croydon, Surrey. 081 654 1231/2040. 3 dem rooms and home dem. Free installation/credit. Linn, Naim, Quad, Arcam, Audioblab, Cyrus, Marantz, Denon, Ruark, Mon-Sat 9-6, Tues 9-8. Closed Wed. Service dept.

PJ HI-FI, The HI-FI Shop, 3 Bridge Street, Guildford, Surrey GU1 4RY. Tel. (0483) 504801. 9-6 Mon-Sat. Linn, Meridian, Rega, Arcam, Quad, Revox. Musical Fidelity, Rotel, NAD, Nakamichi, Marantz, KEF, Reference etc.

ROGERS HI-FI, 13 Bridge Street, Guildford, Surrey, (0483) 61049. Aiwa, Creek, Denon, Dual, JPW, Marantz, Onix, Pioneer, Systemdek, Ruark, Tannoy, Teac. Dem facilities available, no appts necessary, free installation, service dept. Access/Visa. Instant credit upto £1,000 subject to status. Monday-Saturday, 9.30-6pm, later by appt.

SURBITON PARK AUDIO, 48 Surbiton Road, Kingston-upon-Thames, Surrey. (081) 546 5549. QUAD, Castle, Denon, Dual, Kenwood, Mordaunt-Short, JBL, Rotel, Pioneer, QED, B&W and Tannoy. Demo facil. Access, Visa and Switch. 9.30-5pm.

SURREY HI-FI, 45 High Street, Godstone, Surrey, RH9 8LS. (0883) 744755. Specialist Hi-Fi outlet, demonstration room and parking available. Quad, Audioblab, TDL, Tube Technology, Rel Acoustics, Nakamichi, Kef, Thorens, Musical Fidelity, Van Den Hul cables, Bose, Sennheiser, Beyer headphones, Marantz, Denon, Michell, Van den Hul, Musical Fidelity, Tannoy, Target, JPW. Single speaker dem rooms. Free installation service dept, Access/Visa/Mastercard. Open 9-6pm Closed all day Wednesday.

SUSSEX (EAST)

THE POWERPLANT "Brighton's Leading Hi-Fi Shop", 66 North Street, Brighton, Tel. 0273 775978. Comfortable listening rooms. Knowledgeable and approachable staff. Roksan, Micromega, Exposure, Audioblab, Epos, Rotel, Marantz, Cyrus, Regal, Arcam, Mission and more.

WORTHING AUDIO, 20 Treville Gate, W Sussex, BN1 1VA. Tel 0903 212133. "The friendly shop with the best sound systems in the South". Friendly advice, 3 yr guarantees, easy parking, open Mon-Sat

9-6pm. Late night Wed. Arcam, Exposure, Naim Audio, Marantz, Ruark, Restek, Clear Audio, Audio Technica, Target, Tripod, Sennheiser, AR and many more.

CHURCHERS HI-FI, 154 Montague St. Worthing, Sussex. BN11 3HH. Tel. 0903 821595. All major well know brands of Hi-Fi stocked. Please call for details.

WEST SUSSEX

BOWERS & WILKINS Ltd. (est. 1945), 1 Becket Buildings, Little Hampton Road, Worthing, Tel. (0903) 2 64141. Top names in Hi-Fi and audio visual including B&W, Nakamichi, Castle, Denon, Philips, Quad, Technics, Aura Teac, Sugden, Mission Thorens and many more. 4 dem rooms (budget - high end.) expert friendly advice, service dept, local installations free. one minute from A24 & A27, free local parking, Access/Visa. Instant Credit up to £1,000 subject to status. Open 6 days.

CHICHESTER HI-FI, 7 St Pancras, Chichester, W Sussex. PO19 1SJ. Tel. 0243 776402. Linn, Naim, Rega, Creek Nakamichi, A&R, Denon, Roksa, Epos, JPW, Ruark, Rotel, Quad, Spondor. Evening appts available.

TAYSIDE

28-36 Castle Street, Dundee DD1 9NZ. Tel: (0382) 26591. Rotel, Denon, Pioneer, Technics, Aiwa, Mission, Castle, Mordaunt-Short, Monitor Audio, Bose, Infinity. All equipment ready for demonstration. No appt. nec, free installation, service dept. Open 9.30-6pm six days a week. (close 5pm Sat).

TYNE & WEAR

BILL HUTCHINSON HI-FI, 87a, Castle Street, Newcastle-upon-Tyne, (091) 230 3600. For the largest selection of Hi-Fi and audio visual equipment in the North East. Specialist A.V. demonstrations of the highest quality. Best prices guaranteed. Minimum 2 year warranty and an optional 5 yr guarantee available. Instant credit and mail order service on offer throughout the U.K. Pioneer, Denon, Kenwood, Yamaha, Technics, Marantz, Mission, Tannoy plus many more.

WALSWORTH

STRATFORD HI-FI, 25 Henley Street, Stratford-upon-Avon, CV3 0W. Tel. 0789 414533. Pioneer, Technics, Denon, Marantz, NAD. Rotel. Musical Fidelity, Monitor Audio, Mission, Tannoy, Quad, TDL, Sennheiser, 0% finance is available on selected products and all major credit cards accepted. Dem Rooms. Service facilities. open 9.30-5.30pm. Late night Thursday until 8.00pm.

WEST MIDLANDS

FRANK HARVEY HI-FI EXCELLENCE, 163, Spon Street, Coventry CV1 3BB. Tel: 0203 252500. The Midlands first choice for specialist Hi-Fi. Audioblab, Audio Alchemy, Arcam, Audio Quest, Alphason, Bose, Bang & Olufsen, Celestion, Cyrus, Denon, Dual, Foundation, Kef, Reference, Marantz, Monitor, Audio Mission, Musical Fidelity, Nakamichi, Nad, Rega, Rogers, Rotel, Quad, Systemdek, Target, Tripod, Tannoy, Thorens, Van den Hul, Yamaha. 3 floors, 3 demonstration rooms. Open 9.30 till 5.30. Closed Thursday. All credit cards incl. Amex & Diners. Instant credit and Interest free facilities. Home trials. Free installation, home cinema A/V floor. We are a BADA dealer.

MIDLAND VALVE HI-FI, Specialising in true fidelity systems built around valve amplification:- Audion 300B Silver Nights, Audio Innovations, Impulse, Audio Note, KAL, Townsend Audio, Ortofon, Voyd, Micromega, Edison, Stax, Apollo, Dynavector, Seismic Sink, Valves. Home demonstrations and part exchange. Also vintage: Leak, Quad, Croft, Radford, etc. Flexible opening 7 days. phone Gary 021 722 2317.

MUSIC MATTERS, 351 Hagley Road, Edgbaston, Birmingham, B17 8DL. Tel 021 429 2811. Roksan, Nakamichi, Arcam, Audioblab, Kenwood, DPA, Tannoy, Royd, Heybrook, Michell, Panasonic, Aura, Celestion, Musical Fidelity, Mission/Cyrus, Meridian, Kef, Monitor Audio, Pink Triangle, Ruark Epos, Exposure, Pioneer and many, many more! 2 single speaker dem rooms. Appts necessary. Home trial facilities and free install. Service dept. Access/Visa/instant credit upto £1,000. Interest free credit available also. Tues -Thurs 10.30-6pm, Friday 10.30-8.00pm, Saturday 10.00-5.30pm. Check out the new branch in Solihull - Phil works there so it can't be bad! 021 742 0284.

COVENTRY HI-FI, 126, Church Lane (off Walsgrave Road), Coventry. CV2 4AJ. Tel: 0203 440529. Quad sales & service agent, Pioneer Reference Point.

Hi-Fi World Dial-a-Dealer

Kenwood, Aiwa, T.D.I. B&W, Tannoy etc. Private listening room. 2 year guarantee on all new hi-fi. Open 9.30-5.30 Mon-Sat. Closed Thursday.

ELECTRO CENTRE, 244 Soho Road, Handsworth, Birmingham. Tel. 021 554 1878. Full range of HiFi Pioneer, Technics, Kenwood, JVC, Sony, Aiwa, Akai. "Guaranteed the lowest price in the UK" 24 hour mail order facility available.

ELMDON AUDIO, Tel 021 784 8765. Reference Imports Lumley, Alon etc. Esoteric Audio Research 834 integrated on demonstration. Home demonstration can be arranged. Top part exchange prices, lots of used bargains. Quad, Leak, etc. Valves and valve testers, new GEC KT66s available.

FIWEAYS HI-FIDELITY LTD. 12 Islington Row, Edgbaston, Birmingham, B15 1LD 021 4550667. Advent, Albarry, AKG, Alphason, AMC, AR Arcam, Audiquest, Auditechnica, Beyer, Bose, Castle, Chord, Denon, Dual, Gold Ring, Meridian, Michell, Monitor Audio, Nagaoka, Nakamichi, Ortofon, QED Quad, Revox, Sennheiser, Spondor, Target, TDK, TDL, Thorens, Wharfedale, K Monks Record Cleaning Service. Closed Mondays

MUSICAL APPROACH, 37 High Street Aldridge nr Walsall Tel 0922 57926. Linn, Arcam, Rotel, Royd, Heybrook, Marantz, Teac, Celestion, Apollo Target, and others. Mon-Sat 9.30 - 5.30. Closed Thursdays. Home Cinema equipment stocked. Dem rooms service dept. Free installation and credit facilities. Free parking at rear of shop.

SOUND ACADEMY, The ultimate experience for those seeking HiFi. Ac. En., Arcam, Audiolab, AudioQuest, B&W, Bose, Chord, Cyrus, Cable talk, DPA, Epos, Kef, ref. Marantz, Meridian, Mission, Mus Fid, Nakamichi, Ortofon, Project, Quad, Roksan, Tube Tech, Rotel, Micromega, KAR, Kenwood, Lexicon Cannon, Celestion, Beyer & more. 3 Single speaker dem room on two floors incl. AV Cinema. Open 6 days a week. Mon-Sat. All major credit cards taken. Part exchange, enquiries welcome. Just off the high street, Bloxwich, Walsall, W. Midlands. Tel. 0922 493499. (ample free parking)

AMAEOUS SOUND & VISION, 10 Boldmere Road, Sutton Coldfield, West Midlands, Tel. 021 354 2311. Audio Innovations, B&O, Castle, QED, Wharfedale. Single speaker demo, appts preferred. Service available. Installations, B&O link install, home trials, Access/Visa. Interest free credit available subject to status. 9.30-6.00pm 6 days

GRIFFIN AUDIO 94 Bristol St., Birmingham. Tel. 021 622 2230. 021 692 1359. Tues-Sat 10 a.m.-6 p.m. Enjoy music at home with a system from Griffin Audio. We demonstrate and install the very best hi-fi, with systems from £500 to £25,000. Ask for Bob, Tim or Alex. Linn, Naim, Shahinian, Quad, Arcam, Rega, Denon, Marantz, Rotel.

WILTSHIRE

THE AUDIO EXCHANGE, 52 Morse Street, Swindon, Wiltshire SN1 5DP (0793) 539008. Acoustic Energy, Audio Innovations, Beard, Cerwin Vega, C.R. Developments, Impulse, Magnum, Micromega, Michell, REL, Sequence. AV and single speaker demo room. Home trial facilities, free installation, service dept. Mon-Sat 10-6.

AUDIO T, 60 Fleet Steet, Swindon, Wiltshire, SN1 1RA (0793) 538222. Fax (0793) 487260. Great Hi-Fi from Arcam, Audiolab, Denon, Linn, Marantz, Meridian, Mission, Rotel, Sony, Yamaha & many more. Mon-Sat 9.30-5.30. 3 year guarantee on Hi-Fi. Free delivery & installation. 30 day free upgrade scheme. Home demonstrations. Part exchange 2 listening rooms. Home Cinema specialists. BADA Bonded.

WORCESTERSHIRE

SPAINS HI-FI, 2 +2a New Rd., Bromsgrove, Worcs. Tel. 0527 872460. Aura, B&W, Beyer, Denon, Heco, JVC, Kenwood, Marantz, Mission, Monitor Audio, NAD, Nakamichi, Pioneer, Rotel, Sennheiser, Soundstyle, Sony, Systemdek, Tannoy, Target, Thorens. Integral demo room/showroom for instant comparisons on Hi-Fi & AV equipment. Free installation. Part exchange welcome. Service department. Access, Visa, 0% finance on sissted products. Mon-Sat 9.00-5.30 pm. Closed Thursdays.

WEST MIDLANDS

WEST MIDLANDS AUDIO, 158 Ombersly Road, Worcester WR3 7HA. Tel 0905 458046. Fax. 0905 457585. Naim, Rega, Rotel, Marantz, Nakamichi, NAD, Audiolab, Roksan, Meridian, B&W, Audio Research, Krell, Martin Logan, Arcam. 9-5.30 Mon-

Sat, eve's by appt only. Free

YORKSHIRE (SOUTH)

HIFI STUDIO'S, Sunnyfields, Doncaster, Tel 0302 781387 TDL, Sugden, ProAc, Ruark, Teac, Impulse, Systemdek, Alphason, Target, Albarry, Heybrook, Monitor Audio, JPW, Totem, Harbeth, Keswick Audio Research, Michell Engineering, AMC (CD and Valves), CR Developments (Valves), Art Audio (Valves), Rel Acoustics, Projekt, Origin Live, Dual, Yamaha plus home Cinema pro-logic dems. Listening room demo's. Home trial, free install, licensed credit broker, 2 yr guarantee on all equipment, service available. Access/Visa. 10-8pm 6 days. phone for further information and free fact pack.

TRC HIFI, 3 Kings Cross Street, Halifax, HX1 (0422) 366832. Agents for Kenwood, Denon, Castle, Rotel. Demonstrations and advice a pleasure. Call at any time to audition some of the best HiFi and pro-logic systems. Delivering and installation free within 20 miles. "The family firm where the customer matters most."

YORKSHIRE (NORTH)

AUDIO CLINIC, 22 Lord Mayors Walk, Yorks, YO3 7HA Tel (0904) 646309. Revox, QED, Audio Innovation, Allison-Celestion, Yamaha-Teac-Revolver, JPW, Kenwood-Bose-Thorens-Mission-Snell-B&W-Heco-Cannon-NAD-JVC-Musical Fidelity-Wharfedale-Micromega-Ruark-Heybrook. Surround sound and demo rooms, free installation, Service Dept. Credit facilities on request. Access, Visa. Open 10am - 5pm 6 days a week

SCARBOROUGH HIFI, 14 Northway, Scarborough, North Yorkshire YO11 1JL Tel. 0723 374547. Albarry, Aura, B&W Matrix, Cyrus, Pioneer, Philips, Marantz, Cabasse, Bose, Tannoy, DCC wide screen and lazer vision. Home trial facilities and free installation, service dept. Access/Visa. Credit charge, £1,000 instant credit/Amex/Diners.

THE SOUND ORGANISATION (YORK) 2b Gillygate, York, YO3 Tel (0904) 627108. Linn, Meridian, Micromega, Naim, Rega, Arcam, Creek, Nakamichi, Mission, Denon, Epos, Royd, Rotel 3 single speaker dem rooms, appts preferred, home trial facilities, free install, service dept. Credit facilities on request. Access/Visa. 10.00am-5.30pm. Tues-Sat. Sony dealer award nominated '86, '87 and '88.

VICKERS HIFI, 24 Gillygate, York (0904) 629659. Audiolab, Harmon Kardon, Marantz, Musical Fidelity, Pink Triangle, Quad, Systemdek, Tannoy, Technics, and lots more. 3 dem studios. (2 by appointment). Superb showrooms. 2 yr guarantee on all hi fi products. Appts as above. Home trial facilities, free install, service dept. Qualified and experienced staff, over 25 yrs experience. 12 mths interest free credit. 10.30-5.30 Mon-Sat.

YORKSHIRE (WEST)

BILL HUTCHINSON HIFI, 26-28 Woodhouse Lane, Leeds (0532) 427777. For the largest selection of HiFi and audio visual equipment in the Yorkshire, Specialist A.V. demonstrations of the highest quality. Best prices guaranteed. Minimum 2 year warranty and an optional 5 yr guarantee available. Instant credit and mail order service on offer throughout the U.K. Pioneer, Denon, Kenwood, Yamaha, Technics, Marantz, Mission, Tannoy plus many more.

DOUG BRADY HIFI, The Forge Cottage, 19 Cross Gate, Otley, West Yorks, LS21 1AA. Tel. (0943) 467689. Naim, Arcam, Rotel, Pink Triangle, Meridian, Epos, Castletg, Two dem rooms, fair demonstrations and home trial facilities. Access/Visa. Open 10.00-6pm Tues-Sat

HUDDERSFIELD HI-FI CENTRE, 4 Cross Church St, Huddersfield (0484) 544668 B&W, Cyrus, Kenwood, Denon, Rotel, Arcam, Musical Fidelity, Quad, Audio Lab, Marantz, Mission, etc. Dem facilities - appointment reqd. Mon-Sat 9-5.30. Thurs 9-8. Closed Wed. Free installation, credit facilities. Access, Visa.

SCOTLAND

EDINBURGH

BILL HUTCHINSON HIFI, 43 South Clark Street, Edinburgh, (031) 667 2877. For the largest selection of HiFi and audio visual equipment in Lothian. Specialist A.V. demonstrations of the highest quality. Best prices guaranteed. Minimum 2 year warranty and an optional 5 yr guarantee available. Instant credit and mail order service on offer throughout the U.K. Pioneer, Denon, Kenwood, Yamaha, Technics,

Marantz, Mission, Tannoy plus many more

HILLYBELL - 72 Newhaven Road, Edinburgh EH6 50G. Tel: 031 555 3963. Stockists of Micromega, Proac, Audio Innovations, Lumley Reference Tube Technology, DNM, B&W, Systemdek, Nottingham Analogue, Nacamichi, Rehdeko, Dali, Crimson, Harmon Kardon, Goldring. Mon-Sat 10-4.30 pm by appt. Closed Wednesdays. All Major Credit Cards Accepted. Contact Fraser or Mark.

ABERDEEN

HOLBURN HI-FI 441 Holburn Street, Aberdeen. Tel. 0224 585713. Arcam, Audiolab, B&W, Celestion, Denon, Dual, Epos, Heybrook, ION, Kenwood, Creek, Marantz, Meridian, Mission, Cyrus, M.S., NAD, Nakamichi, Pioneer, QED, Quad, Revox, Rotel, Ruark, Tannoy, Technics, Wharfedale, Yamaha. 9.30-5.30 Mon-Sat.

HI-FI EXCELLENCE, Hi-Fi innovators & product designers with 15 years experience. Very much in the business for the music. Musical Fidelity key dealer. Largest Rotel retailer in the area. Particularly keen to make the buying of Hi-Fi a fun experience. Situated in the West End away from the bustle of the City centre - the perfect environment to enjoy quality Hi-Fi. Full time service engineer. Open Mon-Tues 10-6 Wed 10-1, Thurs 10-7 Sat 10-5 or later by appointment. Hi-Fi Excellence, 293 Union Grove, Aberdeen. Tel: 0224 322520

AYRSHIRE

LASER AUDIO, Now at new premises: 1 St Marnock Place, Kilmarnock KA1 1DT. Tel. 0563 40292. Audiolab, Aiwa, Celestion, Cyrus, Denon, Dual, Marantz, Mission, Philips, Pioneer, Systemdek and Tannoy 2 demonstration rooms, AV dem room. Appointments preferred. Home trial facilities. Free installation, service facilities. Access, Visa and written credit. Open Tues-Fri 10-5.30, Sat 9.30-5.30

GLASGOW

STEREO STEREO, 278 St Vincent Street, Glasgow, Scotland. Tel 041 248 4079. Closed Tuesday. Installations throughout Scotland. Credit facilities available.

BILL HUTCHINSON HIFI, 43 Hope Street, Glasgow (041) 248 2857. For the largest selection of HiFi and audio visual equipment in South West Scotland. Specialist A.V. demonstrations of the highest quality. Best prices guaranteed. Minimum 2 year warranty and an optional 5 year guarantee available. Instant credit and mail order service on offer throughout the U.K. Pioneer, Denon, Kenwood, Yamaha, Technics, Marantz, Mission, Tannoy plus many more.

INVERNESS

THE MUSIC STATION, 49 Church Street, Inverness, IV 1DR. Tel. 0463 225523. Beyer Dynamic, Celestion, Denon, Jamo, Kel, Kenwood, Mission, Pioneer, Rotel, Sony. Listening room, service department, free local delivery, part exchange, full range of credit facilities.

IRELAND

DUBLIN

ACOUSTIC DIMENSION, 16 Idrone Lane, Rear of Main Street, Blackrock, Co. Dublin. Tel 2884612 Fax 2833521 (from UK + 0103531). Stockists for speakers: ATC, Acoustic Energy, JPW, Triangle, ProAc, Ref 3A, RuArk, Heybrook, Polk Audio, TDL, Impulse, Chario, Audio Static Amps by Albarry, AVI, LFD, NVA, Alchemist, Marantz, Audio Innovations, Rotel, CR Developments, EAR, Kinshaw, CD Players and DACs by AVI, Pierre Lurme, Micromega, Kinshaw, Turntables by Project, Tables/Stands: Apollo, Cables: Straightwire, Ixos, VLS, Eagle. Credit cards and mail order.

CLONEY AUDIO, 55 Main Street, Blackrock, Co. Dublin. Tel. 2889449/2888477. Fax. 2834887. Products include: Arcam, Classe, Philips, Rogers, Epos, B&W, Naim Audio, Meridian and others. Open Tues/Sat 10am-6pm, Thurs/Fri 'till 9pm Closed Mondays.

LANAETTI HIFI, 50 Wellington Quay - Dublin. Tel: 010 353 1677 0443. Dublin's Hi-Fi Separates Specialists. All leading brands, demonstrations available on request. Open Monday - Saturday 10 am - 6 pm.

PETER DAND & CO LTD. 111 Clonskeagh Road, Dublin 6. Tel. 0103531 2694433. Products include: B&O, Quad, KEF, Thorens, TEAC & many more! 2 demonstration rooms and 2 year guarantee.

BELFAST

LYRIC HIFI, 163 Stanmills Road, Belfast (0232) 381296. Linn, Naim, Rega, Arcam, Denon, Rotel and more. Mon-Sat, 10.00-6.00pm. Late night Thurs

ZEUS AUDIO, 6 Hope Street, Belfast, (0232) 332522. Audio Innovations, Pink Triangle, Roksan, Marantz, Celestion, Meridian and more. Mon-Sat 10.00-5.30pm. Late night Thursday.

COUNTY DOWN

ASTON AUDIO, Unit 8, Kings Road Shopping Centre, Kings Road, Belfast (0232) 402220. Akai, Technics, JVC, Samsung, Toshiba, Panasonic and many more. Demos. Open Mon-Fri 10-8pm Sat 10-5pm.

LONDONDERRY

ZEUS AUDIO, 23a Kingsgate Street, Co. Lond. BT52 4LB. Tel. (0265) 56634. Marantz, Mission, Cyrus, Aiwa, Akai, Alphason, Sony, Pink Triangle, Celestion, Rotel. Mon-Sat 10-5.30pm. Closed Thurs.

WALES

NORTH WALES

THE MUSIC STATION, 4 Ruabon Road, Wrexham, North Wales. Tel 0978 364 500. Audio Visual Specialists. Aiwa, Arcam, AMC, Bose, B&W, Beard, Canon, Celestion, Castle, Cyrus, Jamo, Marantz, Michell, Mission, Mordaunt, Short, Musical Fidelity, NAD, Nakamichi, Micromega, QUAD, Radford, Rotel, Rogers, Rega, Ruark, Spondor, Tannoy, Thorens, Wharfedale, UKD, Yamaha, DSP Club Member, Demo Room, installation service. Easy Parking and Motorway access. All major credit cards accepted. 9.30 - 5.30 daily. Closed Weds pm.

ELECTRO TRADER, 19 Colwyn Crescent, Rhos on Sea, Colwyn Bay, Clwyd, Wales, LL28 4RN (0492) 548932. NOW APPOINTED SUGDEN DEALER FOR THE NORTH WEST. Rotel, Yamaha, NAD, Harmon Kardon, Teac, Alphason, Heco, Infinity, KEF, JBL, Sugden, Tannoy, Rotel, Michi, Haybrook, Acoustic Research, RUARC and Soundstyle tri-rod racks etc. Dem room appts preferred. Home trial. Free install. Access, Visa. Open 9.30 - 1.00, 2.00 - 5.30 Mon-Sat

SOUTH WALES

AUDIO EXCELLENCE WHERE THE MUSIC MATTERS', 134-6 Crwys Road, Cardiff CF2 4NR, Tel. 0222 228565. Fax 0222398201. Great Hi Fi carefully selected and demonstrated by friendly enthusiastic staff. Home installations and check-ups. Two year warranty from our own service department. Open 9.00-5.30 Tuesday - Saturday closed Monday

SOUTH WALES

AUDIO EXCELLENCE WHERE THE MUSIC MATTERS', 9 High Street, Swansea, SA1 1LE. Tel. 0792 474608. Fax 0792 645087. Great Hi Fi carefully selected and demonstrated by friendly enthusiastic staff. Home installations and check-ups. Two year warranty from our own service department. Open 9.00-5.30 Tuesday - Saturday closed Monday.

I&H GRIFFITHS & SONS, 313 High Street, Bangor, LL57 1YA. 0248 370655. Yamaha, Tannoy, Teac, Sony, B&W, Wharfedale, Rotel, JVC. Home trial facilities, free installation, service dept. After hours dems by appointment. Access, Visa, Lombard credit charge. Mon-Sat 9-5.30, Wed 9-1. Audio Visual Specialists.

TOP TAPE, 1 Crystal Way, Elm Grove Road, Harrow, Middlesex, HA1 2RJ. Tel: 081 427 1404. The UK's oldest and largest Tape Mail Order Service. TDK, Maxell, Sony, Ampex audio cassettes plus Fuji, JVC, Konica, Memorex, Scotch & TDK video tapes. Send for complete list of latest prices and offers including Video 8, VHS-C, S-VHS, DAT, MiniDisc and Open Reel and tape accessories including Allisop. Local Dealer Listing available. Telephone orders on 081 427 1404 Mastercard, Visa & Switch accepted.

Simon Hopkins



JIMI SUMEN
Paintbrush, Rock Penstemon
 CMP CMPCD61

● Here's a funny thing: one of European creative music's greatest living talents hails from the continent's furthest extremity. The Finnish drummer, percussionist, bandleader, composer and arranger Edward Vesala has been making some of Europe's finest jazz music for over twenty five years, as both a sideman, and leader, most notably as leader of his extraordinary big band Sound and Fury. That group has always blended ferocity, passion and power with delicacy and lyricism in a way which Scandinavian musicians seem particularly attuned to - think of Garbarek and of Rypdal. As a band it's also spawned some pretty astonishing talent: clarinet and saxist Tapani Rinne, harpist Iro Haarla and guitarist Raoul Bjorkenheim - whose own group Krakatau have been raved about

previously in this column and whose upcoming ECM release we await with genuinely baited breath - among that talent.

Like Bjorkenheim, with whom he has much in common - both in terms of approach and background - Jimi Sumen is another fine guitar player to emerge from Vesala's Sound and Fury; the elusively-titled Paintbrush, Rock Penstemon is his debut as leader. The Finnish-born and largely - despite a period in the mid-80s spent in the UK - Finnish-resident guitarist came to jazz late, and fairly elliptically at that. A self-taught player typically inspired by Hendrix, it was the aggression and power of rock which originally drew him to music making, and when asked in the late 80s to join Vesala's big band, he had no knowledge of even the standard jazz repertoire, let alone the musical minefield that is European Free Jazz. But then, this ain't necessarily a problem for Vesala, whose musicians come from any number of musical backgrounds - from classical, from Free Jazz, from rock, from big band - and whose music is uniquely constructed around the talents of whatever musicians form the band at a given time.

His contributions to the magnificent ECM Sound and Fury albums Lumi and Ode to the Death of Jazz, a lurking, malicious monster in the midst of all that layered - albeit stark - grandeur, were stunning, and a mouth-watering hint of what he might be capable of. Paintbrush, Rock Penstemon confirms all that, and

then some. A collection of nine pieces written by Vesala exclusively for Sumen, the guitarist's debut features the contributions of the drummer himself and percussionist Mark Nauseef (of whom more later), along with all Sumen's cohorts in the current line-up of Sound and Fury: Haarla and Rinne, saxist-flautist Jouni Kannisto, bass clarinetists Kari Krikku and Jorma Tapio, Jukka Orma on the wonderful electric pipa, Pertti Paivinen on a host of horns and woodwinds and trumpeter Matti Riikonen.

Yet Paintbrush is way off a group recording caught live. Instead, the album was carefully constructed over the course of a year, each contribution added at a time, so that Sumen's extraordinary and omnipresent distorted guitar is not so much a single soloing voice in an ensemble - as with Sound and Fury, say - but rather the frame over which the fabric of the music around it has been hung. And a startlingly varied tapestry it is too: from the three minute Free Jazz anarchy of 'Meant to Rippen into Straw' to the lustrous tone poem 'Curtain of Twilight Shimmer', from the darkly ambient 'Deep as a Maze' to the Omette's PrimeTime-like avant-funk of 'Jumpin' in Obscure Mind'... this is a richly variegated listen for sure.

A damn fine debut then for Sumen - a monster guitar player to watch and no mistake - and one which leaves us with the future prospects of further Sumen-Vesala collaborations. We're gagging for it.



MARK NAUSEEF AND MIROSLAV TADIĆ
The Snake Music
 CMP CMPCD60

● Mmm, well, I wanted to like this record just as much, but where Jimi Sumen's debut is a totally gratifying listen from start to finish - and one full of promise - The Snake Music somehow never really cuts it for me, despite the best attempts of its hugely talented creators and their hugely gifted (and, in a couple of cases, hugely famous) collaborators.

Alright, I can't go on about about

“ We don't offer comparisons. Only absolutes. ”

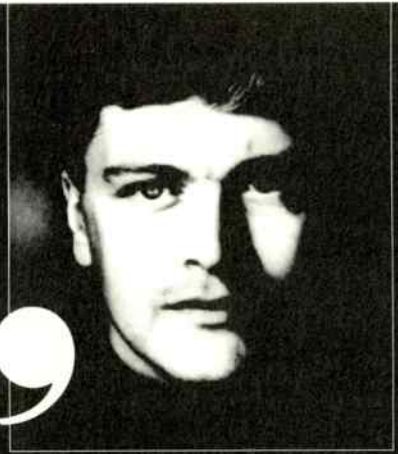

COLIN WELFORD

At Son et Lumière, you won't find us trying to confuse you with numerous hi-fi solutions. As far as we're concerned, we've only got one answer to your requirements.

We hold what we believe is the best audio solution at every price level from £800 to over £25,000.

With our purpose built listening rooms, we make a point of inspiring you with a musical solution that will give unbridled listening pleasure.

Whatever your aspirations.



SON ET LUMIÈRE, 67 TOTTENHAM COURT ROAD, LONDON W1P 9PA. TEL 071 580 9059.

TABULA RASA LOUDSPEAKERS



"It is a rare experience to play a track that you have known for the better part of, say, twenty years and suddenly, to hear new details and information."

(Hi-Fi World - Dec '93 on CT77 loudspeaker kit)

With the increased popularity of "do it yourself" hi-fi, Tabula Rasa are offering an extensive range of quality loudspeaker kits and car audio kits from top German manufacturer Mainhattan Akustik.

All loudspeakers kits are simple, fun to build, and at prices to suit

all pockets. Each kit comprises drivers, filters, connections, terminals, and all the necessary fittings needed to complete your chosen loudspeaker, and every kit is available with or without cabinets. Furthermore, each kit comes with a 10 year warranty as standard and will be delivered within 14 days of confirmation of your order. For a catalogue (including price lists and a brief guide to speaker construction) please send £2.00 (refunded after first kit purchased) and a self addressed A4 envelope to:

Tabula Rasa, 136 Kilnwood, Walters Ash, High Wycombe, Buckinghamshire, HP14 4UR, Tel 0494 565116

Cheques and postal orders should be made payable to Tabula Rasa.
Trade prices available on request.
30 days money back guarantee offered on all drivers & kits.

Hi-End Hi-Fi in the heart of East Anglia.

For the best in Hi-End hi-fi Bury Audio is a must. All the names stocked are individually chosen to complement one another to give the best sound in their class. To get the best from CD there are DAC's like **Pink Triangle - Da Capo or Ordinal**. Great sounds now can mean good looks too thanks to **Michell - Iso, Argo, Alecto**. Now, Gyrodec sounds better still with the **Tesseract - Tags psu**. Valves from **Tube Technology - Unisis**. For fanatics, **Musical Fidelity - F22 and F15**. Open natural sounds from **LFD - PAO, LSO, MMO**. Stunning to look at and to listen to the new **Ruark - Equinox**. These are just a selection of the impressive sounds on demonstration now. Why not come in and have a listen to the best sounds in East Anglia.

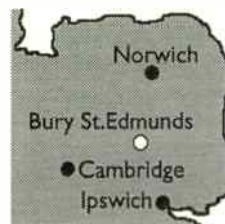

BURY AUDIO 

47 CHURCHGATE STREET, BURY ST. EDMUNDS, SUFFOLK IP33 1RG. TEL: 0284 724337

"hugely gifted" musicians without giving you some hint of their backgrounds, so here goes with the usual round up. The American drummer and percussionist is indisputably one of the most capable and widely-experienced working in contemporary jazz. Himself a recent touring member of Sound and Fury, he has spent twenty years building his vast arsenal of approaches and sounds in the company of, among many, many others, neo-bop jazz guitar star John Scofield, Indian multi-cultural violinist L Shankar, and similarly idiom-exploding North African oud master Rabih Abou Khalil, avant-funk big band leader George Lewis and, most famously, the Velvet Underground. He's also performed works of contemporary music by the likes of Lou Harrison and - at the other end of the spectrum - contributed great thrashing jazz-rock drums to pianist Joachim Kuhn's group Dark.

Which is where I first came upon the Bosnian (now US resident) guitarist Miroslav Tadic. Now this hack is constantly, vampirically on the search for new monster guitar material, and was blown away by Tadic's scorching work with Dark. I had no idea then of Tadic's background, but it turned out to be a fairly remarkable one for all that. Trained initially as a classical guitarist, he went on to study contemporary music with, among others, early Minimalist trailblazer Terry Riley and the great Mauricio Kagel. His training obviously paid off: he performed in the US premiere of Stockhausen's *Stemklang*, and we've all heard just how picky that man is. Anyway, taking entirely the opposite musical journey to that of young Jimi Sumen, he began to adapt the techniques and sounds of jazz and rock into his repertoire, and, like I say, by the time he recorded with Dark, his playing was bursting with all these ideas, and, like so much genuinely creative music-making, it sounded like half of the material was almost in mutual conflict, its creator barely in control of it all. Breathtaking stuff, definitely.

So, these two bring an incredible amount of music to their debut as joint-leaders, from Javanese gamelan to jazz-rock, from European contemporary

classical to Free Jazz. And the music they weave out of it on *The Snake Music* is certainly highly accomplished stuff, melding styles and genres effortlessly and without brandishing them either. And more than any other single element, what they draw from all these styles is a compelling use of rhythm. Whether it be the urgently syncopated opening of, say, the 'Lizard On A Hot Roof' or the ambient rubato textures of their Hendrix tribute, 'The Wind Cries Mary', there's a very special in-time quality about this duo's playing together.

They're joined at various points throughout this record by four other master musicians. Jack Bruce, who surely needs no introduction, adds bass and - as ever - beautiful vocals. American guitarist David Tom, veteran of dates with David Sylvian and Mark Isham, and a fine blender of ambient atmospherics with violent guitar solos, adds haunting textures. And altoist Wolfgang Puschnig and trumpeter Markus Stockhausen - yes, son of *Stemklang*'s inventor - fill out the sound of the group.

And despite all this somehow *The Snake Music* never really gets properly off the ground; there are thousands of ideas here, some great sounds, some wonderful soloing, yet as a recording I personally don't think it all quite gels; despite all that's gone into making this record - or perhaps because of it - it remains an unsatisfying listen. Nonetheless, if you're in the mood for some highly accomplished, state-of-the-art cross-cultural contemporary music, you could look in a lot worse places.

Simon Cooke

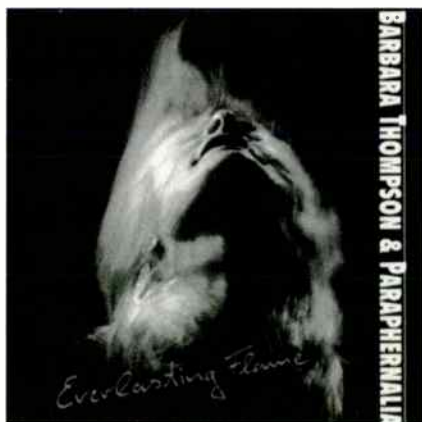

BARBARA THOMPSON AND PARAPHERNALIA *Everlasting Flame* VBR 2058 2

● Once more the denizens of jazz-rock have invaded my CD and, unexpectedly, I enjoyed the experience. Not that it was a particularly jazz-orientated one - in many

ways 'Invisible Threads', the Summers/Etheridge disc I reviewed recently has a more jazzy feel - but that the recording and performance values on this disc seemed higher than average. Linn, Naim, ECM et al can rest easy however, since this cut didn't have me looking behind the sofa for the lead guitarist but, compared with the muddled and confusing sundstages of some recent releases I have heard (and not reviewed for that reason), it impresses.

If you like your rock jazzy- or vice versa - Paraphernalia are an accomplished outfit with a reasonable history of recorded work. Instruments are handled with flair, tempered by accuracy from all performers, giving the group an unusual roundness and coherence lacking in many bands of similar leanings. All round, a good, solid line-up giving acceptable performances, and recorded with workmanlike precision.

It's not just the ability of the group that impresses, either. Individually, each player - Thompson herself on anything you can blow, John Hiseman on drum and percs, Peter Lemer accompanying assorted synths and silicon chips, Malcolm Macfarlane on guitar and Paul Westwood on bass strings, as well as a few 'Special Guests' popping up here and there - manages to do more than just hold their own in the setting. Each has a definite and discrete identity within the recording, being incontrovertibly there without tending towards forwardness; the components are given but, like the elements in a Turner landscape, the whole thing works because of the position and balance of the elements within it. This is a rare thing to have achieved with a jazz-rock band, or any jazz band, since many players seem to think of a band as little more than a foil for their abilities, however small. That Paraphernalia have achieved such a synthesis of equalities is most impressive.

And yet, for all that ability and coherence, it lacks the vital spark which marks out a great recording. Separated, as we hi-fi buffs are, from the musicians by time, technology, and recording expertise, a goodly portion of the performance experience is lost; the best we can hope for is an aural performance without the accompanying sights, smells, and surroundings; it's the price we pay for the consistently high quality of each 'performance' we hear in our homes. A top-flight recording will contain at least a frisson of the excitement of a live performance, and I was convinced that this was one such recording. However, my system, a not unaccomplished amalgam of equipment, failed to translate that excitement. I took it to friends with more accomplished systems, and still they failed. I admit that I am puzzled; either this CD is of such rare quality that it only gives its all in truly 24 Carat systems, or it is the closest also-ran of its kind in the race for 'Essential' status that I've ever heard. Interesting.



“ We stock only one hi-fi that will suit you. ”

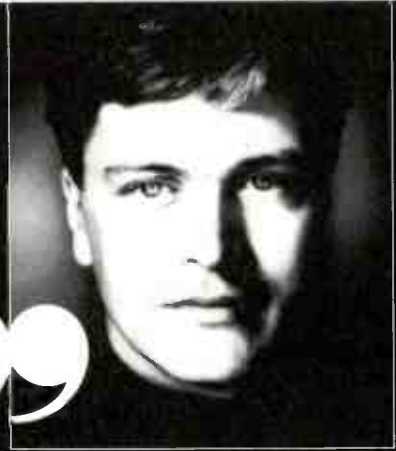

COLIN WELFORD

At Son et Lumière, we hold what we believe is the best audio solution at every price level from £800 to over £25,000.

So, you won't find us trying to confuse you with numerous hi-fi solutions. As far as we're concerned, we've only got one answer to your requirements.

And with our purpose built listening rooms, we make a point of inspiring you with a musical solution that will give unbridled listening pleasure.

Whatever your aspirations.



SON ET LUMIÈRE, 67 TOTTENHAM COURT ROAD, LONDON W1P 9PA. TEL 071 580 9059.

To make the most of your projects, start with the right tool.



1994 Catalogue
The Audio Hobbyist's
Definitive Parts Source

Get connected with the widest selection of audiophile grade parts. Send £2.85* along with your mailing address and you will receive our 1994 parts catalogue and a \$10 discount** coupon good on your first order over \$100.

THE PARTS CONNECTION

A DIVISION OF SONIC FRONTIERS INC

*or \$5.00 US, or credit card information
**catalogue pricing and discounts are in US Dollars



2790 Brighton Road, Oakville, Ontario, Canada L6H 5T4
Telephone (905) 829-5858 Facsimile (905) 829-5388

MIT MultiCap • Wonder Cap • Kimber Kap • Solo • Solen • Siemens • Hovland MusiCap
Wima • Holco • Fel-Cap • Draloric • Vishay • Caddock • Mills • Matsushita • TKD • Noble
Cardas • Kimber Kable • Discovery • Audioquest • MIT • ClearAudio • Alps • Bourns • Elma
Shalco Attenuators • Electroswitch • Elna • Nichicon • Gold Aero • RAM • Mallory
Ruby Tubes • Linear Technology • Analog Devices/PMI • Motorola • Edison Price
International Rectifier • MagneQuest • Sonic Frontiers
Pearl • Tube Sockets • WBT • Neutrik • Curcio Audio Engineering • Kits

V' audio

Hi-Fi Consultants

'My Resistance is Low'

Many people are sceptical about the importance of good quality interconnects and speaker cables in a Hi-Fi system, but there really is no doubt - they are vital. The real question is which one, as they all have their own character and different cables suit different systems. Well help could well be on its way via Max Townsend who has been appointed exclusive agent for patented 'GOERTZ' impedance matched loudspeaker cable. These 4 ohm characteristic impedance transmission line cables correctly match typical loudspeakers with impedance ranges from 2 to 8 ohms, compared to typical speaker cables which have impedance ranging from 470 ohms to 60 ohms. The cables are compact, flexible, easy to terminate (with special banana plugs) and relatively inexpensive at £20 and £40 per mono metre. A correctly engineered termination unit is also available to allow use with NAIM amplification. Do contact us for an audition.

Not too much new happening apart from that, though we are investigating RPG Diffuser systems for room sound treatment; have found that the Kinshaw Phono Stage 5A is better than the standard perception unit; are still running in the Electrocompaniet Amps. have been surprised how good the floor standing Jamo 50Z is for £700, and pleased that so many can afford to buy ATC 50's and 100's. See you again next month.

Ian C. Vaudin

36 Druid Hill, Stock Bishop,
Bristol BS9 1EJ.

Tel. Bristol (0272) 686005 (+ Fax)

AUDIO ACCESSORIES

HI-FI WORLD SOLID SILVER INTERCONNECTS.

Constructed from solid strands of pure silver wire, and with a thick outer casing and screening braid, these interconnects offer the ultimate in transparency, openness and detail. Superb Neutrik Profi phono plugs are silver soldered to the cables in pseudo-balanced configuration for lowest noise/interference and extensive use of adhesive heat-shrink is



used to strengthen the join between cable and plug for long life. Available exclusively through Hi-Fi World Mail Order.

HIFI WORLD SOLID SILVER CABLE.....£139.95/1M PAIR.

HI-FI WORLD SILVER PLATED COPPER INTERCONNECTS.

A similar construction to our solid silver cables, but using silver plated copper and standard Gold Phono plugs. Because the majority of the audio signal passes through the skin of a cable these can approach the quality of silver, but at the cost of normal high quality copper cable.

HIFI WORLD SILVER PLATED COPPER INTERCONNECTS £69.95/1M PAIR.



HIGH QUALITY MAINS CABLES.

Supplied to Hi-Fi World by Campaign Audio Design these mains cables are screened to reduce Radio Frequency and Electromagnetic Noise. They also come with a VDR fitted which protects equipment from mains spikes. The MK plugs have a silver plated fuse and holder for the cleanest supply. Available with IEC or Figure eight (Marantz/Philips CD players) equipment plugs or with a hard wired, soldered 4-way mains block.

**1M WITH IEC PLUG£19.20
1M FIGURE 8 PLUG£15.75
1M 4-WAY BLOCK.....£31.95**

RECORD STORAGE CUBE

Designed to hold about a hundred LPs, with an internal width of 37cm, height of 32.5cm and depth of 32cm. The cubes can be stacked or placed alongside each other - and are even strong enough to be used as seats! Made from 15mm MDF (Medium Density Fibreboard) with a smart durable black paint finish, the

cube is supplied in flat-pack form ready for home assembly.

RECORD STORAGE CUBE£45 EACH

**SIX CUBES FOR THE PRICE OF FIVE £225.00
EIGHT CUBES FOR THE PRICE OF SEVEN!.....£315.00**

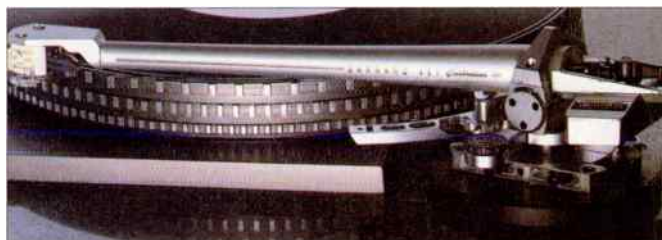

GARRARD 401 CELEBRATION SME IV TONEARM

A special version of the SME IV cast magnesium alloy tonearm, dedicated to the Garrard 401. The SME IV is precision engineered to be fully adjustable, making set-up easy and precise. If you want to get the best from your Garrard 401, this is a fantastic tonearm, sympathetically styled to form a perfect combination.

GARRARD 401 CELEBRATION SME IV TONEARM£820

ANTI-STATIC RECORD SLEEVES

Translucent sleeves, treated to reduce static and dust attraction, supplied in packs of fifty.

They will fit inside ordinary printed inners.

LP SLEEVES (50) PRICE £8.15

AUDIO ACCESSORIES



NEW

NEW

NITTY GRITTY RECORD CLEANER

Bring a glossy shine to your LPs with the Nitty Gritty series of record cleaners. Several versions are available from the basic machine to the near fully-automated Mini-Pro (pictured) which cleans both sides of the LP together. Review in Hi-Fi World August 1994, these machines are a must for the dedicated Vinyl collector.

- BASIC RECORD CLEANING SYSTEM**£199.90
- RECORD MASTER RECORD CLEANING SYSTEM FOR ALL SIZES (7/10/12") WITHOUT ADAPTOR**.....£249.90
- 1.5 FI FULLY AUTOMATIC SINGLE SIDED RECORD CLEANING SYSTEM**.....£399.00
- MINI-PRO I RECORD CLEANING CLEANING SYSTEM BOTH SIDES CLEANED SIMULTANEOUSLY**£599.00

For further details and cleaning fluid cost please contact the Mail Order Department on 071 - 266 0461

BUG AUDIO

A fascinating little device no larger than a hand-held remote which allows the user to adjust bias on any cassette deck perfectly for any tape. You can check the state of your cables and connections with it, too! Supplied with a cassette test tape and full instructions. (See review, Nov. 1992 issue.)

BUG AUDIO£59.99



MICHELL ENGINEERING PLUGS

Craftsmanship marks out Michell Engineering's range of gold and rhodium plated plugs from the competition.

GOLD-PLATED SIDE ENTRY BANANA PLUGS (4)£10.00
GOLD-PLATED SURE-LOC



BANANA PLUGS (4)£14.95
RHODIUM-PLATED SURE-LOC BANANA PLUGS£18.95
GOLD-PLATED SPEAKER CABLE CONNECTORS...£10.00

GOLD PLATED 4MM BANANA PLUGS

Heavy-duty, gold-plated banana plug with a unique type of axial solderless connection for loudspeaker cables. The cable is stripped back and pushed into a clamping collar which is then screwed down tight, accepting cable up to 6mm external diameter and 4mm core diameter. Supplied in sets of four.

BANANA PLUGS (4)£8.00

SOUND SWIVEL

A rotating, upright, double-sided, storage cabinet with space for up to 160 Compact Discs, including 8 double jewel-cases.

Mounted on an all-steel turntable, it swivels smoothly through 360 degrees giving easy access to the storage compartments either side. Manufactured in durable MDF with a Black Ash effect finish, the Sound swivel comes packed for self assembly with full instructions.

SOUND SWIVEL£49.95



Hi-Fi World

AUDIO ACCESSORIES

AUDIO-TECHNICA RECORD CLEANING SYSTEM

Removes both dirt and static; a tiny amount of cleaning agent in the handle removes fingerprints, oil and film, while a pad lifts off dust. Pad brush and fluid are supplied.

AUDIO-TECHNICA RECORD CLEANING SYSTEM £10.50



AUDIO-TECHNICA COMPACT DISC LENS CLEANER

A disc the size of a CD, with fine brushes - one of which is dampened with cleaning fluid. As the disc spins in the player, the brushes clean the laser lens. It may not suit all machines.

CD LENS CLEANER.....£16.25



KONTAK

An effective cleaning solution that removes contaminants from electrical connections. After application, a system regains its original life, sparkle and vigour.

KONTAK£19.00

HI-FI WORLD DRY STYLUS CLEANER

Keep your stylus sharp and bright for perfect tracking without using fluid. Cut a strip about the size of a matchbox striker off this sheet of card and draw it gently under the stylus from back to front. One sheet of this card, with its aluminium-oxide micro-abrasive coating, should be enough to clean your stylus at least forty times.

DRY STYLUS CLEANER...£1.95

EQUIPMENT SUPPORTS

FrameWorks is an innovative range of versatile hi-fi supports whose high standard of strength and rigidity results from their 'triangulate' design. The shelves are supported on struts of thin cross-section and four sturdy corner columns, to reduce resonances.

Versatility is guaranteed by two or three shelf options, an additional isolation shelf and a stacking unit to expand the system as the hi-fi grows. All you need to do is add components as and

when you feel the need.

FrameWorks stands come with attractive 10mm thick toughened smoked glass shelves, supported on rubber-damped spikes to reduce vibration and lessen the tendency for the glass to slide. Metal parts are finished in a hardwearing satin black powder coat.

FrameWorks stands will extract the best out of any equipment.

FrameWorks' excellent hi-fi equipment stands are now available through our Mail Order Department.

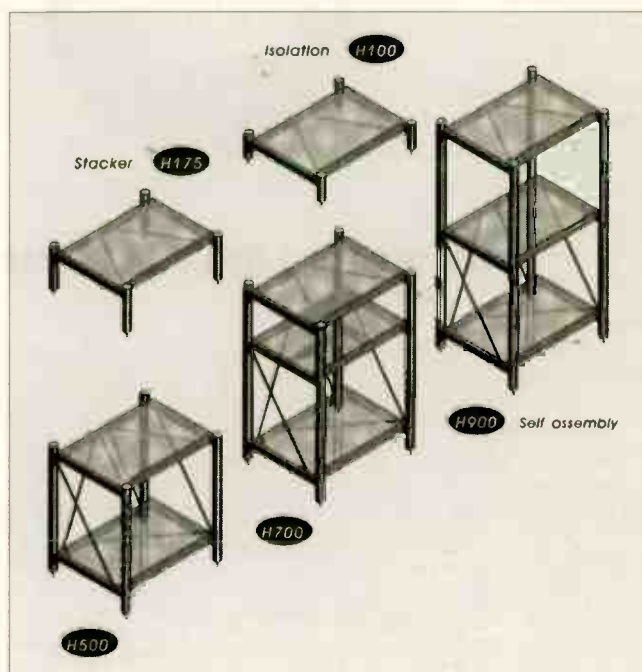

PRICES FOR FRAMEWORKS EQUIPMENT STANDS ARE AS FOLLOWS;

CODE	HEIGHT	PRICE
H100	100MM	£109
H175	175MM	£119
H500	500MM	£205
H700	700MM	£275
H900	900MM	£305

ALL FRAMEWORKS SHELVES ARE 550MM WIDE BY 450MM DEEP. All prices include VAT & p+p for UK only.



H100 ISOLATION TABLE

AUDIO ACCESSORIES

GOLDRING EXSTATIC MAT

For vinyl users, the Goldring Exstatic is a felt mat made with fine carbon fibre strands. This helps to reduce positively charged static electricity that builds up on the surface of records.

GOLDRING EXSTATIC MAT £7.50



SUPER EXSTATIC CARBON FIBRE DISC CLEANER

Effectively removes dust and grime from record grooves, this cleaner is a combination of one million carbon fibre filaments and a soft velvet cleaning pad.

EXSTATIC CARBON FIBRE CLEANER £9.95



MILTY TRIPLE A

Suitable for all types of cassette players including auto-reverse, the Milty Triple A wipes clean single/dual capstans and pinch rollers with a non-abrasive cleaning action.

MILTY TRIPLE A £6.50

MILTY MAGNET IX

The Milty Magnet IX comes complete with battery. It requires approx one second to de-magnetise the heads removing magnetic charge build up. Recommended after every 30 hours of playing time.

MILTY MAGNET IX £10.50

HI-FI WORLD SPECIAL AUDIO ACCESSORIES ORDER FORM

Please send me:

- Audio Technica CD Lens cleaner.....£16.25 each
- Audio Technica Green CD Ring Stabilizers.....£6.50 (Pack of 5)
- Audio Technica Record Cleaning System.....£10.50
- Automatic CD Cleaner.....£21.95
- Basic Record Cleaning System.....£199.90
- Record Master Record Cleaning System (without adaptor).....£249.90
- 1.5 Fully Automatic Single Sided Record Cleaning System.....£399.00
- Mini-Pro Record Cleaning System.....£599.00
- Bug Audio Biasbug.....£59.99
- CD sound swivel.....£49.95
- Garrard 401 Celebration SME IV Tonearm.....£820.00
- Gold plated 4mm plugs.....£8.00 (4)
- Goldring Exstatic Mat.....£7.50
- Goldring Super Exstatic Carbon Fibre Disc Cleaner.....£9.95
- Hi-Fi World Silver Plated Copper Interconnects (1m pair).....£69.95
- Hi-Fi World Dry Stylus Cleaner.....£1.95 per sheet
- Hi-Fi World Solid Silver Interconnects (1m pair).....£139.95
- Kontak cleaning fluid.....£19.00each
- Laserguide.....£14.95
- Michell Gold-Plated Side Entry Banana Plugs (4).....£10.00
- Michell Gold-Plated Speaker Cable Connectors.....£10.00
- Michell Gold-Plated Sure-Loc Banana Plugs (4).....£14.95
- Michell Rhodium-Plated Sure-Loc Banana Plugs (4).....£18.95
- Milty Magnet IX.....£10.50
- Milty Triple A.....£6.50
- Nagaoka Anti-static record sleeves.....£8.15 (50)
- Nitty Gritty Record Cleaner.....£599.00
- ON Stylus Cleaning Kit.....£2.50
- Pixall MkII Record Cleaner.....£10.75 each
- Pixall refill roller.....£2.75each
- Record storage cube.....£45.00 each
- Screened Mains Cable With 4-Way Block (1m).....£31.95
- Screened Mains Cable With Fig 8 Plug (1m).....£15.75
- Screened Mains Cable With IEC Plug (1m).....£19.20

Prices are exclusive of postage & packing, please add £1.00 for postage in the UK and £2.00 for postage overseas. With the exception of the Record Cleaning Systems which are £4.00 UK and £10.00 overseas.

8/94

Please allow 28 days for delivery

Books

- Electrostatic Speaker Design & Construction.....£19.95 + £2.00 p&p
- The Williamson Amplifier.....£9.95 + £1.00 p&p
- Mullard Circuits for Audio Amplifiers.....£13.95 + £2.00 p&p
- The Loudspeaker Design Cookbook.....£23.75 + £2.00 p&p
- The Art of Electronics.....£35.00 + £4.00 p&p
- The Art of Linear Electronics.....£16.95 + £2.00 p&p
- Audio & Hi-Fi Handbook.....£40.00 + £4.00 p&p
- Loudspeakers: The Why & How.....£10.95 + £1.00 p&p

All prices are exclusive of postage & packing. For U.K. and Europe please see above. For 10 or more books p&p is free. Outside Europe please contact us for rates.

I enclose cheque/PO for £.....made payable to **World Audio Publishing Ltd.**

I wish to pay by Visa/Access, please debit my account no:

--	--	--	--	--	--	--	--	--	--	--	--	--	--	--	--	--	--	--	--	--

Expiry date:

--	--	--	--

Signature:.....

Name.....

Delivery Address.....

.....

.....

N.B. If delivery address is different to the credit card holder's address please supply both.

Tel:.....

Please send completed order form together with your cheque/PO to:

HI-FI WORLD,
64 Castellain Road,
Maida Vale,
London W9 1EX.



Credit Card Orders
Telephone 071 - 266 0461
24 hour Mail Order Answerphone

Hi-Fi World WORLD LIBRARY

**ELECTROSTATIC
LOUDSPEAKER DESIGN AND
CONSTRUCTION, by Ronald
Wagner. £19.95**

This book takes you step by step through the design and construction of a full range electrostatic loudspeaker, including the basic operating principles behind electrostatics. Whether you intend to build your own electrostatic, repair and restore a vintage electrostatic or are just interested in the principles behind electrostatics, this book is a must.

The author takes you deep into his design decisions and offers practical advice on how to build the amplifier and set it up for best performance.

principles through to full design exercises and practical circuits.

**LOUDSPEAKERS: THE WHY
AND HOW OF GOOD
REPRODUCTION, by G. A.
Briggs. £10.95**

A popular and easy to understand book on building loudspeakers, using empirical techniques that pre-date computer analysis. A fine grounding, written by a manufacturer with first hand experience - recommended for beginners.

**THE LOUDSPEAKER
DESIGN COOKBOOK,
by Vance Dickason.
£23.75**

This best selling book in the field of loudspeakers offers good, up-to-date practical design information for the home constructor. Like today's manufacturers it uses modern Thiele Small theory and parameters.

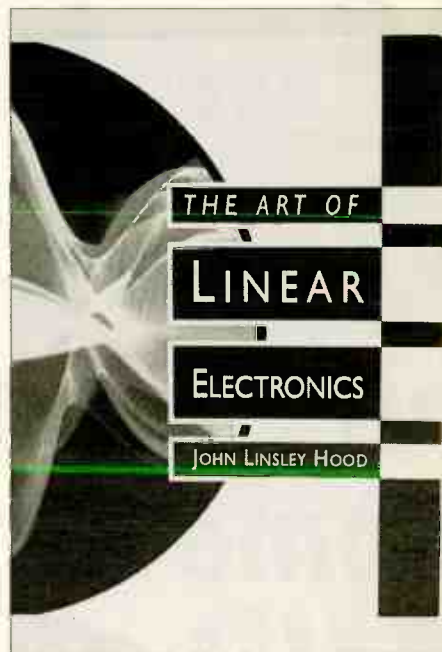

THE ART OF
LINEAR
ELECTRONICS
JOHN LINSLEY HOOD

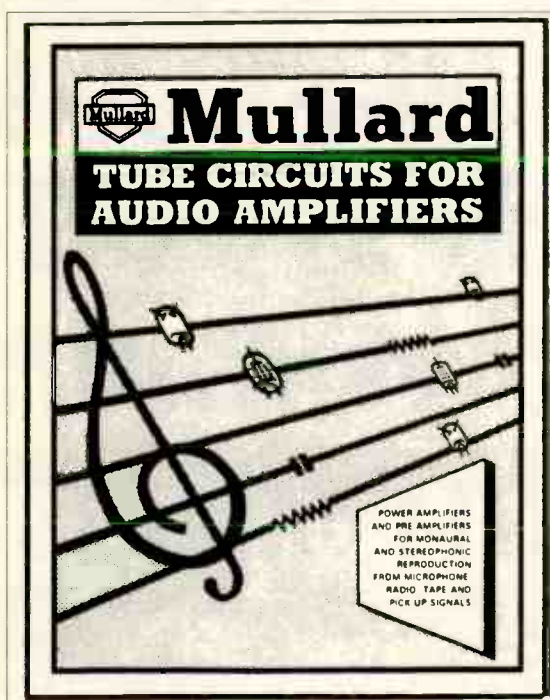

**MULLARD TUBE CIRCUITS
FOR AUDIO AMPLIFIERS.
£13.95**

First published in 1959 by Mullard, this book includes full designs for eleven power and control amplifiers, including the 5-20, using valves. This book begins with a four-chapter tutorial on getting the best sound from valve amplifiers.

**THE ART OF LINEAR
ELECTRONICS, by J. Linsley-
Hood. £16.95**

Concentrates specifically on analogue electronics for audio and goes into detail on obscure topics like the drawbacks of feedback, as well as its advantages. Covers mainly solid state but also includes valves. A must for serious enthusiasts and budding designers.

**THE WILLIAMSON AMPLIFIER,
by D. T. N. Williamson. £9.95**

In April 1947, Williamson's valve power amplifier become an overnight success.

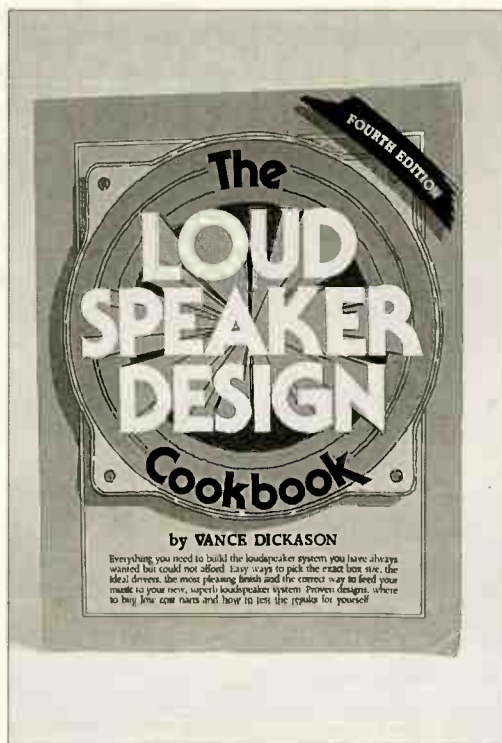

**THE ART OF ELECTRONICS,
by P. Horowitz and W. Hill.
£35**

The definitive electronics book. The Art of Electronics is an ideal book for the beginner through to the engineer. Written in easy to understand English, each chapter takes you from basic first

**AUDIO AND HI-FI
HANDBOOK,
edited by I. R.
Sinclair. £40.00**

The Audio and Hi-Fi Handbook is written by some of the best known designers and spokespeople of the audio industry. It offers an insight into every area of audio, from sound waves and acoustics, through to car hi-fi.

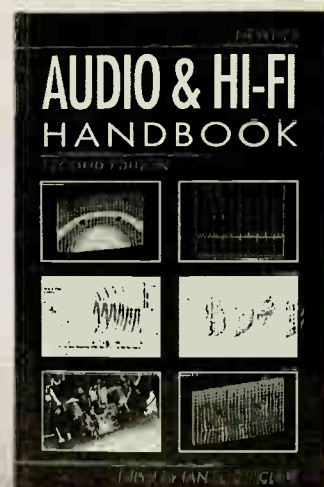

Try me & see **For the very best** **DEALS for 1994!**

**on any current Hi-Fi, A/V,
Home Cinema unit or VCR -
AND all Award Winners**

AMAZING PRICES GUARANTEED

***PHONE NOW - you'll get first-class
service, savings and support.***

- ▶ Budget, Regular and Esoteric Equipment.
- ▶ Insured Overnight Delivery, anywhere in the U.K.
- ▶ Major Credit Cards, Switch/Connect accepted.
- ▶ All goods carry comprehensive Warranty.
- ▶ Goods under Warranty collected and delivered FREE.
- ▶ Extended Warranties up to 5 years available.

*You can always buy from TMS with the complete confidence that we will never let you down.
We ever put our customers first and constantly upgrade and update our systems in order to improve our service.*

081-563 0003
Fax 081-563 0300

**Try Me & See Ltd,
5 Rocks Lane, Barnes,
London SW13 0DB**



readers' queries

CURING CRACKLES

Thanks for your excellent mag. Unfortunately I came across it about a year too late, at the end of a highly traumatic upgrade, in the course of which I wasted a lot of time and considerable amounts of money dem-ing and buying gear which never quite did what the articles I had read said that it ought to. I could write a book about the clangers I committed . . .

Older, wiser, and considerably emptier of pocket, I am now the (almost) totally contented owner of an all-Quad set-up (67 CD player, 34/606 pre/power amplifiers, and ESL-63 electrostatic speakers). I do a lot of listening for the purposes of

Write in with your problems to Hi-Fi World, 64 Castellain Road, Maida Vale London W9 1EX. Our panel of experts will endeavour to solve them or at least offer some practical advice

reviewing discs and I find the Quad sound less fatiguing yet at the same time very natural and involving. For my own particular circumstances it is virtually ideal.

Nonetheless, I am hoping

you can help me make it even better. First, a small, but irritating problem I have noticed with one of the electrostatics. Very occasionally, for no obvious reason, a crackly noise can be heard from just above the base unit of speaker. It sounds a bit like interference on an old style wireless and although it never lasts for long, it is loud enough to be distracting. Is there something seriously faulty?

Second, cables. At present I have Chord Company interconnects (left over from previous "upgrading" disasters) between the CD player and the amplifiers. They seem OK, but could they be improved on? The speaker cable is Audioquest Indigo Blue (again a legacy from previous equipment). Is this getting the best from the electrostatics? I listen exclusively to classical recordings.

Finally, a query about future purchases. I would like to add two further items to my system. One is a tuner. Is there really much difference (apart from styling) between Quad's two models, the FM4 and the 66FM? If I end up buying one of these, what kind of aerial will I need and roughly how much will it cost? I will be listening mainly

to Radios 3 and 4. Are there other tuners worth investigating for my current set-up?

The second item I want to add is a turntable. I no longer buy LPs but I have a large collection of them which I want to start re-playing. Which turntable models should I be looking at? The budget will be the minimum required for a turntable which will do reasonable justice to the other components in the system. Any advice you can give me on this will be much appreciated - I am keen to avoid another financial disaster of Polly Peck proportions.

Thanks for the excellent reviews - I find them clear, objective, lively, constructively critical, and informative about how equipment actually sounds with particular types of music. That is really what is needed - if only I had realised it at the time. . .

**T.B. Blain Esq.
Bingley,
Bradford.**

A crackling noise, huh? If it came through both speakers, the likely culprit would be a badly-suppressed fridge or freezer

Continued on page 105...



Quad 66FM - for pure enjoyment from radio.

CREATIVE AUDIO

9 DOGPOLE, SHIREWSBURY, SHROPSHIRE. Fax: (0743)271010 Tel: (0743)241924 (Closed Mondays)



Times change...values don't

In this topsy turvy world, it's comforting to know that one of the great Hi-fi truths remains unchanged - if you want a superb sounding system, you need to start with a quality source.

Over the past 20 years Rega have sold more than 300,000 turntables and established the Planar 3 as an all time classic. The 1994 Regas, complete with new matching cartridges, are better than ever, and still represent an excellent investment for any vinyl lover.

On the CD front, it is the Arcam Alpha which has quickly established itself as the digital "equivalent" of the Rega. Like the Planar 3, it allows the true musical nature of any performance to shine through, giving an "enjoyability factor" normally associated with much higher priced equipment.

The Rega and Arcam are milestone products, they set the standards by which future value judgments on upgrading can be made.

Ring us now for a free *CREATIVE AUDIO* information pack

Authorised retailer for:

ARCAM • AUDIOLAB • CELESTION • CYRUS • DENON • EPOS • KEF • MERIDIAN
MISSION • NAIM • QUAD • REGA • ROKSAN • ROTEL • RUARK • SOUND ORGANISATION
TRIPODS

.... Continued from page 103

on the ring main, something with which I am cursed myself. However, the sound you mention is a discharge from one panel. Quad told us that if purchased new, the speaker should be returned to the dealer to be checked. Whilst a faint rustling sound is acceptable, especially on damp days, a loud crackle is not. If the speaker was bought second-hand, then contact Quad's service Dept (Tel: 0480-52561).

Now, cables. It's always seemed to me that the '63s are affected less by cables than moving-coil speakers, but the very high-purity copper stuff seems to suit them. Philips Classical use very pricey van den Hul, for example. But save up for the tuner first.

Which tuner? The FM4 is still a broadcast monitor; I have one and at the price it really is hard to beat. But yes, the 66FM is subtly different. It's less coolly calculating, a spot more vivid and fuller in tone. A couple of American magazines prefer it to the FM4, which they say is 'colored on voice'. That's news to me... I tend to listen to my FM4 critically, with an ear to broadcast quality; for pure enjoyment I'd probably choose the 66FM.

The turntable, too, should be the best you can afford. There's not a lot wrong with the Quad's disc board. Start with listening to one of the Pro-ject models, good value since some come with cartridges like the excellent MC15 which is thrown in with the £435 Pro-ject 6.1. Otherwise, there is obviously the Rega Planar 3, whose arm will carry (I've just done it) a superb cartridge like the Ortofon MC20 Supreme. Or a Gyrodec, with the same arm, or even better an SME. (My upstairs neighbour



Ortofon SPK 300, good cable for transparent systems.

uses one feeding a Quad 34.) Alternatively, still thinking in terms of long-term reliability, the Thorens 'UK' range is also worth looking at. **EB**

It's a pity you should find equipment reviews misleading, which is perhaps an indictment upon the magazines they came from. That Quad don't often get recommended is part of the same problem, one of limited outlook. There's been far too much concentration on some forms of musical presentation to the exclusion of all others. Reviewers should, I believe, devote more effort to describing the sound of a product or system rather than making specious conclusions about what is 'right'. One man's meat is another man's poison, especially in hi-fi.

Mags are best used for initial guidance (fingers crossed on accuracy and ability, especially when there's no measurement), dealers for final selection of items that suit your tastes and requirements. That's

why we always implore readers to go to a dealer and listen before buying.

Bradford sits on the river Ouse and is surrounded by the Yorkshire Dales, making reception difficult. Consequently, although Holme Moss transmitter (250kW) sits just 20 miles due South, there are many relays in the area. Precisely which one you need to use depends upon your exact location. It is likely to be Beechcroft Hill (Leeds) North East of Bradford. The only way to be sure is to use a local aerial erector, although the aerials around you may give some idea of what is needed. With luck, you may need only a few elements. All tuners need 1mV or more for optimum sound quality, but much over 10mV threatens overload. **NK**

I've been using '63s for over a year now and, like you, use them for reviewing. The cable I've found works best is Ortofon's SPK300. This is a very high purity copper cable and I find it gives the least coloured sound of any

cables I've tried. It is a touch dry in the bass, but this is no bad thing with the Quads which have a natural bloom in this area anyway. For interconnects I'd go for a silver cable. I use vdH carbon, but these are expensive (£200) and in an all-Quad system may soften the sound a little too far. Silver interconnects retain the sweetness of carbon, but have a brighter character and sharper focus which I think you'd find desirable in your system. Try Campaign Audio Design for reasonably priced silver interconnects. **DB**

STUNNERS & CRAP

My present system consists of Rotel 965BX Discrete CD player, Ion Obelisk 100 amp. Mission 751 speakers and cable is Audioquest F14. My room size is 11ft x 16.5ft.

The sound from my system is unbearable; it is steely, mechanical and uninvolved. The mid is too forceful, the treble is shut in and the little bass available is soft. The sound is aggressive

Continued on page 107... ▶▶



Announcing . . . the
Elektra Integrated &
Eos Power Amplifiers

ELEKTRA INTEGRATED £999
EOS POWER AMP £899
TITAN MAINS FILTER £125
SILVER INTERCONNECT AND DIGITAL
CABLES FROM £75
SILVER SPEAKER CABLES FROM £25 per m

Arion
ACOUSTICS

MAKE THE LEAP
FROM AUDIO TO
. . . REALITY

Worldwide sales agents

KRONOS DISTRIBUTION

35 Farlough Road • Newmills

Dungannon • N. Ireland

Tel. 0868 748632

Fax. 0868 748281

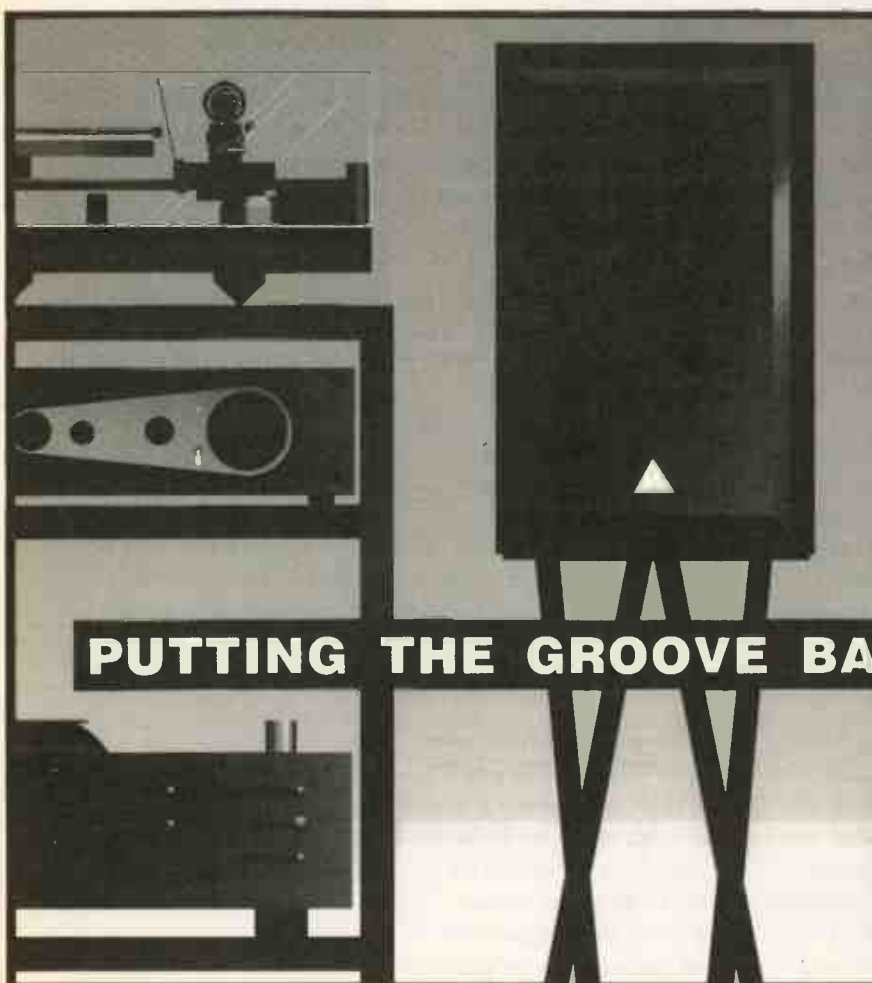

KRONOS

Extraordinary hi-fi for ordinary people.

That would sum up our approach to how we choose the products that we import and distribute.

Pro-ject turntables. *Audiomeca* analogue and digital disc players. *Triangle* amps and speakers. *Lieder* cables. *YBA* and *Arion* amplifiers.

Style, character, top class performance and value for money: another way to sum

PUTTING THE GROOVE BACK INTO MUSIC

For more information, contact

Kronos on: 08687-48632

.... Continued from page 105

due to the over-projecting mid-band. Solos, be it voice or instrument, hit you in the face. It is very irritating.

I want a lively, laid back sound with good staging and imaging. I want presence, something to come home to. I listen to jazz, country, Dire Straights and pop or orchestral. I can spend only £350 on each component. Can I change the drive units of my speaker to get a better sound? If so please recommend some. I like the look of the 751s. Do I need to change any of my components as well?

Your magazine has whetted my appetite for valve amps, and I hope to investigate some when money becomes available. Please keep up the good work and do not be tempted to follow the line of other hi-fi magazines who tend to please advertisers and do battle amongst each other; one house calls a product a stunner, another calls it crap. I hope most reviewers will be bold enough to tell manufacturers where they have gone wrong, like you do, so they can correct products and help the course of hi-fi in general. More grease to your elbow.

**Joe Hagan
Thornton Heath,
Surrey.**

Your system sounds dire, but how do you know and how come you chose it in the first place? Does a friend have a better system you have just heard? I presume you didn't go into a shop and say "I want a system I hate!" It would have been useful to give us a little more to go on, since I don't quite understand how such a situation arose and I have a suspicion that if I did, then it might help.

If your system is so bad,

it sounds like you need to throw it all out and start again. Or maybe you are playing very loud and running into gross overload, since the Ion isn't very powerful. And perhaps your room is small, with hard walls, ceiling and floor, from which you are getting a lot of reflections. This will help make matters worse by contributing messy treble.

The Missions do throw vocals out of the boxes; we like to say they project well. To date, however, I've considered this an attribute. You cannot simply replace the drive units, it's not that simple.

A (good) valve amplifier will give you a much more easy going, fluid sound. They



The EAR834 integrated valve amplifier has a sweet and clear sound.

are superb in resolving timbral colour, restoring character to instruments and vocalists. But on your budget there aren't so many we could recommend, except for low powered vintage designs. Try and listen to an Audio Innovations Series 800 (soft and warm) or an EAR834 Integrated (sweet and clear).

If you do not play loud, then try a good condition Leak TL12+. Another very good proposition might be the Aura VA-50 solid-state

amplifier. This has many valve-like qualities and, I was assured by a dealer recently, sells very well on demonstration. **NK**

PLAYING 78s

I am looking for a turntable to play a collection of old 78s. The only new turntable that I have been able to find that will play them is the Dual CS750-1 and this is unfortunately too expensive to justify the amount of use it will receive. I was therefore considering buying a reasonable quality second-hand turntable.

However, I have no idea which makes and models had the facility to play 78s and was wondering if you could suggest a few names that I should look

facility that will fit all Project turntables. It is simply a different drive wheel which when swapped with the original allows 33 and 78 speeds instead of the standard 33 and 45. It should be available at £10 over the standard price of a Project turntable. These range from the 0.5 model at £145 up to the 6.1 at £435. All come with high quality Ortofon cartridges fitted. For more information from Ortofon - tel: 0753 889949, or write to: Ortofon (UK) Ltd, Chiltern Hill, Chalfont St. Peter, Bucks. SL9 9UG.

DB

Garrard 301s and 401s also have 78rpm and Goldring (tel: 0284-701101) make a cartridge with a stylus suitable for 78s. The Diamond Stylus Co. in Wales (tel: 0492-860881) can also help. **NK**

SHARP RIBBON

My system comprises Pink Triangle Export GTI, SME IV tone-arm, Roksan Corus Black cartridge, Heybrook Signature pre-amp, power amp and power supply, Heybrook Sextet speakers, Quad QLSCR4 speaker cable, Heybrook blue interconnect and Target tables.

The problem is, I find the overall sound sharp and bright and tiring to listen to. I realise the Sextets are very revealing and therefore feel that maybe another cartridge is needed as the Corus Black is quite bright. I am considering the Denon DL304 MC cartridge.

Am I on the right track? I have sensitive hearing and am averse to a sound that is hard and sharp. I hope you can help me out, so I can resume listening to my records again.

**Mr D. Morris
Blackpool,
Lancs.**

out for when searching through the Classified Ads. If you could recommend a dealer in my area who might be able to assist me in either purchasing or servicing such a turntable I would be eternally grateful.

Finally, any advice on a cartridge suitable for playing 78s would be most welcome. Many thanks in anticipation.

**David Wright
Luton,
Beds.**

You're in luck. Ortofon have just announced a 78rpm

Continued on page 109....



FREE Audio Catalogue

**That Will Change
The Way You Buy Hifi**

**Inside the new RDL
catalogue you'll discover:**

- The secret to picking the right speakers.
- Why your home is the only place to test audio equipment.
- How to get more audio for your money.
- How to buy home theatre systems.
- Why the reviewers say RDL offers superior audio equipment at unbelievably low prices.



Buying from RDL is easy and risk free with our **100%** "no strings attached" money back guarantee.

Roy Allison, President and Chief Designer of RDL Acoustics has put together two new, superb ranges of speakers to fit every situation at prices well below normal shop retails.

FREE
32 pg.
AUDIO
catalogue

Order your free catalogue, call:

0484 603333

or fax on 0484 607774

RDL
ACOUSTICS

20 Cleveland Way, Shelley
Huddersfield, HD8 8NQ

Can I try it at home?

YES!

To arrange a home demonstration (with no obligation) or just for friendly chat ring
0257-426100 anytime

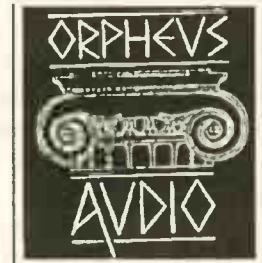

ARION ACOUSTICS • AUDIOMECA
(FRANCE) • AUDIO SYNTHESIS •
AUDIO VALVE AMPLIFICATION
(GERMANY) • KINSHAW • LIEDER •
ORTOFON •
PRO-JECT • TEAC • TRIANGLE •
YBA (FRANCE)
and other selected brands

LEONARD BOOTH



**WHY WAIT A LIFETIME
BEFORE YOU SEE & HEAR
..... AND BUY
YOUR QUAD EQUIPMENT
CALL IN NOW FOR YOUR
IMMEDIATE DEMONSTRATION**

**35 SOUTH STREET
EASTBOURNE
0323 731755**

.... Continued from page 107

The Tonigen ribbon tweeter of the Heybrook Sextets needs some getting used to and it could well be described as hard and sharp. That's what I first thought about this speaker, like many others. Later I realised

so brutally forthright, it will illuminate peaky treble from a cartridge and, as you correctly suspect, an alternative to the Corus Black would be preferable. A Denon DL304 would improve matters, but whether it would improve them enough is open to

academic point of view, if I was to make a change, would any one of the following speaker types theoretically give me better overall results in my set up?

Large Electrostatics (e.g. Quad's ESL 63); large multi-unit box enclosures (reflex port/sealed/transmission line); high quality mini monitors (AEIs, or ProAc Response One S, or ATC SCM 10s) together with a sub-woofer that works (e.g. REL Stadium).

**A.G. Lefebure
Port Louis,
Mauritius.**

Any change to your current system would bring about a complete change in presentation. Big IMFs were designed to drive large rooms (18ft or longer) properly at low frequencies and there's little to touch them for sheer bass depth and power. Their designer was John Wright, who nowadays runs TDL. A new TDL Reference is due out soon, which we will be reviewing, and this is the

natural successor to your IMF Reference MkIVs. I'd expect the same easy going, well integrated, smooth sound. John relies on a lifetime's experience in speaker design and manufacture, copious technical work and measurement, cabinet work that would make most simple box builders blanch and much final listening in real rooms. I've got a lot of respect for the final result.

Quads would need to go up on stands and be

partnered with a subwoofer before they start to approach the wide range nature of the IMFs. I cannot see much benefit in going to box-construction mini-monitors with subwoofers, other than saving room, a superfluous need in a dedicated listening room I imagine. **NK**

MISSION MAN

I have eagerly awaited your review of the Mission Cyrus III amplifier and PSX-R which I purchased in December 1993 and I wholeheartedly agree with Robert Wilson's findings in your April Issue.

I wish to upgrade my CD. The other parts of my system consist of a pair of Mission 753 loudspeakers, Audioquest F-14 cable, Technics SL990 CD player (which was Technics flagship CD some years ago). Also, I have just purchased a Mission FM7 tuner with which I am very pleased.



The Linn Klyde has smooth sound which may tame bright loudspeakers.

that in fact the resolution of high frequency information was exceptional, a well known strength of ribbon tweeters.

I subsequently got to grips with Tonigen when developing our KLS1 loudspeaker, our test equipment showing it possesses a ruler flat response from 7kHz to 20kHz, with no roll-down whatsoever. You can retain its strengths, but moderate its output by simply wiring a 1µF capacitor (Solen polypropylene from Falcon on 0508-578272) in series with a 4Ω resistor (3W) across them. This rolls down upper treble gently (-1dB or so at 20kHz).

Because the Tonigen is

question. An interesting alternative would be the Linn Klyde, providing this is not priced above what you were hoping to spend. **NK**

IMF IN MAURITIUS

My system consists of: Meridian 506 CD player, Passion volume controller, Meridian 605 monoblock power amplifiers and IMF Reference MK IV transmission line speakers. I have a large dedicated listening room with good acoustics, and my musical taste is varied, although I prefer the classical repertoire.

Although I am quite satisfied with the resulting sound, purely from an



The Cyrus III and FM7 - impressive sound for the money.

I recently borrowed from Nottingham Hi-Fi a Marantz CD10 player for a period of one week. However, after

Continued on page 111... ▶▶

THE MIDLANDS FIRST CHOICE FOR REAL HI-FI HI-FI EXCELLENCE

YOU ARE CORDIALLY INVITED TO OUR
AUTUMN SEASON OF MUSICAL EVENINGS.



Oct 5th Arcam
Oct 12th Meridian
Oct 19th Home Cinema
Denon-Pioneer-Canon
Oct 26th Audiolab

Nov 2nd Bang & Olufsen
Nov 9th Yamaha
Nov 16th Rega
Nov 23rd Mission Cyrus
Nov 30th Quad

Refreshments and Wine Available. Evenings Start at 7.00pm.

Tickets are Limited. For Information on These Evenings Please Telephone

The Best Selection of Hi-Fi and Home Cinema from the Worlds Best Hi-Fi Manufacturers.

Audiolab-Audio Alchemy-Aura-Arcam-Audio Quest-Alphason-Apollo-Bang & Olufsen-Bose-Castle-Canon-Cable Talk-Celestion-Creek
Chord-Cyrus-Denon-Dual-Foundation-Heybrook-Kef Reference-JPW-Jamo-Laser Disc-Marantz-Meridian-Monitor Audio-Mission
Michell Gyrodek-Monster Cable-Musical Fidelity-Nakamichi-NAD-Panasonic-Pioneer-Polk Audio-Quad-REL-Rega-Rogers-Rotel
Royd-Sennheiser-Systemdek-Target-Technics-Tripod-Tannoy-Thorens-TDL-Van Den Hul-Wessex-Yamaha and Home Theatre
and Much Much More in Store on 3 Floors with 3 Dedicated Demonstration Rooms of the very Best Hi-Fi

TRUCK CARRIAGE,
UK MAIL ORDER,
EXPORT SERVICE AVAILABLE,
PART EXCHANGE SERVICE,
2 YEAR FULL GUARANTEES,
FULLY EQUIPPED,
SERVICE FACILITIES,
5 YEAR EXTENDED GUARANTEES

BECAUSE PEOPLE LIKE MUSIC FROM
FRANK HARVEY.

163 MEDIEVAL SPON STREET,
COVENTRY CV1 3BB,
TEL 0203 525200 FAX 0203 631403.

INTEREST FREE CREDIT ON
SELECTED PRODUCTS
(DETAILS ON REQUEST)
APR 0%
FREE INSTALLATION AND
DELIVERY SERVICE
OPEN MONDAY TO SATURDAY
9.30 TILL 5.30.



**THE PAST &
THE PRESENT**

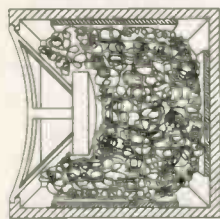

Inside a Typical Cabinet

**LISTEN TO
THE FUTURE**

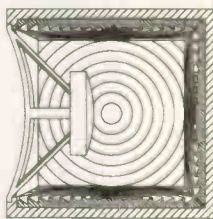

Deflex Panels Fitted

**GET THE MUSIC OUT OF YOUR SYSTEM, AND LET
YOUR SPEAKERS BREATHE!**

Replaces the existing damping material inside your loudspeakers – quick and easy to fit. Available for any loudspeaker.

Deflex acoustic panels have excellent performance characteristics. The polymer is specially formulated to absorb shock and vibration, thus minimising cabinet resonances.

The surface emulation has been carefully designed to eliminate standing waves

The energy inside the enclosure is controlled – **NOT ABSORBED**, as in other cabinets.

Independent tests on MLSSA show energy gains over 50%.

DEFLEX® A.P.T. ACOUSTIC PANEL TECHNOLOGY

PURPOSELY DESIGNED HI-TECH SPEAKER LININGS
NOT BY-PRODUCTS FROM ANY OTHER INDUSTRY

"NEW APPROACH STUNS THE EXPERTS"

"BIGGEST BREAK-THROUGH IN 20 YEARS"

"RESULTS NEVER ACHIEVED BEFORE"

**"THE MUSIC IS FASTER, BRIGHTER,
CLEANER, WITH DEEP, CONTROLLED BASS"**

U.K. DISTRIBUTOR

**The
SPEAKER
Company**

UNIT 9,
WATERSIDE MILL,
WATERSIDE,
MACCLESFIELD, CHESHIRE
SK11 7HG
Phone 0625 500507

CURRENT PRICES

Standard Panels
@ £7.95 each

Sub-woofer Panels
@ £11.95 each

Adhesive from
£3.50 (200ml)



.... Continued from page 109

playing a whole range of CDs from Meatloaf, REM, Kd Lang, Fairground Attraction and numerous classical CDs, I could not notice any significant difference.

Could you please recommend any CD transport/DAC combinations which would allow me to get the best from my set-up. I have thought about an Arcam Black Box 50 DAC and Delta 250 transport, Micro Mega T-drive and DAC. What about a Mission transport and DAC?

Unfortunately, my selection is somewhat restricted by the fact that I do not want a coloured fascia - like the Teac P/D700.

Chris Adkin
Kirkby-in-Ashfield,
Notts.

We use an Arcam Delta 250 transport sync-locked to the Black Box 50 in our In-house listening room at the moment. It has a very engaging sound that seems unusually detailed in comparison to many other CD players costing up to twice the price. It does also have a little artificial brightness or enhancement in the upper mid/lower treble, which is an aurally pleasing colouration with most speakers, but can become annoying with others. I'd suggest having a listen to this first as it represents such good value for money.

Another good combination, which again uses sync-locking, is DPA Digital's T1 transport and Little Bit II convertor. This again has a very detailed sound, but I find it has slightly better focus and a smoother treble than the Arcam, but try both in your own system to see which suits its character and your tastes best. **DB**

I have reservations about the Arcam Black Box 50: although impressively detailed and engaging, it also sounds a

little bright and edgy on a variety of speakers. Through our latest kit speaker, **KLS3**, whose hi-tech Audax carbon fibre drive units are unusually revealing, it comes across as over-sharp. The distortion it produces can, I believe, be heard, yet at the same time it does possess some great properties, including the sort of pin-sharp timing and treble purity that sync-locking provides.

I'd recommend you audition a Pink Triangle Ordinal, a convertor with an extremely smooth and civilised presentation, yet one that isn't bland either. Also watch out for the new DPA series of convertors. **NK**

HOTCH POTCH

I'm looking at changing most, or all, of my system over the next 12 months, it having been assembled in a rather hotch-potch fashion in the last decade, and I'm confused about which components are going to be best both sound and compatibility-wise.

I have very varied musical interests enjoying instrumental, easy-listening, some classical but also rock. I listen mainly to CD but enjoy a modest vinyl collection.

My current system is: Sansui SR 222 Mk 4 turntable, Technics SLPJ20 CD, McLaren 601/701 pre/power amp (a New Zealand brand), Denon DRM 510 tape and B&W DM100i speakers with directional Mission cables

The amp seems to have excessive background hiss which persists despite modifications. At moderate/higher volume levels the bass tends to lose tightness, whilst the treble often becomes shrill and loses definition.

The first step is to upgrade to a Marantz CD63, or similar. The amp would be next and for this I was considering the Audiolab 8000A, Technics SU A900 or the NAD 1000/2100

pre/power combination. Having read recent reviews I wonder if a Marantz PM 44SE or Denon PMA 350II would suffice (allowing the difference to be used elsewhere) or would these two be limiting to the performance of the system being set up?

I would like to upgrade in one step to a turntable of reasonable quality that would suit future upgrades in amp and speaker. My choice would be a Systemdek IIX 900 with an RB300 arm and either a Roksan Chorus Blue



The Systemdek IIX 900 - a fine vinyl source.

or Goldring 1012GX.

As for speakers, I was budgeting £250 - £350 (more if saving on the amp or finances permit). I've heard good things about Rega Kyte, Heybrook and Mission 780 SE. Would a pair of Royds or TDLs suit such a system?

I would really appreciate any comments the team might have regarding the proposed components or any alternative recommendations.

Mark Lever
Farnborough,
Hants.

PS: Could you tell me where I can get a copy of 'A Meeting by the River' by Ry

Cooder & V M Bhatt that you reviewed in August '93 - none of the local shops seem to have the faintest idea where to look.

No amplifier should audibly hiss these days, modern solid state devices are so quiet. The shrillness sounds very much like crossover distortion, which again should not be an audible problem in any competent design. Consequently, I'd look to change the amplifier first. My preferences would be for the Denon PMA350-II

or Audiolab 8000A, the latter having the better disc stage by far. If you want the best from LP, don't forget to audition this amp. via its disc stage as well as through CD in any shop-based comparisons.

A Systemdek IIX 900 turntable with Rega RB300 arm fitted with a Goldring 1012GX cartridge would be a fine choice for your purposes.

Speaker choice depends upon tastes, budget and room size, about which you say little. Generalising, I'd suggest you listen to TDL, Castle, Mission or the new Celestion 5.

Continued on page 113....

THE RECORD SHOP

66 FIFE ROAD
KINGSTON-UPON-THAMES
SURREY
KT1 1SP
TEL: 081-546 3880
FAX: 0372 360996
EST. 1968

SPECIALIST IN NEW VINYL RECORDS

- CHESS BLUES ALBUMS (US VINYL) - £8.49 EACH
 MUDDY WATERS - 'ROLLING STONE'
 BUDDY GUY - 'CHESS MASTERS'
 MUDDY WATERS - 'RARE AND UNISSUED'
 JOHN LEE HOOKER - 'PLAYS & SINGS THE BLUES'
 SONNY BOY WILLIAMSON - 'DOWN & OUT BLUES'
 JOHN LEE HOOKER - 'REAL FOLK BLUES'
 LITTLE WALTER - 'HATE TO SEE YOU GO'
 AZYMUTH - 'LIGHT AS FEATHER' - £7.49
 JOHN COLTRANE - 'BLUE TRAIN' - £8.95
 KEITH JARRETT - 'ARBOUR ZENNA' - £3.99
 TONY REMY - 'BOOF!' - £10.49
 (1ST GRP VINYL IN 2 YEARS!)
- HERBIE HANCOCK - 'MANCHILD' - £7.49
 MILES DAVIS - 'DOO BOP' - £7.99
 ALAN PARSONS - 'TRY ANYTHING ONCE' - £9.99
 BONNIE RAITT - 'LONGING IN THEIR HEARTS' - £9.95
 DOORS - 'FULL CIRCLE', 'OTHER VOICES' - £7.99 EACH
 JOHN MARTYN - 'APPRENTICE', 'COOLTIDE' - £8.99
 BEATLES - ALL TITLES IN STOCK
 £9.95 EACH, EXCEPT:
 WHITE ALBUM - (2LP) - £11.95
 1962-66 (RED 2LP COMP) - £12.50
 1967-70 (BLUE 2LP COMP) - 12.50
 MAZZY STAR - (1ST ALBUM) - £8.99
 BARBARA STREISAND - 'BACK TO BROADWAY' - £9.99
 GRANT LEE BUFFALO - 'FUZZY' - £9.49
 BEACH BOYS - 'PET SOUNDS' - £5.99
 CROWDED HOUSE - 'WOODFACE' - £5.99
 DANIEL LANOIS - 'FOR THE BEAUTY OF WYMONA' - £12.95
 SANDY DENNY - 'WHO KNOWS WHERE THE TIME GOES'
 (4LP BOX SET +BOOK - £30.95)
- BOB DYLAN 'MORE GREATEST HITS' - £9.95
 (2LP, 2 UNRELEASED TRACKS - HAVEN'T SEEN THIS FOR TWO YEARS AT LEAST!)
- GILL SCOTT HERON'S AMNESIA EXPRESS
 'LIVE IN EUROPE' - 2LP - £8.95
 ANDY SHEPPARD - 'IN CO-MOTION' - £4.99
 BILL BRUFORD - 'MASTER STROKES 78-85' - £4.99
 (FEATURES ALLAN HOLDSWORTH & JEFF BERLIN)
- GEORGE BENSON - 'BEYOND THE BLUE HORIZON' - £5.99
 (US VINYL - CLASSIC CTI WITH RON CARTER & JACK DE JOHNETTE
 HINDU LOVE GODS - £4.99
 (WARRN ZEVON WITH BILL BERRY, PETER BUCK & MIKE MILLS OF R.E.M
 ANGLIQUE KIDJO 'LOGO 30' - £6.95
 MARY COUGHLAN - 'SENTIMENTAL KILLER' - £4.99
 PAUL BRADY - 'TRICK OR TREAT' - £5.99
 ROBERT CRAY - 'I WAS WARNED' - £5.99
 IAN MCNABB - 'TRUTH & BEAUTY' - £6.49(2LP)
 HARRY CONNICK JNR - 'WHEN HARRY MET SALLY' - £6.49
 CHRIS REA - 'ON THE BEACH' - £5.95
 PACO DE LUCIA - 'ZYRYAB' - £6.49
 4 NON-BLONDES - 'BIGGER, BETTER, FASTER, MORE' - £9.95

MAJOR STOCKIST OF ECM, LINN, ORIGINAL JAZZ CLASSICS, BLUE NOTE & ACID JAZZ. WE ARE NOT TIED TO ANY PARTICULAR TYPE OF MUSIC. WE LIKE EVERYTHING ON VINYL. HEAVY TO AMBIENT!

POSTAGE & PACKAGING £2.00 +50P PER ALBUM THEREAFTER WE DON'T SKIMP ON THE PACKING - AND ALL LP'S ARE POSTED WITH POLY-LINED INNER SLEEVES

SO PICK UP THE PHONE AND ASK FOR TIM OR MARTIN (SECOND HAND VINYL ALSO AVAILABLE)

ACCESS/VISA WELCOME

RINGMAT

FOR RECORD LOVERS

First record support to be properly designed

Hear what reviewers say:

"A carefully researched and innovative product which genuinely transforms analogue replay at nominal cost. The string bass was more dynamic, the separation cleaner and, more importantly, the phrasing of the music was more fluid - you heard the vocal line arch and fall." **Christopher Breunig (Hi-Fi News, September '93)**

"I found I preferred the RINGMAT and will carry on using it. The results were wholly positive..." **Jason Kennedy (Hi-Fi Choice, April '93)**

"RINGMAT gave a sharper, cleaner, more solid sound, with better fine detail and clarity. On complex material the improvement in stability and focus was remarkable: easily comparable to an expensive tonearm, cartridge or power supply upgrade... Any drawbacks? None I could detect..." **Jimmy Hughes (Audiophile, October '93)**

"I found the sound of my LPs improved significantly, reminding me of the experience of listening to records on a Goldmund Reference turntable with a van den Hul Grasshopper

cartridge with its nude stylus. All of a sudden, much more of the music,

and the space in

which it was

performed, was

evident. I'm sure

that the legions of

Linn and Rega owners

out there who still play their

LPs will want to make the

modest investment required for a

major improvement in vinyl play."

Andrew Marshall

(Audio Ideas Guide, Winter '94)

Hear what your fellow music lovers say:

"I would agree with everything you claim for this product. The music is more natural, more musical, and with a loss of a certain rawness which persisted, no matter what, beforehand."

Mr. C.R., Northants

"RINGMAT goes on my very short list of things that make differences I care about." **Mr. P.F., Washington D.C.**

"This product must be one of the most cost-effective accessories ever to be offer to music lovers." **Mr. R.A., Norway**
Can RINGMAT really be that good?

Yes, it is, but there is only one way for you to find out - try it yourself. But be warned: if you let your best friend borrow it, you will finish up buying another!

Prices

RINGMAT 200 £25.00

RINGMAT 250 £30.00 RINGMAT 330 £35.00

They can be obtained through good Hi-Fi retailers or on mail order direct from:

RINGMAT DEVELOPMENTS
PO BOX 200 BRENTWOOD ESSEX CM15 8QG

Tel.: 0277 200 210 Fax: 0277 201 225

(p&p additional £2.50 UK, £5.50 outside)

USA: Something Worth Hearing, Rochester, N.Y. tel.: 716 461 1295

TAIWAN: Taifu Electronics Corporation, Taipei. tel.: 8862 341 9137

GERMANY: Fortissimo, Düsseldorf. tel.: 211 482 372

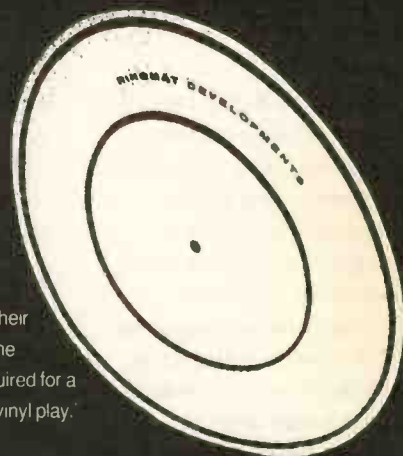

.... Continued from page 111

For CD you'll need better than a Marantz CD63. Try auditioning an Arcam Alpha 5. **NK**

'A Meeting by the River' by Ry Cooder & V M Bhatt is available from our own Mail Order Department; price, including delivery, is £11. **RJ**

CAR BOOT CODA

My system consists of an Audiolab 8000A, Cambridge Audio T50 Tuner, Marantz CD52II, Nakamichi DR3 Cassette deck, Systemdek IIX 900, a pair of KEF Coda IIIs connected to the amp by Linn K20 cable, I also have a recent acquisition of a Philips DCC600 (they are great machines - if only Philips would give the big advertising drive).

I bought the KEFs from a car boot sale after checking them out, and was very pleased when the man was glad to accept £15 for them. Although they sound great I am thinking of changing them for a pair of Rogers LS2a/2s. Do you think that they will be compatible, and will they make my rock music (Prince, Brian

Adam's, ZZ top etc.) sound a bit more punchy and detailed, or do you think the KEFs are more suited to this kind of music?

I would also like to know a little bit about my Coda IIIs. When were they last produced (year), what rating they acquired from your mag, and what I would be expected to pay for them new at that particular time? I would be grateful if you could provide any answers as I have been unable to find any information about them in any old hi-fi magazines.

Also, could you let me know any similar information on the Cambridge Audio T50 tuner.

**N. Redpath
Haverhill,
Suffolk.**

The KEF Coda IIIs, good as they were, are getting a little long in the tooth by today's standards. They were manufactured between 1982 and 1984, before Hi-Fi World began (1991), so we've never reviewed them, their final retail price being £109. The rest of the system you have far outclasses them, and deserves a modern high

quality 'speaker, so I'd find a good dealer and start to audition what's available.

You seem to listen mainly to rock music, in which case try and audition a pair of the £399 RTL3s. These are a monster for the money, having real bottom end bass drive and good kick. Because of their powerful bass, I'd try and get them home for a listen in your own room with your own system - you should be amazed by the difference this speaker will make to your sound.

The Cambridge Audio T50 was made between 1989 and 1992 and is a comparatively modern tuner. Tuners haven't advanced that far over the last few years or so, so unless you listen to a lot of radio, a good aerial should be enough to ensure acceptable sound. If you do feel the need to upgrade, try auditioning the excellent NAD402. Ignore the low price, its performance is equal to many tuners costing £500 or more. **DB**

SHALLOW DEPTH

I am writing to you in the hope that you can give me some guidance as to which

item of equipment I should change to solve my problem.

My system consists of a Michell Gyrodec, Rega RB 300 and Denon DL 304, feeding into a Mission Cyrus 2 and PSX amplifier and then bi-wired with Audioquest Indigo cable into Ruark Templar speakers.

The problem I have is that the system seems dull and lifeless, with very little depth or ambience. I have £700 to £1,000 to correct this, but what should I spend it on? Should I audition a new amplifier or perhaps change the speakers for something more revealing? I have recently borrowed an old A&R Cambridge pre/power combination for a few days, which made some improvement. The bass seemed much deeper, clearer and more controlled, but the sound still lacked some clarity.

All the components are mounted on a dedicated table, and the turntable on a wall shelf. The room is approximately 15ft x 18ft with a large bay window just in front of which the loudspeakers sit.

I hope the information I have provided is adequate and that you can point me in the right direction.

**A. Heavens
Clacton-on-Sea,
Essex.**

We don't understand how your system can sound dull and lifeless, in the light of the items you own. Worn out pickup cartridges can fit this description though; I'd suggest you check out the DL304 very carefully, preferably by substituting a new unit.

Grip, speed and clarity, which is what you may be looking for, can be ably supplied by Naim amplifiers; try for an audition.

By all means listen to other speakers, but we wouldn't classify the Templars as especially dull and lifeless. ProAc Studio 100s may well be suitable. **NK**



Hard not to recommend - the NAD 402 tuner.



AUSTRALIA 613 429 2199
661 8 346 6444



SOUTH AFRICA 333 9735



CANADA 414-691-2584



GERMANY 0208/35977
2961/51640



GREECE 01 8064802



MALAYSIA SINGAPORE



SOUTH AMERICA



U.S.A. 603-831-3433
413-669-7181

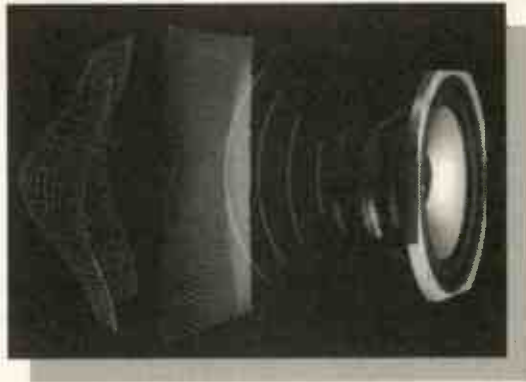

U.K. DISTRIBUTOR (0625) 500507

DEFLEX® acoustic PANELS

"...A marked improvement was obvious from the first few bars of REM's *Automatic for the People* album ..."

"...Vocals took on an air of presence that was stunning compared to what had gone before ..."

"...Rhythm was more definite and seemed to 'glue' the musical experience together ..."

Hi Fi News & Record Review - March 1994

"...The special surface pattern reduces standing waves to cure boxiness and resonance without killing the vitality of the sound ..."

"...expect tighter cleaner bass, crisper articulation, and an increase in liveliness without loss of control ..."

"...The result was sharper imaging, wider dynamics and a more natural sound ..."

Hi-Fi Choice - January 1994

"...Deflex panels seemed to give greater tightness and control, improved internal clarity, and better pitch definition - all without deadening the sound in any way ..."

Audiophile - January 1994

interested?

For further details and a comprehensive information pack - contact:

Spectra Dynamics
(0745) 571600

Studio One

117-119 HAMMERSMITH ROAD
LONDON, W14 0QH.
Tel: 071 371 3037
Fax: 071 371 1790
Mon-Sat 9-7.00



Audio Specialists



Grand Opening

London's newest Hi-Fi Shop

We have been in the trade for 21 years offering excellent service to the HiFi public advice-service and installations to the best of our knowledge. Come and see for yourselves, and enjoy the wonderful world of Audio.

Representative Dealers for:-

Alchemist, Audio Technica, Aura, Alphason, Audio Innovations, Atacama, Boston, B&W, Castle, Denon, Dynavector, Jamo Oriel, Jecklin, JPW, Lyra, Mark Levinson, Michell, Moth, Musical Fidelity, Nakamichi, Ortofon, Pro-ject, S.M.E., Sony, Sequence, Teac, Thorens, Totem, Townshend, and many more.....

Also we include services of the following record cleaning via moth machine at £1.50 per album 78's onto tape.

Exclusive Jazz and Classical and unique Rock vinyl on sale/ CALL US NOW!!

Credit Cards



Open: 10 - 6pm Mon-Sat
10 - 9pm Thursday
World wide tax free export

Welcome
24 hrs. delivery service

071 - 233 0774

ENJOY THE MAGIC OF VALVES

Pure Natural Sound

0%
INTEREST FREE CREDIT
ON SELECTED ITEMS



**Audio Innovation, E.A.R,
Lumley Reference, Tube
Technology, Conrad Johnson,
D.D. Audlo, Hi-Fi World Kit**

We Offer

- 24hrs. delivery services
- Part x-change
- Free three years warranty on selected product
- Home load
- Home installation
- Interest free credit
- We are located very new to Victoria main line underground station. One minute walk & open late 9pm (Thursday)

We have in stock:
Spendor • Quad • Royd • Triangle • KEF
Tannoy • Proac • Castle Speakers
Please ASK for our special offer list

- CD Player From:- Quad • Micromega • Teac • Marantz • Rotel • AMC • Pioneer • Orelle Musical Fidelity
Casette Decks from:- Aiwa • Denon • Sony • Nakamichi • Harman • Marantz
Amps From:- DPA • Orelle • Quad • Albery • Musical Fidelity • Alchemist • John Sheam • Aiwa • Pioneer
Turntables From:- Pink Triangle, Thoren, Alphason, Townsend Rock

DACS from
Pink Triangle • DPA • Kinshaw
Orell • Musical idelity • Teac

HI-FI CONFIDENTIAL LTD

34 Buckingham Palace Road, London SW1W 0RE (Victoria Station) Phone 071 - 233 0774 Fax. 071 - 233 7226

No one was ever sorry that they bought the best!



As audiophiles you demand the best.

Groove Tubes Performance tested valves certainly measure up every time to those demanding standards. Whatever kind of music you prefer, you'll appreciate it better with Groove Tubes. Simply changing to Groove Tubes will create a whole different set of tonal characteristics to your amplifier, and they are used or approved as the ultimate upgrade to any preamplifier or any power amplifier, by many manufacturers.

Hundreds of professional musicians like Bryan Adams, ZZ Top, Tina Turner, Genesis and Chris Rea use Groove Tubes and G.T. Electronics in their stage and recording amplification.

Now we are introducing the Groove Tubes D.75s power amplifier which is a professional 75 watts per channel stereo amplifier currently in use in top recording studios around the world and of course it comes complete with Groove Tubes as standard. *Retail price £1950-00*

and now...



We are pleased to announce an exciting new range of British made valve pre and power amplifiers. Models currently available include:

AMESON-COOPER TWIN 44 MONOBLOCKS

44 watts per channel based on Groove tubes 6L6 valves.

Retail price £1300-00 per pair.

For further information and your nearest stockist contact the Groove Tubes Hotline now.

Telephone: 0902.620156
Fax: 0902.620207

The Groove Tube Centre, Groove Tubes UK, 8 Barn Green, Bradmore, Wolverhampton WV3 7AY England.

DYNAMICS

HIGH END AUDIO BOUGHT/SOLD EXCHANGED

	SALE		LIST
MARK LEVINSON ML7A PREAMP. MINT	2995	S/HAND	£8800
MARK LEVINSON NO26 PHONO BAL. MINT	495	EX/DEMO	£6500
SOTA COSMOS VACUUM PLATTER SME V. MINT	£3,750	S/HAND	£5,300
WELL TEMPERED WTAT TURNTABLE & ARM. MINT	£1,095	EX/DEMO	£1,995
GRAHAM MODEL 1 ARM SPARE ARM TUBE. MINT	£995	S/HAND	£2,350
MERIDIAN 602 TRANSPORT 606 DAC 7 TEST. MINT	£2250	EX/DEMO	£3,100
CAMBRIDGE CD1 CD PLAYER HEAVILY MODIFIED WITH MASSIVE POWER SUPPLY SUPERB	£1,295	S/HAND	PHONE
METAXUS ICARUS INTEGRATED AMPLIFIER CHROME. MINT	£595	EX/DEMO	£895
AUDIO RESEARCH SP15 REVISION A PREAMP BLACK	£3,495	S/HAND	£7,000
AUDIIONOTE M7 SILVER PREAMP V.G.C.	£3,350	S/HAND	£8,000
PINK TRIANGLE PIP 2 MK2 VSHAY MODIFIED PREAMP. MINT	£1,795	S/HAND	£4,500
CONRAD JOHNSON MOTF MC8 PREAMP V.G.C	£895	S/HAND	£2,495
CARY CAD 5500S PREAMP PHONO & PROCESSOR. MINT	£995	EX/DEMO	£2,250
COUNTERPOINT SAIL LINESTAGE & SAS PHONO STAGE GO BLOW YOUR MIND & WALLETT MEGA V.G.C.	£6,995	S/HAND	£12,600
BURMESTER 808 MK3 PREAMP BALANCED. MINT	£3,995	S/HAND	£8,000
AUDIO RESEARCH D70 MK2 POWER AMP. MINT	£895	S/HAND	£1,929
COUNTERPOINT SAIL OTL MONO AMPS V.G.C.	£2,995	S/HAND	£8,000
MARK LEVINSON ML2 REFERENCE MONO POWER AMPS, BALANCED SUPERB V.G.C.	£3,995	S/HAND	£15,000
MARK LEVINSON ML3 POWER AMP. MINT	£3,995	S/HAND	£8,250
NRG A201S POWER AMP BALANCED LATEST SPEC. MINT	£3,495	S/HAND	£6,800
NRG A 401 400 WATT CLASS A MONO POWER HOUSES BALANCED HIGH POWER WITH SEDUCTION V.G.C.			
CONRAD JOHNSON MV75 VALUE POWER AMP. MINT	£5,500	S/HAND	£13,000
OCTAVE RESEARCH OHI POWER AMP V.G.C.	£1,295	S/HAND	£2,500
MERIDIAN D6000 DIGITAL ACTIVE SPEAKERS STUNNING LOOKS AND SOUND TO MATCH. MINT	£1,795	S/HAND	£4,500
ACOUSTIC ENERGY AE3 SPEAKERS & STANDS. MINT	£5,750	EX/DEMO	£7,600
BATH TUB & SPONGES SIMILAR WATTS & PUPPIES WALNUT VERY INTERESTING 3800 V.G.C.	£995	EX/DEMO	£2,300
CELLO AMATI SPEAKERS TWIN MOUNTED PAIR IN OAK ON GRANITE STANDS SUPERB V.G.C.	£2,995	EX/DEMO	PHONE
CANON ESO SPEAKERS & STANDS BLACK MINT	£5,500	S/HAND	£20,000
DYNAUDIO FACETTE SPEAKERS BLACK OR CHERRYWOOD MINT	£250	S/HAND	£400
DYNAUDIO CONSEQUENCE SPEAKERS FLAGSHIP MODEL IN CHERRYWOOD DYNAMIC DRAMA. STUNNING MINT	£1,595	EX/DEMO	£2,619
GALE 401 SPEAKERS & CHROME STANDS, BLACK GOOD	£10,250	EX/DEMO	£15,275
GENESIS 8300 SPEAKERS & STANDS PIANO BLACK. MINT	£395	S/HAND	£1,000
MERIDIAN ARGENT 1 SPEAKERS PIANO BLACK MINT	£1,395	EX/DEMO	£1,895
MERIDIAN ARGENT 2 SPEAKERS ROSEWOOD MINT	£695	NEW	£995
MERIDIAN ARGENT 3 SPEAKERS ROSEWOOD MINT	£575	NEW	£875
PROAC PROSTATIC ELECTROSTATIC SPEAKERS RARE V.G.C.	£995	NEW	£1,495
SNELL A3 SPEAKERS WALNUT V.G.C.	£1,995	S/HAND	PHONE
APOGEE DIVA & DAX TAUPE SPEAKERS MINT	£4,495	S/HAND	£6,995
MARTIN LOGAN MONOLITH SPEAKERS OAK MINT	£6,995	S/HAND	£15,000
METAXUS IRAKLIS MK2 POWER AMP CHROME MINT	£3,995	S/HAND	£8,123
AUDIO RESEARCH D125 KT90 VALVES AMP. MINT	£895	EX/DEMO	£1,500
MUSICAL FIDELITY P270 MK2 POWER AMP. MINT	£2,250	S/HAND	£,4650
APOGEE CALIFORNIA SIGNATURE SPEAKERS GREY MINT	£895	S/HAND	£1,500
SYNTHESIS REFERENCE SPEAKER SYSTEM ASH MINT	£1,995	S/HAND	£3,998
AUDIOPLAN KOWTRAST 2 SPEAKERS ROSEWOOD MINT	£3,995	S/HAND	£8,000
METAXUS CHARISMA PREAMP CHROME MINT	£1,595	S/HAND	£2,800
MARK LEVINSON ML7 PREAMP MINT	£895	EX/DEMO	£1,500
PI HW19 TURNTABLE TRI PLANAR MK3 ARM	£2,495	S/HAND	£5,800
SME IV & V ARMS MINT FROM	£1,995	S/HAND	£4,000
SONOGRAPHIE ATMI AMPLIFIER MINT	£495 TO £3000		
DUNTECH CROWN PRINCE SPEAKERS PIANO BLACK MINT	£1,295	S/HAND	£2,400
EQUATION ZERO SPEAKERS PIANO BLACK MINT	£3,995	S/HAND	£8,500
MERIDIAN 208 CD PLAYER PRE AMP 209 MINT	£695	S/HAND	£1,300
MERIDIAN 200 TRANSPORT 263 DELTA SIGMA MINT	£395	EX/DEMO	£1,290
CRYSTAL REFERENCE MK2 WITH ARTANGENT MINT	£3,495	EX/DEMO	£6,500
MARANTZ LBZ CD PLAYER LTD EDITION BALANCED	£1,595	S/HAND	£3,000
APOGEE DAX CROSSOVER MINT	£195	S/HAND	£4,500
SETA STAR SAPPHIRE 3 ETZ ARM MINT	£1,795	EX/DEMO	£4,000
QUICKSILVER PRE AMP MINT	£1,250	NEW	£1,750
MERIDIAN 601 DSP PRE AMP BALANCED MINT	£1,995	EX/DEMO	£2,750
NESTROVIC NAI VALVE MONO POWER AMPS BALANCED	£2,995	S/HAND	£6,600
CARY 243 VALVE POWER AMP 15 WATT TRIODE MINT	£895	S/HAND	£1,400
CARY 300B VALVE MONO POWER AMPS 40 WATT TRIODE	£2,995	EX/DEMO	£4,800
APOGEE SCINTILLA SPEAKERS GREY 10TH V.G.C.	£895	S/HAND	£1,345
SUMO ARIAS SPEAKERS OAK V.G.C.	£1,495	S/HAND	£2,995
SNELL A2 SPEAKERS WALNUT V.G.C.	£2,495	S/HAND	£4,995

NEW IN THIS MONTH

OXFORD CRYSTAL REFERENCE TURNTABLE BLACK	£1,495	S/HAND	£2,495
AUDIO RESEARCH SP14 PREAMP BLACK MINT	£1,995	S/HAND	£3,300
MUSICAL FIDELITY 3A PREAMP MINT	£225	S/HAND	£400
RESTEK CHALLENGER INTEGRATED AMP. MINT NEW	£799		
RESTEK EXPONENT REFERENCE MONO BALANCED MINT	£7,495	EX/DEMO	£12,000
DIAMOND ACOUSTIC REF 2 SPEAKERS & STANDS OAK MINT	£395	S/HAND	£2,250
B&W ACTIVE 1 SPEAKERS OAK & STANDS VGC	£695	S/HAND	£1,400
BURMESTER 846 LINE PREAMP CHROME BALANCED MINT	£795	S/HAND	£1,650
AUDIO RESEARCH LSI PREAMP SILVER MINT	£995	S/HAND	£1,797
TEAC PI TRANSPORT DI DAC BALANCED MINT	£2,495	S/HAND	£4,500
AUDIO RESEARCH CLASSIC 30 POWER AMP MINT	£1,595	S/HAND	£2,800
MIRAGE MI SPEAKERS PIANO BLACK BIVIRE MINT	£2,995	S/HAND	£5,000
SOUNDLAB DYNASTY HYBRID SPEAKERS WALNUT MINT	£1,395	S/HAND	£4,000
KENWOOD KAV 8500 AV AMP. MINT	£399	S/HAND	£700
ROKSAN DPI CD TRANSPORT MINT.	£795	S/HAND	£1,195
ENLIGHTENED AUDIO DSP1000 DAC MINT.	£595	S/HAND	£1000
CONCORDANT EXHILARANT VALVE PREAMP MINT.	£595	S/HAND	£1000
AUDIO RESEARCH LS2 LINE PREAMP BALANCED MINT.	£1595	S/HAND	£2795
CONRAD JOHNSON PREMIER 3C VALVE PREAMP MINT.	£1995	S/HAND	£3600
CONRAD JOHNSON PREMIER 4C VALVE PREAMP MINT	£1995	S/HAND	£3000
YAMAHA DSP 1000A AV AMP MINT	£595	S/HAND	£1000
CHORD 1200B BALANCED POWER AMP LATEST MINT.	£2295	S/HAND	£3000
DYNACO ST 70 SERIES VALVE POWER AMP MINT.	£695	S/HAND	£1100
REL STENTHOR ACTIVE SUBWOOFER WANG MINT	£695	S/HAND	£1495
MARTIN LOGAN QLSI ELECTROSTAND SPEAKERS VGC.	£1495	S/HAND	£3000
APOGEE DEVITA SIGNATURE & DAX CROSSOVER MINT.	£4995	S/HAND	£10900
APOGEE SCINTILLA SPEAKERS 10" HI GREY GOOD	£995	S/HAND	£5000
LYNX PULSAR PRE & POWER AMPS MINT	£795	S/HAND	£1450
MERIDIAN 602 TRANSPORT 606 DAC MINT	£1595	EX/DEMO	£3100
CAMBRIDGE CDI CD PLAYER MINT.	£795	S/HAND	£1500
MERIDIAN 207 CD PLAYER PREAMP & 209 REMOTE MINT.	£595	S/HAND	£1150
AUDIO INNOVATIONS 600 PRE & POWER MODIFIED VGC	£795	S/HAND	£1400+
MICROMEGA TRIO CD PLAYER MINT	£685	EX/DEMO	£2995
AUDIO RESEARCH SP11 MK2 PREAMP BLACK MINT	£2250	S/HAND	£5600
AUDIO RESEARCH M300 MK2 VALVE AMPS BLACK MINT.	£5995	S/HAND	£13000
MICROMEGA TRIO CD PLAYER MINT	£2495	S/HAND	£4499
KLYNE SK 5A PREAMP MINT	£1495	S/HAND	£2750
ROWLAND MODEL 7 MONO POWER AMPS BALANCED MINT.	£8995	S/HAND	£17000
MK2 ROKSAN XERES HR100 MCS ARM ROSEWOOD MINT	£399	S/HAND	£1385
MICROMEGA DUO CD TRANSPORT MINT	£1095	S/HAND	£1750
CITATION 18 TUNER ORIGINAL ATERICAN V.G.C	£295	S/HAND	£650
REVOK H6 TUNER MINT	£495	S/HAND	£931
MUSICAL FIDELITY MVT 3 PREAMP MINT	£495	S/H	£1100
SUGDEN AUE11C PREAMP 2 BOC MODIFIED BY AVONDALE V.G.C	£895	S/HAND	£1800
JANIS DA 30 VALVE INTEGRATED AMP MINT	£1495	S/HAND	£2790
ROWLAND MODEL 3 MONOS POWER AMP BALANCED MINT	£2495	S/HAND	£4000
ARAGON 4004 MK2 POWER AMP MINT.	£995	S/HAND	£1899
POSSELT ALBATROSS SPEAKERS PIANO BLACK MINT.	£1495	S/HAND	£2200
MARTIN LOGAN AERILIS SPEAKERS BLACK MINT	£1299	S/HAND	£2400
QUAD ESL 63 SPEAKERS ROSEWOOD MINT.	£1695	S/HAND	£2400
MAGNAPLANAR MG 1.5QR SPEAKERS OAK MINT.	£1095	E/D	£1597

"OODLES OF HIGH END CARTRIDGES AVAILABLE RING FOR DETAILS" MANY MORE ITEMS IN STOCK, EFFICIENT SERVICING DEPARTMENT. WE ARE LOCATED IN WELWYN, HERTS

ALL ITEMS GUARANTEED - ALL MAJOR CREDIT CARDS ACCEPTED RING FOR DETAILS AND DEMONSTRATION 0438 714038
10.00 AM - 7.00 PM MON - SAT 10.00 AM - 1.00 PM SUN

Are you making the right connections?

Send for Britain's biggest catalogue of specialist cable and connections. All available by mail order. Phone 081-9429124 or clip the coupon for your Free copy.

CUSTOM CABLE SERVICE

PO Box 4007, London SW17 8XG

Please send me your FREE Custom Cable Catalogue

Name _____

Address _____

Postcode _____

NO FURTHER INFORMATION REQUIRED

Send to: Custom Cable Service
PO Box 4007
London SW17 8XG

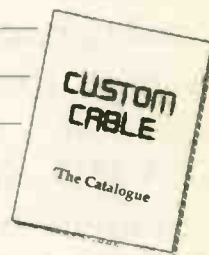

HFV7/84

campaign audio design

LOVE HERTZ

"You pays your money and you takes your choice" but our pure silver cables and quality mains interconnects will improve your Hi-Fi system or we will give you your money back.

- ★High Purity Silver interconnects with PTFE
- ★Silver tone arm wires & digital interconnects
- ★Silver speaker cables & mains leads

"We will improve your Hi Fi or give you your money back!"

Campaign Audio Design
Llandudno Road (HW) Cardiff CF3 8PG

Tel: 0222 779401

TRADE & INTERNATIONAL ENQUIRIES WELCOME

PLAY IT AGAIN SAM,

This Time use

GOLD AERO TUBES



For further information please call.

Tel: 0932 873444
Fax: 0932 873012



You should be looking for only one kind of Hi-Fi.

The Best!

Call me, it's the only kind I deal with.

For the Best...

Apogee, Audio Research, Classé, Copland, Linaeum, Magnepan, Martin Logan, PS Audio, Sonus Faber, Theta, Van den hul

And the Best of British...

DPA, LFD, Michell, Orelle, Pink Triangle

'Phone or fax me anytime, 9am - 10pm, any day including weekends on:

0252 - 377952

0385 - 317952

Secondhand/Ex Demo equipment:

Acoustat Mod 3 electrostatics £1500, Croft Super Micro-A £350, Musical Fid. A370 £1000
Oracle Delphi + Linn Ittok £600, Sonus Faber Electa £1300

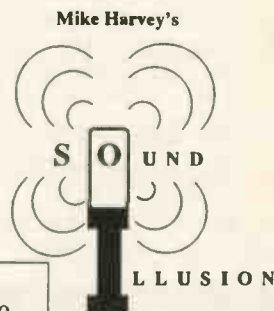

Anywhere in the South.

RING
FOR
DETAILS



UXBRIDGE,
MIDDLESEX
(0895) 253340

Unbelievable but true you can audition all these brands here. Audion, Proac, Michell, Lumley, Levison, Lurne, Triangle, Teac, VHD, Silversounds, Stax, Monitor Audio, Trilogy, Lyra, Sumiko, Ortofon, Decca, Target, Project Moth, Townshend, Edison, Chario, Trichord Research, Cadence, Kinshaw, SD Acoustics, Totem.

7 days a week 10am - 7pm
RING FOR DETAILS
UXBRIDGE, MIDDLESEX
(0895) 253340

DAVID ORTON
AUDIO VISUAL



Cyrus Centre

Marantz, Denon, Pioneer, Cyrus, Mission, Rotel, Ruark, B&W, Thorens, Oracle & More

Dolby Prologic Dem. Room & Hi-Fi Listening Room



6-8 BANCROFT, HITCHIN, HERTS

TEL: 0462 452248

G T AUDIO

At G T Audio we pride ourselves on selling an excellent range of sound reproduction equipment, backed up by first-class after sales service. From the vast range of quality audio equipment available we have chosen that which we feel offers the best sound at very competitive prices with a high degree of reliability. We have extensive servicing facilities to cater for all types of equipment whether new or old.

CROFT, NOTTINGHAM ANALOGUE, ANALOGUE TRACER, POSSELT, UKD CALLAS, MONARCHY AUDIO, XLO ELECTRONIC, MATISSE, GROOVE TUBES, GOLD AERO, TOWNSEND SEISMIC SINKS, G T AUDIO CABLES, ATACAMA supports, CLEMENTS, METAXUS, ZIKRO AUDRO are available on demonstration.

WE CAN OFFER A COMPLETE RESTORATION SERVICE AS WELL AS SUPPLYING AUDIOPHILE COMPONENT KIT FOR UPGRADING ALL LEAK, QUAD, RADFORD, PYE and QUICKSILVER amplifiers. P.O.A

G T Audio is situated on the outskirts of London, 5 minutes from junction 16 of the M25/M40 Motorways.

FOR DEMONSTRATIONS OR BOOKING IN EQUIPMENT TO OUR SERVICE CENTRE contact Graham Tricker.

TELEPHONE 0895 833099

(DEMONSTRATIONS STRICTLY BY APPOINTMENT ONLY)

AMADEUS SOUND & VISION

Aura, Audio Innovations, Bang & Olufsen, Castle Acoustics, Micromega, Musical Fidelity, Nakamichi, NAD, Pioneer, Quad, Royd, Spondor, Technics.

10 BOLDMERE ROAD
SUTTON COLDFIELD

WEST MIDLANDS

Tel: 021 - 354 2311



Interest Free Credit Facilities



Demo room with A/V system set-up.



The Audio Room



Pure Sound



For High End Hi-Fi

Gobsmacked by Goertz!

We have been auditioning this new ribbon speaker cable from the USA recently, and we reckon it outperforms everything else we have heard. **Don't buy speaker cables until you have heard this!** Goertz (pronounced "Go-ertz") cable has been designed to act as a low impedance transmission line to terminate optimally into typical speaker loads. This reduces the amount of electrical energy which is reflected from the speakers back to the amplifier, and so gives superb transparency of sound and much less smearing. The cables are available in copper or silver, wide (20mm for amps

over 150W) or narrow (10mm for amps under 150W) ribbon:
Narrow Copper £20 metre
Wide Copper £40 metre
Narrow Silver £256 metre
Wide Silver £475 metre
Interface for Naim amps £87
Call us to discuss and specify what cable terminations you want. Money back if not delighted.

Impulse H2s !

We have been enjoying the detailed and dynamic sound that these speakers produce even when driven by relatively low power amps. Hear them with the Audio Note and Audio Innovations amps.

Mephisto CD Transport!

This visually and sonically stunning piece of equipment is on permanent demonstration as part of one of our high end systems. Bring your own DAC or hear it with our Audio Notes.

Micromega!

Hear the top end Classic range including the Duo Pro and CD 3.1 .

Counterpoint DA11 / DA10!

Still on the subject of CD front ends, they really do sound different from each other. This superb pair just has to be heard if you're seriously in the market.

0784 458176/081 893 4485

Pure Sound + The Audio Room, Whitton, Twickenham and Staines. Personal service, home demonstrations, excellent hi-fi

JORDAN WATTS ACOUSTICS LTD
201 MARE STREET LONDON E.5
PHONE 081 985 1646
FAX 081 986 0112



A DESIGN NOT COPIED
BUT A DESIGN COPIED
PROBABLY THE BEST SOUND AROUND
TO ARRANGE FOR A DEMONSTRATION
SUPPLY DEALER'S NAME AND ADDRESS

Art Audio MAESTRO

"They are just so stunningly gorgeous and open to listen to, I can barely imagine anything more alluring"

NK Hi-Fi World, June '91

Valve amplifiers from £750 to £4150 Cables from £27 to £1700

Select Audio Glasgow (041) 226 4268	Audio Venture Banbury, Oxon (0295) 261863	K.A.L. (UK) Ltd Folkstone (0303) 245005
Doncaster Hi-Fi Studios Sunnyfields (0302) 731387	The Hi-Fi Consultants London (071) 380 0866	The Hi-Fi Consultants Nottingham (0602) 232450
Paul Green Hi-Fi Bath, Avon (0225) 316197	Evenings (071) 482 0003	Impulse Audio Consultants Westcliff-on-sea, Essex (0831) 616426 or 0374 277736
Hazelmere Audio High Wycombe, Bucks (0494) 437892	Audible Difference Diss, Norfolk (0850) 983233 or (0379) 740227	Sound Academy Bloxwich, West Midlands (0922) 473499

New A4 brochure containing full details of our amplifier and silver cable range contact
Art Audio (UK) Ltd., 130 Main Street, Calverton, Nottingham, NG14 6LU
England UK
Tel. 0602 - 653604
Fax 0602 - 637795

MANTRA AUDIO

• CARTRIDGES AND STYLI
• MAIL ORDER DIRECT 1-10 DAYS
• COMPETITIVE PRICE (inc P&P)

MAKE	MODEL	CARTRIDGE	STYLUS	MAKE	MODEL	CARTRIDGE	STYLUS
Arcam	C 77	£27.00	£15.00	Ortofon	OM11, OMP10 (T4P)	£25.00	£16.00
	E 77	£45.00	£33.00		OM20, OMP20 (T4P)	£54.00	£31.50
	P 77	£56.00	£45.00		OM30, OMP30 (T4P)	£72.00	£56.00
Audio Technica	P 77Mg	£66.00	£49.00	OM N'CLUB S	£29.00	£15.00*	
	AT 95 E	£71.00	£13.50	510	£29.00	£18.00	
	AT 110 E	£48.00	£16.00	520, 520P (T4P)	£49.50	£36.00	
	AT 450 E	£57.00	£33.00	530, 530P (T4P)	£78.00	£57.00	
	AT420 E	£36.00	£22.00	MC 1 TURBO	£54.00	£45.00*	
Denon	AT OC 3	£86.00	£56.00*	MC 3 TURBO	£99.00	£82.50*	
	AT OC 5	£110.00*	£90.00*	MC 10 Super	£78.00	£65.00*	
	DL 110 MC	£85.00	£52.00*	MC 15 Super	£99.00	£82.50*	
	DL 150 MC	£75.00*	£58.00*	VN 35 MR	(V 15 III)	£36.00	
	DL 304 MC	£180.00	£145.00*	VN 45 MR	(V 15 IV)	£30.00	
Goldring	ELECTRA	£24.00	£16.00	V 15 VNR	£225.00	£150.00	
	1006	£44.00	£29.00	SWISS QUALITY DIAMOND STYLI			
	1012 GX	£58.00	£38.00	ADC	R20 XE, QJM 32/34/36, XLM III	£12.50	
	1022 GX	£78.00	£49.00	Dasil	DN 145/155/165E, DN 149S	£12.50	
	1042	£94.00	£61.00	Ortofon	FF 15/VMS 10/20 EI, OMP 10/20	£12.50	
Nagaoka	Erica (LXV)(H)	£90.00	£56.00*	Shure	N75 ED/EJ T2, N95 ED/EJ	£10.00	
	MP 11	£25.00	£12.80	Sontra	Antistatic carbon fibre record cleaning brush	£9.00	
	MP 11 Boron	N/A	£28.00				

* Exchange any MC ★★★ Other types available ★★★ Tel (0757) 288652

SUMMER SALE PRICE. All above UK Supplied/UK Guarantees - No grey imports
Please state style/ident no/color. Cartridges/ret on all orders/enquiries - No credit cards
MANTRA AUDIO (HFW), 22 GARTH AVENUE, NORTH DUFFIELD, SELBY, NORTH YORKS YO8 7RP

The NORFOLK/SUFFOLK High End Dealer audible difference

near DISS, NORFOLK

Audio Research	<i>Audion (Alema)</i>	ART Audio
ATC	<i>Audio Innovations</i>	Audio Note
AVI	CHORD	Copland
Croft	DAWN AUDIO	dpa
EAR	Impulse	Kinshaw Perception
Lineaum	<i>Lyra</i>	LFD Audio
Magnepan	Micromega	neat
Orelle	Pink Triangle	ROKSAN
Sumiko	SME	Sonus Faber
SUGDEN	Tube Technology	van den Hul

At this level of equipment we believe that the highest level of service should be offered.

We will book only three demonstrations a day to ensure that you have ample time to evaluate the option YOU choose,

DEMONSTRATIONS IN OUR LISTENING ROOM OR
YOUR HOME
EQUIPMENT LOAN SERVICE AVAILABLE

Tuesday to Friday, 12 to 9 pm

Saturday 9 to 5 pm

PLEASE RING FOR AN APPOINTMENT

0379 740227 OR 0850 983233

Ezee

ENTERTAINMENT UK LTD

BUY AT A PRICE NOBODY CAN BEAT !!

AVERAGE SAVINGS OF AT LEAST 25%

CD'S TAPES VINYL AND IMPORTS

ALL AT TRADE PRICE - ABSOLUTELY NO MARK UP!!!

*No minimum purchase amount

*No club recommendations to buy

*No minimum membership period

*No restrictions on material

CHECK THESE PRICES FOR A REAL DEAL

ALL FULL PRICE CD'S ONLY £8.99 - TAPES & VINYL ONLY £6.49

WE SUPPLY EVERYTHING
FREE SEARCH FACILITY INCLUDING TRACK LISTINGS AND
PRICE

Membership is only £7.95 a year, which most people recover with
their first order

Don't delay, JOIN NOW and save.

Freephone 0500 78 45 33 9.00am to 8.00 pm

FREE CD OR TAPE WHEN YOU JOIN

The WIZARD



Hand made
Adjustable Shelf
Rotary Unit.

Can hold 1536 CDs
or 1440 Cassettes
or 384 Videotapes
or 575 Penguin
Books; or any
mixture. Books up
to 6 1/4" deep.

Revolves on Ball
Bearings in 30-4"
turning circle
21 1/2 x 21 1/2 x 75" high.

Teak, oak, pine
mahogany, ash,
£1550 inc.
VAT & Delivery.

**FOR OUR BROCHURE
of
CD/Video Drawer Chests
CD racks
Bookshelves
LP, music · Hi-Fi
Cabinets &
the Budget Line
—Specials made to
order—**

Please send 3 x 2nd
class stamps to:

Ian Edwards The Old Chapel
282 Skipton Road, Harrogate
HG1 3HB. Tel: 0423 500442



Chord Electronics Ltd
3 Bower Mount Road
Maldstone ME16 8AX

Tel. 0622 764874/692000 Fax. 0622 764506

Chord UK Dealers

Cottage Audio	0522 702834
KJ Leisuresound, London W1	071 486 8262
Acoustic Arts, Watford, Herts.	0923 245250
Brentwood Music Centre, Brentwood, Essex	0277 221210
Progressive Audio, Gillingham, Kent	0634 389004
Doug Brady Hi-Fi, London WC2	071 379 4010
Doug Brady Hi-Fi, Warrington, Cheshire	0925 828009
Doug Brady Hi-Fi, Liverpool, Mersyside	051 733 6859
Doug Brady Hi-Fi, Leeds, Yorkshire	094 346 7689
Photocraft Hi-Fi, Ashford, Kent	0233 624441
West Midlands Audio, Worcester, West Midlands	0905 580446
The Reference Studio, Heathfield, Sussex	0435 868004
Paul Green Hi-Fi, Bath, Avon	0225 316197
Eastbourne Audio, Eastbourne, Sussex	0323 25828
Surrey Hi-Fi, Godstone, Surrey	0883 744755
Sound Academy, Wallsall, West Midlands	0922 493499
English Audio, Hereford, HR4	0432 355081
Hi-Fi Experience, London W1	071 580 3535
London Hi-Fi Services, London	071 263 1015
Diva Audio Fidelity, London SW11	071 924 5286
Music Matters, Birmingham, West Midlands	021 429 2811
Music Matters, Dourbridge	0384 444184
Vaudio, Stoke Bishop, Bristol	0272 686005
In Hi-Fi	031 225 8854
Audio Reflections	0532 528850
Audible Difference	0379 740227

THE hi-fi ROOM

MANCHESTER



**THE OASIS OF SOUND
FOR HI-FI AND AV**

M A N C H E S T E R

50 BRIDGE STREET 061-832 0888

World Radio History



SLV-280



CCD-TR350



KVM 1400

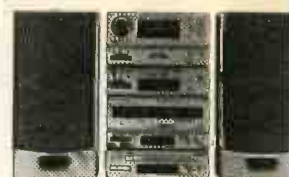

MHC-2800

SONY®

THERE'S ONLY ONE NUMBER
YOU NEED TO KNOW!

0345 716261

Sony product delivered by

Raresupply Ltd

DIRECT

T O Y O U R D O O R

- SONY ACCESSORIES
- SONY'S ENTIRE RANGE • NEW SONY MODELS FIRST
- FREE & INSURED UK MAINLAND DELIVERY • SONY SERVICE, QUALITY AND VALUE

THE BEST SONY PRICES GUARANTEED

Domestic models available only. Some large screen televisions may not be available due to carriage restrictions.

Sussex Surplus

13 STATION ROAD, HORSHAM, WEST SUSSEX RH13 5EZ

Telephone: (0403) 251302 Fax: (0403) 270339

Test Equipment • Components • Accessories
Electromechanical • Mechanical • Engineering

Valves Mostly UK.

Oil Filled Chokes

Oil Filled Paper Capacitors

P.T.F.E. silver plated wire various colours and sizes
50p per mtr.
A.V.O CT160 Valve Tester EX M.O.D
tested and supplied with data book £99 + £20p+p
Solartron varifiable H.T power supplies with meter 0-
500V+DC 100MA/3-15-0-3-15 3A tested very
good condition £75 + £20p+p
P+P add £5.00 +VAT per order UK only unless
otherwise stated.
Overseas postage at cost
VAT at 17.5% to be added to all UK orders.
All items in this advert are made to mill spec

Type	Price
GZ34 MULL	£9.00
KT66 G.E.C.	£65.00
EF86 G.E.C.	£9.00
EF86 MULLARD	£6.00
ECC81 MULLARD	£5.00
ECC82 MULLARD	£5.00
ECC83 MULLARD	£10.00
12Ax7 MULLARD	£6.00
E88CC G.E.C	£8.00
5R4GY	£4.00
6080	£10.00
E810F MULLARD	£10.00
E180F MULLARD	£6.00
GZ37	£3.00
EL84 MAZDA	£4.00
6SN7GT	£4.00
DA42 G.E.C	£15.00
UI9 RECT	£10.00
6x4 RECT	£3.00
4212E S.T.C	£100.00

Type	Price
10H 25MA	£8.00
2.5H 220MA	£10.00
5H 250MA	£12.00
5H 350MA	£18.00
5H 400MA	£20.00
20H 120MA	£15.00
15H 120MA	£15.00
2H 150MA	£10.00
1H 300MA	£10.00
10H 250MA	£20.00
4.5H 220MA	£10.00

Type	Price
2MFD 600V	£6.00
4MFD 600V	£6.00
8MFD 600V	£8.00
8MFD 800V	£10.00
8MFD 1000V	£12.00
1MFD 600V	£5.00
.5MFD 1000V	£5.00
.5MFD 5000V	£15.00
12MFD 350V	£8.00
1MFD 2500V	£15.00
.25MFD 1000V	£5.00

Varnished Chokes

10H 75MA	£10.00
3H 40MA	£10.00

Varnished H.T Transformers

Primary	Secondary
230/240V	612-0-612V
	430 MA £25.00
230V	275-0-275V
	6-3V 2-5A
	6-3V 1A £18.00
	5V 2-5A

Oil Filled H.T Transformers

Primary	Secondary
115/230V	1250-0-1250V 230V
	310MA £35.00 725/700-0-725/700
	4.6V 100MA 385MA
	180-0-180 55MA
	6.3V 6A
115/230V	400-0-4-00 5V 6A £50.00
	250MA £18.00 6.3V1A
	30V 100MA
115/230V	350-0-350 150MA 115/230V
	6.3V 1A 300/250-0-250/300
	6.3V 2A £37.00 125MA
	6.3V 6A £20.00

Oil Filled Heater Transformers

Primary	Secondary
115/230V	6.4V 3A x2
	2.5-5V-6.4x2 £15.00
115/230V	6.4V 10A
	10V 650MA
	26V 650MA £15.00
115/230V	2-5V-5V-6.4V
	2A x 4 £15.00
115/230V	6.4V 5A x 3 £20.00

Parmeko Microphone Transformer

PRI 300 Ω - 300 Ω
SEC 300 Ω - 300 Ω
RATIO 1+1: 1+1 £10 EACH

ROBAND BLOCK H.T. P.S.U.

350V 250 MA
6.3V-0-6.3V 3A £100+
6.3V-0-6.3V 3A £20 P+P

FARNELL STABILISED

H.T./L.T. PSU VARIABLE, WITH METERS

0-350V 150MA
3.15V-0-3.15V 2A
0-2.5V-5V-6.3V 3A £130 + £20 P+P

FARNELL STABILISED

H.T./L.T. PSU. VARIABLES WITH METERS

0.350V 100 MA
3-15V-0-3.15V 2A
0-2.5V-5V - 6.3V 3A £100+£20 P+P

SOLARTRON BLOCK H.T. PSU.

250/300V 200MA
6.3V 6A
6.3V 6A
6.3V 2A £100+£20 P+P

SOLARTRON BLOCK H.T. PSU.

200/300V 100MA
6.3V 1A
6.3V 2A
6.3V 4A £60+£10 P+P

SOLARTRON SR5 152 VALVED H.T. PSU

0-500V 150 MA
6.3V 5A £175 + £20 P+P

All items in this advert are made to mill spec.

KIMBERLEY HI-FI

A Sound Investment

• SEPARATE DEMONSTRATION ROOM •

BRANDS STOCKED: DENON • TECHNICS • KENWOOD • AIWA
• NAD • DUAL • CASTLE • GOODMAN'S • MARANTZ • MONITOR
AUDIO • HECO • ROTEL • PIONEER •

SOUTH LONDON'S & NORTH KENT'S ONLY

0% FINANCE AVAILABLE ON SELECTED ITEMS



193 BROADWAY, BEXLEYHEATH, KENT

081 - 304 3272

CLEARAUDIO, S.M.E, AUDIO RESEARCH, CREEK, E.M.F.

HEATHERDALE AUDIO LTD.

202, Findon Road, Findon Valley, Worthing, West Sussex.
Tel. 0903-872288. Fax 0903-872234

Heatherdale pre-owned guaranteed equipment:	
Apogee Stage complete with stands	£2250
Jadis 30 watt integrated stereo amp	£1195
Lumley Reference 120s Ex demo switchable	£2895
Magnum integrated amplifier Ex demo	£299
Magnum 300 pre-amp Ex demo	£325
Linn LP 12	£395
Audio Innovations 300 int. amp	£295
Audio Innovations 200 power amp	£295
Audio Innovations 200 Pre-amp	£295
Audio Innovations 1st Audio	£995
Audio Innovations 1000 pre-amp	£995
Audio Innovations 800 mo transformers	£120
PS Audio Signature 200 watt power amp	£895
Mod Squad line drive passive pre-amp	£350
Audionote IO cartridge very low hours	£795
Magneplanar Tymperi 1V (The ultimate)	£1995
Wadia DigiMaster 32 DAC	£795
Pioneer PD 93 Reference CD Player	£995
Apogee Centaurus Pre-owned, mint.	£1595
Audio Research SP9. Pre-owned. (Black)	£1895

THREE COMFORTABLE DEMONSTRATION LOUNGES.
VISA WELCOME.

MAGNEPLANAR, MARTIN LOGAN, ROTEL, THETA, JADIS



Chelmer Valve Company for Audio Valves

Audio valves with famous Brand Names of yesteryear such as MULLARD, MOV, GEC, RCA etc., are in very limited supply and their scarcity also makes them very expensive.

We at Chelmer Valve Company however provide high quality alternatives to these old makes. We have over 30 years experience in the supply of electronic valves of all types and during this time have established close ties with factories and sources worldwide.

For high fidelity use we further process valves from these sources using our specially developed facilities. After rigorous testing - including noise, hum, microphony, post burn-in selection and matching as needed - we offer this product as CVC PREMIUM valves.

A selection of the more popular types is listed here.

Price list & Order Form for CVC PREMIUM Audio Valves

	UNIT PRICE	QTY.	TOTAL PRICE		UNIT PRICE	QTY.	TOTAL PRICE																				
PRE-AMP VALVES				CARRIED FORWARD....																							
ECC81/12AST7	5.00			RECTIFIERS																							
ECC82/12AU7	4.00			GZ33	4.50																						
ECC83/12AX7	5.00			GZ34/5AR4	4.50																						
ECC85	4.00			5U4G	5.00																						
ECC88	5.00			5Y3GT	3.20																						
EF86	4.00			5Z4GT	3.50																						
E81CC (GOLD PIN)	6.00			SOCKETS																							
E82CC (GOLD PIN)	6.00			B9A (PCB)	1.60																						
E83CC (GOLD PIN)	6.00			B9A (CHASSIS)	1.60																						
E88CC (GOLD PIN)	7.00			OCTAL (CHASSIS)	1.75																						
E80F	9.00			4 PIN (UX4)	3.00																						
E83F	5.50			4 PIN (FOR 211 & 845)	11.00																						
6SL7GT	4.00			MATCHING CHARGES * POST & PACKING 3.00 (UK)																							
6SN7GT	4.20																										
6922	5.00			TOTAL EXC. VAT																							
POWER VALVES				VAT @ 17 1/2% (ECC)																							
2A3 (4PIN)	14.00			TOTAL TO PAY £																							
2A3 (OCTAL)	14.00			* MATCHING, if required; state valve types & if PAIRS, QUADS or OCTETS - Allow £1.00 per valve for this service.																							
211	22.00																										
300B	50.50			Make CHEQUES payable to: 'CHELMER VALVE COMPANY' or pay by ACCESS/MASTERCARD/VISA, give details:																							
811A	9.50			<table border="1" style="width: 100%; height: 20px;"> <tr> <td></td><td></td><td></td><td></td><td></td><td></td><td></td><td></td><td></td><td></td><td></td><td></td><td></td><td></td><td></td><td></td><td></td><td></td><td></td><td></td> </tr> </table>																							
845	29.90			Signature																							
EL34/6CA7	7.50			Expiry																							
EL84/6BQ5	4.00			Name																							
E84L/7189A	5.10			Address																							
KT66	9.20																									
KT88	12.50																									
KT88 (GOLDQ)	18.50																									
6L6GC	6.50																									
6L6WGC/5881	8.00																									
6V6GT	5.00																									
6146B	10.20																									
6336A	30.00																									
6550A	11.00																									
6550-A	13.50																									
7581A	11.00																									
TOTAL CARRIED FORWARD.....			 Post Code																							

Valves amplifiers sound better still with CVC PREMIUM valves!

130 New London Road. Chelmsford. Essex CM2 0RG, England. Telephone: (0245) 355296/265865 Fax: (0245) 490064

Classic Hi-Fi & Video



NAD • MARANTZ

• ROTEL •

HEYBROOK •

AURA • SUGDEN

• YAMAHA •

PIONEER • LFD •

KEF • JPW •

ROGERS •

MONITOR AUDIO

• CELESTION •

KENWOOD • TDL

• CASTLE •

ONKYO •

KESWICK AUDIO

& MORE



Classic Hi-Fi & Video

School Lane, Kettering, Northants.

Tel: 0536 - 515766

SINGLE ENDED

KT66 Single ended valve mono block power amplifiers

..... £350.00/pair

Valve phono stage MM £179.00

- variable output -

MC step up transformers..... £42.00

The Garrard 301/401 power supply

100/130 volt setting £64.45

All units are fully assembled and tested.

Prices include Delivery and VAT

2 week money back guarantee

SAE for data sheets

F&S Trading

31 Brooks Road, Sutton Coldfield

West Midlands B72 1HP

Tel: 021 321 3357

RARE RECORDS BY MAIL

JON TAYLOR

29 A Lambs Conduit Street,
Holborn, London WC1N 3NG
Tel. & Fax: 071 831 9907; Mobile 0385 323393

**Specialising in rare 60s/70s/80s/90s
Progressive, Psychedelic, Underground, Acid Rock,
Rhythm & Blues, West Coast, Country Rock, Hard
Rock, Thrash, New Wave, Punk, Rock & Pop
Memorabilia.**

Buy, Sell, Trade. Send your wants lists.

Free lists available on all major artists including Abba, AC/DC, Adam & The Ants, Bryan Adams, Aerosmith, A-Ha, Tori Amos, Bangles, Beach Boys, Beatles, Black Sabbath, Blondie, Marc Bolan, Bon Jovi, David Bowie, Kate Bush, Byrds, Belinda Carlisle, Cher, Eric Clapton, Alice Cooper, Cult, Cure, Deep Purple, Def Leppard, Depeche Mode, Dire Straits, Doors, Duran Duran, Bob Dylan, ELO, Eurythmics, Fleetwood Mac, Free, Genesis, Grateful Dead, Guns 'N' Roses, Hawkwind, Jimi Hendrix, INXS, Iron Maiden, Michael Jackson, Jam, Jethro Tull, Elton John, Kinks, Kiss, KLF, Led Zeppelin, Level 42, L7, Madonna, Marillion, Metallica, Meatloaf, New Order, Nirvana, Pearl Jam, Pet Shop Boys, Pink Floyd, Pixies, Elvis Presley, Prince, Queen, R.E.M., Cliff Richard, Rolling Stones, Roxette, Rush, Sex Pistols, Simple Minds, Simply Red, Smiths, Bruce Springsteen, Status Quo, Rod Stewart, Sweet, Thin Lizzy, U2, Velvet Underground, Wham!, Who, Yardbirds, Yes, Neil Young, Frank Zappa.

Please include a SAE or IRC.

**Top prices paid for Records, CD's, Cassettes, Music
Books, Videos, Pop Magazines and Music
Memorabilia.**

Whole Collections bought.

AN EXCLUSIVE

HI-FI DEALER



CAMBRIDGE HI-FI LTD

FOR THE TOTAL EXPERIENCE IN HI-FI

**B&W, BOSE, KEF, KENWOOD,
MARANTZ, TECHNICS,
YAMAHA**

**AND MANY OTHER QUALITY BRITISH &
JAPANESE HI-FI PRODUCTS INC. TAPES
AND ACCESSORIES**

VISIT OUR SHOWROOM FOR ADVICE & A DEMONSTRATION IN OUR DEMO ROOM

**1 -3 HAWTHORN WAY, CAMBRIDGE
AMPLE CAR PARKING**

CAMBRIDGE (0223) 67773



FAX NO. (0223) 353741

VISA

Audio Note

TOPCAPS

Topcap For 807 pentode etc. Nickel 9.75 You may want to start your project with less overall cost, and for this purpose we can offer the following 'industrial grade' ceramic valve bases

Type	Mounting	Price Ex UK Vat
8-pin for EL34 6550, KT66, 6L6G	Chassis with bracket	1.45
9-pin for ECC83, ECC88, 5687, 6350	Chassis with shroud	1.85

AUDIO NOTE AUDIO COMPONENTS PARTS & PRECISET.

We have decided to offer a range of the ultra high quality components used in most of the AUDIO NOTE amplifiers to the discerning "do-it-yourself" valve amplifier enthusiast. These components include special made valve bases, paper in oil signal capacitors, copper & silver foil signal capacitors, Black Gate graphite electrolytic capacitors, solid/oxide-free silver solder, audio output transformers, valves and many other useful bits and pieces for upgrading old or constructing of new valve amplifiers.

All prices are excluding VAT, which, if you live inside the EEC, UK Vat will be added to your purchase, after the addition of postage and packing costs.

We accept VISA, Mastercard, Access, Diners, and Amex, with this way, we will need your address, card no. with start and expiry dates, you can also pay by bankers draft Euro cheque or cheques drawn on a UK bank account. Please note that there is a minimum charge on credit card transactions of £ 20.00

Delivery is normally about 7 days from receipt of cleared funds, but please allow up to 60 days for some items, if not stock at the time or order.

If any of you reading this have possession of any books which contain information relevant to the subject of Audio Design and which would be useful to share with others, please let us know either by fax or telephone, there is an award of £200 (payable in valises or other bills, postage) to anybody who sends us a book which contains useful information about valve amplifier design or theory.

Circuits, valvedata & Basic Technical Information

If you would like some suggestions which to base a future project around, then we shall be happy to provide you with a circuit pack containing good circuits like ONGAKU, KEGON/KASSAI, NERO, GAKU-ON plus several other power amplifier circuits and the M7Tube pre-amplifier which is the best pre-amplifier circuit we have come across. Just send a stamped self addressed A4 envelope, together with 5.00 pounds in small denomination, or if you live outside the UK a US\$ 15.00 in \$ bills will do, please do not send international Response Coupons or International money orders, as they cost more to cash than their value.

We can also supply a set of data sheets for the most commonly used valves, ECC82, ECC88/6922, 12AT7/6022A, 7025/12AX7WA/ECC83, 6SN7, 300B, 211V/4C, 645, EL34/6CA7, 2A3, 6X4, 5U4G, GZ34/SARA4, EL84/6B05, 6V9GT, 6L6G, 5881/6L6GC/6K76G. Again send a stamped self addressed A4 envelope together with - 4.00 in small denomination stamps or if outside the UK another US\$ 15.00 will suffice.

Since nothing really exists which gives a reasonable background to the subject of valve amplifier circuit design, Guy Adams and I have written and assembled a number of articles and extracts from old books which give some background to the subject, do not expect to become an instant expert, but it will serve as a useful reference for the beginner as well as the more advanced, we have expanded this info-pack to include even more useful information, so if you have already bought the old pack, just send £ 2.00 or US\$ 5.00. For the full pack a small charge is required, this time £ 7.00, in small denomination stamps with a stamped self addressed envelope, or outside the UK, please send US\$ 25.00.

We do accept a UK cheque or bankers draft in Pound Sterling for the above charges as well.

SOUND PRACTICES.

If you are seriously interested in the subject of valve amplifier design, without the usual preconceived notions of what is "good" amplifier design and technology (the traditional view, which has brought us the blessings of the transistor amplifier, has obviously disqualified itself quite monumentally), then SOUND PRACTICES is the magazine to read, here you will find articles about design parameters, DIY articles for amplifiers and speakers, reviews of new and old, and other views of the very subjects that none of the self-serving, advertising led traditional press will touch as they do not enhance the business of their normal advertisers. You can buy SOUND PRACTICES from us at - 5.00 per copy (there are currently 4 issues available) or by subscription from SOUND PRACTICES P. O. Box 180662, Austin, TX 78718, USA. A regular modern world bargain and there are practically none of those in Audio today. With enough subscription support SOUND PRACTICES may just bring about the "sound practices" that the hi-fi industry has abandoned for so long. So get a subscription!

SOUND PRACTICES issue 5 is HERE, so your next weekend is saved! Buy a copy for 15.00 + postage (or self addressed envelope with order if you live in the UK), serious stuff like build your own ONGAKU copper version etc. etc.

POSITIVE FEEDBACK.

This is one type of feedback that we are not entirely against! Positive Feedback is the club magazine for the Oregon Triode Society with aspirations towards greatness, not unlike the great underground magazines of the 1970's. It is a quarterly publication of zany, controversial commentary, by in-house writers, members, as well as various industry doyens on the subjects of music, audio, technology and the quest for musical satisfaction. For one, think it is an excellent read and provides a good alternative view to most of the established press, which tends to view the world in the context of what new products is available right now, without giving much perspective backwards. Positive Feedback is available at 16.00 per issue.

COMPLETE KITS.

All the current moment the following kits are under development, and should be available during 1994, the sequence of introduction may be different from the number, as we expect the KIT THREE to become available in March 1994.

KIT TWO 6550 single-ended, 15 watts Class A on a stereo chassis, expected cost 1599.00 incl. Vat. KIT THREE 300B parallel single-ended, mono chassis, 16/17 watts Class A, expected cost about £1,450.00 incl. Vat. KIT FOUR 6V6 push pull, 10 Watts Class A stereo chassis, expected cost 1179.00 incl. Vat. KIT FIVE 6550 push pull, Class AB1, 60 watts, mono chassis, expected cost 799.00. If you are in doubt as to whether a kit project is suitable for you, we suggest you spend £10.00 on buying the instructions for the KIT ONE, single 300B amplifier, this will give you a good idea whether a kit project is for you, if you decide to buy a kit then the £10.00 will be refunded against the cost of the kit. As the other kits become available they'll be available at £10.00 each.

OUTPUT TRANSFORMERS: Specializations: PP = Push-Pull, PPP = Parallel Push-Pull, SE = Single-ended, PSE = Single-ended Parallel UL Supplies 43% ultralinear taps, as a general rule we do not condone the use of UL-taps, as we consider these detrimental to sound quality - • Dynaco replacement.

All primary impedances are calculated for Class A operation, the main consideration given to maximum dynamic power transfer ability and minimum distortion, rather than meaningless steady state sine-

squarewave conditions.

All our single-ended output transformers are air-gapped, and the maximum standing current allowed before saturation is shown in column 5. All our output transformers have a frequency response well beyond the audible range, typically 20Hz - 40 kHz minus 1.5dB, all are IE-coded with high grade silicon steel laminations, wound with oxygen-free copper wire and supplied with either bell-ends or frames, both with flying leads.

We generally overspecify our transformers by 50% power in Push-Pull (which means that a transformer stated as 25 watts will allow about 35-38 watt peaks, our single-ended outputs are generally over specified by 100%, which means that they will instantaneously allow peaks of double the given maximum power through undistorted.

We do not give any further technical information on our output transformers, as we do not wish to take part in technical competitions, our products are designed to criteria which are and will be under-sold since they are listened to!

In addition to the output transformers offered below, we offer a design service, where we can supply almost any requirement for wideband transformers, whether for microphones, moving coil cartridges, line input, phase splitter, interstages, driver or power output, we design and manufacture prototypes in-house, the cost for the paper design is £ 200.00, prototype cost is calculated on a per case basis. We can also produce production quantities.

Sizes are given as Width/Height/Depth, where depth is the depth of the coil test and width is the length of the core.

AUDIO NOTE CHOKE & INDUCTORS

Value	Size	Price Ex UK Vat
0.5H/400mA	1.800	14.00
3H/100mA	14.00	14.00
3H/250mA for ONGAKU/Cu	21.00	24.00
5H/150mA	24.00	24.00
5H/400mA	31.00	31.00
10H/125mA	63x74x76 mm	26.00
10H/200mA	96x65x83 mm	33.00
20H/500mA	68x56x58 mm	24.00

Other values can be supplied by order, ask for quote

AUDIO NOTE PAPER IN OIL COPPER & SILVER FOIL SIGNAL CAPACITORS.

We are currently developing a two further ranges of paper in oil capacitors where instead of using aluminium foil as the above paper caps, in the first range we use an oxygen free copper foil with 99.99% pure solid silver lead out wires, these copper foil paper signal capacitors are considerably better than the standard offerings. Secondly to "bridge" the price-quality gap between the more standard paper/foil caps and the Japanese handmade Silver foil signal capacitors, we will be offering our own 99.99% pure silver foil signal capacitors, which are pretty staggering in quality, even if I have to say this myself (I am the only one who has heard the samples so far) the silver foil caps will also have solid silver lead-out wires. To start with there will be a few values/voltages of each available.

AUDIO NOTE COPPER FOIL PAPER IN OIL CAPACITORS.

Value	DC Voltage	Size	Price Ex UK Vat
0.047mf	630 volt	28x16 mm	12.35
0.1mf	630 volt	33x22 mm	14.65
0.15mf	630 volt	35x22 mm	16.45
0.22mf	630 volt	56x25 mm	19.75
0.47mf	630 volt	56x38 mm	27.45
1 mf	630 volt	65x44 mm	46.85

AUDIO NOTE SILVER FOIL PAPER IN OIL CAPACITORS

Value	DC Voltage	Size	Price Ex UK Vat
0.047mf	630 volt	14x46 mm	41.00
0.1mf	630 volt	16x46 mm	74.00
0.15mf	630 volt	22x36 mm	101.00
0.22mf	630 volt	19x46 mm	135.00
0.47mf	630 volt	25x46 mm	198.00
1mf	630 volt	38x46 mm	486.65

AUDIO NOTE SILVER FOIL SIGNAL CAPACITORS

Best signal capacitors available, quality really speaks for itself, used in amplifiers like ONGAKU, KEGON, GAKU-ON and M7Tube Silver, handmade in very limited quantities at Audio Notes facility in Tokyo, Japan. These capacitors use a fine mylar film dielectric, and are manufactured using considerable tension on the foil and dielectric to give the best possible contact and the least scope for internal resonance.

Value	DC Voltage	Price Ex UK Vat
0.01 mf	500 volt	177.00
0.02mf	500 volt	211.75
0.05mf	500 volt	346.75
0.1 mf	500 volt	645.75
0.2mf	500 volt	995.75

AUDIO NOTE PAPER IN OIL RESERVOIR CAPACITORS

Mainly for use in inductor power supplies, but have other uses.

Value	DC Voltage	Size	Price Ex UK Vat
2mf	400 volt	30x40x55 mm	26.75
2mf	630 volt	35x45x72 mm	33.65
2mf	1000 volt	45x45x72 mm	41.75
2mf	1600 volt	50x70x72 mm	45.95
4mf	1000 volt	45x45x120 mm	49.95
4mf	2500 volt	70x70x120 mm	265.75
10mf	1000 volt	70x100x100 mm	96.75
12mf	1000 volt	70x100x120 mm	109.95
12mf	1600 volt	100x100x120 mm	136.75
12mf	2000 volt	100x100x220 mm	159.75

POTENTIOMETERS

Best available from sound quality - price viewpoint, made by Noble in Japan, high quality conductive plastic film. Volume Controls Impedance Construction Price Ex UK Vat

1.00KOhm Stereo	Frame type, PCB mounted	3.45
100KOhm Stereo	Encapsulated type, PCB mounted	12.65

A better alternative is the KO-ON volume controls which are used in pre-amplifiers like the M7Tube, M7Line, and in a mono version on the input on the NERO, KASSAI, KEGON and GAKU-ON, these are very good sounding pots by any standard.

Impedance	Construction	Price
100KOhm Stereo	Encapsulated	37.25
100KOhm Mono	Large Encapsulated	70.65
100KOhm Stereo	Large Encapsulated, high quality	107.45

Balance Controls	Price
1.00KOhm	Frame type, PCB mounted
100KOhm	Encapsulated type, PCB mounted
KO-ON	also makes a very good quality 100KOhm balance control, similar to the encapsulated 100K pot, this costs £32.25

AUDIO NOTE PRECISION CARBONFILM RESISTORS

In addition to the non-magnetic tantalum resistors, we are going to stock a range of precision goldplated carbonfilm resistors, in many cases the carbonfilm resistor is preferable if you are building an amplifier based on an old circuit, like for example the WE91 or another circuit of similar vintage. We shall be stocking values suitable for projects like the WE91 in 1/2 and 1 watt values, these resistors are made especially for us by a major manufacturer.

They cost for the	1/2 watt	£3.30 each
1 watt	£4.85 each	
2 watt	£6.89 each	

AUDIO NOTE CERAMIC STAND-OFFS

In most handwired valve power amplifiers it is frequently difficult to get the HT and heater filaments properly suspended and separated, safely and neatly from the chassis, this especially applies when building amplifiers using the really high voltage directly heated triodes like 211, VTA-C, 845, 849, 304TL, DA100 etc. When planning design like this, it is important to incorporate suitable layout from the start and AUDIO NOTE stand-offs should be more or less mandatory in that context. They are screw-in type with staalite insulator and either a wrap-round turned "head" on the single way version or separated staalite slots on the multi-way versions.

Type No	Number of Taps	Hebhl/Length	Socket Connection	Chassis Fixing	Price Ex UK Vat
AN-421	1	25.5 mm	Wrap-round	Screw-in bolt	1.41
AN-422	1	17.4 mm	Wrap-round	Screw-in bolt	1.41
AN-423	1	22.6 mm	Solder slot	Screw-in	1.41
AN-452	2	Adjustable, 1.7mm	Solder slots	Dual bolt screw-in	2.42
AN-453	3	Adjustable, 24mm	Solder slots	Dual bolt screw-in	3.05
AN-454	3	Adjustable, 32mm	Solder slots	Dual bolt screw-in	4.04
AN-456	8	Adjustable, 58mm	Solder slots	Dual bolt screw-in	5.79
AN-460	10	Adjustable, 72mm	Solder slots	Dual bolt screw-in	7.31
AN-476	6	25mm/45mm	Solder slots	Screw-In bolts	5.35
AN-479	9	25mm/66mm	Solder slots	Screw-in bolts	7.53

AUDIO NOTE AUDIO QUALITY OUTPUT TRANSFORMERS

Single-ended Circuits	Suggested Valve	Max. Cl. A Power	Prim.-Sec. Impedance	Size/Weight	Max. Current	Price ex. UK VAT
EL84/ECL86/6V6	20 watts	2K5 - 4/8 Ohms	117/98x90 mm	100mA PSE	67.00	
300B/2A3/6B6/4G	25 watts	2K5 - 4/8 Ohms	117/98x90 mm	300mA SE	91.00	
EL34/6CA7	30 watts	1K5 - 4/8 Ohms	115/98x95mm	180mA PSE	113.00	
2A3/6B6/4G	30 watts	1K25 - 4/8 Ohms	98x82x95mm	130mA PSE	97.00	
5881/KT66	30 watts	2K0 - 4/8 Ohms	115/98x95mm	140mA PSE	106.00	
211HT4C	30watts	10K - 4/80ohms	117/98x100mm	150mA SE	114.00	
211HT4C/B45	50 watts	10K - 4/8 Ohms	112x34x50mm	150mA SE	124.00	
300B	50watts	1K25 4/80ohms	135x15x125mm	180mA PSE	151.00	
845	50 watts	2K5 - 4/8 Ohms	137x141x30mm	180mA PSE	172.00	
211HT4C	75 watts	5K-4/8 Ohms	137x15x145 mm	240mA PSE	237.00	

New SE Product	Value	Primary	Secondary	Current	Price
EL34/6550/KT88	20 watts	3K - 4/8 Ohms	117/98x92mm	130mA SE	104.00
300B/2A3/6B6/4G	25watts	2K5-4/8/160ohms	117/98x90mm	90mA SE	102.50
6L6G	30 watts	3K-4/8 Ohms	115/98x95 mm	140mA PSE	107.00

Push-Pull Circuits

Value	Primary	Secondary	Current	Price	
EL84/ECL86/6V6	15 watts	8K-4/8 Ohms	80x67x68 mm	PP	42.00
EL34/6L6G/5881	25 watts	8K-4/8 Ohms	88x73x80 mm	PP	59.00
2A3/6B6/4G/300B	30 watts	5K-4/8 Ohms	88x75x80 mm	PP	63.00
KT88/6550	50 watts	8K6 - 4/8 Ohms	108x103x90 mm	PP	73.00
EL34/KT66/5881	50 watts	8K6 - 4/8 Ohms	98x82x93 mm	PP	74.00
845	50 watts	8K6 - 4/8 Ohms	108x1180 mm	PP	114.00
EL34/6550	60 watts	4K3 - 4/8/16 Ohms	125x104x13 mm	UL PP	111.00
KT88/6550	100watts	2K2-4/8/16ohms	150x47x18mm	UL PP/PPP	134.60

Pure Silver Wired Outputs

Value	Primary	Secondary	Current	Price	
300B/2A3/6B6/4G	25 watts	2K5 - 4/8 Ohms	117/98x90 mm	90mA SE	1.645.00
211HT4-C/845	50watts	10K - 4/80ohms	112x34x50mm	150mA SE	1.975.00

The AUDIO NOTE silver wired outputs listed here are designed and made in the UK, we can supply the AUDIO NOTE Japan manufactured outputs for the ONGAKU or the KEGON, but are especially expensive, as you would expect from items that take upwards from 100 hours each to make, for example an output transformer for an ONGAKU costs £16.500.00.

AUDIO NOTE MAJIS TRANSFORMERS

This range relates to our finished products, mains transformers are notoriously difficult items to offer as the number of permutations of HT and Heater voltages are almost endless. We have added mainstransformers for making replicas of the KASSAI and ONGAKU, as there has been considerable call for these, likewise we are preparing mainstransformers for the WE91 I described in Sound Practices Issue 1, we shall continue to expand the range as opportunities and our experience with you requirements improve.

Primary Voltages	Secondary HT Windings	Secondary Heater Windings	Price Ex. UK Vat
0v/100v/110v/120v	0v - 230v at 350mA	0v-12.6v at 1 Amp	34.00
0v/220v/230v/240v	0v-230v at 0.4 Amp	3.15v-0v-3.15v at 4 Amp	
120v/110v/100v/0v	0v - 230v at 0.4 Amp	0v-12.6v at 1 A	41.00
0v/100v/110v/120v	300v - 0v-300v at 60mA	3.15v - 3.15v at 4 Amp	
100v/110v/0v/20v	0v - 230v at 40mA	12.6v - 0v at 1.5A	46.00
		6.3v - 0v at 600mA	
0v/100v/110v/120v	0v - 230v at 10v/20v	12.6v-0v at 1.5A	26.00
0v/100v/110v/120v	0v/100v/110v/120v	0v - 6.3v at 300mA	72.50
0v/100v/110v/120v	0v/100v/110v/120v	3.1 0v-244v-0v-244v+3.1 0v at 3.15v-0v-3.15v at 4.5 Amp	
0v/100v/110v/120v	0v/100v/110v/120v	1.2 6v at 1.5 Amp	98.00
0v/100v/110v/120v	0v-920v at 1.60mA	0 - 1.0v at 4 Amp, 0v-6.3v at 1.5A, 0v - 5v at 20mA	86.70
0v/100v/110v/120v	1.50v-1.50v at 50 mA	3.15v-0v-3.15v at 1.2Amp, 7v at 3A, 7v at 3A, 5v - 0v at 3A	95.60
0v/100v/110v/120v	1.70v at 50mA	3.15v-0v-3.15v at 2.5A, 7.0v-0v at 2A, 7.0v-0v at 2A, 5.0v-	

AUDIO NOTE ACIO & CHLORIDE FREE SILVER SOLDER

The best solder we have been able to find, does not contain the lead, which over time increases junction resistance. Used in all our amplifiers from OTD to the GAKU-04.

Weight/Measure	Price Ex. UK Vat
50 grammes or about 8 meter 1 mm diameter	19.95
1 kilo roll of 1 mm diameter	210.65

AUDIO NOTE CABLES & WIRES

We are proud to offer the **AUDIO NOTE** range of high quality copper and silver coax, speaker and wiring cables, which, depending on the overall price of the project, will do justice to any hi-fi system, regardless of price.

Gauge	Insulation Material	Price per Meter Ex. UK Vat
0.05mm	Polyurethane	16.75
0.2mm	Polyurethane	22.75
0.35mm	ML	24.95
0.6mm	ML	27.85
0.8mm	ML	31.75
1.1mm	ML	36.75

The above solid silver wires are suitable for Inductors for speaker crossovers, both active and passive or for internal wiring in tonearms, amplifiers etc.

AUDIO NOTE Coax Interconnect Cables

Type/Colour code	Construction	Price per Stereo Meter Ex. UK Vat
AN-A yellow	symmetrical 6N copper Iitz coax	15.32
AN-C red	symmetrical OFH Copper Iitz coax	29.79
AN-S dark grey with yellow stripe	symmetrical 99.99% silver Iitz coax	84.25
AN-V silver grey with yellow stripe	symmetrical 99.99% silver Iitz coax	152.35
AN-Vx silver grey	symmetrical 99.99% silver Iitz coax	382.98

It is recommended to use the internal twin silver wires in the **AUDIO NOTE** coax cables as internal wiring cable, this is what we do in amplifiers like the GNGAKU, M7TUBE etc.

AUDIO NOTE Speaker & Wiring Cables

Type/Colour code	Construction	Price per Mono Meter Ex. UK Vat
AN-O green	single core 6N copper speaker wiring	6.85
AN-B blue	double strand, screened 6N speaker wire	12.34
AN-L blue	double strand, screened 6N Iitz copper speaker wire	25.11
AN-SP silver	single core 15 strand 99.99% Iitz silver speaker wire	106.38
AN-SPx silver	single core 20 strand 99.99% Iitz silver speaker wire	382.98

PTFE Insulated Silver Plated Copper Wires. We can also provide less expensive wiring wires for hard wiring circuits. These PTFE insulated silver plated copper wires are 19 strand of 0.15 mm wire and come in brown, black, blue, pink, red, green, orange, violet, white and red/white, they cost £1.60 per meter in any colour.

AUDIO NOTE HIGH QUALITY STEPPED ATTENUATORS & SWITCHES

Type	Value	Price Ex. UK Vat
Stereo Potentiometer	50KOhms	198.75
Stereo Potentiometer	100KOhms	207.75
2 Channel switch	6-way adjustable	78.75
4 Channel switch	6-way adjustable	101.75

AUDIO NOTE SELECTED AUDIO VALVES

Our valves are selected from the best available sources and are tested to the same stringent standards that we apply in the production of our own amplifiers, they fall into two categories, standard production items and rare, mostly NOS (New Old Stock) valves which are no longer in production. We have compiled a special list of the NOS items, which is available on request, beware the valves on this list are NOT cheap Standard Stock Items.

Type No	Type	Price Ex. UK Vat
ECC83S/12A07		
WA7025	double triode	2.95
E88CC/65Z22/GJ8WA/7308	double triode	3.95
EF86/62B/2Z73	pentode	2.45
ECC82/12A07/5814a	double triode, mlt spec	1.75
65N7GT	double triode, UXB base	5.75
65L7GT	double triode, UXB base	2.85
65J7	pentode	1.75
56B7WA	double triode very powerful	4.55
6350WA	double triode	4.75
EL84/9B05	small power pentode	1.55
EL84M/6BQ5WA	small power pentode, mlt spec version	4.75
6V6GT	small power pentode	2.45
6L6G	medium power pentode	2.75
58B1/KT66/6L6WGC	medium power tetode	4.95
EL34G	power pentode	7.45
6550KT88	large power tetode	12.45
6C33	power regulator, indirectly heated triode	24.65
6AS7/6800	strong regulator, indirectly heated triode	6.45

2A3 4-pin	directly heated small power triode	17.95
300B	directly heated power triode	57.95
5U4G	HT-rectifier	3.25
5Y3GT	HT-rectifier	2.25
5V4GT	HT-rectifier	2.25
GZ34/5A4	HT-rectifier	8.75
6X4	HT-rectifier, very good for pre-amplifiers	2.65

RESISTORS

We offer three quality levels of resistor quality, all are 1%, starting with the Beyschlag metallfilm, which are slightly magnetic (as are the vast majority of other makes of metal film), but nonetheless very good sounding, as used in all our UK-made amplifiers, up to quality level 3 (the WFSH/UP/3) no-feedback triode amplifiers.

Beyschlag 1 watt, 1% resistors up to 500KOhm, 0.11, above 500KOhm 0.13 each
HOLCO

Better sound quality can be achieved with the H2, 1 watt, 1% non-magnetic resistors, which we regard as the best "industrial grade" metallfilm resistors available. They have one small drawback, as they are quite fragile, and require careful handling, do not bend the legs too close to the body, they may become noisy.

HOLCO resistors type H2 500PPM cost £0.36 each from 1000Ohm to 500KOhm, higher and lower values are all £0.63 each.

AUDIO NOTE HIGH QUALITY CERAMIC VALVE BASES

All of our valve bases are of the highest possible quality, made from stainless steel and using the best metal parts from alloys which retain their spring tension around the valve pin for longer. They are recommended as upgrades to most old valve amplifiers and should be an essential part of any DIY project.

Type	Mounting	Plating	Price Ex. UK Vat
4-pin U44 for 300B/2A3/801A	Chassis	Gold	8.25
4-pin U44 for 300B/2A3/801A	Chassis	Nickel	7.25
4-pin U44 WE-type for 300B/2A3/801A	Chassis	Silver	14.75
4-pin Jumbo 4 for 21 V47C/845	Chassis with bayonet	Silver/chrome	159.95
5-pin UY5 for 807	Chassis	Gold	9.75
7-pin B7 for 6X4, OAZ	PCB	Silver	6.15
7-pin B7 for 6X4, OAZ	PCB	Gold	7.85
7-pin B7 for 6X4, OAZ	Chassis from above	Silver	6.75
7-pin B7 for 6X4, OAZ	Chassis from above	Gold	7.95
8-pin UBX for EL34, 6550, 5U4G, GZ34, 6L6G, etc.	Chassis	Silver	5.65
8-pin UBX for EL34, 6550, 5U4G, GZ34, 6L6G, etc.	Chassis	Gold	8.65
9-pin B9 for ECC83, ECC88, 56B7, 6350, etc.	PCB	Silver	3.85
9-pin B9 for ECC83, ECC88, 56B7, 6350, etc.	PCB	Gold	5.75
9-pin B9A for ECC83, ECC88, 56B7, 6350, etc. etc.	Chassis from above	Silver	4.45
9-pin B9A for ECC83, ECC88, 56B7, 6350, etc.	Chassis from above	Gold	6.75
9-pin B9A for ECC83, ECC88, 56B7, 6350 etc.	Chassis from below	Silver	4.95
9-pin B9A for ECC83, ECC88, 56B7, 6350, etc.	Chassis from below	Gold	7.15

TOPCAPS

Type	Mounting	Price Ex. UK Vat
Topcap For 807 pentode etc. Nickel 9.75	You may want to start your project with less overall cost, and for this purpose we can offer the following "Industrial grade" ceramic valve bases	
8-pin for EL34, 6550, KT66, 6L6G	Chassis with bracket	1.45
9-pin for ECC83, ECC88, 56B7, 6350	Chassis with shroud	1.85

AUDIO NOTE CERAMIC STAND-OFFS

In most hardware valve power amplifiers it is frequently difficult to get the HT and heater rails properly suspended and separated, safely and neatly from the chassis, this especially applies when building amplifiers using the really high voltage directly heated triodes like 211, V74C, 845, 845, 30MT, OA100 etc. When planning design like this, it is important to incorporate suitable layout from the start, and the **AUDIO NOTE** stand-offs should be more or less mandatory in that context. They are screw-in with stainless insulator and either a wrap-round turned "head" on the single way version or separated solder slots on the multi-way versions.

Type No	Number of Tags	Height/Length	Solder Connection	Chassis Fixing	Price Ex. UK Vat
AN-421	1	25.5 mm	Wrap-round	Screw-in bolt	1.41
AN-422	1	17.4 mm	Wrap-round	Screw-in bolt	1.41
AN-423	1	22.6 mm	Solder slot	Screw-in	1.41
AN-452	2	Adjustable, 17mm	Solder slots	Dual bolt screw-in	2.42
AN-453	3	Adjustable, 24mm	Solder slots	Dual bolt screw-in	3.05
AN-455	5	Adjustable, 30mm	Solder slots	Dual bolt screw-in	4.04
AN-458	8	Adjustable, 55mm	Solder slots	Dual bolt screw-in	5.79
AN-460	10	Adjustable, 72mm	Solder slots	Dual bolt screw-in	7.31
AN-476	6	25mm/45mm	Solder slots	Screw-in bolts	5.35
AN-479	9	25mm/60mm	Solder slots	Screw-in bolts	7.53

BLACK GATE ELECTRON TRANSFER - High Performance, Graphite Electrolytic capacitors. There are very few audio parts that promise a guaranteed improvement when replacing practically any other part, but this is what the **BLACK GATE** capacitors actually do. Exchanging any electrolytic capacitor anywhere in the circuit of an amplifier or in the crossover of a speaker will greatly improve sound quality. We are working on some guidelines as to where, how and which types of Black Gates to use in different circuits, the first such technical guideline is available now and is called "Improving your CO-Player" and can be obtained by sending a stamped addressed envelope to us requesting this leaflet. All **AUDIO NOTE** Level 2 Signature products use **Black G-ET-Electro Trans-fer** in critical signal/power supply junctions.

It is very important to note that all **BLACK GATE** capacitors take time to charge-up or stabilize when first put in circuit, depending on type and application this "maturing" time can be between 100 and 300 hours.

Value	Voltage	BG-Type	Suggested Use	Price Ex. UK Vat
47mf	25volt	PK	Anywhere	1.65
33mf	35volt	PK	Anywhere	1.75
0.47mf	50volt	PK	Anywhere	1.05
1mf	50volt	PK	Anywhere	1.12
2.2mf	50volt	PK	Anywhere	1.23
3.3mf	50volt	PK	Anywhere	1.38
4.7mf	50volt	PK	Anywhere	1.88
10mf	50volt	PK	Anywhere	1.87
22mf	50volt	PK	Anywhere	2.68
100mf	50volt	Standard	Anywhere	5.47
100mf	100volt	Standard	Anywhere	7.75
1000mf	100volt	Standard	Anywhere	8.22
220mf	100volt	Standard	Anywhere	24.55
470mf	100volt	Standard	Anywhere	4.35
2200mf	100volt	Standard	Anywhere	6.35
10000mf	50volt	Standard	Anywhere	13.45
4700mf	50volt	Standard	Anywhere	14.25
47mf + 47mf	500volt - 550v surge	SK-Type	PSU filter capacitor	85.95
100mf + 100mf	500volt - 550v surge	SK-Type	PSU filter capacitor	101.95
100mf	500volt - 550v surge	SK-Type	PSU filter capacitor	72.75
220mf + 220mf	350volt - 400v surge	SK-Type	PSU filter capacitor	92.65
100mf + 100mf + 100mf	100mf-350volt - 400v surge	SK-Type	PSU filter capacitor	75.35
22mf	350volt	WK-Type	Decoupling or filter capacitor	18.95
220mf	100volt	F-1 Type	Low ESR version	6.75
220mf	100volt	FK-1 Type	Ultra low ESR version, comparable to film caps	9.95
1000mf	50volt	FK-2 Type	As above use anywhere	43.95
2200mf	50volt	FK-1 Type	As above use anywhere	98.85
500mf	50volt	C-Type	For circuits with DC potential difference	2.07
1.75mf	50volt	C-Type	For circuits with DC potential difference	3.35
1mf	50volt	N-Series	Bipolar for use in negative feedback circuits etc.	4.95
4.7mf	50volt	N-Series	as above	5.75
10mf	50volt	N-Series	as above	6.95
47mf	50volt	N-Series	as above	13.75
500mf	50volt	N-Series	as above	18.95
6.8mf	50volt	Bipolar	For loudspeaker crossover networks	8.95
50mf	50volt	Bipolar	as above	10.85
50mf	50volt	Bipolar	as above	17.45
50 volt	50 volt	Bipolar	as above	27.95
6.3volt	6.3volt	BG-NxType	For super low noise PSUs	11.85
1 volt	1 volt	BG-N Type	For super low noise PSU's	24.65
1.5volt	1.5volt	BG-N Type	as above	28.95
1.5volt	1.5volt	BG-N Type	as above	210.45
35volt	35volt	BG-N Type	as above	6.65
50volt	50volt	BG-N Type	as above	99.95
100volt	100volt	BG-N Type	as above	423.35

In our component list you will find a listing of all available Black Gate valves, together their sizes best usage etc. Lastly, we can supply a range of more modestly priced components, still good quality, but more industrial grade, if you like.

SHIMKOH Tantalum Film Resistors

This is definitely the best sounding resistors available, forget the VISHAY, which may be ok in high feedback transistor amplifiers, but in our opinion quite uncomplimentary to the qualities of real Audio Amplification (it is directly heated triode amplifiers running feedback free in single-ended Class A), this is where you will need the tantalum film resistor for the best results.

The 1/2 watt Shimkoh tantalum resistors are non-magnetic and cost £2.06 each.

AUDIO NOTE 1 WATT TANTALUM RESISTORS

Up to now the tantalum film resistors have been extremely difficult to get, however, after much persuasion and against a minimum quantity, guarantee from **Audio Note UK**, the manufacturers have agreed to widen the range of 1/2 watt and reintroduce the 1 watt range, which becomes an exclusive range for **AUDIO NOTE**, we consider this to be major breakthrough, since without a reasonable range of values at the 1 watt rating it is pretty difficult to get the very best out of the best circuits. As with most handmade specialist items, which covers most on this list, delivery can be quite long on some values, so be prepared to wait till the value is not in stock.

The AUDIO NOTE 1 watt 1% tantalum resistor values are £3.70 each		
2200mf axial	50volt	35x18 mm radial, 41x16 mm
220mf axial	0.87	
10mf	160volt	15x10 mm radial
22mf	350volt	25x12 mm radial
450mf	22mf	41x16 mm axial
72mf	450mf	25x21 mm radial
350mf	56mf	30x21 mm radial
56mf	100mf	13x10 mm radial
68mf	400mf	38x18 mm radial
100mf	400mf	30x25 mm radial

220mf	385vml	52x30 mm radial can	4.45
220mf	450vml	40x30 mm radial can	5.85
220mf	550vml	112x35 mm radial screw terminals	27.65

RCA, BNC, BANANA, PLUGS, RCA SOCKETS, SPEAKER & GROUND TERMINALS & LOUDSPEAKER SPADES. Hi.A PLUGS. Standard Gold plug 1.55. AN-C Gold plug 3.65. AN-IP AUDIO NOTE gold plug 8.51. AN-P **AUDIO NOTE** Silver plug, teflon insulated, non-magnetic 25.53.

RCA Sockets.

Type	Mounting	Price Ex. UK Vat
RCA socket nickel plated	Chassis mounted	0.41
RCA socket gold plated	Chassis mounted	0.65
AN-CS AUDIO NOTE non-magnetic, teflon insulated, gold plated	Chassis mounted	3.65

BNC Plugs & Sockets.

Type	Price Ex. UK Vat
Standard BNC plug	3.45
BNC Silver plated socket chassis mounted	2.05

Banana Plugs, Loudspeaker Cable Spades, Chassis Loudspeaker Terminals

Type	Price Ex. UK Vat
Banana plug, gold plated, spring loaded tension	2.45
AUDIO NOTE Loudspeaker Cable spade, silver plated, non-magnetic	4.65
AUDIO NOTE AN-ST/SPEAK Terminal, chassis mounts, nickel plated, red or black	1.85
AUDIO NOTE AN-ST/G Speaker Terminal, chassis mounts, gold plated, red or black	2.75
AUDIO NOTE AN-ST/R Speaker Terminal, chassis mounts, gold plated, non-magnetic, red or black	75
Ground Terminal, chassis mounted and nickel plated	1.45

Our range of components is constantly expanding, as we find new or better suppliers, so stay in touch by reading our adverts in HiFi World and HiFi News.

FERRITE RINGS.

In many systems, especially ones using transistor based amplification, there is often a problem of frequency RF mixing into the feedback loop, especially from controlled CD-players, clamping a ferrite rings around the cable between the CO-transmpart and the DAC or the output of the DAC or CO-player and the pre-amplifier input yields surprising results.

A set of two Ferrite rings costs	£8.50
----------------------------------	-------

AUDIO NOTE COMPLETE KITS.

We are developing a range of complete kits, to give those of you who have the ability, but do not have the time to develop a project from the ground, so to speak. In order to be able to offer this price-quality-relationship the kits we offer will be good basic circuits, with no-bills power supplies and components, all kits have input volume control to allow use of a single source, like CO-player direct.

KIT ONE.

Based around the justly famous 300B directly heated triode, we see this kit as the introduction to real Audio Amplification, as it covers all the important aspects of design necessary, Single-Ended, No-Feedback, Class A, Directly Heated Triode, to become a member of this exclusive club of amplifiers.

Kit One has one 300B per channel running at 420 volts with 75mA current giving 9/10 watts of the cleanest power you will ever hear, the inputstage consists of a 65N7GT with a 56B7 double triode driver stage running in SRPP. The power supply is a capacitor-choke-capacitor with a 5U4GT HT rectifier, the heaters are AC heated. Component quality is similar to our Level 2 treated products. **AUDIO NOTE** paper in oil signal capacitors, Bayschlag 1% metal film resistors, good quality electrolytics (ponny NO Black Gate) and a simple, attractive stereo chassis in grey paintwork. Protecting cover is extra.

World favourites

COMPACT DISC PLAYERS

NAD 501	£180	A break from the MASH tradition, the Philips powered 501 gives excellent results.	Apr'94
ROTEL RCD965 DIS	£350	A smooth and easy sound make this one of the best value players around.	Jan'94
QUAD 67	£790	A new breed of Quad. Lacking nothing in verve or excitement.	May'93
SUGDEN SDT 1	£850	Airy and spacious with a rare quality of ambience.	Mar'93
NAIM CDI	£1598	Single box, 16 bit player. Close to the two box CDS, has vital 'tingle factor'.	Apr'92

COMPACT DISC TRANSPORTS

ARCAM DELTA 250	£750	Transport with sync-lock facility. Good partner to BB50	May'94
DPA DIGITAL T-1	£795	Superbly detailed sounding transport when sync-locked to DPA's converters.	Jan'93
ORELLE CD10-T	£799	Very involving, unforced and natural when used with Orelle's DA-180 DAC.	Feb'94
M'MEGA DUO CD.2	£1850	Seriously priced, serious CD using Philips' CDM-9 PRO mechanism. Exemplary.	Apr'93

DIGITAL TO ANALOGUE CONVERTERS

DACULA	£376	This little devil from Select Systems really gets its fangs into the music.	Dec'93
ARCAM BB50	£450	Detailed, sweet and lively sound. Sync-lock to Delta 250 transport for best results.	May'94
DPA LITTLE BIT II	£450	Clean and confident sound with good resolution and focus.	May'94
ORELLE DA-180	£599	'Analogue' sounding converter, best with matching transport.	Feb'94
P. T. ORDINAL	£695	Pure sound, smooth and free from harshness. One of the best at any price.	Jul'93
P. T. DA CAPO	£1450+	Pink Triangle's own one bit DAC reaches new standards in digital. One of the very best.	
		Even better with DC supply and new filter options.	Mar'94
DPA 1024	£6000	A reference for all other converters. DPA's own discrete design.	July'94

TURNTABLES

PRO-JECT 6	£350	Great involvement and rhythm. Comes with Ortofon MC15 for £399	Dec'93
MICHELL MYCRO	£397	In between the Syncro/Gyrodec, the Mycro has superb midband clarity and poise.	Apr'92
TOWNSHEND ROCK III	£799	The MkIII has a fabulously stable, solid image and terrific bass.	Feb'94
P. T. ANNIVERSARY	£1200	Very neutral turntable. Excellent imagery and detail.	May'92
SME MODEL 20	£2495	The last great turntable, bettered only by the £11,000 Model 30.	Oct'92

TO NEARMS

REGA RB 300	£139	Simple and superb; dynamic with solid bass.	Various
SME 309	£568	Based on IV and V: Aluminium armtube and detachable headshell.	Jan'93
SME IV	£850	Loses little to the fabulous V, possibly the best value for money SME.	Dec'93
SME SERIES V	£1232	A masterpiece of precision engineering, with a cohesive sound.	May'92

CARTRIDGES

GOLDRING 1012 GX	£60	Rounded bass, slightly forward midband, clean transients. A bargain.	Jul'93
GOLDRING 1022GX	£80	Extra degree of dynamic range and speed over the 1012GX	Jul'93
SUMIKO BLUE POINT	£100	The Blue Point casts a romantic charm over all types of music. Robust too.	Oct'92
ORTOFON MC15	£100	Moving coil cartridge at a moving magnet price. Has a tight grip on rhythm.	Jun'92
GOLDRING 1042	£100	A reference to all other MMs regardless of price	May'92
ORTOFON SUPREMES	£225-450	The MC10, 20, & 30 Supremes offer superb sound and value for money.	July'94
LINN KLYDE	£450	Soft treble, but a stonkingly good cartridge.	June'94
ORTOFON MC2000	£650	We came across this one by accident; used on a Garrard 401 with an SMEIV it gave one of the best results we've ever heard.	Dec'93
ORTOFON MC7500	£2000	The best MC available? Produces real-life scale of music.	May'94

CASSETTE RECORDERS

AIWA AD-F850	£230	Fine recording quality and good playback. A real bargain.	July'94
NAKAMICHI DR2	£500	Worth every penny, pushes recordings to the limit and remains unflustered.	Feb'94
NAKAMICHI DRI	£780	Nakamichi sound quality, and manual head azimuth adjustment.	Jun'93
NAKAMICHI CR-7	£1500	No Dolby 'S', but auto tape tuning and motorised head. The Best!	Aug'92

TUNERS

NAD 402	£160	Stunning budget tuner, with a warm and open sound. Can compete with the best.	Jan'94
AURA TU-50	£230	Superb FM-only tuner. Produces a delightful, three-dimensional sound. A cracker.	May'92

World favourites

MISSION CYRUS FM7	£299	Clear and lucid sound. One of the best, regardless of price.	Apr'94
QUAD 66FM	£490	Among the very best in terms of tonal colour and imagery. Remote controllable.	Nov'92
NAIM NAT 03	£500	Warm and easy sound with a good sense of atmosphere. Good value.	Sep'93
NAIM NAT 01	£1377	The best solid state tuner currently available. For better radio, live in the studio!	Mar'92

INTEGRATED AMPLIFIERS

NAD 302	£160	Lots of insight and detail, but could sound a little rough in the wrong system.	Jan 93
PIONEER A-300X	£200	Exceptionally sweet mid and treble, plus the superb dynamic range of the A400.	Dec'92
DENON PMA-350II	£220	Powerful and with deep rhythmic bass drive.	Sep'93
ARCAM ALPHA 5	£230	Lots of life and energy; a good phono stage too.	June'94
ROTEL RA960BXII	£325	Suits a wide range of music always sounding confident and open.	May'94
AURA VA50	£350	Powerful bottom end with detailed and spacious mid and treble.	June'94
AUDIOLAB 8000A	£430	Very neutral and superbly built. Good bass, great imagery, but can be sterile.	Apr'92
J.SHEARNE. Phase2	£495	Gorgeous looks, even better sound. Tight, quick bass and valve-like mid and treble	Dec'93
MISSION CYRUS III	£499	Superb engineering, a solid cast chassis and a clear and spacious sound.	Apr'94
SUGDEN A21a	£639	Class A transistor amp. Sharp, crisp, deep, tight, and it images well too.	Feb'94
EAR 834	£1295	Valve integrated amplifier with a sweet, open and detailed sound.	Feb'93
AUDIONOTE OTO SE	£1500	10watts of the sweetest sound around. Use sensitive speakers though	Aug'94

PRE-AMPLIFIERS

EAR.834P	£290	MM/MC phono stage. Uses valves to create a rich sound with tremendous depth.	Jan'94
A. Innovations. LI	£299	Valve line level preamplifier. Outstanding results with vdH carbon interconnect.	Feb'94
A. SYNTH. PASSION	£475	Or £275 for the kit version. Unrivalled transparency from a passive pre-amp.	Aug 93
ROSE RV23-S	£495	Valve/Transistor hybrid. Smooth and clean, rich and spacious.	Nov'93
DPA DSP 200S	£495	Not quite the 50S, but there's still nothing to match it at the price.	Jun'93
MICHELL ISO HR	£850	Impossible not to recommend. What more does your vinyl want?	May'93
NAIM NAC82	£2000	Remote control preamp. The NAC82 thrusts detail forwards in true Naim fashion.	Apr'94

POWER AMPLIFIERS

ROSE RP-190	£495	Used with the Rose pre-amp it gives 70 watts of smooth relaxing sound.	Nov'93
SUGDEN AU41P	£530	100 Watts of smooth, detailed, full bodied sound. And at a bargain price.	Apr'93
QUAD 606	£675	140W powerhouse. Smooth and civilized, with the legendary Quad back-up.	Aug'93
DPA DPA 200S	£750	Not as cold as the 50S. Better than anything else at the price.	July'93
NAIM NAPI80	£898	Partner to NAC82. Has real drive and grip on loudspeakers.	Apr'94
MICHELL ALECTO (S)	£1300	Valve like transparency, big warm easy going sound.	Sep'93.
MICHELL ALECTOS	£1800	The Alectos have a lucidity and three dimensional realism that is rarely attained.	Dec'92
CHORD SPM 1200	£2995	Massively powerful, dynamic and detailed sound. Among the best of solid state.	Mar'93
E.A.R. YOSHINO	£25,000	Single-ended valve design. Noel is still suffering withdrawal from this product.	Jul'93

LOUDSPEAKERS

GLL MAXIM	£120	Replacing the Maxim 3; not as tight in the bass but still one of the best at the price.	Aug'93
MISSION 760ISE	£150	One of the best miniatures around, very musically involving.	Jan'94
HARMAN LS 0300	£200	Glass fibre woofer gives a forward and open mid with good bass kick	Nov'93
TDL RTL 2	£250	Bass on a budget. Solid, vibrant and spacious sound.	Dec'93
SYSTEMDEK 93 I	£300	Poor man's LS3/5a? Coherent and involving, these little gems really sing.	Mar'94
HARBETH HL-P3	£400	There probably isn't a more neutral sounding design anywhere near the price.	Feb'93
ROGERS LS8a/2	£449	Big, enjoyable, room filling sound from this 2-way floorstander.	Feb'94
REL STRATA	£499	Rel's Strata offers excellent bass depth and power.	Mar'94
JPW RUBY I	£500	Metal driver 'speaker with an exciting and lively presentation.	Aug'93
H'BROOK QUARTET	£555	Sensitive enough to work with low power valve amps. Fast and detailed sound.	Jul'93
CASTLE CHESTER	£600	Good solid sound and beautiful finish. 1/4 wave bass bading.	May'94
SYSTEMDEK 937	£600	Transmission line floorstander that won't offend.	May'94
TANNOY D100	£650	Believable 3D images produced by this small dual concentric speaker.	Jan'94
PROAC Studio 100	£699	Excellent monitors with detailed, natural sound and plenty of atmosphere	Feb'94
SPENDOR SP2/3	£769	Smooth sounding speaker with a superb mid-range. Very easy to listen to.	Feb'94
UKD CALLAS	£850	Powerful bass and high quality sound from a solid wood miniature.	Aug'94
TANNOY D700s	£1970	Dynamic and powerful. Needs a good clean power amplifier for best results.	Sep'93
QUAD ESL63	£3228	A reference to all others; superb imaging qualities and transparent sound.	Various

Cricklewood Electronics Ltd

You don't have to spend a fortune on High Quality Valves. Our valves are manufactured to a very high standard and compare favourably to brand names costing much more.

Good valves at economical prices

ECC81	4.50	GZ34	7.5
ECC82	4.50	6L6G	6.50
ECC83	4.50	6V6GT	4.50
EF 86	4.50		
EL 34	8.50		
EL 84	4.50		

P&P £3.50 + VAT up to 6 valves

Supersound Axial Polypropylene Capacitors

- * Extremely low distortion
- * Detailed acoustic properties
- * High purity tinned copper leads
- * Tight wound thick dielectric for resonance elimination.
- * Low dissipation factor
- * All units proof voltage tested at 150% rated voltage for 15 mins

Tol +5%	250v	400v
100nF	0.85	1.00
220nF	0.85	1.00
470nF	0.85	1.00
1uF	1.00	1.25
2u2	1.35	1.50
3u3	1.50	1.75
4u7	1.75	2.00
6u8	2.25	2.50
10u	3.00	3.50
15u	4.00	4.50
22u	6.25	6.95
25u	6.25	6.95
50u	10.00	11.00
75u	15.00	17.00
100u	19.00	21.00
125u	20.00	22.00

P&P £2.50 + VAT

Elna Cerafine Ultra High Quality Reservoir Capacitors.

The electro-chemical action of superfine particles of ceramic material between the separating sheets ensures extremely even/discharge cycles to produce an excellent reservoir, that allows purity of sound, exceptionally low distortion (3rd HD-150db at 10kHz) and superb low frequency response.

10,000uF 80V Ripple 7.1A	£19.00
22,000uF 56V Ripple 10.8A	£22.00

P&P 1.00 + VAT per capacitor

Bravox Loudspeaker Chassis
Excellent quality though economic price.

Woofers 8 ohms Foam edge

5" 50W Res freq: 70Hz	12.00
6 1/2" 70W Res freq: 50Hz	£13.25
8" 70W Res freq: 45Hz	16.25
10" 100W Res freq: 28Hz	24.00

Full range 8 ohms Paper edge

12" 200W Res freq: 72Hz	46.00
-------------------------	-------

Tweeter 8 ohms polycarb dome

100W 1.2KHz - 20KHz	7.50
---------------------	------

Please phone for post & packing options.
Please add VAT to the above price.

We stock a vast range of power transistors, diodes & ICs, cable, connectors, capacitors etc. Please phone for your requirements. 1995 Catalogue due Oct 94 price £2.50.

Cricklewood Electronics Ltd
40 Cricklewood Broadway
London NW2 3ET
Tel: 081 452 0161, 081 450 0995
Fax: 081 208 1441

DARBY'S OF ST ALBANS

SEASON CLEARANCE OF DISPLAY
USED PLUS SOME BOXED HI-FI EQUIPMENT (All with guarantees)
PLEASE PHONE FOR FURTHER DETAILS

	OUR PRICE	Normal Price		OUR PRICE	Normal Price
Acoustic Energy AE3	999	(2000)	Denon DAP5500	649	(850)
Yamaha NS1000	999	(1300)	Denon AVC 3020	599	(730)
KEF 104.2 (BXD)	1399	(1600)	Denon DCD 1520	279	(550)
RUARK Broadsword	599	(800)	Lynx Quasar	399	(500)
S.D. Acoustic OBS	399	(700)	JBL XPL90	529	(700)
Arcam Delta 170.3/BB5	849	(1150)	Mus. Fid. Pre3A/P1.50	649	(830)
Arcam Delta 100 (C/Deck)	699	(850)	Yamaha CDX1110	249	(700)
Revax B251	499	(1000)	Alphason Sonata/HR8100 999		(1450)
Sony CCD V6000			Sony CDP 338 ES	399	(600)
Camcorder	1499	(2000)			
Pioneer SDT5000					
Proj. TV	3400	(4300)			

Further Examples:-

Arcam Delta 60	229
Arcam Delta 80	249
Arcam Delta 70.3	549
Arcam Alpha 3 1	69
Denon AVC3020	599
Denon AVC3530	899
Denon DCD 1520	299
Denon DRA 545R	269
Harmon TU909	129
Harmon TD4200	159
Musical Fidelity T1	149
Musical Fidelity CD2	269
Pioneer CLD 1750	499
Mission Cyrus 2/PSX	329
Mission PCM 7000	149
Monitor Audio HA 14	349
BOSE 301	319
BOSE 401	399
Celestian 7	189

Further examples:-

QUAD 33/FM3/303 Sleeve	199
Quad 34	219
Quad 44/405	349
Ruark Sobre	299
Ruark Swordshaw	239
Ruark Rhapsody	499
Sony STS 570	179
Sony CDP 222 ES	239
Sony CDPX 303ES	399
Sony TAF 670 ES	349
Sony TCK 730 ES	349
Yamaha DSPA 1000	699
Yamaha DSPA 500	429
Yamaha CC70 system	528
Yamaha CDX 560	179
Yamaha KX 630	229
Wharfedale Coleridge	249
Technics ST9038	59
Arcam A60	59

BARGAIN PRICES ON SONY CAMCORDERS, EDITING EQUIPMENT & ACCESSORIES AND 'S' VHS VIDEOS.

6 MARKET PLACE, ST ALBANS, HERTS
TEL: 0727 851596/850961
ACCESS/VISA/SWITCH/MAIL ORDER WELCOME



REFRESHINGLY DIFFERENT

the powerplant

CYRUS, REGA and ARCAM products now on demonstration

Roksan, Micromega, Audiolab., Rega, Arcam, Aura, ATC, Exposure, Marantz, Ruark, Epos, Thiel and other fine equipment

66 Upper North Street Brighton 0273 775978



Does your CD player sound dull, lifeless, fatiguing? Are you tired of the sound of your amplification system? If so, then you need a musicality injection!

Sequoia Design can provide an upgrading service for your whole system or individual separates.

CD upgrades from £161, amp upgrades from £149 pre-power combinations, cassette decks, loudspeakers all catered for.

All work is carried out by a highly qualified electronics design engineer with a passion for high quality music reproduction. All modifications are fully guaranteed and all money refunded if you are not satisfied.

WRITE FOR DETAILS TO : JOHN CHEADLE
SEQUOIA DESIGN, CEFN-YDFA,
NEWBRIDGE-ON-WYE POWYS, LD1 6HT

"WHERE SERIOUS MUSIC BEGINS"

FOR THE BEST |  ADVICE
 INSTALLATIONS
 DEMONSTRATIONS
 AFTER SALES SERVICE

SPALDINGS

The South East's Leading Hi-Fi Specialists

352-354 Lower Addiscombe Road Croydon Surrey CR0 7AF

081 654 1231/2040

TRAX



STANDARD CASE



FULL AND SEMI FLIGHT CASES

THE ULTIMATE IN RECORD/COMPACT DISC/CASSETTE PROTECTION

Presenting a selection of cases carefully designed to meet the needs of Collectors, DJ's and all Buyers of Records, CD's, Cassettes

Introducing our new range of semi and full flight cases for '94

These Cases are constructed from Plywood/M.d.f. Full Flight finished in Stucco Alloy covering with all heavy duty Aluminium/Steel Corners, Catches, Lift-off Hinges and Angle Trim. Semi-Flight same as full Flight but Finished in Black Vynide Covering.

	Standard	Semi-Flight-	Full-Flight
A - holds 200 singles	£39.99	£59.99	£69.99
B - holds 400 singles	£45.99	£64.99	£75.99
C - holds 600 singles	£49.99	£69.99	£79.99
D - holds 50 albums	£45.99	£64.99	£75.99
E - holds 100 albums	£49.99	£69.99	£79.99
F - holds 100 CD's	£45.99	£59.99	£69.99
G - holds 200 CD's	£49.99	£69.99	£79.99
H - holds 100 cassettes	£45.99	£69.99	£79.99

All prices include Postage & Packaging in the UK. Overseas customers add £25 per case for delivery

Ring now and order by ACCESS/VISA 0803 855746

Standard cases are constructed from high density chipboard/Ply and finished with black vinyl cloth with protective aluminium trim with reliable catches and lift-off hinges.

Please send cheque/PO made payable to TRAXS, BODENA WORKSHOPS, HORSEPOOL ST., BRIXHAM, DEVON TQ5 9LD. Allow up to 21 days delivery.

"Sweet is the sound of music to those who have experienced better hi-fi"



Linn Naim Rega Arcam Quad Audiolab
 Royd Kef Epos Mission Nakamichi Denon
 Rote Teac Micromega

Access & Visa
 % Finance
 BADA

Real Hi Fi
 Hear the difference

Demonstration
 Installation
 Service

BETTER HI-FI

The Essence of Music
 16 COOK STREET, LIVERPOOL L2 9RF ☎ 051-227 5007

Anyone can let you hear music . . . it takes a specialist to help you listen to it.

We're in the business because we realise how important music is.

At our shops the more a system costs, the better it sounds - but only YOU can decide how good a sound you want.

Let us show you how we judge hi-fi equipment and how we can help you decide which equipment will give you the most pleasure.

You will hear for yourself the full range of performance possibilities because we select only the best sounding products.

We won't pressurise or confuse you with sales talk or technical specifications and you can rely on the fact that you won't get a better sound or better value elsewhere.

As independent businesses we both offer:

- A high standard of friendly demonstration.
- A wide range of performance levels.
- Single speaker listening rooms so you can judge easily.
- A professional set-up and home installation service.
- Guidance on how to get the most out of your system.
- Connection of video through your hi-fi system and multi room system installations.
- Expert factory trained service personnel and backup you can rely on.
- Support in the future so you can improve, expand and update your system whenever you want.
- Above all, a commitment to providing all our customers with the best sound possible.

For one hour
of your time, we'll give
you a lifetime of
musical pleasure.

You won't believe how far hi-fi has come until you hear it for yourself. If you're interested in the best sound available you've got to check us out - we will not disappoint you.

Please call in, or ring, fax or write to us for a personal invitation to a private demonstration or one of our public musical evenings - whichever you prefer.



CHRIS BROOKS AUDIO
29 Gaskell Street
Stockton Heath
Warrington Cheshire
WA4 2UN
Tel: 0925-261212
Fax: 0925-264001

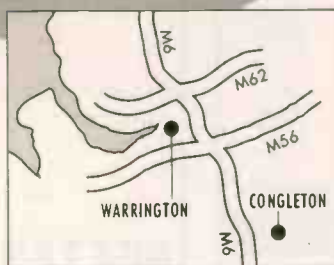

CONGLETON HI-FI
1-1A Duke Street
Congleton
Cheshire
CW12 1AP
Tel: 0260-297544
Fax: 0260-297544

Congleton
HI-FI



LINN

CHESHIRE'S ONLY AUTHORISED DEALERS OF LINN HI-FI PRODUCTS

EX-DEMONSTRATION & SECONDHAND SALE

Quad 66 preamp	£499	Quad 66 power amp	£450
AVI dac	£350	Quad 606 tuner	£375
ATC 10 ldsprks	£795	Rogers LS7t ldsprks	£249
Chord SPM 800 amp	£1399	DNM 3A6 preamp	£980
LFD "O" inc pno stage	£529	KEF 104 AB ldsprks	£175
AE1 ldsprks	£495	Sequence 30 ldsprks	£150
Meridian 206 del/sig	£699	Harbeth HL Compact	£325
Moth 100 wpc monos	£350	NVA A60 power amp	£250
Meridian Dac 7	£249	Origin Live OL2's	£449
NVA P50 preamp	£150	NVA Phono 1	£120
Sansui 417R amplifier	£190		

For new equipment see us in Lincolnshire Dial-a-Dealer

Cottage Audio

17 Bridge Street, Saxilby, Nr. Lincoln. LN1 2PZ
Tel: (0522) 702834 eve: (0522) 696708

CABLE TALK

BRITISH MADE

★★★★★Rated interconnects and speaker cables are available from your local specialist dealer.

.....STOP PRESS.....STOP PRESSSTOP PRESS.

"Talk 3's great sound quality and value for money"
(Dec '92 WHAT HI-FI?)

Can now be obtained in a convenient bi-wire format at £4.50 per metre.

Please telephone 0483-750667 Fax 0344-360866
For Further Information

o v e r t u r e

Tears for Fears ?

Save the distress, visit the best !

- ◆ Linn Products ◆ Arcam ◆
- ◆ Naim Audio ◆ Meridian ◆
- ◆ Quad ◆ Nakamichi ◆
- ◆ Denon ◆ Heybrook ◆
- ◆ Mission ◆ Epos ◆
- ◆ Audioquest cables ◆



◆ Open 6 days ◆ 10.00 to 18.00 ◆ BADA ◆

Overture HiFi Specialists

3 Church Lane
BANBURY

OXON

(0295) 272158

COURT & SPARK

**RHODIUM PLATED MK
MAINS PLUG FOR A
LONGER LASTING
CLEAN CONTACT.
SUPERIOR TO GOLD
RHODIUM WILL LAST
TEN TIMES LONGER!!**

13 Amp £12.95
15 Amp £14.95

Wall Socket
Single £20.95
Double £30.95
I.E.C. Plug 9.95
Speaker Plugs
(pair) £9.95

(p+p included)

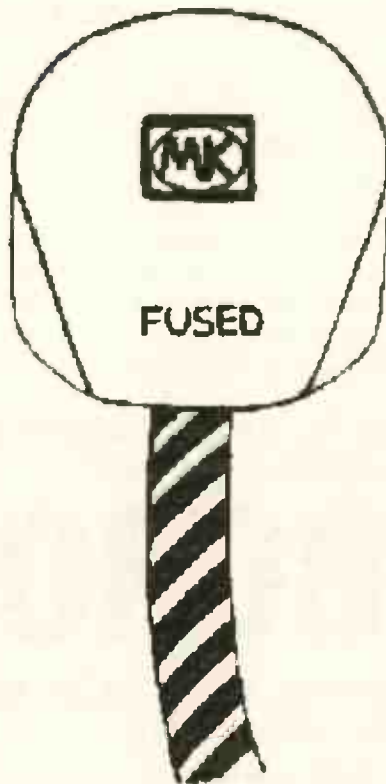

**TO ORDER SEND
CHEQUE/POSTAL
ORDER WITH NAME
AND ADDRESS MADE
PAYABLE TO:**

**T. WESTERMAN
41 GREVILLE STREET
HATTON GARDEN
LONDON EC1**

TEL. 071 - 242 2329

SOCKET 'n' SEE!

FI - RAX

ADJUSTABLE AUDIO FURNITURE

High quality
Aluminium
Construction
Various Finishes
available.

Adjustable
Glass Shelves
sitting on
Isolating Rings.

Any size or
shape custom
made on request.



Tel: 0924 277626

FAX: 0924 270759

**JEM DISTRIBUTION
SPRINGFIELD MILLS SPA ST.,
OSSETT, WAKEFIELD,
WEST YORKS WF5 0HW**



**The Three Musicians
by Steven Emberton**

Limited Edition signed prints available 23" x 16"

also commissions taken.

**Phone for free information pack
071 266 2587**

WANTED

We wish to buy all kinds of secondhand Hi-Fi equipment from budget to exotic, old or new, working or not, odd items or complete systems.

- TURNTABLES - Japanese, Linn, Rega, Thorens, Lenco, Garrard, Dual, Michell etc.
Belt Drive, Direct Drive, Idler Drive, plus Tonearms and Cartridges.
- AMPLIFIERS - Small ones, Large ones, Good ones, Bad ones, Valve ones, Transistor ones.
Japanese, Armstrong, Rogers, Leak, Quad, Meridian, Pre-Amps, Power-Amps etc.
- RECEIVERS - Japanese, Goodmans, Leak, Armstrong etc.
- TUNERS - Analogue ones, Digital ones etc.
- CASSETTE DECKS - Single, Twins, Old Top Loaders etc.
- REEL - REEL - Revox, Aiwa, Philips, Ferrograph etc. Reels of Tape
- CD PLAYERS - Geriatric ones, Modern ones, Multibit ones, Singlebit ones.
- SPEAKERS - Big ones, Little ones, Famous ones, Forgotten ones, Brown ones, Black ones, inc. Diamonds,
Goodmans, Maxims, Celestion, Dittons etc.
Bookshelf ones, Floorstanding ones, Drive Units, Crossovers.

JOB LOTS OF ACCESSORIES, DEALERS TRADE INS., CLEAR-OUTS, DISCONTINUED MODELS, EQUIPMENT RACKS, CABLES, PLUGS, RECORD, TAPE, CD COLLECTIONS, GOOD, BAD, OLD, UGLY, BULKY, TINY, WORKING OR NOT.

LOUGHBOROUGH

HI-FI

**38 BAXTER GATE, LOUGHBOROUGH, LEICS. LE11 1TQ
TEL. 0509 - 239521/236113
OPEN 9 - 5.30 6 DAYS.**

Aria. A new way to look at hi-fi support.

Introducing the Aria Modular Hi-Fi Support System. It can change the way you look at your components.

Build up separate vertical shelves. Or link units side by side. Either way, Aria lets you vary shelf heights to suit your components. Start with a Base Pack and go from there.

There's no limit to the number of ways you can build it up.

Not only does Aria give you more flexibility than any other hi-fi support system, it also provides positive sound deadening and decoupling benefits. With black tubular steel legs. Grey tinted glass or black MDF shelves.

And adjustable carpet-piercing spikes.

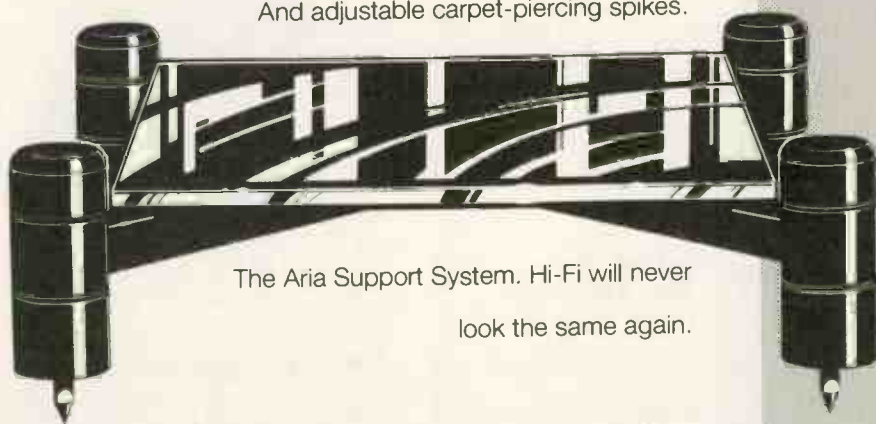
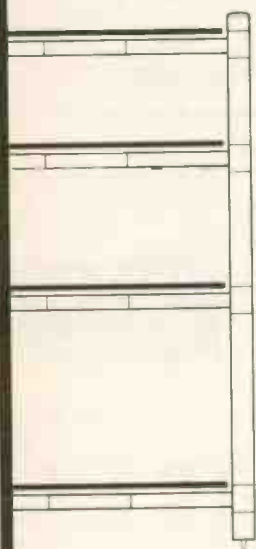

The Aria Support System. Hi-Fi will never look the same again.

I want a good look at the Aria system. Please send me a brochure.

Name

Address

Post code

APOLL
HI-FI FURNITURE

Our components improve yours

Zenith Crown Ltd., Tipton road, Dudley, West Midlands, DY1 4SQ Tel: 021 520 5070/1432

M.J.S. HI-FI



Agencies Include:-

Audiophile Furniture, Basis, CAT, Cogan Hall, Concordant, Dynalab, Gamma, Graham, John Shearne, Kinshaw, Link, L.F.D., Lumley Monitoring, Lumley Reference, Magnum, Moth, Nottingham Analogue, Origin Live, Ortofon, S.D. Acoustics, Silver Sounds, S.M.E., Sonic Pearl, Townshend, Transfiguration, Triangle, Unistar, Wilson Benesche

- Extended Audition Times
- Home Auditions
- Home Visits
- Open Discussions
- Tuning Suggestions
- Evening Auditions

AND ABOVE ALL COMMITMENT TO YOU AND YOUR MUSIC.
FOR MORE DETAILS PLEASE PHONE:

M.J.S. HI-FI
80 Stapleton Lane, Barwell,
Leicestershire LE9 8HE
Telephone: (0455) 846977
BY APPOINTMENT ONLY

IAN HARRISON HI-FI

7 MILL HILL, REPTON, DERBY, DE65 6GQ. *MAIL ORDER ONLY
TEL: 0283 702875 9am-9pm FOR LATEST PRICES

CASSETTE DECKS		HEADPHONES	TUNER
NAKAMICHI DRAGON		SENNHEISER	QUAD SONY
NAKAMICHI DR1		BEYER	MARANTZ
NAKAMICHI DR2		AUDIO TECHNICA	PHILIPS
NAKAMICHI DR3		KOSS	BLANK TAPES
AIWA XH3000		ROSS	TDK, MAXELL
AIWA XH3700		SONY	SONY, BASF
TEAC V8800S		ARG	AMPEX, JVC
TEAC V7010		HI-FI FURNITURE	SCOTCH
TEAC R8800S		APOLLO, SOUND	DEFI
SONY TCM11S		ORGANISATION	DAC PACK £189
SONY TCM11S		SOUND FACTORY	DIGIT £109
SONY TCM11S		TRIPOD	DIGIFLEX £18
SONY TCM11S		GOLORING	POSITRON £89
SONY TCM11S		GABLES	OPTIFLEX £124
SONY TCM11S		AUDIOQUEST	DIGIT REF £20
SONY TCM11S		SONIC LINK	DIGIT REF £350
SONY TCM11S		GOLDRING OEO	ROCKLINK IPOA
SONY TCM11S		ACCESSORIES/PEOA	TEST TAPE/CD
SONY TCM11S		MULTIPLERS	MARANTZ PHILIPS, QUAD, SONY, DENON
SONY TCM11S		CD PLAYERS	HARRISON MULTI PURPOSE TEST CASSETTE £20
SONY TCM11S		MARANTZ	DEON AUDIO TECHNICAL TEST CD £12.99
SONY TCM11S		PHILIPS QUAD	
SONY TCM11S		SONY, DENON, AIWA	
SONY TCM11S		NAKAMICHI, TEAC	
SONY TCM11S		SHURE, ARCAM, STANTON	
SONY TCM11S		MOVING MAGNETS, POA	
SONY TCM11S		EXCEL GS (£210-£290)	
SONY TCM11S		EXCEL (£195-£265)	
SONY TCM11S		ELITE (£70-£100)	
SONY TCM11S		EROICA (£35-£45)	
SONY TCM11S		ORFON	
SONY TCM11S		AUDIO TECHNICA	
SONY TCM11S		MC7500 (£500-£750)	
SONY TCM11S		MC5000 (£375-£550)	
SONY TCM11S		MC3000 (£235-£335)	
SONY TCM11S		MC2000 (£165-£245)	
SONY TCM11S		AT-OC5 (£45-£67)	
SONY TCM11S		AT-ART1 (£285-£475)	
SONY TCM11S		AT-OC30 (£190-£300)	
SONY TCM11S		AT-OC9 (£75-£110)	
SONY TCM11S		DENON	
SONY TCM11S		DL304 (£45-£85)	
SONY TCM11S		OTHER MODELS	
SONY TCM11S		EPOA	
SONY TCM11S		DYNAVECTOR	
SONY TCM11S		MC155H (£20-£35)	
SONY TCM11S		MC10S (£15-£25)	
SONY TCM11S		XXIA (£200-£350)	
SONY TCM11S		17DBMKII (£90-£190)	
SONY TCM11S		GOLDRING	
SONY TCM11S		EXCEL GS (£210-£290)	
SONY TCM11S		EXCEL (£195-£265)	
SONY TCM11S		ELITE (£70-£100)	
SONY TCM11S		EROICA (£35-£45)	

LORICRAFT AUDIO

Turntable Repair and Record Cleaning Service

Sale and Repair of Classic Hi-Fi Specialising in Garrard and Thorens

Manufacturers of high quality plinth systems. Review (copy available)

Electronic low distortion power supply and active power supply for Garrard 301/401 Thorens TD124

Re-manufactured spindle bearing and correct lubrication kit. Specifically designed for this type of bearing

Loricraft specialist services start at £5.00 for platter damper rings

New Catalogue
now
available

4 Big Lane, Goose Green,
Lambourn, Berks. RG16
&XQ. Tel. 0488 72267

See us with Art
Audio at
Chesterfield

DAN DULEY HI-FI

15 St. Georges Square,
Forest Gate,
London E7 8HN
Tel: 081 470 9795
(after 2pm.)

THE NEGUS is a complete studio quality monitor system, with loudspeakers customised to suit your room. LONG demonstration sessions possible.



NEGUS
Electronics:-

COMBINED
PRE-AMP AND
CROSSOVER

THREE
MATCHED
50W_{RMS} PER
CHANNEL
AMPLIFIERS

POWER PAK:-
SUPPLIES ALL
UNITS

HALE HI FI



We stock:-

ROYD, NAD, NAIM, LINN, CREEK,
ARCAM, QUAD, YAMAHA.

A wide range of accessories always
available.

Full demonstration facilities - no
appointment necessary - full service
department.

Free delivery and installation

2 Bold Street, Hale Road Altrincham, Cheshire

WA14 2ER

Telephone: (061) 929 0834

Oxford Audio Consultants

HI-FI SPECIALISTS



Our superb service is the same, regardless of price.

AUDIO RESEARCH LS7/VT60

At last a combination at an affordable price! Quite sensational sound quality to boot!

NOW DEMONSTRATING

AUDIO RESEARCH CD1/CDT 1
 AUDIO ALCHEMY DAC IN THE BOX - staggering sound for £199.95
 MICROMEGA STAGE - the new concept in upgradeability
 ORELLE CD480 - a serious British competitor to the ARCAM
 PINK TRIANGLE DA CAPO - NOW IN STOCK
 THETA DATA BASIC & GENERATION V - real high end
 TEAC VRDS 7/10/20 AND 700 2 BOX SYSTEM
 SME 20 - the finest engineering with superb sonics
 PROJECT TURNTABLES - value for money
 LYRA CLAVIS Mk 2 - even better and only £995
 KINSHAW PERCEPTION PHONO STAGE
 AUDIO INNOVATIONS ALTO - lovely sound and styling
 COPLAND CSA 14 - bargain of the century!!
 DPA 200 SERIES PRE/POWER
 KRELL KRC/KRC 2 preamps with the latest S SERIES power amps - seriously high end - wait till you see the new KPS digital series
 MUSICAL FIDELITY F SERIES - very, very good value
 HEYBROOK SEXTET/QUARTET - very room friendly
 MARTIN LOGAN AERIUS - magic looks and sound
 QUAD ESL 63 - we are now main agents for the complete range of QUAD
 REL STRATA AND STADIUM SUBWOOFERS
 RUARK EQUINOX - furniture for the living room
 SONUS FABER - no apologies! these are our favourites
 DENON DF 10 - mini size components available separately
 BOSE LIFESTYLE SYSTEM - almost invisible hi-fi!

EX DEM & P/EX BARGAINS

ALCHEMIST KRACKEN £250
 KRELL KRC2 £3195
 NAKAMICHI CR7 EX DEM £1395
 AUDIO RESEARCH DAC 1-18 £895
 AUDIO RESEARCH LS2 £1595
 AUDIO RESEARCH SP9 £895
 RUARK TALISMAN MK 2 EX DEM £650
 MUSICAL FIDELITY PRE3A PREAMP £195
 HEYBROOK HB2 SPEAKERS £150
 STAX QUATTRO CD PLAYER £1595
 AUDIO RESEARCH V70 EX DEM £2995
 KRELL CD DSP CD PLAYER EX DEM £2995
 THETA DS PRO PRIME £895



Please ask for details or our current list

Agencies include: Aura, Accuphase, Acoustic Energy, Air Tangent, Apogee, Audio Alchemy, Audio Research, Audio Technica, Basis, B&W, Castle, Classe, Copland, Denon, Denon Cartridges, DPA, Dual, Goldring, Harmonix, Heybrook, HPW, Kimber, Koetsu, Jadis, Krell, Lyra, Magneplanar, Magnum, Mandrake, Marantz, Martin Logan, Michell, Micromega, Music Fidelity, NAD, Nakamichi, Onix, Orelle, Ortofon, Pink Triangle, Pioneer, Polk, Proceed, PS Audio, QED, Quad, REL Subwoofer, Revox, Rogers, Roksan, Rotel, Ruark, SD Acoustics, Seismic Sink, Sennheiser, Sequence, Sequerra, Slate Audio, SME, Sonus Faber, Stax, Target, TDL, Teac, Theta, Thorens, Van den Hul, Wadia, Wharfedale, Wilson

TAX-FREE EXPORT SERVICE
 MAIL-ORDER AVAILABLE ON MANY ITEMS
 Open Mon-Sat 10am-6pm

Oxford Audio Consultants

Oxford Audio Consultants, Cantay House, Park End Street OX1 1JE
 Telephone: Oxford (0865) 790879 Facsimile: Oxford (0865) 791665

THE AUDIO GALLERY

For a Fine Selection of High Quality Audio Equipment

Tube Technology - Audio Innovations - Audio Note - Wadia
 Audio Alchemy - DPA - TEAC - Micromega - Alchemist
 Martin Logan - ProAc - Klipsch - Acoustic Energy - TDL
 Heybrook - JPW - Impulse - Pink Triangle - SME - Denon
 Moth - Audio Synthesis - NAD - Pioneer - Alphason - Tripod
 Sonic Frontiers - Counterpoint - Absolute Sounds
 Replacement Valves by Gold Aero

Demonstrations by Appointment Only.
 Please call 0730 895194 Hampshire, Nr. Petersfield

Inaccessible accessories by post.

If you can't get to us, we'll get our accessories to you.
CARTRIDGES: Arcam, A.T., Denon, Dynavector, Goldring, Lyra, Ortofon, Sumiko. **CABLES:** Audioquest, Cable Talk, Ixos, Kimber, Ortofon, Sonic Link, Van den Hul. (including the new carbon cables.) **STANDS:** Alphason, Sound Organisation, Stands Unique, Target. **HEADPHONES:** Beyer, Sennheiser, Stax. **ACCESSORIES:** Allsop, BIB, Discwasher, Hunt, Kontak Last, Michell, Milty, Nagoaka, Pixall, QED. **LP's/CD's:** Audioquest, DCC, Fone, Klavier, Naxos, Opus, Proprius, Reference Recordings, Sheffield Labs. Plus a full range of quality equipment available.

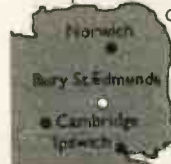

BURY AUDIO

47 CHURCHGATE STREET, BURY ST. EDMUNDS,
 SUFFOLK IP33 1RG. TEL: 0284 724337

Access, Visa, Diners Club, American Express.

SLATE AUDIO

HI-FI Design & Cable Services



Better than a . . .

SLATE AUDIO GARRARD 401

The Garrard is very musical and involving, and entices you to sit back and listen for hours. Bass lines roll along with poise; vocals float around your listening room with a haunting elegance. The 401 never draws undue attention to tiny detail. Instead it pulls the music together, producing a very tightly woven musical fabric. Forward and assertive, it never sounds out of breath or muddled, it just continues to offer music as a total entity. The open qualities that it offers also bring out the best in your ancillaries, nothing sounds under strain or under pressure. Quiet operation is the final surprising feature. The rumble that once afflicted the 401 has been silenced once and for all. The build and performance of the Garrard 401 are really an audio equivalent of the E-type Jaguar, they're both fine examples of sixties British engineering.

AUDIOPHILE

The Slate deck defines what real instrument solidity should be. Bottom end delivery is also in a class of its own. The word controlled kept appearing on my notepad, the turntable giving a Rock-like performance, with stacks of detail.

HI-FI CHOICE

I have never used a turntable system like this one. It seems to get everything right. It relies on massive, yet clever and precise engineering to get the best from LP. With an Ortofon MC2000 cartridge fitted to the arm (SME IV), sound quality was unquestionably superior to CD. The Garrard seems free of what, in comparison, seems like sloppy timing on belt drives . . . it keeps a rigid control on tempo, making for a fast controlled delivery . . . music blossoms out of the speakers and fills the room . . . the Garrard/SME/Ortofon/Slate combination teased so much out of the Vinyl groove, presenting it clearly, that CD was forced to take a back seat. Images on the stereo stage were strongly embodied, they had real substance and life.

HI-FI WORLD

47 GEMINI CLOSE, LEIGHTON BUZZARD, BEDS, LU7 8UD. TEL: 0525 384174



42 St ANDREW STREET ABERDEEN
TEL/FAX 0224 625635

Amplifiers	SALE	LIST
Audio Innovation Series 1000 MK111 Mono Block Power Amp	£975	£1499
Audio Innovation Series 200 Power Amp	£325	£499
Audio Innovation L1 Pre Amp	£195	£299
Audio Innovation L2 Pre Amp	£489	£699
Audio Innovation Series 500 Int Amp	£649	£999
Audio Innovation P2 Phono Stage + Line	£599	£1049
Deltec 200S Pre & Power	£799	£1250
EAR 802 Pre		
Audio Research Classic 30	£1950	£4300
Speakers		
Apogee Centaur	£1499	£2300
Apogee Minor With Stand	£799	£1544
Magneplanar SMGb	£699	£890
Mordaunt Short Classic 40	£399	£650
Snell Type J/111	£499	£769
JBL 5000Ti	£2450	£3499
JBL 1000Ti	£899	£1499
Dynaudio Special One	£650	£1300
DACS		
Pink Triangle Ordinal	£520	£850
Micromega Microdac	£210	£300
Sugden SDA1	£420	£650
Turntables		
Pink Triangle Ordinal	£350	£850
Alphason Sonata t/t		
Alphason HR 100 MCS tonearm		
Alphason Atlas PSU	£1200	£2400

SALE
EXDEMONSTRATION STOCKS
MAJOR CARDS WELCOME

Authorised stockist dealer for: Linn Quad ProAc MS Audio Research Onix Apogee Magneplanar Ortofon Harman Onkyo Audio Technica JBL and many more

VACUUM TUBES are BACK... and they sound better than ever!

Glass Audio is a quarterly journal designed for dedicated music lovers who've always known tube equipment sounds better than solid state.

The articles have special emphasis on construction with projects ranging from simple modifications of existing equipment, to restorations, to construction of the most sophisticated designs available today. The projects include schematics, parts lists and instructions. An annual feature is a world directory of international tube dealers and manufacturers.

Here's a sampling of recent articles: ST-70 with Solid-State Regulation, Rebuilding Tube Amps, An Electrostatic Headphone Amp, Greening the ReVox G36, Restore your Scott Tuner, Soft Start for Tubes, 70 Watts of McIntosh Power, Output Transformerless Amp, Vacuum Tube Voltage Regulator plus Vacuum Tube AC Feedback Amps.

*We don't expect everyone to subscribe—
just those who savor a taste for warm, satisfying tube sound.*

Please enter my airmailed subscription for:

Two years (8 issues) at \$60

One year (4 issues) at \$35



Charge to my VISA Mastercard Bill me

Remit in US \$, drawn on US bank. Allow up to 6 weeks for delivery.

CARD NO. _____ EXP. _____

NAME _____

STREET _____

CITY _____ COUNTRY _____ POSTAL CODE _____

PO BOX 176, DEPT. HFWS Peterborough, NH 03458-0176 USA
FAX (603) 924-9467

LANGREX SUPPLIES LTD

DISTRIBUTORS OF ELECTRONIC VALVES, TUBES AND SEMI-CONDUCTORS AND I.C.S.

1 MAYO ROAD • CROYDON • SURREY CR0 2QP

PHONE
081 684 1166

24 HOURS EXPRESS MAIL ORDER SERVICE ON STOCK ITEMS

FAX
081 684 3056

A selection of our stocks of New Original Mullard - Brimar audio types made in UK.

STANDARD TYPES			SPECIAL QUALITY TYPES			
ECC88	MULLARD	6.00	E88CC - GOLD PIN MULLARD		8.50	
ECH81	MULLARD	3.00	ECC81 - M8162 / CV4024 MULLARD		6.00	
ECL86	MULLARD	3.50	ECC81 - 6201 / GOLD PIN MULLARD		8.50	
EF86	MULLARD	7.50	ECC82 - M8136 / CV4003 MULLARD		6.50	
EL84	MULLARD	6.00	ECC83 - M8137 / CV4004 BRIMAR		6.50	
GZ32	MULLARD	8.50	EF86 - M8195 / CV4085 G.E.C		10.00	
GZ34	MULLARD	12.50	AMERICAN TYPES GE.			
6SL7GT	BRIMAR	4.50	6146B.G.E	15.00	6L6GC G.E	12.50
6SN7GT	BRIMAR	4.50	6550A.G.E	17.50	12AX7A G.E	7.00
6V6GT	BRIMAR	4.25	7581A.G.E	12.00	12BH7A G.E	6.50
					12BY7A G.E	7.00

OPEN TO CALLERS MON.-FRI. 9AM - 4PM. CLOSED SATURDAY

QUOTATIONS FOR ANY TYPES NOT LISTED.

OVER 6000 TYPES AVAILABLE FROM STOCK

OBSOLETE ITEMS A SPECIALITY

TERMS C W O/VISA/ACCESS ETC...

P&P 1-3 VALVES £1.00, 4-6 VALVES £2.00 ADD 17.5% VAT TO TOTAL INC P+P

VISA

Access

PRIVATE

CAMBRIDGE CD2, mint condition complete with box. Very light use. Remote control and superb sound for £295. Also Celestion SL600s with box, mint, light use £350. Tel: 071 286 4143 (Richard)

REVOX B77 3 1/4 and 7 1/2 IPS 4 track, little used, boxed with manual. Working cover and remote control. 20 10 1/2 and 57 1/2 tapes, boxed and unused, £750. (0643) 821137.

ROKSAN XERXES, natural Ash finish Tabnz-zi arm £595. Ion Obelisk 300 pre and power amps £395. Naim IBL speakers £395. All in Excellent condition 0829-733756 or 0606-79671.

MERIDIAN 205 Mono Block amplifiers and Audio Innovations Passive pre amp G395 boxed, incredible value and Deltec PDMI MKII DAC £150. Phone after 6pm (0992) 763812.

DPA 50s PRE/POWER amps plus line-stage and power supply. The Power mains filter with cable. Slink Interconnect plus IS19. All boxed, superb condition. £1,600, open to offers. Telephone 0602 - 817078 evenings or 0602 - 424770 day.

SWAP my LINN KEILIDH Speakers with ceramic base for your Epos ES14 with dedicated stands. Must be less than 18 months old and perfect. Other free space designs considered 0226 764749.

RCA 6L6G VALVE cinema amplifiers, huge transformers with original pre-amps 6' 19" rack, with door! Swop 753s, 105s, CD10 or equivalent. Possibly cash. Can deliver. View S. Devon 0483 428906, more available, ask.

AVI MONOBLOCK amps £650. Oracle Delphi Mark 3 Turntable £500. Both in immaculate condition with packaging. 2.25m Audio Synthesis SilverBlue interconnect. Short lengths Siltech 56 and ribbon. (0787) 247897 evenings.

LEAK TROUGHLINE 3 Tuners for sale. Stereo model £150, mono £115, both excellent condition. Thorens TD125 transcription deck in SME plinth, with SME 3009 arm exc. £120 ono. Telephone: 0702 294452.

GARRARD 401/SME 3009 S2 mounted on custom plinth with lid. Manuals and spare idler wheel. Offers write C. Coakes 82A Southampton Road, Parkgate, Southampton SO31 6AH.

MERIDIAN TRANSPORT £495 AVI DAC £295. Townsend Siesmic Sink £95 Epos ESII Speakers including stands £295. All boxed and in good condition. Telephone (0703) 738271.

QUAD ESL 63s £1,100, KEF 104/II black ash £625, Celestion SL600. £280, Thorens TD150 SME arm and plinth, Shure V15 £150, Quad 33/303 £150 FM3 Tuner £80. Telephone (0977) 643629.

AUDIOLAB 8000A £150, Musical Fidelity MA100 Monoblocks £650, Musical Fidelity Digilog DAC £100, Meridian MCD CD Player £100, all boxed with original receipts. Tel Simon on 081-743 4654 (eve) 071 - 334 0088 (day).

ARCAM ALPHA 5 CD; Delta 290 Amplifier; Kef Q50 Speakers, 7 months old, boxed. NAD 6340 Tape Deck (no box); 1 set Audioquest Ruby Interconnects; 1 set CD feet; tripod table. £1,000 o.n.o. Telephone 0386 - 554872 (works).

DELTEC (DPA) DSP50S Pre/Power amp. Matched phono stage. Black Slink speaker cable, Power mains filters, power Slink cables etc. £1,800. 0732-883360 (Kent).

B.B.C. MODIFIED 301 (no turntable spindle). Leever-Rich prof. Floorstanding recorder valve-mono (needs overhaul). Troughline Stereo, Thorens 150 (no arm). Radford SC22 pre. Quad II control-mono. Leak 75 receiver. Offers. Wanted: Nakamichi, FM4. Liverpool 734 0965.

QUAD ELS bronze grided Loudspeakers in excellent condition, having been refurbished 18 months ago, £325. Quad 34/306 pre and power amplifiers in good condition, £350. Telephone George (0428) 712973.

ART VPI PREAMP, with high spec. valves. Inputs for phono, CD, Tuner/Aux only. Tape switching facilities omitted for improved sound quality. As new £300. ART transformer £50. Telephone 081-203 2120.

TANNOY BERKELEY'S superb condition, much loved speakers reluctantly being sold (moved house and will have to settle for something smaller). Outstanding speakers for the hi-fi enthusiast. Price £350. Telephone (0264) 860530.

NAIM NAP 180 £600. Naim NAC 42.5 £120. Hi-Cap (old style) £280. Ruark Templars (Burr) £300. Telephone (0432) 268484.

FANTASTIC, RARE OPPORTUNITY to acquire some of the best Hi-Fi ever! Leak 20-75 speakers completely re-built, drive units, crossovers, and cabinets fully restored £750 o.n.o. Also Leak, Quad, Tripletone, Rogers valve amps. Garrard 301 - 401 and Thorens 124, 125, 160, 147, turntables. All excellent. Phone for details: (0548) 560913.

MUSICAL FIDELITY Pre-amp MVX.2, boxed, immaculate £895 o.n.o. Telephone (0903) 261931 (Sussex) after 6pm.

WANTED: circuit/service info for Pye Mozart Tuners HFT 108/111. Valves, 211 prefer GE/RCA types. ECC81/82/83 prefer British origin. Telephone 031-447 9979.

PAIR LOWTHER Acoustas, pair Dual Position Acoustas. Latest P.M.6-A High Ferric Drivers, all round (original cobalt magnets). Superb, original examples. Bargain at £400.00 pair, cash. No dealers/time wasters, genuine sale. Telephone (0446) 735768.

NAIM NAT 02 TUNER. New style, perfect condition £575. 0964 622725 (Hull).

WANTED: Musical Fidelity P150 power amplifier. Must be in good condition and boxed. Telephone Stuart on Oxford (0865) 511133 with details.

MUSICAL FIDELITY speakers Reference 3's. Black. New. Reason for sale. Very efficient. Bi-wireable. (New £300) £175. (0923) 857031.

KOETSU TONEARM, very rare. Boxed. Offers around £400. Quad 34, recent service, boxed £170. Sumo Andromeda Power Amplifier, sounds/looks superb. £500. Monitor Audio MA14 Golds, £275. (0280) 701145.

GARRARD 401, 3009/111, Solid Plinth, mint £249.00. Arcam Two's, modified £160.00. Arston RD90S, D.C. P.S.U., mint £295.00. Leak Troughline III mono V.G.C. £130.00. Radford SC22 £120.00 o.n.o. Plus others. Tel: Paul (0895) 446713.

GARRARD 301 with Strobe platter, wooden plinth, Connoisseur arm. very good condition £180 o.n.o. Garrard 401 wooden plinth, good condition £120 o.n.o. May consider exchange. Telephone (0382) 24681.

FOR SALE: A pair of Leak TL12+, just overhauled by Station Sounds £295. Sugden A48 MK1 £60. Rare, power supply for MYST G-OHM power amps. Offers. (0342) 712653. Gatwick.

RADIO ENGINEERS HANDBOOK by Frederick Emmons Terman. Professor of Electrical Engineering, Stanford University. Published by McGraw Hill 1943. First edition, seventh impression. 1019 pages. Hardback. Perfect condition. Offers (0273) 566558.

ACOUSTIC ENERGY AE 1s MKII, Rosewood, mint £500. Arcam B/Box 5 £250. Rotel Michi RHQ-10 as new £650. Rotel RC 870 pre £190. Quad 34 MKII £195. Telephone Jules (0792) 280061.

WESTERN ELECTRIC 755A drive units, boxed, unused (as used by Joe Roberts, Sound Practices) EMT 928 Turntable, EMT arm, Koetsu Red, Fisher 100B valve tuner, offers? MFB200 £195 (0642) 559543.

GARRARD 301 immaculate, in white with original knobs, Garrard Mat etc. strobe platter. SME 3012 arm (12") will separate. Must sell hence best offer secures. Telephone (0275) 853204 now.

AUDIO INNOVATIONS S 800 Class A Power Amplifier, excellent condition £355. Telephone (0883) 34928, Surrey.

QED DIGIT perfect & boxed bargain £100 save £39. DENON DAP 2500 pre amp inputs CD DAC DAT Analogue MM/MC headphone input record motorised volume everything boxed and instruction manual. As new £290 new £550. Tel: 0502 476249

DELTEC PDMI/II £299 including CO-AX. Denon 1520, 20 bit £175 (£550). Myst limited edition Tuner (new) £160. All pristine, boxed. Rega 3 £80. Cables: Sonic Link, DNM, Naim, Supra. 091-414 4221.

NAIM EQUIPMENT for sale by executor: NAC72 pre (new) £425. NAPI40 & HiCap power (old) £800. SBL speakers £1,100. 2 x 5m NACA4 cable, terminated £15. All boxes, manuals & interconnects. Telephone 0734 843740 (Reading).

AUDIO RESEARCH SP10 Pre-amp (world renowned) with separate power supply. Ceramic gold plated valve seats fitted and new gold plated valves - £1,450. Musical Fidelity A370 power amp - £995.00. Lewes (0273) 477436.

LEAK STEREO 20 fully re-built £320. Michell Gyrodec - bronze finish with RB300 Arm/AT-F5 MC power supply - motor outer ring £700. AVI S2000A power amp 250 wpc £850. Phone 081-531 5979.

QUAD 606 £380. MF 3B pre-amp £250. Meridian 263 DA converter £300. Yamaha DSP-E1000 (brand new) £450. Also NSE80 effect speakers and MS CS-1 centre speaker. S. Ellerton. Telephone (071) 253-1845 after 7pm.

GARRARD 401, Decca arm and cartridge, plinth and cover v.g.c. only £275. Carver TXII tuner (cost £800+) only £225. Telephone (0462) 678158 N. Herts.

PRIVATE SALE: Pentachord pentacolumns (active stereo crossover) £850.00 o.n.o. Orelle DA 180 D.A.C. £450.00 o.n.o. Audiolab 8000P Power Amp £400.00 o.n.o. Deltec Goretex Black Slink Stereo interconnect (VBT locking phonos) 0.5m £50.00. XLO RS dedicated Digital Cable 0.5m £50.00. Tel: 0235 850393.

LINN KABERS, walnut, current spec.+ KuStone stands, immaculate. £700. Tel: (0342) 834364.

hi Best prices for new, xdem & s/h equipment *fi*

Audio Inn 2nd (2A3,82)	mint s/h	£1595	Ensemble PA 1 ref.	mint s/h	£1995
Audio Research D240 mkII	mint s/h	£1695	Audio Static ES300	as new	£2995
Audion 300B (Silver Knights) as new		£1595	Infinity IRS Beta	mint s/h	£4995
Krell KSA 150	mint s/h	£2995	Apogee Diva & Dax	mint s/h	£3900
VTL Manley 350 monoblocks	mint s/h	£2750	Martin Logan Quest	mint s/h	£2500
Roksan L2/S1 pre/pwr	mint s/h	£1495	Acoustic Energy AE1	mint s/h	£595
Nestrovic Labs A-1	mint s/h	£1995	Castle Howards	mint s/h	£595
Musical Fidelity A370.2	mint s/h	£1195	Naim SBL's	mint s/h	£1100
Threshold S150 pwr amp	mint s/h	£895	Wilson Watt 3 Puppie 2	as new	£7995
Tesserac Tamp-60 monoblocks	x-dem	£4500	Apogee Duetta	mint s/h	£795
Naim 135 monoblocks	mint s/h	£1800	TDL Reference	mint s/h	£1195
Conrad Johnson MV50	mint s/h	£795	Magneplanar 1.4	as new	£795
Beard P35/CA 35	mint s/h	£995	Quad ESL 63 and		
AVI s2000 pwr (90wpc)	mint s/h	£450	Gradient s/w	mint s/h	£2800
Krell KSA 100 mkII	mint s/h	£1795	Audio Note ANK sp	as new	£695
Musical Fidelity P270 mkII	mint s/h	£895	ATC SCM 10	as new	£795
Audio Innovations S1000 mono's	mint s/h	£895	Sonus Faber Extrema + stds	mint s/h	£4995
Audio Research SP9 mkII	mint s/h	£995	Sonus Faber Electa Amator	mint s/h	£1995
Trilogy 90 pre-amp	as new	£795	Meridian 200/203 dac 7	mint s/h	£895
Tesserac TAADA mm/mc	new	£995	Meridian 602 /606	as new	£1995
Tesserac TALA Line pre-amp	new	£995	Naim CDS (latest)	mint s/h	£2200
Tesserac TAP-A/TAHA-			Wadia 2000 tran/dac	mint s/h	£4500
TAPS	pre x-dem	£4500	Wadia 7+9 tran/dac	mint s/h	£15995
Counterpoint SA 11 pre	mint s/h	£3500	Mark Levinson No 30/31 tran/dac	mint s/h	£15500
Counterpoint SA9 phono	mint s/h	£2500	Roksan DP1 transport	mint s/h	£695
Linn Kairn	mint s/h	£795	AVI S2000 dac	mint s/h	£395
Gryphon Limited Edition pre	mint/sh	£2995	CAL Tempest mkII c.d.	mint s/h	£1395
NRG PA1 pre-amp	mint s/h	£2995	Micromega Trio CD2	as new	£1995
Audio Innovations L2	mint s/h	£495	Pierre Lurine J1/Sowther	mint s/h	£1995
Audio Research SP10 mkII	mint s/h	£1695	VPI mkII/ETII/stand	mint s/h	£3995
Threshold FET 10E pre	mint s/h	£2500	Roksan Zerexes/Artemiz rosewood	as new	£1295
Audio Note OTO int.	as new	£650	Audio note I/O	as new	£795
Audio Innovations S500	as new	£695	Koetsu Red	mint s/h	£495
Beard BB 100	as new	£795	Koetsu Blk	mint s/h	£350
Audio Research classic 60	mint s/h	£1995	Van Den Hul MC1	mint s/h	£550
Snell E II + Stds	mint s/h	£895	Burmester 838 phono stage	mint s/h	£550

MINT S/H - Second hand as good an example as we've seen anywhere

AS NEW - Typically less than 4 months old in new condition

X-DEM - Typically 'as new' but may be older

G.C.N.G.C - In perfect working condition but may be marked

hi **CHOICE** *fi*
(081) 568 8808

Equipment bought or part exchanged
Full demonstration facility - by appointment
Major credit cards accepted
9.30am - 8.00pm 7days

CHOICE Too Introduces The Hi-Fi Exchange

Whether buying or selling Audiophile equipment register your requirements with us now. All enquiries are entered on our sophisticated database where equipment matching takes place. A complete catalogue of equipment wanted and for sale, available weekly, is free * to anyone both here and abroad. The Hi-Fi Exchange is continually updated and is the most comprehensive source of second hand and x-dem equipment anywhere.

* 1st issue free to advertisers,
subscriptions available.

Trade enquiries welcomed.

CHOICE Too
(081) 568 8808

9.30am - 8.00pm

Audio Classic

FOR SALE

CHAPMAN stereo Valve integrated, Parmenco, mint	£130	QUAD FMII tuner + stereo decoder	£75
Counterpoint SA5 / SA20, mint boxed, save £1000's	£2200	Radford FMT2 stereo tuner	£75
Elite Townsend 600, 85 wpc power amp	£250	Rogers stereo Valve tuner	£75
Heath S99 integrated valve amp	£100	Gale 401 loudspeakers, mint pair	£250
Goodmans 150 receiver	£75	Castle Conway II	£150
Leak TL12+, pair valve monoblocks, mint	£300	J.R. 149 round speakers	£75
Naim Nait	£150	Jordan Watts MODULE pair,	£75
Pioneer SX747 Quadrophonic receiver	£75	KEF Correll, pair, good condition	£75
Radford STA25/III, SC22, FMT2 mint pre/power/tuner	£500	Leak LK18 sandwich speakers, pair, good condition	£35
Rogers JUNIOR Stereo valve power amp, vgc	£200	Pro Ac Super E.B.T. pair, small & mint	£150
Rogers CADET III stereo valve integrated	£100	Richard Allan 'Minette', pair, brand new to clear	£50
QUAD 303/33 pre/power	£185	Rogers LS7 loudspeakers, pair, mint £250	
Quad 33 preamp, mint	£75	Rotel RL850II, brand new boxed speakers	£75
QUAD 44 preamp, mint, boxed	£200	Vitavox 12" bass units, monster magnet, pair	£100
Hadcock G220 arm, mint boxed	£75	Wharfedale Linton 3XP, brand new, boxed	£50
Decca FFSS arm & pick up	£60	Marconi 42 radio, c. 1930, v.g.c.	£200
S.M.E. 3009/II v.g.c	£60	GEC 'O' Phono radio, c. 1930 good condition	£100
Thorens TD135 turntable, c/w arm & cartridge	£40	Philips 830 radio, c. 1932, mint	£400
Revox G36 open reel recorder 1/4 track valve	£200	Rock-Ola 1448 Juke Box, 1954, 120 selections	£2500
Leak Troughline STEREO, aligned & serviced	£200	Sobell Table radio gram, c. 1948	£50
NAD 4020 tuner	£75	Winsor Valve tester, c/w book	£50

Mail Order - no problem. Next day delivery £15

Part exchange / swapsies welcomed

Access / Delta / Eurocard / Mastercard / Visa = + 5%

Haden Boardman, Audio Classics / Mellotone Acoustic Co.
Telephone 0942 57525 Fax 0942 525861

definitive audio nottingham

Tel/Fax (0602) 813562

Import/Export

LIVING VOICE HØRNING WADIA AUDIO INNOVATIONS MIRO IMPULSE SME
TOWNSHEND VITAVOX EMT XLO GOLDRING DALI VOYD SYSTEMDEK
PIONEER REVOX LOWTHER

During the past few years there has been a substantial increase in the availability of simple low power valve amplifiers - particularly in single ended configuration. This would have been a more valuable development if there had been a corresponding increase in availability of high sensitivity loudspeakers. A 5-9 watt valve amplifier needs to see a very even load and a sensitivity of 98 dB/w @ 1m. or more. Without this the full benefit of these simple amplifiers cannot be fully realised. In many ways the amplifier/loudspeaker relationship is so important that it should be considered as a single unit. Definitive Audio represents a coherent hierarchy of such loudspeaker/amplifier combinations ranging from 3 to 50 watts. 94 to 108 dB/w and from £450 to £14,000.

USED ITEM FOR SALE				
*denotes full warranty				
Ortofon Quartz	100	*JPW AP2 walnut/ash	100	175
Quazar	150	Linn Kan 1 + mk II stands	150	
*Audionote I.O. (10 hours use)	700	Fullers Audio Sultan	190	400
Kesiki Purple Heart		Tannoy 601 inc stands	100	200
Saphire (200 hours use)	400	* Audionote.e. [ANB] oak	600	1400
		* Audionote.j. [ANSP] oak	400	1000
		* Pioneer PD 901S		
		< 8 months old	300	500
		*Micromega leader (4 months old)	300	750
Audio Innovations:-		* Sugden SDT 1 (as new)	500	960
* 200 pre amp mm+mc	200/240	* Revox B215 S gold (black)		
* First Audio -7.5 watt triode	850	< 12 months old	900	1850
* Second Audio 15 watt monost	1400	* Systemdek IIX 900 oak	100	220
* P2 phono stage		Linn Axis Akito K9	330	
<12 months old	550	* Voyd .5 Reference oak	2000	3600
NVA phono stage	150	Helius Orion III	250	550
* Snell AII mahogany	2000	Souther Linear Arm	550	1300
Meridian Argent II	300	LP 12 SME 3009	380	
Lowther Acoustia [pm 2c]	200			

CARRIAGE EXTRA
PHONE OR FAX DIRECT (0602) 813562

ENTHUSIASTS CLEAROUT:

Yamaha Cassette Deck TC800GL (mint), Lowther Accoustas, Rock Record Deck c/w plinth/cover (latest platter), Paravicini modified Quad 50E's (pair), SPU gold cartridge, SME 3009/S2, Technics Electronic Stylus Scales, GA glass platter, Quad racks (34/FM4/306, 66 series), Quad 34/FM4 sleeve (matches 606).
Tel: 0603 714528 for details.

BEARD, CA35 pre-amp and P35 50 w.p.c. power amp. Superb sound - amazing bass. Cost £1,750.00. Will sell for £1,250.00. Telephone 081-428 3815 (evenings only).

FOR SALE: Magneplanar MG 1.4 American Panel loudspeakers. Superb imagery and vocals. Immaculate condition, boxed with manuals. Demo a pleasure. £720. Telephone Mick on 021-502 2550 (West Midlands).

ARCAM ALPHA Plus CD Player, £225, Alpha 3 Amplifier, £100. Both mint. Mission Cyrus One Amplifier, excellent, £75. Linn Index Speakers (recent) plus Ku-Stone stands, £230. Phone (0347) 822253, evenings.

MERIDIAN 208 (DAC7) CD player/pre-amp, £850. Meridian M30 active loudspeakers plus stands, £600. All mint, recent. Thorens TD160 turntable plus arm, £75. Arcam Alpha 3 tuner £75. Phone (0347) 822253, evenings.

TARGET ST 15" stands. Heavy, 3-legs, spikes t&b. £50. Logic DM101, Mission 774, Goldring. Massive construction, Linn rival 13 years ago. Offers. Speakers, homemade but good. £45. (0296) 730095, Buckingham.

FOUR KEF B139 Speakers. Suit sub-woofer £200. Telephone 051-531 0731.

GOOD HOME WANTED for assorted cables. Van den Hul, 3 half metres of silver. 2 pairs of half metre gold. 1 metre of Furkova optical. Offers considered. Vinegrad Telephone (0482) 666910.

TANNOY / ROKSAN. Tannoy original unchanged vgc 15" DC monitor gold Lancasters. Rok DPI transport. RokDAI DAC, Rok DSI power supply, 12 months old, hardly used moved to flat so therefore sale. Highest offer takes equipment. Also 4 Mission Isoplats and 5 shelf Alphason rack. Telephone: 081-658 8765.

NAIM SBL LOUDSPEAKERS £650. Naim NAXO crossover with power supply for SBL £300 (0803) 297691 evenings, South Devon.

MUSICAL FIDELITY A200 amp 60 w.p.c. Class A. Very good condition £329.00. Phone (0403) 250570, Horsham, Sussex.

RADFORD 2D 100 power amp 100 wpc £250.00. Thorens 126 MKII Linn LVII arm £135.00. Rega RB 300 arm £35.00. IMF CM3 Compact Monitors (Transmission Line) £175.00. Musical Fidelity MC2 speakers £185.00. Heybrook speaker stands £30.00. Scandyna Monitors / including stands £100.00. Musical Fidelity "The Pre-Amp II" £65.00. Tel/Fax 021 704 2756.

YAMAHA KX650 Cassette, remote control £165. Naim Nait £165. Marantz CD56 £100. Magnum MF250 Pre-amp £295. Meridian M3's active speakers £395. Meridian 200/203 (7) £745. Albany M1008 II/AP4 £795 Artemiz £295. Colchester (0206) 861457.

SME SERIES V TONEARM on Pink Triangle PT T00 turntable, with recently renewed Audio Technica AT OC7 MC cartridge. Gift at £850. No offers - buyer to collect. 061-747 5642.

LINN EKOS TONEARM and Linn armboard - excellent condition £500. Installation arranged if required. Call 061-432 7018, evenings.

ORACLE ALEXANDRA MK IV, mint, boxed, 6 months old, forced sale, £680 o.n.o. Wanted: Spares and literature for Phase Linear Model 700, Series 2 power amp. Telephone (0222) 499561.

SPENDOR SPI/2 + M.A.F. Stands £900. Sonus Faber-Minima Amator + stands £1,200. Michell Gyrodec + RB300 + P.S.U. + AT-OC5 £650. Trilogy 948 power amp 50 w.p.c. £550. Leak Stereo 20 + Leak TL 12 + pair. Phone any time 081-531 5979.

CROFT SERIES 5 valve power amp, £295. A & R T21 tuner (teak sleeve) £55. Also Olympus OMNI SLR camera with 35mm lens, £135. All in very good condition. Telephone Chns (0202) 735987.

ALPHASON ORPHEUS speakers, with stands, 9 months old. Hi-Fi Choice recommended. Good base, works well against wall, no boom. Cost £1,200, sell for £650. Phone (0884) 32465, Devon.

QUAD ORIGINAL DESIGN ESL speakers. Working but need manufacturer's service to bring up to spec, £300. Also Quad Mono FM1 valve tuner, £45. Telephone 091-285 0097 (evenings).

MERIDIAN 200 CD Transport, mint condition £425. Telephone (Steve Collins) 081-975 2311 day, or 0962-713 832 evenings.

PIONEER A400 AMPLIFIER £140. Leak Troughline 3 stereo valve tuner, over £300 spent updating by GT Audio in 1993, new stereo decoder and gold plated phonos. £250. Telephone 081-521 3239, evenings.

LINN LP12 (black) / Lingo / Cirkus with Ekos / Arkiv. Set-up and serviced by Grahams Hi-Fi Ltd, in immaculate condition, boxed £1,950 (no offers). Telephone 081-291 1744.

LINN KAIRN/LK100 PRE/POWER combination. Boxed with manuals etc. £1095. Tel: (0642) 542395 (day), (0429) 274638 (eve.)

HI-FI WORLD 5-20 Valve Monoblocks, 36 w.p.c. class A, wood side cheeks £400. Edison I2 class A valve power amp. 12 w.p.c. £250. Audio Innovations S200 MM pre-amp, £200. Arcam Delta Black Box 5 DAC, new 1/94, £250. Marantz CD63, new May/94, immaculate, £180 or swap for Rotel RCD965BXD. Tel: (0706) 345418.

SENSIBLE OFFERS FOR: Speakers; Quad Electrostatic Bronze, Wharfedale Linton, Leak Sandwich. Cassette Decks, National Panasonic RS2600S, Akai GX-R6, Pioneer CT-200, Aiwa F660. Turntables; Beogram 1200, Thorens TD124/11 SME 3008 Ortofon cartridge and pre-amp, Stratheam STM4, Garrard 80SB MkII. Tuners; Leak Troughline 3, Leak Fectic FM, Sugden RDS1, Pioneer TX-940L. Quad FM4. Amplifiers; Leak Stereo 30, Leak Stereo 30 plus, Sugden stereo, Hart Lindsey Hood. CD player; Marantz CD63T. Tel: (0723) 372473.

LINN LP12 (black), Circus, Naim ARO, Troika (new), Exposure active power amplifier system, Naim SBL loudspeakers, Mana reference tables, all cables, £8000. All boxed and immaculate. Tel: (0934) 522635 (Answer phone).

LINN ITTOK pickup arm, as new, boxed with instructions, £200. Tel: Mike (0843) 592066 after 6pm.

FOR SALE. AIWA ADF-660 cassette deck 3 heads, Dolby B/C £65 o.n.o. Lynwood Advanced Mains Conditioner £95 o.n.o. Tel: (0642) 559078

NAIM ACTIVE SYSTEM. 72 pre-amp 2x140 power amps NAXO, dual power supply RATA Regs+caps etc. £1530. SNAPS, 2x140 power amp boards. £120. Tel: (0670) 354726.

LONDON JUBILEE (Decca) phono cartridge. As new £500 o.n.o. Tel: (0403) 733055.

WANTED Audio Innovations S700 or Beard BB100 amplifier or other interesting line level valve amp around £500. For sale, Musical Fidelity A100, boxed £200 Tel: (0480) 460502 (Cambridge Area).

WANTED: SONY TAE-1000 Dolby Pro-Logic pre-amplifier. Tel: (0272) 695936.

MAGNUM MF250 POWER AMP. 150Wrms, £295. Meridian M3s active 105Wrms speakers £395, 200/203 DAC7 £745. Albany AP4/1008II £795. Artemiz £295, Naim NAC42 £130, Nait I £165 p/exchange? Tel: (0206) 861457 (Jim).

AUDIOLAB 8000All latest spec, mint £295. Linn LP12 black/Akito/K5 £395. Wharfedale 507s + stands £100. Tel: (0474) 812753 (after 7pm + weekends)

GARRARD 401 £150. Lowther Acoustas £150 pair. Quad 100 watt mono valve amp £50. Thorens TD125MkII, SME3009 and Shure V15 £85. Vortexion mono valve amp £20. Tel: Alan (0661) 852874.

GARRARD 301, v.g.c., original plinth, SME3009, Shure ME75 £150. Nitty Gritty record cleaning machine £100 Tel: (0533) 553176.

NAIM NAP 140, six months old, as new £450. Epos ES11 mint condition with stands £295. NAC 42, MC boards, excellent performance for £75. Tel: (0734) 866616

MISSION 753 SPEAKERS. Immaculate condition and boxed. £475 ono. Sumo-Polaris power amp 250W.p.c. of American muscle. £250 ono. Mint. Tel: (0480) 435930 eves. (Mission service engineer)

QUAD ESL63. Excellent condition £1150.00 Tel: (0730) 817188.

TRIO TUNER KT615 Analogue. Smashing performance but needs alignment £40. Sansui AU217 amp in sound working order £35. SME 3009IIIS tonearm with Ortofon VM530EII £35. Tel: Bob Parsons (0895) 674136 (day) (0628) 662135 (home).

REGA PLANAR 3 plus AT95E cartridge. A really great deck, little used. £175. Tel: (0532) 621130.

REGA PLANAR 3. RB200 arm. Arcam C77 cartridge (20+ hrs use) mint, boxed £125.00. Quad 33-303 pre/power amps. v.g.c. £150.00. Cyrus solid core speaker cable 4x3m £18.00. Tel: David (081) 348 0612 (home) (081) 741 3119 (days).

TANNOY CORNER LANCASTERS £450, Leak TL50+s £200 each, Stereo 20 £180, Troughline £50. Garrard 301 £150, Linn Akito arm £60, Decca Gold £50, Wharfedale SFB3s £200. Wanted good pre-amp (exchange?) Tel: (0709) 555403.

TWO QUAD 405IIs £120, £160. K9 pick-up £7.50. Lynwood mains filter £40. Tel: (081) 556 9102.

ZEN AUDIO

GEORGE STREET HULL. TEL 0482 587397

Comfortable listening room

Home demonstrations

Free home installations

AUDIOLAB, AUDIO INNOVATIONS, AURA, B&W,
CABLETALK, DPA, HEYBROOK, JPW, KAR,
MICROMEGA, MICHELL, HARMAN KARDON,
IMPULSE, RUARK, ROTEL, SUGDEN,

 naim your
price!



The new naim audio NA CD3
now on demonstration
at

The
Hi-Fi
Showrooms

12a West Street, Congleton,
Cheshire, CW12 1JR
Telephone (0260) 280017.



FOR STATE OF THE ART HI-FI

STUDIO ONE

Our dedicated 'Absolute Sounds' Studio. We have on permanent demonstration the following equipment:
APOGEE – from Centaur Minor to Diva
AUDIO RESEARCH – including the LS2b, LS3b & D200
CLASSE – 30, 70, DR4, DR5, DR6, DR10, DR15
KRELL – amplification and digital, now on dem the new KSA50s
MAGNEPLANAR – from SMGa to MG3.3
P S AUDIO – complete range including the Lambda transport
SONUS FABER – Minima Amator, Minuetto, Electa
THETA – Data Basic, Pro basic, Pro prime
WILSON AUDIO speakers

STUDIO TWO

Our new purpose built audio visual room
ADCOM processors
CELESTION shield speakers
CELESTION HT3 package
DENON av amplifiers
LEXICON processors

STUDIO THREE

ACOUSTIC ENERGY
ADCOM
AUDIOLAB
CHORD ELECTRONICS
KEF REFERENCE
MICHELL
MICROMEGA
ORELLE
PROFESSIONAL MONITOR COMPANY
ROKSAN
SME
TANNOY
TDL

Call us or drop in for a chat or to arrange a demonstration. We stock a complete range of speakers from £109 including B&W, CELESTION, HEYBROOK, KEF, SEQUENCE & TANNOY and separate components from £119 from DENON, MARANTZ, SONIC LINK and THORENS all available for audition in **STUDIO FOUR**

A wide range of accessories, headphones and equipment supports available.



Tel: 0923 233011 Tel: 0923 245250 Fax: 0923 230798

Acoustic Arts Ltd

101 St Albans Rd, Watford WD1 1RD
Opening hours: 10am – 6pm Tues to Sat
100 yards from Watford Junction Station

VALVE GEAR: Avantic SP11 £120, tuner £30. Armstrong amp £60, receiver £60, Leak Troughline £50. Goldring GL75 Vanspeed £45, Decca Gold £50, Lowther Accousta horns new Ticonal PM6s £350. Tel: (0709) 555403

AUDIO NOTE I.O. 50 hours use, made by Kondo in Japan, not British, £995. Koetsu Red £275, DNM3 pre-amp six power supplies offers, wanted, Apogee Stage, KEF 105III, QED Digit. Tel: (0642) 559543.

LOWTHER ACOUSTA HORNS, efficient, fast, dynamic £390, Fisher FM100B valve tuner £495, Kelly Ribbon tweeters £95, Garrard 301, Decca FFSS, MkIII head £195, Technics tuner ST-53 £39. Tel: (0642) 559543.

SWAP your Primare 928 remote pre-amplifier for my mint not remote Primare 928 with cash adjustment and it sounds better. For sale; Pink Triangle PIP11 pre-amplifier, new power supply, mint. boxed £1200 (2670). Tel: (0943) 466381 (home).

QUICKSILVER VALVE PRE-AMP, pair 60w Quicksilver valve monoblocks, cost £4000, bargain £1695 only for this superb sounding high-end combo. Naim MC boards £40, adjustable CD boards £40. Tel: (0449) 676335.

GARRARD/DECCA AP76 Decca teak plinth with smoked perspex and teak cover £60. Garrard Synchro Lab72B £30. Hi-Fi World first issue to 21, mint condition, offers please. Tel: (081) 391 5956.

FOR SALE: Ion Nexus amplifier system. SP-1 pre-amp (MC and MM). X-PAC 2 power supply. SAM 40 power amp. £450. 4x6m Kimber speaker cable £75. Target table. 2-tier, 4-shelf. Suit Ion/Naim amps. £40. All mint. Tel: (051) 342 8463.

TEAC VRDS-10, CyrusII and PSX, Mission 751s, Linn K400 bi-wire, Target HS24 stands, Audioquest Emerald interconnects. 10 months old, boxed, £1200 ono. 66cm Hitachi Nicam TV and Hitachi Nicam Videoplus video. Cost £1400. Sell £700. Tel: (0792) 298417.

SUGDEN SDT1 CD PLAYER. 13 months old. Little use, excellent sound and excellent condition £500. Denon PMA 250II integrated amplifier, 2 years old, good condition £70. Musical Fidelity B200 amplifier £150. Tel: (0702) 618922 (Southend).

TECHNICS SU-A900 £280 - cost £400, Technics SH-GE90 £175 - cost £250, Philips CD692 - £50. Tannoy DC2000 £120 - cost £320. All only six months old. Tel: Marcus (0704) 573646.

TRANSMISSION LINE SPEAKERS professionally built to 'Wireless World' specification, KEF units £170. Leak solid state amp 80 w.p.c. 3900A in original box £50. Tel: (0922) 722486 (West Mids. Evenings)

THORENS TD124 TURNTABLE c/w Fidelity Research FR64S arm with heavy counter weight and silver output cables, Garrott Brothers Micro Scanner Linn Asak cartridge. £250 ono. Genuine reason for sale. Tel: Mike (0934) 518072.

NAIM 72 PRE-AMP, current style, good condition. Variable and straight through boards. £400 Tel: (0734) 731776.

QUAD 606 POWER AMPLIFIER with QED passive pre-amplifier and good quality interconnects. All excellent. Boxed etc. £390. Tel: Plymouth (0752) 341719.

FOR SALE: Quad power amps (re-valved). Quad 22 pre-amp. Quad FM2 (two available). Quad AM tuner (LW/MW/SW). All in very good condition. £350 Tel: (0962) 861894 (Hampshire).

RUARK TALISMAN IIs. Black finish. Excellent condition. 15 months old, £400 ono. Tel: (081) 360 3799 (day/eves).

LINN LK280 POWER AMP, including interconnects, excellent condition, boxed £325-00 o.v.n.o. Tel: (0582) 592211 (evenings).

AUDIO SYNTHESIS Ultra Analogue DAC £595; Krell KSA50 MarkII £950; Krell KST100 £1395 (Balance of warranty); Sonus Faber Electa £950. All items mint and boxed. Tel: (0543) 274199.

NAIM NAPI35 power amps, £1425 pair, NAC32.5 pre-amp, type 72 boards, £235, HI-CAP power supply £215. Linn Kaber speakers, latest specification, Linn tri-wire cables, £725. All as new, boxed. Tel: (0489) 798890.

PYE MOZART pre and power amps. Excellent condition and sound quality £300 ono. Mullard 510 power amp (one only) £25. Kenwood DPX9010 CD transport £275. Tel: (091) 487 7796 (Tyneside).

MUSICAL FIDELITY A1 class A amplifier £110. Technics SL-PS620A compact disc player £110. Both immaculate with original packaging. Tel: (0742) 746790 (7-9pm).

WANTED: Private Buyer wants Thorens 3001/Rega or TP90S, or Thorens 520/SME or TP90S, or Townsend Rock MkIII/Rega or Voyd Helius. Must be in excellent condition. Tel: (0482) 842740 (evenings. Ask for Paul)

AUDIO INNOVATIONS: First Audio amplifier (2A3/88) £865 (New £1550); Series 200 pre-amplifier - only three months use - £235 (£350); Series 1000 MC transformer £140 (£300). Standesign Penta 5 shelf equipment support £75 (£160+). All perfect, can demonstrate. Near offers invited. Tel: (0455) 636695 - Please leave contact number if unlucky.

MICHELL GYRODEC, Rega RB300, Audio Technica AT OC10 moving coil cartridge and Gyro PSU. 11 months old, mint condition, little use. Bargain at £850 ono. cost £1320. Tel: (0202) 482124 (Christchurch).

LARGE COLLECTION of early hi-fi for sale as one lot, including Leak TL50 plus amps, Leak Stereo 50 and 60 amps, pre-amps, Troughline mono and stereo tuners, Leak spares, (inc. transformers), new boxed valves. Garrard 301, 401 and Thorens TD124 turntables, Decca FFSS heads, SME arms, Tandberg tape decks. Write only please enclosing SAE for full list to Mr Snow, 7 Edith Avenue, Peacehaven, East Sussex, BN10 8LJ.

LEAK TROUGHLINE stereo tuner and Leak Stereo 70 amplifier in matching teak. want a good home, £160 ono. Will sell separately. Tel: (0604) 760804 (Northampton)

ONIX BWD1-FM Stereo tuner with power supply, boxed, mint condition £350. Tel: (021) 553 5759.

FOR SALE
1) Audio Alchemy DAC DDEv1.0 and 'Clearstream' interconnect. Boxed as new, cost £499-00, accept £245-ono.
2) Leak Troughline stereo FM3 tuner, mint condition £149-ovno.
3) Wanted- Class A headphone amp! Preferably valve design! Tel: (081) 347 6077.

MAGNEPLANAR MG1B panel loudspeakers. Excellent sound as usual, mint condition, oak/black, £495 o.n.o. Wanted: One Quad II power amp (original condition). Tel: (0734) 722880.

AUDIO TECHNICA AT1005II pick-up arm complete with hydraulic lift. Despite its age is still in excellent condition with box, instructions etc. Also Shure M75EDII cartrdng. Good home needed - Yours for the price of the postage or free to anyone who can collect. Tel: Adnan Webber (0275) 393520 (Bristol)

CABLE CLEAROUT 50% OFF NEW PRICES? Interconnect: 1/2m Siltec MC4-24 £100 (2 pairs available) WBT connectors. Speaker cable: 5m pair Van den Hul CS122 £50. 3m pair Vecteur CV30 £25. 2.3m pair Exposure £6. Tel: (021) 430 3416.

YOU WOULD BE WARMLY WELCOMED at 'Fasganeoin', a long established, well recommended quiet country house hotel set in lovely grounds in Pitlochry, the heart of the Scottish Highlands. Tel: (0796) 472387 Fax: (0796) 474285.

LINN KEILIDH loudspeakers, black finish with ceramic bases. 10 months old. Price new £690, will sell for £490. Tel: (0900) 85344 (after 6pm)

ROKSAN TABRAZ Z1 tone arm + Isoda phono leads. 12 months old. RRP £330, will accept £135. Tel: Andy (081) 361 6050 (day) (072) 834561 (eve).

DELTA LITTLE BIT DAC, plus DNN interconnects; boxed, excellent condition; £190. Tel: (031) 554 8883.

WANTED: DENON POA6600 monoblock power amplifiers for cash. No telephone, please write: D Webster, 111 Strathmore Road, Hinckley, Leics. LE10 0LP.

WANTED: AUTOCHANGE DECK capable of playing 45s and 78s. Garrard AT60Mkill or Thorens, or W.H.Y.? Tel: Peter (0202) 659714 (eves, Poole) (0202) 595488 (day).

QUAD FMII TUNER, 33 pre-amp, 303 amplifier (boxed, mint) £150. FM Tuner (early model) £35, II pre-amp and amplifier £115, 22 pre-amp & amplifier block £40. ESL Bronze speakers £250. 100+ Mullard valves various, unused, boxed £45. Audiomaster stereo valve pre-amp £35. Dulci monoblocks (need attention) £25. Tel: (0306) 743469.

REBUILT GARRARD 401 turntable (silver) £200 ono. Logic Tempo turntable with Datum arm (black) and cartridge £120 ono (MC). Triangle speakers (floor standing), various Deltec and LFD cables. Deltec mains filter. Several speaker stands (offer or exchange). Tel: (0292) 441544.

"LOWTHER" HORN LOADED mini-monitors with newly re-coned PM6 drivers £350. "Stax Lambda Professional" earspeaker plus "Stax SRD-X Professional" energiser. Hardly used, boxed, £400. "Audio Technica ATH70" electret headphone with energiser. Mint, boxed, £100. Tel: (051) 426 1600 (day) (051) 426 1352 (after 6pm).

AUDIO INNOVATIONS SERIES 500, excellent condition, boxed £495. Musical Fidelity CD2, excellent condition £160. DAT, Sony DTC690, excellent condition £295. NAD 5020 Monitor Series CD, brand new £150. Tel: (0332) 271088.

AUDION

EST.1987



300B SINGLE ENDED
PURE TRIODE
STEREO

£995*
UK MODEL RETAIL

GOLD MEDAL WINNERS DO IT AGAIN!!!

SO LIFELIKE
hi fi news

"HERE'S AN AMPLIFIER
THAT SETS STANDARDS"
HI-FI WORLD

"INCREDIBLY POWERFUL!"
HI-FI EXCLUSIVE GERMANY

TONALLY SUPERB
SPAIN



A hi fi dream
Germany

"THESE ARE TRULY
EXTRAORDINARY AMPLIFIERS"
STEREOPHILE
U.S.A.

A WONDERFULL POWER AMP
SUONO ITALY

"OUR AMPLIFIERS SPEAK FOR THEMSELVES!"

***** 92db IMPEDANCE MATCHED TRANSDUCERS NOW AVAILABLE *****

CONTACT YOUR NEAREST DISTRIBUTOR OR SHOP FOR MORE INFO

LONDON
K J LEISURE
071-4868262/3

HEATHROW
AUDIOCRAFT
0895-253340

KENT
PROGRESSIVE
0634-389004

HEREFORD
ENGLISH AUDIO
0432-355081

ABERDEEN
ASTRAL
0224-582825

SUFFOLK
SIGNALS
0473-622866

NOTTS
CHANTRY AUDIO
0777-870372

SURREY
FARNHAM AUDIO
0252-714555

WEST MIDLANDS
SOUND ACADEMY
0922-473499

SUSSEX
JEFFRIES
0273-609431

HUMBERSIDE
ZEN AUDIO
0482-587397

NORFOLK
AUDIBLE
DIFFERENCE
0850-983233

***EXPORT MODEL £1250.00**

OVERSEAS DISTRIBUTERS

SWEDEN
TURNING POINT
+46-8-7443477

ITALY
ART OF MUSIC
+39-51-231172

GREECE
EXCLUSIVE
+30-18236225

HONG KONG
ELITE AUDIO
+852-530-1567

SINGAPORE
LANDMARK AUDIO
+65-3383867

SPAIN
MULTIMEDIA
+34-77-240794

JAPAN
SB INTERNATIONAL
+81-3-34057177

CANADA
CANORUS INC
+1-416-972-1387

SLOVENIA
K.A.T.
064-43391

PORTUGAL
LUZESOM
+351-2-9532235

PHILLIPINES
UPSCALE
+632-7415167

FRANCE
MAGAVOX
+33-59321134

AUSTRIA
LIVING SOUND
+43-316-82281044

HOLLAND
AUDIOVORM
+31-23-322774

AUSTRALIA
KEDKORP PTY
+61-2-708-4388

NEW ZEALAND
INTRINSIC
+64-3-33499119

GERMANY
MARVEL HEISS
+44-234-37430

SWITZERLAND
MAR ELECTRONICS
+41-1463-81-05

AUDION AMPLIFIERS UNITED KINGDOM
ALEMA UK FAX 0273 722250

Advertisers Index

ACOUSTIC ARTS	142	DAN DULEY	136	ORPHEUS AUDIO	108
ALEMA	144	DARBY'S OF ST. ALBANS	130	ORTOFON	16,18
AMADEUS S&V	118	DAVID ORTON	118	OXFORD AUDIO	
APOLLO	135	DEFINITIVE AUDIO	140	CONSULTANTS	137
ARCAM	62	DIVA	30	P.M. COMPONENTS	20
ARION ACOUSTICS	106	DPA DIGITAL	I.F.C.,3	POWER PLANT	130
ART AUDIO	119	DYNAMICS	116	PROGRESSIVE AUDIO	44
AUDIBLE DIFFERENCE	120,134	ELECTROFLUIDS	84	RARE RECORDS	125
AUDIO CLASSICS	140	EZEE ENTERTAINMENT	120	RARE SUPPLY LTD	122
AUDIO FREAKS	24	F & S TRADING	125	RDL ACOUSTICS	108
AUDIO GALLERY	134	FRANK HARVEY HIFI	110	SELECT SYSTEMS	88
AUDIO ROOM	119	G.T. AUDIO	118	SEQUOIA DESIGN	130
AUDIO SUITE	138	GLASS AUDIO	138	SERIOUS KITS	70
AUDIOCRAFT	118	GROOVE TUBES	116	SLATE AUDIO	137
AUDIOLAB	62	HALE HIFI	136	SON ET LUMIERE	94,96
AUDIONOTE	126,127	HEATHERDALE	123	SONIC FRONTIERS	96
BANDOR	24	HI FI CONFIDENTIAL	115	SOUND ILLUSION	117
BETTER HIFI	131	HIFI SHOWROOM	142	SPALDINGS	131
BILL HUTCHINSON	121	IAN EDWARDS	120	SPEAKER CO.	110
BRENTWOOD AUDIO	24	IAN HARRISON HIFI	136	SPECTRA DYNAMICS	114
BRENTWOOD MUSIC		INFIDELITY	16	STEVE BOXSHALL AUDIO	10
CENTRE	112	J.E.SUGDEN	I.B.C.	STEVE EMBERTON	134
BURY AUDIO	94,134	JAMO	22	STUDIO ONE	115
CABLE TALK	133	JEM DISTRIBUTION	134	SUSSEX SURPLUS	123
CAMBRIDGE HIFI	125	JORDAN WATTS	119	SWIFT OF WILMSLOW	137
CAMPAIGN AUDIO DESIGN	117	KEF	8	TABULA RASA	94
CHELMER VALVE CO.	124	KIMBERLEY HIFI	123	TESSERAC	16
CHOICE HIFI	140	KINSHAW ELECTRONICS	24,133	THE RECORD CONNOISSEUR	44
CHORD ELECTRONICS	120	KRONOS	106	THE RECORD SHOP	112
CLASSIC HIFI	125	LANGREX SUPPLIES	138	TRAXS	131
CONGLETON HIFI	132	LEONARD BOOTH	108	TRY ME & SEE	102
CONNECTIONS	84	LIVE '94	12,13	TUBE TECHNOLOGY	10,117
COTTAGE AUDIO	133	LORICRAFT	136	V'AUDIO	96
COURT 'N' SPARK	133	MANTRA AUDIO	119	WEST MIDLANDS RADIO	
CREATIVE AUDIO	104	MISSION	O.B.C.	SUPPLIES	84
CREEK	36	MJS	136	WILMSLOW AUDIO	44
CRICKLEWOOD		NAIM AUDIO	6	WOLLATON AUDIO	18
ELECTRONICS	130	NEAT ACOUSTICS	18	ZEN AUDIO	142
CUSTOM CABLES	117	NORTHWOOD AUDIO	44		



SUGDEN

HAND CRAFTED ■ FAIT À LA MAIN

DESIGNERS & MANUFACTURERS OF HI-FI & AUDIO EQUIPMENT

J. E. SUGDEN & CO. LTD.

Valley Works,

Station Lane, Heckmondwike,

West Yorkshire WF16 0NF

Tel. Heckmondwike 0924 404088/9

Fax No. 0924 410069

World Radio History

MISSION

because...



Mission Group, Huntingdon PE18 6ED England Tel: 0480-451777 Fax: 0480-432777.

World Radio History