

HI-FI CHOICE

THE WORLD'S NUMBER ONE GUIDE TO BUYING HI-FI

SEPTEMBER 1990 £2.95

Loudspeakers

FULL REVIEWS ON 25 MODELS

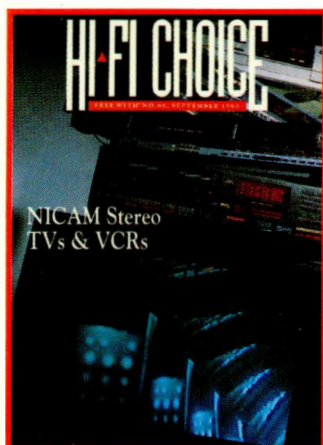

FREE
Supplement

RECEIVING NICAM STEREO:
TESTS ON TV SETS AND
VIDEO RECORDERS

Best Buys
Awarded

WE CHOOSE THE
BEST BUYS &
RECOMMENDED
PRODUCTS

Competition

A COMPLETE ARISTON
SYSTEM MUST BE WON!

OVER
950 Test
Summaries

IN THE CHOICE
BUYER'S GUIDE

ISSN 0955-1115



9 770955 111007

NEW ON THE STREET AND OUT AT THE HI-FI SHOW

THE WORD ON THE STREET
IS THAT THE NEW RANGE
OF ARISTON SEPARATES
IS OUT SOON - SEE THEM
AT THE HI-FI SHOW
HEATHROW PENTA HOTEL
14-16 SEPTEMBER* ROOM 1179

CD'S

DECKS

SPEAKERS

AMPLIFIERS

TUNERS

ARISTON



SEPARATES
BY DESIGN

*AFTER 4pm ON 14TH SEPTEMBER

THE WORLD'S No.1 GUIDE TO BUYING HI-FI

HI-FI CHOICE

ISSUE NUMBER 86: SEPTEMBER 1990

EDITOR:

John Bamford

CONSULTANT EDITOR

Paul Messenger

PRODUCTION EDITOR

Janet Moorhouse

NEWS/FEATURES EDITOR

Dan Houston

REVIEWS EDITOR

Jason Kennedy

CONTRIBUTORS

Alvin Gold, Victor Lewis Smith, David Foxon

ART EDITOR

Andrew Ryan

PHOTOGRAPHY

Chris Richardson

ADVERTISEMENT MANAGER

Fiona Hunt

ASSISTANT ADVERTISEMENT MANAGER

Rob Debenham

SALES EXECUTIVE

Miriam Young

CLASSIFIED SALES EXECUTIVE

Jane Woolner

ADVERTISEMENT PRODUCTION MANAGER

Kathryn Balchin

PRODUCTION MANAGER

Judith Middleton

MARKETING SERVICES MANAGER

Zoe Ringrose

SUBSCRIPTION FULFILMENT MANAGER

June Smith

NEWSTRADE CIRCULATION MANAGER

Stephen Ward

PUBLISHING DIRECTOR

Marianne McNicholas

ADVERTISEMENT DIRECTOR

Alistair Ramsay

FINANCE DIRECTOR

Colin Crawford

MANAGING DIRECTOR

Stephen England

CHAIRMAN

Felix Dennis

PUBLISHED by Dennis Publishing Ltd, 14 Rathbone Place, London W1P 1DE.

Tel: 071-631 1433. Fax: 071-323 3547 (Editorial); 071-636 1640 (Advertising)

Company registered in England.

REPRO: Graphic Ideas.

TYPESET by: Time Graphics Ltd. PRINTED by: Riverside Press.

DISTRIBUTED by: SM Distribution,

6 Leigham Court Road, Streatham, London SW16 2PG.

Tel: 081-677 8111.

A



PUBLICATION

Enquiries regarding the content of this journal should be made in writing to *Hi-Fi Choice* Editorial, 14 Rathbone Place, London W1P 1DE. We regret enquiries cannot be dealt with by telephone. While every care has been taken in the preparation of this journal, the publishers cannot be held responsible for the accuracy of the information herein, or any consequence arising from it. Readers should note that all judgements have been made in the context of equipment available to *Hi-Fi Choice* at the time of review, and that 'value for money' comments are based on UK prices at the time of review, which are subject to fluctuation and are only applicable to the UK market. This edition © 1990, Felden productions. ISSN No. 0955 111 5.

Member of the Audit Bureau of Circulation.



(July-Dec 1989 - 23,847)



Menu

Loudspeakers come in all shapes and sizes, the batch of 25 models tested for this edition of *Choice* featuring everything from affordable and 'conventional' boxes like NAD's 8225 to the rarified Audioplan *Kontra-Punkt* and highly unusual Seventh Veil *System IV*. As Paul Messenger explains in *Choosing and Using*. . . on page 39, when selecting the best loudspeaker for your requirements you have to take into account the characteristics of the partnering system and size/shape of your living room. How powerful is your amplifier? Will the loudspeakers need to be positioned against a wall? What kind of stands will be most suitable?

A specialist hi-fi dealer should be able to help make the decision process a less tortuous experience, conscientious dealers usually offering a home trial to ensure you make a wise choice. On a higher plain entirely, for enthusiasts who know what they want from an audio system and would rather a more 'hands-on' hi-fi experience, La Maison de L'Audiophile in Paris is a shop like nothing we've seen on these shores. *Aspirations* this month visits this hi-fi hedonists' Mecca on the rue de Belfort, and it turns out to be a feast for the eyes and the ears. Chris Richardson's photographs hopefully give you a flavour of this extraordinary hi-fi emporium.

In addition to reviewing loudspeakers for this issue, the *Choice* team has been busy testing NICAM-equipped TVs and VCRs for this month's free supplement. Once you've experienced high quality TV sound through a hi-fi system there's really no going back. Gazing into my crystal ball, I predict that as more regions come on stream with stereo broadcasts during the next twelve months we will witness an increasing number of hardware manufacturers producing affordable standalone NICAM TV tuners. The separate tuner is surely the most elegant way of integrating TV sound with a hi-fi system.

Alvin Gold is currently adding the finishing touches to his cassette deck reviews for next month's issue. He has also been testing a handful of CD players including models from Ariston and Radford - plus Meridian's new 203 D-to-A converter. And the October issue comes with a FREE cover-mounted gift from **CDextract**. Don't miss it!

John Bamford

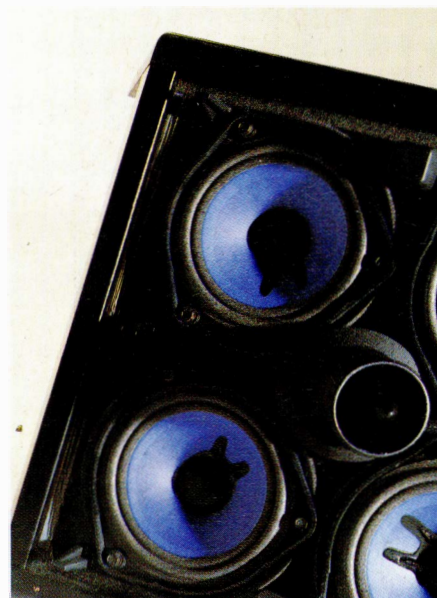

Cover photograph
by Chris
Richardson

Contents

THE WORLD'S NUMBER ONE GUIDE TO BUYING HI-FI

Lindley Audio's amazing singing tube – check it out in Sessions.



La maison de L'Audiophile, Paris – not your average hi-fi shop!

The Front End

7

UPDATE

Scoop city . . . What, where, when and how. *Hi-Fi Choice* brings you the hottest news from the world of hi-fi, including show reports from New York and Chicago.

17

CHOICE SESSIONS

Lindley Audio's tall, tubular *New Age* loudspeaker, and Bose's latest

around-the-house system are investigated by our intrepid reporters. Plus Victor Lewis Smith experiments with DAT for his upcoming Radio 1 series.

22

COMPETITION

This month we're giving away a complete Ariston system – plus one of their CD players and turntables as runner up prizes! Just think, this fabulous gear could be yours!

28

THE CRAFTSMAN

The Radford Apprentice . . . Dan Houston visits the home of Woodside Electronics, makers of Radford valve amplifiers and CD players, and finds that the brand's heritage dates back nearly half a century.

35

READERS WRITE/CHOICE ANSWERS

Another sackful of mail is aired and answered by our resident audio agony uncle.



Aspirations

24

LA MAISON DE L'AUDIOPHILE

This month *Aspirations* goes international and visits the home of France's most esoteric audio journal. Not surprisingly it's something of an Aladdin's cave.

The waiting's over. Courtesy of Aiwa, DAT recorders are now on sale.

Pauline, Marina and Gerry get stuck in on the Radford production line.

Loudspeakers

39

CHOOSING AND USING LOUDSPEAKERS

There's more to choosing loudspeakers than you might expect, but worry not, Paul Messenger has some useful hints and tips.

41

LOUDSPEAKER REVIEWS

Comprehensive technical and subjective reviews of 25 new loudspeakers by our man with the stands.

85

TECH TALK

So what do all those graphs and numbers mean to the end user? Try this page for some insight into loudspeaker testing.

86

CONCLUSIONS, BEST BUYS AND RECOMMENDATIONS

Which speakers were the loudest, most dynamic or seriously mind blowing – Paul tells all.

Focus

91

A PILGRIM'S PROGRESS

Are you getting the most from your CD player? If you understand a



circuit diagram and are confident with a soldering iron, David Foxon has a few ideas for seriously tweaking the electronics of inexpensive digital machines.

The Directory

98

CHOICE DEALER DIRECTORY

Classified listings of hi-fi dealers and private and trade sales.

113

THE CHOICE DIRECTORY

Our buyer's guide gives comprehensive 'at a glance' information on all the available equipment we have reviewed.

Take it or leaf it (groan) but this fabulous Ariston system will be free to this month's competition winner.



Choice Matters

21

COMING UP

Next month Alvin Gold gets a firm grip on the *Choice* reins and reviews a hefty stack of cassette decks and half a dozen CD players too.

49

BACK ISSUES

Missed an issue? Catch up on past reviews using this page.

102

AUDIOPHILE RECORDINGS

A selection of LPs and CDs that have been recorded with considerable care – guaranteed to bring out the best in your system.

107

CHOICE SUBSCRIPTIONS

Save money, time and effort *and* get your copy of *Choice* before everyone else – what could be easier?

109

QUANTUM CABLES

Stop here for discounts on the excellent range of YFERE and Furukawa cables.

144

PERSONAL MESSAGES

This month Paul Messenger discovers the delights of flicker free television.

EVERY DROP



OF HANDEL'S WATER MUSIC.

SL-PS70 CD

MASH

Actually if you want the technical handle on it, a glance below will reveal all you need to know.

However, it's enough to say that with the development of our unique MASH system you'll get everything from the sniggers and asides of a live CD to the massive choral splendour of the Messiah.

Exactly as it was recorded, and well worth splashing out on.

MASH 1-Bit DAC high resolution system with 8 times oversampling for no zero-cross distortion and high linearity.

Centre disc tray and multi-layer construction for better balance and excellent protection from vibration.

*Digital optical output terminal.
43 key remote control.*

20 key programmable function with just-time edit and full editing guide.

Contact your nearest Technics dealer as listed in Yellow Pages & Thomsons Directories.

Technics

For Music Lovers.

MUSIC TO YOUR EARS

(AND GRAHAM'S AND ALVIN'S . . .)



“What the Yamaha CDX-530E does so convincingly where other budget models tend to fail, is to produce a sound that reproduces the dynamics of real music” . . . “It is a first class performance at a very low price.”

Graham Mayor, 'Which CD' – May 1990



“The Yamaha CDX-730E has a crisp, well-defined sound that emphasises transients well and which consequently portrays tonal colours boldly and styles of placing with force and vigour.”

Alvin Gold, 'High Fidelity' – June 1990

Yamaha Hi-Fi products are designed and manufactured to the very highest standards and consistently achieve worldwide acclaim — such as the two advanced Compact Disc players featured here. To ensure that you derive the maximum enjoyment from your investment, we offer an exclusive, two-year guarantee on all our Hi-Fi products.

naturally.

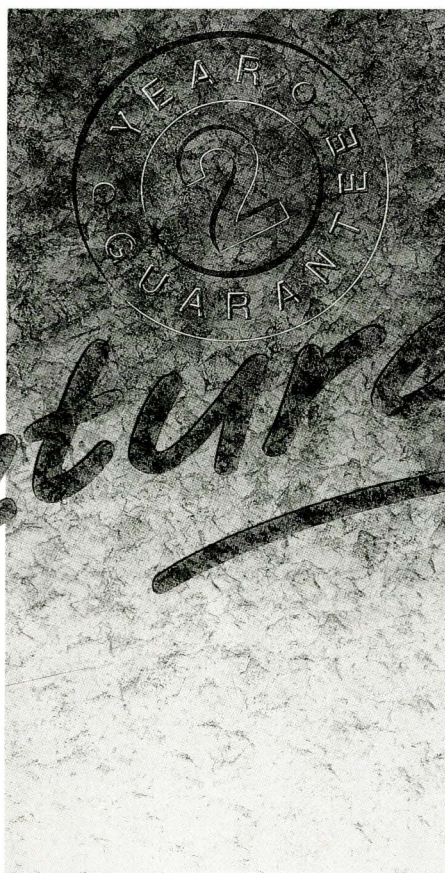

For your **FREE** range brochure and details of your Yamaha Hi-Fi dealer, contact:

YAMAHA HIFI

Over a Century of Musical Experience

Yamaha Electronics (UK) Ltd
Yamaha House
200 Rickmansworth Road
Watford, Herts WD1 7JS
Telephone: 0923 33166



Many Yamaha Hi-Fi system components feature RS Integrated Remote Control compatibility

Update



PRODUCTS

Worth waiting for?

DAT is at last being introduced to the UK public in the form of an Aiwa machine which will be available in September at around £600. The Aiwa DAT *HD-S1* uses the solo copy system (allowing users to only make one purely digital copy of a compact disc). It is a portable machine using Philips one-bit digital to analogue (and NTT MASH analogue to digital) conversion and offers true versatility. The *HD-S1* is a high quality personal stereo – it weighs 610g with battery, can be hooked into a suitable in-car system or it can be used as a digital tape recorder – both in the field and at home.

The solo copy chip (or Serial Copy Management System as it is properly known) allows one copy of a digital source such as a compact disc to be made. The tape is then encoded with a signal which inhibits the making of further copies. The idea is to stop pirates making high quality copies of



Late arrival: The tape is no longer red for DAT.

CDs by daisy-chaining several players together and recording in real time. Used normally, (ie by not plugging it into the digital outlet of a CD player) the machine functions the same as any conventional cassette player.

Patrick Chambers, for Aiwa UK, said that as soon as the solo copy system was agreed between the hi-fi and record industries last year, Aiwa had developed a suitable chip and had released the machine as soon as possible. The UK introduction follows an American lead by several Japanese majors who

for the *UPA-200* preamplifier or £229 for the *UCD-400R* CD player.

Uher's *Classic* series comprises four integrated amplifiers (starting at £129), a brace of tuners, three cassette decks, two compact disc players, two turntables and a pair of receivers. Six loudspeakers comprise the *Fairplay* series which starts with the bookshelf £149 two-way *FP60* and goes to the *FP2000E* – an oak-finished four-way £749 floorstanding model. Oak finish is available on the two most expensive models.

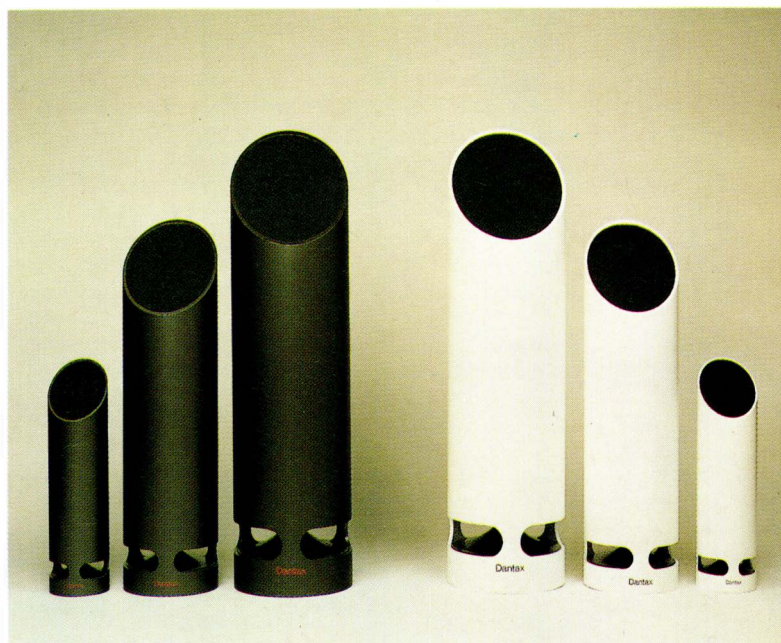

Tubular belles or sonic fertility symbols?

launched DAT in the States in July following Congress' ratification of the solo copy concept.

The newer Uher

A complete range of electronics and loudspeakers has been launched under the Uher name. Uher is best known for its 'indestructible' portable reel-to-reel tape recorders which have been used by broadcast journalists for decades. In a blitz on the domestic market, three series of Uher equipment are being introduced. The *Royal* series comprises a range of pre and power amplifiers, a tuner and CD player. Prices start at £169

Music in the Tube

A new range of tubular loudspeakers from Denmark is being imported in the UK. The Dantax *Tube* range consists of three different models. Tube 1 is a two-way unit which is described as suitable for wall or ceiling mounting. The *Tube 2* and *3* are larger, floor-standing three way models. The Tubes use a novel drive system consisting of mid and treble units firing up through the speaker's cylindrical enclosure and a bass unit firing downwards onto an acoustic cone in the base, and outwards through ports. Public address specialist



Uher: hi-fi from a name trusted by BBC correspondents.

DNH, of Uckfield in Sussex imports the range and claims full 360 degree coverage saying that precise stereo imaging, low distortion and high sensitivity are the speakers' strengths. "Even if you place the Tube behind a chair it still delivers the full dynamics of Shakin' Stevens or the subtleties of Brahms," the company vouches. The Tubes are joined by another, wall-hung square speaker – the Dantax SQ 65II.

Sony joins the stream

Sony has launched five new 'bitstream' CD players. All three incorporate Sony's variation on the 1-bit theme known as PLM (pulse length modulation). This is a digital to analogue conversion system that operates at far higher clock speeds than found in the Philips and Technics bitstream DACs.

The new ES models that use PLM are called CDPX33ES, 55ES and 77ES and are priced at £400, £600 and £1000 respectively, while the CDP-790 and 990 are rather more affordable at £200 and £300. The ES series models have two step switchable displays which show full, basic or no information, the latter being recommended for maximum

sound quality. The other new full size player launched this summer is the CDP-590, an 18-bit 8-times oversampling player with a modest £170 price tag and a relative dearth of facilities by Sony standards.

Hi-fi TV

Although NICAM stereo transmissions are still not available nationwide, and even in the right areas the number of programmes transmitted in stereo is still limited, the public is waking up fast to the fact that stereo sound TV is here, and is worth paying a bit extra for.

Ferguson estimates that 17 per cent of the large screen colour televisions sold in 1990 will be stereo chassis with on-board NICAM decoding, which is three times the 5 per cent or so sold during 1989. It's also more than double the take-up ratio of NICAM Hi-fi Stereo VCRs, which is perhaps a little surprising.

Ferguson's latest *Soundline* colour televisions stress good sound quality as the prime feature, thanks to built in amplification with 2x40W Music Power rating – well ahead of the television norm – plus no fewer than five built-in loudspeakers, including a rear mounted



Stereo TV: Anyone know any dancing horse jokes? - Ed.



Portable CD sound comes cheaper from Goodmans.

'subwoofer' reflex system with front port outputs.

Both models feature the advanced Black Super Planar tube with anti-reflective coating, the 59M5 (59cm/24in) model costing £600 and the larger 68M5 an extra hundred pounds. Both are styled with the loudspeakers symmetrically

The price includes a carry case, in-ear headphones, AC adaptor and bass booster.

All that glisters

"There is a general feeling that for the Nineties something other than black was called for. . ." reads the press release for Denon's new



Denon's Midas touch for budget gear.

flanking the screen, and feature unusually flexible 'connectability' for interfacing with other (video, audio and satellite) equipment.

The latest ICC5 chassis incorporates an interesting new Interactive Menu Control system with advanced on-screen graphics, which is a particularly effective way of coping with the increased complexity that new sources and sound capabilities are bringing to television.

Your price?

Goodmans new portable CD player is being imported from Japan at a price of £99.90. The GCD40 has the usual features, including a 16 random memory track, and it also has a line out socket for compatibility with your hi-fi.

gold finish separates. Apparently targeting the designer and female markets, the company has introduced gold painted versions of its budget amplifier, cassette deck, tuner and CD player, at no extra price. Denon says it will expand the gold range if the project proves successful.

First fifteen

The latest integrated amplifier from Exposure Electronics of Portslade, Sussex, is the £600 15. The 35W 15 is described as improving on the company's 10 integrated amp, with a new preamplifier buffer stage and transformer. It offers a separate recording selector and is housed in a glossy black case with gold lettering, instead of the traditional yellow.



Demon Records: Devilishly yours via Roksan dealers.

BUSINESS

NAD moves

Hi-Fi Markets has relinquished its distribution of NAD products. NAD has now set up its own distribution network – NAD Marketing Ltd, based temporarily at the company's head office in Finchley, N London. HFM recently acquired the Cambridge name – famous for its amplifiers and CD players. Malcolm Blockley, who runs HFM said: "We wanted to put all our efforts into Cambridge and there are certain areas where it directly competes with NAD. Yes, we are planning more budget separates from Cambridge soon, and we didn't want to be looking over our shoulder at NAD in doing so. It was an entirely amicable split and they have taken our stock and all the staff who were involved with the brand.

Grist for the vinyl lover's mill

Turntable specialist Roksan Engineering has taken on the worldwide distribution of Demon Records. In a bid to combat dwindling supplies of vinyl records on the high street, Roksan says its own dealers will now sell the Demon catalogue which

features both well known and specialist artists on several labels from Bam Caruso to Rounda Europa. While Demon's media do include cassette and CD, the company says: "One cannot escape the fact that there are a fair number of records which sound better on vinyl than they do on CD – as zealous and impressionable CD buyers are discovering to their discomfort."

High-end ICE gets organised

In-car entertainment retailing has a new look. Car Audio Labs is a group of ten dealers which wants to set new standards for installation and sound quality in the booming (groan) world of ICE. It aims to promote the existence of hi-fi car audio by pooling resources and buying space in non audio publications. The consensus seems to be that there are plenty of people who could afford the relatively high price of high quality installations and would want good sounds in their autos if they knew it was available in forms other than that encountered in your average XR3i.

The group includes high end ICE luminary Mike Wells, the man who practically introduced the

notion of quality in-car sound to these shores. The technical approach used at his Fulham workshop will be employed throughout the group, ensuring high and consistent standards of sound and installation.

If the group manages to live up to its aims the future of in-car hi-fi will undoubtedly benefit. For your nearest dealer call Mike Wells on (071) 381 0789.

Shows go on

Some of the best hi-fi available in the UK will be on show at the Heathrow Penta Hotel this month. As this is the UK's premier annual independent hi-fi show, many manufacturers will be exhibiting new products. The free show will take place over the weekend of September 14-16, starting at lunchtime on the Friday, and running from 10am 'til 6pm over the weekend.

In October the National Sound and Vision Show will be staged in the Last Drop Village, just outside Bolton, Lancashire. The show runs from October 5 to October 7 and will open from 12 to 8pm on Fri, 10am-7pm on Saturday and 10am to 6pm on Sunday.

Last, but not least, for those readers who bought an early copy of *Hi-Fi Choice* there's an In Car Hi-Fi show in Bristol in August. This show will feature the best of ICE plus exotic show cars and it promises 'fun for all the family' with the likes of a Scalextric competition and beauty contests. It will take place in the Bristol Exhibition Centre and runs from 8.30am to 7pm on Saturday August 25, and from 8.30am 'til 6pm on Sunday.

IN BRIEF

The BBC's new radio station – Radio 5 will start on August 27 using Radio 2's frequencies of 693 and 909 kHz. Radio 2 is to be evicted from the medium wavelength and will only be available on FM (88-90.2MHz).

Stereo Stereo, a Glasgow retail hi-fi specialist, is hosting a series of musical evenings in October. Naim Audio is featured on October 2; Linn Products on October 9 and 10 and Arcam equipment on October 23. Details from the shop – Tel: 041 248 4079.

Following last month's announcement that Swisstone Electronics is to take over the Luxman brand in the UK, we now understand that a separate company has been formed to handle Luxman distribution – from the Swisstone address, at Mitcham in Surrey.

New York, New York

Steve Moore, of London's *The Cornflake Shop* store, visits a high-end exhibition in New York organised by *Stereophile* magazine. . .

At the end of April, New York played host to the 'High-End Hi-Fi' show, sponsored by America's *Stereophile* magazine. I've only been to the annual, giant, Consumer Electronics Show (CES) in Chicago before now, and this *Stereophile* show proved to be



The first Fifteen amp, from Exposure.

quite different in character. This was a purely 'high end' exhibition, with around 80 demonstration rooms from retailers as well as manufacturers.

The main purpose of my trip was to visit New York dealers and get a feel for the trends in their market, particularly in custom installation – so I had spent some time in most of the stores anyway. At the show I found dealers' rooms (in general) sounded excellent, but boy, did their shop systems sound bad! And what a miserable bunch they were. If you've been to New York, you'll know what most shops and restaurants are like: the staff are most friendly, and the customers are really aggressive and grumpy (the opposite of London!). Well, New York's hi-fi shops certainly buck this particular trend. I found the staff at all but one store to be downright rude, to say nothing of being patronising and pseudy. Which store wasn't? Sound by Singer – a store to put almost any other to shame. A friend and I heard the Wilson *Watt/Puppy* combination (a £10,000 loudspeaker) here, in conjunction with some Krell Reference amps and the Krell *CD Turntable*. This produced easily the best sound that I've ever heard from CD, in a friendly, smart, air-

conditioned store.

There was a strong British presence at the show, including brands such as Arcam, Rogers, Castle, QED, Onix, Beard, Creek and Exposure. Roksan was there playing the *Xerxes/Artemiz/Shiraz* front-end, with its excellent new *ArtaXerxes* cartridge preamplifier which was sounding good through some JDI amplification and the new *Castle Winchesters*. B&W showed its outrageous *Matrix 800s* (as seen at last year's Penta show), and the *801s* (regarded as 'reference' moving coil speakers in the US) were much in evidence throughout the show. Meridian played the gorgeous (looking and sounding) new *600 Series* CD transport and preamplifier which each fill two normal Meridian-size boxes. The transport can be used straight into the company's *D600* speakers, or via the DAC/preamplifier into a power amp, or their more conventional active speakers.

There were scores of power conditioners in use around the exhibition and I don't think this was just a response to the hotel's undoubtedly inadequate mains supply. I see this as evidence of an increased tweakiness in the high-end. Other tweaky products include a vast range of CD treatments and a veritable

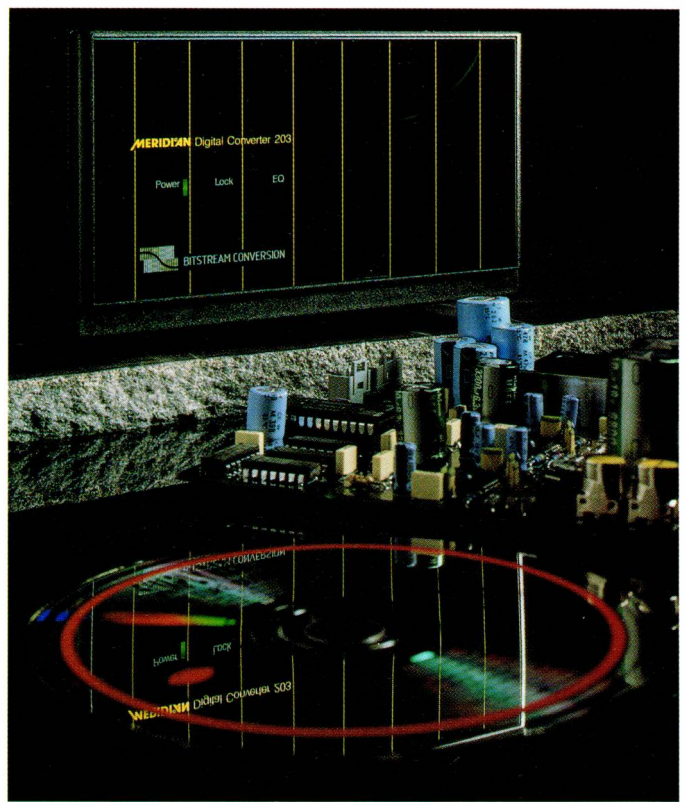

Meridian's vaunted 203 DAC: making analogue waves.

tangle of 'world's-best' cables – all at crazy prices. Why all this tweakery? Well, it's a bit of a paradox really, but since the CD player has stolen the limelight from analogue sources you could argue that some specialist dealers are finding it difficult to justify their existence. In the old days they could tell of their prowess in setting up notoriously difficult high-end turntables – these would have to be lovingly installed and chanted over before they gave of their best.

No sign of this mechanical (or zen) expertise being needed with a CD player. How well (or badly) can you plug one in? So why shouldn't you buy it mail order and save yourself a few quid? The sensible dealers would argue that you still need all the demo facilities (to make a good choice in the first place) and warranty backup (for peace of mind later), but the crankier ones now point to a whole load of accessories for your CD system that only they can offer.

As a specialist dealer myself I think that, taking account of the now bewildering range of hi-fi on offer, good dealers are needed more than ever to sift out the good equipment and give advice on how best to use it. Despite this, most US dealers are moving more and

more into areas where their specialist knowledge is reflected in a large labour bill to the client (like multiroom installation) and leaving some of the domestic work to the discounters.

Why does this concern me? Well, I think it all goes to make the industry (and its products) less accessible to a baffled public. I worry particularly about the lack of women in our industry – and this show was no exception. I would have thought the ratio of men to women must have been about 50 to 1 and, whilst exhibitors continue to talk of 'wife-acceptance factors' and flaunt their 50kg metal boxes like fertility symbols, I don't see this situation changing. Perhaps 'heatsink posturing' is the correct medical term for this undoubtedly male condition. Jan Donaldson, distributing Linn Products on the East Coast, was one of the few women I saw working at the show.

I asked Jan how turntable sales were going. Not great, but OK, was the gist of her reply. It seems that turntable sales are drifting upmarket (she had pointed out that the introduction of the Linn *Basik* turntable had just meant more *Axis* and *LP12* sales) which seems to be the experience of retailers in the UK too. I always carry out a rough 'turntable-count' at hi-



Krell 'Best CD sound I've heard' player. But £10,000 - ouch!

fi shows, in these CD-dominated days, and I spotted a few Roksans and VPIs, two Linns, and what seemed like a million CD players.

The Krell *CD Turntable*, and the Barclay *Cabernet CD* transport (not yet seen on these shores) seemed very popular, along with the excellent, if expensive, Wadia D-to-A converters. One of the chief attractions of CD players in the States must surely be the low (realistic?) price of discs. Check out the window of Tower Records (a bit of a misnomer these days). Never mind the sale prices, look at the full prices: \$9 to \$12. It's almost impossible to find LPs in record (wrong word again!) shops in New York (never mind in Sticksville, Utah) – even singles are only available on CD and cassette. You can even make up your own custom-cassette from a huge selection of digitally-stored tracks which can be duplicated at high speed onto a blank cassette which is cut to just the right length. This system – Personics – can be found in many record stores in major cities. It's easy to use, and costs about \$15 for a complete cassette. You pay upwards of \$1 per track, and the sound quality is reasonably good.

Back at the show there were a couple of noteworthy products from mainland Europe – Burmester (remember them?) showed a beautiful DAC/preamplifier that has been getting rave reviews in its native Germany, and Philips introduced the *AV1001* preamplifier, featuring (in no particular order) Dolby surround sound, bitstream D-to-A conversion, 9 audio & 5 video inputs, an S-VHS input and a 52 button universal remote control. Next year they plan teletext, weather forecasting, teasmade. . .

CHICAGO SHOW

In June every year SCES, the world's premier consumer electronics show, is held in



SME's exceedingly serious turntable guarantees Precision.

Chicago. Its relevance to the UK hi-fi experience is limited, so few freelancers get the opportunity to travel there very often. My last visit was five years ago, so I jumped at the chance to join the 1990 Mission Press Gang. The trip turned out to be one of the experiences of a lifetime – though the show made a much smaller contribution than the city of Chicago itself.

Before getting down to the hi-fi – at any rate the bits with real UK relevance, in which sense SCES is just as important as Penta or Bristol – Chicago itself deserves a plug as probably the most exciting city in the world, musically, culturally and architecturally.

And this year, the Chicago Symphony Orchestra was in town. Some rate the Berlin and Vienna Philharmonics higher; I've experienced neither (live) so won't attempt the comparison. But the Chicago Symphony Orchestra is certainly one of the three greatest; its brass playing alone makes London orchestras sound embarrassingly under-rehearsed. And with Klaus Tennstedt conducting *Mahler 1* a peak experience was guaranteed.

SCES itself is no hi-fi show. In a country where the money spent on in-car entertainment more or less matches that spent on domestic audio, hi-fi separates probably amounts to around 15% of the whole shebang. That in turn leaves enthusiast hi-fi with maybe 1.5% of the cake at my guesstimate, which sounds like exceedingly small beer.

But even the crumbs from a cake as big as US consumer electronics still amount to rather more calories than that provided by the much smaller population and spending power of UK consumers. Which is why

America is vitally important for British specialist hi-fi companies, and why many firms save their most important model launches for Chicago in June or Vegas in January.

Since it was picking up the tab, Mission deserves first bite of the cherry. But the company qualifies on merit too, courtesy the utterly delightful *Cyrus 780* miniature loudspeaker, and the similar, ultra-competitive *Mission 760*.

Mission also deserves congratulations for having had the sheer nerve to fly in the face of 'size equals price' by launching products that look so similar, at both £99 and £169. The *Cyrus* is slightly deeper and veneered in real wood, but both share the same baffle area and drivers. However, they don't sound the same: the extra money has been spent where it matters – beefing up cabinet and crossover to very good effect.

The anticipated complement to the successful

3, the *Celestion 5*, made its debut. This takes the opposite approach, increasing cabinet size by 50% and using a larger driver to gain a couple of dB extra sensitivity. At the top end of Celestion's range, there's now an *SE* variation on the *700* theme.

Big in the US of A, B&W was really pushing the boat out, with a whole raft of new models: a pair of smallish *300s*, the *DM310* and *DM320*; a trio of floorstanding *600s*, the *DM620*, *DM630* and *DM640*; and a couple of new *Matrix* models (*Matrices?*), complete with little tweeters perched on the top.

KEF was a little lower in profile this year, with just a couple of range fillers, the *C65* and *C85* slotting into gaps towards the top of the popular *C-series* lineup.

However, sister company Meridian's *D6000* loudspeaker was one of the show stealers. It's an active 2-box (subwoofer+satellite) system that accepts a direct digital feed and actually carries out the active crossover filtering in the digital domain, prior to the inbuilt analogue power amplifiers and drive units. Even the assembled press was sufficiently awestruck by the sound quality to stop eating breakfast and shut up



Seen there, from here: Monitor Audio's latest 14.

AFTER CHRIS PORTER MIXES IT WITH GEORGE MICHAEL HE TAKES THE MIX HOME TO HIS AKAI.

It's hard to imagine from the clarity and precision of the "Faith" album that throughout much of its recording the engineer Chris Porter was "legless"

This, however, didn't stop it walking away with a much coveted "Grammy" award (the Music Industry's Oscar) as The Album Of The Year.

In fact, working on crutches following a riding accident whilst keeping up with the exacting standards demanded by George Michael is just one example of Chris's professionalism.

Fortunately the rest of his career has seen him leaping around the world as a producer/engineer producing a Number One for Aswad, and also working with top bands in the USA and Europe.

Not surprisingly he's working again with George Michael on his forthcoming album

Sitting in his own studio deep in rural Surrey he says, "The engineer's job is to make it look effortless", adding, "when the artist has an idea I get it going quickly".

Getting it going isn't that difficult. He's surrounded by equipment that wouldn't look out of place on the Space Shuttle

"10 years ago, 90% of this didn't exist", says Chris as he indicates the banks of black boxes, serried rows of dials and switches and pulsating lights.

But then machines like the Akai Pro-Audio Professional range changed everything. Now, at his fingertips Chris has a range of digital effects, samplers, musical computers and drum machines

Today, George Michael's

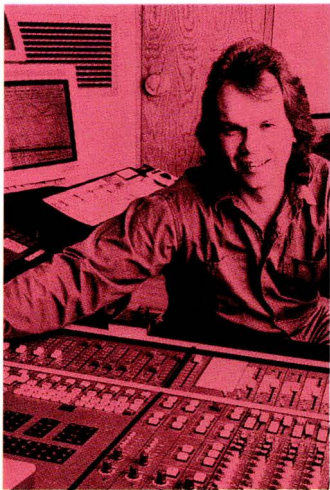
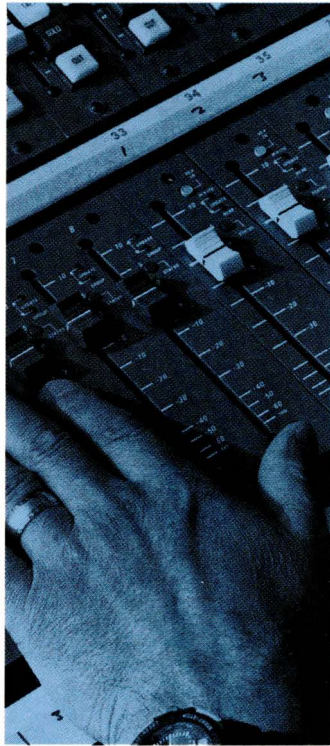

songs are created with the assistance of computers and multi-track recorders.

"Equipment technology seems to change month by month" says Chris. But Akai remains at the forefront. "The Akai S1000 Sound Sampler is the industry standard", he adds

After spending up to six hours a day over the past eight months perfecting what he calls the "sound picture" of each song, Chris often listens to the tape on his Akai midi-system. Doesn't he

notice an incredible difference in quality?

"Not at all" he says, "of course the sound's only as good as the equipment it's played on... listening on some systems is like viewing a painting through out-of-focus glasses"

The Akai range could never be accused of that. Akai's expertise

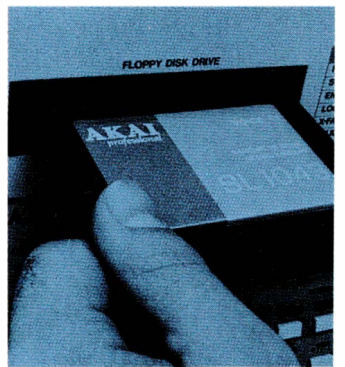

in satisfying the professionals has created HiFi systems and separates that keep the sound picture in perfect focus

They completely live up to Chris's description of good equipment. "Something that keeps the detail and the punch of what we achieve on the master."



AKAI

always professional

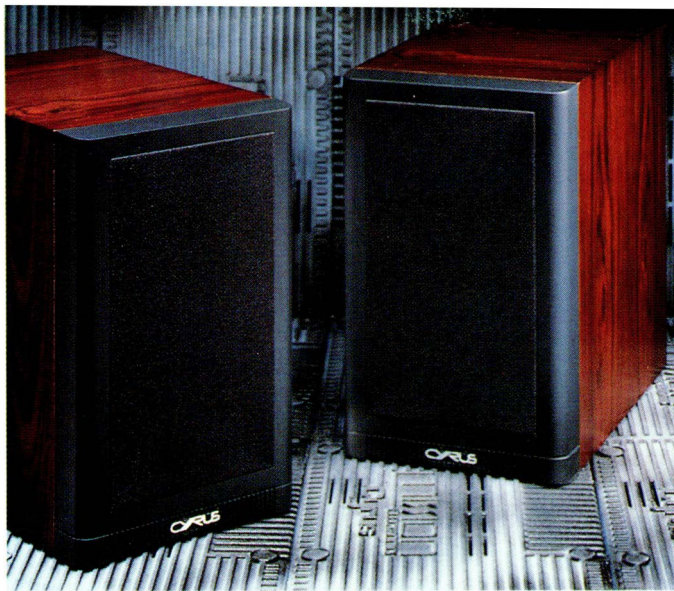

Another Yankee debut: Mission's Cyrus speakers.

for a few minutes – a few more moments silence greeting the news that the price would be £6,000/pair. Nor is Meridian resting upon the laurels won by its recent 206 and 208 CD players: the 602 and 603 are CD transport and DAC/preamplifier, and represent the next 2-box development stage beyond 208.

Another stunning contender for the US 'high end' action, this time on the analogue front, is the eagerly awaited *Model 30 Precision Turntable* from tonearm specialist SME. I unfortunately missed the dem, arriving just as the last bits of polystyrene were being fitted into the flight case, but the photograph and description are more than enough to trigger the adrenalin in any enthusiast. It's a real heavyweight, turning the scales at 38kg, the platter weighing 6.7kg and subchassis a further 21kg. The moving parts are isolated by a suspension of 96 rubber strands, backed up by dashpot damping. The bad news is a £10,000 price tag. . .

Certainly more affordable and in its way just as interesting is a new top-of-the-line loudspeaker from Rogers. *Project 24* (as it's currently known) breaks with company tradition in two important respects: it's floorstanding and has three drive units. Tall and slim, the midrange and tweeter are mounted on a small slanted baffle towards the top; the bass driver is hidden within the enclosure, delivering its output through twin bandpass reflex ports adjacent to the other drivers, thus keeping as close to a point source as possible.

More affordable still, Monitor Audio is building on the solid reputation established by the 7 and 9 to introduce a 2-way twin woofer *Monitor 11* at £299, and 2¹/₂-way floorstanding *Monitor 14* (£349).

The Mordaunt-Short takeover has finally enabled Creek to get its 'Creeker' *LS50* loudspeaker off the starting blocks. It's a compact £200 model that takes its

inspiration from that established favourite of ten years ago, M-S' legendary *Pageant 3*.

Having concentrated thus far on UK products, a couple of imports also deserve mention. Oracle has rationalised its turntable range, which now starts with the very pretty lacquer finish *Paris* at £650, moving up via the £1,295 *Alexandria* to (and beyond) the £2,000 *Delphi*. An Oracle/SME tonearm is now available too.

And for those who can't decide how to decode their digital bits, California Audio Labs now has a CD player wherein the digital-to-analogue converter (DAC) circuitry is a removable module. Tweakers will be able to try the alternatives, and the arrangement makes good sense in enabling simple future upgrading of this key component.

Away from hi-fi and over in consumer electronics land, camcorders are at the sharp edge of both technology and politics. Sony stole a lead last year with its handheld Video 8 *TR-55*, so this year Panasonic and JVC both have ultra-compact VHS-C machines, Panasonic's threesome dubbed '*Palmcorders*'.

Multi-changer CD mechanisms have grabbed something like 30% of US hi-fi sales, and this year all manner of new and ingenious variations on the theme appeared. Sony's carousel spawned various imitator/improvers, Technics' top-loading variation enabling discs to be substituted during play. Sanyo's carousel is even more ingenious, since the 5-disc

tray doubles as a vinyl turntable by spinning at 33 and 45rpm beneath an analogue pickup arm.

Both Sansui and Nakamichi have new subst-changers too, the former's 3-disc carousel being small enough to fit on top of a mini system, retaining 5-disc capability by an autochanger style stacking system.

Elsewhere in audio and video, much of the talk is of integration, which may at last be starting to happen. The stimuli have been the steady spread of stereo TV and the Dolby Surround encoding of feature films on both videotape and the 'higher-fi' Laserdisc format. Led by Pioneer, Laserdisc's importance continues to grow in the US, as hardware prices drop.

The results are a steady upgrading of TV screen sizes and sonic performance across the board, with the creation of a home entertainment 'high end' with the full projector-with-surround-sound 'home theatre' concept. The Barco/Fosgate/Stewart dem, using the magnificent Duntech *Black Night* speakers, gave a stunning display of standard and high definition source material, the latter clearly matching the experience of a movie theatre (aka cinema).

Numerous large console CTVs now incorporate not only better quality amplifiers and loudspeakers than before, but also circuitry like Dolby Pro Logic surround sound decoding, the whole 'budget theatre' effect being achievable simply by adding a couple of extra rear loudspeakers.

Back in 1982, film

producers Lucasfilm (the operation behind both *Star Wars* and Indiana Jones) developed a special high quality, rigidly specified sound system called *THX* for cinemas, to give movie-goers a chance to hear films the way they were intended to be heard. Now a domestic version has been licensed to Technics, as well as US specialists Lexicon (professional effects) and Snell (loudspeakers).

Technics' *Home THX* system goes at least one step beyond Dolby Pro Logic, using six channels of audio amplification and side/rear loudspeakers with carefully specified directivity characteristics.

Elsewhere in home-theatreland, Philips' rear-projection *WallVision* system is a stunning piece of design work, though some might question the practicality of finding 30-34 inches of behind-wall installation depth.

Home theatre with surround sound is one growing trend, the other is for round-the-house hi-fi (see Bose item in *Sessions*). Both are well served by a growing band of 'custom installers', who specialise in flush-mounting components in stud walls. Leading speaker brands like KEF, B&W and Boston have introduced loudspeakers for this purpose, but it's interesting to note the growth of US 'architectural audio' specialists such as Sonance. Very much a grass roots US operation, the company has developed all manner of useful switches, relays, sensors, boosters, subwoofers and so on.

Such is the nature of show reports, there's always more left out than gets fitted in. Should I have addressed such weighty issues as the future of home automation – or given a plug to the barking dog telephone? For anyone with any interest in consumer electronics, SCES is a vital education – but at the beginning of June especially, Chicago is simply a great place to be.

Paul Messenger

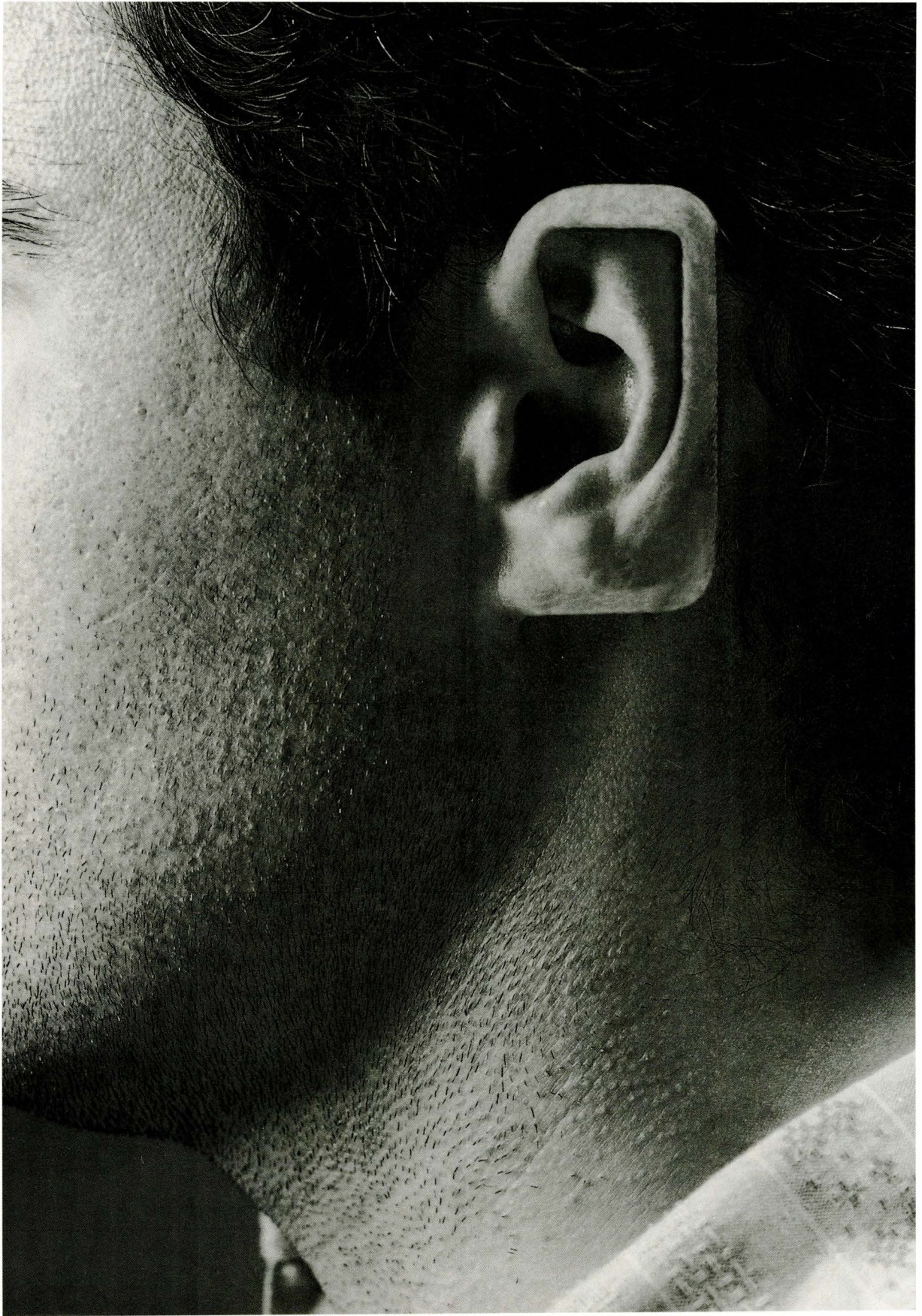

what happens when you plug your tv into our nicam tuner?

Apparently, when you're hooked on tv, your eyes can become distinctly rectangular. Plug our new Delta 150 Nicam tuner into your tv and you should anticipate a similar transformation to your ears.

Nicam stands for (deep breath) Near Instantaneously Companded Audio Multiplexing (as if you didn't know!). This is the system invented by the Beeb for transmitting digital stereo sound signals within the normal tv signal. Already being broadcast by ITV and Channel 4, Nicam brings CD quality sound to tv programmes. The Delta 150 is the tuner that decodes the digital sound signal from the picture signal. Plug your tv into the Delta, plug the Delta into your hi-fi and caramba!... unbelievably realistic sound to accompany your tv picture.

The Delta 150 can be used with any good quality hi-fi amplifier and speakers, and with any standard tv. However, if your tv has an AV input, using the Delta 150 will actually improve the picture. This is because the Delta separates the sound signal from the picture signal so they don't interfere with each other.

As in CD players, the heart of the Delta tuner is the digital to analogue conversion circuitry. These critical components are the key to high quality sound. Arcam's experience in building thousands of award-winning CD units ensures the Delta 150 captures every subtle nuance of the stereo sound. And it's not just music programmes that benefit. Sport, films, dramas and natural history programmes also suddenly become totally involving to give you a genuine sense of "being there". (The same, we're relieved to admit, can't be said of party political broadcasts just yet).

If you'd like to experience how to put your tv fairly and, dare we say it, squarely in the audiophile league, call us for details of your nearest dealer and experience the remarkable sound of Arcam hi-fi. Now in glorious colour.

ARCAM

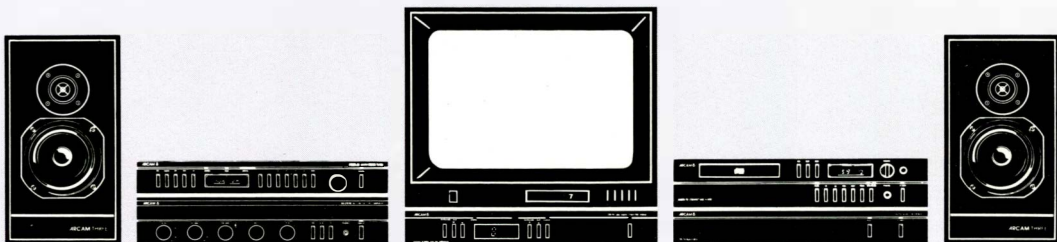

AKG
ACOUSTICS

PICTURE



PERFECT



SOUND



Perfect sound is subjective, influenced by your favourite recordings and your hifi system, carefully assembled from individually chosen components. Since no two listeners have the same conception of what is perfect or nearly so, AKG, who are a world leader in broadcast and recording studio equipment design, have developed a diverse range of headphones incorporating differing acoustic and physical design features. Now you are able to buy headphones that will satisfy your own personal listening criteria, both for your treasured vinyl recordings and the newest compact discs. Whatever the scribes prescribe, the final choice is yours.

Don't make it without listening to AKG headphones first.

K 145 / S

Advanced electrostatic plus dynamic twin capsule principle ~ Dynamic 'woofer' delivers high energy bass, and electrostatic 'tweeter' a detailed high end.



K 280 PARABOLIC

Twin capsules in each earpiece focus the sound parabolically into the ear canal for acoustic efficiency. High levels of performance and comfort.



K 240 MONITOR

Probably our most consistent best seller to 'serious' listeners, due to its exceptional performance and wide dynamic range. Very comfortable too.

AKG Acoustics Ltd., Vienna Court, Lammas Road,
Godalming, Surrey GU7 1JG.



Telephone (04868) 25702. Facsimile (04868) 28967.
Telex 859013 AKGMIC G.



Creative thinking behind Bose's ultra-compact multi-room system design.

Round the house Lifestyle

Paul Messenger reports on a new concept in round-the-house sound from Bose.

Though hardly off the starting blocks here in Britain, home theatre and round-the-house hi-fi are two areas which have recently shown significant growth in the US of A. Both started with 'custom installers' putting together packages of equipment mainly from small specialist suppliers, but the time now seems ripe for the bigger operators to get in on the act.

Many of the multinationals were showing their 'home theatre' concepts at the recent Chicago show, while one of America's largest loudspeaker specialists, the Bose Corporation, has just announced ambitious plans to enter the round-the-house hi-fi scene, with the so-called *Lifestyle Music System*.

Being Bose, the approach is entirely individual, and in several ways very creative and imaginative. One of the big difficulties in existing round-the-house technology is the complexity of and disruption caused by the installation work. To tackle this Bose has adopted 'minimal intrusiveness' as a major design priority, and this is pursued relentlessly in the design of the total system and in the individual components thereof.

Perhaps the cleverest touch is the use of RF (radio frequencies) in place of the more normal infra red for the remote handset. IR works fine within a single room, but is restricted to line-of-sight applications, which is highly inconvenient for full round-the-house operation. Hitherto available commercial approaches have used extensive back-to-base wiring to achieve remote con-



trol, but HF (high frequency) RF signals penetrate through most barriers and have a range of 50ft or more, just like a cordless phone. No less clever, Bose has successfully obtained the necessary DTI (Department of Trade and Industry) approval for UK use, at 27.465MHz (the same bands used for garage door opening and model car radio control).

Four distinct products make up the package so far, though others are planned and the core components already have the necessary inbuilt future flexibility to accommodate these developments. Heart of the system is the ultra-compact *Lifestyle Music Center* (Bose spelling). First seen in Tokyo at the end of 1989 (see *Choice Feb '90* page 13), this pretty little unit combines CD player with AM/FM tuner and two separate remote controllable preamplifiers. The latter feature allows the various source signals (built in or from auxiliary inputs) to be supplied at line level to two separate strings or 'zones' of active (powered) loudspeakers sited wherever required in the dwelling.

Just as much a core component is the remote handset. Besides the RF operation, it's been thoughtfully designed with 'smart' keys and intelligent inter-

nal logic, so as to provide full function capability without too much complexity or too many buttons.

Two different speaker systems are currently available. Key entertainment rooms will use a powered version of the commercially very successful '3-box' *Acoustimass AM-5* loudspeaker, the compact subwoofer unit in this case incorporating the built-in power amplifiers (100W + 2 x 50W) for itself and the two tiny satellite units.

For secondary rooms like bedrooms, bathrooms and kitchens, a less expensive powered *Lifestyle Speaker System* is available, with amplification and manual volume control built into one of the pair.

The music centre unit has five switchable line sources, two of which are used by the built in tuner and CD player, the others being labelled video, tape and aux. The external source inputs could be used for future *Lifestyle System* components, whereby the existing remote handset will handle the operating functions. But they could also be fed from, say, an existing midi system or record deck plus amplifier to give vinyl disc replay, or from a NICAM VCR for stereo TV sound. Alternatively, the Bose sys-

*Things we hear . . .
This month, a
Sessions Extra
including a
'lifestyle' home
system from Bose,
Lindley Audio*

*Applications'
New Age
loudspeaker,
and Victor
Lewis Smith
on the
wonders of
DAT in a
home studio.*

Choice Sessions

tem could be an adjunct to an existing hi-fi in the lounge, yet be used to extend that system elsewhere in and around the building.

Bose certainly has its own tape deck under development, and also discussed the possibility of a caddy-type CD multi-changer that could be loaded with six current favourite CDs and hidden out of sight in a cupboard, while still responding to remote control commands when required, the CD deck in the *Music Center* being conveniently accessible for single disc replay.

The two outputs (known as 'zones') operate independently of one another, so that two separate programme requirements may be met simultaneously in different parts of the house. Any number of active speaker pairs can be connected to each zone, using slim coaxial cable to 'daisy chain' from room to room, with a run potential of around 100ft without significant HF loss. In a typical basic scenario the music centre and powered *AM5s* would be installed in the lounge, running off zone 1, while kitchen and bedrooms might each have *Lifestyle* pairs running on zone 2.

At present the remote control cannot address the different loudspeakers of a zone individually, which does introduce some constraints. But a switch already on the handset will bring this feature into the package in due course, presumably when the RF-addressable powered speakers have finished development.

The presently limited loudspeaker independence, and the fundamental constraint of just two separate zones do represent restrictions on the system's suitability to the more elaborate installations. But its basic simplicity, the compactness and the good range of the RF remote control should all make discrete installation very straightforward.

However, the components are clearly aimed primarily at the home entertainment customer rather than the hi-fi enthusiast. The CD player will certainly play compact discs with no difficulty, but the DAC and disc drive technology is rather mundane by the current standards of the hi-fi separates market.

Although the *Lifestyle* system is likely to be somewhat cheaper than the round-the-house systems from B&O, Revox and Meridian, the basic package of *CD-10* plus one set of powered *MS5s* is nevertheless expected to cost around £2,000, while additional loudspeakers and source components will soon add another grand or two. This is expensive in the context of the UK midi system



Tubular New Age loudspeaker from Lindley Audio Applications.

market, but Bose is confident that the combination of near invisibility and user friendliness that attracted so many customers to the £500+ *Acoustimass* loudspeakers will apply even more to this complete system package, despite the premium price.

Living with the New Age

Not a discussion about Michael Hedges' records but an assessment of a tubular loudspeaker by the tube man – or JK as he's known round these parts.

Peter Lindley is a large jovial chap and not the sort of person to whom one says "No" when he offers you a pair of speakers to audition. Not that he's in the slightest bit menacing, far from it, rather his enthusiasm for music and the sort of components that I generally find very effective at reproducing it make his products hard to resist. I mean, a man who rewires his Radford *STA 15* with silver wire and uses a Townshend *Rock Reference* turntable has got to have a pretty good idea of where it's at, hasn't

he? OK, so not everyone might agree, but to the folks here at *Choice Mansions* things like vacuum tubes, silver wire and troughs full of viscous fluid are what hi-fi is all about.

Rebuilding valve amps is only a sideline for Peter; the *raison d'être* of Lindley Audio is the production of distinctive loudspeakers. Some of you may remember our Penta show report (1988) which showed the first Lindley loudspeaker, a massive and fabulously built seven-sided behemoth with folding doors to cover up the drive units and make the speakers look like drinks cabinets. This beauty, however, costs more than £5,000 and weighs Lord knows how much. So Lindley decided to build something rather more affordable and, for that matter, transportable. He came up with another unusual looking design which was christened the *New Age*.

The £850 *New Age* is a narrow tubular design that takes up less floorspace than your average speaker stand and comes finished in a wide variety of colours and textures. The model shown in our photograph is slightly different in appear-

ance to production samples because the letter box-like reflex port is narrower and deeper than usual. The standard port looks a bit neater as it wraps around the full width of the baffle. Our sample was finished in red hide but the impression I got from Lindley Audio was that almost anything that could be used would be supplied if required. So if you fancy speakers to match your three-piece suite or your curtains . . .

Its unusual appearance is a result of the desire to create a speaker that doesn't take up much space but has good bass extension and imaging abilities. The tube has an internal baffle extending down from the visible baffle to a point close to the bottom of the cabinet, which is itself offset to avoid parallel surfaces and thus minimise internal reflections. The tubular cabinet is made out of an unspecified plastic, probably polypropylene, and resonates at low frequencies creating what Lindley terms a transmission line effect whereby low frequencies are radiated by the cabinet. The cabinet's footprint is small and as a result the *New Age* isn't among the more stable of designs. In both sonic and practical terms it would probably benefit from a flat, cross-shaped stand to give it a more stable footing. This would however be aesthetically unappealing and potentially dangerous if you wander around in your socks!

The driver complement in the *New Age* underwent something of a modification during the time that the speakers were under test. The original tweeter was a metal dome unit from Elac which produced quite acceptable results, but Lindley found there was too much sample variation in the units for the company to be able to produce consistent results. As a result both the tweeter and the crossover had to be replaced, the former with a Dynaudio soft dome unit.

If you look closely at the *New Age* you'll notice a small silver knob to the right of the tweeter. This is a high frequency attenuator designed to be used for room and system matching without degrading sound quality or altering the impedance of the driver. The mid/bass driver is an eight inch polypropylene unit made by Scanspeak that uses hexagonal wire in the voice coil. The crossover is hardwired (quarter section network with an additional component) and sits in the base of the speaker where it can be accessed with the minimum of hassle. Logically enough the cable terminal is located at the bottom of the speaker as well. I say terminal in the

singular because the *New Age* employs a Neutrik Speakon connector instead of conventional binding posts. This is a fairly complex device that makes a very positive connection and can be locked in place. Needless to say it's a refugee from the studio world and as such is exceptionally reliable and sturdy, if difficult to attach very meaty cables to.

I listened to the *New Ages* with 'Innovations triode amps, T&R MPP 9 power amps with a Townshend *Rock* vinyl source and the T&R-tweaked CD94 disc player. For comparison the trusty Snell *JlIs*, which retail for £50 less than the Lindleys but prefer expensive stands, and Wharfedale 505.2s were wheeled in.

The *New Ages* have many positive qualities, not least of which is their ability to resolve precisely the information that creates a tangible sonic image behind and to each side of the speakers. Well recorded acoustic instruments were reproduced with a very real sense of position and acoustic environment.

These speakers are also very polite and sophisticated-sounding. They seem almost incapable of uttering a harsh or distorted note of their own accord. Given suitable amplification you can drive them hard and they never lose their sense of poise, maintaining balance and power without a hint of break-up. I had quite an enjoyable hour or so listening to ZZ Top's *Tejas* and Aerosmith's *Pump* at levels that wouldn't have been endurable with many other speakers. In fact the *New Ages* sounded better at these sort of levels than they did at more usual volumes, the bass showing good weight and articulation and the midrange proving more revealing than had previously been hinted at.

There were a couple of aspects that I found less endearing, the first being a mild cuppyness or lack of naturalness about acoustic instruments and, to an extent, voices. The other, which proved more limiting in the long run, was a lack of dynamic involvement. Because this is an area in which my system generally scores very highly, reducing it is quite obvious and results in many records becoming less interesting to listen to. But that's not to say that the *New Age* isn't an enjoyable speaker. In fact it's the sort of speaker that would be well suited to many systems, and has many of the positive qualities of models like the Linn *Kaber* for example.

At the end of the day the Lindley *New Age* is a well made loudspeaker built by a man who probably cares more about

his products and his customers than the income he makes from them. He's a craftsman. If that counts for you then listen to his speakers. You should be pleasantly surprised.

Note: As we went to press Lindley Audio announced that the latest and finalised version of the *New Age* has the reflex port set in the flat baffle itself rather than on the curve of the tube. This is claimed to improve phase response and imaging. Further information can be had from Lindley Audio Applications Ltd, Herdgate Lane, Pinchbeck, Spalding, Lincs PE11 3UP. Tel: (0775) 722346.

DAT's the way

Victor Lewis Smith, *Mary Whitehouse's 'favourite' satirist, has been using DAT recorders to produce his forthcoming Radio 1 series. But for fine editing he still needs open-reel tape and a razor blade.*

Driving around York in my Madison open-top two-seater, I am frequently stopped by automobile experts asking me, "Is this the one with the twin-reversible #410 with vanadium cylinder rings fitted?" My reply is that it is a white car, and that you have to put petrol into the hole near the back, otherwise it won't go. And when it won't go, I call a man from the AA and he fixes it.

I have a similar attitude towards my recording studio. I know how everything works in front of the desk, but nothing at all about the insides, or all those wires sticking out of the back. For that, I rely entirely on John Warburton, a BBC engineer who built and designed my studio and who, during its teething period, was phoned up at 3am more often than he cares to remember by a manic voice pleading, "Help - it's gone down again" (by no means the only time I've used that expression at 3am).

I served my apprenticeship in radio on a Mark III, the standard BBC local radio desk, where the only possibility of multi-tracking is to bounce from one machine to another. This works well for double-tracking but, after the fifth bump, track 1 is generally sounding like the inside of a pressure cooker. For all of that, the *Loose Ends* pieces I produced between 1986-89 (early ones were recorded at BBC Radio York, later ones in my own studio modelled, to some extent, on a Mark III) were passable. But although no BBC engineer ever com-

plained about the quality, I became increasingly dissatisfied with the lack of clarity in sections involving seven or eight bounces.

Colleagues with access to 24-track studios tend to regard this bouncing process as hilariously archaic. However, I prefer it for many reasons, not least because it forces me to use my ears all the time. There is no post-recording mix where levels can be tweaked and mistakes rectified – on a Mark III desk, irreversible decisions are continually being made during recording, because if the level or the timing is wrong on track 1, the mistake will be compounded as you bump from machine to machine.

When *Hi-Fi Choice's* Dan Houston came to visit the studio last year (see issue No.75), he recommended a change from analogue reel-to-reel in favour of DAT. "It will change your life", he stated, with a certainty usually only exhibited by scientologists in Tottenham Court Road trying to unload Dianetics books onto recalcitrant passers-by. At the time I defended my studio equipment, arguing that I preferred to work in mono to stereo, much as many photographers prefer monochrome to colour (although the real reason I worked in mono on the Mark III desk was because it does not produce acceptable quality when multi-tracking in stereo). But earlier this year, when Radio 1 invited my co-writer Paul Sparks and I to write, record, and produce a series for them (second series coming this autumn, if you missed the first), we looked at our two clapped-out Ferrograph *Series 7s*, a Revox *A700*, and the £50 Casio keyboard, and decided it was time we upgraded the studio.

To that end, before we began recording, we lashed out on a very expensive Kurzweil *K1000* synthesiser, a Yamaha clavinao, a Roland *U110* soundbox, a Yamaha effects box, an Atari computer running the "Creator" music programme, and a Swanee whistle. Finding that we only had 10 pence left and nothing to record onto, we staked the entire florin on a 'phone call to Dan Houston, who agreed to send us some DAT machines to experiment with.

First to arrive was the bizarre Grundig *DAT-9000*, part of the £5,000+ *Fine Arts* hi-fi, aimed at the luxury market and one of the very few DAT machines generally available to the public (inasmuch as a £5,000 hi-fi can be generally available). My initial reaction was surprise at the general sluggishness of DATs. Like video machines, there is a



Victor Lewis Smith: likes DAT, but prefers baby sitars.

wait of several seconds for the thing to get itself into gear and, also like video machines, they have very accurate timing and tape ident facilities. As the Radio 1 series progressed, I soon found myself regarding the Grundig as the master machine, partly no doubt because of its imposing size and luxurious appearance, but more because the controls were so easy to operate. One oddity of the machine was its production of an occasional high-pitched F#-G#, which I assume is some sort of sync tone. Although I suspect I only ever used it at 50 per cent of its potential, it still offered far more, in both clarity and ease of use, than any analogue tape recorder.

Next came a Sony *TCD-D10 Pro* portable, with the looks and size of a car radio. This was slower to operate than the Grundig, and for me its portability was of no use. (It had only one outing during the series, as far as my lavatory for recording some unspeakable sound effects.) Being smaller, it was more awkward to operate under studio conditions, and although the LCD display is back-lit, the information on it is not easy to read. The machine has rechargeable batteries, and when it ejected a tape the movement sounded smooth, well-engineered, and very expensive. The quality of sound reproduction seemed exactly the same as the Grundig, although it was more prone to dropout. It may be just an old wives' tale, but I was told that dropout can be largely avoided by winding through the first four minutes of each DAT tape before starting to record. In any event, I eavesdropped on several old wives in the Haxby Road Co-op saying that this is how they avoid dropout on DATs, and after following their advice encountered few problems.

The third machine I tested was the Casio *DA-2*, which looks exactly like the Sony but performs slightly less well in almost all respects. The engineering is rougher, but then it is a lot cheaper, and the sound is still extremely good. If the Sony machine operated like a luxurious 747, then the Casio is more of an old Fokker, but it did appear robust and able to withstand a few knocks, an important consideration for a portable machine. A considerable disadvantage was the lack of back-lighting on the LCD, which made it extremely difficult to read the display. Another peculiarity was its tendency to wind back too far when cuing itself up, thus clipping off the last 3 seconds of the previous section. This made me reluctant to consider using it as the master machine.

Final editing is still performed with a razor blade on a reel-to-reel machine. Experts may feel it makes a mockery of DAT to dump the finished result onto an analogue Revox, and then back to DAT, but I have so far found no other way of editing that gives me the fine control over timing necessary for producing comedy.

The most technically complex sketch in the entire series was never broadcast for legal reasons, involving as it did the Bishop of Southwark, Robert Maxwell, three feet of greased rubber tubing and a funnel, Bernie Clifton's comedy ostrich, and a gerbil with its claws removed. However the editor of *Hi-Fi Choice* tells me that he cares nothing for censorship, libel laws, exemplary damages, or indeed his own future in publishing – so, for the first time in print, here is that sketch in full . . .

[The end of this article has been deleted for reasons of space – Ed].

Don't miss next
month's issue of

HI-FI CHOICE

Packed with
in-depth reviews!



CASSETTE DECKS ON TEST

Including the latest from Dual, Kenwood, Pioneer,
Sherwood, Sony, Sansui and many more.
PLUS . . .

Further reviews on CD players from Ariston,
Radford, Cambridge, Rotel and
Meridian's 203 1-bit D-to-A converter.

Also, a FREE cover-mounted gift from CDextract
AND, OF COURSE . . .
NEWS, VIEWS, AND MUCH, MUCH MORE!

HI-FI CHOICE

OCTOBER ISSUE ON SALE
SEPTEMBER 14th

*'Craftsman's art and music's measure
For thy pleasure
All combine'*



New Age
by
LINDLEY



LINDLEY
AUDIO APPLICATIONS

Herdgate Lane, Pinchbeck, Spalding, Lincs. PE11 3UP.

Tel: 0775-85 626, Fax: 0775-85 648

Win an Ariston system!

For this month's Hi-Fi Choice competition we've a superb Ariston system to give away. First prize is a complete system comprising Q Deck, CD Player, Amplifier and Image II loudspeakers. And we've two runner-up prizes as well: second prize is an Ariston CD Player and third prize an Icon turntable.



How To Enter

Our simple hi-fi quiz requires six answers which must be written on the entry form provided. Fill in the form, remembering to include your name and address and send it to the address shown in bold type at the bottom of the form. Mark your envelope **Ariston competition**.

The Prizes

The first correct entry drawn from our mailbag after the closing date will win an Ariston system comprising *Q Deck* turntable/arm, *CD Player*, *Amplifier* and *Image II* loudspeakers. (Total value approx £900). The second correct entry will win an Ariston *CD Player* (worth £345), and the third an *Icon* turntable/arm (worth £215).

The Questions

Please write your answers in the space provided on the entry form.

1. Which British manufacturer produces a loudspeaker called *New Age*?
2. Victor Lewis Smith is well known for his comedy programmes on Radio 1. Name Victor's co-writer.
3. In which year did Arthur Radford found Radford Electronics?
4. Which British manufacturer of record players and loudspeakers imports the Japanese *Isoda* brand of cables?
5. The Ariston factory is situated adjacent to which Scottish airport?
6. What is the commonly used acronym for 'decoupled anti-resonant transmission line'?

Entry Form

NAME:

ADDRESS:

POSTCODE TEL:

HFC/SEPTEMBER/90

Closing date: Monday, 8th October, 1990

Your answers:

1

2

3

4

5

6

COMPETITION RULES

1) All entries must be on the entry forms provided. Photocopies will not be accepted. Incomplete forms will not be considered.

2) There is no cash or other alternative to the prize.

3) Employees of Dennis Publishing Ltd and associated companies, the manufacturers and suppliers of the prizes, their agents and relatives, are not eligible to enter the competition.

4) The competition is not open to readers living outside the United Kingdom.

5) The prizes will be awarded to the first sets of correct answers opened after the closing date. The Editor's decision shall be final and binding. No correspondence whatsoever will be entered into regarding the competition.

6) The winners will be notified by post and the results will be published in *Hi-Fi Choice*.

Send your completed forms to:
**Ariston Competition, Hi-Fi Choice,
Dennis Publishing Ltd., 14 Rathbone Place, London W1P 1DE.**





Choice ships out to Paris to bring news of a hi-fi emporium unlike any other. If you're an audio zealot

La Maison De L'Audiophile

*it's well worth checking out: by Dan Houston.
Photography: Chris Richardson.*



The larger listening room shows the DIY Verdier record deck and speakers which transform themselves into a jazz band.

Paris in the rain goes to work on the senses like few other cities. The famous painters' light diffracts to show up the details of shuttered windows and cobblestoned streets momentarily less populous. The air is mixed with the evocative scents of Gauloises cigarettes; garlic and chicory-coffee from the cafés' frontage, and the ripe pungence of fruit stalls. Women walk differently here.

But early on an evening in June it was our ears that were making the most of a continental treat. It wasn't that the Parisian habit of leaning on the car horn, or the huge number of cacophonous Citroën engines were suddenly appealing . . . we were in The House of the Audiophile. Regular read-

ers may be asking: "So what? You're in the house of some audiophile (or other) every month. What's new about Paris?"

The difference this month is that the featured 'house' is a shop, and there's nothing else like it in this quarter of the globe.

La Maison De L'Audiophile sells kit hi-fi for enthusiasts who like to get close to their hobby. But more than that, it sells what it believes to be the best components and designs available, and caters for the music lover who regards hi-fi as an amateur science. Visitors can listen to completed kits and combinations and then buy what they need - including explanatory books which, even with my basic French, I could see are straightforwardly written. With its

listening sessions the shop is also a forum for new ideas in hi-fi and in many senses it is a cutting edge both sharper and more ahead to what is happening in Britain. By only selling components L'Audiophile aims to keep equipment costs down and during the morning, when the shop is closed, staff run a telephone advice service for existing and would-be customers.

A serious system from here can set you back 100,000 French francs (not including a soldering iron), but the manager William Walther was able to

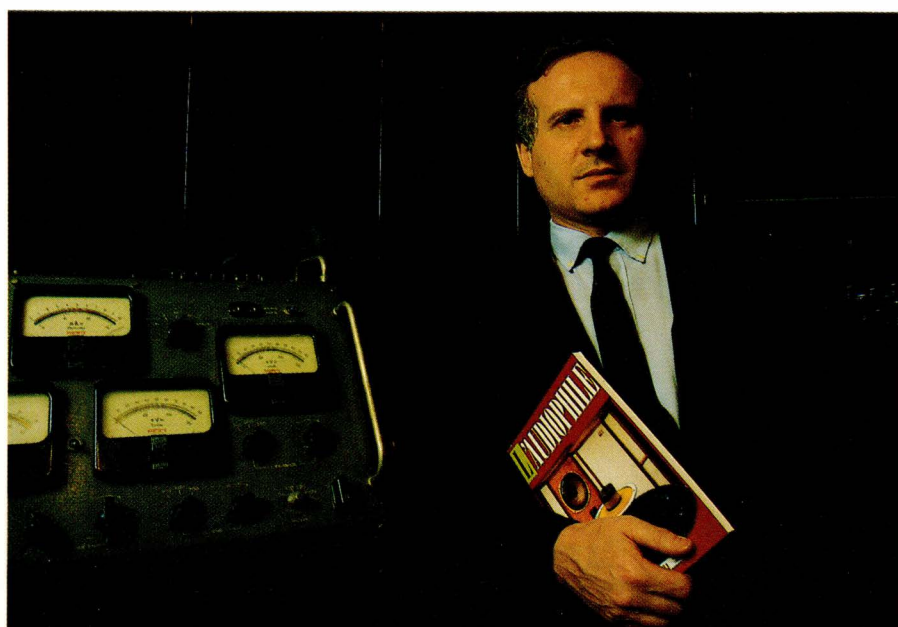

William Walther and the journal which gave rise to the shop.

demonstrate an astounding set of loudspeakers which use just one full range driver costing about £35 each. The speakers are a tapered quarter wave tube (TQWT) design using a 16 cm Diatone driver, set in a 90 cm high Medite cabinet. The design is discussed in full by Jean Hiraga, in his book on loudspeakers. The latter, as well as its sister editions on other aspects of electronics and hi-fi, is essential for those who wish to take full advantage of what La Maison has to offer, though sadly they are not available in English yet. (Many of the diagrams in these books are self explanatory however).



Being an enthusiasts' shop it is not surprising that La Maison isn't on the 'High Street'. Instead it's halfway up the rue de Belfort, a cobbled street offering few signs of wealth to the eye, with a couple of shops standing empty. At first sight it could almost pass for a launderette . . . until you look behind the huge 'front-loading' loudspeakers in the window. The shop is in a 19th century building in the Republican Quarter, south of the city centre, but close to an underground station (Place Voltaire).

An Aladdin's cave

Inside the shelves are stacked with valves, different types of cable and the finished kits for demonstration, while drawers contain everything necessary – from capacitors up. The tone of La Maison is a bit like a haberdasher's; it assumes that you have a certain skill or knowledge of the subject. But the atmosphere is more 'specialised' than daunting and the staff are enthusiastic and ready to dispel any notions you may have about hi-fi kits being a black art.

"It's not complicated to make these kits yourself," says Walther, "we try not to be too technical about it; you just need the will to do it. And you can get a lot of satisfaction from making a kit." Initiates are shown the current systems performing in either of the two demonstration rooms. Sensibly, the smaller room houses the less outrageous gear and I was surprised to see a Sony ES CD player hooked into one of the shop's valve amplifiers. You can't get this in kit form, but La Maison keeps a few players for demonstration purposes. "Half of French audiophiles buy analogue systems, half buy CD," said Walther, who nevertheless rates the analogue sound as superior. His state of the art record deck – The *Verdier* – uses huge slabs of marble for mass and an almost indus-

trial motor unit (similarly solid) which sits at a distance turning the chunky cylindrical platter with about two yards of drive belt.

The *Verdier* was playing in the larger room where the loudspeakers are getting to PA proportions. "The pair here," said Walther setting up a record, "are a very old system made in 1978; they were designed for cinema use." The colossal speakers, with their pick-a-back tweeters and extended baffle wings are . . . uh, not the sort of thing you'd buy if you're into keeping up with the Joneses. Unequivocally they are going to take over most rooms. In terms of sound they're not an inch less impressive; with the Maison's latest valve power amps – the *300B Legends* – the transparency and scale was breathtaking.

La Maison offers equipment which essays to excel in the areas of dynamics, definition and transparency. "These are the most important qualities," explained Walther. "Soundstaging and imaging is a false idea because imaging will affect the rest of the system – it restricts the dynamics, definition and transparency." No surprise that you cannot find an electrostatic or ribbon kit there then? "Non."

Although you can buy transistor kits (Class A only) at La Maison, valves take centre stage and there are several variations to choose from. A display case holds a range from small pentodes up to the meaty single ended types used in the *300B*; they are sourced from all over the world. The preferred transformers are made by Partridge in the UK, and the shop rates Isoda cable from Japan as best. (It's imported in the UK by Roksan Engineering.)

La Maison De L'Audiophile was founded in 1981. It is attached to the same company that publishes the French specialist magazine – *L'Audio-*

phile, itself founded in 1978. The magazine began running articles on build-it-yourself hi-fi, coming up with new designs by Jean Hiraga and others, and the shop was born of enthusiasts' demand. France had not supported a specialist electronics industry for a couple of decades before then and there was no tradition of non-mainstream products as there has been in Britain. Nor were the components – or a place to listen to the finished kits – available. The magazine's founder, Edward Pastor, wanted to provide French audiophiles with something different from imported Japanese equipment (or latterly Quad and the American equivalent) if they were deadly serious about music reproduction.

"People like things which are hand-made," he told me. "they like things which have a kind of Cartier appeal. And this is a particular aspiration of the new generation of audiophile who wants individuality. They want things which look different and that requires a different approach. It's the same as a pretty woman in a gorgeous dress. And

present remain nearly the same. The shop can deduct the 25 per cent French tax when you buy, but on entering the UK (with more than £265 worth of goods) you'd pay 15 per cent VAT and the excise duty of 14 per cent which is cheaper at present (if the office calculator is right!). Unless you're a regular traveller to Paris it wouldn't pay to just go and buy a valve at a time! Come 1992, or January of '93 to be precise, things will change and you'll be paying VAT in the country of purchase.

Backing it up

But what happens when a piece of equipment goes faulty; valves in particular can be finicky beasts and many have a life expectancy similar to a light bulb. "That's very easy, we can mend anything because we have everything here," beams Walther, vouchsafing the system where enthusiasts can use the telephone advice service if they run into problems. (Valves are also becoming increasingly available in Britain.) Making a valve amplifier such as the 300B takes around 20 hours according to Walther. It's not cheap, the *Legend* costs 21,000FF (or 20,648FF by the time you bring it into the UK), and you'll need two for stereo. But it's still cheaper than having it made for you – the Triode valves alone cost around £200 each! Of course there are less ambitious projects for sale such as the loudspeakers mentioned earlier and the shop puts its hand on its heart saying it delivers value for money.

La Maison can't make the kits itself; Walther says that he doesn't have the time. "Many people do come here and say how good the system is but they are afraid to get their hands on the project," he added. But for customers especially shy of a soldering iron, he told me it would be quite easy to put them in touch with one of the shop's regular customers who may complete the kit for a fee. But I felt that this would be going against the grain of what La Maison is trying to do. Yes, the philosophy behind selling kits is to achieve audio excellence on the cheap (!), but Walther is adamant that by taking the plunge and getting to know the equipment piece by piece, link by link, one's enjoyment of music will be enhanced. It reminded me of what the poet William Wordsworth said; that in order to appreciate the true beauty of a landscape you had to understand the geology beneath it.

La Maison De L'Audiophile 14, rue de Belfort 75011 Paris Tel (1) 43 79 12 68.

Record sleeves look like postage stamps next to the speakers (above left). Mix and match valves (above).

don't you want a woman to be your unique woman? It's a joke but you have to understand. There is also a certain mystery (behind what we do). It's like the mystery of catholicism; without mystery there would be no Catholic church."

I knew we'd meet with sexual and religious metaphors sooner rather than later, but on the face of it Pastor's judgement has been right. His enterprises have helped create a burgeoning industry in France with many of the readers of his magazine becoming customers of the shop. William Walther reckons that La Maison has had about 10,000 visitors with some 60 per cent buying a piece of equipment or system. There are two other shops in Paris which sell loudspeaker kits, he says, and about 20 specialist hi-fi shops in the city. "This is the only successful attempt of its kind outside Japan where there are about seven shops doing a similar thing to our-

selves," claims Walther.

It comes as no shock that La Maison boasts very few women customers. "Women do come in with their husbands, but they want to listen rather than buy a kit. It's a shame because it's not that complicated to do it yourself. Most of our customers are French, and we have had some from Holland, Germany, Italy, Switzerland and Sweden . . . but none from the UK."

If you do buy kit from La Maison and bring it back to the British Isles, prices at



Heavily re-wired SME arm graces Verdier

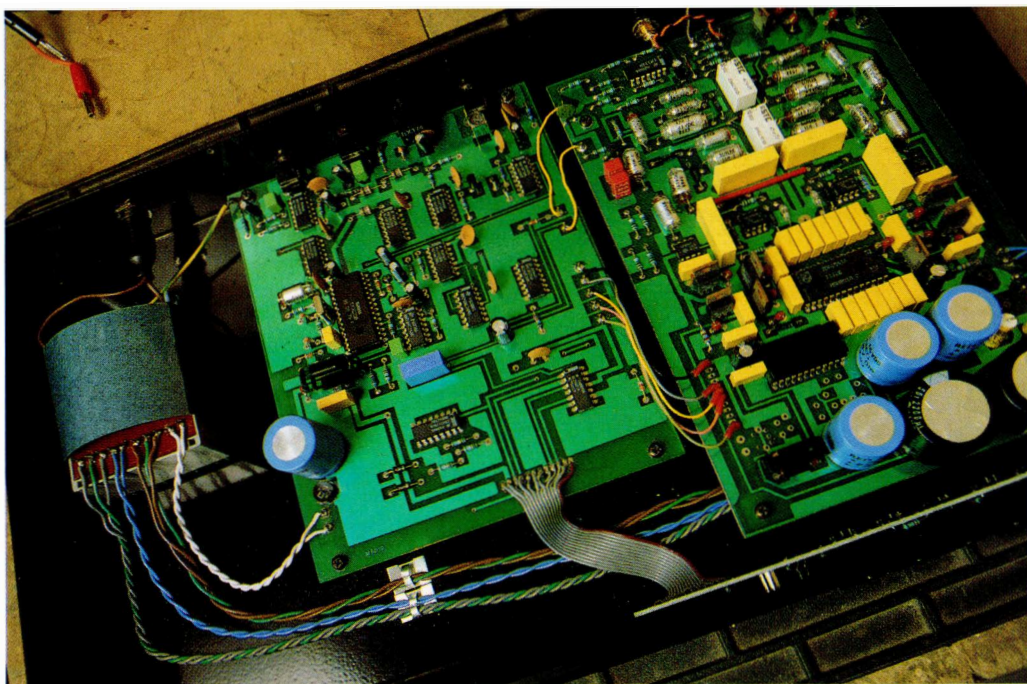

John Widgery (below) is carrying Arthur Radford's legacy into the digital future with this DAC (left).

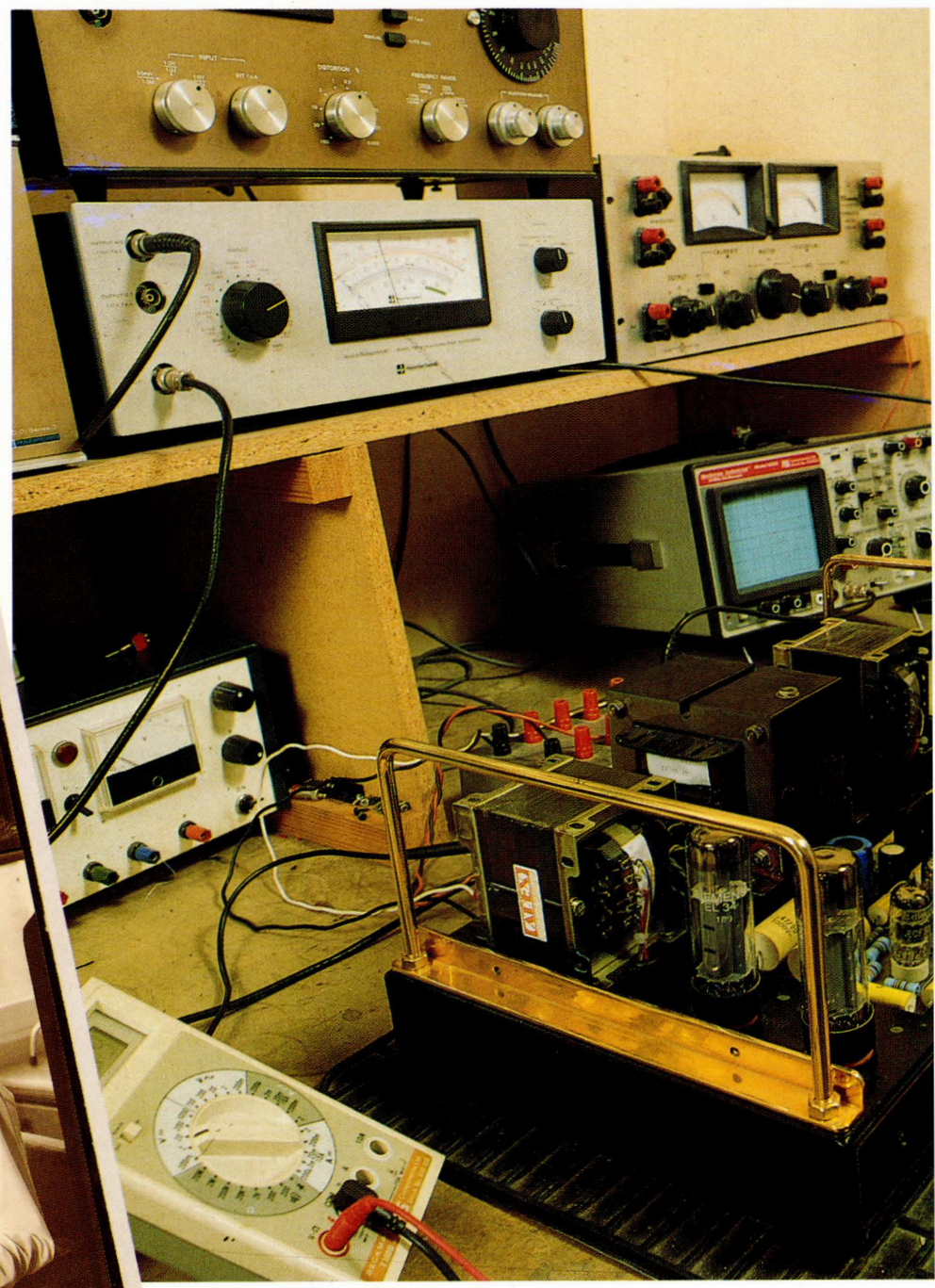

The Radford Apprentice

When the makers of a range of cult valve amplifiers came up with a compact disc player they gave credibility to the digital medium for audiophiles. By Dan Houston, photography: Chris Richardson.

Founded in 1946 by Arthur Radford, Radford Electronics has become one of those names in hi-fi which are associated with excellence in terms of performance, but which have never grown much beyond cult status. Radford is perhaps best known for its range of valve amplifiers dating from pre 1970, a range which was resurrected before Arthur retired in 1988. These were taken over and refined when Woodside Electronics took over the Radford name at that time. Woodside surprised the hi-fi community by developing a CD player shown at London's Penta hi-fi show last year.

Although other relatively small British companies, such as Meridian, Ariston, Mission, Arcam and Cambridge had been producing mainstream CD players for some time, it was the first instance of a garden shed (excuse the phrase) operation taking on the multinationals – albeit around the £1,000 price bracket. “Surely,” the light-bulb was on above the collective *Choice* editorial head, “these are craftsmen?”

The route to Radford is west out of London, taking the M4, M5 to Clevedon on the coast of the Bristol Channel just south-west of Bristol itself. When one gets there it's difficult to imagine a smaller place – a door in the wall of a line of suburban light-engineering firms reads: Woodside Electronics. Upstairs there are just five rooms: an office, a listening room, stockroom, assembly area and test bay with draughtsman's desk. Eight employees including the two partners John Widgery, 46 and Mike Davis, 45, produce the Radford range of a stereo valve power amplifier, valve monoblok, compact disc player and now a standalone digital to analogue converter. The company also makes several pieces of test equipment such as a low distortion oscillator, noise level and total harmonic distortion measuring

equipment. “Those are the main items but we can alter things to people's requirements,” says John.

Radford's Apprentice

Woodside runs a design, assembly and testing operation. Casework and components are bought from outside contractors who deliver according to specification. It's a far cry from the company under Arthur Radford in its heyday. Based in Bristol, Radford Electronics was employing nearly 200 people in the late Sixties and early Seventies according to John Widgery. He was apprenticed to Radford in the late Fifties. His apprenticeship coincided with Arthur Radford's first commercial audio product: The *DSM* Stereo Control Unit, which was shortly joined by a stereo power amplifier – the *STA12*. Both were valve designs in this pre-transistor age.

John supplied the company's biography before then: “Arthur founded Radford Electronics in 1946 when he left the services at the end of the war. At the beginning of the war he had worked for the Royal Navy specialising in Radar. Somewhat unusually he changed to the army and became a captain in REME (Royal Electrical and Mechanical Engineers) doing something similar. After the war he was familiar with all the ex-government electrical equipment that was flooding the market and he began buying and selling surplus. He also knew about transformers and one of his biggest concerns was winding transformers for Pamphonic Amplifiers and Heathkits (kit amps). When I joined, 50 per cent of the factory's output was transformers.” John's five year apprenticeship and subsequent years with the company saw several refinements and upgrades to the amplifiers until the age of the transistor demanded a change of direction. “We introduced our first transistor integrated amplifier – the *SCA30* –

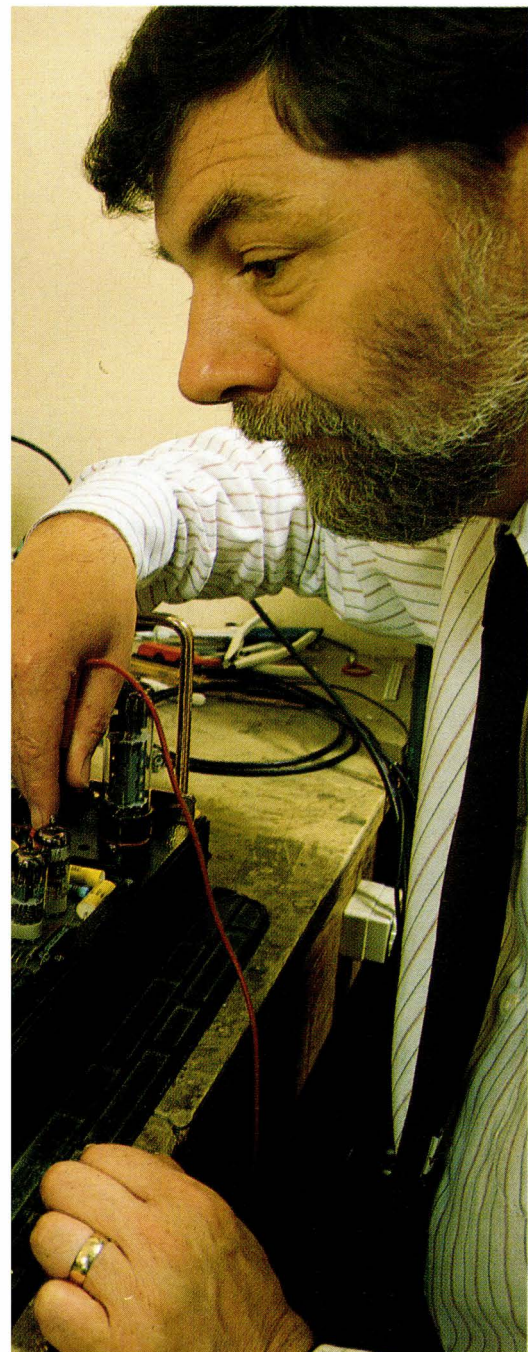

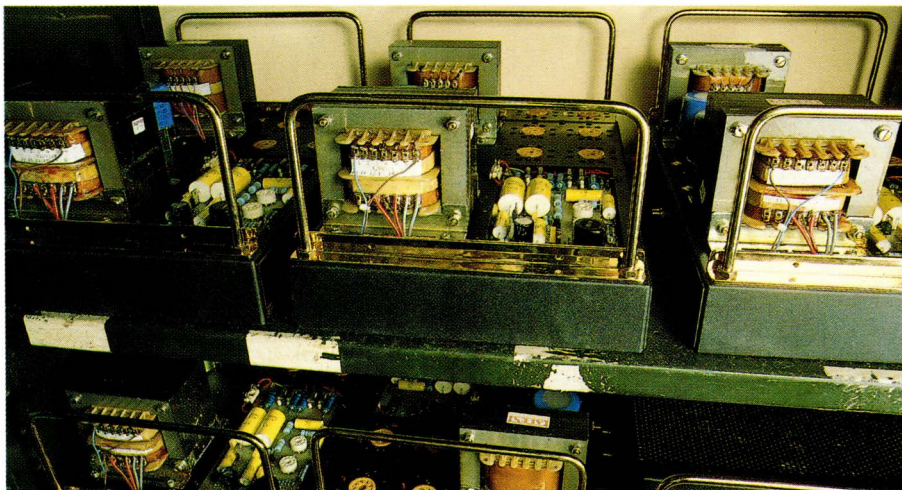

in 1970. In those days transistors were the in-thing and people thought that valves were dead. We stopped making valve amps altogether about then."

John wasn't much involved with the Radford transistor amps; he left the company in 1970 to take up a job as an engineer with a recording studio in Australia. In 1982 Arthur Radford, by now in his late-sixties, stopped making transistor amplifiers and wound up the Bristol factory but continued some production at a smaller unit in Weston-Super-Mare, which is where he lived. "He had no one in the family to take over the business," said John, "but he carried on winding transformers and his main interest was in loudspeakers such as these Tri-stand T90s we're still using in our listening room." John credits Radford, working with Arthur Bailey of Bradford University, with the invention of the original transmission line loudspeaker. "But he never got a patent for it," he added.

Returning from Australia, John Widgery had worked for Arthur Radford for a short period before setting up Woodside Electronics on his own in 1986. While working for Radford a second time the company had re-released a limited edition valve power amplifier – the STA25. It was a straight copy of one of Radford's Sixties models and was produced partly due to the enthusiasm of Ken Kessler – the *Hi-Fi News & Record Review* critic who had noted how good-sounding those earlier valve amps were. "When I started Woodside we were doing sub-contracting work for Arthur among other things. The first product we made was

Amplifiers waiting for shipment (and their valves).

the Radford *Renaissance ST25* stereo power amp followed by a valve preamplifier and monoblocks in late '87. When he retired Arthur suggested that we make the amplifiers under licence and that represented an opportunity to expand faster than we could have using our own name. The Radford name was far better known, especially in this country, and so making amplifiers became our main business."

Mike Davis joined the company in 1988 with responsibility for buying and selling; although he's since developed more and more interest in the design side of the business.

Woodside has refined the Radford amplifiers, designing its own output transformers, made by a Devon firm, and adding other tweaks to the original including design features such as the gold-plated 'handles'. Components are bought in from tried and tested sources, the casework is from a Bristol firm, valves are from Siemens in Germany and many of the smaller components like capacitors are also from abroad. The switches for the CD player and DAC, which have a pleasing solid feel are also specially made for Radford. "We considered whether we should move to bigger premises and start producing more of our own components but the subcontractors we use are good enough," explained John, hinting at the hassle involved with running a larger operation. In the stock room with its racks of component trays there are some old amplifiers in varying states of repair.



"We offer a repair service to original customers; it's not a very big part of our business, but we're using the Radford name so we feel we have an obligation to these people," John told me.

Making a CD Player

Both Mike and John recognised that however healthy, the valve amplifier market of the late Eighties was limited. So they decided to make a CD player. Why? "I don't know if we can answer that," Mike laughed. "We had got to the stage where we needed to make a decision about where the company was going, and a CD player was the obvious avenue. The market will go towards CD because that it is undoubtedly the future. At the £200 budget price point a CD playing system walks all over analogue record players. And the majority of music will be available on CD only – the market will be forced that way.

"We began work in January last year, and it took us eight months to do it. We had a lot of co-operation from Philips and we had some outside consultancy advice from Martin Colloms – he took it a long way. What surprised us most was the phenomenal help from Philips in



Craftswoman Marina gets to grips with the early stages of a Radford CD player.

Belgium. Why they should waste so much time on a small company like us is beyond me but they were great. We couldn't have done the whole thing on our own in that time, but having done the groundwork it's quite easy to go on from there and we're nearly ready to launch the second generation player." The player is a 16-bit four times oversampling model and as such would be criticised by some reviewers for not using PDM, or PWM/MASH (bit-stream) technology. "We listened to 1-bit PDM and we've got a few prototype DACs lying about," said Mike. "At the moment we feel we can't get the same sound quality that we can on the 16-bit chip. The idea (behind PDM) is sound but its application at present isn't good enough for us. We've heard some machines like the Meridian 208, and in our opinion there's no soundstage, no depth to them. Philips would be the first to admit that it was designed as a budget system and it's developing a more professional system for some time towards the end of the year; we'll invest

igate that at the time."

Having developed the WS1 CD player which was in production in the autumn of 1989, Woodside followed with a separate £890 DAC (digital to analogue converter) in the spring of this year. "We saw a niche in the market for people to upgrade their existing machine incorporating our DAC," John said. Having a standalone DAC the next logical step is to develop a Radford CD transport to cater for fans of two-box players. They have done some preliminary work and intend to launch one before the year is out.

Other plans at Woodside are for a new valve preamplifier and they won't rule out the possibility of loudspeakers. "We can't make loudspeakers under the Radford name because our licence is only for electronics. So we'd have to use a different name but most people associate our products with Woodside anyway so that wouldn't be a problem." The pair are also interested in making a top quality transistor amplifier. "The problem is that they are very expensive to make," John said. "We would like to make a transistor amp but we don't want to make anything which clashes

with the valve range. We feel that there is room in this country for something big like a Krell. It would be high powered, of course, which is impossible with valves so it wouldn't clash with our existing products at all."

Woodside has limited its dealer network so that certain outlets cater for an area of the country. "We're pretty badly off in the Midlands but it's expanding all the time," John said frankly. "Our aim is to have about 30 dealers around the country and we're not far off that target; it was surprising (for a small manufacturer selling exotic equipment) when we introduced the CD player and the dealers started ringing us up!" Export is also going well, if not a whole lot better than the depressed home market. Woodside says 85 per cent of its products are going abroad, with Germany being an especially strong market.

The business looks healthy, but marketing speak (read bull....) isn't what Mike and John are about. They are at their happiest when relating stories about happy customers: "You know valves do give this warmer sound. . . we get people ringing us up and going crazy about how their STA25 has just walked all over their XYZ. It's amazing how often that happens."

Curriculum Vitae

Radford Electronics
run by: Woodside Electronics

Turnover: £400,000

Employees: 8

- 1959 First product *DSM* Stereo Control Unit; *STA12* power amplifier
- 1964/5 Upgraded *SC22* pre and *STA25* power amplifiers
- 1970 First transistor integrated amp, *SCA30*
- 1988 Arthur Radford retires
- 1987/8 Woodside Electronics takes over Radford brand name
- 1987 Valve Stereo power amp *STA25*
Valve Stereo preamp *SC25*
- 1988 Valve monoblok *MA50*
Valve stereo power amp *STA35*
- 1989 CD player *WS1*
- 1990 D-to-A converter
- 1990 *SC26* preamplifier

Woodside Electronics, Kimberley Road,
Clevedon, Avon BS21 6QJ.
Tel: (0272) 877611.



THE UK'S BUSIEST HI-FI STORES-

FREEPHONE 0800 591 366
FOR YOUR FREE COPY OF OUR FUN BARGAIN-PACKED CATALOGUE PRICE LIST.



...and we still put the customer first!

0% INTEREST FREE CREDIT
ON ALL SYSTEMS (no forms, only subject to simple clearance.)

SEPTEMBER NEWS

WELCOME BACK to all our readers who've returned glowing and refreshed to these green and soggy lands. Our commiserations to those who succumbed to temptation and bought duty-free hi-fi. Ours includes VAT, but as you know is much, much cheaper - and congrats to anyone who prudently kept a few bob back in the hope of new bargains from yours truly. You're in luck...

GOODMANS MAXIM II SPEAKER SHOCK... not a misprint (the printers wouldn't dare), just a stunner from the Richer cheque-book. A single £50 note now buys you a pair of these beautiful gems.

CASSETTE DECK SURPRISE We have what we think is our best cassette deck deal ever, but we promised this major manufacturer that the details wouldn't be put in print. Call any of our branches or pop in for a full exposé.

CRACKING CD DEALS... this month are on £69.95 compact home players, the top range Denon DCD920 for a mere £199.95 and clearance prices on famous Philips models. See you soon...

We are the system specialists

We pride ourselves in being able to put together a proper hi-fi separates system for little more than £100.

Although admittedly quite basic, thousands of our customers have started on the hi-fi road with a system similar to this comprising a turntable, cartridge, stereo amp and a pair of speakers.

For customers with a little more to spend we offer a second to none selection of hi-fi separates, specialist friendly service, and of course our world renowned value for money! We will happily arrange Interest Free Credit subject to simple clearance, give you generous packages of free accessories depending on the size of your purchase, and a price beat promise that's unbeatable (and is valid even after you've purchased your equipment!)

We welcome part exchange and offer a 3yr extended guarantee and buyback scheme at a very reasonable cost. If you live near to our shops we can deliver by hand and advise / help with installation and setting up.

We genuinely believe we put the customer first and offer the best all round system deal, why not give us a try?

Our hefty buying power and unbeatable price beat promise guarantee you the most competitive prices on these top brands:

- | | | |
|----------|----------------|-------------|
| AKAI | KENWOOD | SANYO |
| AIWA | MARANTZ | SHARP |
| AR | MORDAUNT-SHORT | SENNHEISER |
| ARISTON | MONITOR | SONY |
| B&W | AUDIO | TANNOY |
| DENON | NAKAMICHI | TEAC |
| DUAL | NAD | TECHNICS |
| FISHER | ONKYO | THAT'S |
| GALE | PIONEER | TOSHIBA |
| GOODMANS | PHILIPS | VIDEOTONE |
| HITACHI | QED | WHARFDALE |
| JAMO | ROTEL | YAMAHA |
| JPW | SANSUI | AND MORE... |
| JVC | | |

'BEST BUY' SPEAKER SUPERDEAL



GOODMANS MAXIM II We've scooped a winning deal here... for less than £50 treat yourself to a pair of these famous superbly crafted compact speakers, boasting a brilliant Hi-Fi Choice 'Best Buy' review, and What Hi-Fi? magazine 'Recommended' status too. Described as 'offering a smooth and integrated sound', with five stars for value-for-money - even at their £90 RRP! Quality Walnut finish.

RICHER'S CRAZY PRICE

£49.95
WERE £79.95
Pr.

RRP £89.95pr.

Price with adv.

WE'LL BEAT THAT PRICE 'TIL IT HURTS!

We want your business even if it means losing money! If you've seen it cheaper * we'll beat that price by £10 with a smile! Some suppliers don't like us advertising discount prices so do shop around to help us give you the best deal.

*Hi-fi separates must exist (i.e. be in stock!) anywhere locally (within 75 miles) at any time up to 7 days after purchase.

AN EXCEPTIONAL DENON CD FOR UNDER £200!

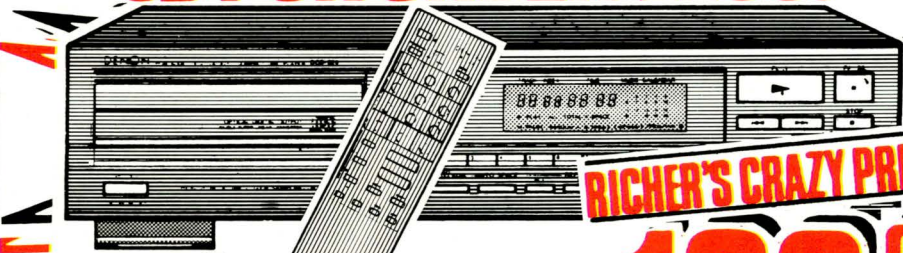

DENON DCD920 By careful bulk buying we've managed to secure an exclusive quantity of this top-range remote control player at £130 off our normal price. Boasting a stunning 20-bit super linear converter, 8-times oversampling digital filter, optical & coaxial digital output options, motor-driven remote volume control and a specification to match.

RICHER'S CRAZY PRICE

£199.95
WAS £329.95

Birmingham 10 Smallbrook Queensway, B5 (In front of the Albany Hotel) **021 6431516**

Bristol 20 Cotham Hill, BS6 (Opposite 'Crookers Pub') **0272 734397**

Cardiff 5 Central Square. (By the Bus Station) **0222 383311**

Edinburgh 1B Chambers Street, EH1 (Near the Royal Scottish Museum) **031 226 3544**

Leeds 55 The Headrow, LS1 (Opposite Lewis' Department Store) **0532 455717**

Liverpool 99 Renshaw Street, L1 (Opposite Rapid On corner, top of Bold Street Hardware Store) **051 708 7484**

London Central 2 London Bridge Walk, SE1 (above Duke St. Hill) **071 403 1201/4710**

London North 25 Northways Parade, College Cres, NW3 (Bottom of Fitzjohns Ave) **071 722 3359**

Stockport 4 Wellington Street, SK1 (yds Stockport Station, 10 yds off the A6) **061 480 1700**

York 66 Walmgate, YO1 (3 doors from the 'Yorkshire Evening Press' office) **0904 645535**

We are open: 10-6pm Monday-Friday, 10-5pm Sats (except Birmingham, Liverpool & Leeds 9-5pm), London central open late 'til 7pm Thurs & Fri. Open all Bank Holidays 12-4pm.

We welcome: Access, Visa, Cheques (up to £1000 subject to simple clearance) and Part Exchange. All goods brand new in sealed boxes unless otherwise stated. inc. VAT and g'teed 1 year. E&OE. All stores have a clearance corner full of ex-display and secondhand bargains and browsers are definitely welcome!

WE LOOK FORWARD TO SEEING YOU SOON!

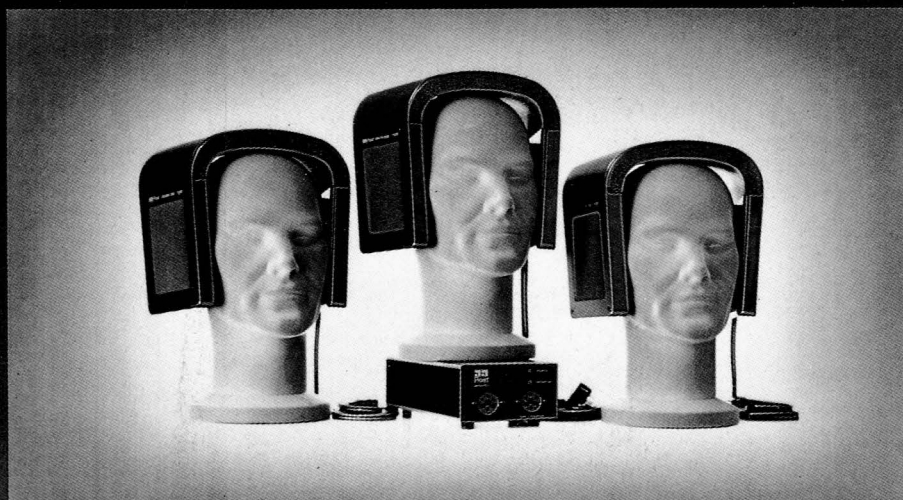

JJ FLOAT · JJ FLOAT ELECTROSTAT · JJ FLOAT II

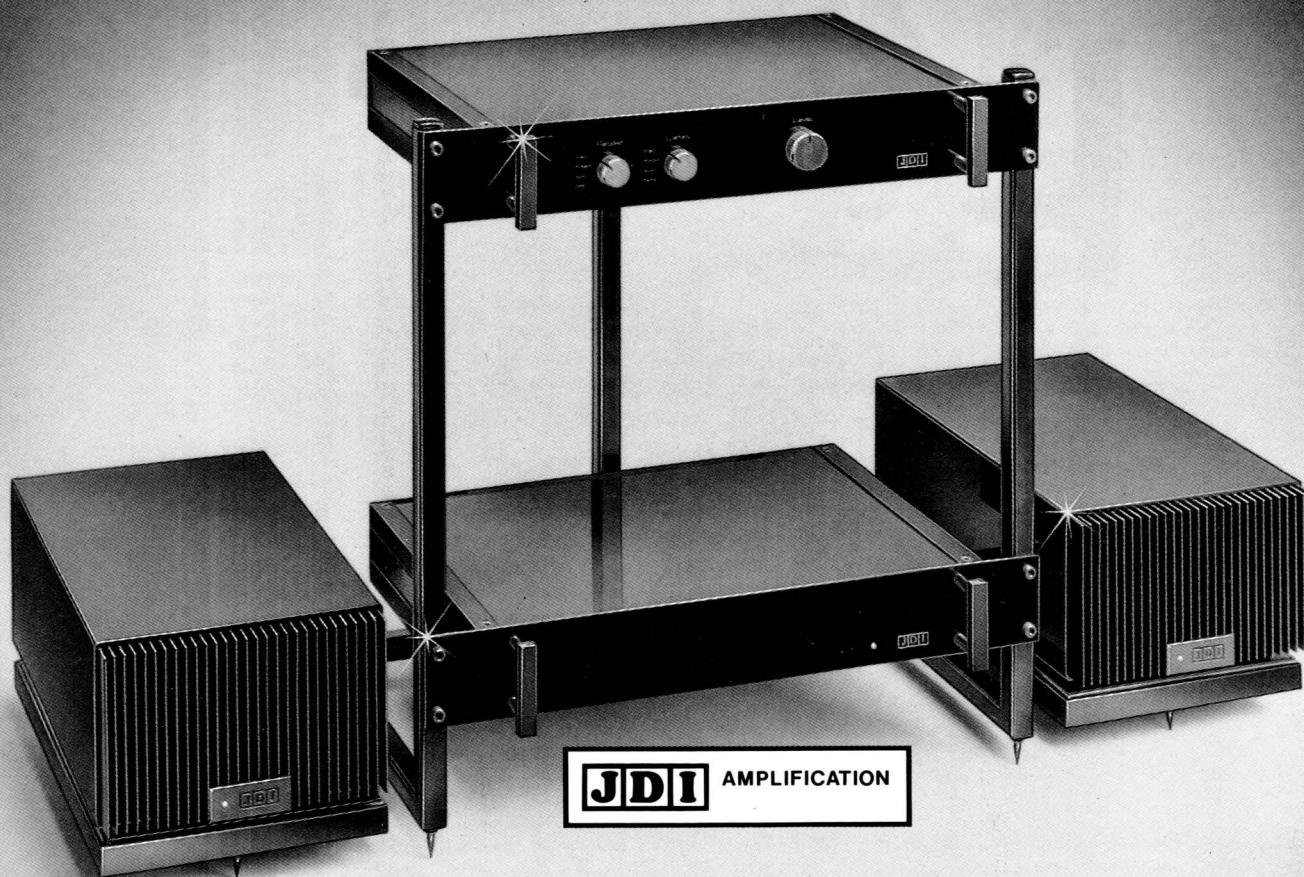

Distributed

by

Castle Acoustics Ltd.

Park Mill, Shortbank Road, Skipton, North Yorkshire BD23 2TT

Tel: (0756) 795333 Fax: (0756) 795335

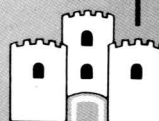

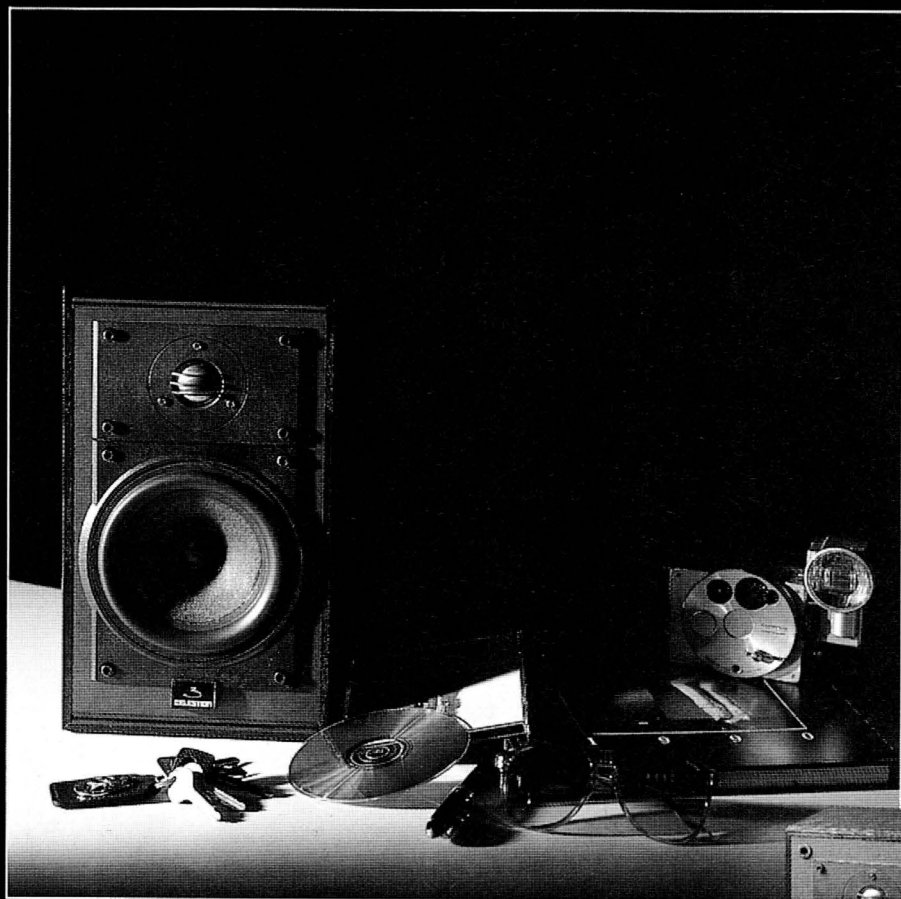

3 AND 5



*Performance,
Technology
and Style.*

CELESTION



Readers Write Choice Answers

The return of Bass

A couple of months ago I wrote to you with details of the way I use Sorbothane CD feet and a 10mm thick glass slab as a home-made 'Isoplat' under each component in my system. Although my letter was not published, I am writing to you again because I have since experimented with several combinations and my original arrangement was not as good as I first thought: although clearer, there was some definite loss of bass.

I have tried various arrangements and found that the best sound is with Partington Toppers placed on a Target shelf points up, supporting the glass slab, and the Sorbothane feet used in the correct manner directly under the equipment, i.e. the exact reverse of my previous set-up! The missing bass has returned, but the glass slab also helps improve clarity compared to using Sorbothane feet alone – giving a slightly more natural sound, especially with solo vocalists.

My second point is prompted by a phrase in your test on the Deltec PDM One DAC in Issue No 83: the sound quality section opens "Driven from a high quality CD transport . . .". A stand-alone DAC such as the Deltec (et al) is an obvious potential upgrade for anyone with a modest digital output-equipped player (I will certainly consider such an option when I upgrade my Arcam Alpha). Therefore, when testing CD players, would it be worthwhile to include comments on the quality of the digital outputs, or put another way, the quality of each player when used as a stand-alone transport? Even with the widespread use of standard Philips based transport/laser head assemblies, there is surely a significant difference in digital output quality dependent upon the player's power supply, internal vibration resistance, coaxial



Sorbothane damping feet from Audioquest.

or optical output, etc.
COLIN H HICKSON,
READING, BERKS.

Thanks for the tips on CD player isolation. It looks like this will become at least as big an issue as turntable tables and we welcome any ideas that improve CD sound quality. Perhaps someone should try out Richard Black's concrete slab and inner tube idea which he uses for turntables but which may prove effective with silver disc players. We'll be running a piece on this particular design in a forthcoming issue so anyone that's interested should stay tuned. Testing out the digital as well as analogue output of players seems like a good, if time and space-consuming idea. We'll give it some thought.

Disc damping disaster

I read with interest your review of the CD Interface Mats in the July edition of *Hi-Fi Choice*. Based on this, and in the furtherance of audiophile knowledge, I immediately rushed out to Frank Harvey's in Coventry which duly furnished me with a set.

Initially I fully agreed with the findings of Roy Gregory, noting improved dynamics and 'slam' (by the way, what is that?) along with a much more vivid timbre. Thus convinced I set about

equipping the ten most treasured CDs in my collection. All went well until I came to apply one of the said items to my copy of *Colours* by The Christians. On application, I failed to correctly align the interface mat with the hole in the centre of the disc. Realising the error, I tried to remove the partly applied mat and to my horror found that a substantial portion of the silver surface of the disc came away, rendering the disc useless.

This came as a great surprise especially as Roy Gregory recommended "an audition safe in the knowledge that you won't do any harm – the dampers are removable". My experience seems conclusive evidence that they should not be removed from a disc after application. This agrees with the instructions that came with the dampers to "not remove the mat once it is properly attached" although it could be argued that it was not 'properly attached' in this case.

I was also surprised that it was so easy to damage a compact disc. We all now know that CDs are not as indestructible as they were first made out to be, but I was under the impression that the important parts were buried in the plastic to resist attack and that if adequate care was

taken to ensure that the playing surface remained clean and scratch-free all would be well. From this experience it also seems that care must be taken of the label side as in this case that is where the information is stored. I shall certainly not risk using any more of these dampers, but shall invest in a Sicomin damper safe in the knowledge that no damage will be incurred upon removal.

May I take this opportunity on congratulating you on the production of a superb magazine. I especially enjoy reading your more technical articles delving into how and why audio equipment works rather than simply if it works. Keep up the excellent work!!
RICHARD AUGUST,
REDDITCH.

Rega variations

Towards the end of last year I decided to buy a hi-fi system. I went to a dealer with £850 to spend and informed him that I wanted a tuner, amplifier and loudspeakers that would be suitable for a good quality record player when sufficient funds became available. He sold me a Creek T40 tuner, 4040S2 amplifier and Rega ELA loudspeakers with a Target table for the electronics and some inexpensive speaker cable.

I was a little concerned at the time, spending £405 on the loudspeakers and only £179 on the amplifier; however the dealer assured me that this was a good combination, so I bought it. I'm not sure if this was the right decision. Shortly afterwards I changed the speaker cable to Audioquest *Livewire Black* and bought an Alphason *Sonata/HR100S/Linn K9* turntable arm and cartridge combo from another dealer. The choice being at least partly based on your excellent review, I am very pleased with the quality of the deck.

I now have about £800 to improve my system. From

Rayleigh Hi-Fi

THE SPECIALISTS

216 MOULSHAM STREET, ON-THE-PARKWAY

Ghelnstford

TEL: 0245-265245
(3 LINES)

44A HIGH STREET,

Rayleigh

TEL: 0268-779762
747571

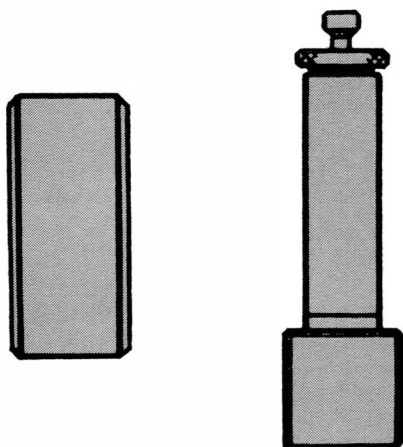
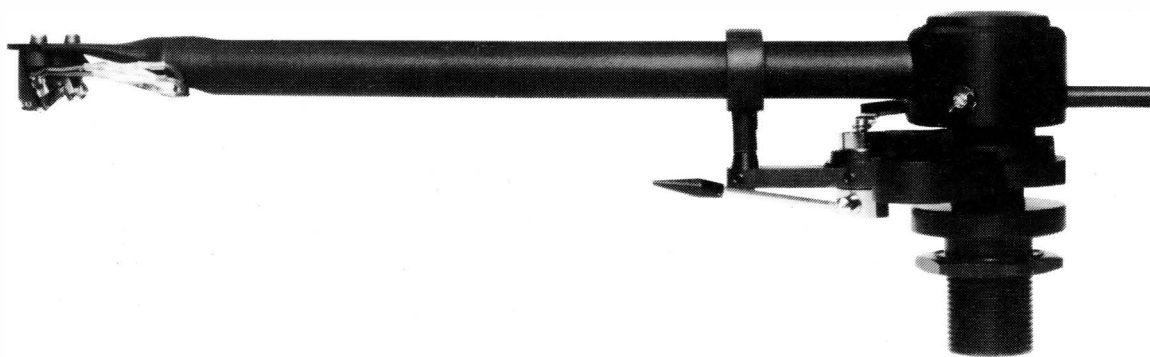

The Tabriz doesn't sound like what it is — cheap — and one reason for this is simply that it doesn't sound, full stop.

The effect of a change to the Tabriz zi spec was immediately apparent. Justifying the claims for the intelligent counterweight, the bass goes deeper and sounds purer.

High Fidelity April 1990

TABRIZ £149.00
TABRIZ ZI £229.00
Z1 UPGRADE £99.00

ACOUSTIC ENERGY ★ A&R ★
AUDIOLAB ★ AUDIO TECHNICA ★
BEYER ★ BLQ ★ CAMBRIDGE AUDIO
★ CASTLE ★ CREEK ★ CYRUS ★
DENON ★ DUAL ★ EPOS ★ GALE ★
HEYBROOK ★ ION SYSTEMS ★ LINN
PRODUCTS ★ MANTRA ★ MISSION ★
MONITOR AUDIO ★ MUSICAL
FIDELITY ★ NAD ★ NAIM AUDIO ★
NAGAOKA ★ NAKAMICHI ★ ONKYO ★
ORIGIN LIVE ★ PROAC ★ QED ★
QUAD ★ QUART ★ REGA ★ REVOX ★
REVOLVER ★ ROKSAN ★ ROTEL ★
ROYD ★ STAX

ROKSAN LINN
XERXES V SONDEK

**COME AND HEAR
FOR YOURSELF!**



3 YEARS PARTS AND LABOUR GUARANTEE ON HI-FI SYSTEMS
LICENSED CREDIT BROKER — FULL FINANCE FACILITIES AVAILABLE — DETAILS ON REQUEST — APR 26.5%

All prices and specification correct at time of publication, all prices include VAT.



what I can gather the amplifier is the weakest link and therefore the component to change, but have little idea of what would be best to replace it with. Should I spend all my budget on an amp and then later (when funds permit) buy a good moving coil cartridge, or would it be more logical to buy both at the same time. I listen mainly to classical music.

ALLAN MACREGOR,
BASILDON, ESSEX.

Pooling opinions from Paul Messenger, Richard Black and Beverly Francis (née Reynolds of The Audiophile) it would seem that the ELA is a musical rather than totally accurate loudspeaker that doesn't need a lot of driving. That's not to say that it won't benefit from a first class source such as your Sonata turntable and good quality amplification.

There are many options you could consider. Firstly you should assess whether you are likely to want to upgrade the speakers at any point in the future. If you think you might, then it would be worth going for a reasonably expensive high quality integrated amp such as the Audio Innovations Series 500 which we're told works very nicely with the Regas and is as good an amp as your budget is likely to get you. Alternatively you could opt for something less expensive but well matched such as the Naim Nait, or Harman/Kardon HK6500 which has a decent MC input. Either of these will give the system more life and depth and leave plenty of resources for a first class cartridge. However, the Series 500 coupled with a competent MM cartridge (very few valve amps have MC inputs and generally require step-up transformers) would be superior and we would urge you to audition that particular combination before making a final decision.

As for cartridges, if you go for an amp with an MC input or use a step-up the Goldring Eroica LX or Audio Technica's more expensive OC7 would seem rational choices; magnetic alternatives include Goldring's 1042 and Shure's VST V which did so well in our August review.

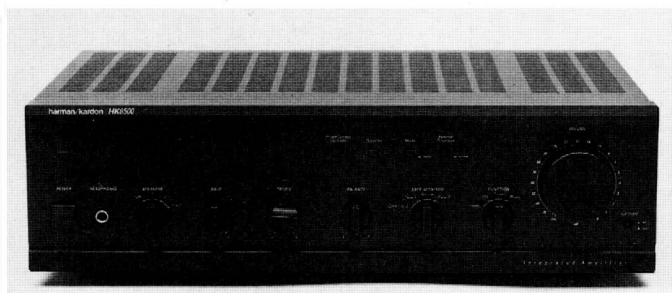

Harman/Kardon's highly underrated HK6500.

The well-tuned CD player

Hi-Fi Choice of June 1990 was most interesting to me as a prospective owner of a compact disc player. I have been given some particularly finely recorded discs from Saydisc and Nimbus and I need something on which to play them. Here is the problem: I work in the music industry. I am a piano tuner and an interviewer for tape services for blind people – hence my recent visits to Saydisc and to Nimbus (Nimbus actually has an association with blind people as it is working on a system for transferring our talking book library from tape to compact disc and for using CD-ROM to provide speech output from personal computers).

Tuners develop acute and idiosyncratic hearing which cannot be disconnected on leaving work. One of the awful results is the spoiling of our enjoyment of many piano recordings because of poorly set up, tuned, pitched and recorded pianos. When we do find good recordings we can find ourselves in a quandary about the equipment we like to listen to. Just as no piano is a jack of all trades, so is no hi-fi rig. We can agree that broad frequency ranges and dynamic ranges are important, and already you will see that we cannot have both – records score in the former department whereas compact discs shine in the latter. (You will appreciate that although we cannot claim to hear sounds above 20kHz we can hear the effects, or on CD the missing effects, of these frequencies on lower pitched sounds). We

also favour minimal distortion, to which end many of us like to use Class A amplification and loudspeaker systems with crossovers which are simple and which act over ranges of frequencies outside our most sensitive aural ranges (usually around 200Hz and 3-4kHz). Most of us learn to put up with what seems to us to be excessive mechanical noise emitted by most equipment.

This leads me to one question and one suggestion. How can I assess whether a CD player is suitable for a Class A amplifier? I am using Audio Innovations Series 800C pre- and 800 triode coupled power amplifiers (lovely performance but dreadful mechanical noise), Audionote cables and Spendor SPI loudspeakers on Spendor stands.

Incidentally, how do you physically arrange to earth equipment to ground – what connects to where and what manner of spike should one use? As a blind person I am not really a do-it-yourselfer. Who can help?
C J BRIDGEMAN,
WINDSOR, BERKS.

We are sorry to hear that you haven't heard a turntable capable of extracting wide dynamic range from LPs. They do exist, if only in rarefied atmospheres.

However, what you want is a CD player that's good enough to stand up to the scrutiny afforded by Class A amplification and transparent loudspeakers, a pretty tall order but one that we'll endeavour to assist with. You don't mention a budget but the calibre of the equipment you already own suggests a fair degree of commitment. For the sake of

keeping things within realistic realms we'll stick to sub £1,000 options.

Of the standalone machines in this bracket the ones that we've found most impressive are Meridian's 206, Pioneer's PD91, Cambridge's CD3 and the Radford WS1. Of those the most competitive are likely to be the ones made in this country as the Pioneer is now a little long in the tooth by CD player standards, though no less listenable as a result.

An alternative approach would be to go for the increasingly popular option of a separate transport and D-to-A converter. This is somewhat trickier for under a grand, but converters like Deltec's PDM One, Meridian's 203 and Arcam's Black Box 2 combined with the Arcam Delta 170 transport make it just about feasible.

If funds were more bounteous the Meridian 208 at a shade under £1,500 is the machine to beat, although the latest 'bitstream' Micromegas will undoubtedly give it a run for its money. As for players with Class A output stages, here you're talking big money for serious products like the CAL Tempest II or the Stax valve DAC. Beard Audio showed a prototype of its valve DAC in April which may be closer to affordability but it's unlikely to be less than £1,000.

Even if you had given us a specific budget we couldn't point to one particular player which would give you the best results in your system. We'd always suggest auditioning alternatives in a system that is similar to your own.

As for system grounding, the most rational arrangement that we've heard of involves avoiding the building's earth and running a separate wire from the system to a water filled copper pipe sunk into the ground. A slightly simpler system would be to earth the various components directly to the earth point on the incoming mains casing – that is the same point that is used by the consumer unit.

Both systems are supposed to be particularly beneficial, and we should imagine that any electrician would undertake a job like this.

EQUINOX

MOVING COIL HEAD AMPLIFIER

TREATS YOUR MUSIC WITH THE RESPECT IT DESERVES

AVAILABLE FROM SELECTED DEALERS

(0327) 704231

The central graphic features the Spaldings logo, a stylized 'S' composed of three horizontal bars, above the text 'SPALDINGS' and 'HI-FIDELITY SPECIALIST'. This is set against a background of white line-art illustrations of various audio equipment, including turntables, amplifiers, cassette decks, and speakers. The names of these brands are written in a circular path around the central logo: 'F. DENON · DUAL · ROKSAN · AUDIO LAB · NAKAMICHI · REVOLVER · R · QUAD · LINN · A & R · CAMBRIDGE · NAIM · MONITOR · AUDIO · S · M · E · MERIDIAN · MUSICAL FIDELITY · SONY ES · SYSTEM DEK · SETAK'.

The most extensive range of quality products in the south-east. Backed by our service department and wide ranging delivery service. Please phone or call in for a demonstration or a copy of our new in house magazine. 

352-354 Lower Addiscombe Rd. Croydon, Surrey CR0 7AF. Tel. 081-654 1231/2040

Choosing and Using . . . Loudspeakers

Paul Messenger guides you through the maze of loudspeaker selection.

The first step on the road to choosing your loudspeakers is to specify your personal and particular requirements. It is possible to do this on a basic, simplistic level, checking the price, size and intended location. But there are real benefits for those prepared to take a little more trouble. With a little care, the assistance of the data in this issue, and (hopefully) the co-operation of a skilled retailer, the end result can be that much more worthwhile.

Those buying just loudspeakers will have a pretty good idea of the money they have available, which as ever is the fundamental bottom line of any purchasing decision. But there is – and always has been – controversy over the proportion of a budget that should be devoted to loudspeakers, vis à vis that spent on the other components.

Ten years ago conventional wisdom recommended devoting as much as possible to the loudspeaker, as it was regarded as the weakest link in the chain. An alternative philosophy, pointing out that the loudspeaker could do nothing to compensate for an inadequate source, switched attention towards turntables and amplifiers.

When setting the loudspeaker budget, it is vital to allow sufficient funds for a decent stand or support, and good quality connecting wire. From £200, for example, one should probably allocate £140 for the speaker itself, £50 or so for stands, and maybe a tenner for the cables.

Where one listener may be barely conscious of the subtleties of stereo imagery, another will take particular pleasure in pin-pointing musicians within a recorded acoustic. Likewise those who listen predominantly to electronic rather than acoustic instruments are liable to sacrifice coloration in favour of dynamic impact.

While a magazine can

assist in presenting these alternatives, it is only through skilled demonstration that an individual can be confronted with the different but equally valid options to make an educated choice for himself.

At the time of writing I am temporarily living with a £1,000 system which suits me very well, but which certainly represents one extreme. It consists of a £600 turntable with £200 amplifier and £80 loudspeakers on £100 stands. At the other extreme, another could enjoyably combine a £500 remote control multi-source midi-system with £500 worth of high performance, low coloration loudspeakers and stands. But unless one actually has the opportunity to hear the difference between these two very distinct approaches, how can one possibly have any basis for making a choice?

The site chosen for loudspeakers is often as influential as the choice of loudspeakers themselves. Over the years I have used open stand locations, both with conventional box speakers and panel types, and also stand-mounted wall-backed designs. Each has its own strengths and weaknesses and imposes its own characteristics on the sound, so again personal preference enters into the equation.

Having chosen the siting, one may then choose the loudspeakers and stands to suit. Alternatively, choose the speakers you like in the shop, and then move them around at home until they sound to your taste.

The end result comes from a complex interaction between the loudspeaker, its support, its site, the acoustics of the room, and the general characteristics of the driving system. That is rarely entirely predictable. For those intending to spend a fair amount of money, it is not unreasonable to expect the luxury of a home

demonstration, and/or the option to return and change a pair which do not suit after a day or two.

For any given budget there is an obvious choice between large or small loudspeakers. One instinctive reaction is to favour the big one, particularly if it has lots of drive units, but others will plump for a miniature or compact on aesthetic grounds. In fact the differences and trade-offs are much more subtle and far-reaching.

Fundamentally, the larger the box the more extended the bass is for the same specific loudness. Ultimately a good big 'un is going to beat a good littl'un on loudness and bass extension, hands down. But it is also going to cost a great deal more. The large enclosed volume remains the route to extended bass, and this in turn adds 'weight' and 'scale' to the sound. But it can also reveal the low frequency inadequacies of the sources, be they the equipment or the recordings themselves.

Big speakers suffer from several innate disadvantages. Large box enclosures are expensive to build and ship, and represent an undesirably

large surface area of unwanted radiation, which can colour the sound and blur stereo precision. Extra drive units do increase power handling, but bring problems of crossover complexity and unit integration.

Little speakers can prove more fragile if used for the occasional party, and are certainly not at their best when trying to recreate the power and drama of rock or a full concert hall acoustic.

Given the excessive number of different models competing for attention, manufacturers are inclined to make much of the uniqueness of their particular brew. As a result the industry has become riddled with buzz words to describe any single type of engineering solution, and this leads to the sort of stereotyping which entirely misses the point of loudspeaker engineering.

Examples are legion, from the bextrene bass/midrange cones of the early '70s through to the latest metal dome tweeters which are currently springing up everywhere. The result is that people talk of a 'metal dome sound' as something desirable (or not) per se, whereas in fact there will be a whole range of different metal dome sounds, in all probability some distinctly more 'equal' than others.

The underlying axiom is that great loudspeakers are not created by adopting a quick technological 'fix'. Indeed, history has often shown that the 'radical innovation' is a mere flash in the pan, with benefits in one area more than offset by unforeseen penalties elsewhere.

Technology has steadily improved the performance of loudspeakers over the years, and some innovations have proved decidedly worthwhile. But the whole is much greater than the apparent sum of the parts, and the buyer would do well to bear this in mind.



Roksan's Darius with stand and separate crossover. See review on page 71.

THOROUGHBREDS

Since 1962 we have received eighteen prestigious awards for our precision pick-up arms. One of the models shown here could well transform the performance of your deck and cartridge, realising, probably for the first time, the full potential of your L.P. records. Glance through one of our instruction books, sometimes 24 pages with more than 40 illustrations, to appreciate the attention to detail. Only SME arms provide the precise adjustments essential for true cartridge performance and the build quality to minimise sound colouration. Insist on SME, the thoroughbred arm, to update your present equipment.

SERIES V flagship of the range, acknowledged by leading international authorities with the Audio Component of the Year Award in Japan, the Federation of British Audio Award for Excellence and the Absolute Sound International 'Golden Ear' Award for Pick-up Arm Design in the United States.



SERIES IV owes much to Series V technology. Although at a lower price, it retains the unique one-piece magnesium tone arm, dual lock base and other advanced features. Selected for the Federation of British Audio Source Component of the Year Award, 1988.

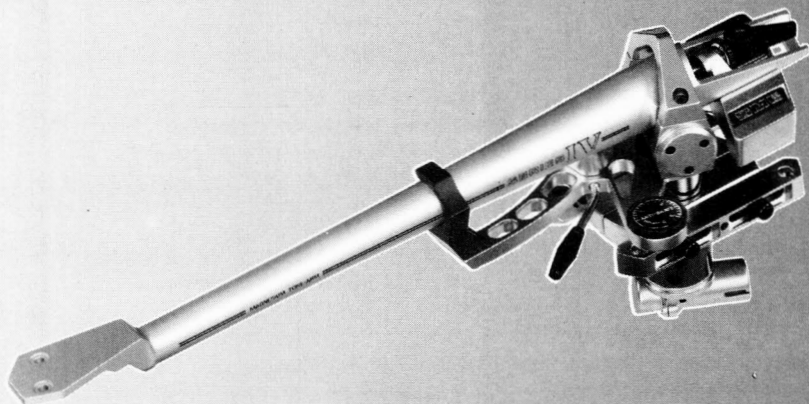

SERIES 300 embraces three models: the 309, 310 and 312. The influence of the classic V will be clearly seen but here the aim has been to meet the needs of a broader market in which price, alternative arm lengths and an interchangeable shell facility are important considerations. The Series 300 offers performance and manufacturing excellence unmatched by many more expensive arms.



SME

The best pick-up arm in the world

Write or phone for advice and descriptive leaflets. Our sales and service departments would be happy to hear from you:

SME Limited, Steyning, Sussex, BN44 3GY, England.
☎ (0903) 814321 FAX (0903) 814299

Acoustic Energy AE3

Recommended

ACOUSTIC ENERGY LTD, 3A ALEXANDRIA ROAD, EALING, LONDON W13 0NP. TEL: (081) 840 6305.



Acoustic Energy's original *AE1* – an upmarket metal cone/dome miniature – was an instant hit. To go on to create something larger with all the charm of the original is to attempt one of the most difficult tricks in the hi-fi book.

Designer Phil Jones' first attempt at a full size model was the *AE4*, which attempted – rather unsuccessfully – to integrate the singleton tweeter with no fewer than four bass/mid drivers. Placing tweeter in the geometric centre of the quartet of bass/mid drivers sounds neat from the point of view of making the two sources coincident (or at any rate coaxial), but in practice leads to an enormous discontinuity in the effective diameters – and hence distribution characteristics – of the two sources through the crossover region.

The decision to use multiple 90mm drivers for the '4' was presumably because said 90mm driver was AE's

own proprietary technology. But to do the job properly it was necessary to await the development of a proper metal cone bass driver, to operate below the single mid and treble drivers in a classic 3-way configuration.

That's the *AE3* formula, which reflex-loads a 165mm metal-cone bass driver (c40mm voice coil) to cover the range below what looks like the mid and top of a '1. It's not a big box, though I suppose it's big enough by today's diminutive standards. It is, however, expensive (£1,650) and massive (35kg) beyond its dimensions. Each was accompanied by a matching twin-pillar stand, which is nearly as massive once the columns are filled with the supplied lead shot.

Cosmetically the design follows AE's Pro-influenced house style, finished in a textured gunmetal grey throughout with rebated drivers, which looks smart and fashionably high tech. The grille has a thick frame and spoils the aesthetics, so is best ignored – the metal dome tweeter has its own protective mesh cover. Reflex loaded by four little tubes around the bass driver, the cabinet is built and braced in massive 28mm MDF. The complex crossover is similarly over-engineered, hardwired to the drivers with hawser-like cabling. However, the bolts securing the drivers were not particularly tight.

Test Report

As with the earlier AE designs, sensitivity is somewhat below average, though that is part of the price for obtaining decent bass extension from a compact enclosure. A powerful amplifier is needed to exploit its power handling and obtain the high loudness potential, while the load – dipping quite seriously around 100Hz and only slightly less so at 1.5kHz – demands high current capability.

The room responses are commendably smooth, though close-to-wall siting must clearly be avoided. Crossover integration looks first class, especially at the upper, mid-to-tweeter transition, while the narrow spread is indicative of close control throughout.

Sound Quality

If not perhaps a revelation, the listening test results were certainly a vindication of AE's design philosophy, and its extension to a middle sized enclosure.

The '3 is no bass excavator, but it nevertheless manages to deliver the music with a power and authority that few

rivals can match. It's neither exceptionally fast nor particularly light on its feet, but it's no sluggard either, and remains so splendidly in control that the slightly 'thickened' bass textures, the mild hardness and 'cuppy' quality in the midband are easily forgiven.

Passively tri-wired they match the characteristics of the stand pretty well; tri-amped the bass began to overwhelm, and was better balanced on a pair of lightweight JRT stands. Which if it proves nothing else shows how sensitive this transducer is to the subtleties of system matching; you have been warned.

Conclusions

It has its character and flaws like any other, but the *AE3* is certainly a very impressive loudspeaker that provides fine insight. It is, however, first and foremost a monitor, rather than a musical instrument.

TEST RESULTS

Size (height x width x depth)	63.5 x 26.5 x 37 cms
Weight	35 kgs
Recommended amplifier power	20-250 watts
Recommended placement	stands in free space
In room averaged response limits 50Hz-10kHz	+/-4db
Large room/space LF rolloff (-6dB ref midband)	23Hz
Large room/wall LF rolloff (-6dB ref midband)	23Hz
Small room LF rolloff (-6dB ref midband)	27Hz
Large room output at 20Hz (ref midband)	-10dB
Estimated midrange sensitivity (ref 2.83V, 1m)	85dB
Impedance characteristic (ease of drive)	needs good current delivery
Typical price per pair (inc VAT)	£1,650

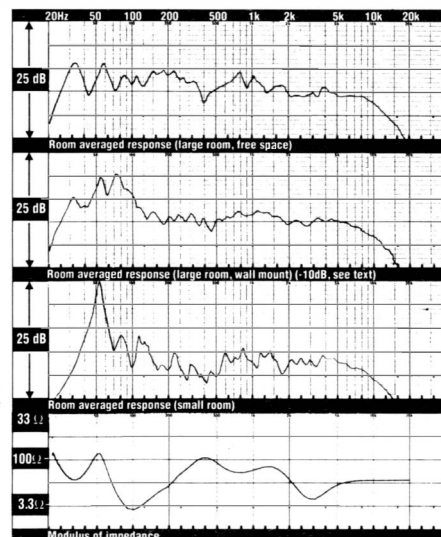

Pick up your hi-fi at audio eXcellence

Whether it's a turntable, an amp, a C.D. or speakers, audio excellence stock a wide range of the world's best hi-fi.

All the stores have single speaker demonstration rooms where with our experience we can advise on the right system for your personal requirements.

As four times winners of the Sony Hi-Fi



News Dealer awards we know that our

customers endorse our policy of putting the music first.

Telephone or write for our brochure or drop in at one of our stores and experience audio excellence.



audio eXcellence
WHERE THE MUSIC MATTERS

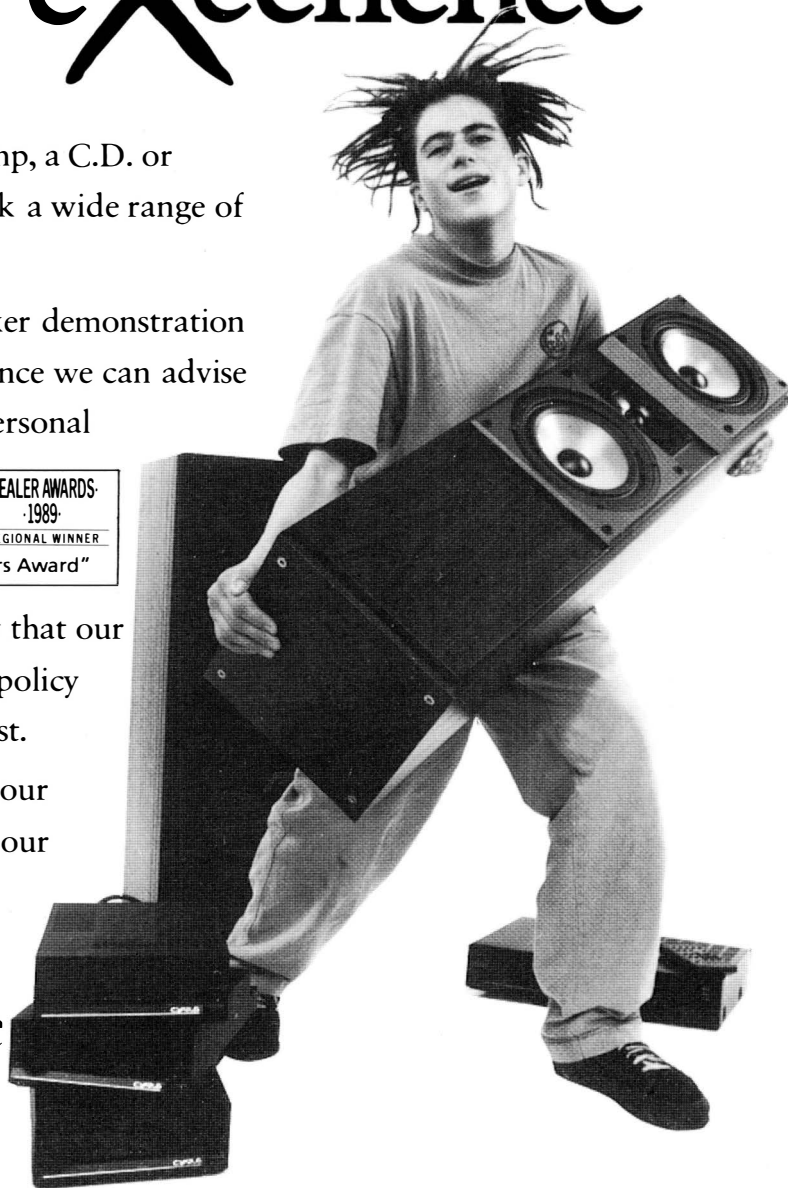

drop in at one of our stores

CARDIFF

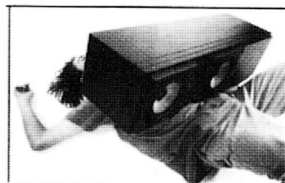

134/6 Crwys Road, Cardiff
Wales CF2 4NR
Telephone (0222) 228565

SWANSEA

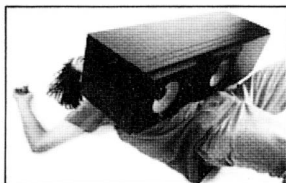

9 High Street, Swansea
Wales SA1 1LE
Telephone (0792) 474608

GLOUCESTER

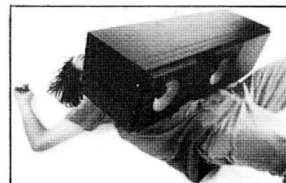

58 Bristol Road, Gloucester
Gloucestershire GL1 5SD
Telephone (0452) 300046

Tuesday-Saturday 9.00-5.30 CLOSED MONDAY

ACOUSTAT, ACOUSTIC ENERGY, AR, ARCAM, AUDIOLAB, AUDIO RESEARCH, DUAL, CELESTION, DELTEC, DENON, HEYBROOK, KEF, KOETSU, KRELL, LINN, MAGNEPLANAR, MARANTZ, MERIDIAN, MISSION, NAD, NAKAMICHI, NAIM, QUAD, REVOLVER, REVOX, ROTEL, SME, SONY, SD ACOUSTICS, TANNOY, WHARFEDALE, YAMAHA.

Ariston Q

ARISTON ACOUSTICS LTD, FREEPORT SCOTLAND, PRESTWICK AIRPORT, SCOTLAND KA9 2TA. TEL: (0292) 76933.



Turntable specialist Ariston has added loudspeakers as well as amplifiers and CD players in its graduation to a full line brand. The Q covered here is twice the price and less than half the size of the *Image* covered last time, and is much less conventional, though it does bear more than a passing similarity to the *QLN One*, also covered earlier this year.

The designation Q is a reference to Ariston's proprietary *Q-board* – a self-damping panel material employing a laminate of particle board and visco-elastic damping. Besides the mechanical contribution made by the *Q-board*, the cabinet has been carefully shaped to optimise its acoustic performance too. The tapered-baffle-and-sides shape has a number of favourable consequences. It provides maximum lateral dispersion with minimum focusing for the acoustic output of the drivers themselves, helped by the chamfered edges and velcro-and-foam grille. It provides a measure of time alignment between the acoustic centres of bass/mid and treble drivers. And the internal dimensions show sufficient variation to minimise specific standing wave resonances.

The whole thing is immensely solidly built, as indicated by a total weight of 8kg, which is a great deal for such a small box. Part is due to the large magnet fitted to the reflex-loaded main driver. This has a cheerful yellow synthetic woven cone 120mm across, mounted on a pressed steel frame and recessed a few millimetres into the baffle. The tweeter is a conventional 25mm soft dome device. These are hardwired to a complex, generously rated, separate arm PCB crossover, and thence to two pairs of class Y Michell socket/binders.

The enclosure has a small rear panel port and is built throughout in substantial 25mm thick *Q-board*, rendering any further stiffening quite unnecessary. The inside is pretty well stuffed with wadding, and the walls are lined with absorptive foam too.

Test Report

Some bright spark up at Ariston managed to wire one of this pair out of phase with the other. With hindsight I should have guessed from the initial measurements, but was probably on auto-pilot while ploughing through these. Several sharp-eared listeners noticed immediately, so later on I remeasured, but only in the large room.

Sensitivity is somewhat below average, but the impedance is kind to amplifiers and bass extension quite good for a near-miniature. The responses show that the midband, (150Hz-1kHz) is rather prominent when pulled well clear of walls, but the midbass (50-250Hz) dominates close against a rear wall. The happy medium should be about 1ft away. Elsewhere the presence region is slightly recessed across a broad span of two octaves, or alternatively the main tweeter range, 4-14kHz, is somewhat exposed. Close up measurements show the best response is with the middle of the enclosure at about ear height, so highish stands are advisable.

Sound Quality

Having unjustly accused Jason, who was in charge of conducting the blind listening tests, of getting the phase wrong, and having decided to reverse Ariston's assembly error, the auditioning finally got underway. The Q didn't

by any means disgrace itself, but didn't really do well enough to justify the £400 price tag.

The recessed presence band caused much of the problem, compounded by a rather ponderous and heavy bass balance that neither variations in siting nor stands seem able to cure. Scale and 'welly' are quite impressive – more than one panelist thought this was a large floorstanding model – but the total response was somewhat lukewarm, due to the thickened textures and 'chesty' qualities: "Suffering from a terrible head cold" was one comment.

Conclusions

Setting aside the wiring error as practically inconsequential, if inconvenient, the Q is not without appealing qualities, delivering a good impression of scale from a small box. But no listener was particularly happy with the overall sound, which is rather laid back and over-rich at the same time.

TEST RESULTS

Size (height x width x depth)	35 x 16.5-25 x 20-27 cms
Weight	8 kgs
Recommended amplifier power	20-80 watts
Recommended placement	high stands in space
In room averaged response limits 50Hz-10kHz	+/-7db
Large room/space LF rolloff (-6dB ref midband)	30Hz
Large room/wall LF rolloff (-6dB ref midband)	30Hz
Large room output at 20Hz (ref midband)	-13dB
Estimated midrange sensitivity (ref 2.83V, 1m)	85dB
Impedance characteristic (ease of drive)	very good
Typical price per pair (inc VAT)	£395

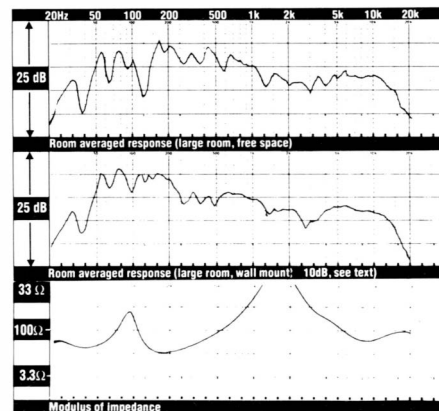

Uxbridge Audio

BADA
THE ULTIMATE IN
SOUND ADVICE

Dear Sir

Wembley Park,
Middlesex.

The EXCELLENT service, personal attention and professionalism I found with your staff, compels me to write this letter.

Having embarked on the daunting task of looking for the right music system I visited many Stores and purchased a lot of literature. I was attracted by your advertisement in What Hi-fi magazine. First class sound quality was my top priority and from another article in the same magazine I had made up my mind to purchase a system recommended therein.

A quick phone call to your Shop to find out whether you had them in stock and I was lectured on how a Music System should be purchased . . . "HAVE YOU LISTENED TO IT? HOW DO YOU KNOW YOU WILL LIKE IT'S SOUND? It isn't the same as buying a washing machine, when it has to be taken on faith that it will do the job as you want it. It is more like buying a musical instrument, where personal preference dictates. You do not need to be an expert, you only need to listen to it and decide for yourself . . ."

Not too keen on the lecture, I was, none the less, taken up by what he said, and decided to pay you a visit. This turned out to be quite an experience! After listening to a few systems I had already decided I would be buying my own combination and not the one recommended in the magazine. A MUSIC SYSTEM SHOULD, INDEED, BE LISTENED TO, BEFORE PURCHASING. In addition, the personal attention, friendly, untiring and "non pushy" attitude of your sales assistant, Jas, turned the daunting prospect of choosing the right hi-fi into A MOST PLEASANT EXPERIENCE.

When I first read the letter from a satisfied customer in your advert I didn't think it genuine. But after my experience I know just what he meant. I echo him in commanding you and your staff and I will not hesitate to recommend you. I, once again, thank you for the help in choosing my system and the excellent service and attention I have received at and since it's installation.

Wishing your Company every success

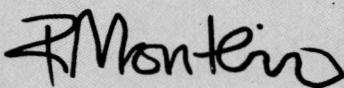

Mrs. F. Monteiro



ACOUSTIC ENERGY • A&R CAMBRIDGE • AR • ARISTON • AUDIOLAB • AUDIOTECH • CAMBRIDGE AUDIO • CREEK • CYRUS • DENON • DUAL • EPOS • EXPOSURE • HEYBROOK

ION OBELISK • JPW • KEF • LINN PRODUCTS • MARANTZ • MERIDIAN • MICHELL • MISSION • MONITOR AUDIO • NAD • NAIM • NAKAMICHI • QED • QUAD

REVOLVER • REVOX • ROGERS • ROKSAN • ROTEL • ROYD • RUARK • STAX • TANNOY • THORENS • WHARFEDALE • YAMAHA

Uxbridge Audio
278 High Street, Uxbridge
Middlesex. Tel: 0895-30404 multi-line
Open 10am till 6pm – 6 days a week

*Music from the best
equipment at all
price levels*

TWO DEMONSTRATION ROOMS • 7 DAY EQUIPMENT EXCHANGE
OR REFUND • UNBIASED ADVICE • MAIL ORDER ANYWHERE
2 YEARS GUARANTEE PARTS AND LABOUR • FULL INSTALLATION
SERVICE • 0% INTEREST FREE CREDIT • FULL SERVICE &
TURNTABLE SET UP FACILITIES



ATC SCM20

LOUDSPEAKER TECHNOLOGY LTD, GYPSY LANE, ASTON DOWN, STROUD, GLOUCESTERSHIRE GL6 8HR. TEL: (028576) 561.



Having built a strong reputation in the professional sound arena for an uncompromising approach to drive unit design, ATC is turning its attention towards the hi-fi market, the *SCM20* being the company's *Choice* debut. It looks superficially like a conventional 2-way bookshelf loudspeaker, which in some senses it is. But at 21kg each it's five times the weight of the typical speaker of similar size – and at £1,320 it's also five times as expensive too.

It's actually the baby in the range, though that only serves to emphasise where ATC is coming from, as does a pile of paperwork listing the various recording studios which use ATC monitors. Unlike most Pro monitors, the *20* is actually quite pretty in its real wood veneer and neatly chamfered grille shape. By domestic hi-fi standards it counts as a compact bookshelf model, though anyone contemplating using anything other than quality stands must have great faith in their Rawlplugs.

Amongst the blurb was a letter warning me against attempting to get inside without proper tools. There was also a full description of the innards to save me the trouble, but I felt I ought just to try the hex bolts for tightness – and was very surprised to find them all no more than finger-tight, which is apparently deliberate. The enclosure walls are 18mm MDF with 6mm bitumen pads, while the baffle is 36mm thick.

The pièce de resistance is ATC's own bass/mid driver, itself responsible for 9kg of the weight. It uses a damped polyester weave diaphragm some 130mm in diameter, driven from a 75mm coil. The tweeter is a 25mm soft dome unit, while the high power

crossover is appropriately elaborate, though inappropriately not equipped for bi-amping.

Test Report

The low sensitivity means that 'normal' power amplifiers will not generate the same loudness levels they would with 'normal' loudspeakers. The answer is certainly to buy a bigger power amplifier, since I suspect the '20 could handle a kilowatt if called upon to do so. It should respond well to plenty of volts, and doesn't draw excessive current.

The payoff accompanying the low sensitivity is a very respectable degree of bass extension considering the small box size, but one sacrifice here is that the region below 150Hz is 5-10dB less than that above (measured in-room, far field), though wall reinforcement lowers the step frequency an octave and a half to round about 50Hz. Elsewhere the response is pretty well balanced, albeit with some unevenness and mid forwardness, the former more noticeable with wall loading, the latter in free space. The crossover region is not entirely seamless, but is good nonetheless, as is the general consistency at different measuring positions. The listening axis is refreshingly uncritical, and the grille best left in place.

Sound Quality

I had a good play with the *SCM20* as soon as it arrived, finding both potential and flaws. So did the listening panel, where the overall result was disappointing. Strengths include delightful mid-range vocal dynamics and transparency plus fine coherence and integrity, but criticisms were directed against a signif-

icant degree of harshness and mid-forwardness, and an apparent lack of genuine bass extension and power.

Though some of the harshness and forwardness is innate, I can't help wondering how much might be avoided by further tightening up, though that is speculation. Although the bass is light, it's exceptionally fast, authoritative and detailed too. It does rather lack 'bounce', but much of the lightness is down to the lack of normal resonances and boxiness.

Conclusions

At the end of the day I've grown to respect rather than like the *SCM20*. I find its presentation invariably informative and elucidating, but frequently a mite uncomfortable too. It's not for bass freaks, needs a very powerful amplifier, and £1,300 is an awful lot to pay for a speaker this small. But clearly this ATC is still one of the more interesting models around.

TEST RESULTS

Size (height x width x depth)	44 x 24 x 31 cms
Weight	21 kgs
Recommended amplifier power	30-200 watts
Recommended placement	stands close to wall
In room averaged response limits 50Hz-10kHz	+/-4dB
Large room/space LF rolloff (-6dB ref midband)	28Hz
Large room/wall LF rolloff (-6dB ref midband)	28Hz
Small room LF rolloff (-6dB ref midband)	32Hz
Large room output at 20Hz (ref midband)	-10dB
Estimated midrange sensitivity (ref 2.83V, 1m)	82dB
Impedance characteristic (ease of drive)	fairly good
Typical price per pair (inc VAT)	£1,320

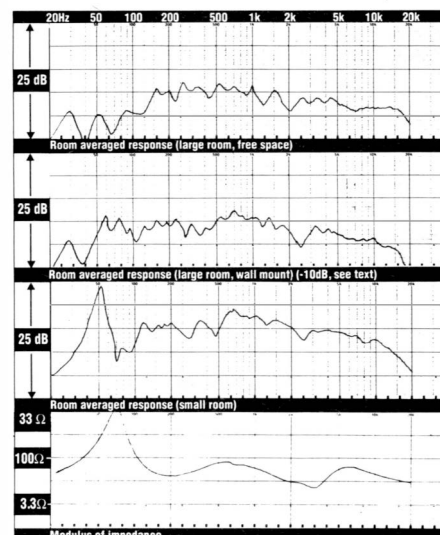

Audioplan Kontra-Punkt **R**ecommended

THE MUSICAL DESIGN COMPANY, PO BOX 13, LONDON E18 1EG.
TEL: (0268) 590789.

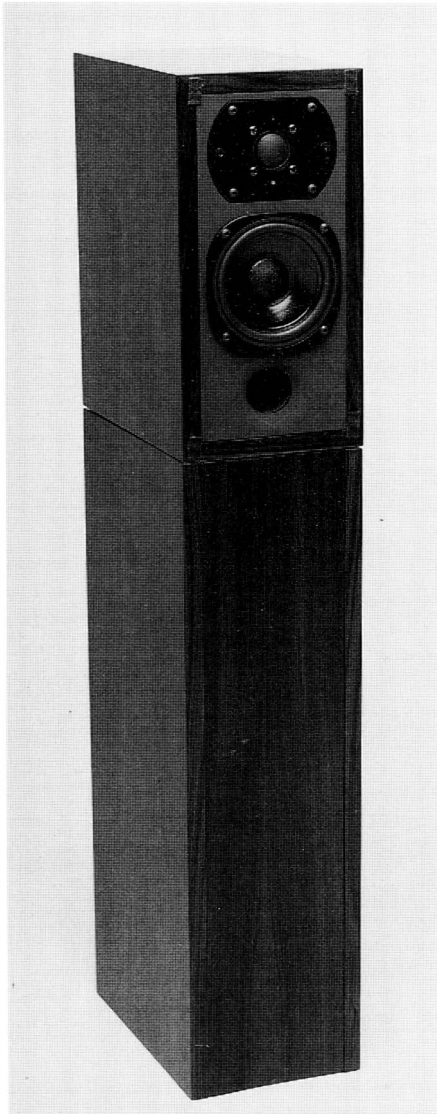

I have to admit to knowing little or nothing of Audioplan, though the fact that it's West German is pretty obvious from the name *Kontra-Punkt*, which presumably translates as the musical term counterpoint. However, I gather it's a small family company which takes as much pride in the finish and presentation of its product as it does over the sound quality. UK distribution is by the same group responsible for Linx electronics.

Certainly the *Kontra-Punkt* and its aesthetically well matched stands is one of the prettiest loudspeakers I've come across, though it's also one of the smallest, and far from inexpensive at £800 (including stands).

The photograph can probably do a better job than I at describing the unusual combination of stand and speaker. Visually the stand is an extension of the speaker – or vice versa. The

nice touch is the way top quality veneers are used and matched between enclosure and stand, and between the pair. Which makes a very pleasant change from cluttering up the lounge with ironmongery.

The stand has spikes at the bottom to connect to the floor, and sockethead screws set into its top surface to accept the similar spikes coming down from the speaker itself. It's also full of sand, or some other heavy damping material.

The speaker itself is absolutely tiny, a factor which is bound to restrict performance significantly, but which will also help minimise cabinet coloration and promote stereo imaging. It's reflex loaded by a little shaped port set into the grey front baffle. There is a rather silly little stick-on grille, but you're not really expected to use it, so I didn't.

The main driver has a tiny little cone just 80mm across, made of lightly doped paper. It also has a hefty magnet and a neat cast frame, but could have been more tightly secured by the little machinehead bolts. The tweeter is a 25mm soft dome of conventional appearance. The baffle is 19mm MDF, but the sides are nearer 24mm thick, some of which at least appears to be damping material. Inside the *Kontra-Punkt*s the units are wired using massive cables but the crossover is invisible, encapsulated in a brick of damping material nearly 4cm deep that covers most of the back panel; thick felt loosely lines the walls.

Test Report

Miniature loudspeakers tend to have limited bass extension or sensitivity. The *Kontra-Punkt* has both. Do use a powerful amplifier and don't expect shattering loudness or floor shaking bass: such histrionics lie well outside the performance envelope of this tiny transducer. Even in the listening room there's little output below 50Hz, and wall mounting is unlikely to offer any real assistance. The traces confirm that the *Kontra-Punkt* is best used away from the wall, in order to avoid a 75Hz 'bump' and to obtain maximum smoothness elsewhere too.

Much of the midband is impressively smooth, and the crossover transition seems pretty well handled, albeit with some loss of output in the presence region. Though the impedance is moderate enough through most of the power band, it drops quite seriously at high frequencies, which may place a premium on amplifier stability.

Sound Quality

The good news from the listening tests is that the *Kontra-Punkt* sounds a lot prettier than its name, and nearly as sweet as its looks. Notwithstanding miniature dimensions and free space sitting – nor the strength of the competition – it well deserves its comfortable top ten placing.

At the end of the day it is no great achiever, excelling nowhere save minimalism. But it remains unfailingly jaunty and pleasant, with ample detail and little or no vices bar a slightly 'dark' and recessed balance and a certain gutlessness. Leading edge definition could be sharper and bass could certainly be both faster and deeper.

Conclusions

Simply by winning the beauty contest outright (after penalties), the *Kontra-Punkt* deserves a Recommended flag. Obviously it's no great bargain, and suffers all the usual performance constraints of a miniature. But it's engagingly musical in its own little way, and that's what really matters.

TEST RESULTS

Size (height x width x depth)	31 x 24 x 13 cms (stand 57 cms)
Weight	7 kgs
Recommended amplifier power	25-70 watts
Recommended placement	matching stands in free space
In room averaged response limits 50Hz-10kHz	+/-5db
Large room/space LF rolloff (-6dB ref midband)	48Hz
Large room/wall LF rolloff (-6dB ref midband)	45Hz
Small room LF rolloff (-6dB ref midband)	45Hz
Large room output at 20Hz (ref midband)	<20dB
Estimated midrange sensitivity (ref 2.83V, 1m)	83dB
Impedance characteristic (ease of drive)	tricky at HF
Typical price per pair (inc VAT)	£799

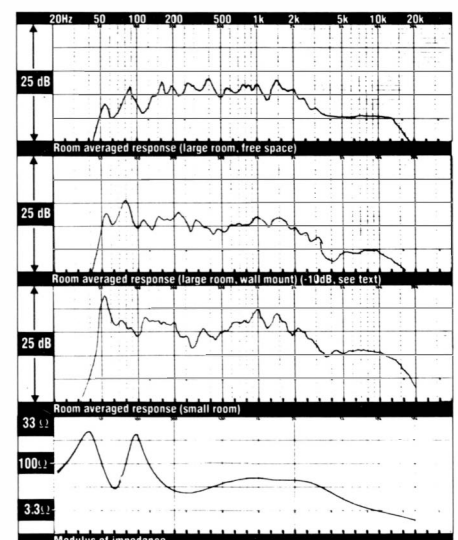

Bose 901 Mk VI

BOSE UK LTD, TRINITY TRADING EST, MILTON REGIS,
SITTINGBOURNE, KENT. TEL: (0795) 475341.



Few loudspeakers are more controversial than the direct/reflect Bose 901, and now that it has reached MkVI status few have been around as long or been as commercially successful.

The whole issue of direct/reflect and omnidirectional loudspeakers as a breed has generated considerable argument and criticism in the UK. To do the debate full justice would take pages. The Bose contention is that most of the sound of a live performance reaches the listener after reflection from the walls, ceiling and floor of the concert hall, club or whatever. The 901 seeks to mimic this by pointing eight ninths of its output away from the listener, but this is a philosophical non sequitur that doesn't really stand up to close scrutiny. (See unspecified future feature. . .)

Conceptually the 901 is from the same background and era as the 300 series models, though it's much more radical and expensive in concept and execution than the 305 Recommended last June. The enclosure is very compact considering the £1,600 price tag, and rather unusually shaped too, but that's only the start. The box contains no fewer than nine small identical drive units, eight of which face backwards towards the rear and side walls of the listening room. Free space siting is mandatory.

Much of the enclosure surface is taken up with drivers, covered by a fixed perforated plastic grille, though top and bottom plates are vinyl woodgrain. The inside is a complex moulded plastic matrix, complete with turbine-shaped reflex ports. Even the paper cone driver frames are moulded plastics, each held by just three little bolts.

All these drivers are used full range,

so this is an active drive system. However, considerable equalisation is necessary to generate anything like a flat response. To do so with a passive network would waste lots of power, so instead each pair of 901s is only sold with a mains powered active equaliser, which is connected between pre- and power amplifier or in a spare tape deck in/output. Besides saving amplifier headroom, this approach provides extra tone control flexibility.

Test Report

Sensitivity is not really appropriate to an active system, but the raw unequalised level is a very high 92dB in the midband (150Hz-1kHz); the equaliser boosts both bass and treble up to match, so the system goes very loud, aided by almost unlimited power handling and an easy impedance.

The (equalised) response is impressively well balanced across the bulk of the audio band, 150Hz-10kHz, albeit with a rather ragged unevenness. Above 10kHz the output dies rather sharply, while the bass from 30Hz-150Hz is clearly too strong at the normal setting, though better at the reduced setting, and cuts off rapidly below 30Hz. The dotted line on our RAR graph shows the bass EQ change.

Sound Quality

The active equaliser doesn't integrate easily with my normal hi-fi system, so 'blind' auditioning was impossible. The following comments are therefore based on sighted listening, and some prejudice is inevitable.

Clearly too heavy with bass button 'out', it's also slightly bandlimited and

boomy with it in. The direct/reflect approach seems to give a nice stability of the stereo image, but the price is extracted in vague focus and loss of precision. Individual reactions to this trade-off vary, so prospective purchasers should check it out for themselves. The sound is mighty impressive, and goes very loud, but the music is less well served. Bose's *Pedestal* stands sounded confused and coloured so Linn *Kan* stands were successfully used for backup listening.

The lack of cabinet coloration is refreshing, the 901 sounding quite quick in consequence, though the reflective approach increases the influence of room colour. However, there's a fundamental indelicacy that acts as a barrier to real musical involvement. The treble sounds weird, lacking timing and transparency. There's a mechanical quality too: people seem to become cardboard cutouts, percussionists turn into drum machines. The sound finds difficulty in conveying a convincing musical argument, as the flow is distracted by turbulent timing.

Conclusions

The *Active Equaliser* approach enables the 901 MkVI to deliver remarkably high levels across a near full bandwidth from a very compact enclosure, even when using low powered amplifiers. Ideal for generating disco levels at a party, a high price is extracted in lost musical subtleties.

TEST RESULTS

Size (height x width x depth)	33 x 54 x 32 cms
Weight	16 kgs
Recommended amplifier power	15-250 watts
Recommended placement	rigid stands in free space
In room averaged response limits 50Hz-10kHz	+/-7db
Large room/space LF rolloff (-6dB ref midband)	28Hz
Large room output at 20Hz (ref midband)	-16/-26dB (both settings)
Estimated midrange sensitivity (ref 2.83V, 1m)	n/a
Impedance characteristic (ease of drive)	very good
Typical price per pair (inc VAT)	£1600

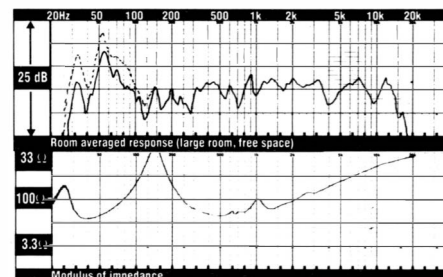



UNVEILED ON STAND 18 (GROUND FLOOR)
THE HI-FI SHOW, HEATHROW, PENTA HOTEL
13th - 16th SEPTEMBER

*If you can't be there please write or
telephone for your new 1990 brochure.*

TARGET
AUDIO
PRODUCTS LTD

Units 3&4 Townsend Centre,
Blackburn Road, Houghton Regis,
Dunstable LU5 5BG
Tel: (0582) 472037
Fax: (0582) 472039

THE SPECIALIST SPEAKER STAND & EQUIPMENT RACK MANUFACTURER

Back Issues

All the issues you wish you'd never missed. Here's how to order back numbers and binders for your copies of Hi-Fi Choice.

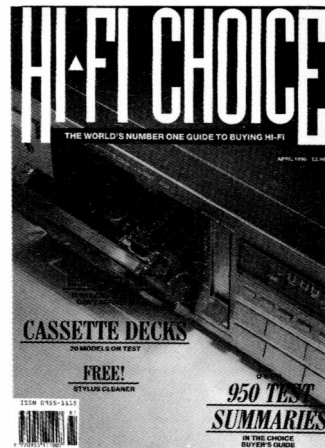
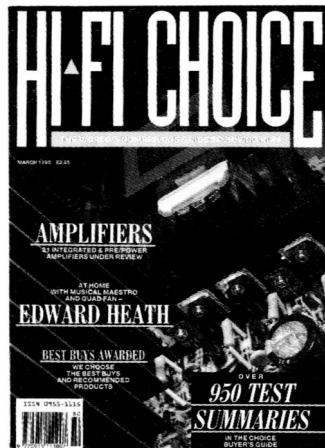
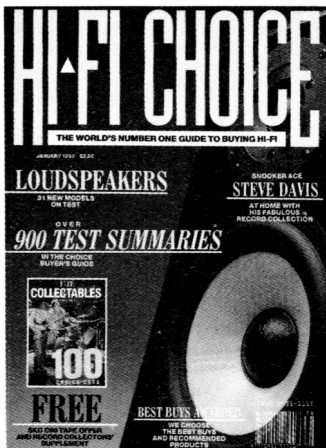

TO ORDER BACK ISSUES: Please tick those you require

- Oct 88 CASSETTE DECKS (63)
Also includes: Valve amplifiers
Plus: Headphones
- Nov 88 COMPACT DISC PLAYERS (64) (with free CD)
Also includes: Digital amplifiers
Plus: Loudspeaker cables
- Dec 88 CD MIDI SYSTEMS (65)
Also includes: Floor standing loudspeakers
Plus: Tuners
- March 89 AMPLIFIERS (68)
Also includes: Loudspeakers
Plus: High-end in-car audio
- April 89 CASSETTE DECKS (69)
Also includes: Cassette tapes
Plus: Tweaking tactics
- May 89 CD PLAYERS (70)
Also includes: Satellite and subwoofer loudspeakers
Plus: Receivers
- June 89 LOUDSPEAKERS (71) (with free speaker supplement)
Also includes: Hi-fi VCRs
Plus: Radio Caroline
- July 89 THE COLLECTION (72) (with free Rock supplement)
Includes: Reviews of state of the art equipment
Plus: High end Aspirations
- Aug 89 SEPARATE SYSTEMS (73) (with free cable labels)
Also includes: Yuppie Blasters
Plus: Studer C37 rebuild, part one
- Sept 89 AMPLIFIERS (74) (with free Jazz supplement)
Also includes: Miniature loudspeakers
Plus: Focus on CD testing
- Dec 89 CD MIDI SYSTEMS (77)
Also includes: Valve amplifiers
Plus: Multi-bit and bitstream DAC technology explained
- Jan 90 LOUDSPEAKERS (78) (with free Collectables supp.)
Also includes: Personal Cassettes
Plus: Valve amplifiers
- Feb 90 TURNTABLES AND TONEARMS (79)
Also includes: Dolby Pro-Logic explained
Plus: Focus On Ortofon MC3000MkII
- Mar 90 AMPLIFIERS (80)
Also includes: Tweaking ideas
Plus: Statements . . . on the High-end
- Apr 90 CASSETTE DECKS (81)
Also includes: Free stylus cleaner
Plus: Focus On recordable CD

- May 90 LOUDSPEAKERS (82)
Also includes: Free Classical music supplement
Plus: An alternative approach to cartridge mounting
- June 90 CD PLAYERS (83)
Also includes: Free cables, tables & stands supplement
Plus: Statements on the Naim NAC52 preamp
- July 90 SYSTEMS (84)
Also includes: Free Rock music supplement
Plus: Moving coil cartridges
- Aug 90 AMPLIFIERS (85)
Also includes: Free Classical records supplement
Plus: Magnetic cartridges
- Sept 90 LOUDSPEAKERS (86)
Also includes: Free NICAM TV/VCR supplement
Plus: A visit to La Maison de L'audiophile in Paris

COMING SOON

- Oct 90 CASSETTE DECKS (87)
- Nov 90 CD PLAYERS (88)
- Dec 90 CD MIDI SYSTEMS (89)

Individual issues including postage and packing: UK £3.50, rest of the world £4.25 (air service)

TO ORDER BINDERS:

Keep your copies of *Hi-Fi Choice* in prime condition with our 8-issue binder finished in black and gold. £5.95 (UK), £7.95 (air service) inc. postage and packing

PAYMENT

- I enclose my cheque/Post Order made payable to *Dennis Publishing Ltd.*
- Please charge my Access/Visa (delete as appropriate)

Credit card number _____ Expiry date _____

Signature _____

Name _____

Address _____

Postcode _____

(86) Please send order form and payment to: **Hi-Fi Choice, Mail Order, P.O. Box 320, London N21 2NB.**

Bigger... Better... Hafler!



“very impressive specification . . . the XL600 can be unreservedly recommended.”

GRAMOPHONE
SEPT. 1989

“IT WAS DIFFICULT NOT TO BE IMPRESSED... A CONSIDERED BLEND OF FLEXIBILITY, GOOD SOUND AND VALUE FOR MONEY”

New Hi-Fi Sound
June 1989

“this amplifier does indeed represent fine value, while the big and very natural sound quality must surely place it near the top of any enthusiast's shopping list...highly recommended.”

HI-FI CHOICE
September 1989

“Superb bass control, very high power output capability, modest price ... the XL600 represents impressive value for money.”

WHICH COMPACT
DISC April 1989

Applying the recognised success of the Hafler XL280 amplifier which has a truly linear transfer characteristic, the new XL600 heralds a new era of affordable high powered accuracy. It has already won wide acclaim amongst press and public alike.

From its gold plated input and output jacks to its relay-protected output, which exceeds 1000 watts mono and 360 watts

per channel stereo into 8 ohms, this is an amplifier to be compared by any standards with the most expensive alternatives. Audition the XL600 at your nearest Hafler dealer soon.

Hafler

HW International, 3-5 Eden Grove, London N7 8EQ.
Tel: 071-607 2717

To: HW International, 3-5 Eden Grove, London N7 8EQ. Please send me details of the Hafler Range.

Name _____

Address _____

Post code _____

Boston Acoustics A120

Recommended

BOSTON ACOUSTICS, 2 BALFOUR COTTAGES, BURCOT, ABINGDON, OXON. OX14 3DR. TEL: (086730) 7331.



One of America's leading specialist loudspeaker brands, Boston probably has enough to cope with in satisfying demand in hi-fi's largest marketplace to worry overmuch about exporting speakers to the UK. The brand has been available in Britain for several years, but until recently this availability consisted of little more than the singleton A40 model – one of America's favorite budget bookshelf designs, but inevitably price handicapped by overseas manufacture and shipping compared to UK contenders.

Things may be changing, however. Following the appointment of a new distributor, *Choice* received a large yet modestly priced floorstanding T830 model for the last group test, which proved a most competent performer. The A120 tested here clearly comes from the same design studios, costs £50 less and is significantly smaller. It doesn't look such obviously good value – but of course looks have remarkably little to do with how a loudspeaker sounds.

Judged on appearance alone, the A120 is something of disaster area. For very good reasons modern loudspeakers tend to be slim and deep; this one's fat and shallow. Modern speakers tend to use two drivers, and this looks like a 3-way (it isn't). And decent quality hi-fi loudspeakers don't fit nasty spring-loaded terminal blocks on the back panel like the ones fitted here. The best thing about the aesthetics is the rather neat plastic frame grille, which uses an artfully chamfered moulding to create minimum interference.

Although nicely rebated, under the cover the driver array looks decidedly like an old fashioned 3-way, with

190mm plastic cone bass, 120mm plastic cone midrange and 25mm soft dome tweeter. The tweeter was screwed home nice and tightly, the mid slightly less so and the bass less so still. But when I popped out the bass unit to have a look inside, it turned out to be a drone cone, or ABR (auxiliary bass radiator), with no magnet or motor. Such a unit acts much like a reflex port, with the advantage of greater design control over mechanical parameters and much larger cross-sectional area (hence lower excursion). The small main driver, on the other hand, has a substantial magnet.

The large box is built up from a high density particle board, with 19mm front baffle and 15mm sides. There's no panel damping, though a brace couples the midpoint of front and back and a horizontal strip stiffens the baffle higher up, between main driver and tweeter. Some loose wadding fills the space behind the main driver only.

Test Report

Sensitivity is above average, uncompromised by a mild impedance characteristic, but power handling is compromised by the excursion of the little main driver. Given the decent enclosure size, it's maybe surprising that the bass isn't a little more extended.

The frequency balances are pretty good overall, especially the important region 150Hz-1kHz, though a bit lumpy here and there too, with some loss of output in the crossover region and a slightly exposed treble. Wall siting is probably better avoided, since the boost in output 50-80Hz is not needed and will probably make the sound a little boomy. The grille may happily be left in

place (sigh of relief), while the best height for listening is round the tweeter axis.

Sound Quality

For the second time in successive editions an unlikely looking loudspeaker from Boston acquitted itself with honors in the blind listening test. The judgement wasn't unanimous, but the aye's came out well on top, praising the lively dynamic qualities and oneness whilst forgiving the mild coarseness.

The big box chips in its share of distortion inevitably, and the bass has something of a 'fool you' quality – a little over-energetic higher up to compensate for the lack of reach. Describing the sound as "a bit scrappy", one listener worried it could become tiring in the long term, while acknowledging the impressive instant appeal.

Conclusions

It may look hideous, but the A120 delivers a sufficiently generous, bighearted and lively sound, at the expense of a few rough edges, to justify confident recommendation.

TEST RESULTS

Size (height x width x depth)	62.5 x 31.5 x 25cms
Weight	12kgs
Recommended amplifier power	10-80watts
Recommended placement	stands in free space
In room averaged response limits 50Hz-10kHz	+/-5db
Large room/space LF rolloff (-6dB ref midband)	48Hz
Large room/wall LF rolloff (-6dB ref midband)	48Hz
Small room LF rolloff (-6dB ref midband)	40Hz
Large room output at 20Hz (ref midband)	<-20dB
Estimated midrange sensitivity (ref 2.83V, 1m)	89dB
Impedance characteristic (ease of drive)	fairly good
Typical price per pair (inc VAT)	£349

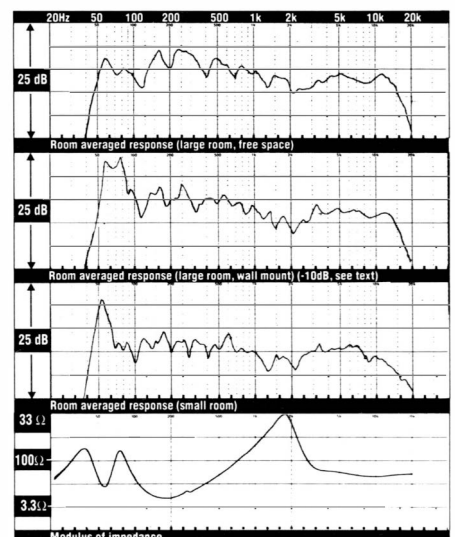



Solo

by HEYBROOK

You won't miss a single note

An exceptional loudspeaker at the remarkable price of £149.00

HEYBROOK _____ *made for music* _____

Heybrook Hi-Fi Ltd., Estover Close, Estover Industrial Estate, Plymouth PL6 7PL.
Tel : 0752 780311. Fax : 0752 793954.

B&W Vision DS2

B&W LOUDSPEAKERS LTD, MARLBOROUGH RD, CHURCHILL IND EST, LANCING, W SUSSEX. TEL: (0903) 750750.



The research facilities down in East Sussex may be the envy of most rivals, enabling B&W to operate right up against the frontiers of loudspeaker technology with state of the art designs. But at the end of the day, and especially as far as the UK market is concerned, the ability of any loudspeaker manufacturer to go on paying the overheads usually comes down to its competitiveness in the under-£150 bookshelf market – the one sector where cost is king and technology tends to represent the unacceptable face of extravagance.

The £150 DS2 tested here is part of a Vision foursome, the cheapest of which was Recommended in *Choice's* last loudspeaker test group. The family resemblance is evident in construction and cosmetics which sail perilously close to the divide between cheap'n'cheerful and cheap'n'nasty, thanks in part to a garish yellow and red stick-on badge on the rear, and in part to the raw chipboard edging around the back panel, which is a pity since the speaker needs to be sited well clear of a rear wall. That aside, the DS2 certainly has a generous size enclosure, albeit fabricated in modest 12mm chipboard. The grille has a plastic moulded frame to minimise its acoustic profile, while the chamfered shape lines up with a similar baffle edging.

The baffle includes a plastic tube reflex port, a 120mm paper cone main driver with generous magnet, and a small (19mm) soft dome tweeter with short horn flare. The outside is finished in normal black vinyl woodgrain print, while foam lines the inside walls. The drivers were properly tightened up with substantial woodscrews, and the printed circuit board crossover uses generously

rated components.

Test Report

Sensitivity is close to the overall market average, though bass is not particularly extended, falling off pretty rapidly below 50Hz. Furthermore the impedance is low, so the partnering amplifier should be capable of delivering good power into 4ohms. Measurement shows that the response is somewhat smoother with the grille removed.

Measured clear of walls the response is pretty well balanced from 70Hz-1kHz, if a bit strong around 300Hz, while there's a clear tendency to exaggerate 50Hz on all traces, which also happens to be the frequency to which the port is tuned. Close-to-wall siting is obviously better avoided for this reason. Although the overall trend above 2kHz is balanced, the response is distinctly up and down, the 8kHz prominence being clear evidence of a lack of tweeter smoothness.

Sound Quality

Although it didn't disgrace itself, the DS2 was undistinguished, doing no more than is expected of a £150 speaker in the listening tests. Later, sighted experiments across a range of some seven different types of stands suggest this B&W is distinctly stand-sensitive, working much better on Heybrook HBS1 and Foundation Fred types than on the others tried – neither of which were used in the blind listening.

Vocals are pretty well handled, but most panelists criticised the rather 'laid back' presence region as being over polite and tending to 'slow' the sound somewhat, while the treble proper is a

shade exposed and inclined to 'splash'.

Though it lacks the extension to create genuine scale and weight, the bass balance is clearly on the heavy side, especially when placed close to a rear wall. Even out in space there is a certain murky and 'thickened' bass quality that inhibits communication and pace, and is probably the cabinetwork making its contribution. Indeed, at low levels the sound quality is rather more appealing than when the speaker is being required to work hard for its living.

Conclusions

On the basis of our test programme the Vision DS2 is a respectable but rather prosaic performer for its price. The measurements provide grounds for criticism, in both driver integration at crossover and the somewhat unruly bottom end, both factors that received comment during the listening tests. Although falling short of formal recommendation, careful experiment with stands does show that this model can nevertheless make music that transcends the expectations of the measurements.

TEST RESULTS

Size (height x width x depth)	50 x 24 x 25 cms
Weight	6 kgs
Recommended amplifier power	10-60 watts
Recommended placement	stands in free space
In room averaged response limits 50Hz-10kHz	+/-8db
Large room/space LF rolloff (-6dB ref midband)	43Hz
Large room/wall LF rolloff (-6dB ref midband)	42Hz
Small room LF rolloff (-6dB ref midband)	35Hz
Large room output at 20Hz (ref midband)	<-20dB
Estimated midrange sensitivity (ref 2.83V, 1m)	89dB
Impedance characteristic (ease of drive)	current hungry
Typical price per pair (inc VAT)	£150

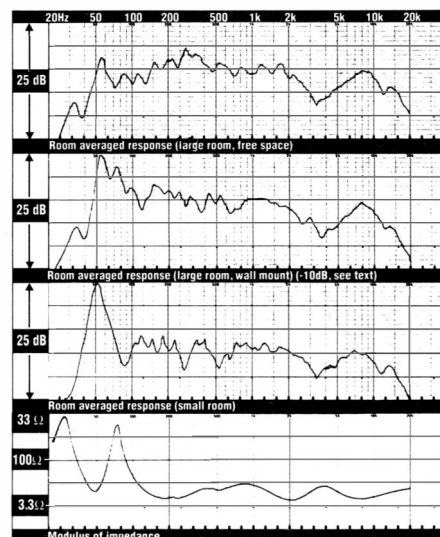

Cyrus 781

MISSION ELECTRONICS, STONEHILL, HUNTINGDON, CAMBS.,
PE18 6ED TEL: (0480) 52777.

Recommended



It's not so long ago that I reviewed the Cyrus 781. It didn't do badly, but didn't do sensationally well either. It hasn't apparently changed to any significant degree, but Mission was convinced that I had underestimated the capabilities of one of the company's own favourites, feasibly because the review samples had never achieved a full potential which is only realised after extensive running in.

As the review unfolds it seems quite possible that may indeed have been the case. The whole business of running in is poorly researched and understood, though certainly some designs do change more noticeably than others, especially during the first few weeks of use. This places the reviewer in a difficult position, especially the *Hi-Fi Choice* loudspeaker reviewer who is dealing with a couple of dozen models.

Ideally of course loudspeakers shouldn't need running in, and as far as I'm concerned, it's got to be up to the manufacturer/distributor to ensure that any necessary running in is already carried out before submission. But Mission managed to persuade the editor to give the 781 another try, so I'd better get on with reviewing these new and definitely (?) run in samples.

It's a chunky, compact little bookshelf speaker with the luxury touches and build quality necessary to justify a £250 price – note the substantial 9kg weight. There's also a matching open-frame tripod stand which seems to do the business very well, sonically and aesthetically.

Veneered in real wood, and a pretty, modern looking baffle when the grille is removed, the carcass of the 781 is built up in solid 18mm MDF. Using Mission's

intelligent 'upside down' configuration, the drivers are properly rebated, and as before, both drivers were extremely tightly secured – a regrettably rare phenomenon in my experience. The bi-wire/-amp crossover has good power handling while the grille is an innocuous looking plastic frame affair, of little aesthetic merit, but little acoustic demerit.

Test Report

Although a completely fresh set of measurements was made, these merely serve to confirm the consistency of both Mission's production and our own test programme. Sensitivity is marginally above average and the load reasonably benign, so the decent power handling will allow good levels to be achieved, even with modest amplification.

The in-room traces show a fair amount of unevenness, especially around the crossover region, and a balance which is probably useable against or away from the wall. In practice about a foot from the wall proved ideal in our larger room, but it's important to try out several options, as getting this right is well worthwhile.

Close up measurement implies that the grille is quite useable, if better removed, while the 781 proved unusually tolerant of movement in the vertical plane.

Sound Quality

Twice placed behind the black curtain which is no respecter of reputations, the 781 came up trumps on both occasions, convincing most panel members that they were hearing something significantly larger and more expensive. And

of the two presentations, it did best of all when mounted on the Cyrus stand, which confirms that the people up in Huntingdon actually listen to their products.

Speed and dynamics are the main strengths. Even though there's a lack of a genuine bass extension and a certain amount of mid-bass cabinet honk, the 781 trucks along in a most convincing manner, with a freedom and ability to differentiate tonal variations in the lower octaves that many boxes four times the size might envy.

Toe tapping aside, the mid and treble more than passes muster, reproducing leading edges in a convincing and communicative way and attaining fair transparency despite some congestion and coloration.

Conclusions

I just wish I still had the original, little used review pair from the end of last year, just to see how much difference there really is. Whatever the running in factor, assessed this time around the 781 clearly deserves enthusiastic recommendation.

TEST RESULTS

Size (height x width x depth)	43 x 22.5 x 28cms
Weight	9kgs
Recommended amplifier power	15-70watts
Recommended placement	stands 1ft from wall
In room averaged response limits 50Hz-10kHz	+/-4dB
Large room/space LF rolloff (-6dB ref midband)	45Hz
Large room/wall LF rolloff (-6dB ref midband)	28Hz
Small room LF rolloff (-6dB ref midband)	32Hz
Large room output at 20Hz (ref midband)	<-18dB
Estimated midrange sensitivity (ref 2.83V, 1m)	88dB
Impedance characteristic (ease of drive)	fairly good
Typical price per pair (inc VAT)	£250

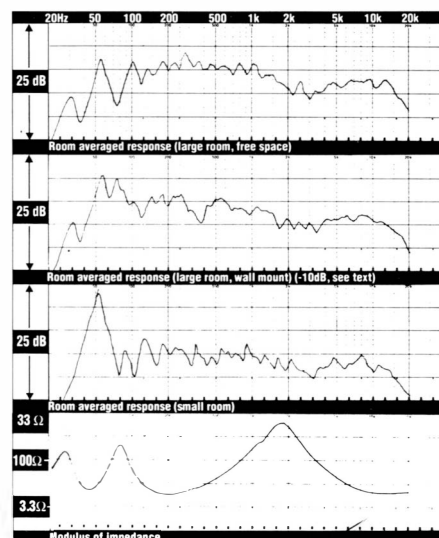

Goodmans M100

Recommended

GOODMANS LOUDSPEAKERS LTD, 1 & 3 RIDGWAY, HAVANT,
HAMPSHIRE PO9 1JS. TEL: (0705) 492777.



Although the 1988/9 *Sterling* range did little to excite either *Hi-Fi Choice* or the marketplace, Goodmans' new *M-series* threesome looks set for better things. Certainly the £100 *M300* proved good value for money in our last loudspeakers group test, and now it's the turn of the baby £79 *M100* to come under scrutiny.

The 'budget miniature' loudspeaker in any manufacturer's range is the model that generates the volume sales – provided of course that the engineers have got the formula right. Goodmans already has one of the market leaders in the successful £89 *Maxim 2*. However, it's a couple of years old now, and is also a singleton model – that is it doesn't form part of a range, all of which the company would like its dealers to stock.

To describe the '100 as a member of the *M series* is to divert attention away from the true nature of this model. Tarded up with grey baffle and cheerful badge it may be, but the *M100* is in fact nothing more nor less than a budget price version of the *Maxim 2*.

So what has Goodmans done in order to shave a tenner off the price of the *Maxim*? The *100* certainly shares the same enclosure, and a similar looking paper cone bass/mid driver and rear tube port too. However, it doesn't weigh as much, 'cos it uses a much smaller magnet. And it doesn't use the neat little Audax tweeter that has formed the basis of more than half the best budget speaker designs of the past decade or so.

In other respects this is very much the familiar *Maxim* mixture: a grille which would be better converted into a fly

swat; a simple but inherently stiff 12mm chipboard box; a hardwired commercial grade crossover mounted inside the terminal block.

Test Report

Sensitivity is comfortably (3dB) below average, and power handling is obviously restricted, so high loudness levels are not part of the *M100's* repertoire. Nor is gut-wrenching bass on the agenda: the port is tuned to 70Hz and in-room output rolls off rapidly below 50Hz. The load is simple enough for even the least capable amplifiers.

The limited engineering budget is clearly seen in the unevenness of the bass/mid driver output, covering the vital region below 1.5kHz in a decidedly lumpy manner. In stark contrast the tweeter has a remarkably smooth and nicely extended response. Wall siting is clearly beneficial in smoothing and extending the region below 150Hz, and the units should be placed on highish stands to place the main axis roughly at ear height for the seated listener. The discontinuity from 1-1.5kHz will certainly add a degree of character to the sound: interestingly, both the *Maxim 2* and TGI stablemate Mordaunt-Short's *MS3.10* show similar traits in this region. The grille is definitely better discarded.

Sound Quality

One might have hoped that the *M100* would repeat the blind listening test successes scored by the two similar models mentioned above, where inherent charm and lively 'bounce' more than compensate for a degree of coloration. However, the results were less kind to

this cheaper model, and direct sighted comparison confirms that the sound quality doesn't match up to those other two cheeky chappies.

Timing and pace are reasonable enough, though there's no real authority or drive to the music, never mind anything much in the way of weight or power. The midrange is pretty communicative, if rather coloured and occasionally fierce, while the treble has a rather relentless quality that tends to emphasise the limitations of compact disc, and which several listeners considered irritating.

Conclusions

The *M100* is not a bad loudspeaker, rather it is an unexceptional one that hovers uncertainly on the dividing line between real hi-fi and just plain audio. That it provides at least half the *Maxim's* charm while saving a tenner is probably sufficient for recommendation, but this endorsement doesn't carry any great enthusiasm here I must admit.

TEST RESULTS

Size (height x width x depth)	20 x 17 x 26 cms
Weight	2.5 kgs
Recommended amplifier power	15-60 watts
Recommended placement	close to rear wall
In room averaged response limits 50Hz-10kHz	+/-5dB
Large room/space LF rolloff (-6dB ref midband)	50Hz
Large room/wall LF rolloff (-6dB ref midband)	50Hz
Small room LF rolloff (-6dB ref midband)	40Hz
Large room output at 20Hz (ref midband)	<-20dB
Estimated midrange sensitivity (ref 2.83V, 1m)	85dB
Impedance characteristic (ease of drive)	very good
Typical price per pair (inc VAT)	£79

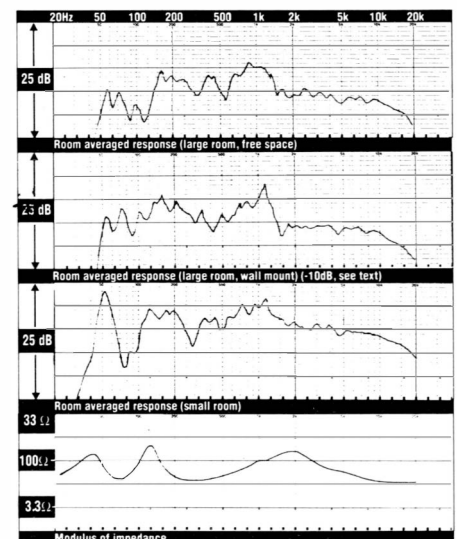

THE FAMOUS FIVE FROM ortofon

Quartz
£119.95



- Higher output moving coil cartridge
- Nude, elliptical stylus
- Aluminium armature
- Powerful magnet assembly
- 0.35mg effective stylus tip mass
- Ortophase technology
- Extruded aluminium housing
- 20-25,000Hz frequency response
- MC amplifier input compatible

Quattro
£179.95

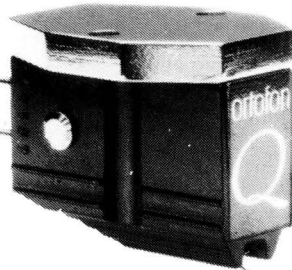

- Higher output moving coil cartridge
- Nude, Fritz Gyger Type II stylus
- Aluminium armature
- Powerful magnet assembly
- 0.50mg effective stylus tip mass
- Ortophase technology
- Ortofon Wide Range Damping System
- Extruded aluminium housing
- 20-40,000Hz frequency response
- MC amplifier input compatible

Quasar
£299.95



- Higher output moving coil cartridge
- Nude, Ortofon Replicant 80 stylus
- Aluminium armature
- Powerful magnet assembly
- 0.30mg effective stylus tip mass
- Ortophase technology
- Ortofon Wide Range Damping System
- Extruded aluminium housing
- 20-40,000Hz frequency response
- MC amplifier input compatible

MC 2000 Mk II
£599.95



- New top-of-the-line cartridge
- Nude, Fritz Gyger Type I stylus
- Lightweight carbon fibre armature
- Neodymium permanent magnet
- 0.25mg effective stylus tip mass
- Ortophase technology
- Aluminiumoxide cartridge housing
- 20-60,000Hz frequency response

MC 3000 MkII
£849.95

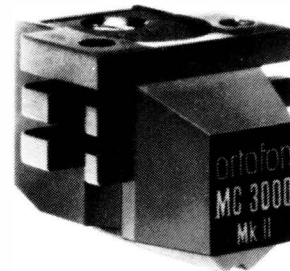

- Nude, Ortofon Replicant 100 stylus
- Lightweight carbon fibre armature
- Neodymium permanent magnet
- 0.25mg effective stylus tip mass
- Ortophase technology
- 5-90,000Hz frequency response



ortofon
KEEPING MUSIC LIVE

ORTOFON UK LTD, 0753 889 949
Chiltern Hill, Chalfont St Peter, Bucks SL9 9UG

Heco Superior 940

ZENONLEC, FOURBURY HOUSE, 36 VICTORIA ROAD, MORTIMER,
NR. READING RG7 3SG. TEL: (0734) 333636.



Since beginning UK distribution a couple of years back, Heco has taken a stake in its agent Zenonlec, and its loudspeakers have been a familiar feature of recent *Choice* test groups. There are two distinct ranges, the cheaper *Interior* models with synthetic cabinet finish, and the luxury finish *Superior* models, such as the imposing £1,000 940 reviewed here – one model down from the top of the line.

It's a tall, slim and classy floorstanding enclosure. Ours came in oak, but a variety of different real wood and lacquer alternatives are also available. The grille looks useable, though it does have a rather thick frame. However, the baffle looks quite pretty with it removed, the area around the well finished drivers being covered in a black flock material.

There are four drive units in total, none of which was tightly secured by spindly little woodscrews (some of

which had already stripped their threading). The main enclosure is divided into two halves horizontally, so each bass driver works within its own sealed box, the lower one being what Heco describes as an 'integrated sub-woofer system' (ISS).

Both bass drivers look identical and are built on square cast frames with doped paper cones some 160mm across; these have an unusual double magnet stator, presumably to ensure magnetic field symmetry. The midrange is handled by a 75mm plastic cone driver, while the tweeter is a 19mm metal dome with a phase compensator that provides a measure of protection.

The enclosure is 22mm MDF, the only bracing being provided by the central divide, while the inside is well stuffed with wadding. Both Heco and Zenonlec have now separately tackled the question of spike coupling, the former with some gold pointed cones with lossy backing, the latter with a small tripod spike-up-and-down frame, codenamed bruTe.

Test Report

Despite its size, the 940 has only about average sensitivity, and is current hungry too, with a resolutely 4ohm Euro impedance tradition. Power handling is unlikely to pose problems, and bass extension is generous.

The responses are impressively smooth across most of the range, especially above 500Hz, though the rising output above 5kHz certainly departs from the UK norm, (it's common enough amongst German designs). Room placement looks tricky. Indeed, neither site in our largish (25 x 15ft) room gives an even balance below 300Hz, and I suspect the 940 would really be happier in a much bigger room still.

Sound Quality

Assisted by bass extension and relative midbass level that is comfortably ahead of the other test group speakers, the 940 turned in a very respectable result on the listening tests. Behind the curtain it actually sounded rather louder than the measured sensitivity would suggest, I suspect because the frequency balance is not dissimilar to the 'loudness' contour that used to be fitted to amplifiers.

Beside the good scale, the main strength is a smooth and transparent midband that sounds particularly good with vocal material. The downside is

that although there's no lack of weight, the bass lacks tautness, authority and timing, following rather than driving the music along. There is also something of a relentless quality about that tweeter, which undoubtedly assists clarity but which I found all too obvious during extended listening.

Conclusions

Probably too 'easy listening' for the hi-fi enthusiast, the 940 has an impressively smooth, open and well integrated midband that alone makes for an enjoyable experience. It's clearly best suited to very large rooms, and will need a correspondingly hefty amplifier.

TEST RESULTS

Size (height x width x depth)	110 x 26 x 31.5 cms
Weight	24 kgs
Recommended amplifier power	15-200 watts
Recommended placement	floor in free space
In room averaged response limits 50Hz-10kHz	+/-6dB
Large room/space LF rolloff (-6dB ref midband)	20Hz
Large room/wall LF rolloff (-6dB ref midband)	20Hz
Small room LF rolloff (-6dB ref midband)	20Hz
Large room output at 20Hz (ref midband)	-6dB
Estimated midrange sensitivity (ref 2.83V, 1m)	88dB
Impedance characteristic (ease of drive)	current hungry
Typical price per pair (inc VAT)	£1,000

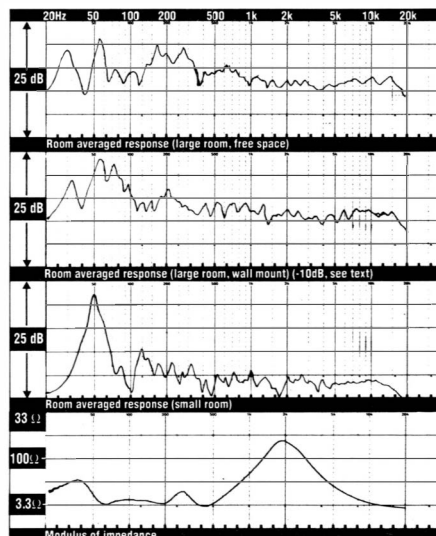

Radlett Audio

"THE GREATEST LITTLE SHOP IN THE COUNTRY"

CONSULTANTS

Maybe it's just an opinion (we're too modest to suggest otherwise), but during our 11 years here we have been told many times by importers, manufacturers and customers, that we are "The best little shop in the country."

Being small has advantages. Without the vast overheads of a large, flashy shop, we can devote as much time as it takes to ensure our customers get the best for their money, whether it's £5 or £5,000. Furthermore, we are all knowledgeable enthusiasts (not salesmen on commission) with no need to push the most profitable lines. And we never rush, hassle or waffle—we like to keep our customers as friends.

Our demonstration studio is furnished as a sitting room, but stocked with one of the finest ranges of Hi-Fi in the country, including the largest selection of valve amps anywhere. Each and every item is ruthlessly chosen for its sound quality, performance, reliability and value. If it's worth having, we probably stock it and would be delighted to demonstrate why. So, give us a ring or drop in—you'll be very glad you did.

We stock fine equipment from:-

LINN PRODUCTS · REGA · PROAC · CROFT · AUDIO RESEARCH · VTL · MENTOR · EAR · ORACLE · QUAD · INFINITY · KOETSU · MERIDIAN · DENON · AUDIOLAB · SD ACOUSTICS · VOYD · J.A. MICHELL · RUARK · ROTEL · CAMBRIDGE AUDIO · CREEK · EPOS · APOGEE · TUBE TECH · MAGNEPAN · MUSICAL FIDELITY · MONITOR AUDIO · ARCAM · SME · ALBARRY · MARANTZ AND JEFF ROWLAND



Radlett Audio Consultants
141 Watling St, Radlett, Herts.

☎ 0923-856497

ALSO AT: Sounds Good,
147b Uxbridge Road
Ealing, London W13 9AU

☎ 081-579 3963

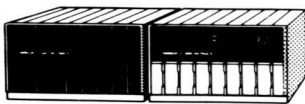

MERIDIAN CD PLAYERS



LINN LP 12

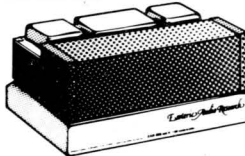

EAR 509 MKII

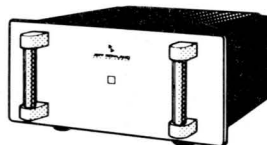

ROWLAND RESEARCH

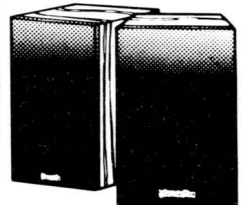

PRO AC TABLETTE

SONY
HI-FI
NEWS
RECORDS & VIEW
DEALER AWARDS
1986 and 1989
WINNER
GREATER LONDON

GRAHAMS HI-FI

“One of the 5
best Hi-Fi shops
in the world.”

High Fidelity magazine, May 1990

Grahams Hi-Fi Ltd. Canonbury Yard 190a New North Road, London N1 7BS. Telephone: 071 226 5500

Come to Canonbury Yard,

where our new purpose-built
premises are situated. and listen

...in one of five air-conditioned
demonstration rooms with probably the
finest hi-fi facilities in Europe, plus lots of
free parking.

Listen and compare selected models from
manufacturers such as Linn, Naim, Rega,
Arcam, Meridian, Creek, Denon, Yamaha,
Nakamichi, Onix, DNM, Royd, etc.

Evaluate systems and products, chosen
with more than 20 years experience, in a
relaxed atmosphere, with the assistance
of helpful, trained staff. Our reputation
has been established by providing the
highest standards of personal service.

We are here to help you.

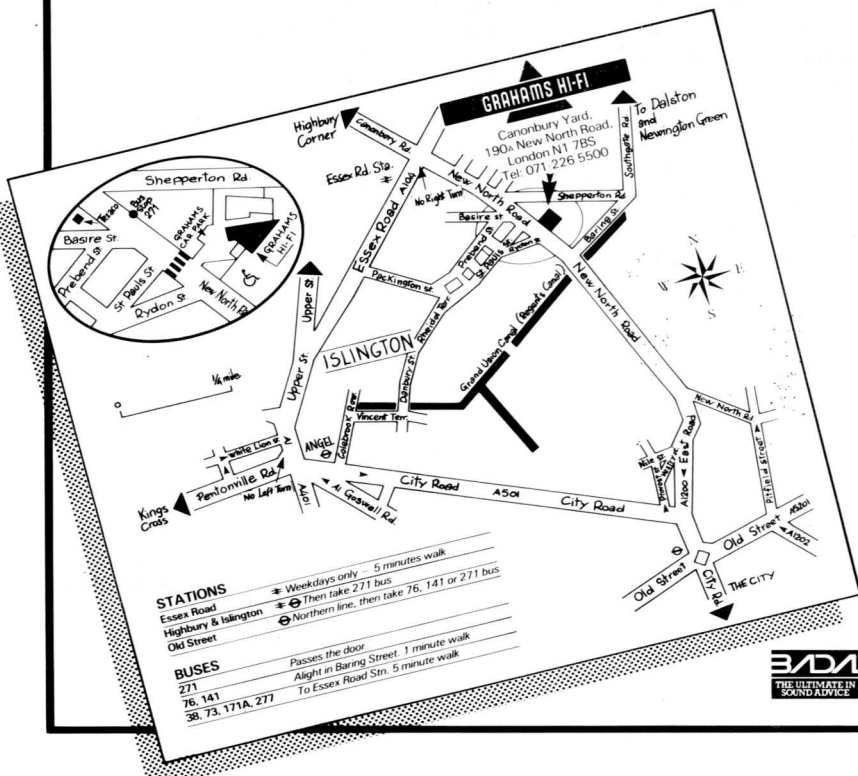

Infinity Modulus

GAMEPATH LTD, 25 HEATHFIELD, STACEY BUSHES, MILTON KEYNES MK12 6HR. TEL: (0908) 317707.



Choice has recently covered several Infinities which could aptly be described as unconventionally conventional, combining normal wooden box cabinets with careful detailing and advanced drive units.

However, the *Modulus* system covered here is a very different package. Very much a luxury 'niche' product, it makes no attempt to provide a box size commensurate with the £695 price tag. Instead it looks like another strong candidate for the upmarket miniature market, which UK brands like Celestion and Acoustic Energy have done so much to create.

In fact the *Modulus* concept is rather more than just a pair of miniature loudspeakers. The *Pedestal* is a dedicated stand that looks almost impressive enough to justify the hefty £200 price. There's also an optional matching subwoofer, actively drive, which adds £1,500 to the total system price.

Alongside the product, I received a 14 page Technical White Paper, not to mention catalogue, owner's manual, and a scattering of letters and press releases. Sadly, a *Hi-Fi Choice* loudspeaker review is roughly 650 words long, so there's little room to cover most of the subtler aspects of this very thorough and thoughtful design.

In its distinctive high tech way this is one of the prettiest little speakers I've seen. The complex enclosure is finished in high gloss black lacquer, and an elaborate moulded grille squares up the cuboid, but the *Modulus* looks so good with its space age structural foam stepped baffle and sci-fi drivers exposed it would be a shame to use it, especially as it doesn't work too well. All feels

reassuringly solid and heavy, though it's actually the least massive of the upmarket miniatures included in this month's batch of loudspeakers.

Finding the drivers impressively well tightened, I made no attempt to dismantle, relying on the brochure description of an extensively braced high density particle board enclosure with damping laminate and wadding. It's a sealed box with bi-wire/-amp terminals. The tweeter is one of Infinity's EMITs (a species of ribbon) while the main bass/mid driver has a tiny 95mm injection moulded cone made of an advanced plastic/carbon fibre composite and fitted with a low hysteresis surround. Controversially, the stand/speaker interface is lossy, so as to decouple the speaker mechanically from the environment.

Test Report

Following the expected pattern for an upmarket miniature, sensitivity is comfortably below average and bass extension somewhat compromised. The impedance will pose no problems for any decent amplifier though loudness capability and power handling must inevitably be excursion limited.

The response trend is impressively smooth across the important midband, from 150Hz up to 2kHz. Below that range bass extension is pretty fair, but the 'stepped' response suggests that some wall reinforcement will be helpful, though this is at variance with Infinity's recommendation and does upset the midband evenness somewhat. The treble balance looks well judged, though there is some loss of output around the crossover point.

Sound Quality

With the black curtain firmly in position, the *Modulus* was presented on three separate occasions, using different stands and positions each time. The overall scoring was virtually identical each time, and was pretty close to the average for the test group, which is something of a disappointment at nearly £700.

Using the *Pedestal* it sounds clean, quick and clear in the midband, if a little thickened lower down. There's a distinct lack of genuine bass extension and authority, and dynamics are rather muted too. Bi-amping helps to a degree, as do changes in stand and position, my favourite being the heavyweight *Foundation Designer* about a foot away from the wall.

Conclusions

Undeniably attractive in the midrange and treble, I never managed to get the *Modulus* to handle the bass end of the spectrum as successfully, despite endless fiddling about – and extensive running in too.

TEST RESULTS

Size (height x width x depth)	30 x 18 x 26 cms
Weight	6 kgs
Recommended amplifier power	20-80 watts
Recommended placement	stands 1ft from wall
In room averaged response limits 50Hz-10kHz	+/- 5dB
Large room/space LF rolloff (-6dB ref midband)	55Hz
Large room/wall LF rolloff (-6dB ref midband)	45Hz
Small room LF rolloff (-6dB ref midband)	38Hz
Large room output at 20Hz (ref midband)	-15dB
Estimated midrange sensitivity (ref 2.83V, 1m)	84dB
Impedance characteristic (ease of drive)	needs good current delivery
Typical price per pair (inc VAT)	£695 (stands £200)

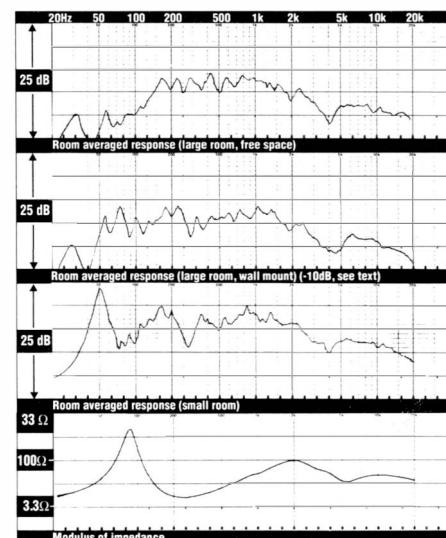

REAL HI-FI IN SOUTH KENSINGTON . . .

The Listening Rooms is one of London's **best specialist Hi-Fi shops**, with the principal staff, John Oliver and Paul Tam, having over **thirty years' experience** between them.

Whether you are thinking of spending £300 or £30,000, our aim is always to give the best possible sound within your budget.

We have **two comfortable Listening Rooms** where you can audition Hi-Fi in a relaxed and friendly atmosphere. We offer a full **installation service** and all equipment comes with a **two year guarantee**.

The Listening Rooms is London's **leading multi-room Hi-Fi specialist** and provides a full planning and installation service.

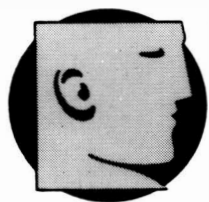

THE **listening**
rooms

LINN · EPOS · QUAD
ARCAM · CELESTION
MUSICAL FIDELITY · SME
MISSION · MERIDIAN
MARTIN LOGAN · VDH
AUDIO RESEARCH · DUAL
MARANTZ · YAMAHA
DENON · NAKAMICHI
ACOUSTIC ENERGY · SD
SONUS FABER · KOETSU
APOGEE · GOLDMUND
CREEK · KISEKI · REVOX
ROGERS · MAGNEPAN
MICHELL · DELTEC · STAX
KRELL · TANNOY · ETC

THE LISTENING ROOMS LTD.,
16+ OLD BROMPTON RD, LONDON, SW5 0LJ.
TEL: 01-244 7750/59. FAX: 01-370 0192.
(0 7 1 - f r o m M a y 6 t h)
VISA ACCESS AMERICAN EXPRESS
EXPORT AND CREDIT FACILITIES
Monday - Saturday - 10am - 6pm
Nearest Tube: Sth Kensington or Gloucester Rd

T H E N A T U R A L C H O I C E

Rogers

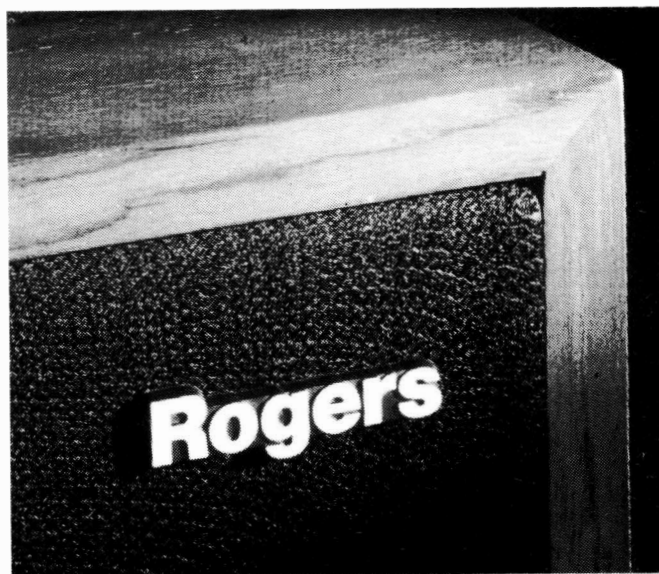

Manufactured by Swisstone Electronics Limited, 310 Commonside East, Mitcham, Surrey CR4 1HX, Tel No: 01 640 2172, Fax No: 01 685 9496, Telex: 893980 Rogers.
Distributed by Audio Influx Corp. N.J. USA, Plurison PQ. Canada, Audio 2000 NSW Australia, Excel Hi Fi Hong Kong, Denco Audio New Zealand, Atlas Hi Fi Singapore.

JBL XPL 90

HARMAN (AUDIO) UK LTD, MILL STREET, SLOUGH, BERKS SL2 5DD.
TEL: (0753) 76911.



Certainly one of the best known speaker brands around, JBL has always typified the West Coast US approach to loudspeaker design. There are sufficient models in its lineup to get even the importer a little confused: that which concerns us here is an upmarket, small – yet at 9kg decidedly heavy – ‘bookshelf’ model of unusual shape, christened *XPL 90* and yours for a little less than £700.

In a test group which seems to be crammed with new ‘luxury miniatures’, it’s interesting to contrast the JBL approach. This doesn’t go as far as some down the road to miniaturisation, and seems to take normal traditional good engineering practice and then over-engineer it – which should not be taken to imply criticism.

The drivers are both state-of-the-art engineering and technology, the tweeter being a variation on JBL’s proprietary pleated titanium dome, firmly screwed in place. The bass/mid driver has a massive magnet, a chunky cast chassis and a small 115mm plastic cone within a generous surround. It was less well tightened, with rather coarse pitch woodscrews. The crossover is pretty substantial too, and internal wiring uses Monster Cable, but with tag connections to the drivers.

Even more engineering has gone into the cabinetwork. Tree wood or some such is obligatory at this price, and that used in the *90* is very nicely figured indeed. The enclosure itself has an irregular plan shape based on a hexagon, fairly wide at the front, though narrowed by heavy chamfering either side of the drivers, then tapering towards a continuously curving rear, which accommodates a chunky pair of termi-

nals and a reflex port tube.

Light damping felt covers all internal faces, which seem to be 19mm MDF for the main carcass, while sections of the stepped baffle are up to 46mm thick! The stepping enables relative adjustment of time delay between the drivers, the whole thing is covered in a damping foam and then covered by a clever moulded grille which preserves the smooth vertical front.

Test Report

Luxury miniatures usually have below average sensitivity, assuming that those spending £699 on a pair of loudspeakers will not be looking to drive them with a budget amplifier. This JBL comes in at 85dB, which is better than many but still comfortably below average. Bass extension is sharply curtailed below 50Hz too, which won’t help create a full scale soundstage, but will restrain excursion and in turn promote power handling and hence loudness capability.

The balance is pretty good overall, though 55Hz seems to stand out rather prominently on all traces, and is rather too strong irrespective of siting, so experimentation is probably the best way of achieving optimum results. The traces show sufficient unevenness to introduce a degree of coloration and character, while the mid treble, c6-7kHz, is a shade prominent. The grille is actually better left off, while the best response is obtained at or just around the tweeter axis.

Sound Quality

The panel showed some confusion and differences of opinion; indeed, my own notes from the listening test remind me

that I found the *XPL90* rather perplexing. I still do, and can’t really put my finger on the problem. It somehow manages to sound both quick and dynamic yet boxy and overhung at the same time, which is a bit close to a contradiction in terms.

Moving the boxes around from stand to stand, varying height and wall proximity still left a feeling of unease underlying a cosmetically quite appealing sound. Dynamics are impressive, and unusually high levels are available from this very compact box thanks to the generous power handling. But room and stand matching both seem problematic, the low frequency ‘corner’ remaining audible and somewhat intrusive.

Conclusions

Though undoubtedly pretty and very elaborately engineered, the *XPL90* didn’t really convince the majority of our listeners that it was capable of delivering the sound quality to match its elevated price.

TEST RESULTS

Size (height x width x depth)	39.5 x 24 x 24 cms
Weight	9 kgs
Recommended amplifier power	20-100 watts
Recommended placement	stands in free space
In room averaged response limits 50Hz-10kHz	+/-7db
Large room/space LF rolloff (-6dB ref midband)	45Hz
Large room/wall LF rolloff (-6dB ref midband)	45Hz
Small room LF rolloff (-6dB ref midband)	35Hz
Large room output at 20Hz (ref midband)	<-20dB
Estimated midrange sensitivity (ref 2.83V, 1m)	85dB
Impedance characteristic (ease of drive)	good
Typical price per pair (inc VAT)	£699

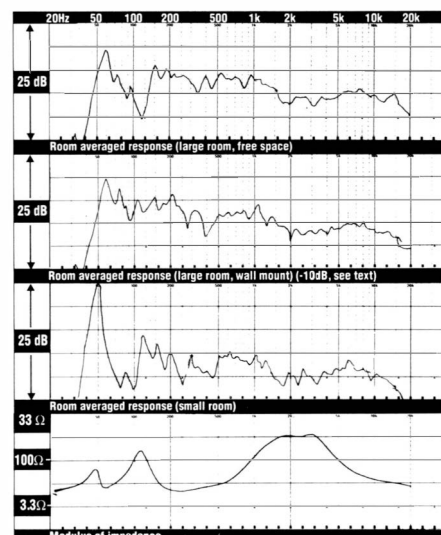

THIRTY YEARS OF HI-FI CHOICE

In this issue you find reviewed a collection of exciting new products.

Most of them, and, indeed, the best of their rivals, you will find at Doug Brady Hi-Fi.

We believe in giving our clients the widest choice of high quality equipment.

For example you can hear the best of C.D. compared with the best of analogue. (e.g. Linn, Alphason, Gyrodek, & Roksan and Pink Triangle!).

You are the reviewer! What suits your ears, what fits your budget is yours to decide. After all, the menu card is no substitute for the meal, performance figures are no substitute for driving the car, and the review is no substitute hearing the equipment you want to test via your own ears.

The specification is irrelevant - what matters is how well the illusion of the original recorded performance can be recreated.

So close your eyes, open your ears and make your hi-fi choice at Doug Brady Hi-Fi. We have systems from £500 to £50,000, a 2 year guarantee, and after 30 years we are still a friendly family business.

Doug Brady Hi-Fi

14/18 Monmouth Street,
Covent Garden,
London WC2H 9HB
(071) 379 4010
Fax: (071) 497 9205
Open seven days.

Kingsway Studios,
Kingsway North,
Warrington, Cheshire.
(0926) 828009
Fax: (0925) 825773
Open six days

401 Smithdown Road,
Liverpool L15 3JJ.
(051) 733 6859
Closed on Wednesday.



Brady's for a greater musical choice

AUDIO CHOICES

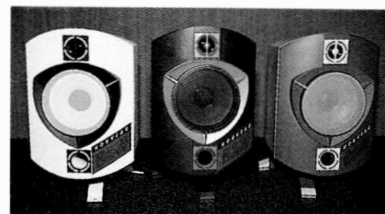

B&W NEW SPEAKERS

We stock:
Marantz, A&R,
Musical Fidelity,
S D Acoustics, Rotel,
Audio Technica,
Ruark, Roksan, Moth,
Nakamichi, B&W,
Van den Hul, Dual,
Pink Triangle, Allison
Acoustics...

This is a friendly Hi Fi Shop.
Demonstration room & home
demonstrations within the
M25 area.

AUDIO CHOICES
66 HIGH ROAD,
LEYTONSTONE,
STRATFORD E15
TEL NO: 081-534 6987

OPENING HOURS
10.30 - 7.30

JRT AD1

JRT ACOUSTIC DESIGN, 13 LONG MEADOW WORKS, THREE LEGGED CROSS, WIMBORNE, DORSET BH21 6RD. TEL: (0202) 826474.



I was introduced only recently to JRT loudspeakers, by Cliff Stone of Foundation Audio fame, who happened to have a pair of miniatures in his car on the day he brought some speaker stands down. I took down the telephone number of one Julian Taylor, and duly invited him to send in a loudspeaker for the next *Choice* tests. The expected pair of miniatures didn't turn up. Instead three fairly bulky and heavy cartons appeared, comprising a pair of decent size loudspeakers and flat-pack open frame stands to match them.

I wouldn't go so far as to call the £500 AD1 a large loudspeaker – by the standards of ten or twenty years ago it's quite compact. But it's as big or bigger than most in this month's test group, and certainly isn't going to melt into the background amongst the room furnishings. So it's just as well that JRT has had the good sense to specify a top quality real wood veneer on all six faces: our samples were aesthetically superb, apart perhaps from the odd looking clear see-through cone of the main driver, and the alternative of a nondescript grille with a very thick frame. The stands look pretty neat and effective – and are quite reasonably priced at £95.

At 3.4kg/£100 and with classy finish, the AD1 is clearly pretty good material value. It's a 2-way reflex enclosure, close to classic BBC monitor size and proportions – just a little deeper and narrower. The foam-lined cabinet walls are 18mm MDF, stiffened by two horizontal braces above and below the main driver. Neither driver had particularly tight screws, but short of taking a hammer and chisel to the task I was completely unable to remove either, so

maybe they're glued in as well. The main driver uses a 155mm transparent plastic (TPX) cone and a very strong cast frame, while the tweeter is a titanium coated 25mm soft dome type.

Test Report

To some extent the AD1 doesn't really take advantage of its relatively generous box size since sensitivity is a little below average and bass extension is nothing special. Power handling is pretty good, and the amplifier load is very kind.

The large room traces show how effectively the response has been tailored for optimum results when mounted close to a rear wall. Under these design conditions the overall frequency balance is fine: apart from a slight dip around 500Hz, the whole range from 40Hz up to 2kHz is impressively flat, though things become a little uneven thereafter and the treble looks rather prominent and exposed.

Sound Quality

Presented twice to our blind listening panel, the AD1 distinguished itself, especially on its own stand (it was also tried on the heavyweight AE3 stand). It has at least its fair share of cosmetic deficiencies, but these do little to spoil the impressive coherence and timing that makes listening to the AD1 so enjoyable.

Lacking in genuine weight and authority and also a little on the dry side, the bass nevertheless has a jaunty 'bouncy' quality with good freedom and timing. "Very analogue . . . very musical" were the words of one panelist (who also found it a bit honky). Another summarised: "Lacks real welly and can

Recommended

be a bit relentless, but coherent, fast and together". Dynamic shading is unusually convincing, and the feeling that there are real people over there making music comes across strongly.

Conclusions

This loudspeaker is remarkably good value for money, and must be strongly Recommended. (Buy the matching stands, but throw the grilles away.)

TEST RESULTS

Size (height x width x depth)	59.5 x 28 x 36 cms
Weight	17 kgs
Recommended amplifier power	15-100 watts
Recommended placement	own stands close to rear wall
In room averaged response limits 50Hz-10kHz	+/-4dB
Large room/space LF rolloff (-6dB ref midband)	30Hz
Large room/wall LF rolloff (-6dB ref midband)	28Hz
Small room LF rolloff (-6dB ref midband)	35Hz
Large room output at 20Hz (ref midband)	-14dB
Estimated midrange sensitivity (ref 2.83V, 1m)	86dB
Impedance characteristic (ease of drive)	very good
Typical price per pair (inc VAT)	£500 (stands £100)

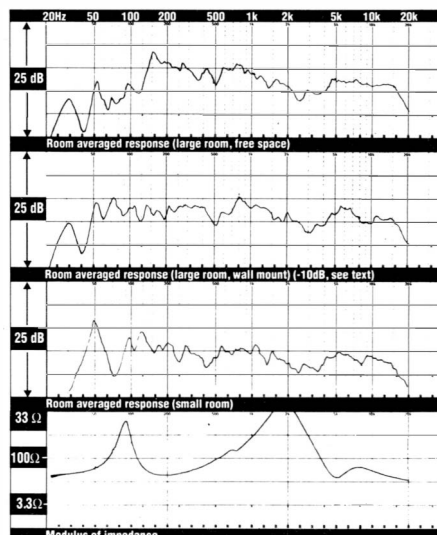

KEF C45

KEF ELECTRONICS LTD, TOVIL, MAIDSTONE, KENT ME15 6QP.
TEL: (0622) 672261.

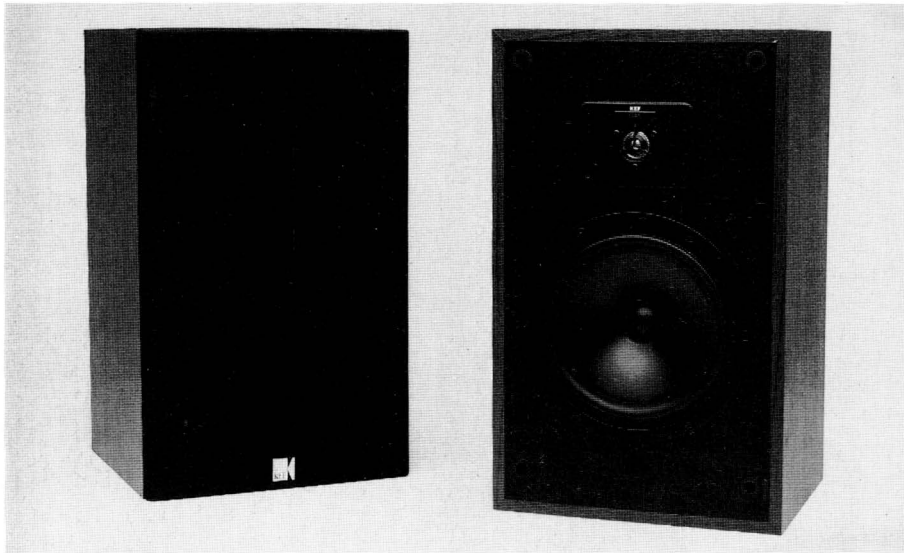

KEF Manufactures two distinct ranges of domestic hi-fi loudspeakers. The *Reference* models feature the very latest technologies irrespective of cost, while the *C-series* is aimed at the popular price points that exist in the marketplace.

That doesn't exclude the Cs from offering radical solutions – the very clever *Uni-Q* co-axial driver was introduced for the first time in the larger models of the current Cs. But C can also stand for conventional, and the new £199 C45 reflects the conservative streak in many purchasers. For every customer who perceives the advantages of *Uni-Q*, another worries that he's only getting one driver instead of two.

In many senses C45 is the same basic package as that which has formed the foundation of KEF's success over more than a generation. The combination of a large (155mm cone) plastic cone main driver in a substantial, bluff shaped bookshelf box has been around since the *Celeste* and its successors. Bringing the concept firmly up to date, C45 uses a complex metal dome tweeter and features a split crossover with double terminals for bi-wiring.

It's a sealed box, and the discovery that the main driver was mounted using 'lossy' washers that decouple it mechanically from the enclosure made its removal for further internal examination unwise. This is a controversial technique that KEF uses in a number of models: it certainly reduces and controls the vibration fed into the large radiating area represented by the enclosure, but it also significantly reduces the mass loading represented by the driver stator.

The tweeter is firmly fixed, and could therefore be removed to reveal that the

box is stuffed to the gills with damping material, rendering further inspection almost impossible, save to note that the baffle is 18mm chipboard. Styling is rather anonymous, with or without the neatly shaped plastic framed grille. Both front and back panels are covered in black textured plastic, while the wrap and picture frame is a wood print vinyl.

Test Report

Sensitivity is a shade below average, but generous power handling will ensure that good loudness levels can be achieved with a reasonably muscular amplifier, but the impedance is resolutely low too, so the muscle is necessary.

There's little bass extension below 50Hz, and this particular frequency does seem to be reproduced with rather too much enthusiasm under all three room measurement conditions. Room matching and placement will require care – some wall reinforcement helping to avoid exposing the midrange, too much risking midbass boom. Bass room matching apart, the midrange of the C45 is decidedly smooth and flat while the treble looks admirably well in line, with just a mild but broad loss of output through the crossover region.

Sound Quality

It has been suggested that the C45 benefits from an extended warm up period, which is certainly impractical for blind listening tests. In fact our findings were rather the reverse. Most listeners responded pretty positively at the beginning of the test programme, but ennui and disinterest were setting in long before the end.

Summarized, the overall reaction was

far from positive, with comments recorded including: "Slow and turgid; not my sort of speaker" and "Offensively inoffensive...whether it be love or loathing, give me some emotion".

Subsequent sighted experiments show that the C45 at least delivers an impressively consistent sound, almost irrespective of the type of stand being used. Which in turn perhaps suggests that the main driver decoupling has succeeded in reducing the influence of the cabinet, but in so doing has placed a ceiling on the ultimate performance obtainable with top quality support furniture.

Conclusions

Those searching for something inoffensive that will work predictably and competently even if bunged up on a bookshelf should find the C45 fits the bill pretty well. Those seeking something more incisive which is capable of bringing greater insight into the music may be less impressed.

TEST RESULTS

Size (height x width x depth)	47.5 x 28 x 24 cms
Weight	8.5 kgs
Recommended amplifier power	15-80 watts
Recommended placement	uncritical
In room averaged response limits 50Hz-10kHz	+/-5dB
Large room/space LF rolloff (-6dB ref midband)	30Hz
Large room/wall LF rolloff (-6dB ref midband)	30Hz
Small room LF rolloff (-6dB ref midband)	35Hz
Large room output at 20Hz (ref midband)	<-15dB
Estimated midrange sensitivity (ref 2.83V, 1m)	87dB
Impedance characteristic (ease of drive)	needs good current delivery
Typical price per pair (inc VAT)	£199

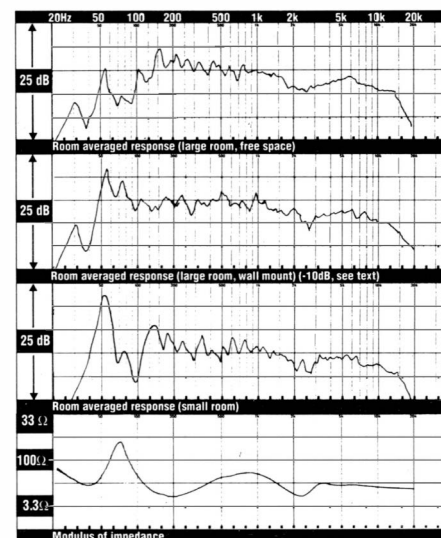

Mordaunt-Short MS3.40

MORDAUNT-SHORT, UNIT A1, HAZELTON IND PARK, HORNDEAN, HANTS PO8 9JU. TEL: (0705) 597722.



Three down, two to go was the state of play between *Hi-Fi Choice* and the latest Mordaunt-Short range as I began gathering data for this particular review.

The 3.40 is the fourth one up the five-strong range, and closely resembles the 3.30 that was reviewed some eight months back. Both share the same drivers and box width, the £50 premium for the £230 3.40 being justified by a significantly larger enclosure.

Two factors distinguish the new 3-series Mordaunt-Shorts from their predecessors and competition, both involving the extensive use of plastics. The first and most important is the moulded baffle (front panel) and covering trim, which is then fixed on to a conventional wooden box. The other innovation is an adjustable height stand based on a central pillar made up of what look like giant lego bricks, and which serves for all the models in the range.

The plastic bafflework certainly helps the appearance. It's made up of two layers: the underside one has all the structural stiffening and threaded inserts for fixing the drivers, then this is covered by a sleek cover with post-formed verticals. A peripheral groove between the two enables the stockingmask grille option – surely the most elegant solution to covers yet devised – while the 25mm metal dome tweeter has its own protective grille.

The main driver has an expensive cast alloy frame and substantial magnet plus advanced 140mm cone. It was really properly tightened home, using narrow pitch screws. The enclosure carcass is built from 15mm stock, uses a large front port and is only lightly damped. An internal figure-8 brace stiffens top,

bottom and sides, and a simple, generously rated crossover is hardwired into the terminal block, along with M-S' Positec protection circuitry.

Test Report

The 3.40 rates a shade below average on sensitivity, but should have sufficient power handling for decent loudness capability. The impedance is very kind, to even the least capable of (midi system?) amplifiers.

Taken in isolation, the response above 100Hz looks well enough balanced, if a bit lumpy here and there. Close-to-wall siting clearly lifts the 50-100Hz octave to an unacceptable degree, but 50Hz itself remains worryingly prominent under each room measurement, so care will be needed to obtain optimum matching between room and speaker. Set the height so the midpoint between the drivers is at about ear height, for best presence balance.

Given the commonality of drivers, one might have expected the 3.40 to deliver very similar measurements to the 3.30 covered last January. There are similarities to be sure, plus the expected extra (upper) bass output from this larger 3.40. But the transition between bass/mid and tweeter is much smoother here, with a less obvious step between upper midrange and treble, and the tweeter output has been peaked up a shade at around 10-11kHz, avoiding the slight dullness measured on the junior model.

Sound Quality

Despite the promising list of ingredients, the panel wasn't all that impressed by the 3.40. None took a particular dis-

like to the sound of this model, but none was particularly enthusiastic either. "Not obviously flawed but a little mundane . . . informative, tuneful, even balanced but uninspiring" is one typical reaction.

While the mid and top is sweet and clear – rather more so than with the 3.30 in my recollection – the bass seems to suffer from an unavoidable lack of get up and go. I don't much like M-S' own stand, but even after trying half a dozen others I didn't find a 'magic' combination. Changes of stand do introduce changes in the sound, but even expensive types like Slates and Foundation *Designers* don't quite do the trick here, though a little wall assistance does help the overall balance.

Conclusions

Despite the engineering innovation and technical promise, the M-S 3.40 failed to generate any real excitement under our listening conditions. It looks pretty and sounds civilised, but is that enough?

TEST RESULTS

Size (height x width x depth)	57 x 23.5 x 27.5 cms
Weight	9 kgs
Recommended amplifier power	15-80 watts
Recommended placement	stands in free space
In room averaged response limits 50Hz-10kHz	+/-5dB
Large room/space LF rolloff (-6dB ref midband)	45Hz
Large room/wall LF rolloff (-6dB ref midband)	30Hz
Small room LF rolloff (-6dB ref midband)	35Hz
Large room output at 20Hz (ref midband)	<-20dB
Estimated midrange sensitivity (ref 2.83V, 1m)	87dB
Impedance characteristic (ease of drive)	very good
Typical price per pair (inc VAT)	£230

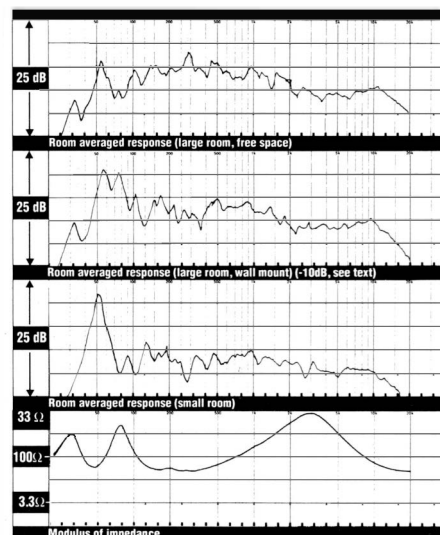

murray hi-fi

FOR REAL SOUND



103 a BEVERLEY ROAD, HULL,
HUMBERSIDE, HU3 1RX
TEL: 0482 227867

19, MIDDLE HILLGATE, STOCKPORT,
CHESHIRE. TEL: 061 429 7566

**ENJOY THE BEST OF BOTH WORLDS
TOP QUALITY SOUNDS AT UNBEATABLE PRICES**

POWER CONDITIONER

Notice the huge improvement in sound quality when you run your system from a clean mains supply. How do you describe the difference? It's as if all this time your favourite artists have been playing and singing inside a wardrobe...and someone just opened the door and let them out. You could spend twenty times as much on special cables, plugs, mats etc without achieving a tenth of the difference.

Try it for yourself.

The sophisticated circuitry of the Power Conditioner begins with a bank of six VDRs to eliminate impulsive spikes. Then comes a massive filter with thirteen capacitors and two current-balanced inductors to smooth away every trace of noise and interference. A logarithmic display flicks up and down as each spike is eliminated, and gives a second by second account of the interference removed. Maximum load 1.5kW.

**For Free Brochure on all Products
PHONE OR WRITE TODAY!
RADAR DEVELOPMENTS LTD**

**15 Sheep Street,
Highworth, Nr Swindon,
Wilts, SN6 7AA.**

Tel: (0836) 258 282



**YOU KNOW THE PRODUCT
— WE STOCK THE RANGE**

ROTEL hi-fi

Ask someone who knows ...

(RA) INTEGRATED AMPLIFIERS

RA810A	20x20 watts RMS.
RA820AX	20x30 watts RMS.
RA820BX4	30x30 watts RMS.
RA840BX4	50x50 watts RMS.
RA870BX	80x80 watts RMS.

PRICE

£119.95
£149.95
£189.95
£249.95
£299.95

(RC/RB) PRE/POWER SEPARATES

RC850	Preamplifier.
RC870BX	Preamplifier.
RB850	50x50 watts RMS Power Amplifier.
RB870BX	100x100 watts RMS Power Amplifier.

£139.95
£219.95
£160.00
£230.00

(RT) TUNERS

RT830AL	FM.LW.MW. Analogue.
RT850AL	FM.LW.MW. 16 Presets/Digital.
RT870L	FM.LW.MW. 16 Presets/Digital.
RTC850L	FM.LW.MW. Remote Control — Tuner/Pre-Amp.

£119.95
£179.95
£229.95
£309.95

(RX) RECEIVER

RX850AL	RA820A & RT850AL Combination. 30W.
---------	------------------------------------

£249.95

(RP) TURNTABLE

RP855	Belt Drive, 2 Speed Inc. AT110E.
-------	----------------------------------

£159.95

(RCD) COMPACT DISC PLAYERS (Inc. Numeric Remote Control)

RCD855	16 Bit 4 Times O/S. Twin D/A Conv.
RCD865	PDM — Bit Stream, One Bit Dual D/A Conv.

£249.95
£299.95

(RD) CASSETTE DECKS

RD845	Dolby B/C, Metal, Soft Touch.
RD855	Dolby B/C, Metal, Full Logic.
RD865	Dolby B/C, HX Pro, Metal, Full Logic, FL.

£129.95
£179.95
£229.95

(RL) LOUDSPEAKERS

RL850/II	Black Ash Finish, 75 watts, 2 Way 8".
----------	---------------------------------------

£139.95

(RK) HI FI CABINET

RK820	Mahogany Finish.
-------	------------------

£99.95

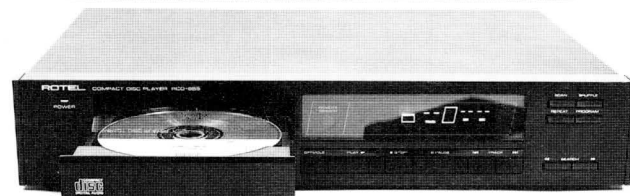
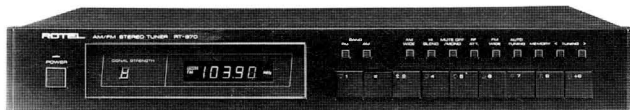

Demonstration room available.

Hypertec

6-8 Bancroft, Hitchin Herts, SG5 1JQ

Tel: 0462 452248 Fax: 0462 422476

Send or Telephone Your Order

We Accept Access and VISA

FURUKAWA ELECTRIC CO., LTD.

IF YOU CAN FIND A BETTER CABLE.....WE'LL REFUND YOUR MONEY.

I have a little story which won't take long to tell about a firm called Quantum and the cables that they sell. They're made by Furukawa in PCOCC, and at this very moment they have a guarantee.

**"IF YOU FIND A BETTER CABLE,
YOU CAN HAVE YOUR MONEY BACK".**

But from our recent sales we know there's not much chance of that, so go and see our dealers, they're the people in the know, you'll find their expert comments in the list below. They'll demonstrate the cables and put them to the test, so you can hear yourself that Furukawa are the best...
Grace Jamieson.

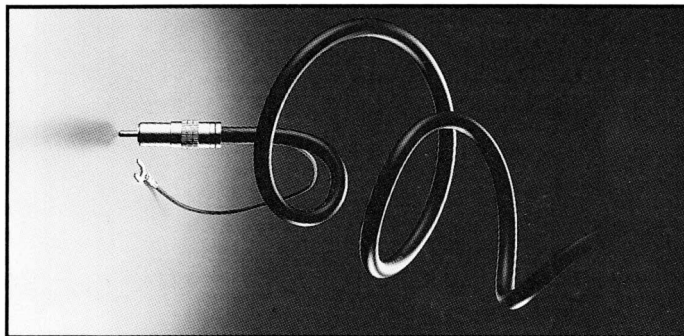

The best interconnects regardless of price. - *David Wren, Radlett Audio, Radlett. (0923) 856497.*

These cables represent tremendous value coupled with staggering performance.- *David Campbell, Zeus Audio, Belfast. (0232) 332522.*

If you can find a better interconnect below £600.00 we want to know about it. - *Jack Lawson, The Music Room, Glasgow. (041) 248 7221.*

Amazing cables probably the best regardless of price.- *Barry Haycock Hi-Fi Excellence, Aberdeen, (0224) 624408.*

Superior cables at very impressive prices.- *Tony Gascoigne, Lintone Audio, Gateshead. (091) 477 4167.*

Amazing, at last we can hear the music. - *George Bartlett, Bartletts Hi Fi, London. (01) 607 2296.*

Musically Magic.- *David Speirs, The Music Room, Manchester. (061) 835 1366.*

Furukawa clearly know cables better than anyone else,- *Ian Padbury, Reading Hi Fi, Reading. (0734) 585463.*

Well done Quantum Audio, Furukawa are the best cables we've heard.- *Bill Cochrane, Laser Audio, Kilmarnock. (0563) 40292.*

Clearly the best.- *Peter Adams, Audible Difference, Norfolk. (0379) 740227.*

Fantastic stereo imaging and bass resolution.- *Tony Lisle, Elite Hi Fi, Harrowgate. (0423) 521831*

This is live music! - *Keith Hobson, Moorgate Acoustics, Rotherham. (0709) 370666*

Furukawa do everything good cables should - **add nothing!** - *John Jeffries, Reference Studio, East Sussex. (04352) 8004*

Contact any of the above, or for further information, ring **Grace Jamieson at:**

Quantum Audio., 22-26 Nelson Street, Kilmarnock, KA1 1BA Tel: (0563) 71122.

If within 14 days of purchase, you're unhappy with these interconnects or cables, the above participating sales outlets will refund the purchase price in full.

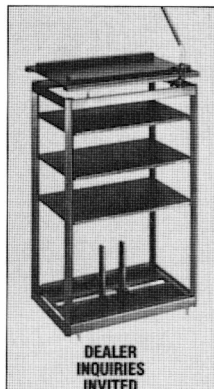

Superstructure component rack system.



The legendary lead balloon turntable isolation stand

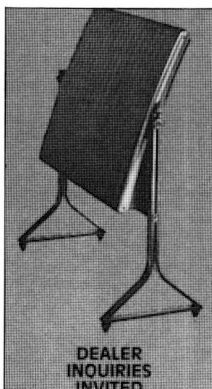

The Q-Z Quad stand for the original (classic) Quad Electrostatics



The Quad stand by Arcici.

SEE US AT
PENTA
ROOM 1189

*The Quad Stand
by Arcici, Inc.
(U.S.A.)*

The Quad Stand by Arcici is the only commercially available stand for the Quad ESL-63 which works *with* the construction of the Quad instead of against it. The Arcici Stand clamps firmly to the upright channels that make up the sides of the ESL-63. It becomes an integral part of the loudspeaker giving the whole assembly rigidity and stability that, up 'til now, has been unattainable.

IMPORTED BY AND DISTRIBUTED IN THE U.K. BY ELECTROACTIVITY,
SHAMINT LIMITED, 11 MUSWELL AVENUE, LONDON N10 2EB. TEL: 081-445 6151. TELEFAX: 081-365 3614

NAD 8225

Recommended

HI-FI MARKETS LTD, ST IVES IND EST, BURRELL ROAD, ST IVES,
CAMBS PE17 4LE. TEL: (0480) 496496.

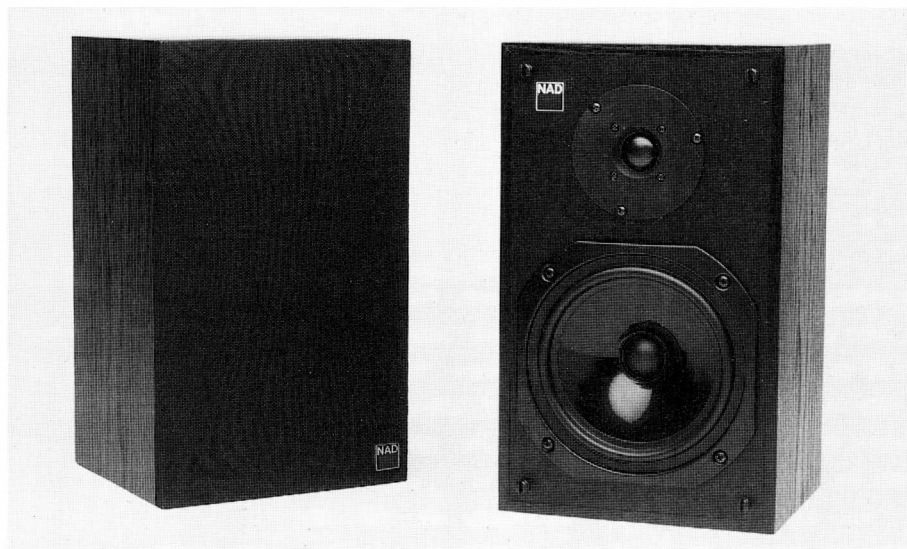

NAD is a curious company in several ways. Originally created by an international consortium of dealers and distributors, it combines European and American design skills with predominantly Far Eastern sourcing to achieve a frequently impressive cost performance ratio.

The brand is best known for amplifiers, the 3020 series being one of hi-fi's all time classics. Loudspeakers have occasionally featured in the repertoire, but play a much smaller role in NAD's UK operations than electronics. Which means, in effect, that there's little pedigree for the little £150 8225 that is the subject of this review.

Though miniature in size, this model is less miniature in price, implying that rather more than basic budget engineering is involved. To step back for a moment, loudspeakers have historically and traditionally been priced according to size, but with occasional rare exceptions like the BBC LS3/5a. However, we are now moving towards a situation where you can pay anything from £80 to £800 (or even more) for a miniature loudspeaker, and in many cases the high priced models fully justify themselves on the basis of performance.

The premium price ought to add some engineering embellishments to the basic hundred pounders, though in practice these are far from obvious. The small rear ported enclosure is built from vinyl woodgrain finished 15mm stock, with no special treatment bar some fibrous wadding lining the inside.

At least the PCB crossover uses generous components, while the UK-built main driver has a decent magnet and advanced polymer cone, though it's

built into a cheap pressed steel basket. The tweeter is a 25mm soft fabric dome with short horn flare, while the grille has a nasty thick MDF frame with badly glued covering material – though in fact it's acoustically quite harmless and the rest of the speaker is properly screwed together. There's nothing wrong with the appearance or aesthetics, save that they're deadly dull.

Test Report

Despite its diminutive dimensions, the 8225 is only just below average sensitivity, though this is largely because its 4ohm impedance characteristic pinches 3dB which in turn implies the use of an amplifier with good power and current delivery – such as many of NAD's own.

Naturally the bass extension is rather limited, falling rapidly below 50Hz, but elsewhere the free-space room response shows a beguilingly flat midband, 150Hz-3kHz, alongside the sort of stepped bass response that invites wall-loading. Close-to-wall siting admirably fills in the 50-150Hz octave and a half, albeit at some expense in overall smoothness. The crossover is admirably well integrated, especially on and around the main driver axis.

Sound Quality

The little NAD did pretty well in the listening tests, and certainly better than expected in the light of both size and price. It came in my personal top ten under blind conditions, and subsequent sighted listening only serves to confirm my own liking for its sound quality. Tried over a range of stands the 8225 continued to deliver the goods, responding rather well with various

Foundation models.

Bass is inevitably limited: the sound is irremediably lightweight, but there's a lightness of touch – a jauntiness, as one panelist described it – that adds a welcome sense of urgency to the music. A couple of listeners criticised the lack of muscle, pronouncing the end result rather plodding and boring, but the busy, detailed and neutral midband delivers its own welcome tension and articulation, while stereo images are well formed too.

Conclusions

In term of the engineering content – not to mention rather lacklustre styling that will do nothing to help it shift off dealers' shelves – the 8225 is something of a disappointment at £150. But to NAD's credit the whole turns out to be worth significantly more than the sum of the parts, reflected in the good measured performance and very respectable sound quality. At the end of the day it's a borderline recommendation, and certainly worth trying out for taste.

TEST RESULTS

Size (height x width x depth)	34 x 20 x 18 cms
Weight	4 kgs
Recommended amplifier power	15-60 watts
Recommended placement	Foundation stands close to wall
In room averaged response limits 50Hz-10kHz	+/-5db
Large room/space LF rolloff (-6dB ref midband)	45Hz
Large room/wall LF rolloff (-6dB ref midband)	45Hz
Small room LF rolloff (-6dB ref midband)	35Hz
Large room output at 20Hz (ref midband)	<-20dB
Estimated midrange sensitivity (ref 2.83V, 1m)	87dB
Impedance characteristic (ease of drive)	current hungry
Typical price per pair (inc VAT)	£150

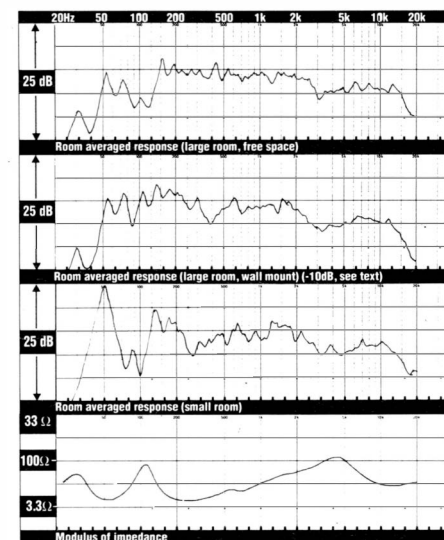

Philips FB815

PHILIPS ELECTRICAL LTD, CITY HOUSE, 420-430 LONDON ROAD, CROYDON, SURREY CR9 3QR. TEL: (081) 689 2166.



Philips is not a brand one normally associates with loudspeakers, though we've come to associate it with practically everything else in consumer electronics, so why not? In fact I suspect Philips has been building loudspeakers for as long as it's been making light-bulbs.

Although I'm sure that Dutch and German hi-fi shops have always stocked Philips loudspeakers, they haven't been around much in the UK, at least in the past five years. Go back a little earlier and *Hi-Fi Choice* gave positive reviews to more than one example. Earlier still, clever Motional Feedback active designs were way ahead of their time.

The box under scrutiny here is nothing so radical. If anything it's a throw-back, such is comparative rarity today of conventional bass/midrange/tweeter 3-way designs. It is, however, substantial in size and build quality considering the relatively modest £230 asking price: 13kg total weight normally costs rather more. And there can be no quibbling with the attractive appearance and standard of finish either. The box has attractive post-formed edges in all three planes, and one of the more convincing species of plastic wood around.

The grille looks a bit of an afterthought, so it's just as well the baffle looks pretty, trim rings helping disguise the rather prosaic standard driver engineering. The main bass driver is a lightweight affair, with lightly doped 155mm paper cone, pressed steel basket and small magnet, fixed by four tiny woodscrews. The 75mm paper cone midrange operates in its own small sub-enclosure, and the tweeter has a tiny 17mm soft dome with short flare.

If much of this is ordinary enough, the 28mm thick baffle is anything but, and goes a long way towards explaining that 13kg. The sides are pretty hefty 19mm too, though there are no attempts at bracing and the panel areas are quite large. There's not much damping either, just a very thick wool lining fixed along the rear panel.

Test Report

Given the size of the box, a sensitivity rating some 3dB below average was a bit of a surprise, especially since the '815 is no bass excavator. Philips claim 88dB, but I can't agree, so don't expect the sort of loudness capability the box size and substance tends to suggest. The grille is best thrown away, while close up measurement tends simply to confirm the difficulties of integrating a 3-way system.

The room measurements show good overall balance alongside some local unevenness. The important range 100Hz-1.5kHz is impressively flat, though there's some unevenness through the crossover and a rather sharp 'corner' at 11kHz. Placed close to a rear wall, output is clearly too strong in the midbass, though the reverse is the case in free space; a near ideal compromise will be found with care and experiment.

Sound Quality

The 815 turned in an impressive account of itself in the listening tests, bouncing along at a decent pace without adding too much unwelcome coloration. It sounds a bit too rich when back against the wall, but a little assistance is nevertheless helpful in achieving the right

overall balance.

Basic timing is pretty good, but coloration lurks just below the surface, and subsequent sighted listening soon raised doubts in my mind, especially when driving the system to higher levels than those adopted during the blind tests.

There's an incipient 'hardness' and 'brittleness' that is not just a function of the tweeter peak. It's easily perceived as clarity at moderate levels, but is inclined to become fatiguing over the long term and although the bass is decently quick and impressively free from overhang, it nevertheless lacks the authority and power that more compact competitors are capable of delivering.

Conclusions

Certainly the 815 has some appealing qualities, not the least of which its imposing and impressive physical appearance. Simply on the basis of the blind listening tests I ought to award a Recommended flag, but can't shake off my reservations over the slightly brittle and disjointed vocal quality, so will settle for a 'worth considering' rating.

TEST RESULTS

Size (height x width x depth)	63 x 27 x 27 cms
Weight	13 kgs
Recommended amplifier power	15-100 watts
Recommended placement	stands in free space
In room averaged response limits 50Hz-10kHz	+/-4dB
Large room/space LF rolloff (-6dB ref midband)	30Hz
Large room/wall LF rolloff (-6dB ref midband)	27Hz
Small room LF rolloff (-6dB ref midband)	30Hz
Large room output at 20Hz (ref midband)	<-13dB
Estimated midrange sensitivity (ref 2.83V, 1m)	85dB
Impedance characteristic (ease of drive)	very good
Typical price per pair (inc VAT)	£230

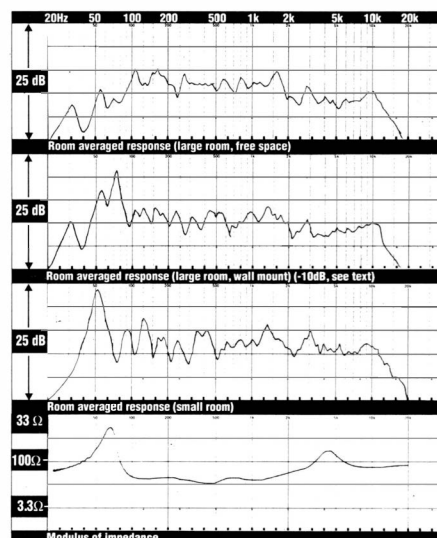

Rogers LS6a

SWISSTONE ELECTRONICS LTD, 310 COMONSIDE EAST, MITCHAM, SURREY. TEL: (081) 640 2172.

Recommended



A small British manufacturer with a very long and honorable tradition behind it, Rogers is most aptly described as one of the guardians of the BBC tradition in monitoring loudspeaker design – a tradition whereby minimal midrange coloration is placed at the top of the list of design priorities.

Although Rogers makes no attempt to compete at mass market price points, there's a pretty extensive range which starts with the £180 *LS2a* reviewed in May this year, and which includes this £285 *LS6a* two rungs further up the ladder and half as heavy again.

It looks elegant enough in its rather restrained and conservative way, with the recessed grille surrounded by a slim picture frame clearly intended to be left in place. Since this is constructed from a slim sheet of hardboard which is carefully shaped to fit the baffle, these should be no problem. The cabinetwork itself seems to be quite thin for the panel sizes – 15mm MDF or thereabouts in my opinion – but substantial extra mass and damping is added in the form of a complete lining of bituminous pads all around the inside, and then a thick layer of foam inside that.

The front panel is nicely detailed, with rebates routed out for the pressed steel main driver frame and tweeter faceplate. There's a port too, the exit chamfered to minimise turbulence. The main driver has a hefty magnet and an opaque plastic cone some 145mm in diameter, held within a lossy surround which is nearly 20mm wide. The tweeter is the same small metal dome device protected by a mesh cover used in other models in the range. Where the main driver is secured (none too tightly)

with T-nuts, which can be kept tight without difficulty by the user, the tweeter screws had already bit too enthusiastically into the MDF and some were no longer gripping properly. The crossover looks a fairly ordinary PCB device, though three terminals are provided on the rear (use bi-wire cable with earth returns connected together).

Test Report

Sensitivity is a shade below the market average, though good power handling should permit decent loudness when used with a powerful amplifier, and the impedance trace is benign. Bass extension is impressive considering the comparatively modest enclosure volume.

Rogers models are invariably intended for free space siting, and the *6a* is no exception. Close-to-wall siting looks certain to lead to boomy bass, while the free space response is impressively flat and extended, though the relative strength 120-400Hz looks likely to affect the absolute neutrality. There's unevenness in the important 1-5Hz range too, but the tweeter looks rather better integrated than in the *2a*. Close up checks confirm that the grille is best left in place and crossover region output is well maintained between the driver axes.

Sound Quality

With impressive unanimity the panel managed to describe a sound quality that corresponds very closely with what is generally recognised as the stereotype Rogers sound. Stereotype or not, it's also clearly very competitive, gaining marks that would do credit to a significantly more expensive model. As one

panelist described it: "Bass extension and evenness pretty good, not too excited by the rest". Or in another's words: "Clear, refined and with excellent image focus; I like that a lot: even balance and very refined".

Some lack of midrange vitality and excitement was criticised, bass resolution is just a shade ponderous and leading edges could be more precisely defined. There was also some unease about the sound of the tweeter, since it does sound a little obvious and might prove fatiguing in the long term. The balance is clearly best away from the wall, and of stands tried, the *6a* really started to sing when placed on the expensive Slates, while also responding pretty well to the much cheaper Foundation *Classics*.

Conclusions

This is yet another Rogers model that clearly deserves recommendation, and as usual prospective purchasers will have to weigh the fine balance and naturalness against the slightly lazy dynamics and timings.

TEST RESULTS

Size (height x width x depth)	51 x 27.5 x 28cms
Weight	12kgs
Recommended amplifier power	15-80watts
Recommended placement	stands in free space
In room averaged response limits 50Hz-10kHz	+/-4db
Large room/space LF rolloff (-6dB ref midband)	25Hz
Large room/wall LF rolloff (-6dB ref midband)	24Hz
Small room LF rolloff (-6dB ref midband)	28Hz
Large room output at 20Hz (ref midband)	<-10dB
Estimated midrange sensitivity (ref 2.83V, 1m)	86dB
Impedance characteristic (ease of drive)	very good
Typical price per pair (inc VAT)	£285

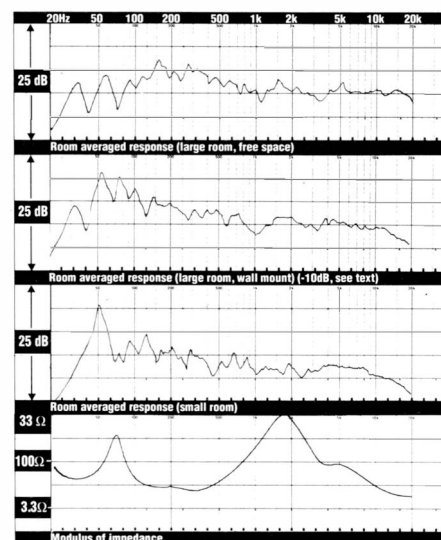

Roksan Darius

Recommended

ROKSAN ENGINEERING LTD, 21 DDOLE ROAD, LLANDRINDOD WELLS, POWYS LD1 6DF. TEL: (0597) 4911.



Roksan's *Darius* made a previous appearance in *Choice*, back in December '87. The current incarnation maintains much of the outline but also differs significantly from that original version. Gone is the dramatic exoskeleton frame/stand, though the basic box remains the same, complete with unusual, spring-decoupled tweeter. It still sits at a funny angle, tilted backwards and pointed so the main axes cross well in front of listeners, only now the whole thing sits much closer to the ground and so takes up much less room space than before. Price is now £1,395, but the stand adds a further £345.

The new stand (see pic on page 39) sets the tilt and incorporates a substantial external crossover unit, supporting the speaker from below on three carefully placed spikes. A substantial vertical member reaches up the back panel to where a fourth spike is tuned to complete the mechanical enclosure coupling; five more make a generous floor footprint. The base cradles the external crossover, keeping it away from the magnetic fields and mechanical vibrations of the loudspeaker, providing total flexibility for bi-wiring/-amping or even active drive.

The front panel is no bigger than most bookshelf speakers, but decent total volume is achieved by making the box unusually deep. The tweeter is a conventional looking 25mm soft dome, mounted on a tiny sub-baffle and suspended on four springs within a cavity in the baffle. The 150mm plastic cone of the main driver is large for a 2-way design, which is presumably why the crossover occurs nearly an octave lower than usual, at around 1.5kHz.

According to the blurb, the enclosure itself is very elaborate, rendering dismantling inadvisable. It's a sealed box built from 25mm MDF finished in real wood veneer and has all manner of damping and bracing.

Test Report

The tests show just how much *Darius* has changed. Gone is the over-bright treble, high sensitivity, and the easy load, though the new, very low sensitivity rating of 82dB is certainly justified by the excellent bass extension in the context of a modest enclosure volume. However, the other the reason for this good performance is an appallingly current hungry impedance characteristic. Very few (very exotic) amplifiers are capable of driving this load to their voltage rails without current limiting. The consequence of both sensitivity and impedance is to restrict practical loudness capabilities quite seriously.

Darius is intended for free space sitting, so no attempt was made to measure it against the wall. That the intended overall balance is now very well judged is clear from the large room trace, but this also shows considerable unevenness along the way. Crossover integration is very good indeed, but the prominence at 1kHz – probably the main driver 'focusing' at the top of its working range – is less impressive in such a costly design, while extreme treble is a little lacking. Luckily, the grille works.

Sound Quality

As one of the sighted operators noted: "Cor blimey this has changed since I last heard it, going on three years ago". Overall the panel wasn't all that

impressed, but that's partly because one member took a particular dislike. But everyone's entitled to make the odd mistake, and as author I'm allowed to overrule the panel too, especially when subsequently finding what a big improvement bi-amping can make.

Darius is not without its colorations: the sound is a little ragged and untidy, and the upper mid peak is probably the cause of some audible 'boxiness'. But those are mere cosmetic deficiencies, paling into insignificance against the superb sense of musical timing and excellent subjective speed.

If the sound's a shade boxy, the speaker isn't in the least: instead it spreads a beautifully focused stereo soundstage across the space in between. Dynamics are a delight, while the treble is notably clear, especially when driving it hard, which suggests the curious tweeter mounting is doing its job.

Conclusions

Highly Recommended, simply because *Darius* is one of the most musically involving loudspeaker systems I have ever encountered, at any price. The downside is the low sensitivity and evil load, which restricts loudness and suggests that an amplifier budget of around £3,000 might be necessary to realise the speaker's potential.

TEST RESULTS

Size (height x width x depth)	box 47 x 27 x 40 cms, total 91 x 27 x 50 cms
Weight	19 kgs (inc stand)
Recommended amplifier power	30-150 watts
Recommended placement	own stands angled in space
In room averaged response limits 50Hz-10kHz	+/-4db
Large room/space LF rolloff (-6dB ref midband)	20Hz
Small room LF rolloff (-6dB ref midband)	20Hz
Large room output at 20Hz (ref midband)	-6dB
Estimated midrange sensitivity (ref 2.83V, 1m)	82dB
Impedance characteristic (ease of drive)	
Typical price per pair (inc VAT)	£1395 (+ £345 stand)

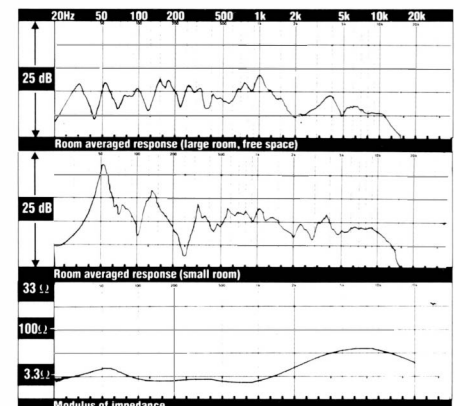

ON DEM IN KENT

Superb equipment from:- Michell, Voyd, Systemdek, Townshend, Kuzma, Rega (arms only), Helius, SME, Audionote, Goldring, Koetsu, Milltek, Ortofon, Decca, Audio Innovations, Rose Industries, Audion, Audio Technica, Quicksilver, Kelvin Labs, Albarry, Sugden, Proac, TDL, Glastonbury, Snell, Spica, JPW, Celef, Alexander, Ruark, Marantz, Alphason, Supra, Kimber, Vecteur, QED, Target, Pirates, Cardas Cable, Meridian 208 CD Player.

ON DEM EXCLUSIVELY IN KENT

Conrad Johnson valve and solid state amps and CD player, Raymond Lumley valve monoblocks and Pre-1 Pre-amp, Oakley Pre-amps, Sonograph pre and power amps, Vanderstein speakers and Cardas cable and British built Audiophile products.

Now demonstrating Pink Triangle PT Too
and Little Pink Things and Acoustat loudspeakers.

ON DEM EXCLUSIVELY IN THE UK

Sound-Lab full electrostatic and hybrid loudspeakers.

PROGRESSIVE AUDIO



Situated 5 minutes off the M2 near Rainham, Kent, we offer first class no obligation dems here or in the more realistic environment of your own home.

PHONE DAVE ON 0634-389004

the
sound
gallery

ALL CONSULTANTS ARE
THE SAME. AREN'T THEY?

THE SOUND GALLERY HAS
ESTABLISHED AN ENVIABLE
REPUTATION FOR ITS
PROFESSIONALISM IN THE
RECOMMENDATION AND
DEMONSTRATION OF DOMESTIC
HI-FI. WHATEVER YOUR BUDGET
WE CAN PROVIDE YOU WITH THE
HIGHEST LEVEL OF MUSICALITY.

SO WHY COME TO US?
FOR SERVICE IT'S FRIENDLY YET
INFORMATIVE. PROFESSIONAL
YET COST-EFFECTIVE.
TRY IT!

THE SOUND GALLERY
65, CASTLE STREET
HIGH WYCOMBE
BUCKS HP13 6RN
Tel: (0494) 31682
Fax: (0494) 464670



MOORGATE ACOUSTICS

STOCKISTS OF THE WORLD'S
FINEST AUDIO EQUIPMENT

Including: Linn, Roksan, Krell, Audio Research, Musical Fidelity, Exposure, The Rock, Cyrus, Quad, Meridian, Magna Planar, Audio Innovations, Croft, Nakamichi, Celestion, Allison, Sonus Faber, Apogee, E.A.R., Marantz, Rotel, Denon & Van den Hul



MOORGATE ACOUSTICS LTD
QUALITY · SERVICE · INTEGRITY

8 WESTGATE CHAMBERS S60 1AN
(0709) 370666

184 FITZWILLIAM ST., SHEFFIELD
(0742) 756048



The Reasons for visiting us

Our amplifiers ~ Naim ~ Linn ~
Exposure ~ Audio Innovations ~ Ion.

Our turntables ~ Linn ~ Roksan ~
Rega ~ Dual.

Our CD players ~ Rotel ~ Denon ~
Cambridge Audio ~ Marantz ~
Mission.

Our speakers ~ Linn ~ Naim ~
Ruark ~ Acoustic Energy ~ Snell ~
Royd ~ JPW ~ Mission.

The Reason for buying from us
...our experience

...our service
and of course...

...your satisfaction.

 **mike manning** AUDIO
The Hi-Fi Emporium

110 Middle Street, Yeovil, Somerset
Telephone (0935) 79361 (closed on Mondays)

One of the few specialist hi-fi dealers in the South West

SD Acoustics SD3

Recommended

UNIT F, 179-183 RIVERSIDE BUSINESS CENTRE, BENDON VALLEY,
WANDSWORTH, LONDON SW18. TEL: (081) 874 7764.



SD Acoustics is one of Britain's smaller loudspeaker makers, but the various models so far assessed by *Choice* have also been amongst the more interesting and unusual around.

Such is not the case with the little SD3, which looks like nothing more than a conventional sealed box of very compact dimensions and a fairly hefty £350 price tag. By the time you've added a top quality stand, the price could rise to something comparable to the floorstanding 3-way *OBS*, but then nowadays there seem to be plenty of customers who would rather settle for the smaller box, even though this inevitably introduces its own set of constraints.

Those familiar with the large *OBS* will notice the SD3 shares two of the drive units. In fact, it's the top two-thirds of an *OBS*, using the latter's midrange as a bass/mid unit loaded by a sealed box. Though this sacrifices the open baffle, dipole operation that is one of SD's trademarks, the 3's enclosure is unusually deep, so as to help control the back panel reflections.

All is solidly built, as shown by the 7kg total weight, though I should have liked to have found the machine head screws tightened a little more firmly into their T-nuts. The box is built from pretty substantial MDF - 18mm sides and 22mm baffle, using just a thick foam lining to control internal reflections.

The tweeter is a conventional enough 25mm soft dome device, while the unusual main driver, sourced from Dynaudio in Denmark, has a voice coil around 70mm diameter, driving a plastic cone only 115mm across, so much of

the radiating area is the large dustcap. The surround feels like natural rubber, and clearly has much less hysteresis than many synthetics. The separate arm crossover uses generously rated components and is fitted with bi-wire/-amp terminals.

Test Report

Following the pattern for 'luxury miniatures', the SD3 opts for low sensitivity with quite good extension. The downside is that a reasonably powerful amplifier is needed for best results.

The response shows an impressively flat midband 150Hz-1kHz, something of a step down around the crossover point, and a slight 'corner' around 9kHz. Comparison of space and wall curves shows the '3 will probably work pretty well in either position, though the 50Hz component (exaggerated by both test rooms) comes on a bit strong. The grille is useable, but better removed, while the main driver axis provides the best response.

Sound Quality

Despite its near-miniature dimensions and consequent bass limitations, the SD3 brought a unanimously favourable response from the listening panel. "Open, lively and clear, with good timing and pace" are the main characteristics of this doughty little box, though things do get a little ragged and untidy in the mid-to-upper treble.

Although it doesn't seem to cause undue boxiness, there's a certain lumpiness in the bass that makes careful site and stand matching quite important. In my room the bass balances best with the speakers a few inches clear of the wall.

Foundation *Fred* and *Sir Fred* stands both gave good results, as did the Linn *Kans*.

I doubt there's any danger of burning out such a large voice coil, but the size of driver, sealed box loading and (undoubtedly deliberate) avoidance of high pass filtering does mean the power handling is excursion limited. All hangs together very well, giving a good impression of headroom up to a point, but there's absolutely no point in trying to go beyond that point.

Conclusions

At the end of the day, the SD3 comfortably passes muster. It's not cheap, and it's not perfect, but it is both engaging and entertaining, and that after all represents the bottom line.

TEST RESULTS

Size (height x width x depth)	38 x 19 x 29 cms
Weight	7 kgs
Recommended amplifier power	25-70 watts
Recommended placement	stands 10cm from wall
In room averaged response limits 50Hz-10kHz	+/-4dB
Large room/space LF rolloff (-6dB ref midband)	45Hz
Large room/wall LF rolloff (-6dB ref midband)	30Hz
Small room LF rolloff (-6dB ref midband)	30Hz
Large room output at 20Hz (ref midband)	-14dB
Estimated midrange sensitivity (ref 2.83V, 1m)	83dB
Impedance characteristic (ease of drive)	very good
Typical price per pair (inc VAT)	£350

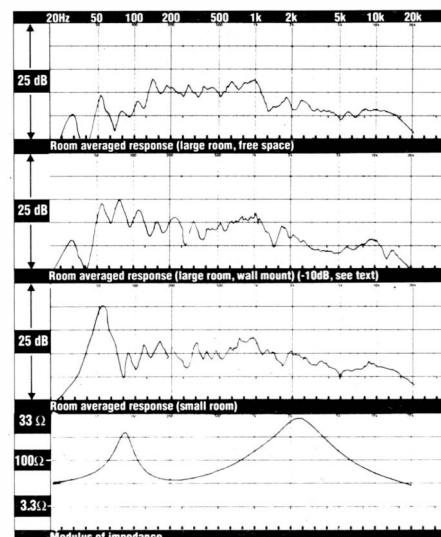

THE ACOUSTAT SPECTRA II

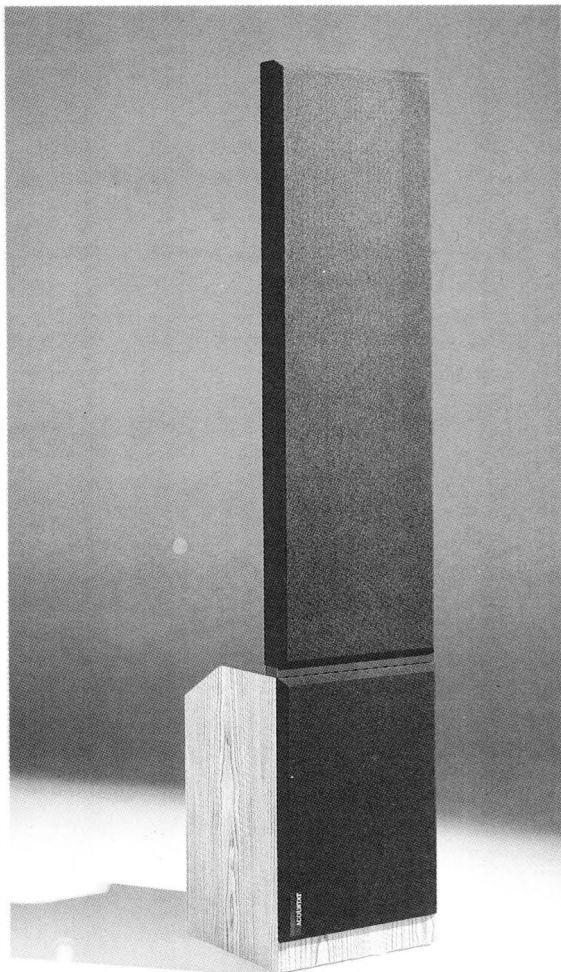

EVERY NOW AND THEN SOMETHING VERY SPECIAL
EMERGES ON TO THE HI-FI SCENE AND THE
ACOUSTAT SPECTRA II IS JUST THAT.

"EXCEPTIONAL PERFORMANCE FOR THE PRICE"
(excerpt from a review from Ken Kessler in the May issue of HFN)

IF YOU WISH TO KNOW MORE OR HEAR FOR
YOURSELF WHAT CAN ONLY BE DESCRIBED AS A
BARGAIN IN ITS PRICE RANGE THEN CONTACT ONE
OF OUR SPECIALLY SELECTED DEALERS BELOW OR
CALL US DIRECT FOR MORE INFORMATION ON THE II
OR ANY OTHER MODEL FROM ONE OF THE WORLD'S
LEADING ELECTROSTATIC SPEAKER
MANUFACTURERS.

ACOUSTAT DEALERS

DORCHESTER HI-FI	DORCHESTER DORSET 0305 64977
PROGRESSIVE AUDIO	RAINHAM KENT 0634 389004
LINTONE AUDIO	GATESHEAD TYNE & WEAR 091 4774167
AUDIO EXCELLENCE	CARDIFF GLAMORGAN 0222 28565
AND AT	SWANSEA GLAMORGAN 0792 474608
AND AT	GLOUCESTER GLOUCESTERSHIRE 0452 30046
NORMAN AUDIO	PRESTON LANCASHIRE 0772 53057
THE REFERENCE STUDIO	HEATHFIELD SUSSEX 04352 8004
AUDIO SYSTEMS	CANTERBURY KENT 0227 457292
THE AUDIBLE DIFFERENCE	DISS NORFOLK 0379 740227
AUDIO CRAFT	UXBRIDGE MIDDX 0895 53340
CHANTRY AUDIO	TUXFORD NOTTS 0777 870372
EXOTIC SOUND CO	HULL HUMBERSIDE 0482 216468
HIGH TOWN AUDIO	CREWE CHESHIRE 0270 211091
SHROPSHIRE HI-FI	SHREWSBURY SHROPSHIRE 0743 232065

REFERENCE IMPORTS HEATHFIELD SUSSEX
04352 4481

WE'VE GONE WEST!

PORTSMOUTH

NOW

OPEN



J^{hi-fi}effries

69 London Road
Brighton
0273 609431

4 Albert Parade
Green Street
Eastbourne
0323 31336

29 London Road
Portsmouth
0705 663604

Excellent Listening Facilities



LATE NIGHT - WEDNESDAY - 8 PM.

CLOSED MONDAYS

PM Components Ltd

Selectron House, Springhead Enterprise Park, Springhead Road,
Gravesend, Kent, England DA11 8HD
Tel: (0474) 560521 Telex No. 966371 TOS-PM G Fax: (0474) 333762

HI-FI VALVES

General Electric USA Range	Mullard Special Quality
6CA7/EL34 11.50	E80CC 25.00
6DJ8/ECC88 3.95	E81 CC/6201 6.45
6L6GC 10.50	E88CC 6.95
6LF6 14.50	E182CC 7.50
12AT7/ECC81 5.50	E288CC 17.50
12AT7WA/6201 6.50	EL84 4.50
12AU7A/ECC82 3.95	EL86 2.75
12AX7A/ECC83 3.95	M8136/ECC82 7.00
12AX7WA/5751 6.50	M8137/ECC83 7.95
12BH7A 6.50	M8162/ECC81 5.50
211/VT4C 25.00	
6080 8.50	
6146B/8298A 15.00	
6550A 15.95	
7027A 13.95	
7308/E88CC 8.95	
7581A/KT66 11.95	
7868 11.95	
8417 11.95	
	British 'RAF' Military Spec.
	CV2492/E88CC 6.50
	CV2493/E88CC-01 7.50
	CV2975/EL84 4.50
	CV4085/EF86 7.50
	CV4003/E82CC 6.50
	CV4004/E83CC 6.50
	CV4024/E81CC 4.50
German Valves	Teonex Valves
ECC81 Siemens 3.50	6DJ8/ECC88 1.50
ECC81 Teonex 3.95	6SN7/GT 3.15
E81CC Siemens 5.50	12AT7/ECC81 1.95
EL34 Siemens 4.50	12AU7/ECC82 1.50
EL84 Siemens 2.50	12AX7/ECC83 1.95
EL84 Teonex 3.50	ECC83 Super 3.50
PCC88 Siemens 2.50	EF86 3.50
6201 Siemens 6.45	KT66 5.00
	EL34 4.50
Ceramic Valve Sockets	B9A Ceramic Chassis 0.95
B9A Ceramic Chassis 0.95	B9A Ceramic with Can 1.50
B9A Ceramic with Can 1.50	Octal Ceramic 0.95
Octal Ceramic 0.95	GZ34 4.50

7th Veil System IV

Recommended

5 LYLE COURT, KING STREET, WELLINGTON, SHROPSHIRE TF1 3AD.
TEL: (0952) 605215.

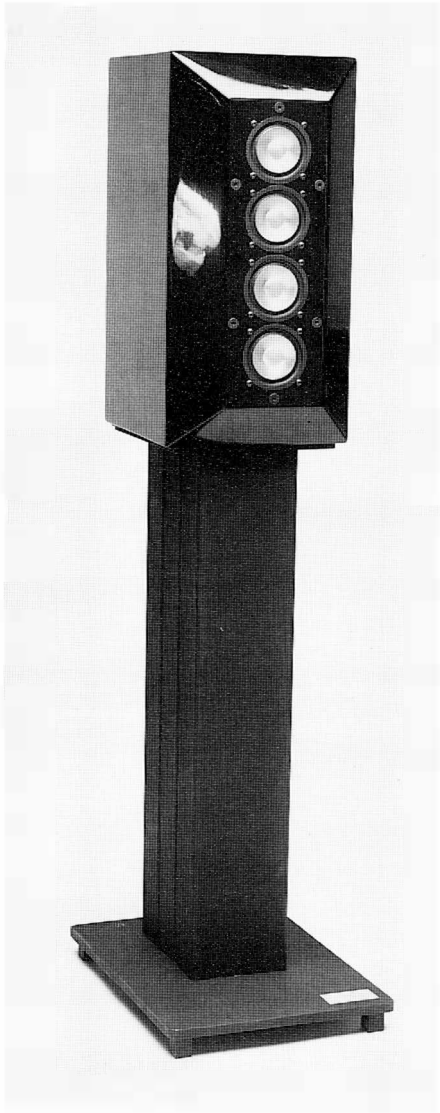

This is a truly weird one, from a new British company. The folksy name is a clue to the obsession which inspired its designer, a passion for transparency and coherence, which is pursued single-mindedly at the expense of other arguably equally important parameters.

It's actually a species of loudspeaker known to cognoscenti as a *Daline* – an acronym for decoupled anti-resonant transmission line, described in a constructional article published some 15 years ago in *Hi-Fi News* – which combines reflex and transmission line bass loading principles.

Neither top chamber nor series coupled line are constructed using normal techniques. The very heavy (22kg) top section is heavily damped by means of a sand-filled sandwich construction, with black lacquered wood finish outside and a sort of egg-shaped glass fibre chamber inside (to spread the internal

resonance modes).

This £1,290/pair unit may be used on its own, as a compact sealed box or reflex depending on whether the underside port is left open or closed off. But in the version reviewed here, the upper enclosure is firmly attached to an even heavier (36kg) and elaborate £340/pair *Stand-Line* whose central pillar consists of three flat 5x10cm rectangular tubes bonded together. These form a folded transmission line of nearly 2m in length which exits between the spikes at floor level, just above the sprinkling of sand which had leaked out of one unit.

The drivers are equally strange: four identical 5cm (2inch) metal-cone Bandor units are mounted in a vertical array, connected in series/parallel and used full range. There's no crossover – to all intents and purposes this is an active drive system, which is bound to help the coherence. However, it also brings in the compromises. In actual radiating area, the four Bandors together only have the same total area as a 100mm cone, which ain't much. The primary sound source is therefore effectively 5cm wide and some 25cm high, which Physics dictates will cause significant beaming of the highest frequencies. Stand up or sit on the floor and the treble vanishes: this is very much a 'sweet spot' design which will only give its best in relatively few listening positions.

If a little ungainly, it's aesthetically quite pleasing, though t'would be much more so was the stand finished in high gloss to match the top. Naturally there's no grille (why add another veil?), so the drivers are vulnerable.

Test Report

Given the curious driver/line makeup, it's perhaps surprising to find that *System IV* measures quite like a conventional loudspeaker – with the emphasis on quite. Sensitivity is solidly below average, which is the norm for expensive small boxes, though in this case power handling will be limited by the excursion of the tiny cones so loudness will be restricted too.

The transmission line is certainly doing its bit to fill in the low bass, which is genuinely extended when wall sited as intended. However, the bass is also a bit vague, and there's a clear lack of upper bass energy. There's no crossover to trouble the penchart recorder of course, though the upper midband is decidedly forward and there's a fair amount of 'spikey' uneven-

ness through the treble region, while the treble 'beaming' causes variations of 10dB across a small vertical angle.

Sound Quality

Not surprisingly, the 'differentness' of the *IV* caused some confusion amongst the panel, leading to a rather disappointing overall rating. But the Seventh Veil has little to do with creating a balanced overall performance, and its strengths came through as obviously as its weaknesses.

It's forward and 'middy', lacking body and power. The treble's distinctly scrappy (young ears might be perturbed by the 16kHz peak), and the mid has more than its fair share of coloration. But it's also exceedingly quick and coherent – stopping, starting and defining leading edges in a most invigorating way. Reactions seemed to vary according to the type of music being played: in an almost magical way the *IV* really does seem to lift the seventh veil obscuring female vocalists (only to reveal the next seven underneath).

Conclusions

There are all sorts of reasons why I shouldn't Recommend this loudspeaker, but I'm going to do so anyway. It's a very bad allrounder, but that's all part of the charm, and evidence of the commitment of the designer to an ideal. Nine out of ten enthusiasts can cross it off their lists straight away, but maybe one in every hundred will fall so hopelessly in love with its coherence and delicacy as to tolerate willingly the balance, coloration and loudness constraints.

TEST RESULTS

Size (height x width x depth)	72 + 44 x 21 x 29 cms
Weight	22 kgs (58 kgs inc stand)
Recommended amplifier power	20-60 watts
Recommended placement	close to rear wall
In room averaged response limits 50Hz-10kHz	+/-5dB
Large room/wall LF rolloff (-6dB ref midband)	28Hz
Large room output at 20Hz (ref midband)	-10dB
Estimated midrange sensitivity (ref 2.83V, 1m)	84dB
Impedance characteristic (ease of drive)	very good
Typical price per pair (inc VAT)	£1290 (+£340 stand)

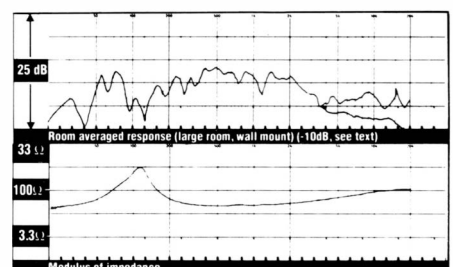



There will be more hifi equipment on display and more audition facilities available for your convenience.

Authorised dealers of :

Alphason, Ariston, Alexander, Atc, Audio Innovations, Audio Technica, Beard, B&W, Cambridge Audio, Creek, Celestion, Carver, Castle, Chord Company, Dual, Denon, Heybrook, Hafler, Infinity, J.P.W., Kelvin Labs, Pink Triangle, Mantra/Musician, Mission, Musical Fidelity, Mordaunt-Short, Moth, Marantz, Monster Cable, Nakamichi, Orell, Oracle, Presence Audio, Proac, Proton, Philips, Quad, Ruark, Rotel, Sennheiser, S.D.Acoustics, SME, Snell, Spendor, Sony & Sony ES, Systemdek, Target, Thorens, van den hul, and Yamaha.

PHONE 071-233 0774

Due to expansion a new branch is opening on 13th August at

**34 BUCKINGHAM PALACE ROAD
LONDON SW1**
(next to Victoria Station)

AMPLIFIERS

A.R.A05	£199.95	£149.95
Ariston Amp	£199.95	£99.95
Kenwood KA660D	£169.95	£124.95
NAD 3225	£149.95	£129.95
NVA AP30	£299.95	£229.95
Conrad Johnson PV8	£1995.00	£1250.00
Conrad Johnson MV100	£3300.00	£2250.00
ORELL SA040	£359.95	£279.95
SA040SE	£399.95	£379.95
Pioneer A223	£119.95	£89.95
Pioneer A616	£249.95	£194.95

SPEAKERS

A.R. RedBox	£99.95	£84.95
A.R. 112	£124.95	£99.95
A.R. 122	£149.95	£124.95
Ariston Image	£159.95	£99.95
Allison 105	£149.95	£109.95
Allison 120	£399.95	£329.95
JPW Sonata	£99.95	
JPW P1	£139.95	£129.95
JPW AP2	£165.95	£109.95
Monitor Audio R1200	£799.95	£699.95
Monitor Audio R1800	£1299.95	£1199.95
Musical Fidelity R2	£199.95	£149.95
Mordaunt Short MS350	£349.95	£289.95
Tannoy E11	£129.95	
Tannoy M15	£169.95	
Tannoy M20	£229.95	£199.95

CD PLAYERS

Denon DCD820	£249.95	£224.95
Kenwood DP5010	£249.95	£209.95
Kenwood DPX9010	£499.95	£399.95
Kenwood DP460	£179.95	£139.95
NAD 5320	£189.95	
Revox B226	£749.95	£599.95

Alphason Opal
Normal price £129.95
Sale Price : £109.95

Alphason Delta
Normal Price £189.00
Sale Price £169.95

Helius Scorpio
Normal Price £ 139.95
Sale Price £99.95

**SONANCE
FLUSH MOUNTING SPEAKERS**

M30	199.95	159.95
M2	189.95	159.95
M3	279.95	219.95
M4	469.95	399.95

The Sound Shop

**58 THE BROADWAY
MILL HILL
LONDON NW7 3TC**
TEL: 081-906 3364

MAIL ORDER
EXPORT
SINGLE SPEAKER
DEMONSTRATION ROOM

NEW AMPS FOR OLD

At Avondale Audio, we take your Naim, Quad, Musical Fidelity, pre or power amplifier and expose the full potential of the original design. By the use of premium grade components and techniques, our engineers will transform the sound of your amplifier to sound as good as those costing twice as much. Please telephone for more details of your system or SAE please.

AVONDALE AUDIO

THE HOLLIES AVONDALE ROAD CHESTERFIELD S40 4TF
TEL: (0246) 200 096

**If you're serious about HI-FI
in the South of England**

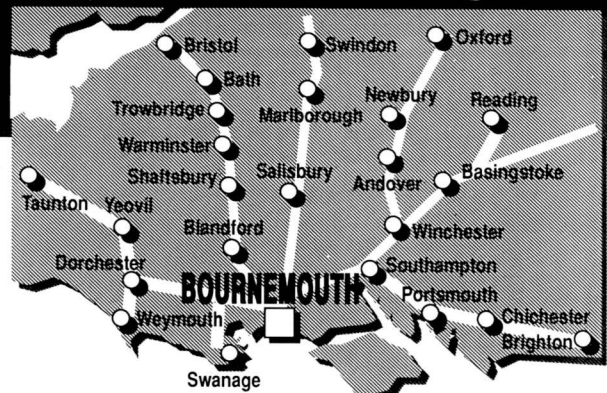

All roads lead to Bournemouth

It's where you will find superb HI-FI listening facilities, staff with expert knowledge and one of the finest selections of HI-FI equipment including...

LINN, DENON, YAMAHA, NAIM, ROTEL, MONITOR AUDIO, NAD, MARANTZ, CREEK, ARCAM, NAKAMICHI, A&R, EXPOSURE, CELESTION, AFWA, DUAL, AUDIOLAB, QUAD, PIONEER, TECHNICS, OED, WHARFEDALE, TANNOY, HECO, SONY ES, SENNEISHER, TARGET, SOUND ORGANISATION, ROYD, ROGERS and others

If you're serious about HI-FI you probably know these names and you probably already know the name Suttons...we've been around for 42 years.



18 Westover Road, Bournemouth Tel: 0202 25512
Also at 3 Endless Street Salisbury. Not all manufactures.

Sony APM-121ES

SONY UK LTD, SONY HOUSE, SOUTH STREET, STAINES, MIDDLESEX TW18 4PF. TEL: (0784) 467000.

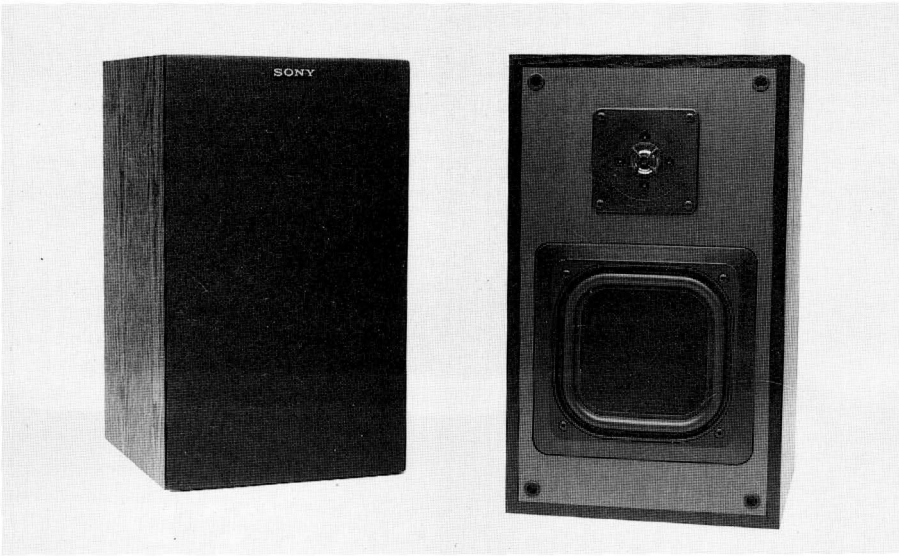

Believe it or not, Sony is widely reckoned to be the biggest serious hi-fi loudspeaker brand in Europe. One reason is that it has a significant share in all the major national markets; another of course is that selling large quantities of electronics makes it easy to sell speakers of the same brand alongside. But a third reason is undoubtedly that Sony treats the specialist speaker market with respect, and has adopted an 'if you can't beat them, join them' strategy that is unusual for a multinational company.

Instead of attempting to impose global loudspeakers on the world at large, Sony has set up what amounts to a small company whose job is to design a model range specifically for the European market, using local market sourcing as far as possible.

There are four models all told in the range, hitting the major price points between £100 and £300. Three have already been assessed in previous *Choice* tests, the two models either side of the £150 *APM-121ES* tested here both gaining recommendation – as much for the generosity of their engineering content as the subtlety of their balances.

The *121* has much in common with the *101ES*, the 50% price premium buying a 50% larger box volume plus extra terminals for bi-wiring. The same – rather enthusiastic – small metal dome tweeter is used, and the bass driver is also similar – a slightly larger variation of Sony's proprietary smallish flat square APM driver, on this occasion equivalent to a 140mm cone. Beneath the neat plastic trim and honeycomb diaphragm this is actually a rather more prosaic cone driver on a square pressed steel frame, and could have been more

tightly secured with more substantial screws.

The generously rear ported enclosure is built from 18mm vinyl finished chipboard and is quite elaborately braced and stiffened, which is unusual at this price level. It's also well stuffed with fibrous wadding.

Test Report

Not too surprisingly, the '121 shows close similarity to its brethren. Compared to the '141 that was tested earlier this year (*Jan '90*) the differences relate much more to the bass than the midrange and treble end of things – measurements above 500Hz are almost identical, but variations below are sufficient to peg back the sensitivity rating a couple of dB. The impedance is nice and kind, ensuring wide compatibility.

As before, the steady treble rise beyond the crossover is bound to add at least a touch of subjective 'tizz', while bass is also exposed, though over a narrower band than with the larger *141* before: the free space room measurement 50Hz prominence is likely to be audible, whilst any exaggeration by wall loading looks most unwelcome.

Close up measurement shows that the grille is reasonably benign, if better removed, while the speaker struggles to maintain output through the crossover region.

Sound Quality

Sonically, this Sony is defeated by its balance. It measures 'loudness contour', and sounds that way too, to such an extent that none of the listening panel was comfortable with the overall sound.

Certainly close-to-wall siting is quite

unacceptable, but even out in space the bass has a one-note quality which robs the music of any dynamic excitement. Some panelists simply switched off, dismissing the sound as muddled and boring. The creative writer amongst our panel of the day notes: "This is quite sad . . . still doesn't excite. No foot movement from the panel: in fact, one has dropped off and another is trying to o/d on Fisherman's Friends . . ."

Other members of the panel did find genuine merit in an attractively spacious midrange, a decent impression of scale and a generous soundstage, especially worthwhile with classical material.

Conclusions

Although this Sony model appears to offer plenty of perceived value in an attractively designed and presented package at a very competitive price, it's a regrettable example of the whole failing to gel together harmoniously, at any rate as far as the UK tastes of our listening panel are concerned.

TEST RESULTS

Size (height x width x depth)	43 x 25 x 28 cms
Weight	9 kgs
Recommended amplifier power	15-70 watts
Recommended placement	stands in free space
In room averaged response limits 50Hz-10kHz	+/-7dB
Large room/space LF rolloff (-6dB ref midband)	25Hz
Large room/wall LF rolloff (-6dB ref midband)	25Hz
Small room LF rolloff (-6dB ref midband)	25Hz
Large room output at 20Hz (ref midband)	-14dB
Estimated midrange sensitivity (ref 2.83V, 1m)	86dB
Impedance characteristic (ease of drive)	very good
Typical price per pair (inc VAT)	£150

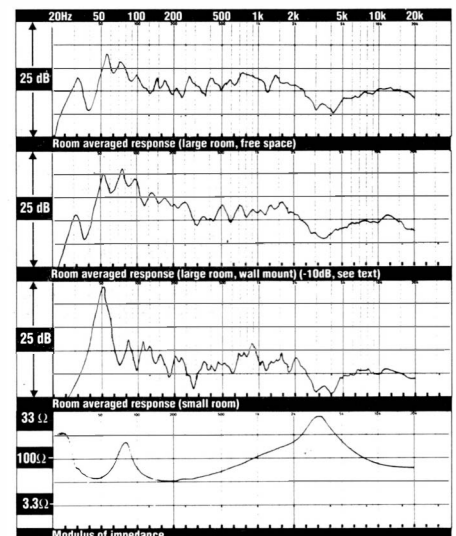

O'BRIEN hi-fi

QUALITY EQUIPMENT ON DEMONSTRATION ON MOST OF THE BEST BUYS



ROGERS LS6A -RECOMMENDED IN HI-FI CHOICE.

FAMOUS NAMES IN HIGH FIDELITY EQUIPMENT
 ALLISON, ALPHASON, ARCAM, AUDIO TECHNICA,
 CASTLE, CELESTION, DENON, DUAL, DYNAVECTOR,
 FOUNDATION, GALE, GOLDRING, KEF, LINN,
 MARANTZ, MICHELL, MOTH, NAD, NAKAMICHI,
 ONKYO, ONYX, ORTOFON, PINK TRIANGLE, PROTON,
 QED, QUAD, REVOX, ROGERS, ROYD, SENNHEISER,
 TARGET, THORENS.

95 HIGH STREET, WIMBLEDON VILLAGE, LONDON, SW19. 01-946 0331

- CREDIT FACILITIES (Ask for details)
- SERVICE FACILITIES • ACCESS/BARCLAYCARD
- FULL ORDER & EXPORT SERVICE • Opening Hours: Tues-Sat 9-5.30

HI-FI MARKETS

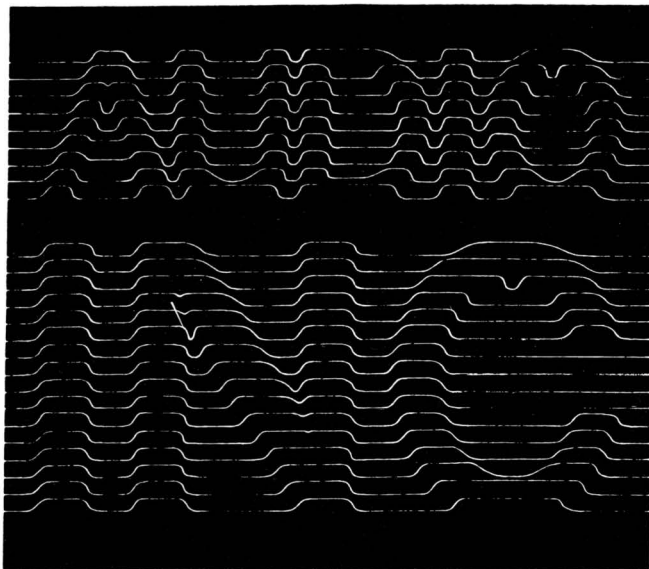

ALPHASON, CELEF, CROFT, DENON, EMINENT
 TECHNOLOGY, LINX, MICHELL, MICROMEGA,
 ORTOFON, PROAC, ROTEL, RUARK, VAN DEN HUL,
 CONRAD-JOHNSON, SOUNDLAB,
 MORDUANT-SHORT, ETC ETC . . .

**44 WALTON ROAD, EAST MOLESEY,
 SURREY KT8 0DQ
 TELEPHONE: 081-941 4234**



101, St. Albans Road,
 Watford, Herts.,

☎ Watford 245250

Open Mon - Sat 9.30am-5.30pm

AVONDALE AUDIO

☎ (0246) 200096

"SONIC LINK AVAILABLE HERE"

In Concert **WAF**
 Quality HiFi on the Wirral

144 Seaview Road,
 Wallasey, Wirral
 Merseyside L45 4PE
 ☎ (051)630 5055

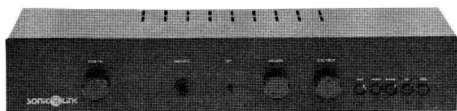

**SONIC LINK DM20
 AMPLIFIER**

**ON
 DEMONSTRATION
 AT
 THESE
 DEALERS**



**SONIC LINK MAINS
 CABLE SET**

SONIC LINK AMPLIFICATION, 6 MILL CLOSE, BORROWASH, DERBY DE7 3GU TEL: (0332) 674929

Mid Shropshire Audio

4, Holland Court, Dawley,
 Telford, Shropshire

☎ (0952) 630172

"FOR SONIC LINK"

Agencies include: Alexander, Apollo, Ariston, Audio Inovations,
 Audio Technica, Bose, Cambridge Audio, Denon, Dual, Goldring,
 Heco, Ion Systems, JBL, Manicore, Marantz, Michell, Monster,
 Moth, Onkyo, Ortofon, Pink Triangle, QED, Royd, Ruark Acoustics,
 SD Acoustics, Sennheiser, Sherwood, S.M.E., Snell, Soniclink,
 Systemdek, Tannoy, Target, That's Tape.



STANDENS FOR SOUND

**SONIC LINK ON
 DEMONSTRATION**

92a High Street, Tonbridge,
 Kent TN9 1AP

☎ (0732) 353540

Sussex Audio MID SUSSEX ELECTRONICS

163 - 165 Church Road,
 Burgess Hill, West Sussex

☎ (0444) 242336

HI-FI MARKETS

Technics SB-CS5

Recommended

PANASONIC UK LTD, PANASONIC HOUSE, WILLOUGHBY ROAD, BRACKNELL, BERKS RG12 4FP. TEL: (0344) 862444.



Technics is the number one hi-fi brand in the UK, certainly as far as sales of separate hi-fi electronics is concerned. However, despite several valiant attempts over the years, this specialist subdivision of Matsushita, the biggest consumer electronics company of them all, has never really managed to crack the UK loudspeaker market.

One could discuss the possible reasons for several paragraphs, the most likely being a tendency to opt for technology for its own sake, often to tackle just one particular problem, the end result consequently often lacking the overall balance of its competitors.

But this reasoning has little to do with the £70 SB-CS5 that is the subject of this review. For £70 you don't get flashy Japanese high tech, any more than you're going to get Japanese manufacture. What you do get in this case is a Spanish built refugee from the midi system market.

It's designed by Technics, built in Panasonic's Barcelona factory, and is one of a range of three Eurospeakers, this model being normally served up as accompaniment to the CD C10 and C30 midi systems.

Saying something about the differences between the midi system and proper hi-fi markets, the enclosure here is big enough to justify a price point much higher than £70. Indeed, it's as big as many specialist brands' £129 and £159 models, and at 6kg weighs as much too, the main bass/mid driver having a generous 135mm cone. All is nicely styled and finished, and aesthetically pleasing with or without the grille in place, thanks largely to nicely post-formed baffle edges.

The box is built from 17mm particle board, finished in black vinyl woodprint, but the midi heritage is seen in the rather unpleasant spring loaded terminals on the rear. Beneath the skin the cost constraints are that much more obvious. There's no bracing for the quite large panels and there's little damping material either. The crossover is a very cheap affair and the main driver has a tiny magnet and very little mass – the torque of my electric screwdriver managed to crush part of the frame during re-fixing.

Test Report

Sensitivity is below average, but only slightly so, while bass extension is quite generous for such a low cost model, thanks to the generous enclosure, and the load is nice and easy, so as not to embarrass even cheap amplification. Although the 100Hz-2kHz span is very well balanced, the response traces are nevertheless rather ragged.

The crossover region is pretty well handled with minimal loss of output, and the treble is only slightly exposed. Sited in free space, the midband looks a shade prominent, so a little wall assistance will probably be helpful, though beware of adding too much. The response is smoothest at or below the main axis, so highish stands will be best.

Sound Quality

Averaged out, the CS5 did quite well on the listening tests, especially considering its price, but such a statement glosses over some differences of opinion between the panelists, half of whom gave praise, the other half criticism.

As reviewer I have to assume the role of referee, and acknowledge that the

CS5 is not one of my personal favourites. It's quite well balanced, but is inclined to sound rather thick and rich even when sited well clear of a rear wall, thanks I suspect to rather active cabinetwork.

Though a bit chesty and congested, the sound is tidy, with good stereo focus and fair tonal accuracy. But at the end of the day it betrays its midi heritage in a lack of rhythmic poise, pace and timing, and an inescapable gutlessness besides. Comparison across a range of stands suggests that the open frame Heybrook HBS1 is a good match.

Conclusions

Clearly fine material value for money, the CS5 is certainly competent enough for recommendation at £70. Simply on the basis of size and weight versus price it would appear to be strongly in the running for a Best Buy rating, but in this instance the quest for size for its own sake has merely served to compromise the performance of both enclosure and main driver.

TEST RESULTS

Size (height x width x depth)	42.5 x 25 x 24 cms
Weight	6 kgs
Recommended amplifier power	15-60 watts
Recommended placement	HBS1 stands, clear of walls
In room averaged response limits 50Hz-10kHz	+/-6dB
Large room/space LF rolloff (-6dB ref midband)	48Hz
Large room/wall LF rolloff (-6dB ref midband)	45Hz
Small room LF rolloff (-6dB ref midband)	38Hz
Large room output at 20Hz (ref midband)	-15dB
Estimated midrange sensitivity (ref 2.83V, 1m)	86dB
Impedance characteristic (ease of drive)	very good
Typical price per pair (inc VAT)	£70

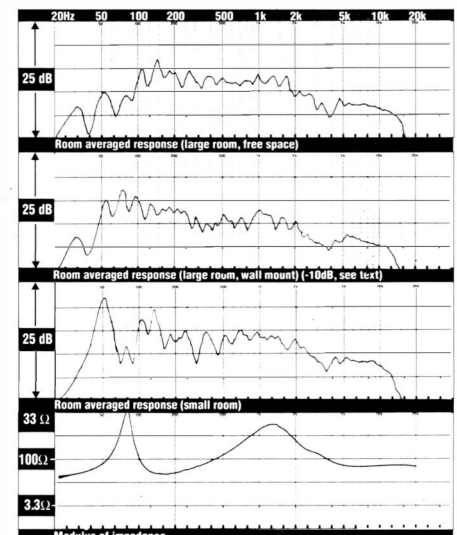

Bill Hutchinson

HI-FI, AUDIO & C.D. Centre

★ Sales ★ Service ★

ROYAL SONNY KENWOOD
marantz Technics

MISSION Dual AIWA
DENON Mordaunt-Short TANNOY
NAD BOSE

YAMAHA PIONEER

**BEST PRICES GUARANTEED
ON ALL LEADING BRANDS**

Our aim is to provide
the highest level of
service and value available.

43 HOPE STREET
(opposite central station)
GLASGOW 041 248 2857

43 SOUTH CLERK STREET
EDINBURGH 031 667 2877

**JUST OPENED
AT 87A CLAYTON
STREET
NEWCASTLE
091 230 3600
SPECIAL
OFFERS**



NO1 FOR
SERVICE
AND VALUE



griffin AUDIO

BIRMINGHAM

*Something Spiffin'
from Griffin!*

LINN, NAIM, MISSION, REGA, QUAD, CREEK, DUAL,
MORDAUNT SHORT, EPOS, HEYBROOK, CAMBRIDGE
AUDIO, NAKAMICHI, DENON, ARCAM, MARANTZ, REVOX, ROYD

94 BRISTOL ST., BIRMINGHAM
692 1359, TUE-SAT 10 am-6 pm

Chiltern Sound & Vision

Bourbon Street, AYLESBURY, Bucks. HP20 2RR
Tel: 0296 431020/84470

7 The Colonnade, Verulam Road, ST. ALBANS
AL3 4DD Tel: 0727 66935

1A Exchange Parade, Lake Street,
LEIGHTON BUZZARD LU7 8RS Tel: 0525 383021

**You've READ THE BOOK
You've SEEN THE PICTURES
NOW
COME AND LISTEN**

FREE
SAMPLER
DISC
WHEN YOU
PURCHASE
ANY CD
PLAYER

FINANCE
AVAILABLE
ON SOME
MODELS
CERT 1B

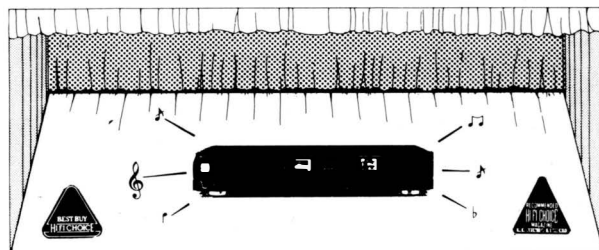

YAMAHA TECHNICS DENON KENWOOD PIONEER Dual

Also starring:-
B&W, Castle, Celestion, Kef, Mordaunt Short,
Panasonic, Tannoy.
Demonstrations:- A pleasure — please
ring first.

All shops closed Thursdays



CamAudio

If we can't help you —

*— We'll tell you where
to go —*

**SPECIALIST AUDIO RETAILERS
110 MILL ROAD
CAMBRIDGE
(0223) 60442**

Tannoy M20

TANNOY LTD, ROSE HILL IND ESTATE, COTBRIDGE, STRATHCLYDE
NL5 4TF. TEL: (0236) 20799.

Recommended



Tannoy's domestic hi-fi loudspeakers are organised in several distinct ranges, the *M20* covered on this occasion belonging to the cheaper, more conventional series of bookshelf-size two-way designs – natural descendants of the successful *Planet* models of a few years ago.

It's the third model up this range, and the last of the threesome to come under *Choice* scrutiny. Results have been mixed so far, the *M15* deserving recommendation but the *E11* proving a rather surprising disappointment in view of the enthusiastic reception it has received from other reviewers elsewhere.

In fact the *11* and the *20* had been delivered at the same time, and the original intention was merely to hold the '*20*' over for this edition. However, Tannoy decided to change it for a later sample, having recently modified the characteristics of the main driver surround in the search for greater subjective 'speed'.

The *M20* is fundamentally a tarted up *Mercury*. The £170 *M15* still carries this planetary dedication and shares precisely the same box dimensions as this £250 variation. The difference in price is due to in part to a skin made of real tree wood and in part to extra under the skin refinements. The whole thing feels pretty meaty and solid.

The main driver has a decent magnet and generous 150mm plastic cone, while the tweeter is a 25mm exposed metal dome device (handle with care). The rear-ported cabinet is lightly damped by thin absorbent material lining the panels. The baffle is a full 18mm section while sides and internal braces use 12mm stock.

Interlinked lateral and vertical braces

stiffen all the enclosure panels and connect via a damping blob to the rear of the main driver. The hardwired, bi-wired crossover uses top quality components.

Test Report

Sensitivity is close to average and bass extension quite respectable for the size of box. Good power handling should ensure that decent loudness is available with a respectably powerful amplifier, the load presenting no problems for even the least capable.

The balance is pretty good, running quite smoothly above 150Hz, albeit with a slight loss in the crossover, presence region and a rather restrained upper treble. At lower frequencies the 50Hz room resonances tend to be a bit strong for wall assistance, so free space will probably give the best results, though experimentation is advised. Axially the smoothest crossover integration is found on or close to the main driver, and the grille is acoustically benign.

Sound Quality

I wouldn't like to speculate whether the new driver roll surround or the real wood veneer is responsible; whichever, the *M20* is a much livelier and more entertaining loudspeaker to listen to than the *M15*. Listeners' notes were sprinkled with adjectives like open, informative, tuneful, and natural, while the sound manages an unusually good combination of solidity and dynamic range alongside fair transparency. On the debit side there is a certain relentlessness in the treble, the midband is a little pinched and 'cuppy' while the bass doesn't really achieve full freedom.

Like its brother the *M20* is very stand sensitive, and care should be taken to find the best possible combination with system and room. Blu-tack coupling is preferred to spikes, but both open frame and pillar stands are worth trying, the *Foundation Designers* generating awesome scale bi-wired, the *Slates* something special when bi-amped. At lower prices the *Foundation Classic* and *Heybrook HSB1* are both very capable partners.

Conclusions

The *M20* is much more of a success than the *M15*, well deserving recommendation for its unusually clever combination of 'traditional' virtues like transparency and low coloration alongside the more trendy strengths of speed and pace. The non-enthusiast can simply fit, forget and enjoy while those prepared to spend time experimenting and tweaking should find the procedure very rewarding.

TEST RESULTS

Size (height x width x depth)	50 x 25 x 22 cms
Weight	8 kgs
Recommended amplifier power	15-80 watts
Recommended placement	stands in free space
In room averaged response limits 50Hz-10kHz	+/-5dB
Large room/space LF rolloff (-6dB ref midband)	25Hz
Large room/wall LF rolloff (-6dB ref midband)	25Hz
Small room LF rolloff (-6dB ref midband)	28Hz
Large room output at 20Hz (ref midband)	<-12dB
Estimated midrange sensitivity (ref 2.83V, 1m)	87dB
Impedance characteristic (ease of drive)	very good
Typical price per pair (inc VAT)	£250

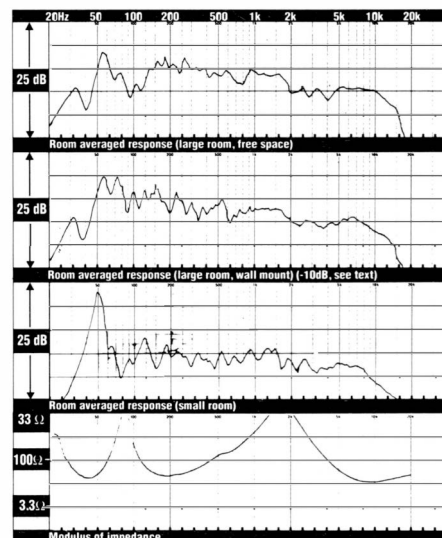

studio 0.5

Being perhaps the world's smallest transmission-line speaker, the TDL Studio 0.5 is a loudspeaker of exceptional bass performance – modest in size yet large in acoustic stature. Indeed, for the first time, those enamoured with the bass of transmission-line speakers, but not their size, can now benefit from their majestically apportioned sound.



TDL
ELECTRONICS

transmission line speakers

Transducer Developments Limited

PO Box 98 High Wycombe Bucks HP13 6LN England Tel: (0494) 441191 Fax (0494) 461803

652 Glenbrook Road Stamford Connecticut CT 06906 USA Tel: (203) 324 7269 Fax: (203) 324 7027

Vandersteen Model 1B

STUDIO ACOUSTICS, 12 BURNLEY ROAD, NEWTON ABBOT, SOUTH DEVON TQ12 1YD. TEL: (0626) 67060.

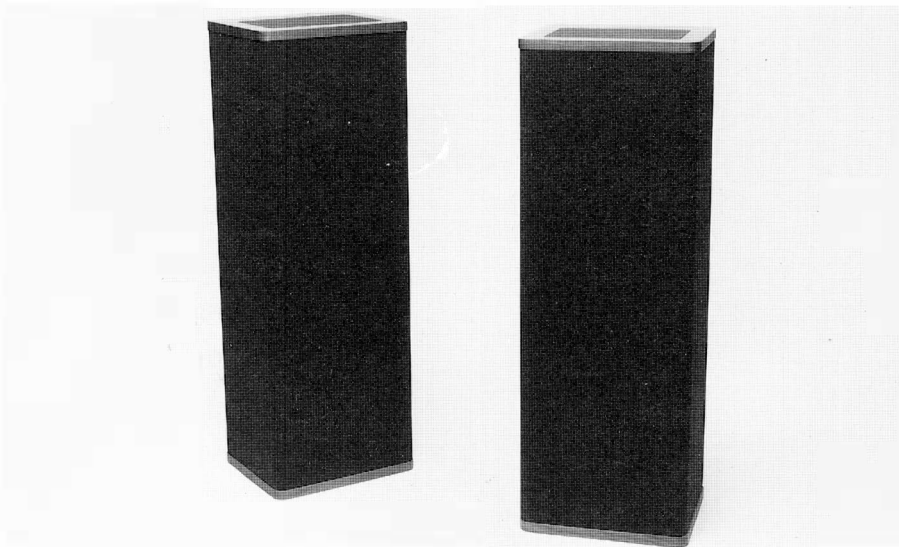

Vandersteen will probably be a new name to most readers, though it has been a highly respected US specialist loudspeaker company for a number of years. At American hi-fi shows I've always been impressed by Vandersteen's demonstrations, and been surprised that no serious attempt has been made to bring them over to the UK. Now Studio Acoustics has decided to have a go, and I must admit I was intrigued to see how they would fare against the UK competition.

Vandersteen doesn't make budget bookshelf loudspeakers. The range begins here, with the £1,000 *Model 1B* which is a fairly compact example of its type, but a floorstanding model nonetheless. The construction might have been expressly designed to prevent reviewer interference; after ten minutes getting nowhere I gave up. There are parallels with the Norwegian Doxa which defeated me last time: the whole speaker is encased in a black stockingmask tube, decorated only by nice wooden endplates top and bottom. Unlike the Doxa, the Vandersteen is wider than it is deep, and the stocking-mask conceals a complex cabinet shaped to tackle cabinet edge and grille diffraction effects.

My investigation was further hampered by a brochure which describes – in great detail – the *Model 2C*, the next one up the line. The *1B* has similarities, but differences too. Peering by torchlight through the grille, it has two not three drivers, though the baffle array is somewhat similar.

The lower half is a bass enclosure, reflex loaded by a port at the lower rear, with post-formed verticals that are con-

tinued as simple posts to the top plate in order to keep the grille properly tensioned in place. Above the bass section – and presumably acoustically contiguous internally, though maybe mechanically decoupled – the main bass/mid driver is tightly framed by a narrower sub-baffle/enclosure, and the tweeter is set similarly on top of that. The main driver looks to have a largish 160mm-or-thereabouts cone, the tweeter a 25mm soft dome unit. The rear panel carries the pair of input terminal pair plus a treble level potentiometer; I wish someone had been able to do one for the midrange too. . .

Test Report

Model 1B combines close-to-average sensitivity with impressive bass extension for what is really a quite compact unit. Impedance is benign and power handling seems no problem.

There's a clear tendency to emphasise the c50Hz modes in both our measuring rooms, while the low frequency siting variations all point to the need for careful experimentation: away from the rear wall looks likely to be favourite. Elsewhere the responses look well enough balanced overall, but there's plenty of unevenness along with notable mid forwardness. There's also a bit of a 'corner' at 6kHz.

Sound Quality

Listening panels are apt to react negatively when presented with something different, and that turned out to be the fate of these Vandersteens. My subsequent sighted listening tends to suggest the panel (self included) rather overreacted, and *Model 1B* is rather better

than its rating suggests. But the blind criticisms as usual carry more than a germ of truth even if the judgement may have been a little harsh.

In fact the mid and top is refreshingly free from the usual cabinet boxiness, but it is also a little exposed, and this rather draws attention to its other shortcomings, especially some unfortunate hardness and unevenness in the vocal band. The generous bass extension deserves due praise, but qualitatively the bottom end tends to thump, lacking timing and poise.

Conclusions

The various basic performance parameters versus price make good sense, and the sound is also good enough to be worth considering in a carefully matched system, provided the rather forward balance is to taste.

TEST RESULTS

Size (height x width x depth)	100 x 30.7 x 25.6 cms
Weight	20 kgs
Recommended amplifier power	15-150 watts
Recommended placement	floor clear of walls
In room averaged response limits 50Hz-10kHz	+/-7dB
Large room/space LF rolloff (-6dB ref midband)	23Hz
Large room/wall LF rolloff (-6dB ref midband)	23Hz
Small room LF rolloff (-6dB ref midband)	25Hz
Large room output at 20Hz (ref midband)	-9dB
Estimated midrange sensitivity (ref 2.83V, 1m)	87dB
Impedance characteristic (ease of drive)	very good
Typical price per pair (inc VAT)	£1,000

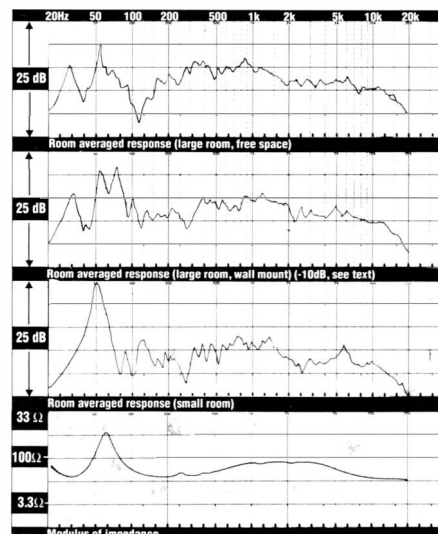

COUCHER AT
EARTONE:
 Road, Tel: 0204 31423
MANCHESTER
 189-191, Tel: 061 835 1856
ALTRINCHAM
 189-191, Tel: 091 978 1610
ROCHDALE
 189-191, Tel: 0706 324657
WIGAN
 51 Drake Street, Tel: 0942 313897
WOLVERHAMPTON
 79 Victoria Street, Tel: 0902 772901
NOW OPEN IN MIDSTONE
 Level 2, The Chequer Centre Opposite the
 Scaobard Shop, Tel: 0612 763801
WOODS
WEDNESBURY
 1 Upper High Street, Tel: 091 528 0473
DARLSTON
 39 King Street, Tel: 091 837 2881
MANCHESTER SONY CENTRE
 66-68 Bridge Street, Tel: 061 837 2881

ENTRY £1.50 FOR ADULTS
 (ACCOMPANIED CHILDREN UNDER 14 FREE)

EXTRA 50% DISCOUNT VOUCHER
 ON TOP OF THE ALREADY GREATLY REDUCED PRICES AVAILABLE AT ALL CLEARSTONE AND WOODS STORES
 This voucher entitles you to 5% off all store prices until October 31st 1990. Excludes all other promotions and offers.
CLEARSTONE
 HI-FI · VIDEO · TV

SPONSORED BY
CLEARSTONE LTD.
 235 BLACKBURN ROAD,
 BOLTON. TEL: 0204 31423 FOR INFO.

AT THE LAST DROP VILLAGE
BROMLEY CROSS, BOLTON.

Friday, Oct. 5th 12 noon to 8.00pm
Saturday, Oct. 6th 10.00am to 7.00pm
Sunday, Oct. 7th 10.00am to 6.00pm

FREE PARKING FOR 1000's OF CARS



MORE EXHIBITORS THAN ANY OTHER HI-FI & VIDEO SHOW IN THE U.K. INCLUDING:
 Aiwa, Akai, Arcam, Audio Technica, Apollo (Zenith Crown), Beyer, Dynamic, Creek, Dual, Goodmans, Harman UK Ltd, Haydon Labs (Denon/Semm), Haymarket Magazines Ltd, JVC, JWS Audio (GB Ltd), Kenwood, Linn Products, Marantz, Maxell, Mission, Mordaunt Short, Philips, Portfolio Thorens/Proton, Revox, Rotel, Sony TV+Video, Sony ES Hi-Fi, Sharp, TDK, Teac, Technics, Wharfedale, Nad and Grundig International.

Don't miss The Show of the Year. Your chance to see and hear all the latest in Hi-Fi, Video, Camcorders, TVs and In-Car from the world's top manufacturers. Visit the giant marquee, tour the studio listening rooms, and buy direct from the manufacturers.
 ★ Spectacular New Product Launches
 ★ BBC broadcasting live from the Show
 ★ Live entertainment by TV and radio personalities ★ Meet top hi-fi magazine writers ★ Bar, Refreshments, Barbecues.

UP TO 10% OFF EQUIPMENT PURCHASED OR INTEREST FREE CREDIT ON MANY ITEMS DURING THE SHOW
 SPECIAL OFFERS AND PROMOTIONS FROM MANUFACTURERS AT THE SHOW

THE BIGGEST HI-FI & VIDEO SHOW IN THE UK

10TH GREAT YEAR

DON'T MISS IT!

The National **SOUND AND VISION SHOW**

Tech Talk

The whys and wherefores of the loudspeaker test programme explained by Paul Messenger

Recent *Choice* loudspeaker tests have introduced a number of changes in the test procedures, partly reflecting the changes in the magazine itself in the last few years. In the small format A5 days, a batch of 50 or 60 models was assembled once a year, making the logistics and costs of hiring an anechoic chamber reasonably practical.

Now the loudspeaker schedule involves almost continuous testing of smaller batches. Major tests of 20-25 models happen thrice a year, and are supplemented by smaller groups – miniatures, giants or whatever – which makes ‘one-site’ testing the sane and sensible option.

Listening

The ‘blind’ tests on this occasion lasted three days with about five listeners, making up around 30 separate presentations of about half an hour each. Split evenly between vinyl and compact disc, the programme covers as broad a range of music as possible.

Care is taken to try and ‘normalise’ the relative volume of each loudspeaker, though differences in frequency balance, bass extension and room drive unavoidably get in the way.

Choice of ancillary components inevitably influences the type of sound, possibly by as much as the room itself, and is one potential source of prejudice I know no way of avoiding. The main drive system comprises Naim amplification and cables, sourced from Linn *Sondek/Troika*/Naim ARO vinyl disc and Radford WS1 CD player all mounted on Mana tables. Grilles are deliberately left on.

Bi- and tri-wiring is adopted where possible, using heavy multi-strand cables (Linn, Naim, Hitachi). Again for the sake of consistency, except where specifically instructed otherwise, the speakers are auditioned both sited against a rear wall and in free space.

My particular thanks go to

Jason Kennedy for all his hard work as operator on the blind listening tests, and also to panelists: John Bamford (*Hi-Fi Choice*), Ken Weller (Tannoy), Richard Dunn (NVA), Alan O'Rourke (Ruark), Chris Jackaman (Mission), Bill Livingstone (Linn), Russell Kaufman (Studio Power), Ian Bolt (Musical Design Co.), Ian Rankin, Chris Bryant and John Coward.

Measurements

Without decrying the value of anechoic work, especially when developing a single product in isolation, there's no doubt that the room-averaged measuring technique which Martin Colloms originally introduced has proved by far the most effective predictor of listening test behaviour, and is particularly relevant to group testing.

Although a solitary in-room measurement of any specific loudspeaker is of very little value, a good idea of the subjective balance is obtained by averaging the measurements at a number of points in the listening area. Further, the comparison of a number of loudspeakers enables the effects of the room to be identified and taken into account.

The main change from before has been to focus exclusively on room measurements and room-averaged response (RAR) traces for the published data. Where MC used a single free-space RAR as back-up to the anechoic work, the current test programme involves three separate sets of room measurements in most cases. Two of these are the specific wall and free space sites used in the listening tests (large room); intermediate positions produce more or less intermediate results. A third trace has been taken in an irregularly shaped smaller room.

The MC technique is based on feeding one speaker at a time, mounted clear of walls, with broadband pink noise, storing and averaging the

results for a range of microphone positions using a (very expensive) 1/3-octave digital spectrum analyser.

My alternative (analogue) approach uses a conventional pen recorder/mike set-up (Neutrik) to carry out sequential rapid sinewave sweeps (high pen and paper speeds) for a succession of microphone positions. By the time half a dozen sweeps have been completed on the same piece of graph paper, an obvious ‘average’ pattern will have emerged that clearly delineates the averaged response in the listening area.

Initial experiments with known reference loudspeakers that had already been RAR tested in my room by MC's associate Christ Bryant showed that this low tech approach gave pretty close correlation, and I must admit I rather prefer the continuous to the 1/3-octave presentation. I have also extended the technique to examine wall-mounted behaviour, again with results that show fine subjective correlation – specifically the mid-bass in-fill and midband unevenness that often are the consequences of wall-siting.

A perfectly flat straight line is not the ‘target’. Careful comparison with listening findings and established references suggest that ideal ‘large room’ balance should be a flat and straight line up to around 1-2kHz, followed by a gently but steadily increasing downtilt through c-5dB at 5kHz to c-10dB at 20kHz. Low frequencies are heavily modified by the main room modes – most notably the c10dB boost at 30Hz (or 10dB suckout at 42Hz if you prefer). For the rest, even and smooth variations are better than sharp discontinuities.

The speaker and microphone sites parallel the listening tests, giving a measuring distance of 3- 4m, the room itself being a sparsely furnished 4.5 x 5.5m plus bay. An extra trace was also taken in a second room about half the size, the speakers sited about 20cms from the wall and measured

from 2-2.5m. Additional nearfield measurements examined the influence of grilles and axis variations.

Sensitivity differences have as much to do with impedance variations as with conversion efficiencies – which is one reason why the impedance has also been plotted and presented. Halve the impedance and the speaker sucks twice the current and therefore twice the power for the same volume setting. By adopting 4ohms rather than 8ohms impedance, ‘current hungry’ designs therefore ‘pinch’ 3dB of extra sensitivity. Few amplifiers have the capability to deliver this extra 3dB in full, most settling for 1.5-2dB, so an apparent sensitivity advantage may well be partly negated in practice.

One consequence of the RAR-based testing is that alternative bases need to be set to define low frequency extension. Tradition defines the low frequency roll-off as the -6dB (sometimes -3dB) point referred to the sensitivity. Such a technique can be applied to room measurements, but the results tend to be strongly modified (even modulated) by the main room modes.

Probably more useful and meaningful is to specify the relative level of 20Hz ref the midband sensitivity. However, the big drawback here is that a good percentage of speakers don't even manage 20dB, and many are unmeasurable below 30Hz.

Until I can figure out a better approach, I am quoting the -6dB points for all three measurement conditions – large room, free space; large room, wall mount; small room, 1+ft from wall, plus the 20Hz level. The *Directory* ‘bass from’ entries for the recent reviews carried out using RAR techniques therefore refer to the large room/best position -6dB point for the speakers concerned, and cannot be compared with earlier ‘anechoic’ entries on this parameter, though each has its own internal consistency.

The highly unusual Seventh Veil System IV: quirky, but ever so seductive.

This has been a strange group of loudspeakers. Since *Choice* reviews so many models at a time - 25 on this occasion - our invitation to manufacturers to send in whatever models they choose usually results in a pretty good cross-section of the market, with the majority falling into the popular under-£300 price bracket.

This time nearly half the models cost more than £300, and rather than forming a steady continuum up the price ladder, they seem to cluster into several distinct groups, making this project more like several concurrent group tests.

One obvious overall trend has to be the rise and rise of the small and/or miniature loudspeaker. The days when the price of a loudspeaker was inextricably linked to its size and number of drivers are fading fast.

There are still plenty of examples of instances where showroom 'perceived value' has clearly taken priority over purely musical considerations. Both the Technics and Sony speakers would probably have worked better had they used smaller cabinets, but both are also sold as part of midi systems, where showroom appeal is all.

Hundred pound or so miniatures like the *Maxim*, *Diamond*, *M-S 3.10*, *Celestion 3* or *KEF C15* always head up the loudspeaker sales charts. But it's becoming easier and easier to spend several times that price on a similarly small loudspeaker with genuine state of the art aspirations.

This probably all started with the BBC *LS3/5a*, which was itself something of an accident, being originally put together as a scale model speaker for studio acoustic modelling purposes. Linn's superficially identical *Kan* started off as a parody, providing the obverse side of the sound quality. Both these have sold steadily and



Conclusions, Best Buys and Recommendations

Paul Messenger sums up this month's loudspeaker tests.

successfully for many years, bringing considerable credibility to the miniature concept.

Raising the stakes in price and size, the *Celestion SL* series - especially the *600* and *700* - made a big impact, as subsequently have the *Acoustic Energy AE1* and *AE2* models.

Now everybody seems to be joining in. This issue sees entries from two of America's bigger speaker specialists, *JBL* and *Infinity*, plus four models from smaller British and German companies (*ATC*, *SD Acoustics*, *Seventh Veil* and *Audioplan*). Remarkably, the bookshelf size *ATC* and *7th Veil* speakers weigh half as much as large floorstanding models like the *Linn Isobarik* and *B&W Matrix 801*.

Though such small designs are still unable to match bigger rivals in terms of scale and loudness, the small enclosures provide their own advantages, helping to minimise the problems of cabinet coloration and promote stereo precision.

If small speakers are increasingly fashionable, my recent visit to the US

suggests that '3-box' systems - a 'tucked away' subwoofer backing up two tiny satellites - could well be the next trend. There are no examples in this issue - and as loudspeaker reviewer I can't say I'm looking forward to dealing with them, 'cos placement is very tricky - but this approach can certainly add sonic scale to the miniature concept.

The sensitivity ratings are another clue to the miniature and upmarket biases of this particular test group. The market average is around 87-88dB/W, whereas this test group average came out at a low 85.6dB/W. That so many of the models are described as 'below average' is not the contradiction in terms which it first appears.

I haven't given any **Best Buy** ratings on this occasion, though the *Cyrus 781* and *Tannoy M20* both came close, and to some extent the value for money of these high quality bookshelf models will depend on how much value the prospective purchaser places on the attractive real wood veneers both use.

The **Recommended** hit rate is around 50 per cent,

which is a little less than our last *Loudspeakers* edition (May issue) but pretty close to the norm. But rather more than usual, such a simple statistic tends to disguise a range of differentness and scope of choice that is wide even by loudspeaker standards. Variety is the spice of specialist hi-fi, and nowhere is it more piquant than in the world of loudspeakers.

Recommended models

Clearly fine material value for money, the £70 **Technics SB-CS5** is certainly competent enough for recommendation. Simply on the basis of size and weight versus price it would appear to be strongly in the running for a Best Buy rating, but this is at heart a midi system loudspeaker, where size versus price equals showroom perceived value. In fact a smaller version with improved ingredients would probably have performed better.

Smallness is certainly one of the main strengths of the nimble little £80 **Goodmans M100**. It's actually an

attempt to shave a tenner off the price of Goodmans' established market favourite, the *Maxim 2*, and it suffers somewhat in the comparison, lacking some of the charm (as well as the tweeter) of the *Maxim*.

Take an enclosure little bigger than the Goodmans and lavish a little more expense on the drivers and construction and the £150 **NAD 8225** comes into the picture. It looks neither pretty nor particularly good value for money, but the whole turns out to be significantly greater than the sum of the parts: it's a subtle recipe that is clearly the result of painstaking design work.

Much the same may be said of the two models Recommended at £250, the **Cyrus 781** and **Tannoy M20**. I reviewed the Cyrus not long ago and didn't give Recommended status. This time the company supplied properly run in samples, and the resultant listening test findings leave me no alternative. So if you choose

Cyrus after an impressive experience with well used demonstrators, then get home with a new pair and wonder whether you've done the right thing, give them a few days grace - and do use the matching stands and experiment with room positioning too.

The **Tannoy M20** is also very set-up sensitive - and very stand sensitive too. Recent drive unit developments seem to be improving the subjective 'speed' of the *Mercury* derivatives, and the *M20* stands out for its unusually clever combination of 'traditional' virtues of transparency and low coloration with more trendy strengths in pace and timing. The non-enthusiast can simply fit, forget and enjoy, while those prepared to spend time experimenting and tweaking should find the procedure very rewarding.

Speed and agility are not qualities one associates with Rogers loudspeakers, and the rather lazy presentation

won't be to every taste. But the degree of refinement and subtlety, together with impressively precise and generous stereo soundstaging are all qualities which go to make the £285 **Rogers LS6a** a fully competitive proposition.

Although both cost £350, there doesn't look to be much else in common between the **Boston A120** and the **SD Acoustics SD3**. Certainly the big and blowsy Boston looks like better value than the small and neat SD, but they're actually closer than one might expect, sonically and designwise.

Both use small plastic cone main drivers and deliver a lively and dynamic sound, while paradoxically the wallmounted SD actually shows the greater bass extension. By way of compensation, the *A120* will go rather louder, and/or use rather less amplifier power in achieving similar loudness. But the contrast does serve to show how competitive a good miniature like the *SD3* can be.

The £500 **JRT ADI** turned out to be a very pleasant surprise indeed, and is seriously good value from every point of view - the all veneered real wood box alone would probably command a higher price tag from a better known manufacturer. One might carp that the sensitivity/bass extension compromise doesn't really take full advantage of the box size or close-to-wall site, but the sheer ability to communicate the messages of the music is well ahead of the pack.

Luxury presentation is higher on the £799 **Audioplan Kontra-Punkt's** design priorities than value for money per se. Serious loudness or bass extension are not on the agenda, but for those prepared to tolerate these constraints, the *Kontra-Punkt* is as sweet as a nut (sorry), and a lot prettier besides.

The three final Recommended models come from a group of five, all of which cost £1,300-£1,600, give or take the odd stand.

The group only serves to illustrate the fact that the higher one goes up the price ladder, the greater the differences between individual models.

Oddest of all is the £1,520

Seventh Veil System IV/Stand-Line. In some respects it's one of the least capable speakers I've come across, but its strengths are as seductive as the name implies. Severely lacking in welly, authority and loudness capability, and undeniably coloured as well, the *IV/SL* has the sort of sweet midrange coherence that can make one's hair stand on end (on a good day, with a following wind and the right sort of music on the turntable).

Somehow brutish by comparison, the £1,650 **Acoustic Energy AE3** oozes authority and competence, challenging one to take liberties with a really powerful amplifier. It's very much a modern version of the classic compact 3-way stereotype, and still carries the legacy of some of the difficulties that have always plagued the breed. Though not the nimblest or musically most engaging sound around, the *AE3* always provides a confident, accurate monitoring of the source, with neutral balance, fine stereo and well controlled colorations.

At £1,740, the latest, new-stand-and-crossover **Roksan Darius** looks rather expensive - the whole caboodle only weighs 19kg. But low mass can be its own reward, when handled with the subtlety of this clever integral-stand decoupled-tweeter design. *Darius* has its own set of colorations, but these are easily forgiven in the light of the exceptional speed, timing and transparency. The changes counter much of the criticism directed at its predecessor, though the current version is appallingly power hungry and insensitive, and won't give its best without top quality electronics and sources. But get all of that right and the level of musical communication can match the very best - and it doesn't take up half the room either.

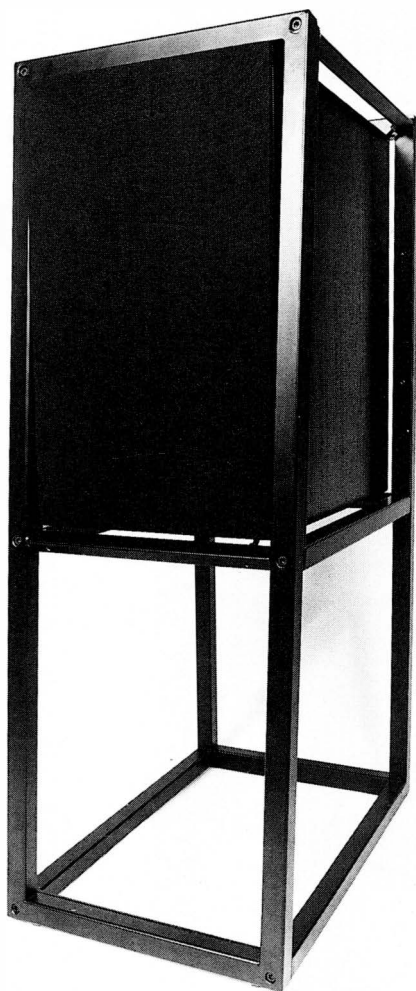

Ringling the changes: Roksan's Darius (seen here with the old-style stand) has been much improved.



SEVENOAKS HI-FI & VIDEO

This advertisement is valid until at least 31st August 1990.

SAVE £100

SYSTEM OF THE MONTH £299.95

Including cartridge and all leads. Free carriage UK mainland

- Dual CS503/1 or (Ariston Q deck add £30) or (Dual CS505/3 add £25)
- Rotel RA810A or (NAD 3020i add £10)
- Celestion DL4 II or (Superb New Monitor Audio 'Monitor 7' add £20)



SUGGESTED SYSTEMS

The suggested systems priced below all include the popular Dual CS503/1 turntable, but an alternative turntable or CD player is available at extra cost. Please see "OPTIONS" list below for further details.

SPEAKERS All system prices include the Dual CS503/1	Widale Diamond III Goodmans Maxim II Widale Delta 30 JPW Minim Gale GS210	Celestion 3 JPW Sonata Goodmans Sterling Pt 3 Royd A7 M/Short MS 3.10	Celestion DL4 II Tannoy E11 A/Research 112 JPW Sonata +	H/brook P15 A/Research 122 Celestion DL6 II Monitor Audio R7	Tannoy M15 Castle Warwick Wharfedale 505.2 Monitor Audio R9 M/Short MS 3.30	KEF C45 Castle Durham Celestion DL8 II A/Research 132 Rogers LSA4 Add £30	Heybrook HB1 Tannoy M20 (Blk) Heybrook HB100 Tannoy DC 2000 Add £50 M/Audio R352MD Add £50
Rotel RA820AX	294.95	309.95	329.95	349.95	369.95	389.95	429.95
Rotel RA820BK4	329.95	339.95	359.95	379.95	399.95	429.95	469.95
Cambridge P50	349.95	359.95	389.95	399.95	419.95	439.95	489.95
Pioneer A300	319.95	329.95	349.95	369.95	389.95	419.95	459.95
Rotel RA840BK4	379.95	389.95	409.95	419.95	449.95	459.95	499.95
Harman PM6100	299.95	309.95	329.95	349.95	369.95	389.95	399.95
Rotel RA810A	264.95	284.95	299.95	319.95	339.95	359.95	399.95
QED A240CD II	334.95	354.95	379.95	399.95	414.95	429.95	474.95
Yamaha AX330	274.95	284.95	299.95	319.95	339.95	364.95	409.95
Arcam Alpha II	329.95	349.95	379.95	449.95	469.95	499.95	549.95
Rotel RA870BK	419.95	429.95	449.95	389.95	399.95	409.95	424.95
Kenwood KA5010	349.95	359.95	314.95	329.95	334.95	334.95	409.95
Nad 3225PE	289.95	299.95	309.95	309.95	329.95	349.95	364.95
Nad 3020 I	279.95	289.95	309.95	349.95	369.95	389.95	419.95
Marantz PM 30SE	319.95	329.95	309.95	319.95	349.95	369.95	369.95
Technics SU 810K	279.95	284.95	309.95	309.95	319.95	429.95	439.95
Musical Fidelity B1	334.95	354.95	379.95	379.95	389.95	429.95	474.95

FREE

Cartridge supplied with these systems
Leads provided with these systems (QED 79 strand add £1/metre)
Carriage for mail order customers on all systems in excess of £250 (UK mainland only)
NB speaker stands are NOT included but highly recommended — wide range available from £20 per pair

LISTEN TO THE SUPERB MISSION ELECTRONIC RANGE AT SEVENOAKS HI-FI

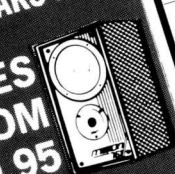

PRICES FROM £129.95

- MISSION 761 £129.95
- MISSION 762 £199.95
- MISSION 763 £299.95
- MISSION 764 £459.95
- MISSION 765 £599.95

OPTIONS

The following Compact Disc Player or Turntable may be ordered instead of the Dual CS503/1 in the above systems.

- CDs**
- Denon DCD520 add £50
 - Denon DCD620 add £80
 - Denon DCD820 add £130
 - Denon DCD920 add £180
 - Marantz CD40 add £80
 - Marantz CD50 add £130
 - Marantz CD50SE add £180
 - Marantz CD60 add £230
 - Marantz CD60SE add £70
 - Nad 5320 add £100
 - Nad 5325 add £100
 - Philips CD840 add £220
 - Philips CD610iII add £50
 - Rotel RCD855 add £130
 - Rotel RCD865 add £180
 - Technics SLP277 add £40
 - Technics SLP477 add £100
 - Technics SLP550 add £140
 - Technics SLP570 add £160
- TURNTABLES**
- Dual CS503-2 add £20
 - Dual CS505-3 add £25
 - Dual CS430 deduct £20
 - AR EB 101 add £100
 - Nad 5120 deduct £20
 - Nad 5120 add £100
 - Revolver black inc. arm add £60
 - Revolver Rebel add £150
 - Systemdek + moth add £125
 - Systemtek inc. arm add £30
 - Ariston "Q" Deck add £70
 - Ariston ICON add £60
 - Thorens TD280 II add £80
 - Thorens TD166 V add £30
 - Rotel RP855 add £30

SELECTED SEVENOAKS SUPERBUYS AVAILABLE FROM THESE BRANCHES NEAR YOU

music made live... music made live... music made live...

CYRUS

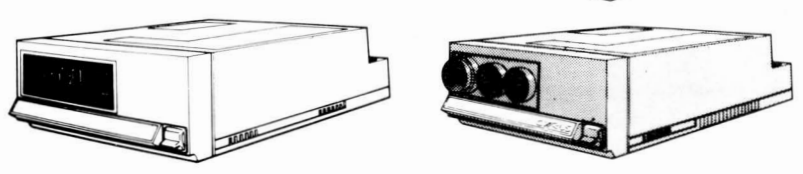

Full range of Cyrus products stocked. 3 year guarantee

**MISSION 767
ON DEMONSTRATION
BOOK YOUR
APPOINTMENT NOW!**



**MISSION
ELECTRONICS**

Full range of Mission speakers stocked. 5 year guarantee

- STOCKISTS OF
- Aura
 - ADC
 - Arcam
 - Aiwa
 - Allison
 - Audiolab
 - Cyrus
 - Celestion
 - Denon
 - Dual
 - Exposure
 - Infinity
 - JPW
 - JVC
 - KEF (reference)
 - Linn
 - Marantz
 - Mission
 - Musical Fidelity
 - NAD
 - Nakamichi
 - Philips
 - PRO-AC
 - Quad
 - Revolver
 - Rotel
 - Sony
 - Systemdek
 - Tannoy
 - Technics
 - Wharfedale
 - Yamaha



Price guarantee

If you can buy cheaper — including leads, cartridge, carriage and 3-Year Guarantee — we will match it. Prices correct for the life of this magazine, but are subject to change*



Free cartridge, cable, 3-year guarantee, carriage*

All systems supplied with cartridge, speaker cable and 3-Year Parts and Labour Guarantee. Carriage is FREE for UK Mainland*

Improved turntables (inc. cart)

Dual C5 430 deduct £20.00 · Dual C5 505-3 extra £5.00 · Revolver Rebel extra £35.00 · Revolver extra £100.00 · Rotel RP855 extra £10.00

CD instead of turntable front end

Denon DCD 520 extra £30.00 · Denon DCD 620 extra £60.00 · Denon DCD 820 extra £110.00 · Denon DCD 920 extra £160.00 · Marantz CD40 extra £60.00 · Marantz CD50 extra £110.00 · Marantz CD50SE extra £160.00 · Marantz CD60 extra £160.00 · Marantz CD60SE extra £210.00 · NAD 5320 extra £50.00 · NAD 5325 extra £80.00 · Rotel RCD 855 extra £110.00 · Rotel RCD 865 extra £140.00 · Philips CD 610 £30.00 · Philips CD 620 £60.00 · Philips CD 630 £110.00 · Philips CD 840 £220.00 · Technics SLP 277 extra £50.00 · Technics SLP 377 extra £60.00 · Technics SLP 477 extra £120.00 · Technics SLP 550 extra £120.00 · Technics SLP 570 £150.00

SUGGESTED SYSTEMS

	Amps		Speakers					
	Wharfedale Delta 30 JPW Minim	JPW Sonata Wharfedale Diamond 4 (extra £10) Celestion 3 Allison AL100	Tannoy E11 JPW Sonata+ Celestion DL411	Celestion DL6 11 Allison AL105	Tannoy M15 Infinity RS2001 W/dale 505.2	Celestion DL 811 Allison AL1 10	Tannoy M20	
All systems come with Dual CS503/2	Arcam Alpha II	349.95	369.95	399.95	419.95	434.95	449.95	489.95
	Denon PMA 250	299.95	317.95	324.95	364.95	385.95	402.95	417.95
	Denon DRA 325R	443.95	461.95	477.95	503.95	527.95	553.95	570.95
	NAD 7020E RECV	379.95	399.95	419.95	439.95	469.95	479.95	509.95
	NAD 3020i	299.95	309.95	329.95	349.95	354.95	384.95	429.95
	NAD 3240PE	384.95	401.95	426.95	443.95	467.95	486.95	521.95
	NAD 3225PE	309.95	329.95	334.95	354.95	369.95	394.95	444.95
	Rotel RA 810A	284.95	304.95	319.95	339.95	359.95	379.95	419.95
	Rotel RA 820AX	314.95	319.95	349.95	369.95	389.95	409.95	449.95
	Rotel RA 820BX4	349.95	359.95	379.95	399.95	419.95	449.95	489.95
	Rotel RA 840BX4	399.95	409.95	419.95	439.95	449.95	479.95	519.95
	Rotel RA 870BX	449.95	469.95	489.95	499.95	519.95	539.95	569.95
	Yamaha AX330E	294.95	304.95	319.95	334.95	359.95	384.95	429.95
	MF B1	354.95	374.95	399.95	409.95	419.95	439.95	494.95

BARTLETT'S

175 HOLLOWAY ROAD, LONDON N.7 TEL: 071-607 2148/2296

Access, Visa cards accepted. Demonstration by appointment. Please phone
Opening times: 9.30-6.00 Mon-Sat.

E & OE

A Pilgrim's Progress

*Fancy getting up to your elbows in a CD player?
David Foxon describes how to make the most of a modest machine*

When I bought my first CD player – the highly recommended Marantz 273SE – I was disappointed by the sound quality through my modestly transparent and neutral system of old Quad electrostatics driven by a Counterpoint SA12 hybrid amp and passive preamp. After many experiments in damping and isolation some of the worst problems were alleviated, but I could see exactly why vinyl lovers condemned CD. It was only when I started tweaking the electronics of an 873SE that I discovered how much better it could be, and found to my surprise that the necessary changes were quite simple and cost less than £50. I don't doubt that more sophisticated modifications which are commonplace in the USA could give even better sound, but in my experience once you've made the electronics transparent the problems of vibration in the transport become the limiting factor. That's material for another article. If you tweak both, CDs can begin to sound as enjoyable as vinyl on all but the most revealing systems.

As you will realise if you read this account, I'm an amateur. Forty years ago I used to design and build my own equipment, but it's only since I retired that I've tried to understand the 'new world' of transistors and op-amps and have once again taken up my soldering iron. As a result, almost all the theoretical discussion here is taken second-hand from the professionals; I hope I've got it right. On the practical side, while the modifications I recommend are quite simple and applicable to almost any Philips or Marantz machine, you should not consider trying them unless you can read a circuit diagram, trace it on the circuit board, make a neat soldered joint, and use solder wick or a solder-sucker to remove components. If anything goes wrong, you'll be lucky to find a professional to put it right.

A circuit diagram of the audio section in typical Philips/Marantz CD players such as the 273SE that David Foxon has been revamping.

Principles

In 1986 Walt Jung, author of the standard work *Audio IC Op-amp Applications* (3rd ed. 1986) wrote an article in *The Audio Amateur* (3/86) claiming that the dual op-amps normally used in the audio stages of CD players, the LM833 and NE5532, were responsible for many of the problems of CD sound because they were not fast enough – he recommended trying the high-speed dual AD712. Major manufacturers have taken little notice and are still using them or the equivalent single versions even in their top-of-the-line two box players. There is, however, support for Jung's view from the chip makers themselves.

Harris Semiconductor, one of the leaders in high-speed op-amps, has a section in the application notes for its 16-bit converter headed 'Any Old Op-Amp Won't Do'. After examining what is necessary the author concludes that 'no single monolithic op-amp can meet all these requirements'; he proposes the use of two sophisticated op-amps with

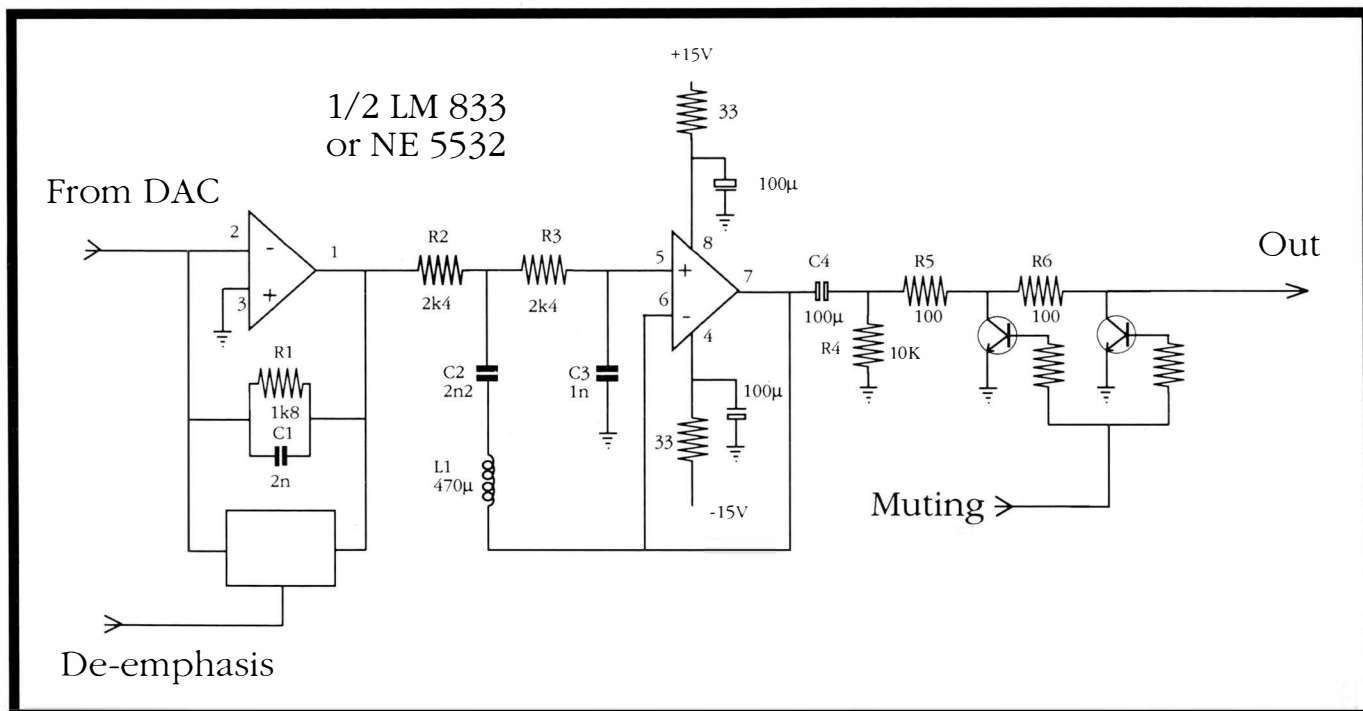

complementary virtues linked by a JFET buffer. Contrariwise, the makers of Jung's proposed AD712 recommend it for use with 12-bit converters, but doubt its capacity to deal with 16-bit systems. Jung himself has recently adopted the principle of adding an LT1010 high-speed buffer to each op-amp.

There are just three simple functions for the audio stages of a CD player. Almost all D/A converters produce their signal in the form of variations in output current, so the first (and most critical) stage is a current-to-voltage converter. Then a filter is needed to remove the high-frequency products of the oversampling digital filter; the four-times system used by Philips calls for an 18dB per octave slope with a 3dB point around 33kHz. Finally we need an output stage with provision for muting the signal.

The circuit that Philips/Marantz has used with only minor changes over the years is shown for one channel in fig. 1. The current output from the DAC is fed to the inverting input of the first half of the op-amp, and the audio voltage is developed across R1 in the feedback loop. The capacitor C1 gives a 6dB per octave roll-off at 44kHz, which forms the first pole of the filter. A further resistor/capacitor network for de-emphasis, switched by an FET under logic control, appears across this. (Later models using the TDA1541A converter reduce R1 to 1k Ω to retain the standard 2 volt output and consequently increase capacitors across it by 20 per cent.)

The remaining 12dB per octave roll-off is provided by the Sallen & Key feedback circuit around the second half of the op-amp, R2, R3 and C2. C3 sets the Q of the filter. The inductor L1 was introduced (and the value of C2 changed) to steepen the curve from the original pure Bessel function in order to reduce the level of spurious around 88kHz which had been blamed for the bad sound of early players. This second op-amp, coupled by C4 and R4, gives a low impedance output. R5 and R6 isolate the output and combine with the earthing transistors to provide muting; more expensive models use a relay.

There is no need to use op-amps for these functions; Jan Didden in *The Audio Amateur* (2/89) proposed using a single transistor (with a constant-current source and an offset-nulling circuit) for the current-to-voltage converter, followed by a passive filter - which only needs a single inductor and a couple of capacitors. The highly-praised Meridian

206 uses this approach but adds an output buffer. Didden gives a distortion figure of less than 0.005 per cent, almost purely second harmonic, at 10kHz and full output. Others have used valves successfully.

Typical op-amps have two main problems in this kind of circuit: inadequate dynamic range at the input and poor drive capacity at the output. The NE5532 has an exceptionally powerful output stage for an op-amp and can sound very pleasant in audio circuits, but its input signal here is not an audio one. After oversampling, the input is essentially in steps at 176kHz in addition to lots of high-frequency rubbish and digital switching spikes; the full-power bandwidth of the 5532 is specified as 140kHz. The problem here is the old one of SID or slew-induced distortion: if the op-amp is not fast enough, the very high level of negative feedback on which it depends for its performance can do nothing to correct the nonlinearities which result from clipping internally. Apart from what that does to the signal, it also destroys the stability of the input stage; and the DAC is dependent for its accuracy on seeing a stable load. At the other end the output stage is having to drive a nasty capacitive load which becomes increasingly demanding at high frequencies.

Let's try and put some figures into the question of speed. The NE5532 has a slew rate at unity gain of around 6 volts per microsecond, whereas the latest generation of op-amps easily reach 50V/ μ s. (Discrete transistor amplifiers have no difficulty in exceeding that.) The AD712 has a figure of 20V/ μ s, but slew rate alone is not the final criterion. Jung has popularized a measurement of input stage overload using the equation $V_{in} = SR / (GBP \times 2\pi)$ (where GBP is gain bandwidth product); this is the maximum voltage step an op-amp can accept without overloading. For the 5532, this works out at less than 0.1 volt, whereas for the AD712 and other high-speed devices it is typically around 1 volt.

Application

When Jung's 1986 article recommending AD712s appeared, I tried without success to find them through the usual suppliers catering to the amateur. (Since then, though I've hardly begun to penetrate the professional supply networks, I've found that some suppliers can be very helpful.) In 1988 they appeared in the Electromail Catalogue (stock no. 637-810) at about £2 each. By then Jung

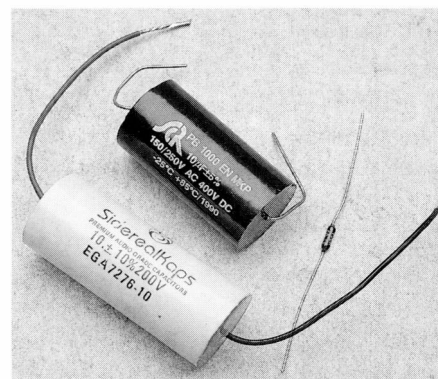

Fancy caps and the diminutive AD712.

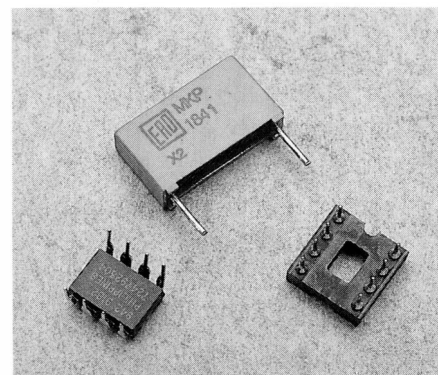

had published an article in *Audio* (June 1987) proposing a simple modification to Philips players, replacing the output capacitors with 330 μ F Panasonic HS types and the 5532s with NE5535s with pull-down resistors. (This bipolar alternative to the AD712 is still not readily available here, so I haven't tried it.) A much more drastic rebuilding project developed jointly with Hampton Childress appeared in the *Audio Amateur* (1,2/88); meanwhile it raised a couple of matters easily included in a simple modification

The first problem was to get at the circuit board. David Heaton of Audio Synthesis had kindly sent me Xeroxes of the circuit and board layout of the CD873, but I had no idea how to take out the player mechanism to get at the board, and anyway the screw heads needed an unfamiliar screwdriver. I now know that Marantz service manuals are readily available from their stores department and that the screwdriver is a Torx no.10. These are elusive, but my local auto parts shop sells a good set of Torx screwdrivers from 8 to 30 at under £10; since Torx is becoming standard on everything from cars to toasters, this isn't a bad investment. At that time, though, the simplest thing seemed to be to cut a hole in the underside of the plastic case; it had the great advantage that I could easily make one change after another to see the effect without the time and trauma of taking it all to pieces. (The whole machine is more resistant to mistreatment than you might fear, but if anything goes wrong

you're on your own – any guarantee is void.) So, with a fine saw and a Stanley knife I cut out a 2.5 inch square beneath the op-amps and associated circuitry, and was ready to begin (alternatively you could use a circular hole cutter).

First came the output capacitors and their load resistors, C4 and R4. Their values can vary in different models; R4 is normally 10k and C4 100 μ F, but the *Special Editions* use pairs of Elna 220 μ F Cerafines back to back, giving an effective value of 110 μ F. (The circuit board makes provision for this and many other variations by the use of surface-mount links which look like resistors.) Jung and Childress recommend the use of a 10 μ F film capacitor of your choice with a 100k resistor to give the same bass extension; on its own that would give a 3dB roll-off at 0.159Hz. (The formula for calculating roll-off frequency is $1/2\pi RC$ where C is in Farads, *not* microfarads. The combinations above are equivalent to 1F and 1ohm; 2π is 6.283, and its reciprocal 0.159.) In practice, the 100k will be shunted by the input impedance of your preamp, and if it has a capacitor-coupled input that will be in series with the 10 μ F, both giving a higher roll-off. (Two resistors in parallel have a value equal to the sum of their reciprocals: $\frac{1}{R} = \frac{1}{R_1} + \frac{1}{R_2}$; the same formula

applies to capacitors in series.) I followed instructions by removing the surface-mount 10k resistors (a very fiddly operation – they are minute, and you may well never see them again – for which the service manual gives instructions) and replacing them with audiophile 100k Holco H8 resistors from Audiokits or RATA. These don't have to be soldered to the original pads; there are usually more kindly spaced alternatives on the tracks.

You may be able to save yourself this unfamiliar task and leave the 10k resistors in place. If, for example, your preamp has a direct-coupled input of 25k impedance, the 100k replacement in parallel gives a product of 20k and a roll-off point of 0.8Hz. Leaving the original 10k would give a total of 7.1k and your 3dB point would rise to around 2.2Hz. You might feel this would meet your needs – indeed you might feel you could save money with a 5 μ F capacitor and be satisfied with a cut-off of 4.4Hz. Don't take the argument too far if you're a perfectionist – remember that in this case there'll be a 0.1dB roll-off at 44Hz and the phase will already be beginning to change. The British are

much more tolerant of early low-frequency roll-off than the Americans – wrongly, I think; Moncrieff and others report that the effects of introducing a roll-off as low as 0.5Hz can be heard in the audio band on first-rate equipment.

Playing safe

There's a hidden hazard that is widely ignored: unless your preamp and amplifier are direct-coupled, there will be other bass roll-offs from coupling capacitors, and these cumulate. If you have two or three around the same frequency you will have 12dB or 18dB per octave roll-offs with consequent phase changes. These result in bad transient response and abnormal demands on the power supply where it is already likely to be stressed. For best results one should stagger roll-offs as well as keeping them as low as possible. You probably have little idea what goes on inside your black boxes, and it's not easy to find out, so there's a good argument for playing safe here with as large a capacitor and resistor as you can manage. That's the reason for the original values.

If you are a hardened tweaker you probably have your own preference for the expensive and bulky Wondercaps from Audiokits or Siderealkaps from RATA, and may wish to by-pass them with 0.1 or 0.01 μ F capacitors to maintain high-frequency response and clarity. For the beginner I would suggest the Solen 10 μ F polypropylenes at around £2 each from RATA. These are now more compact than they were, about the same size as the 5 μ F Siderealkaps. If you use the latter you will have to carefully enlarge the holes in the circuit board. Sleeve and dress the leads against the body and then to a T-shape to minimize the pick-up of electronic dirt. Insert in place of the electrolytics, keeping them apart to minimize cross-coupling.

When you turn on, remember that all these high-end caps need breaking-in; they can sound harsh and bright at first, gradually getting sweeter and sweeter over a week or more. (Cables are the same; I've found Vecteur speaker cable still improving after a couple of months in a friend's system – you wouldn't notice it so clearly in your own. Teflon is notorious for this phenomenon.) This makes trial by substitution meaningless unless the capacitors (or cables) have already been broken in and may explain why some dismiss the improvement they make as fantasy.

There was no doubt of the improvement in my CD player; the original Cerafines sounded very warm and musical but masked a great deal of detail, perhaps because they are heavily damped. There's no doubt that merely changing electrolytic output capacitors can change a player's sound, and you can experiment if you wish. I find that polypropylenes are unbeatable for a sound that is crisp and clear without losing sweetness.

Now to change the op-amps. (The *Special Editions* use NE5532s from JRC which are of superior quality. I've not been able to find out how their specification varies from the original, but it's worth saving them for future use.) I unsoldered them easily enough and substituted gold-plated, turned-pin DIL sockets to make further experiments with op-amps easy. As we have seen, one weakness of all normal op-amps like the AD712 or NE5535 which only draw around 2mA of standing current is that the output is incapable for providing any real power without becoming non-linear. In this circuit they have to drive heavy capacitive loads, so Jung suggested one remedial measure, 'pull-down' resistors between the outputs and the negative supply which will

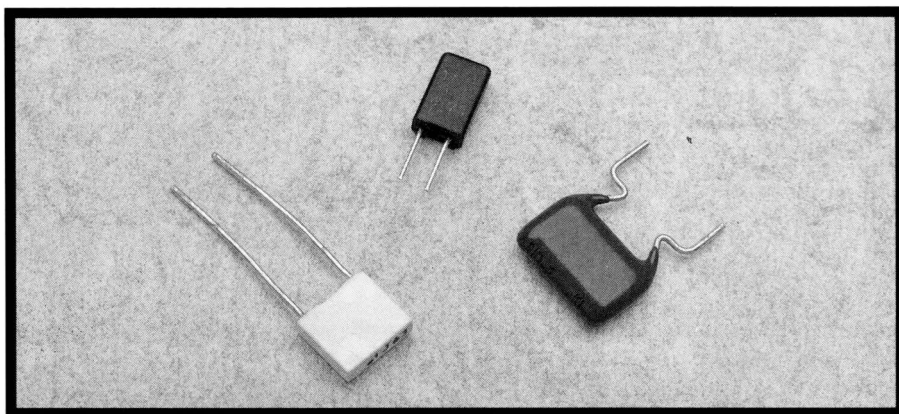

Miniature polyester 0.1 μ F capacitors from Philips (orange) and Wima (red).

BILLY VEE SOUND SYSTEMS

INVITE YOU TO
A MUSICAL EVENING
WITH

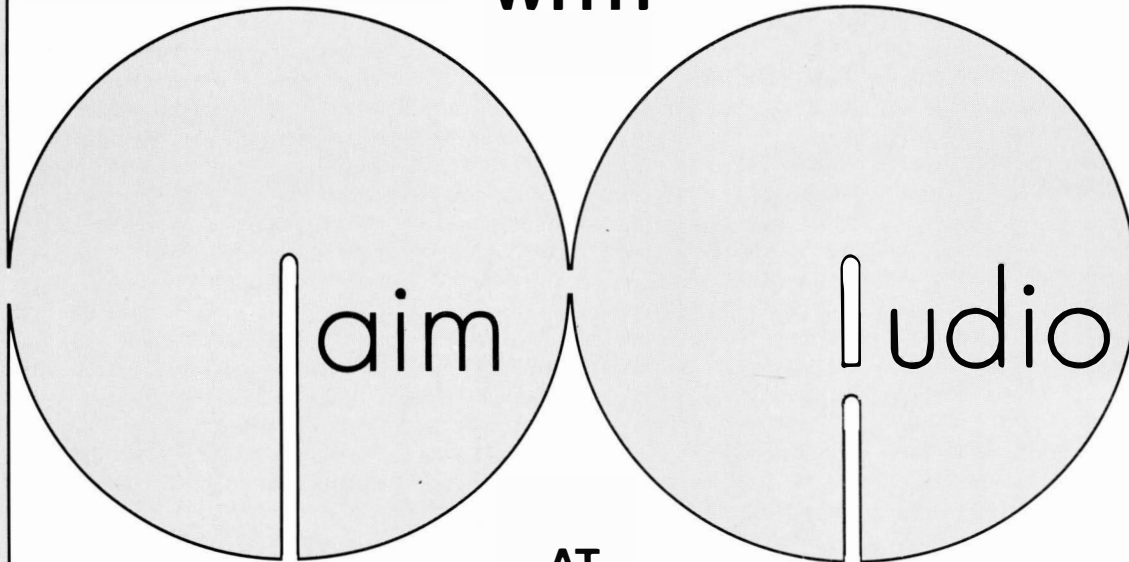

AT
THE CLARENDON HOTEL
MONTPELIER ROW, BLACKHEATH SE3
FROM 7.30pm TO 10.30pm
ON THE 22nd AUGUST 1990
FOR TICKETS CONTACT IAN RIDGE
ON 318 5755 OR WRITE TO THE ADDRESS BELOW



UP TO £1000 INTEREST FREE CREDIT
AVAILABLE TO PERSONAL CALLERS ONLY



EXPOSURE
XI/XII/VIII MR



THE NEW MONO 8
A TRULY STUNNING
PERFORMER

LINN
INTEK AMPLIFIER



BOOK AN APPOINTMENT

NAIM AUDIO
72/HI/250

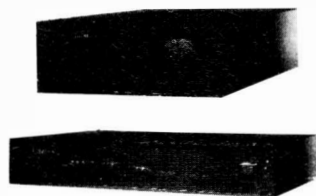

WHO DID WHAT?
AND WHERE?

REGA 2 + CREEK 4040 + AR112 £439
(INC AT95E)

INC 6 MTRS QED 79 SPKR LEAD + T60 STANDS OR INT FREE CREDIT

248 LEE HIGH ROAD, LEWISHAM, SE13.
TELEPHONE 081-318 5755 OR 852 1321
(OPEN FROM 10.00am TO 6.30pm MON-SAT. CLOSED THURSDAY)

AIWA
ARCAM
AR
CREEK
DENON
DUAL
EXPOSURE
HEYBROOK
JPW
KEF
LINN
MARANTZ
MONITOR
AUDIO
NAIM
NAD
NAKAMICHI
QUAD
REVOLVER
REGA
ROTEL
ROGERS
TANNOY
YAMAHA

draw more current through the output stages and bring them further into Class A operation (he now uses a 2mA constant-current source). Accordingly I added 3.9k resistors under the board between the outputs (pins 1 and 7) and the negative supply (pin 4). I used Holco H8 resistors, but they are quite long and tricky to fit; the 0.125W metal-film resistors from Electromail (rated at 0.33W for commercial use) are much easier to handle and seem to be of high quality.

I fitted the AD712s, taking care to protect the pins from static charges by earthing myself (one expedient is to work on a sheet of kitchen foil connected to earth), and switched on – yes, lots more transparency, but I was vaguely uneasy. Although the improvement in detail was obvious, something agreeable that I was accustomed to had vanished. I used the player for several days without identifying the problem and, finding I wasn't enjoying the music any more, I got out the old 5532s to replace them. Then I realised that I had damped them with squares of adhesive Sorbothane sheet at my girlfriend's suggestion when I was damping the DAC: surely that couldn't be the cause of the difference? But it was. I stuck Sorbothane on the AD712s and had all the advantages and none of the problems. I was incredulous, and so will you be; it's like finding the philosopher's stone, pure alchemy. No one I know has ever suggested that op-amps were microphonic – other components like capacitors and transistors, but not them. All I can say is that this was in effect a double-blind test and the difference quite obvious. Try it yourself.

Power supplies

Finally I looked at the power supplies to the op-amps. Ken Ishiwata of Marantz is said to consider that power supplies are responsible for 20 per cent of the sound quality of CD players (as much as the DAC itself) and his *Special Edition* modifications mainly consist of replacing the electrolytics in both digital and analogue circuits with Elna Cerafines, often of larger values. The main reservoirs are bedded down to the circuit board in a sort of mastic. The improvement can be judged from the universal approval from reviewers. Marantz players that have been available in *Special Edition* trim can be brought up to SE spec by Sontec Electronics of Norwich for £50.

One standard audiophile tweak is to

bypass electrolytics with low-value film capacitors which will be effective at the very high frequencies where the increasing ESR (equivalent series resistance) of electrolytics affects performance. So I added 0.1µF polypropylene capacitors soldered directly across the leads of the decoupling electrolytics in the positive and negative supplies. In the 873 and the many similar players these are immediately beside the op-amps; if they are further away as in the later board used for the 583, these additions should go directly from the supply pins 4 and 8 to earth. There's an extra bonus here: as one goes to faster op-amps it's vital to ensure that the supplies are well decoupled at high frequencies to avoid instability.

Because I had cut a hole in the case it was possible to fit the inexpensive Ero 0.1µF polypropylene capacitors from Audiokits – they project slightly through the base. I think it is important to isolate the circuit board from the case to avoid the transmission of vibration, so if you don't cut a hole any alternative should be thin enough to lie flat against the board. That probably means using polyester caps – the miniature dipped case in the Electromail catalogue from Philips (115-578) or the other miniature (114-840) or sub-miniature (115-023) models listed there.

The 33ohm resistors (the values may vary in other models) which feed the positive and negative supplies to the electrolytics and the op-amps appear to provide a normal decoupled supply. (Philips/Marantz labels them as 'safety resistors', and they would limit the flow of current in case of a catastrophic breakdown.) But as we have seen, the op-amps do not operate in Class A; so when a transient or loud passage comes along they call for more current. That inevitably means a larger voltage drop across the resistors and hence less power available. That's just what you don't want, and as a result dynamics seem compressed.

The power rails are provided with three-pin regulators which (in theory at least) provide a very low output impedance and a voltage independent of current, so it should be possible to power the op-amps directly without the current drain of one affecting the voltage and hence the signal of the other. Jung therefore proposed by-passing or replacing the 'safety resistors' with wire links. It certainly works; not only is the dynamic range significantly increased, transients are much cleaner and more

exciting, with a 'rightness' to the pace and weight of the music. Nevertheless, since the op-amps share common circuit board traces as far as the safety resistors (and the negative rail with the DAC supply) there is likely to be some interaction – another reason for adding the 0.1µF capacitors to cope with frequencies where the impedance of the traces become significant. The elegant solution would be to run separate pairs of twisted wires for each op-amp back to the regulators. An alternative solution would be to reduce the resistors to a value like 1ohm which would give some decoupling at the cost of a very slight loss in dynamics – I recently saw this in the schematic of a big Denon amplifier. But despite these theoretical doubts, I've found nothing but good come from this simple change: the results are very obvious. By now my CD player was producing a clear, lively, and detailed sound; I felt my efforts were properly rewarded.

If you are more adventurous you can get even better results by using two separate op-amps per channel, but this calls for a dual header to split the eight pin contacts. One is available from Audio Synthesis at £6, but it may be difficult to fit on some circuit boards; I built my own from three DIL sockets in a U formation, with miniature 470ohm resistors at the inputs to the second amp to prevent instability. I find that OP42s from Electromail (£4) give a sound with the depth and sweetness of valves.

Suppliers

Audiokits, 6 Mill Close, Borrowash, Derby, DE7 3GU. Tel: (0332) 674929

Audio Synthesis, 99 Lapwing Lane, Manchester M20 0UR. Tel: (061) 434 0126

Electromail, PO Box 33, Corby, Northants NN17 9EL. Tel: (0536) 204555

Marantz Audio (UK) Ltd, 15-16 Saxon Way Industrial Estate, Moor Lane, Harmondsworth, Middlesex UB7 0LW. Tel: (081) 897 6633

RATA (Russ Andrews Turntable Accessories Ltd), Edge Bank House, Skelsmergh, Kendal, Cumbria LA8 9AS. Tel: (053) 983 247

Sontec Electronics, Unit 4, 183 Aylsham Road, Norwich NR3 2AD. Tel: (0603) 483675



GLOSSARY

The Hi-Fi Choice dictionary of audio terminology, explaining all the weird and wonderful adjectives used by our reviewers, as well as technical abbreviations.

AM: Amplitude modulated; see 'Medium Wave'.

ACOUSTIC BREAKTHROUGH: Sound that gets into the turntable and hence the cartridge from the air and thereby creates a risk of acoustic feedback.

ACOUSTIC FEEDBACK: If any sound in the room can find its way through the body of the record deck to the cartridge stylus, then that sound will be reproduced from the loudspeakers, along with the wanted programme material. If too much of this sound from the loudspeakers is picked up by the cartridge in this way then a vicious circle of acoustic feedback will be created.

ACTIVE: Speaker systems which contain electronic crossovers and where the drive units are connected directly to power amplifiers.

ALIGNMENT PROTRACTOR: A device used to minimise the lateral tracking error of a cartridge/arm combination.

AMPLITUDE: Size or magnitude; hence the amplitude/frequency response, known normally simply as the frequency response, which describes the relative loudness of the system at different frequencies with a constant input voltage.

ANCHOIC: Without echo; a special room or 'chamber' with thick sound absorbing materials on all surfaces to prevent reflections.

ARM MASS: More accurately called *effective* arm mass, because it is *not* the weight of the arm on a pair of scales. It is the mass of the arm and cartridge combination that appears to be concentrated at, and thus felt by, the stylus tip which is tracking a record groove. There is nothing inherently good or bad about arms with light or heavy effective mass; what matters is the manner and choice of their combination with cartridges of different compliance and the low frequency resonance produced by such combination.

AZIMUTH: With reference to tape and cassette recorders, the alignment of head gap to tape path.

BALANCE: 1) The overall relative loudness perceived at different frequencies (eg bass, treble); 2) the accuracy of the match between the two channels of a stereo transducer (eg cartridge or pair of loudspeakers).

BANDWIDTH: A range of frequencies with presumed defined upper and lower limits.

BASS: Lower part of the frequency spectrum.

BELT DRIVE: The motor has its rotational speed geared down to the required platter speed (33 $\frac{1}{3}$ rpm for LP discs) by a rubber or similar resilient belt which runs round a small pulley on the motor shaft and a large pulley attached to or part of the platter.

BEXTRENE: A plastics material frequently used for bass and mid-range cones.

BIAS: (*turntable/arms*) Because the cartridge on a pivotal arm is being drawn across the record surface by the stylus tracking at an angle offset from the pivots, groove friction produces an imbalance of lateral force. Bias is the application of a compensatory lateral force acting in the opposite direction.

BIAS: (*tape*) This refers to a high frequency current passing through the record head which allows the audio current also passing through the head to produce reasonably linear magnetisation of the tape at all levels permitted by the combina-

tion of each machine with the tape. The lowest level of bias is required for ferric cassettes, a slightly higher one for ferrichrome, an even higher one for chrome or pseudochrome, and the highest for metal.

BOTTOMING: The stylus scraping on the distorted rounded bottom of the groove due to incorrect stylus geometry.

CANTILEVER: The thin rod or tube that connects the stylus to the armature and hence the cartridge body.

CAPACITANCE: An element of electrical impedance that is particularly important when matching pickup cartridge, arm leads and amplifier input characteristics to achieve a flat frequency response from discs.

CLIPPING: This is reached when a circuit is overloaded and overdriven, resulting in bad waveform distortion and audibly unpleasant effects.

COLORATION: A general term used to describe the audible effects of distortions, particularly in loudspeakers and record players. These are usually caused by frequency response irregularities and/or resonances.

COMPATIBILITY: The selection of interdependent components to achieve optimum system performance; notably arm/cartridge mass/compliance matching, cartridge electrical loading, or loudspeaker compatibility with amplifiers.

COMPLIANCE: A measure of the springiness of the cantilever/armature seen from the stylus, expressed in compliance units (Cu), where 1 cu = 10⁻⁶ cm/dyne.

CROSSOVER: An electrical circuit which uses combinations of inductors, capacitors and resistors to divide the signal from the power amp into the required frequency bands and with any necessary equalisation for feeding to the individual drive-units of the speaker system.

CROSSTALK: The leakage from one channel to the other in a two channel stereo system.

CUTTER: Mechanism used to cut recorded signal onto lacquer master; consists of turntable, lathe, cutting head, cutting and servo amps.

DIN: German standards body, responsible amongst other things for a popular range of standard plugs and socket specifications.

DAMPING: A means of controlling resonances by means of a resistive medium (electrical, mechanical, or acoustic depending on situation).

DECIBEL (dB): A logarithmic unit that is convenient for expressing ratios that span a wide range on a linear scale. For simplicity it can be regarded as a measure of relative loudness.

DISTORTION: Literally this can mean any deviation from the original, but usually refers to harmonic rather than intermodulation distortions when not specified.

DOLBY: Covers various signal processing/deprocessing systems, but normally refers to the B & C noise reduction systems used in cassette record/replay, and the B system used for music-cassette replay.

DOPING: A technique involving the application of damping to a loudspeaker driver cone in order to assist in controlling resonances.

DOWNFORCE: The weight, measured at the stylus, which holds it down in the groove.

DRIVE UNIT (DRIVER): The term used to distinguish the loudspeaker unit itself, be it bass, midrange, treble or fullrange in application, from the complete loudspeaker system which combines drive units, cabinet and crossover into a total design.

DROPOUTS: Momentary reductions of programme level due to inadequate head/tape contact caused by oxide particles shedding off the tape onto the head gap, or inadequacies in tape transport or tape.

DYNAMIC RANGE: The ratio in dBs between the quietest sound that can be successfully recorded and the loudest which can be accepted without serious distortion on an average programme.

EFFECTIVE MASS: The inertia, or mass-controlled resistance to movement, of a device, particularly important with regard to tonearms.

EFFICIENCY: The amount of acoustic power delivered for a given electrical input power.

ELECTROSTATIC: A principle employed in some loudspeaker transducers using static electricity effects to set up a polarising field within which the modulated transducer medium moves.

ELLIPTICAL STYLUS: A specially shaped stylus profile that makes the 'plan view' radius along the length of the groove smaller than the 'elevation view' contact radius viewed from the front.

EQUALISATION: (*general*) The deliberate modification of frequency response, usually in response to some engineering limitation or deficiency.

EQUALISATION: (*tape*) This refers to the necessary change in frequency response required of an amplifier so that overall flat frequency response is obtained from a tape medium. Equalisation is required both on record and replay. Any tape recorded on a good cassette recorder should have the same inherent response when played back on another correctly set up machine, since all playback equalisations should have been standardised. These standards are normally specified by the time constants of the circuits involved, eg 79 μ s or 120 μ s (see 'Microseconds').

FARAD: Measure of capacitance.

FM: Frequency modulated; often used to describe radio transmissions of high fidelity potential on the VHF band.

FARAD: Measure of capacitance.

FERRITE ROD: A short rod type aerial used for AM reception; may be fitted internally or externally to a tuner or receiver.

FERRO-FLUID: A magnetic fluid which is introduced into the voice-coil gap to provide damping and/or improved cooling.

FILTER: A circuit (normally) used to restrict the bandwidth of a system; may be fixed or switchable.

FREQUENCY RANGE OF SPECTRUM: Can refer to any particular group of frequencies, but commonly applied to the audible band from 20 to 20,000 cycles per second (Hz), extending from the deepest bass to the highest audible harmonics.

FREQUENCY RESPONSE: The variation in output over a frequency range, particularly of a transducer; can be expressed as a range with decibel limits, or depicted graphically.

Hz (HERTZ): 1 Hz = 1 cycle per second and is a measure of frequency which corresponds to musi-

cal pitch (the higher the frequency the higher the pitch).

HF: High frequency.

HARMONIC: Harmonics are the whole number multiples of a base frequency called the *fundamental*.

HARMONIC DISTORTION: The addition of unwanted harmonics to a signal.

HUM: A low frequency interfering sound produced by break-through or interference from mains wiring or circuitry.

IHF: American Institute of High Fidelity, an important standards body.

IEC: An international standards body.

IMPEDANCE: Measure of resistance (and reactance) in alternating (ie audio) signals; this is of some importance in the compatibility of both cartridges and headphones with amplifiers. For convenience sake is measured in ohms.

INTEGRATION: Used to describe the success with which the output from two drive units combine to give smooth output through the crossover region.

INTERMODULATION (IM): A form of distortion arising from two or more signals producing non-harmonic signals that correspond to the sum or difference of the two frequencies.

KILO (k): prefix meaning one thousand.

LED: Light Emitting Diode; an indicator light.

LF: Low frequency.

LATERAL FRICTION: The resistance to movement of an arm and cartridge combination in the horizontal plane (ie across a record), caused by friction in its bearings.

LINEAR: A transducer that produces an output that exactly portrays its input over the required operating range is described as linear, and is hence distortion free. Hence also nonlinearities (distortions).

LINE-CONTACT: A special stylus profile that extends the ellipse, increasing contact length up and down the sides of the groove.

LOAD OR LOADING: The impedance (including resistive and reactive components, ie ohms, mH, pF) seen by one component looking back to its interconnected component; of importance in compatibility of cartridge/amp, and amp/headphone.

'LOUDNESS': An equalisation circuit frequency switchable on amplifiers which is designed to compensate for presumed hearing characteristics at low listening levels by boosting bass and treble.

MOL: Maximum operating level of tape normally referring to 5% distortion of 315Hz or 3.15kHz.

MEDIUM WAVE: An AM transmission band incapable of high fidelity signals.

MICRO-(μ): Prefix for units meaning one millionth of.

MICROSECONDS (μ s): The time constant of a resistor capacitor combination involving a frequency response change (equalisation).

MIDRANGE, MIDBAND: The central part of the audible frequency range where the ear is most sensitive.

MILLI-(m): Prefix for units meaning one thousandth of.

MODULATION: The audio signal is 'stored' by means of modulations within a medium, eg the 'wiggles' in the groove of a plastic disc, or the

magnetic coding on a tape.

MODULATION NOISE: An additional noise added to tape noise, which increases with the degree of modulation of the tape, caused by the properties of the magnetic coating. This noise has most of its energy near the modulation frequency (causatory tone).

MOVING COIL: A transducer (eg cartridge or headphone) where the signal is generated by the movement of a coil within a magnetic field.

MOVING MAGNET: The most common form of cartridge transduction, where the magnet moves while the coils are held relatively stationary.

MULTIPLEX FILTER (MPX): A circuit which introduces severe attenuation at supersonic frequencies to decrease interference encountered with the output from some stereo FM tuners.

NANO (n): Prefix meaning a thousandth of a millionth of.

NOISE: Random unwanted low level signals.

NOISE MODULATION: An unwelcome breathing effect that can be heard on some programme material, produced by poor noise reduction systems, or circuits.

OCTAVE: Two-to-one ratio of pitch or frequency.

OFFSET ANGLE: The angle measured between the centre line of the pickup cartridge and the line which joins stylus and arm pivot point.

OHM: Unit of electrical impedance (including reactance) or resistance; also kohm, where 1 kohm = 1,000 ohms.

OVERHANG: The extent to which the cartridge stylus extends beyond the centre of the platter is critical, and controlled by fore and aft adjustment of the cartridge on the arm.

PASSIVE: The most common type of system, where drivers and crossover are driven from a single power amplifier.

PEAK RECORDING LEVEL: A level above which distortion becomes apparent. This distortion is introduced when the oxide particles almost reach magnetic saturation, and thus will accept no more level.

PHONO: The most commonly used plug/socket combination in audio components.

PICO (p): Prefix meaning one millionth of a millionth of.

PORT: An opening in a cabinet which is tuned to characteristics of the bass driver and the enclosure volume to provide reflex type bass-loading.

POWER AMPLIFIER: The part of an amplifier that provides power to drive the loudspeakers; usually integrated, it is sometimes a separate component.

PREAMPLIFIER: The part of an amplifier that accepts the input signals, sorts them, applies any necessary equalisation, and then passes the signal to the (normally integral) power amplifiers.

PRESENCE: A quality of forwardness or immediacy in a sound balance, generally related to an upper-middle frequency response boost.

PRINT-THROUGH: A pre- or post-echo of a loud signal created by magnetisation occurring from one layer to an adjacent layer after the tape has spooled or been recorded.

Q: A measure of the magnitude and shape of a resonance; the higher the Q, the sharper and more severe in amplitude the resonance.

REFLEX: a system of bass loading (using port or ABR) which offers improved efficiency and bass power handling at the expense of subsonic control compared to a sealed box.

RUMBLE: The low or medium frequency sound produced mechanically by any moving parts in a turntable, mainly the motor and platter bearings.

SENSITIVITY: The volume of sound output for a specific electrical voltage input.

SEPARATION: As between the two channels of a stereo pickup; see *crosstalk*.

SHIBATA: A special stylus extending the elliptical to a 'line-contact' type of profile.

SIDE-THRUST: A force acting on cartridges in pivoted (ie not parallel tracking) arms, due to the stylus/vinyl 'friction' acting along the line of the offset angle; hence bias or side-thrust compensation.

SIGNAL-TO-NOISE, SIGNAL/NOISE, S/N: The difference in total output when an applied signal is removed.

STYLUS: The specially shaped piece of diamond in contact with the groove and connected to the cantilever.

SUBSONIC: Below the audible range, ie below 20Hz.

SQUARE WAVE: A signal which consists of a fundamental plus a (theoretically infinite) series of odd (3rd, 5th etc) harmonics in a precise phase and amplitude relationship. It is useful for examining transient performance, symmetry, resonance control and 'ringing'.

THD: Total harmonic distortion.

TRACING: The following of the groove modulations by the stylus; hence for example tracing distortion, caused by the inability of a spherical stylus to trace the high frequency inner grooves on a disc.

TRACKABILITY: The ability of cartridge to cope with large amplitude modulations (or of the arm and cartridge to follow the groove itself properly).

TRACKING ERROR: The discrepancy between the truly tangential angle at which a record is cut and the slightly off-tangential angle at which it is tracked by a stylus on a pivoted arm during some parts of the arm's travel.

TRANSIENT: Signal of very short duration.

TREBLE: Upper part of frequency spectrum, typically above about 3kHz.

TWEETER: A small drive unit designed to operate over the high frequency range.

ULTRASONIC: Frequencies above audibility, ie greater than 20kHz; also *supersonic*.

VERTICAL TRACKING ANGLE (VTA): The angle at which the plane of motivation of the stylus is set with respect to the vertical when viewed from a side elevation of the cartridge. Should match the 20° cutter standard.

WEIGHTING: A factor or function that is applied to a measurement to increase its relevance and usefulness.

WOOFER: A drive unit that operates over the bass portion of the audio range.

WOW AND FLUTTER: Low and high frequency pitch variations (from poor tape transport of turntable platters with speed drift).

DEALER GUIDE

BEDFORDSHIRE



PINK TRIANGLE, REVOX, ACOUSTIC ENERGY, MUSICAL FIDELITY, INCATECH, MICHELL, YAMAHA, STUDIO POWER, KENWOOD, ARISTON, MOTH, SME, etc.
WENTWORTH AUDIO
 83 HIGH STREET NORTH. DUNSTABLE
 TEL DUNSTABLE (0582) 663383
 OPEN MON-FRI 2.30-7.30 SAT 10-5.30

CHESHIRE



AIWA ■ CASTLE ■ QED ■ PHILIPS ■ SONY ■
 TECHNICS ■ MORDAUNT SHORT ■ CELESTION ■
 REVOLVER ■ CREEK ■ B+W ■ AURA ■
 INCATECH ■ HECO ■

4 Duke Street, Congleton (0260) 273206
1 Stanley Street, Leek (0538) 383780



STOP PRESS
 Arcam
Musical Evening
on Wednesday 5th
September 1990
Free tickets
available now.

4 WEST STREET
 ALDERLEY EDGE
 CHESHIRE
 0625 582704
 Closed Monday

MARANTZ SPENDOR KEF
 AUDIO-TECHNICA TANNOY
 QUAD ARCAM REVOLVER
 YAMAHA STAX
 MORDAUNT-SHORT SME
 DENON CELESTION
 MONITOR AUDIO ROGERS
 B+W NAKAMICHI CELLO
 MERIDIAN AUDIOLAB
 AMADEUS ZARATHRUSTRA
 CAMBRIDGE AUDIO ROTEL
 ROKSAN

DISCOUNT CD & TAPE
 EXTENDED GUARANTEE
 INTEREST FREE CREDIT



DURHAM



neat hi-fi
 NORTH EASTERN AUDIO TRADERS

The North's Specialist Dealer in Used and Ex Dem. equipment.

ALL EQUIPMENT FULLY GUARANTEED -
 *VISA/ACCESS/MAIL ORDER FACILITIES
 *EFFICIENT SERVICE DEPT
 *SEPARATE DEMONSTRATION ROOM

62 HIGH NORTHGATE, DARLINGTON
TEL: 0325 460812

ESSEX



... sounds outstanding

ADC · AKAI · ARCAM* · BANG & OLUFSEN · CELESTION
 CAMBRIDGE AUDIO* · DUAL · HARMAN KARDON
 MERIDIAN · MORDAUNT-SHORT · MUSICAL FIDELITY
 PIONEER · QUAD* · RUARK · SONY · YAMAHA

*Epping and Saffron Walden only

148 HIGH STREET · EPPING · ESSEX · TEL: (0378) 74242
 26 KING STREET · SAFFRON WALDEN · ESSEX · TEL: (0799) 23728
 70 SOUTH STREET · BISHOP'S STORTFORD · HERTS · TEL: (0279) 656401

HAMPSHIRE

COMPACT Music
 THE HI-FI SPECIALISTS

ACOUSTIC ENERGY, AUDIO TECHNICA,
 CAMBRIDGE AUDIO, CASTLE, DELTEC, DENON,
 DUAL, KENWOOD, PINK TRIANGLE, PROAC,
 QED, ROTEL, SD ACOUSTICS, SENNHEISER,
 SME, STANDESIGN, SYSTEMDEK,
 TARGET, TANNOY, WHARFEDALE.

27, Market Parade, Havant,
 HAMPSHIRE PO9 1PY.
 Tel: (0705) 473952.
 OPEN 10-1, 2-6 TUES - SAT



STOCKISTS OF:-
 AIWA, AKG, A.R., ARISTON, BOSE, B&W, CREEK,
 CYRUS, DENON, DUAL, GOLDRING, KENWOOD,
 MAXELL, MISSION, MORDAUNT SHORT, NAGAOKA,
 NAKAMICHI, PIONEER, PHILIPS(CD), Q.E.D.,
 SENNHEISER, SONY, STANDESIGN,
 TARGET, THAT'S, YAMAHA.

BRANCHES AT
 24, Arundel Way Portsmouth. 174, Fratton Road Portsmouth.
 Tel: 0705 811230 Tel: 0705 864756

SOUND WAVES

NAIM, LINN, CREEK, EXPOSURE,
 ARCAM, MORDAUNT SHORT,
 EPOS, DENON, NAKAMICHI ETC.
 CLOSED MONDAYS . 3 YRS GUARANTEE

1 Holbury Drove Precinct, Holbury, Hants.
 Tel: 0703 899131

HERTFORDSHIRE

The Audio File

27, Hockerill St,
 Bishops Stortford,
 Herts. 0279 506576.

1988. Sony-Hi-Fi News Regional Award Winner.
 F.B.A. National Dealer Award.

1989. Sony Hi-Fi News National Award Winner.
 F.B.A. National Dealer Award.

NEED WE SAY MORE.

TO ADVERTISE IN THIS SECTION PLEASE CALL
JANE WOOLNER
ON 071 631 1433

HUMBERSIDE

MANDERS HI-FI LTD.

For: Nakamichi, Quad, Dual,
 Kef, Michell, Denon, Revox, Harman-Kardon,
 A+R, Thorens, QED, Sendor, Monitor
 Audio, Rotel, Ariston, Revolver, Technics,
 Musical Fidelity, Wharfedale, Celestion,
 Meridian, Proton, A.E. Speakers etc.

Two year guarantee on hi-fi.

**2 Edward St, Grimsby,
 Humberside**
(0472) 351 391

ISLE OF MAN

DOUGLAS SHOP
 NOW OPEN
 ON LOCH
 PROMENADE
 0624 74505

0624-815521

ARISTON · AKG · HECO · SNELL · GOLDRING · ARCAM ·
 PHILIPS · JBL · BURE · MUSICAL FIDELITY ·
 PARLIAMENT SQUARE · RAMSEY · ISLE OF MAN
 9-5:00PM

TELE: (0624) 815521

ORIGIN LIFE · OPERING TIMES · MON-SAT

INNOVATIONS · MICHELL ·
 BEYER DYNAMICS ·
 KOSS · SUGDEN · TEAC · PHILIPS ·
 SUGDEN · WHARFEDALE ·

ISLAND COMPACT DISC & HI-FI CENTRE

KENT

HI-FI CENTRE Ltd
 The new specialist Hi-Fi shop in Ramsgate

RADFORD KENWOOD *MARANTZ*
 CELESTION GOODMANS *TANNOY*
 ARISTON NAD*

For all your Hi-Fi needs call at:
65 King Street, Ramsgate, Kent
 or phone us on 0843 590321 (fax: 0843 581962)

* Trade in * Service and repairs * Credit (subject to status) *
 * Visa * Access * Hi-Fi Markets card *
WRITE OR PHONE FOR OUR MAIL ORDER PRICE LIST

LANCASHIRE

MS MONITOR SOUND

Hi-Fi Specialists

■ A & R Cambridge ■ Ariston
 ■ B&W ■ Castle ■ Celestion
 ■ Creek ■ Denon ■ Dual
 ■ Foundation ■ Kenwood
 ■ Marantz ■ Mission ■ Monitor Audio ■ Mordaunt Short ■
 ■ Nakamichi ■ Pioneer ■ Philips CD ■ Quad ■ Rogers ■
 ■ Rotel ■ Revox ■ Sony ■ Sendor ■ Tannoy ■ Technics
 ■ Thorens ■ Yamaha etc.

Two year guarantee
Private listening room
 Excellent comparator demonstrations

54 Chapel St., Chorley, Lancs.
 Telephone (02572) 71935

CLASSIFIED

DEALER GUIDE

LONDON

▲AUDIO▼ENUE

AUDIO CONSULTANTS AND RETAILERS

24, CHURCH ROAD, CRYSTAL PALACE,
LONDON SE19 2ET - TEL: 01-771 7787

Stockists of: Linn Hi-Fi, Naim Audio, Creek,
Audio Tech, Epos, Denon, Dual, Revolver, BLQ,
Yamaha, Marantz, Nakamichi, Cambridge etc.

2 single speaker demonstration rooms,
Interest free & various credit facilities available.
All equipment delivered & installed.
Comprehensive turntable rebuilds etc

2 year warranty
Open 10-6pm - Closed all day Wednesday



NORTH HANTS

THE AUDIO SHOP HI-FI SPECIALISTS

Appointed stockists of loudspeakers from:-
Castle, Creek, Denon, Goodmans, JPW, Mordaunt-Short,
Rotel, Royd, Ruark, Tannoy.

(Demonstration Room)

Coffee Tavern Court,
37a High Street, Rushden.

Tel: (0933) 56651

OXFORDSHIRE

o v e r s e e HI-FI SPECIALISTS

arcam	jpw
audiolab	linn products
creek	marantz
cyrus	mission
denon	mordaunt-short
dual	quad
epos	yamaha



3 Church Lane, Banbury, Oxon
(0295) 272158

SHROPSHIRE

Mid Shropshire Audio

4, Holland Court, Dawley, Telford, Shropshire
Telford (0952) 630172

Agencies include: Alexander, Apollo, Ariston,
Audio Innovations, Audio Technica, Bose, Cam-
bridge Audio, Denon, Dual, Goldring, Heco, Ion
Systems, JBL, Manticore, Marantz, Michell,
Monster, Moth, Onkyo, Ortofon, Pink Triangle,
QED, Royd, Ruark Acoustics, SD Acoustics,
Sennheiser, Sherwood, S.M.E., Snell, Soniclinc,
Systemdek, Tannoy, Target, That's Tape.

Credit facilities - 2 demonstration lounges. Ac-
cess, Visa. Open six days a week, Sundays and
evenings by arrangement. We specialise in audio
visual and surround sound (Marantz SP50) also
pub/club sound systems (no labour charges).

SHROPSHIRE HI-FI THE HI-FI SPECIALIST

ARISTON, AUDIO TECHNICA, CAMBRIDGE AUDIO,
CELEF, DELTEC, DENON, DUAL, HEYBROOK,
INFINITY, MANTRA, MORDAUNT SHORT, MUSICAL
FIDELITY, MONITOR AUDIO, PROAC, QED, ROTEL,
TARGET, TEAC, ROKSAN, TOWNSHEND, ETC.

Demonstration Room. Free Parking. Free
installation. Repairs.
CLOSED THURSDAY

SHROPSHIRE HI-FI, ST. MICHAEL'S
STREET, SHREWSBURY 0743 232065
SMC GROUP

SHROPSHIRE

SHROPSHIRE'S HI-FI CENTRE!

Quad
B&W
Kenwood
JVC
Celestion
NAD
Onkyo
A&R
Nakamichi
Beyer Dynamic
Dual

AVON Hi-Fi Limited

12 Barker Street, Shrewsbury
(0743) 55166

SUSSEX

SUSSEX AUDIO

MID SUSSEX ELECTRONICS

EXPOSURE · MANTICORE · ROKSAN
AR · NAD · CAMBRIDGE · B&W
TANNOY · NAKAMICHI · DENON
RUARK · PIONEER
PHILIPS · CELESTION



163-165 CHURCH ROAD,
BURGESS HILL, WEST SUSSEX.

(0444) 242336

HIFI MARKETS

Eastbourne Audio

Audio Innovations, Castle, Celestion, Chord, Finestra,
Kelvin Labs, Nakamichi, Pink Triangle, Oracle,
Radford, Snell, Sumo, Spondor, Townshend,
Yamaha and many more.

16, Albert Parade, Green Street, Eastbourne,
BN21 1SD. Tel: (0323) 25828

PERFECT FIDELITY

That's our goal at the REFERENCE STUDIO.

Every item of Hi-Fi equipment adds some form of
colouration. We however have tested many items
and after careful selection can offer some of the very
best. If your quest is total fidelity to music then give
us a call to make an appointment for a demonstra-
tion in our superb studio.

"HIGH END SPECIALIST"

* MEGAVOX LUMLEY * ACOUSTAT * NRG *
DIAMOND ACOUSTICS * ZARATHUSTRA

* DELTEC * TOWNSEND * THRESHOLD
* MAGNUM * RADFORD * MARK LEVINSON *
CARDAS * KISEKI * KIMBER * SLATE * CONRAD
JOHNSON * VANDERSTEEN * CHORD * WADIA etc.

Ben Jeffries

THE REFERENCE STUDIO
HEATHFIELD SUSSEX 04352 8004

FOR
YOUR
HI-FI
NEEDS

BOWERS & WILKINS WORTHING

1 Bucket Buildings, Little Hampton Road.

Tel: 641 41

SUSSEX



KENWOOD · MARANTZ · CAMBRIDGE ·
HECO · INFINITY · SUGDEN · NAKAMICHI ·
ROTEL · B&W · BOSE · REVOLVER · SUPRA
· AURA · MICHELL · MUSICAL FIDELITY ·
TANNOY · NORDMENDE · ALLISON ·
DENON · CERWIN-VEGA · PIONEER ·
HARMAN · MONITOR AUDIO · DUAL ·
AKAI · JBL · YAMAHA · LOEWE · SONY

LASER DISK - CD - CDV STOCKIST
72 Terminus Road, Eastbourne
E. Sussex BN21 3LX Tel (0323) 640911

WEST MIDLANDS

BRIDGE HIFI

3 Tudor House, Bridge Street, Wasall. (0922) 640456.
NAD, Dual, Yamaha, Kenwood, Technics, Pioneer, Mission,
Celestion, Denon, Mordaunt Short, Marantz, Aiwa, Akai.

Demonstrations, Home trial and free
installations. Access, Visa, Diners, Amex.
Credit to £1,000. 9.15-5.30. Mon-Sat
Service Dept.



Tel: 0922
473499

MAINWAY Hi-Fi Centre.

Tel: 0922
473499

Private Listening Studio

Ample free parking. Instant credit. 2 Year
Guarantee. Free delivery. Service dept. The
Midlands British Hi-Fi Centre. Exclusive Audio.
Quality Surroundings.

Sharing Asda Car Park,
High Street, Bloxwich,
Walsall, West Mids.



Norman H. Field Hi-Fi

Consultants for Home High Fidelity

■ B&W ■ Thorens
■ Denon ■ Tannoy
■ Castle ■ Yamaha
■ Dual ■ Kenwood
■ Mordaunt-Short
■ Technics



Two-year guarantee
Private listening room

HURST STREET
BIRMINGHAM B5 4BJ

Telephone: 021-622 2323

EIRE

DUBLIN

STUDIO ONE VIDEO — HI-FI — T.V.

DENON : MISSION : REGA : DUAL :
SENNHEISER : AR : SONY :
TECHNICS : PIONEER : NAGAOKA

Trade ins taken

17/18 Upper O'Connell St.,
Dublin 1, Ireland.
Tel. 742550

CLASSIFIED

DEALER GUIDE

N.IRELAND

BELFAST

SONY
HIFI
NEWS
RECORD COMPANY

DEALER OF THE YEAR
SCOTLAND & N. IRELAND

6. HOPE STREET, BELFAST
TEL: (0232) 332522 OPENING
HOURS MON-SAT 10AM -
5.30PM THURSDAY TIL 8.30

ZEUS Audio



FOR SALE -TRADE

WHAT RUSS ANDREWS CAN DO FOR YOUR CD PLAYER

If you love CD definition, impact, solidity and clarity but want analogue openness, smoothness, reality and involvement as well, you have just found the answer - our accessories will give you exactly that.

- **TORLYTE CD PLATFORM** Improves all round performance but particularly bass definition and imaging.
- **KIMBER KABLE INTERCONNECTS** will give sweeter high frequencies, more believable voices and a more spacious, relaxed sound stage.
- **KIMBER KABLE DATA LINKS** for two box players are a revelation in all areas!
- **KIMBER KABLE MAINS CABLE** eliminates that high frequency aggression so common in CD players and seriously improves bass too!

Send for full details and prices. We accept credit card telephone orders. Full money back guarantee if you are not delighted.

RUSS ANDREWS TURNTABLE ACCESSORIES LTD
EDGE BANK HOUSE, SKESMERGH, KENDAL,
CUMBRIA LA8 9AS TEL: SELSIDE (053 983) 247

WANTED

BUY! SELL! EXCHANGE!

We accept for cash or exchange **ALL 2nd hand Audio & Video** equipment. Everything accepted in **ANY** condition - absolutely nothing **MUSIC & VIDEO EXCHANGE**
56 Notting Hill Gate, London W11
Open 7 days 10am - 8pm
Tel: 071 727 0424

FOR SALE -PRIVATE

FOR SALE -TRADE

ANALOGUE EXPERIENCE LTD

Your sound is affected by the National Grid

The A.N.E.X. FE150 is not just another passive mains filter or conditioner

The A.N.E.X. FE150 is the only quartz referenced AC synthesiser supplying 150w of clean immediately available power.

For a 14 day home trial & further details contact
Analogue Experience Ltd, 114 Manxman Rd,
Blackburn, Lancs BB2 3EP
Tel: (0254)676538



STOP

the noise from domestic electrical equipment eg. fluorescent lights, televisions, fridges, etc. affecting your Hi-Fi system by fitting a **Lynwood Mains Conditioner**. This results in :-

- ★ Huge increase in soundstage width, height and depth.
- ★ More space around each now clearly distinct instrument.
- ★ Much deeper, extended bass with better control and focus.
- ★ More natural, relaxed sound especially with CD. Cuts out RF interference.

This is the only unit we have found which accomplishes these things without degrading the music in any way. The Lynwood Conditioner will supply over 500 W of clean power and is fitted into an expanded mains plus to replace the ordinary plug on your equipment leads or extension sockets. Available on a sale or return basis for

£49.95
incl P&P send a cheque or SAE for further information to
LYNWOOD ELECTRICS
Coley Lane Farm, Wentworth,
Rotherham S62-750

Snell Type A II, Oak finish, very rare, (£4250 new), £3100.

Snell Type E with Pirate Stands (£1408 new) slight cabinet damage hence £1000.

Audio Innovations 15 watt Triodes (second audio amplifier) (£2500 new) - ex demo £1850

Octave Research Amplifier ORI, 40 watts, Class A very rare - sought after. Designed in conjunction with Snell Acoustics £3000.

Acoustic Energy AEII, 12 months old, £550.

Monitor Audio 852MD Loudspeakers £200.
Tel: 0602 813562

Deltac DPS-50, **DPA-50 Pre Power Amplifier** with cables £1000. **Snell JI II Speakers** with Pirate Stands £600. **Beard P50 Power Amp** £225.
Telephone Dean on 00742 533009.

Rata Torlyte turntable stand. Rare opportunity to purchase this Hi-Fi industry reference table. Realistic offers over £120 required. Box 279, Hi-Fi Choice Advertising Dept., 14 Rathbone Place, London, W1P 1DE.

HI-FI CHOICE CLASSIFIED

RATES PER ISSUE: Private 40p per word minimum £10 (including VAT) Trade 47p per word minimum £15 (including VAT)

CLASSIFIED COUPON

Please tick the heading under which you would like your ad to run

For Sale / Private For Sale / Trade Wanted Services Music

Box Number required (£3 extra) Yes No

One Word Per Box (Please include address/tel. no.)

Number of issues to start from _____
Unless otherwise requested advertisements will be placed in the first available issue.
Name: _____
Address: _____
Tel No: _____

Expiry Date _____
For the sum of _____
Signature _____
Date _____

Please make cheques payable to Dennis Publishing Ltd.
Please return completed coupon to Hi-Fi Choice Classified, Dennis Publishing, 14 Rathbone Place, London W1P 1DE

Terms and Conditions

1. The publishers reserve the right to refuse advertisements at their discretion.
2. Whilst the publishers will endeavour to take every care in the preparation of the advertisement no liability for any errors will be accepted.
3. Orders for lineage ads can only be accepted when supplied on the coupon provided - no telephone orders will be accepted.
4. The copy for inclusion in the August issue must reach the Hi-Fi Choice office by 21st June 1990

CLASSIFIED



good dealer
good equipment

the foundation of a good music



system
from

Hampshire Audio Ltd

Kingfisher House
2-12 Hursley Road
Chandlers Ford, Hants SO5 2FU
Tel: Southampton (0703) 252827 & 265232

We stock selected items for: Aloi, Audiolab, A&R, Audio Technica, B&W, Celestion, Celet, Cliff Stone, Creek, Cyrus, Denon, Dual, Gale, Goldring, Gyrodek, Heybrook, Hunt, Infinity, Jordan, KEF, Koetsu, Linn, Marantz, Mark Levinson, Maxell, Meridian, Michell, Mission, Monitor Audio, Monitor PC, Musical Fidelity, Nagaoka, Nakamichi, Ortofon, Perreux, ProAc, QED, Quad, Revolver, Revox, Rogers, Rotel, Sennheiser, Tannoy, Target Audio, Supex, Wharfedale, and others. Active systems on demonstration.

with
The new **Cyrus** amps -

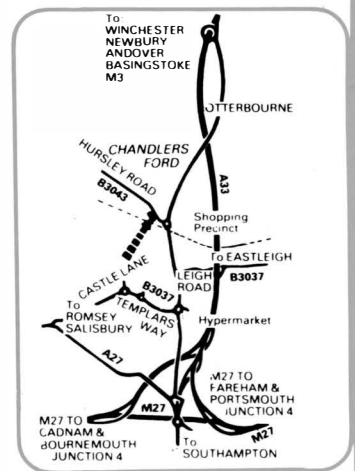

OPENING HOURS
TUES-SAT 10-6 THURS 10-8
CLOSED MONDAYS
(EXCEPT IN DECEMBER)

Audiophile Recordings

Our mail-order service allows Hi-Fi Choice readers to buy some of the world's best audiophile records and CDs.

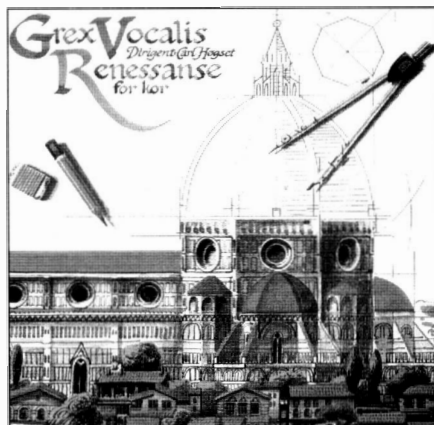
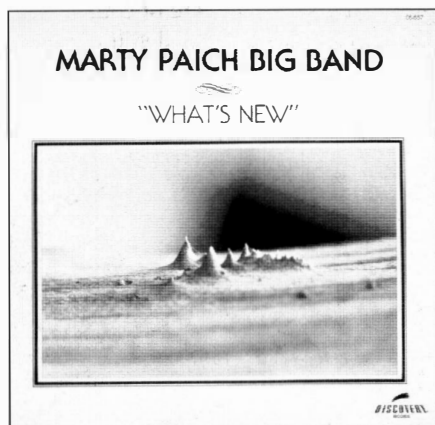

As top-quality 'audiophile' recordings seem to be becoming more and more difficult to find in High Street record shops, *Hi-Fi Choice* is making a determined effort to source some of the best recordings from around the world and make them available to readers by mail order.

You might stumble across one or two of these records in some specialist record shops, but for the most part these records and/or CDs are not readily available in the UK. You certainly won't find them in your local record store! We have already added many exciting discs from specialist American record labels such as Reference, Wilson and Sheffield - and we expect our catalogue of LPs and CDs to expand considerably during the next few months.

RADKA TONEFF: Fairytale

Ref LP1 £12.95

Ref CD1 £14.95

The well known audiophile (digital) recording of female voice and piano. Worth the asking price alone for the opening song, *The Moon's A Harsh Mistress*. Odin CD03/LP03

ODIN SAMPLER

Ref CD2 £14.95

The Odin record label was established by the Norwegian Jazz federation in 1981. This 75-minute compilation on CD provides a taster from the label's catalogue. Not available on vinyl. Odin NJ-4028-2

GEMINI/TAURUS SAMPLER

Ref CD3 £14.95

A pure jazz label, Gemini records was formed by producer Bjorn Petersen to record Norwegian jazz musicians who deserve wider recognition. Taurus is a subsidiary label presenting less mainstream music. This 15-track sampler is available only on CD. Gemini GMCD 6239

SMITH/RICCI: Paganiniana

Ref LP10 £14.95

Ref CD10 £17.95

Breathtaking purist analogue audiophile recording of classical works performed on piano and violin. On the

Water Lily Acoustics label, sponsored by Conrad-Johnson and imported from America. An essential addition to any audiophile's record collection. Water Lily CJCD/CJLP

TOTTI BERGH: I Hear A Rhapsody

Ref LP4 £12.95

Ref CD4 £14.95

On the Gemini label, saxophonist Totti Bergh plays a selection of jazz standards. *Jazz Journal* magazine described this as "A delightful 'wee small hours' album". Gemini GMCD48/GMLP48

MARTY PAICH BIG BAND: The New York Scene

Ref LP13 £12.95

Featuring Art Pepper, Victor Feldman, Jimmy Guiffre and Bill Perkins, this soundful set includes extended modern stylings of some classic Broadway musical tunes by the likes of Cole Porter and Rodgers & Hammerstein. Discovery DS-844

MARTY PAICH: What's New

Ref LP14 £12.95

Another superb recording of big band 'swing' jazz, this time featuring mostly Marty Paich original compositions. It doesn't seem possible that this was recorded in 1957. Like *The New York Scene* LP, which dates from 1959, the

sound is quite breathtaking: vibrant, dynamic, and with a superbly natural soundstage. They knew what they were doing in those days. Discovery DS-857

OPUS 3 TEST RECORD 1: Depth Of Image

Ref LP11 £12.95

Ref CD11 £14.95

Produced with the idea of analysing hi-fi systems and their ability to reproduce depth of image. This is Opus 3's best selling recording, containing examples of the work of many of its recording artists. Opus CD7900/LP7900

OPUS 3 TEST RECORD 3: Dynamics

Ref LP12 £12.95

Ref CD12 £14.95

Another compilation on the Swedish Opus 3 label, with musical extracts carefully chosen to illustrate what is meant by musical dynamics and comprehensive liner notes to show you what you should be listening for. How good is your hi-fi system? Opus 3 CD8300/LP8300

GREX VOCALIS: Renaissance For Kor

Ref LP15 £12.95

Ref CD15 £14.95

A capella performances of Renaissance and medieval songs, beautifully

recorded in natural acoustic environments for the Norwegian For-X label.

CD: For-X FXCD39

LP: For-X FXLP39

YTRE SULOENS JASS-ENSEMBLE / BARBARA ANN SHORTS: A Stone For Bessie Smith

Ref LP16 £12.95

Ref CD16 £14.95

Blues and gospel singer Barbara Ann Shorts, backed by a small jazz ensemble with musical roots in the New Orleans tradition, plays tribute to the great US blues singer Bessie Smith who died in 1937. This collection of songs includes a fascinating re-working of Sting's *Moon Over Bourbon Street*. For-X FXCD69/FXLP69

ROAR ENGELBERG / STEIN-ERIK OLSEN: Mosaic

Ref LP17 £12.95

Ref CD17 £14.95

Scandinavia's only professional pan flautist, Roar Engelberg, plays a collection of arrangements with Stein-Erik Olsen (classical guitar) — pieces by Ravel, Bach, Faure, Desportes and more. Superb dynamics! For-X FXCD81/FXLP81

JIM BROCK: Tropic Affair

Ref CD18 £15.99

Ref LP18 £15.99

Vibrant contemporary jazz, recorded live to two-track by Reference Recordings' Prof. Johnson. Remarkable clarity and a tremendous 3-D soundstage. RR31



WILLIAM WALTON: Facade Suite

Ref CD19 £15.99

Ref LP19 £15.99

One of the Reference label's earlier analogue recordings (these days the company concerns itself with improving digital techniques), featuring the superb playing of Chicago Pro Musica. "A true state-of-the-art recording", said *The Absolute Sound* magazine. RR16

STRAVINSKY: L' Histoire du soldat Suite

Ref CD20 £15.99

Ref LP20 £15.99

Chicago Pro Musica again. The US underground magazine *The Absolute Sound* reckoned this to be one of the best (analogue) recordings ever made! RR17

VIVALDI / BACH: Sinfonia in C; Trio Sonata in C, etc

Ref CD21 £15.99

Ref LP21 £15.99

An exemplary digital recording of the Helicon Ensemble playing Baroque music from Vivaldi and Bach. The CD contains an extra track, Bach's *Prelude in C*. RR23

COPLAND: Appalachian Spring Suite

Ref CD22 £15.99

Ref LP22 £15.99

The *Appalachian Spring Suite* in its original version for thirteen instruments, recorded with a Nakamichi DMP-100 digital encoder. Plus the Pacific Symphony Orchestra in a world premiere recording of *Eight Poems of Emily Dickinson*. The CD contains an extra (analogue) recording of *An Outdoor Overture* (8m 50s). RR22

NATIONAL SYMPHONIC WINDS:

Winds of War and Peace

Ref CD23 £15.99

Ref LP23 £15.99

Conductor Lowell Graham leads performances of John Williams' *Liberty Fanfare*, Samuel Barber's *Commando March* and many more. A pure analogue audiophile recording from 1988 using John Curl's Ultramaster recorder. W8823, WCD8823

JAMES B. WELCH: Concert

Ref CD24 £15.99

Ref LP24 £15.99

W177, WCD177/278

JAMES B. WELCH: Recital

Ref CD25 £15.99

Ref LP25 £15.99

W278, WCD177/278.

Two of the Wilson Audiophile label's famous recordings of classical organ works. On a big system these discs are truly breathtaking — watch out for your woofers!

The Choir of Grace Cathedral, San Francisco

Ref CD26 £15.99

Ref LP26 £15.99

W805, WCD794/805.

Another breathtaking example of Wilson Audiophile's pure analogue recordings, used as reference discs by hi-fi gurus around the world. The discs are hard to find in the UK.

THELMA HOUSTON & PRESSURE COOKER: I've Got the Music In Me

Ref LP27 £15.99

Ref CD27 £15.99

One of Sheffield Labs' most famous recordings. The original direct-cut has been out of print for many years and is now highly collectable — but the recording sessions were of course taped, and this issue will still blow

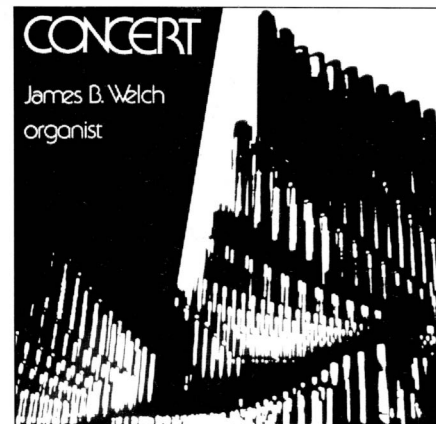

your socks off! Sheffield ST200, CD2. Listed below are further highly collectable Sheffield Labs discs which are astonishing in their sense of realism and truly awesome dynamics:

DAVE GRUSIN: Discovered Again

Ref LP28 £15.99

Ref CD28 £15.99

ST500, CD5.

HARRY JAMES & HIS BIG BAND: Comin' From A Good Place

Ref LP29 £15.99

Ref CD29 £15.99

LAB6, CD6

JIM KELTNER & RON TUTT: The Sheffield Lab Drum Record

* The CD also includes The Sheffield Track Record

Ref LP30 £15.99

Ref CD32 £15.99

LAB14, CD14/20

The Sheffield Lab Track Record

* The CD also includes 'The Sheffield Lab Drum Record'

Ref LP31 £15.99

Ref CD32 £15.99

LAB20, CD14/20.

JAMES NEWTON HOWARD: James Newton Howard and Friends

Ref LP33 £15.99

Ref CD33 £15.99

LAB23, CD23.

SPECIAL OFFER

Order any 3 LPs or 3 CDs and receive a **FREE** copy of *First Sampling* (RRS1CD), Reference Recordings' compilation CD featuring a variety of classical tracks from its catalogue.

TO ORDER YOUR LPs AND CDs

(tick selections)

All prices include VAT and postage and packing

Radka Toneff: *Fairytales*

- Ref LP1 (£12.95)
- Ref CD1 (£14.95)

Odin Sampler

- Ref CD2 (£14.95)

Gemini/Taurus Sampler

- Ref CD3 (£14.95)

Totti Bergh: *I Hear A Rhapsody*

- Ref LP4 (£12.95)
- Ref CD4 (£14.95)

Smith/Ricci: *Paganiniana*

- Ref LP10 (£14.95)
- Ref CD10 (£17.95)

Opus Test Record 1: *Depth Of Image*

- Ref LP11 (£12.95)
- Ref CD11 (£14.95)

Opus Test Record 3: *Dynamics*

- Ref LP12 (£12.95)
- Ref CD12 (£14.95)

Marty Paich Big Band: *The New York Scene*

- Ref LP13 (£12.95)

Marty Paich Big Band: *What's New*

- Ref LP14 (£12.95)

Grege Vocalis: *Renaissance For Kor*

- Ref LP15 (£12.95)
- Ref CD15 (£14.95)

Ytre Suloens Jass-Ensemble / Barbara Ann

Shorts: *A Stone For Bessie Smith*

- Ref LP16 (£12.95)
- Ref CD16 (£14.95)

Roar Engelberg/Stein-Erik Olsen: *Mosaic*

- Ref LP17 (£12.95)
- Ref CD17 (£14.95)

Jim Brock: *Tropic Affair*

- Ref CD18 (£15.99)
- Ref LP18 (£15.99)

William Walton: *Facade Suite*

- Ref CD19 (£15.99)
- Ref LP19 (£15.99)

Stravinsky: *L' Histoire du soldat Suite*

- Ref CD20 (£15.99)
- Ref LP20 (£15.99)

Vivaldi, Bach: *The Helicon Ensemble*

- Ref CD21 (£15.99)
- Ref LP21 (£15.99)

Copland: *Appalachian Spring Suite*

- Ref CD22 (£15.99)
- Ref LP22 (£15.99)

National Symphonic Winds: *Winds of War and Peace*

- Ref CD23 (£15.99)
- Ref LP23 (£15.99)

James B Welch: *Concert*

- Ref CD24 (£15.99)
- Ref LP24 (£15.99)

James B Welch: *Recital*

- Ref CD25 (£15.99)
- Ref LP25 (£15.99)

The Choir of Grace Cathedral San Francisco: *Music for Easter, Ascension and Pentecost*

- Ref CD26 (£15.99)
- Ref LP26 (£15.99)

Thelma Houston and Pressure Cooker: *I've Got The Music In Me*

- Ref LP27 (£15.99)
- Ref CD27 (£15.99)

Dave Grusin: *Discovered Again*

- Ref LP28 (£15.99)
- Ref CD28 (£15.99)

Harry James and his Big Band: *Comin' From A Good Place*

- Ref LP29 (£15.99)
- Ref CD29 (£15.99)

Jim Keltner and Ron Tutt: *The Sheffield Lab Drum Record*

- Ref LP30 (£15.99)

The Sheffield Lab Track Record

- Ref LP31 (£15.99)

Jim Keltner and Ron Tutt: *The Sheffield Lab Drum / The Sheffield Lab Track Record*

- Ref CD32 (£15.99)

James Newton Howard & Friends

- Ref LP33 (£15.99)
- Ref CD33 (£15.99)

ORDER ANY 3 LPs OR CDs AND YOU WILL RECEIVE A FREE CLASSICAL SAMPLER CD FROM REFERENCE RECORDINGS

PAYMENT

- I enclose my cheque/PO made payable to Dennis Publishing for £ _____
Total number of items ordered: _____

- Please charge my Mastercard (Access)/Visa (delete as appropriate)

Credit card number _____

Expiry date _____

Signature _____

Name _____

Address _____

_____ Postcode _____

Please send order form with payment to:
Hi-Fi Choice Mail Order, PO Box 320, London N21 2NB

Goods are usually dispatched within 10 days of receipt of order. Whilst we endeavour to maintain stocks, some of these discs are extremely rare - so please bear with us in the event of any delays.

Available to UK readers only

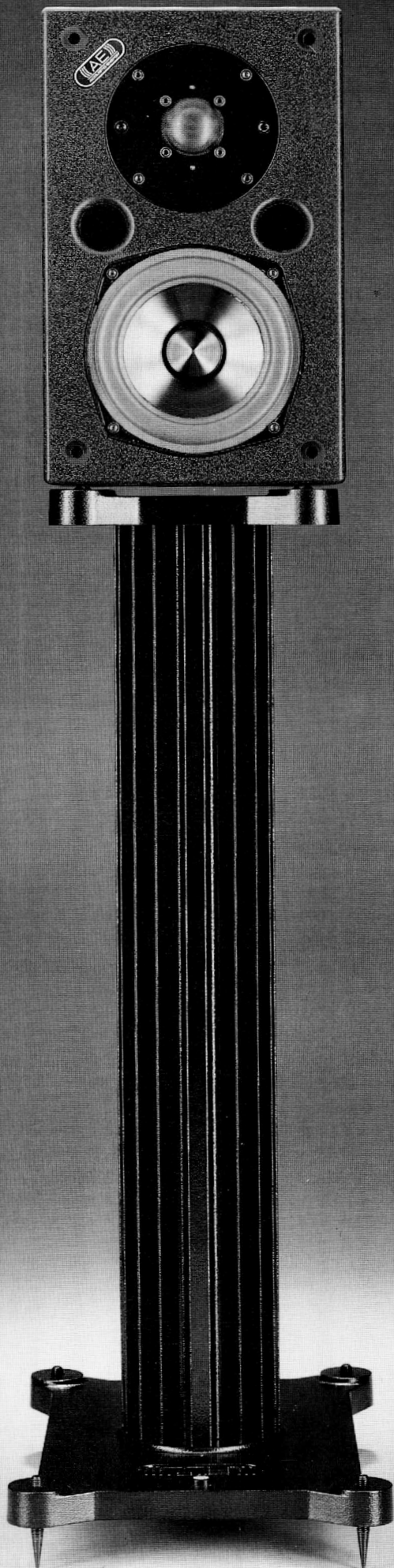

ACOUSTIC ENERGY SPEAKS FOR ITSELF.

"As far as I'm concerned, the AEI re-defines the art of miniature speaker design"

**John Atkinson,
Stereophile, Sep. 1988**

"To the author's knowledge, the most awesomely dynamic and articulate miniature ever made"

Alvin Gold, Hi-Fi Choice, June 1988

". . . the best looking, most immaculately turned out stands I've ever clapped eyes on"

**Jonathan Kettle,
New Hi-Fi Sound, July 1989**

"The AEI leapfrogs existing references and sets new standards of technical and musical excellence . . ."

**David Prakesel,
Hi-Fi Answers, March 1988**

HEARING IS BELIEVING

To audition Acoustic Energy loudspeakers – contact any of the dealers listed below.

- | | | | |
|--|---|---|--|
| Doug Brady Hi-Fi
London WC2
Tel: 071-379 4010
(Also at Warrington & Liverpool) | Steve Boxshall Audio
Cambridge,
Cambridgeshire
Tel: 0223 68305 | Lintone Audio
Gateshead, Tyne & Wear
Tel: 091 477 4167
(Also at Whitley Bay & Durham) | Basically Sound of Norfolk
Nr. Norwich, Norfolk
Tel: 0508 70829 |
| Grahams Hi-Fi
London N1
Tel: 071-226 5500 | Audio Excellence
Cardiff, Wales
Tel: 0222 228565
(also at Gloucester & Swansea) | Manders Hi-Fi
Grimsby, Sth. Humberside
Tel: 0472 351391 | Sound Approach
Norwich, Norfolk
Tel: 0603 622833 |
| KJ Leisure Sound
London W1
Tel: 071-486 0552 | Chelston Hi-Fi
Chelston, Torquay, Devon
Tel: 0803 606863 | PJ Hi-Fi
Guildford, Surrey
Tel: 0483 504801 | Audio Counsel
Oldham, Lancs.
Tel: 061 633 2602 |
| Le Set
London SW3
Tel: 071-581 3676 | Data Sound
Dorking, Surrey
Tel: 0306 882897 | Compact Music
Havant, Hants
Tel: 0705 473952 | Stilton Audio Systems
Peterborough, Cambs.
Tel: 0733 297152 |
| Peter Jones
London SW1
Tel: 071-730 3434 | Wentworth Audio
Dunstable, Beds
Tel: 0582 663383 | The Sound Gallery
High Wycombe, Bucks
Tel: 0494 31682 | Rayleigh Hi-Fi
Rayleigh, Essex
Tel: 0268 779762
(also at Chelmsford) |
| The Cornflake Shop
London W1
Tel: 071-631 0472 | Jeffries Hi-Fi
Eastbourne, Sussex
Tel: 0323 31336
(also at Brighton) | Audio Projects
Leeds, Yorks
Tel: 0532 304565 | Audio Centre
Sheffield, Yorks.
Tel: 0742 737893 |
| The Hi-Fi Centre
Barrow-in-Furness, Cumbria
Tel: 0229 38757 | Hi-Fi Corner
Edinburgh, Scotland
Tel: 031 220 1535
(also at Falkirk & Glasgow) | The Leicester Hi-Fi Co.
Leicester, Leic.
Tel: 0533 539753 | Tonbridge Hi-Fi
Tonbridge Wells, Kent
Tel: 0892 24677 |
| The Listening Rooms
London SW5
Tel: 071-244 7759 | In Hi-Fi
Edinburgh, Scotland
Tel: 031 225 8854 | Pure Sound
Liverpool, Merseyside
Tel: 051 645 6690 | Uxbridge Audio
Uxbridge, Middx.
Tel: 0895 30404 |
| The Audio File
Bishops Cleeve, Herts
Tel: 0279 506576 | | Unilet Products
New Malden, Surrey
Tel: 01-942 9567 | Acoustic Arts
Watford, Herts.
Tel: 0923 245250 |
| Clearstone
Bolton, Lancs
Tel: 0204 31423
(also at Manchester) | | Audio Insight
Milton Keynes
Northants
Tel: 0908 561551 | West Midlands Audio
Worcester, Worcs.
Tel: 0905 58046 |

Acoustic Energy have distributors in the following countries:

Australia	Finland	Korea	Portugal	Switzerland
Austria	France	Netherlands	Singapore	Thailand
Canada	Germany	New Zealand	Spain	Taiwan
Denmark	Hong Kong	Norway	Sweden	U.S.A.
Eire	Italy			

(((AE)))
ACOUSTIC ENERGY

Acoustic Energy Limited
3A Alexandria Road London W13 0NP
Tel: 081-840 6305
Fax: 081-579 1761 Tlx: 266834

WHAT THE PRESS HAS TO SAY ABOUT THE BEST RANGE OF CASSETTE DECKS ON THE MARKET

“

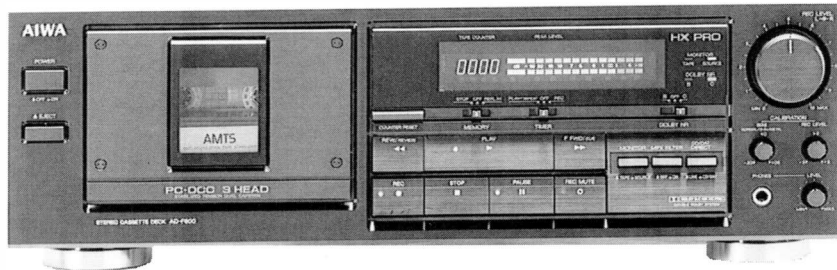

AD · F800

£249.99*

”

“Offering a superb technical and fine subjective performance the AIWA AD-F800 is strongly recommended”.

New Hi-Fi Sound - Dec. 89

“Its excellent, high quality tape transport helps it to achieve a stunning level of sound quality at the price.”

What Hi-Fi? - Feb. 90



XK · 009

£549.99*

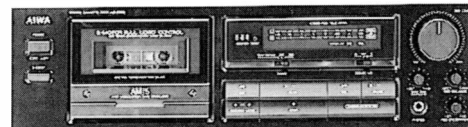

AD · F500

£149.99*

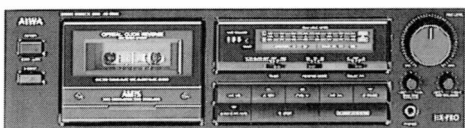

AD · R505

£149.99*

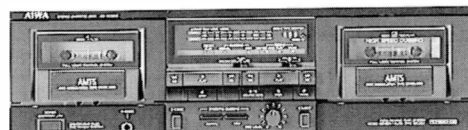

AD · WX616

£149.99*

The 1990 range of Aiwa Cassette Decks. A range that caters for every discerning audiophile's critical requirement; from the attractive small budget to the esoteric! A range that builds upon all the traditional strengths of Aiwa's long-established track record of innovation and specialisation in the audiotape recording and replay industry.

A range that — quite simply — represents the widest possible choice in the entire country.*

That, at least, is what we have heard.

Free 2 year guarantee from AIWA HI-FI Specialist Dealers.

Digital Audio & Video

AIWA®

Call for a brochure and the name
of your approved local dealer.

081-200-0200

*16 models. Featuring twin tape, auto reverse, Dolby HXPro and Aiwa's unique AMTS system.
Prices inclusive of VAT. Correct at time of going to press.

HI-FI CHOICE

THE WORLD'S NUMBER ONE GUIDE TO BUYING HI-FI

Every month Hi-Fi Choice tests more products than any other hi-fi magazine and awards 'Best Buy' and 'Recommended' accolades. A must for hi-fi buyers and enthusiasts, Hi-Fi Choice is packed with news, reviews, features and an extensive buyer's guide containing test summaries on over 900 hi-fi products. **At Hi-Fi Choice the only corners we cut are on our tags - so if you're serious about hi-fi you can't afford to miss it.**

Why not save 40% on the news-stand price of Hi-fi Choice by subscribing today? This has got to be the Hi-Fi Choice 'Best Buy' at only £19.95* for 12 issues.

Or better still, save an amazing 50% by subscribing for two years.

*UK rate only

Check the benefits:

- **Guaranteed receipt of 12 monthly issues of Hi-Fi Choice**
- **Priority despatch to your door before it reaches the shops**
- **A saving of £15.45 - 40% off the annual cover rate - that's equivalent to over five free issues!**
- **Further low cost renewal offers**
- **Special reader offers**



**SAVE!
SAVE!
SAVE!
OVER
£15.00
ON NEWS
STAND PRICES**

YES! I would like to save over £15.00 by subscribing to Hi-Fi Choice, the Number 1 Guide to Buying Hi-Fi, starting with the next available issue.

Please tick the appropriate boxes

12 Issues (One year)

- UK £19.95
- Europe/Eire £29.95
- Rest of World £39.95

24 Issues (Two years)

- UK £34.95
- Europe/Eire £54.95
- Rest of World £74.95

I enclose my cheque/Postal Order* made payable to Dennis Publishing Ltd (all payments should be drawn in sterling on a UK bank). *delete which is applicable

Please charge my Access Visa

Account number

Expiry Date

Signed Date

Please send my copies of Hi-Fi Choice to:

Name

Address

for fast delivery please quote your Post code

Telephone

Please return completed form, with your payment to:

(UK only)

**Hi-Fi Choice
Subscriptions Department
FREEPOST 7
London W1E 4EZ**

(Abroad)

**Hi-Fi Choice
Subscriptions Department
14 Rathbone Place
London W1P 1DE
England**

Or better still, telephone the **Hi-Fi Choice Subscription Hotline on 071 580 8908**

or send your completed form by **Fax on 071-636 5668**

Your details may be added to our mailing list, please tick box if you would prefer not to receive details of special offers and promotions.

<i>Audio Innovations</i>	ORACLE	ALLISON
THORENS	AUDITION ANY OF THE HIGHLY ACCLAIMED HIFI IN OUR DEMONSTRATION ROOM. KAMLA ELECTRONICS 251 Tottenham Court Road London W1 Tel:071-323 2747	Infinity
TOWNSEND		kuzma
NVA		JEFF ROWLAND DESIGN GROUP
conrad-johnson	■ Snell	

Choose From:

- ACOUSTIC ENERGY
- A&R
- BLQ
- CASTLE
- CREEK
- EPOS
- EXPOSURE
- KEF
- LINN PRODUCTS
- MARANTZ
- MORDAUNT SHORT
- NAIM AUDIO
- NAKAMICHI
- ONIX AUDIO
- QED
- REGA RESEARCH
- SOUND ORGANISATION
- TARGET STANDS

TWO SHOPS THAT ARE SIMPLY BETTER

at TUNBRIGE WELLS AND GILLINGHAM











TONBRIDGE HI-FI CONSULTANTS

31 High Street,
Tunbridge Wells, Kent
(0892) 24677



BADA
THE ULTIMATE IN
SOUND ADVICE

96 Woodlands Rd,
Gillingham, Kent
(0634) 52858

Quantum Cables Offer

Improve the sound quality of your hi-fi system with these top quality LC-OFC interconnects, PC-OCC speaker cables and save pounds.

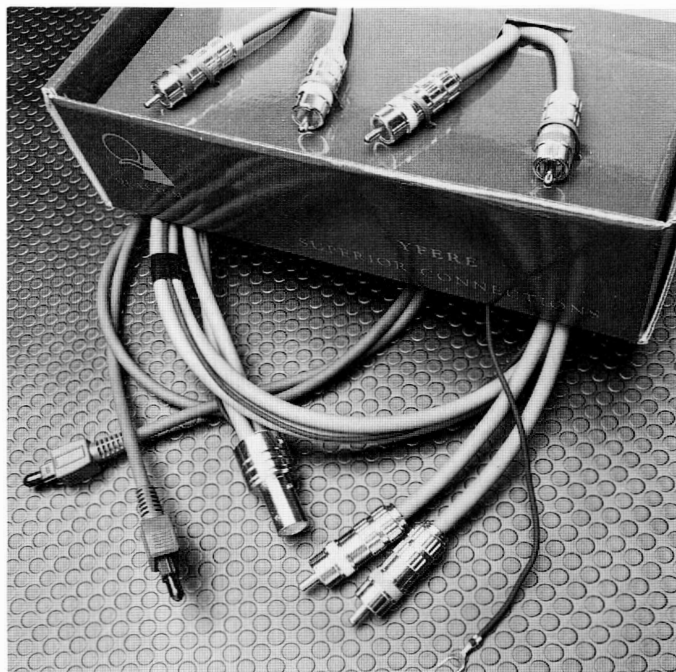

YFERE and YBLENT cables and plugs are the latest accessories to be distributed here by Quantum Audio of Scotland. These high quality cables all use linear crystal oxygen free copper wires (LC-OFC) and beautifully crafted solid copper phono plugs which are gold plated. There are two basic configurations: Twin and Quad. The Twin leads employ two LC-OFC conductors of 22 strands, whereas the Quad leads use four conductors of 20 strands.

The *Superior* range of cables really are a gorgeous addition to your hi-fi system. However, for those of you who are on a tighter budget there is also the YFERE *Super* range which uses the Twin wiring configuration but the leads are terminated with less elaborate plugs.

For digital aficionados there is also a high quality fibre optic cable (yes, cables really do make a difference even in the digital domain). And the analogueophiles looking to get the best from their record collection might care to upgrade their arm cable with the *Superior* tonearm cable which uses YFERE's Quad wiring.

Also new to this country are *Furukawa* loudspeaker cables. All are two-core cables (twisted in the FS2T20 and '35 versions, flat in the FS2T09) using PC-OCC wire with a high density polyethylene dielectric and flexible PVC jacket.

Thanks to an exclusive deal with Quantum Audio *Choice* is able to offer its readers these cables at discount prices. With the *Furukawa* speaker cables, you can have your leads terminated with 4mm banana plugs or spade connectors free of charge!

Simply fill in the form opposite and leave the rest to us.

All our prices are inclusive of postage, packing and VAT. Please allow 28 days for delivery.

TO ORDER QUANTUM CABLES

(Tick selections)

SUPER

		Rec. Retail Price	Our Price
<input type="checkbox"/>	004-003 LC-OFC Twin .5m pair	£43.00	£39.95
<input type="checkbox"/>	004-004 LC-OFC Twin 1m pair	£53.00	£49.95
<input type="checkbox"/>	004-005 LC-OFC Twin 1.5m pair	£63.00	£59.95
<input type="checkbox"/>	004-006 LC-OFC Twin 2m pair	£73.00	£69.95

SUPERIOR

<input type="checkbox"/>	004-001 LC-OFC Tonearm Cable 1m pair	£80.00	£76.95
<input type="checkbox"/>	004-010 LC-OFC Phono Quad .5m pair	£75.00	£71.95
<input type="checkbox"/>	004-011 LC-OFC Phono Quad 1m pair	£85.00	£81.95
<input type="checkbox"/>	004-012 LC-OFC Phono Quad 1.5m pair	£95.00	£91.95
<input type="checkbox"/>	004-013 LC-OFC Phono Quad 2m pair	£105.00	£99.95
<input type="checkbox"/>	004-020 LC-OFC Phono Twin .5m pair	£65.00	£61.95
<input type="checkbox"/>	004-021 LC-OFC Phono Twin 1m pair	£70.00	£66.95
<input type="checkbox"/>	004-022 LC-OFC Phono Twin 1.5m pair	£75.00	£71.95
<input type="checkbox"/>	004-023 LC-OFC Phono Twin 2m pair	£80.00	£76.95
<input type="checkbox"/>	004-040 Fibre Optic 1m pair	£150.00	£139.95

FURUKAWA SPEAKER CABLES

FS2T09 (0.09mm², 33-strand)

<input type="checkbox"/>	2 metre pair	£24.00
<input type="checkbox"/>	3 metre pair	£36.00
<input type="checkbox"/>	5 metre pair	£60.00

FS2T20 (2mm², 80-strand)

<input type="checkbox"/>	2 metre pair	£48.00
<input type="checkbox"/>	3 metre pair	£72.00
<input type="checkbox"/>	5 metre pair	£120.00

FS2T35 (3.5mm², 7 x 20 strand)

<input type="checkbox"/>	2 metre pair	£100.00
<input type="checkbox"/>	3 metre pair	£150.00
<input type="checkbox"/>	5 metre pair	£250.00

I would like my speaker cables terminated with . . .

- 4mm banana plugs
 spade connectors
 unterminated

If you're not satisfied we will refund your money if the product is returned within 14 days.

PAYMENT

- I enclose cheque/PO made payable to Dennis Publishing

for _____

- Please charge my Mastercard (Access)/Visa (delete as appropriate)

Credit card number _____

Expiry date _____

Signature _____

Name _____

Address _____

Postcode _____

Offers available to UK readers only.

Please send order form with payment to:
 Hi-Fi Choice Mail Order, PO Box 320, London N21 2NB.

THE CHOICE DEALER DIRECTORY



Member of
British Audio
Dealer Association

Choosing a good hi-fi dealer is the most vital step in acquiring the system that is right for you. This unique directory gives full information on dealers in your area.

AVON

PAUL GREEN HI FI LTD, Kensington Showrooms, London Road, Bath, (0225) 316197. Linn, Musical Fidelity, Krell, A&R, Creek, Rogers, Quad, Cust. car park. Best selection in the West. **BADA**
RADFORD HI FI, 52-54 Gloucester Rd, Bristol, (0272) 428247. Linn, Naim, Mission, Denon, Nad, 3 dem rooms. Installation, Access, Visa + credit. Service dept. **BADA**

BEDFORDSHIRE

ASHTON AUDIO, 6 High Street, Dunstable, (0582) 608003. AR, Cambridge Audio, Denon, Incatech, JVC, Kenwood, Marantz, Monster, NAD, Nakamichi, etc. Credit to \$1,000. Access, Amex, Diners, Visa. Service dept. Dem room. Open 6 days, 9.5.30, 6p.m. Friday.
CAMBRIDGE HI FI, 31 Cuthbert St, Bedford, (0234) 325035, Mission Cyrus, Rotel, Kenwood, Pioneer, Manti core, Revolver, Ariston, I.T.L., KEF, Monitor Audio. Single speaker dem room. 9.30-5.30 6 days. Free installation. Service Dept. Visa, Access, Credit facilities.

BERKSHIRE

NEWBURY AUDIO, 2 Weavers Walk, Northbrooke Street, Newbury, Berkshire RG13 1A1 (0635) 33929. 6 days 9.30 6.00. Linn, Naim, Roksan, Exposure, Creek, Epos, Royd, Denon, Nakamichi. Single speaker dem. room. Appts. necessary. Home trial facilities. Free installation. Service department. Late appointments. Access, Visa. Interest free credit subject to status. 6 days 9.30am-6.00pm.
READING HI FI CENTRE, 4 Queen's Walk, Reading RG1 7QF. (0734) 585463. "The best equipment, advice and service from Berkshire's premier Hi Fi Emporium". **BADA**

BUCKINGHAMSHIRE

AUDIO INSIGHT LTD, 53 Wolverton Rd, Stony Stratford, Milton Keynes, (0908) 561551. Arcam, Audiolab, Heybrook, Ion, Linn, Meridian, Quad and more. Access, Visa, Finance, Dem. room etc. **BADA**
AYLESBURY HI FIDELITY, 98 Cambridge St, Aylesbury, (0296) 28790. Denon, Dual, Exposure, Heybrook, Marantz, Musical Fidelity, NAD, Roksan, Rotel, Systemdek, 2 Dem rooms, appointment reqd. Mon-Fri 10-6. Sat 9.30-5.30. Home trial, free installation, credit to \$1,500. Access, Amex, Diner, Visa. Service dept.
TECHNOSOUND, 7 Graville Square, Wilton Centre, Milton Keynes, (0908) 604949. Bang & Olufsen, Denon, Rotel, Technics, Yamaha and enthusiast hi fi. Also at Luton and Dunstable. **BADA**

CAMBRIDGESHIRE

STEVE BOXSHALL AUDIO, 41 Victoria Rd, Cambridge CB4 3BW. (0223) 68305. 10.6-6 days. 3 dem rooms, home trial, appts. preferred. Free installation and service dept. Access, Visa + credit. **BADA**
STILTON AUDIO, 489 Lincoln Road, Peterborough PE1 2PE. (0733) 558838 897152. Linn, Mission, Arcam, Rotel, Teac, Meridian, TDL, Cambridge Audio, Musical Fidelity, Creek/Mordaunt Short. Home trial, free installation. Credit facilities. Access, Visa, Amex, Avco Finance. 10.00-18.00 Mon Sat.

CHESHIRE

ASTON AUDIO, 4 West St., Alderley Edge, (0625) 582704. Wide range of specialist audio, interest free credit. Visa, Access, Home trial, Closed Mon. **BADA**
DOUG BRADY HI FI, Kingsway Studios, Kingsway North, Warrington, (Padgate 0925) 828009. "Largest choice of specialist Hi Fi in N.W.". All credit cards. 3 Dem rooms. Open 6 days. **BADA**
CHRIS BROOKS HI FI, 29 Gaskell St, Stockton Heath, Warrington, 0925 612123, Tues Sat 10.6, 2 dem rooms. Credit facilities. All credit cards. Total absence of bull**** **BADA**
NEW DAWN HI FI, 13 Castle St, Lower Bridge St, Chester, (0244) 24179. Linn, Quad, Technics, National Panasonic, Denon, Rotel, Dual, Meridian, Aiwa, Philips.
SOUNDSTAGE, 21 Nantwich Road, Crewe, Cheshire CW2 6AF. (0270) 255488. Linn, Alphason, Creek, Onix, Royd, Epos, NAD, Denon, Mission, Rotel, Two dem rooms. Home trial. Free installation. All major credit cards. Credit facilities. 9.30-6. 6 days. Evening dems by appt. Part exchange welcome.
SWIFT OF WILMSLOW, 4 St Aunes Parade, Wilmslow, (0625) 526213. Arcam, Denon, Kenwood, Musical Fidelity, Marantz, NAD, Cambridge, 2 dem rooms. Tues Sat 9.15-6pm. No pressure! **BADA**

CUMBRIA

PETER TYSON, 6 Abbey St., Carlisle, Cumbria, CA3 8TX. "Cumbria's premiere hi fi centre". Part exchange welcome. (0228) 46756. Linn, Musical Fidelity, Cyrus, Marantz, Denon, Philips, Nakamichi, Technics, Pioneer, Creek & more. Dem room. Dems without obligation. Home trial. Free Install. In house service dept. Visa, Access, HP. 9.5.30. Closed Thursday.
LAKELAND HOME MUSIC, "Fair Place" (200yds past church), Water millock, Penrith, CA11 0LR 07684 86235. Hear the full Quad range and ATC SCM 50A monitors and SCM 20 monitors, and Revex Easyline multi room systems here (B&B available), or in your own home, without obligation, in N. England and Scotland. Castle, Spendor, Sugden, Marantz, Townshend, Suno and compact discs available.

DERBYSHIRE

ACTIVE AUDIO, 12 Osmaston Rd, The Spot, Derby, (032) 380385. Arcam, Ariston, Celestion, Denon, Kef, Kef Reference, Cyrus, Marantz, Revox, Rotel, Rogers, etc. etc. Meridian Musical Fidelity. Account and credit cards. Ring for opening times and free "Fact Pack". **BADA**
The only BADA MEMBER in Derbyshire.
LISTEN HEAR! LTD., la Regent Street, Ilkeston Derbyshire, (0602) 304602. Quad, Heco, Harman Kardon, Marantz, Sugden, Spendor, Ruark, Revolver, Denon, BLQ. One single speaker demonstration lounge. Home dems. Free installation. Access, Visa, Diners. Licenced credit brokers. Open 9.30-6 daily except Weds 9.30-1.

DEVONSHIRE

CHELSTON HI FI, 38 Walnut Road, Chelston, Torquay, Devon TQ2 6HS. Tel: (0803) 606863. Denon, Marantz, Rotel, Musical Fidelity, Acoustic Energy, NAD, Castle, Heybrook, Celestion, JPW etc. 2 dem rooms. Home trial. Free installation. Access, Visa, Amex, Diners, Hi Fi Markets Chargecard. Credit facilities. 9.30-7.30 Mon Fri. 9.30-6 Sat.

DORSET

THE AUDIO SHOP, 128 Poole Road, Westbourne, Bourne mouth, (0202) 762160. Arcam, Quad, Michell, Marantz, Linn, Celestion, Spendor, Cambridge Audio, Absolute Sounds, Roksan, 2 dem areas. Home trial. Free installation. Access, Visa, Tues Fri 10.6, Sat 9.5.

ESSEX

1st AND FOREMOST HI FI CENTRE, 49-55 North Station Road, Colchester, Essex CO1 1RQ. Tel: (0206) 549842. Fax: (0206) 762900. Tlx: 987873 SAIDG. Trio Kenwood, JVC, Akai, Aiwa, Sony, Pioneer, Technics, Nakamichi, Panasonic, Revox, etc. Home trial, free installation. Service dept. Instant credit available + all credit cards accepted. Monday to Saturday 9am-6pm.
A.T. LABS, 442/4 Cranbrook Rd, Gants Hill, Ilford, (01) 518 0915. Mon Sat, 10.6. Two dem rooms. Access, Visa, Sony Hi Fi News Best Dealer '86 & '88 (National). **BADA**
BRENTWOOD MUSIC & HI FI CENTRE, 2 Ingrave Rd, Brentwood, (0277) 221210. Alphason, Denon, Marantz, Quad, DNM, Rock/Glastonbury, E.A.R., Exposure, Kelvin Labs, Rotel, plus many more. Dem facilities, home trial, evening appts. (high end). Home installations. System problem diagnosis. Mon Sat 9.30-5.30 (Thurs from 10am, Sat from 9am). Credit facilities. Access, Visa. Hi Fi Markets Chargecard. Service facilities.
LYON AUDIO, 16 Peartree Business Centre, Peartree Road, Stanway, Colchester, Essex CO3 5JN. (0206) 560259. Quad, Rogers, Mission, Denon, Cyrus, Marantz, Audiolab, Heybrook, Rotel, NAD. Dem facilities. Mon Sat 9.6. Installations. Access, Visa, Hi Fi Markets. Instant credit. Service dept available.
PRO MUSICA, 6 Vineyard Street, Colchester, (0206) 577519. Linn Products, Naim Audio, Rega Research, Creek, A&R/Cambridge, Ion Systems, Denon, Rotel, Epos, Ruark etc. Two single speaker dem rooms. Credit facilities. Access, Visa. Appts bookable. Mon Sat 10am-6pm.
RAYLEIGH HI FI, 44a High Street, Rayleigh, Essex, (0268) 779562/747571, 216 Moulsham St, On the Parkway, Chelmsford, Essex. Southend shop opening soon. (0245) 265245. A&R, Creek, Cyrus, Denon, Epos, Ion, Linn, Mission, Naim, Quad, Rega, Roksan, Rotel, Royd, 0% finance.
THOMSONS, 2 High Street, Great Baddow, Chelmsford, Essex. Tel (0245) 71465. JVC, Kenwood, Mitsubishi, Toshiba, Tannoy, Mordaunt Short, Acoustic Research,

Wharfedale, Philips, Audio Visual dealer. Home trial. Free installation. Service dept. Access, Visa, HP. Open 9.1.2 5.30 Mon Sat. Open 9.1 Wed.

GLOUCESTERSHIRE

AUDIO EXCELLENCE, 58 Bristol Road, Gloucester, (0452) 30046. Audio Research, Dual, Krell, Linn, Magnephar, Naim, NAD, Yamaha and lots more. Closed Mon. **BADA**
ROBBS OF GLOUCESTER, 13/15 Worcester Street, Gloucester GL1 3AJ. Sony, Technics, Aiwa, Pioneer, Denon, Bose, Celestion, Dual, Kenwood, JVC. Largest selection in Gloucestershire. Dem facilities. Home trial. In house service dept. Access, Visa. 9.5.30 6 days.

HAMPSHIRE

HAMPSHIRE AUDIO Ltd, 212 Hurstley Rd, Chandlers Ford, (0703) 252827/265232. Quality CD and analogue agencies. 5 dem studios. Large free car park. **BADA**
HOPKINS HI FI, 38/40 Fratton Rd, Portsmouth PO1 5BX. (0705) 822155. Technics, Quad, Monitor Audio, Tannoy, Denon, Nad, Heybrook, Onkyo, Dual, Marantz plus others. Dem facilities, appointments necessary. Access, Visa 9.5.30. Open to 6 Thurs. Closed Wed. Service dept.
TRU FI SOUND & VISION, 10 12 Grosvenor Road, Aldershot, Hants, Tel/Fax: (0252) 26300/332424. Aiwa, Audio Technica, B&W, Nakamichi, Mission, Mordaunt-Short, Nagaoka, Sony, Technics, Dem fac. Free install. Service dept. 0% finance. Access, Visa. Mon Sat 9.30-6.

HEREFORDSHIRE

ENGLISH AUDIO, 95 Whitecross Road, Hereford, (0432) 355081. Musical Fidelity, Pink Triangle, Heybrook, Arcam, Nakamichi, Systemdek, Denon, Cambridge Audio, Rogers and others. Dem room. Home trial. Free install. Service dept. Access, Visa. Open Mon Sat 10am-6pm.

HERTFORDSHIRE

ACOUSTIC ARTS Ltd, 101 St Albans Rd, Watford, Herts, (0923) 245250. A&R, Audiolab, Audio Research, Apogee, Denon, Krell, Magneplanar, Meridian, Quad, Rogers, TLD. Mon Sat 9.30 5.30. **BADA**
AUDIO IMAGE, 15 Middle Row, Stevenage, Herts SG1 3AW. Tel: 0438 360606. Aiwa, Goodmans, Harman Kardon, JBL, JVC, Kenwood, Panasonic, Pioneer, Sony, Technics. Dem room & lounge. Home trial. Free installation. Service dept. Access, Visa. Instant credit \$1,500. Closed Weds. Open 9.6.
DARBY'S OF ST. ALBANS, 6 Market Place, near the clock tower, St. Albans, Herts. (0727) 50961. Alphason, A&R Cambridge, Bang & Olufsen, Denon, JPW, JBL, Harman Kardon, Quad, Ruark, Sony. Home demonstrations, free delivery and installation. Sales rental service. In house credit. Lombard, Tricity. Mon Sat 9.6.
HYPERTEC, 6 Bancroft Road, Hitchin, Herts. (0462) 452248. B&W, Denon, Dual, Marantz, Pioneer, Rotel, Tannoy, Technics, Wharfedale, Bang & Olufsen. 2 dem rooms without appointment. Private dem room + evening dem by appt. Home trial. Free Install. Service dept. Access, Visa, Hypertec creditcharge. 9.30-5.30 6 days per week.
THE AUDIO FILE, 27 Hockerill St, Bishops Stortford, Herts CM23 2DH. (0279) 506576. 9.30-5.30 6 days. Dealer Of The Year 1988/89. Linn, Naim, Rega, Quad, Cyrus, Arcam, Musical Fidelity. 0% credit. **BADA**

ISLE OF MAN

ISLAND COMPACT DISC CENTRE, Parliament Square, Ramsey, (0624) 815521. Arcam, Ariston, Audio Innovations, Celestion, E.A.R., Marantz, QED, SD Acoustics, Snell, Sugden. Mon Sat 9.5.00. Dem and home trial facilities. Free installation. Full credit, no limit. Access, Elite. Service dept.

KENT

JOHN MARLEY HI FI CENTRES, 2 Station Rd West, Canterbury, (Canterbury) 69329. Also at Dover - (0304) 207562. B&W, Heybrook, Magnuon, M.Y.S.T., Nakamichi, Pink Triangle, Rotel, Sansui, Technics, Quad, Dem and home trial fac. Mon Sat 9.5.30 closed Thurs. Free install. Credit to \$1,000. Access, Visa. Creditcharge. Service dept.
PHOTOCRAFT HI FI, 40 High St, Ashford, (0233) 624441. No. 1 in Kent for Linn, Naim, Rega, Roksan, Exposure, Onix, Epos, Royd, Creek. But before you choose equipment choose where to buy it. Dem room, appts. necessary. Home trial and free installation. Visa, Access, Bada Chargecard. 9.5.30 Mon Fri (Wed & Sat to 5 only). Serv.

ice Dept. **3AD**
PROGRESSIVE AUDIO, Rainham, Kent. (0634) 389004
 Alphason, Audio Innovation, Conrad Johnson, Proac, Raymond Lunley, Rock Reference, Snell, TDL, Voyd and others. Dem by appt., please phone. Home trial. Free installation. Access, Visa.
TONBRIDGE HI FI, 31 High Street, Tonbridge, Wells, Kent TN1 1XL. (0892) 24677. If your interest is music pay us a visit + find out what we do. **3AD**
VJ HI FI, 29 Guildhall St, Folkestone. (0303) 56860. Mon Sat 9-6. NAD, Yamaha, Marantz, Cambridge Audio, Denon, Kenwood, Rogers, Dual, Musical Fidelity, Quad. Dem and home trial facilities, free installation, credit to \$1000. Amex, Diners, Visa, Access. Service dept.

LANCASHIRE

MONITOR SOUND, 54 Chapel St, Chorley. (02572) 71935. A&R, Dual, Mission, Quad, Rogers, Rotel, Spondor, Thorens, Nakamichi, Yamaha, etc. 2 dem rooms. Open Mon Sat, closed Weds. Free installation. Credit to \$1,000. Access, Visa. Service dept.

LEICESTERSHIRE

MJS HI FI, 80 Stapleton Lane, Barwell, Leicester LE9 8HE. (0455) 46977. The Rock, Audio Innovations, Kelvin Labs, Snell, Helius, Sugden, Ruark, Concordant, Valdi, JPW. Dem and home trial facilities. Mon Sat 9.30-7.00. Free installation and service dept. Visa, Access.
THE LEICESTER HI FI CO, 6 Silver Walk, St. Martins Square, Leicester LE1 5EW. (0533) 539753. Arcam, Creek, Marantz, Mission/Cyrus, Musical Fidelity, Naka michi, QED HI Fi, Quad, Rogers, Roksan, "and oodles more". 2 dem rooms, home trial arranged, free installation service department, credit facilities, Hi Fi Markets, Access, Visa, Diners, Amex. 6 days 9.30-5.30.
SOUND ADVICE, Duke Street, Loughborough LE11 1ED. (0509) 218254. Arcam, Creek, Linn, Epos, Mission, Cyrus, Naim, Rega, Rotel, Yamaha etc. Dem facilities. Appts required. Free installation. Service dept. Credit facilities, Access, Visa, Amex. Mon Sat 9.30-6.

LINCOLNSHIRE

BOSTON HI FI CENTRE, 65a Wide Bargate, John Adams Way, Boston, Lincs PE21 6SG. (0205) 65477. Quad, Nakamichi, Creek, Ariston, NAD, Denon, Marantz, Castle, JPW, B&W. Separate demo studio. Home trial, free installation, service department. Access, Visa, Hi Fi Markets Chargecard. Tues Sat 9.5.30 pm.

LONDON

A.T.LABS, 190 West End Lane, London NW6. (071) 794 7848. Mon Sat 10.6. 2 dem rooms. Access/Visa. Sony Hi-Fi News Best Dealer '86 & '88 (National). **3AD**
AUDIO CHOICES, 66 High Road, Leytonstone, Stratford E15. 081 534 6987. Marantz, A&R, Musical Fidelity, SD Acoustics, Rotel, Audio Technica, Ruark, Roksan, Moth, Nakamichi, B&W, Van den Hul, Dual, Pink Triangle, Alison Acoustics. Dem room, home dems within M25 area. 10.30-7.30.
CORNFLAKE SHOP, 37 Windmill Street (just off Tottenham Court Road), London W1. (071) 631 0472. Mon Sat 10.7. Rega, Roksan, Naim, Monitor Audio, Koetsu, Marantz, Yamaha, SME, DNM, Epos. Three dem rooms. Delivery and installation service. Credit facilities. Access, Visa.
DIN, 25 Melcombe Street, London NW1 6AG. Tel: (071) 224 4413. Roksan, Quad, Denon, Meridian, Mission, Celestion, Krell, Apogee, Arcam, Nakamichi. Full dem + delivery. Free install. Access, Visa, Amex, Diners.
DOUG BRADY HI FI, 14-18 Monmouth St, London WC2H 9HB. (071) 379 4010. Wide range of top specialist hi-fi from Britain, America and Japan. 3 Dem rooms. **3AD**
GRAHAM'S HI FI, Canonbury Yard, 190a New North Rd, London N1 7BS. (071) 226 5500. Winner Sony/HFN Greater London Dealer Award 1986/1989. Linn, Naim, Rega etc. \$300 \$3,000 \$13,000. **3AD**
HI FI CONFIDENTIAL, 35/37 Marsham St., London SW1. (071) 233 0774. Open Mon-Fri 10.6, Sat 10.3. Creek, Denon, Hafler, Kelvin Lab, Musical Fidelity, Oracle, Quad, Rotel, S.D. Acoustic, S.M.E. etc. Large single speaker dem room. Limited home trial facilities. Export worldwide.
JUST MUSIC, 52 Upper Tooting Road, London SW17 7PB. (081) 767 1233. Aiwa, Dual, Denon, Marantz, Quad, Rogers, Thorens, Musical Fidelity, Sugden, Heybrook and many more. Dem facilities. Appts can be arranged. Home trial. Free installation available. Access, Visa, Amex, Hi Fi

Markets, Chargecard, Creditcharge, finance arranged. 10am-7pm Mon-Thurs, 10.6 Fri & Sat.
KAMLA ELECTRONICS, 251 Tottenham Court Road, London W1. (071) 323 2747. Amadens, Ariston, BLQ, Gale, Incatech, JPW, Linn, Mordaunt Short, SME, Systemdek, Thorens, Townshend, Ruark, Wharfedale.
KJ WEST ONE, 26 New Cavendish St, London W1M 7LH. (071) 486 8262/63. Fax (071) 487 3452. Arcam, Audio Research, Acoustic Research, Apogee, Arcam, Audiolab, Creek, Epos, Linn, Meridian, Musical Fidelity, Pink Triangle. Appts. nec. Home trial. Free installation. Service dept. Major credit cards. Mon Sat 10.6pm. (Late night Thursdays til 7pm.)
NICHOLLS HI FI, 430-434 Lee High Street, Lewisham, London SE12 8RW. (081) 852 5780. Sony, Technics, Harman, JBL, Mordaunt Short, Kenwood, Panasonic, Hafler, Suno, B&W. Dem facilities. Home trial. Free installation. Service dept. Credit available. Visa, Access. 9.30-6 Mon-Sat, Thurs till 1 o'clock.
ORPHEUS HOME DEMONSTRATIONS. (081) 299 0075. Alexander, Alphason, Cadence, Castle, Kiseki, Moth, Proton, Thorens, Townshend, Systemdek. Home demonstrations only. Appts. necessary. Home trial, free installation. Service dept. Three month interest free credit. Open 24 hours. All goods guaranteed two years.
THE SOUND SHOP, 58 The Broadway, Mill Hill, London NW7. (081) 906 3364. Denon, Kenwood, JPW, Marantz, Monitor Audio, Musical Fidelity, NAD, Ruark, SD Acoustics, Tannoy etc. Home trial. Free installation. Service department. Access, Visa, Amex, Diners. Credit facilities. \$1000 instant credit. 10.6 Mon Sat.

MIDDLESEX

A.T.LABS, 159 Chase Side, Enfield, Middx. (01) 367 3132. Mon Sat 10.6. Two dem rooms. Car Park Access/Visa. Sony/Hi-Fi News Best Dealer '86 & '88. **3AD**
A.T. LABS, 173-175 Station Rd, Edgware, Middx. (01) 952 5535. Mon Sat 10.6. 2 dem rooms. Access, Visa. Sony/Hi-Fi News Best Dealer '86 & '88 (National). **3AD**
HARROW AUDIO, 27 Springfield Rd, Harrow. (01) 863 0938. Mon Sat 3.30-5.30. A&R, Audiolab, Cyrus, Denon, Dual, Heybrook, Linn, Monitor Audio, Musical Fidelity, Quad, Rotel, Tannoy etc. **3AD**
UXBRIDGE AUDIO LTD, 278 High St, Uxbridge, Middx UB8 1LZ. (0895) 30404 (Multi line). A&R, AR, Ariston, Creek, Cyrus, Denon, Dual, JPW, KEF, Manticore, Meridian, NAD, Nakamichi, Quad, Rotel, Wharfedale, Yamaha, etc. 2 dem rooms. Mon Sat 10.6. **3AD**

MERSEYSIDE

W.A. BRADY & SON, 401 Smithdown Rd, Liverpool L15 3JJ. (051) 733 6859. Largest choice of specialist Hi-Fi in N.W. \$100-\$20K+. All credit cards. 3 dem rooms. Closed Monday. **3AD**
IN CONCERT HI FI, 144 Seaview Road, Wallasey, Wirral, Merseyside. (051) 630 5055. Denon, Audiolab, QED, Alexander, Spica, Shan Acoustics, Systemdek, Musical Fidelity, Audio Dimensions, Voyd. Single speaker dem room. Home trial + free installation. 10.6 - closed Mon. Access + Visa.

NORFOLK

BASICALLY SOUND, The Old School, School Rd, Bracon Ash, Norwich NR14 8HE. (0508) 70829. Arcam, Linn, Naim, Denon, Spondor, Heybrook, Audio Technica, Creek, Rega, Epos, etc. 2 comprehensive dem rooms. Home trial. Free installation. Visa, Access. HP facilities. Tues Sat 9.30-1, 2, 5.30.
SOUND APPROACH, 161 Unithank Road, Norwich. (0603) 622833. Kuzma, Ariston, Castle, Denon, Exposure. Ion, Royd, NVA, Roksan, Ruark, etc. etc. Dem and home trial facilities. Mon Sat 9.6.30. Free installation. Credit to \$1,500. Visa, Access, Diners Club. Service dept.

NORTHAMPTONSHIRE

CLASSIC HI FI + VIDEO, School Lane, Kettering, Northants. (0536) 515766. Cambridge Audio, Marantz, Creek, Trio, Kenwood, Harman Kardon, Onkyo, KeF, Celestion, Bose, Wharfedale and many more. Home trial, free instal. service dept. Access, Visa, credit facs. 9.30-5.30pm.
SOUND PRINCIPLES, 52 Queen Street, Wellingborough, Northants. (0933) 441907. Aura, Heybrook, Marantz, Mission, Nakamichi, QED, Quad, Roksan, Rotel, Spondor, Systemline, Yamaha and others. Demo room. Home demo's by appt. Appts advisable out of hours available. Free installation. Access, Visa + credit scheme available. Mon-Fri 10.6, Sat 9.5.

THE AUDIO SHOP, Coffee Tavern Court, High St, Rushden. (0933) 56651. Audio Technica, Denons, Goodmans, Rotel, Tannoy, Ion Systems, Thorens, Gale, BLQ, Royd. Dem room. Home trial and free installation. Mon-Sat 9.30-5.30 (Thurs 9.30-2). Service dept.

NOTTINGHAMSHIRE

CHANTRY AUDIO, Chantry Walk, 18a Eldon Street, Tuxford, Newark, Notts NG22 0LH. (0777) 870372. Pink Triangle, Royd, JPW, Rotel, BLQ, NVA, Michell, Art Audio (valve), Kelvin Labs, Thorens, + much more. Single speaker dem room. Appts preferred. Home trial, free installation. Access, Visa + credit facilities and mail order. Mon-Fri 10am-4.30pm. Sat 9.30-5.30. Sun home dem by appt. Closed Weds.
DEFINITIVE AUDIO. (0602) 813562. Voyd, Audio Innovations, Snell, Helius, Systemdek, Revox, Deltec, JPW, Pirate, Loowe Audio Visual plus more. Home dems throughout Notts and E. Mids. Free install. 10-7, 7 days. Tel: (0602) 813562 for further info + appt.

WEST MIDLANDS

ALTERNATIVE AUDIO Ltd, 93-95 Hobs Moat Rd, Solihull. (021) 742 0254 (sales), 0248 (service). The widest range of quality hi-fi and CD in the West Midlands. Tues-Sat 10.6. **3AD**
AUDIO CENTRE MAINWAY, Sharing Asda Car Park, High Street, Bloxwich, Walsall, W. Midlands. (0922) 473499. Linn, Ariston, Aura, Arcam, Cambridge Audio, Linn, Denon, Musical Fidelity, Rogets, etc. The midlands most exclusive Hi-Fi Centre with private listening studio. Open evenings by appointment. Home trial. Free installation. Own service department on premises. Instant credit, Chargecard. Interest free. Access, Barclaycard. Mon-Sat 9.5.30.
BRIDGE HI FI, 3 Tudor House, Bridge St, Walsall. (0922) 640456. NAD, Dual, Yamaha, Kenwood, Technics, Pioneer, Mission, Celestion, Denon, Mordaunt Short. Appts required. Home trial and free installations. Access, Visa, Diners, Amex. Credit to \$1,000. 9.15-5.30 Mon-Sat. Service dept.
FIVEWAYS HI FIDELITY LTD, 12 Islington Row, Edgbaston, Birmingham. (021) 4550667. Alphason, Arcam, Denon, Meridian, Musical Fidelity, Quad, Revox, Spondor, TDL, Thorens, etc. Dem facilities. Tues Sat 9.30-6. Free installation. Access, Visa. Service Dept.
GRIFFIN AUDIO LTD, 94 Bristol Street, Birmingham. (021) 692 1359/(021) 622 2230. Castle, Creek, Cyrus, Denon, Linn, Marantz, Naim, Quad, Rega, Rotel. Tues Sat 10.6. **3AD**
HORTON ELECTRONICS (1987) LTD, 8.9 Lower Temple St, Birmingham B2 4JD. (021) 643 0972. Aiwa, Dual, Marantz, Goodmans, JVC, Mission, Sony, Technics, Wharfedale, Sennheiser. Dem facilities. Credit to \$1000. Access, Visa. 9.5.30 Mon Sat. Service dept.
MIDLAND RADIO SUPPLIES, Maypole Lane, Birmingham B14 4PG. (021) 430 7817. By appointment only - listen quietly and hear everything through Croft valve amplifiers and Tannoy speaker systems.
MUSICAL APPROACH, 37 High Street, Aldridge, Walsall, W. Mids. (0922) 57926. Linn products, Arcam, Creek, NVA. Revolver, Onix, Epos, Marantz, Rotel, Quad & more. Dem facs. Home trial. Service dept. Credit facs available. Access, Visa. 9.30-5.30 Mon Sat. 9.30-1 on Thurs.

OXFORDSHIRE

ASTLEY AUDIO LTD, 3 Marketplace, Wallingford. (0491) 39305/34349. Technics, Panasonic, Pioneer, Kenwood, Sony, Yamaha, Denon, Dual, Mission, Tannoy. Home trial, free installation. Service dept. Access, Visa, Amex, Diners. Instant credit. Tue-Fri 9.5.30, Sat 9.5. Records & CDs stocked.
HORNS OF OXFORD LTD, 6 South Parade, Summertown, Oxford. (0865) 511241. Alphason, Ariston, B&W, Celestion, Marantz, Nakamichi, Pink Triangle, Quad, Sony, Technics. Free installation. Service dept. Access, Visa. 9.5.30. Closed Thurs. **3AD**
OXFORD AUDIO CONSULTANTS LTD, Cantay Hse, Park End Place, Oxford OX1 1JE. (0865) 790879. Oxford Acoustics, Audio Research, Krell, Magneplanar, Apogee, Aragon, Stax, Marantz, Wharfedale, Cambridge Audio. Home trial and free installation. Instant Credit. Access, Amex, Visa. 10.6 Tues Sat. Service dept.
WITNEY AUDIO & VIDEO, 28 High St, Witney, Oxford. (0993) 2414. A&R, Aiwa, Akai, Bose, Denon, Dual, Gold star, JBL, Mordaunt Short. Dem facilities. Mon Sat 9.5.30. Free installation, credit to \$1,000. Access, Visa. Service dept.

THE CHOICE DEALER DIRECTORY

 Member of
British Audio
Dealer Association

SHROPSHIRE

CREATIVE AUDIO, 9 Dogpole, Shrewsbury. (0743) 241924. Marantz, Meridian, Linn, Naim, A&R, Mission, Nakamichi, Revolver, Castle, Audio Technica. Dem room. Home trial and free installation. Credit to £1000. Access, Visa. Tues-Sat 9.30-5.30. Service dept.
MID SHROPSHIRE AUDIO, 2 Holland Court, High Street, Dawley, Telford, Shropshire. (0952) 630172. Cambridge Audio, Marantz, Onkyo, Rubric, Tannoy, Alexander. Apollo, Ion Systems, Audio Innovations, SD Acoustics. 2 dem lounge. Home trial. Free Installation. Service dept. Access, Visa. Credit facilities available. Instant credit subject to status. Mon-Sat 10-5 evenings/Sunday by special arrangement.

SOMERSET

WATTS RADIO - the engineers, Jim Badman, 1 West Street, Somerton. (0458) 72440. Castle, Dual, Denon, KEF, Mordaunt-Short, Ortofon, Quad, Rogers, Thorens, Yamaha. Dem and home trial facilities. Mon-Sat 9-1. 2-5.30, Wed 9-1. Free installation. Credit to £1,000. Access, Visa. Service dept.

STAFFORDSHIRE

ACTIVE AUDIO, 29 Market Street, Tamworth, Staffordshire. (0827) 53355. Arcam, Ariston, Celestion, Denon, Heybrook, Kef, Cyrus, Musical Fidelity, Marantz, Revox, Rotel, Rogers, etc, etc. The only BADA Member in Staffordshire. Full demonstration and home trial facilities. Account and credit cards. Ring for opening times and free 'Fact Pack'.
GRANGE HI-FI LTD, 153 Branston Road, Burton-on-Trent DE14 3DQ. (0283) 33655. Audio Innovations, Arcam, Creek, Systemdek, Snell, Spondor, Rotel, Pink Triangle, Quad, Voyd, etc. 2 dem rooms. Mon, Tues, Thurs, Fri, Sat, 9-6. Closed Wed. Free installation. Credit facilities. Visa, Access, Service dept.
MUSICAL APPROACH, 137A Newport Road, Stafford (above Royal London Insurance). (0785) 55154. Linn Products, Arcam, Creek, NVA, Revolver, Audiotec, Onix, Epos, Marantz, Rotel and more. Home trial. Free installation. Service dept. Credit facilities available. Access, Visa. 9.30-5.30 Mon-Sat.

SUFFOLK

EASTERN AUDIO 41 Bramford Rd Ipswich. (0473) 217217. Quad Audio Lab Denon Dual Marantz Mission NAD Nakamichi Technics Arcam. Mon-Sat 9.30-6.

SURREY

PJ HI-FI - the Hi-Fi Shop, 3 Bridge Street, Guildford, Surrey GU1 4RY. Tel: (0483) 504801. 9-6 Mon-Sat. Linn, Creek, Arcam, Quad, Revox, Musical Fidelity, Rotel, NAD, Nakamichi, Marantz.
ROGERS HI-FI, 13 Bridge Street, Guildford (0483) 61049. Ariston, Acoustic Research, Akai, Denon, JPW, Mordaunt-Short, Marantz, Onkyo, QED, Tannoy etc. Mon-Sat 9.30-6. Dem. facilities. Instant Credit. Access, Visa. Service dept.
SPALDINGS HI-FI, 352-4 Lower Addiscombe Rd. Croydon, Surrey. (01) 654 1231. 3 dem rooms + home dem. Free installation. credit. Mon-Sat 9-6. Tues to 8. Closed Wed. Service dept.
SURBITON PARK RADIO, 48 Surbiton Rd, Kingston-Upon-Thames, Surrey. (01) 546 5549. Quad, Dual, Denon, Kenwood, Nakamichi, Rotel, Pioneer, QED, B&W, Tannoy. Dem and home trial facilities. Access, Visa. 9.30-5.00 Tues-Sat. Service dept.
TRU-FI SOUND AND VISION, 2 Central Parade, Redhill, Surrey. (0737) 767404/766128. Aiwa, Audio Technica, B&W, Nakamichi, Mission, Mordaunt-Short, Nakoaka, Sony, Technics. Dem. facilities. Free installation. Service dept. 0% finance. Access, Visa. Mon-Sat 9.30-6.
TRU-FI SOUND & VISION, 10 Church St. Leatherhead, Surrey. (0372) 378780. Sony, Technics, Panasonic, Mitsubishi, Ferguson, Aiwa, Pioneer, Sanyo, B&W, Mission. Free installation. Credit facilities. Access, Visa. 9.15-5.30 Mon-Sat. Closed Wed. Service dept.
UNILET HI-FI, 35 High St, New Malden, Surrey KT3 4BY. (01) 942 9567. Kef, Mission, Musical Fidelity, NAD, Nakamichi, Quad, Rotel, Tannoy, Demos. Amex, Access, Visa, etc.

SUSSEX (EAST)

DEFINITIVE AUDIO BRIGHTON, 8 Dyke Road Mews, 74-76 Dyke Road, Brighton BN1 3JD. (0273) 208649. Voyd, Systemdek, Audio Innovations, Helius, Audionote, JPW, Snell, Pirate Stands, Goldring etc. Home dems throughout Sussex. Credit facilities. Visa.
HASTINGS HI-FI, 33-35 Western Road, St. Leonards, E. Sussex TN37 6DJ. (0424) 442975. Linn, Musical Fidelity, Quad, Nakamichi, Arcam, Celestion, NAD, Denon, Yama-

ha, Tannoy, 2 listening rooms. Home trial. Free installation. Service dept. All credit cards welcome. Instant credit up to £1,000, written details on request. 9-6pm Mon-Sat.
JEFFRIES HI-FI, 69 London Rd. Brighton, East Sussex. (0273) 609 431. 2 dem rooms, closed Mon, late night Wed. Parking, bus route. Credit facilities.
JEFFRIES HI-FI, 4 Albert Parade, Green St. Eastbourne, East Sussex. (0323) 31336. 2 dem rooms, closed Mon. Late night Wed. Parking, bus route. Credit facilities.

LASER SOUND & VISION, 72 Terminus Road, Eastbourne, East Sussex BN21 3LX. (0323) 640911. Marantz, Cambridge, Kenwood, Denon, Rotel, Infinity, Tannoy, Michell, KEF, Heco etc. Dem room. Home trial. Free installation. Service dept. Visa, Access. 9am-6pm Mon-Sat.

SUSSEX (WEST)

ALTERNATIVE SOUNDS, 10 Eastgate Square, Chichester PO19 1JM. (0243) 784710. Rotel, Musical Fidelity, Nakamichi, Marantz, JPW, Yamaha, Tannoy, Cambridge Audio, JBL, Kef. One hi-fi dem room, one surround sound dem room. Home trial. Free installation. Service dept. Credit available. Access, Visa. 9.30-5.30 Mon-Thurs. 9.30-6.00 Fri/Sat.
BOWERS AND WILKINS Ltd, 1 Becket Buildings, Littlehampton Rd. Worthing. (0903) 64141. B&W, Nakamichi, Castle, Denon, Dual, JVC, Mordaunt-Short, Philips, Quad, Sony, Technics. 3 dem rooms. Mon-Sat 9-5.30, Weds 9-1. Home trial facilities, free installation. credit to £1,000. Access, Visa. Service dept.
CHICHESTER HI-FI, 7 St Pancras, Chichester, W. Sussex PO19 1SJ. Tel: (0243) 776402. Linn, Naim, Rega, Creek, Nakamichi, A&R, Denon, Roksan etc. Tues-Sat. 10-1. 2-5.15 (closed Mon).

TYNE & WEAR

BILL HUTCHINSON LTD., 87A Clayton Street, Newcastle-Upon-Tyne. Tel: 091 230 3600. A.R., AIWA, Denon, Dual, JVC, Mission, Mordaunt-Short, Omar, Technics, Yamaha, etc. Demonstration facilities, free installation, service department. Instant credit. Access, Visa. Mon-Sat 10-6.
RED RADIO SHOP AND HI-FI CENTRE, 11 Olive St. (Off Park Lane) Sunderland. (091 567) 2087. Castle, Denon, Bose, JVC, Kenwood, Mordaunt-Short, Michell, Teac, Tannoy, Shure. Dem room, large with comparator facility. Free install. Service dept. Interest free credit and no deposit interest free credit. 9am-5.30pm daily.

WARWICKSHIRE

AUTHENTIC AUDIO, 25 Henley Street, Stratford-upon-Avon, Warwickshire CV37 6QW. (0789) 414533. Linn, Quad, MF., Denon, NAD, etc. Dem room. Home trials. Part-ex. Service dept. Mon-Sat 9.30-5.30.

YORKSHIRE (NORTH)

ELITE HI-FI, 178 Kings Road, Harrogate HG1 5JG (0423) 521 831. Voyd, Valdi, Avalon, Systemdek, Helius, Audionote, Goldring, Audio Innovations, Sugden, Marantz, Mon-Sat 9-5.30. Free installation. Service dept.
SCARBOROUGH HI-FI CENTRE, 53 Dean Road, Scarborough YO12 7SN. (0723) 374547, Cambridge Audio, Rotel, QED, Denon, Nad (incl. Monitor series), Thorens, Onkyo, Tannoy, Marantz, Ruark. Dem Room. Appts preferred. Home trial facilities. Mail order and part exchange. Visa, Access, Diners, Hi-Fi Markets Chargecard facilities. Open 10-6 Mon-Sat.
SOUND ORGANISATION YORK, 16 Gillygate, York YO3 7EQ. Tel: (0904) 627108. Linn, Naim, Rega, Roksan, Sony, Arcam, Mission, Denon, Ion, Rotel. 2 single speaker dem rooms. Appts. preferred. Home trial. Free installation. Service dept. Access, Visa. Instant free credit available. 10am-6pm Tues-Sat. Sony dealer. Award nominated 86, 87, 88.

YORKSHIRE (WEST)

AUDIO PROJECTS, 45 Headingly Lane, Leeds. (0532) 304565. A&R, Audiolab, Creek, Heybrook, Linn, Musical Fidelity, Naim, Quad, Rega, etc. Tues-Fri 9.30-6. Sat 2.30-5.30.
ERRICKS, Hi-Fi Experience, Fotosonic House, Rawson Square, Bradford (0274) 309266. Dem facilities. Sales/service agents for A&R, Linn, Quad, Exposure, Nakamichi, Mission etc.
HUDDERSFIELD HI-FI CENTRE, 4 Cross Church St, Huddersfield. (0484) 544668. B&W, Kenwood, Denon, Dual, Arcam, Musical Fidelity, Quad, NVA, Audio Lab, Philips, Mission, etc. Dem facilities - appointment reqd. Mon-Sat 9-5.30, Thurs 9-8. Closed Wed. Free installation, credit facilities. Access, Visa.
IMAGE HI-FI Ltd, 8-10 St Annes Rd. Headingley, Leeds.

(0532) 789374. AR, Audio Lab, Denon, Linn, Marantz, Meridian, Mission, Monitor Audio, NAD, Quad, SELECTIVE AUDIO, The Forge Cottage, 19 Crossgate, Otley. (0943) 467689. Exclusively handles Alphason, Roksan, NVA, ProAc, TDL, JDL, in the area and other minimalist British designer products for the discerning listener. Dem facility. Member of the Cognoscenti. Mon-Sat 10-6.

NORTHERN IRELAND

LYRIC HI-FI, 163 Swanmilus Road, Belfast. (0232) 381 296. Linn, Naim, Rega, Arcam, Denon, Rotel, Musical Fidelity, Revox, Mission etc. Mon-Sat 10-6. Late night Thurs.

EIRE

CEOL PRODUCTS, 185 Lower Rathmines Road, Dublin 6. Tel: 0001 975984 961358. Alphason, Audio Innovation, Exposure, Linn, Marantz, Monitor Audio, Mordaunt Short, Musical Fidelity, Rega, Roksan, Single Speaker listening rooms. Free installation. All major cards. Mon-Sat 9.30-6.00.
CLONEY AUDIO, 55 Main St, Blackrock, Dublin. 0001 889449/888477. Arcam, Acoustic Energy, Apogee, Linn, Naim, Creek, Rega, Rogers, Sony, Nakamichi, 2 single speaker dem rooms. Home trial. Free installation. Service dept. All major credit cards. Interest free credit. Tues-Sat 10-6. Thurs and Fri till 9pm.

SCOTLAND

EAST KILBRIDE

DAVID STEVEN HI-FI, 1-3 Main Street, East Kilbride, Strathclyde. (03552) 44145. Denon, Infinity, KEF, Marantz, Mission, Quad, Technics, Sony, Yamaha, Dem. room. Home trial facilities. Installation facilities available. Service dept. Access, Visa. Licenced credit broker. 9.30-5.30 Mon-Sat. 5.30-9.30 Mon-Fri by appointment.

EDINBURGH

BILL HUTCHINSON Ltd, 43 Clarke St, Edinburgh. (031) 667 2877. AR, Aiwa, Denon, Dual, JVC, Mission, Mordaunt-Short, Omar, Technics, Yamaha, Dem facilities. Mon-Sat 10-6. Free installation. Instant credit. Credit cards: Access, Visa. Service dept.

GLASGOW

BILL HUTCHINSON Ltd, 43 Hope Street, Glasgow. (041) 248 2857. A.R., Aiwa, Denon, Dual, JVC, Mission, Mordaunt-Short, Omar, Technics, Yamaha etc. Dem facilities. Mon-Sat 10-6. Free installation, instant credit. Access, Visa. Service dept.
STEREO STEREO, 278 St. Vincent St, Glasgow G2 5RL. (041) 248 4079. Linn, Naim, Rega, Arcam, Creek, Epos, Exposure, Revox, PT, etc. Mon-Sat 10-6. Interest free credit.

GRAMPIAN

HOLBURN HI-FI Ltd, 441 Holburn St, Aberdeen (0224) 585713. Linn, Rega, Quad, Audiolab, Mission Cyrus, Rotel, QED, NAD, Krell, Nakamichi, Denon, Sony, KEF, Wharfedale, Monitor Audio, Kenwood, etc. 9.30-5.30 Mon-Sat.

TAYSIDE

W.M. COUPAR, 33 Reform Street, Dundee, Tayside. (0382) 29588. Bang & Olufsen, Nada, Technics, Denon, Kenwood, Dual, Nakamichi, B&W, Acoustic Research, JBL. No appointment necessary. free installation, service department. All demonstration systems wired through a demonstration compatitor. Licensed credit broker. Access, Visa. Monday-Saturday 9.00 am-5.30.

WALES

GLAMORGAN

AUDIO EXCELLENCE, 134 Crvys Road, Cardiff. (0222) 28565. Audio Research, Dual, Krell, Linn, Magneplanar, Naim, NAD, Yamaha, etc. Closed Mon.
AUDIO EXCELLENCE, 9 High St, Swansea. (0792) 474608. Audio Research, Dual, Krell, Linn, Magneplanar, Naim, NAD, Yamaha, etc. Closed Mon.

NORTH WALES

ELECTRO TRADER, 19 Colwyn Crescent, Rhos On Sea, Colwyn Bay, Clwyd. (0492) 48932. Ariston, Arcam, B&W, Heco, Infinity, Onkyo, Rotel, Tannoy, TDL, Yamaha etc. Dem room. Appts preferred. Home trial. Free installation. Access, Visa, American Express, Diners. 9.30-1.00, 2.00-5.30 Mon-Sat.

THE DIRECTORY

The *Hi-Fi Choice Directory* was conceived as a reference guide to all the audio products reviewed by *Choice* that are currently available. The products are split into suitable categories, each with its own introduction containing information about the product type and its applications. They are particularly relevant to the uninitiated first time buyer and help sort out the order of priorities when buying a piece of equipment.

Each product along with its retail price is placed in its respective category in alphabetical order. For instance the Acoustic Research *EB101* is presently at the beginning of the Turntables and Tonearms section; however, the Ariston *Superior* heads the Motor Units section as it is sold and was reviewed as a separate component – requiring a separate arm. Where there are several products with the same name but different model numbers these are in price ascending order.

Then come the ratings for the standard achieved in laboratory and listening tests, with the exception of certain product groups where lab tests

were not carried out. One important point to remember is that they cannot be used to compare products from different categories – ie a cassette deck rated 'excellent' in sound quality will not usually offer the same standard of fidelity as a similarly rated turntable or CD player (unless you can get hold of first generation copies of the master tape!).

The Comments column contains a potted summary based on the original review, emphasising the salient points of a product's character and sonic performance. The space available doesn't allow for great detail but in the 20 or so words we have attempted to put across the essence of the review, in some cases using quotes from the review itself. Obviously, important information on compatibility or auxiliary equipment used in the test cannot be included, and it is best to refer to the original review for this, of which more later.

The next column(s) varies from category to category but is usually either features or specifications, the former being facilities available on a cassette deck or amplifier or the type of drive

system on a turntable.

Specifications vary with product type but usually relate to suitability or capability, for instance arm matching figures are given with the cartridges which tie in with the mass figures for the tonearms themselves, making it easier to avoid compliance/ mass mismatches.

Perhaps the most influential letters in the Directory are those found in the Value column, the *Rs* and *BBs* denoting the Recommended and Best Buy ratings that are appended to products we consider meritorious. The Best Buy tag means that a product not only offers good sound quality but is reasonably priced as well. With source components a price limit of approximately £300 is usually used as a guide. Recommended means that either the performance of a product is particularly good irrespective of price or, alternatively that a good value standard is achieved but overall attainment falls short of Best Buy classification. An ideal situation would be to choose suitably priced Best Buy or Recommended products from relevant categories and create a Best Buy system, but, due to

the variety in tonal balance that exists in much audio equipment (especially the electromechanical elements – ie cartridge and speaker) system building is not quite that simple. These ratings make a useful guideline for shortlisting components, but only experiencing the actual combination will tell you whether it works for you.

The final column contains a reference to the issue of *Hi-Fi Choice* which featured the complete review. If you wish to get a better idea of a product by reading the complete review it is possible to order a copy (if still in print) through our back issues department. Every *Choice* issue contains a Back Issues page for this purpose.

The Directory is constantly updated with the latest reviews and price changes as well as having discontinued products removed. If a listed product is updated to a 'mark two' form and the alterations are purely cosmetic or not too extensive we sometimes leave the product in with its current model number and an asterisk to denote that it has changed since our original review was published.

SYSTEM BUILDING

Pre-packaged one-make systems have been commercially very successful, with advantages like cosmetic consistency, competitive pricing, and (assumed) technical compatibility. However, despite the mass market clout of the consumer electronics giants, the hi-fi tradition of specialised separate components seems as strong as ever, and certainly represents the route taken by those who place sound quality first.

Yet those who choose the separates route still have lingering doubts – usually completely unjustified – over the compatibility of components from different manufacturers. Gross incompatibilities are very rare nowadays, only likely to rear their heads amongst the most exotic components. Here the delicate art of 'supercompatibility' really takes over the major role and might be regarded as the key to 'real' hi-fi.

There are now three different pre-recorded music media competing for the attention of the hi-fi user, and to go for all three will either cost a lot of money or involve substantial compromises in the sound quality of each. For this reason many separates purchasers may start with just one source, adding others or a tuner when funds permit.

There will always be controversy over the relative qualities of LP, CD and cassette. LP is still the choice for ultimate sound quality – particularly for those prepared to spend a substantial sum on a good quality turntable system.

Cassette has never really challenged vinyl's superior quality, but it is a multiple role format, offering 'go anywhere' flexibility, a uniquely useful recording capability, plus a broad catalogue of pre-

recorded music cassette material. As a hi-fi medium cassette suffers from pre-recorded material which has been improving but is still patchy in quality, and can usually be bettered by a home recording. There is also the worry that a tape made on a specific machine usually replays best on that machine, which may cause aggravation when upgrading a few years hence.

CD is the latest challenger to these two established media, using a digital instead of analogue storage format. The sound quality remains controversial, hailed as near perfect by its fans but derided by vinyl freaks, so it is probably fairest to say that CD is fine for most listeners, but may not suit everyone; certainly the lack of background noise, defects and deterioration over time are major strengths.

While there will always be arguments about the different music storage and transmission formats available to the hi-fi listener, there is also controversy over the relative importance of the different components which make up the system chain – by which is meant the source, the amplification, and the loudspeakers (and for the pedantic the room itself, though there's often little that can be done here).

For many years the 'weakest link' theory proposed that the loudspeakers needed the most attention, that amplifiers merely had to have sufficient power, and that turntables were pretty well perfect. However, this perspective has become steadily discredited by an alternative 'theory of precedence', which stresses that no subsequent component can make up for the inadequacies of its

predecessors – all it can do is supply its own additional degradations. In such a context it is not uncommon to find more than half the system budget allocated to the record player, with scrimping and saving made on amplifiers and loudspeakers.

Choosing the components of a system is only part of the task of getting the system as a whole working as well as possible. Good turntables and loudspeakers both benefit to a surprising degree from proper support – from stands that enable them to give their best performance, whether floor-standing or wall mounted.

Siting of components within a room can play a significant role, as can the room itself. Some people may prefer an acoustically more 'live' room than others, but most will agree that the larger it is the better, because this tends to provide smoother and better extended bass reproduction. All rooms create reflections and standing waves, and the effects of these are more severe if all opposing walls are parallel, similar distances apart, and with hard reflective surfaces.

Provided that the loudspeakers can be placed fairly symmetrically, slight asymmetry elsewhere in the room is usually helpful.

The loudspeakers are most critical of placement, because it is their job to create the stereo image, and it will be impossible to do this if the sound from each is not roughly similar at the listening position. Each loudspeaker should operate in a similar immediate acoustic environment, unencumbered by other furnishings and structure, and a similar distance from listener, nearby walls, and

corners. Some loudspeakers are designed to operate close to a rear wall, others a metre or so out into the room, but all loudspeakers benefit from being closely mechanically coupled via proper stands to the floor.

Mixing and matching the components of a record player to get optimum results can be something of a black art, over and beyond the fairly simple business of choosing a cartridge of roughly the right compliance to suit the arm effective mass. Certainly the combining of turntables and tonearms is not a simple matter, and this is where a good specialist dealer will come into his own, both in terms of recommending good combinations from the models he holds in stock, and then in correctly carrying out the sometimes tricky set up procedures which are often required to get the best results.

The key to getting the best results from a separates system lies in finding an experienced and skilled dealer in the first place, one who takes the trouble to find out what you really want and then demonstrate some likely alternatives.

The Directory has been compiled so that it can be used by *Choice* readers as a buying guide. A guide in the sense that you should use the information in it to make a shortlist of equipment suited to your needs and budget, and then audition it at a dealers before taking the plunge. Because tastes inevitably differ it would be unwise to buy purely on the basis of our recommendation and dealers are the most experienced people around when it comes to making systems work as a whole.

THE DIRECTORY

TURNTABLES & TONEARMS

The schizophrenic split between consumer electronics and 'real hi-fi' is most obvious amongst turntables. The former are supplied simply as a means of playing vinyl in a system context. Cheaply manufactured in the Far East, these are complete players with a variety of automatic facilities, sometimes tied into system remote control. But engineering compromises severely limit sound quality, cartridge choice may be P-mount restricted, and such machines are rarely stocked by specialist hi-fi dealers these days.

Specialist turntables offer big sound quality

improvements, but lack so-called convenience features (that practised users often find irksome). Such turntables at the cheaper end of the market (sub-£350) tend to be supplied with matching tonearm, and often include a 'starter' cartridge. Still better quality is found at higher prices amongst the separate motor units and tonearms. Careful partnering and set-up is essential for these individual components, but 'naturally sympathetic' combinations do exist, and the good dealer can help.

Listed separately as integrated players and as turntable motor units and tonearms, our **sound**

quality rating is based on results achieved using a high quality system – but in point of fact the turntable is usually the limiting factor soundwise in any system. **Lab performance** summarises the speed stability, vibration generation and environmental isolation of turntables, along with the friction, alignment and adjustment of tonearms. The tonearm's physical characteristics also define a range of mechanically compatible cartridges (see cartridge listings).

INTEGRATED TURNTABLES

NAME PRICE	LAB SOUND	COMMENTS	FEATURES ARM EFF. MASS	VALUE	BACK ISSUE FULL REVIEW
Acoustic Research EB101 £230	Good Good	This genuine high fidelity product offers an impressive package at a competitive price	Subchassis, manual, 13.5g	BB	48
Alphason Solo/Xenon MCS £420/£300	Average+ Good	The deck is warm and euphonious with high levels of clarity. Wow artefacts occasionally just audible.	3 point suspended motor unit, optional quartz PSU/speed change 13g		67
Alphason Sonata/HR-100S MCS/atlas £720/£480/£340	Very Good Very Good	Good sound in all areas – bass, clarity and neutrality all in the top class and bettered by very few decks. Atlas PSU expensive but worthwhile	Belt drive, suspended, optional PSU, 13g	R	79
Ariston Q-Deck £165	Good Average+	Well engineered and good sounding low cost package which is both easy to set up and to use	Semi-auto, belt drive, solid	BB*	67
Ariston Icon £215	Good Good	A thoughtful and efficient design that offers good sound, excellent value and semi-automatic operation too! Good vibration isolation eases siting	Belt drive, suspended, semi-automatic, 10g	BB	79
Ariston Forte £350	Average– Average	Heavy on engineering, short of soul? The Forte almost makes it, losing out only because of some residual pitch variations and a lack of bass power. The arm is modestly good	Manual 2-speed belt drive player and detachable arm, 10g		67
Dual CS430 £100	Average Average–	Ragged, sometimes unpleasant cartridge mixes with a modest pleasing player in a very sharply priced package.	Belt drive, with cartridge, auto return, 5g	R	67
Dual CS505-3 £160	Very Good Good	Continuous steady improvements have kept this model at the forefront of the budget market. Practicality is excellent and the deck has excellent timing bass/mid and stereo imaging	Semi-auto belt drive, 8g	BB	67
Dual CS5000 £230	Average Average+	The rare 78 facility may give grandma's collection a new lease of life but the player did not merit recommendation on price vs sound	Electronic, belt drive, subchassis, 10g		48
Goldmund ST4 £4,589	Very Good Excellent	The Studio turntable takes on a cheaper tonearm than the T3F, yet provides a similar reference standard objective and subjective performance at £2,000 less, in a neatly integrated though bulky package.	Solid subchassis, direct drive, parallel arm, detachable headshell	R	60
Heybrook TT2 turntable & arm £424/£269	Average Good+	A gradual process of informed evolution and a sensibly designed arm combine to make this a good sounding middle of the road package. Well supported by dealers	Manual subchassis motor with arm, belt drive, 14g	R	67
JVC AL-FQ555 £170	Below Average Poor	Clear midband sound but woolly bass and crude treble. Ease of use however ranks highly, and there's little to go out of adjustment	Auto, direct drive, 5.5g		67
Kenwood DP-990 £400	Average Average	Smart, slick and massive player suitable for low compliance cartridges only. A good but not inspired performer.	Semi-auto 2 speed direct drive, 16g		67
Kuzma Stabi/Stogi £699/£399	Average+ Stabi: Good; Stogi: Excellent	Stabi is powerful, spacious but not sufficiently subtle. Stogi is an excellent all rounder with even spread of abilities.	Manual, belt drive, subchassis. 12.5g	Stogi: R	60
Linn Axis/Akito £399	Good– Average+	A neat, attractive and well-made package which delivers a rather harsh sound with a 'one-note' effect in the bass, but it's well suited to mid market systems	Belt drive, semi-suspended, electronic PSU, 10g		79
Linn Sondek/Ittok/Troika* £549/£483/£669	Excellent Very Good	Superb sound – the best LP12 combination yet. The Troika gives the system real solidity and strength, stretching the deck and arm qualities to the full. Arm has since been upgraded	Manual subchassis player, belt drive, 14g	R	60
Manticore Mantra/Musician £340/£170	Good+ Good+	Well engineered deck with satisfying sound. The arm is particularly fine and very good value	Belt drive, suspended, 15g	R	79
NAD 5120 £90	Average Average	A number of running improvements have given this player a range and tautness denied its lazier sounding antecedents.	Semi-auto belt drive, detachable armtube/weight, 9g	BB	67

AIWA - AKAI - AR - AMADEUS - AUDIO INNOVATIONS - CERWIN VEGA - C.E.C. - EXPOSURE - HECO - INFINITY

TANNOY - TEAC - VIDEOTONE

PINK TRIANGLE



LITTLE PINK THING

JPW - MANTICORE - MISSION

Audition them now at the:

NORTHWOOD AUDIO
126 PINNER ROAD, NORTHWOOD,
MIDDX HA6 1BP
09274 20877

Separate Demonstration Room Available

THE FINEST TURNTABLE AT ITS PRICE
 **CREDIT FACILITIES AVAILABLE**

SUGDEN-SHERWOOD-REVOLVER-ROTEL-QED -PINK TRIANGLE-NIKKO-MUSICAL FIDELITY-MONSTER CABLE

TO ORDER BACK ISSUES OF HI-FI CHOICE SEE PAGE 32

THE DIRECTORY

INTEGRATED TURNTABLES

NAME PRICE	LAB SOUND	COMMENTS	FEATURES ARM EFF. MASS	VALUE	BACK ISSUE FULL REVIEW
Omega Point Silver/Black £895/£295	Good Good+	An avowedly stripped down turntable that lacks even an on/off switch, the Omega Point Silver offers fine midrange clarity and good stereo, but some HF compression and a lack of 'wellie'	Manual, solid, belt drive, unipivot, 11g		55
Opus 3 Continuo/Decca London International (Revised)* £599/£99	Poor Good	Heavyweight motor unit with many fine properties, but which needs further development. The idiosyncratic arm is a suitable (though not ideal) platform for the Decca cartridge. For all its faults though, the whole transcends the sum of the parts	Belt-drive manual, damped unipivot arm, 12g		67
Rega Planar 2 £155	Average+ Good	A remarkable product at the price, surprisingly articulate and confident	Manual, 11.5g	BB	48
Rega Planar 3 £207	Good Good	A long time leader in its price category, the '3 (with its excellent RB300 arm) sounded nicely 'musical' in a balanced and coherent manner	Manual, 11.5g	BB	48
Revolver Rebel £169	Average- Average-	Fat, assured and forward presentation, but ragged and subjective speed stability problems. With a little further development, it will be a winner	Manual, 2-speed belt drive inc cartridge, 13g		67
Revox B291* £892	Average- Average-	Sound quality ranks as below average. Subjective bandwidth is narrow and the music lacks grace and energy. Ease of use however is unrivalled	Automatic, remote controllable, direct drive parallel arm, prefitted cartridge		55
Roksan Xerxes/Artemiz/Shiraz £695, £595, £655	n/a Very Good	Imaginatively designed, sophisticated front-end system, a little drier than some perhaps, with superior stereo, resolution and presence	2-speed manual, MC cartridge, 9g	R	72
Rotel RP-855 £189	Good Good	Great sound for the money - detailed and clear with good bass and no irritating nasties	Belt drive, solid, speed adjust, 9g	BB	79
Systemdek IIX £248	Good Average+	Poised, clean sounding deck, forward and explicit in character. A good value deck under £250, and a relatively cheap and satisfactory suspended model	2 speed belt drive manual turntable and arm, 11g	R	67
Technics SLBD-22 £90	Average- Average-	Not bad for the price and a great improvement on the L20, it performs reasonably when not stretched	Semi automatic, solid plinth, electronic, 6g P-mount	R	48
Technics SL-DD33 £110	Average Average	As with the QD33 though better value	Automatic, direct drive, solid plinth, 7.5g, P-mount	BB	48
Technics SL-L20 £115	Poor Average-	A rather lightweight parallel tracker achieving a poor overall rating, with little to recommend it unless you dig facilities	Electronic, solid plinth, 5g, P-mount		48
Technics SL-QD33 £140	Average Average	The quartz speed controlled version of the DD is short on sound quality but not features. But it did have fair focus and some depth	Automatic, Quartz, direct drive, solid plinth, 7.5g, P-mount	R	48
Thorens TD 280 Mk II £180	Good- Good-	Legendary Thorens build quality on the cheap - slightly unobtrusive sound but eminently liveable-with and very good value	Belt drive, solid, electronic PSU, 12g	BB	79
Thorens TD 166 Mk V £200	Good Good	Classic suspended-subchassis deck with clear, stable sound of no particular character. Unlikely to make enemies	Belt drive, suspended, 12g	BB	79
Thorens TD 316 Mk II £220	Good Good-	Very solid deck with neat split-chassis construction. Sound is a bit insecure in the bass, but it could suit classical music lovers well	Belt drive, suspended, electronic PSU, 12g	R	79
Thorens TD320 Mk II £350	Good Good	Good, consistent sounding deck with much improved (but not ideal) arm. A little expensive for performance offered	Semi-auto two speed belt drive, 14g		67
Townshend Rock Reference/Excalibur £1,800/£650	Excellent Excellent	Overall, the closest reproduction to master tape we've yet heard, with stunning real bass and excellent neutrality. Front-end damping trough improves LF detail significantly	Belt drive, suspended, electronic PSU, front-end damping, 12g	R	79
Well Tempered WTAT £1690	Average Very Good	Intriguing and challenging design. Musically it is not ideal, but it has a limpid quality and a lack of artificiality that sets standards as well as turning the ear, though it's not completely uncoloured. A charmer yet mainstream enough in its virtues to be viable	Manual 2-speed, damped, suspended arm, 7.5g	R	67
Zarathustra S4/Pluto 5A Prestige/PSU £1500/£2500/£500	n/a Excellent	The very well made and finished heavy platter S4 with the superb Pluto arm make a devastating combination ranking up there with the very best	Subchassis, manual, available without PSU	R	72

MOTOR UNITS

NAME PRICE	LAB SOUND	COMMENTS	FEATURES	VALUE	BACK ISSUE FULL REVIEW
Ariston Superior £598	Good+ Good	Good but slightly damped sound quality, with powerful and stable bass. The pro quo is a certain lack of pace, energy and resolution	Belt drive, subchassis, electronic		55
CEC ST930 £599	Good Good++	A rarity - a serious hi-fi product that loses nothing to budget rivals in finish or convenience. Good clean sound, very stable and assured	Belt drive, external PSU, 78 speed inc	R	79
CS Audio Resan kit for Rega £80	Good- Good	After-market kit to convert Rega 2 or 3 to semi-suspended subchassis style. Looks good and sounds tidier than original. Feedback is much reduced	Conversion kit, all work reversible	R	79
Michell Synco £265	Good Good	A particularly happy blend of qualities endows the Synco with a blend of subtlety and force - the mailed fist in the velvet glove. Easy on the ear in the best sense.	Manual, belt drive, suspended motor unit	R	67
Michell Gyrodec £595	Good Good	Sweet and natural sounding player, well exploited by the Rega RB300 arm. Aesthetics, and the acres of acrylic, are unique	Manual, belt drive, suspended motor unit		55
NVA Senior £450	Good- Average	Very high sensitivity to low-frequency vibration, especially on NVA stand, gives strange subjective bass response and confused sound. Looks are unusual but pleasing	Belt drive, electronic PSU, two-part plinth		79
Oracle Alexandria Mk III £995 - £1095	Very Good Very Good	One of the most beautifully presented players made, and fully supported by superb separation, dynamics and a euphonious style of delivery.	Manual 2-speed belt drive	R	67
Origin Live Oasis B £199	Average Average+	Aesthetics are not its strong point, but its lively and articulate - if idiosyncratic - sound will please some tastes. Highly resonant construction is very sensitive to feedback	Belt drive, 33 1/3rpm only, solid plinth/subchassis		79
Origin Live Oasis A £495	Good- Average	Rather coarse sound with lack of detail resolution - but lively presentation may appeal. Appearance is industrial	Belt drive, external mains filter, 33 1/3rpm only, suspended subchassis		79
Oxford Acoustics Crystal Reference £2395	Very Good Excellent	This big, open and powerful sounding turntable works beautifully with Airtangent arm to give superb 3-D imagery	Manual, belt drive, subchassis, stand	R*	60
Pink Triangle Little Pink Thing £345	Good+ Very Good	Leads the field for clarity and neutrality at this price or a good bit more. It also looks very smart! Excellent value. Arm cut-out suits Rega or Linn style	Belt drive, semi-suspended, electronic PSU	R	79
Pink Triangle PT T00 £650	Very Good Excellent	Uniquely clear sound, uncoloured, free from ringing and with good bass. Very close to master tape, given a good arm and cartridge	Belt drive, external PSU, suspended subchassis	R	79
Revolver £150	Average Average	Nicely balanced, but unimpressive timing and lightweight bass made this deck rather average for the price. Manufacturer has since made several changes, but not re-submitted for review	Manual, belt drive, solid plinth		48
Roksan Xerxes £695	Excellent Very Good	This unique design cuts a swathe through the conventions of turntable design, providing superb resolution and stereo. Power supply has since been upgraded - see issue 78 for our latest report	Manual, belt drive, solid/decoupled	R	67
Systemdek IIXE £248	Good Very Good	Fine, honestly specified and well built player which easily better its closest stablemate, the IIX. Frankly, at the price it's a sonic bargain	Manual 2-speed, external PSU	R	67

Sounds Expensive

HI-FI

MIDLANDS'S LARGEST

compact discs centre

12 Regent St, Rugby 0788 540772

CD PLAYERS in STOCK

DENON

DCD620.....	£199
DCD820.....	£249
DCD920.....	£320
DCD1420.....	£399
DCD1560.....	£550

KENWOOD

DP3010.....	£200
DP5010.....	£450
DPX9010.....	£499
DP8010.....	£449

marantz

CD40.....	£199
CD50SE.....	£229
CD60.....	£229
CD60SE.....	£379
CD80.....	£549
CD94 II.....	£899

MERIDIAN

206.....	£799
203 Bitstream Convertor.....	£499
208.....	£1499

CD880.....	£499
CDV475.....	£499

PHILIPS

CD160.....	£160
CD582.....	£199
CD610.....	£159
CD620.....	£199
CD630.....	£249
CD840.....	£349
CD880.....	£499
CDC586.....	£229

QUAD

QUAD CD PLAYER VERY LIMITED SUPPLY
SPECIAL ORDER ONLY £449

NAD

CD5320.....	£189
CD5325.....	£219

YAMAHA

CDX630E.....	£199
CDX810.....	£299
CDX1000.....	£699
CDX530.....	£179
CDX730.....	£229

SONY

CDP770.....	£199
CDP228ES.....	£399
CDP338ES.....	£599

ROTEL

RCD855.....	£249
RCD865.....	£299

OVER 5000 CD'S IN STOCK

AGENTS FOR

A&R — ADC — Aiwa — Alphason — Beyer — Bose — Cambridge Audio — Castle — Celestion — Creek — DBX — Dual — Denon — Harman Kardon — Heybrook — Kenwood — Marantz — Meridian — Monitor Audio — Mordaunt-Short — Musical Fidelity — Nagaoka — Philips — Proton — QED — Quad — Rotel — Sennheiser — SME — Sony — Spendor — Tannoy — Thorens — Yamaha

For Demonstrations, Installations and Expert Advice
12 Regent Street, Rugby, Warks.

To SOUNDS EXPENSIVE HI-FI, 12 REGENT ST, RUGBY, WARCS.
Please send me.....
I enclose cheque/cash/Card No.....
Name:.....
Address:.....
.....
.....

HFC/09/190
CD VOUCHER
FREE FULL PRICED CD
FOR EVERY £150 SPENT
MINIMUM 3 MONTHS ONLY

For CD System
Demonstrations
or MAIL ORDER service
RING NICK on **0788 540772**

THE DIRECTORY

MOTOR UNITS

NAME PRICE	LAB SOUND	COMMENTS	FEATURES	VALUE	BACK ISSUE FULL REVIEW
Systemdek IV £495	Good Very Good	The level of wow is a theoretical concern at least, but elsewhere this player shines, combining euphony, information and imaging in a polished, untemperamental package	Two-speed manual belt drive	R	67
VPI HW-19 £1,317	Very Good Very Good	Built to accommodate parallel tracking arms, this large but elegant deck produced clean, smooth sound when fitted with an SME arm. Good bass	Belt drive, suspended subchassis	R	79
Voyd Valdi £680	Good— Good+	Slight 'one-note bass' effect and lack of pitch stability compromise the performance of this well-made deck	Belt drive, suspended subchassis, electronic PSU		79
Voyd "The Voyd Plus" £2,777	n/a Excellent	Based on the standard 3-motor Voyd but with upgrade options (better bearing, platter, etc) which take it half way to a Voyd Reference, so we've dubbed it The Voyd Plus. Superb build and finish; colourful, dramatic performance. A thoroughbred	Belt drive, 3 motors, subchassis, outboard PSU	R	72

TONEARMS

NAME PRICE	LAB SOUND	COMMENTS	ARM EFF. MAS	VALUE	BACK ISSUE FULL REVIEW
Airtangent 1B £1990	n/a Excellent	A complex but superbly built arm for high quality systems, giving excellent stereo and resolution	7.5g (vertical)	R	This
Alphason Opal £130	Good Average	This is a straightforward adequate sounding low cost arm, priced just above where it rightly belongs	10g		55
Alphason Delta £190	Good Average+	A highly competent design from Alphason gives good sound quality but with slight blurring and treble fizz	16g	R	48
Alphason Xenon £240	Good Good+	A trimmed down HR100S, the Xenon has inferior bearings and a simpler finish, but sounds crisp and coherent. Fits any Linn cutout	12.75g	R	55
Alphason HR100S £420	Good++ Very Good	This S-shaped arm sounds smooth, but nevertheless reproduces transients with fine attack	10g	R	48/Coll
Ariston Enigma £99	Average Average+	Good but not the best in its class: mid-band sounds a little uneven; treble a trifle "brash"	11.5g		48
Audio Technica AT1130 £186	Good Good	Well suited to most cartridges including high compliance ones, the AT is smooth and tonally neutral, if slightly lacking in 'balls'	8.5g	R	67
Decca London International £49	Average+ Average+	This uni-pivot design gives a rather rich tonal balance and some bass muddling. Could be good with Decca cartridges, but not well built	12g		48Summary
Eminent Technology £1000	Good+ Good++	One of the best sounding tonearms around, the linear tracking Eminent delivers impressive stereo imagery, focus and transparent sound	9g (vertical)	R	48/Coll
Goldmund T3F arm £4400	Excellent Excellent	This complex parallel tracker created an "ear-opening" experience when tested with a (since updated) Goldmund Studio turntable	16.5g	R	Coll 2
Grace G707 £299	Good Good+	This venerable is still capable, if not competitive with modern alternatives	7g		48
Helius Orion 2 £490	Very Good Very Good	Excellent engineering with rigid bearings, free from slack. It remains expensive but the level of performance deserves Recommendation	12g	R	48
Kuzma Stogi Reference £699	Very Good Very Good	A large, solid and well-made arm that holds the cartridge firmly, giving exceptionally clear sound with just a hint of brightness	12g	R	79
Linn Ekos £895	Very Good Very Good	Superb, state of the art design which builds significantly on Linn's strengths	9g	R	67
Mission Mechanic £900	Good Good+	Nearly right, but inconsistency with level and vague imagery spoil what is otherwise a firm, powerful advocate for black vinyl	11g		55
Moth Arm £78	Good Good+	The ultimate budget arm? Refined, detailed, sweet and natural – performance improves in line with the rest of the system	12g	BB	60
Rega RB300 £115	Good++ Good++	Despite its modest price this sets exceptional performance standards and could be used on a number of high-quality turntables	10-11g	BB	60
Roksan Artemiz £595	Average Good	Interesting design which works a treat on the Xerxes deck. Fits Rega cut-out. See issue 72 for up to date assessment	8g		67
SME 3009 Series IHS £165	Good Average+	A simplified less flexible (as regards adjustment) Series III with a similarly 'soft' sonic character	5g		48
SME 3009 Series III £229	Good Average+	Comprehensively adjustable and very well made, suited to MM and high compliance MC cartridges	5g		48
SME 3009R £291	Average+ Average+	A higher mass version of the Series III designed for low compliance MC cartridges	12g		48
SME 309 £495	Very Good Very Good	Beautifully made, finished and presented, this arm is fully and easily adjustable and a highly neutral performer	10g	R	79
SME Series IV £810	Excellent Very Good	Superb engineering and finish with a finely balanced sound giving impressive stereo focus and low coloration	10.5g	R	60
SME Series V £1206	Excellent Very Good	Excellent in terms of design engineering and sound quality, this arm arguably sets a new reference standard regardless of price	10.5g	R	60
Souther Tri-Quartz £895	Average Good	A unique parallel tracking arm that makes up for what it lacks sonically in its unusual appearance	3-4g		48

* rating refers to original tested model

CARTRIDGES

Very much the 'slave' of turntable and tonearm and to some extent undermined by the supply of free 'starter' cartridges on many turntable systems, the cartridge is still worth taking seriously. The quality of both the stylus itself and the cartridge's tracking performance are important in preserving that most important part of the hi-fi system – the record collection – and the cartridge also plays a significant role in determining the overall balance of a system

Cartridges fall into two groups: high output models, capable of working directly into any amplifier, and more expensive low output models. Stereotypically, low output cartridges use the moving coil principle of operation, have better mechanical integrity and tighter tolerances, and give better performance but at much higher cost. Most under-£150 amplifiers and many valve designs need either an extra head amp or transformer to cope with the low output. **Cartridge/amplifier**

interfacing can be very subtle, but even basic high output moving magnet designs benefit in overall balance from optimised amplifier capacitance loading. Still more important, the mechanical cartridge characteristic of cantilever compliance ("springiness") needs to be considered in the light of the effective mass of the tonearm which will be used (see Turntable & Tonearm entries).

NAME PRICE	LAB SOUND	COMMENTS	ARM OUTPUT/type	VALUE	BACK ISSUE FULL REVIEW
Arcam C77 £22	Average+ Average+	A sensible moving magnet package with good bounce at a competitive price	6-16g Normal, MM	BB	48

TO ORDER BACK ISSUES OF HI-FI CHOICE SEE PAGE 32

THE DIRECTORY

CARTRIDGES

NAME PRICE	LAB SOUND	COMMENTS	ARM OUTPUT/type	VALUE	BACK ISSUE FULL REVIEW
Arcam C77Mg £30	Average— Average	Punchy sound quality with plenty of extra energy to liven things up. The solid body seems well worth the extra £10	4-8g Normal, MM	BB	67
Arcam E77Mg £50	Average Average	Our sample had a disappointing stylus, but gave a coherent, rich and laid back sound, with good 'scale'	3-8g Normal, MM	R	48
Arcam P77Mg £60	Average+ Average+	Cautiously recommended, the P77Mg was preferred to its cheaper partner by virtue of a better tip. Channel balance could have been better	4-9g Normal, MM	R	48
Arcam PMX10 £100	Good+ Good++	Not the very clearest in complex high-frequency sounds, but lively and exciting, good transients.	5-11g Low, MC	R	85
Audionote I02VDH £895	Good Very Good	One of the best, giving 'an extraordinarily relaxing midrange clarity', needs a transformer	8-18g Very low, MC	R	43
Audioquest MC5 £220	Average Average	Offers high-output benefits but the drooping frequency response and severe VTA error preclude recommendation	10-20g Normal, MC		54
Audioquest AQ 404i-L £400	Good++ Good+	Slight harshness detracted from the performance of this otherwise clear-sounding and detailed cartridge	8-16g Low, MC		84
Audio Technica AT95E £18	Average— Average	Clear, dynamic if richly balanced, the magnetic '95E is a definite Best Buy	8-14g Normal, MM	BB	48
Audio Technica AT-420E OCC £31.50	Average Average	Better suited to pop recordings this MM bears some of the sonic hallmarks of the Linn K5	7-14g (damp) Normal, MM	R	67
Audio Technica AT-430E OCC £44.50	Average+ Average	A rising high frequency response yields something of a treble sting, not a good all-rounder	3-7g Normal, MM		67
Audio Technica AT-F3/OCC LE £74	Average+ Good	Though the 'limited edition' badge is a trifle tongue-in-cheek the 'F3 still offers excellent value	8-15g Low, MC	BB	67
Audio Technica AT-F5/OCC LE £106	Average Good+	This latest sample demonstrated some technical weaknesses but its spacious, fluid sound quality still represents a benchmark at this price	4-10g Low, MC	BB	67
Audio Technica ATOC7 £265	Good+ Good+	The OC9 is better if you can afford the extra. But OC7 is at least a taste of the high-end at a sensible price	6-13g Low, MC	R	54
Audio Technica ATOC9 £400	Average+ Very Good	Tonal colours are reproduced faithfully and it rarely puts a foot wrong. Slightly less transparent than more costly MCs but it has got real welly. Good value (really!)	6-14g Low, MC	R	60
Audio Technica ART1 £800	Good+ Very Good	This is a delicate and very fluid-sounding MC that tracks well, offers very low distortion and exceptionally good stereo separation	9-18g Low, MC	R	72
B&O MMC5 £24	Average+ Average	Cheapest in the family – smooth treble and good focus, but the bass was left in the wings	5-15g Normal, MM		38 (Summary)
B&O MMC4 £43	Good Average+	Solid and well balanced in the midrange, the '4 lacks bass impact	5-15g Normal, MM		48
B&O MMC3 £57	Good Average	Slightly "laid back" sound quality but a good performer for the price. Best suited to B&O equipment	5-15g Normal, MM		48
B&O MMC2 £87	Good Average+	Only a modest improvement on its cheaper brothers (and sisters)	5-15g Normal, MM		48
B&O MMC1 £112	Very Good Good	Great clarity and detail at high frequencies but a slightly plodding bass. It may appeal more to the classical enthusiast	5-13g Normal, MM		48
Cello Chorale £750	Average+ Good	Now available through a new distributor at a saving of some £300, the Chorale is still blessed with a delicate but highly detailed treble. Arm matching is a problem	3-9g Low, MC		72
Clear Audio Gamma £295	Average Average+	Brimming over with enthusiasm, the unusual-looking Gamma is more than an audio oddity, but it lacks a little subtlety at times	4-11g Low, MC		54
Clear Audio Delta £450	Average+ Good	Midway between the Gamma and exotic Pradikat, the Delta sounds like neither! Nevertheless, it delivers the goods	6-17g Low, MC	R	54
Clear Audio Signature £995	Average+ Good	This latest MC to emerge from Clearaudio features yet another graded version of its proprietary generator. Its sound strikes a balance between the Delta and Prad	4-11g Low, MC		72
Clear Audio Pradikat £1225	Average+ Very Good	Sounded absolutely glorious, creating a full sense of scale and a large well-focused soundstage – but watch for record wear	8-18g MC		Coll
Clear Audio Accurate £2,000	Good Excellent	A remarkable cartridge, not only by virtue of its effortless and highly neutral sound quality but also because this has been achieved with the same basic design as Clearaudio's cheapest MCs	4-11g Low, MC	R	60
Denon DL110 £69	Good Good	Firmly recommended as a fine all-rounder, this high-output moving coil model is likely to perform well in nearly all circumstances	6-16g Normal, MC	BB	48
Denon DL160 £89	Average+ Good	Although listeners just preferred the 110 its brother here proved a twin in lab tests and is still "thoroughly competent"	6-16g Normal, MC		43
Denon DL 103 £99	Average Good	This classic spherical stylus model gives a lively sound with powerful bass, and is popular in broadcast studios	6-16g Low, MC	R	48
Dynavector DV-50X £99	Good Average	A high-output MC model with impressive lab performance, but whose tip and sound quality both disappointed	6-14g Normal, MC		48
Dynavector DV10X IV £125	Average Average+	Fine sounding and realistically priced, damping is recommended to ensure successful tracking ability	8-18g Normal, MC	R	48
Dynavector DV23RS £230	Average+ Good	Sound quality was described as "shut-in", lacking energy and sparkle but with some "edginess" in high frequencies	10-22g Low, MC		28
Dynavector XX-1 £680	Good++ Good+	Good, but not immensely competitive at the price, and not helped by comparison with the low output version	7-15g Normal, MC		84
Dynavector XX-1L £680	Good++ Very Good	Very clear, very detailed, no troubles with tracking; response lift around 20kHz seems to do no harm	7-13g Low, MC	R	84
Empire 800 Mk II £33	Good Average	This very high output MM appears to be based on the classic Ortofon VMS series. A trifle uninspiring overall	7-17g Normal, MM		67
Empire MC-5M £110	Average+ Good	A very low compliance renders this MC best suited to heavy tonearms while its sweet, non-aggressive sound quality earns it a recommendation	13-20g Low, MC	R	67
Empire Benz Micro MC-2 £600	Average Good+	Similar to both the Empire MC1000 and vdH MC2 in design, the Benz offers a warmer and very transparent account of the music. Its tracking prowess is slightly limited	5-12g Low, MC	R	72
Glanz MFG 110EX £25	Average Average	A little bright but giving detailed bass and clear treble this was competitive at the price	6-16g Normal, MM	R	Systems
Glanz MFG310-LX £50	Good+ Good++	Detail and treble outstanding for sub-£100 cartridge. Slight coloration may be due to body resonance	6-10g Normal, MF	BB	85

THE WORLD'S NO 1 GUIDE TO BUYING HI-FI

THE DIRECTORY

CARTRIDGES

NAME PRICE	LAB SOUND	COMMENTS	ARM OUTPUT/TYPE	VALUE	BACK ISSUE FULL REVIEW
Glanz MFG610-LX £90	Good + Good +	Similar to cheaper '310 but slightly clearer transients and bass. Benefits from lowish impedance loading.	3-10g Normal, MF	R	85
Glanz GMC-10EH £50	Good Good	The rising HF trend of this high o/p MC may cause problems in certain systems but with a favourable wind its seductive qualities will win out.	8-14g Normal, MC	R	67
Glanz GMC-10LX £80	Average + Average +	Bearing some of the hallmarks of the '10EH, the '10LX is still less competitive in the sonic stakes.	7-15g Low, MC		67
Glanz GMC20E £129	Average Average	You could try haggling but we thought the makers of this number were demanding too much lucre for their product.	3-6g Low, MC		48
Goldmund Clearaudio £1500	Average + Very Good	Something of a mixed bag overall, its sonic character bears a strong resemblance to the Pradikat though it shares some of the hallmarks of the more expensive Accurate.	5-12g Low, MC		60
Goldring 1012 £40	Good + Good	Slightly harsh sound but plenty of life and quite good detail. Some very high frequency coloration apparent.	6-12g Normal, MM	R	85
Goldring 1022 £60	Good + Good	As with 1012, a touch harsh; detail and transient purity improved, though, and it goes well with electric guitar!	5-11g Normal, MM	R	85
Goldring Elan £16	Average + Average	A lightweight and frisky-sounding MM that appears to be based upon the same body as the Nagaoka mm4.	7-15g Normal, MM	R	67
Goldring Epic II £26	Average Average +	An excellent budget choice though the limitations of the stylus are rather obvious at higher frequencies.	5-12g Normal, MM	R	67
Goldring Eroica £100	Good Good -	More confused and coloured than its low-output sibling - high output less of an issue in these days of cheap MC-compatible amplifiers.	8-15g Normal, MC		84
Goldring Eroica LX £115	Good + Good	Not the most subtle cartridge in the world; can sound edgy at times, but lively and informative.	8-14g Low, MC	R	84
Goldring Excel £500	Average + Good	Goldring's most expensive cartridge to date errs on the warm and heavy side of neutral. Strong bass lines are its forte though its ability to resolve subtle treble details is weaker.	6-13g Low, MC		72
Grace F9E II £240	Good Good	For lively presentation, excellent separation and generally satisfactory sonic delivery - consider this model.	5-10g Normal, MM		48
Grado ZTE + 1 £26.50	Average - Average	Bass and treble are a trifle coloured but the midband proved highly enjoyable. Ideal for budget systems.	6-13g (damping) Normal, MM	R*	54
Grado ZF3E + £47.50	Average - Average	Downtilting balance disguises the brightness of this cartridge; bit of a mixed bag at this price.	9-20g (damping) Normal, MM	*	54
Highphonic MCA3 £360	Very Good Good +	Exquisitely crafted by a group of ex-Denon engineers, this superb tracker had a sweet and seductive (if rather bright) treble.	5-12g Low, MC		43
Kiseki Blue Goldspot £450	Good + Good +	Good bass and imaging, but hints of spit and coloration let the side down slightly.	8-15g Low, MC		84
Kiseki Purpleheart Sapphire £799	Good + Good +	Rare, beautiful to look at and sweet to listen to, our review of this high-flyer conjured up images of Japanese art.	5-14g Low, MC		Collection
Kiseki Blackheart £1795	Good Good	This cartridge demonstrated refined poise and a delicate but at once potent security, however, the price did seem a little on the high side compared to other Kisekis.	6-16g Low, MC		60
Kiseki Lapis Lazuli £4000	Good Very Good	Combining very sensible design concepts at a silly price, the Lapis Lazuli is best thought of as combining the detail of the MC3000 and the fluidity of the Clearaudios.	4-12g Low, MC		60
Koetsu Black S £612	Average Good +	The S is an OEM design built to Koetsu's blueprint. It features a sturdier fixing plate and offers a brighter, faster and more tactile sound than the earlier K.	8-15g Low, MC	R	72
Linn K5 £32.50	Average Average +	Not as crisply focused as the costlier Linn magnetics, the K5 offers a smoother presentation.	7-16g Normal, MM	R	67
Linn K9 £81	Average Good	Linn threw this model into the leading pack by beefing up the Basik's bodywork, adding a super stylus, and keeping the price fair.	6-15g Normal, MM	BB	48/Coll
Linn Asaka £299	Good + Good +	Disciples of Linn who are trying to realise their true "Karma" may find that saving money is not a short cut to heaven.	9-18g Low, MC	R	48/Coll
Linn Karma £465	Very Good Very Good	A specialist which is strongly recommended for Linn-based systems; results may be less predictable in more general application.	9-18g Low, MC	R	48/Coll
Linn Troika £669	N/A Very Good	Ex-Karma users have been seen with glazed expressions indicating smug self-indulgence the morning after fitting a Troika.	8-18g Low, MC		Coll
London Maroon £149	Average Average +	Now manufactured under the London brandname this Decca cartridge is as iconoclastic as ever.	9-20g (damp) Normal, MM		67
London Super Gold £300	Poor Average -	Immediate and (in the midrange at least) detailed, but very coloured, very nonlinear and questionable effect on records. Devotees swear by it.	9-15g, damp Normal, fixed stylus MM		84
Milltek Aurora £249	Good + Good +	An overall feeling of relaxed ease characterised this clear and atmospheric Kiseki-built cartridge.	8-16g Normal, MC	R	48/Coll
Milltek Olympia £349	Average + Good +	Warm and detailed sound - packs the punch of the best MCs with high output as a bonus.	12-20g (damping) Normal, MC	R	54
Nagaoka MM4 £9	Average - Average -	Clear punchy sound that delivers the rudiments of a good performance.	6-16g Normal, MM	R	54
Nagaoka MP10 £18	Average Average	High frequencies sounded "shut-in" with this spherical-stylus model, but mid and mass were energetic, bouncy and punchy.	5-13g Normal, MM	R	48
Nagaoka MP11 Boron £40	Average Average +	Responding well overall in PM's equipment and listening room, this model was mildly criticised for low level and dynamic limitations.	5-13g Normal, MM	BB	48
Nagaoka MP11 Gold £47	Average - Average +	There were mild criticisms directed at most areas, but in general the sound was clear, open and even.	3-8g Normal, MM	R	48
Nagaoka Stilton TS10 £50	Good - Good	Stilton-designed solid body (with three-point mounting) certainly gives remarkably resonance-free sound, but tip and generator are less good - a little rough at times.	5-10g Normal, MM	R	85
Nagaoka Stilton TS11 £70	Good - Good	Differs from TS10 in having Vital stylus with better tracing but still some high frequency harshness.	5-10g Normal, MM		85
Ortofon OM5E £15	Average - Average -	The OM10 is a hi-fi cartridge - the OM5E is not.	5-16g Normal, MM		43
Ortofon OM10 £20	Average Average	One of the leading "cheapies", this gives a fine level of sound quality for the price, with good matching compatibility.	5-15g Normal, MM	BB	48
Ortofon OM20 £45	Average Average +	This turned out to be the listening panel's favourite among Ortofon's moving magnet models.	5-16g Normal, MM	R	48
Ortofon 510 £30	Good Good +	For the price, a good blend of virtues - weight, clarity and neutrality.	3-11g Normal, MM	BB	85

TO ORDER BACK ISSUES OF HI-FI CHOICE SEE PAGE 32

THE DIRECTORY

CARTRIDGES

NAME PRICE	LAB SOUND	COMMENTS	ARM OUTPUT/TYPE	VALUE	BACK ISSUE FULL REVIEW
Ortofon 520 £50	Average Average +	Very sensitive to load capacitance this new Ortofon maintains the company tradition for a lively, effervescent SQ	7-16g Normal, MM	R	67
Ortofon 530 £80	Good + Good +	Very clean and assured sound; transients not quite perfectly pure but plenty of detail.	4-11g Normal, MM	R	85
Ortofon X1 £50	Average Average	The cheaper X1 scored higher marks with our listening panel than the X3, but both were a disappointment	6-15g Normal, MC		48
Ortofon MC10 Super £70	Average Good	"What a delightfully sweet-sounding cartridge this is..." we said	5-15g Low, MC	BB	48
Ortofon X3 £70	Average Average	A lack of bass power, definition and a "zitty" top end makes this competent but uninvolved	5-15g Normal, MC		48
Ortofon OM40 £90	Average Average +	Highly competent engineering, secure tracking and decent sound quality are major strengths. But it's a little cold, a little polite	3-8g Normal, MM		48
Ortofon 540 £100	Average - Average	Graced with an advanced FGII stylus our sample possessed too high a compliance for broad arm matching. It could also sound a little unforgiving	3-8g Normal, MM		67
Ortofon MC20 Super £200	Average + Good +	An "inviting" sound quality; polite rather than exciting it approaches much more expensive models, but does not better them	6-15g Low, MC	R	48/Coll
Ortofon MC30 Super £270	Very Good Good +	Beautifully engineered and well-balanced, it was slightly criticised as bland, though some may appreciate the lack of rough edges	5-14g Low, MC		Coll
Ortofon Quasar £300	Good + + Very Good	Many of the qualities of the MC3000, although a touch bright. Good detail and delicacy	8-15g Low, MC	R	84
Ortofon MC3000 MkII £850	Very Good Excellent	Low levels of body resonance are a real ear-opener. Nothing to criticise elsewhere; one of the very best	9-16g Low, MC	R	84
RATA RP20 £22	Average - Average	Good integration, a clear dynamic midrange and the beginnings of fine stereo imagery merits clear recommendation	6-14g Normal, MM	R	48
RATA RP40 £44	Average Average +	The '40 did a good job of sorting out the layers and complexity of the mix, with good focus, excellent stereo spread and fine scale	6-15g Normal, MM	R	48
RATA RP70 £77*	Average Average +	Clearer and sweeter than the '40 this also seemed heavier and less lively. For £99 you can have a van den Hul stylus	6-14g Normal, MM		43
RATA RP70vdH £99	Average + Good	Able to retrieve bags of musical detail (thanks to the vdH stylus), RATA's top cartridge ranks as one of the most articulate MM's available	11-18g Normal, MM	R	67
Rega Bias £34	Average Average +	Difficult to mount in some arms due to its shallow build, the bias offers a gentile, refined SQ that certainly makes it worthy of audition	4-10g Normal, MM		67
Rega Elys £74	Good Good	Clearly superior to the Bias, despite their common heritage, the Elys is both more detailed, accurate and musically convincing	8-15g Normal, MM	R	67
Revolver £20	Average + Average	This modified AT-95E enjoys a very lively mid and treble even if the bass is somewhat 'slower' in protection. A firm budget buy	8-16g Normal, MM	BB	67
Shure M92E £17	Average - Average	Though lacking depth, the overall sound quality was competent, but treble was not its forte	10-15g Normal, MM		43
Shure M99E £29	Average - Average -	Sister to the 92E this is a solid but not particularly exciting cartridge	5-10g Normal, MM		38 (Summary)
Shure ME75ED £26.50	Average Average -	Rather bright and splashy in the high frequencies but nevertheless a competent model	5-10g Normal, MM		38
Shure M104E £36	Average - Average	Capable in many ways, but giving no substantial improvement over the 92E in our view	5-15g Normal, MM		38
Shure ME97HE £49	Average Average +	It won't turn a sow's ear of a turntable into a silk purse, but will at least keep going and produce an acceptable result	8-20g Normal, MM	R	48
Shure M105E £49	Average Average -	A slightly 'spitty' sound lacking deep bass and dynamic contrast, but can be used in virtually every system where it will perform "unobtrusively"	5-12g Normal, MM		38 (Summary)
Shure M110HE £60	Average Average	Sound quality was thought eminently presentable, but not exciting; smooth clear high frequencies, but a loss of bass definition	5-10g Normal, MM		38 (Summary)
Shure M111HE £72	Average Average	Early reviews of this cartridge complained principally of the price - which has since come down	5-10g Normal, MM		38 (Summary)
Shure ML120HE £95	Average + Average +	Quite decent sound quality and a generally fine balanced performance	6-18g Normal, MM		48
Shure ML140HE £120	Average + Good	Qualitatively the treble of this well-balanced moving magnet model was a match for many moving coil cartridges	6-16g Normal, MM		43
Shure V15 VMR £215	Good Average +	Initial listening gave promising results, but extended familiarity gave the feeling of a lack of energy and a "shut-in" sound	5-12g Normal, MM		38
Shure VST V £158	Good + + Very Good	Quite exceptional assurance with difficult material; very stable and clear sound. One of the best. Dynamic Stabilizer actually works!	4-11g Normal, MM	R	85
Shure Ultra 500 £499	Good Good	There was no doubting the accomplishments of what could well be the finest moving magnet cartridge around	6-14g Normal, MM		48
Stilton/AT-F3 £110	Good + Good +	At a premium of some £40 this modified AT-F3 offers a startlingly refined performance and is strongly recommended	8-18g Low, MC	R	67
van den Hul MC10 £499	Good Good +	A neutral balanced performer giving transparent midrange, fine depth and focus with firm extended bass. Gosh!	5-10g Low, MC	R	60
van den Hul MC One £699	Good Very Good	This extended all the positive qualities of the '10 but added greater authority and scale - worth it for the extra money	6-12g Low, MC	R	60
van den Hul MC1 Super £800	Good + + Very Good	Slight softening effect on transients was the only real flaw, but it didn't quite seem to have that special touch one expects for the money	8-15g Low, MC		84
van den Hul MC Two £899	Good Very Good	Connected directly to any standard MM input the vdH MC Two rewards with a highly detailed yet fluid and musically convincing portrayal	6-13g Normal, MC	R	72

* rating refers to original tested model

THE WORLD'S NO 1
GUIDE TO BUYING HI-FI

THE DIRECTORY

AMPLIFIERS

The amplifier sits at the heart of the system, processing the outputs from all the various music sources as necessary and then driving the loudspeakers. These two (quite separate) functions are integrated into a single box at the low-to-middle price points; separated pre- and power amplifiers become increasingly common as one moves upmarket. At the upper end of the specialist market, valve amplifiers provide a popular alternative to the transistor types amongst enthusiasts.

There is a substantial difference between specialist (sound quality oriented) amplifiers and the consumer electronics style models. The former

are bleakly simple, avoiding all unnecessary features to provide the most direct signal path in the interests of best sound quality. The latter range from models with just basic tone controls and tape recorder switching, to those with elaborate facilities such as graphic equalisers, remote control (including volume), surround sound options etc. etc.

Lab measurement provides some useful data, particularly in regard to an amplifier's ability to drive a wide range of different types of loudspeakers, but this is only obliquely related to sound quality. We also include our measured power output (RMS, 8ohm load, 1 channel driven) – but

again, paradoxically, this doesn't necessarily correspond to the loudness capability of the amplifier, which has as much to do with the elegance of the overload characteristics within a given system (valve amplifiers invariably sound more powerful than their rating would suggest). The listing of **features** provides some indication to the complexity of an amplifier: many users prefer to retain the option of tone controls to 'shape' the overall sound according to taste; many others have found living without tone controls surprisingly easy, with additional benefits in terms of transparency.

NAME PRICE	LAB SOUND	COMMENTS	FEATURES	VALUE	BACK ISSUE FULL REVIEW
Acoustic Research A03 £160	Average+ Average	New slimmed down version of the A04 with less power and facilities but also a slightly 'fuzzy' sound	38W, MM disc, CD direct and 3 aux inputs		74
Acoustic Research A07 £299	Very Good Average+	Relatively smooth but ineffectual sound quality that lacks some weight and impetus at very low frequencies	75W, 4 line, 2AV and MM/mc inputs		68
Aiwa XA-005 £130	Good+ Average-	A technically competent amp with big, friendly but not overly engrossing sound quality	61W, MM 5 line inputs, source-direct		80
Akai AM-52 £230	Average+ Average-	Basically equipped, this amplifier offers a comfortable but hardly over-detailed sound	95W, MM/mc disc, 5 line inputs, loudness		74
Akai AM-65B £299	Good Average	On-board 18-Bit DAC's actually give better sound than standard CD inputs! Punchy via MM disc	101W, MM, 6 line, digital inputs		80
Akai AM-93 £550	Average Average-	Unfortunately Akai's on-board D/a convertors were less successful than its conventional analogue CD input.	112W, coax and optical dig inputs. MM/mc		68
Amadeus Silver £270	Average- Good	Limited headroom via disc but still offers a sweet, lush sound. Limited current delivery	37W, MM/mc, 3 line inputs	R	80
Amadeus Gold £360	Average- Good	There is some indication of instability but otherwise sounds very rich, warm and musical. High-ish IMD.	56W, MM/mc plug-in cards, 3 line inputs	R	74
Aragon 4004 £1795	Good Good	Despite its imposing bulk the Aragon is something of a softy at heart. It can deliver oodles of power but its musical presentation is more laid-back	231W power amp		72
Arcam Alpha II £180	Good Good+	Very confident, convincingly musical and punchy sound that sets the standard for other budget amps	41W, 4 line and MM inputs	BB	68
Arcam Delta 60 £280	Good Good+	Very refined and highly detailed sound via MM and CD without any of the hardness noted via the MC stage	59W, 4 line, MM/mc inputs, no tone controls	R	68
Arcam Delta 90.2 £400	Average+ Average+	Dark but slightly dead or conservative sounding version of the original Delta 90. Improved disc stage	73W, MM/mc, 4 line inputs, tone bypass, bi-wire	R	74
Ariston Amp £219	Average Average+	Slightly veiled and thin sound but proved suitably attractive in the listening tests	32W, full logic control, MM and 4 line inputs	R	68
Audio Innovations Series 200 £429	Poor Good++	Like most 'Innovations valve power amps, compatibility with other brands is unpredictable. Hardly a powerhouse, but nicely 'open', transparent and dynamic sound in small(ish) systems	12W	R	77
Audio Innovations Series 300 £479	Poor Good++	Something of an anomaly the 300 is an integrated valve amp that looks awful in the lab but sounds remarkable in a system	10W, MM, 6 inputs	BB	63
Audio Innovations Series 400 £625	Poor Good++	Superior styling and better build quality than the Series 300 make for a very attractive integrated valve amp. Capable of fine results in the right system, but can sound too 'thin' and lacking in welly	12W, MM and 4 line inputs	R	77
Audio Innovations Series 1000/2nd Audio Amplifier £1379/2579	Poor Excellent	This valve combination offered awesome dynamic range with superb transparency and power to match. Compatibility with other brands is unpredictable	15W, MM, 6 inputs, monoblocks	R	63
Audiolab 8000C £325	Excellent Good	A well established preamp with a highly controlled sound, though it could do with more life and depth	MM/mc, 5 inputs, hdph, tone controls	R	62
Audiolab 8000A £350	Very Good Good+	Exceptionally detailed, tactile and transparent via CD but slightly more clouded via disc. A stalwart design	72W, MM/mc, 4 line and full record out selection	R	74
Audiolab 8000P £495	Excellent Good+	A dynamic powerhouse, load tolerant and sonically reliable	100W	R	62
Audion CD-1 £399	Average+ Good++	Nicely presented valve (line-only) preamplifier with fine bandwidth and enjoyable, musical sound. Great – if you can justify the cost. Well worth hearing	5 line inputs		77
Aura VA-40 £189	Average Average+	Based on ITL's earlier MA80, this amp sounded slightly withdrawn or 'dead' if inoffensive	55W, MM 4 line inputs, MOSFET output		80
Beard Audio CA35/P35mkII £695/£895	Fair+ Very Good	Good build quality and a very smart finish combine with a characteristic valve sound to make a first class amplifier capable of giving hours of musical enjoyment	35W, MM/mc, 4 inputs	R	63
Beard 506 £1195	Good+ Good+	A versatile valve preamp – the bass sounded lively if a touch softened while the treble was detailed but lacked a little sparkle and air.	4 inputs MM/mc	*	50
Beard M70 £1995 pair	Good Good+	A substantial British monoblok power amplifier, but not a great deal more impressive than the P35 at half the price	70W	*	50
Bryston 0.5B/2B £695/£695	Very Good Good	Very rugged Canadian pre/power combo that sounds cool confident and punchy. Headamp available to suit MC cartridges	65W, MM and 4 line sources, overload LEDs on power amp	R	74
Bryston 12B/4B £1295/£1395	Good+ Good	Bryston's massive 4B power amp stood out as the backbone of this combo, the preamp sounding a trifle unbalanced between MM and MC inputs	272W, bridgeable to 800W. 6 line, 2 disc inputs, subsonic filter		68
Cello Audio Suite £1200	Excellent V Good/Excellent	Cello's preamp represents a whole new ball game in flexibility and sound quality (or war of attrition on your wallet)	Optional inputs MC etc	R	50
Concordant Excelsior £856	Good++ Excellent	Cottage industry styling might not inspire confidence, but sonically this preamp is tremendously vivid and detailed. Real high-end performance. We loved it!	MM plus 3 line inputs, External power supply	R	77
Conrad Johnson PV10 £1,395	Excellent Excellent	Pricy, yes, but a fabulous preamplifier which confirms C-J's high reputation in the States. Beautiful imaging, superb detail, plenty of gain on the phono stage – classy build quality too.	MM plus 4 line inputs	R	78
Conrad Johnson MV50 £1995	Good+ Good+	Coupled with the PV5, this CJ power amp performed well on audition	50W		Collection
Conrad Johnson Motif MC-8 £1995	Very Good Very Good	A cheaper alternative to the '7, this preamp is an undoubted success in maintaining the Motif sound but does not compare on sound quality	MM/mc	R	50

TO ORDER BACK ISSUES OF HI-FI CHOICE SEE PAGE 32

THE DIRECTORY

AMPLIFIERS

NAME PRICE	LAB SOUND	COMMENTS	FEATURES	VALUE	BACK ISSUE FULL REVIEW
Conrad-Johnson Premier Seven £8995	n/a Excellent	Price has increased since we tested it – but at this price who cares? The 'Seven' is designed without compromise, and it's clearly one of the finest (valve) preamplifiers money can buy. Absolutely gorgeous!	MM, 4 line inputs, sep. Rec Out, versatile cartridge matching	R	72
Creek CAS 4040 S2 £179	Good Good	More neutral than its predecessor tonally, substantial improvements in transparency were also noted, while the lively punchy, character is retained	30W, MM, 4 inputs, tone controls	BB	62
Creek CAS 4140S2 £219	Average Good	Disc headroom still poor but the open and detailed, if slightly bright, sound wins through	40W, MM/mc, 3 line inputs, mono and mute	R	80
Creek CAS-5050 £399	Average Good	Strong RF IMD compromises the sound of the CD input which contrasts with the delightful performance via MM/mc	72W, MM/mc, aux CD and video + pre/power mode	R	74
Croft Super Micro A £549	Average+ Very Good	The looks are somewhat improved, while this 'hot rod' version with tuned components performed very well indeed. There is still no gain on the line inputs	4 inputs, MM, straight line	R	57
Croft Series IV(S) £850	Good Good	The original IV is still available now supplemented by the higher price and power (S); both are fine performers	40(60)W channel	R	57
Croft Series IVSA £1000	Good Very Good	Featuring tuned components chosen for their sound quality, the 'A' variant is an impressive example of Croft's technique in valve design	60W special supply regulation	R	57
Cyclone Catalyst £1995	Good+ Very Good	Exceptionally load tolerant and very refined in delivery. Extra options available in future	74W, external MM or MC stages, 3 line inputs	R	80
Deltac DSP-50S DPA-50S Pre/Power £725/£925	Excellent Very Good+	Remarkable pre/power combo based around the highly linear DH-0A32 hybrid op-amp	63W, external feedback wiring, 3 line, MM/mc no tone controls	R	68
Deltac DPA 100S £2200	Very Good Very Good	A top-quality transistor power amp, sounding fast, articulate and well controlled, though maybe a touch clinical for some tastes	80W	R	50
Denon PMA-250II £140	Good Good+	Spacious yet tactile and gutsy sound via all inputs. Worthwhile upgrade over original PMA-250	53W, MM 3 line inputs, source-direct	R	80
Denon DAP-2500 POA-4400A Pre/Power £549/£599 pr.	Very Good Good	Denon's fully-fledged preamp also incorporates D/a converters that did not improve the sound of our £299 CD player. The power amps are brilliant!	172W, monoblocks Opt/Coax dig + 2 tape, 4 line and MM/mc inputs	R	68
Denon POA-6600 £1,000/pair	Excellent Very Good	Delivers abundant high quality sound, solid engineering expertise and content clearly compensating for any compromising of purist audiophile principles	250W monoblok, remote power	R	60
DNM 3A From £1000	Good+ Very Good	The DNM3 in its acrylic case is a remarkably revealing and neutral state of the art preamp	5 inputs MM/mc twin vol controls	R*	44
E.A.R. 802/509mkII £1098/£1868	Average Very Good	Extremely well made and combining the sonic strengths of both transistors and valves this EAR combo warrants attention	100W, MM, 6 inputs, monoblocks	R	63
E.A.R. 549 £3,628/pr	Very Good Very Good	A valve monoblok that measures like a solid state amp is itself an achievement, but exceptional power delivery and bass 'slam' is not fully matched by delicacy and transparency elsewhere	200W monoblok, bias setting	R	60
Exposure VII/VIII £430/£470	Very Good Good	Supplied as a combination without the separate preamp power supply, this pre power combination performed satisfactorily especially on the moving coil input	50W, MM/mc, 3 inputs, straight line	R	62
Exposure VI/VII*/VIII Pre/Power £320/£500	Good Very Good	An established company like Exposure could do more to improve the 'look' of these amps which, nevertheless, sounded confident, dry and musical. Dual version no longer available	63W, Super mod. 4 line and 2 disc inputs with full rec-out switching	R*	68
Exposure XI/XII/VIII Super £1600	Good Very Good	New preamp and improved power amp led to a smooth and refined sound, MM/mc less transparent than CD	61W, MM/mc, 5 line inputs	R	80
Grant G60AMS £948 pr.	Good Very Good	This neat and compact 60W valve monoblok gave good sound on the 8ohm tap, better still on 4ohms. The midrange was particularly natural	60W monoblocks 8ohms	R	57
Hafler DH120 kit form £295	n/a Fair	We didn't build one; see below	60W	R	44
Hafler XL-600 £1,145	Very Good Very Good	Sounds remarkably open, transparent and inherently 'musical'. XL-600 is tremendously powerful and very compatible	426W in stereo mode, 1.5kW in bridge	R	74
Hafler DH120 assembled £360	Very Good Fair	Sound quality results were decent enough, but this power amp won't set the world on fire at this price	60W	R	44
Harman Kardon HK6100 £159	Good Good	Re-packaged version of the popular PM635. Still offers very up-beat and exciting sound	47W, MM, 5 line inputs, tone controls	R	80
Harman Kardon Citation 25/22 £649/£899	Good Average+	Not as outrageous as previous Citation amplifiers but neither as punchy nor exciting in the sonic stakes. A good all-rounder but lacks sparkle	138W, MM/mc full range of input and record out	R	74
Jadis JP30/JA30 £4,145/£4,200	Fair Excellent	Two-box preamp plus monoblok power amps, classic valve design gives stereotype valve sound. Beautiful build, nostalgic styling and delightful sounding midrange transcend limitations at frequency extremes, in lab, and re cartridge matching	30W 2-box pre-, monoblok power, MM-only, 4 line inputs	R*	60
Jeff Rowland Coherence One/Model 7 £3950/£9900	Very Good Very Good	The technical design of these amps is very elaborate but ensures they achieve an extraordinarily transparent and potent sound. However, the CD i/p is clearly superior to the disc inputs	448W monoblok MM/mc with variable loading options. Balanced topology	R	72
Kelvin Labs Absolute Zero/M30 £395 + £295/£595pr.	Good+ Average+	Latest versions of the M30 offers a true 30W Class A and a slightly muddled but very comfortable sound. MC preamp is a very linear design	33W monoblok MC only + 4 line inputs. Separate L/r balance	R	74
Kelvin Integrated £395	Good+ Very Good	A true 20W Class A amp with lush, detailed and very musical sound to match. Watch out for re-style	18W, MM/mc, 4 line inputs	R	80
Kenwood KA-550D £130	Very Good Fair	Having dropped its moving coil input, this latest version has British style dynamics and rhythm but is not first grade yet	35W, MM, 4 inputs, hdph, tone controls	R	62
Kenwood KA-4010 £170	Good Average+	A flexible design at moderate cost. Smooth and cultured sound if slightly lean in balance	81W, MM/mc, 4 line inputs, source-direct	R	80
Kenwood KA-5010 £210	Good Good	Offers a slightly bass-light but very smooth, fresh and alive sound. Well built and sensibly equipped	101W, MM/mc, cd 3 tape, tuner, aux + direct	R	74
Kenwood KA-7010 £300	Average+ Average+	More powerful version of the 5010 but less successful in the listening tests. RF IMD is the likely cause.	123W, as above plus —20dB mute facility	R	74
Klyne SK5a £2590	Very Good Very Good	Beautifully made and presented this American thoroughbred has a good lab performance, but although versatile, is rather expensive for the quality of sound offered	Balanced output, versatile cartridge loading	R	72
LFD £2,995+	Very Good Excellent	Can set the subjective standards that others merely aspire to, but this outstanding if unconventional multi-box preamp needs careful matching to ancillary components	MC (with care), passive line extra	R	60
Lectron JH50 £2,300	Average Very Good	Sexily presented valve power amplifier from France. Lovely valve sound too, with delicate and airy top end. Not especially powerful and rather expensive – but very desirable!	50W	R	78
Linn LK1/LK280 Pre/Power £545/£695	Good Good-	A very modern, logic-controlled amp with distinctive and inoffensive sound quality. Its restrained sound could do with extra insight and zip.	84W, compact amp CMOS sw. for 2 tape, 2 line and MM/mc. xlr sockets.	R	68
Marantz PM-50 £230	Good+ Average+	One of Marantz's new breed, the PM-50 has a big and beefy sound yet one that lacks refinement	92W, MM/mc, 4 line inputs, source-direct	R	80
Marantz PM-75 £500	Good Average	More successful than most amps with on-board DACs but still not as balanced as other Marantz products	136W, opt/coax dig inputs, 6 line + MM/mc	R	68

THE WORLD'S NO 1 GUIDE TO BUYING HI-FI

THE DIRECTORY

AMPLIFIERS

NAME PRICE	LAB SOUND	COMMENTS	FEATURES	VALUE	BACK ISSUE FULL REVIEW
Marantz PM94 £1,200	Very Good Good	At 23kg the PM94 is no lightweight in either physical or sonic respects. A very powerful and comprehensively equipped amplifier	140W MM/mc tone controls (switchable)		60
Marantz PM-95 £1,800	Very Good Average+	Beautifully constructed, this amp was less convincing via its digital i/p than via line. Class A option best suited to sensitive speakers. Costly	151W with 30W available in Class A. Opt + coax inputs		74
Meridian 201/205 £599/£425 each	Very Good Good+	A fine preamp with additional luxury option of full system remote, plus competent and attractive monoblok power amplifiers with generally good performance	100W MM/mc 6 line inputs remote capable straight line	R/—	62
Mission Cyrus One £200	Very Good Good	A red hot class winner, which caused the whole issue to be re-rated! It's even well built – however, the headphone socket will only take a 3.5mm jack	30W, MM/mc, 5 inputs, hdph, straight line	BB*	62
Mission Cyrus PSX £230	Very Good Very Good	The PSX does make the Cyrus Two sound better; and also improves the PCM II CD player giving more wallop and clarity	Auxiliary power supply	R*	62
Mission Cyrus Two £330	Very Good Very Good	Also a top performer in its group with fine moving coil and compact disc sound. Since our review Mission has omitted the headphone socket on the Cyrus Two	50W, MM/mc, 5 inputs, straight line	R*	62
Musical Fidelity B1 £200	Average+ Good+	The subject of much controversy, this 50W wonder offers a very deep, solid and powerful sound	50W, MM/mc, 5 line inputs, tape monitor	R	80
Musical Fidelity A1 £269	Good Good+	Fine-ranking in terms of overall sound quality for money, the excessive heat output could be hazardous to your vinyl if you're careless	20W MM/mc 4 inputs straight line	BB	56
Musical Fidelity B200* £349	Very Good Good+	Running cooler than other MFs, the B200 delivered fine musical and dynamic sounds with plenty of power	80W MM/mc 4 line inputs straight line	BB	62
Musical Fidelity A100 £459	Good+ Very Good	This is another one recommended for fine sound with which you could keep your Chinese carry-outs warm	50W MM/mc 5 inputs straight line	R	62
Musical Fidelity MA-50 £875 pair	Good Excellent	An audiophile bargain. One of the best sounding power amplifiers made	50W, monoblok	R	62
Musical Fidelity P270 £1,399	Very Good Very Good	If the hot-box aspect is not a deterrent, this is something of a bargain. A big amplifier scale of sound which is just a little rough-edged	135W	R*	50
Musical Fidelity MVX/a370 £2399/£2399	n/a Excellent	In its latest guise, the A370 confirms its status alongside the MVX as amongst the best indigenous components for both sound and presentation	MVX – mm/mc/4 line/phase invert. A370 – 150W	R*	72
NAD 3225PE £160	Average+ Average+	Light and detailed if not as rich or weighty sounding as others. MM input sounds warmer than CD	42W + 70W dyn. headroom; soft-clipping, MM only	R	68
Naim NAIT 2 £339	Average+ Fair	Well built with good load tolerance the NAIT delivered a fully competitive sound in spite of its modest measured power output. Recent modifications as yet unchecked	15W pc MM 3 inputs	R*	50
Naim Separates £560-c£8,000	Very Good Good	A consistent and coherent series of 'building blocks' for conventional passive or active operation. Sound quality ignores conventional audiophile standards of presentation, but achieves fine musical communication	40-70W, MM/mc etc	R*	60
NVA P70MC/a60 £830	Fair Average+	NVA's speaker cables are a must, the amp offering well-integrated but not particularly crisp sound	68W, MC, 3 passive line inputs		80
Oakley S £499	Good Very Good	Much improved version of the original Image preamp from Yugoslavia. This one won't disgrace itself even in top-notch systems. Image Six model (£150 more) is really fabulous	MM plus 3 line inputs	R	78
Orell SA-040 £359	Good Good+	This promising newcomer from a brand new company sounded pretty good and should improve as production settles	45W MM/mc, 4 line inputs, straight line	R	56
Philips FA-880 £200	Good Average	A new and cheaper design from Philips that sounds best via MM disc. Can appear soft and unbalanced via CD	108W, MM/mc source-direct tone		74
Philips FA960 MkII £300	Good+ Average	The MkII '960 still failed to grasp our listeners' attention but it remains a competent amp nonetheless	122W, 6 line & 2 disc inputs + tone controls		68
Philips DFA-888 £300	Good Average	As above but including a modified disc input and onboard DAC. Sounds tight but also slightly thin	107W, as above + opt and coax digital inputs		74
Pink Triangle PIP £2670	Excellent Excellent	This state-of-the-art preamp is one of the few truly high end products to come out of this country this year. It will most certainly worry the competition	MM/mc, 4 inputs, battery supply	R	62
Proton 520 £115	Average Average	Very well equipped budget amp with a slightly flat and undynamic sound – acceptable at the price though	31W, MM/mc with variable MC gain, 4 line inputs	R	74
Proton AP-1000/AA-1150 £250/£395	Good+ Average+	Bags of headroom available from this pre/power combo, but can seem bloated or unrefined via MM	67W, MM/mc, adjustable MC gain, 5 line inputs		80
QED A240 CD II £199	Good+ Good	Latest 240CD is fine value for CD and has competent MM disc input as well	45W MM 5 line inputs straight line	BB	62
QED A240 SA II £259	Good+ Good+	Redesigned 240SA represents a significant allround improvement over its predecessor, and provides a good moving-coil disc input in a competitive price	45W MM/mc 5 line inputs straight line	BB	62
QED A270 £299	Good+ Good+	Building on the strengths of the '240, the '270 sounds weighty, fast and dynamic. A bit 'lumpy' via MC	51W, 5 line and 2 disc inputs, pre-out	R	68
Quad 34 £299	Very Good Fair	This well-built durable preamp has useful filtering and above average tone controls but was found lacking in sound quality (viz: detail/dynamics)	4 inputs MM/mc tone controls		44
Quad 405 £389	Very Good Fair	Not an impressive power amp but easy on the ear if not pushed and very reliable	100W		44
Ray Lumley Model 75 £1,995 pr	Average Good+	Monstrous valve monobloks which represent good value. What they lack in musical subtlety they make up for in sheer muscle. And these are Lumley's small monobloks!	75W monoblok		78
Revox B150 £1,047	Very Good Average+	Beautifully constructed but hampered by Revox's convoluted logic control. Open and smooth sound. Still costly.	117W, CMOS sw. for 3 line, 2 tape and MM		68
Revox B250 £1,467	Very Good Good	With much improved sound over its predecessors plus amazing remote control facilities, this could form the heart of a round-the-dream-house system	150W MM/mc system/house remote tone controls		56
Rose RV-23 £395	Good Very Good	Beautifully built classy British 'hybrid' preamplifier. You can spend more to get a more transparent sound – but it's hard to criticise the Rose given the competitive price	MM plus 3 line inputs	R	77
Rotel RA810A £120	Very Good Fair	As a cut price RA820AII this is a very successful little amp that loses little in sound quality to its predecessor. Excellent value	20W, MM, 5 inputs, hdph, tone controls	BB	62
Rotel RA-820AX £150	Very Good Very Good	The spacious, detailed and very musical performance of this budget amp is almost too good!	47W, MM, 4 line inputs	BB	80
Rotel RA-840BX4 £250	Good Good+	Very sedate and controlled in presentation but must check phasing for optimum stereo effect	63W, MM/mc, 4 line inputs, passive tone	R	80
Rotel RA870BX £330	Very Good Good+	A powerful blockbuster with solid and well focused sound, good versatility and fine load tolerance	85W MM/mc 7 line inputs tone controls	R	56
Rotel RB/RC850 £160/£140	Good+ Good+	Quality separate pre and power amplifiers at near budget integrated amplifier prices. A notable achievement	60W MM/mc 4 line inputs tone controls	BB	62
Rotel RC-870BX/RB-870BX Pre/Power £219/£230	Excellent Good+	Reduced price makes the 870 combo better value but, despite mods to the preamp, it is the power amp that must take the lion's share of credit	128W or 208W in bridged mode. CD direct, 4 line, 2 tape and MM/mc	R	68

TO ORDER BACK ISSUES OF HI-FI CHOICE SEE PAGE 32

THE DIRECTORY

AMPLIFIERS

NAME PRICE	LAB SOUND	COMMENTS	FEATURES	VALUE	BACK ISSUE FULL REVIEW
SAE P102/A202 £499/£599	Average+ Average+	Microprocessor-controlled pre and power amp that sounds much better at low rather than high volume levels. Pro-oriented aesthetics	151W, MM/mc + CD tuner and 2 tape tone memory, spk switching		74
Solen Tiger B50 £870	Average— Food+	Stylish French hybrid with a very rich, melodic and beguiling sound. Not so hot with complex recordings	45W, optional disc, 5 line inputs		80
Sony TA-F200 £130	Average— Average	Over-ambitious protection circuit is hardly in keeping with modern amp design. Lean but 'dead' sound quality.	74W, 2 tape, 3 line and MM/mc inputs		68
Sony TA-F400 £200	Good Average+	Some lack of integration across the frequency range but still offers a more open and detailed sound than the F200	76W, 2 tape, 3 line and MM/mc inputs. Rec-out		68
Sony TA-F530ES £300	Good Average+	Chunky UK-oriented design that offers a rich, smooth and full sound. Slight loss of focus via MM/ mc disc	120W, MM/mc, 4 line sources + record out + tone	R	74
Sony TAF 500ES £349	Good+ Fair	Not too hot at the price, lacking in bass action, rating poorly on vinyl, and only marginally improving on CD	75W hdhp tone controls MM/mc		50
Sony TA-F630ESD £350	Good Average	Based on the '530 but equipped with PDM D/a convertor. Amp is competent but DAC sounds truly magnificent!	130W, as above + opt. and coax digital inputs	R	74
Sony TA-F730ES £450	Very Good Good	A very stable and coherent amp but one that lacks a crucial sense of involvement	133W, MM/mc, 3 tape, 2 line, full rec-out		80
Sony TAF 700ES £500	Good++ Fair	Scoring higher than the 500 but still not offering the sort of standards set by the competition. But many buttons to push	100W MM/mc tone controls		50
Sumo Athena/Polaris £695/£695	Very Good Very Good	Very good value US pre/power combo with transparent, detailed and gutsy sound via all inputs	128W, MM/mc, 2 tape and 3 line inputs	R	80
Sumo Nine+ £1200	Very Good Excellent	Macho styling of this class A stereo power amp conceals a sonic subtlety that is exceptional for the price, limited by lots of waste heat and a noisy fan on our sample (being improved)	65W	R	60
Sumo Andromeda £1585	Very Good Very Good	Well made with lots of power from a sensibly sized box. It was good in the lab and demonstrated a sound which offers a fine blend of performance at an almost reasonable price	200W, balanced input	R	72
Technics SU-V660 £250	Good Fair	Chunky build but integrated output stage infers a weak, insubstantial and rather monophonic sound	107W, MM/mc, cd aux, tape + tuner + power amp-direct		74
Technics SE-M100 £550	Very Good Good+	An unusual disc-less poweramp with volume control. Standard line input sounds very open and clean. Digital input is harsher and less convincing	123W, coax and opt digital inputs, var and direct CD no MM or MC disc	R	74
Vacuum State FVP £999	Good Very Good	This well thought out valve preamplifier is designed for optimum musicality and transparency, a goal which is handsomely achieved	5 inputs, MM, straight line	R	57
Yamaha AX-330e £130	Average+ Average+	An improvement on earlier efforts but still a little bland or lack-lustre. Very compatible though	48W, MM, 3 line inputs, source-direct option		80
YBA Model 3 pre/power £995/£995	Good Good	Suited to highish sens. loudspeakers this duo produced see-through, ethereal stereo images that were more convincing towards the centre of the soundstage than at the edges	56W stereo amp MM only with 3 line i/p's. Separate L/r volume controls		72
YBA 2 pre & pwr £1395/£1695	Good++ V Good/Excellent	Superbly finished French audiophile separates, with very good space and transparency, slightly softened bass. Needs extra transformer (£300) for MC cartridges	70W MM (MC extra) straight line	R	56
YBA 1 preamp £2895	Very Good Excellent	A front line French audiophile product. Great stereo and a fine Krell style finish	MM/mc, 3 inputs, straight line	R	62
YBA 1 power amp £2995	Good Excellent	This equally well finished power amp offers front rank stereo staging and transparency, and is capable of driving the most difficult loads	85W	R	62

* rating refers to original, tested model

LOUDSPEAKERS

Last item in the hi-fi chain, to some extent the loudspeaker is merely the slave of what has gone before, capable only of reproducing a signal as good as it is fed. Nevertheless the distortions (colorations and stereo effects) introduced by loudspeakers (and rooms) tend to be more immediately obvious than those anywhere else in the chain, so careful choosing according to taste is very important.

The average loudspeaker consists of a smallish enclosure, much of which may have begun life as

part of a tree, plus a couple of drive units hidden behind a removable grille. Inside the box lurks a simple electrical circuit known as a crossover, which divides the incoming (full range) signal into the right bits for the drivers to handle. Variations on the above formula are specifically identified in the entries. The designer's primary task is to balance the **sensitivity** of the loudspeaker (how loud it goes for a given electrical input) against the **bass** extension (how low does it go) for the given box **size**. After that such subtleties as coloration and

dispersion come into the equation.

Careful **placement** of the loudspeakers within the room is as important as the initial choice of model. For good stereo they need to be more or less the same distance from nearby walls, and preferably on similar rigid stands. The listener should be about the same distance from and listening angle to each loudspeaker. The ideal **placement** depends on the way a particular model has been balanced (not to mention a number of other factors), and our recommendation is given in the entries.

MODEL PRICE	LAB SOUND	COMMENTS	SIZE PLACEMENT	SENSITIVITY BASS FROM	VALUE	BACK ISSUE FULL REVIEW
Acoustic Energy AE1 £696	Good Very Good	To the author's knowledge, the most awesomely dynamic and articulate miniature ever made	29.5 x 18 x 25cm semi-open space	88dB/w 60Hz	R	59
Acoustic Energy AE2 £1138	Good Very Good	Dynamic, solid and lively, a great allrounder if a bit small considering the price. AE proves that metal cone/dome drivers really work.	39 x 23.5 x 29.5cm heavy stands in free space	88.5dB/w 45Hz	R	66
Acoustic Energy AE4 £1800 (stands £552)	Good Good	Magnificent but also seriously flawed, the AE4 possesses tremendous dynamic realism but a very mid-dominant balance. Large rooms and wallets only need apply.	54 x 32.5 x 44cm own stands in free space	90dB/w 40Hz		71
Acoustic Research Red Box £100	Average Average	Lively and balanced if a bit crude and uneven, this under-£100 econobox succeeds partly because of its simplicity, and works well with some rear wall assistance.	32 x 19.5 x 17cm close to rear wall	87dB/w 85Hz	R	74
Acoustic Research AR112 £125	Average Average—	Nicely presented and engineered, but sounds a bit small and boxy without true coherence.	36 x 19 x 18.5cm stands near rear wall	87dB/w 75Hz		66
Acoustic Research AR122 £150	Average Average	Despite a promising enough list of ingredients, the 122 failed to excite real enthusiasm amongst the listening panel	38.5 x 19 x 22cm stands near rear wall	87dB/w 68Hz		68
Acoustic Research AR132 £200	Average+ Average—	Good presentation and detail engineering was not sufficient to counter bass heavy balance problems on auditioning	44.5 x 23 x 25.5cm stands 1ft from rear wall	87dB/w 50Hz		66
Alexander SE5 £199	Average Average	Particularly well suited to surround sound A/v applications, the SE5 can give any miniature a run for its money on bass performance, hardness and coloration mar good detail and clarity, and price is a little high	40.5 x 12 x 15cm ALS stands near wall	82dB/w 50Hz (in room)		78
Alexander SE11 £299 (stands £69)	Good Good	Clearly better than its cheaper stablemates, the metal jacket delivers a different – and in some respects superior – sound than the wood-based competition	52 x 14 x 17.5cm stands close to wall	86dB/w 25Hz (in room)	R	82
Allison AL105 £150	Average Average—	Pretty enough in appearance, sonically the AL105 doesn't really make the grade at the £150 asking price	37 x 24 x 21cm high stands against wall	87dB/w 45Hz (in room)		78

THE WORLD'S NO 1 GUIDE TO BUYING HI-FI

THE DIRECTORY

LOUDSPEAKERS

MODEL PRICE	LAB SOUND	COMMENTS	SIZE PLACEMENT	SENSITIVITY BASS FROM	VALUE	BACK ISSUE FULL REVIEW
Allison CD6 £290	Average Good—	An unusual cube-shaped model designed for wall mounting gives exceptional bass extension from a small box, though it's also a bit heavy, coloured and slow	28.5 x 28.5 x 28.5cm stands against rear wall	88dB/w 45Hz	R	71
Alphason Amphion £680	Good Good	This fine-sounding, nicely finished compact wall-mount is just a little too expensive for formal Recommendation, but is a good performer for all that	44 x 23 x 27.5cm high stands against wall	88dB/w 47Hz (in room)		78
Alphason Orpheus £1000	Good Good+	Large hi-tech two-way features unusual, sweet-sounding isodynamic tweeter; well engineered and balanced if a shade odd in appearance	65.5 x 28 x 34cm stands near rear wall	87dB/w 43Hz	R	71
Apogee Caliper Signature £3350	Good+ Very Good	Pretty but power hungry full range panels have remarkable transparency and delicacy, though loudness and bass 'grunt' both a bit lacking; need very costly amplification	122 x 59-70 x 6.5- 28cm floor, free space	81dB/w 30Hz (in room)	R	81
Arcam Three+* £150	Average+ Average—	Arcam's baby speaker did not delight our listeners, but it might do better in less expensive systems	34 x 18 x 23cm close to wall at head height	88.5dB/w 95Hz		53
Arcam Alpha £199	Good Good	It has its own colorations to be sure, but delivers a fine room balance with unusually good dynamics, timing and 'life', and is fine material value for money as well	46 x 26.5 x 26cm stands close to wall	89dB/w 30Hz (in room)	BB	82
Arcam Two+* £280	Good Average	Most things to most men this compact is unlikely to disappoint with its lively "bally" character though lacking weight... a bit	38 x 23 x 28cm near wall shelf or 40cm stands	88dB/w 55Hz		59
Arcam One+ £380	Good Average	Provides a solid, weighty and rich sound, but is a little raw in the treble and indefinite in the midband	22.3 x 28.1 x 37.8cm open space, on stands	88.5dB/w 60Hz		59
Ariston Image £180	Average— Average—	Despite a sweet treble character, the Image fails to impress with a 'lumpy' over-rich balance that has room integration problems	42 x 22 x 27.5cm stands in free space	89dB/w 28Hz (in room)		82
Audio Electronics TC10 II £599	Good— Good+	Oddball appearance is rescued by a respectable technical performance, interesting and impressive engineering and fine sound quality at a realistic price.	70 x 33.5 x 33.5cm low stands in free space	87.5dB/w 40Hz	R	68
B&W Vision DS1 £99	Average Average—	Although significantly hampered by upper bass cabinet coloration, the DS1 cleverly combines high sensitivity with a rich and generous soundstage	36 x 21 x 19cm stands quite close to wall	91dB/w 40Hz (in room)	R	82
B&W DM550 £149	Good+ Average—	Beautifully presented, well engineered near-miniature with precise sound but a distinct lack of 'wellie'. Ideal for considerate flat dwellers	35 x 20.5 x 22.5cm stands in free space	86dB/w 70Hz		71
B&W DM560 £200	Average+ Average—	Fine cosmetic presentation and good engineering for the price; overload protection may be handy but listening panel was underwhelmed	49 x 23.5 x 30cm stands in free space	88dB/w 55Hz		66
B&W CM1 £345	Good Average	Cleverly thought out luxury design package is also fundamentally well engineered, if a shade pricey on 'sound for pound' basis	24.5 x 16 x 22cm close to rear wall	84dB/w 90Hz		74
B&W Matrix 801 £2500	Good+ Good+	Lacks the transparency of the best panels, and the drama of the best dynamics, but is something of an acoustic tour de force, with low coloration and fine stereo imaging	77/99 x 56 x 43cm floor or stands, free space	86dB/w below 20Hz (in room)	R	81
BLQ Q2 £275	Average— Average	Nearly a good loudspeaker, the basic balance is good, but the midband is very uneven and there are severe losses of resolution, 'space' and dynamics	43 x 25.1 x 24.5 semi open on stands	87.5dB/w 70Hz		59
Bose Interaudio 3000XL £150	Average Average—	Lots of perceived value and well enough balanced, but low cost cabinet and driver engineering results in a crude and unsuitable sound	46.5 x 29 x 23cm stands in free space	89dB/w 45Hz		71
Bose 305 £350	Average Good—	A bit of an oddball, fine dynamic liveliness and a good room match more than make up for the strange stereo imaging and treble	28 x 45 x 23cm high stands near wall	88dB/w 40Hz (in room)	R	78
Boston A4011 £120	Average Average—	Competent performance for size and price but below average relative to the UK competition	34 x 21 x 20cm on stands near wall	88.5dB/w 63Hz		41
Boston Acoustics T830 £399	Good Good	A lot of speaker for the money, the T830 is a smooth and accomplished performer with a big and easy – or alternatively a lazy and laid back – sound	82.5 x 25.5 x 24cm floor, away from walls	91dB/w 28Hz (in room)	R	82
Castle Clyde £159	Average+ Average	A tidy little performer packing punch, but beginning to show its age in the light of new competition	37 x 21.5 x 22cm open space on stands	89.5dB/w 64Hz	R	46
Castle Warwick £179	Good Average—	Excellent presentation and fine engineering with overload protection, but a sonic disappointment in bass and dynamic qualities	46.5 x 25 x 23cm stands 1ft from rear wall	88dB/w 50Hz		66
Castle Durham £209	Average+ Average	Listening results were encouraging, well engineered and finished, but lean on treble and a bit weak on bass; still recommended	41 x 21.5 x 25cm near rear wall	89dB/w 67Hz	R	46
Castle Pembroke £229	Good Average+	Comfortably recommended, a sweet smooth sound with good overall balance of engineering-based performance	55 x 37.5 x 30.5cm open space on stands	88dB/w 46Hz	R	31
Celef Cirrus £180	Average Good	It's nice to see Celef back in the UK, with this decent sounding small reflex box that seems unusually tolerant of siting	39 x 20.5 x 23cm stands in free space	84dB/w 60Hz	R	66
Celef CF2 Nimbus £230	Good— Good—	Nicely balanced overall but a little uneven with it, this lively and dynamic large bookshelf model came close to Recommendation	46 x 25.2 x 24cm stands in free space	86dB/w 55Hz		71
Celestion 3 £109	Average+ Average	This attractive little wall-mount gives good balance and stereo imagery, with a character which leans more towards inoffensiveness than excitement	31 x 18.5 x 21cm high stands against wall	86dB/w 55Hz (in room)	R	78
Celestion DL6 Series Two £159	Good Average	Good tonal colouring and plenty of bass for the enclosure size; the metal dome tweeter is excellent, but bass and mid lack clarity and 'bite'	45.4 x 24.5 x 26.2cm near wall, on stands	87dB/w 65Hz		59
Celestion DL8 Series Two £199	Very Good Good	A refined middle market speaker has a smooth but slightly dull quality, with good definition and deep, if slightly boxy bass	50 x 27.5 x 27.8cm open, stands	87.5dB/w 60Hz	R	59
Celestion SL12Si £579	Average Average	Careful setting up does reveal elements of fine sound quality, but this 'grown up' SL6 variation has a lumpy response alongside its improved power handling	53 x 20 x 27cm matching stands clear of walls	85dB/w 50Hz		66
Celestion SL600Si £799	Good+ Good	This Aerolam high tech miniature has certain remarkable qualities that some will find irresistible, but needs careful system and room matching	27 x 20 x 23cm matching stands in free space	82dB/w 52Hz		68
Celestion SL700 £1349 inc stands	Good Good	Very sophisticated, mostly smooth and accurate transducer, with fast but not very deep bass and a rather bright treble	37.5 x 20 x 23.5cm free air on tall stands	83dB/w 45Hz		60
Celestion 6000 £1470	Very Good Very Good	A genuine fullrange audiophile quality speaker system – with Star Wars styling to suit a high tech environment	Complex, on floor in free space	82.5dB/w	R	60
Doxa 5 – 2 £900	Average Good	The high sensitivity and seductive midband makes an obvious partner for valve amplifiers, though obtaining a good room match may prove a little tricky	98 x 21 x 28cm floor well away from walls	91dB/w 30Hz (in room)	R	82
Duntech PCL500 Marquis £3998	n/a Very Good	Better value for money than the Crown Prince – and arguably more dynamic, with real bass 'slam' – but a little less refined in the higher registers	147.5 x 27 x 40 free standing away from walls	92dB/w 48Hz	R	65
Duntech PCL1000 Crown Prince £6120	n/a Very Good+	Immensely 'listenable', refined sounding speaker capable of creating lifesize musical images. Not overly transparent to source, but very civilised nonetheless	180 x 30.5 x 43.5 free standing away from walls	90dB/w 42Hz	R	72
Energy 22 Pro Monitor £600	Good Good	Presentation is a bit rough for the price, but this Canadian entrant is an impressive sonic allrounder that will appeal to most listeners	62.5 x 27 x 30cm stands in free space	87dB/w 40Hz	R	66
Goodmans Maxim Two £90	Average+ Average	More wham-bam-thankyou-mam sound that imitates much bigger speakers when you let these babies yell. (A well-controlled yell)	26 x 17 x 19cm near wall on shelf or stand	86dB/w 85Hz	BB	59
Goodmans B-Max/Maxim Two £90 + £90	Poor Average—	Stick with the Maxims on their own until you can afford some real grown up loudspeakers	60 x 21 x 26 + see above, suck and see	89dB/w 55Hz (in room)		78
Goodmans M300 £99	Average Average—	Conveying much of the charm and life which has made the Maxim 2 so popular, the M300 is sensitive, but also significantly hampered by upper bass cabinet coloration	38.5 x 21.5 x 17cm stands close to rear wall	89dB/w 50Hz (in room)	R	82

TO ORDER BACK ISSUES OF HI-FI CHOICE SEE PAGE 32

THE DIRECTORY

LOUDSPEAKERS

MODEL PRICE	LAB SOUND	COMMENTS	SIZE PLACEMENT	SENSITIVITY BASS FROM	VALUE	BACK ISSUE FULL REVIEW
Harbeth LS3/5A £343	Good Average	Still a classic miniature, though not to every taste, and none the better for the recent update under our listening conditions. Limited dynamic range	30.5 x 19 x 16cm stands in free space	81dB/w 60Hz		66
Harbeth HL Compact From £539	Very Good Average	The clean and neutral sound lacks resolution and gives rather unobtrusive though well differentiated stereo. Can be bi-wired to advantage	52 x 27.2 x 28.1cm open space, on high stands	87.5dB/w 65Hz		59
Heco Interior 90S £159	Good Average—	Neatly finished and engineered miniature, but the disappointingly 'lifeless' sound left the listening panel decidedly underwhelmed	27 x 18 x 16cm on high stands	87.5dB/w 90Hz		74
Heco Interior 120 £169	Good Average	Drab appearance belies a lively enough character, though the balance is altogether a bit bright for UK tastes	32 x 23 x 23cm high stands against wall	88dB/w 50Hz (in room)		78
Heco Interior 430s £429	Good Good—	This tall floorstanding enclosure delivers an impressively even sound balance with good bass extension, if not the lively dynamics to satisfy enthusiasts	85 x 24 x 27.5cm free space	88dB/w 43Hz	R	71
Heco Superior 740 £599	Good Good—	A similar sonic package to the cheaper Interior 530, these Superior clothes are very pretty indeed, though spikes are still awaited	84.5 x 22 x 25cm on floor in free space	88dB/w 30Hz (in room)		78
Heybrook Point 5 £139	Average Average	"Uncouth yet still satisfying", the Point 5 gives good dynamics and bass for a compact wall-mount, but is burdened by a somewhat unhappy treble	37.5 x 23 x 24cm high stands against wall	85dB/w 32Hz (in room)		78
Heybrook Point 7 £185	Average Average	Physically an attractive package, but not entirely convincing in lab or listening panel test; interesting for all that	40.5 x 23 x 23cm stands against rear wall	85dB/w 60Hz		68
Heybrook HB1 £199	Good Average+	No longer an over-bright character, a strikingly clear sound and fine transient performance now merits recommendation	47 x 29 x 23cm on stands near wall	88dB/w 61Hz	R	46
Heybrook HB100 £255	Average+ Good	Well matched for wall siting, the HB100 is a lively and informative performer in the tradition of the popular HB1	47 x 26 x 28cm stands near rear wall	86dB/w 50Hz	BB	66
Heybrook HB150 £319	Average Good	Convincingly communicative but a bit colored and congested, this lively compact wall-mount is nicely finished but a little costly for the content	40.5 x 23 x 22cm stands close to rear wall	89dB/w 42Hz (in room)		82
Heybrook HB200 £399	Average Average	This luxury successor to the HB2 is lively and informative, but sounded insufficiently balanced to convince our listening panel	46 x 23 x 26cm stands against rear wall	87dB/w 55Hz		66
Infinity RS2001 £180	Average Average+	A little coloured and unruly in the treble, the 2001 nevertheless retains the lively dynamic bounce of its predecessor; pity the price has gone up	36.5 x 22.5 x 20cm lightweight stands	87dB/w 50Hz (in room)	R	78
Infinity Kappa 6 £795	Good Good	Interestingly styled US loudspeaker has unusual high tech drivers and good neutrality, but the sound seriously lacks excitement	63 x 38 x 24cm stands, free space	85dB/w 35Hz		66
Infinity Kappa 8 £1850	n/a Good++	Very nicely made and unobtrusive but large four-way speakers which have a tendency to sound bass heavy unless used with solid core cables	118 x 51.5 x 17.5cm floor standing, open space	89dB/w 33Hz		72
Jamo Concert 2 £230	Good Average—	A thoroughly respectable 'bookshelf' performer that needs free space siting but includes attractive cabinetwork and a neat grille	41 x 24 x 25cm stands in free space	85dB/w 48Hz		66
JBL TLX12 £149	Good— Average	This smart near-miniature has a 'boppy', lively bottom end, but beware of the fizz in its top	37 x 23 x 23cm stands 0.5m from rear wall	87dB/w 55Hz	R	71
JBL LX33 £259	Average+ Good	A bit of a cheat, but a lot of speaker for the money, which manages a better room balance than many 'large bookshelf' rivals, and delivers a fine acoustic performance	80 x 25 x 21cm floor, 1ft from wall	89dB/w 48Hz	R	82
JBL LX44 £340	Good— Average	This generously built model offers good power handling, bass extension and dynamic range, but suffers from the 'three-way syndrome', with middle muddle	58.5 x 30 x 29cm stands in free space	89dB/w 40Hz		71
JPW Minim £79	Average+ Average—	Very civilised but dynamically limited, the Minim is well suited to the smaller room and where limited loudness is acceptable	27.5 x 18 x 19.5cm stands against wall	85dB/w 28Hz (in room)	R	82
JPW Sonata £99	Good Average+	Well balanced and integrated, this near-miniature offers fine sound if limited bass and dynamic range, plus real tree wood at a nearly silly price	32 x 23 x 20cm stands near rear wall	86dB/w 55Hz	BB	71
JPW P1 £139	Good Average+	Honest and basically articulate if not very sophisticated, resolution is good but it can sound a little wearing in bright systems or with rough sounding material	44 x 25.9 x 26.1cm free space on stands	89dB/w 60Hz	R	59
JPW AP2 £165	Good Good	Few grounds for criticism but purchasers should check out the treble qualities to avoid hammering the ear anvils	46 x 26 x 25cm 40cm from wall on 45cm stands	89dB/w 65Hz	R	53
JPW AP3 £219	Good Average+	Pretty good stereo and well balanced overall it had its own character which is well suited to vinyl replay	52 x 25 x 29.5cm near wall on stands	90dB/w 57Hz	R	46
KEF C15 £99	Good Average	One of the tiniest around delivers a surprisingly 'big' and well balanced sound, with excellent stereo from free space siting	26.5 x 18 x 14cm stands in free space	85dB/w 60Hz	R	71
KEF C25 £139	Average+ Average—	Very safe and competent, but rather short on inspiration, the '25 lacks the brio and flair of its smaller C15 brother	34 x 20.5 x 17cm high stands near wall	87dB/w 60Hz (in room)		78
KEF C55 £219	Good Average+	Similar to but less good value than C75, the '55 provides Uni-Q stereo stability but not real wood veneer or good low frequency room match	48 x 24.5 x 25cm stands, free space	91dB/w 30Hz (in room)		82
KEF C75 £349	Good Good	Compact floorstanding model's Uni-Q driver provides fine crossover integration, giving stable stereo and fine dynamic range within a slightly 'rich' balance	72 x 24.5 x 25.5cm floor in free space	90dB/w 45Hz	R	71
KEF R102 £365	Very Good Very Good	High class near-miniature with expressive, articulate midband and clean, accurate bass and top. The sound quality of the Kube circuitry, however, is suspect	33 x 20.7 x 26.3cm near wall or open on stands	89.5dB/w 60Hz	R	59
KEF C95 £599	Good Good	Rich and lazy, but nonetheless very endearing in a cosy sort of way, the '95 is a lot of speaker for the money, and delivers a big sound with grace and subtlety	88.5 x 24.5 x 31cm floor in free space	90dB/w 28Hz (in room)	R	78
KEF 103/3 £680 inc. stand	Good+ Good	Technically impressive, excellent bass/power handling for size, but not for the audiophile system. Better among cheaper components, and good in a large room	56 x 27 x 30cm supplied stands free space	90-95dB/w 35Hz		53
KEF 104/2 (inc KUBE equaliser) £895 (£994)	Very Good Good++	A reference point for dynamics, preferred without KUBE, suited to many rooms. Good stereo, high sound levels	90 x 28 x 41.5cm floor standing in free space	92dB/w 50Hz	R	60
KEF 107 £2025	Very Good Good+	A welcome sense of ease and lack of strain at most normal levels. Minor criticisms included a dulling in the extreme treble. Excellent bass extension	116.5 x 33 x 45cm on floor in free space	87.5dB/w 20Hz	R	60
Linn Helix £279	Average+ Good	Attractive presentation is coupled with an attractively lively sound which is more neutral if less committed than earlier Linn loudspeakers	51 x 25.5 x 28cm stands 1ft from rear wall	88dB/w 53Hz	R	66
Linn Kan 2 £339	Average+ Average+	A niche product for those prepared to tolerate its strong character for the sake of its fine bass performance and near invisibility	30.5 x 18.5 x 16.5cm Kan stands against wall	82dB/w 35Hz (in room)		78
Linn Nexus £379	Good Average	Good features include a solid, meaty bass plus good imagery and tonal balance. The catch is that Nexus lacks resolution and timing	49 x 23.5 x 30.4cm near rear wall supplied stands	89dB/w 60Hz		59
Linn Kaber £989	Average Good+	Discreet wall-mount package trades sensitivity for fine bass extension and midbass performance; can be a little relentless but has prodigious dynamic capabilities	93 x 19 x 28cm floor against rear wall	86dB/w 28Hz (in room)	R	82
Magneplanar SMGa £675	Average— Average	Tonally 'rich', in the right room it proved a satisfactory musical experience	122 x 48 x 4.5cm on floor clear of wall	85dB/w 56Hz		46
Magneplanar MG1.4 £1190	Good+ Good+	Replaces the stalwart MG1c with a revised panel layout. Offers a very crisp and articulate sound, particularly revealing of upper mid vocal details	155 x 8 x 57cm open space	88dB 40Hz	R	72
Magneplanar MG2.5R £1998	Good Good	Offers the low coloration and profound musical insight of better electrostatic loudspeakers but without loss of low frequency extension	183 x 56 x 4.5cm Open space	83-85dB/w 35Hz	R	60

THE DIRECTORY

LOUDSPEAKERS

MODEL PRICE	LAB SOUND	COMMENTS	SIZE PLACEMENT	SENSITIVITY BASS FROM	VALUE	BACK ISSUE FULL REVIEW
Magneplanar MG11a £2700	Good Very Good	Another excellent true-audiophile loudspeaker this American panel speaker helps to convey much of the original character of the music	180 x 62 x 38cm well clear of walls	84-86dB/w 35Hz	R	46
Marantz LD20 DMS £170	Average Average	Recommended more for CD users than vinyl keepers, soundly engineered and built but should be heard before bought	36 x 23 x 24cm free space on 45cm stands	86, 5dB/w 55Hz		53
Marantz LD50DMS £200	Very Good Good—	Well behaved larger two-way has fine balance, stereo and integration with good bass extension, albeit with mid 'boxy', 'chesty' and 'fizzy' effects	42.5 x 27 x 28cm stands in free space	87dB/w 50Hz	R	71
Martin Logan CLS II £398	n/a Very Good	Much improved high resolution design, fussy about system set-up and demanding of ancillaries and software alike. It rewards the efforts though	60 x 28 x 7.5cm open space	86dB/w 45Hz	R	72
MB Quart 220 £270	Average— Average	The elaborate and pretty enclosure in a wide range of finishes works better than the drivers and crossover, which impose a lumpy balance	30 x 22.5 x 21cm stands in free space	87.5dB/w 80Hz		74
MB Quart 280 £340	Average— Average	Despite redoubtable build quality and good dynamics, the 280 has a rather 'obvious' mid bass and a balance that adds rather too much of its own character	44 x 27 x 29cm uncritical	88dB/w 40Hz (in room)		78
MB Quart 390 £469	Below Average Poor	An aggressive, messy sounding design whose uncouthness undermines the positive level of detail	52 x 31 x 30.5cm open space, on stands	89.5dB/w 60Hz		59
Meridian M30 £775	Average+ Average	Pricey but easy on the ears and worth considering especially where space is at a premium	38.5 x 18 x 32cm free space on stands	Active 40Hz		46
Mission 761 £130	Average Good	One helluva speaker for the price, if a shade small and short of subtlety and refinement – should prove a worthy successor to the 70 and 700	38 x 21 x 21cm stands near rear wall	87dB/w 60Hz	BB	66
Mission 762 £200	Average Average—	Mission's 'bookshelf middleweight' offers high sensitivity and loudness capability, but at the expense of a somewhat untidy and rather 'heavy' sound	50 x 25 x 27cm stand, experiment advised	91dB/w 55Hz		66
Mission Cyrus 781 £250	Average+ Average+	Superb build, finish, presentation and engineering for the price, this romantic sounding Cyrus needs careful system matching to achieve good results	43 x 22.5 x 28cm medium stands near wall	88dB/w 40Hz (in room)		78
Mission 763 £300	Average+ Average+	A very artful combination of generous volume and good bass extension at a modest price. Works well in the listening room despite a few rough edges	77 x 25 x 32cm near rear wall	86dB 40Hz	BB	68
Mission Cyrus 782 £350 (stands £80)	Good— Good—	Lively, articulate and beautifully finished, this compact wall-mount model with twin main drivers has good integration but a rather rich, 'Loudness' balance	50 x 25 x 32.5cm Cyrus stands near wall	90dB/w 50Hz		71
Mission 764 £450	Good Good—	Large floorstander has fine bass extension but limited dynamic range, and sounds 'lazier' than Best Buy 763	86 x 25 x 32cm 0.5+m from rear wall	86dB/w 43Hz		71
Mission 767 from £2500	Very Good Very Good	Magnificent and massive part-active monoliths have fine acoustic subtlety and impressive loudness capability, ultimately limited by partnering (Cyrus) electronics	138 x 29 x 43cm floor, flexible	91dB/w below 20Hz (in room)	R	81
Monitor Audio Monitor 7 £150	Average— Average	This lively and punchy near-miniature looks pretty enough and is good value but is let down by an unruly and indifferently integrated tweeter	34 x 16.5 x 17cm stands 1ft from wall	84dB/w 70Hz		74
Monitor Audio Monitor 9 £190	Good Average	Despite a much better treble balance than the 7, the Monitor 9 is less engaging and lively at low frequencies than its smaller sibling	37 x 20 x 21cm high stands near wall	84dB/w 40Hz (in room)		78
Monitor Audio R300/MD £250	Average Average—	An attractive 'large bookshelf' model that's handicapped by poor crossover and integration between paper cone bass and metal dome tweeter	47.5 x 25 x 30.5cm stands in free space	88dB/w 50Hz		71
Monitor Audio R352/MD £299	Average+ Good	A good value large box that sounds more engaging than subtle, providing a good compromise between bandwidth and sensitivity	64 x 25 x 32cm stands in free space	89dB/w 45Hz	R	66
Monitor Audio MA700/Gold £349	Good Average+	Lacks bass authority and timing, but could suit the smaller room, at the end of a CD-based system used primarily for classical music at modest levels	35 x 21.5 x 25cm stands, free space	87dB/w 48Hz (in room)		82
Monitor Audio R852/Gold MD £449	Good Good	Luxury build and 'high tech' tweeter or not, this compact model offers good refinement and detail on an open soundstage	45 x 25 x 26cm stands in free space	86dB/w 50Hz	R	66
Monitor Audio 1200 Gold MD £799	Average Average+	This smooth and civilised slimline floorstanding loudspeaker is well built and nicely presented. But it is also expensive	94 x 20 x 26cm in free space	85dB/w 48Hz		68
Monitor Audio MA1800/Gold £1299	Good Average+	Attractive and beautifully finished, even when ballasted with lead shot the 1800 inclines towards upper bass richness and lacks genuine extension	106 x 22 x 32cm floor, free space	88dB/w 30Hz (in room)		81
Mordaunt-Short 3.10 £100	Average Average+	Probably the liveliest and most communicative miniature around, this beautifully presented design is probably better suited to budget 'real hi-fi' than the blandness of the midi system	28.5 x 17.5 x 20cm high stands near wall	84dB/w 50Hz (in room)	BB	78
Mordaunt-Short MS 3.20 £130	Average Average+	All the charm of its BB-rated £99 baby 3.10 brother, plus a smidgen more bass for those in a suggestive frame of mind	35.5 x 18 x 20cm open stands against wall	85dB/w 50Hz (in room)	R	82
Mordaunt-Short 3.30 £180	Average Average+	A little too mid-forward for neutrality or formal recommendation, this attractive, good-sized model nevertheless has more than enough appealing qualities to merit serious consideration	46 x 23.5 x 27cm high stands 1-2ft from wall	87dB/w 38Hz (in room)		78
Mordaunt-Short MS100 £189	Average+ Average+	A 'mid forward' tonal balance is its main drawback but other aspects such as ambience, transparency and stereo depth compensate	32.5 x 22.5 x 21.5cm stands near wall	85dB/w 80Hz	R	46
Mordaunt-Short MS300 £319	Average+ Average+	Not considered particularly competitive in its class, though it has good power handling and stereo focus	54 x 22.5 x 25cm on stands near wall	89dB/w 65Hz		46
Mordaunt-Short 442 £1150	Good+ Good++	A resounding success with the listening panels. Make sure your room can accommodate the bass	95 x 26 x 38cm floor standing in free space	87.5dB/w 40Hz	R*	60
Musical Fidelity Reference 2 £199	Good— Good—	This compact wall-mount design with advanced drivers has good dynamics, balance and stereo, plus flashy styling and some midband 'boxy' coloration	38 x 25 x 20cm stands near rear wall	88dB/w 50Hz		71
Musical Fidelity MC-2 £299	Very Good Good++	This exceptionally clean and clear design offers real subtlety and finesse. Bass quality is light but exceptionally clear; the treble is smooth if slightly shallow	48.5 x 25.5 x 16.5cm open space and stands	87.5dB/w 65Hz	BB*	66
Musical Fidelity MC-4 £499	Very Good+ Good++	Achieving a very high standard, the MC-4 sounds detailed and coherent like the MC-2, but with more bass depth and solidity, and large image scale	56.5 x 26.9 x 29cm open space on stands	87.5dB/w 60Hz	R*	59
NVA Cube 2 £380	Average Good	A rude but exciting miniature, with unusually accomplished bass capabilities for its size	28.5 x 27 x 28.5cm NVA stands against wall	85dB/w 48Hz (in room)	R	82
NVA Cube 1 £600 (stands £200)	Good— Good+	Attractive, cube-shaped semi-omni is very sturdily built, and gives an idiosyncratic but unusually open, spacious and informative sound	33 x 32 x 32cm own stands c0.5m from wall	85dB/w 52Hz	R	71
NVA Cubix £1,100	Average Good	Too idiosyncratic for formal recommendation, the Cubix possesses remarkable bass extension for its size, but is tricky to optimise and has some aggressive tendencies	60 x 32.5 x 32.5cm low stands against wall	88dB/w 20Hz (in room)		78
Opus 3 Credo £399	Average Average	Credo's odd-shaped silicate-based cabinet confers good box and bass performance, but the sound could be more neutral for the price	32 x 28 x 32cm stands in free space	88dB/w 65Hz		74
Opus 3 Capella £599	Good Good	The sound of this Scandinavian curiosity certainly benefits from the crushed marble enclosure, though presentation is strictly DIY	32 x 40.5 x 26(ave)cm amongst books in bookcase	86.5dB/w 45Hz		66
Pearl & Oakley Victoria 200 £1099	Average— Average—	Extraordinary – and to many very attractive – 'ginger jar' presentation in Staffordshire ceramics, but let down by need for further acoustic and mechanical development	93 x 33 x 33cm on floor in free space	87dB/w 30Hz (in room)		78

TO ORDER BACK ISSUES OF HI-FI CHOICE SEE PAGE 32

THE DIRECTORY

LOUDSPEAKERS

MODEL PRICE	LAB SOUND	COMMENTS	SIZE PLACEMENT	SENSITIVITY BASS FROM	VALUE	BACK ISSUE FULL REVIEW
QLN Model One £700	Good Average	Similar to Signature at two thirds the price, Model One exaggerates the latter's rich and heavy midbass and lacks its velvet smoothness	35 x (16-25) x (21-27)cm pillar stands, free space	85dB/w 28Hz (in room)		82
QLN Signature £1,100	Good Good	Beautiful but expensive luxury compact has a rather laid back and 'heavy' sound, but coloration is low and stereo imaging very good	37 x 18 x 36cm heavy stands in free space	83dB/w 30Hz (in room)		78
Quad ESL-63 £1690	Good + Good + +	With its unusual but subtle characteristics this classic electrostatic may not be punchy in the bass, but has strengths that some cannot live without	92 x 66 x 27cm open stand well clear of wall	84dB/w 34Hz	R	60
Richard Allan CD5 £184	Average — Average —	This neatly presented small reflex design can sound engagingly communicative, but is flawed sonically and technically and quite expensive too	38 x 19 x 23cm on rigid stands	88dB/w 80Hz		68
Rogers LS2a £180	Average Average	Provides very good engineering and stereo performance for the price, alongside some 'boxiness' and certain dynamic constraints	36 x 23 x 21cm low stands 1ft from wall	88dB/w 50Hz (in room)		82
Rogers LS4A £219	Good Good —	This artfully voiced and well balanced compact gives a fair flavour of the classical 'BBC sound' at a very reasonable price	43 x 25.5 x 24.5cm stands 1ft+ from wall	87dB/w 32Hz (in room)	R	78
Rogers LS7t £399	Good + Good +	A fine combination of classic qualities at reasonable price produces the "R" tag, but try to get a pair home on approval to check for bass 'heaviness'	56 x 27 x 28cm free space on 40cm stands	88.5dB/w 48Hz	R	59
Rogers Studio 1a £579	Very Good Good —	The classic BBC monitor style sound sensitively updated — transparent and natural with fine stereo, but a touch 'heavy' in balance	63.5 x 30.5 x 30.5cm stands in free space	87dB/w 36Hz	R	66
Rotel RL850 II £140	Average + Average +	Strongly recommended. Well-balanced, clear, with decent focus and fine stereo, but tendency to 'heaviness' needs decent stands and space	44 x 25 x 24cm free space on 40cm stands	86.5dB/w 50Hz	BB	59
Royd A7 Series 11 £115	Average + Average	Lively clear sound; good upper bass and dynamics, but treble "ramp" made vocals sound shut in. Try before you buy	31 x 20 x 17cm shelf or 50cm stands near wall	86dB/w 75Hz	R	53
Royd Eden £235	Average Average +	Delightful mid/treble speed and transparency but determinedly bass light, this oddball miniature threatens cult status but could use a sweeter tweeter	31 x 20.5 x 18.5cm stands close to rear wall	87dB/w 85Hz	R	66
Royd Apex £485	Average + Good	Not the smoothest sound around, it more than compensates with an impressively communicative and informative musical presentation	85.5 x 20 x 30cm on floor close to wall	87dB/w 33Hz (in room)	R	78
Ruark Swordsman £219	Good Average	Very attractively styled and finished, the Swordsman is a well built 'small bookshelf' model that delivered better test than listening results	38.5 x 20 x 27.5cm stands 0.5m from wall	84dB/w 50Hz		71
SD Acoustics OBS £695	Average Good	Recent changes have added some refinement to a seductive midrange, good timing and fine sensitivity, though bass extension is limited and coloration obvious	102 x 35 x 25cm floor, angled, away from walls	92dB/w 30Hz (in room)	R	82
SD Acoustics SD1 £1150	Average Very Good	A large scale, airy and unusually detailed system with excellent dynamics. Current model has more civilised top-end and warmer balance than original model	123.5 x 38.2 x 31.9cm free space	90dB/w 50Hz	R	60
SD Acoustics Ribbon £2000	Average Good +	Entertaining but a little underdeveloped and rather amplifier sensitive, the Ribbon is a lively and loud hybrid marred by some colorations; some like it, others don't	152 x 30 x (15-30)cm floor, angled, away from walls	91dB/w 30Hz (in room)		81
Shan Shimna £280 (stands £75)	Average + Good —	Pretty little miniature in cast mineral/plastics has limited dynamic range and could sound smoother, but integration is good and box effects slight	31 x 16 x 17cm stands near rear wall	84dB/w 65Hz	R	71
Snell Type C £2350	n/a Very Good	Pricy, yes, but an extremely capable loudspeaker. Musical and transparent; excellent bass extension	112 x 38 x 33 free standing away from walls	90dB 35Hz	R	65
Sony APM-101ES £100	Good Average	Big hearted sound from small bookshelf successor to BB '10ES, sounds a little untidy at frequency extremes, so suits CD better than vinyl	39.5 x 22.5 x 23.5 stands in open space	86dB/w 52Hz	R	71
Sony APM-141ES £200	Average Average	A great deal of loudspeaker for the money, the rich-sounding '141 needs a big room and still shows significant 'loudness' (boom'n'tizz) tendencies	61.5 x 26 x 32cm large room, free space	88dB/w 30Hz (in room)	R	78
Sony APM-181ES £300	Very Good Average	Big and beefy but also somewhat fat and bass heavy, this well engineered three-way has notable strengths but lacks transparency and sounds better at lower levels	57.5 x 29 x 36cm stands in open space	87dB/w 40Hz		71
Sony APM 66ES £700	Average + Average +	Powerful heavyweight sound with a brilliant midband — clear articulate and transparent. But the bass is on the boomy side and the treble can sound grainy	66 x 38 x 36.5cm open space, low stands	89dB/w 60Hz		59
Spendor SP2/2* £500	Very Good Good +	Conceding little to the SP1, this 30 litre model displayed good tonal balance with a highly articulate midrange, only slightly marred at frequency extremes	50 x 25 x 30cm free space, stands	87dB/w 45Hz	R*	59
Spendor SP1 £800	Very Good Good	A very subtle and musical performer that works particularly well with digital material. An exceptional allrounder	63.5 x 29.5 x 30.5cm stands in open space	87dB/w 41Hz	R	60
Spica TC50 £599	Good — Good	This triangular-profile 'grown up' miniature is a shade boxy and laid back but has good rhythmic and musical integrity	40.5 x 33 x 29cm stands in open space	88dB/w 55Hz		71
Spica TC50SE £799	Good — Good	A heavily UK-modified TC50, the SE sounds less boxy and more spacious, but lacks some of the urgency of the standard model	40.5 x 33 x 29cm stands in open space	88dB/w 55Hz		71
Spica Angelus £1295	Good Average	A little bass shy and soft in the bass and lower mid, the free standing Angelus is otherwise tidy, extremely lively and fluid, if uneven overall	116.8 x 53.3 x 26cm away from walls	86.5dB/w 50Hz		60
Studio Power DMS100 £249	Average + Average +	Close to a BB rating, and in many respects remarkable value for money. Delivers an impressively smooth and large sound, but sheer ugliness will limit its appeal	51 x 26 x 32cm open stands 1ft from wall	86dB/w 25Hz (in room)	R	82
Sugden CL £275	Average + Good —	A thoroughly impressive and likeable near-miniature, the CL is prettily and properly built, and needs a good driving amplifier	35.5 x 18 x 26.5cm high stands in free space	86dB/w 35Hz	R	78
Tannoy E11 £129	Average Average —	Fundamentally turgid and slow, thanks to leaden upper bass and 'shut in' treble, though stereo images are convincing, as are the reasonably uncoloured vocals	39 x 21 x 22cm stands, free space	87dB/w 45Hz (in room)		82
Tannoy M15 £170	Good Average +	Somehow lacking the magic of its predecessors, the M15 remains a fine value compact that needs careful set-up to give optimum results	50 x 25 x 21cm Blu-tack to stands 1-2ft from wall	88dB/w 40Hz (in room)	R	78
Tannoy DC1000 £200	Average Average —	The smaller of two DC models with dual concentric drivers, the '1000 is much less well balanced than the larger, floorstanding '2000	50 x 24 x 25cm	91dB/w 53Hz		71
Tannoy DC2000 £300	Good Good	Remarkably high sensitivity from unique dual concentric driver that has an involving but characteristic sound. Bass could be better	68.5 x 26 x 27cm floor in free space	93dB/w 55Hz	R	66
Tannoy DC3000 £600	Good Good	Giving new meaning to terms like dynamic range and headroom, the magnificent '3000 is a must for those who enjoy high-level monitoring. But spare a thought for the neighbours	94 x 26 x 31cm floor 1ft+ from wall	94dB/w 30Hz (in room)	R	78
Tannoy Westminster £3600	n/a Good +	These awesome horn loaded speakers are remarkably controlled and impressive, if only suited to a few pockets and rooms	Huge, flat against rear wall, away from corners	96dB/w (manuf.)	R	Coll
TDL Studio 1 £549	Average + Good	Delivering genuinely extended bass from a compact floorstanding enclosure, the Studio is very detailed but a shade clinical and detached in presentation	76 x 23 x 33cm low stands in free space	84dB/w 25Hz (in room)	R	78
TDL Monitor £1799	Very Good Very Good	Fine solidity and good accuracy, with enough bass extension to satisfy even organ freaks. Needs a big room and can sound a bit lazy and a shade tinkly	118.5 x 30 x 47cm 0.5m from walls	85dB/w 28Hz	R	66
Technics SBC 250 £140	Average + Average —	Despite a fairly even tonal balance, the 250EK sounded muddled in the midrange and dull in character	36.5 x 23.5 x 20.5cm free space, stands	86dB/w 60Hz		46
Technics SB-RX50 £500	Very Good Average +	With its unique coaxial drive unit the RX50 proved a smooth and well balanced loudspeaker, its minor weakness being a mildly excessive low bass	48 x 30 x 26cm free space on 40cm stands	86dB/w 40Hz	R	46

THE WORLD'S NO 1 GUIDE TO BUYING HI-FI

THE DIRECTORY

LOUDSPEAKERS

MODEL PRICE	LAB SOUND	COMMENTS	SIZE PLACEMENT	SENSITIVITY BASS FROM	VALUE	BACK ISSUE FULL REVIEW
Videotone Minimax 2 £80	Poor Average—	Cheap in build and QC as well as price, but cheerful (if coarse) with it – if a little too cheerful after extended listening...	27.5 x 17 x 20cm near rear wall	84dB/w 90Hz	R	74
Visonik David 6001 £173	Average— Poor	Sharp styling a classy looking miniature makes, but the complex grillework worsens a sound which starts off with too much top and not enough bottom	20 x 12 x 13cm against rear wall	87dB/w 130Hz		74
Wharfedale Delta 30 £80	Good Average	Very clear and surprisingly neutral for the price, with good dynamics and stereo within limited volume ceiling	37.9 x 20 x 16.9cm near wall on high stands	88.5dB/w 80Hz	BB	59
Wharfedale Delta 50 £100	Average+ Average—	"There's nothing obviously wrong, but it seems a bit mundane," is what we said when the Delta 50 was £129. But since then the price has dropped by 30 per cent, making it great value	48 x 27 x 19cm near wall on 40cm stands	88dB/w 55Hz		53
Wharfedale Diamond III £100	Below Average Average—	This latest version of the long running Diamond sports a better tweeter, but bass, though deep, is soft, and the midband is indistinct and uneven	24 x 18.5 x 20.5cm near wall, stands	86.5dB/w 75Hz		59
Wharfedale Super Diamond £140	Average Average—	Although there are improvements on the basic "legendary" model, listening panelists did not get airborne about this upgrade	24 x 19 x 19cm close to wall at head height	88dB/w 57Hz		53
Wharfedale 504/2 £150	Average Average	Not strictly accurate, this musically involving miniature sounds unusually coherent and well integrated, if a shade dull in balance	29 x 18.5 x 19cm stands against rear wall	84dB/w 60Hz	R	68
Wharfedale 505/2 £180	Average Good	This lively Wharfedale provides plenty of speaker with unusual refinement for the money, and should be fairly tolerant of room siting	44 x 25.5 x 24cm stands 1ft from wall	86dB/w 55Hz	BB	66
Wharfedale 507 £220	Average+ Average—	Generous in size but uningratiating sonically, the 507 doesn't seem to gel in the way the smaller 505.2 does, finding a good in-room balance difficult to achieve	49 x 25.5 x 29.5cm high stands 1ft+ from wall	86dB/w 35Hz (in room)		78
Wharfedale Coleridge £499	Average Good	Compact, beautifully finished and extravagantly engineered box sacrifices bass extension in the cause of high midband sensitivity; communicative, but can be a little unforbearing	48 x 26 x 26.5cm stands 1ft from wall	91dB/w 48Hz (in room)	R	82
Yamaha NS 1000M £900	Good Good+	Living up to its monitor label, and tonally well suited to digital material, the NS 1000M is superbly crafted and capable of high levels	67.5 x 37.5 x 32.5cm 30cm from wall, stands	90dB/w 40Hz	R	46

* rating refers to original, tested model.

CASSETTE DECKS

The bad odour of copyright theft hangs around the compact cassette, but there is no doubt it is the world's most versatile and ubiquitous music storage medium. Hi-fi buffs may wrinkle their noses pointedly, but are still happy to use cassette decks to make up tapes for the car or personal – at the same time complaining loudly about the quality of pre-recorded material. (In fact the very best decks can do a surprisingly good job with musicassettes.)

There is no problem in connecting a cassette deck to any normal amplifier, but some care needs

to be taken in choosing the best tapes for a specific machine. (Trial and error is one effective technique, but many decks have manual bias adjustment and some match up to the tape automatically.) Lab performance and sound quality often go hand in hand, and are frequently somewhat dependent upon factory alignment. The mechanical integrity of the mechanism itself is another crucial factor, that is often reflected in the asking price.

All modern hi-fi decks have Dolby B and the majority have Dolby C besides; the very worthwhile

HX Pro system is becoming steadily more widespread. Remote control remains rare, though sometimes it is available as a system option. Three-head recorders allow simultaneous checking of the recording being made. Auto-reverse is a useful convenience feature, but usually with some mechanical compromise, while double-mechanism 'dubbing' decks of dubious quality are fashionable at the bottom end of the market. The writer of different 'music search' systems available is some indication of their frequent ineffectiveness.

NAME PRICE	LAB SOUND	COMMENTS	FEATURES	VALUE	BACK ISSUE FULL REVIEW
Acoustic Research RD-06 £280	Average Average+	Acceptable middle market player with very simple facilities and cramped control section, but unusually good looks	Dolby B/c hx pro, fine bias, counter memory, repeat		69
Aiwa AD-F270 £90	Average Average+	An excellent budget machine, adequately equipped and satisfactorily built. Sound quality is in severe danger of transcending the price category	Dolby B/c, fine bias adjust	BB	75
Aiwa AD-F370 £130	Average Average	Adequate but uninspiring recorder with detail shortcomings but good control layout and successful sounding with recorded musicassettes	Dolby B, C, HX Pro, bias adjust		63
Aiwa AD-R470 £150	Average Good	For once, an auto-reverse deck with the performance of a decent unidirectional one at a similar price. The Aiwa is modern in concept and execution, and has good, transparent electronics	Dolby B/c/hx pro, auto reverse, cue & review, bias adjust	BB	69
Aiwa AD-WX777 £179	Very Good Very Good	Excellent, middle price dual deck with quick side change and a living, breathing sound – though prerecorded tapes sound bright	Twin auto-reverse, one records. Dolby B/C, fine bias	BB	75
Aiwa AD-F700 £199	Good Average—	Somewhat less than the sum of the (most fine) individual parts, this deck has an artificial quality which spoiled the efforts of a fine transport	Dolby B/c/hx Pro, fine bias, CD Direct input		75
Aiwa AD-F800 £249	Good Very Good	Close to first class performance – and superb value. The Aiwa is purposeful and finely engineered. It provides a near irresistible blend of good mechanics and electronics	3 head, dual capstan, Dolby B/c/hx Pro, tape calibration	BB	75
Aiwa AD-WX888 £249	Good Good	Inaccurate set-up spoils metal tape operation, but with other tapes the deck works well. This deck offers fine engineering, facilities and sound	Dual auto-reverse twin deck, Dolby B, C and HX Pro	R	75
Aiwa XK-007 Excelia £400	Good Good	Downmarket version of XK-009 with simplified bias/equalisation adjustment section and more forgiving but less informative sound. Still good, but less exciting than XK-009	Dolby B, C, dbx, HX Pro, 3 Head, tape alignment		63
Aiwa AD-WX909 £400	Good Good	Convenience meets sound quality, and both win. An essentially clean, positive recorder which works alongside an auto-reverse player of lower standard – a sensible compromise	Dual deck, auto-reverse, track search, Dolby B/c/hx pro, bias adjust, 3 Head	R	57
Aiwa XK-009 Excelia £550	Very Good Very Good	Excellent detail, stable articulate midband and slightly obvious treble. The most interesting Aiwa for yorks	Dolby B, C, dbx, HX Pro, 3 Head, tape alignment, CD direct	R	63
Akai GX-32 £170	Average Poor	Constrained and smeared sum this deck well. It has poor bass and treble definition alike, though it proved well aligned for prerecorded cassettes	Dolby B/c, variable bias, headphone out, track search		69
Akai GX-52 £250	Very Good Very Good	Well finished and a pleasure to use this well specified deck sounds clean and defined with all tape groups, with or without Dolby	Dolby B, C, HX Pro, track locate features	BB	57
Akai GX-65 £299	Poor Poor	Uneven sounding deck with poor bass reproduction and dynamics. A pity this, because the deck looks and feels good	3-head, Dolby B/c/hx pro, optional remote		81
Akai GX-6 £330	Good Good	There is a strong sense that someone has really thought this one through; it has an indefinable 'specialness'	Real-time counter, track search, Dolby B, C, bias adjust	R	52
Akai GX-95 £400	Good Very Good	Well designed and finished cassette deck with features well judged to please the audiophile – especially switchable Dolby HX Pro and switchable panel display. The calibration system is simple and effective, and the deck sounds great	Dolby B/c/hx pro, 3 head, manual tape set-up	R	69
Denon DRM-400 £140	Poor Poor	Messy, confused sound terminally lacking in detail and space under all conditions of use due to high mechanical flutter levels.	Dolby B/c, memory stop, track search		81
Denon DRM-500 £180	Good Very Good	Powerful, refined and detailed sound, and an excellent transport are keys to the success of this cleanly styled addition to the range – but why no timer standby?	Dolby B/c/hx pro, variable bias	BB	75

TO ORDER BACK ISSUES OF HI-FI CHOICE SEE PAGE 32

THE DIRECTORY

CASSETTE DECKS

NAME PRICE	LAB SOUND	COMMENTS	FEATURES	VALUE	BACK ISSUE FULL REVIEW
Denon DRW-750 £250	Good Good	Polished and articulate, the only significant shortcoming is poor performance with prerecorded material	Dolby B/c/hx pro, twin unidirectional, one records	R	69
Denon DRM-700 £250	Good Very Good	Sloppily executed (though attractive) user interface contrasts with a high standard of music making belying its modest price	3 head, Dolby B/c/hx pro, record return	R	81
Denon DRM-800 £330	Good Very Good	There are some niggling faults and limitations (no timer standby is particularly annoying), but as a means of recording music it sets a very high standard	Dolby B/c/hx pro, off tape monitoring, dual capstan	R	75
Goodmans GSW-5200 £90	Poor Poor	Musically unimpressive but at least it's cheap!	Dolby B, twin, one records		69
Grundig Fine Arts CCT-903 n/a (system component)	Good Good—	[Competent part of complete Grundig system]. Solid and well engineered deck with small but significant problems preventing it scoring highly. Basic design generally – and transport specifically – are excellent	Dolby B/c, twin auto reverse, one records		69
Harman Kardon CD491 £695	Good Good+	Excellent audio engineering and tremendous flexibility make this an audiophile cassette deck 'par excellence'	Real-time counter, auto reverse, track search, Dolby B, C, HX Pro, bias adjust	R	52
Kenwood KX-440HX £130	Average + Poor	Uneven, unstable sounding player with limited resolving power, but good control layout and finish	Dolby B, C, HX Pro, intro scan		63
Kenwood KX-3010 £170	Average + Average	Minor ergonomic shortcomings notwithstanding, this is a workmanlike deck that only misses recommendation due to an azimuth problem leading to very dull sound with prerecorded tapes	Dolby B, C, HX Pro, auto bias		75
Kenwood KX-4520 £260	Good + Very Good	Some high frequency Dolby misalignment and obscure minor functions aside, this is a vital and engaging performer	Dolby B/c/hx pro, 3 heads, various search functions	R	81
Kenwood KX-5010 £270	Very Good Excellent	This important new middle price deck is a well thought through and thoroughly developed design which eschews gimmicks for the sake of musical excellence	Dolby B/c/hx pro, auto tape calibration, track/intro search	BB	69
Kenwood KX-9010 £400	Very Good Average +	Clean, detailed but flat and overtly hi-fi-ish sound quality makes the 9010 a little less than the sum of its parts.	3-head, auto tape calibration, Dolby B/c/hx pro, remote control		75
Marantz SD-40 £170	Average Average—	Transitory sounding electronics mar a basically good recording machine. Prerecorded material suffers from effects of Dolby pumping	Dolby B/c/hx pro, bias adjust		81
Marantz SD-50 £220	Good Very Good	Fine, exacting all-rounder offering good stereo, precision and focus. Good with prerecorded tapes too.	Dolby B/c/hx pro, track & intro search, variable bias etc	R	81
Marantz CP230 £300	Average Average	This is a competitively priced portable recorder though not suited to replay of musicassettes	Dolby B, bias adjust	R	52
Marantz SD585 £300	Average Average—	Sound quality is a little sat upon, and control ergonomics are somewhat opaque, though the twin auto-reverse/recording capability makes this a powerful machine	Dolby B/c, twin auto-reverse & record, parallel recording etc		69
Marantz SD-60 £350	Good Very Good	A first rate, highly capable deck offering energetic yet refined sound largely due to good electronic design	3-head, Dolby B/c/hx pro, variable bias & sensitivity	R	81
Memorex SCT-84 £200	Average + Average +	The playback only transport is a little disappointing, but the record one is a quality item and the deck works well. Ergonomics are good, but styling and control feel are decidedly tacky.	Dolby B/c, fine bias, twin with auto-reverse record, unidirectional play	R	69
NAD 6300 £550	Very Good Very Good	Solid and homogeneous sound quality and very good replay compatibility thanks to 'play trim'. Distinctive, musical – and costly	Dolby B, C, HX Pro, 3 Head, bias adjust	R	63
Nakamichi CR-1E £345	Very Good Good	Modestly equipped by any standards, the CR-1E stands or falls by its build quality, which is high, and sound which is highly competent	Dolby B & C		57
Nakamichi CR-2E £395	Very Good Good +	Ordinary to look at, in some respects rather awkward to use (tape switching especially), the CR-2E sounds very slightly better than the CR-1E, and therefore ranks well. But it doesn't come cheap	Dolby B & C, bias adjust, remote control	R	57
Nakamichi RX-202E £545	Good Very Good +	Fine, clear and articulate sounding player. Excellent with prerecorded material, but idiosyncratic and sometimes obstructive control system	Auto reverse. Dolby B, C, 2 Head	R	63
Nakamichi CR-3E £595	Very Good Very Good	The user interface is a little clumsy, though conceptually straightforward. Sound quality approaches the CR-4E, and is amongst the best at the price.	Dolby B & C, bias adjust, remote control	R	57
Nakamichi CR-4E £745	Very Good + Very Good +	High class deck with a reasonably full range of features and superb sound at a slightly unlikely price	Dolby B & C, bias adjust, remote control, 3 Head	R	57
Nakamichi CR-5E £995	Excellent Excellent	A slightly simplified version of the all-conquering CR-7, the CR-5 has a very similar standard of audio performance – the best	Dolby B/c, fine bias, 3-head	R	69
Nakamichi CR-7E £1500	Excellent Excellent	Remarkably this deck is not only ergonomically but also sonically superior to the Dragon, particularly on record/replay	Real-time counter, track search, Dolby B & C, tape alignment adjust, bias adjust, remote control, 3 Head	R	60
Nakamichi Dragon £1750	Excellent Excellent	Previous to the birth of the CR-7E, this machine stood head and shoulders above the rest. It is still the ultimate for musicassette replay	Auto reverse, Dolby B & C, tape alignment adjust, bias adjust, remote		60
Onkyo TA-2120 £130	Average + Good	Clear, vivid sound with good timing and resolution when using Type II tapes without Dolby. The controls are less inspiring – the meters in particular are plainly inadequate	Dolby B/c, auto tape sensing, block/ side repeat	R	63
Philips FC566 £179	Average + Average +	Mostly well equipped, though some tape search facilities fail to exploit the auto-reverse capability. Sounds clean and stable – with prerecorded tapes too	Auto reverse, track search, Dolby B & C		57
Philips FC870 £250	Average Average	Disappointing at the price, this is a well equipped deck with off-tape monitoring, but a somewhat listless, smeared musical style	Dolby B/c/hx pro, 3-heads, track/intro search etc		81
Philips FC567 £279	Average Poor	Well equipped but ergonomically substandard; sound quality is messy and lacking in clarity and dynamics	Dual deck, auto reverse, track search, Dolby B & C		57
Pioneer CT-225 £100	Average + Average—	At last – a cheap Pioneer with auto-tape select! Well specified ultra cheapie, but poorly set up, especially for commercially recorded material	Dolby B/c, track search		81
Pioneer CT-335 £150	Average Average	Mostly satisfactory mainstream deck, at its worst with prerecorded material which sounded edgy. It made very good Type II recordings	Dolby B/c/hx pro, track search		81
Pioneer CT-445 £180	Good Good	Exactly engineered and fine sounding deck with a strict emphasis on function. Best with good Type IIs	Dolby B/c/hx pro, electronic counter	BB	81
Pioneer CT-656 £250	Good Good	Well conceived and executed low cost 3-head recorder. It benefits from and makes good use of metal tapes, but is never less than couth and stable sounding – even with ferric tapes	3 heads, off tape monitoring, fine bias, Dolby B/c/hx pro	R	75
Pioneer CT-737 Mk II £350	Good Average +	Easy to use and sensibly equipped, the CT-737 is much improved, but sound quality is still a tad lacklustre	3-head, Dolby B/c/hx pro, manual record bias/sensitivity		75
Pioneer CT-91a £500	Very Good + Very Good +	Superb, near state of the art recorder with an excellent dual capstan transport and very capable electronics. At the price, this one is a mould breaker	3-head, tape calibration, Dolby B/c/hx pro	R	75
Revox B215-S £1,826	Very Good Very Good +	This is a superbly engineered deck with a classically fine performance that almost transcends the stereotypes. Ergonomics are flawed but the user interface is both powerful and flexible	3-head, dual capstan, Dolby B/c/hx pro, auto calibration	R	75
Rotel RD-845 £130	Below Average Good/Poor*	Extremely fine transport and clean sounding electronics for the price. Bass lacks weight, but deck works remarkably effectively with chrome tapes. *See text	Dolby B/c, manual tape selector	R	81
Rotel RD-865 £200	Good Very Good	Fine, architecturally solid sound quality in a package with a low gimmick count and strong audiophile appeal	Dolby B/c/hx pro, fine bias	BB	75

THE WORLD'S NO 1 GUIDE TO BUYING HI-FI

THE DIRECTORY

CASSETTE DECKS

NAME PRICE	LAB SOUND	COMMENTS	FEATURES	VALUE	BACK ISSUE FULL REVIEW
SAE C102 £549	Average + Good	Looking most unlike a cassette deck designed in the States and proving competitive in its price group. Not sonically that outstanding, however	Real-time counter, track search, Dolby B & C		52
Sansui D-X301i £180	Average + Good	Lively, informative and well equipped basic deck, if rather obscure operationally	Dolby B/c/hx pro, variable bias, track search	R	69
Sansui D-X501 £230	Poor Poor	Unhappy mixture of good looks, excellent ergonomics and mediocre, sometimes poor sound	Dolby B/c, random track search		81
Sansui D-X701 £340	Average Average	A little flat and smeared under some conditions, this design is at its best with metal and prerecorded tapes	Dolby B/c, 3-head, variable bias & output, track search		81
Sony TC-FX110B £90	Poor + Poor +	Woolly bass and scrappy treble combine to make a meal of many music types, despite accurate response shapes with most types of tape. Prerecorded material sounds dull	Dolby B/c		75
Sony TC-TX55 £150	Average Average +	The sound quality ranking is a good one for an auto reverse machine at this price level. Clean, sharp sound, only slightly let down in the deep bass.	Auto reverse, Dolby B, C & HX Pro	R	75
Sony (WMD6C) ProWalkman £249	Good + Very Good	"One of the finest sounding cassette decks on the market today. A mandatory Best Buy, which also fits in your pocket"	Dolby B, & C	BB	60
Sony TC-RX60ES £250	Average Average	For once a stable sounding auto-reverse deck but sound quality is rather 'dirty' and compressed, especially with Dolby C	Auto-reverse, Dolby B/c/hx pro, auto tape recognition		63
Sony TC-K630ES £300	Average - Average	Acceptable-to-good sounding deck despite some measured shortcomings. At its best with metals; lacks vitality with lower bias tapes	3-head, Dolby B/c/hx pro, bias adjust		81
Sony TC-RX80ES £350	Average + Good	Clean, powerful and detailed sound, especially without Dolby C. Stable pitch - but prerecorded cassettes sounded disappointing	Auto reverse, Dolby B/c/hx pro, bias/level adjust	R	63
Sony TC-K730ES £500	Very Good Very Good +	First rate cassette deck that scarcely betrays it is a cassette deck on audition. Features and control wise, it feels a little dated	Dolby B, C, bias and equalisation adjust	R	81
Teac V-270C £89	Average - Average -	Not quite cheap enough to compete solely on price, the V-270C is a rather messy and unstable sounding deck	Dolby B & C, bias adjust		63
Teac V-480 £129	Average Average +	A rather utilitarian model, the V-480 just makes it on to our recommended list by virtue of a clean, open sound that to an extent transcends the measurements	Dolby B/c/hx pro, fine bias	R	75
Teac W-470 £129	Average - Average	A low grade transport is allied to respectable electronics to give sound quality ranging between acceptable and good. Prerecorded tapes sound bright	Twin deck, one records, Dolby B/c, intro-search		75
Teac V-870 £349	Good + Good	Cut-down V-970X for the proletariat. Expensive and carefully engineered with mostly very good but slightly cold sound quality	Dolby B, C, HX Pro, 3 Head, manual tape calibration	R	63
Teac V-970X £449	Very Good Very Good	An excellent sounding deck with useful features (tape calibration etc) that fully justifies the price	Real-time counter, track search, Dolby B/c/dbx & Dolby HX Pro, bias adjust, remote control, 3 Head	R	57
Teac W-990RX £445	Good Good	A mess with dbx, but taut and articulate otherwise. The 990, though expensive, has a powerful range of features, making it one of the few really ambitious decks to successfully straddle both sets of requirements	Dolby B/c 9 dbx, dual auto-reverse/record, parallel & sequential recording, remote	R	69
Teac R-919X £489	Very Good Average	Superbly equipped, yet usable - and well built too. But sound quality is something of a disappointment at this price level, being appropriate for a model about half the price	3-head auto-reverse, tape calibration, Dolby B/c/hx pro/dbx		75
Technics RS-B555 £160	Good + Good +	Very good value. Resolution, stability and quality of set-up are strong points, a slightly strained, synthetic quality is sometimes apparent	Dolby B/c/hx pro, bias adjust, track search	BB	81
Technics RS-TR255 £160	Average Average	Neat, sensibly designed middle of the road dual transport recorder, suitable where the ability to dub tapes is a particular priority	Twin transports, one records and auto-reverse, Dolby B/c	R	75
Technics RS-B655 £200	Good Very Good	Excellent middle price deck, well equipped with a not over-refined but highly articulate and crisply defined style of musical presentation	Dolby B/c/hx pro, bias adjust, track search	BB	81
Technics RS-TR355 £200	Average Average	Serviceable middle market dual deck without serious fault but with some annoying inadequacies, notably an inability to play side A and B and then stop	Twin auto-reverse, one records, Dolby B/c/hx pro		75
Technics RS-TR555 £300	Average + Average	Sound quality varies with mode of use, but is rarely less than competent, and is often highly enjoyable. dbx is best avoided	Dual auto-reverse/dual record/Dolby B/c/hx pro & dbx	R	81
Technics RS-B905 £350	Good Good	Good, well set up cassette deck with a clean, accurate sound but some compression. dbx circuit sounds poor	Dolby B, C, HX Pro, dbx, bias adjust, 3 Head		57
Yamaha KX-230 £140	Average + Average +	A strong near-budget performer, the strengths include good overall sound, excellent search aids. Weaknesses: ergonomics, soggy bass with prerecorded material	Dolby B/c/hx pro, variable bias	R	75
Yamaha KX-300 £160	Average + Average -	Uncommonly well equipped and adequately made and presented, this model turned out to be a disappointingly uncertain proposition on audition	Track search, Dolby B, C, HX Pro with 'play trim', bias adjust, remote control		57
Yamaha KX-500 £210	Very Good Very Good	An accomplished performer, strongest in the areas of pitch and spatial stability, but slightly rough around the edges	Real-time counter, track search, Dolby B/c/hx pro with play trim, bias adjust, remote control	R	57
Yamaha KX-630 £300	Good Very Good	Well equipped and immaculately presented, offers fine, articulate music making with a bias towards high bias tapes, especially metals	3 head, Dolby B/c/hx pro, optional remote	R	81
Yamaha KX-800 £330	Good Average	The present Yamaha range seems oddly inconsistent. This sophisticated model sounds fine (almost) but came a clear second best to the KX-500	Real-time counter, track search, Dolby B, C, HX Pro with play trim, bias adjust, 3 Head		57
Yamaha KX-1200 £500	Excellent Average +	A veritable rats' nest of buttons and dials, albeit well laid-out. This is nearly a great recorder, but lacks simplicity of sound	Real-time counter, track search, Dolby B, C, dbx, HX Pro, bias adjust, remote control		52

DAT RECORDERS

NAME PRICE	LAB SOUND	COMMENTS	FEATURES	VALUE	BACK ISSUE FULL REVIEW
Aiwa Excelia XD-001 £1300	Very Good Very Good	Clear and very listenable recorder roughly comparable to but slightly sweeter sounding than the Sony DCT-1000ES - but with an inferior front panel design	Track ID and search, remote	R	63
Grundig Fine Arts DAT-9000 n/a (system component)	Good Good	Conventional DAT recorder offering standard facilities. The deck is well made and equipped, and is engineered to a satisfactory quality standard. It performs to an acceptable standard, though it is not state of the art	2/4 hour recording, mic inputs, digital in/out		69
Luxman KD-117 £1499	Good Good	Slightly soggy, earth-bound sound quality, this model trails the other DAT decks tested so far	Two analogue inputs, remote twin address		63
Sony DTC-M100 £799	Very Good Very Good	Clean, clear sounding 2nd generation model with most of the features and sound of the DTC-1000ES	Mid-width, alpha-numeric display, remote, optical interfaces	R	63
Sony DTC-1000ES £1299	Very Good Very Good	Fine, consistent performer with accomplished tape handling and good build quality	Standard track ID and search, remote	R	63

TO ORDER BACK ISSUES OF HI-FI CHOICE SEE PAGE 32

THE DIRECTORY

CD PLAYERS

This all-digital music source is well established, despite still high disc prices and the opposition of many hi-fi enthusiasts. Compact Disc's strengths over conventional vinyl are complete freedom from surface noise with automatic and programmable play, plus track skip and fast music scan – frequently under full remote control. However, many vinyl enthusiasts find CDs sound less involving than

top quality vinyl replay

Introduced five years ago at around £500, CD players now average less than half that price, and for the main offer improved performance besides. Even cheaper players may have the latest decoding chips and the most useful play features; extra money can buy remote control, remote volume control, audio 'tweaks', plus improved build and component

quality control.

Compared with many hi-fi components, CD players give impressive lab performance, though there are differences between players nonetheless. **Sound quality** variations are even more marked, particularly in a good quality system. As it behaves very like a preamp, there are no problems connecting a player to a normal amplifier

MODEL PRICE	LAB SOUND	COMMENTS	FEATURES	VALUE	BACK ISSUE FULL REVIEW
ADC CD 2000E £330	Good+ Fair+	One of the slimmest players in the business but nothing special inside. Nice ergonomics but overpriced	Remote, timeshared 16 bit		64
Aiwa DX-M45 £149	Fair Fair	Cutdown Philips technology, but results are quite good for this British made machine	Manual	R	64
Aiwa XC-005 £280	Average Average+	Very comprehensively equipped including double digital and audio outputs. The average performance was still sufficient for recommendation at this price	Power vol, edit-dubbing, shuffle 2 digital op	R	76
Aiwa CD-001 £300	Good Good	Pretty close to Recommendation, delivering a respectable sound quality and lab performance from an ergonomically attractive package, but ultimately failed to excel in any particular respect.	Track entry/volume remote, direct recorder connection etc.		58
Aiwa XC-007 £499	Very Good Good	Creditable sound despite inverted output, high tech engineering with very good lab performance. A worthy contender but not cheap	Remote, keypad, timer, digital output, pseudo 20 bit, dual DAC		64
Akai CD 558 £230	Good Average-	Budget model which fails to compare with the CD52	Remote, hdph, Good programming		83
Akai CD-52 £249	Good Good	A nice surprise from Akai, genuinely good sound from this mid-priced model. Better linearity will help further	Remote, digital output, headphone socket	BB	64
Akai CD-62 £330	Fair Very Good	Looks, build quality and the technical specification are right up to date. As it stands it sounds very good but if the indifferent lab performance could be improved, it would probably sound even better.	Remote, programme, hdph, comprehensive display etc	BB	70
Akai CD-73 £450	Good Average	A little uneven musically, the Akai tends to smother fine detail, but has first class dynamics and stereo imagery. Worth auditioning	Track entry keypad remote, menu display (switchable)		62
Akai CD93 £700	Good Very Good	Undoubtedly a CD player of real class in build, presentation, lab performance and sound quality, but also a shade expensive for formal Recommendation – though that's not to dissuade lovers of black lacquer wood finish.	Track entry remote, menu display etc.		58
Arcam Delta Black Box £260	n/a Very Good	This rich, powerful and articulate sounding DAC transforms the majority of medium price CD players	Needs D-out CD players	R	60
Arcam Black Box II £300	Very Good Very Good	An addition to the BB I, it also offers improved sound and more inputs	Optical and wired input digital decoder	BB	76
Arcam Alpha £375	Very Good Very Good	Arcam's new star, its best CD player yet and great value	Remote, hdph, etc, coax dig. out	BB	83
Arcam Delta 70 II £600	Very Good Good	Now in Mk II form a further improvement is seen in features, performance and sound quality. Solidly built and British	Now adds simple remote vol + std features; also display off	R	76
Arcam Delta 170 Transport £600	Very Good Very Good	While no bargain, this is a well made metal boxed transport providing clean digital data for outboard decoder/processors	Transport only, display off, usual programming	R	76
Carver TL 3100 £340	Average Average-	The sound quality did not live up to the excellent fascia. Carver's DTL did not aid the indifferent sound	DTL sound shaping, usual facilities, remote, memory		76
Carver TL-3300 £700	Good+ Poor	Carver needs to listen critically to CD sounds; in our opinion. DTL does not improve the recipe	DTL, remote, programming, digital output		83
conrad johnson DFI £1,995	Average- Good+	Setting a decent standard and including an FET line preamplifier, the unusual DFI is worth investigating	Line preamp built-in, simple remote facilities		76
dbx DX5 £640	Good Poor	Sound quality proved a single disappointment, though it's refreshingly unique in providing semi-pro post-production facilities that some users will undoubtedly relish.	Track entry/volume remote, compression, impact recovery, ambience etc.		58
Deltec PDM-One £500	Average Very Good	A no frills audiophile bitstream converter at an affordable price	Coax-in, special cable and mains filter options	R	83
Denon DCD 620 £180	Average+ Average-	Not competitive on performance though feature pack is good	Hdph + vol, edit, remote		83
Denon DCD820 £270	Average+ Average-	A powerful combination of features and build for the money ensures recommendation. The sound is just good enough	Well equipped, power vol, edit etc, digital out	R	76
Denon DCD 920 £320	Good Average+	Highly featured and well presented but unexceptional performance	Everything! inc remote volume		83
Denon DCD1420 £400	Very Good Average	Superbly equipped with a fine lab performance, this modern player needs a touch more sonic spice to get recommended	20-bit, very comprehensive, remote, power volume etc		76
Denon DCD-1520 £550	Very Good Very Good	High tech, high profile, high gadget content, good sounding player at an almost affordable price	Programme, hdph socket, remote, track entry, optical digital output	R	70
Denon DCD 3520 £1000	Very Good Good+	Built like a battleship this new model takes its place at the top of the Denon range with a smooth and powerful sound, quite free of graininess	Composite 20-bit DACs, full programming features	R	72
Ferguson CD007 £130	Good Fair	The cheapest recommendation in the test group; don't expect the earth but the value is good	Manual, digital output, headphone socket	R	64
Ferguson CD008 £150	Fair Fair	Not as strong as its relatives, sample fault perhaps? Though performance is fair enough overall	Remote, midi digital output, 2x 0/s, timeshare 16 bit		64
Goodmans GCD300 £129	Average Average	It may be adequately made, but with cheap good sounding players available this particular Goodmans isn't quite good enough	Programmable, skip, search, repeat		70
Goodmans GCD530 £140	Good Poor	Old fashioned sound, cheap and cheerful, includes remote	Simple remote, basic controls and programming		83
Goodmans GCD550 £199	Average+ Fair+	A slow autochanger with a weakish lab performance but the sound is fair enough, the features good and the price is low	Remote, 6 disc autochanger, 2x 0/s	BB	64
Goodmans GCD555 £219	Average Average-	Scores approval on grounds of low price. You must pay more for better sound and a faster mechanism	6 disc changer, 32 track memory, remote etc	R	76
Grundig CD9000 £1000	Good Good	Aimed at a market which puts external styling above sound quality. Although this player is of slightly above average competence in most departments it is expensive	Remote, programme, hdph socket, calendar display etc		70
Harmon Kardon HK7300 £199	Average Average-	Budget low bit technology, does not deliver enough for a recommendation	No remote, no digital out, basic control features		83

THE WORLD'S NO 1 GUIDE TO BUYING HI-FI

THE DIRECTORY

CD PLAYERS

MODEL PRICE	LAB SOUND	COMMENTS	FEATURES	VALUE	BACK ISSUE FULL REVIEW
Harmon Kardon HK7500 £299	Average + Average	Decided improvement over 7300 in all respects. Still fairly unimpressive sound	Remote, hdph + vol, remote vol, good programming, A-B repeat etc.		83
JVC XL-Z1010 £499	Good Average—	Despite some high tech design and a good lab result this model did not deliver good sound quality	32 track prog., disp off, auto fade, 2 digital op		76
Kenwood DP-8020 £500	Excellent Very Good	Fine build and finish, a fine performer in the lab, and in sound quality	Comprehensive remote inc volume, display off, opt & coax digital output, versatile	R	83
Marantz CD50SE £330	Very Good Very Good	Souped up CD50 delivers reference performance in its class. Worthy successor to the '65SE legend	Full remote, power (7 step) volume. Hdph, (fixed). FTS disc memory. Good programming	BB	83
Marantz CD60SE £380	Very Good Very Good	Luxury '50SE with superior remote volume and variable headphone socket; a fine performance all round	Optical digital output, full remote, power vol. FTS, hdph	BB	83
Marantz CD12LE £2800	Very Good Excellent	This top of the range two-box player may be very expensive but it is very well made. Technical performance is very good and the sound is the best from Marantz yet	Two box, digital processor, FTS, optical connection, hdph socket, comprehensive display, balanced output etc	R	70
Meridian CD206 £800	Very Good Very Good	Fine build, finish and styling, very good sound, classy	Good programming, remote, coax digital output	R	83
Meridian CD208 £1490	Excellent Excellent	State of the art CD sound combined with a decent preamp and full remote control	Opt & coax dig. output, fixed and variable output. Hdph + remote level. Programming, phase invert	R	83
Micromega CDF1 Classic £1400	n/a Very Good	A very well made and stylish player from France, the CDF1 is a CD player for analogue lovers or as close as we've come across	Basic remote, digital output, suspended chassis	R	72
Micro Seiki CDM100 £3850	Very Good Good	One of the hernia inducing bricks of hi-fi, the Micro is extravagantly styled, finished and built. The good lab performance led to an 'only good' sonic display when the price demanded excellent	Balanced output, remote, display blanking		72
Mission Cyrus PCM II £400	Very Good Good+	Improvements in price and performance keep this classic remote player in the running	Remote vol, phase inv, display of, dig op. PSX option	R	83
NAO 5320 £169	Average— Average—	A low cost player devoid of features but at this low price it should still offer better sound	Budget facilities, 20 track program		76
NAO 5220 £230	Average— Poor	Conforms sonically to a stereotype of the medium that most players have grown out of. Hard, thin and raw sound with poor stereo and resolution.	Time/track display, memory		62
Nakamichi OMS-1E £395	Good Good	This neat enough player doesn't really follow the Nakamichi tradition of providing exceptional sound quality while at the same time perpetuates that of selling at an above average price	Simple remote etc.		58
Nakamichi COP-2E £495	Very Good Good	It's ergonomically superior and has above average sound, but it isn't cheap. The standard of build quality and finish is first class which isn't quite matched by the sound quality	Programming, hdph, remote track entry, digital output		70
Nakamichi OMS-4E £1200	Very Good Very Good	Solidly controlled and comparatively simple this clearly represents one of the major benchmarks for CD sound quality, though the midrange sounded a touch thin	Skip and scan, headphone socket		51
Nakamichi OMS-5EII £1500	Good+ Very Good	"... delivers near state of the art performance and build quality in a deliberately starkly functional package, but at a very high price..."	Skip and scan, simple track programming, manual control		51
Nakamichi OMS-7EII £2000	Good+ Good	The only serious criticism here is of the price. And in our not always humble opinion you can get better sound quality for less elsewhere in Nakamichi's range	10 digit track entry keypad programming, headphones		51
Onkyo DX-1500 £170	Average Fair	Ruled out on the grounds of its poor DAC filter, but it's not so bad really given the price	Manual, 2x 0/s, timeshared 16 bit		64
Onkyo DX-7500 £490	Good Very Good	This comes close to the state of the art performance in many areas. It has lots of facilities and is well made too.	Key pad remote, memory, hdph, comprehensive display, optical output etc	R	70
Philips CD610 £160	Average + Average	Built down to the price the sound is OK while the package performance and features constitute fine value	Remote, hdph, programming etc	BB	76
Philips CD630 £250	Very Good Good	Large clear display with an international flavour. Strong Philips style, high value CD player	FTS, digital op, versatile programming, remote, remote vol (7 steps) hdph (fixed)	R	83
Philips CDC875 £300	Average + Average—	The changer works well and this machine is very well equipped. The sound quality is below par but may not matter too much in its likely 'muzak' application	6 disc changer/dig op remote, hdph, memory, shuffle		76
Philips CD840 £350	Good+ Very Good	Philips best yet and bitstream too! Very versatile programming and easy to Recommend. Fine stereo imaging for price	FTS, hdph + vol, full remote programming	BB	83
Philips CDV185 £350	Average + Average	Hard to value with the video singles facility but it all works well enough for a recommendation	Video singles + CD scart + digital out etc	R	76
Pioneer PD9300 £499	Excellent Average	A mid price flagship of excellent build and lab performance but only average sound – interesting though	Remote, 24 track programming, 2 digital op		76
Pioneer PD-91 £899	Excellent Very Good+	Close to state of the art in nearly all areas – soundstaging, clarity and simple lack of artificiality. A well made and sophisticated player	Track entry remote, calendar display, index search, etc.	R	64
Proton AC-120 £180	Average Average—	Fine styling, low price but barely average performance	15 track memory, simple design, remote, hdph		76
Revox B126 £649	Very Good Good	Made in Switzerland so the build quality and technical performance is high but then so is the price and the sound quality is only good	Programming, Revox remote system compatible		70
Revox B226S £840	Good Average	Top quality build and finish for the Revox system enthusiast. For high value sound look elsewhere	Remote vol, hdph, 19 track memory, digital op		76
Rotel RCD855 £250	Good Good+	Stripped for action this well built Philips technology player delivers fine performance and sound. First rate value	Remote, 20 track prog, 1 audio op, 1 digital op	BB	76
SAE D102 £700	Good Good	Considering the high price of this player, most of the innards seem fairly prosaic. Sound quality and lab performance are both respectable enough, but hardly justify the price premium involved, though styling is unusual.	Remote (inc volume), skip, scan etc.		58
Sansui CD-X711 £550	Excellent Very Good	Luxury features, finish and sound from this classy Sansui; no excuses required here	Balanced and normal op, Digital; opt & coax; hdph + vol, remote full programming	R	83
Sharp DX150 £129	Fair Fair	This is a none oversampled player which is rather outclassed for technical and sonic merit by the vast majority of the competition. Pretty enough but would you want to put discs in it?	Programmable, skip, search, repeat		70
Sharp DX750 £179	Fair Fair	It has a remote control but it's too like the 150 which is rather outclassed for technical and sonic merit by the vast majority of the competition	Remote, programmable, skip, search, repeat		70

TO ORDER BACK ISSUES OF HI-FI CHOICE SEE PAGE 32

THE DIRECTORY

CD PLAYERS

MODEL PRICE	LAB SOUND	COMMENTS	FEATURES	VALUE	BACK ISSUE FULL REVIEW
Shure Ultra D6000 £495	Average+ Fair	Ergonomically well thought out with full function remote control, but not really scoring sonically considering its price	Remote control (full function inc volume)		51
Sonographe S01 (by CJ) £799	Good Very Good	Distinctive with oak end-cheeks, using Philips based 14 bit x 4 oversampling, Conrad Johnson electronics make this a musically rewarding player	Full search programme and timing	R	51/Coll
Sony CDP-M47 £160	Good+ Average-	Clean styling, rock bottom price, near music centre performance	remote, hdph + vol, edit-fader, good programming. No digital op		83
Sony CDP-770 £200	Average Average	Very well equipped player with good ergonomics belying the moderate price. Average overall performance	Remote, remote vol, hdph + vol, edit, fade etc	R	83
Sony CDP-228ESD £400	Very Good Average+	Good value, this is Sony's best mid price design and comes superbly equipped	hdph, remote, rem vol, custom file	R	76
Sony CDP-338ESD £600	Excellent Good	Only a bit better than the 228 the 338 is a good machine, but not quite good enough for formal recommendation at the price	Custom file, remote, rem vol, hdph, shuffle etc, 2 digital op		76
Sony 557ESD £1000	Excellent Good+	Superbly built flagship model that produced excellent lab results and very good sound. Many luxury features though not that good value	Full remote, disc directory, digital output, power volume, 8x 0/s, 18 bit		64
Sony CDP-X7ESD £1300	Good+ Average	A Sony flagship, build and finish is exemplary, styling is unusual but the sound is just average	Custom file, remote, 2 digital op, balanced audio + phonos		76
Sony CDP-R1/DAS-R1 £5000	Very Good Excellent	Sony has aimed high with the R1 and in some ways has created the reference player. Build quality is amazing and it offers a high level of facilities. One or two faults were revealed in both the lab and the listening, but it's generally excellent	Two box, dual optical connection, digital processor, FTS, remote		72
Stax Quattro £2995	Very Good Very Good	Now in mkII guise this substantial player recreated exceptionally strong and convincing bass lines together with a beguilingly musical midband	18-bit DACs, 20-track memory, full IR remote, variable o/p	R	72
Teac PD470LE £279	Average Average	With the LE upgrade the 470 has improved to a just average position	Remote, hdph, 20 track prog		76
Teac ZD880 £450	Good Fair	Decent enough in most respects with a very good build and finish. Its sound isn't competitive enough to inspire any real enthusiasm	Remote, track key access, auto space, comprehensive display, hdph socket etc		70
Technics SL-P227A £160	Very Good Average+	High value, budget priced, yet well equipped and finished, a strong example in its group	Remote, programming, hdph + level. No BB digital op.		83
Technics SL-P550 £220	Very Good Average	Superb, slick presentation, well equipped, average sound, fine build	Remote vol (6 steps) hdph + var, remote programming, edit/fade, digital optical only		83

CD MIDI SYSTEMS

So you want a hi-fi, but you don't want to make a fuss about it. A pre-packaged system with everything matching up and no aggravation may not rank with carefully chosen separates on **sound quality**, but there's no denying the attractiveness or popularity of this approach – the market for pre-packaged component hi-fi systems is at least as big as that for separate items, even ignoring the vast numbers of low-cost single unit stacker systems.

The arrival of compact disc led to a new fashion for shelf-standing compact systems, or 'midis' as

they are known in the trade, as a replacement for earlier floor-standing rack systems (themselves the upmarket development from music centres). Only some 330mm wide, midis can more or less match full-size (430mm) rack components for performance, and are certainly cheaper to make, ship, sell and buy.

Whereas specialist hi-fi is moving steadily towards ultra-simple 'no frills' components, midi systems tend to be sold on a feature count at a price point, usually with little opportunity for

demonstration and comparison. Our test programme includes extensive auditioning and lab testing, while making allowance for the different aspirations of designers and expectations of users. Key features valued highly by customers include system remote control, automatic switching, double 'dubbing' cassette decks, and elaborate equaliser tone controls. And the top end of the market is developing with surround sound audio/video-ready packages.

NAME PRICE	LAB SOUND	COMMENTS	FEATURES	VALUE	BACK ISSUE FULL REVIEW
Aiwa X-D80K £550	Poor Poor	Congested and harsh sound quality, the cassette deck, amp and loudspeakers being well below par. The built-in timer adds some operational flexibility	Auto-reverse, CD synchro record, remote, timer		77
Aiwa X-D100 £1000	Average- Fair	Very fully equipped with wide ranging in and outputs but poor upgradeability. Sound quality is reasonable on the whole	Digital & optical in/outputs, dual auto reverse, disc file CD etc		77
Ferguson HFD28 £300	Poor Poor	Similar to Goodmans 5000 system but with greater power and marginally superior sound	One-piece, semi-remote		77
Goodmans 5500 £320	Poor Poor	It offers the basic features (but no Dolby or magnetic cartridge) and rough and ready sound	One-piece, remote		77
Goodmans 5300CDM £400	Average- Average+	Crisply styled system with gutsy amplifier and sophisticated speakers. CD player works well, other sources are variously mediocre	Combined cassette/tuner/amp, plus T/ t and CD with remote	R	65
Goodmans Maxim-Midi System £520	Average Average+	De-luxe version of 5200 system – very good value for money and readily upgradeable. Sonics rough but OK and speakers good; CD crude	All separates with twin cassette	R	54
Grundig Studio Line 1 £330	Poor Average+ / Poor	Intriguing package with warm, woolly but attractive sound let down by poor attention to detail and suspect cassette deck. Amplifier appears to be inadequately protected	CD/cassette tuner plus preset equaliser		77
Hinari DK200 Disc Deck £300	Poor- Poor-	Confused user interface is matched to inadequate electronics. Poor – and poor value	Single unit, two cassettes, CD, tuner, remote		77
JVC Midi-W900CD £1111	Good Good+	A competent allrounder, with important convenience related features, and powerful linked recording facilities. Less strident speakers would be appreciated	Separates system, equaliser, auto-reverse cassette	R	65
JVC Midi-W91CDM £1111	Good- Average	Very well equipped (viz: multi-disc player, powerful tape related features) with acceptable but rather nondescript sound	Multi-disc player, twin auto-reverse cassette, equaliser		77
Marantz MX493AVCD £549 with LD20 speakers, £449 without	Average Mixed	Good source components (ex cassette) let down by poor amplifier. Flexibility is strong point, and the system may prove attractive where the A/v possibilities can be fully utilised	Twin auto reverse, opt speakers, surround processor etc	R (with LD20)	77
Marantz MX583 £750	Average- Poor	The system has potential in an A/v context, but is patently lacking in a purely audio one. Only the CD excels	Component system with A/v amp, no speakers		65
Marantz MX673CD System £900	Average+ Average	Tremendously flexible audio/visual system. Sound quality is satisfactory at best and ergonomics a mess	Various A/v inputs, remote, speakers optional		54
Pioneer S-11 £510	Average- Average-	Fine lower middle market system, with one useful extra – the built in timer. Only the record deck is disappointing	Twin auto reverse cassette, built in timers, one piece amp/cassette		77
Pioneer S-330D £1080	Very Good Very Good	High standard of reproduction on all sources, though mistracking with Dolby C was a limitation. There are few gimmicks and plenty of fine engineering	Dolby C/hx pro, multi-disc, amp with DAC etc	R	77
Proton AI-3000 £550	Good Good	There are a host of minor problems, including no LW, but the unit is attractively packaged and can be made to sound very good despite a woolly sounding amplifier	One piece CD, cassette, tuner and amp, remote	R	65

THE WORLD'S NO 1 GUIDE TO BUYING HI-FI

THE DIRECTORY

CD MIDI SYSTEMS

NAME PRICE	LAB SOUND	COMMENTS	FEATURES	VALUE	BACK ISSUE FULL REVIEW
Sanyo 39CD £260	Poor Average—	Acceptably compromised basic low end system, offers broadly respectable if unambitious music making for those on a tight budget	One piece + CD, non-remote, manual tuner		77
Sanyo 49CD £300	Poor Average—	Similar to 39CD, but with Dolby B, preset tuning, remote control and more power. Audio wise, it's more of the same, but there's greater stature when loud and cassettes are helped by Dolby B	One piece + CD, partial remote control, digital tuner	R	77
Sanyo 59CD £380	Average— Average—	Adequate performance overall, though endemic lack of pitch integrity takes edge from tape and records. Some inconsistencies in control system too	As 49CD, + full remote, auto source select, separate turntable		77
Sharp CD-X17E £550	Average Average+	Highly specified miniature with detachable speakers. AC mains power only. Good sound let down by crude upper midband and treble. Expensive for what it is	CD luggable with dual cassette & tuner, detachable speakers		77
Sony Compact 301CD £400	Average— Average	Mainly crisp, articulate sound and excellent ergonomics offset by modest FM results and lack of pitch integrity on cassette	Twin unidirectional cassette, equaliser, 30 preset tuner etc		77
Sony 501CD £500	Average Average	Fair all round performance except noisy FM. Ergonomics and visuals good, but no auto source select, tuner stereo defeat	Twin auto-reverse, 3-band tuner, equaliser etc	R	77
Sony Compact 701CD/711CD £700/£800	Average+ Good	Sound quality good all round, though cassette pitch accuracy is below par. Features average but system control is weak	Twin auto-reverse, graphic equaliser (711 only), 30 preset tuner	R (701CD)	77
Technics X900CD £470	Average Average—	Good build and mostly good sound is offset by mediocre amplifier and loudspeaker and some operational oddities	Main cassette/tuner/amp, separate T/t and CD		65
Technics X1 £500	Good Good	Superb value for money from a system with solid straightforward engineering at an attractively low price	Auto-reverse record transport, auto-disc/tape editing, surround sound, remote	BB	77
Technics X5D £800	Very Good Very Good	A mainstream system offering considerable flexibility and power in a traditional suit of clothes, and embodying values that place music first	Twin auto-reverse, tuner/timer, auto record deck, digital amp	R	77
Yamaha AST-C10 £600	Average+ Very Good	Brilliant if flawed luggable with weighty, powerful bass, and a rare combination of expressiveness and clarity unprecedented from such a small package. Good features.	Mains portable twin cassette/CD/radio system detachable speakers, remote	R	77

TUNERS

The radio medium operates at a much lower profile than TV, but in areas outside pop music the BBC service is the envy of the world. Live Prom concerts can rival all other sources from a hi-fi perspective. Only the FM (VHF) bands give stereo hi-fi sound, though AM (MW & LW) are useful for receiving certain transmissions in the UK.

Something of a hi-fi afterthought, tuners are often selected merely to match a chosen amplifier

cosmetically. However, the task they carry out is far from simple (or cheap), combining the skills of RF (reception) and audio (signal processing) engineering. The importance of the former will depend on local reception conditions, but money invested in a high quality outside aerial system is well spent.

Tuners come in two basic types. Analogue models tune gradually (and usually manually) across

the bands, and can have analogue or digital displays; they are often preferred for sound quality, and are certainly best for AM bands. Digital tuners offer convenient automatic tune facilities and hold many station positions in pre-set memories.

(The Lab and Sound results for models tested in issue No. 65 refer to FM only. For AM results see under Comments.)

NAME PRICE	LAB SOUND	COMMENTS	FEATURES	VALUE	BACK ISSUE FULL REVIEW
Akai AT-52L £150	Very Good Very Good	Holds its own on FM against many much more expensive tuners, but AM is very poor	All bands	BB	65
Akai AT-93L £250	Good+ Good+	By AM standards presentable (good) while FM delivers the goods	All bands, aerial switch	R	65
Arcam Alpha £120	Good Average+ +	Attractively classic British analogue tuner with sound quality comfortably better than most	FM/am analogue	BB*	50
Arcam Delta 80 £300	Very Good Very Good	Hi-fi sound on FM, good on AM, a dependable British all-rounder	6AM, 6FM presets. FM/mw. lw display manual tune	BB*	55
Harman Kardon TU920 £299	Good Average	Rather weak sound quality for the price despite good lab test results	16 presets, AM/fm, digital auto scan, active tracking		55
Harman Kardon Citation 23 £559	Good Very Good	Fine performance, interesting features and ease of use are this tuner's forte, and the sound quality is top notch	FM/am seek/manual adjustment muting 16 presets remote control	R	60
Kenwood KT-660L £130	Fairly Good Fairly Good	You get your money's worth of gadgets and the radio's basically sound although programming is complicated. AM - fairly good	Timer, clock, all bands	R	65
Kenwood KT-1100D £300	Good+ Good+	Behind a gaudy and rather useless display the radio is much better than you might first think. AM - good	Firework display. FM/mw bands only	R	65
Linx Theta £400	Good Very Good	A Magnum Dynalab on the cheap with the hallmark styling of this small British newcomer. Some of the best midrange from any tuner	Manual analogue tuning, no presets, signal strength meter	R	72
Magnum Dynalab FT101 £599	Good Very Good	Although expensive for its fairly minimum set of facilities its excellent sound makes up for what it lacks elsewhere	Analogue manual tuning, no presets, signal strength meter	R	72
Marantz ST35L £125	Good+ Average—	It works well enough but the sound could be better for the money	16 presets, AM/fm, digital auto scan, active tracking		55
Meridian 204 £525	Good+ Good	Pleasant sounding with a fine finish but does not make the grade at this price	FM only, auto scan, digital, remote, clock timer		55
Musical Fidelity TI £300	Good+ Very Good	Top class FM stereo sound on good signal strengths from this audiophile model. Watch out for local CB!	FM only, analogue box dial, manual tune, signal meter	R	55
NAD 4020 £139	Good Average+	Not the quietest or most sensitive tuner tested, it still provided good sound for the money, being 'musical and ambient'	Analogue FM/am	BB	50
Naim NAT 01 £1098	Very Good Very Good	There may be better sounding tuners in the world, but we have yet to hear one	No presets. Two box, flywheel tuning FM only, Analogue	R	50
Nakamichi ST-7E £750	Good+ + Good+	Exceptionally good for weak-signal areas, and good all round	16 AM/fm presets, Schotz enhanced sensitivity, auto tune digital		55
Onkyo T9090 II £590	Very Good Very Good	It has most of the facilities you could possibly want and more beside. Lab performance and sound quality are both good enough to ensure recommendation even at this price	FM only, digital, 20 presets, auto scan etc.	R	72
Pioneer F91 £350	Excellent Good+ +	Easy to use, this model has excellent RF performance and scored very high ratings on the listening tests	FM/am 24 presets	R	60

THE WORLD'S NO 1 GUIDE TO BUYING HI-FI

THE DIRECTORY

TUNERS

NAME PRICE	LAB SOUND	COMMENTS	FEATURES	VALUE	BACK ISSUE FULL REVIEW
Proton AT-300 £199	Good Good	The AT-300 is pretty on the outside, orthodox on the inside and rather dear. AM - poor	FM/mw only	R	65
Quad FM4 £289	Very Good Good+	Fine sound, excellent ease of use, good build and finish and a more than satisfactory technical performance	7 presets. Digital	R	50
Revox B260 £918	Excellent Very Good	Sophisticated and expensive, the B260 is ideally suited to the rest of the Revox range and should also work well in other systems	FM - virtually everything	R	60
Rotel RT-830AL £110	Good+ Good	Fine sounding budget audiophile material, no frills, no fuss	Manual dial analogue, FM, MW, LW	BB	55
Rotel RT-850AL £160	Good+ Good+	Scoring well on listening tests and one of the best sounding tuners at its price level, it was a bit let down on AM but RF performance was good	FM/am, digital	BB	50
SAE T-102 £449	Good+ Good+	Expensive for all the radio you get, but sounds interesting. AM - poor	FM/mw only	R	65
Sony ST-S300L/ ST-S100L £140/£100	Good Good	A reasonable entry point, not for difficult areas. AM - poor	All bands	R	65
Sony ST 500ES £200	Good+ + Average-	Disappointing sound quality but good lab performance. (Includes long wave)	10 AM/fm presets, auto scan digital		55
Sony ST-S 700ES £299	Very Good Very Good	First class in every respect including FM sound quality. Even AM was well above average	FM/am, 10 presets, digital scan	BB	60
Yamaha TX-L400 £130	Good+ + Good+	Good FM sound, let down by poor AM but otherwise good value	16 presets, auto scan, digital, FM, MW, LW	BB	55
Yamaha TX-500 £150	Average+ Average	Under a gaudy coat, this sensitive tuner gave reasonable stereo results. However, the AM had again been thrown down a well	20 presets (10 buttons) digital		50

Rating refers to original, tested model

HEADPHONES

There are a variety of different approaches to headphone design, and examples of each turn up in this group. Amongst the more expensive esoteric models, electrostatic drivers are used in square open-backed phones such as the Jecklin and Stax models. The majority of these come with some form of transformer which takes the signal initially from the speaker terminals on the amplifier. The actual speaker cables then travel from this unit *via* a

bypass switch to the loudspeakers.

The more down to earth models feature dynamic drivers in circular open-backed designs. The advantage of open backs seems to be a correspondingly open sound and a less claustrophobic feel to the music. One can also of course hear external noises and irritate people on public transport.

The third category are closed-back designs,

which are useful in situations where it is necessary to block out background noise.

Another means of distinguishing different types is the way they sit on your head or ears. There are three styles: circumaural models enclose the ear and rest on the side of the head; supra-aural designs press on the outer ear (pinna); and intra-aural types rest inside the ear and are popular amongst users of personal stereos.

NAME PRICE	COMFORT SOUND	COMMENTS	TYPE	VALUE	BACK ISSUE FULL REVIEW
Aiwa HP-X30 £30	Good Good-	A flashy personal stereo phone which alternatively could be used at home. A slight LF tonal preference slightly colours the response, but it ain't a bad can.	Supra-aural, closed-back, dynamic		75
Aiwa HP-V99 £50	Good- Average+	Horn loaded in-ear miniatures with plenty of guts but not enough transparency or bass to compete with the headbanded competition	Intra-aural, closed-back, dynamic		75
Aiwa HP-X80 £50	Good Good	A headphone that's highly suited to non acoustic music and portable sources, nicely made and slickly finished. Sound quality doesn't quite match the price	Supra-aural, closed-back, dynamic		75
Aiwa HPEX-200 £90	Good Good	Modern looking and well finished the Excelias, as they are dubbed, had meaty bass and sounded reasonably open for the type	Circumaural, closed-back, dynamic		63
AKG K135 £35	Poor Fair	Despite a very appealing design the K135s don't live up to the usual AKG standards, though they do have the ability to reproduce rhythm well	Supra-aural, semi-open, dynamic		63
AKG K145/S £58	Good+ Good+	Electrostatic tweeters combine with a dynamic mid/bass unit to create very confident sounds in a comfortable headphone. Balance is on the bright side	Supra-aural, semi-open, electrostatic/ dynamic	R	75
AKG K240 Monitor £60	Very Good Good	Something of a classic these AKGs are very user friendly in all respects; sonically on the warm side of neutral	Circumaural, semi-open, dynamic	R	63
AKG K280 Parabolic £110	Good Very Good	A very revealing and unusual twin driver design that uses the same principle as a satellite dish to beam sound into the ear	Circumaural, open-backed, dynamic	R	63
AKG K340 £136	Good Excellent	Heavyweight cans in most respects, the K340 with its electrostatic tweeter is a very revealing headphone. Gives the total electrostatics a good run for their money	Circumaural, closed-back, electrostatic/dynamic	R	75
Audio Technica ATH 909 £55	Average Average	Quite impressive in the treble though a bit bass shy, the 909s worked well at highish levels	Circumaural, semi-open, dynamic		55
Audio Technica ATH 910 £65	Average Good	The closed-back 910s are an improvement on the 909s with a nice rhythmic quality rarely found with headphones	Circumaural, closed-back, dynamic	R	55
Audio Technica ATH-911 £75	Very Good Very Good	Nicely finished dynamic headphones with all the trimmings, plus a very clean and subtle sound	Circumaural, open-backed, dynamic	R	63
Beyer DT 325 £30	Very Good Fair	Lightweight in more ways than one, the 325s may be a little bright for some systems and tastes but will suit duller sources	Supra-aural, open-back, dynamic	R	63
Beyer DT330 Mk II £45	Good Poor	Not the most revealing 'phones encountered, the 330s were nevertheless enjoyable and rarely offended	Circumaural, semi-open, dynamic		55
Beyer DT550 £69	Good Good	On their own the 550s sound articulate with a slightly 'gritty' treble and 'keen' midrange; not suitable for headbangers!	Circumaural, semi-open, dynamic		55
Beyer DT880 £90	Good Good	Well made cans with a warmish sound but fairly solid midrange, though they're not that informative for the price	Circumaural, semi-open, dynamic		63
Beyer DT990 £119	Very Good Very Good	The 990s are definitely a significant pair of dynamic headphones; they have a smooth and yet revealing, neutral sound that is hard to criticise	Circumaural, open-back, dynamic	R	55
Beyer IRS690 £200	Good+ Very Good	High quality infra-red headphones with soft comfy earpads and mellow but informative sound quality which is hard to dislike	Circumaural, open-back, dynamic	R	75
Jecklin Float Model One £79	Good Very Good	Whilst very unusual in appearance the Floats give remarkable sound quality and openness at a reasonable price	Circumaural-ish, open-back, dynamic	BB	55
Jecklin Float Model Two £99	Good Very Good	Helmet shaped and pretty unflattering but open sounding and comfortable in the long term. Note lack of adjustment means you should try before you buy	Circumaural-ish, open-backed, dynamic	R	63
Jecklin Float Electrostatic £399	Good Excellent	One version of the state-of-the-art, these electrostatics have an openness of sound rarely found in the breed, with good dynamic range to boot	Circumaural-ish, open-back, electrostatic	R	55

TO ORDER BACK ISSUES OF HI-FI CHOICE SEE PAGE 32

THE DIRECTORY

HEADPHONES

NAME PRICE	COMFORT SOUND	COMMENTS	TYPE	VALUE	BACK ISSUE FULL REVIEW
JVC HA-D990 £65	Good + Good +	Good looking well made cans that offer good sound quality for the money. Sonic nature is of the easy-going, laid-back variety	Supra-aural, closed-back, dynamic	R	75
Koss TD/60 £20	Good Average	Although they're devoid of channel identification and have a decidedly Stateside approach to sound, these are very listenable phones for the price	Supra-aural, closed-back, dynamic		75
Koss K/6X Plus £30	Fair Poor	'Sixties-style' phones from the good ole US of A, their sonic style is unique and can make a system sound quite different	Supra-aural, closed-backed, dynamic		63
Pioneer SE-72 £30	Good + Average—	Neat, nicely made personal stereo oriented phones along the lines of Sony V3s. Sound is on the veiled side, good for aggressive sources	Supra-aural, closed-back, dynamic		75
Quart Phone 30 £40	Good Fair	Whilst not as seductive as their PMB25 predecessor the 30s are reasonably neutral and do improve on some of the competition – though not stunning	Circumaural, semi-open, dynamic		63
Quart PMB 25II £40	Good Good	Despite a somewhat unconventional suspension system the 25s put in a convincing and enjoyable performance with warm yet lively balance	Circumaural, open-back, dynamic	BB	55
Quart Phone 70 £70	Good Good	Competent performers that were hard to criticise but lacked the life and sparkle of which some of the competition are capable	Circumaural, closed-back, dynamic		63
Quart PMB 65 £70	Good Good	Quite revealing and neutral albeit with the usual closed back sound, this competes well with more established models	Circumaural, closed-back, dynamic	R	55
Quart PMB 85 £90	Fair Very Good	These more expensive Quarts bear a striking resemblance to the Jecklin Float models and use two drivers per ear. Sound is a bit bass heavy but not bad overall	Circumaural, open-backed, dynamic		63
Realistic Pro-X £25	Poor Average—	Robust, unanimously uncomfortable and heavily veiled in sonic terms – not a great success	Supra-aural, closed-back, dynamic		75
Ross RE2530 CD £20	Average Average	Rather an 'average' £20 phone that some found uncomfortable due to high pressure on the ears. Sonic balance is on the bright side	Supra-aural, closed-back, dynamic		75
Ross RE2560 CD £25	Good Average +	If you're not too fussy about quality of finish and don't have an elfin head then these British phones warrant attention. Sound could be smoother	Supra-aural, semi-open, dynamic		75
Ross RE-2760 £35	Poor Fair	Stylish white cans from the only British firm in the business. Unfortunately sound quality is not up to par in this price range	Supra-aural, closed-back, dynamic		63
Sennheiser HD40 £20	Very Good Good—	Very light and comfortable headphones with an even sonic balance that will suit most sources, but jack is 6.3mm and not suited to personals	Supra-aural, semi-open, dynamic	BB	75
Sennheiser HD450 £35	Good Fair	Modern, simple and lightweight phones that are remarkably robust and which turned in a relaxed if weighty performance that was at worst pleasant	Supra-aural, semi-open, dynamic	R	63
Sennheiser HD480 £45	Good Fair	Using the same shell as the 450s, the 480s were a little softened and unrevealing by comparison with their competitors	Supra-aural, semi-open, dynamic		63
Sennheiser HD520 £65	Good + Good +	A very comfortable and musically capable headphone. If you've got this sort of bread to blow on cans, give 'em a blast	Circumaural, semi-open, dynamic	R	75
Sennheiser HD530 £75	Very Good Good +	One of the better dynamics in its group, the 530s create a sense of space that eludes most sub £100 cans, and they're dead comfy to boot	Circumaural, semi-open, dynamic	R	75
Sennheiser HD540 Ref Gold £160	Good Very Good	The 540 Golds prove that dynamic headphones can be subtle, informative and capable of creating a remarkable sense of space	Circumaural, open-back, dynamic	R	55
Sony A21 L £20	Good— Good—	Forward facing in-ear drivers on a folding plastic band provide exceptional clarity for such an inexpensive phone. However, no bass, and fit isn't to everyone's taste.	Intra-aural, semi-open, dynamic	BB	75
Sony MDR V3 £30	Fair Good	Portable stereo oriented phones that are very nicely made and combine clarity with a pleasant lack of distortion	Supra-aural, closed-back, dynamic	BB	63
Sony MDR-V5 £50	Very Good Average +	A nicely made comfortable headphone let down by a limited ability to reproduce music in a natural fashion	Supra-aural, semi-open, dynamic		75
Sony MDR V7 £70	Very Good Very Good	Classy sounding cans that are very slick and work well with all types of music, setting the standard in their price range	Circumaural, closed-back, dynamic	R	63
Sony MDR-CD999 £120	Good + Very Good	A very nice headphone in all respects, the 999s are worthy of the best headphone outputs and high quality sources	Supra-aural, semi-open, dynamic	R	75
Sony MDR-R10 £2500	Excellent Very Good +	Costly state of the art sealed moving coil design built to the highest standards using the finest materials. Sound quality reflects this care, being big, clear, sweet and refined	Circumaural, closed-back, dynamic	R	72
Stax SR34 £140	Fair Very Good	The least expensive Stax headphones around, the SR34s are lively and rhythmic with good tight bass and a sweet midrange	Supra-aural, open-back, electret		55
Stax SR84 £210	Very Good Very Good	The stepping stone between dynamics and full electrostatics, these electret phones are revealing, open and highly enjoyable	Supra-aural, open-backed, electret	R	63
Stax Gamma pro/SRD-X pro £296/£230	Very Good Excellent	The Gamma pros are like a stethoscope for your hi-fi, revealing subtleties that many loudspeakers fail to resolve	Circumaural, open-backed, electrostatic	R	63
Stax SR Gamma £299 (inc. SRD-6 Adaptor at £100)	Very Good Very Good	The next model down the Stax range from the Lambda, the Gamma is an excellent headphone with little to criticise but the price.	Circumaural, open-back, electrostatic	R	55
Stax SR Lambda Pro £545 (inc. SRD-7SB Mk 2 Adaptor at £185)	Very Good Very Good	A bit of an industry reference the Pros are frighteningly revealing, bringing across more information than loudspeakers costing twice as much	Circumaural, open-back, electrostatic	R	55
Stax SR Lambda Pro SRM-1 energiser £360/£635	Very Good Excellent	This combination extracts layers of information that other headphones only hint at. The SRM-1 has more edge than the SRM-T1, but it's good	Circumaural, open-back, electrostatic	R	75
Stax Lambda Signature/SRM-T1 £470/£895	Very Good Excellent	The Signature when combined with the SRM-T1 valve driver must be the most transparent headphone available	Circumaural, open-backed, electrostatic	R	72
Yamaha YHL-006 £30	Average Average	Unusual personal stereo oriented phones that curl up when not in use. Earphones are like golf balls and balance is well suited to Walkmans	Supra-aural, open-back, dynamic		75

TO ORDER BACK ISSUES
OF HI-FI CHOICE SEE PAGE 32

THE DIRECTORY

PERSONAL STEREO

Whilst not exactly hi-fi components, personal stereos probably play more music to more ears than all manner of domestic systems and as such demand some attention. Now that personal CD players have joined the ubiquitous Walkman in the market, the variety and standard of sound quality is huge, with obscurely named cassette players practically falling out of your cornflakes packet and Discmen going for £300.

Despite their diminutive size personals attempt to incorporate as many gimmicks and features as

possible, cassette players often incorporating tuners, graphic equalisers and Dolby noise reduction. CD players are still relatively expensive and don't tend to vary that much on the features front, rather the amount and quality of accessories differs. Most models come with a mains adaptor and some include remote control.

Sound quality on the cassette front seems to have a proportional relationship to price and integrity of construction – wow and flutter being quite obvious on the cheaper models. CD players

become less noisy as they get dearer and also reduce in size; one drawback of the latter seems to be that immunity to shock suffers as a consequence. Cassette players do, on the whole, seem better suited to the outdoor life than their digital counterparts, as does the software. Bear in mind that the sound and lab ratings given below cannot realistically be compared to those in other categories or between cassette and CD personals

PERSONAL CASSETTES

MODEL NAME PRICE	LAB SOUND	COMMENTS	FEATURES	VALUE	BACK ISSUE FULL REVIEW
Aiwa HS-PL300 £110	N/a Average	Good looking, simply laid out player with a sensible selection of features and reasonable sound quality for a small player of this price	Dolby NR, chrome/metal eq, remote		78
Aiwa HS-PX303 £150	N/a Good	Chunky and macho styling combines with comprehensive features and a half decent transport to make a powerful personal	Dolby B & C, chrome/metal eq, remote	R	78
Panasonic RQ-P505 £100	N/a Poor	Very attractive and neat little player with nicely designed controls and XBS bass boost, but sonically it's limited by distinct wow and flutter	Dolby, chrome/metal eq, remote		78
Panasonic RQ-P525 £120	N/a Average+	Fitted with what is effectively a bass only tone control and harbouring all the necessary features the 525 also has a knack with tape replay	Dolby B & C, chrome/metal eq, remote	R	78
Philips D6658 £30	Very Poor Poor	The low price limits sound quality, and this is not a spectacular machine, but it does a reasonable job nonetheless	Graphic EQ, AM/fm		56
Saisho PS90R £40	Poor Poor	A bit of a jumble of features and gadgets, the PS90R has on-board speakers, an extending aerial and even records, but sound quality is dubious	Graphic EQ, types I, II & IV, AM/fm, recorder		56
Sharp JC-270E £130	N/a Average-	Slightly old fashioned design combines with a basic feature count and mediocre sound quality to make an apparently uncompetitive player	Dolby, chrome/metal eq, remote		78
Sony WM-BF65 £90	N/a Average+	Regular size radio/clock/cassette player with a bright even open balance and Sony's forward facing phones. Not as glamorous as slightly more expensive models but sonically not bad	Dolby, chrome/metal eq, radio, alarm clock	R	78
Sony WM-701C £150	N/a Good-	Beautiful little machine with all the necessary buttons n' switches and a fundamentally exceptional sound quality, marred unfortunately by wow and flutter	Dolby B & C, chrome/metal eq, remote, folding phones		78
Sony Walkman Pro £249-£289	Good+ Very Good	One of the finest sounding cassette decks on the market today. A mandatory Best Buy, it takes other personals to the cleaners (except on weight and power consumption)	Dolby B, C, types I, II & IV, record, line in/out, varispeed	BB	52/56
Toshiba KT-4549 £80	N/a Poor	Fully equipped with 10 preset radio and alarm clock the KT-4549 is a bit aggressive on the sonic side and the bass boost system lacks balls	Dolby, chrome/metal eq, radio, alarm clock		78

PERSONAL CDs

MODEL NAME PRICE	LAB SOUND	COMMENTS	FEATURES	VALUE	BACK ISSUE FULL REVIEW
Goodmans GCD-10 £120	Average- Poor	Cheap, flashy and not short on accessories the GCD-10 is a rather noisy player that left a lot to be desired on the sound quality front	13.5 x 3.7 x 18cm, 478g, mains adaptor		66
Kenwood DPC-77 £270	Good+ Very Good	Very chunky and well made, the DPC-77 is the only player to include a digital output and sounds very good through its analogue output – a suitable domestic alternative	12.8 x 3.5 x 14.5cm, 750g, digital output, mains & in-car adaptors	R	66
Philips D6800 £130	Average Average-	A competitively priced and reasonably attractive looking player whose sonic performance is somewhat marred by a rather grainy top end	13 x 4 x 17.5cm, 516g, 3" ready, twin hdph sockets		66
Sanyo CP-12 £260	Fair Good+	Sonically amongst the more enjoyable personal CD players and capable of revealing the musical aspects of a disc in an interesting and entertaining fashion	12.5 x 2 x 12.7cm, 380g, wired remote, mains adaptor	R	66
Sony D-20 £150	Average+ Fair	Not bad for a machine at this price, it's nicely designed and reasonably robust, with reasonable sound quality	13.8 x 3.8 x 15cm, 450g, mains adaptor	R	66
Sony D-88 £300	Average- Fair+	A stylish and 'cultish' object, the D-88 is very small and has an adjustable disc drive for three and five inch discs. Sound quality doesn't quite match appearance	9.4 x 3 x 9.8cm, 300g, 3" ready, mains adaptor, no line out		66
Sony D-150 £300	Fair+ Very Good	One of the most enjoyable machines encountered, sounding informative and sweet and looking very tasty to boot. Comes complete with a tough carrying case	12.6 x 2.1 x 13.5cm, 420g, 3" ready, mains adaptor	R	66

HI-FI CHOICE

SUBSCRIPTION
PRICE – ONLY

£19.95!

SUBSCRIPTION HOTLINE: 071-580 8908

THE DIRECTORY

CD PORTABLES

CD Portables or Yuppie Blasters as we classified them are basically portable stereos gone digital, ie a compact disc player is included alongside the usual AM/fm radio and single or double cassette deck. Compact disc is a novelty that seems to add a fairly hefty premium onto the price of the standard ghetto blaster, but the improved sound quality over standard cassettes may justify this for some. In virtually every case a CD output socket is

fitted which means that it's possible to play silver discs through a domestic amplifier and loudspeakers, thus they are some sort of substitute for standalone mains machines (as are the personal CD players). One drawback with having a CD player on board is that batteries are gobbled up even quicker than usual, up to ten batteries being required in some cases. Neither are the units particularly light, the heaviest weighing eight kilos!

However they do all run off the mains too, and come with an appropriate lead for this purpose. Other useful features common to most are spare input sockets to record from an external line source such as a preamplified vinyl disc signal, and microphone sockets for recording live events (although the usual lack of record level adjustment is a nuisance).

MODEL PRICE	SOUND	COMMENTS	FEATURES	VALUE	BACK ISSUE FULL REVIEW
Aiwa CSD-XL25 £150	Poor	It's cheap, cheerful and not too low on features but sound quality from disc is frankly uninspiring	Twin headphone sockets		73
Bose Acoustic Wave £750	Very Good	Not exactly a CD portable as it doesn't play discs, but a highly versatile and stylish radio cassette player that has bass	Input sockets, Dolby NR, PA capable etc	R	73
Grundig RR9000CD £300	Average	Relatively slick machine with full CD function and volume remote control, low on features for price and unspectacular sounding	Remote, motorised volume pot, condenser mic		73
Philips AZ8394 £200	Average—	Stylish in a wasp like fashion, unfortunately the disc playing lets it down somewhat but otherwise it's OK	Twin decks, graphic eq., bass boost, condenser mic		73
Sharp QT-CD43 £280	Average	Quite a beefy box that comes complete with remote control for volume and CD functions. It even has a surround sound option which enhances imaging	Clock, speaker outputs, powered volume pot		73
Sony CFD-D73 £280	Good	The model we received was intended for the Japanese market and thus may not be entirely representative but it made reasonable sounds and has novel features	UHF bandwidth, input sockets, graphic eq., Megabass	R	73
Sony CFD-DW83 £300	Average	A macho looking beast capable of highish levels, but unimpressive sound for the price. Nice styling and good for scratching	Clock, timer, balance, input sockets, graphic eq.		73
Toshiba RT-8089 £200	Poor +	Square and long but rather drab on the sound quality front, as well equipped as most but rather tinny in many respects	Clock, twin decks		73

STANDS AND SUPPORTS

It's becoming more and more apparent that all the components in a hi-fi system benefit from being placed on the right kind of support. It is already acknowledged that performance of electro-mechanical transducers, such as turntables and loudspeakers, can be greatly improved by using highly rigid supports. This notion has been expanded to include electronics such as amplifiers and compact disc players, and inevitably a broad range of stands and supports have been produced to cater for this requirement.

With loudspeaker stands there seems to be two

broad schools of design. The most common is the open frame type which uses square section steel tubing (usually less than an inch square) made up to form a tripod or quadropod stand usually fitted with spikes top and bottom to ensure good coupling to both floor and cabinet. However, for reasons of domestic harmony this latter option is often not pursued as eagerly as perhaps it should be. The alternative approach is to use mass. Larger section (approximately 3 inch x 2 inch) tubing is welded between square top and bottom plates and filled with sand and/or lead shot. Again, this type uses

spikes at the base but Blu-tack or the like for coupling with the speaker cabinet.

Equipment supports generally place isolation quite high on the list of priorities and usually use a lightweight steel frame to support an MDF platform. Once again spikes are used to minimise contact with the platform and ensure good coupling to the floor. Minimising weight without compromising rigidity seems to be the aim with turntable supports but those designed for electronics often employ some form of damping to kill vibration, sometimes in the form of mass.

LOUDSPEAKER STANDS

MODEL PRICE	TYPE FINISH	COMMENTS	TOP PLATE SIZE HEIGHT	VALUE	BACK ISSUE FULL REVIEW
Appolo A820 £44	4 leg Fair	A light open-framed budget design slightly lacking in rigidity and subjectively superceded by other stands costing £10 more.	19 x 19cm 53cm		58
Appolo A10 £52.50	4 leg Fair	A robust and lightweight model, it would make an ideal upgrade for those still happy with the big boxes of old	19 x 19cm 44cm	R	58
Audio Dimensions Classic 2 £110	4 leg Average	Built in the heavyweight tradition and damped with chalk. Solid, stable, tactile sound	20.3 x 20.3 x 52cm	R	83 supp.
Foundation Fred £70	2 leg Average	With sand filling the Freds made speakers sound tight and coherent with a more even balance.	19 x 19cm 36/43/59cm		58
Foundation Sir Fred £80	2 leg Good	Upgraded 'Fred' with special in-fills. Sweet sound but one that also lacks bite and edge	19 x 19 x 46.5cm		83 supp
Foundation Maggi £159 to order	Pair Very Good	Made for Magneplanar and other similar panel speakers they seem to have a healthy effect on the sound quality thereof.	50 x 2cm 2cm	R	58
Foundation Pi £269 to order	2 leg Very Good	Overpriced in material terms the Pi nevertheless has a very positive effect on the low frequency performance of conventional speakers.	20 x 20cm 25/38/46/53cm	R	58
Goldring Black Satin £65	1 leg Very Good	Screw together stand tastefully hewn from medite. Some loss of bass but still pleasantly rhythmic	18 x 20 x 46cm	R	83 supp
Heybrook Point 5 £55	3 leg Very Good	An unusual triangulated open frame stand that can help certain speakers sound more transparent and fluent — a good value stand	23 x 21.5cm 47cm	BB	58
Heybrook HBS1 £99	4 leg Very Good	With its new aluminium base frame the HBS1 fared very well in the listening tests. It allowed much of the speakers own 'sound' to remain intact.	23 x 21cm 47cm	R	58
Linn Kan II £79	4 leg Very Good	Built to support Linn's Kan speaker this stand is well suited to the task, but is less successful with other loudspeakers.	19 x 16cm 59cm		58
Linn Sara £85	4 leg Very Good	The Sara exhibits some odd properties so its use other than with the Sara loudspeaker should be viewed with caution	25 x 21cm 53cm		58
Monotrak Engineering M1 £58	1 leg Good	The M1 gave the mid and treble a commendably smooth and detailed presentation but bass sounded rather lacklustre and muddy.	19 x 18.5cm 48cm		58
Monotrak Engineering M4 £58	4 leg Very Good	Begging comparison with Heybrook's HBS1 the M4 maintained much of the openness and forthright detail of that model.	23 x 21.5cm 53cm	R	58
Monotrak Engineering M4S £58	4 leg Very Good	Its stature and stability would seem to mark it out as most suitable for smaller, lighter cabinets. The M4S possessed an open midband and clear treble.	20 x 17.5cm 53cm		58
Origin Live Three Leg £89	3 leg Good	An unusual tripod stand devoid of top plate and taking up more floor space than normal, subjective and technical performance was exemplary.	(support area) 22 x 17.5cm 52cm	R*	58
Origin Live Advanced £145	3 leg Good	One of three related tripod-like stands. Stable sound with good sense of depth and power	22 x 20.6 x 44cm		83 supp

THE WORLD'S NO 1 GUIDE TO BUYING HI-FI

THE DIRECTORY

LOUDSPEAKER STANDS

MODEL PRICE	TYPE FINISH	COMMENTS	TOP PLATE SIZE HEIGHT	VALUE	BACK ISSUE FULL REVIEW
Partington PP4 £60	1 leg Good	The PP4 offers a rather mixed performance, though when damped with sand infill it was less ready to embellish the overall sound and low frequencies became tauter and quicker.	18 x 16.5cm 48cm		58
QED TS22 Tristand £60	3 leg Very Good	Most tracks sounded uplifted or buoyant, never thick nor coloured. It worked well with most of the speakers tried and encouraged a fluid and revealing midband.	19 x 17cm 45/50/58cm	BB	58
Stand Design Z20 £70	1 leg Excellent	Well built and finished with optional sand in-fill. Ideally suited to Wharfedale 505.2's	16.5 x 19 x 50cm	R	83 supp.
Target T-40 £48	2 leg Very Good	Not very stable, tends to infer a slightly forward, ragged sound with diluted pitch	19 x 19 x 40cm		83 supp.
Target HS20 £60	1 leg Excellent	This monopod stand can be used either filled or unfilled and encourages different characteristics in the sound accordingly.	19 x 16.5cm 53cm		58
Target HJ15/3 £100	3 leg Very Good	Sound quality was basically very good though without the sand infill some loudspeakers may sound a little unbalanced as both bass and treble regions are subjectively exaggerated.	28 x 28cm 40cm	R	58

EQUIPMENT SUPPORTS

MODEL PRICE	TYPE FINISH	COMMENTS	SIZE (H x W x D)	VALUE	BACK ISSUE FULL REVIEW
Alphason New Concept £99	Rack Good	A heavyweight structure with stressed MDF shelves, ideally suited to the Sonata turntable	82 x 60 x 39.5cm	R	83
Audioquest Sorbothane Feet £40 for four	Feet Good	These large gumdrops are very useful for damping vibrations in amplifiers and especially CD players.	6.5 x 2.5cm (circular)	R	57
Cornflake TCS6 £60	Shelf Good	A squat and rigid frame supports a Medite top board with four adjustable spikes, better suited to suspended sub-chassis turntables.	43 x 23 x 33cm		57
Foundation Stable Table £100 (with Super Board)	Table Good	Similar to Stand Design's table though less well finished and certainly less stable	64 x 46.5 x 36cm		83
Origin Live Skyline Super £100	Table Good	An asymmetric table that helps provide a quick, lucid and solid sound with most decks	41 x 50 x 40cm	R	83
Roksan Equipment Table £169	Rack Good	An upgradable/expandable system suited to Roksan's Xerxes if not other competing turntables	65 x 52 x 38cm		83
Sound Organisation Table £55	Table Very Good	A deceptively simple structure that just happens to be engineered in a thoughtful, and ultimately successful manner.	37 x 45 x 35cm	BB	57
Sound Organisation Wall Stand £40	Shelf Very Good	The first of its ilk and still amongst the best, this simple framework represents a vast improvement over standard furniture shelves.	27.5 x 43 x 35cm	BB	57
Sound Organisation ZD22 £97	Table Excellent	A small but costly table made from thin steel tubing. Suited to the LP12 but not other decks	49 x 45.5 x 36cm		83
Stand Design Duplex £75	Table Very Good	Well made and nicely finished, this table is broadly compatible with most heavy turntables	63.5 x 46.5 x 36cm	R	83
Target TT1 £46	Shelf Excellent	This rigidly braced shelf offers both good sound quality and material value for money	26 x 46.5 x 35.5cm	BB	57
Target TT2 £55	Table Very Good	Standing up to the best in most areas, the TT2's only real fable concerns a slight loss of bass 'stam'.	52 x 46.5 x 35.5cm	BB	57

* rating refers to original tested model

CABLES AND CONNECTIONS

Although cables and connections are sometimes thought to be the least important items in an audio system there has been a growing awareness in recent years that they have a significant effect on sound quality. To this end there is now a vast array of exotic cables and interconnects available to those interested in experimentation. The key observation on cables is that they are much more than mere accessories. Carrying the audio signal, just as any amplifier does, it's really not too surprising that they can influence sound quality.

The characteristics of any cable are determined by the materials and topologies utilised in its construction. The purity of the conductor, nature of the insulator dielectric, mechanical construction, physical geometry, RF characteristics, efficiency of screening and finally the connectors themselves, all play vital roles in the sonic character. These factors tend to vary more with interconnect cables which are used to carry the signal between active components like pre and power amplifiers. The interconnects summarised here were tested in 1m

terminated lengths and therefore the results and prices relate to that length - some cables may well perform differently when used in longer lengths. What's more most cables are significantly cheaper if you are prepared to fit plugs yourself.

The features column contains information on the material make-up of the different cables with the following abbreviations: OFC - oxygen free copper, OFHC - oxygen free high conductivity (Audionote define the HC as high crystal), PC-OCC - pure copper by ohno continuous casting, LC-OFC - linear crystal oxygen free copper.

INTERCONNECT CABLES

MODEL PRICE (per metre)	LAB SOUND	COMMENTS	FEATURES	VALUE	BACK ISSUE FULL REVIEW
Audioquest Livewire Topaz £35	Good Fair	Sounding 'bigger' and faintly richer than Reference 2, Topaz was also slightly grainy at the top end.	Gold-plated plugs, OFHC copper		59
Audioquest Livewire Ruby £49	Fair Good	Smoother sounding than the Topaz, the extended crystal Ruby is less grainy and coarse, better able to resolve complex passages.	FCL copper twin axial	R	59
Audio Technica AT6115 £40	Very Good Fair	This cable sounds somewhat 'quieter' than the original LC-OFC interconnect, but is also less transparent and three dimensional.	PC-OCC copper coaxial		59
Audionote Copper ANC £44	Fair Good	ANC sounded punchy with a faintly lean but tightly-focused bass character. This crystalline precision waned slightly at higher frequencies	OFHC copper twin-axial	R	59
Audionote Flexible Silver ANS £99	Fair Very Good	ANS scored a hit with its transparent midband and revealing but quite unforced treble quality. Bass transients were slightly softened.	Silver signal & Copper screen	R	59
Audionote Silver ANV £154	Poor Excellent	Far weightier-sounding than the flexible ANS, ANV interconnect also possesses a fair degree of treble clarity and sparkle.	21 strand silver Litz		59
Budget Patch Cords see text	Fair Poor	As thrown in gratis with cassette decks and the like - frequency extremes were restricted and performances were veiled.	Thin coaxial		59
Budget OFC circa £7	Fair Fair	Subjectively, this cable did lift much of the aural fog experienced with scrawny standard hook-up leads	OFC		59
Chord Mono-t £27/1.2m	Average+ Average+	Offers a slightly rolled-off treble but its rich sound is an upgrade from patch-cords	Unsymmetrical 4-conductor cable		83 supp

TO ORDER BACK ISSUES OF HI-FI CHOICE SEE PAGE 32

THE DIRECTORY

INTERCONNECT CABLES

MODEL PRICE (per metre)	LAB SOUND	COMMENTS	FEATURES	VALUE	BACK ISSUE FULL REVIEW
Deltec Slink £32	Good Very Good	Ideally used in lengths of under 4 metres, it errs on the lean side of neutral but has an uncommon transparency in the midrange.	4 silver plated OFC strands PTFE dielectric	BB	59
Deltec Black Slink £152	Excellent Excellent	Inherently neutral the cable faithfully reproduced broad and deep stereo soundstages with precise focus and a sense of tactility.	8 silver plated OFC strands PTFE dielectric	R	59
Deltec Gortex Black Slink £152	Very Good Excellent	A true reference quality cable providing an exceptionally detailed and transparent sound	Symmetrical, 8-conductors, Gore-tex ins	R	83 supp.
Denon LC-OFC N/a separately	Very Good Fair	Supplied with Denon's dearer CD players this cable introduced a peculiar 'twangy' coloration at high frequencies, and a slightly soft bass.	LC-OFC, non-magnetic gold plated plugs		59
DNM Solid-core £23	Fair Good	Transparent in the midband and full of sparkling detail in the treble, low bass was slightly curtailed (unterminated price £2.30 per m.)	Single strand nickel-plated copper. Unshielded	R	59
Isoda Electric HC-05-PSR £54	Good Good	A pleasantly lively and fluid sounding cable though softens some subtle, midband detail	Aluminium + brass multistrand cable	R	83 supp.
Kimber Kable PSB £41.40	Very Good Very Good	An exceedingly transparent midband but slightly 'clanky' treble. It always managed to sound remarkably uncluttered and open.	OFC, PTFE dielectric	BB	59
Kimber Kable KC-1 £65.55	Very Good Fair	Tonally faintly leaner and brighter than the more open-weave PSB, KC-1's treble detail was just too sharp and grainy.	Multi-gauge PTFE dielectric		59
Kimber Kable KC-AG £390	Good Very Good	Treble detail resolution was perceived in a slightly abrupt if wholly controlled fashion. Depth re-creation and lateral separation were excellent.	Multi-gauge silver, PTFE dielectric	R	59
Monster Interlink 300 £22	Average + Average	A big, larger-than-life sound but with some emphasis of midband detail and loss of bass	Screened, symmetrical cable		83 supp.
Monster Interlink 400 £32	Good Good	Bass is solid and punchy, counterpointed by a slightly overblown midband which tends to make vocalists sound larger-than-life.	Multi-gauge	R	59
Origin Live Soli-Core Super £60	Good Fair	Improves over previous Soli-core samples in stereo depth and bass weight, but a 'loud' treble presentation remains.	Solid-core gold-plated AT plugs		59
QED Incon P1-Gold £15.95	Good Good	A lively open presentation that just borders on the lean side of neutral, the quick and lucid delivery affording considerable musical insight	OFHC, gold plated Deltron plugs	BB	59
QED Incon Graphite GP1 Gold £18.95	Fair Fair	A shielded version of Incon P1, it sounded thicker at the frequency extremes, the top end being coarser and more out of focus. Good for long runs though.	OFHC Graphite shielding	R	59
Sterling £250	Fair Good	Possessing a neutral if faintly rich overall balance it supplies a pleasantly open and transparent perspective. (Reviewed in pre-production form.)	2 silver strands per conductor		59
Supra EFF-1 £60/0.75m	Average Average	A new, costly and mildly disappointing addition to the range. Edgy, smeared sound	Screened, symmetrical dir. cable		83 supp.
Thorens SAC 100 £50	Good Fair	Performance is undermined by a slightly coarse and splashy treble, not necessarily bright, simply rather confused – and fine detail lacks resolution.	Silver-plated OFC, coaxial		59
van den Hul MC-D300II £45	Poor Good	It tended to highlight some upper mid detail, but a generally open and spacious acoustic proved its saving grace. Slightly soft at LF.	Silver plated single strand VdH plugs	R	59
van den Hul MCD-1021II £69	Good Good	Possessing the same endearing qualities as the D300 it presented open and transparent soundstages and improved timbral resolution	Twin axial silver plated copper	R*	59
van den Hul Thunderline £150	Good Fair	Thunderline essentially parallels the sonic performance of the cheaper D102. HF is occasionally tainted by a 'tizzy' 'coarseness', bass is tight and dry.	Silver plated 'matched copper'		59
van den Hul MC-Gold £250	Fair Good	It possesses a rich and beguiling treble balance that matches a weighty, slightly warm bass character. Seductive balance may prove worthwhile in some circumstances.	Silver & gold plated copper		59
van den Hul MC-Silver £750	Good Good	Although remarkably transparent for an asymmetric design this costly cable was not considered to be of 'state-of-the-art' standard, and is bettered by cheaper models.	19 silver plated copper strands		59
Vecteur 8045 £49	Very Good Good	Sounding solid and forthright it might seem slightly cold in some systems but the treble 'edge' is mercifully clean. Very low frequencies were a little lacking in 'slam'.	LC-OFC signal & screen	R	59
Yfere LC-OFC Quad £85	Very Good Very Good	New cable with a very refined sound. Very transparent with good sense of focus and space	Symmetrical, star-quad with screening	R	83 supp.

LOUDSPEAKER CABLES

MODEL PRICE	LAB SOUND	COMMENTS	FEATURES	VALUE	BACK ISSUE FULL REVIEW
Absolute Wire Force 4 £4.75 per metre	Good Fair +	By current standards there was a loss of fine, sharp detail at the frequency extremes, but it has a big and friendly sound	744 OFC strands, PVC dielectric		64
Audio Innovations OR-200 £16 per metre	Fair + Fair +	Open and detailed throughout the midband but a grainy coloration tended to corrupt subtle timbral information at very high frequencies	200 LC strands, polyurethane and cotton dielectric		64
Audionote AN-SP £100 per metre	Average – Excellent	A clean and open sounding cable that offered a deep and pleasantly detailed perspective. Bass was slightly restricted, but seemed tight and coherent nonetheless	15 silver strands, polyethylene dielectric		64
Audioquest Livewire Black £15 per metre	Good Good	It proved clear and punchy but with some grain across the treble. Nevertheless Black remains an interesting concept and proved better than Livewire Green	OFHC, surface only – foam core construction	R	64
Audiospec Latitude L4 £3 per metre	Average + Average +	Warm, ruddy but also mildly muddy sound with some slight emphasis of bass notes	Figure-of-eight multi-strand, PVC dielectric	R	83 supp.
Audio Technica AT6120 £10 per metre	Fair + Fair	Compared to earlier LC-OFC cables this PC-OCC derivative sounded smoother and less aggressive	PC-OCC, PVC dielectric		64
Bellwire 12p per metre	Poor Average –	Broadly speaking it delivered a bright and tizzy sounding treble with a fairly open and detailed mid with little or no bass resolution	0.5mm single strand, PVC dielectric		64
Deltec 8S £144 – 5m pair	Good Good +	The unerring transparency and detail resolution of 8S throughout the midband makes it a far cleaner and more spacious sounding cable than others at the price	4 silver plated OF copper strands, PTFE	R	64
Deltec Gortex Black 16 £528 – 4.5m pair	Very Good Excellent	Improvements in bass resolution, transparency and treble pure maintains status of this cable	Silver-plated OF copper with Gore-tex ins.	R	83 supp.
Deltec Black Sixteen £648 – 4.5m pair	Very Good Excellent	Bass was deep and rhythmically secure, the mid tonally pure and free of additional sibilance while the treble was both relaxed, sweet and highly detailed	16 silver plated OF copper strands, PTFE dielectric	R	64
DNM Solid core £3 per metre	Average Fair	A good general-purpose solid-core, though too bandwidth limited for high-end applications. Sounds great in some systems	0.65mm single strand, webbed PVC dielectric	R	64
Exposure £2.50 per metre	Good Good	It could sound a trifle matter of fact but this emotive flattening was also somewhat dependent on the music program. It is also highly suited to long runs	56 OFC strands, webbed PVC dielectric	R	64
Furukawa FS-2F09 £6 per metre	Good Average +	Some loss of bass weight but otherwise offers a fresh and open sound. Good value	Multi PC-OCC stranding, PVC dielectric	R	83 supp.

THE WORLD'S NO 1 GUIDE TO BUYING HI-FI

THE DIRECTORY

LOUDSPEAKER CABLES

MODEL PRICE	LAB SOUND	COMMENTS	FEATURES	VALUE	BACK ISSUE FULL REVIEW
Furukawa FS-2T15S £50 per metre	Good+ Very Good	An advanced solid-core cable with a highly fluid, detailed and inherently musical sound	Single 1.5mm Super PC-OCC strands	R	83 supp.
Kimber 4VS £7.15 per metre	Average+ Average	Similar construction to 4TC but dissimilar materials infer a slightly tizzy sound	Open-weave, multi-strand with PVC ins.		83 supp.
Kimber Kable 4PR £54 - 5m pair	Fair Fair+	This directionally marked cable benefitted from an open and airy treble quality but seemed notably leaner than 4TC. Bass was well round and satisfyingly taut	4 x 7 copper strands per conductor, PVC dielectric		64
Kimber Kable 4TC £17.65 per metre	Good Good+	4TC made a great impression in the listening tests with an open midband, a smooth and unfatiguing treble with slightly rich but suitably weighty bass	OF copper, PTFE dielectric	R	64
Linn K20 £2.20 per metre	Good Fair	Subjectively it erred on the forward and bright side of neutral but enjoyed an essentially clear and punchy delivery	56 OFC strands, webbed PVC dielectric		64
Marantz ML-55S £30 - 10m	Fair Fair	Subjectively this cable offered a loose and splashy treble which, though not overtly bright, did compromise both tonal and timbral accuracy	30 OFC strands, 3 conductors PVC dielectric		64
Mission Cyrus £2.50 per metre	Average+ Good	Because of its impedance characteristic this cable will deliver a smooth and unfatiguing treble balance with loudspeakers offering an easy load	0.8mm single strand, PVC dielectric	BB	64
Monitor PC Silverline PC4 £5.75 per metre	Good Average	Sonically it laboured under a heavy and claustrophobic balance, lacking the see through transparency and lucidity of the better solid core cables	2072 x 0.07mm silver plated copper strands		64
Monster SCI 16-4 £2.50 per metre	Average Average	Not as thick-sounding as early Monster cables but still slightly unbalanced. Versatile construction	4 x 16-gauge conductors, OF copper strands		83 supp
Monster Original £4 per metre	Good Fair+	Original sounded relatively congested and murky at higher frequencies but possessed weight and conviction in the bass	Multistrand		64
NVA LSI £6 per metre	Average+ Good	A light and breezy sounding cable best suited to short lengths, NVA benefitted from a clear and transparent outlook	7 x 0.25mm silver alloy strands, PTFE	R	64
Origin Live Soli-Core Ordinary £1.80 per metre	Good Fair+	Subjectively it bettered the performance of the costlier Super version, affording a pleasantly detailed and spacious soundstage with firm bass but slightly coarse treble	1.8mm and 0.5mm single strands	R	64
QED 79-Strand £1 per metre	Good Fair	For much of the last decade QED 79-Strand has been the first port of call for enthusiasts on the upgrading ladder, a tradition that should still hold true today	79 strand, PVC dielectric	R	64
QED Incon Graphite £2 per metre	Fair+ Fair+	This graphite version of Incon sounded cruder and generally more heavy handed than the cheaper unshielded type. Overall presentation was mildly restricted and cloaked in a faint aural fog	OFHC, polymeric screen		64
QED Flat 200 £2.20 per metre	Good Good	I detected a degree of confusion at low frequencies but this did not stifle the acoustic atmosphere which remained open and positive	200 strands, flat webbed PVC dielectric	R	64
Rotel Supra 4 £2.57 per metre	Good+ Good	Ideal for both long and short runs, it furnishes a big sound that benefits further from a smooth, unfatiguing treble	1,036 OFC strands, webbed PVC dielectric	R*	64
Rotel Supra 10 £6.91 per metre	Good+ Good	Supra 10 provided a very free and open sound that was unhindered by any excess at low frequencies. Worth its weight in scrap copper!	2,562 OFC strands, webbed PVC dielectric	R*	64
Sony RK-55ES £60 - 5m	Fair+ Fair+	The sound of this cable was also somewhat controlled and over damped. The treble was relatively free and airy but lower octaves, including the midband, were constrained	350 x 0.08mm OFC strands, heat shrink dielectric		64
Solid core mains cable 36p per metre	Fair+ Good	It enjoys much of the smooth treble and articulate midrange usually associated with the better solid core derivatives. Lean but taut and rhythmically coherent	1.5mm square, 3 cores, PVC dielectric	BB	64
Sterling £99 per metre	Fair Fair	This pre-production sample possessed a strangely muddled and reserved sound quality. It suffered from a progressive instrument modulation	Pure Silver, PTFE dielectric		64
Townshend Isolda £400 - 5m pair	Fair+ Good	Isolda possessed a truly dark background out of which rose a very solid and extended bass together with an excellent sense of transparency through the upper octaves	8 coax cables per conductor - very thick	R	64
van den Hul CS-122 £5.95 per metre	Fair+ Good-	Characterised by a driving and powerful bass, CS-122 proved to be a heavy sounding cable. Mid treble detail was refreshingly clear but there was a slightly muted air about the extreme treble	19 x 0.45mm silver plated strands, webbed rubberised dielectric	R	64
van den Hul CS-352 £12.95 per metre	Good Fair+	Subjectively it sounded like CS-122 only more so, the deep rumbling bass tending to overwhelm subtle musical details. It also appeared a trifle peaky in the treble	7 x 0.76mm + 168 x 0.125mm silver plated strands, rubberised dielectric		64
van den Hul SCS-12 £29.95 per linear metre	Good+ Good+	SCS-12 set a high standard with a tight and well focused soundstage populated with tactile stereo images. Bass wasn't as extended or resolved as some other cables	19 silver plated strands of 12 different gauges, PTFE dielectric	R	64
van den Hul SCS-2 £99.95 per linear metre	Good+ Good+	Overall it was commendably neutral and transparent but nothing less would be acceptable bearing in mind the tremendous cost of a stereo pair	665 silver plated matched crystal copper strands, PTFE dielectric	R	64
Vecteur R-CV30 £4.99 per metre	Fair Good	Subjectively the better of Vecteur's three-strong cable line-up offering a neutral overall perspective but with a slight loss of detail resolution at both frequency extremes	4 x 0.8mm LC-OFCC PTFE insulated strands	BB	64
Vecteur S-CV90 £69 per metre	Fair+ Fair+	It seemed both less transparent and integrated throughout the midband than R-CV30, though both frequency extremes were spruced up with a tighter sharper delivery	6 x 0.7mm LC-OFCC strands		64

IN-CAR ENTERTAINMENT

In-car entertainment is an area not usually associated with the esoteric world of domestic hi-fi. However, it represents a source of musical entertainment that many of us are exposed to every day. The majority of new cars are fitted with some form of radio before they leave the showroom and in many cases this usually very basic player is taken for granted and accepted as representative of in-car audio standards.

For the price of a budget amplifier or more, there is a wide variety of in-car machines to choose from,

including cassette, CD and even DAT players. The majority of sub £300 players are integrated units featuring a cassette player, AM/fm tuner and amplifier, all in one remarkably compact standard sized box. At this price level the cassette players tend to be fairly basic affairs, although autoreverse and noise reduction systems are both fairly common. Tuners are usually of the digital variety with varying degrees of sophistication in signal tuning and presetting, with some machines featuring as many as 18 FM presets. The emphasis is on the frequency

modulated band and AM often suffers as a consequence, but fortunately for radio enthusiasts there are some exceptions.

The amplifier is usually designed to drive two pairs of speakers mounted fore and aft of the vehicle, and a fader is fitted to adjust the balance between the two. The dearer machines feature separate bass and treble controls which can be quite handy given the unusual acoustic of the car environment and the variety in balance and presentation to be had from car speakers.

MODEL PRICE	LAB SOUND	COMMENTS	FEATURES	VALUE	BACK ISSUE FULL REVIEW
Alpine 7282L £250	Good Very Good	A very attractive and seductive sounding player. The matt surfaced transparent preset keys are especially sexy	Bass/treble controls, 12 FM 6 AM presets, chrome eq., clock, 8W	R	61
Alpine 7905M/3539 £650/£350	Excellent Excellent	An easy to use and attractive CD/tuner, partnered with a powerful and flexible amplifier to give an effortless source of in-car entertainment	Bass/treble controls, 12 FM, 12 AM presets, slide-out, 150W	R	68

TO ORDER BACK ISSUES OF HI-FI CHOICE SEE PAGE 32

THE DIRECTORY

IN-CAR ENTERTAINMENT

MODEL PRICE	LAB SOUND	COMMENTS	FEATURES	VALUE	BACK ISSUE FULL REVIEW
Blaupunkt Windsor SQR 38 £275	Good Average	Not very enthralling sonically, the Windsor is rather low powered but does have a reasonably stable tape transport	5 FM, 10 AM presets, 3.1W		62
Clarion 916HP £160	Good Average	With its rubbery buttons and touches of white this is a modest looking player let down by a weak cassette	Bass/treble controls, 5 FM, 5 AM presets, 9W		61
Clarion 946HP £250	Very Good Very Good	A good FM side let down slightly by AM performance. This Clarion is particularly nice to use with its nifty SAM tuning system	Bass/treble controls, 12 FM/6 AM presets. Slot-in, 15.1W	R	61
Clarion CDC7000/10028HA £650/£250	Very Good Excellent	Despite a slightly off-beat cartridge system the Clarion combo put in a performance that had the sonic edge over other CD/tuners in its test group	Bass/treble controls, 12 FM, 12 AM presets, security code, 80W	R	68
Goodmans GCE229 £150	Fair Average	If knobs, switches and legends are your bag then the GCE229 is the one for you – a lot of gizmos for the price and it even sounds OK	Bass/treble controls, 6 FM/6 AM presets. Chrome eq., clock, MSS, 10.1W	BB	61
Hitachi CSK-402E £250	Good Good	An attractively designed little player that for once doesn't disappoint when it comes to playing music, and it even has a security system	Bass/treble controls, 6 FM, 12 AM presets, Dolby, chrome eq., music search, 7.4W	R	62
Nakamichi TD-400E/pa-300 II £495/£329	Very Good Very Good	If you want your in-car entertainment to compete on sound quality grounds with your domestic system, this combo offers a very strong challenge	Bass/treble controls, 5 FM, 10 AM presets, music search, Dolby, 75W Dolby B, C, 75W	R	62
Nakamichi TD-700E/pa-300II £874/£329	Very Good Excellent	For those who appreciate the wonders of analogue there are few in-car players to really compete with this superb cassette/radio. You can even adjust azimuth	Bass/treble controls, 6 FM, 6 AM presets, music search, Dolby, 75W	R	68
Panasonic CQ-497 £117	Fair Poor	The CQ-497 has a traditional style analogue tuning system making it easy to use. AM reception was good but the other sources are less encouraging	Bass/treble controls, chrome, NR, 7W		62
Philips DC680 £180	Average Good	A colourful and musically competent player that despite a gammy volume knob is well worth checking out.	8 FM, 4 AM presets 3.5W	R	61
Pioneer DEX-M300/CDX-M100/ GM-3000 £300/£450/£280	n/a Very Good	Separate control unit and boot mounted multi play autochanger make this a bit of a hefty installation but it uses the same magazines as their domestic players and sounds fine	Bass/treble controls, 18 FM, 6 AM presets, 80W, removable fascia		68
Proton 214CD/d275 £300/£175	Very Good Very Good	This Proton cassette/tuner offers good power and a level of fidelity appropriate to its price. Musically it has a Decca-like charm that is very appealing, plus a sensitive radio	Bass/treble controls, 8 FM, 8 AM presets, Dolby B/c nr, chrome eq., 85W	R	68
Sharp RG-F816E £200	Poor Average	Nothing if not novel the 816, with its unusual anti-theft system is custom built for the furry dice brigade, but is sonically a bit lacklustre	Four band graphic, 8 FM, 16 AM presets, ASP, Dolby, MSS, 10.9W		62
Sharp RG-F882E £220	Average Average	Again a glitzy full feature machine with a flip out control panel and plenty of lights. However, sound quality is a bit disappointing	Seven band graphic, 5 FM, 10 AM presets, ASP, chrome eq., Dolby, 8.5W		62

RECEIVERS

Purists will look down their noses at the very idea of combining two functions into one box, and indeed they always have done. But unless we're talking about the exotic elite, the creme de la creme of amplifier and tunerdom, intrinsic technical shortcomings simply aren't an issue.

One obvious reason why you should buy a receiver if you were otherwise considering an amplifier and a tuner is that there are savings, ie of

size. Generally you end up with one box in place of two similarly sized boxes, which has got to be a good idea. Receivers are also simpler to operate, in principle anyway. At the very least you save on one power switch, and typically you are presented with an integrated control system that is bound to oil the wheels of ergonomics.

But there is one important point to watch. Because receivers don't sell in vast quantities in

this country, and because this is one of the very few countries to use Long Wave for public service broadcasting, many – no, most – receivers on sale in this country cover FM and MW only. Remember that LW is the home of Radio 4, where it can be heard on the all too frequent occasions it is not on FM

MODEL NAME PRICE	LAB SOUND	COMMENTS	FEATURES	VALUE	BACK ISSUE FULL REVIEW
Harman Kardon HK330Vi £259	Average Average—	No LW, and FM section best suited to strong, local transmissions. The amplifier is quite powerful but favours the treble. Bass is tuneful but lacks weight	5 inputs (inc 2 tape), FM/mw tuner		70
Harman Kardon HK440Vxi £299	Good Good	Clear, dynamic, slightly bright sounding design, a little grainy in extremis. Mono switching and LW missing from tuner, which otherwise performs well	5 inputs (including 2 tape) with FM/mw tuner	R	70
JVC RX-777VL £500	Good Good	Sharp, lively but euphonious sound quality from line and phono source is matched to a high grade tuner. However, many half-baked facilities blunt value for money	A/v capable with 6 inputs, equaliser, digital ambience, FM, MW/lw		70
JVC RX-1001V £770	Average Poor	Power output is well below spec, and sound quality is cluttered and messy on all inputs	Digital ambience processing, Dolby Surround, 2/4 speaker, 40 FM/mw presets		70
Revox B285 £1782	Average Average—	Sophisticated and capable tuner is married to a muddled, compressed sounding amplifier, which also has low sensitivity preventing the amplifier being driven fully in many situations	70 watts/ch, 4 inputs (inc 2 tape), 29 FM/mw/lw presets		70
Rotel RX-850AL £230	Good Good	Well built and sensibly equipped receiver with outstanding sound quality for the price via the tuner, phono and line sources alike. It majors on subtlety however, and may not impress the heavy metal brigade	4 inputs (inc 1 tape), FM/mw/lw tuner	BB	70
SAE R102 £599	Average— Average	This is an uneven but mostly good performer. It sounds constrained but musical, but the tuner is weak on both wavebands.	4 inputs (inc 2 tape), FM/mw tuner		70

THE WORLD'S NO 1
GUIDE TO BUYING HI-FI

Personal Messages

Fresh from reviewing NICAM TV sets for this month's supplement, Paul Messenger basks in a 'flicker free' viewing experience.

After several months devoted to the tweakier aspects of hi-fi furniture, the World Cup provided a splendid opportunity to get up to date with some of the latest happenings on the television side of things.

There's more detail in the supplement which accompanies this issue, but the big picture is that the modern CTV is built down to a price which imposes much the same constraints as a music centre.

The average selling price hasn't really changed in the 25 years since colour was first introduced – during which time the cost of a cheap family car has gone up at least ten times! From such a perspective the modern CTV is a bargain indeed. In terms of engineering content, just compare the component count, bulk, weight or what have you between the £700 CTV and £700 audiophile power amplifier!

But to create such a package at such a price involves the same sort of compromise as those which characterise the music centre. Which are precisely the sort of compromises which those afflicted by the hi-fi habit are prepared to spend money to avoid.

The sound limitations are easily avoided by hooking the TV (or VCR) audio outputs up to an existing hi-fi. Even mono FM sound is well worth the effort, and NICAM stereo that much more so. But the televisual experience is about picture quality, and there's little – if any – picture display equipment that deserves the term 'hi-fi'.

There've been attempts in the past to introduce 'component video' – notably Sony's *Profeel* and the Philips *Matchlines*. B&O TVs are also a bit special, while the latest Pioneer and JVC monitor TVs both show promise. But by and large, all you get to choose between at the moment is different brands of 'music centres'.

However, times are changing. New technology

based on digital signal processing and framestore memories are starting to bring improvements that are adding a genuine hi-fi dimension to picture quality, albeit at a price.

I first saw 'flicker free' television three years ago, but various reasons (a world shortage of high capacity RAM) delayed the first commercial models until the end of '89.

Sony has one of these, catchily called a *KV-FX29TU*. The tube is a big, so called 29 inch Trinitron, while the set weighs a massive 52kg and costs over £2,000. For that sort of price you could buy larger screen sizes still, but you won't get the flicker-free feature which so distinguishes the Sony.

Is it worth the price of three 'standard' 24 inch sets? The answer is an unqualified yes, for anyone in the fortunate position to be able to afford it. Until you've experienced flicker-free, you've absolutely no idea what you're missing. The whole viewing experience becomes much less fatiguing, and picture quality is dramatically improved over even the best conventional sets.

Opening Windows

The Sony provides a much more transparent monitoring 'window' onto the (conventional terrestrial) broadcast signal. and I don't doubt it would be even more impressive fed RGB from a BSB satellite decoder, but that's a luxury I for one can't presently afford.

In a nutshell, 'flicker free' technology artificially doubles the refresh rate of the tube. The picture is displayed as normal, but also stored in memory and repeated again before the next picture arrives. It's one of several new techniques which are beginning to appear on upmarket television displays (tube or projection), and which for convenience are lumped together under acronyms like IDTV (improved definition TV) or

ADTV (advanced definition TV). (Extended definition EDTV and high definition HDTV are two further stages that are still several years away.)

As far as picture and sound quality was concerned, the World Cup signals from Italy left much to be desired. (I'm sure it was no coincidence that the best one came from Rome, covering the matches the Italian team was playing.) But when the London studio transmissions and ad breaks came on, the superiority of the Sony over normal TVs was immediately apparent.

The most obvious improvement is that bright areas no longer glare in the way that normally persuades me to keep the white level (contrast) lower than I would like. The absence of 'flicker' has much to do with this no doubt, and in isolation a normal CTV doesn't seem to suffer from 'flicker'.

But as soon as one has experienced the Sony, 'normal' TVs become unsatisfactory by comparison. The whole luminance (relative brightness) dynamic range (grey scale) seems both better extended and much more precisely differentiated. The ultimate impression is one of uncanny stability and solidity, even under the compromises imposed by normal terrestrial PAL broadcasts.

As with good quality hi-fi, it's the small details which spring to mind. Particularly memorable is the uncanny realism of studio lights glinting in the eyes of presenters, or reflecting off the earrings of (female) newsreaders. The textures of surfaces and reflections in water are much more convincingly depicted too.

Though genuine 3-D TV is in no way on the agenda, one is much less conscious of the 'flatness' of the normal TV image, and much more conscious of the depth perspectives in the scene being viewed.

Indeed I'd go so far as to say that even though it makes

no serious attempt to tackle the limitations imposed by PAL (cross-colour etc.), the Sony brings at least as big an improvement to the conventional broadcast signal as that offered as a matter of course by the MAC/RGB signals broadcast from the BSB satellite.

The end result is so infuriatingly watchable, one just sits there hoping one's favourite advertisements are going to be screened. The Sony simply rams home the fact that for production values and cinematographic quality the adverts are the best things on TV.

Best of all, the fact that the Sony is dramatically superior on the best quality pictures does not mean that it is unpleasant to watch the low resolution, noisy pictures that came over the airwaves from Italy.

To back up the *FX29*'s superb display technology, Sony has fitted a top quality tuner, while in this instance the 'crispener' or 'sharpen' which is the video equivalent of a tone control (or more precisely a low pass filter) is unusually well designed.

I've criticised cheaper Sony CTVs in the past because of a tendency to 'peak up' the upper end of the luminance bandwidth and so artificially hype and over-sharpen detail. That is not the case here. It's possible to hype the picture by turning the crispener way up, but at the mid, 'flat' position the luminance band looks beautifully judged, while reducing the setting and softening the resolution was all that was needed to make the lousy football signals eminently watchable.

By the time this piece is published, I'm sure that Sony will have repossessed the *FX29*. and I can honestly say that I shall miss it more than any other piece of review equipment that I can recall. At £2,000+ it joins Naim's *NAC52* preamp in combining total desirability with utter inaffordability. Sometimes a hi-fi reviewer's lot can be very frustrating.

SOUND AND STYLE



REACH FOR THE BEST



RCD855 COMPACT DISC PLAYER DUAL D/A CONVERTER



At a time when others are becoming lost in the bit war Rotel's no nonsense approach to quality engineering sets new standards for this Classic 16 bit 4 times oversampling system with a product which will offer lasting value. This new model from Rotel incorporates the very latest in understanding of circuit board layout and component selection resulting in very high levels of performance and musical involvement together with outstanding build quality.



RCD865 COMPACT DISC PLAYER PULSE DENSITY MODULATION



Rotel are proud to be one of the first companies to introduce a high performance C. D. player utilising the new bit stream PDM conversion system. Our research has shown that PDM, in conjunction with high quality circuitry and components, can produce outstanding sound quality with a level of musical involvement hitherto not available from compact discs. We strongly urge you to audition this fine product at the earliest opportunity.

These fine components are but a small selection from Rotel's award winning range of performance Hi-Fi Products which offer very high standards of technical excellence and musical enjoyment. The RCD855 and RCD865 are supplied with a numeric remote control handset and are fully remote compatible with Rotel's new RTC850L Tuner-Preamplifier. Phone or fax Rotel UK for further information and nationwide dealerlist.

UK DESIGN AND DEVELOPMENT

ROTEL UK,
25 Heathfield, Stacey Bushes,
Milton Keynes, MK12 6HR.
Tel. (0908) 317707 Fax. (0908) 322704

ROTEL hiFi
Ask someone who knows...

MEMOREX[®]



AMERICA'S FASTEST SELLING TAPES

MEMOREX AUDIO AND VIDEO TAPES, UNIT 4, SUMMIT CENTRE,
HATCH LANE, HARMONDSWORTH, WEST DRAYTON, MIDDX UB7 0LJ