

£2.95

DECEMBER 1987

HI-FI CHOICE

THE WORLD'S No.1 GUIDE
TO BUYING HI-FI

47 TURNTABLES/23 TONEARMS
TESTED

89 CARTRIDGES TESTED

65 CD PLAYERS TESTED

£10,000 SYSTEM MUST BE WON!

10 NEW BUDGET CDS ON TEST

12 CD MIDI SYSTEMS TESTED

47 CASSETTE DECKS TESTED

OUR VERDICT
ON 8 YUPPIE BLASTERS

91 LOUDSPEAKERS TESTED

92 AMPLIFIERS/16 TUNERS
TESTED

OVER 30 NEW LOUDSPEAKERS ON TEST

TEST RESULTS ON OVER 500 HI-FI PRODUCTS - FROM OUR OWN INDEPENDENT LABS

LISTEN TO

system R...

UNIQUE METAL DOME DESIGNS R852/MD AND R952/MD

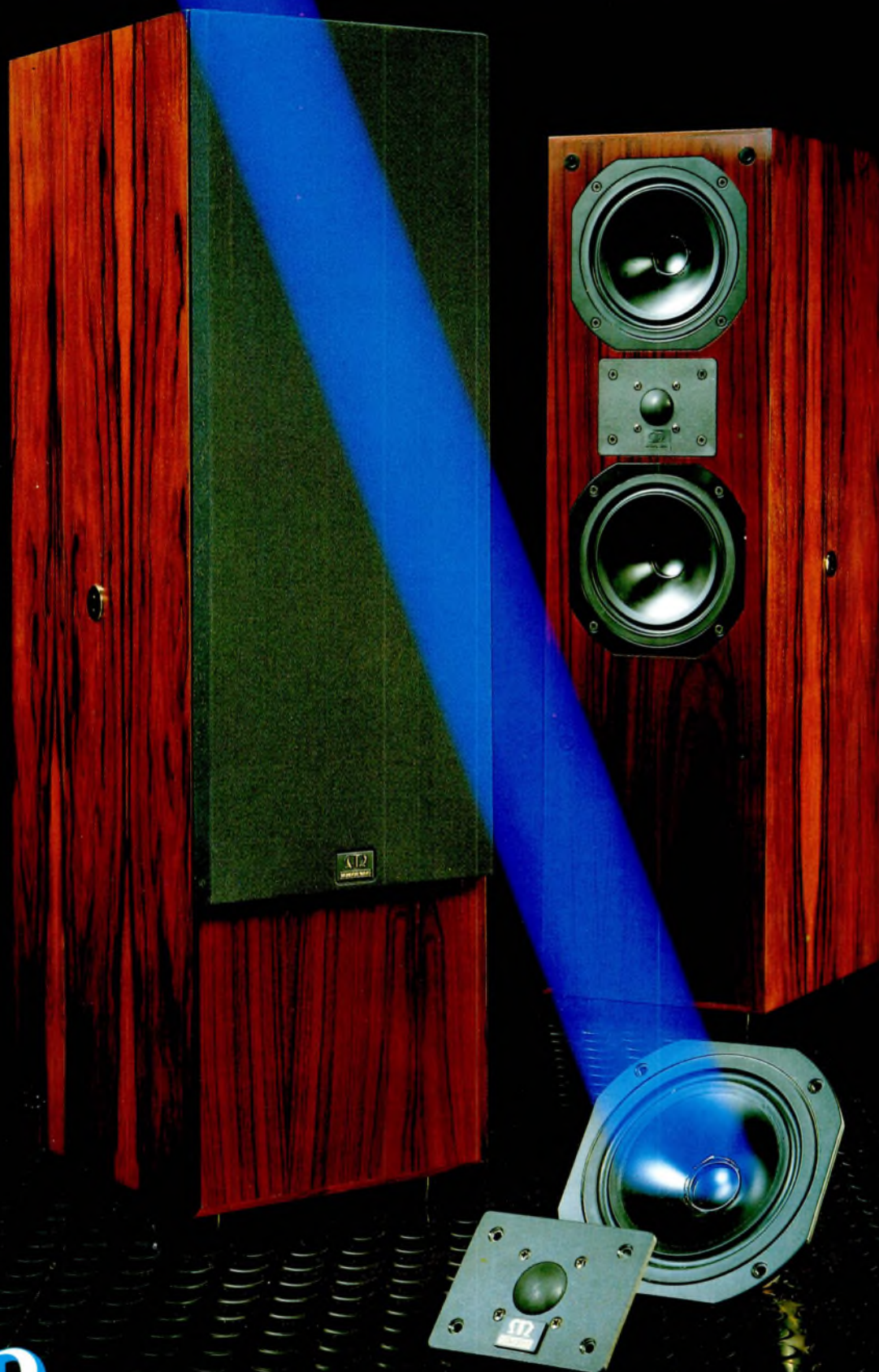

The Symbol of Quality

MONITOR AUDIO LTD

Unit 34, Clifton Road, Cambridge CB1 4ZW
Tel: (0223) 242898 / 246344 Telex 817904 MONTOR-G



R352 WINNER 1987/88 SPEAKER OF THE YEAR AWARD

If you think these reviews are over the top complete the coupon below.



ARCAM ALPHA+ AMPLIFIER

"In certain respects it is the best of all the amplifiers tested, it has the sweetest and, in many ways, most natural and unforced delivery. There is virtually no sense in which it points to itself in circuit, it is self-effacing to the last, while the system it powers just sings."

"I'm very impressed by what has been achieved by A&R"

ALVIN GOLD, WHAT HIFI, APRIL 1985.

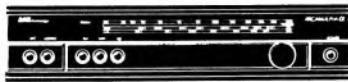

ARCAM ALPHA TUNER.

"The Alpha impresses not by being seductive or feature-laden, but by giving a very pleasing sound quality."

JOHN SEABURY, WHAT HIFI, MARCH 1986.



A60+ AMPLIFIER.

"England's classic low cost, high performance amplifier that just goes on getting better"

NEW HIFI SOUND, AUG 1986.



T21 TUNER.

"The A&R T21 is an FM only tuner complete with the minimum facilities but a superbly smooth sound quality. Exceptionally easy to use and available in four different finishes, it remains one of our favourite hi-fi tuners"

WHAT HIFI AWARDS 1986.



ARCAM DELTA 90 AMPLIFIER.

"From the outset the amplifier showed itself capable of a very solid dynamic performance. It also took and kept a grip on the subtleties of the stereo signal..."

"The amp looks well set for as long and honourable a life on the hi-fi market as the A60 has had"

DAVID PRAKEL, NEW HIFI SOUND, DEC 1986.



ARCAM DELTA 80 TUNER.

"The tuner performed well and was simple to use. With strong FM signals it gave a clean and detailed stereo sound..."

"The Delta 80 is thoroughly competitive and can be recommended as good value for money"

JOHN SEABURY, WHAT HIFI, MAR 1987.



ARCAM ONE LOUDSPEAKER.

"A&R have a convincing performer in this fine loudspeaker. The sound was clear and open, with fine musical detail & accurate stereo presentation."

MARTIN COLLOMS
HIFI CHOICE LOUDSPEAKERS.



ARCAM TWO LOUDSPEAKER.

"The Arcam Two is a superbly subtle and informative design that pleases the more it is listened to. As a speaker to live with and enjoy it has few superiors"

JIMMY HUGHES HIFI ANSWERS OCT 86.



ARCAM THREE LOUDSPEAKER.

"Of the budget plus group of speakers the Arcam 3 made a strong impression with its stereo resolution and imaging abilities. It is definitely a speaker for the smaller room system"

NEW HIFI SOUND, OCT 1986.



MG SERIES CARTRIDGES.

"A&R have done their job right. I'm sure these cartridges will quietly establish themselves and proceed to sell forever more..."

ALVIN GOLD HIFI ANSWERS JAN 87.



DELTA 70 COMPACT DISC PLAYER.

"The Arcam Delta is Britain's latest and most significant compact disc product."

GRAHAM S. MAYOR, WHICH COMPACT DISC, JULY 1987.

Here are a few examples of the accolades we've garnered from the press.

If you can handle a whole wodge of glowing reviews and technical information, feel free to send in the coupon.

We'll also send you a list of dealers so you can hear for yourself what all the fuss is about.

ARCAM
audiophile products
from A&R Cambridge

A&R CAMBRIDGE LIMITED, DENNY INDUSTRIAL CENTRE, WATERBEACH, CAMBRIDGE CB5 9PB, ENGLAND. TELEPHONE: (0223) 861550. TELEX: 817345.

Please help keep my postman fit: send me my wodge of rave reviews and technical information.

Name ----- Address -----

HI-FI CHOICE

ISSUE NUMBER 53: DECEMBER 1987

C O N T E N T S



UPDATE 7

A choice selection of events and product launches.

READERS' WRITES/CHOICE ANSWERS 11

For the very first time, space for some of your comments and queries. We look forward to your continuing contributions.

AND THE SHOW GOES ON . . . 14

Show reports with much of the Autumn news, from Heathrow, Berlin and Tokyo.

STATE OF THE ART COMPETITION 20

Win a £10,000 dream hi-fi system (part 1) in our mammoth re-launch never-to-be-repeated easy-to-enter competition.



Loudspeakers

CHOOSING & USING LOUDSPEAKERS 23

Practical hints on loudspeaker use.

LOUDSPEAKER REVIEWS 26

30 new reviews plus ten established favourites.

TECH TALK 83

The background to the reviews.

CONCLUSIONS, BEST BUYS AND RECOMMENDATIONS 88

Our famous roundup on the current state of loudspeaker play, plus the accumulated Recommendations of this and previous projects.

MARKET SURVEY 93

Dealer Feedback – our innovative market survey summarises dealers' opinions on the current state of the loudspeaker market, and such factors as consistency and reliability.



CD Players

TEN BUDGET CD PLAYERS 99

Chris Bryant provides full technical and subjective reviews on ten of the latest budget CD players, tying in with the findings of last summer's 50 or more in the Conclusions, Best Buys and Recommendations.

EDITOR: Paul Messenger; ASSISTANT EDITOR: Jane Hadley; EDITORIAL ASSISTANTS: Daniel Houston, Jason Kennedy; ART DIRECTOR: Paul Carpenter; ADVERTISEMENT EXECs: Fiona Galvin, Karen Oakley; PUBLISHER: Marianne McNicholas; PHOTOGRAPHY: Derek Gourd, Anthony Marland; COVER PHOTOGRAPHY: Jonathan Lovekin; COVER DESIGN: Steve Nanson of Miller & Kendall Advertising; PUBLISHED by Dennis Publishing Ltd, 14 Rathbone Place, London W1P 1DE. Tel: 01-631 1433; DISTRIBUTED by SM Distribution, 16-18 Trinity Gardens, London SW9 8DX; TYPESET by Time Graphics Ltd, Northampton; PRINTED by Thamesmouth Printing Group, Essex.

All the current volumes of the Hi-Fi Choice Series are available direct from our Mail Order Service. See page 87.

Enquiries regarding the content of this book should be made in writing to Hi-Fi Choice Editorial, 14 Rathbone Place, London W1P 1DE. We regret enquiries cannot be dealt with by telephone. While every care has been taken in the preparation of this book, the publishers cannot be held responsible for the accuracy of the information herein, or any consequence arising from them. Readers should note that all judgements have been made in the context of equipment available to Hi-Fi Choice at the time of review, and that 'value for money' comments are based on UK prices at the time of review, which are subject to fluctuation and are only applicable to the UK market. This edition © 1987, Felden productions.



Choice discovers a Crystal amongst the Oxfordshire hills, proving that real hi-fi can be beautiful. Will Turkoman rugs become the latest tweak?

Portables

YUPPIE BLASTERS 121

Introduction, conclusions plus reviews on eight CD-equipped portables, by our latest recruit Jason Kennedy

SELECTED DEALER DIRECTORY 154

Where to find the best hi-fi demonstrations and advice in your area.

THE CHOICE DIRECTORY 139

Hi-Fi Choice's unique review-based directory to currently available hi-fi equipment, with advice on putting together a system.

GLOSSARY 157

Technical terminology made simple.

REVIEW INDEX 160

For easy reference to this month's review content.

BEST BUYS & RECOMMENDATIONS

In our reviews, the Best Buy flag denotes very good value for money and good performance in products up to a specific price point. Recommended models may be of any price, and deliver fine performance, either for the price or in absolute terms.



12 YEARS ON . . .

Welcome to the first edition of *Hi-Fi Choice*. The Magazine, now appearing monthly in its new large A4 format. For the past 12 years we have published a mixture of A5 and A4 volumes – last year five and three respectively – and the passing of the handy small format editions is cue for a moment's nostalgia and regret. But some rationalisation was long overdue, and the new format offers lots of exciting possibilities for breaking out of the strict topic-based straightjacket.

In fact the new format *Choice* offers a lot more than its predecessor – about the only thing we will be leaving out is some of the reprinted reviews from earlier editions. From now on each edition will contain an extensive directory to much currently available hi-fi equipment of all kinds, based on our accumulated database of reviews. This will be updated monthly to keep abreast of new reviews, and so will remain the most comprehensive review-based guide to hi-fi available.

We will of course be continuing with the large scale 'main topic' group reviews that are the basis of our reputation. This month it's Loudspeakers turn, with full lab and listening tests on 30 new models, plus reprints on ten established favourites. In fact this particular project is one of the most elaborate we have undertaken, comprising two completely separate series of listening tests held in different

environments, so as to ensure maximum fairness to all the models. Another innovation here is our new market survey, quizzing dealers on their experiences with various brands and models. And then there's the backup data on a total of 91 loudspeaker entries in the directory.

In addition to the central review theme of the issue, we will also be including two other review sections on alternative projects. In broad terms one of these will be used to update an existing category of equipment, the other to explore avenues which are new to our pages.

For instance, this month we have covered ten new budget CD players, most of which are recent releases on the market. The Conclusions tie in with the earlier reviews, so providing a definitive Best Buy and Recommendation listing for anyone contemplating buying themselves a budget CD player as a Christmas present.

The other group test covers products that are new to *Choice*, and fairly new to the marketplace as well. CD-equipped portable systems – known affectionately as 'yuppie blasters' in the trade – certainly present an attractive and flexible alternative for someone planning to 'go CD' this Winter, though not without compromise to be sure. Presenting a contrast with the budget mains CD players on the one hand, they also provide a natural extension to the 25 plus CD Midi Systems which comprise

next month's main review topic.

On this occasion both our 'secondary' topics have been undertaken by reviewers making their *Choice* debut, so a few words of introduction are appropriate. Chris Bryant, author of the budget CD players, works closely with Martin Colloms, in the lab and listening room, and now on the word processor as well. And our new editorial assistant, Jason Kennedy was a little taken aback to be given a pile of yuppie blasters to crack his teeth on at short notice (partly because Alvin Gold was busy having babies), but has risen to the occasion very well.

Elsewhere in the issue you will find a number of other new regular features. The Letters page will allow you to get your own back on *Choice* for the first time. The News pages will be keeping you up to date with hi-fi and consumer electronics developments around the world – and this month sees show reports from the Heathrow Penta, the Berlin Funkausstellung and the Tokyo Audio Fair, in addition to new product launches and other stories. And to provide a little escapism from all those hard facts, Aspirations is our new photo-feature devoted to the sort of hi-fi systems and houses most of us merely dream about.

All in all, it's been a busy time. Do write and let us know what you think of the new look – or let us know if we've made any mistakes! See you next month.
Paul Messenger

Put on the red light
You don't have to
put on the red light



Roxanne

Technics
new 360 series.
For Music Lovers.

A range of 8 midi-systems with full remote control, including 2 CD based systems. X880 Model above features 80W per channel Class AA amplifier with digitally encoded volume control, digital direct switching, AV surround sound, twin cassette deck with auto reverse, *Dolby B/C NR, and high speed editing, Quartz synthesizer tuner with 24 pre-sets, programmable linear tracking turntable, 3-way speakers, optional CD player and graphic equalizer. All components also available as separates.

TECHNICS, 300-318 BATH ROAD, SLOUGH, BERKS. SL1 6JB. TEL: SLOUGH 34522

Lyrics from 'Roxanne' written by Sting © 1978 Virgin Music (Publishers) Ltd. Reproduced by kind permission of Virgin Music (Publishers) Ltd.

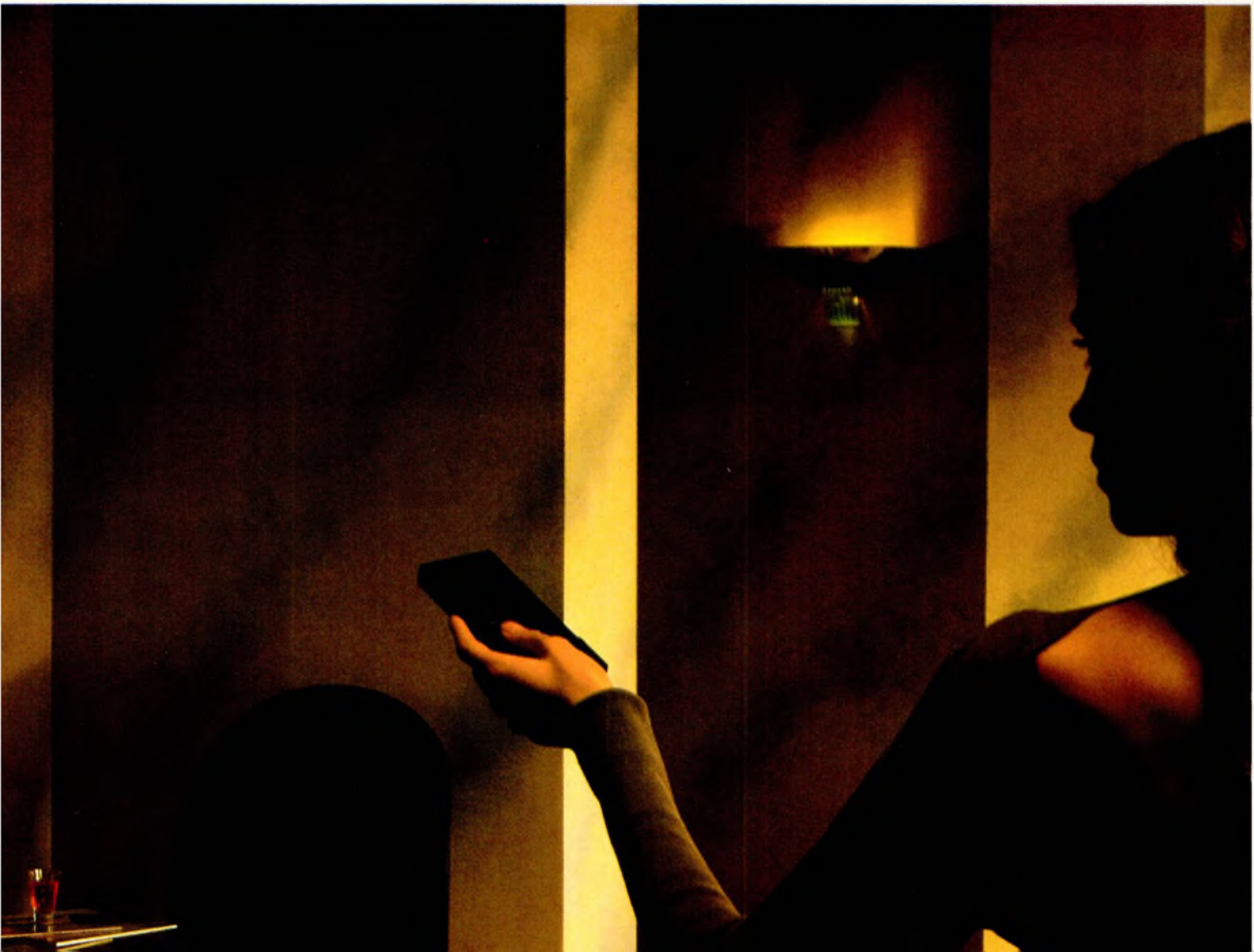



Proven Accessories

from QED

INCON Interconnect Cables

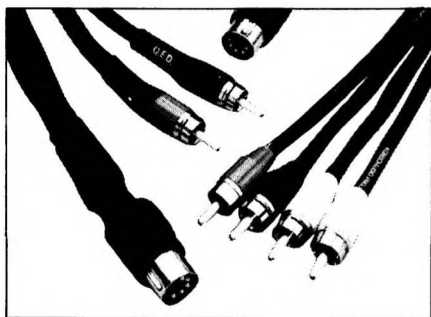

New technology cables using OXYGEN FREE HIGH CONDUCTIVITY copper conductors. HI-FI Answers (May 84) commenting on INCON "With INCON the sound was sweet, open, transparent, tuneful and very easy to follow. Both sonically and musically the QED cable transformed the sound."
Prices from £9.95 for a half metre pair of phono to phono cables or cable off the reel at £1.20 per metre.

QED 79 Strand The BEST BUY of Speaker Cables

Over 4 million metres of genuine QED 79 strand speaker cable has so far been sold, making it the most popular speaker cable ever produced. HI-FI Answers (Nov 82) concluded that, "Changing from bell wire or mains lead to QED 79 STRAND SPEAKER CABLE is the cheapest upgrade you will ever make."

PRICE
90p
per metre

A new addition for this season is a flat configuration 79 Strand cable (a profile of only 2.5mm). This makes it ideal for concealing under carpets.
F79 Price per metre £1.20.

NEW

Switching & Control

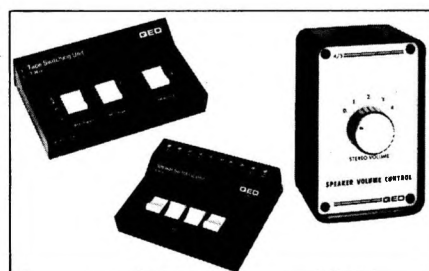

A full range of Amplifier, Speaker, Tape C.D. and Phono switching units together with Volume Controls and Headphone Adaptors. The range now includes a new 2 way Speaker Switching Unit (SSU2) which will accept QED 79 strand speaker cable and a new 4 way unit (UHSS4) that will accept Monster and C38 type cables.

PRICES FROM
£9.95

C.D. Switching Unit



A C.D. player needs a special input to work properly, but many (otherwise very good amplifiers) do not have such a dedicated C.D. input.

This need not be a problem with the QED COMPACT DISC SWITCHING UNIT, because not only does it switch between tuner and C.D. it also adjusts the level for optimum performance.

PRICE
£18.50

Input Expander

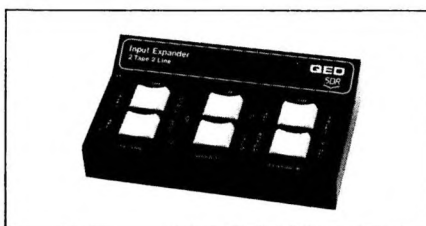

As the name suggests, the IX 4 is designed to expand both the 'tape' and 'line' inputs of a 'minimum facilities' pre-amplifier or integrated amplifier. Provision is made for the connection and control of two tape decks, with full record, playback and tape to tape functions, plus two line inputs. The line inputs are marked 'video' and 'aux/C.D.'.

PRICE: IX-4
£39.95
IX-4 GOLD
£49.95

SDR SOUND DEFINITION RANGE

This year sees a whole new range of premium accessories from QED under the Sound Definition range banner. These products are designed to maintain the maximum possible signal integrity from input to output and features the following

- Full independent earth wiring.
- Switches with silver plated contacts.
- Non-Ferrous casework (aluminium) to avoid any sonically degrading electromagnetic effects.
- Professional quality gold plated phono sockets.
- Special 'gold' solder to ensure the best possible electrical joints.

QED Products are recommended by all leading manufacturers and importers of HiFi Equipment. They are available from around 1000 HiFi retailers throughout the U.K. Alternatively, order direct and we will despatch your order within 24 hours (subject to availability). Post and packing free*. All prices include V.A.T. @ 15%.
*Add 50p to orders under £5.00

For technical and nearest dealer information ring 0784 246236

QED Audio Products Ltd., Unit 12, Ashford Industrial Estate, Shield Road, Ashford, Middlesex TW15 1AU.
North American Distributor May Audio Marketing Ltd., 646, Guimond Blvd., Longueuil, QUE. J4G 1P8
Tel (514) 651-5707

A QED Accessory Catalogue is a must - send for yours now!

FOR MORE INFORMATION
Please send me your latest Catalogue No. 10 and the name of my nearest dealer.
I enclose a First Class stamp.

NAME _____
ADDRESS _____ POST CODE _____



PRODUCTS

PATENTLY ORTOFON

Cartridge giants Ortofon have released their latest high-end offering – the *MC3000* – which you can own for a cool £800.

The good thing is that it's compatible with most moving coil inputs, which its predecessor the *MC2000* was not.

The revolutionary stylus design which Ortofon are patenting looks

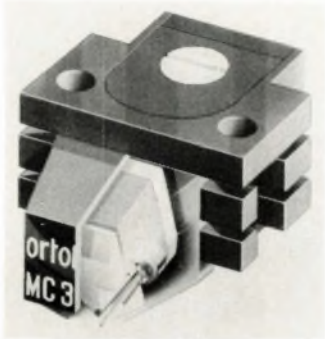

like a ploughshare in the record groove and is as close to the shape of a disc master cutting stylus as one can get without actually cutting the vinyl, they claim. The slim design allows a wide contact area for the effortless, accurate retrieval of subtle details.

HEYBROOK POINT FIVE

Their first new product in loudspeakers for several years, the *Point Five* is smaller and cheaper than the popular *HBI* model and sells for a competitive \$119. It incorporates several interesting features including a bass/mid unit developed in collaboration with Elac which does not need a crossover. More novel, however, is the cabinet construction which wraps the 'V' cut MDF in the four vertical planes, with the top and bottom recessed.

CREEK'S CHRISTMAS CRACKER

Mike Creek's new feature-laden amplifier will be hitting the shops in December with the promise: "it's better sounding than any other amplifier we have made before".

Retailing at £350, the *CAS 5050* is an integrated amplifier featuring a host of inputs with the



Linn's NAC 52 remote control pre-amp. Engineering prototype at Penta; production in '88?

facility to record from one source while you listen to another. Tone controls are available but can be switched completely out of the circuit, and there is a 22dB attenuator to knock down the sound level, if you're answering the phone say. Other facilities include a headphone socket which automatically switches off the speakers when used, and protection measures against the likes of direct current offset and overheating. All these goodies sit in a black aluminium casing which is described as slimline... and rather sleek.

NEW CLEAR MC

At \$450 the Clear Audio *Delta* is the latest of these West German cartridges to be brought to our shores by Vital Systems. Like other models in the range it is a moving-coil design with a healthy



0.4mV output, suited to most MC-ready preamplifiers. It offers similar performance to the extortionately priced *Pradikat* model we could have a recommendable new cartridge on our hands.

MAKING THE CONNECTION

Linn's *Neous CS250* (not a Soho dating agency) will be launched at the second Edinburgh show this month in a bid to strengthen the firm's loudspeaker manufacturing. The \$350, 21-inch-high speaker is designed to slot into the Linn range between the *Kan* and *Sara*, and will be available in black vinyl only.

The two-unit speaker will use current *Kan* tweeter with a new bass unit, loaded rather surprisingly by a ported (reflex) cabinet measuring 21 x 10 x 11½ inches. The *Neous*, which took a year to develop, can be bi-wired and comes with its own stands (\$48 extra). Linn say the reaction has been "very good so far". Linn Products Ltd, Floors Road, Waterfoot, Eaglesham, Glasgow. Tel: (041) 644 5111.

WALK RIGHT BACK

Alphason have announced that they will continue to manufacture the *CJ58 II* following Colin Walker's retirement, while fitting the revised *Opal* pick-up arm. The arm has now been improved by using three-bolt fixing with a better quality interconnect. Turntable and arm come at the price of \$268.

DAT FROM LUXMAN

This month Luxman plan to introduce their *KD-117* DAT recorder, first seen at the Penta Show. This \$1499 player features

digital and analogue outputs and will directly interface with their *LV-09* digital amplifier. It has no protection circuitry as such against recording digitally from CD, but in practise will only record from analogue inputs, as the machine does not recognise the 44.1kHz CD sampling rate.

It features three sampling frequencies: 32, 44.1 and 48kHz but the 44kHz rate is for playback only.

BUSINESS/TRADE

ENDAKA & RIOTS

Far Eastern importers are facing a difficult time this Autumn. Product from Japan continues to suffer from *endaka* – the continued strengthening of the Japanese Yen. This is reducing margins and forcing up prices of Japanese manufactured goods to the point where competitiveness is becoming difficult to maintain, particularly for the smaller brands and those with limited off-shore manufacturing arrangements.

In response, many are making strenuous efforts to move upmarket. Sony already have a success on their hands, the *ES* range performing well ahead of expectations in the UK. Akai now have some real new product on the way, majoring on upmarket separates rather than cheap racks and stackers, having recovered from the temporary indigestion of their Mitsubishi nuptials.

One of the biggest of all, Sanyo, is busy sharpening up its high-tech image, introducing 'world's smallest' CD players and personal stereos. Aiwa too are seeking to expand separates sales in categories beyond their successful cassette decks.

Sansui seem to be shaking all over. A brand new image and logo, and more emphasis on upmarket separates was pulling in the Japanese crowds at the Tokyo show. Yet just at the time they opened up a brand new German subsidiary they decided to hive off the UK operation to the Hi-Fi Markets group! This was handled with such aplomb that certain senior Sansui UK management found out about it in the pages of one of the monthly hi-fi mags.

The move is no surprise given Sansui UK's lacklustre

performance in recent years, the management-heavy operation inherited from the boom years, coupled with the 'endaka' (esp US) difficulties this 40 year old company has faced recently. The move to Germany reflects the increasing influence of Europe's most valuable market – indeed at one point we might even have ended up with a Sansui UK GmbH!

In contrast, two Japanese brands are busy setting up UK subsidiaries. Teac smashed the saké barrel in some style at Claridges in October, and plan to use the UK base to provide backup for their various European distributors as well as covering UK professional and domestic hi-fi sales (the former dominating by about four to one).

Teac's hi-fi division is another brand showing every intention of moving up the hi-fi market. A new range of high performance separates includes five CD players priced from £179-£899, five cassette decks of various configurations from £159-£599, plus a \$450 'bootlegger special', the AD-4 combining CD player and cassette deck in a single package with various integrated dubbing functions.

For the first time in many years, the Nikko brand is scheduled to reappear on the UK market this Autumn, a little earlier than planned due to pressure from Laskys who will be the main outlet in the initial stages at least. The Nikko UK operation is reportedly being operated under the wing of the German distributors, with Paul Macfarlane as sales manager.

Other Far Eastern countries have shown a ready ability to learn Japanese manufacturing knowhow, and usually operate in dollar-liked currencies, so their prices have become steadily lower in real terms.

Much of the consumer electronics production momentum has come from South Korea in recent years, mainly in manufacturing original equipment for other brands (retailer-based or multinational). Yet here too there has been an Autumn hiccup, this time in the form of rioting on the streets of Seoul and striking in the factories – just at the time when stocks are being built up and shipped for the European and US 'seasons'.

Keith Harrison, new MD of the

rapidly expanding UK base of the Korean Goldstar conglomerate, admitted they had lost 9 or 10 days and had to air-freight some stocks during their recent start up phase. But he anticipates turning over £7.5m by the end of '87 (most outsiders expecting him to wait until '88 to get going), and will be carrying out 100 per cent QC to start with. He also feels the political shakeups and repercussions may have helped clear the industrial relations air within the factories, which should result in improved quality without significantly affecting international competitiveness.

However, Goldstar may have got off lighter than some other brands, and deliveries of some portables, stackers and midi systems could well be coming through a little late. And consumers would do well to watch out for quality and reliability amongst downmarket items, if they choose to buy from the less reputable outlets where after-sales satisfaction is not always guaranteed by a need to rely on reputation and repeat trade.

BORING & USELESS

John 'Glass house' Vizor, erstwhile co-proprietor of ill-fated Midlands dealer JCV and leading light in Hi-Fi Experience, has launched a monthly trade magazine called Private Eye-Fi.

However, one section entitled 'Boring but Useful', purporting to provide the telephone numbers of all UK hi-fi suppliers was clearly inspired by Python's Hungarian/English phrasebook. A first time wrong number might have been bad luck; the second in succession smacks of practical jokery on

Vizor's part. To then claim only three errors in 20 pages (tell that to Malcolm Blockley, or to Malcolm Blockly for that matter) is akin to organising a BADA conference on 'how to run a successful business' the day before the receivers are brought in!

Nevertheless, it is in fact an entertaining read, if a trifle OTT and waspish at times, even though Vizor's proof reader clearly merits defenestration.

RETAIL EXPANSION SCHEME

Lockton Shops plc, heavily funded from Guinness Mahon's tax-favourable Business Expansion Scheme flotation last March, is bringing a new look to electrical and hi-fi retailing in the South East. Masterminded by MD John Edwards (ex-Kimberleys), the first of a planned 30 Wires outlets has just opened in Reading, featuring classy high-tech fittings for selling classy high tech hi-fi and video products in central (leasehold) shopping centre sites.

A BES scheme requirement is that at least 50 per cent of the capital goes into freehold rather than leases, so alongside Wires – and more relevant to the hi-fi world – Lockton is also planning an Auditions series of specialist hi-fi shops. Again based on an upmarket integrated design and presentation concept, twelve Auditions are expected to open over the next three years, in off-centre sites. At two per county each will serve a wider catchment area than the Wires shops.

The Auditions chain is being developed with George Bartlett as

consultant – a key BADA figure, proprietor of the eponymous and successful North London shops and sometime exhibition organiser (Westmoreland etc). The first shop is due to open in Walton on Thames in December, and the planned intention is to concentrate heavily on British made specialist hi-fi equipment. However, at present there are no details on which brands have agreed to supply.

SNIPPETS

▲ Tandberg's distribution is changing yet again, and will now be handled by John Reddington's Ortofon UK operation which should give this once successful Norwegian brand more UK clout than it has had for some time.

▲ In a surprise move AR have announced the apparently amicable yet undeniably precipitate resignation of their UK General Manager Peter Curry "to pursue his own interests".

▲ The effervescent and musicological Neville Farmer has resigned as Editor of Haymarket magazine *New Hi-Fi Sound* to pursue a freelance career. The succession has been established but not yet announced.

TECHNOLOGY

FORMAT 88?

While the British hi-fi industry sits around busily knitting loudspeakers and crocheting turntables to satisfy an ever increasing world demand for 'real hi-fi', foreign technocrats are plotting and planning the new media that they intend will replace our existing home entertainment systems by the end of the century.

CDV (CD video), DAT (digital audio tape) and RDS (radio data service) are all due for imminent UK and Euro-launches. CD-I (CD interactive) and a 3 inch small format CD 'single' are both waiting in the wings. Stereo sound with TV and DBS (direct broadcast satellite) broadcasting are increasingly overdue. And MOD (magnetic optical disc) and variants, allowing record as well as replay with optical discs, lurks just below the horizon. A roundup and



Japanese products – going upmarket and going silver (Akai and Mitsubishi/Diatone at Japan Audio Show).

overview of the current state of play should help sort out some of the confusion.

DAT

DAT was launched in Japan six months ago, and is expected to appear in Europe this Autumn. For the odd ostrich out there, it is a digital audio cassette system offering quality akin to CD, using cassettes half the size of audio compact cassettes (albeit thicker), offering up to two hours continuous record or play with accurate and fast track access arrangements.

Record companies have lobbied hard against a format they see as 'perfect for CD piracy' – despite the fact that the tape cost per hour is currently as high as CD. There is therefore no pre-recorded material yet. Direct digital copying from CD has been rendered not possible, but for the moment the Copycode system which might prevent the DAT (or other format) copying of any commercial coded material appears to be back in the pending file. Ironically, as Sony recently pointed out, they have been supplying portable and mains processors (PCM-F1 and 701S) capable of just such direct 44.1kHz digital dubbing onto much lower cost Betamax tape for some years.

Considering the pent-up world demand from professional and semi-pro users, initial sales in Japan have been disappointingly slow; perhaps because of the D-to-D prohibit; perhaps the lack of pre-recorded software; perhaps the lack of compatible in-car and DATmen; or perhaps because prices are very high, and the often-nipped Japanese consumer knows they'll come down if he waits for a while. £200 discounts are already available on first generation machines in Akihabara, but an expected UK price of £1300 and \$10 per tape should keep initial activity mainly in the tax-deductible VAT-recoverable Pro sector.

A knight whose shining armour could help get DAT going is the computer data storage industry. Sony and Hewlett Packard are working together to use that 1.2Gigabytes of low cost memory for archive and backup computer work, which should help to bring

unit costs of tape and hardware down.

CD PLUS

Now that the world has achieved an overcapacity of compact disc production, and hardware manufacturers' sales are starting to flatten out, the next generation of optical disc media are on the way.

Philips have been busy prematurely 'launching' CD Video around the world, starting with NTSC in Chicago in May, then in PAL for Europe at Berlin and Heathrow. Appearance on the UK market is expected in the Spring. Players capable of existing CD and new CDV replay will cost in the £400-£500 price range, from Philips, Pioneer, Yamaha and others – but also of course with the need to hook up to a colour TV as well as a hi-fi system.

The format itself is a bit of a hybrid. The brand new 5 inch audio-with-some-video CDV is an attempt to create a 'singles' format for CD, while providing an excuse to re-heat 8 inch and 12 inch LaserVision (now with a digital audio soundtrack) for another crack at the UK market. The 'single' combines up to 5 minutes of video with up to 20 minutes of audio (including 15 minutes of blank screen), the 8 inch 'album' 40 with 40, and 12 inch 'feature film/opera' 90 with 90.

Successive demonstrations show that prototype performance is still improving – and still leaving room for improvement, particularly with the new 5 inch size in PAL. But assuming this will get sorted out, one critical factor is likely to be the software prices, which are not yet announced (though rumours are rife).

The other is whether a record-capable VCR-oriented UK marketplace of traditionally limited quality aspirations can be persuaded to go for a high quality replay only system as well. And whether the youth market at whom the music biz aims singles is interested in sitting at home and hooking up a TV.

An alternative approach to CD 'singles' is being proposed by Sony, based on a 3 inch audio only disc, samples of which are already circulating even though formal format agreement has not been reached yet. There are clear

advantages for miniaturisation of course, though pressing costs won't be significantly cheaper than for a 5 inch disc, and even Sony themselves haven't yet built an appropriate indent into their loading trays, so for the moment clumsy 5 inch adaptors are necessary.

Talk and simulation demonstrations of CD-I have been going on for more than a year now, but no firm launch date has been announced for a medium that no one seems quite sure how to use. CD interactive combines CD player, microcomputer, CTV and hi-fi (or low-fi) to provide a form of electronic publishing with still picture video, computer graphics and searching, and audio.

The data reading and searching rates are a little slow, so full motion video is not possible (unlike professional interactive Laservision). High resolution in one area is only obtainable at the expense of low resolution elsewhere (ie trading picture update rate against sound quality).

Ultimately optical disc technology will probably be available with record as well as replay capabilities. The technology has been in the labs for some years now, and Thompson showed a (presumably) working magnetic optical disc prototype at Berlin.

Although it appears that products could be brought to the market within two or three years, this is unlikely. Even the technology has not been standardised yet, let alone any inter-company agreement on how to use it, while prices for the discs themselves could be horrendous. The technology will be developed, but is more likely to find applications in competition with magnetic hard-disk (Winchester) storage systems than for consumer audio purposes in the foreseeable future.

BROADCASTING

Ever since the government decided to index-link the BBC license fee to inflation, the technical development of broadcasting has been a hostage to politics. The BBC has been (and is) test transmitting NICAM 728 stereo signals from Crystal Palace for more than a year. JVC (for one) has developed decoding chips, yet the BBC's battle with the

government may leave things sitting on ice for quite some while. And ever since satellite launch systems started falling out of the sky, direct broadcast satellites have been sitting in line, waiting.

Audio/video integration has been pencilled in for several years now as the next major step in consumer electronics hardware. But its development is largely dependent on high quality stereo sound broadcasting as the major stimulus to purchasing 'component video' and 'hi-fi' VCRs – and so providing an environment suitable for other innovations like CDV and CD-I.

European satellite broadcasting will provide high quality stereo sound as a matter of course. But the launch dates are still uncertain, programme content as yet unknown, and hardware update prices (including MAC TV reception and small satellite dishes) likely to be substantially higher than simply 'going stereo' by adding NICAM 728 decoding to existing terrestrial PAL broadcast reception.

The other broadcast innovation could also prove to be a bit of a damp squib, judging by the current apparent level of interest amongst UK hardware companies. The BBC have been one of the pioneers of RDS (radio data services), are already sending out limited test broadcasts, and plan to be properly up and running when a linking computer is installed next Spring. However, the main appeal of its auto-tuning, station identification readouts and traffic information will be to the motorist, and the value to hi-fi enthusiasts may be limited. The BBC themselves are expected to license and brand a \$50-\$60 table radio aimed at the granny market.

The stage is set for the 'nineties leavened with optimism that the public actually wants all this new technology. Given that the LP is clinging on to its popularity well, and that the UK *increase* in the number of pre-recorded cassettes sold last year was larger than the *total* number of compact discs sold, there's going to be an awful lot of work for the marketing men to do. And much will hinge on the quango broadcast side of the equation, where politics seem more important than economics.



FOR YOU TO PLAY, NOT OTHERS TO PLAY WITH.

Catch someone playing with your Marantz PM35 Amplifier, and chances are, you'd be after their blood.

You'd be furious at their failure to appreciate its customised components, selected during months of listening tests, with the objective of getting the best 'musicality' and not just the best figures.

You'd be horrified that its superior build quality (unmatched in any other Amplifier under £160) was being taken for granted.

And you'd take great exception to the fact that someone was blind to the benefits of the CD/Phono direct switch.

A feature enabling the signal to be fed directly to the power amp via the volume control, which together with the tone defeat, brings out the full emotion and power of the music.

Ask your Marantz dealer for a demonstration, we promise he won't snap your head off.

marantz
Hear the music



READERS' WRITES CHOICE ANSWERS

PRAISE INDEED . . .

I must congratulate you and your colleagues for such a concise and informative series of *Hi-Fi Choice* consumer guides which must surely rate as the most consistent and unbiased collection of hardware reviews around.

I am currently seriously considering a total upgrade of my hi-fi system and am interested in the potential advantages that a CD source might possess.

From consulting your guides, I have my eye on the Sony CDP 710 player which I hope to listen to very shortly, in concert with models from Marantz, Technics, Denon and Yamaha.

There are two questions I have concerning the above player:

1) In your guide's specifications you note that the 710 has twin DACs which give zero phase difference between channels. However, no reference is made to this in Sony's 1987 catalogue, although the CDP222esd specs state that it has twin DACs.
2) Also, a Sony shop assistant told me in 'complete confidence' that the 710 will be increased in price by £50 by the end of this month as a result of your praise! Can you verify this rumour, and if so as quickly as possible.

Do you think that spending a similar amount on an analogue front end would give me better sound quality? I am considering the Linn Axis, Systemdek IIX, AR Legend or even AR EB101/Rega Planar 3. I could stand the pops & crackles (I look after my records) but am worried about committing myself now and having to change to CD in five years anyway.

P.S. *Hi-Fi Review* hates CD in favour of LP12's etc, are they biased?

J W GRONOW,
GLAMORGAN

As you may have noticed there has been considerable debate in the Hi-fi press about the supposed superiority of digital over analogue music reproduction. At this price level neither type is as obviously superior as if you were to spend say two hundred more, when a

good turntable can offer, in our opinion, better fidelity.

The proof lies in extended listening to both sources and deciding for yourself. The Axis and EB101 can both offer the silver disc serious competition, while an Elite Rock at £350 without arm should put most CD players in their place.

As regards the twin DACs in the CDP 710, we are assured by Sony themselves that this is the case. The price increase rumour you mention has not so far reached our ears, and Sony also deny all knowledge, so this may just have been keen salesmanship. Interestingly, the popularity of Sony's ES range is about to result in price reductions on some of these more expensive components. P.S. Is the Pope a Catholic?

AGRICULTURAL PERAMBULATIONS

Your review of the Quad ESL 63 is an insult to that remarkable company's 18 years work on the product. Tony Faulkner, a leading recording engineer who monitors on them called it: "a very significant advance in sound reproduction".

In a recent visit to a hi-fi show at the Penta hotel, the only decent demonstration was in the Quad room using CD as source (of which much rubbish is written by your ignorant scribblers). No one in that dem room was rushing for the door or retching in anguish, it sounded pretty good to me.

Most of the equipment in *Collection II* is only suitable for rock and pop music where finer, subtle details are of no real importance, an idiom that many reviewers seem to prefer. I, like others have been misled by so-called 'real hi-fi' products pushed by deaf reviewers and salesmen, but discarded the lot a long time ago. A 'real hi-fi' turntable has had a number of improvements made to it over the years and after each improvement sounds more like my cheaper reference.

The only suggestion I have is you take up farming instead.

Regards.

PAUL SMITH.

BUCKS

Ladies and gentlemen we give you Paul Smith.

WHEN IS A BARGAIN A BARGAIN?

I am writing concerning the now discontinued Philips CD104 compact disc player. As a student I am looking for a budget player to add to my present system which consists of a Dual 505-2 DL, Denon PMA707, Teac CX 3LO and B&W DM 110s. I bought *Hi-Fi Choice* vol 51 on compact disc players, and reading this confirmed my intention to go for either Philips CD 160 or a Marantz CD273.

However the Philips CD104 is now heavily discounted (as is the CD 150) and I was wondering whether this would be the better machine to go for. I have always admired its build, quality and appearance, but would like to know your opinion on how superior the 160/273 are (if at all), particularly in view of the fact that the 104 has only 14-bit four times oversampling. I have listened to the machines in a shop, but as you will appreciate this is hardly the best way to hear the differences, and I could not really tell them apart.

I would be most grateful if you could let me have your thoughts on this problem. The CD104 is some £40 cheaper than the other two machines.

K J MABBUTT,

BURY-ST-EDMUNDS

The Philips CD104 was reviewed in issue 40. It was later reviewed with the suffix 'B' at the lower price of £200 and achieved a Best Buy rating.

However, players in general have improved since the 104 and both the players you mention represent a definite sonic improvement.

You say that you auditioned these players and found little difference between them. This doesn't say much for the

auditioning facilities of the shop. We would suggest you visit a local specialist shop and do some listening there. They should be able to offer you a proper dem room and demonstrate some players using your amplifier and loudspeakers.

Given the amount you will be spending it would be worthwhile finding out what these players really sound like prior to purchase. It is also worthwhile considering good quality interconnect cables in order to get the most out of your player.

INTERCONNECT COUNTS TOO

I have a copy of "Compact Disc Players 1987". Your book is very detailed but you mention Celestion SL600's Cliff Stone stands, Van den Hul speaker cable, Krell KMA100, Cello Audio Suite Pre-Amp, but no mention of what interconnect between CD and Amp.

Could you please inform me as to what interconnect you recommend. I like a nice smooth sound and was thinking of the Marantz 273.

G A FISHER,

N. HUMBERSIDE

During the tests we used Siltech interconnect, but the very high price means it is probably not a realistic recommendation.

There are, however, several types of interconnect available that give satisfactory results at down to earth price. They include the DNM solid core type at £2 per metre unterminated, QED incon at £3.30 per metre, or the more expensive MDM terminated cable at £8.95 per metre. If you make up your own cables, remember that the quality of the soldering and plugs themselves all have a bearing on sound quality.

Regarding the purchase of a player we would suggest that you use our guide in conjunction with your ears and audition your own shortlist, preferably in the context of your own amp and speakers.

FROM THE INVENTORS
OF COMPACT DISC, THE
PHILIPS CD 473. A NEW
BRILLIANCE IN DESIGN.

BRILLIANCE

With compact disc, Philips introduced new levels of fidelity to sound reproduction. ▶ Now with the CD 473, they combine technological flair with the designer's art. ▶ It offers a specification so complete, no other player matches it at the price. ▶ The brilliance of its sound comes as no surprise. ▶ Philips' own 16 bit 4x oversampling where each piece of digital information is checked four times, sees to that. ▶ Less expected, perhaps, is the wealth of features designed into the machine. ▶ Philips' unique Favourite Track Selection system, for example, is included. ▶ So you can edit a disc to play only the tracks you like, in the order you like, as often as you like. ▶ Full remote control is specified with key pad and, unusually, a volume control. ▶ A beautiful shape where form follows function is also part of the deal, with controls placed logically for easy operation. ▶ It is a shape, moreover, that fits in totally with Philips' new range of hi-fi separates, allowing you to build yourself a perfectly matched system. ▶ Other niceties abound. ▶ A volume control on the headphone socket. ▶ An uncannily quiet loading tray. ▶ And a price that takes some believing - £250. ▶ The most brilliant touch of all, perhaps? ▶

TAKE A CLOSER LOOK

COMPACT
disc
DIGITAL AUDIO

PHILIPS FTS

PHILIPS

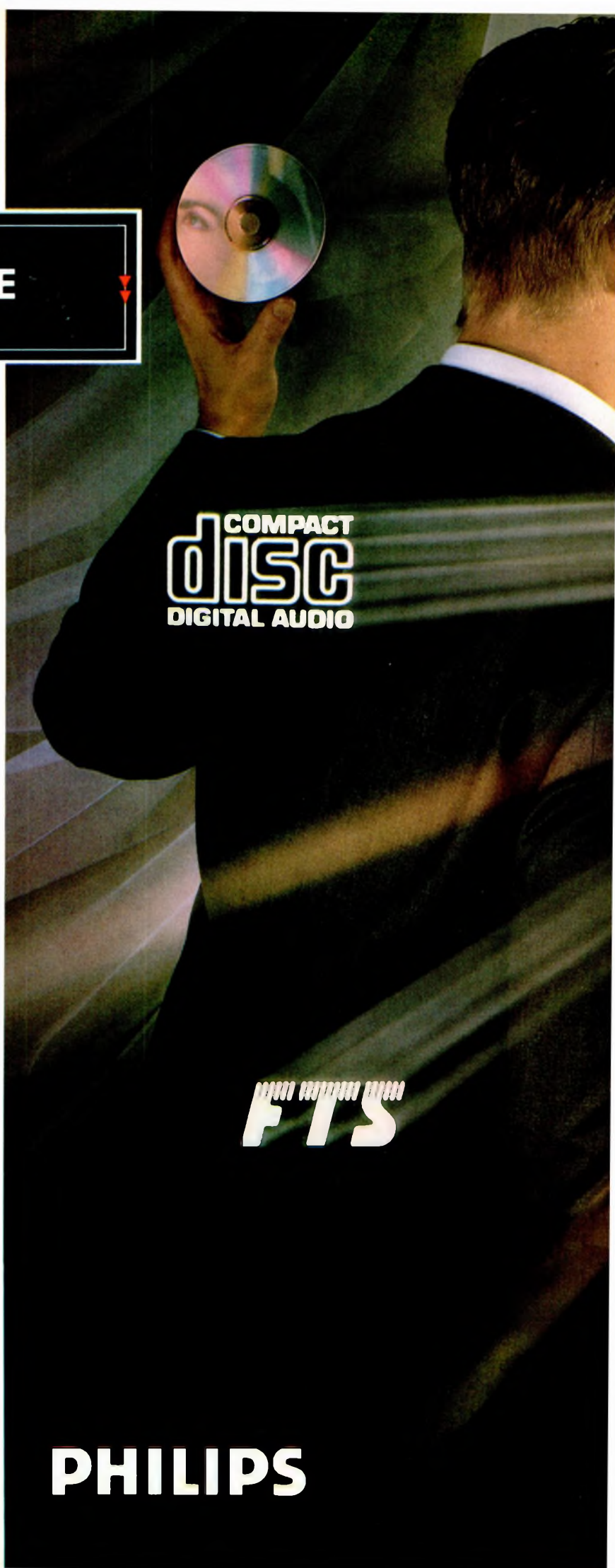

TIME

PAUSE

REPEAT

FTS



PHILIPS

SHOPY

POWER

WARNING: REMOTE CONTROL IS TRANSMITTER OF RADIO WAVES. EXCESSIVE EXPOSURE MAY BE DANGEROUS TO HEALTH. PLEASE USE REMOTE CONTROL WITH CARE.



FTS REMOTE TRACK SELECTION

FLUORESCENT TUBE DISPLAY

COMPACT DISC PLAYER CD 473

327

REMOTE CONTROL

PLAY/REPLAY STOP/PAUSE

DISC SEARCH

OPEN/FEEDBACK PAUSE REPEAT PREV. TRACK NEXT TRACK





AND THE SHOW GOES ON . . .

Our roving reporters bring you their findings from the recent crop of hi-fi shows across the globe, keeping you up to date on the very latest products and developments in the industry.

BERLIN REPORTBACK

The Berlin Show is ten times the size of Olympia, and plays to packed public crowds for ten days every other year. It's no hi-fi show – the real aficionados had been in Frankfurt a few weeks earlier – rather it is a fascinating alliance of broadcasters and consumer electronics manufacturers, generating a powerful vision-oriented spectacle, with audio cacophony thrown in.

Still, this was the first year the hi-fi specialists had been given a hall of their own. It may have been tucked away beneath the South Koreans, and in total area approximately the size of the Grundig stand, but they were putting on a brave face, and attracting enough attention to make photo-journalism near impossible.

Hence the near impossible pix of some near impossible hi-fi, plus some fairly desperate captioning to fail to make any kind of sense of it all. If you think the UK high end is sometimes bizarre, just take a look at what the Germans can come up with – or for that matter what our very own Michell can help them come up with for the German market. Maybe we need to learn something about styling . . . Maybe we'd rather not. And just maybe they pay rather too much attention to the window dressing . . .

On more mainstream matters, Sony's opening-day announcement that they would market DAT (digital audio tape) in Europe in October took the show by surprise, and caused much political rumbling. Others kept their 'prototype' stickers firmly in place, but Sony's frustration at the delays is clear. Not only do they have a range of three domestic and two Pro machines virtually ready to go, they also showed all the equipment for real-time or high speed (sprinter-style) software duplication.

One possible reason for DAT delay paranoia may be the MCD magneto-optical compact disc recorder seen on the Thomson stand. Clearly still very much a prototype, with unknown and possibly horrendous current hard- and software costs, its appearance outside the laboratory must be a warning that this rival digital recording format could be only a few years away. However, it is likely that initial applications will be in the pro audio and data storage markets, so there's no need to panic just yet.

TOMORROW'S VISION

Future TV developments were the key fea-

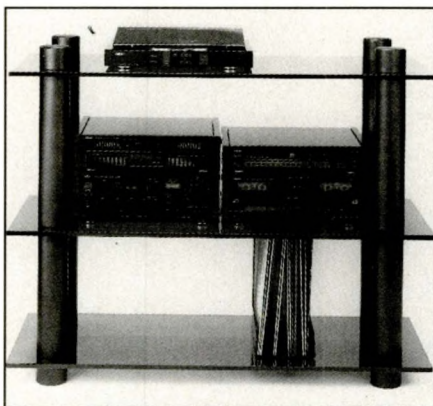

ture of the 1987 Funkausstellung, from products that can be expected to appear in the UK during 1988, via the European Eureka initiative towards high definition over the next five years, to other intriguing future possibilities such as an (almost) practical and highly effective experimental 3-D system.

However, the fact that the BBC have just decided to postpone the introduction of stereo sound on TV broadcasting yet again suggests that the integrated Audio/Video future the UK has been expecting for so long is now firmly back in the slo-cooker. Without stereo TV broadcasts as the major equipment purchasing incentive, hi-fi video, CDV and what have you will all find the going slow in the UK. (Cue to go and spend some more money on real hi-fi instead!)

CD Video appeared in the European PAL format in time for the show – but only just, giving engineers plenty of evening overtime keeping the prototypes in fettle. Picture quality still has lots of room for improvement, particularly from the 5-inch singles, but one positive sign is that visible progress was made during the ten-day span of the show! Spring '88 still looks the likely UK

Left: Akai separates, with furniture designed specifically for a finnickier German market. Right: Tomorrow's planned Euro TV, courtesy MAC encoding, gives higher definition, a wider viewing angle, less interference, and digital sound. A 5-10 year plan.

launch date.

Most impressive development to this pair of eyes was Sony's 'flicker free' colour TV, operating at a 100Hz refresh rate and using an on-board framestore of (undisclosed) memory size and coding. Compared side by side with a standard 50Hz set, the picture was much less fatiguing, with less flicker and much better definition in the bright areas.

I for one will be queueing up to add an expected £150-£200 premium when this becomes available, probably in Summer '88. Philips have a similar product in their 'Digital 100' top-of-the-line set, and Thomson too showed framestore 'flicker free' in their most impressive 'high tech' presentation. This is a real upgrade that will appeal to many hi-fi people who suffer watching fatigue when exposed to their TVs for too long.

JAPAN AUDIO FAIR 1987

Chuffed by the commercial success in the UK of their ES range of hi-fi, Sony took a dozen journalists off to see the 1987 Tokyo Audio Show, held concurrently with Penta. Hard-pressed editors took about 30 seconds to decide where their priorities lay, deputised the Penta reports and flew off towards the rising sun. (Well, wouldn't you?).

The chance to visit Japan's Audio Fair is rare and fascinating, if sometimes a little irrelevant. Having done the trip once, ten years before, the longterm perspective was sobering.

The show had certainly shrunk, but partly because some of it had shifted out to hotels and a manic schedule didn't leave time to do the full rounds. The main exhibition centre contained most of the big consumer electronics names, but few of the small specialist or imported brands. And there were some surprising omissions too – Sanyo, Toshiba, Sharp, Marantz, Rotel were all absentees.

That didn't stop the others from making a go of it, however. Stand design and the degree of marketing p'zzazz and professionalism was stunning to those reared on the UK's lacklustre showmanship. But the lack of specialist grass roots support for the multinational gloss left a rather superficial overall impression.

Analogue was notable for its absence. There is still some cassette deck activity, but hardly a turntable was seen apart from the obligatory plastic toy stuck on top of a downmarket midi stack. As far as the big boys are concerned, digital is here, now, and you'd better believe it!

The need to hype DAT was leaving conventional cassette decks (for all their virtues and compatibility) firmly in the shade – though whether DAT will make it still looks very much a moot point out there in the marketplace. And although plenty of manufacturers were paying lip service, their half-hearted efforts left Philips/Polygram to do the lion's share of the CDV (CD Video) drum banging, as they have been doing around the world.

SONY'S DIGITAL TOUR DE FORCE

If there was one genuine *Tomorrow's World* product on show at Harumi, it was certainly Sony's digital pre-amp. The technology is pretty hairy stuff, reportedly using 32-bit coding internally, and what we saw was clearly a prototype (though a beautifully presented one), reportedly only completed the day before.

But this is the one product digital audio needs if it is to offer something genuinely different from (even perhaps superior to) analogue. Hitherto the capabilities have been basically similar, with the digitals leading on convenience, lagging on quality. This pre-amp not only provided normal mixing,

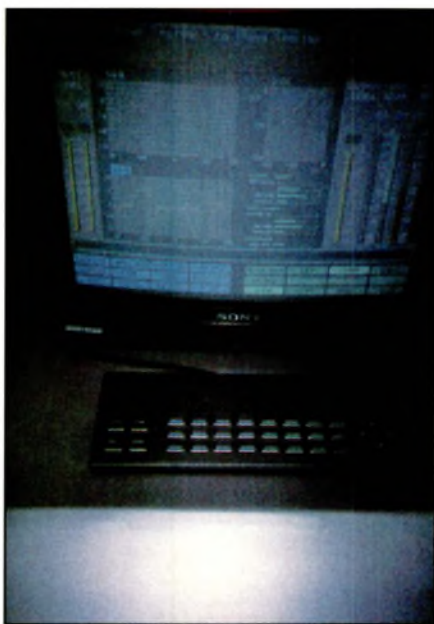

From top to bottom: Sony's prototype digital pre-amp, with 'black box' and on screen menu under microcomputer control. Sony's soft-look Soundy – next year's colour co-ordinated audio portable? Teac's top end silver CD separates. Unusually macho audiophile power amp from Stax.

equalisation and switching, but also a range of functions in the digital domain that are denied analogue by their very nature.

The prototype shown was unlike any other amplifier or pre-amplifier seen before. It consists of a large, featureless 'black box' about the size of a compact VCR, a small dedicated microcomputer-style keyboard, and a VDU (CTV monitor). The latter's menu was divided into 'static' and 'dynamic' processing; the former offered various tone control/filter/equalisation functions of unusual versatility; the latter could vary such parameters as attack, recovery time, pre-delay, and noise gating – definitely something completely different.

I'd be surprised to see UK availability before the beginning of the next decade. But one cannot deny the achievement, nor the additional rationalisation and credibility it provides for digital audio as a whole.

SOFTLY SOFTLY DAT

This year's hard sell saw clonelike machinery on most stands, though Sony are still on their own with a public commitment to October launch in Europe (at £1,300). (However, rumour has it JVC will be following only 24 hours behind.)

Technics and Sony alone showed portables – the former comfortably the smaller and less power consumptive, using a 180 degree head wrap, half-size head drum and outboard auxiliary power supply. However, Sony made it clear that their machine was carefully targetted at the serious amateur enthusiast, and implied that they were already capable of producing a DAT-man – and would do just that when the market was ready.

All manufacturers seemed to have one or three DAT machines, including mains and in-car variants. A couple particularly caught the eye. Aiwa showed a midi-size unit as part of a midi system, and this represents the first official erosion of prices on the Japanese market (by about 20 per cent). JVC too have an interesting (if somewhat abstruse) technical 'tweak' called *K2* on their top model, which is claimed to improve data fidelity.

DAT's future is still clearly in the balance, and manufacturers are gearing themselves for the long haul. Predictions of 30,000 machines for 1987 look decidedly optimistic, and the sharp merchandisers down in Akihabara are already pushing DAT out of the limelight and offering generous cash discounts.

There's no pre-recorded software on the Japanese market yet either, though we've seen a batch of European classical releases. One factor which should help bring down costs will be DAT's adoption as a computer data storage medium (*vide* recent Hewlett Packard/Sony announcement) – while any threat from re-recordable optical discs looks like being delayed a few years yet.

BUSINESS

Compact disc remains the source of hi-fi's current financial health – in Japan even more

TO QUOTE THAT WELL KNOWN MAXIM

Look at the nice things they said about the Maxim, with improved power handling and bass response, judge Maxim 2 for yourself by having a listen at your local dealer.

“So here is a loudspeaker that is truly more than the sum of its essentially modest parts. I wish you could have heard these matchboxes playing Mahler as though their very lives and soul depended on it...and all with a tangible stereo image and solidity. Great stuff!”

New Hi-Fi Sound Feb 1987.

“This is a powerful package at a remarkably civilised price. The Maxim is probably the cheapest true high fidelity loudspeaker on the market, which therefore brings down the entry price of a hi-fi system. Alternatively, when substituted in plans originally calling for more expensive loudspeakers, the Maxim can mean that money could be diverted to a better CD player.”

Compact Disc Review Dec/Jan 1987.

“To sum up then, I must say that I liked the Maxim a lot. It is strong on subtlety, rhythmic push and detail articulation. It has a surprisingly flawless treble quality, lacking in the usual cheap-speaker nasties, and its overall balance makes it a smooth, integrated and highly listenable speaker. I have no hesitation in recommending it.”

Hi-Fi Review Jan/Feb 1987.

“It has the slightly easier and more relaxed quality of the kind that generally goes with bigger loudspeakers – I preferred the Goodmans Maxim.”

Hi-Fi Answers March 1987.

Call Goodmans on (0705) 486344

2 Marples Way, Kingscroft Centre, Havant, Hampshire PO9 1JS

Goodmans SOUND

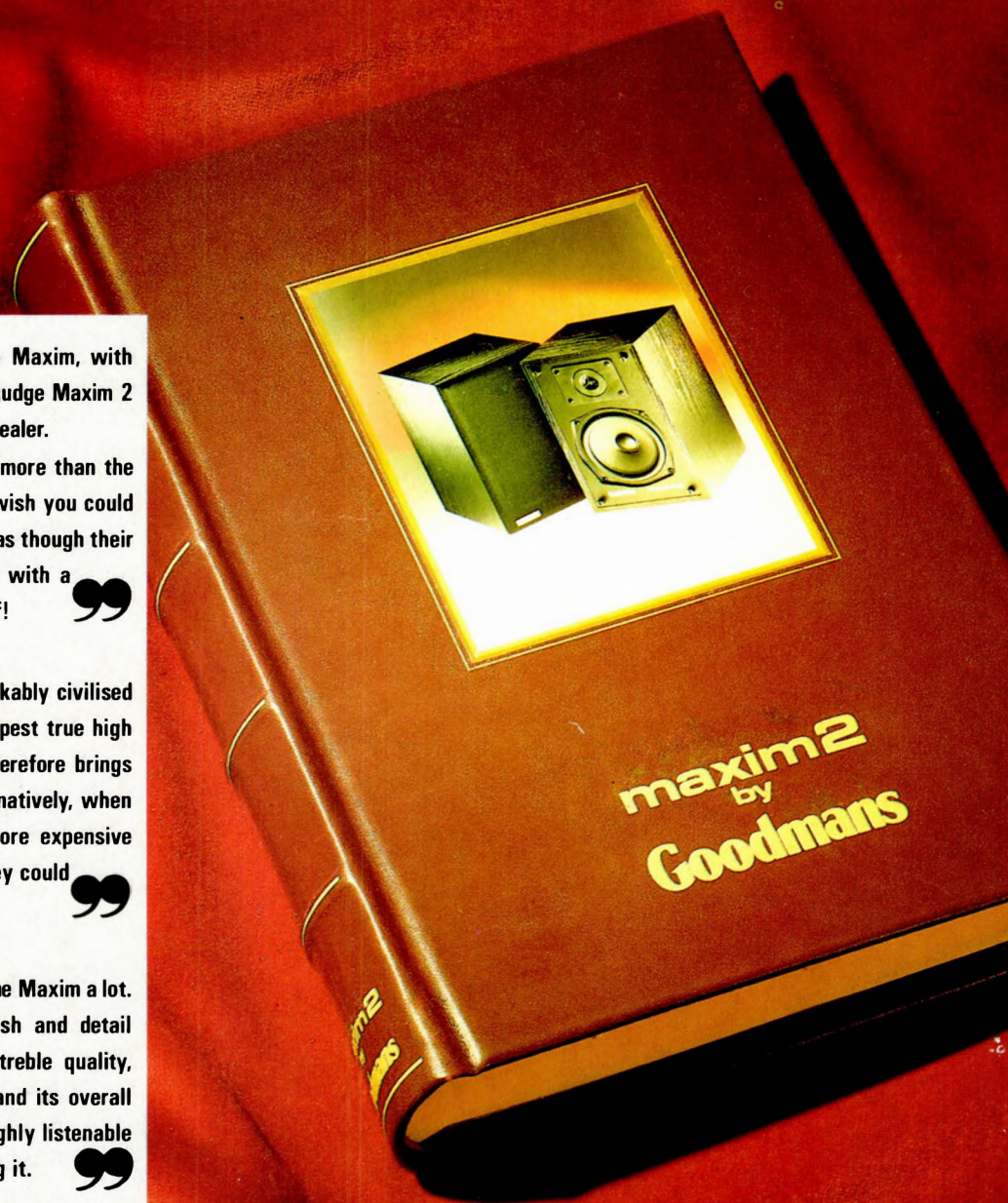



Sony's proposed c£2,500 'Grandad' system has CD player/tuner amplifier/subwoofer unit plus small satellites for stereo, all in piano finish cabinetwork. Should go well in Harrods.

so than the UK. The £400+ player accounts for only 2 per cent of UK sales (by numbers), the proportion in Japan is nearer 20 per cent. Sales of separate standalone players seem to have stabilised, though pre-packaged CD system sales should match this in the second half of 1987 alone. Integrated stacker systems are running at 1:4 against packaged systems, while portables are growing strongly to a similar total. It is interesting to note that Sony's *D-100* personal has occupied 1st or 2nd slot in the Japanese sales league from November '86 through to July '87 (and presumably thereafter).

Though the brands are still being kept separate overseas, in Japan Akai and Mitsubishi/Diatone have joined forces in a new A&D brand. Their display concentrated on Mitsubishi's technological strength, with plenty of emphasis on AV product, but it would be unwise to anticipate similar trends in the UK.

Sansui's new 'soft' revamped image seemed to be pulling in the crowds, with its pastel colours, raw metal sheeting and fishing net (*a la* Neal St.) decor, plus a little help from a Brooke Shields poster. Kenwood too

have strengthened their position on the Japanese market, with financial and distribution help from Toshiba.

SEPARATES

There are technical trends in separates too, notably a steady tweaking of digital circuitry as the learning curve continues to rise. Technics new up(Japan)market models feature 18-bit resolution with doubled-up DACs. Sony are sticking to sixteen bits, but with 8X oversampling on their ES model, along with some clever new error correction algorithms which prevent laser focus-pulling when faced with a disc blemish.

Most manufacturers showed digital amplifiers – though I can't for the life of me see any real point in paying lots of money to duplicate the DACs already in the CD player. These are interim products, offering little if any advantage over more conventional designs.

Onkyo in particular were promoting the virtues of 'opto-coupling', transferring digital signal from CD or DAT to the amplifier in the digital domain *via* fibre optic links. This technique does keep the earth paths clear of

DAC spurs – but also introduces whatever distortions arise from the optical to and from conversions.

Yamaha continue to build on the success of their *DSP1* surround sound processor and sundry semi-pro effects devices, which use digital techniques but interface normally with analogue amplifiers. A new *DSP 3000* has the nice new grey finish and allows direct digital input together with other improvements, but at a similar £1,000+ price point.

THE FASHION SHOW

We all know hi-fi separates are black, and have been so for several years. So maybe it's time for a change. After all, this is a fashion business, and there's no use trying to claim black is stylish when it's ubiquitous. Several top end 'luxury' separates are starting to appear in bright finish of one sort or another.

Yamaha's gunmetal is particularly attractive, while a variation on the champagne theme was seen at Sony. It's not even the tip of an iceberg so far, but I bet it gets bigger, as it certainly offers designers and engineers a chance to show off their finishing skills in a way black never can.

Not even pretending to be hi-fi, but certainly the fashion style in portables that everybody will start imitating in a year's time must be Sony's *Soundy*. By crossing a simple cassette portable with a handbag, they've come up with a new 'soft' line – that looks good in pastel colours; doesn't savage the owner or passers by when carried in crowds; and has useful little pockets for keeping cassettes in.

Again in the indefatigable search for untapped market niches, Sony have something for Grandpa to spend his maturing annuities on too. Priced at around £2,500 and shown in both Berlin and Tokyo, this slim and attractively shaped piano-finish central tower contains tuner, amplifier and CD player, plus a subwoofer bass, while two cute little satellite loudspeakers add midrange, treble and stereo with the minimum aggravation. The whole thing is convenience-oriented with full remote control and extensive features. Certainly not hi-fi in the specialist sense, neither is it consumer electronics nor furniture. My guess is that upmarket London department stores will welcome it with open arms.

Saving perhaps Sony's ES initiative, one was ultimately left wondering whether any of the companies really know where they are going on the hi-fi side. DAT still gives off an odour of mild desperation, while many of the most creative ideas seem oriented towards the personal/portable sector, the pro or semi-pro user (Yamaha, Teac), or the video consumer.

PENTA 1987

The 5th Penta Hi-Fi Show at Heathrow last September was to all intents and purposes a constructive exercise – on the first trade day alone, the numbers exceeded the total trade visitors for the previous year. Over 80 rooms and stands were exhibiting, with the usual mixture of bad and just about good sound – the latter is not intended as a criticism, as I defy anyone to produce an accurate sound in a hotel room, no matter what its size. But the public do appreciate good presentations – witness the queues outside the rooms with an appointment system, and the large numbers of disappointed punters who failed to get in.

General comments from the public? The usual complaints about the price of refreshments, and the preference for a central London venue. But more significantly, the absence of certain manufacturers was noted and regretted: UK companies such as Quad and Linn, besides foreigners like B&O, JVC, Sony, Akai, Aiwa, Sanyo and Technics. Purists might say that the non appearance of the larger consumer electronics companies was no bad thing, but I feel the market importance of 'mainstream' products should not be overlooked.

CDV was a hit; I am convinced that the manufacturers demonstrating machines need not have brought anything else with them. It is an exciting medium (*tell me that again five years from now – Ed*), and the discs will cost from £5 up, depending on length of play. Eventually 5, 8 and 12 inch discs will be available, offering different mixtures of Laservision video and CD sound. Launch is expected next Spring in the UK – but you will need a CDV-compatible machine, which is expected to cost around the £550 mark – a yuppie treat for Xmas 1988 perhaps?

In rarefied territory, selling the sort of equipment that is the stuff of dreams for most, Absolute Sounds were demonstrating the Apogee *Divas* and the Magneplanar 2.5s (respectively £8-9000 and £2,000 a pair), the latter sounding very smooth driven from the dapper little Goldmund *Mimesis* power amplifier. The *Amator* and Wilson *Watts* loudspeakers were also in evidence (£2,000 and £5,000), and not to be outdone Automation Sciences had new amplifiers from Conrad Johnson/Motif, plus an elegant high end turntable from Pierre Lurné, (estimated £4,000).

Again using titanium dome tweeters, B&W introduced the 1600 (£399 including stands), the 1800 (£499 inc) and their slim floor-standing *Concept 90* model (£895). Wharfedale's dem room was done over as a

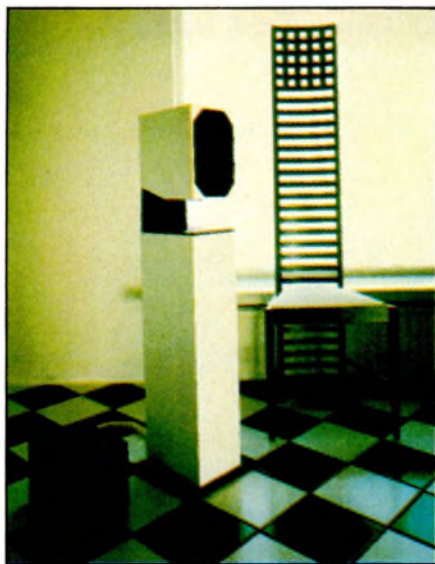

The B&W CM2 Mini Matrix tower and subwoofer, offering the Mackintosh chair a little competition on style grounds

restful sunny beach scene – a bit kitsch perhaps, but at least it was different enough to draw attention to their new *Ritz Diamond* (£149) and *Delta 70* (£159).

British CD manufacturers were also represented. There was Cambridge Audio with the now improved *CD2*, and A&R Cambridge with their new player. Meridian's *207* combined CD player/pre-amplifier now incorporates a phono input option, with all functions under remote control. The units can be fitted into an attractive wooden up-market rack (for want of a better word).

The only new product shown by KEF was 'KAR' – as the name suggests, a car speaker system. The company put on a display of 9 TV monitors showing how KEF speakers were designed, assembled and tested.

Celestion were successfully demonstrating their long awaited *SL 700* (£1,220 inc stands), as well as the revised *DL* range of speakers, now using titanium tweeters. Aristor had bi-wired versions of the *QLN* speakers they recently acquired, and Tannoy their *Eclipse* – a new budget two-way using all their own drive units. The *TDL* range, designed by John Wright of IMF fame, is now more widely available from dealers, and attracted its fair share of attention.

The British companies revealed a mix of innovation and nostalgia. The latter manifest itself in the old but revamped Leak *Stereo 20* tubed amplifiers, used by Simon Croft alongside a Garrard *301* and Quad's original *Electrostatic* to highlight his *Micro* pre-amp – and prove what a good sound can be had for a modest secondhand outlay.

Thoroughly modern valve technology was apparent in the Beard room; the company is all set for major expansion in the future, and was exhibiting a new mid-priced all valve pre-amp, the *CA35* (estimated £600). Radford Audio also had their new £600 valve pre-amp plus a 75watt £776 monoblock, and the heavily revamped old-timer *STA25 Renaissance* (£897).

Less exciting was the apparent nostalgia

for old design forms, although to be charitable, these have alternatively been described as 'timeless'. Cambridge Audio were showing their *C* range of amplifiers and preamplifiers, which strongly remind me of their 1960s predecessors. Mordaunt-Short are making their first entry into the electronics market with their £330 integrated *MSA500* amplifier, again a design which is distinctly reminiscent of certain '60s models.

It was good to see a proliferation of analogue sources at the show. Roksans and Voyds plus the odd Linn usurping CD in many rooms. Roksan themselves introduced a range of German amplifiers including the rather delicious Omtecs, plus a more down to earth valve preamp from Orange audio. Innovative as ever, Max Townshend had brought along his back-breaking gypsum cabinet loudspeakers, which feature a leaf tweeter and Aluminium woofer cones.

Naim were showing off their first concession to lazy audiophiles, the fully remote *NAC 52* preamp, but their long awaited electrostatics were tucked away in a trade only room, avoiding public gaze. Helios have obviously been encouraged by the success of the *SME V* to produce their own expensive tonearm. The close-to-a-thousand-pounds *Cyalene* is a substantial but attractively designed piece of equipment, which found some favour amongst the Voyd and Pink turntables around the show.

Vital Systems were making the most of a tiny room with the glamorous *Crystal Reference* turntable made by Oxford Acoustics, which was pushing out some pretty tangible sounds. Ion systems of *Obelisk* fame were sharing a room with Akroyd and making some floor shaking sounds with their *Nexus* power supply and amp unit – one box that can be upgraded without affecting the outward appearance by fitting various modules.

Anthony Michaelson, the gourmet behind Musical Fidelity, had spared no expense on tasty Continental biscuits. And of course brought along his new speakers. Taking up considerable floorspace but not actually in use was their new *A470* power amp which looks as if it could cause the Krells of this world a few sleepless nights – it even looks good. Indeed British hi-fi manufacturers in general seem to be paying more attention to aesthetics, which is good to see.

In the final analysis, Penta was about diversity and the great range of choice offered by specialist manufacturers. The rift between mass market hi-fi and the exotic 'high end' is now so great, it is very encouraging to see a healthy British industry busy building bridges, with decent sounds at decent enough prices.

The UK's biggest selling amplifier.



NAD 3130 £149.⁹⁵

The nearest competition.



NAD 3020E £109.⁹⁵

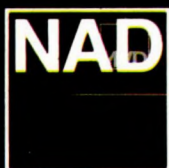

The most acclaimed Hi-Fi in the World

To NAD Sales, Axis 4, Rhodes Way, Watford, Herts. WD2 4YW. Tel: 0923 226499. Please send me literature on the full NAD range.

Name _____ Address _____



Don't miss the chance of a lifetime competition. Ten thousand pounds worth of Absolute Sound esoterica, the short cut to audio nirvana, must be won!

How long have you dreamed of owning the ultimate state-of-the-art hi-fi system? One that costs even more than your car!

Now's your chance to win such a prize in this *Hi-Fi Choice* competition. With the relaunch of the publication we are giving away the totally awesome system pictured opposite. Put together by high-end audio guru Ricardo Franassovici of Absolute Sounds, you know this one's gonna be a killer.

The system comprises the following goodies:

Oracle *Delphi III* turntable
SME *V* tonearm

Koetsu *Black K* moving-coil cartridge
Audio Research *SP-9* valve/FET pre-amplifier

Audio Research *D-115* valve power amplifier
Magneplanar *MG2.5* planar loudspeakers

Alternatively, fans of the parallel tracking arms and cone speakers can choose the Air-tangent tonearm and Sonus *Faber Electa* loudspeakers in place of the SME and Magneplanars. To be in the running to win this £10,000+ system, all you have to do is answer the five competition questions in this and the next two issues of *Hi-Fi Choice*, and send the completed forms to us. The first correct set of answers pulled out of the bag will win.

**WIN
A
£10,000
-PLUS
STATE
OF
THE
ART
SYSTEM!**

This month's questions are:

1) In which three sizes are CDV's available?

2) Who designed the Well Tempered arm?

3) Which 1960's hard rock album featured Jeff Beck, Ron Wood and Rod Stewart?

4) Who were Roksan's loudspeakers named after?

5) Which corporation pioneered the Accurate Pistonic Motion loudspeaker?

COMPETITION RULES

1) All entries must be on the entry forms provided. Photocopies will not be accepted and only one entry per reader will be considered. Entrants must submit completed entry forms for all three parts, in a single envelope. Incomplete entries will not be considered.
2) There is no cash or other alternative to the prize.
3) Employees of Dennis Publishing Ltd and associated companies, or their agents, or of the manufacturers and suppliers of the prize system components or their rela-

tives are not eligible to enter the competition.

4) The competition is not open to readers living outside the United Kingdom.

5) The main prize will be awarded for the first set of correct answers opened. The Editor's decision shall be final and binding. No correspondence whatsoever will be entered into regarding the competition.

6) All entries must be received by Friday, January 29, 1988. The winner will be notified by post and the results will be announced in the April 1988 issue.

Please keep this entry form until you have completed Part Two (January issue) and Three (February issue) then send all three completed entry forms to:

**HI-FI CHOICE COMPETITION,
39 GOODGE STREET,
LONDON W1P 1FD**

HEARING IS BELIEVING.



Introducing new audio wizardry
unlike any other system you have
heard before. Make sure to fly
long soon and ask your hi-fi
dealer for a demonstration.

For a free colour brochure ring
01-900 2866, 9am to 5pm, Mon-Fri.

MUSICAL
FIDELITY

CHOOSING AND USING . . . LOUDSPEAKERS

A pair of loudspeakers is as personal as a pair of shoes. A little care spent in choosing and correctly using will pay long term dividends.

If you're planning to spend one or even several hundred pounds on a new pair of loudspeakers, it does make sense to take at least as much care over the decision as one would in buying a pair of shoes. If you get the shoes wrong your feet will protest, so if you get the loudspeakers wrong your ears will rebel, and you will find yourself not using the system as much.

The first step on the road is to try and specify one's own personal and particular requirements, he writes glibly, opening several cans of worms. It is possible to do this on a basic, simplistic level, checking the price, size and intended location. But there are real benefits for those prepared to take a little more trouble. With a little care, the assistance of the data in this book, and (hopefully) the co-operation of a skilled retailer, the end result can be that much more worthwhile.

SETTING THE BUDGET

Those buying just loudspeakers will have a pretty good idea of the money they have available, which as ever is the fundamental bottom line of any purchasing decision. But there is – and always has been – controversy over the proportion of a budget that should be devoted to loudspeakers, *vis à vis* that spent on the other components.

Ten years ago conventional wisdom recommended devoting as much as possible to the loudspeaker, as it was regarded as the weakest link in the chain. An alternative philosophy, pointing out that the loudspeaker could do nothing to compensate for an inadequate source, switched attention towards turntables and amplifiers.

When setting the loudspeaker budget, it is vital to allow sufficient funds for a decent stand or support, and good quality connecting wire. From £150, for example, one should probably allocate £100 for the speaker itself, £40 or so for stands, and maybe a tenner for the cables.

PERSONAL PREFERENCES

Where one listener may be barely conscious of the subtleties of stereo imagery, another will take particular pleasure in pin-pointing musicians within a record acoustic. Likewise, those who listen predominantly to electronic rather than acoustic instruments are liable to sacrifice coloration in favour of dynamic impact.

While a magazine can assist in presenting these alternatives, it is only through skilled demonstration that an individual can be confronted with the different but equally valid options to make an educated choice for himself.

At the time of writing I am temporarily living with a £1000 system which suits me very well, but which certainly represents one extreme. It consists of a £600 turntable with £200 amplifier and £80 loudspeakers on £100 stands. At the other (rather less) extreme, another could enjoyably combine a £500 remote control multi-source midi-system with £500 worth of high performance, low coloration loudspeakers and stands. But unless one actually has the opportunity to hear the difference between these two very distinct approaches, how can one possibly have any basis for making a choice?

SITING IS IMPORTANT

The site chosen for loudspeakers is often as influential as the choice of loudspeakers themselves. Over the years I have used open stand locations, both with conventional box speakers and panel types, and also stand-mounted wall-backed designs. Each has its own strengths and weaknesses and imposes its own characteristics on the sound, so again personal preference enters into the equation. Some will suit one room layout better than another, and choice must frequently take as

much account of the visual as the sonic aesthetics.

Having chosen the siting, one may then choose the loudspeakers and stands to suit. Alternatively, choose the speakers you like in the shop, and then move them around at home until they sound to your taste.

The end result comes from a complex interaction between the loudspeaker, its support, its site, the acoustics of the room, and the general characteristics of the driving system. It is rarely entirely predictable. For those intending to spend a fair amount of money, it is not unreasonable to expect the luxury of a home demonstration, and/or the option to return and change a pair which do not suit after a day or two.

BIG ONES OR LITTLE ONES

For any given budget there is an obvious choice between large or small loudspeakers. One instinctive reaction is to favour the big one, particularly if it has lots of drive units, but others will plump for a miniature or compact on aesthetic grounds. In fact the differences and trade-offs are much more subtle and far-reaching.

Fundamentally, the larger the box the more extended the bass is for the same specific loudness. Ultimately a good big 'un is going to beat a good little 'un on loudness and bass extension, hands down. But it is also going to cost a great deal more. The large enclosed volume remains the route to extended bass, and this in turn adds 'weight' and 'scale' to the sound. But it can also reveal the low frequency inadequacies of the sources, be they the equipment or the recordings themselves.

Bigspeakers suffer from several innate disadvantages. Large box enclosures are expensive to build and ship, and represent an undesirably large surface area of unwanted radiation, which can colour the sound and blur stereo

precision. Extra drive units do increase power handling, but bring problems of crossover complexity and unit integration.

Little speakers can prove more fragile if used for the occasional party, and are certainly not at their best when trying to recreate the power and drama of rock music or a full concert hall acoustic. Their appearance is bound to be more discreet, but they will nearly always need a special stand to produce the best results.

MODUS OPERANDI

Given the excessive number of different models competing for attention, manufacturers are inclined to make much of the uniqueness of their particular brew. As a result the industry has become riddled with buzz words to describe any single type of engineering solution, and this leads to the sort of stereotyping which entirely misses the point of loudspeaker engineering.

Examples are legion, from the bextrene bass/midrange cones of the early 'seventies through to the latest metal dome tweeters which are currently springing up everywhere. The result is that people talk of a 'metal dome sound' as something desirable (or not) *per se*, whereas in fact there will be a whole range of different metal dome sounds, in all probability some distinctly more 'equal' than others.

The underlying axiom is that great loudspeakers are not created by adopting a quick technological 'fix'. Indeed, history has often shown that the 'radical innovation' is a mere flash in the pan, with benefits in one area more than offset by unforeseen penalties elsewhere.

Technology has steadily improved the performance of loudspeakers over the years, and some innovations have proved decidedly worthwhile. But the whole is much greater than the apparent sum of the parts, and the buyer should bear this in mind.

Beware of imitations

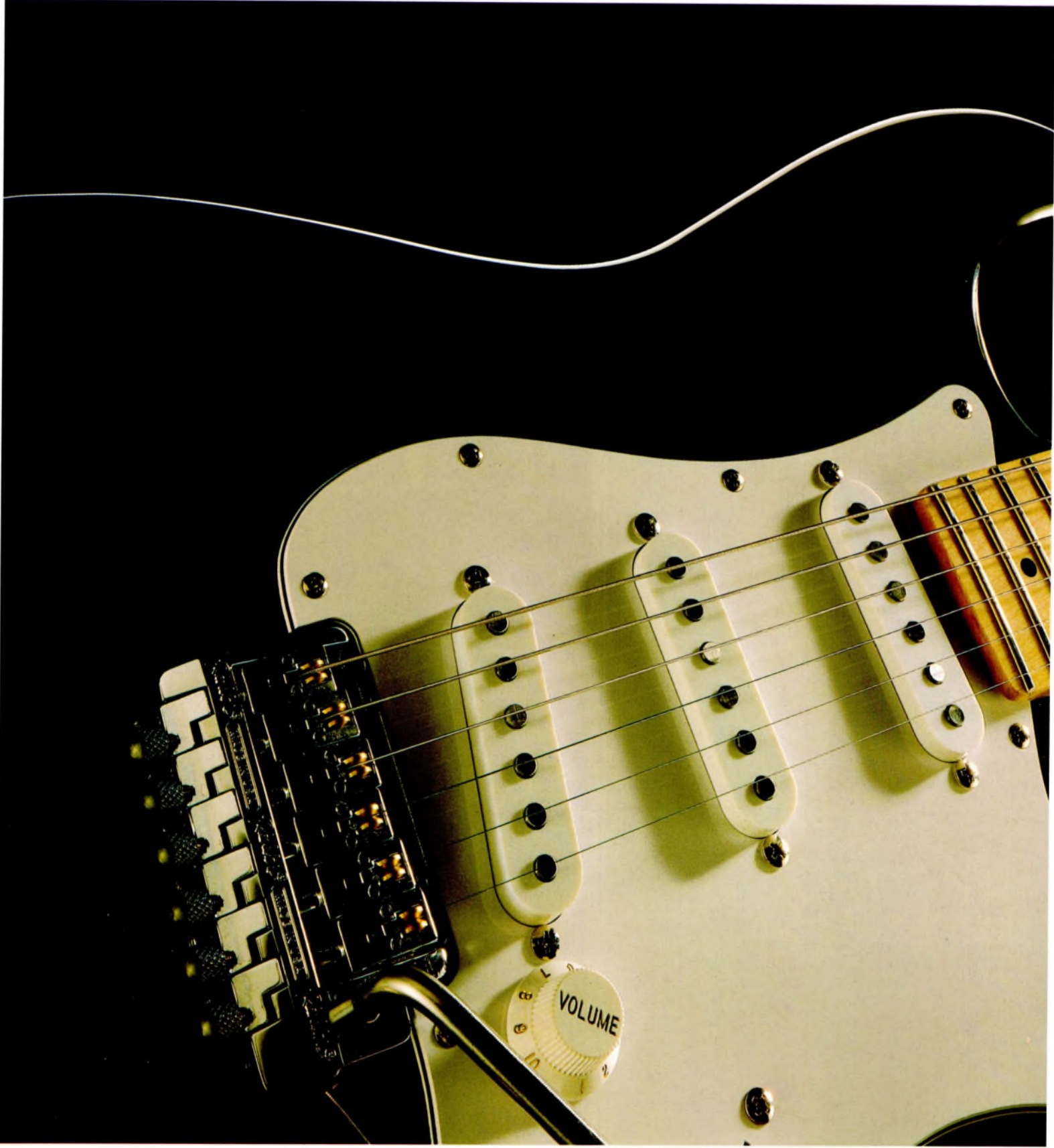



Akai M512 CD 2x55W midi system with CD player and infra-red remote control

A Fender Stratocaster is considered to have no equal. Many have tried to copy it. Few have succeeded in capturing its unique qualities. It may look the same, but it doesn't feel or sound the same.

In hi-fi, Akai is also considered to be among the very best.

We may have many imitators whose products look the same, but they're not quite like an Akai.

Since 1926, our belief has been the same. We've no desire to be the biggest, but we'll make every effort to be the best.

We are specialists in hi-fi products.

We are totally committed to research and development.

We welcome innovation. We copy no-one. If an idea is good and improves performance, then we adopt it.

Like Fender, we won't compromise.

Akai: For people who insist on having the genuine article.



For more information on the Akai range of products,

please phone our Sales Desk on: 01 897 0951.

AR 8BX

ACOUSTIC RESEARCH LTD, HIGH ST, HOUGHTON REGIS, BEDS LU5 5QJ. TEL: (0582) 867777

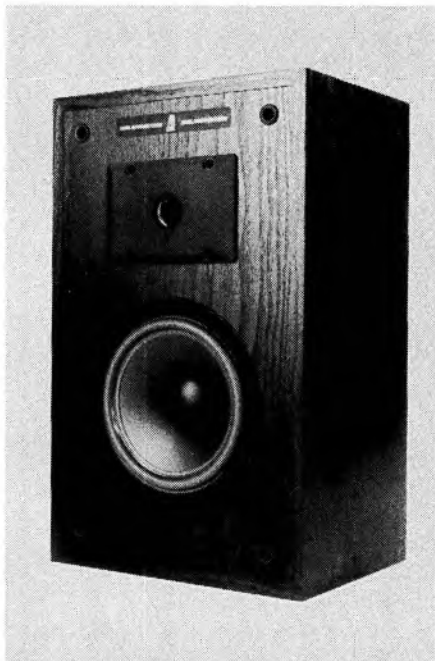

A little larger than some of the miniatures which have become successful recently, the AR 8 (and the slightly larger and even better known '18) are basic designs whose ancestors are now pretty well lost in the mists of time, though the BX suffix indicates fresh updating for the 1987 season.

This simple two-unit bookshelf model has a shallow sealed box enclosure and sells at a budget £100, the size suggesting that wall-mounting will be necessary to augment bass output. Finish and presentation are unexceptional, but the small cabinet's inherent rigidity is enhanced by a recessed rear panel and the use of 19mm chipboard throughout ('black ash' vinyl covered). Internal damping merely consists of a polyester wad.

The main change over predecessors is the introduction of mineral loaded polypropylene as the main bass/mid unit cone material. This (rather small diameter) unit has been carefully developed to provide natural mechanical roll-offs, allowing 'direct coupled' (crossover-less) operation. The ferro fluid-damped cone/dome tweeter is similar to that used previously.

The crossover is about as simple as is possible, consisting merely of one capacitor and one resistor as necessary protection of the tweeter unit against high amplitude low frequency signals. Internal wiring is joined using clips, and the rear panel carries 4mm sockets/binders. Build quality is essentially budget – the sealing ring of one bass unit was slightly offset, for example.

AR supplied special single pillar stands of substantial construction and appropriate

height to suit their various loudspeakers: these are made and marketed by Monotrak Engineering (122 Southland Park Rd, Wembury, S. Devon), and retail at around £49/pair.

LAB REPORT

Sensitivity is a highish 88.5dB/W, while the simplicity of the crossover ensures a good amplifier loading, typically of 8ohms with only gentle variations. An amplifier power of 20W will be sufficient to provide decent levels, while a maximum power handling of 50W seems logical in view of the limited cone diameter. Low frequency extension is inevitably compromised by a 95Hz system resonance, but the '8's -6dB point is a fairly respectable 70Hz, with in-room output down to around 60Hz.

The frequency responses showed a rather 'lumpy' effect in the mid and treble, and rather more unevenness than some of the competition. However, the off-axis integration was pretty good, and the grille played little part in the proceedings. The in-room averaged response showed some prominence around 1kHz, the expected bass deficiencies, a fair treble, and a fairly smooth overall character.

Distortion was quite good considering the small size, registering 1% or better even at a highish 96dB sound level. Some rise at 17kHz is noted, corresponding to a mild response peak at extreme high frequencies.

SOUND QUALITY

The PM listening panel rated the '8BX a very creditable average overall, praising a basically spacious, open and informative presentation, but with inevitable reservations regarding the lack of bass extension and power. The bass that was there seemed under pretty good control and coloration was fairly mild, though some criticism was directed at a treble quality described as a little crude and insistent, and some mid/treble muddle was noted on complex material.

Though rating the '8BX a little below average, the MC panel findings also indicate a good performance for the price and size. Good mid-range clarity again competed with the lack of 'weight', but in a miniature context this is certainly above average sonically, though it would have benefitted from a little more 'life'.

CONCLUSIONS

Inevitably hampered by its small size, the '8BX nevertheless delivers a respectable sound quality, competent lab performance, and acceptable build quality at a very reasonable price, and in the context of miniature speakers is certainly well worth considering.

GENERAL DATA

Size (height x width x depth)	40 x 25 x 19cms
Recommended amplifier power per channel (for 96dBa minimum per pair at 2m) (20) – 50W	
Recommended placement	on shelf or 50cm stand near wall
Frequency response (+/-3dB, 2m)	95Hz – 20kHz
Low frequency rolloff (-6dB, 1m)	70Hz
Voltage sensitivity (ref 2.83V or 1W into 8ohms, 1m)	88.5dB/W
Approximate max sound level (pair at 2m)	100dBa
Impedance characteristic (ease of drive)	good
Forward response uniformity	below average
Typical price per pair inc. VAT	£100

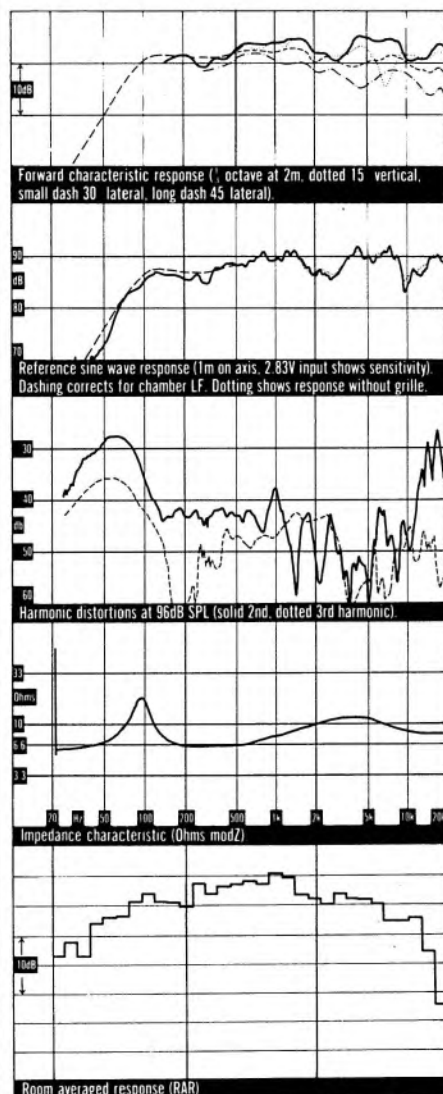

AR 22BX

ACOUSTIC RESEARCH LTD, HIGH ST, HOUGHTON REGIS, BEDS LU5 5QJ. TEL: (0582) 867777

RECOMMENDED



AR's 22 was a recommended model in *Choice: Loudspeakers*, 1986. Remarkably similar to the Best Buy '18, it shared the same drivers and similar cabinet dimensions but had a more elaborate crossover network (though in our opinion the cheaper 18 was slightly better balanced). This year all these various AR models have received the BX treatment, and the company has shuffled the ingredient pack so that the 22BX becomes a slightly larger mid-size two-way bookshelf model costing around £160.

The polypropylene bass/mid driver is now used '18-style, sans crossover circuitry, though a new network now feeds the slightly modified 26mm tweeter. The sealed box cabinet has additional internal bracing and uses 19mm chipboard with a vinyl 'wood' veneer of reasonable quality. Internal damping consists merely of a polyester wad, while the woven polyester grille has been carefully mounted to avoid sonic interference.

The 22BX is best sited close to a rear wall, on stands about 50cm high or (if you must) a bookshelf. AR supplied special single pillar stands of substantial construction and appropriate height; these are made and marketed by Monotrak Engineering (122 Southland Park Rd, Wembury, S. Devon), and retail at around £49/pair.

Finish was good, and construction sound enough if a little on the cheap and cheerful side, with internal wiring held by clips. The bass/mid unit is 'direct coupled' to the amplifier, relying on the natural roll-off of the drive unit, while a second order network feeds the tweeter

LAB REPORT

The high sensitivity of 89.5dB/W is well suited to budget amplifiers, providing good levels from as little as 15W, plus decent maximum loudness from a suggested 75W maximum. The impedance characteristic looks gentle enough, averaging around 8ohms and providing a simple amplifier load. The system resonance of 73Hz provides a -6dB bass roll-off at 55Hz and useful in-room output down to 45Hz - figures which show a slight improvement over the earlier 22, reflecting the slightly larger enclosure.

The response trace is clearly optimised for wall mounting, being +3dB above 250Hz when measured in free space. The on-axis curves are pretty smooth overall, but the off-axis plots are much less even through the crossover region; the grille had little effect. The in-room averaged response showed quite good bass extension for this type of loudspeaker, but a mild prominence centred on 1kHz with a slight loss of energy above the midrange.

Distortion was poorer than average, with a consistent 1% 2nd harmonic through the mid-band and significant rises at low frequencies at higher levels. Pair matching was within a close +/-0.5dB.

SOUND QUALITY

The PM listening panel warmed to the sound of the 22BX, giving a solidly above average rating which is very creditable for the price. Though slightly forward and 'projected', the sound was nicely 'out of the box', lively and informative, with fair separation of detail and some 'air'. There was mild criticism of the treble 'fierceness' and some mid unevenness. The sound could have been tidier, but the lively, 'bouncy' qualities more than compensated.

The MC listeners were less enthusiastic, rating the 22BX a little below average, finding the balance difficult to come to terms with either wall-mounted or in free space, though the former was preferred. The bass showed reasonable beat and drive, clarity and detail projection was good, but piano had a 'middy' tendency, lacking real body and power, and criticism was directed at a 'vicious' character on vocals and strings.

CONCLUSIONS

The 22BX shows some improvement over the 22 in some areas, but not consistently so - the earlier treble 'sting' has been tamed if not eliminated, but off-axis response is now less even. Nevertheless, it is basically soundly engineered and gave very respectable sound quality for the price, albeit not consistently from one listener

to another, so firm recommendation is still appropriate.

GENERAL DATA

Size (height x width x depth)	47 x 29 x 22cms
Recommended amplifier power per channel (for 96dBA minimum per pair at 2m)	(15) - 75W
Recommended placement	shelf on 50cm stand near wall
Frequency response (+/-3dB, 2m)	68Hz - 20kHz
Low frequency rolloff (-6dB, 1m)	55Hz
Voltage sensitivity (ref 2.83V or 1W into 8ohms, 1m)	89.5dB/W
Approximate max sound level (pair at 2m)	104dBA
Impedance characteristic (ease of drive)	good
Forward response uniformity	below average
Typical price per pair inc. VAT	£160

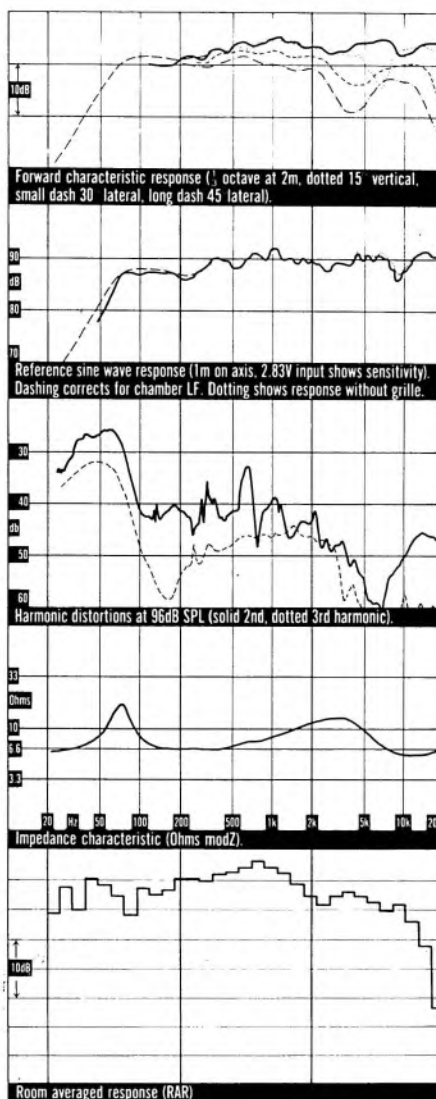

AR 35BX

ACOUSTIC RESEARCH LTD, HIGH ST, HOUGHTON REGIS, BEDS LU5 5QJ. TEL: (0582) 867777



The success of the £340 44 has prompted AR into developing this new, smaller three-way design along similar lines, to sell at a commensurately cheaper price. The result is this new £250 35BX, a 'compact monitor' size enclosure with an internal volume half that of the 44, suitable for free space siting on rigid spiked stands 40cm or so high. Plain yet smartly finished in a 'wooden' vinyl wrap, the woven polyester grille cloth is fixed on a regrettably thick frame with no effective rebating.

The sealed-box enclosure is constructed from substantial 19mm chipboard, and has internal bracing and a recessed back to improve rigidity. Internal damping consists of polyester wadding, and presumably in the interests of economy there is no separate chamber for the midrange unit, *a la* 44. Build quality is sound enough, though clearly within close budget constraints.

The bass and mid units are quite similar, featuring mineral-loaded polypropylene cones in steel baskets. They operate in tandem at low frequencies, the 210mm bass unit rolling off gently early on to allow the 165mm unit to take charge in the midrange. This approach allows the mid-unit to be direct coupled to the amplifier, relying on its natural high frequency roll-off. The bass unit has a 1st order roll-off, while the tweeter is fed *via* a 2nd order network. Wire clips connect to the driver terminals.

LAB REPORT

The 35BX recorded a remarkably high sensitivity of 91.5dB – nearly 3dB more than the original 44, and more than enough to get high loudness levels from even the smallest amplifier. However, the price is twofold: first, the impedance is pretty low (3.3ohms min., 5ohms typical), drawing 3dB worth of extra current from the amplifier than an 8ohm model; secondly, the bass is not particularly extended considering the size of the box. The system resonance at 84Hz results in a –6dB at 55Hz, so in-room output extends no lower than 45Hz.

The response traces are distinctly unpromising. Not only does the grille introduce its own measure of distortion, but the tweeter seems unable to match the bass and mid level as one moves further than 1m away, and there is a substantial 10dB suckout through the presence region spanning nearly two octaves. Elsewhere the trends are quite smooth, with reasonable off-axis performance. These trends are confirmed in the averaged in-room response, which indicates fair low frequency extension. Distortion was moderate at both 86dB and 96dB.

SOUND QUALITY

Suckout notwithstanding, the 35BX was given a reasonable enough reception by both panels, rating average overall though with some disagreement between individuals. There was a definite touch of the 'boom'n'tizz', with the mid bass and lower treble both sounding a trifle exposed, leaving some midrange coloration besides.

The balance inaccuracies seemed rather more unsettling on classical material, where there was some tonal confusion, detail muddling and stereo flattening. In contrast, rock material tended to sound a little larger than life – not strictly accurate but not unattractive in a system where the bass was qualitatively pretty good, with power, differentiation and liveliness.

CONCLUSIONS

High sensitivity (= loudness) often proves a most effective point-of-sale stimulus when demonstrated on the shop floor, but it is difficult to avoid the conclusion that AR have gone a little too far in the case of the 35BX, compromising a neutral overall balance in the quest. As an allrounder it doesn't quite make the grade, though rock enthusiasts could well find the total package much to their taste.

Note: As our first preproduction models were faulty we were unable to carry out pair matching.

GENERAL DATA

Size (height x width x depth)	58 x 26 x 27cms
Recommended amplifier power per channel (for 96dBA minimum per pair at 2m)	(10) – 75W
Recommended placement	free space, 40cm stand
Frequency response (+/-3dB, 2m)	see text
Low frequency rolloff (-6dB, 1m)	55Hz
Voltage sensitivity (ref 2.83V or 1W into 8ohms, 1m)	91.5dB/W
Approximate max sound level (pair at 2m)	104dBA
Impedance characteristic (ease of drive)	below average
Forward response uniformity	below average
Typical price per pair inc. VAT	£250

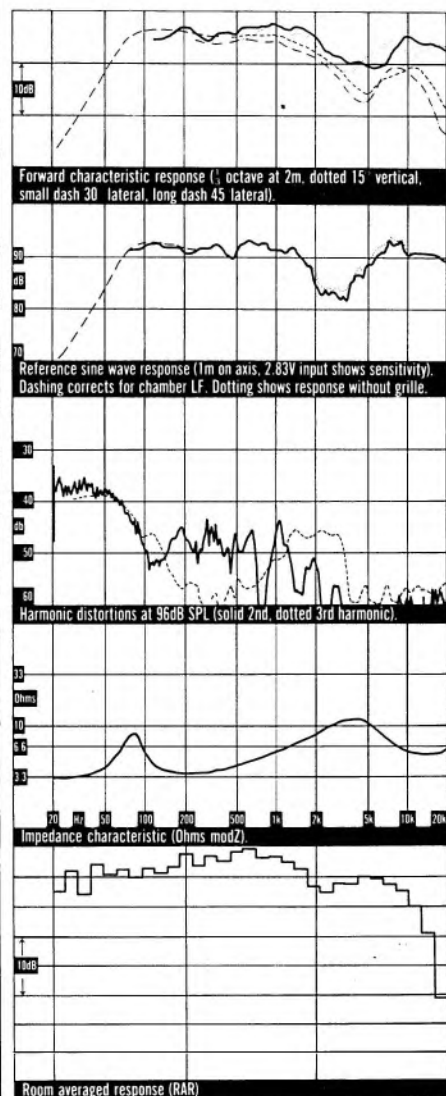

ARCAM TWO

A&R CAMBRIDGE LTD, DENNY INDUSTRIAL ESTATE, WATERBEACH, CAMBRIDGE CB5 9PB. TEL: (0223) 861550

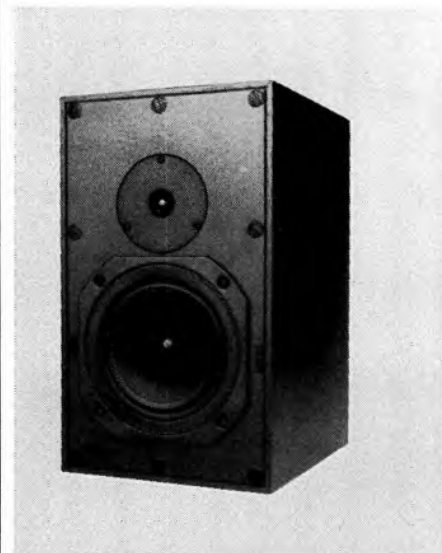

Originally famous for their amplifiers and tuners, A&R have also found success with their range of cartridges and the Arcam series of loudspeakers. (They are now trying their hand with cables, and will happily supply *Livewire* to go with Arcams.)

This latest version of Arcam *Two* is similar to its eponymous predecessor in overall format, but with numerous detail changes. It is a compact 14 litre two-way with a number of luxury refinements in the construction. Reflex loaded to provide good sensitivity and bass extension, the bass alignment nevertheless needs some wall reinforcement. Though the various ingredients all look very promising, build quality was regrettably marred by a dry joint in one of the crossovers, due to inadequate soldering of heavy gauge wire. Finished in real black ash veneer, the side panels and (braced) baffle are 19mm MDF, with internal bituminous damping pads, plus foam and polyester fibre infill. A quality foam grille avoids any acoustic compromise.

The bass/mid driver is on the small side, with a 125mm Kobex cone on a steel frame, crossing over to a 19mm plastic dome tweeter. The 2nd-order 4-element crossover uses generous components with high power handling capacity, plus substantial wiring. Too late for our tests, the current Arcam *Two Plus* is now delivered ready for bi-wire operation. A matching Medite pillar stand costs an extra £40.

LAB REPORT

Sensitivity is an above average 88dB/W, giving good levels from as little as 20W/channel amplifiers and well matching the Arcam amplifiers; 75W would seem a sensible

maximum, giving pretty good loudness for the size. The sensitivity has not been achieved by drawing extra amplifier current, the *Two* being an easy load, while the reflex loading and wall site alignment help provide quite respectable bass extension (-6dB/55Hz).

The response trace confirms the need for wall proximity, and even so the balance might be a touch 'lean'. There is some general unevenness, with a particular problem at 550-650Hz. However, the mid/treble integration is good, crossover integration excellent, and the off-axis consistency very good, though it is as well to avoid listening from above the main axis. The in-room response was less promising, confirming the 600Hz cone breakup and showing some midband energy prominence, plus some bass unevenness and reflex boom with rapid roll-off below 50Hz.

Distortion was a little high, typically 1-2 per cent at 96dB, though better at lower levels; once again the 600Hz problem is emphasised. Pair matching was excellent - +/-0.25dB!

SOUND QUALITY

The Arcam *Two* scored a straight average rating in both listening tests, which is a respectable result for such a compact design, indicating wide acceptance with different systems and listener tastes, albeit with a slight bias towards CD as source. The *PM* panel praised a generally lively, 'bally' character with good 'speed' but mild treble 'brashness' and midband coloration. Upper bass was a trifle rich, helping to fool the ear into overlooking the inevitable lack of extension and 'weight'.

The *MC* panel corroborated the slight bass 'heaviness', but confirmed the preference for wall siting. Specific praise or criticism was in short supply, replaced by a (faintly grudging) acceptance of consistent, well integrated allround competence - generally good, but lacking 'magic'.

CONCLUSIONS

A&R Cambridge have a particular knack for creating well balanced 'most things to most men' products, and the current Arcam *Two* fits squarely in this category. Unlikely to disappoint, it is unlikely to attract cult allegiance either. But it is certainly worth considering, especially with the prospects of further improved sound through the now available bi-wire option (not tested).

GENERAL DATA

Size (height x width x depth)	38 x 23 x 28cms
Recommended amplifier power per channel (for 96dBA minimum per pair at 2m)	(20) - 75W
Recommended placement	near rear wall on shelf or 40cm stands
Frequency response (+/-3dB, 2m)	80Hz - 20kHz
Low frequency rolloff (-6dB, 1m)	55Hz
Voltage sensitivity (ref 2.83V or 1W into 8ohms, 1m)	88dB/W
Approximate max sound level (pair at 2m)	102dBA
Impedance characteristic (ease of drive)	V good
Forward response uniformity	good +
Typical price per pair inc. VAT	£250

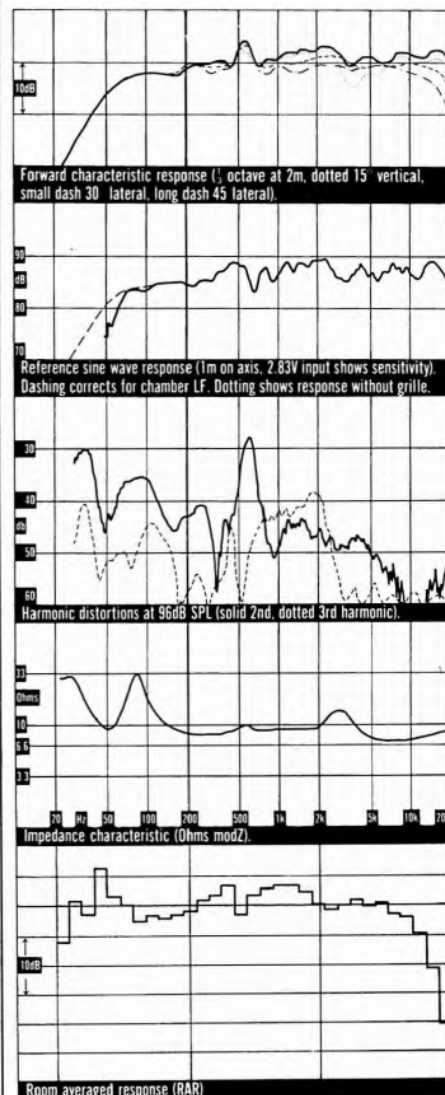

For your

AX-330 (60 watts per channel).

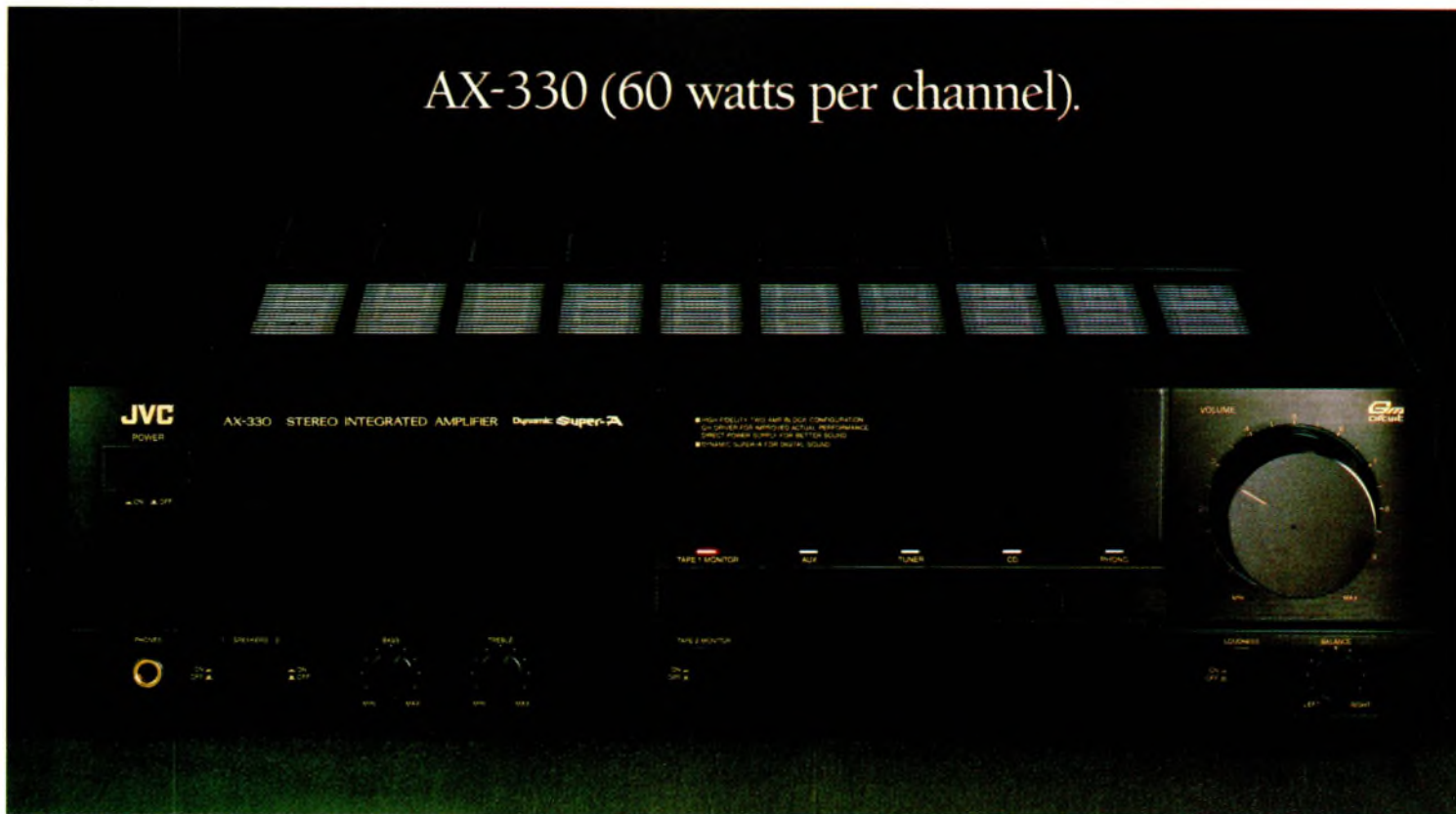

AX-440 (85 watts per channel).

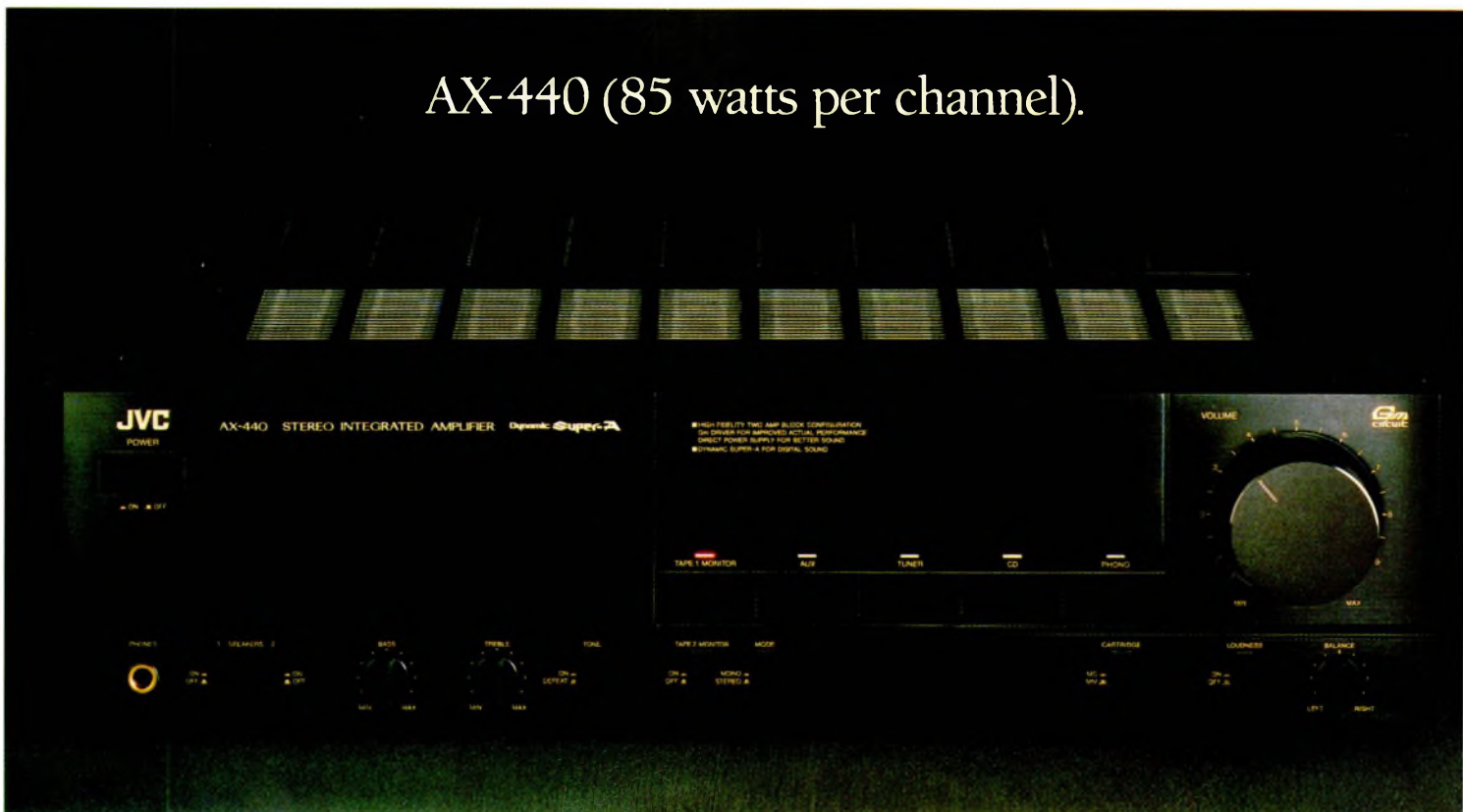

ears only.

Amplifiers, unlike children, should be heard and not seen. Chosen by ear, not eye.

Too often however, the listening ear fails to pay attention, as batteries of dancing lights catch the eye.

But now, with the realism of sound available from compact disc, even greater demands are made on the amplifier.

At JVC we believe we have met these demands.

But our answers are, as you see, not flashy ones.

Firstly there is the AX-330 BK.

It has a power output of 60 watts per channel, and features a dynamic super-A power amp, unique to JVC, that ensures low distortion throughout the whole audible frequency range.

It has JVC's GM driver circuit and 2 amp construction with direct power supply.

This renders harmless the effects of counter-electromotive force and variation in speaker impedance, and helps keep total harmonic distortion to the exceptionally low level of just 0.007%.

In simple terms; a purity of sound.

Our AX 440-BK amplifier boasts all the same features. But the power output is boosted to a powerful 85 watts per channel.

It also has a high gain phono equalizer for moving magnetic or moving coil cartridges, and a THD level of 0.007% at 8 ohms.

Both amplifiers have modest prices to match their modest looks; £149 and £199 respectively.

Thank you for listening. And may you never be led astray by the bright lights again.

The JVC logo is displayed in a bold, sans-serif font. The letters 'J', 'V', and 'C' are connected, with the 'V' being the tallest and the 'J' and 'C' being shorter and wider. The logo is rendered in a light gray color.

The JVC range of amplifiers consists of 9 models priced from around £80 to around £490.

ARCAM THREE

A&R CAMBRIDGE LTD, DENNY INDUSTRIAL ESTATE, WATERBEACH, CAMBRIDGE CB5 9PD. TEL: (0223) 861550



The *Three* is the baby amongst the Arcam speakers, the company numbering down rather than up the range. The £150 pricetag is significantly higher than some other miniatures, but tends to reflect an unwillingness to compromise in the quality and cost of materials used – though A&R have resorted to vinyl rather than real wood finish in order to keep the price down. Optional £46 pedestal spiked stands are available, and these or something similar should be used to bring the speaker up to listening head height with rigid support – shelf mounting is feasible, but less satisfactory from a performance perspective.

This latest version of the *Three* is similar to its eponymous predecessor in overall format, but with numerous detail changes. It is a compact 8 litre two-way design, reflex loaded to provide good sensitivity and bass extension, but the bass alignment definitely needs some assistance from a nearby rear wall. The ingredients are promising enough, with 18mm cabinetwork throughout and the front baffle in 19mm MDF, plus foam and polyester internal damping. The grille is foam too, and so will not prejudice the sound at all.

The small (100mm active diameter) steel frame bass/mid unit now uses a polypropylene cone in place of the Cobex of earlier versions and other Arcams. Construction and build quality is good for the price, the crossover being a 4-element hard-wired design.

LAB REPORT

For such a small loudspeaker, the sensitivity is an ambitious 88.5dB – usefully high for in-shop comparisons and in terms of making life easy

for a modest amplifier, but with inevitable compromises in bass extension. The crossover provides a minimum load at 2-3kHz, right in the midband, but the value of 60ohms is conservative enough and should be kind and considerate to the amplifier.

The response traces are less promising, showing a quite pronounced 'forwardness' peaking in the midband and depressed in the bass, with some general unevenness besides. Even though wall mounting will help to compensate for the suppressed bass range, it cannot add sufficient boost to give a balanced end result – as the room response confirms. Driver integration and overall dispersion are both pretty good, the dotted trace (2m) confirming A&R's recommendation that the speaker is best heard at or below the main axis, perhaps by means of a slight backwards tilt.

Distortion was pretty well controlled with good consistency, but treble region spurs are a little higher than most designs. Pair matching was reasonably good, within +/-1dB from 500Hz-1.5kHz.

SOUND QUALITY

The *Three* was not liked by the *PM* panel, rating poor overall despite care taken in siting and resort to alternative stands. The problem area was a thin 'bright' balance – a characteristic this panel tended to like in moderation but not to the extent encountered here. In fact the bass/mid balance was less to blame than the 'fierce' characteristics of the treble, though dynamics, focus and integration were all considered pretty good.

The *MC* panel rating was slightly better, though still below average overall, again as a result of a 'thin', 'bright', if clear sound. Potentially good ingredients were marred by the lightweight if tuneful bass, the forward balance and 'squeaky' violins, and some vocal coloration.

CONCLUSIONS

Though there are many promising elements in the Arcam *Three*, the whole failed to gel with our listening panels, partly because of the sacrifice in bass level and extension, and partly our suspicion of the treble quality. Engineering, however, is entirely competent in other respects, and there could well be system contexts which give rise to a different judgement.

GENERAL DATA

Size (height x width x depth)	34 x 18 x 23cms
Recommended amplifier power per channel (for 96dB minimum per pair at 2m)	(20) – 50W
Recommended placement	close to wall on shelf or stand at head height
Frequency response (+/-3dB, 2m)	140Hz – 20kHz
Low frequency rolloff (-6dB, 1m)	95Hz
Voltage sensitivity (ref 2.83V or 1W into 8ohms, 1m)	88.5dB/W
Approximate max sound level (pair at 2m)	100dB
Impedance characteristic (ease of drive)	good
Forward response uniformity	good
Typical price per pair inc. VAT	£150

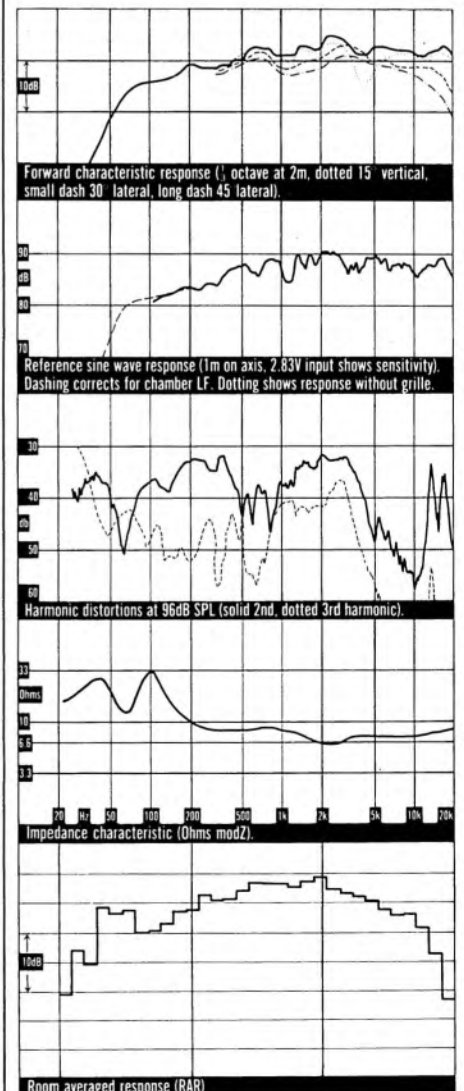

AVANCE 120

HW INTERNATIONAL LTD, 3-5 EDEN GROVE, LONDON N7 8EQ. TEL: 01-607 2717



The Danish Avance range of loudspeakers have been available in the UK for a year or so now, though the model tested here is their latest and cheapest so far. All are characterised by an enclosure which is cast from a fibrous concrete composite, and finished in a textured white enamel.

The amalgam of polyester fibre loaded with ceramic material gives various worthwhile characteristics – it is rigid, heavy and inherently inert. A further by-product of the concrete casting process is the ability to form shapes which avoid the parallel sides and standing wave modes of the traditional box shape. There are therefore several justifications for Avance's cabinet approach, but it must be pointed out that the results are aesthetically unusual, and not to every taste: white concrete may slip easily into the high tech environment, but it doesn't do a lot for stripped pine.

Quite distinct from the larger floorstanding pentagonal models which 'til now constituted a four model Avance lineup, the new £280 120 is a pyramidal 'bookshelf' size design, featuring two drivers in a sealed box enclosure. However, because only the base is wooden, this is where the terminals are sited, which can be inconvenient from a wiring point of view. Special stands are available for £39, but these were not supplied so we did the best we could.

The drivers consist of a 170mm steel frame doped paper cone bass/mid unit (VIFA), coupled to a 19mm soft dome tweeter. The 2nd order 4-element crossover is hard-wired with good power capacity, and uses a film capacitor to feed the HF unit. Build quality was reasonably good, though a slight leak was detected on one cabinet. Nominally intended for free-space siting on 40cm stands, some environments will benefit from siting closer to a rear wall, and in

fact the best response was found from an angle of 7 per cent above the horizontal, so low stands might be preferred. Regrettably the unrebated grille had a significant effect upon the response, so might be better left off (try listening in sunglasses!).

LAB REPORT

Sensitivity is about average, suggesting a minimum amplifier power of around 25W, with a sensible power ceiling of about 75W. The impedance characteristic is quite gentle, providing an easy amplifier load with a minimum of 7ohms. Despite the smallish (12 litre) internal volume, bass was quite extended, giving effective in-room output down to 48Hz. Indeed, the compromises between sensitivity, loudness and LF extension seem very well judged.

The benefits of removing the grille and sitting a little above the line of the 120 is evident from the curves. Bar the mild 7.5kHz peak and 3-4kHz axial suckout, the response is commendably flat. The averaged in-room response is surprisingly smooth and well integrated, with a slightly lightweight balance indicated by the gentle, extended bass roll-off.

Distortion was only average, beginning to show a few signs of strain at the 96dB level. Pair matching was respectable enough.

SOUND QUALITY

The Avance rated a straight average in both sets of listening tests, which is a perfectly respectable result considering the small size and near average price, but is perhaps also a mild disappointment in view of the very promising ingredients. (Perhaps the proper stands might have helped?)

Comments were generally quite consistent. The lack of 'boxy' coloration was notable, giving a clean, clear overall impression, with good focus and stereo. Tidy and competent, the sound was somehow lacking excitement and 'drive'. Acoustic guitar rendition was particularly good and vocals were refreshingly free of nasality, but the PM panel found the bass qualitatively sluggish and unappealing on rock-oriented program.

CONCLUSIONS

Despite possessing many unusual and worthwhile ingredients which have great potential for cooking up an exceptional loudspeaker, the seasoning necessary to create a classic dish has not yet quite achieved optimum balance. Defi-

nitely worth considering by those attracted to the unusual presentation, a little further development could take the *Pyramide 120* into the Recommended class.

GENERAL DATA

Size (height x width x depth)	42 x 30 x 30cms
Recommended amplifier power per channel (for 96dBA minimum per pair at 2m)	(25) – 75W
Recommended placement	30cm from wall on 40cm stands
Frequency response (+/-3dB, 2m)	80Hz – 20kHz
Low frequency rolloff (-6dB, 1m)	60Hz
Voltage sensitivity (ref 2.83V or 1W into 8ohms, 1m)	86.5dB/W
Approximate max sound level (pair at 2m)	101dBA
Impedance characteristic (ease of drive)	V good
Forward response uniformity	good
Typical price per pair inc. VAT	£279

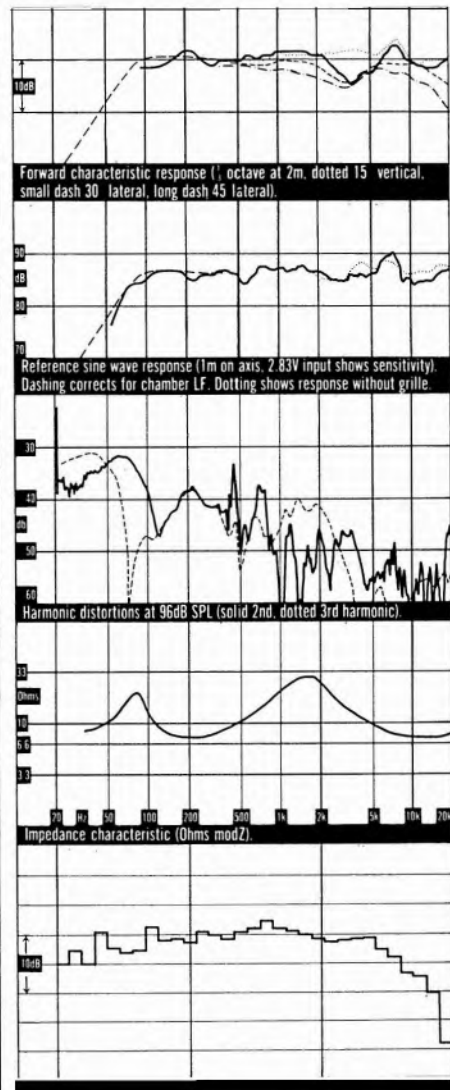



Two manufacturers are currently licensed by the BBC to produce *LS3/5As*, and must stick to the Corporation's tight specifications. Designed as a miniature broadcast monitor for cramped spaces, by offering a fine sound quality in its own right it has stood up to much larger competition for more than ten years. Mounting on high stands well clear of room walls at approximately ear level provides best results.

A sealed plywood box of 5½ litres volume, the *3/5A* is a two way system employing selected KEF drivers, a 110mm Bextrene cone bass/midrange and a 19mm plastic dome treble unit. An elaborate and costly crossover is employed to equalise the drivers to a strict specification.

LAB REPORT

Sensitivity was low, measuring 81.5dB/W and necessitating a minimum amplifier power of 30W per channel. A 50W maximum is suggested although with care 100W amps may be used. The bass rolloff -6dB point measured 57Hz, quite good for the size, while pair matching was very good (all three current makes). The impedance curve never dipped below 7.5ohms, so the design qualifies as an easy 10ohm load. Modest 96dBA maximum sound levels are possible.

Reference curves were taken for the samples and showed good agreement with the reference unit, though the 1.2kHz prominence seems to have become more pronounced over the years. This perhaps reflects a change in the B110, although it is still within specification. By modern standards the response looks a trifle lumpy, though in its time this system was regarded as a very smooth performer.

SOUND QUALITY

The *LS3/5A* has consistently done well in previous live-versus-recorded sessions and fairly well on analogue programme sources. However, with digital material, problems which were only hinted by analogue material were now clearly apparent, making the design sound more dated. Several areas attracted criticism – the bass lacked extension and sounded 'boomy' in the upper bass register, while the mid had a noticeably 'hard', 'nasal' quality and the treble seemed forward with a grainy, 'zitty' effect at the extreme top end. Some 'tubby', wooden and boxy colorations were also evident, with only moderate rendition of stereo depth.

However, it continued to provide good voice detail and articulation, with a reasonably accurate tonal balance. Comparison between different versions showed great similarity while a much older model from Audiomaster (no longer in production) sounded slightly dimmer by comparison, with less mid nasality. However the difference was small by speaker standards.

CONCLUSIONS

At risk of offending the BBC, we feel that the *3/5A* is due for a revision; as a working broadcast tool it no doubt does its job, but as a piece of value engineering it is beginning to fall behind. Other speakers have shown a progressive reduction in price as well as an improvement in sound quality, but the *LS3/5A* has steadily increased in price more or less in line with inflation. Nevertheless, on the most recent listening tests the *LS3/5A* scores were sufficient to retain recommendation!

First reviewed: Rogers 1978. Spendor, 1983 (retested) 1984, reassessed 1985/86).

GENERAL DATA

Size (height x width x depth)	30 x 18.5 x 16cms
Recommended amplifier power per channel (for 96dBA minimum per pair at 2m)	(30) – 50W
Recommended placement	open stands
Frequency response (+/-3dB, 2m)	see text
Low frequency rolloff (-6dB, 1m)	57Hz
Voltage sensitivity (ref 2.83V or 1W into 8ohms, 1m)	81.5dB/W
Approximate max sound level (pair at 2m)	93dBA
Impedance characteristic (ease of drive)	excellent
Forward response uniformity	good
Typical price per pair inc. VAT	£265

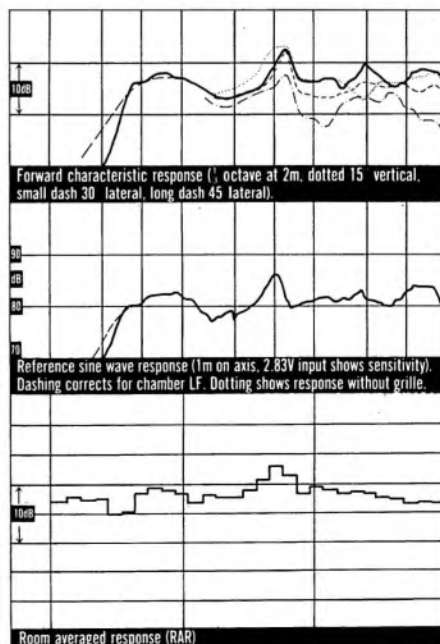

B&W MATRIX 1E

NAKAMICHI B&W (UK) LTD, MARLBOROUGH RD, CHURCHILL IND. EST., LANCING, W. SUSSEX. TEL: (0903) 750750

RECOMMENDED



Though compact, the *Matrix 1E* is a high-tech luxury-finish model, and at \$595 clearly makes no compromise on costs. *Matrix* refers to a series of B&W models which have in common a radical advanced cabinet construction technique, designed to provide high stiffness through a 'honeycomb' internal structure, the '1' being the smallest and least expensive of these. The matrix cabinet is constructed in MDF and chipboard, with foam damping/filling, and has an effective internal volume of 12 litres.

The enclosures are narrow but fairly deep and surprisingly heavy, and are beautifully veneered in real walnut on all six faces. An access plate fits flush into the base, and this proved to be the unfortunate nemesis of the fine cabinet-work of our samples. Moving 30 or so pairs of speakers around and stacking them as pairs, we realised too late that the screws retaining these plates had not been properly aligned and driven home, and had savaged and mutilated the top surfaces. Fortunately this is not likely to happen in actual use, but is certainly a point B&W could do well to note.

The bass/mid unit uses a die-cast 200mm frame and polypropylene mix cone, while the tweeter is a 26mm polyamide soft dome. They are fed from a 4th-order high quality, hard-wired crossover network, which incorporates polypropylene film capacitors and high power devices. Bi-wiring is available, accessed via the inset baseplate. Build quality throughout is first class.

LAB REPORT

Sensitivity is a little below average, but one would imagine a *Matrix* owner is unlikely to be

short of a few watts to drive them with. A minimum power of 25W is suggested, but despite its diminutive size the '1' is quite capable of handling 150W. It is a fairly easy amplifier load, and a worthwhile by-product of the sensitivity is an unusually extended bass for the size, despite an alignment for free space siting. Loudness capability is about average.

The response trace, with grille removed, is excellent, with fine extension at bass and high frequencies and excellent frontal off-axis driver integration. Pity about the grille though . . . The in-room averaged trace shows an astonishingly close room match; bass happily extends down to 30Hz; the midrange is superbly balanced; the treble shows a near perfect roll-off (+/-3dB 25Hz-8kHz in-room!).

Distortion was moderate in the bass and midrange, and very good in the treble. Pair matching was to a fine +/-0.5dB throughout.

SOUND QUALITY

The *Matrix 1* was certainly one of the 'finds' of the project, rating a comfortable 'good' overall from both panels, and attracting some enthusiastic and quite consistent praise. Impressively neutral, it was also revealing and seductive in its fine midband and treble detail.

Bass was nicely extended, but the *PM* panel found it a little 'full', and less clear than the rest of the range, while the one significant dissenter complained of general 'sluggishness'. Perhaps the *Matrix 1* is not the last word in dynamics and pace, and to some tastes might be considered a trifle bland. But it has qualities of subtlety unmatched by more 'fiery' designs, and gave exceptional clarity and focus when bi-wired.

CONCLUSIONS

Celestion may have led the way in establishing high quality no-cost-compromise compact loudspeakers, but B&W's *Matrix 1* proves that they too have the technology and expertise to come up with the goods – albeit by adopting an entirely different approach. Clearly recommended, the refined nature of the *Matrix 1* makes it somehow better suited to the delicacy of acoustic instruments than the flagellation of synthesiser bass and percussion.

GENERAL DATA

Size (height x width x depth)	41 x 23 x 32cms
Recommended amplifier power per channel (for 96dB minimum per pair at 2m)	(25) – 150W
Recommended placement	free space on rigid 45cm stands
Frequency response (+/-3dB, 2m)	60Hz – 20kHz
Low frequency rolloff (-6dB, 1m)	50Hz
Voltage sensitivity (ref 2.83V or 1W into 8ohms, 1m)	85.5dB/W
Approximate max sound level (pair at 2m)	102dB
Impedance characteristic (ease of drive)	V good
Forward response uniformity	V accurate
Typical price per pair inc. VAT	£595

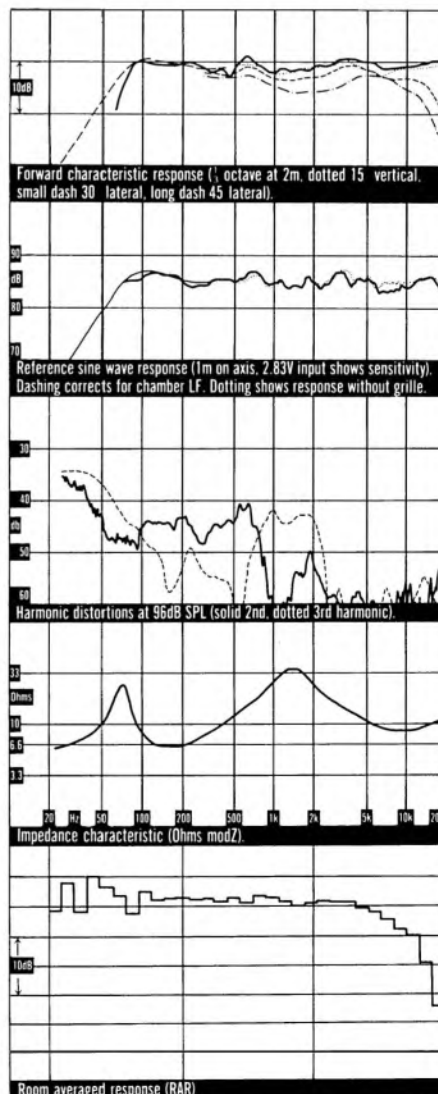

Your loudspeakers may well have some of the most advanced drive units and crossovers in the whole world.

Even so, something is still standing between all the natural sound they produce and your ears.



The loudspeaker cabinet walls.

When the drive units vibrate, they will make the cabinets vibrate as well. Stopping the complete sound spectrum that comes from the drive units from ever reaching you.

This effect is known as colouration. And it's the reason you're always conscious that you are listening to music produced by two loudspeakers rather than a truly live concert performance.



INSIDE EVERY BOX IS THE NATURAL SOUND STRUGGLING TO GET OUT

Colouration is a great barrier to pure sound reproduction. Loudspeaker manufacturers all over the world have been searching for a way to break through it.

Now B&W have finally done it. With an invention that's the most exciting and important breakthrough in loudspeaker technology that even they have made in the last 20 years.

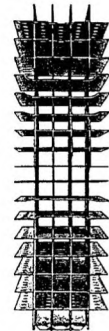

It's the Matrix series of new digital monitors. The first ever loudspeakers to totally eliminate the colouration from the loudspeaker cabinet.

The bass has depth and body and no resonant boom.

The mid- and high-frequencies have a new sparkle and definition.

And, for the first time ever, the natural decay of reverberation is heard exactly as it's heard in a live performance.

The familiar, but greatly unloved hangover effect is dead. Long live the Matrix.

This revolution was achieved with an idea so very simple that B&W practically invented the Matrix by accident.

They discovered that all that

is required to virtually eliminate unwanted sound radiation from the cabinet is a honeycomb-like structure of unique design inside it.

They also discovered that this so improved the performance of the cabinet that they also had to improve the quality of all the drive units.

Consequently, as well as the drivers with homopolymer cones manufactured under licence from CBS Inc., Matrix also features a newly designed ferrofluid tweeter.

The new Matrix series itself features three digital monitors.

Matrix 1, 2 and 3.

Each has a different size, maximum acoustical output and bass extension. All have the same enhanced stereo imagery, improved transient response, low distortion and total freedom from colouration.

The Matrix series takes its place in the B&W range, succeeding loudspeakers that in their time have made history. You just cannot miss them at your B&W stockist.

They are truly the only loudspeakers that are seen but definitely not heard.

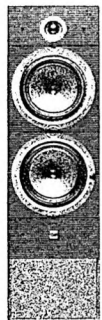

LISTEN & YOU'LL SEE

B&W Loudspeakers (UK Sales) Limited Marlborough Road Lancing West Sussex BN158TR Telephone (0903) 750750

CASTLE DURHAM

CASTLE ACOUSTICS LTD, SHORTBANK ROAD, SKIPTON, N. YORKS BD23 2TT. TEL: (0756) 5333

RECOMMENDED



The *Durham* is a fairly new design, selling for £179, and so sits at the higher quality end of the budget speaker sector. Such models typically use a larger 210mm frame for the main bass/midrange driver, but here the Castle designer employs a small, high power driver with 150mm pressed steel frame and 110mm active cone diameter. This flared pulp cone is suspended on a strong mechanical system designed for reflex-loading.

Castle themselves make both drivers, the treble range being handled by their established 30mm plastic cone, which is fitted with a large central phasing plug that results in an annular radiating element. The good quality crossover essentially conforms to 12dB/octave second-order form, and is distinguished by the use of film capacitors for the treble section. Hard-wiring is used internally, external system connection is made *via* combined 4mm socket/binding posts, and posistor overload protection is fitted.

The enclosure is robustly constructed from 19mm chipboard, finished in real walnut veneer, and the side panels are internally reinforced by a cross-brace. Bituminous pads further damp panel resonances, and an acoustic foam lining moderates internal standing waves. The 15 litre internal volume is reflex-tuned to 65Hz by a ducted port 40mm in diameter and 30mm long. A foam grille ensures good frontal dispersion characteristics. The standard of construction is as good as the finish, and a site fairly close to a rear wall mounted on a good quality stand, will take account of the slightly 'forward' frequency balance.

LAB REPORT

Assessed from the 1 metre response, the lab sensitivity is a fairly high 89dB/W, though the bass extension to 67Hz, -6dB is unexceptional in this price range. A minimum power of 10W per channel is suggested, while a sensible 50W maximum will provide peak sound levels of up to 102dBA, ample for all normal purposes.

Under anechoic conditions, the output rises smoothly by some 5dB from 80Hz to 1kHz. Some loss is seen in the presence range, while the treble shows mild unevenness. The impedance curve had an average value of 8ohms, and constitutes an easy amplifier load since it did not fall below 6.4ohms. The forward frequency response group at 2 metres proved uniform, with a fine consistency over the range of forward axes. The speaker's 'light' frequency balance is plain to see, and the output is notably uncritical of the precise listening axis.

In the listening room, the computer measurements showed a properly defined output through the mid and treble ranges, but with a loss of level in the upper bass to low midrange, 90-250Hz. The bass output was shy, did not match the mid level even with the help of wall lift, and fell off quickly at lower frequencies. The distortion was judged about average at 86dB; by 96dB the range above 60Hz was nicely controlled, but signs of stress were apparent below 60Hz.

SOUND QUALITY

Handling realistic peak power levels without noticeable limiting, the *Durham* scored above the group average during the listening tests. It sounded quite clear, giving some resolution of the recorded acoustic. Depth was not particularly well constructed in the stereo image, though frontal plane focusing was more than satisfactory.

Coloration in the usual sense was low, but like so many recent speakers, the tonal balance tended to 'thinness' with a 'forward' upper-midrange. While the mid-treble balance was quite uniform, the upper treble hinted at brightness with some 'grain' or related imprecision. The bass was of an average standard - somewhat shy and lacking extension though fairly articulate and tuneful.

CONCLUSIONS

Though evolved from a smaller system, the *Durham* performed quite well in this issue. Despite a 'lean' midrange, the listening results were encouraging, and this system is clearly well engineered, sensitive and nicely finished. The bass is on the weak side, but does not prevent this model from meriting recommendation.

GENERAL DATA

Size (height x width x depth)	40 x 21.5 x 25cms
Recommended amplifier power per channel (for 96dBA minimum per pair at 2m)	(10) - 50W
Recommended placement	near rear wall
Frequency response (+/-3dB, 2m)	100Hz to 20kHz
Low frequency rolloff (-6dB, 1m)	67Hz
Voltage sensitivity (ref 2.83V or 1W into 8ohms, 1m)	89dB/W
Approximate max sound level (pair at 2m)	102dBA
Impedance characteristic (ease of drive)	V good
Forward response uniformity	V good
Typical price per pair inc. VAT	£180

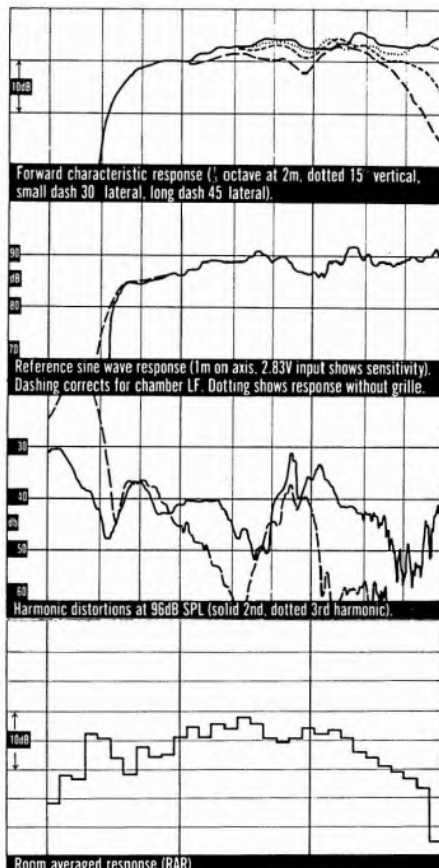

CELESTION SL6S

CELESTION INTERNATIONAL LTD, DITTON WORKS, FOXHALL RD, IPSWICH, SUFFOLK IP3 8JP. TEL: (0473) 723131



A 'luxury compact' loudspeaker, the *SL6S* is a thoroughgoing redesign of the famous *SL6* primarily aiming to cure the sensitivity and bass limitations of the original design. The new 32mm aluminium dome tweeter offers both a higher frequency first bending mode and a lower mass, leading to higher sensitivity than the electroformed copper dome tweeter which it displaces. The closed-box cabinet is now made in medium density fibreboard (MDF), with thinner panels to reduce energy storage. A 'figure 8' brace and inset back panel help make the cabinet rigid; foam absorption is now used internally. It is available in black or walnut wood veneer finish, with optional high twin-pillar stands.

The 165mm Kobex-coned mid/bass driver is now built in a lugged die-cast chassis, which is bolted rather than clamped onto the cabinet. The unique two-part surround is effectively a mechanical crossover, the outer half in soft rubber giving a freer suspension at lower frequencies for improved bass articulation and 'speed'. The voice-coil inductance of this driver has also been reduced, to give better bass 'attack'.

The crossover is hard-wired and gives improved integration; a change of slope on the high pass leg has altered polar distribution, and stand height is now less critical. Gold-plated binding posts are fitted.

LAB REPORT

For the 'S' model sensitivity has improved by roughly 2dB, and the maximum sound level achievable by a pair in-room is now increased

to just over 100dB, from the previous 98dB. The speakers showed good pair matching, and the grille and its frame had little effect on the anechoic measurements. The 2m forward response curves are particularly even, showing evidence of the increased treble energy.

The 96dB distortion plots showed some improvement in high frequency figures over the *SL6*, but at this level this compact speaker is nearing its limits. The 86dB traces showed a dramatic reduction in the 200Hz third harmonic cabinet problem, which was very clearly seen in traces taken on the earlier *SL6*. The distortion performance at this level is good.

The *SL6S* computer averaged in-room response shows much better driver integration than before. A uniform output with surprisingly extended low frequencies combines excellent room interfacing with an impressively smooth treble rolloff. The '6S' crossover presents a better load than *SL6*, the isolated 60hm minimum confirming a true 8ohm load.

SOUND QUALITY

The *SL6S* has a generous, open sound with good stereo depth and separation – an altogether brighter, more out-of-the-box sound than its predecessor, it is also more capable of catching the impact and power of bass notes. *SL6* bass performance was marred by cabinet effects and the 'slowing' effect of the stiff mid/bass driver surround; the new speaker has a notably articulate bass, free from 'congestion' or 'drumming' coloration.

Furthermore, *SL6S* delivers something of the exceptional stereo imagery achieved in the more expensive metal-cabinet *SL600*.

A comparison of response traces shows the extra treble energy in the '6S' which makes the speaker a little 'bright', and can produce a slight 'pinched' coloration, though otherwise the midband sounds unusually transparent.

CONCLUSIONS

Retaining the strengths of the *SL6*, the *SL6S* loses none of that design's sweet treble and musical detail. Bass performance has been improved in both extension and clarity, and the redesigned speaker is altogether more neutral, producing some of the excellent imaging properties of the *SL600* at under half the price, and carries a clear recommendation.

Author Martin Colloms' involvement as design consultant finds David Praker writing this review, based on his own interpretation of the lab and listening data.

GENERAL DATA

Size (height x width x depth)	37.5 x 20 x 27cms
Recommended amplifier power per channel (for 96dB minimum per pair at 2m) (20) – 150W	
Recommended placement	free space, 40cm stand
Frequency response (+/-3dB, 2m)	60Hz to 16kHz
Low frequency rolloff (-6dB, 1m)	50Hz
Voltage sensitivity (ref 2.83V or 1W into 8ohms, 1m)	84dB/W
Approximate max sound level (pair at 2m)	101dB
Impedance characteristic (ease of drive)	good
Forward response uniformity	good+
Typical price per pair inc. VAT	£350

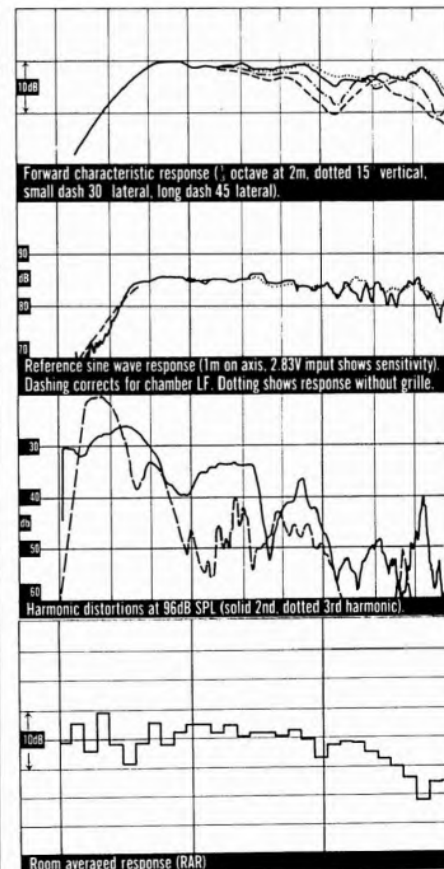

SILVER SERVICE CD

- *WE SUPPLY ANY CD, CURRENTLY AVAILABLE IN THE UK
- *£4.75 CREDIT, GIVEN FOR ANY CD (BUDGET OR SAMPLER EXCLUDED)
- *STOCK ITEMS DESPATCHED SAME DAY
- *ALL ORDERS SENT BY FIRST CLASS POST

Post and packing (U.K.)
please add 35p per disc

Orders over £50 post free
(U.K.)

Orders from Europe
please add 80p per disc

Please send for our lists of
used CDs

We also supply **HAFLER**
Audio Equipment.
Details on request

Please make cheques/P.O.'s
payable to Silver Service CD



24 HRS ANSWERING SERVICE

**24 Touch Wards
DUNFERMLINE
Fife KY12 7TG
Tel: (0383) 738159**

OFFICE HOURS
10AM TILL 6PM
MON TO FRI

IMP Red Label	£7.64
Galleria, Ovation, Silver Line, Bonsai	£8.24
Fidelio, Gimmell, Forlane, Hyperion, Nimbus, Sound, Supraphon, Arabesque, Bourg, Claves, D Sharp,	£10.75
Argo, Archiv, Capriccio, Charisma, Decca, DGG, Ensayo, Hong Kong/ Marco Polo, Schwann, L'Oiseau-Lyre, Philips, Polydor, Eurodisc	£11.25
Amon Ra, ASV, Saydisc, CRD, Caprice, Chandos, Accent, Etcetera, EMI, Orfeo, Unicorn-Kanchana, Pro-arte, Harmonia Mundi (UK)	£11.55
BIS, Conifer, CBS, Delos, Erato, EMI, Denmark, Finlandia, Chant Du Monde, Harmonia Mundi (Germany), Hungaroton, Lodia, Meridian, MMG, Teldec, MCA, RCA, Rodolphe	£11.65
A&M, Arista, Virgin	£11.45
Denon, Telarc, Calliope	£11.95
Sheffield Lab, WEA, GRP, JVC	£12.35

ALL YOU NEED IS IN ESSEX JUST OFF THE M25

Over 300 Separates & Systems in Stock
Extensive Range of Hi-Fi Accessories

Alphason	Ariston	AR
British Loudspeakers	Castle	B&W
Cambridge Audio	Cemac	Bose
Citation	Denon	Dual
Elite Rock	Logic	JBL
Goodmans	Luxman	NAD
Harman/Kardon	Onkyo	QED
Infinity Loudspeakers	Proton	Quad
Kenwood	Rotel	Teac
Marantz	Ruark	Trio
Mordaunt-Short	Sansui	ADC
Musical Fidelity	Tannoy	AKG
Nakamichi	Yamaha	Beyer
Philips (CD)	Beyer	DNM
Revolver	Chord	Glanz
Spendor	Decca	Grado
Thorens	Jecklin	Hunt
Wharfedale	Kiseki	Koss
Avance Loudspeakers	Maxell	MDM
Audio Technica	Milltek	Rata
Foundation	Nagaoka	Ross
Goldring	Ortofon	Shure
Sennheiser	Target	TDK
Van den hul	Tiffany	etc.
	Vecteur	

BRENTWOOD MUSIC & HI-FI CENTRE

Ground & First Floor

2 Ingrave Road, Brentwood, Essex
Corner of Brentwood High Street and Ingrave Road (A128)

Tel: (0277) 221210

Shop & Home demonstrations
On-site customer parking by appointment

HARBETH

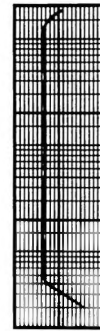

ACOUSTICS

Designers and Manufacturers of Audio Equipment
Triangle Road, Haywards Heath, West Sussex RH16 4HN
Tel: 0444 414439

HL Mk4

During our demonstrations at the Penta hifi show it was enlightening and enjoyable to meet so many classical musicians and music lovers who own Harbeth loudspeakers.

Proof again that the 'Harbeth formulae' is unbeatable.

The HL Mk4 and our new HL Compact advance our long tradition of excellence in design and testing.

Individually made and tested in Britain - Harbeth loudspeakers lead the world for accuracy in sound reproduction.

Please call for our dealer list and more information.

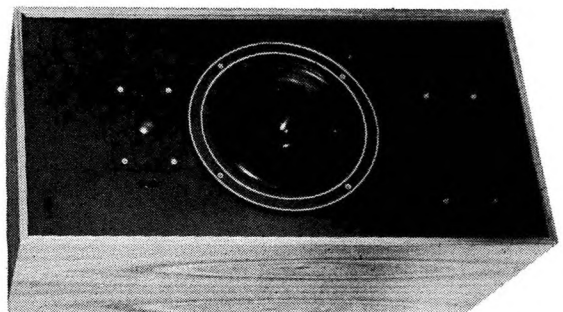

GOODMANS MAXIM 2

GOODMANS LOUDSPEAKERS LTD, 2 MARPLES WAY, KINGSCROFT CENTRE, HAVANT, HANTS PO9 1JS. TEL: (0705) 486344

BEST BUY



Last year's revival of Goodmans' classic *Maxim* came through as a firm Best Buy. This year they are hoping to get three bites at the cherry, the ongoing £70 *Maxim* being supplemented by the £80 *Maxim 2* reviewed here, and a £100 *Maxcamp* which has on-board power amplifiers.

The *Maxim 2* differs only slightly from last year's model, but incorporates improvements in the power handling and smoothness of the tweeter, which is now ferrofluid-cooled. That apart, it is a tiny (5 litre) cabinet, reflex-loaded at the rear, tidily enough finished in a 'black ash' vinyl wrap. Cabinet walls are only 15mm, but are stiffened by the inseting of front and rear panels. The two drivers take up much of the front baffle, the small 125mm diameter paper cone handling bass and midrange duties before handing over to a ferrofluid version of the familiar 19mm Audax tweeter. A rather thick frame for the grille lacks any rebating and looks acoustically unpromising.

Such a small enclosure is fated to be tucked away on bookshelves, and the *Maxim 2* will certainly benefit from some degree of wall assistance in the bass. But it is also a serious enough loudspeaker to be given a proper stand – even though this could add 50-100 per cent to the cost. *Maxim* can also be used in free space, with appropriate amplifier bass boost. Build quality was good throughout, the 3rd order crossover hard-wired with thin cabling.

LAB REPORT

Sensitivity was a reasonable enough 86dB – falling a little below today's norm but more than adequate nonetheless. This was accomplished

while maintaining a kind amplifier load, with the minimum a very conservative 7.3ohms – but not without compromising the bass extension, which provides a –6dB point at a highish 85Hz (inevitable perhaps for such a tiny 'miniature'). An amplifier power range of 20-50W is indicated, noting that the absolute loudness capability is somewhat limited.

Though the characteristics have a somewhat different shape to the norm, broadening the mid-dominance typical of small miniatures to a degree which is likely to create an individual sound character, the response traces are generally smooth and progressive – and singularly improved when the grille was left off. The two drive units are well integrated, and off-axis responses tie in quite well. The room response shows the mid dominance clearly enough, but also that it is notably smooth and even, and well balanced overall, despite the early bass rolloff.

Distortion shows improvements over the *Maxim* tested last year in a number of areas of the spectrum, so clearly Goodmans have done more than tweak the tweeter, and the results compare favourably with other models in this price/size class. With our samples pair matching proved to be a close enough +/-0.7dB.

SOUND QUALITY

The *PM* panel were less than enthusiastic about the *Maxim 2*, finding it difficult to come to terms with the lack of scale and 'weight', and not unduly impressed by the rather 'boxy', 'forward' midband. Indeed one dealer panelist correctly identified the *Maxim* characteristic from his knowledge of the original – gaining much respect and kudos from the other panelists as a result! Accepting these limitations, there was praise for the basically sound integration and balance, for the lively and communicative presentation, and several brownie points for trying hard!

The *MC* panel was sufficiently impressed to rate the '2 slightly above average overall, which is an exceptional result for the price. Again, commenting on the inevitable lack of 'scale', the sound was considered well controlled and communicative, with good clarity and fine focus, and nicely musical in the upper bass.

CONCLUSIONS

The *Maxim 2* is a clear refinement of the *Maxim* that more than justifies the extra tenner on the price, and comfortably merits a similar Best Buy rating. However, it is a slightly idiosyncratic speaker in terms of sound presentation, appealing strongly to some listeners and leaving others underwhelmed, so prior audition should be mandatory.

GENERAL DATA

Size (height x width x depth)	26 x 17 x 19cms
Recommended amplifier power per channel (for 96dB minimum per pair at 2m)	(20) – 50W
Recommended placement	near wall on shelf or stand, free space with bass boost
Frequency response (+/-3dB, 2m)	105Hz – 20kHz
Low frequency rolloff (-6dB, 1m)	85Hz
Voltage sensitivity (ref 2.83V or 1W into 8ohms, 1m)	86dB/W
Approximate max sound level (pair at 2m)	97dB
Impedance characteristic (ease of drive)	V good
Forward response uniformity	V good
Typical price per pair inc. VAT	£80

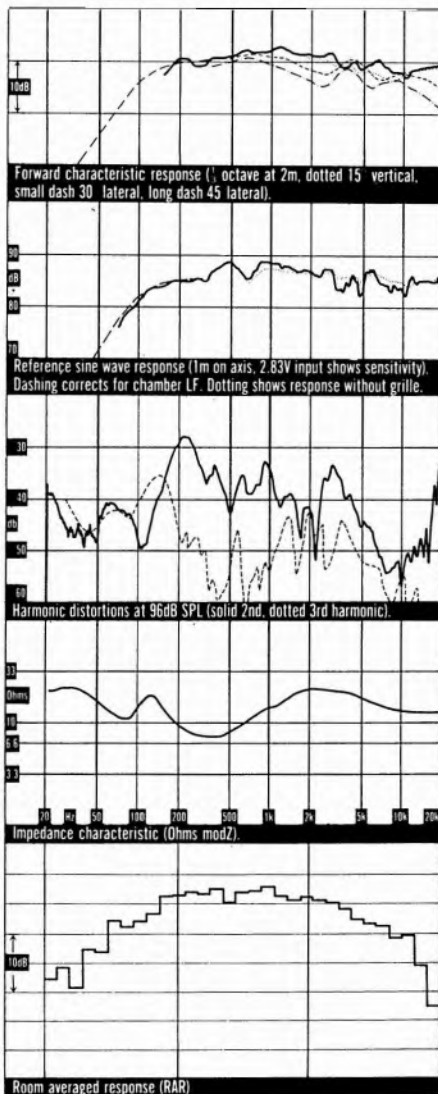

GOODMANS POINT 3

GOODMANS LOUSPEAKERS LTD, 2 MARPLES WAY, KINGSCROFT CENTRE, HAVANT, HANTS. TEL: (0705) 486344

RECOMMENDED

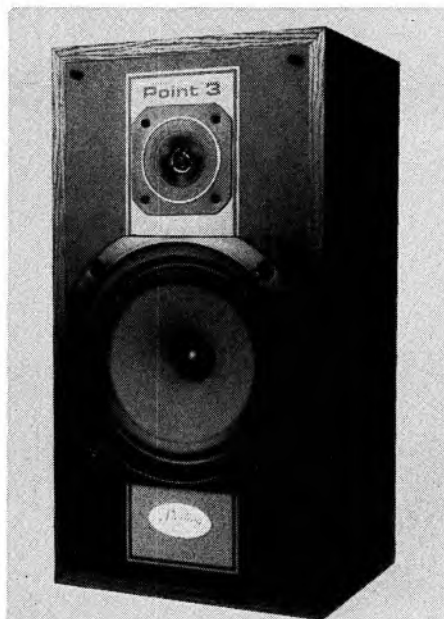

These were certainly not the most prepossessing speakers in appearance, but presumably the pre-production status of our review pair was the reason for a standard of finish that was a little below par – samples shown at the launch were decidedly better. Nevertheless, this bottom model in Goodman's new *Sterling* range encloses 16 litres and has a good size main driver besides, which is more than most of the competitors can manage for £90.

Two low-cost drivers are set in a rather pretentiously decorated baffle, which may be covered by a polyester grille that has a thick, unrebeated frame. The bass/mid unit has a decent (165mm diam) radiating area on a 235mm pressed steel frame, using an undamped paper cone; the tweeter is the latest titanium-sputtered version of the familiar Audax plastic cone/dome 19mm unit. Build quality was economical but adequate, the sealed box enclosure in vinyl 'black ash' using 15mm chipboard cabinet walls plus internal polyester wadding, and incorporating inset baffle and rear panel to add stiffness.

The simple second-order 'star earth' crossover has little power-wasting equalisation, and our units were hard-wired internally with good quality 4mm wire. A simple pair of 4mm socket/binding posts are provided for amplifier connection. The small size and relatively restricted bass extension suggests that wall mounting will probably give best results, with the enclosure lifted up to ear height on (preferably) rigid stands or (if you must) a convenient bookshelf.

LAB REPORT

A sensitivity rating of 90dB is high for any

loudspeaker, let alone a comparatively small one like this, so the *Point 3* will deliver plenty of level from as little as 10W of amplification; 75W seems a safe enough maximum to avoid abuse. But an inevitable consequence of the high sensitivity is a -6 dB bass roll-off point at a high 80Hz, and the system's fundamental resonance at 100Hz means there will be little room drive available below 75Hz, even with the assistance of wall mounting – as confirmed in the in-room plot.

The too-early bass roll-off apart, the axial frequency responses are quite good, particularly with the grille removed, showing careful system design. The forward response set at 2m confirms that this speaker is best sited around ear height or slightly below, and auditioned on-axis – off-axis laterally, an increasing crossover region suckout becomes steadily more obvious.

The impedance characteristic lies typically between 7 and 11 ohms, with no dramatic rates of change, so the *Point 3* should prove a particularly easy amplifier load. However, distortion performance was unexceptional, with a significant content at around -40 dB at 96dB across the band rather than restricted to low frequencies. Pair matching was a close ± 0.6 dB, though this could be a function of the pre-production nature of our samples.

SOUND QUALITY

The first (*PM*) listening panel was not particularly impressed, rating the *Point 3* below average, but this is no disgrace at such a low price point. Though quite well balanced, there was general criticism of a 'boxy', 'small' sound, and of some lack of subtlety and muddling of detail and instrumental separation. Stereo was generally good, but dynamics were undistinguished; 'ordinary' was a term that proved difficult to avoid.

The *Point 3* had a rather better reception in the second (*MC*) tests, rating a straight average, but this is no disgrace at such a low price point. Though quite well balanced, there was general criticism of a 'boxy', 'small' sound, and of some lack of subtlety and muddling of detail and instrumental separation. Stereo was generally good, but dynamics were undistinguished; 'ordinary' was a term that proved difficult to avoid.

CONCLUSIONS

Though it is difficult to raise enormous enthusiasm for this new budget model, there can be little doubt that it represents solid value for money and merits recommendation. Differences in the panel findings suggest the *Point 3* should certainly be auditioned prior to purchase.

GENERAL DATA

Size (height x width x depth)	47 x 25 x 20cms
Recommended amplifier power per channel (for 96dB minimum per pair at 2m)	(10) – 75W
Recommended placement	shelf or high stand near wall
Frequency response (± 3 dB, 2m)	95Hz – 20kHz
Low frequency rolloff (-6 dB, 1m)	80Hz
Voltage sensitivity (ref 2.83V or 1W into 8ohms, 1m)	90dB/W
Approximate max sound level (pair at 2m)	103dB
Impedance characteristic (ease of drive)	V good
Forward response uniformity	good
Typical price per pair inc. VAT	£90

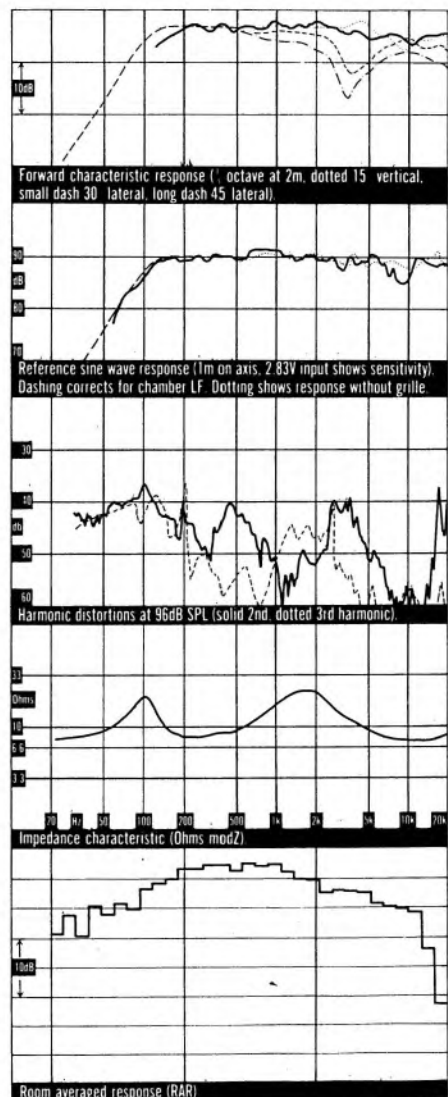



The Cornflake Shop is a small, friendly shop selling hi-fi. We're just off Tottenham Court Road on Windmill Street. We sell a carefully selected range of equipment – just what we think is the best available – and we can install and service everything that we sell.

We don't rip you off – systems start from £300, and all our prices are competitive.

So, if you'd like to abandon the nightmare of Tottenham Court Road, come and have a chat – you'll find us friendly, helpful, knowledgeable and honest.

the cornflake shop

37 WINDMILL ST LONDON W1P 1HH 01-631 0472

GOODMANS POINT 7

GOODMANS LOUDSPEAKERS LTD, 2 MARPLES WAY, KINGSCROFT CENTRE, HAVANT, HANTS. TEL: (0705) 486344



Middle model in Goodmans' new *Sterling* threesome, the *Point 7* is a medium sized three-way loudspeaker, priced very competitively at £170 – a type of loudspeaker that is historically difficult to get right. The finish of our pre-production samples might have been better, but later examples look well up to par. The rather flashily trimmed design may be obscured by a polyester grille, but the latter's thick unrebrated frame looks unlikely to assist performance.

The enclosure is a sealed box as far as the bass unit is concerned, but the midrange driver is vented through a short transmission line type tunnel set into the rear panel, so isolating the mid from the bass while avoiding the problems of reflections and pressure build-up in a small sealed sub-enclosure. Though only of 15mm chipboard, the 'black ash' vinyl cabinet has a horizontal brace and inset front and rear panels to assist rigidity. Internal damping consists of a simple polyester wad.

The steel frame/paper cone bass and mid units are generously proportioned, if economically manufactured. The tweeter, common to the whole *Sterling* range, is the latest titanium sputtered version of Audax' familiar 19mm cone/dome unit. The drivers are hard-wired to a simple star-earth 3rd order crossover, though the wire here was thin. Build quality was sound, if economical, with normal 4mm socket/binding posts. The size of this 45 litre enclosure indicates floor-mounting on rigid 35cm stands.

LAB REPORT

The 89dB sensitivity is nice and high, and the impedance graph showed a kind amplifier load with only gentle changes, so the *Point 7* will deliver decent sound levels from even the most modest amplifier. The three unit configuration will permit up to 100 watts of amplifier drive without problems, and also ensures that there is little compromise in bass extension. In technical terms, it has plenty of 'welly'.

The various response traces show pretty good driver integration, some regrettable grille-induced perturbations, and some loss of output and unevenness around 1-2kHz. However, the latter did not appear in the averaged in-room response, which was better than expected, showing a well balanced if slightly prominent midband, well extended low frequencies, and a slight depression through the lower mid. The system resonance at 65Hz ensures a -6dB point below 50Hz and typical worthwhile in-room output down to 30Hz.

Distortion was moderate enough in general, though the midband third harmonic product at 96dB was rather below par. Pair matching was a close +/-0.5dB, though it should be remembered that our samples were not from regular production.

SOUND QUALITY

Rating a slightly disappointing below-average in the *PM* tests, the *Point 7* still showed a worthwhile improvement over the smaller *Point 3*, but in this case the bass was considered rather over-rich and lacking precision. However, the extension and weight were both praised, and good clarity and that jargon-term 'welly' appeared again in the panel notes. A general competent all-rounder, the mid and treble seemed a little coarse, lacking in subtlety.

The second (*MC*) panel also had a somewhat mixed reaction, but rated the *Point 7* a perfectly respectable straight average. The sound was basically competent, with a fairly neutral balance, reasonably good bass, and good focus, but there was some midrange coloration and dynamic compression, plus some loss of stereo depth.

CONCLUSIONS

Panelist opinion showed sufficient variation to urge a little caution in recommending the *Point 7*. Though it does offer a basically competent performance-mix plus good bandwidth and sensitivity, there is a slight lack of refinement which mutes our enthusiasm a trifle. Ulti-

mately, it seems to be a brave attempt at a difficult design brief which goes a long way towards coming off.

GENERAL DATA

Size (height x width x depth)	69 x 33 x 26cms
Recommended amplifier power per channel (for 96dB minimum per pair at 2m)	(15) – 100W
Recommended placement	free space, 35cm stand
Frequency response (+/-3dB, 2m)	50Hz – 20kHz
Low frequency rolloff (-6dB, 1m)	47Hz
Voltage sensitivity (ref 2.83V or 1W into 8ohms, 1m)	89dB/W
Approximate max sound level (pair at 2m)	104dBA
Impedance characteristic (ease of drive)	good
Forward response uniformity	good
Typical price per pair inc. VAT	£170

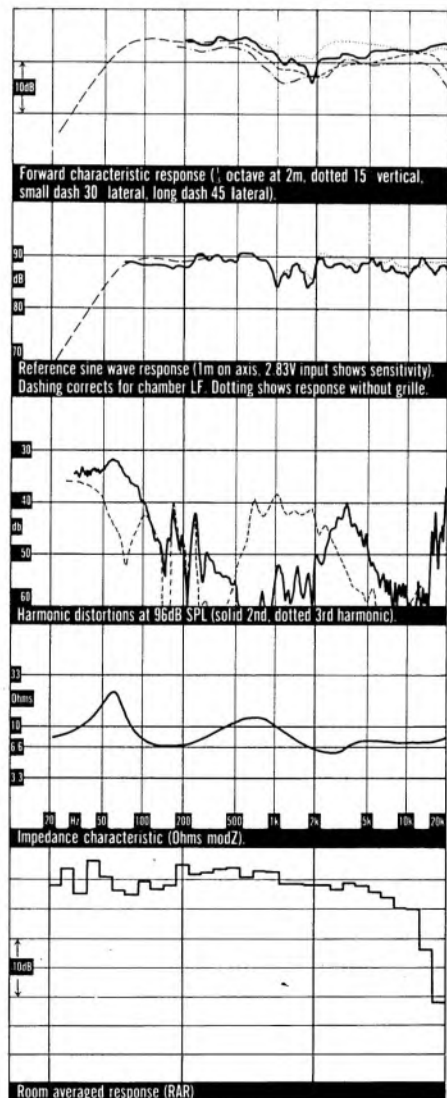

HARBETH HL MK 4

HARBETH ACOUSTICS, TRIANGLE RD, HAYWARDS HEATH, WEST SUSSEX. TEL: (0444) 414439



This loudspeaker has its roots firmly in the BBC monitor tradition, and was one of the first commercial models to use polypropylene for bass/mid driver cones. The company was founded by the legendary Dudley Harwood, who was a leading BBC researcher for decades, but it has recently passed into new hands which are adding extra vigour and improved professionalism on the production side. An inevitable side effect of tighter quality control has been a significant price rise, but the pill is sweetened a little by the bi-wire option, scheduled to be introduced as standard around our publication date.

Bi-wiring apart, the *Mk4* follows the BBC traditions very closely, adopting the classic formula of a 2 cu. ft. reflex-loaded cabinet of damped and foam-lined thinwall birch-ply construction. A very good crossover with autochoke tweeter matching uses high quality film capacitors and hard-wiring to the drivers. Real walnut veneer enhances the feeling of quality, while the foam grille ensures no sonic compromises here. Build quality was very good throughout.

The main bass/mid driver is built on a magnesium cast frame using a TPX polymer cone, while the tweeter is a 25mm soft fabric dome unit. The slightly bass heavy character typical of this basic configuration makes free space mounting essential – in any case it is the only way to obtain full advantage of the traditionally clean midrange. So substantial, preferably high stands are mandatory.

LAB REPORT

Confirming that the design has evolved to keep pace with the times, the sensitivity is a generous 89dB/W, though the 4.6ohm minimum at 5kHz does not provide the easiest load for an accompanying amplifier. Nevertheless, low powered amplifiers should be very comfortable, and a respectable loudness of 103dBa is obtainable with about 75W drive. Bass extension is well maintained down to 30-40Hz, but sharply curtailed below that.

The response traces show very good integration for what is by today's standards quite a big box. The midband is smooth and well integrated off-axis, though the slightly 'rich' bass character is confirmed by a slight 50Hz boom effect on the room-averaged trace, but with good ultimate extension. A slight mid prominence at 800Hz is also indicated here.

Distortion was quite low, and certainly better than the norm, again with the low frequency rise that distinguishes this type of design. Pair matching is very good (see reference response), confirming the efforts of the new management.

SOUND QUALITY

Rating 'good plus', the *HL4* was well received in the *PM* tests, with particular praise for its clean, clear and uncoloured midband. There was consistent criticism of the 'heavy' bass character, but this might be less obtrusive in the context of a different room or system; careful experiment with placement will help too. Dynamics and stereo were both praised, and the sound was attractively 'out of the box', though accompanied by some mild 'chestiness'.

The *MC* panel had broadly similar findings, with an overall 'good' rating, praising the very clear and articulate midrange, that gave good depth and focus. The sound was typical BBC-style monitor, with a lively open presentation, and here the bass was less troublesome, showing good extension with acceptable quality.

CONCLUSIONS

Though the recent price rise looks quite steep, the Harbeth is still cheaper than other designs of its type, and the good results on both technical and subjective tests comfortably guarantee recommendation. The new management has already resulted in improved build quality, and the introduction of bi-wiring further enhances its capabilities. Care in placement is essential for best results.

GENERAL DATA

Size (height x width x depth)	64 x 33 x 30cms
Recommended amplifier power per channel (for 96dBa minimum per pair at 2m)	(10) – 75W
Recommended placement	free space on 46cm rigid stand
Frequency response (+/-3dB, 2m)	45Hz – 20kHz
Low frequency rolloff (-6dB, 1m)	40Hz
Voltage sensitivity (ref 2.83V or 1W into 8ohms, 1m)	89dB/W
Approximate max sound level (pair at 2m)	103dBa
Impedance characteristic (ease of drive)	average
Forward response uniformity	V good
Typical price per pair inc. VAT	£475

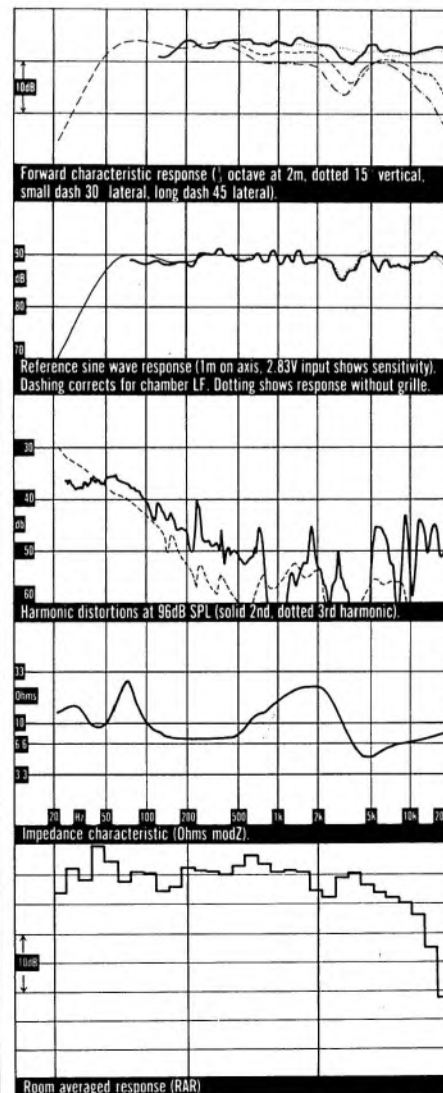

RECOMMENDED

HEYBROOK HB1

HEYBROOK HI-FI LTD, ESTOVER CLOSE, ESTOVER IND. EST., PLYMOUTH, DEVON PL6 7PL. TEL: 0752 780311



One of the consequences of inviting loudspeaker designers onto listening panels is that they are apt to arrive with their latest creation tucked under the arms. Peter Comeau duly arrived at *MCs* with his current *HB1*, hoping to redress the situation of a year ago when it lost its Recommended flag.

The lab testing was already long finished, so the only measurement relevant to the latest pair is the room-averaged response. Please note therefore that the lab data, curves and descriptions apart from RAR refer to the earlier samples from mid-'86. However, in other design and constructional respects the model is unchanged and the existing review stands.

The response suggests a character which might suit stand (or shelf) mounting against the wall, and in fact the *HB1* did work quite well in this position, but for the listening tests the cleanest results were felt to come from positioning on rigid stands in open space.

LAB REPORT

Excellent pair matching was demonstrated with a high 90dB/W sensitivity, despite which the bass was reasonably extended to 55Hz, -6dB on the anechoic response, and was also free of overshoot.

In view of the 80W maximum power handling, decently loud 104dBA sound levels were possible, while as little as a 10W input raised

pretty good levels of around 95dB in a typical room.

Measured at 96dB the distortion was moderate at 0.8% to 1.5%, with a further improvement noted on reducing the signal level to 86dB.

Occasionally the *HB1* impedance almost approached 50ohms, but it represents a simple amplifier load reactively and should prove fairly easy to drive. System resonance was noted at 65Hz.

The two room-averaged responses - from last year and this - remain our only point of reference, given the unorthodox nature of this review submission. At first sight they look surprisingly similar, but closer inspection shows that the treble peak that proved so subjectively troublesome in 1986 has shifted down nearly an octave, so that it is now far less 'exposed'.

The mid prominence around 1.3kHz remains a noticeable characteristic, as does a bass alignment which could be assisted a little by placement fairly close to a rear wall. There remains sufficient of the 'three-humped' effect to suggest the balance will not be entirely neutral, but the overall trend is smoother than last year.

SOUND QUALITY

The *HB1* has historically steered an occasionally uneasy line between good clarity and slight overbrightness. Too much of the latter was the reason for the lukewarm reception it received in last year's review project, yet the 1987 samples suggest the problem has been rectified, allowing its more positive virtues to become more apparent.

The overall rating from the *MC* panel was average but on the plus side thereof, with praise for the good clarity and fine dynamics. The bass was qualitatively good and showed fair extension, while the midrange was a touch forward and slightly 'shouty', though not severely so. In contrast to the samples of a year earlier, the upper treble seemed quite retiring.

CONCLUSIONS

While we must record the caveat that the current *HB1* did not undergo our full measurement programme and was only auditioned by the *MC* panel, the changes do appear to have done the trick and the model returns to a state of grace and Recommendation. It is likely to appeal more to vinyl than CD enthusiasts, and prospective purchasers should try to ensure their particular samples do not sound 'over the top' in their system and room. But it sounds good for the price, is properly built, and deserves to be treated to its matching stands as well.

GENERAL DATA

Size (height x width x depth)	47 x 29 x 23cms
Recommended amplifier power per channel (for 96dBA minimum per pair at 2m)	(10) - 80W
Recommended placement	open stands
Frequency response (+/- 3dB, 2m)	65Hz - 20kHz
Low frequency rolloff (-6dB, 1m)	55Hz
Voltage sensitivity (ref 2.83V or 1W into 8ohms, 1m)	90dB/W
Approximate max sound level (pair at 2m)	104dBA
Impedance characteristic (ease of drive)	good
Forward response uniformity	fairly good
Typical price per pair inc. VAT	£169

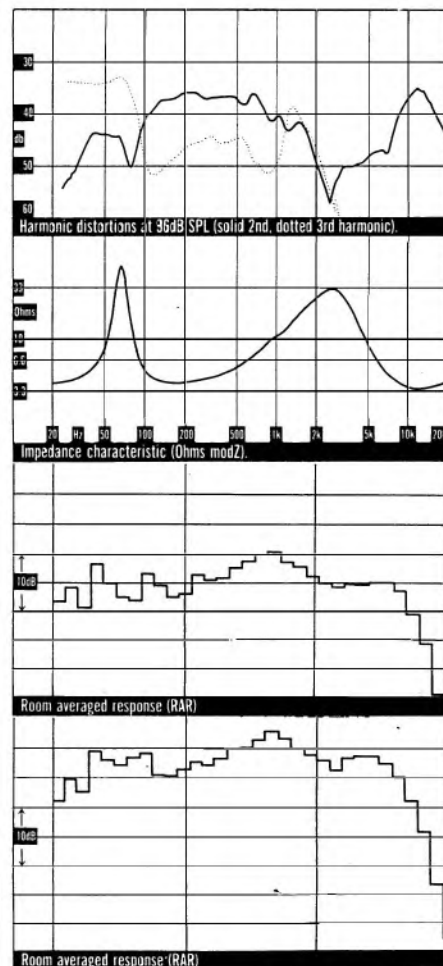

Upper RAR last year; lower RAR current model.

THE PLANETS BY TANNOY

*Gustav would
have approved*

It's hard to believe that Mr. Holst, were he alive today, would be composing with the aid of synthesisers, digital effects units and the like. But we like to think that our Planet range, the Mercury Mk II, the M20 Gold and the new Eclipse, has received his celestial nod of approval.

Quite simply, we sought to combine our acoustic engineering expertise in cabinet design and loudspeaker manufacture into cost effective systems that would gratify even the unforgiving ears in the hi fi press test labs. That our design standards were strictly adhered to has been demonstrated in the Mercury Mk II, a 1986 Hi Fi Choice Award Winner that follows three consecutive annual Awards from Hi Fi Choice for the Mercury Mk I.

The Eclipse, with a power handling capability of 90 watts and incorporating many of the major design features of the Mercury Mk II, including its new high efficiency tweeter, is now available at Tannoy stockists. It demonstrates that in speakers, as in music itself, the absolute is attainable.

Mr. Holst has introduced many to the beauty of music. We like to think that the Planet range will increase their enjoyment of it too.

TANNOY®

Tannoy Ltd., The Bilton Centre, Coronation Road,
Cressex Industrial Estate, High Wycombe,
Bucks HP12 3SB. Tel: (0494) 450606.
Telex: 83251 TANNOY G. Telefax: (0494) 37431.

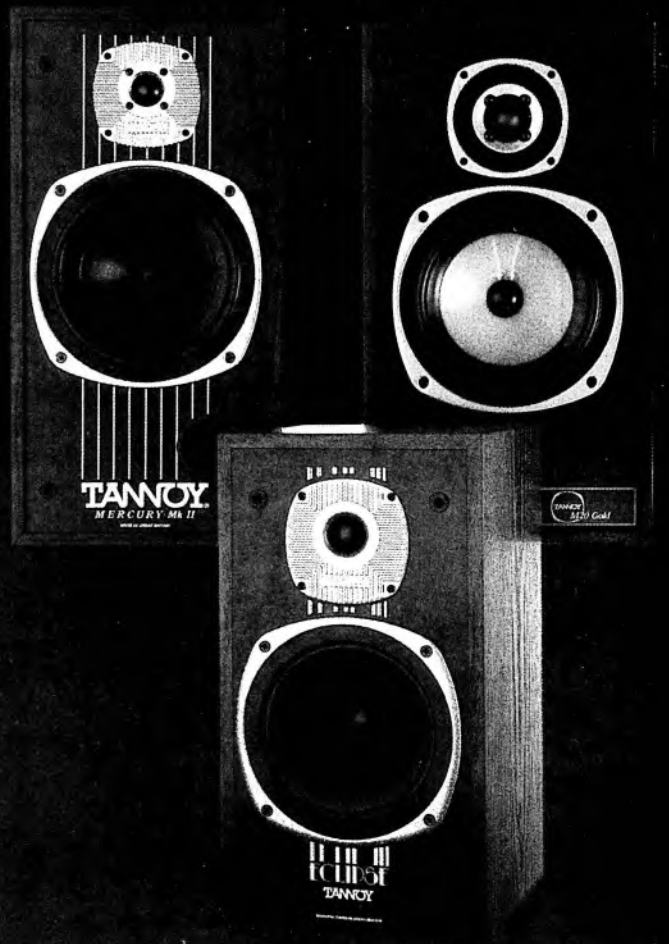

JBL 60T

HARMAN (AUDIO) UK LTD, MILL STREET, SLOUGH, BERKS SL2 5DD. TEL: (0753) 76911

RECOMMENDED



Placed at the quality end of the compact loudspeaker market, the *L60* is a quite substantial loudspeaker – at a quite substantial price tag of £370 a pair. For a start, this is a floor-standing design, which has its own particular appeal, to the many people conscious of the visual obtrusiveness of hi-fi. It must, however, be said that for perfectionists a better performance will be obtained by elevating the speaker on rigid low stands, designed with a floor-keying feature. Standing 78cm high, the *L60* is a two-way reflex-loaded system of some 35 litres. It is tuned to a low 26Hz, which promises good bass extension.

The bass/mid unit has a die-cast frame fitted with a light pulp cone with foam surround. The frame measures 230mm overall, while the actual diaphragm diameter is 160mm. The generous motor system has an oversize high-power 50mm voice-coil. Crossing over at around 2.5kHz, the treble range is handled by a version of JBL's 25mm titanium dome tweeter with its integral 'diamond pleat' surround. The high quality 12dB/octave four-element crossover includes two polypropylene capacitors, and uses internal push-on connectors; combination 4mm socket/binding posts are used for external connection.

The main enclosure construction material is 19mm chipboard, finished in natural walnut veneer. There is no internal bracing, but a 20mm fibreglass lining helps absorb internal standing waves. The port is reasonably sized, 48cm in diameter and 128mm long. An assem-

bly fault on our sample left one bass unit mounting nut loose inside the enclosure.

LAB REPORT

The average 88dB/W sensitivity was mildly compromised by a load impedance below the 8ohm standard tolerance; in fact the lowest value was a touch over the 4ohm level, and was not considered too severe in amplifier loading terms. A minimum input power of 10 watts per channel is suggested, while the system showed fine power handling to 150W peak program, so good peak sound levels of 104dBA are possible in a typical room.

The bass was well extended to 40Hz, -6dB, and as the room curve testifies, the response was well maintained down to 25Hz, albeit with some excess below 60Hz. Above 100Hz the computed room response shows fine balance and most even output, bar some mild aberration in the mid treble.

This speaker measured pretty good on axis at 1 metre, bar a degree of crossover interaction around 3kHz. Removing the grille effected a small improvement (dotted line). The 2m set of forward responses indicated fine driver output integration except in the 3kHz area, and the lateral off-axis curve was particularly good. Reflecting JBL's experience in this area, the audibly significant third harmonic distortion at 86dB was held to low levels. The second harmonic trace rose somewhat at the higher 96dB sound level, but the general trend showed good control right down to 20Hz.

SOUND QUALITY

The *60T* scored above average for the listening tests, which is an appropriate rating for the price, and was impressive in several respects. While the bass was somewhat rich and a little too powerful, it was also fairly clean and well extended. Furthermore the upper-bass to mid-treble balance sounded agreeably uniform, in contrast to many modern systems. This helped to give a good sense of scale to a wide variety of program material.

Some moderate 'boxy' colorations were present in the midband, and the treble could sound a little 'wiry' and 'brash' on strings and brass. Stereo focus was quite good, with a fair representation of depth. Dynamics were also above average.

CONCLUSIONS

This speaker possesses many positive qualities including a fine treble, an extended and powerful bass suited to larger rooms, moderate distortion levels, and the capability for high sound levels. It offers realistic value for money, and thus merits *Choice* Recommendation.

GENERAL DATA

Size (height x width x depth)	78 x 30.5 x 26.5cms
Recommended amplifier power per channel	(for 96dBA minimum per pair at 2m) (10) – 150W
Recommended placement	floor or low stand (15cm)
Frequency response (+/-3dB, 2m)	45Hz to 20kHz
Low frequency rolloff (-6dB, 1m)	40Hz
Voltage sensitivity	(ref 2.83V or 1W into 8ohms, 1m) 88dB/W
Approximate max sound level (pair at 2m)	104dBA
Impedance characteristic	(ease of drive) average (not 8ohm)
Forward response uniformity	V good
Typical price per pair inc. VAT	£370

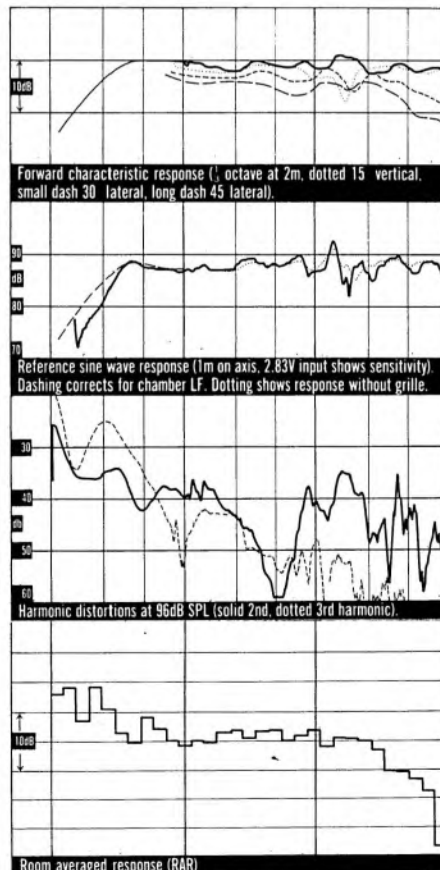

JPW AP2

JPW LOUDSPEAKERS LTD, PO BOX 31, PLYMOUTH, DEVON PL1 1YH. TEL: (0752) 784284

BEST BUY



JPW are a small and relatively new loudspeaker manufacturer, but have built a fine reputation in a short time. We have reviewed some of their products before in *Choice*, with generally favourable results, but as seems so often the case these days production samples evolve as a consequence of ongoing development 'tweaking' - the AP2s covered here sporting the little PWB stick-ons which 'improve the sound' (a claim we do not endorse, but would certainly not refute either).

The two-way £145 AP2 sits in the middle of a three model line-up, though in some senses it could be regarded as a luxury version of the more popularly priced PI. These two share the same basic cabinet dimensions and unit configurations, but the '2 is 25 per cent heavier and offers the flexibility and future-readiness of an active/passive adaptable crossover. It is a medium sized so-called 'bookshelf' model, though the use of rigid stands like the £65 MSIs, which were thoughtfully provided, is strongly recommended. The bass alignment suggests that siting near a rear wall will help provide the best balanced results.

The 18.5 litre enclosure is strongly built in 19mm chipboard, and nicely finished in real wood veneer. Though there is no bracing as such, the cabinet feels reassuringly solid, and contains polyester wadding for damping. The grille frame is rebated, but still has a significant influence upon the frequency response, so might be better removed. The generously dimensioned bass/mid driver uses a doped paper cone on a magnesium die-cast chassis, the tweeter being a 19mm polyamide soft dome. Build quality was good throughout, the 2-pole (removable) crossover being hard-wired with good quality multistrand cable.

LAB REPORT

Sensitivity was a comfortably above average 89dB/W, and the load should be very easy for any amplifier, so low power systems can still get good levels and higher power systems should obtain substantial loudness. This sensitivity has been obtained at some cost in bass extension - system resonance is at 80Hz - though the curtailment is not severe given the size of the cabinet.

The response traces are generally pretty good, though the influence of the grille is quite pronounced. There is a touch of the 'three-humped' effect on the 1m reference trace, but this smooths out somewhat at 2m, where the system shows good dispersion and integration on and below the main axis. The room response confirms the good mid/treble integration and the mild midrange forwardness, and also shows that in-room bass is comfortably extended to 47Hz.

Distortion was good throughout, with the expected deterioration as levels increased. Pair matching was a little disappointing, maintaining only +/- 1.25dB through the treble.

SOUND QUALITY

The AP2 was particularly well received by the PM panel, its particular character harmoniously matching the drive system, room and placement therein - not to mention the panel's predilection for the slightly 'dry' and 'forward' presentation. There was a slight 'edge of seat' aggressiveness and some untidiness in the treble, but the overall sound was well integrated and nicely balanced without significant boxiness, giving a lively and dynamic impression from the music.

The MC panel gave a straight average overall rating, clearly less happy with the treble qualities, noting 'brittleness' and sibilance exaggeration, along with a slightly 'thin' midband giving a 'wiry' quality to violins. Nonetheless the lively dynamic qualities were again praised, the punchy, fluid bass underpinning decent midband depth and atmosphere.

CONCLUSIONS

There are few grounds for criticism here, though prospective purchasers should check the treble qualities are to their (or their system's) taste. That apart AP2 is a well engineered and decently built package that justifies a Best Buy rating at its fairly modest price, and is conveniently well suited to wall mount siting.

GENERAL DATA

Size (height x width x depth)	44 x 26 x 25cms
Recommended amplifier power per channel (for 96dBA minimum per pair at 2m) (10) - 100W	
Recommended placement	40cm from wall on 45cm stands
Frequency response (+/- 3dB, 2m)	65Hz - 20kHz
Low frequency rolloff (-6dB, 1m)	65Hz
Voltage sensitivity (ref 2.83V or 1W into 8ohms, 1m)	89dB/W
Approximate max sound level (pair at 2m)	104dBA
Impedance characteristic (ease of drive)	V good
Forward response uniformity	above average
Typical price per pair inc. VAT	£145

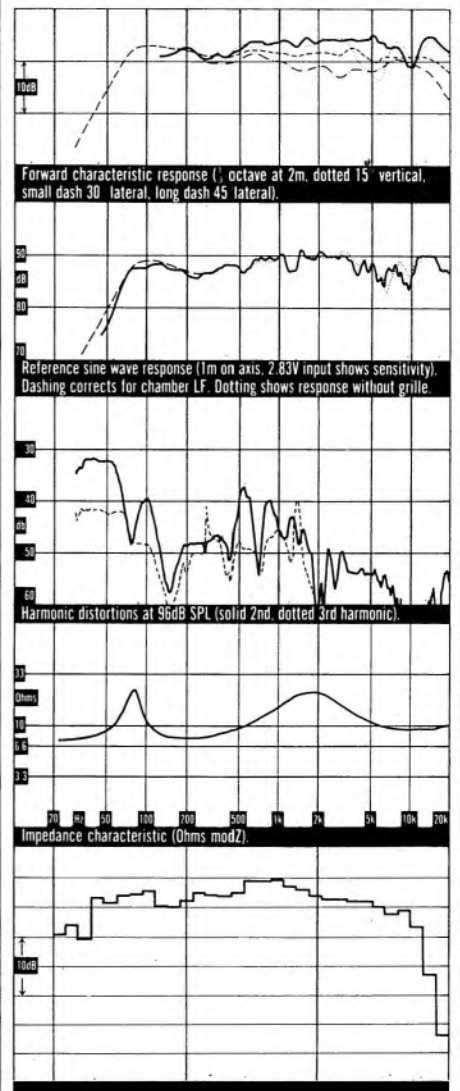

JWS QUINTET

JWS AUDIO (UK) LTD, UNIT 8, UNITED TRADING ESTATE, UNITED RD, OLD TRAFFORD, MANCHESTER M16 0RT. TEL: (061) 848 0545

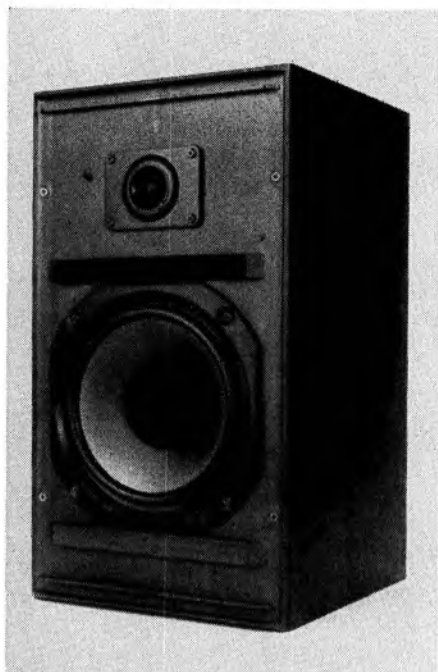

Though well established for a decade on their home market, the Swedish born JWS speakers have only been on the UK market for about a year, in which time they have arranged distribution through no less than 95 dealers. The range as a whole is distinctly budget oriented, the *Quintet* reviewed here being a \$100 two-way bookshelf model. However, it is a fairly generous 22 litre sealed-box enclosure, designed for free space mounting on open stands.

Build and presentation are a little unorthodox, starting with a rattly metal/plastic grille of unpromising acoustic potential. Though the carcass is constructed from generous enough 19mm chipboard, the front baffle is a thin plastic moulding, and the drivers are merely glued in position. The crossover consists simply of a 3.3uF capacitor in series with the bass unit, providing first order roll-off here, and is hard-wired with thin cable to cheap spring clip terminals on the rear panel.

The bass/mid unit uses a polypropylene mix cone of quite generous dimensions on a steel frame, while the tweeter is a soft fabric 25mm dome unit. Build quality is basically poor.

LAB REPORT

Sensitivity is a reasonable enough 86dB, sufficient to give decent loudness levels from a 20W amplifier, yet capable of handling 50W or thereabouts without problems. The impedance characteristic is very smooth, assisted by the simple crossover arrangements, and is very

easy to drive. Bass shows reasonable extension with -6dB at 50Hz, though this is not quite the whole story.

The frequency responses show all manner of problems around 2kHz, where a broad and deep suckout emphasises the crossover region between the two drivers. Though the alignment confirms the need for free space siting, there is also clear evidence of a mildly 'hyped' bass which will probably sound 'boomy', and the treble as a whole is distinctly peaky, showing significant variations with measuring axis. These various characteristics are reflected in the room-averaged response, where broad but isolated peaks are seen in both bass and treble, along with loss of energy in the crossover region.

Distortion was unexceptional, and pair matching not very good, registering +/- 1.5dB which allows for up to 3dB of difference between the two channels.

SOUND QUALITY

Regrettably, the *Quintet* did poorly in the listening tests too, reflecting the problems noted in the frequency response, with consistent criticism from both panels. The *PM* panel were rather less severe, and some panelists remained basically neutral, but the bass lift, mid suckout and treble unevenness led to complaints of coloration, boom and 'sting'.

The *MC* panel described 'honky' coloration, 'scratchy' top, and boomy undifferentiated bass, with poor stereo focus and unbalanced tonality. And the grille rattled too...

CONCLUSIONS

It is difficult to summon any enthusiasm for this new brand on the basis of the *Quintet*. The engineering is fundamentally crude, with seriously flawed basic frequency balance, and the sound quality inexorably follows suit.

GENERAL DATA

Size (height x width x depth)	46 x 26 x 28cms
Recommended amplifier power per channel (for 96dBA minimum per pair at 2m)	(20) - 50W
Recommended placement	free space on open stands
Frequency response (+/-3dB, 2m)	see text
Low frequency rolloff (-6dB, 1m)	50Hz
Voltage sensitivity (ref 2.83V or 1W into 8ohms, 1m)	86dB/W
Approximate max sound level (pair at 2m)	99dBA
Impedance characteristic (ease of drive)	V good
Forward response uniformity	poor
Typical price per pair inc. VAT	£100

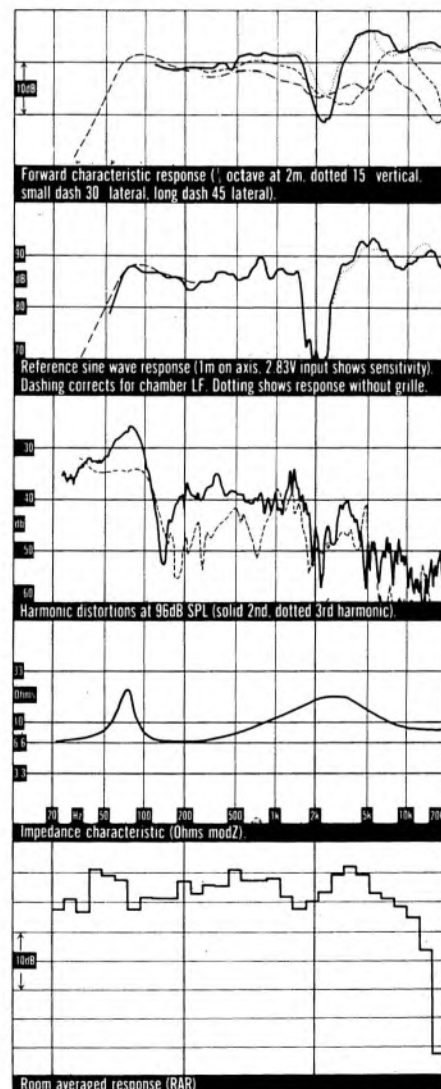

KEF 103/3

KEF ELECTRONICS LTD, TOVIL, MAIDSTONE, KENT ME15 6QP. TEL: (0622) 672261

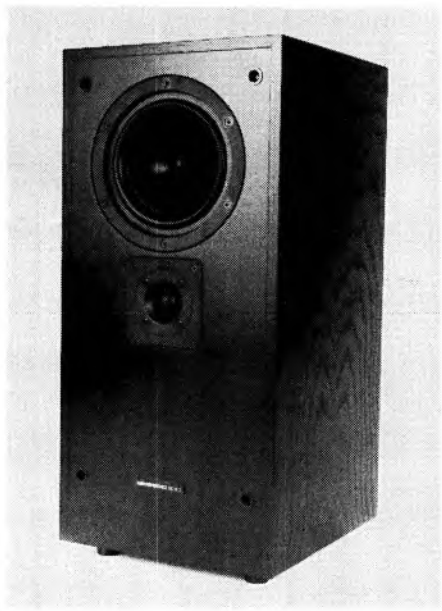

This compact monitor from KEF's *Reference* series is unusual in a number of respects. Supplied as a complete £630 package with special stands and a *KUBE* bass equaliser, it needs to be used as such, with the speakers sited in free space and the *KUBE* connected within a spare tape loop of the amplifier. Though this may sound a little daunting, in fact it is done for very good reasons, and allows unusual flexibility in optimising bass output while providing exceptional sensitivity.

The enclosures themselves each contain three drive units: the tweeter is a 25mm doped fabric soft dome; the midrange uses a 160mm polypropylene cone unit operating in its own two litre sub-enclosure; a 200mm pulp cone bass unit is mounted vertically inside the box, using a 'coupled cavity' loading with the port situated in the base (hence the need for the special stands, to avoid blocking up the hole). Constructed from substantial 19mm and 22mm chipboard, the excellent external finish is real 'black ash' veneer, and rigidity is bolstered by the internal bass unit baffle. The substantial grille has been properly integrated acoustically, but the wooden stands do feel a little flimsy compared with metal tube designs.

In addition to performing the main equalisation for the speaker system more precisely and efficiently than a passive crossover network, the supplied *KUBE* has three user-adjustable functions: it changes the relative bass level to compensate for room siting, and switches the bass cut-off point between 35 and 50Hz; it may also avoid using up the amplifier's normal tape recorder connections. The passive crossover within the loudspeaker is a complex 'conjugate impedance' device, with extra elements that

neutralise impedance variations. The result is a very simple if slightly current-hungry 4ohm 'resistive' load.

LAB REPORT

It is difficult to quote sensitivity for an active EQ system such as this, but around 92dB is a rough practical equivalent. Certainly it is very high, so the *103/3* will play loudly with the smallest amplifier, while excellent power handling should enable levels of 108dBa to be achieved, remarkable for such a compact yet bass-extended loudspeaker. Amplifier loading is 4ohms resistive, easy enough except perhaps for some valve amps.

The curves show how effectively *KUBE* tailors the response, giving an unusually extended bass, a generally smooth even mid-band, a quite subdued but extended treble, but some lack in the upper bass. Removal of the grille worsens the response somewhat (a sign of good engineering), while the off-axis curves show fine consistency and integration; textbook stuff. However, the room-averaged response is less promising, the low bass looking rather exaggerated (with or without *KUBE*), and the mid slightly exposed as well.

SOUND QUALITY

The *PM* panel rated the *103/3* 'good' overall, though this perhaps referred more to the potential than the experience. In some respects (dynamics, 'speed') the *KUBE*-less sound was preferred, though the consequent balance was of course unacceptable. With *KUBE* and careful tuning there were a number of good qualities (stereo, balance, loudness), but also a loss of transparency and communication, and a 'ponderous' bass quality.

The *MC* panel came to similar conclusions regarding the loss of transparency and muted dynamics, holding the rating down to just above average. Good points included the neutral balance, good focus and fine sense of 'scale', but the overall performance was somehow clouded and dulled, and extreme bass 'overhang' was a little disconcerting.

CONCLUSIONS

Though *103/3* is a fascinating and impressive exercise in loudspeaker engineering, its sheer complexity works against it in the context of a high quality 'audiophile' system. That said, its ability to enhance less ambitious systems than those used in our listening tests could be considerable, and there can be no doubt regarding the fundamental engineering and build quality. Moreover its overall balance could well suit large rooms quite well.

GENERAL DATA

Size (height x width x depth)	56 x 27 x 30cms
Recommended amplifier power per channel (for 96dBa minimum per pair at 2m) (15) - 200W	
Recommended placement	on supplied stands free space
Frequency response (+/-3dB, 2m)	50Hz - 20kHz
Low frequency rolloff (-6dB, 1m)	45Hz
Voltage sensitivity (ref 2.83V or 1W into 8ohms, 1m)	90-95dB/W see text
Approximate max sound level (pair at 2m)	108dBa
Impedance characteristic (ease of drive)	average
Forward response uniformity	excellent
Typical price per pair inc. VAT	£630

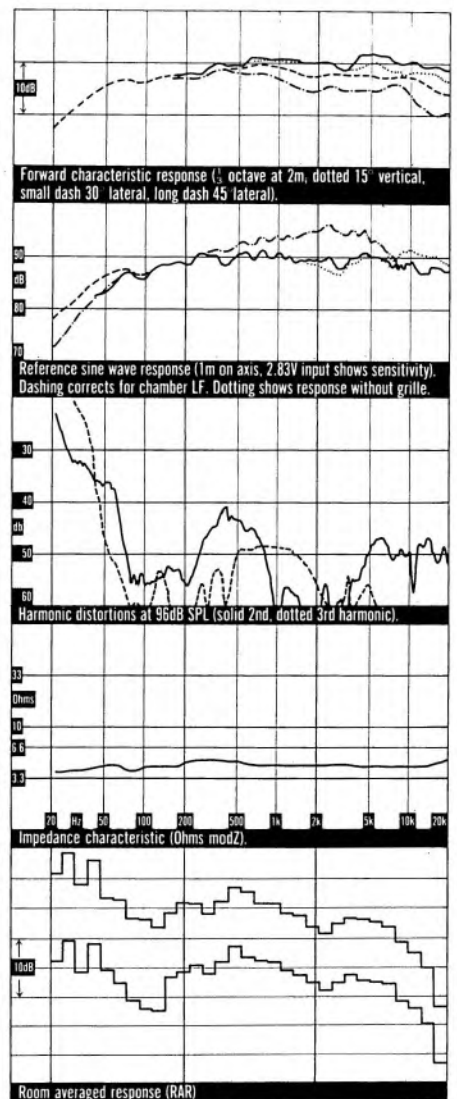

KEF 104/2 (inc. KUBE)

KEF ELECTRONICS LTD, TOVIL, MAIDSTONE, KENT ME15 6QP. TEL: (0622) 672261

RECOMMENDED

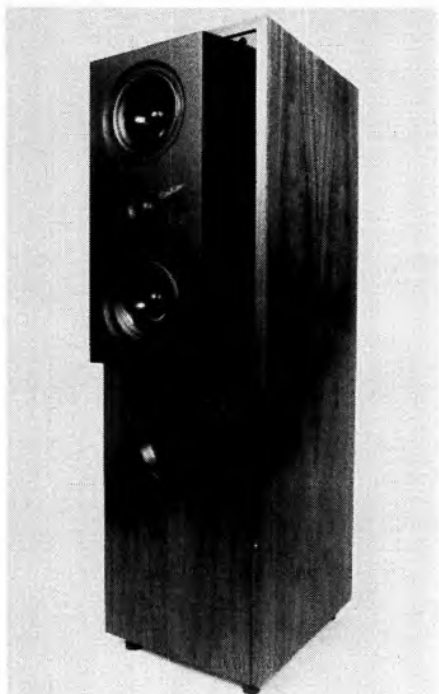

Few speakers have ever combined as much innovation in one package as the Kef 104/2, and the fact that it is still regarded as a key model some four years after introduction shows that it is standing the test of time well. Our original review covered an early sample, so the introduction of an optional additional *KUBE* bass equaliser provided an excuse to try a sample from current production.

The 104/2 is a substantial floor-standing speaker, supplied with adjustable spikes or studs, and designed for siting well away from side and rear walls. The main carcass, properly veneered on all faces, is a special form of 'coupled-cavity' bass system. Two matched, vertically opposed drivers are mounted inside the box, providing highly efficient and carefully 'tailored' output through a large shaped port situated just below the mid/treble sub-assembly. Twin 100mm midrange drivers flank a single 25mm tweeter on this slim sub-baffle fixed to the front of the main carcass.

The five drivers are linked using a complex 'conjugate load' crossover in order to cancel any impedance variations and leave a flat 4ohm load – easy for an amplifier to drive, but quite demanding in terms of current delivery.

The £800 104/2 is now available with a special *KUBE* equaliser costing an extra £100, which is an electronic 'black box' that sits between pre- and power amp or in a tape monitor loop. This allows very precise 'tailoring' of the bass-end to suit particular room and siting characteristics, and a measure of control over the 'loudness vs bandwidth' trade-off.

LAB REPORT

There seemed little point in carrying out a full repeat measurement programme on this model, though we did check room-averaged responses with and without *KUBE*. The sensitivity is a substantial 92dB, needing minimal amplifier power for really high levels, and the load is basically easy, though one which may draw current a little heavily for smaller valve amplifiers. Without *KUBE* the bass is not perhaps as extended as one might expect, though this is part of the sensitivity trade-off, which *KUBE* users can avoid if desired.

The response measurements are very good indeed, flat and with good integration between the drivers. And the grille is better left on, a refreshing change indicative of painstaking skill at the design stage. Distortion and compression were both low.

The room responses show improved mid and treble smoothness over the earlier model tested, with just a hint of presence 'brightness' remaining. The low frequencies show the same mild upper bass heaviness but with decent extension when checked without the equaliser. With the equaliser in circuit the lower mid/upper bass has been flattened out, while the lower bass is very well extended but also distinctly 'heavy'.

SOUND QUALITY

Used without equaliser, 104/2 managed a good overall rating on the *PM* tests despite a wider than usual variation between listeners. There was praise for the power and 'punchy' dynamics, good stereo imagery and generally low coloration (albeit with some 'boxiness'). But the bass was a bit 'thumpy' and the treble a little forward, and qualitatively not to all tastes. The addition of *KUBE* flattened the bass noticeably but also compromised transparency – to a degree which may depend on the driving system.

The *MC* panel rated the 'straight' 104/2 a fine 'good plus', but downrated this to merely 'above average' when *KUBE* was in use, whereupon clarity, transparency and 'speed' seemed affected and the bass became too heavy. The 104/2 on its own was liked for its fine combination of liveliness with powerful tight bass and low coloration with precisely focused stereo images.

CONCLUSIONS

Still capable of polarising opinions and interacting unexpectedly with different rooms, KEF's 104/2 remains a reference point, offering excellent engineering and quality build with considerable subtlety and prodigious loudness

capabilities. Clearly recommended in standard form, we are less convinced by the *KUBE* option; probably innocuous and maybe useful in more modest systems, the transparency loss with the ancillaries used for our listening tests was too large to ignore.

GENERAL DATA

Size (height x width x depth)	90 x 28 x 41.5cms
Recommended amplifier power per channel (for 96dBa minimum per pair at 2m)	(10) – 200W
Recommended placement	free space floor standing
Frequency response (+/-3dB, 2m)	60Hz – 20kHz
Low frequency rolloff (-6dB, 1m)	50Hz
Voltage sensitivity (ref 2.83V or 1W into 8ohms, 1m)	92dB/W
Approximate max sound level (pair at 2m)	110dBa
Impedance characteristic (ease of drive)	average
Forward response uniformity	V good
Typical price per pair inc. VAT	£800 (KUBE £100)

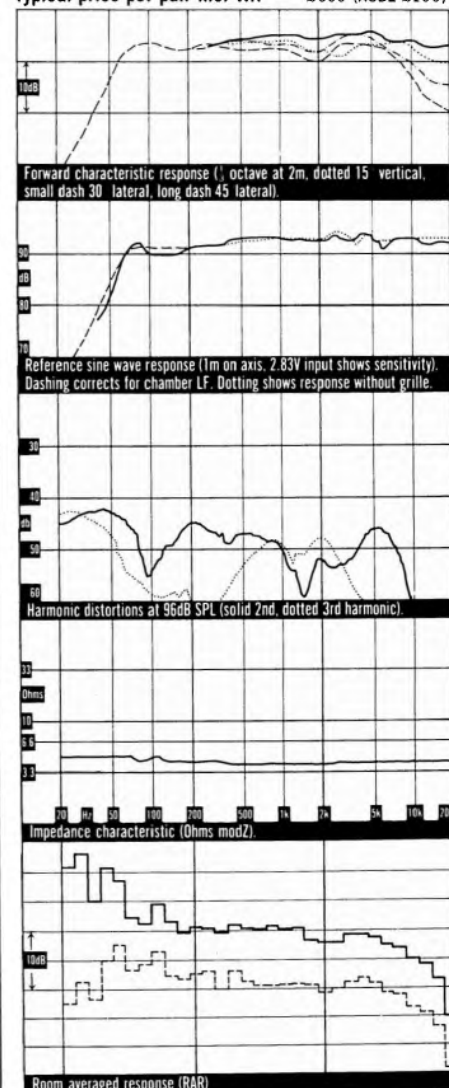

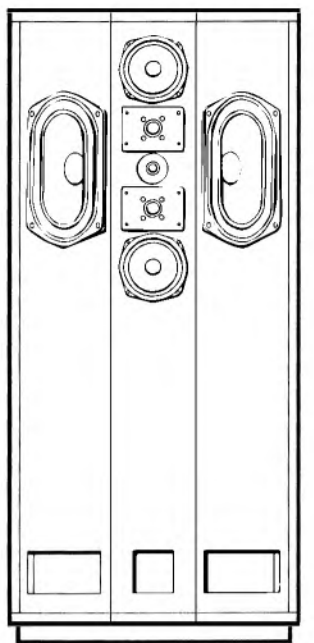

REFERENCE STANDARD TLS

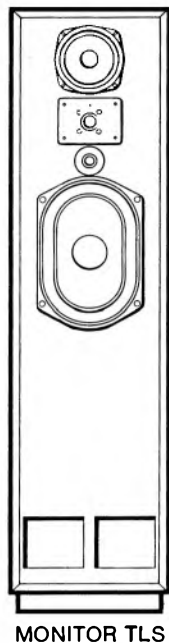

MONITOR TLS

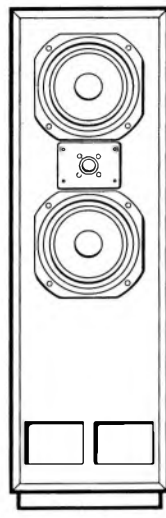

STUDIO 3 TLS

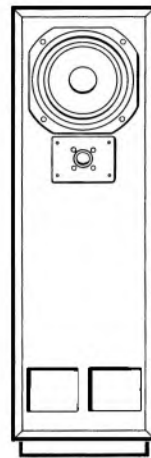

STUDIO 2 TLS

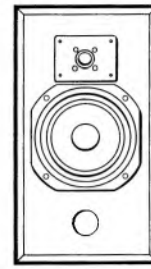

SUPER-COMPACT

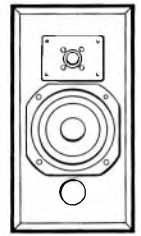

COMPACT

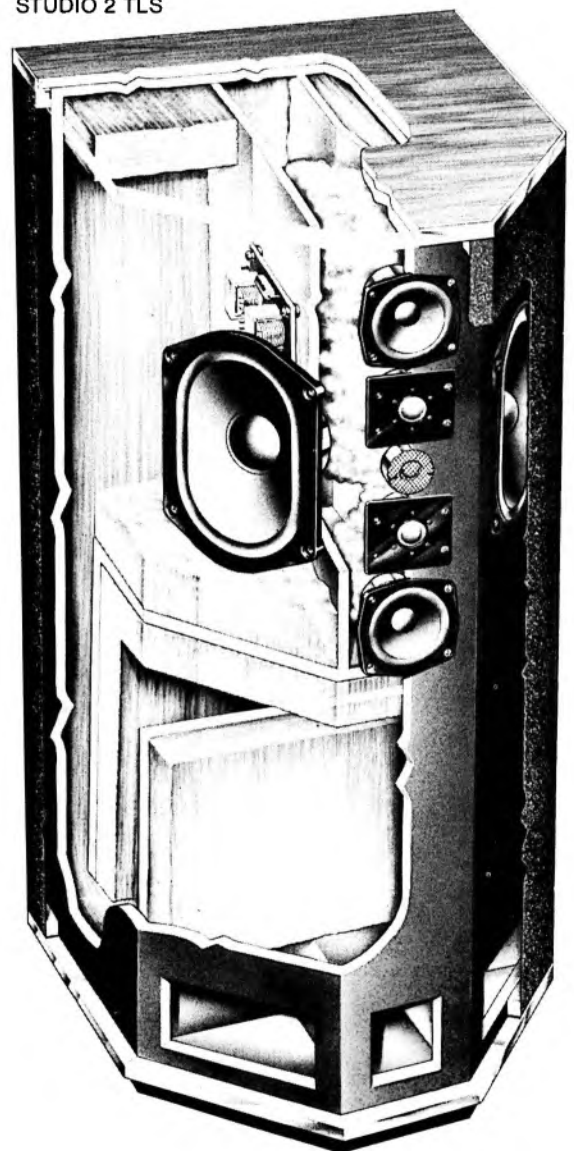

The TDL Reference Standard Transmission Line Speakers head a regeneration of loudspeakers developed by John Wright; innovator of the transmission-line speaker.

The quality of the bass is open, extended and uncoloured in a way known to be unique to the transmission-line; but with their much greater power handling can reproduce the full dynamic range of recent digital recordings with a sense of ease, rare in other speakers.

This represents a radical improvement in the state-of-art; the entire concept being one of performance at a price, rather than to a price



transmission line speakers

RSTLS

Transducer Developments Limited PO Box 98 High Wycombe Bucks HP13 6LN England Telephone (0494) 41191 Telex 838050TDL-G

MARANTZ LD20 DMS

MARANTZ AUDIO (UK) LTD, 15-16 SAXON WAY IND EST, MOOR LANE, HARMONDSWORTH, MIDDX UB7 0LW. TEL: 01-897 6633



Best known for their CD players and other electronic components, Marantz have always been active in loudspeakers, and their 'tweak' team (Ken Ishiwata and Steve Harris) invariably create one or more 'budget audiophile' models primarily for the UK market.

The *LD20* is one such model – though the use of a *DMS* suffix might be regarded as a little pretentious as applied to a very compact 9 litre two-way reflex-loaded design selling for a competitive £130. The enclosure is a standard enough 'black ash' vinyl-covered construction in 15mm board, with chipboard for the carcass and MDF for the baffle, and extra help from a circumferential brace above the bass driver. This has a clear unmodified 130mm polypropylene cone operating in a 170mm pressed steel frame, while the tweeter is a 19mm polyamide dome.

Build quality is pretty damn good, though the '20 loses a few brownie points for using a thick unrebrated grille frame. The high quality third-order crossover uses film caps and is hard-wired with high quality multi-strand cable. Three 4mm socket/binders offer a half-way house to bi-wiring (separate return from each driver arm and common signal), which is an unusual feature at this price point. The speaker is intended for free space mounting, clear of walls and on 45cm high stands.

LAB REPORT

Sensitivity is an average 86.5dB/W, sufficient for decent levels with quite modest amplifiers

and a respectable maximum loudness. Amplifier loading should be no problem, though the low frequency extension is quite sharply curtailed, the -6dB at 55Hz somewhat exacerbated by the 24dB/octave slope of the bass reflex loading.

The response is a little unorthodox, reasonably flat but with a strong down-tilting trend into the treble, lending a 'richness' to the overall balance despite limited low-frequency extension. Though the grille had a slight effect, it was not in any way serious, so its removal is entirely optional. The room-averaged response confirms the treble down-tilt, but also indicates some midband excess, and shows that the bass holds up quite well in practice.

Distortion was quite low, especially considering the compact dimensions, while pair matching was only reasonable, with a 1dB mismatch through the treble.

SOUND QUALITY

Probably as a function of a balance which suited neither room nor system particularly well, the *PM* panel rated the *LD20* below average overall. The heavy, rich mid-bass stuck out above a lack of real extension, though in other respects the overall balance was quite liked for its warm, cuddly and forgiving nature. Clarity and integration were pretty good, and coloration low, while the balance clearly suited CD better than vinyl LP.

The *MC* panel rated this new *LD20* a straight average, and largely confirmed this speaker's prediction for CD sources. In this environment the bass was far less of a problem, though the lack of extension was again noted, while the 'laid back' character was generally appreciated.

Performance was a trifle uneven, with some mid hardness and mild 'nasality', plus a rather 'lazy' presentation, but with fair focus and depth and a general lack of unwanted exaggerations. (Three-wired for *MC* listening).

CONCLUSIONS

We are much happier recommending this model for CD users than for those of a vinyl persuasion. It is soundly engineered and built, with a good technical performance, but the overall balance is sufficiently different from the norm to suggest that it should not be purchased unheard. Free space siting is mandatory.

GENERAL DATA

Size (height x width x depth)	36 x 23 x 24cms
Recommended amplifier power per channel (for 96dB minimum per pair at 2m)	(20) – 75W
Recommended placement	free space, 45cm stands
Frequency response (+/-3dB, 2m)	62Hz – 18kHz
Low frequency rolloff (-6dB, 1m)	55Hz
Voltage sensitivity (ref 2.83V or 1W into 8ohms, 1m)	86.5dB/W
Approximate max sound level (pair at 2m)	100dB
Impedance characteristic (ease of drive)	good plus
Forward response uniformity	V good
Typical price per pair inc. VAT	£130

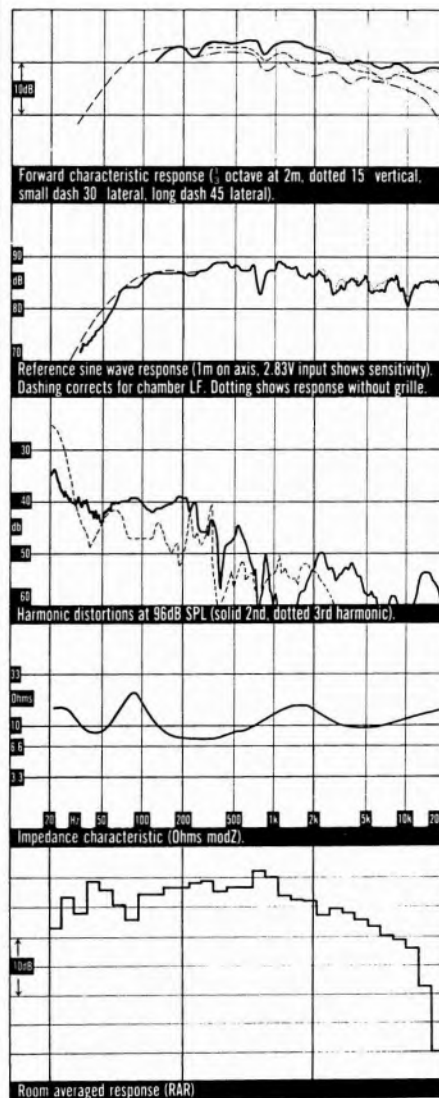

MISSION 700LE

MISSION ELECTRONICS LTD, STONEHILL, HUNTINGDON, CAMBRIDGE PE18 6ED. TEL: (0408) 52777



Reviewed and Recommended in last year's edition, Mission re-submitted the popularly priced 700LE for 1987, though any changes appear to be small in nature and degree – even the price has only increased by a fiver, to £130.

The 'Leading Edge' is a compact 9.5 litre 'bookshelf' model aligned for mounting and almost touching a rear wall (on stands such as Mission's spiked optional extras rather than bookshelves please). The response is tailored to give optimum listening seat response with the speaker directed straight ahead, and with Mission's 'inverted' baffle configuration (tweeter below bass/mid).

The baffle itself is a single plastic reinforced moulding, as is the properly rebated grille frame, while the carcass is 12mm chipboard, clad in 'black ash' vinyl. Bass and midrange comes from a 150mm coated pulp/paper unit, while the tweeter is a 19mm polyamide dome. The mild second-order crossover uses decent quality components, but with tag connections to the drivers; the spring-loaded terminals can (just) take 4mm plugs.

LAB REPORT

Sensitivity is a generous 89dB/W, capable of delivering good levels with even the smallest amplifiers, while fine power handling confers substantial maximum loudness capabilities. Amplifier loading characteristics were not the easiest, but the 5 ohm minimum is innocuous enough nevertheless, and most unlikely to give

any difficulties. Though improved in the latest samples, bass extension is still somewhat limited, -6dB being at a highish 66Hz.

The basic frequency responses show very close correspondence with those obtained last year, albeit with a slight improvement in treble smoothness (possibly due to tweeter sample variations); there is some improvement with the grilles removed. The mid bass shows slight underdamping, but the general integration on- and off-axis was pretty good confirming Mission's designed optimisation to the 20 per cent horizontal listening axis. The room response again showed close similarity to last year's model, the slightly 'mid forward' character being a little more noticeable.

Distortion, however, showed a significant improvement on the latest samples, while pair matching was fairly good, albeit showing occasional +/- 1dB treble variations.

SOUND QUALITY

Again confirming the 1986 findings, the 700LE scored a straight average with encouraging consistency on both listening tests. The PM panel found the sound quite clear, lively, open, tight, and 'out of the box', if a touch small and aggressive, with some criticism of bass quality and midband congestion.

The MC panel findings were very similar, again praising articulation and lively dynamics, and again noting some mild mid coloration, hardness and brightness, with a slightly 'light-weight' balance and limited stereo depth.

CONCLUSIONS

With hindsight it was probably unnecessary to re-review the 700LE, though the exercise has at least helped confirm the good consistency of our review methodology. The results are much as before, the LE remaining a full competitive model, carefully contrived to be suitable for close-to-wall siting and deserving confident Recommendation.

GENERAL DATA

Size (height x width x depth)	38 x 21 x 21cms
Recommended amplifier power per channel (for 96dBA minimum per pair at 2m)	(10) – 100W
Recommended placement	straight ahead on stand near wall
Frequency response (+/-3dB, 2m)	80Hz – 20kHz
Low frequency rolloff (-6dB, 1m)	66Hz
Voltage sensitivity (ref 2.83V or 1W into 8ohms, 1m)	89dB/W
Approximate max sound level (pair at 2m)	103.5dBA
Impedance characteristic (ease of drive)	above average
Forward response uniformity	good plus
Typical price per pair inc. VAT	£130

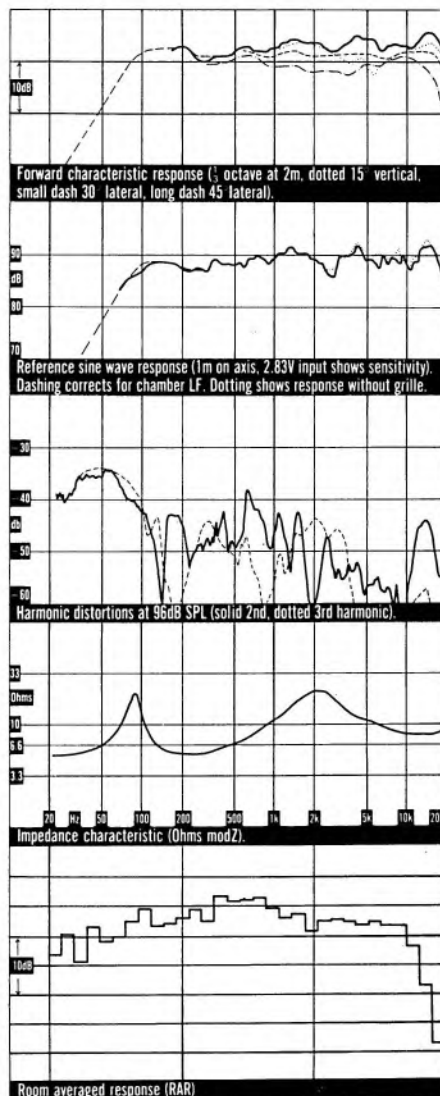

MISSION ARGONAUT

MISSION ELECTRONICS, STONEHILL, HUNTINGDON PE18 6ED. TEL: (0408) 52777

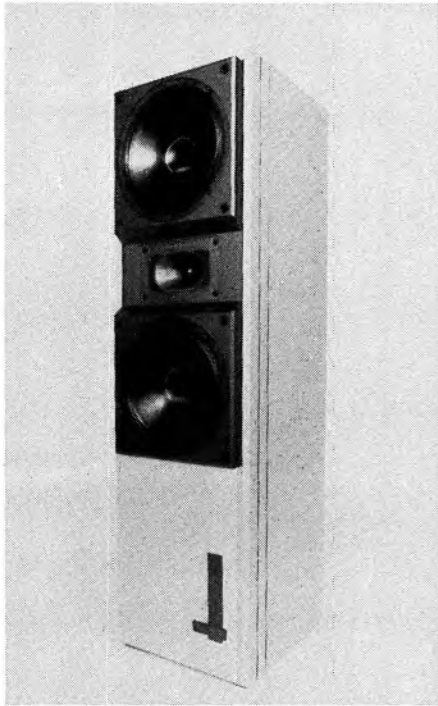

This top £700 model in the extensive and popular Mission range has only recently become available in the UK. Quite large, it is a floor-standing model which needs no separate stand, is slim with a small (spiked) 'footprint', and is aligned to be sited fairly close to a rear wall. The review pair were supplied in the most attractive grey-stained veneer thoughtfully tone-matched to the editor's new carpet and leaving him finding excuses to hang on to them. The front baffle has a step to aid driver time-alignment, and though the grille has some clever shaping it is still better left off whereupon the elaborate baffle trim lends a slightly aggressive appearance.

This is a three-way design, using twin 200mm polypropylene cast-frame units for the bass, rolling off the lower one quite early and allowing the upper driver to handle most mid-range chores. This in turn is succeeded by a mildly horn-loaded tweeter – an unusual approach for a dynamic loudspeaker, but helpful in achieving this design's very high sensitivity. Extra terminals allow for normal single-run or bi-wire configurations, and the comparatively simple crossover uses high quality components – film caps, WW resistors and heavy multi-strand hard-wiring.

Build quality and finish are both excellent. The 60 litre sealed box enclosure is made from fairly lightweight 12mm board, but there are two circumferential braces and additional cabinet wall damping pads, and the main front baffle is built from substantial 24mm MDF.

LAB REPORT

Sensitivity is a remarkably high 91dB, so amplifier power availability will not be any problem, though residual power amp noise could start to become irritating! Bass extension remains quite generous, though the load presented to the amplifier is a little current-hungry at low frequencies as is often the case with tandem bass systems. No problem for decent transistor amplifiers, but valve fans should check compatibility. Given the power handling, loudness capability is prodigious.

The response traces are pretty decent, though with unmistakable evidence of a steady rise on-axis at high frequencies, probably due to the horn coupling. However, with the speakers sited straight ahead, a well placed listener will probably receive just about the right off-axis angle for optimum response. Grille removal makes a slight improvement in smoothness, but overall integration and off-axis responses are all pretty respectable. The room-averaged response shows an excellent extended low frequency match, with a basically neutral balance enlivened by slight richness, forwardness and brightness. Distortion was low, and pair-matching within an excellent +/- 0.2dB.

SOUND QUALITY

After a little experimentation in finding the optimum position, the *Argonaut* rated a fine 'good plus' in the *FM* tests. There was a tendency to low frequency richness, and some criticism of forwardness and treble harshness and 'shimmer'. But this was more than compensated by the fine dynamics, weight and scale, the lively and articulate presentation.

The *MC* panel came to very similar conclusions, experimenting also with bi-wire and near free space conditions to advantage. Described as 'a bit of a rock machine', the sound could have been purer and sweeter, and a 'sheeny' treble was not to every taste, but again good detail, dynamics and power were well appreciated.

CONCLUSIONS

Not perhaps the sweetest or subtlest of speakers, the *Argonaut* nevertheless offers impressive drama and excitement, and a sound quality rating quite sufficient to merit Recommendation. It provides a rare combination of fine room-matched bass extension with the capability to go really loud, while at the same time taking up a bare minimum of space in the domestic environment. On the grey carpet they blended in so beautifully...

GENERAL DATA

Size (height x width x depth)	95 x 23 x 31cms
Recommended amplifier power per channel (for 96dBA minimum per pair at 2m) (10) – 200W	
Recommended placement	floor standing near rear wall
Frequency response (+/-3dB, 2m)	60Hz – 20kHz
Low frequency rolloff (-6dB, 1m)	40Hz
Voltage sensitivity (ref 2.83V or 1W into 8ohms, 1m)	91dB/W
Approximate max sound level (pair at 2m)	109dBA
Impedance characteristic (ease of drive)	below average
Forward response uniformity	above average
Typical price per pair inc. VAT	£700

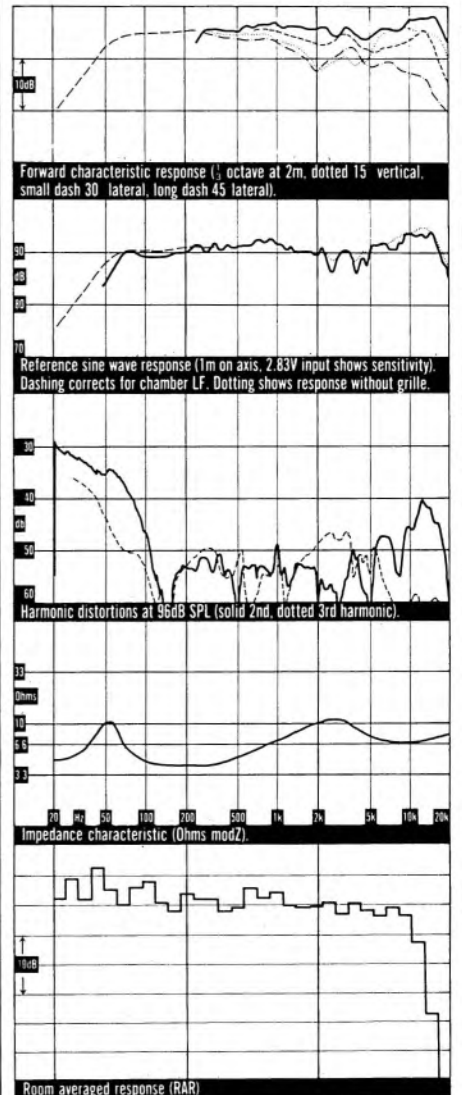

A BREATH OF FRESH SOUND

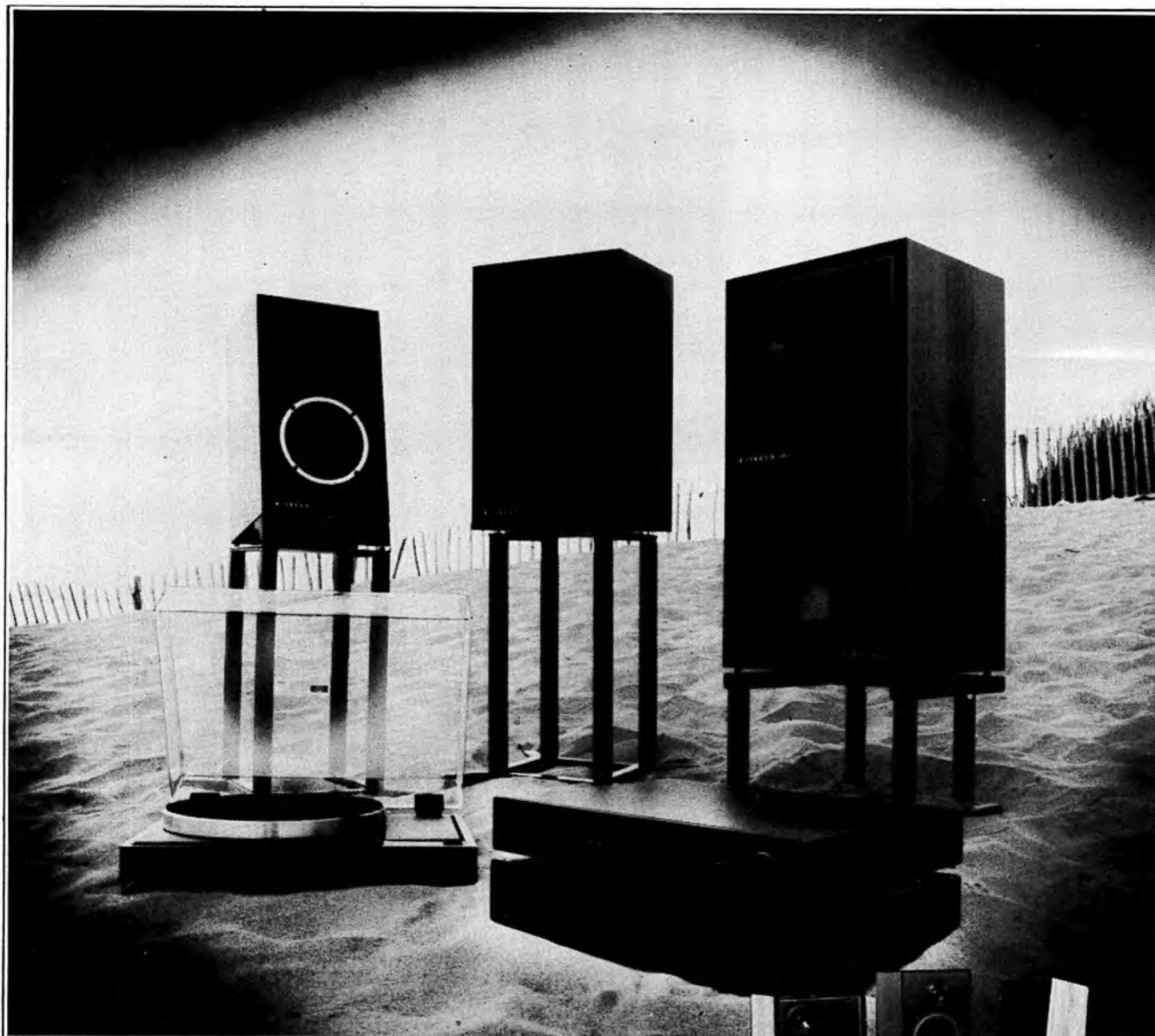

Heybrook brings a breath of fresh sound to your listening environment with a brilliant realism that's almost beyond belief.

Savour aural excellence from an award winning range of audio products; contact your Heybrook dealer listed opposite, or send the coupon today.

HEYBROOK



66 **HB1** LOUDSPEAKER OF THE YEAR 1984, 1985, 1986 - WHAT HI-FI BEST BUY 1983, 1984, 1985 - HI-FI CHOICE
HB2 RECOMMENDED 1979, 1980, 1981, 1982, 1983, 1984 - HI-FI CHOICE. "THEY POSSESS THAT EFFORTLESS SOUND QUALITY WHICH WAS ALMOST IMPOSSIBLE TO BELIEVE". PRACTICAL HI-FI 1980. "...A CLEAR RECOMMENDATION". HI-FI NEWS 1983.
HB3 "EXCITING AND VERY DRAMATIC... WITH AN EFFORTLESSNESS AND EASE. RHYTHMS ARE WELL DEFINED AND CRISP... A WARMTH AND RICHNESS OF TONAL COLOUR... HIGHLY INFORMATIVE... EXCELLENT LEVELS OF INSTRUMENTAL SEPARATION... AND DYNAMICS". PRACTICAL HI-FI 1983. "HIGH SOUND LEVELS WITHOUT ANY NOTICEABLE COMPRESSION. CONVINCING REALISM ANALYTICAL SOUND REMINISCENT OF STUDIO MONITORS". HI-FI FOR PLEASURE 1984.
TT2 RECOMMENDED 1983, 1984, 1985 - HI-FI CHOICE. "IN TERMS OF PERFORMANCE THE TT2 CAN BE WELCOMED TO THE SELECT BAND OF HIGH QUALITY UNITS". GRAMAPHONE 1984. "...EXCELLENT WELL MADE. ABOVE AVERAGE PERFORMANCE". HI-FI ANSWERS 1983. "THE TT2 IS A SUPERIOR PRODUCT". HI-FI NEWS 1984.
HBS1 LOUDSPEAKER STAND OF THE YEAR. FEDERATION OF BRITISH AUDIO AWARDS 1984.
C2/P2 "...ONE OF THE VERY BEST COMBINATIONS AVAILABLE UNDER £1000". NEW HI-FI SOUND 1986. "...BETTER THAN ANY EQUIVALENTLY PRICED AMPLIFIER I HAVE HEARD". HI-FI ANSWERS 1986.

99

MONITOR AUDIO R352MD

MONITOR AUDIO LTD, 34 CLIFTON ROAD, CAMBRIDGE CB1 4ZW. TEL: (0223) 246344

RECOMMENDED

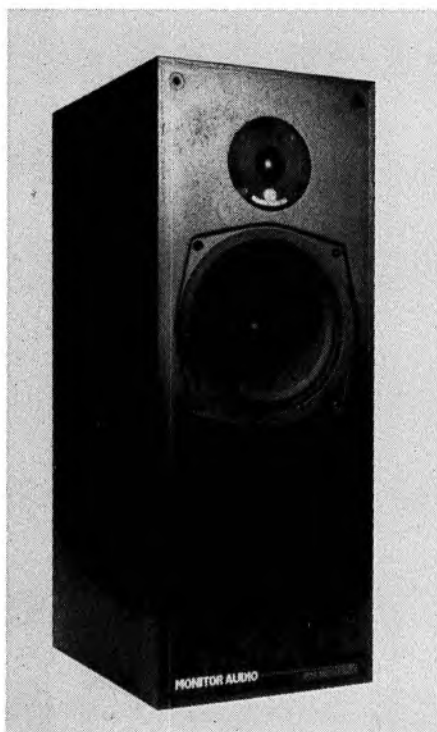

The long established Monitor Audio brand are currently concentrating their efforts on the £250-£400 sector of the market – within which lie no less than four out of their nine or so models, with different shapes, sizes and finishes, and perhaps the most confusing nomenclature in British audio. They submitted no fewer than three of these for this 1987 edition, two of which we had space to cover.

The *R352MD* is in fact a development of the well respected *352*, incorporating MA's new metal dome tweeter. Old *352s* can be MD updated for £44. It is a quite large and heavy loudspeaker, more than twice the enclosure volume of the *652*, yet costing £90 less at £280; slightly less 'polished', it still shows much the same attention to construction quality.

The 36 litre reflex-loaded box has real wood veneer, and is built from 18mm chipboard, with additional internal reinforcement, and foam providing some enclosure damping. The grille frame has been rebated to reduce acoustic interference. Built quality is good, and the design is intended for free space siting, on low (eg 25cm) stands.

The bass/mid driver is a 200mm unit with a flared pulp/paper cone built on a steel frame, while the tweeter is a 25mm metal alloy dome device. The crossover is simple and direct (1st/2nd order), of good commercial quality and with internal hard-wiring.

LAB REPORT

Sensitivity is a pretty high 89dB/W, and good power handling allows levels up to 104dB – alternatively a low powered amplifier will still give plenty of level. This has not been achieved at the expense of the amplifier load characteristic, which is very easy, though the bass extension has perhaps been compromised somewhat considering the size of the enclosure (–6dB at 45Hz, rolling at 12dB/octave).

The response curves are basically flat with no trace of serious discontinuity, though they could be smoother and show a distinct falling trend from bass to treble.

The grille is better left off (see 1m reference curve), but the overall axial and off-axis integration is very good, aided by the narrow baffle. The room curve looks promising too, confirming the limited bass extension but generally smooth elsewhere, with just minor emphasis in the midband and the mid treble.

Distortion is very low, particularly at high frequencies, while pair matching of our samples was within an excellent ± 0.3 dB.

SOUND QUALITY

Rating on the borderline between 'above average' and 'good' on both listening tests, the *352MD* was well received. Though not unanimous in their enthusiasm, the *PM* panel liked the open 'out of the box' character and good 'scale', notwithstanding a somewhat 'rich', 'heavy' and dulled overall balance. Some commented on a degree of coarseness and untidiness.

The *MC* panel praised a generally clean, neutral and uncomplicated sound with good treble quality, but again commented on a 'heavy' but not particularly extended bass. The *352MD* sounded healthy at high levels, gave decent stereo focus, and sounded pleasantly well controlled.

CONCLUSIONS

This loudspeaker is clearly good value for money, both sonically and in terms of engineering and build quality. The balance will not be to every taste, and is perhaps better suited to CD rather than vinyl sources, but Recommendation is mandatory.

GENERAL DATA

Size (height x width x depth)	64 x 25 x 32cms
Recommended amplifier power per channel (for 96dB minimum per pair at 2m)	(10) – 100W
Recommended placement	on 25cm stands in free space
Frequency response (+/–3dB, 2m)	48Hz – 20kHz
Low frequency rolloff (–6dB, 1m)	42Hz
Voltage sensitivity (ref 2.83V or 1W into 8ohms, 1m)	89dB/W
Approximate max sound level (pair at 2m)	104dB
Impedance characteristic (ease of drive)	V good
Forward response uniformity	good plus
Typical price per pair inc. VAT	£280

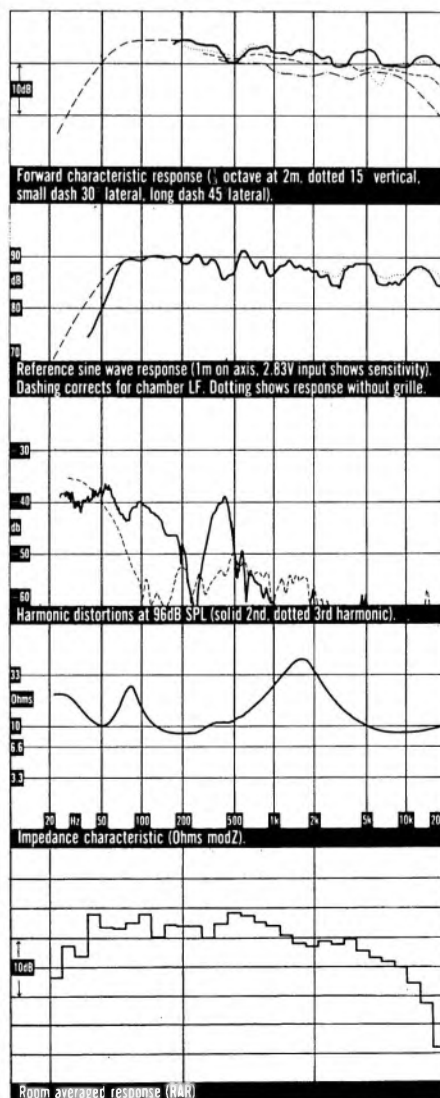

MONITOR AUDIO R652MD

MONITOR AUDIO LTD, 34 CLIFTON ROAD, CAMBRIDGE CB1 4ZW. TEL: (0223) 246344



Monitor Audio currently seem to be specialising in the £250-£400 mid-priced sector of the market, wherein lie no less than four models of different shapes, sizes and finishes though even they seem uncertain as to which is which. They submitted three of these for this 1987 edition, two of which we had space to cover.

The £370 652 is a slim and compact (16.5 litre) two-unit model, with a number of luxury touches. Real wood veneer extends to the baffle – though it was not of the prettiest patterning or most attractive colouring on our samples. Designed for free space siting on good quality stands, the carcass and baffle are 15mm chipboard, with additional side panel thickness and longitudinal bracing, plus damping pads and foam lining. The grille frame is properly rebated to minimise acoustic interference.

A rear port provides reflex loading for the smallest 160mm bass driver, which uses a cast magnesium frame and polypropylene cone. The MD of the type number refers to the 25mm tweeter's metal dome. An ultra-simple 1st-order crossover uses good quality components such as film capacitors, and is hard-wired using decent cabling. Build quality and finish are as promising as the impressive list of basic ingredients.

LAB REPORT

Sensitivity is an average 86.5dB/W, while bass extension and power handling are quite gener-

ous for the size of the enclosure and bass unit. The load characteristic is easy, and amplifiers in the 20-100W range should match well, allowing a decent loudness maximum of around 102dBA.

The basic frequency response is quite well balanced, but there is a fairly mild yet broad suckout around the crossover region (depending on the measuring axis). Forward responses show generally good driver/baffle integration albeit with some vertical axis dependency. The tweeter axis gives the best overall results, while removal of the grille also brings a mild improvement. The bass Q is rather high at around 50Hz, and there is a sharp increase in tweeter output around 25kHz typical of a metal dome resonance and (fortunately) beyond the range of human hearing. The room response could be smoother, and highlights the potential bass 'boom'.

Distortion is generally good, and pair matching was held to an excellent ± 0.2 dB.

SOUND QUALITY

The PM panel were quite well impressed by the 652, which rated above average overall. There was some criticism of bass 'boominess' and a tendency towards 'blandness', but the extension and 'scale' was liked, along with good clarity and reasonable neutrality.

MC's panel held the rating down to a straight average, but came up with similar enough descriptions. Again the main complaint was of a 'one note', 'heavy' bass, but with quite good transparency and articulation elsewhere. Stereo was unexceptional, lacking precise focus, and there was also mild midband hardness, but the treble was nice and clean.

CONCLUSIONS

In many ways an attractive loudspeaker, there is clearly still room for improvement in the 652 – a little more development could improve the mild weaknesses in bass and crossover regions perhaps. Nevertheless the ingredients and build are sound, and the sound was quite well liked, so it is certainly a model worth considering if size and presentation attract the eye.

GENERAL DATA

Size (height x width x depth)	51 x 20 x 26cms
Recommended amplifier power per channel (for 96dBA minimum per pair at 2m) (20) – 100W	
Recommended placement	free space on 40cm stand
Frequency response (± 3 dB, 2m)	50Hz – 20kHz*
Low frequency rolloff (-6 dB, 1m)	45Hz
Voltage sensitivity (ref 2.83V or 1W into 8ohms, 1m)	86.5dB/W
Approximate max sound level (pair at 2m)	102dBA
Impedance characteristic (ease of drive)	V good
Forward response uniformity	good
Typical price per pair inc. VAT	£369

*see text

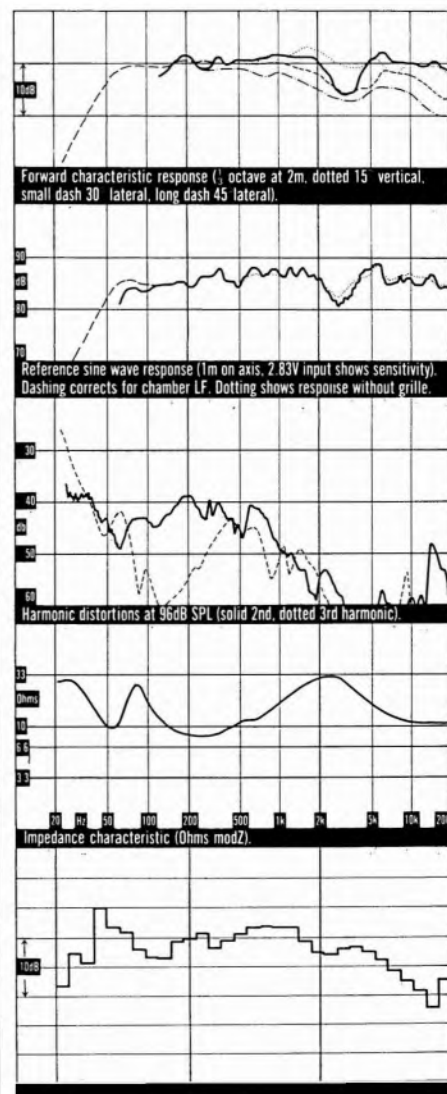

MORDAUNT-SHORT MS10II

MORDAUNT-SHORT LTD, DURFORD MILL, PETERSFIELD, HANTS GU31 5AZ. TEL: (0730) 80721

BEST BUY



Mordaunt-Short's *MS10* has been a popular miniature for a couple of years now, and has been recommended in previous editions of *Choice*. This *MkII* version shows only detail changes, but sufficient to warrant a full new review, at the now slightly higher typical price of £90. The *10II* is a tiny reflex loaded two-way design of just 6.6 litres internal volume, and certainly requires the assistance of a rear wall to boost the bass, despite the coloration compromise this will introduce in the midrange.

The cabinet is built from 12mm chipboard finished in 'black ash' vinyl, while the baffle is 15mm thick. There is no additional bracing, though this is hardly necessary for such a small, inherently strong box. Damping is a simple polyester wad, while the 10mm grille frame secured by M-S' neat new plastic trim is unrebated, so the grille may be better left off.

A small 130mm paper cone driver covers bass and midrange, whereupon the familiar 19mm Audax tweeter takes over. The crossover is reasonably simple, with normal commercial quality components and tagged wiring. However, M-S' *Positec* protection system brings added peace of mind, and is particularly appropriate in such a tiny loudspeaker. Finish and build quality are both pretty good.

LAB REPORT

Sensitivity is still a shade below average, but nevertheless a dB (or so) better than the *MkI* and more than adequate for decent levels. Inevitably, power handling is somewhat restricted, though our estimated 99dBa should be quite adequate for most purposes, short of lively parties, and amplifiers should have no difficulty driving the simple load. Bass extension is naturally limited, but again improves slightly on the *MkI*.

The basic response shape shows some unevenness, but is well balanced to benefit from close-to-wall mounting (perhaps on wall brackets?). Removal of the grille improves the relative treble output and smoothness quite markedly. The off-axis curves show good integration and consistency, as is usually the case with a well-engineered miniature. The room-averaged response confirms the absence of deep bass, and highlights some mid forwardness and a mild treble 'corner' besides.

Distortion is satisfactory enough considering the size, though poorer than average nonetheless. Pair matching was also reasonable, with the HF region holding within ± 1 dB.

SOUND QUALITY

The *PM* panel were not particularly impressed, rating the *10II* well below average, though this is consistent with this panel's general dislike of 'miniatures' as a breed, the *10II* doing better than most. The lack of bass and 'welly' dominated comments, and some 'shout' and treble 'untidiness' also received remarks. But the general consensus was of a basically lively and well-balanced design, with good stereo and reasonable detail.

The *MC* panel's average rating would have been better still had it not been for the limited bass. Regarded as very competent despite its size, speed and clarity were both good and the bass balanced well when fully wall mounted. Stereo showed some depth, though there was some 'nasality' and 'small box' sound to add colour in the midband.

CONCLUSIONS

The *MS10II* is one of the best miniatures around, with a general all-round competence at a modest price which is hard to fault. In view of the discrepancy between the two panels it is a borderline Best Buy, depending perhaps on how important the bass limitations are considered by a prospective purchaser.

GENERAL DATA

Size (height x width x depth)	29 x 20 x 17cms
Recommended amplifier power per channel (for 96dBa minimum per pair at 2m)	(20) - 50W
Recommended placement	wall bracket
Frequency response (± 3 dB, 2m)	90Hz - 20kHz
Low frequency rolloff (-6 dB, 1m)	75Hz
Voltage sensitivity (ref 2.83V or 1W into 8ohms, 1m)	86dB/W
Approximate max sound level (pair at 2m)	99dBa
Impedance characteristic (ease of drive)	V good
Forward response uniformity	V good
Typical price per pair inc. VAT	£90

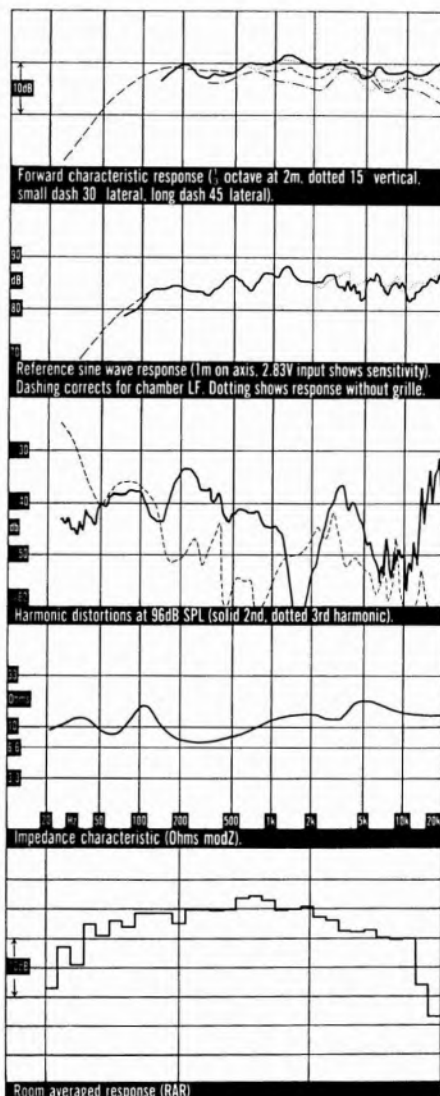

RECOGNITION



Since its introduction in October '83 the RL850 has gained much critical acclaim in the hi-fi press. Offering an involving and dynamic sound the RL850 represents fine value achieving best buy status with Hi-Fi Choice since 1984.

The RL850 has also been a critical component in Rotel's award winning system for the past 4 years.

In its latest form the RL850 II benefits from an improved tweeter and crossover which have further refined its performance.

To find out why this loudspeaker has now received What Hi-Fi's prestigious award for the best loudspeaker of 1988, call Rotel for details of your nearest dealer.

DESIGNED, DEVELOPED AND MANUFACTURED IN THE U.K.

ROTEL[®] hi-fi

25 HEATHFIELD, STACY BUSHES, MILTON KEYNES MK12 6HR. TEL: (0908) 317707

SOUND AND STYLE

MORDAUNT-SHORT MS45Ti

MORDAUNT-SHORT LTD, DURFORD MILL, PETERSFIELD, HANTS GU31 5AZ. TEL: (0730) 80721



Mordaunt-Short have built much of their recent reputation on the basis of successful miniature and bookshelf designs like the *MS10* and *'20*. The £220 *'45Ti* is significantly larger than these, and adds an extra driver to augment bass output and power handling. However, this is not a three-way design in the bass/mid/treble sense. Instead, two identical 200mm pulp cone drivers operate in tandem in the bass, the lower one rolling off fairly early while the upper one continues on up until it crosses over to a (largish) 27mm titanium cone/dome tweeter.

The generous 35 litre sealed box enclosure is constructed economically from 15mm chipboard, and clad in a good quality vinyl 'veneer'. The cabinet is reinforced by a square brace between the main drivers, but the grille frame is 15mm thick, with only a slight attempt to chamfer the inside edge.

LAB REPORT

Sensitivity is a very generous 90.5dB/W, and power handling is good too, so this speaker goes loud even with small amplifiers, and can produce high levels when fed from something powerful. The impedance characteristic is good too, though the bass extension is some-

what compromised considering the size of the box: -6dB being a highish 52Hz.

The response curves are rather unpromising, the most noticeable characteristic being a 'shelving' effect, with a discontinuity between midband and treble, the latter being at a significantly lower level. The grille is better left off.

The speaker could do with some room boundary assistance at low frequencies, while the above-axis response gives a smooth transition through the crossover region, so low stands fairly close to a rear wall look the best option. The room averaged response is better balanced overall than the sinewave curves, but still shows some unevenness. Distortion was very low, and pair matching good.

SOUND QUALITY

The *PM* panel rated the *45Ti* 'average' overall, which is a pretty respectable result. The sound was quite 'big' and lively, with good rhythm and dynamics, marred by the lack of real extension, a 'heavy' upper bass, and a degree of congestion.

The *MC* panel were less kind, the 'below average' rating reflecting a reaction to midband coloration and a lack of depth and focus. Reasonably punchy with brighter rock material, the treble sounded somewhat 'detached' and some 'boxy', 'megaphonic' effects were described.

CONCLUSIONS

The *MS45Ti* shows fine sensitivity and exceptional loudness capabilities, but as is often the case with competitively priced 'tandem bass' systems, it falls down on balance and subtlety. It is nevertheless worth considering for those seeking the former qualities and less perturbed by the imbalance and coloration limitations.

GENERAL DATA

Size (height x width x depth)	63 x 26 x 30cms
Recommended amplifier power per channel (for 96dB minimum per pair at 2m) (10) - 200W	
Recommended placement	low 20cm stand, near wall
Frequency response (+/-3dB, 2m)	60Hz - 20kHz*
Low frequency rolloff (-6dB, 1m)	52Hz
Voltage sensitivity (ref 2.83V or 1W into 8ohms, 1m)	90.5dB/W
Approximate max sound level (pair at 2m)	108dB
Impedance characteristic (ease of drive)	good plus
Forward response uniformity	above average
Typical price per pair inc. VAT	£220

*See graph

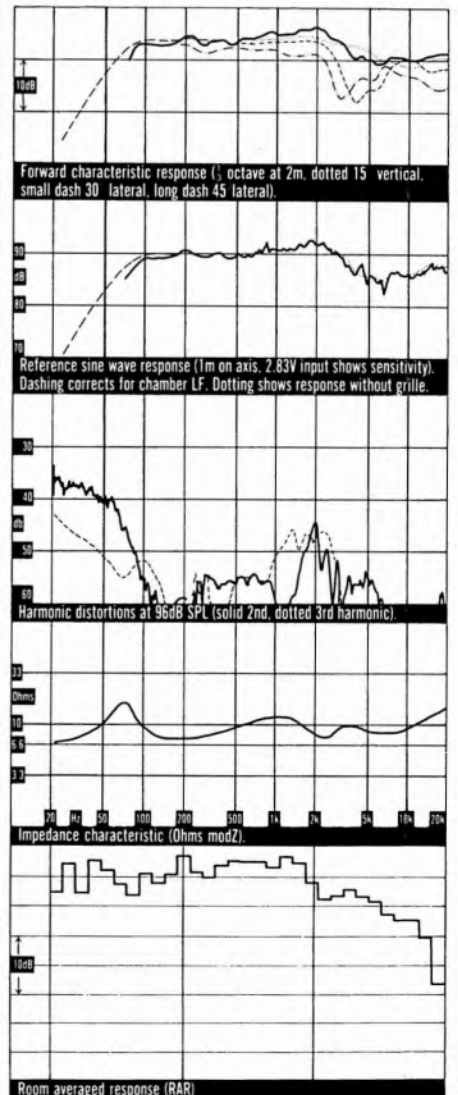

MORDAUNT-SHORT 442

MORDAUNT-SHORT LTD, DURFORD MILL, PETERSFIELD, HANTS GU31 5AZ. TEL: (0730) 80721

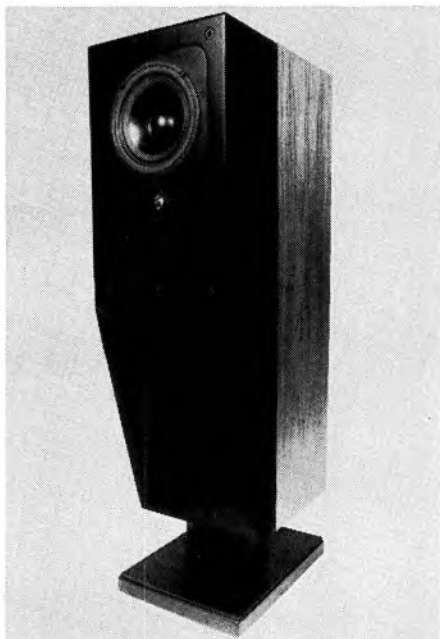

This brand new flagship from Mordaunt-Short – their first for many years – is also a trendsetter in integrating loudspeaker and stand, a development which looks set to become increasingly important over the next few years. M-S's application is original and unique, with a number of other radical techniques. The result is an expensive but attractively compact design – if a touch robotic in appearance.

The 442 starts with a rigid backbone stand, to which the drive units are firmly mechanically fixed. The 35 litre reflex-loaded cabinet is then attached *via* vibration absorbing gaskets, still acting as enclosure for driver rear radiation, but avoiding most vibration excitation. A further feature is an extra rear-mounted bass driver which opposes the mechanical movement of the main driver at low frequencies and helps improve linearity.

More so than other integrated stand designs, the 442 is easy to set up and install, merely requiring the removal of two transit screws underneath to float the cabinet. Additional refinements include the direct coupled main bass/mid driver, using a polypropylene cone in cast magnesium frame, and subtly designed mechanically to need no crossover circuitry. The crossover permits tri-wiring, while M-S' effective Positec protection circuitry provides some user peace of mind.

Build quality is excellent, with real wooden veneer cabinetwork combined with extensive black fabric grille material. Inside the steel backbone connects to the aluminium baffle and rear driver by tuned aluminium rods, while the rubber finished foot is equipped with proper adjustable spikes. The £1150 price may seem

steep, but is much less so when the quality of the ingredients and radical engineering are taken into account. Free space siting is essential, to avoid unwanted bass boost and reflection effects from the rear driver.

LAB REPORT

Sensitivity is a comfortable 87.5dB/W, capable of giving decent levels from a modest 20W of amplifier power. Yet power handling is clearly very generous, so high sound levels are available, but a rather low impedance in the bass region is best driven by a good quality amplifier with healthy current delivery.

The bass shows decent extension, albeit with some lift at very low frequencies. The responses show a notch effect in the mid bass, a function of cancellation in this twin driver arrangement, and this is likely to produce some sensitivity to precise siting – careful experimentation will be worthwhile. The responses are generally very even, smooth and flat through the midband and treble, with decent off-axis integration but mild evidence of unwanted grille effects (a pity, as the rebating is good and the speaker looks odd with grille removed). The loss of upper bass energy and mild low bass boom is seen in the room-averaged response, but the extended bass and smooth mid and treble are both confirmed.

The distortion was very good at 86dB, and still much better than average at 96dB.

SOUND QUALITY

Though not auditioned blind because of siting constraints, the 442 was a clear favourite amongst the PM panel, largely because the sound was fundamentally very clean and unfatiguing, even though there was mild criticism of the slightly heavy, rich bass, and a slight lack of sparkle and speed.

The MC panel confirmed these findings quite closely, and under blind conditions – and further confirmed the audibility of removing the transit screws to float the cabinet properly, and the efficacy of the tri-wire option. There was some criticism of slight blandness and mid hardness, and the bass heaviness was again noted, but the fine, smooth clarity with good focus and decent depth, low cabinet coloration and convincing dynamics were all praised.

CONCLUSIONS

Though there are one or two detail oddities, and probably room for a little further developmental refinement, the 442 was a resounding success with the listening panels. It is attractively styled yet conveniently compact, while the technical innovations are clearly linked to an unusual degree of refinement. Given the

mild caveat over the interaction of bass with specific rooms, the 442 is probably more nearly all things to all men than many other top loudspeakers.

GENERAL DATA

Size (height x width x depth)	95 x 26 x 38cms
Recommended amplifier power per channel	(for 96dB minimum per pair at 2m) (20) – 250W
Recommended placement	floor-standing in free space
Frequency response (+/-3dB, 2m)	see text
Low frequency rolloff (-6dB, 1m)	40Hz
Voltage sensitivity	
(ref 2.83V or 1W into 8ohms, 1m)	87.5dB/W
Approximate max sound level (pair at 2m)	106dB
Impedance characteristic	
(ease of drive)	below average
Forward response uniformity	above average
Typical price per pair inc. VAT	£1150

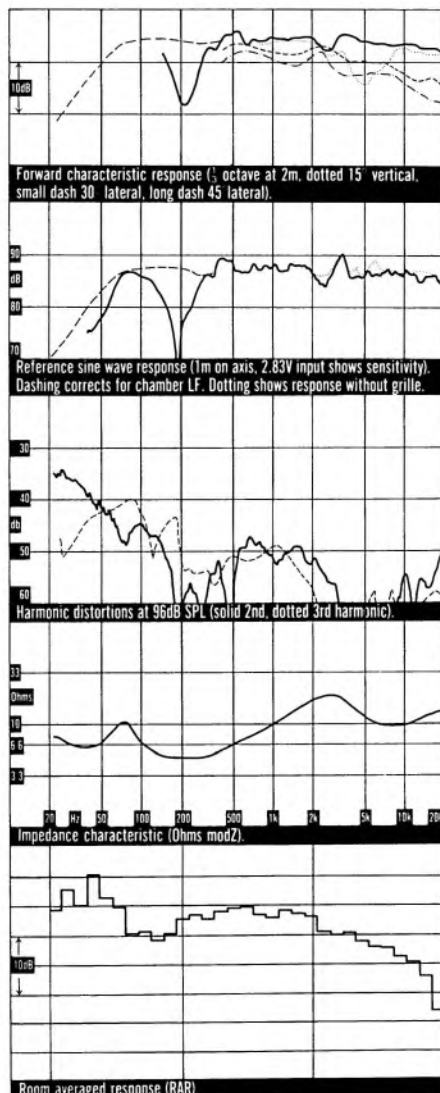

**ONLY ONE PART OF THE ES RANGE
DOESN'T SOUND LIKE THE BEST BRITISH HI-FI.**

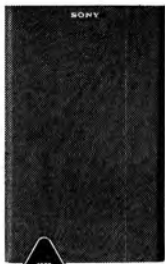

APM 66 ES.
Award winning flat diaphragm design.
Hi-Fi Choice: 'Worth Considering.'

No one appreciates good hi-fi as much as the British. That's why we consulted them when we wanted to improve our ES range. As each new product was developed we sent a hand-built sample to a team of British hi-fi experts.

After the strictest examination, they suggested improvements which we took on board.

But even the toughest critics approved our Gibraltar Chassis. The CDP 555 ES as well as each amplifier is built on a solid base of marble and fibreglass. So vibration and magnetic interference are kept to an absolute minimum.

Judging by their response, hi-fi magazines are impressed too. Though if you think our separates sound good on paper, wait until you hear them in your living room.



APM 66 ES.
Award winning flat diaphragm design.
Hi-Fi Choice: 'Worth Considering.'



CDP 555 ES.
CD player with Gibraltar Chassis, 4 times over sampling, and twin transformers.
Hi-Fi Choice: 'Recommended.'



STS 700 ES.
FM stereo/MW/LW synthesiser tuner.
Hi-Fi Choice: 'Best Buy.'



TCK 700 ES.
3 head quartz lock, direct drive, cassette deck.
Hi-Fi Choice: 'Recommended.'



TAF 700 ES.
110W stereo integrated amplifier with Gibraltar Chassis.
Hi-Fi Choice: 'Worth Considering.'

SONY. ES

QUAD ESL-63

QUAD ELECTROACOUSTICS LTD, 30 ST. PETERS ROAD, HUNTINGDON PE18 7DB. TEL: (0480) 52561

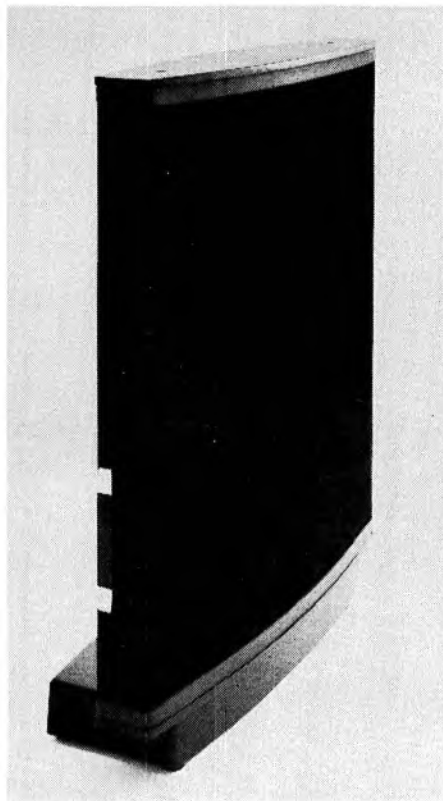

Development work on this design started, as the model number suggests, as long ago as 1963, though it did not go into production until 1981. In the '63, the old *Electrostatic's* problem areas, namely directivity, bandwidth sensitivity, power handling and amplifier loading, have all found at least partial solutions, albeit at a high price.

A single large-area damped plastic film diaphragm is electrostatically energised to operate as a phased array of eight concentric elements, so the emerging wavefront is an approximate simulation of the radiation from a theoretical point source 30cm behind the centre of the panel. A high voltage delay line feeding the multiple elements incorporates compensation for the clamped boundary of the diaphragm, and equalisation for the axial frequency response. The size and apportionment of frequency range and delay to the elements allows control of directivity, which is adjusted to give a smooth and uniform decay at increasing off-axis angles. But it should still be borne in mind that distribution from the '63 is poor by comparison with the best moving-coil designs, and that the speaker remains rather critical of listening angle.

The latter characteristic presented a problem on tests, since in the modest confines of my listening room only two of the six panelists

could be in the optimum zone, and when used as suggested on the floor at our typical 3-3.5m listening distance, the main axial treble response was directed nearer to chests than ears. Accordingly, the speakers were elevated by about 20cm on open stands and tilted marginally backwards. Further auditioning was also conducted with solo listeners to augment the panel's subjective data.

The *Quad '63* is a bipolar design which generates regions of acoustic power fore and aft that are suppressed in the sideways directions. This results in a rather different room drive and reverberation compared with considerably more omni-directional small box speakers. So even if the Quad did provide an identical axial frequency response to a low coloration moving-coil model, it would not sound the same due to the significantly different room reverberation tonal balance. Furthermore, the different manner of 'throw' into the room produces a more even spread of intensity compared with dynamic loudspeakers.

LAB REPORT

The sensitivity reading was not comparable with a normal speaker due to the doublet directivity. Furthermore, the 1 metre reference response was theoretically too close, risking proximity and integration errors. Approximation or not, the reading was below average at 84dB/W, though as with all panel speakers intensity is maintained well at a distance from the speakers. The reference response met ± 2 dB limits between 50Hz and 9kHz, outside of which some irregularities were charted which could not be wholly blamed on proximity, as 2m and 3m response checks verified.

Averaged in $\frac{1}{3}$ -octave bands at 2m, the speaker demonstrated a superbly even mid and low range response, with some mild 'lumpiness' above 5kHz. The response sensitivity to axis was shown by a measurement just 7.5° off-axis vertically, which revealed a more than 5dB loss above 12kHz. The output decayed much more than average off-axis, but the decay pattern was exceptional in terms of consistency and evenness. In practice the bass rolloff was indeterminate, depending on the listening room boundaries and in particular the distance to the rear wall (with zero bass when placed against the latter). In open air or in large rooms 34Hz, -6dB is possible, but at a modest acoustic level.

While not as kind a load as Quad suggest, with dips to 3.5ohms recorded at 50Hz and 10kHz, the speaker should not cause amplifiers too much trouble. But when the speaker is heavily overloaded it protects by a short-circuit 'crowbar' which may damage some

amplifiers. Above 60Hz, even at a full 96dB, the distortion performance was superlative, though the '63 would not accept inputs over 30W or so below this frequency without diaphragm rattling. Above 100Hz the distortion was 10-100 times better than usual, but compression occurred at a 100W peak input, due to the speaker's protection circuit; however, at 50W, just 3dB less, the pulse reproduction was simply too perfect to register measurements.

SOUND QUALITY

At risk of appearing to make excuses for the '63, The subjective data did partly reflect its directionality, and side positioned listeners were not well served. Prolonged solo listening suggested that to some extent the sound was something of an acquired taste, and that if its particular qualities appealed, these could assume such overriding importance that no other model

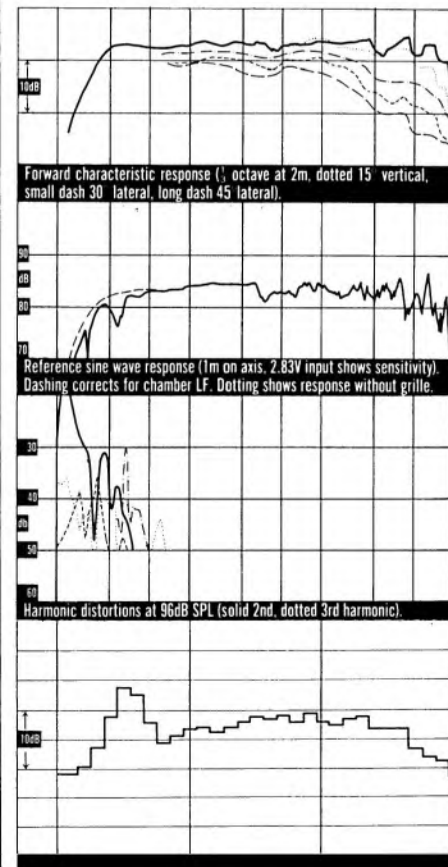

would suffice. On first hearing however it can sound somewhat 'dead' and 'clothy', due in part to the loss of reverberant energy in the upper frequencies when compared to a conventional speaker. A trace of a 'whistly' quality in the extreme treble was audible to a few keen-eared listeners, while the sweetness and integration of the mid/treble band at first lends a dim impression until experience shows that the necessary treble detail still exists but in an unusually natural form.

Listeners accustomed to a dynamic and punchy bass of good power handling, particularly on rock-oriented programme, found the 63 disappointing since it could not play very loud, and the bass power, though more extended than an LS3/5a, was a little greater. Without the 'liveness' and 'excitement' of some of the better box systems, the '63 at first appears to lack detail and transparency. But prolonged listening showed that this was due to the misleading frequency balance, and that superb image depth as well as detail were apparent on-axis.

CONCLUSIONS

Since our original review minor improvements have been made to this speaker, notably considerably revised protection circuitry, allowing louder and better reproduction of bass transients. While not a powerhouse, it does at least now do respectable justice to the bass on rock material, particularly if this is digitally derived and hence free of overhang or subsonic excitation. Fully re-auditioned for recent editions, it achieved very respectable scores, especially on digital master programme.

The Quad has uniquely musical qualities through the vital mid registers, and deserves auditioning on high quality material if its blend of strengths and weaknesses are to be fairly assessed by the intending purchaser. The results continue to justify a *Choice* recommendation despite the elevated price.

GENERAL DATA

Size (height x width x depth)	93 x 66 x 27cms
Recommended amplifier power per channel (for 96dBa minimum per pair at 2m)	(25) - 100W
Recommended placement	on open stand, well clear of rear wall
Frequency response (+/-3dB, 2m)	40Hz - 18kHz
Low frequency rolloff (-6dB, 1m)	34Hz
Voltage sensitivity (ref 2.83V or 1W into 8ohms, 1m)	84dB/W
Approximate max sound level (pair at 2m)	99dBa
Impedance characteristic (ease of drive)	fairly difficult
Forward response uniformity	good*
Typical price per pair inc. VAT	£1459

*see text

FARNBOROUGH HI-FI

FOR PEOPLE WHO LOVE MUSIC

RUARK SABRES

Listening pleasure

"Guaranteed For A Lifetime"

Suberly designed, built and finished in real wood, this small speaker packs a big punch. Bass extension and control is comparable to much bigger and more expensive units, whilst the mid and upper range is clean and finely detailed. Stereo imaging and focus are good, resulting in a soundstage far bigger than the size of the enclosure suggests.

Quality of construction and internal damping make the *Sabre* a suitable candidate for wall or shelf mounting although the best results are obtained as usual on a pair of high quality speaker stands.

In our view a speaker that must be auditioned in this price range.

RUARK SABRE - £299 inc VAT:

black or walnut finish:

Carries a lifetime guarantee

Selected products from:

Pink Triangle, Exposure, Linn, Gale, Rogers, Systemdek, A&R, Heybrook, Tannoy, Mordaunt Short, Cliff Stone, Dual, Yamaha, NAD, Denon, Aiwa, Rotel, Marantz, Philips CD, Celestion, Apollo, SME, Revolver, Onix, Quad, Ariston, Incatech etc.

Facilities include:

- two single speaker demonstration rooms.
- Two-year warranty on most hi-fi.
- Seven day money-back guarantee.

FARNBOROUGH HI-FI

7 Queensmead, Farnborough, Hants GU14 7RG
Telephone: (0252) 520146

'P2' WORKS ON CD'S TOO!

"Reductions in error correction"

"Increase in sound level and output"

"Improved clarity and greater spaciousness"

Available from most good HiFi Dealers or £9.95 inc. P&P. Cheques, Postal Orders To:-

Hunt Steele Partners Ltd,
68 High Street, Puckeridge, Herts SG11 1RX

ROGERS LS6

SWISSTONE ELECTRONICS LTD, 310 COMMONSIDE EAST, MITCHAM, SURREY. TEL: 01-640 2172



The LS6 slots in below the LS7, and offers a similar basic package in terms of size but at a lower price. A newly developed polypropylene cone is used for the bass/midrange unit, built on a steel frame and fitted with a generous magnet. The treble is handled by a 19mm soft plastic SEAS dome unit, crossing over at around 3.5kHz.

Standing 51cm high, this speaker is suited to free space mounting on solid stands, like the LS7. The 23 litre enclosure is reflex-tuned to 50Hz by a 50mm diameter port; the internal section is slant-cut to an approximately 110mm length. Reflexing gives a fourth order bass response but in fact this system is fifth order, achieved via a 440µF series capacitor.

The high quality crossover network is essentially to a third order pattern and is built using excellent components.

Built from plain chipboard, the enclosure has a MDF driver baffle with a chamfered port opening and grille frame baffle.

The constructional quality and standard of finish is high. Electrical connection is via 4mm socket/binding posts.

LAB REPORT

At the reference 1 metre microphone distance, set on the median driver axis, this speaker provided a very uniform, well controlled response. There was no difficulty in establishing a sensitivity at a solid 87.5dB/W. With the grille off

the response met very credible ±2dB limits from 55Hz to 16kHz, with a -6dB low frequency limit at 50Hz, about average for the price and size.

Out at 2 metres, this speaker's fine driver outputs are excellently integrated, producing a first class set of off-axis responses.

In the listening room the forward energy was finely balanced above 80Hz but bass was also up a few dB at the 50Hz system resonance, falling quickly at lower frequencies. A lower system tuning frequency could improve matters here.

Driven to 96dB sound pressure, the speaker offered moderate distortion levels, averaging a good 0.3 to 0.4%. At the 86dB level, the frequency range above 100Hz averaged a fine 0.25%.

With a 150W maximum power handling, this speaker will provide generous sound levels up to 104dBA in a typical room. Conversely, as little as 15W will produce enough volume for normal purposes. The sensitivity was not compromised by the impedance characteristic, which showed an easy 80hm amplifier load.

SOUND QUALITY

Scored with great consistency by the panel, the LS6 achieved a very similar rating to the LS2, though with superior bass extension and power handling. The 'δ' was found to be very well balanced with a transparent, informative mid, and an open, 'airy' nature. Stereo depth was quite well developed, with good width and image focus.

Quite lively and dynamic, coloration was generally low. While the upper treble could sound 'grainy' on occasion, when re-auditioned for 1986 the overall midrange balance and the bass tuning were both significantly improved. It handled high powers well, showing a convincing superiority here over the LS2, but not quite reaching the standard set by the LS7.

CONCLUSIONS

This honestly built loudspeaker has achieved sufficiently high standards in both laboratory and listening tests to qualify for strong recommendation. With its neutral balance, smooth response, fine stereo and a consistent off-axis uniformity, it also provided low distortion as well as good power handling into the bargain, and merits a Best Buy rating.

GENERAL DATA

Size (height x width x depth)	51 x 27 x 28cms
Recommended amplifier power per channel (for 96dBA minimum per pair at 2m)	(15) - 150W
Recommended placement	open stands
Frequency response (+/-3dB, 2m)	50Hz - 20kHz
Low frequency rolloff (-6dB, 1m)	50Hz
Voltage sensitivity (ref 2.83V or 1W into 8ohms, 1m)	87.5dB/W
Approximate max sound level (pair at 2m)	104dBA
Impedance characteristic (ease of drive)	V good
Forward response uniformity	excellent
Typical price per pair inc. VAT	£230

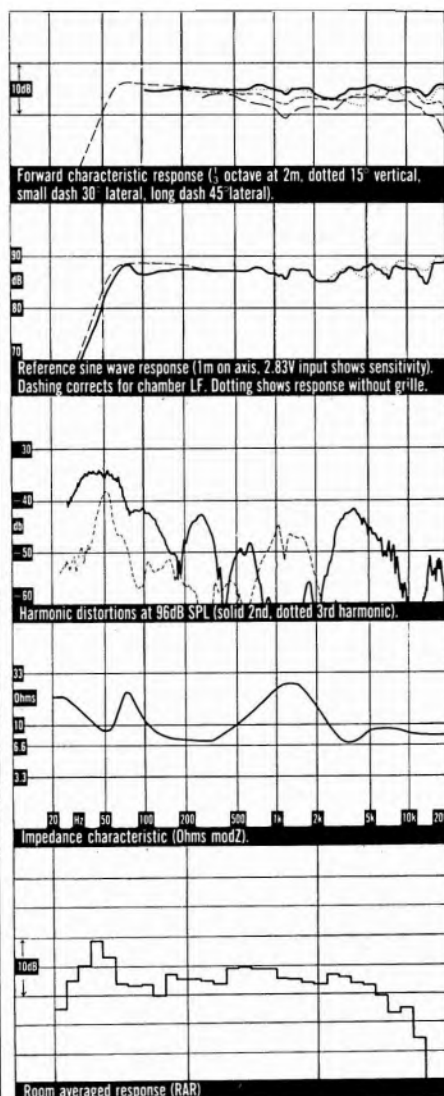

ROGERS LS7t

SWISSTONE ELECTRONICS LTD, 310 COMMONSIDE EAST, MITCHAM, SURREY. TEL: 01-640 2172

RECOMMENDED

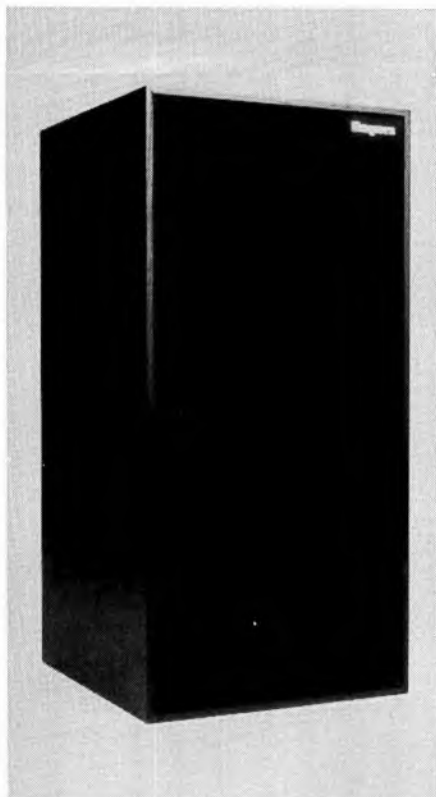

Rogers have been known for decades as one of the guardians of the 'BBC sound', and the £360 7t (and its sister *Studio 1a*) are latest in a long line of medium sized reflex-loaded models. The 7t still owes much to the original *LS5/6* and its numerous subsequent offspring, which were amongst the pioneers of plastic cone technology, but is slightly more compact and more cost-effectively engineered.

The 7t uses a newly refined 200mm polypropylene-coned driver for bass and midrange duties, and the *t* suffix refers to a new 25mm metal (Titanium) dome tweeter. Another innovation is the bi-wired crossover, allowing each driver and its crossover circuitry to be driven independently by separate cables if desired.

The carcass of the 34 litre real wood veneered enclosure is 12mm chipboard, with additional bituminous damping panels and internal foam, while the baffle is 19mm MDF. The grille frame is not only thin but also chamfered to reduce unwanted reflections, while the port is also carefully shaped. The 3rd-order crossover is of decent quality, with film capacitors and hardwiring, plus average quality multistrand cable. The speaker designed and aligned for free space mounting, on good quality 40cm stands.

LAB REPORT

Unlike those early BBC-style monitors, the 7t has a quite high sensitivity of 88.5dB/W – enough to give good level from low powered amplifiers, yet with the power handling to deliver high output from a powerful amplifier. Furthermore, the loudspeaker's impedance characteristic presents a very easy load. Bass shows reasonable extension, the -6dB point being at 48Hz but with moderate rolloff thereafter despite the reflex design.

Frequency responses are generally very promising – even, well-balanced and unusually smooth, though with the merest suggestion of the 'three-humped' effect that boosts the mid-band and frequency extremes. The two-metre off-axis curves show remarkably good integration and correspondence, and although the grille does have a marked effect, it is probably best left in place. The room-averaged response is generally good too, but does appear to reinforce the slight band emphases referred to above. Free space siting is clearly mandatory.

Distortion measured much better than average, and pair matching was held to an impressive ± 0.3 dB.

SOUND QUALITY

Though the bass performance was disappointingly 'overblown' and uneven under the *PM* listening conditions – probably a function of room, system, placement and predominately vinyl sources – the 7t still scraped a 'good' overall rating, by virtue of its fine midrange, low coloration, decent stereo, and good loudness capabilities.

The *MC* panel was more complimentary, rating the 7t 'good plus' and particularly praising the bi-wire option for extra focus, definition and clarity. Here criticism of the bass was limited to a slight 'softening', while the sound overall was considered lively, clear, open and transparent. Balance was largely neutral, with a touch of mid 'forwardness', while the treble was qualitatively well liked.

CONCLUSIONS

The *LS7t* clearly deserves Recommendation, offering a fine combination of 'classic' qualities at a reasonable price. However, it will not suit all systems and rooms equally well, so a home trial is worth pursuing prior to purchase. Free space siting and good quality stands are mandatory, and the overall alignment probably favours CD rather better than vinyl LP.

GENERAL DATA

Size (height x width x depth)	56 x 27 x 28cms
Recommended amplifier power per channel (for 96dBA minimum per pair at 2m)	(12) – 150W
Recommended placement	free space on 40cm stands
Frequency response (+/-3dB, 2m)	50Hz – 20kHz
Low frequency rolloff (-6dB, 1m)	48Hz
Voltage sensitivity (ref 2.83V or 1W into 8ohms, 1m)	88.5dB/W
Approximate max sound level (pair at 2m)	105dBA
Impedance characteristic (ease of drive)	V good
Forward response uniformity	excellent
Typical price per pair inc. VAT	£360

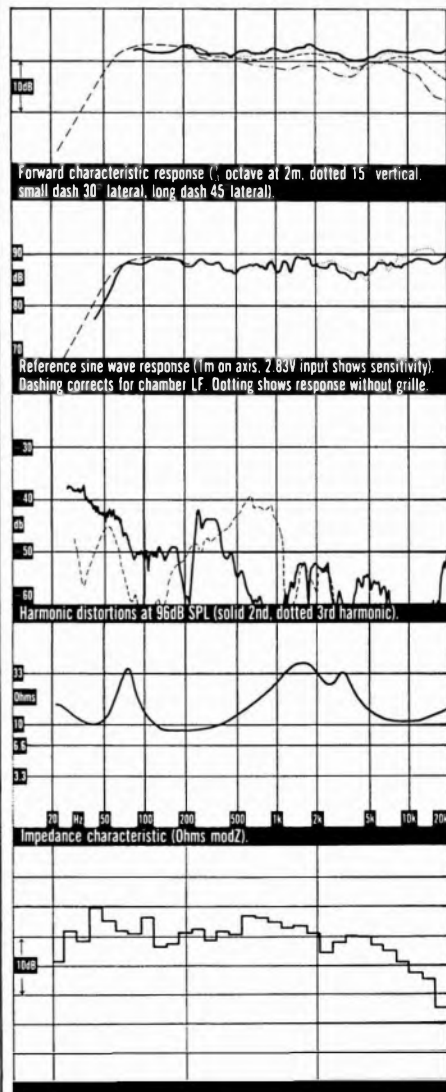

MISSION ELECTRONICS

CONTROL CENTRES



AT Labs

159 Chase Side
Enfield
Middlesex EN2 0PW
01-367 3132

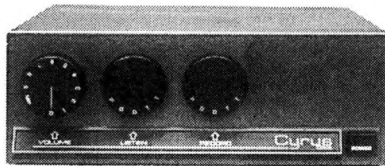

CYRUS ONE £149.90

Mission's Cyrus One has firmly established itself amongst a very select group of amplifiers which deliver a sound quality and dynamic range performance previously only attainable at much higher prices. Elegant in appearance, devoid of gimmicks, the Cyrus One must be auditioned by everyone searching for the best value for money in amplifiers today.

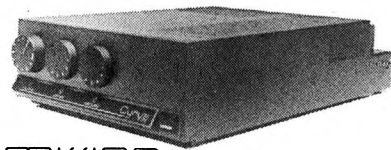

CYRUS TWO £299.90

The Mission Cyrus Two. A more sophisticated amplifier than the Cyrus One, but with a similar design philosophy. The main difference being the greater current delivery capability which means smoother, more exciting sound. By adding the PSX power supply even greater current delivery is obtained to further increase spaciousness and dynamics.



PCM 7000 £599.90

Also stocked
PCM 4000 £399.90

MISSION, one of the few British companies who fully recognised the full potential of compact discs, had to produce something quite exceptional to replace the excellent DAD 7000. In the recently-released PCM 7000, they have produced the finest sounding machine yet to reach the market. A delight to use with an infra-red remote control that can also control volume.



CYRUS TUNER £179.90

Designed to perfectly match the Cyrus One and Cyrus Two amplifiers in both appearance and performance, the Cyrus Tuner stands on its own as a state of the art component whose sonic qualities leave behind many more expensive competitors. High sensitivity and the convenience of auto-search and 19 pre-set FM stations, as well as manual tuning, make this probably the most attractive tuner option available.

AT Labs

442-444 Cranbrook Rd.
Gants Hill Ilford
Essex IG2 6LL
01-518 0915



Audio T

190 West End Lane
London
NW6 1SQ
01 794 7848

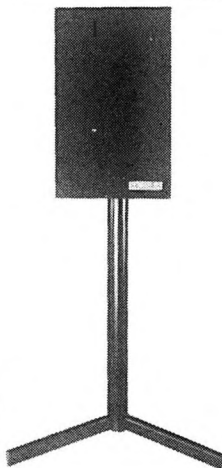

70 MK II £99.90 per pair

If space is at a premium, then the excellent Mission 70 MK TWO should be on your short list to audition. To be placed close to a wall, this, the smallest speaker of the Mission range, produces really surprising bass. Few peers at the price!



700 LE £129.90 per pair

Sometimes, because of the success of their excellent electronics, we forget that Mission are one of Britain's leading speaker manufacturers. Mission's latest speaker, the 700 Leading Edge, re-emphasises their position in the fields of speaker design and production. A ferro-fluid cooled 19mm dome tweeter, inverted drive unit geometry, and a bass unit with an ultra-fine voice coil gap combine to produce a speaker with high power handling and low colouration.



See the **MISSION ELECTRONICS** range at the LONDON CONTROL CENTRES

ROKSAN DARIUS

THE TURNMILL, 63 CLERKENWELL ROAD, LONDON EC1 5BH. TEL: 01-251 1021

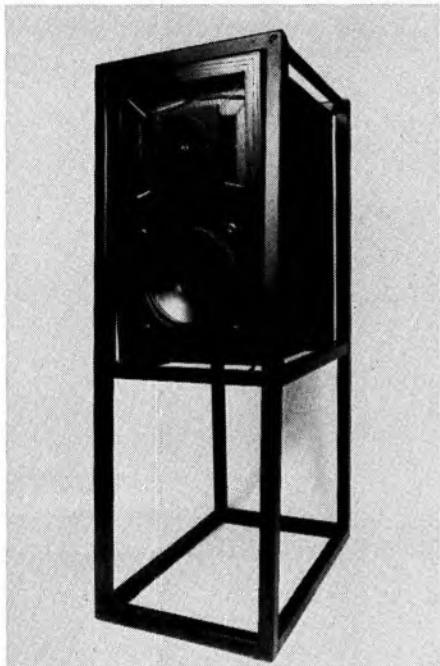

This extraordinary looking loudspeaker looks like it might have escaped from the *Star Wars* set, its speed-frame exoskeleton conveying a robotically anthropomorphic air, heightened by the four-inch spiked pegs used at the front corners. The frame considerably expands the visual intrusiveness of a comparatively compact basic enclosure, which is heightened by the recommendation to site them backed against the side walls a third of the way down a room and almost facing each other – restricting the range of suitable rooms somewhat. Roksan stress the need for careful experimentation.

The compact cabinets are quite deep and unusually heavy, made in 25mm MDF with substantial internal bracing, with excellent real wood veneer and a luxury filling of long-hair wool. The horizontal edges each have two flats at vibration nodes, and the stand spikes clamp into these to grip the enclosure.

The tweeter is not mounted on the baffle in the normal way, but instead has its own sub-baffle, hung suspended and decoupled on coil springs within a recess in the baffle; this arrangement avoids excitation from main cabinet vibrations and also allows the tweeter axis to be adjusted with respect to the enclosure/stand. The crossover is in an external (exceedingly ugly) box, allowing all manner of permutations of bi-wiring, bi-amping etc, though design and construction was not quite up to the rest of the system. The review pair had a separate (£135) crossover box for each channel, and was supplied with DNM solid core cable. Drivers are a modified KEF B200 bass/mid and 25mm soft dome Scan tweeter.

LAB REPORT

Sensitivity is a generous enough 88dB/W, and the amplifier loading is quite kind, allowing a wide range of amplifiers to be used and substantial sound levels to be achieved. Despite the modest 26 litre enclosure volume, bass is quite well extended (–6dB, 50Hz), giving useful output in-room down to 30Hz.

The frequency responses are either wrong and/or unorthodox according to one's point of view. The on-axis mid/treble shelf is an alarming 8-10dB above the bass level, and shows quite serious irregularities besides. However, the 45 per cent off-axis response is less implausible, and the room-averaged response likewise, though the latter still shows losses in the midbass energy, partly compensated by a lift from the high-Q fundamental resonance (55Hz).

Distortion was not particularly good, with rather more treble effects than one might expect, particularly in such an expensive and elaborate design. Pair matching was a very good +/-0.5dB.

SOUND QUALITY

Darius the polariser? Roksan's speaker was the only one amongst 30 or so models to receive completely contrasting value judgements from the two listening panels.

The siting idiosyncracies prevented the *PM* panel from undertaking 'blind' presentation, so their knowledge of the speaker's price and pretensions could have influenced a very good overall rating. Furthermore, this rating disguises considerable disquiet over the overall balance, so most comments were laden with excuses while still praising exceptional dynamics and clarity. Bass was considered restrained though reasonably clean, stereo a trifle uncertain with some midband coloration, while the treble added an 'edge of the seat' quality that could be considered beguiling – or fatiguing.

Blind presentation to the *MC* panel gave a contrary overall poor rating, reaction to the tonal balance distortions outweighing any appreciation of more favourable characteristics. Nevertheless the comments showed that both panels heard much the same thing, and merely reacted in different ways according to taste and the other components of the listening test situations.

CONCLUSIONS

As it stands *Darius* shows significant flaws, but also considerable potential. Sonically too controversial for recommendation, it will

nevertheless have an irresistible appeal to a small minority where taste, ancillaries and siting considerations combine favourably.

GENERAL DATA

Size (height x width x depth)	98 x 31 x 51cms inc. stand
Recommended amplifier power per channel	(for 96dBA minimum per pair at 2m) (15) – 100W
Recommended placement	see text, needs trials, integral stands
Frequency response (+/-3dB, 2m)	see text
Low frequency rolloff (–6dB, 1m)	50Hz
Voltage sensitivity (ref 2.83V or 1W into 8ohms, 1m)	88dB/W
Approximate max sound level (pair at 2m)	104dBA
Impedance characteristic (ease of drive)	good
Forward response uniformity	below average
Typical price per pair inc. VAT	£1150+

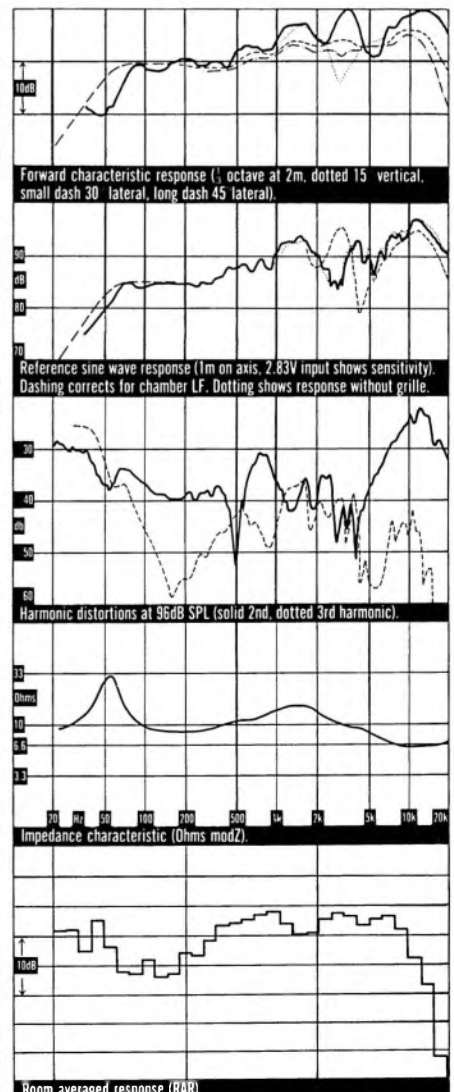



Royd loudspeakers used to be known as Akroyds, after their founder and designer Joe Akroyd. They have been operating now for a number of years, but show no particular inclination to expand beyond a restricted number of carefully selected dealers and overseas distributors.

The A7 II is the well established current version of their 'miniature' model, which has always been a favourite in the range. It is a simple two-way design with a small (6.5 litre) reflex loaded enclosure. The reflex loading is accomplished by an aluminium tube which is claimed to act as a stiffening brace between the magnet and rear panel, though the fixing glue was a little soft. The carcass and baffle are constructed in lightweight 12mm chipboard, with a decent 'black ash' vinyl finish. Aesthetically the foam grille may not be to all tastes, but it is certainly the best (if not the cheapest) solution acoustically. Internal damping is provided by polyester wadding, and build quality is very workmanlike for the price.

The main bass/mid driver has a small effective diameter, but is fitted with the generous magnet necessary for reflex operation, built onto a steel trochoid frame. The tweeter is the almost ubiquitous 19mm Audax unit. The 4mm socket/binders are directly coupled to the bass/mid unit, while the tweeter is fed via a four-element third order network. Hard-wiring is used throughout. Royd do not make metalwork, but suggest rigid, spiked wall brackets, or stands such as Sound Advice, Sound Organisation or Linn *Kan* types.

LAB REPORT

Sensitivity is a little below average at 86dB, but a 25W amplifier will still give good sound levels, and the 7 should be happy enough driven by 60W or so maximum. By not going for the ultimate in sensitivity, and with assistance from the reflex port, bass extension is greater than most miniatures. The driver resonance at 95Hz results in -6dB at 75Hz, but worthwhile in-room output continues down to 50Hz, the port's limited contribution peaking at 55Hz. Amplifiers will have no problem driving a gentle impedance characteristic averaging 11ohms with a minimum of 7ohms.

The respectable enough overall frequency balance should be improved still further with rear wall positioning. But the curves are marred by a discontinuity around the crossover region at 2kHz, resulting in a depressed lower treble and mild 'two ramp' effect. The grille has a negligible effect, and off-axis forward integration shows good consistency. The in-room response confirms good power down to 50Hz and a smooth midrange, but highlights the power loss at the lower end of the tweeter range and shows a mild peak around 8kHz.

Distortion was quite high, especially at higher levels, registering 1-2% generally at 96dB. The pair matching of our samples was disappointing, varying by as much as 2dB through the treble region.

SOUND QUALITY

Both listening panels rated the A7 II below average, but this is a perfectly respectable result given the compromises of size and price. The two panels agreed quite closely in describing the Royd, and the comments also tended to reflect the measurements.

The basic balance was liked, and the sound considered lively and quite clear, with good upper bass and general dynamics. However, the lack of 'weight' and extension was an inevitable detraction, and the treble 'ramp' made vocals a bit 'shut in' and added slight harshness and emphasis to violins and close-miked instruments.

CONCLUSIONS

The A7 II is a generally competent performer in both the lab and the listening room. The overall value for money is therefore pretty good, though the character imposed on the sound is sufficiently individual to suggest prior audition by prospective purchasers.

GENERAL DATA

Size (height x width x depth)	31 x 20 x 17cms
Recommended amplifier power per channel (for 96dBA minimum per pair at 2m)	(25) - 60W
Recommended placement	shelf or 50cm stand near wall
Frequency response (+/-3dB, 2m)	100Hz - 20kHz
Low frequency rolloff (-6dB, 1m)	75Hz
Voltage sensitivity (ref 2.83V or 1W into 8ohms, 1m)	86dB/W
Approximate max sound level (pair at 2m)	98dBA
Impedance characteristic (ease of drive)	V good
Forward response uniformity	good
Typical price per pair inc. VAT	£99

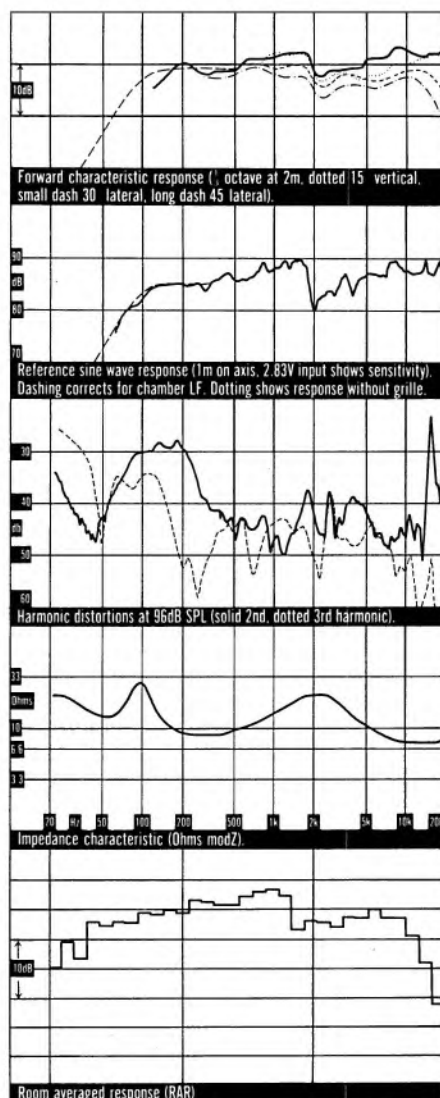

ROTEL RL850 II

ROTEL HI-FI, HEATHFIELD, STACEY BUSHES, MILTON KEYNES, MK12 6HR. TEL: (0908) 317707

BEST BUY



Rotel's 850 loudspeaker has been around a few years now, but has been recently updated in a number of areas – including the price! Selling at around £120, this is a conventional enough, medium sized two-way 'bookshelf' model, built in Britain to Rotel UK's design, and clearly intended to partner their popular range of amplifiers and other electronics.

The ingredients have changed little, with a 200mm doped paper cone bass/mid driver, and a newly revised 25mm soft fabric dome tweeter, connected via a simple 2nd order crossover curiously using tags instead of hard-wired as previously. The sealed box enclosure is finished in 'black ash' vinyl and constructed from modest 15mm chipboard. There is no added bracing apart from the recessed baffle, though the ensemble feels encouragingly rigid nonetheless. The woven grille is built onto a thick chipboard frame with no rebating, so is probably better left unused.

Build quality is average, with clear evidence of careful cost control but also plenty of the ingredients that help maximise sound quality. The low frequency alignment suggests the enclosures should be sited away from nearby walls in free space, on 40cm stands.

LAB REPORT

Comparison with its predecessor shows that Rotel have managed to upgrade the measured performance overall by small but distinct margins. Sensitivity is little different, and plumb average, while the generous main driver has sufficient power-handling to create decent loudness levels. Bass is nicely extended for this class of speaker, with -6dB at 50Hz. The impe-

dance curve is mild; the loading minimum of 7ohms providing a kind load for the amplifier.

The response curves do show certain specific balance characteristics (an unavoidable brightness, for example) but are well ordered, fall between respectable limits across the band, and show small but distinct improvements in smoothness and flatness over its predecessor. The grille is better left off, though its influence is less pernicious than might have been feared. The room-averaged response again shows many similarities to the original, but also confirms the more even energy-balance through the mid and treble.

Distortion has been significantly improved, and is most commendable by any standards, and pair-matching on our samples was again good – within $\pm 0.5\text{dB}$ across the band.

SOUND QUALITY

The *PM* panel were a little reserved in their praise, but still rated the 850 a straight average, which is no mean achievement. Treble was a little 'spiky' and obtrusive, while bass also seemed a touch heavy under these listening conditions. "Lacking thrill power" was how one listener expressed his feelings, though thoroughly workmanlike and competent nonetheless.

The 850 did rather better during the *MC* tests, scraping an 'above average' overall, which is very good for the price. The bass clearly worked better here, and although there was still some criticism of treble 'brightness' and mild 'grain', the rest of the package proved well balanced and clear, with good presence, decent focus, and fair stereo depth.

CONCLUSIONS

Loudspeaker design is the art of compromise, and on these grounds it hard to argue with Rotel's very competitive package. Strongly Recommended, but with the usual caveat that it will not be to every taste. Prospective purchasers should note the need for decent stands and free space siting.

GENERAL DATA

Size (height x width x depth)	44 x 25 x 24cms
Recommended amplifier power per channel (for 96dBA minimum per pair at 2m)	(15) – 75W
Recommended placement	free space on 40cm stands
Frequency response ($\pm 3\text{dB}$, 2m)	60Hz – 20kHz
Low frequency rolloff (-6dB , 1m)	50Hz
Voltage sensitivity (ref 2.83V or 1W into 8ohms, 1m)	86.5dB/W
Approximate max sound level (pair at 2m)	100dBA
Impedance characteristic (ease of drive)	V good
Forward response uniformity	good plus
Typical price per pair inc. VAT	£120

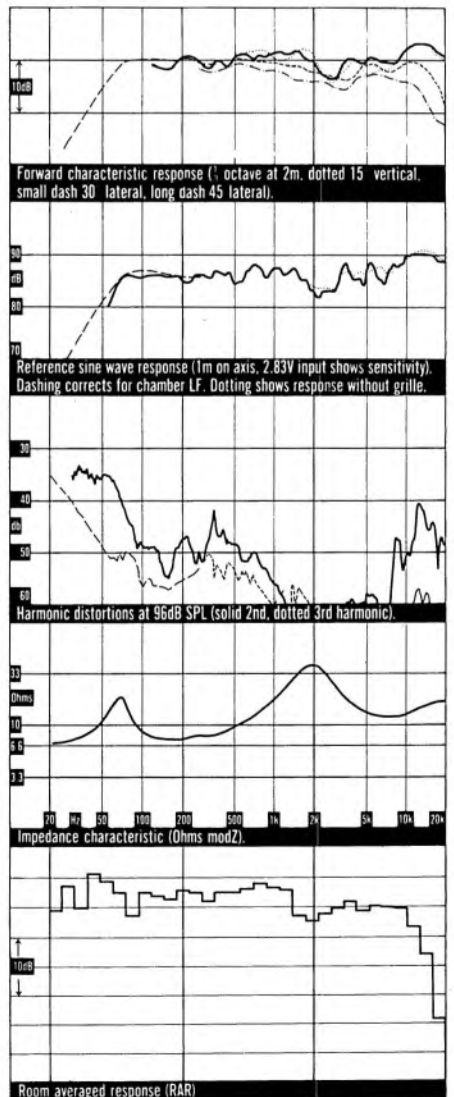

A.T. Labs
Who
Enfield

A.T. Labs
Cares-
Gants Hill, Ilford

Audio T.
Wins...
London NW6



We are proud to have been voted, by the readers of Hi-fi News **NATIONAL DEALER** of 1986. We work hard to maintain our high standard of service and friendly advice – its nice to know service means as much to you as it does to us...

Where to Buy?

The hi-fi purchaser is faced with countless options when he decides where to buy hi-fi – the big high street multiples, the discount warehouse or the small specialist dealer round the corner. It's often a hard choice. The look of the store won't tell you a lot – appearances are often deceptive. How can you be sure of satisfaction?

What separates one store from another is really quite simple – the service they are able and prepared to give.

We regard our expertise and service as the most important aspect of our business. It is the only thing that makes us different from a hundred other dealers in London. The attention to detail and care we take with our customers to ensure they enjoy their hi-fi purchase is essential.

What to Buy?

You don't have to be a genius to realise there are thousands of products to choose from. Putting these products together to make up a hi-fi system makes the choice virtually limitless. This is where a good dealer becomes a necessity – only with his experience can you be sure to make the right choice.

Remember – price isn't everything. What matters most is long-term satisfaction from your purchase so you can be sure you made the right decision and get on with the important part – listening and enjoying music.

Why us?

Well, if you've never visited our stores how can you be sure we'll live up to your expectations? Because in 1986, we were voted, by the readers of Hi-Fi News, **NATIONAL DEALER OF THE YEAR**.

Still not convinced? Well, let us quote Steve Harris, Editor of Hi-Fi News: 'The choice of retailer is a more crucial decision for a consumer to make than the choice of equipment itself. Any dealer can sell you a selection of components; but a good dealer can provide you with a system that really works and will give years of listening pleasure.'

'We are pleased to encourage dealers who give first-class service to the public. Dealers have been nominated for the Awards by satisfied customers – surely that must be the best endorsement they could have.'

The most coveted award was deservedly won by 'AT Labs/Audio T' which accumulated a massive number of votes for its three excellent shops in Enfield, Gants Hill and West Hampstead.

AT Labs
159 Chase Side Enfield
Middlesex EN2 0PW
01 367 3132



Audio T
190 West End Lane
London NW6 1SQ
01 794 7848



AT Labs
442/4 Cranbrook Rd. Gants Hill
Ilford Essex IG2 6LL
01 518 0915

RUARK BROADSWORD

RUARK ACOUSTICS, ANNWOOD LODGE IND. EST., ARTERIAL ROAD, RAYLEIGH, ESSEX SS6 7UA. TEL: (0268) 728890



Though quite recently established, Ruark's principals have been involved in the industry for many years. This small Essex-based speaker manufacturer has its roots in cabinet building, and this is reflected in the quality of external design and finish. Expensive cosmetic touches like gold-plated cap-head bolts securing the drivers make the £699 *Broadsword* look a little bit special (if rather over the top for some tastes). Indeed it is the company's considered policy to produce a luxury product, rather than try and battle it out at the value-for-money box-stuffing end of the market.

The enclosure is a quite compact 19 litre sealed box, though designed for stand mounting in free space, away from walls. The 19mm panels are veneered in real wood inside and out; extra thickness in the base and additional crossbracing further stiffen the foam-damped cabinet. The grille frame is fairly slim but has no rebating, and is probably best removed (to reveal the full glory of the baffle to impressionable friends and neighbours).

The drivers are unusual in coming from Danish manufacturer Dynaudio, and consist of a 150mm polypropylene-coned bass/mid with large diameter voice coil, and a 30mm soft fabric dome tweeter. The crossover uses good quality components – film caps, an air-cored inductor, and hard-wiring with good quality multi-strand 'Monster' cable. Build quality was very good throughout.

LAB REPORT

Sensitivity is a very low 82dB, so the *Broadsword* would benefit from a decent sized amplifier, and very high sound levels are not really practical. However, the system presents a nice easy load for the amplifier, and some of the reason for the sensitivity may be seen in the well-extended bass, -6dB at 43Hz is quite unusual in such a compact loudspeaker.

The frequency responses are simply unacceptable, indicative of the drive units being connected out of phase with each other and resulting in a broad midband suckout, even though the pattern of forward responses show quite reasonable consistency. Whether this is a design or assembly error is not clear, though we are inclined to suspect the former as the two speakers were similar in this respect. The room-averaged response shows that matters are not as bad as the axial responses suggest, but still show a slight 'saddle shape', with some treble rise and 50Hz boom.

Pair matching was rather poor, needing wide +/-1.5dB limits, and distortion was unexceptional.

SOUND QUALITY

Though not particularly liked by the *PM* panel, the *Broadsword* at least avoided serious censure, though its 'differentness' was noted. Some found the 'laid back' character rather appealing, though others found the change unsettling. There was some 'boom'n'tizz', with the boom the more obvious and irritating, while the treble was considered quite clean and clear.

The *MC* panel was much less complimentary, though again some members were seduced by the false ambience and 'air' caused by the phase/suckout problem. The bass sounded compressed and bumpy, the midband sucked out, while the treble emphasised sibilants unduly, giving brittle vocals which lacked body, and no real stereo depth or focus.

CONCLUSIONS

Recommendation is hardly appropriate in view of this loudspeaker's technical weaknesses, for which the fancy cabinetwork is no real compensation. Our advice is extreme caution, for in our experience the *Broadsword* often sounds initially impressive, but this impression can quite quickly wear thin.

GENERAL DATA

Size (height x width x depth)	43 x 23 x 28cms
Recommended amplifier power per channel (for 96dB minimum per pair at 2m)	(25) – 75W
Recommended placement	free space on 40cm stand
Frequency response (+/-3dB, 2m)	see text
Low frequency rolloff (-6dB, 1m)	43Hz
Voltage sensitivity (ref 2.83V or 1W into 8ohms, 1m)	82dB/W
Approximate max sound level (pair at 2m)	96dB
Impedance characteristic (ease of drive)	V good
Forward response uniformity	crossover region problems
Typical price per pair inc. VAT	£700

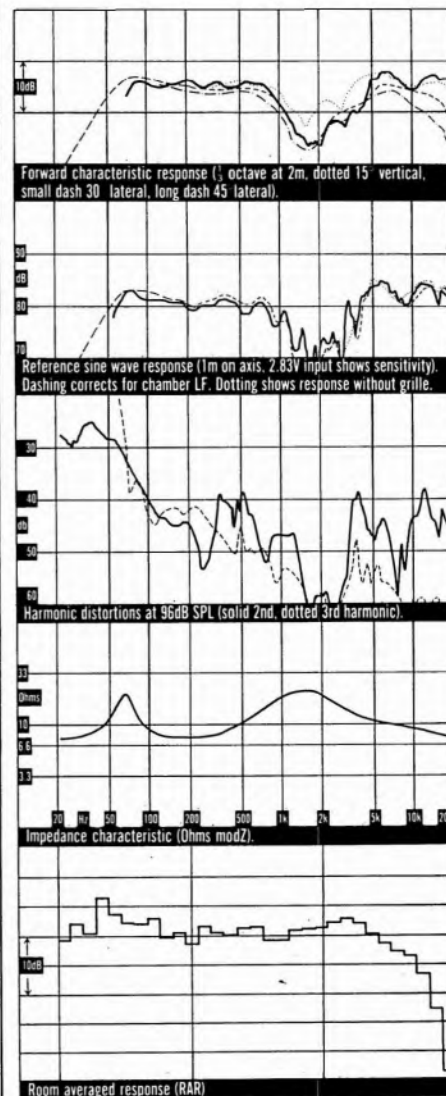

SONY APM10ES

SONY UK, SONY HOUSE, SOUTH STREET, STAINES, MIDDLESEX. TEL: STAINES 61688

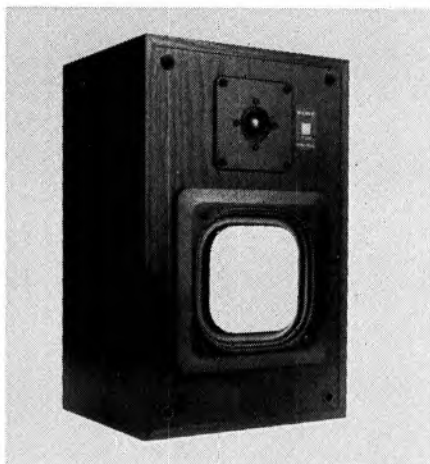

Damping consists of a polyester wad plus additional material on the carcass sides, while a 120mm square of 15mm chipboard reinforces the back panel behind the tweeter. The 11mm grille frame lacks any rebating. The 3rd order PCB crossover is hardwired using multistrand cable – thicker to the bass unit, and the drivers are seated on silicon sealant.

LAB REPORT

Late delivery meant the *APM10s* missed the anechoic chamber work, so we are forced to rely on measurements supplied by Sony with inevitable methodology inconsistencies. Nevertheless there is sufficient to provide a reasonably clear picture.

Sensitivity is around average, and sufficient to give decent sound levels without recourse to an unusually powerful amplifier. The impedance curve errs on the low side, but not unacceptably so for any decent amplifier.

The response trace shows some small scale irregularities but an impressively even overall progression, with a steadily rising trend into the treble. Clearly this balance would benefit from some assistance at low frequencies by wall mounting. The room-averaged response is very promising – just a little mid forward and bass shy, but with good overall balance and a very respectable low frequency extension. Distortions appear to be acceptably under control.

SOUND QUALITY

The Sony distinguished itself on the *PM* listening tests, with a 'good' overall rating that was far better than one has any right to expect for the price. The panel may have been swayed by its superiority over the immediate predecessors, but the overall balance and system integration were particularly praised, though there were criticisms of a slightly brash and coarse treble, and a mild lack of *joie de vivre*.

The *MC* panel were less effusive, but still rated the *'10ES* a more than respectable average overall. There was praise for the lack of coloration and good dynamics and stereo focus, though the mid sounded a little 'hard', thin and unforgiving. Once again elements of treble harshness and bass 'lightness' were noted.

CONCLUSIONS

At its highly competitive £100 price point, the *APM10ES* is an obvious Best Buy. Not without criticism, and with the caveat that we were unable to carry out our usual comprehensive lab tests, it still provides fine all round qualities with little serious compromise, and can do justice to a good quality hi-fi system of Sony or specialist origins

GENERAL DATA

Size (height x width x depth)	40 x 25 x 20cms
Recommended amplifier power per channel (for 96dBa minimum per pair at 2m)	(15) – 75W
Recommended placement	on 40cm stands, 40cm from rear wall
Frequency response (+/-3dB, 2m)	80Hz – 18kHz
Low frequency rolloff (-6dB, 1m)	55Hz
Voltage sensitivity (ref 2.83V or 1W into 8ohms, 1m)	87dB/W
Approximate max sound level (pair at 2m)	102dBa
Impedance characteristic (ease of drive)	good
Forward response uniformity	no checked*
Typical price per pair inc. VAT	£100

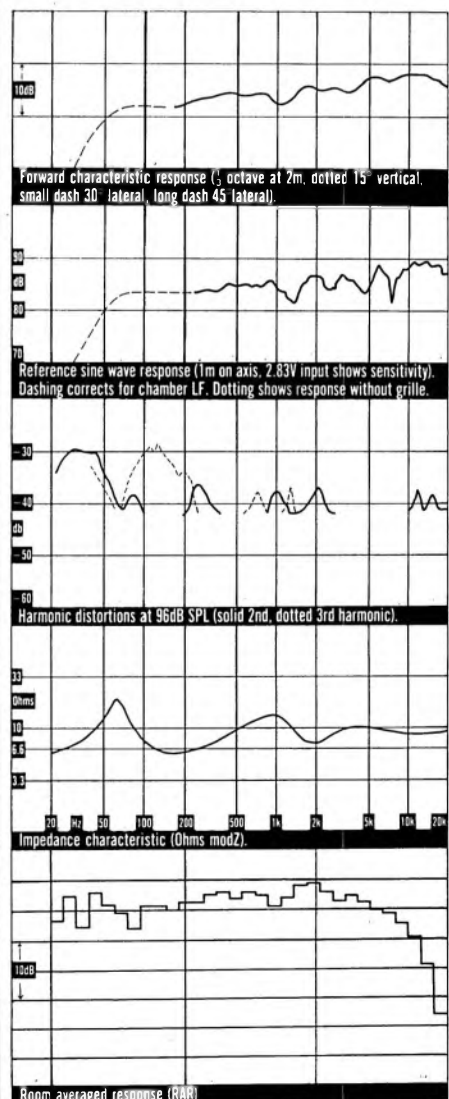

Sony have already had significant success with their recent German-sourced hi-fi loudspeakers, notably the *APM 22ES* and *20ES*, but in an effort to provide even sharper price competition, the new £99 *APM10ES* is taking over from the *'20*. Consequently manufacture is being started up in the UK, where in fact much of the design work was carried out.

Not surprisingly, it is a simple two-way 'bookshelf' model, with a sealed-box enclosure of 14.5 litres, aligned for siting fairly close to a rear wall on good quality stands. Luxury touches can hardly be expected at this price point, but a distinguishing feature linking Sony's *ES* speakers is the Japanese-made APM alloy honeycomb flat diaphragm drive units, which offer a measure of time alignment. A variant of this is used for the bass/mid unit here, while the largish (27mm) tweeter is a more conventional plastic dome type.

Build quality of our pre-production samples was very good, and the ingredients seem pretty good on the whole, particularly considering the modest price. The cabinetwork is chipboard, 12mm for the carcass and 15mm for the baffle.

SPENDOR SP2

SPENDOR AUDIO SYSTEMS LTD, UNIT 47, STATION RD IND EST, HAILSHAM, SUSSEX BN27 2ER. TEL: (0323) 843474

RECOMMENDED



With the original *BC1* and its virtual successor the *SP1* well established, Spendor has been researching a less expensive 30 litre alternative for a few years now. The *SA2* came first, to some degree then eclipsed by the superior and cheaper *Prelude*. Now, developed from the *SP1* and sharing that fine model's 200mm polypropylene coned bass-mid unit, we have the *SP2*. The treble is handled by a special version of the established Scan *D2008* tweeter, a 19mm soft dome offering a superior performance, and in this case, ferro-fluid damped. Optimum positioning is in free space, on 40-50cm high stands.

The finely veneered enclosure is critically balanced by an optimum choice of chipboard grade and thickness, the panels bitumen damped internally. This is a reflex loaded design, tuned to 33Hz, and the ducted port is internally damped by a foam lining absorbing the higher resonant modes in the duct.

LAB REPORT

Reference sensitivity was about average at 87dB while the axial frequency response showed a highly uniform characteristic, ± 2.5 dB 50Hz to 15kHz. The bass was well extended, reaching 45Hz, -6 dB.

A minimum power rating of 15W was indicated, while the *SP2* coped with up to 150W peak programme, generating decent sound levels of 104dBA from a pair in a typical room. The impedance curve showed an easy load.

At 2 metres, the ± 3 dB response was a wide 48Hz to 20kHz, with the set of forward responses showing quite excellent uniformity. The slightly down-tilted response is typical of subjectively well balanced compact box sys-

tems. In the listening room the speaker showed an even, well balanced characteristic with good power down to 30Hz. Integration was very good through the frequency range.

At the high 96dB sound level, the distortion above 150Hz held to a moderate 0.4%, bar some minor clutter above 100Hz. With level reduced to 86dB, third harmonic averaged 0.25%, second 0.1%, both fine results.

SOUND QUALITY

On test the *SP2* achieved a very high ranking position, only a little behind that of the *SP1*.

Stereo images were well focused, and showed very good width and depth. Well balanced tonally, the response sounded very uniform, though with a touch of 'softness' in the low bass despite good extension. In the upper mid, a hint of 'hardness' was noted, plus slight 'wispieness' in the high treble.

In the Spendor tradition, the *SP2* offered a highly articulate, detailed midrange. Dynamics were presented well, the system sounding open and relatively uncoloured. Just a touch of 'boxiness' was present in the low midrange, but even this was much less than usual.

CONCLUSIONS

Spendor now have their compact 30 litre monitor. Offering great consistency and accuracy, it slots in neatly below the *SP1*, conceding little to that respected, larger model. With its natural, extended response, low coloration, wide dynamic range, easy amplifier loading and very fine stereo, the *SP2* is a class winner and may be strongly recommended.

GENERAL DATA

Size (height x width x depth)	50 x 26 x 30cms
Recommended amplifier power per channel (for 96dBA minimum per pair at 2m)	(15) - 150W
Recommended placement	rigid open stands
Frequency response (± 3 dB, 2m)	48Hz to 20kHz
Low frequency rolloff (-6 dB, 1m)	45Hz
Voltage sensitivity (ref 2.83V or 1W into 8ohms, 1m)	87dB/W
Approximate max sound level (pair at 2m)	104dBA
Impedance characteristic (ease of drive)	V good
Forward response uniformity	excellent
Typical price per pair inc. VAT	£420

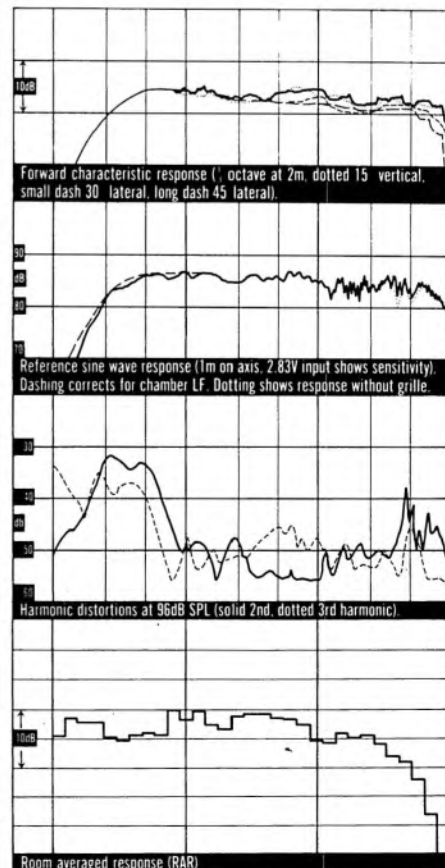

SPICA TC-50

PRESENCE AUDIO, THE OLD POSTHOUSE, PLUMMERS PLAIN, HORSHAM, W. SUSSEX. TEL: (0403) 76777

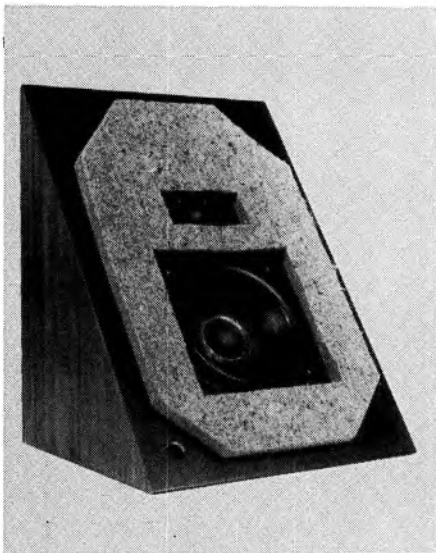

This American speaker comes to the UK with a strong reputation from its homeland, though inevitably crossing the Atlantic Ocean places a premium on the price. The consequences are a smallish two-unit sealed-box bookshelf model of unusual appearance and advanced engineering, selling at a rather hefty £595, but with the weight to match. And for an extra £200 you can have the *SE* version (not tested), substantially 'tweaked' in the UK to offer bi-wiring, stiffer cabinet and the like.

One key *Spica* feature is the wedge-shaped cabinet. This not only prevents the pernicious practice of superimposing a pot plant, or the eventual appearance of coffee cup rings, but has beneficial consequences for dissipating internal reflections, time-aligning the drivers, beefing up cabinet rigidity and distributing resonances in general. A worthwhile pay-off despite the constructional difficulties.

The baffle may look a bit tatty when the grille is removed, but that is immaterial when the grille and the baffle's 'acoustic blanket' work so very well in the system. Only the sides are veneered, but in every other respect build quality is good, with superior materials used – 20mm chipboard and MDF, long-haired wool internal absorption, multistrand hard-wired crossover etc. The drive units come from the Audax catalogue: a 160mm treated paper cone bass/mid and 25mm doped soft fabric dome tweeter. Though the appearance suggests wall mounting, free space on high stands proved to be the correct option.

LAB REPORT

Sensitivity is a little below today's average at 85dB/W, and this is further compromised by an

impedance curve which is a little below 8 ohms nominal, so a decent amplifier is mandatory. The pay-off is that the bass is quite well extended, so in this respect *Spica* can mimic much larger loudspeakers, and still offers respectable loudness.

Measured on the correct axis, the basic response is pretty damn flat, but away from this prime direction there are broadband losses centred on 2kHz (the upper mid/lower treble 'presence' region) which will tend to 'deaden' the sound somewhat. This is reflected to a mild degree in the room-averaged response, but apart from a mild excess in the treble this is a most promising distribution. The bass-alignment can be seen to favour high stands in free space. In-room the response goes down well, to around 30Hz, despite the small enclosure volume.

Distortion was satisfactory enough, but by no means exceptional considering the price, while pair matching was rather disappointing, the range of variation covering ± 1 dB.

SOUND QUALITY

Notwithstanding the diminutive dimensions, the *PM* panel were pretty impressed by the *TC-50* rating it 'good plus' and helping to justify the highish price. Most praised the bass evenness and tunefulness, finding the balance a touch bright, but the overall effect pleasantly crisp and airy. Dynamics, 'punch' and 'scale' were all present, though there was some mid and treble coarseness and 'smear'.

MC's panel was a little less enthusiastic, but still rated the *Spicas* good overall. There was further criticism of the treble quality and slight brightness, and a feeling that the bass lacked solid dynamic impact. Detail and clarity were good, and the soundstage was transparent with quite good depth and focus, but ultimately a feeling that something was lacking (Perhaps the bi-wire option would turn the trick?)

CONCLUSIONS

The *Spica* just merits recommendation despite its highish price. For those seeking a high quality compact, it is basically soundly engineered and built, and offers unusual bass extension for its size. However, it still looks as though it wants to be mounted flat against the wall, while acoustically preferring clear surroundings.

Note. The agent can now offer a UK upgraded option with improved bracing and bi-wiring.

GENERAL DATA

Size (height x width x depth)	40 x 33 x 28 (max) cms
Recommended amplifier power per channel (for 96dB minimum per pair at 2m)	(15) – 75W
Recommended placement	free space on high (50-60cms) stands
Frequency response (± 3 dB, 2m)	60Hz – 20kHz
Low frequency rolloff (-6 dB, 1m)	48Hz
Voltage sensitivity (ref 2.83V or 1W into 8ohms, 1m)	85dB/W
Approximate max sound level (pair at 2m)	98.5dB
Impedance characteristic (ease of drive)	below average
Forward response uniformity	above average
Typical price per pair inc. VAT	£595

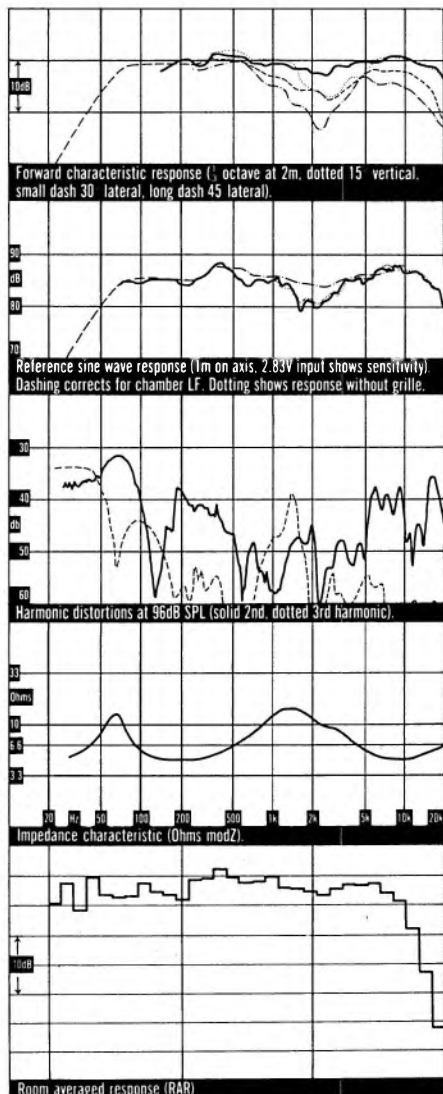

Bill Hutchinson

HI-FI, AUDIO & C.D. Centre

* Sales * Service *

ROTEL KENWOOD

marantz Technics

ARISTON

Dual

KEF

AIWA

DENON **TANNOY** JVC

M

Mordaunt-Short

YAMAHA

AR
ACOUSTIC
RESEARCH

P

PIONEER

MISSION
STEREO

Leading loudspeakers. Plus all leading brands. Our aim is to provide the highest level of service and value available in the West of Scotland

041-248 2857

43 HOPE ST. GLASGOW



**NO 1 FOR
SERVICE
AND VALUE!**



*"More lights than a Christmas tree more knobs than a Concorde more sound to the pound."
And, "Oh yes John, it plays music?"*



Naturally you wouldn't fall for this. Would you?

As a lover of music you would realize that it is the quality of sound that must be your first consideration. You would look for reliability. You would look for style. You would look for a specialist dealer who knew his product and allowed it to speak for itself. Look no Further ...

LINN PRODUCTS - MUSICAL FIDELITY - GALE - KEF
AUDIO TECHNICA - AR CAMBRIDGE - CREEK - QED
HEYBROOK - ARISTON - NAKAMICHI - MERIDIAN - VTL
YAMAHA - ELITE - VAN DEN HUL - PLUS MANY MORE



DERBYSHIRE HI-FIDELITY

3 OLD BLACKSMITHS YARD, SADLER GATE,
DERBY. TELEPHONE 44638

studio

99

there's more to us than meets the ears...

From leading equipment makers including: Linn Products · Naim Audio · Rega · Quad · KEF · Mission/Cyrus · Creek · A&R Cambridge · Nakamichi · Ion Systems (Nytech) · Yamaha · Philips · Denon · Gale · Epos · NAD · Rogers · Acoustic Research · Revolver · Mantra · Akroyd · Heybrook · N.V.A. S.M.E. · Audio Technica · Dual · BANG & OLUFSEN ·  

studio

99

79/81 Fairfax Road
Swiss Cottage
London NW6 4DY
01-624 8855/6
Mon-Fri 10-7 · Sat 10-6

82 The High Street
Harpenden Herts AL2 5P
05827 64246
Mon-Sat 9-5.30 (Closed Wed)

TANNOY MERCURY II

TANNOY PRODUCTS LTD, THE BILTON CENTRE, CORONATION RD, CRESSEX IND EST, HIGH WYCOMBE, BUCKS. TEL: (0494) 450606



Tannoy have enjoyed a very successful run with the *Mercury* and over the past year or so have produced an upmarket derivative called The *M20 Gold*. 1987 saw the introduction of new *Mercury*, incorporating significant design changes. The cabinet has been reshaped and is now taller, while the Audax soft dome tweeter has been replaced by a Tannoy soft plastic dome design. The polypropylene-coned bass unit has undergone continued development, while other changes relate to the low frequency tuning and the crossover network.

The new *Mercury II* is a compact two-way model with a 20 litre internal volume, reflex-tuned at low frequencies by a 50mm front port, 105mm long. The bass unit is energised by a generous magnet and has a 155mm flared cone on a 235mm pressed steel frame, whose central area has been reinforced to prevent flexure. Mounted on a specially cast asymmetric plate, the tweeter employs a 25mm polyamide dome. The high quality crossover is built for simplicity and clarity and designed to 12dB/octave slopes with good quality components. Though the crossover is hardwired, spring clips are used to connect the drivers.

Built mainly from vinyl walnut 14mm chip-board stock, the enclosure includes a circumferential brace between the two drivers, and a lining of acoustic fibre. On our sample the grille was unrebated, and for critical listening is better left off. Ideal placement is in free space, on open stands around 35-45cm high.

LAB REPORT

A good sensitivity of 88dB/W was easily established from the smooth axial response at 1 metre. The bass was quite well extended to 55Hz, -6dB, but the sensitivity was somewhat compromised by the dip in load impedance at high frequencies, to 3.8ohms over a short

stretch around 6kHz; elsewhere the impedance averaged an easy 8ohms. A 10 watt minimum amplifier power is suggested, while the speaker performed ably on inputs up to 150W, permitting peak sound levels of up to 103dB.

The forward responses measured at 2 metres looked very tidy, with excellent integration seen in the forward axes. Frequency response limits of ± 3 dB were easily met from 55Hz to 20kHz. Some distortion rise was noticed around 200Hz, to 3% second harmonic at 96dB for example, with a similar anomaly on the third harmonic. Tuned to 40Hz, the system handled low frequency power well.

The *Mercury* proved to be as well balanced as it sounded on the computer-averaged room measurement, right down to 30Hz in the bass. A mild prominence was evident at 1kHz, but otherwise the curve was most presentable.

SOUND QUALITY

The *Mercury II* scored well in the listening tests, substantially beyond its price expectations and virtually repeating the success of the original *Mercury* in its day. The sound was well balanced, uniform, and well integrated. Coloration was moderate and generally well disguised; some mild 'boxiness' and 'thickening' on piano was noted, plus a touch of 'grain' and 'edge' in the treble.

The bass was very competent, showing fair extension and good control. Stereo images were well focused with a fair measure of depth and transparency. While no significant aberrations were detected in the subjective frequency response, a couple of panelists felt that this speaker was mildly 'soft' and undynamic, though their scoring did not appear unduly affected by this. Driven by clean source material, the *Mercury II* performed equally well on rock and classical sources, both CD and analogue.

CONCLUSIONS

Compared to the original, the new *Mercury* is even better balanced, has better response uniformity and lower distortion, while the price is barely greater than when the speaker was first introduced in real terms. This genuine all-rounder represents an exceptionally accurate free-space system for the money, and merits a Best Buy classification.

Note: The author provided a private opinion on an earlier version of this model for the manufacturer.

GENERAL DATA

Size (height x width x depth)	50 x 25 x 23.5cms
Recommended amplifier power per channel (for 96dB minimum per pair at 2m)	10 - 150W
Recommended placement	open stands, 45cm
Frequency response (+/-3dB, 2m)	55Hz to 20kHz
Low frequency rolloff (-6dB, 1m)	55Hz
Voltage sensitivity (ref 2.83V or 1W into 8ohms, 1m)	88dB/W
Approximate max sound level (pair at 2m)	103dB
Impedance characteristic (ease of drive)	good
Forward response uniformity	excellent
Typical price per pair inc. VAT	£150

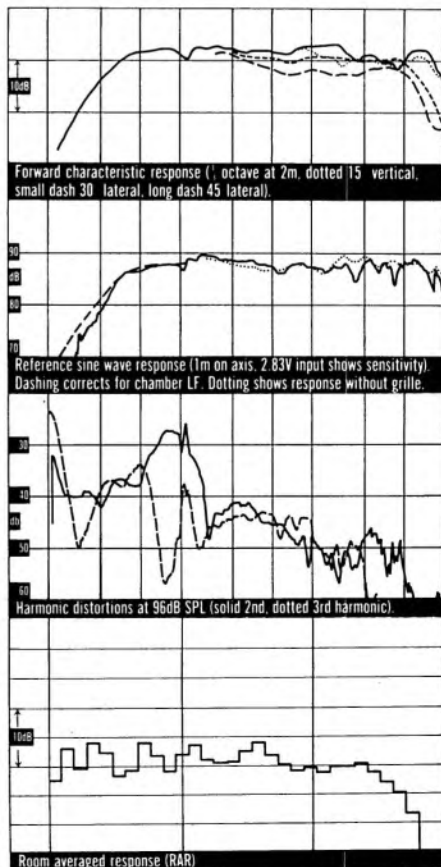

WHARFEDALE SUPER DIAMOND

WHARFEDALE LOUDSPEAKERS LTD, SANDLEAS WAY, CROSSGATES, LEEDS LS15 8AL. TEL: (0532) 601222



Largely responsible for the current fashion in tiny 'miniatures', Wharfedale's *Diamond* and *Diamond II* have become something of a cult with hi-fi buyers over the past few years, and this design could be said to have been instrumental in spawning a whole raft of rivals from other manufacturers. While it is true to say that *Choice* panels have been less enthusiastic in their praises than other sources, there can be no denying the models' commercial success, and consequently *Diamond* fans are now offered this 'luxury' £140 version, finished in red-stained real wood veneer.

To help make the most of the tiny 5.5 litre enclosure, the *Super Diamond* is reflex-loaded with a rear tube, and aligned for siting close to a rear wall, with the speaker itself best placed on a rigid stand to bring it up to head height. The carcass and baffle are both constructed from lightweight 12mm chipboard, but the dimensions and shape ensure that this is an inherently rigid design. The grille frame is only 8mm thick, but there is no rebating and it is better removed.

Though build quality was generally sound, the polyester filling covered only the bottom of the enclosure, and the plastic port tube was a loose push fit (and fell out). The third order crossover, built on a printed circuit board, uses tag connectors with standard multistrand wire. The bass/mid driver has a small polypropylene cone on a pressed steel frame, while the tweeter is a 19mm polyamide dome.

LAB REPORT

Midband sensitivity is a respectable 86dB/W, though this is achieved at the expense of both bass extension and the size of the 'step' between bass and midband – rather too large for full compensation by wall assistance. However, the amplifier load is kind, and decent enough levels can be achieved.

While the bass is impressively flat, the midband region is decidedly lumpy – though a noticeable improvement over the *Diamond II*. Moreover the situation is improved significantly when the grille is removed. There is a tendency to midband forwardness, and a slight loss of energy around 3-4kHz, while forward integration is reasonable enough. The room-averaged response looks promising enough – significantly smoother than *Diamond II* – if inevitably lightweight in the bass, and with some indication of the unevenness noted elsewhere.

Distortion was rather poorer than average, but the trend nevertheless showed generally good control, and again a major improvement over the standard model. Pair matching was within an excellent ± 0.15 dB.

SOUND QUALITY

Under 'blind' conditions, the *PM* panel were not too impressed by the *Super Diamond*, which sounded 'small' and rather restrained. Though bouncy and quite dynamic, the upper bass was a bit heavy and 'bonky', and the midband a trifle boxy. The balance emphasised the midband, and was at least sensibly constrained elsewhere, but detail and clarity were not considered too impressive.

The *MC* panel corroborated these findings, criticising a 'ploddy', 'bumpy' upper bass, some treble grain, but a generally dulled sound with some mid 'boxiness'. The sound was easy on the ear, but considered basically unexciting, rather soft and undynamic.

CONCLUSIONS

While the *Super Diamond* shows some worthwhile improvements in frequency balance and distortion over the standard model, not to mention an attractively classy finish, build quality might have been better and the listening panels were not too impressed. On balance recommendation is not appropriate, but the restrained character could well suit a cheaper 'fiercer' system better than it did our expensive reference components.

GENERAL DATA

Size (height x width x depth)	24 x 19 x 19cms
Recommended amplifier power per channel (for 96dB minimum per pair at 2m)	(20) – 60W
Recommended placement	close to wall, head height
Frequency response (± 3 dB, 2m)	see text
Low frequency rolloff (-6 dB, 1m)	70Hz
Voltage sensitivity (ref 2.83V or 1W into 8ohms, 1m)	86dB/W
Approximate max sound level (pair at 2m)	99dB
Impedance characteristic (ease of drive)	V good
Forward response uniformity	below average
Typical price per pair inc. VAT	£140

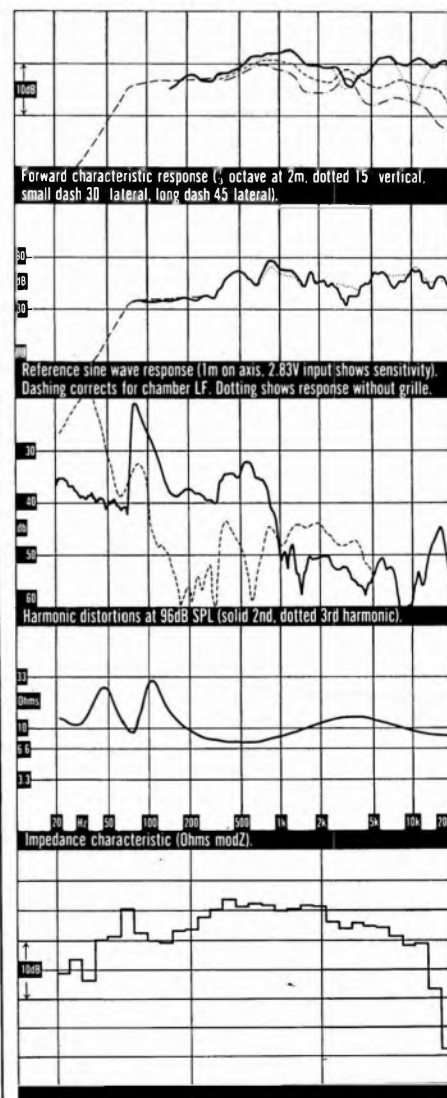

WHARFEDALE DELTA 50

WHARFEDALE LOUDSPEAKERS LTD, SANDLEAS WAY, CROSSGATES, LEEDS LS15 8AL. TEL: (0532) 601222

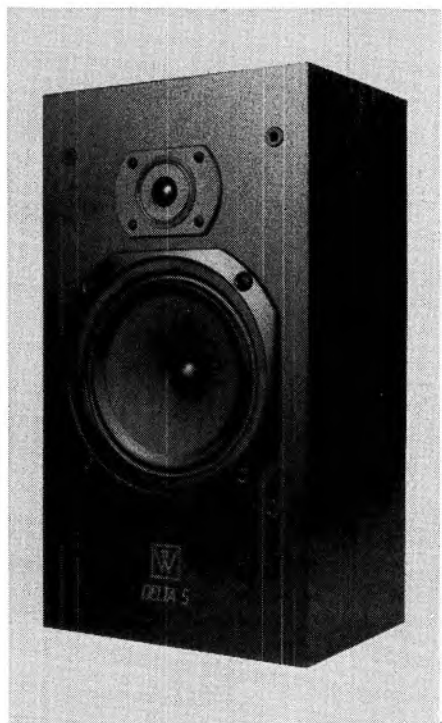

This medium sized £130 'bookshelf' loudspeaker is very much the standard two-way sealed box of the kind Wharfedale have been successfully making for decades, but in this case enlivened by a rather indiscreet green stripe behind the grille on the front baffle. Though the basic frequency response might suggest free space mounting, in fact some rear wall assistance doesn't go amiss, though proper rigid stands are also recommended.

The 18 litre enclosure is quite shallow and fairly wide. Finished in 'black ash' vinyl, the carcass is constructed from rather thin 10mm chipboard, while the baffle is from thicker 15mm sheet. There is no bracing, and enclosure damping consists of a simple polyester wad. The grille frame has no rebating, but in point of fact had little negative effect.

Both drivers are of Wharfedale design, namely a 200mm paper cone bass/mid unit crossing over to a 19mm polyamide dome tweeter. The crossover is a standard enough second order affair, with multistrand wire but tag connectors, standard commercial components, and nasty spring-clip terminals. Build quality is average enough – basically sound but lacking luxury or audiophile touches.

LAB REPORT

Sensitivity is a generous 88dB/W, sufficient to give good loudness from the smallest amplifiers, and capable of a surprising

maximum output when and if required. This has been achieved without compromising the 'good plus' amplifier loading characteristic, though perhaps at some expense in terms of bass extension, the system resonance of 85Hz giving a -6dB point at 57Hz.

The response is commendably flat, with only mild unevenness (note a breakup at 500Hz), and the gentlest of downtilts from bass to treble. Off-axis uniformity is pretty good, and the grille had minimum influence on the sound. The room response is very presentable, with a mildly exposed treble, and a bass alignment which suggests the speaker could either be used in free space or against a wall and still give good balance.

Distortion is respectably low, and pair matching for our samples was held within an excellent +/-0.2dB.

SOUND QUALITY

The *Delta 50* delivered a straight average sound quality according to the *PM* panel, which is a perfectly respectable result for the price. There was little negative criticism, the sound being balanced and quite explicit with good control and low coloration. However, enthusiasm was also muted, with reservations regarding a lack of bass 'drive' and overall 'liveliness'.

The *MC* panel rated the *Delta 50* below average, again with only mild criticisms of colorations, of 'lispiness' and loss of space and depth, but again with little enthusiasm. Bass was OK, but lacked some weight, dynamics sounded fair, but presentation was rather flat.

CONCLUSIONS

Given the £130 price-tag, the *Delta 50* is a mild disappointment. There's nothing obviously wrong with the design, and certain aspects of the engineering show considerable skill. But ultimately the ingredients and the end-result seem just a trifle mundane, though that should not deter a prospective purchaser who finds the package suits his/her taste.

GENERAL DATA

Size (height x width x depth)	48 x 27 x 19cms
Recommended amplifier power per channel (for 96dB minimum per pair at 2m)	(10) – 75W
Recommended placement	near wall on 40cm stand
Frequency response (+/-3dB, 2m)	60Hz – 20kHz
Low frequency rolloff (-6dB, 1m)	57Hz
Voltage sensitivity (ref 2.83V or 1W into 8ohms, 1m)	88dB/W
Approximate max sound level (pair at 2m)	102dB
Impedance characteristic (ease of drive)	V good
Forward response uniformity	good plus
Typical price per pair inc. VAT	£130

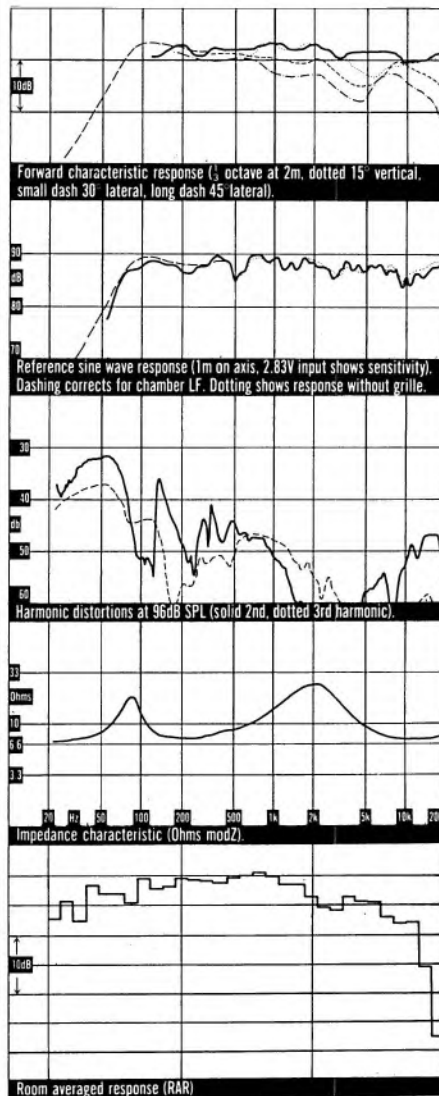

TREBLE YOUR CHOICE THEN BASS YOUR OPINION



DARBY'S

LOCKEY HOUSE ST PETERS STREET
ST ALBANS TEL 0727 50961

50 years of Sound Advice

• HOME DEMONSTRATIONS • FREE DELIVERY

and INSTALLATION

• Access • Barclaycard

• Instant Credit— subject to status*



THE · AUDIO · CONCEPT

9 Ley Side, Bromham, Bedford MK43 8NE
Tel. Ookley (02302) 3048

Consultant, MILAN, call to arrange an appointment, evenings and weekends inclusive

THE GIANT KILLER IS BACK

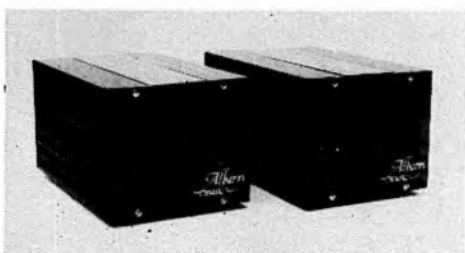

Albarry Music M408 MKII

Also M100 MKII (100 WPC)

Available On Demonstration

Other products Stocked

Kuzma, Excalibur, Moth, Eminent Technology, Synco, Mantra, Elite Rock, Audiolabor, Sonographe SD1, Nagaoka A-1 C.D. Infinity, Helius Chameleon, Rogers, Minimax, Copland Pre/Power, Amadeus Gold/Silver, E.A.R. 509 MKII van den Hul Cartridges, Cables and Interconnect, Tiffany, Foundation Audio, SoundSink, RockBed, Target + many other quality audio components.

Custom Built plinth/covers for skeletal turntables. Marble Hi-Fi units, ring for details.

■ Credit and 0% available S.T.A.

NATIONWIDE DELIVERY AND INSTALLATION ON
APPROPRIATE PRODUCTS

In every instance call for information, quotation and appointment

LISTEN TO US BECAUSE WE LISTEN TO MUSIC (NOT HI-FI)

SNELL LOUDSPEAKERS, A superb range of Loudspeakers that have a surprisingly electric static open quality and not a boxy sound which means that you listen to musical instruments being played not a Hi-Fi pair of speakers. Prices from £395-£3,500 approx.

"Everything from Solo Piano, small group jazz, folk and chamber music, rock and full orchestral pieces all handled in a believable and enjoyable way." — Alan Bateman, *Hi-Fi Answers*, April '87.

"Hear the type K's for their remarkable openness, Lack of Cabinet, Colouration, excellent dynamics and absence of serious vices . . . you know you're listening to real musicians performing." — Jonathan Kettle, *New Hi-Fi Sound*, 1987.

JPW's Basically a 'poor man's' Snells P1's £125; P3's £210

Audio Innovations all valve integrated amp from £299.

"To say I'm impressed with the performance of the Series 300 is an understatement." — John Banford, *March '87*.

"The best valve amp I've heard (series 800)." — Alvin Gold, *Hi-Fi Answers*.

Second Hand Equipment Available. Ring for details. Dems strictly by appointment. So bring your own equipment if you wish and by listening to music you will hear the difference. Other superb equipment from Audio Note, Foundations, Goldring, Helius, Jecklinn Float, Marantz, Nagaoka, Pink Triangle, Rotel, Supra, Sugden, Target, Voyd, Valdi, etc.

Donnington AudioHi-Fi Consultants

Basingstoke (0256) 20344

Spaldings

ESTABLISHED IN SOUND

BEST BUY

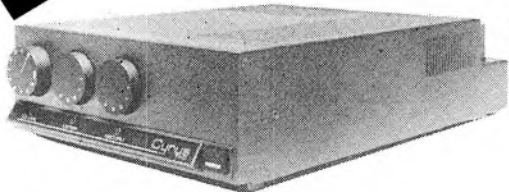

MISSION CYRUS TWO

RECOMMENDED

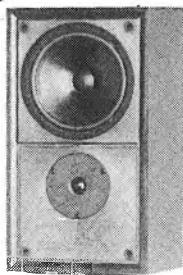

MISSION 700LE

RECOMMENDED



MISSION CYRUS TUNER

BEST BUY

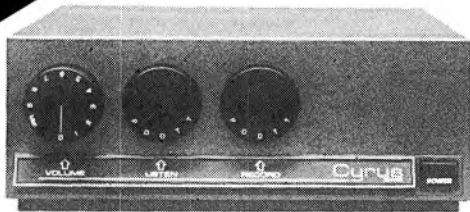

MISSION CYRUS ONE

RECOMMENDED



MISSION PCM 7000

FULL RANGE ON DEMONSTRATION

01-654-1231/2040 - 352/4 LOWER ADDISCOMBE ROAD, CROYDON, SURREY, CR0 7AF



MONITOR AUDIO · WHARFEDALE · A & R CAMBRIDGE · CREEK · NAD · DUAL · DENON · GALE
 MERIDIAN · MICHELL · THORENS · YAMAHA · REVOX · REVOLVER · ROGERS · MARANTZ · ROTEL
 AIWA · BEARD · KOETSU · AUDIO RESEARCH · MAGNA PLANAR · ORACLE · HELIUS · KRELL



SONY ES · MISSION · LINN · TECHNICS · KEF · B & W · NAKAMICHI · NAIM AUDIO · SPENDOR · HEYBROOK · QUAD · AUDIOLAB · B&O

TECH TALK

The background to the latest series of Loudspeaker reviews, including a full and detailed explanation of the test conditions.

Reviewing loudspeakers – or indeed any item of hi-fi equipment – is a desperately difficult undertaking. Carefully conducted listening tests can be impressively consistent internally, but results inevitably vary somewhat according to the room and ancillary equipment. And despite some international measurement standardisation, the results taken from different test programmes usually show substantial discrepancies.

While it will always be possible to pick the occasional nit in a particular test programme, the unique strengths of the *Hi-Fi Choice Loudspeakers* series are the consistency in methodology that has evolved over many years, and the breadth of perspective afforded by the large number of models which have been covered.

This is now author *Martin Colloms'* eighth *Loudspeakers* project, and represents the distillation from an accumulated data base on some 430 past and present models. Each successive project sees careful refinement in both measurement and listening test techniques. But similarly strenuous efforts are made to compare the results from previous reviews with those of the latest tests, rescaling the former where necessary to take account of the steadily rising standards of fidelity.

The context of a test programme is an essential part of the interpretation of the results. The experienced enthusiast will welcome the full and detailed explanation of the test conditions described in this introduction.

This new edition of *Choice: Loudspeakers* incorporates a major innovation in the test procedures – namely a completely separate and additional series of 'blind' listening tests.

We have retained the continuity of the *Martin Colloms (MC)* tests (see later), but also added a set carried out by editor Paul Messenger (*PM*) under an alternative set of conditions, so

that the whole procedure would be as fair and evenhanded as possible to all the loudspeakers.

PM LISTENING TESTS

The conditions used for the *PM* tests were deliberately chosen to contrast with those used by *MC*. The *PM* room itself is of similar overall construction (*i.e.* Victorian with solid walls but suspended floor and ceiling), and broadly similar size, but most of the other circumstances were different.

The room is very sparsely furnished, with a much more 'lively' acoustic, though flutter echoes and the like are largely avoided as none of the walls are parallel to each other, and the floor is heavily carpeted. Much of the left hand wall (facing the loudspeakers) consists of a large bay window whose curtains were kept drawn, both to improve the acoustics and preserve the anonymity of the speakers auditioned behind a thin black veil. Murphy's law dictated that the testing took place on some of the few hot and sunny days of a forgettable summer.

The layout of the room meant that a few loudspeakers could not unfortunately be presented 'blind', while the majority were first auditioned on rigid, spiked, open-frame (*JPW*) stands some 17ft. from a rear wall. Further sighted corroborative tests were carried out on alternative stands, including those supplied by other manufacturers and some ultra-heavy pillar-type *Pirates* (*Audio Innovations*), and the opportunity was also taken to try different sites with respect to the room boundaries. Bi-wire and blind *KUBE* comparisons were left to the *MC* tests.

PM apart, the listeners were all in their early twenties, the source material had a rock bias, and was predominately vinyl LP based. The driving equipment consisted of a Linn *Sondek/Ittok/Troika* (one substantially modified by

Naim Audio and incorporating a built-in moving coil head amp/equaliser). CD was supplied by a Meridian *207*. Amplifiers were Naim Audio *NAC32* pre- and *NAP135* monoblock power (kindly loaned by Jeffries Hi-Fi in Brighton).

The main vinyl based programme consisted of excerpts from the following discs:

On Vinyl: The B52s (*ILPS 9580*, 1979) (heavy rock); Black Uhuru, *Red* (*ILPS 9625*, 1981) (reggae); Sibelius Symphony No5 (*Marriner, Decca D7D4*) (orchestral); Ry Cooder, *The Border* (*MCF 3133*, 1982) (complex, acoustic/electric); Bob Dylan, *Another Side of ...* (*CBS BPG 62429*, 1964) (simple, acoustic). On CD: Tina Turner, *Private Dancer* (*CDP 7460412*, 1984), (heavy rock).

Our thanks to panelists Jason Kennedy, Paul Franks, Rob Dowse, and Dominic Wilcox, for their Vitamin D sunbathing sacrifices, and their patience and endurance.

MC LISTENING TESTS

Procedures were much as in previous years, with checks to establish long term consistency. However, for the sake of conciseness and clarity only the conditions for the latest series of tests are reported here.

The room itself is medium sized, Victorian in construction, with solid walls and suspended floor and ceiling, approximately 18ft. long by 14ft wide, with 9ft. ceiling. Heavy furnishings and carpet plus several floor-to-ceiling bookcases along the side walls provide a well-damped acoustic, with a reverberation time close to IEC recommendations. Listeners are seated in front of the windows at one end (blinds down), the speakers sited at the other end behind an acoustically transparent curtain next to the door.

Driving equipment consisted of Pink Triangle *PT T00/SME Series V/Koetsu Red*, plus Cambridge

Audio *CDI*. Main amplification was from Cello (*Audio Suite Premium*) and Krell (*KMA100 II*), with Mission *Cyrus 2* backup. Cabling was van den Hul, with a variety of different speaker stands from Heybrook, Stand & Deliver, Cliff Stone, *JPW* and others.

The following vinyl and compact discs made up the main listening test programme:

On Vinyl: Vivaldi, *Four Seasons* (*Marriner, Argo ZRG 654*); Joni Mitchell, *Wild Things Run Fast* (*GEF 25102*); Beethoven (*Fischer Dieskau, 415189-2*). On CD: Ricki Lee Jones (*03296-2*); Britten, *Variations on a Theme by Frank Bridge* (*NIM 5025*); Miles Davis, *TuTu* (*Warner 925 490-2*).

Grateful thanks to the following panelists: Peter Comeau (*Heybrook*), Andrew Whittle, Steve Harris (*Hi-Fi News*), Chris Huggill (*B&W*), Richard Ross (*Rogers*), Robert King, Phil Ward (*Mordaunt-Short*), plus sighted operator Chris Bryant (and *MC* and *PM*).

LAB TEST PROGRAMME

For the fourth successive edition the Cambridge Electroacoustics anechoic chamber was used. Despite the comparatively large size of this facility, a degree of low frequency correction is still desirable to approximate true anechoic conditions. Such correction has been added to both the 1m (reference) and 2m (forward characteristic) response traces.

Naturally enough, the computer-averaged in-room 1/3-octave analysis was conducted in the *MC* listening room.

The Characteristic Forward Response (2m)

This primary measurement presents visually the forward

radiating character of the loudspeaker, over a sensible forward solid angle and throughout the audible frequency range.

The uniformity of response traces taken on and around the main axis represent a crucial aspect of speaker performance, which determines whether good stereo imaging is possible, and whether the speaker will sound markedly different on- and off-axis.

Taken at a realistic 2 metres distance from the loudspeakers, the Characteristic Response set comprises: axial, 15° above in the vertical plane (below if relevant, eg in the case of a tall floor standing model); 30° in the lateral plane; 45° lateral.

Reference curve

All loudspeakers (both left- and right-hand models) were measured using sine wave excitation at 1 metre. This provides an accurate representation of the low frequency response. Pair matching can be checked by over-laying the curves of left- and right-handed speakers, and the measurement also sets a reference level against which the distortion can be scaled and the quoted lab sensitivity established.

The standard 'one watt' input was established by a voltage of 2.83V RMS on the speaker terminals. For this purpose the impedance was assumed to be a nominal 8ohms.

Listening room responses

Naturally specific to the room used during the listening test, the computer-averaged in-room response has evolved into one of the most powerful predictions of subjective performance. The intention is to create a plot of the average forward sound energy arriving at the listening area.

These curves should *not* be expected to give perfectly flat

Plan of MC's listening room.

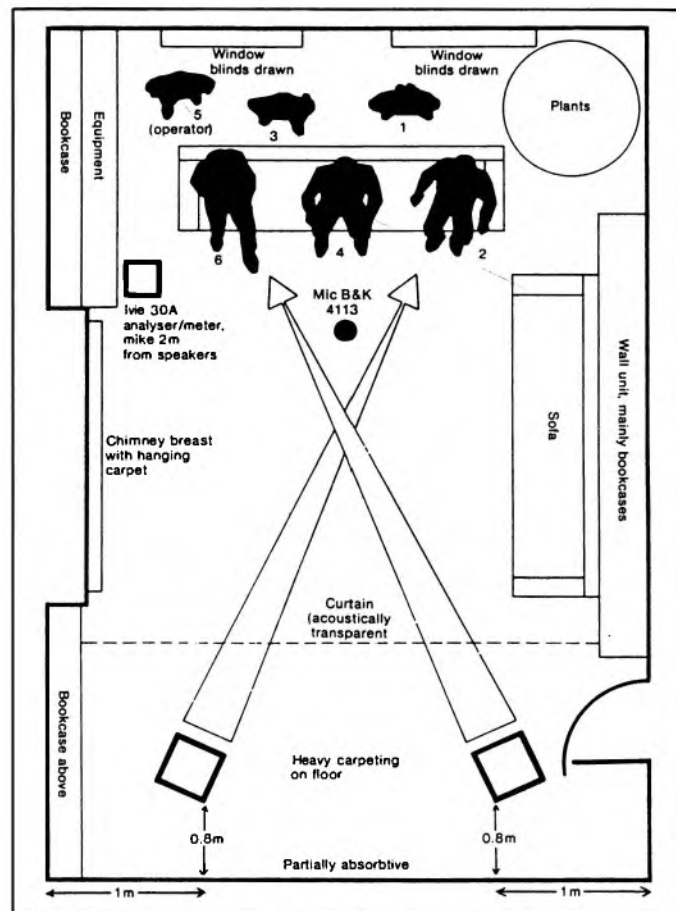

responses. At low frequencies there are some inevitable irregularities corresponding to resonances peculiar to the particular room.

The near ideal speaker may be expected to run more or less flat up to 5kHz, beyond this the response should gradually fall away. Sharper changes in slope will correspond to irregularities in response or directivity, and are therefore suspicious.

Distortion

Using a swept tracking filter, second and third harmonic distortions were plotted at 96dB and 86dB.

It is generally accepted that third harmonic distortion is more aurally obtrusive than second, so

we pay particular attention to the level of third order effects in the midband, where the value should be significantly below 1%. Higher figures are permissible below 100Hz - say 2%, with up to 5% satisfactory levels under 50Hz.

Second harmonic distortion values of perhaps double the level of third may be considered acceptable. A decibel (dB) scale is given on the graphs, referenced to midband 0dB only, so this will require rescaling if a chosen frequency is materially different from that reference level.

Impedance

The impedance curves were plotted for all loudspeakers, while the phase angle was monitored and 'worst case' combinations of

phase and impedance have been recorded.

Sensitivity and power rating

From the reference curve, a mean midband sensitivity figure was recorded, corresponding to the sound pressure at 1 metre from the enclosure when energised by 2.83V (sine). A nominal 8ohms draws 1 watt from this voltage, and lower impedance draws more power, on a *pro rata* basis. Since amplifiers (within their limits) are theoretically voltage sources, this method of specifying voltage sensitivity is a sensible one. Likewise, as no loudspeaker presents a constant impedance value, a power input sensitivity rating is a rather pointless one.

From the power handling, sensitivity and impedance data, a recommendation can thus be made concerning the loudspeaker's minimum and maximum amplifier power rating (per channel, 8ohms). It should be appreciated that this is only a recommendation, and will be modified in practice by individual taste; *ie* a requirement for low or high listening levels as well as by the size and acoustics of the particular listening room involved. The minimum amplifier power that is quoted relates to a typical maximum sound pressure level of 96dBA (2 metres) from a stereo pair of speakers in an average room of volume 80 cubic metres.

It is almost impossible to specify a maximum power rating, as a complex relationship exists between the type of programme, the maximum power input (peak and average) and how long this maximum level is maintained. In this test we found most of even the smallest speakers could sustain a 500W peak, 250W mean power input on solo instruments in the midband provided that its duration did not exceed 15 to 20 seconds.

THE SPECIALISTS

Rayleigh Hi-Fi

44a High Street,
Rayleigh
Tel: 0268-779762
747571

216 Moulsham Street, On-the-Parkway,
Chelmsford
Tel: 0245-265245

CHOOSE YOUR HIGH QUALITY SYSTEM



REGA PLANAR 3 TURNTABLE	£188.00
A&R E77 Mg. CARTRIDGE	£47.00
A&R ALPHA AMPLIFIER	£149.00
HEYBROOK HB1 SPEAKERS	£169.00
TOTAL = £553.00	
NO DEPOSIT FINANCE — 36 MONTHS @ £21.36 (£4.93 per week)	
OPTIONAL EXTRA : A&R ALPHA TUNER	£149.00

MISSION



REVOLVER TURNTABLE WITH LINN ARM & BASIK CARTRIDGE	£253.00
MISSION CYRUS 1 AMPLIFIER	£149.90
MISSION 737R LOUDSPEAKERS	£239.90
TOTAL £642.80	
NO DEPOSIT FINANCE - 36 MONTHS AT £24.83 (£5.73 PER WEEK)	
OPTIONAL EXTRAS:	
MISSION CYRUS TUNER	£179.90
MISSION PCM 7000 CD	£599.90

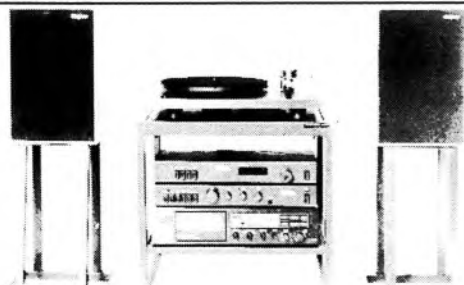

REGA PLANAR 3 TURNTABLE	£188.00
LINN K9 CARTRIDGE	£65.00
CREEK CAS 4040 AMPLIFIER	£145.00
ROGERS LS2 LOUDSPEAKERS	£165.00
TOTAL = £563.00	
NO DEPOSIT FINANCE — 36 MONTHS @ £21.74 (£5.02 per week)	
OPTIONAL EXTRA : CREEK CAS 3140 TUNER	£149.00
DENON DRM-07 CASS	£139.90

Visit either of our superb showrooms and discuss your requirements with our enthusiastic and knowledgeable staff who will be pleased to tailor a system to suit YOU

HIGH QUALITY HI-FI FROM:-

A&R ★ AUDIOLAB ★ BEYER ★ BLQ ★ CREEK ★ CYRUS ★ CELESTION ★ DENON ★ DNM ★ DUAL ★ EPOS ★ GALE ★ GRACE ★ HEYBROOK ★ INCATECH ★ ION SYSTEMS ★ LINN PRODUCTS ★ MANTRA ★ MISSION ★ MONITOR AUDIO ★ MORDAUNT SHORT ★ MUSICAL FIDELITY ★ NAD ★ NAIM AUDIO ★ NAKAMICHI ★ ONKYO ★ QED ★ QUAD ★ REGA ★ REVOX ★ REVOLVER ★ ROGERS ★ ROTEL ★ ROYD ★ SUPEX ★ SYSTEMDEK ★ YAMAHA

SPECIAL OFFER: RING IN (OR JUST MENTION) THIS ADVERTISEMENT FOR:
FREE SPEAKER STANDS PLUS
FREE SPEAKER LEADS AND PLUGS FOR ABOVE SYSTEMS
OR

0% FINANCE
AVAILABLE
FOR LIMITED PERIOD ONLY.



2 MUSICAL EVENINGS
30th NOVEMBER
9th DECEMBER

3 YEARS PARTS AND LABOUR GUARANTEE ON HI-FI SYSTEMS



FULL FINANCE FACILITIES AVAILABLE - DETAILS ON REQUEST - APR 26.5% LICENSED CREDIT BROKER.



THE SPECIALISTS

SUBSCRIBE TO HI-FI CHOICE NOW AND GET A FREE LIMITED EDITION ALBUM OR CD!

**FREE GIFT
WORTH UP TO
£17!**

● By the time you've read through this copy of the new, monthly *Hi-Fi Choice*, we're positive you won't want to miss a single issue.

● Now, you can actually guarantee you're one of the first people to see *Hi-Fi Choice* – delivered direct to your home, carefully packed, straight from our printers.

● When you take out a subscription to the new *Hi-Fi Choice*, you are not only assured of your own priority copy every month, you'll also qualify for a rather special free gift (UK only): your choice of an album or CD from a carefully compiled catalogue will be sent with your first issue.

● Choose from a veritable treasure trove of import and limited edition vinyl and CDs, some of which are worth well over £16 at retail. There's classical, rock, new age and jazz music to suit every taste.

● And, should you have any doubt, just remember our money back guarantee. If, at any time, you are not satisfied with *Hi-Fi Choice*, just tell us. Without question or fuss, we'll refund the unused portion of your subscription immediately.

● Take advantage of this time-limited offer right away. Just fill in the form below. You can use any major credit card.

● Do it now and get a free CD or album!

ORDER YOUR COPIES NOW!

Make sure you are the first to receive copies of new issues as they appear.

BACK ISSUES

Please tick issues you require

CD Midi Systems (Special Ed.)	Nov 86 <input type="checkbox"/>	Amplifiers & Tuners (50)	April 87 <input type="checkbox"/>
Turntables, Arms, Cartridges (48)	Dec 86 <input type="checkbox"/>	Compact Disc Players (51)	June 87 <input type="checkbox"/>
The Best Buy Guide	Oct 87 <input type="checkbox"/>	Cassette Decks & Tapes (52)	Aug 87 <input type="checkbox"/>

Subscription requests received before January 31st will be at the special introductory rate of £35 U.K., \$46 overseas.

I would like to take a year's subscription to *Hi-Fi Choice* at the special discount rate of £35 U.K. , \$46 overseas .

Individual issues including postage and packing: U.K. £3.50, rest of the world £4.25 (air service)

Name _____ Address _____

Postcode _____

I enclose a cheque/I wish to pay by Amex, Access, Visa

Card Number _____ Expiry Date _____

Please send order form and payment to:

Hi-Fi Choice, Mail Order, P.O. Box 320, London N21 2NB.

Or ring 24 hour answer phone leaving Name, Address, Tel No. and order and card No. 01-360 6797

CONCLUSIONS BEST BUYS AND RECOMMENDATIONS

A run down of our findings throughout the loudspeaker tests plus the models which stand out as particularly good value.

While the batch of 30 odd loudspeakers tested on this occasion illustrate quite clearly a number of trends in loudspeaker design, it must also be said that many previously tested models remain fully competitive on sound quality. The art advances – but only slowly – and not always surely.

Midband sensitivities continue to increase year by year, though sometimes by compromising bass extension or amplifier loading. Distortion too has improved steadily, though correlation with behaviour on program material at normal listening levels is still a trifle uncertain.

More important than either, is the role played by the speaker stand. Steady improvement in the performance of turntables, CD players and amplifiers now make loudspeaker support absolutely vital. Paradoxically, budget miniature loudspeakers usually need taller supports than larger designs, so the stands may cost nearly as much as the loudspeaker – but they're still very worthwhile.

The latest innovation amongst top end models is to incorporate the stand as an integral part of the design (see Mordaunt-Short *MS442* and Roksan *Darius* in this issue, Naim *SBL* in *The Collection* 1987). The *MS442* is the easiest of these to set up, simply requiring removal of transit screws. Blind listening confirmed the efficacy of the stand: mechanically 'shorted out' with the transit screws still in place the speaker attained an 'above average' rating; properly decoupled and 'floating' as designed it scored two ranks higher.

It is difficult to make definitive rules about partnering loudspeakers and stands, so it is logical to investigate that recommended by the manufacturer, although cheaper alternatives from stand specialists may be worth pursuing. By and large, lightweight loudspeakers seem to prefer heavy, solid stands, the heavier designs the lighter

open-frame type of support.

Both metal dome tweeters and bi-wired crossovers are becoming increasingly widely available. The latter, and its variations, splits the crossover and provides extra terminals so that each driver/crossover can be connected directly to the power amplifier terminals. Tested under blind conditions, the improvement in control and 'tightness' more than justifies the cost of the extra cable, usually taking the design up a complete grade against conventional connection.

One is inclined to graduate speakers according to size and/or price first and foremost, with other criteria following on behind. But more important than anything else in practice is the intended placement in the listening room, while choice of stands and cables also play a significant role.

Achieving a smooth overall frequency balance remains the prime criterion in getting a good quality sound, but no current loudspeaker can be expected to work equally as well out in free space or alternatively sited against a rear wall. Speakers that work well close to a wall sound gutless in free space, and their counterparts boom like mad if they are not free standing – and the compromises never quite find the right position. As the siting is normally determined by the room itself and other domestic considerations, this may very well be the best place to start when choosing a loudspeaker.

Though we got pretty good consistency between the two separate listening tests, certain factors were highlighted, most notably that the difference between vinyl and CD sources can play a significant role in overall judgement. There are also interesting possible correlations between taste in room acoustics, types of music, and capabilities of systems, but that remains speculation at the present . . .

BEST BUYS & RECOMMENDATIONS

Best Buy denotes exceptional value for money, and we have drawn an upper price limit for the Best Buy category, this time at £300. Above this price the 'law of diminishing returns' comes into effect, so better examples at more than £300 are 'Recommended' instead.

Recommended means that either the performance was particularly good irrespective of price or that good value is offered but overall attainment falls short of Best Buy classification. However the dividing line between what constitutes a Best Buy or a Recommended system is often quite hard to draw, and obviously depends on *our* interpretation of performance characteristics.

The 30 or so new reviews in this issue build on a background of well over a hundred that we have tested in the past and which are still available. The following Best Buys and Recommended models incorporate past and present reviews, with careful re-assessment of the older ones in relation to current standards pertaining.

UNDER £100

Price constraints mean that these models tend to be miniatures or near-miniatures, and benefit from mounting near a rear wall. In some cases a wall bracket is a cost effective alternative to a decent rigid stand which could cost as much as £75 extra.

New Best Buys include the £80 Goodmans *Maxim II* and £70 Maxim, £90 Mordaunt-Short *MS10II*, while the £99 Mission *70II* and £80 Toshiba *33es* continue from previous editions. Sony's brand new UK-made £100 *APM10* comfortably made the grade subjectively too, but it was sent too late for the lab tests and Sony's

supplied measurements are not strictly comparable.

Recommended models include the Royd *A7II* (£99) and Goodmans *Point 3* (£90), with the Wharfedale *Diamond II* (£90 if still available) and Royd *A25* (£99) from earlier editions (this last somewhat larger than its rivals).

£100-£175

Moving on to the next and most popular price band, the majority are best described as 'bookshelf' size 'compacts' – though purpose-built stands will make them sound better than on any bookshelf – and will again benefit from some rear wall reinforcement. But some are aligned to work out in free space, with consequent benefits in coloration (sometimes at the expense of sensitivity and power handling).

There are two new Best Buys, though neither achieved the status unanimously, and each was liked rather better by one panel than the other – which is fair warning to listen for yourself before deciding. Nevertheless the rock/vinyl oriented JPW *AP2* (£145), and classical/CD biased Rotel *RL850 II* (£120) both attracted more than their fair share of praise.

From last year's project, only the Tannoy *Mercury II* (£150) and Sony *APM20ES* (£150) are believed to have survived unchanged. Many of last year's Best Buys have undergone slight design updates, yet the latest samples were not available in time for reviewing. Consequently, latest versions of the AR *18BX* (£129), B&W *DM100* (£120) and *DM110* (£149), and the Celestion *DL4* (£120) deserve close attention, as their predecessors did very well.

There are plenty of Recommended models – but again many come from earlier projects. New entries include the wall-

aligned £130 Mission 700LE, the £130 Marantz LD20DMS (good for CD buffs), and the AR22BX (£160). Heybrook's HB1R (£170) was re-audited by the MC panel, doing sufficiently well to re-instate the recommendation lost last year, while the Goodmans Point 7 (£170) is worth considering too.

Survivors from previous editions include the IPW P1 (£125), Castle Clyde (£130) Wharfedale 504 (£130), Monitor Audio R252 (£150), Mordaunt-Short MS100 (£170), Rogers LS2 (£165), while the Celestion DL6 (£150) is another previously well-regarded model to have undergone recent revision.

£175-£300

The six contenders from this year's test group failed to meet the standard set by the Rogers' LS6 (£230), which remains the sole Best Buy in this mid price range.

However, the Monitor Audio R452MD (£280) is fully Recommended, while the Arcam T700 (£250), Avance 120 (£279, but use its special stand) and Monitor Audio R652MD (£300) are also worth considering.

Amongst the many survivors from a price band where product

cycles tend to be longer than those found in the fiercely contended budget end of the market are the following: BBC LS315A, Castle Durham (£180) and Pembroke (£250), IPW AP3 (£210), Monitor Audio R700MD (£270), B&W DM220 (£240), Tannoy Venus (£290), Sony APM22ES (£250). JBI's L20T (£250) is worth checking out too.

£300-£1000

Above £300 we withdraw the Best Buy category with its emphasis on value for money, but there are many highly recommended models nonetheless. These fully justify their highish prices in the context of a decent hi-fi system, but in fact show greater variation between models than is found at lower prices. Many offer a 'bi-wiring' option, and this should certainly be taken up if available.

From the latest tests, brand new Recommended models include the B&W Matrix 1E (£595), Spica TC-50 (£595), and Mission Argonaut (£700), while the current versions of the following models confirmed their Recommended status: Rogers LS7t (£360), Harbeth HL Mk 4 (£475), KEF 10412 (£806, used without the K11BE equaliser).

Several established favourites continue unchanged: the Celestion SL6S (£350), Spondor SP2 (£420) and SP1 (£640), JBI 60T (£370), Technics RX50 (£500), and Yamaha NS1000 (£900). A number of others have been recently revised, but their track record from the past suggest they should not be overlooked: Rogers Studio 1M (£500), Spondor Prelude (£320), Celestion SL600 (£700), Linn Sara (£660), AR44BX (£350), Sony APM66ES (£700).

OVER £1000

At these exalted prices designs differ enormously, and opinions by nearly as much. None should be purchased without careful prior assessment by the individual concerned.

Of the two £1000+ models tested on this occasion, Mordaunt-Short's £1150 MS442 clearly makes the grade, being nearly all things to all men, whereas Roksan's £1150+ Darius remains highly controversial (see review). Both require special care in placement, the M-S well away from walls and corners, the Roksan well down into the room but close to side walls and over-angled inwards.

A number of models were included in our recent 'high end' guide *The Collection*. Each is Recommended in its way, but none is universal in application, so it is vital to take into account other system components, room size and shape, as well as personal preferences. Grouping such distinct individuals into any logical order is difficult.

The Linn Isobarik D/PMS (£1569), Naim SBL (£1100), and Tannoy Westminster (£3110) are all designed for rear wall siting, and provide fine dynamic performance while sacrificing something in stereo imaging. The Tannoy in particular prefers a large room – as do the free-standing KEF R107 (£1890), Spondor SA3 (£1320), and Infinity RS11B (£3850).

The Quad ESL63 (£1459), Magneplanar MG3a (£2750), and Apogee Scintilla (£4950) are three panel designs that have their own particular subtlety and transparency – and some disadvantages as well of course. The dipole-bass Celestion 6000 (£1470) maybe fits in here, or maybe alongside the dynamics, as it combines some of the characteristics of each. Visually it doesn't fit in anywhere...

~ THE HOME OF HIFI ~

We offer you a bigger range of superior Hifi brands, superb service, free advice and extended guarantees.

Among our stock are Mission, Quad, Denon, Philips, AIWA, Celestion, Systemdek & Wharfedale – *We also have the ideal listening facilities.*

HI-FI-CORNER

- 52, GORDON STREET, GLASGOW. ☎ 041 248 2840
- ROSE ST. PRECINCT, EDINBURGH. ☎ 031 220 1535
- 1 HADDINGTON PLACE, EDINBURGH EH7 4AE.
☎ 031 556 7901
- 44 COW WYND, FALKIRK FK1 4PU. ☎ 0324 29011

HOME
DEMONSTRATION
A
PLEASURE

Sussex Audio

COME AND LISTEN TO THIS TOP QUALITY
EQUIPMENT IN OUR SINGLE SPEAKER LOUNGE

VAN DEN HUL
Interconnects
Made to length
& Suppliers of
Chord Interconnects

CAMBRIDGE CD1

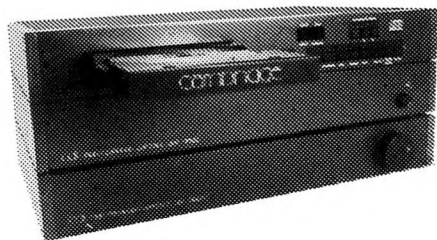

EXPOSURE ELECTRONICS
INTEGRATED AMPLIFIER X



CAMBRIDGE CD2

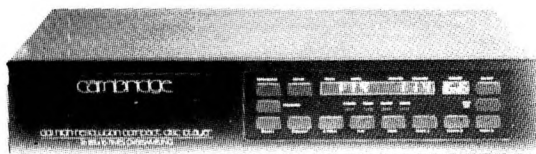

MANTICORE MANTRA
(Electronic and Manual)

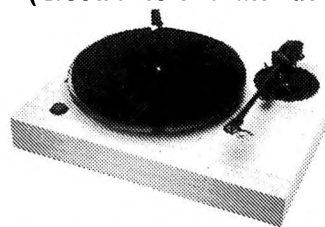

MAIN AGENCIES

EXPOSURE · ELITE ROCK · MANTICORE · CAMBRIDGE AUDIO · ACOUSTIC RESEARCH (inc Electronics) · NAD · ROTEL · B&W (inc matrix) · NAKAMICHI · DENON · TANNOY · BLQ · INFINITY · THORENS · DUAL · KEF (inc Reference) · ONIX · HARBETH · VAN DEN HUL · NAGAOKA · GOLDRING · ORTOFON · AUDIO TECHNICA · SENNHEISER · BEYER DYNAMICS · TARGET · MARANTZ · PHILIPS · MORDAUNT SHORT · TDK · THATS TAPE · GOODMAN'S MAXIM · HUNT EDA QED (Accessories) · TRIO · AND MORE



MID SUSSEX ELECTRONICS
163/165 CHURCH ROAD
BURGESS HILL
SUSSEX. 04446 42336



HI-FI MARKETS
The place where people care about hi-fi

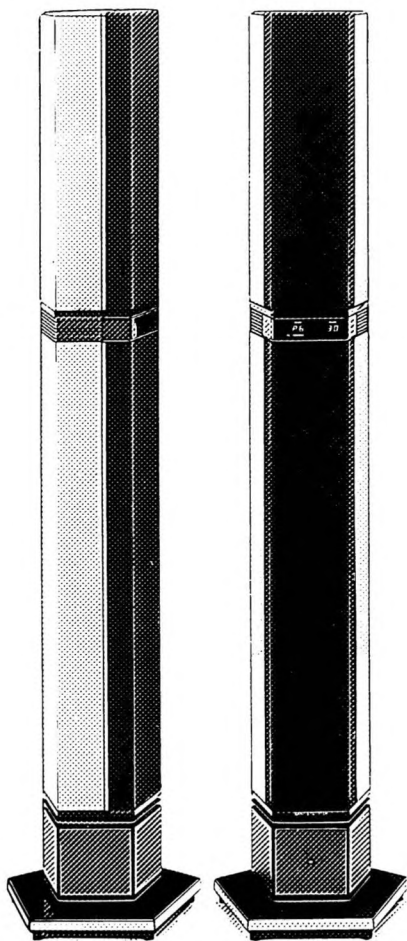

There's one tall story that's totally true.

Bang & Olufsen Beolab Penta Speakers

The best hi-fi needs the best speakers. Tall and elegant, Bang & Olufsen's revolutionary 150W Beolab Penta speakers will give you new heights of hi-fidelity. Their special design prevents sound reflections from the floor and ceiling from distorting the audio image. The result is a sound so true that you can almost see the orchestra! You can choose the advanced 150W Beolab amplifier separately; and opt for Beovox Penta where you don't need the additional power. Come on in and listen! Hearing is believing.

Carl Dyson
Sound & Vision Centres

Waverley Market, Edinburgh EH1 1BQ Telephone: 031-557 2917
10/12 Hamilton Place, Edinburgh EH3 5AU Telephone: 031-225 1771

IN HI-FI

You can buy your next Hi-Fi by perusing a best buy guide. You choose carefully from the comments and opinions in the reviews, take it all home and you wonder where all that sound quality has disappeared to! It's fallen into the chasm between your eyes and your brain. That space is only filled with your ears.

Come and listen to your best buy at In Hi-Fi.

*Sponsors of the Festival of Sound and Vision, Edinburgh
Sheraton, 6th-8th November 1987.*

We stock:-

*A+R . AIWA . A.T. . ALPHASON . AUDIOLAB . BEARD .
CASTLE . CONRAD JOHNSON . DECCA . DENON . VAN
DEN HUL . INFINITY . JBL . KEF . KRELL . MARANTZ .
MAGNEPAN . MICHELL . MISSION . NAIM . QED . QUAD .
QUICKSILVER . REVOLVER . ROGERS . ROKSAN .
SONY ES . SYSTEMDEK . WTA . YAMAHA . ZETA .*

63 GEORGE STREET EDINBURGH

Tel:031-225 8854

Mon-Sat 9.30-6 Evenings by appointment

Woodside Electronics

RADFORD

Woodside Electronics

The 'RENAISSANCE' Range of Classic Valve Audio Equipment

STA25

50 watt stereo amplifier

MA75

75 watt monoblock

SC25

pre-amplifier



Woodside Electronics

Kimberly Road, Clevedon
Avon BS21 6QJ
Telephone: 0272 877611

USA & Canada **Tertel Audio Marketing**
P.O. Box 147, 7723 Yonge Street
Olde Thornhill Village, Ontario
Canada L3T 3N1. Tel: (416) 731-9708

At LeSet, the newest sound and vision shop in Brompton Cross, you'll find a carefully chosen selection of the finest equipment from around the world. Our choice of the MARTIN-LOGAN CLS electrostatic speakers should therefore come as no surprise.

They are both a technological breakthrough to a higher quality of sound and, with their choice of solid wood frames, a pleasure to the eye as well as the ear. Superbly transparent both sonically and visually.

AT LESET THERE'S NO ROOM FOR THE AVERAGE

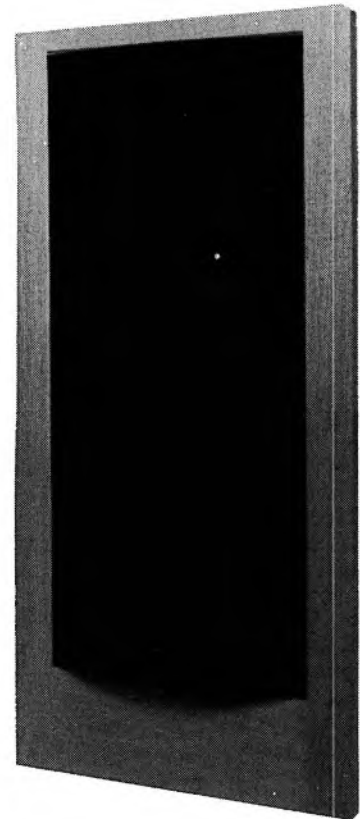

If, on the other hand, you're looking for a compact speaker system LeSet offers you the incomparable ENSEMBLE PA-I loudspeakers. What other box speaker, is capable of matching the best electrostatic designs, reproducing a wide frequency range, and an outstanding transient and bass response from such a small enclosure?

If you refuse to live with the merely adequate, ENSEMBLE loudspeakers will soon find a small space in your life.

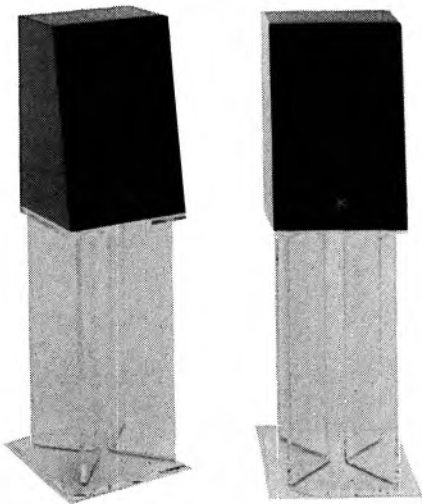

leSet

TOMORROW'S SOUND AND VISION

115 Fulham Road, London SW3 6RL

Telephone 01-581 3676

Monday-Friday 10am-7pm Saturday 9am-6pm

Please write or telephone for our brochure.

All specialised equipment can be heard in our Sound Studio, for which appointments are preferred.

MARKET SURVEY

Dealer Feedback – our innovatory market survey summarises dealers' opinions on the current state of the loudspeaker market, and such factors as consistency and reliability.

MARKET RESPONSE

For this new monthly incarnation of *Hi-Fi Choice* we plan to supplement our detailed subjective and objective reviews with a series of reports 'from the field', linked to the main review topic of the month but not influencing our judgements there in any way.

With the best will in the world, engineers and listening panels can only establish a certain viewpoint on the products. No less useful is the collective experience of hi-fi dealers around the country. This can provide its own perspectives on the state of the market, in terms of the popularity, consistency and reliability of particular models and brands.

Accordingly we sent a circular letter and questionnaire to around 100 UK specialist hi-fi dealers, asking for help in compiling data on these rarely explored areas. Our particular thanks to the fifteen or so who took the trouble to respond by post. We then telephone-polled our way through the list until we had accumulated 36 responses.

Though our selection was essentially random, the pool of dealers was certainly biased towards the independent hi-fi specialist, avoiding the chains which cater to a substantial percentage of hi-fi consumers. This will probably favour the smaller manufacturer who supplies most of his product to the independent sector.

Our information regarding reliability is also likely to work in favour of the smaller manufacturer, simply because one is more likely to encounter faulty examples in the larger sample. However, there is also the need to identify and eliminate the 'batch problem' effect – a fortunately rare event which may strike a manufacturer through his production engineering or even *via* a component supplier, but which is usually quickly rectified once discovered, by which time a number of units may have been shipped. In this comparatively small industry, good communication between dealers and manufacturers often stops such problems in their tracks, and to publicise such isolated incidents would serve no useful purpose.

THE MARKETPLACE

It is difficult to specify the size of the UK hi-fi loudspeaker market, estimates ranging from £10-20 million per annum, simply because it

is hard to know where to draw the line between hi-fi and audio.

There are similar value/volume difficulties in specifying the market shares of the different manufacturers. Wharfedale, for example, probably have the widest distribution in terms of numbers of dealers, but tend to concentrate on budget products, so their large sales volume may not be any greater than another's value output. More succinctly, you can buy ten pairs of *Diamonds* for the price of a pair of *10412s*.

Disregarding the consequences of recent takeovers and mergers (Tannoy, Goodmans, Mordaunt-Short) in the UK at least, no single brand dominates. In the best capitalist tradition there are about ten companies holding between five and ten per cent, and another ten with less than five per cent, presenting an astonishing range of choice for the consumer and ensuring that prices remain fiercely competitive.

The core market has been fairly static for some years as enthusiast attention focused on the turntable, leading to depressed sales of higher priced models. Nevertheless demand for these does exist, as some have found, and to some extent the others can be blamed for failing to come up with suitably credible products to justify the higher price points.

The arrival of CD has perked things up a little at the mass market end, because CD-upgraders often look next to their loudspeakers when contemplating further improvement. But prices have risen a modest 10-15 per cent in the last five years, partly due to the psychological difficulty in breaking the £100 price point for the industry's staple product, the 200mm 2-way bookshelf model.

Things look pretty good for potential loudspeaker purchasers. Our feedback from dealers indicates that high standards of quality control are being achieved. The loudspeaker is the simplest element, engineering-wise, in the system and is therefore the least likely to suffer from unreliability.

Although some dealers were able to come up with their least reliable model, this often turned out to be their biggest seller – the numbers being sold heightening the chances of finding a duff connection, woofer, or whatever. Considerably more surprising in view of the engineering tolerances involved, many

retailers replied that their loudspeakers were very consistent in terms of sound quality.

GENERAL COMMENTS

One matter of concern was the build-quality of the cabinets. It was felt that the wood used in cabinet making – mostly chipboard and medite (MDF) – has deteriorated in quality over the years, so that most speakers now look as though they started life like pack-flat furniture. Bygone craftsmanship, often lamented, is again mentioned as missing. Missing, but not presumed dead – quality wooden-cabinet speakers are still available but they come at a price. The nature of the material used in construction does not necessarily alter the sound quality, but if you haven't filled your home with MFI furniture it may be a deciding factor for you. Dealers found that 'style' was very important to many customers.

Internal construction was generally praised, and it was felt that crossover design and components had been improved significantly in the last two or three years. Many loudspeakers now incorporate a bi-wiring facility, which is a very cost effective means of improving sound quality, enabling the user to run specifically tailored cables for low and high frequencies.

One dealer did mention that some manufacturers were overlooking an easy area for upgrading sound quality. He pointed out that the wiring used inside the speaker was generally of 'tuppence-halfpenny' standard. Having tweaked his own loudspeakers with QED 79-strand cable he had noticed 'significant sound improvements through the whole range'.

Many retailers felt that the importance of stands and good-quality speaker cable was still being underestimated by their customers. Equally people misunderstand the effect that positioning within the room has on the tonal response of their loudspeakers. Both these points are very relevant if you want to get the best from your system.

Dealers also did some bugling and flag flying about British loudspeakers generally. It seems the foreign competition haven't got a patch on our boys when it comes to building the ultimate soundbox. Comments included 'beautifully made, musical, fine-sounding

84

CHARING CROSS ROAD

HOME OF

COVENT GARDEN RECORDS

READ THE BOOK — SEE THE FILM — AND NOW
VISIT LONDON'S LARGEST CD CENTRE

THE COMPACT DISC SPECIALISTS

- ▶ Complete systems and components by A&R Cambridge, B&W, Denon, Marantz, Meridian, Mission, Monitor Audio, Nakamichi, Pioneer, Quad, Rogers, Rotel, Sony ES, Wharfedale, Yamaha and more.
- ▶ All equipment on demonstration in our two private listening rooms – fitted with surround sound (Yamaha DSP1).

**DAT ON DEMONSTRATION.
STOP WONDERING
COME AND HEAR
FOR YOURSELF**

- ▶ AN OUTSTANDING RANGE OF CD PLAYERS FROM PHILIPS, SONY, MARANTZ, DENON, YAMAHA, MISSION, MERIDIAN, A&R CAMBRIDGE, PIONEER, NAKAMICHI, KENWOOD, AND ROTEL
- ▶ CD SERVICE DEPARTMENT
- ▶ OVER 6,000 CD TITLES IN STOCK

THE COVENT GARDEN RECORDS PHILOSOPHY

We at Covent Garden believe that musical enjoyment should be the end product and that your audio equipment purchased should be a means to that end. We believe that certain CD's can be found to enhance the apparent performance of a Compact Disc player. We therefore suggest that you demand music with which you are acquainted, bring your own disc or select a disc from the **BIGGEST DEMONSTRATION STOCK OF ANY CD DEALER IN THE COUNTRY.**

PRICE PLEDGE

If, having bought a Compact Disc Player or system from Covent Garden Records within a period of 30 days you see the same product, new and boxed, from an authorised UK dealer, we guarantee to refund the difference in price on production of that dealer's official quotation.

SERVICE PLEDGE

Covent Garden Records will replace any sub-standard audio product within 30 days of purchase provided full documentation and original packing, etc. are supplied. If an audio product or Compact Disc player becomes faulty between the second and twelfth month of purchase we will loan you equipment during the period of repair..

INSTALLATION PLEDGE

Covent Garden Records will install complete audio systems or selected CD players (ask for details) in your home within the Greater London Area. This system operates between 7.30 pm and 11.30 pm weekdays and from 9.00 am to 9.00 pm at weekends.

THE FINEST SELECTION OF COMPACT DISCS

- ▶ Mid price Classical new releases only **£6.95** and Classical full price new releases only **£9.95** per CD for the first 30 days after issue Decca, DG, Philips, EMI, CBS, RCA and others. **PERSONAL CALLERS ONLY.**
- ▶ All back catalogue releases from EMI, DG, DECCA, Philips at the exceptionally low price of **£10.95** per CD
- ▶ Unique scheme of one token for each CD you buy (value **£9.95** and over) entitles you to a free CD (at **£10.95**) when you've collected ten
- ▶ Mail Order Service – by first class recorded delivery, **POST FREE IN UK.**
- ▶ We buy and part-exchange secondhand CD's – secondhand CD's on sale from **£5.99**
- ▶ **WARNING:** Buying CD'S without listening first can mean expensive mistakes. We offer headphone listening facilities



COVENT GARDEN RECORDS

84 Charing Cross Road, London WC2H 0JA

Tel: 01-379 7674/7635/7427

Open Mon – Sat 10am-7.30pm

2 mins from Leicester Sq. and Tottenham Court Road Tube



£6 Off

On Purchase
Of 5 CD's over **£9.95**

84 Charing Cross Road, WC2
NO TOKENS GIVEN
VALID TO 31.12.87*

HFC/12/87

£50 OFF. Get **£2 off** your next 25 CD's
(**£10.95+**) when you buy a CD player
... Offer also applies to Hi Fi systems over **£750.**
Ask for details

*Sale and special offer goods excluded valid to 31/1/88



£1 Off

On Purchase
Of 1 CD over **£9.95**

84 Charing Cross Road, WC2
NO TOKENS GIVEN
VALID TO 31.12.87*

HFC/12/87

and reliable'. How often do you hear that?

Incidentally members of the British Audio Dealers' Association (BADA), were less responsive as a group than others. Some thought that BADA had told them not to participate but this was rejected by Chairman Jerry Lewin who said there was no official line as yet, but that the matter would be discussed at their next meeting on November 4. The worry is that information of this nature is confidential and its publications might be a disservice to the industry.

RELIABILITY

As far as reliability is concerned we found that standards were pretty high, with an average of just over one per cent of the units supplied to dealers having to be returned to the manufacturer or serviced by the dealer as faulty.

An average 1.5 per cent of speakers were being returned as faulty *after* sale. But where speakers had been damaged in use, dealers felt that it was mostly due to overloading the unit – that irresistible urge to screw the volume control clockwise at the wildest moment of the party no doubt!

If your speaker does go wrong, or if you blow it up, we found that you can expect a manufacturer to repair it in ten days on average. However some manufacturers were taking up to four weeks, whereas others (such as Quad or Linn, for example) could get it back in a few days. We also found that some dealers stock spare parts and promise 'same day' repairs.

Dealers were on the whole reluctant to single out manufacturers as being particularly good or bad in terms of product reliability, however certain names did crop up more often than others.

Most popular were Monitor Audio and Linn Products, with very few complaints about reliability. Other notables were Rogers and Mordaunt-Short. These last two had no complaints against them at all, but are not stocked by as many dealers as the former brands so did not score so highly in our points system.

A number of adverse comments were levelled at Wharfedale, who scored the lowest overall but who are also among the top best-sellers in the budget sector. No-one else came in for serious adverse criticism in terms of reliability.

CONSISTENCY

We wanted to find out which manufacturers maintained the highest standards of sonic consistency. Did the sound quality of a particular model vary from batch to batch? The answer seems to be rarely. However, dealers did have their favourites, and some claimed that certain brands always sounded exactly the same.

Reviewers are unable to test for sample variation (apart from comparing the two examples of a stereo pair), which makes this one of the more important factors in our survey. Of course if you buy the demonstration pair that you listen to in a shop, consistency is less important than if you end up with a pair from stock.

From the response we got, Linn Products and Rogers were clear leaders, with Gale, KEF, B&W and Monitor Audio also highly commended. On the other hand, Wharfedale and Mission were considered to vary the most in this respect.

TOP SELLERS

In the broad budget sector up to £150, the best selling models from our necessarily limited survey are:

- 1) Monitor Audio *R252*
- 2) B&W *DM 1101*
- 3) AR *18BX*
- 4) Wharfedale *Diamond*
- 5) Mordaunt-Short *MS25Ti*

In the midprice sector from £150 to £299 our top five are:

- 1) Heybrook *HB1*
- 2) Linn *Inde.x*
- 3) Rogers *LS6*
- 4) Monitor Audio *R352*
- 5) Linn *Kan*

Best sellers in the over £300 range are:

- 1) Monitor Audio *R852*
- 2) Rogers *LS7*
- 3) Linn *Saras*
- 4) Quad *ESL 63*
- 5) KEF *104/2*

These results are based on sales over August and September this year, and many dealers mentioned this was a particularly slow time for hi-fi sales in general. We wouldn't dare claim that the results are necessarily representative, but they are interesting nonetheless.

Being the first survey of its kind we expect fairly diverse reactions from dealers, manufacturers and the public alike. But we feel that in publishing it we are offering useful information to all of these groups, and acting as a neutral communications interface besides.

PARTICIPATING DEALERS

We would like to thank the following for helping us compile this survey:

Active Audio Hi-Fidelity Products, Derby.
Aerco Ltd, Woking, Surrey.
Audio Excellence, Cardiff.
Audio Excellence, Gloucester.
Audio Excellence, Swansea.
W. A. Brady and Son, Liverpool.
Beechwood Audio, Braintree, Essex.
Steve Boxshall Audio, Cambridge.
Brentwood Music and Hi-Fi Centre, Essex.
Cambridge Hi-Fi, Cambridge.
Chichester Hi-Fi, West Sussex.
Clearstone Hi-Fi, Altrincham, Cheshire.
The Cornflake Shop, London W1.
Covent Garden Records, London.
Elite Hi-Fi, Harrogate, Yorkshire.
Erricks of Bradford, Yorkshire.
Fiveways Hi-Fidelity Ltd, Birmingham.
Grahams Hi-Fi Ltd, London N1.
Paul Green Hi-Fi Ltd, Bath, Avon.
Hampshire Audio Ltd, Chandlers Ford.
Hi-Tech Audio, Clitheroe, Lancashire.
John Marley Hi-Fi Centres, Canterbury.
Phonograph, London.
Reading Hi-Fi Centre, Berkshire.
Robert Ritchie Hi-Fi, Montrose, Scotland.
Sound Advice, Loughborough, Leicestershire.
Swift of Wilmslow, Cheshire.
The Music Room, Manchester.
True-Fi Sound and Vision, Aldershot, Hampshire.
True-Fi Sound and Vision, Redhill, Surrey.
Truro Hi-Fi and E.T.S. Ltd, Cornwall.
Bill Vee, London SE13.
Warstones Hi-Fi Studio, Wolverhampton, W. Midlands.
Watts Radio – The Engineers, Somerton, Somerset.
Westwood and Mason, Oxford.
Witney Audio, Oxford.

NB Any hi-fi dealer who feels aggrieved he is not on this list, and who would like to be consulted in the future, either regularly or intermittently, please write to us at 39 Goodge Street, London W1P 1FD, or telephone 01-631 1433. We didn't leave you out deliberately, and would welcome your future participation.

THE BEST SYSTEMS IN BIRMINGHAM



MISSION PCM4000

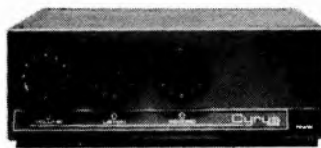

MISSION CYRUS ONE



MISSION 70II

£649
incl.
leads



MISSION PCM4000



MISSION CYRUS TWO



MISSION 737R

£939
incl.
leads



MISSION PCM7000



MISSION CYRUS TWO



MISSION PSX



MISSION 780A

£1799
incl.
leads

DUAL 505/2, ROTEL RA820, AR8BX or DL4 or 70II or MS15 or TRENT £299.95
 DUAL 505/2, ROTEL RA820BX2, AR8BX or DL4 or 70II or MS15 or TRENT £339.95
 DUAL 505/2, NAD 3020E, AR8BX or DL4 or 70II or MS15 or TRENT £289.95
 DUAL 505/2, NAD 3130, AR8BX or DL4 or 70II or MS15 or TRENT £334.95
 DUAL 505/2, ARCAM ALPHA PLUS, AR8BX or DL4 or 70II or MS15 or TRENT £329.95
 DUAL 505/2, ACOUSTIC RESEARCH A04, AR8BX or DL4 or 70II or MS15 or TRENT £349.95
 DUAL 505/2, YAMAHA AX300, AR8BX or DL4 or 70II or MS15 or TRENT £289.95
 DUAL 505/2, YAMAHA AX400, AR8BX or DL4 or 70II or MS15 or TRENT £339.95
 ALL SYSTEMS SUPPLIED WITH CONNECTING LEADS & 10 METRES OF 79 STRAND CABLE

COMPACT DISC PLAYERS

Acoustic Research CD04	£289.90	Philips CD160	£179.95
Arcam Delta 70	£499.00	Philips CD360	£249.95
Cambridge CD1	£1500.00	Philips CD650	£299.95
Cambridge CD2	£599.00	Philips CD960	£699.95
Denon DCD 300	£209.95	Philips EM2000 Remote Control	£39.95
Denon DCD 500	£249.95	Rotel RCD820	£249.95
Denon DCD 900	£299.95	Rotel RCD820BX	£349.95
Denon DCD 1300	£389.95	Technics SLP111	£179.95
Denon DCD 1500	£479.95	Technics SLP220	£229.95
Denon DCD 1700	£599.95	Technics SLP320	£249.95
Denon DCD 3300	£1199.95	Technics SLP520	£349.95
Marantz CD273SE	£239.95	Technics SLP720	£399.95
Marantz CD65	£379.95	Technics SLP1000	£699.95
Marantz CD75	£449.95	Technics SLP1200	£799.95
Marantz CD94	£799.95	Technics SLPJ30	£249.95
Meridian CD 207	£950.00	Technics SLPJ22	£179.95
Meridian 209 Remote Control	£85.00	Technics SLPJ44	£249.95
Mission PCM 4000	£399.95	Yamaha CDX5	£199.95
Mission PCM 7000	£599.95	Yamaha CDX500	£269.95
NAD 5220	£229.95	Yamaha CDX700	£299.95
NAD 5240	£279.95	Yamaha CDX900	£449.95
NAD 5330	£269.95	Yamaha CDX110C	£699.95

EXTRA FOR THE FOLLOWING LOUDSPEAKERS:

Acoustic Research AR18BX	£30.00	Monitor Audio R100	£30.00
Acoustic Research AR22BX	£60.00	Monitor Audio R252V	£45.00
Heybrook HB1	£70.00	Mordaunt Short MS26ti	£20.00
Mission 700LE	£30.00	Mordaunt Short MS35ti	£40.00
Mission 707	£60.00	Tannoy Mercury mkII	£50.00

EXTRA FOR THE FOLLOWING TURNTABLES:

Ariston 'Q' Deck with cartridge	£20.00	Thorens TD 166 mkII (without cartridge)	£55.00
Acoustic Research EB101 with cartridge	£90.00	Thorens TD 166 mkII (without cartridge)	£55.00
Dual 505/2 Deluxe with cartridge	£20.00	Thorens TD 316 (without cartridge)	£70.00
NAD 5120 with cartridge	£30.00	Thorens TD 318 (without cartridge)	£100.00
Rotel RP830 with AT110E cartridge	£30.00		
Revolver with Revolver arm & cartridge	£80.00		

★ THOUSANDS OF COMPACT DISCS FROM ONLY £6.95 !!! ★



ALTERNATIVE AUDIO LTD.

93-95, Hobs Moat Road,
 Solihull, West Midlands,
 SALES: 021-742-0254
 SERVICE: 021-742-0248

Send now for our Price List of the widest range of HiFi in the Midlands

The Music Room

NEWSLETTER

Vol 3 No 7 - December 1987

This has been a year of progress for Hi-Fi in Britain. Many of our famous manufacturers have strengthened their position at home and overseas markets with excellent new products, more professional marketing and growing financial strength. However, as Hi-Fi Exhibitions demonstrate, few British manufacturers or importers properly understand the elusive magic of a properly matched and set-up system which we consider to be the only justification of the whole industry.

As CD continues to mature, turntables, arms and cartridges also gained strength with many excellent designs reaching the marketplace this year. The moving-coil cartridges from Audio-Technica are remarkable value from £69.95 right up to Kiseki/Koetsu territory although we do, of course stock many moving magnet and other ranges for customers to discuss and audition. We are very happy with the excellence and choice of turntables we can offer from the budget Ariston Q-Deck and the new Dual 503-1, through Systemdek, Elite Rock, Roksan Xerxes and the revised Gyrodek from Michell Engineering. The new specification at no price increase makes it hard to resist, and inexpensive tonearms such as the Rega or the Audio-Technica (both under £100) make it affordable. The Michell Syncrodek could be considered as a budget Gyrodek, and it certainly is a mistake to believe that such a stylish turntable couldn't possibly be state of the art sound!

Manufacturers of tonearms continue to convert those who still find it hard to believe their contribution to sound quality. Now that SME have released the Series IV, many music lovers are making this wise investment and we are proud to represent this aristocratic British company in our Glasgow and Manchester shops.

COMPACT DISCS

The gulf now widens between the gimmick CD players with video, multi stacking trays and optical outputs on the one hand, and well-designed and built machines. These have overcome the sonic

disasters which marred the early years of Compact Disc. We recommend the Nakamichi OMS-4, the Denon DCD-3300, and the Marantz CD-94 which are all finished to the finest Japanese levels, and a few of the new models from Britain. We urge buyers to compare these machines in our demonstration rooms and buy whichever they prefer. Just as much as turntables, the sound differences are quite apparent and reviewers' opinions are just that!

The Music Room was the only specialist British dealer who remained open-minded when CD was launched; then condemned it as unmusical while others reversed and cashed-in. We now express great satisfaction that many manufacturers have identified the problems. The best CD players do not equal analogue standards, but are musical even through the most revealing (high definition, uncoloured) systems and this year deserved serious consideration in our end of year prize-giving.

THE MUSIC ROOM AWARDS - 1987

This is now the Sixth Year in which we spotlight the most outstanding contributions to the audio connoisseur, at budget, mid-price and state-of-the-art levels (Bronze, Silver and Gold). In 1984, we introduced a special award for outstanding audio-journalism to recognise the contribution of Ken Kessler. Not everyone likes his style, but we felt that his expertise and hard work were stimulating and valuable. This year we feel that it is time that the work of J. Peter Moncrieff of IAR is brought to the attention of British audiophiles, and we have written to him this day offering to distribute his journal. We have found his comments preceding the arrival of new American models to be perceptive and accurate; thus they must be as useful to our customers as they are to us, and the trend towards an international market is inevitable.

At the budget level, the Audio-Technica AT-F3 moving-coil cartridge at £69.95 wins outright. It is one of the least expensive and

easiest upgrades, especially when you need a new stylus. (We could cheat here and mention the new range of interconnects and speaker wire from Audio-Technica, the PCOCC cables which offer amazing clarity and freedom from an electronic sound.)

The concept of mid-priced systems is stretched a little when we are forced to recognise the revolution offered by the idea of Audio Research not only being affordable, but offering for £1,696 a pre-amplifier which equals their own SP-11 when introduced two years ago. At its price of £5,000 it was universally received as a breakthrough. The Silver-level award must go to the Audio Research SP-9: no competition.

We feel embarrassed that every year Audio Research Corporation wins, but we are joined by reviewers and authorities throughout the world. Like them, we must cut through politics and politeness and state our findings: the gap widens. Owners of the SP-11 need not worry, for that model has now evolved far beyond its original (SP-9) performance level, and we can arrange these circuit and component modifications at no charge on request. When you buy Audio Research, you must be prepared for constant revision, but at least ARC are open and honest. At this point we will expose a problem which the presence of our own Design Engineer has exposed. We will not, at present reveal names, but certain high-end manufacturers are either too secretive or complacent to issue circuit diagrams to enable speedy, cost-effective and guaranteed repairs to customers' valuable equipment. We will pursue this topic, and although no longer members of BADA, we would suggest that this emotive issue be taken up with the offenders.

We commend the integrity of Audio Research Corporation who publish circuit diagrams within their Owners' Manuals, thus risking their highly innovative research to benefit their dealers and customers. Now, the Music Room Newsletter is proud to

announce in Britain the SP-11 Mk. II. We told you: the gap widens, and their partners, the M-300 monoblock power amplifiers combine new levels of musical performance with unprecedented technical specification including the ability to drive very low impedance loads.

Did they have in mind the loudspeakers from Apogee Acoustics? Many people believe that The Music Room simply praises the most expensive and acclaimed audiophile products. Yet we were divided in our opinions on Apogee; until now. The DIVA (a prima-donna) proves that Apogee's daring full-range ribbon technology was the right way to go, and to use an LARism "It is now time to invest". It is probably the world's first neutral loudspeaker: it does not stand in the way of the music, as does its cost, alas. Its architectural grandeur, especially in the new charcoal grey finish matches its sound.

The DIVA should be outright winner of a competition to identify the most outstanding contribution to audiophile engineering, but the genius of Sugano has silenced the critics with the Koetsu Gold Signature. Like the Apogees, this phono cartridge creates a new and exciting standard and deserves to share the Gold level award.

1987 has seen some re-organisation within The Music Room, and we have now grown into a small group of companies: we will adopt, and attempt to justify the slogan "Large enough to cope, Small enough to care". Our Music Rooms in Scotland and England place unrivalled expertise and stock at the disposal of customers who share our commitment to the audiophile goal. Now, for the first time in Britain, Stereo Showcase offers a unique Designer and high-tech option to audio/video products and by the time this Newsletter is published, will boast a major B&O Studio. Mobile Fidelity brings to Scotland a concept neglected outside USA and London: real Hi-Fi for the car, a concept which depends, like all genuine hi-fi, upon expert selection and installation of products of integrity.

The Music Room,
221 St. Vincent Street,
Glasgow G2 5QY.
Tel: 041-248 7221.
(Open Six Days)

The Music Room,
50 Bridge Street,
Manchester M3 3BN.
Tel: 061-835 1366.
(Now Open Six Days)

DESIGNER & LIFESTYLE HI-FI,
TV & VIDEO: Stereo Showcase,
98 Bath Street, Glasgow G2 2EN.
Tel: 041-332 5012.
(Now Open Six Days)

IN CAR HI-FI &
AUTO-ELECTRONICS:
Mobile Fidelity, 98 Bath Street,
Glasgow G2 2EN. Tel: 041-332 5775.
(Closed Tuesdays)

All shops accept ACCESS, VISA and AMEX on presentation or by 'phone and are licensed brokers. Instant and personalised credit readily available subject to normal requirements. We will shortly open a private Showroom and Service dedicated exclusively to ultimate components and systems optimising and invite you to contact Jack Lawson and obtain a copy of our Information Sheet No. 9 (Source Owners should request a copy of No. 8.)



INSTANT CREDIT



FOUNDER MEMBER

good dealer
good equipment
the foundation of a good music
system
from

Hampshire Audio Ltd

Kingfisher House
2-12 Hursley Road
Chandlers Ford, Hants SO5 2FU
Tel: Southampton (0703) 252827 & 265232

We stock selected items for:
Aloi, Audiolab, A&R,
Audio Technica, B&W, Bowers,
Celestion, Cliff Stone, Creek,
Cyrus, Denon, Dual, Gale, Glanz,
Grado, Gyrodek, Heybrook,
Hunt, Jordan, KEF, Koetsu, Linn
Isobarik, Linn Sondek, Marantz,
Mark Levinson, Maxell, Meri-
dian, Michell, Mission, Monitor
Audio, Musical Fidelity,
Nagaoka, Nakamichi, Ortofon,
Perreaux, QED, Quad, RATA,
Revolver, Revox, Rogers, Rotel,
Sennheiser, Snell, Stanton, Sys-
temdek, Supex, Wharfedale,
and others. Active systems on
demonstration.

with

The new **Cyrus** amps -

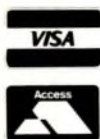
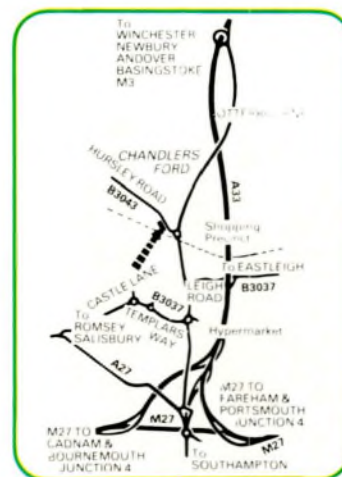
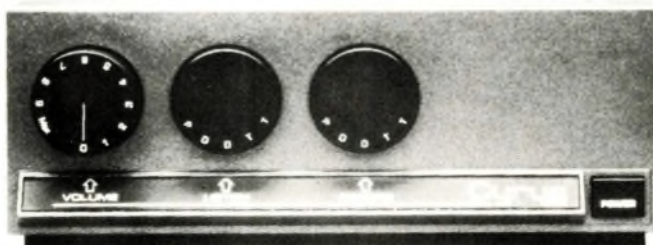

OPENING HOURS
TUES-SAT 10-6 THURS 10-8
CLOSED MONDAYS
(EXCEPT IN DECEMBER)

ADC CD-250X

SOUNDTEC MARKETING, UNIT 9, BELFONTE TRADING EST, MUCKLOW HILL, HALESOWEN, W. MIDS. B62 8DR. TEL: (021) 550 7387

RECOMMENDED



The long established American cartridge manufacturer ADC have previously sourced some of their products in Japan, so it comes as no surprise that this is the origin of the CD-250X. They also market a range of sound shapers/equalisers and mixing desks, should your interests take you in that direction.

This particular player is a full sized manual model, though a 250XR remote version is available, albeit at a higher price. Built into a solid steel two piece case and utilising single board construction it has attractive, clean, square, styling. The large control pushbuttons are sized with respect to their relative importance and are easy to use. Play and pause share one button while stop and open/close another. Other functions available are the normal skip and search and the less important programme and repeat. The programme mode allows 16 tracks to be randomly accessed, and the repeat facility operates on any single track, the programmed tracks, or the entire disc.

The green display informs about the player's current status (such as open, close, focus and play), as well as the more normal track number and elapsed or remaining times. A flag indicates which repeat facility is in use. Furthermore, ADC claim that their D/A converter reduces distortion at critical frequencies to a tenth of that from conventional DACs.

LAB REPORT

Distortion measured particularly well at both full level and all the way down to -80dB. However, the down-band products of a full level 20kHz signal could have been better suppressed, and there was some clipping on a full level white noise signal. Intermodulation distortion products of the 19kHz and 20kHz tones were

very low, particularly at -10dB. The frequency response showed a rise of 0.8dB at 18kHz, but was within 0.1dB below 10kHz; the bass roll-off shown on the graph is caused by interaction with the input impedance of the measuring instrument.

Channel balance was reasonable, deviating somewhat at high frequencies. Channel separation was good up to 1kHz, but worsened as frequency increased. Output level was a little high, and the output impedance will not cause any matching problems. De-emphasis and error correction circuits worked as they should, and ultrasonic spurious were well suppressed. The signal-to-noise ratio will not win any prizes, but will not bother anyone. Low level resolution was an exceptional 15.9 bits, and the ADC produced one of the best -90dB sine waves I have encountered from any CD player. Mechanical noise was low, resistance to shock and vibration very good, but the track access time of five seconds is a little slow.

SOUND QUALITY

Liked immediately for its detailed and fairly neutral midrange and treble, the 250 lacked a little bass 'slam'. It managed to remain tuneful with some 'air' and 'sparkle' throughout most of the band. Further listening revealed good treble clarity; open and lively, if not a bit bright at times, it was not harsh or fatiguing.

Dynamics were quite good, but on some material the midrange could sound slightly 'thin', noticeably on trumpet, though well liked on stringed instruments such as violin. The bass was a little softened but had good extension, while the soundstage was well presented with good width, average depth and reasonable imaging.

CONCLUSIONS

The very fine lab performance tends to support ADCs' claim that they are using special DAC chips. If they could uprate to 4X oversampling and dispense with some of the output filtering, they would probably have an exceptional player on their hands, but I suspect that there are some good reasons for not following this path. As it stands, the 250X is good technically, above average sonically, easy to use, and quite well made.

TEST RESULTS

	20Hz	1kHz	20kHz
Channel balance	0.16db	0.12dB	0.29dB
Stereo separation	111dB	95dB	68dB
Channel phase difference	0°	5°	77°
Total harmonic dist, 0dB	-95dB	-97dB	-76dB
Total harmonic dist, -10dB	—	-82dB	—
Total harmonic dist, -60dB	—	-42dB	—
Total harmonic dist, -80dB	—	-27dB	—
Intermodulation, 19kHz/20kHz, 0dB			-94dB
Intermodulation, 19kHz/20kHz, -10dB			-98dB
Frequency response, left channel	0.1dB	0	0.36dB
Frequency response, right channel	0.1dB	0	0.23dB
Signal-to-noise, 20Hz-20kHz unweighted			95/99dB
Signal-to-noise, CCIR/ARM, 1kHz ref			90/94dB
Output level, 0dB, left/right			2.19V
Output impedance			670ohms
De-emphasis 1kHz, -0.23dB; 5kHz, -4.17dB; 16kHz, -8.6dB			
Track access time			5 secs
Error correction capability	>900µm gap,	>800µm dot	
Mechanical noise			low
Spurious up to 100kHz			-95dB
Resolution at -90dB			-90.5dB
Headphone socket			no
Dimensions (w x d x h)			43 x 31 x 8.6cms
Estimated typical purchase price			£230

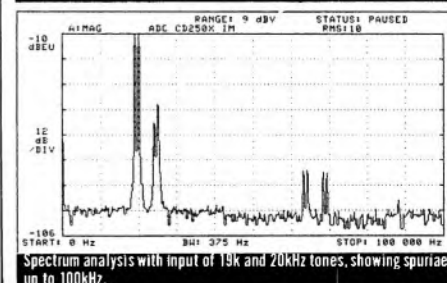
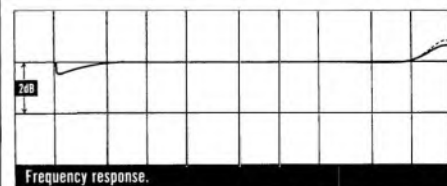

AIWA DX-500

AIWA (UK) LTD, UNIT 2, DUKES ESTATE, WESTERN AVENUE, LONDON W3 0SY. TEL: 01-993 1672



AIWA is a subsidiary of Sony, and is probably as famous for its personal stereos and midi systems as its cassette decks and other hi-fi separates. The company has a factory in the UK which assembles some CD players, though this particular model is sourced in Japan, and so suffers some tariff barriers.

Nevertheless it ties as the cheapest player tested in this issue, and was quite well made too. The case was steel, and a single board carried all the active circuits, with no evidence of audiophile components. Though well equipped in terms of operating facilities, there is no remote control or headphone socket.

Up to 15 tracks may be programmed at any one time *via* the buttons under the loading drawer, and the open/close button clears the programmed memory. Other features available are the standard ones, such as fast track skip, audible music search and repeat one or all.

The display is small but attractive and you can choose between track number or track time. In programme mode the display contains both the track number and the programme number. The play indicator flashes when paused, and a flag appears when the repeat facility is being used.

LAB REPORT

Channel balance was good in the midrange but tended to diverge at the frequency extremes, while channel separation deteriorated at high frequencies to -70dB . Frequency response was almost ruler flat up to 2kHz , then dropped slightly before rising to a $+0.8\text{dB}$ peak at 20kHz . The inter-channel phase difference indicated that a linear time-shared DAC was used, and the consequent brickwall filter caused some ringing with the impulse test, which also showed this player is phase inverting.

Total harmonic distortion at full level was good at 20Hz , but deteriorated as the frequency was increased to a comparatively poor -85dB at 1kHz . But it improved again at -10dB , indicating slew limiting at high frequencies when the converter or associated circuits were working at full level. The poor intermodulation distortion at 0dB also supports this theory, as do the strong downband products of a 0dB 20kHz signal. There was also some clipping on a full level white noise signal.

Output level was close to the industry standard, but the output impedance was a little high. The de-emphasis circuits worked well, as did the error correction. Track access time was slow by recent standards, and mechanical noise was on the high side. The signal-to-noise ratio was poorer than -90dB under all measurement regimes. On the other hand ultrasonic spurious were well suppressed, and low level linearity very good, indicating a good 15.8-bit resolution. Resistance to shock and vibration was considered good.

SOUND QUALITY

After rating well below average in the lab, the sonic performance was also somewhat disappointing. The midrange had a neutral enough tonal quality with good detail, and female voice in particular could sound quite natural. The treble was to some degree attenuated – not 'tizzy' as such, but 'obvious' nonetheless. The bass was both a little ponderous and lightweight at the same time, characterised by a loss of attack on transients.

The soundstage showed below average width and depth, and stereo images were slightly 'smeared' and 'defocused' by a 'phasey' top. This effect was distracting on any material with plentiful treble, be it rock or classical.

CONCLUSIONS

Though very reasonably priced, with decent build quality and ample facilities, this unit did not perform very well in the lab, particularly at high frequencies. Moreover, the sound performance was disappointing by today's standards.

TEST RESULTS

	20Hz	1kHz	20kHz
Channel balance	0.2dB	0.08dB	0.26dB
Stereo separation	101dB	96dB	70dB
Channel phase difference	0°	5°	80°
Total harmonic dist, 0dB	-98dB	-85dB	-39dB
Total harmonic dist, -10dB	—	-93dB	—
Total harmonic dist, -60dB	—	-44dB	—
Total harmonic dist, -80dB	—	-23dB	—
Intermodulation, 19kHz/20kHz, 0dB			-52dB
Intermodulation, 19kHz/20kHz, -10dB			-68dB
Frequency response, left channel	-0.02dB	0dB	0.13dB
Frequency response, right channel	-0.02dB	0dB	0.37dB
Signal-to-noise, 20Hz-20kHz unweighted			88/88dB
Signal-to-noise, CCIR/ARM, 1kHz ref			85/90dB
Output level, 0dB, left/right			1.92V
Output impedance			1.8Kohms
De-emphasis 1kHz, 5kHz, 16kHz	-0.45dB, -4.73dB, -9.05dB		
Track access time			6 secs
Error correction capability	>900µm gap.	>800µm dot	
Mechanical noise			high
Spuriae up to 100kHz			-101dB
Resolution at -90dB			-88/-88.5dB
Headphone socket			no
Dimensions (w x d x h)			33 x 30 x 8.5cms
Estimated typical purchase price			£179

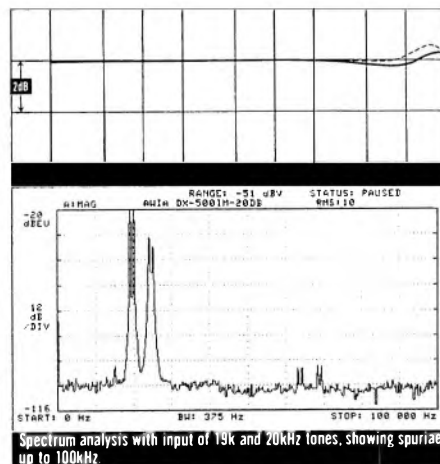

HITACHI DA-7000

HITACHI SALES (UK) LTD, HITACHI HOUSE, STATION RD, HAYES, MIDDX UB3 4DR. TEL: 01-848 8787

BEST BUY



The hi-fi division of Hitachi produce everything from semiconductors and wire to complete sound systems, and although one of the first to launch a compact disc player, they seem to have kept a fairly low profile of late. This particular player is at the bottom end of our price group; although not the cheapest available, it is one of the cheapest we have tested. Made in Taiwan, this is a simple device without remote control, but retains both memory and repeat facilities as well as the basics.

Apart from the transport open/close button which is sited by the drawer, all the other controls are situated at the opposite, right hand end, of the player. Ergonomic in use, the buttons are sized in order of their importance, with the larger play/pause and stop buttons above skip and search.

A little austere with its satin black finish, dull gold lettering, and red LED display, it is attractively understated. Construction is neat and tidy, with the boards and mechanism contained within a reasonably substantial steel case. The loading drawer also performed very smoothly and quietly. One facility I did miss was the ability to time tracks and get a running display of playing time and time remaining, which I have always found useful.

LAB REPORT

Like most of the earlier CD players, this uses a linear 16-bit shared D/A converter. This results in a 90° phase shift at high frequencies, and the impulse test showed the expected ringing due to the output filtering required with this type of converter.

Channel separation was adequate, falling slightly at 20kHz, while channel balance was unexceptionally within 0.5dB until high frequencies were reached. The frequency

response differed slightly between the channels, there was a rise of 0.4dB at high frequencies, and a 0.15dB shelf below 100Hz.

Output impedance was a presentable 470ohms, and output level lower than most, but no problems should be incurred in use. The de-emphasis circuits functioned efficiently, and the error correction tests exposed no problems. Signal-to-noise ratio was not that good, but stayed within reasonable limits. Mechanical noise was low and resistance to shock and vibration were above average. Low level resolution was around 15 bits, and spurious above 20kHz were well suppressed.

At 0dB harmonic distortion was respectable at 20Hz and 1kHz, but the downband products of a 20kHz signal were a little too strong at only -63dB. At lower levels the distortion deteriorated, and were unremarkable at -60dB and -80dB. The 1kHz products of the 19kHz intermodulation tone were well suppressed, particularly so with a -10dB signal.

SOUND QUALITY

Scoring just a little below average is no mean feat at this price level. Our sample had good width and depth, but also a tendency to sound slightly 'defocused' on more difficult pieces. The general sound was nice enough but needed more 'bite' and 'speed'. Treble was civilised, but lacked ultimate 'air' and 'sparkle' and showed a loss of transparency. The mid-range compressed dynamics somewhat, though clarity and detail were well portrayed. The upper mid showed some coarseness on strings, and the bass was inclined to be boomy, but the latter was not considered too serious. Generally competent, there was nothing we found particularly unpleasant or fatiguing.

CONCLUSIONS

Not a bad CD player then, considering the price. Although lacking some facilities, the decent construction, reasonable styling and average sound quality create an interesting package for those on a tight budget. Given the level of attainment reached together with the low asking price the 7000 qualifies for a Best Buy rating.

TEST RESULTS

	20Hz	1kHz	20kHz
Channel balance	0.47dB	0.48dB	0.78dB
Stereo separation	87dB	88dB	77dB
Channel phase difference	0°	5°	92°
Total harmonic dist, 0dB	-87dB	-91dB	-63dB
Total harmonic dist, -10dB	—	-83dB	—
Total harmonic dist, -60dB	—	-33dB	—
Total harmonic dist, -80dB	—	-15dB	—
Intermodulation, 19kHz/20kHz, 0dB	—	—	-91dB
Intermodulation, 19kHz/20kHz, -10dB	—	—	-92dB
Frequency response, left channel	0.15dB	0dB	0.23dB
Frequency response, right channel	0.15dB	0dB	-0.08dB
Signal-to-noise, 20Hz-20kHz unweighted	—	—	92/96dB
Signal-to-noise, CCIR/ARM, 1kHz ref	—	—	86/91B
Output level, 0dB, left/right	—	—	1.78V
Output impedance	—	—	470ohms
De-emphasis 1kHz, -0.22dB; 5kHz, -4.45dB; 16kHz, -8.23dB	—	—	—
Track access time	—	—	2.5 secs
Error correction capability	—	—	>900µm gap, >800µm dot
Mechanical noise	—	—	low
Spurious up to 100kHz	—	—	-99dB
Resolution at -90dB	—	—	-85.5dB
Headphone socket	—	—	no
Dimensions (w x d x h)	—	—	37 x 27 x 7.2cms
Estimated typical purchase price	—	—	£180

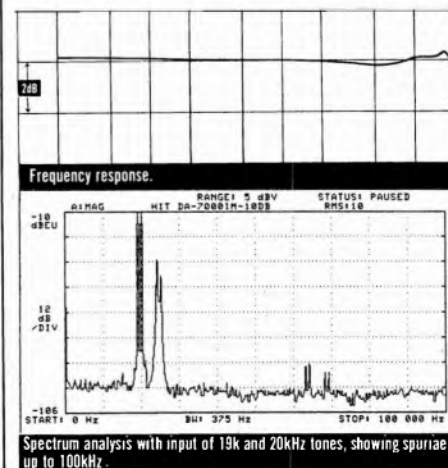



**Spend £250 on CD, and you'll
Spend £250 on a cart**



When you have more than £150 to spend on a cartridge, you are into a new realm. The realm of the moving coil. Unlike the moving magnet cartridge you are probably used to, in which magnets are attached to the cantilever, the cantilever of a moving coil has very fine metal coils wound round it. Which makes it much lighter and far more responsive to the transients cut into the grooves of a record.

As a result, a moving coil cartridge gives a much sharper, more clearly defined sound, with appreciably greater depth and spaciousness. It will also pick up the leading edges of the transients; the more detailed elements of the music that moving magnets can miss.

A moving coil is more expensive, because it demands more costly components and highly exacting engineering.

But it will not only make your records sound much better. It will actually reveal subtleties in the original recording, which you never knew existed. To say buying a moving coil cartridge is like getting a new record collection is no idle boast. **FIRST THEN. FIRST NOW.** Back in 1948, Ortofon were the first people to produce moving coil cartridges. Prior to that, the company had spent many years using the same principle in the construction of state-of-the-art cutting heads.

This parallel between the manufacturing of records and their reproduction explains, in part, the superior accuracy of moving coil cartridges.

Since then, Ortofon have been consistently developing and refining them. The MC30 Super exemplifies how much progress has been made.

The stylus is the new FG Type 1, named after Fritz Gyger, the Swiss diamond manufacturers who are the only company in the world capable of cutting such a minute diamond with the necessary precision.

need a new record collection. ridge and you'll have one.

Its shape has been designed to make contact with the walls of the groove, where musical information is embedded, without touching the bottom and picking up surface noise.

The aluminium cantilever is tapered, to eliminate standing vibrations which can start distorting sound at source. And the coils surrounding the cantilever are made from pure silver, one of the finest conductors known to science.

To get the best from such sensitive components, the cartridge body must combine minimum mass with maximum rigidity, to prevent resonance. To achieve this, the MC30 uses two aluminium extrusions, bolted together for extra rigidity, and a carbon fibre base-plate, to repel static.

HEARING IS BELIEVING. While delivering superb sound reproduction, the MC30 Super also avoids a drawback traditionally associated with moving coil cartridges. Namely, the need for a step-up device to compensate for low output voltage.

A tiny, cross-shaped armature (originally developed for Ortofon's legendary MC2000 model) allows extra coil windings, without an increase in mass or any reduction in performance. And a more than adequate voltage output of $> 0.2\text{mV}$ at 1kHz.

You can get full information on the MC30 Super and other models in Ortofon's moving coil range, by writing to: Ortofon (UK) Limited, Denmark House, Tavistock Industrial Estate, Ruscombe, Twyford, Berks RG10 9NJ.

But an even better idea might be to take your favourite album along to your nearest Ortofon dealer, and ask to hear it through an Ortofon moving coil cartridge.

The few minutes you spend doing so could make you think twice about spending years building up a new collection.

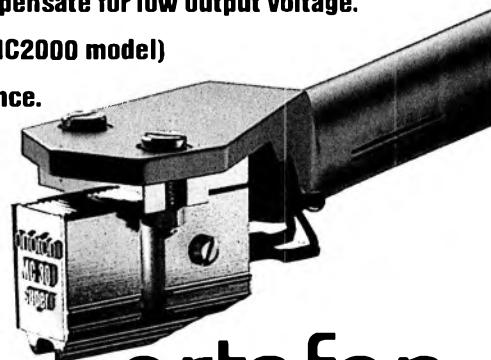

ortofon
accuracy in sound

BEST BUY

MARANTZ CD873

MARANTZ AUDIO (UK) LTD, 15-16 SAXON WAY IND. EST., MOOR LANE, HARMONDSWORTH, MIDDX UB7 0LW. TEL: 01-897 6633

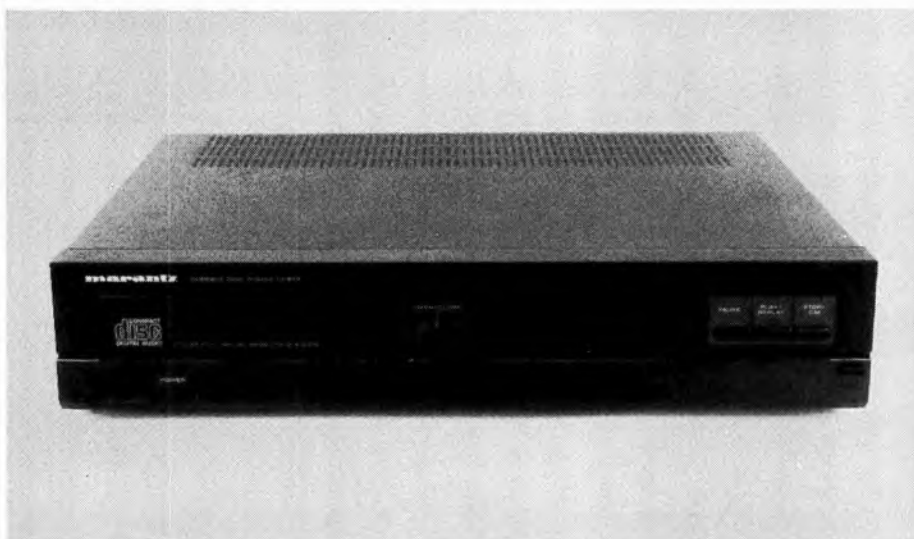

Marantz are a Philips subsidiary specialising in hi-fi separates, commissioning and marketing their own range, yet apparently utilising Philips facilities as they see fit. This player is very closely related to the new generation of Philips budget CD players, sharing the same circuit board and mechanism, but is built to a slightly different specification set by Marantz UK. Its size is unusual, being somewhere between a midi and a full size player, so some may find it does not fit in with the rest of their system. A 'limited edition' version is also available, which includes audiophile components of a higher specification, albeit at a higher price.

Unlike its Philips brethren this player comes without remote control. The front panel is uncluttered, with only the major controls displayed. All the minor controls are placed under a flip forward cover which extends the length of the front panel; a slight problem is that some of the controls on the left are inaccessible when the drawer is open. The result is an aesthetically if not ergonomically pleasing player, with good finish. The construction is light but adequate, being mainly plastic with a steel cover to the top and sides. The facilities are typically budget Marantz, and manifestly the same as the earlier *CD273*. The display is of good size and the user is able to select between elapsed time or time remaining while both track and index number are simultaneously provided.

LAB REPORT

As you would expect with a machine using twin DACs with 4X oversampling, there was no inter-channel phase difference. The player generally measured very well, but with the typical Philips converter problem of poor -90dB resolution. Frequency response was extremely

flat from 20Hz to 20kHz, albeit with a characteristic small high frequency ripple. Total harmonic distortion was above average until low levels were reached, and intermodulation distortion was very low.

There was slight clipping on full level white noise, but this should cause no problem on music programme, which on the majority of CD software peaks around -10dB. Signal-to-noise figures were exceptionally good, and ultrasonic spurious were well controlled. A low source impedance allows long cable runs, and passive volume controls may be used. Mechanical noise was low, resistance to shock and vibration very good, and the track access time was reasonably fast. The resolution, assessed at 15 bits, was just adequate.

SOUND QUALITY

After the first few bars it was obvious that this player was rather special in the context of the group. Its sound quality exceeded that obtained from the previous 'Best Buy' Marantz *273SE* tested earlier in the year.

The bass is clean and firm, with excellent dynamics extending into the un-fatiguing and lively midrange. The treble is explicit and well defined, with good transparency, 'air' and 'sparkle'. In addition a very good soundstage has ample width and fair depth.

The stereo image is quite precise, with instruments and vocals well separated, detail and ambience well rendered. With the 'digital out' socket shorted (using a shorted phono plug) the sound improved still further, maintaining the same characteristics but more so, with a feeling that depth and space benefited in particular. It now puts many 'audiophile' CD players (costing several times the price) to shame - an excellent result.

CONCLUSIONS

Rated very highly on listening tests while delivering a good lab performance in a nicely styled package, Marantz have yet another Best Buy on their hands. If this level of performance is maintained in continuing production they will have to improve the rest of their range to keep pace. The only mild drawback is the slightly deficient ergonomics.

TEST RESULTS

	20Hz	1kHz	20kHz
Channel balance	0.08db	0.08dB	0.08dB
Stereo separation	127dB	106dB	93dB
Channel phase difference	0°	0°	0°
Total harmonic dist, 0dB	-94dB	-94dB	-85dB
Total harmonic dist, -10dB	—	-85dB	—
Total harmonic dist, -60dB	—	-45dB	—
Total harmonic dist, -80dB	—	-16dB	—
Intermodulation, 19kHz/20kHz, 0dB			-104dB
Intermodulation, 19kHz/20kHz, -10dB			-95dB
Frequency response, left channel	0.03dB	0dB	0dB
Frequency response, right channel	0.03dB	0dB	0dB
Signal-to-noise, 20Hz-20kHz unweighted			104/105dB
Signal-to-noise, CCIR/ARM, 1kHz ref			100/103dB
Output level, 0dB, left/right			2.07V
Output impedance			200ohms
De-emphasis 1kHz, -0.37dB; 5kHz, -4.55dB; 16kHz, -9.06dB			
Track access time			3.5 secs
Error correction capability	>900µm gap, >800µm dot		
Mechanical noise			fairly low
Spurious up to 100kHz			-87dB
Resolution at -90dB			97.9/115.5dB
Headphone socket			no
Dimensions (w x d x h)			36 x 31 x 8cms
Estimated typical purchase price			£240

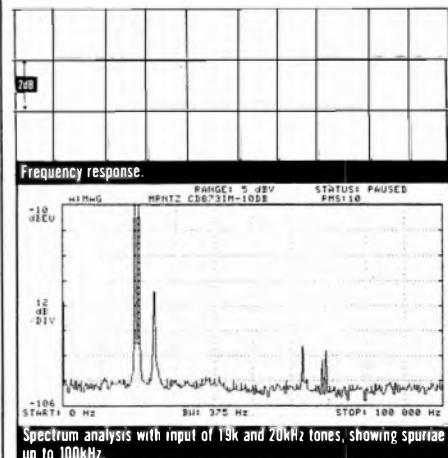

PHILIPS CD473

PHILIPS ELECTRICAL LTD, CITY HOUSE, 420-430 LONDON RD, CROYDON, SURREY CR9 3QR. TEL: 01-689 2166

BEST BUY

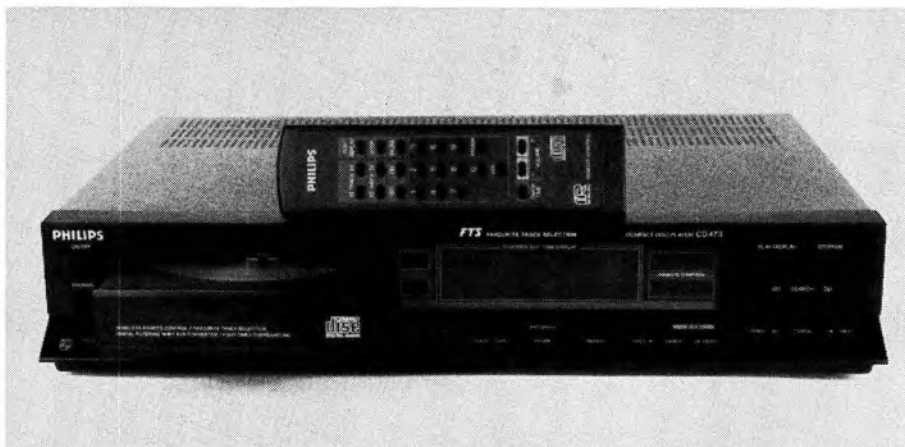

Competitively priced, the full-sized CD473 is fitted with FTS (favourite track selection), a useful facility which allows the programmed storage of a personalised playing order for several hundred discs. The front panel control layout is functional, with all the facilities needed for efficient operation – some on an angled lower section.

The display is switchable between track/index number and elapsed time for each track, and there is also a matrix calendar (up to 20) display: The progress of play is denoted by first flashing and then deleting these numbers. Flags appear for pause, repeat and FTS functions. Also included is a comprehensive remote control device complete with volume control and discrete track selection – unusual at this price level until very recently.

A variable headphone output socket (yet another improvement over its predecessor) is situated under the on/off switch. The player is well finished with a steel case over a plastic chassis, and a digital output socket is sited on the rear panel along with the audio outputs

LAB REPORT

Light construction aside, this player features a new design printed circuit board which contains all the main digital and audio functions. Separate DACs with four times oversampling means an almost textbook set of measurement results – the exception being the poor –90dB resolution which we have now come to accept from this series of Philips DACs (though interestingly Sony's application avoids the problem).

An extra circuit board has been added to include the digital volume control, which allows only eight individual steps in coarse 3dB increments. Also contained on this board are the output buffering and muting circuits.

The player mechanism has been improved and is smoother in action. Resistance to shock

is excellent, and mechanical noise is very low. Spurious could be better suppressed, but the figures obtained are adequate for the price. The headphone socket has an output impedance of 150ohms, and is therefore not really suitable for driving low impedance types.

The distortion figures are very good until low output levels are reached, and at –80dB are below average. The signal-to-noise ratios under all measurement regimes are entirely satisfactory. Channel separation was not as good as expected, being some 10dB worse than the earlier Philips 360, but is still reasonable nonetheless.

SOUND QUALITY

This new design continues to keep Philips' budget players at the forefront in regard to sound quality. The advance over the previously highly rated Philips CD360 was immediately apparent: this player had definitely moved up to the next grade, and is very close to some existing audiophile products. (But we must not forget that the CD360 wasn't that far away either.)

The bass is articulate, with commendable 'speed' and 'slam'. The midrange was detailed and open, and we were unable to catch it out on a range of program from classical to jazz. The treble has little trace of grain, is well balanced and integrated with appealing transparency and resolution, but could be accused of being somewhat 'brash' at times.

The soundstage exposes some of the depth and 'layered' information normally only available from more expensive offerings, while width and imaging are well above average, with good ambience and separation. With the 'digital out' socket shorted this unit seduced and inspired even more, highlighting the characteristics of an already classy sound. As with the Marantz, the reproduction outclassed many established players costing considerably more.

CONCLUSIONS

Although a pre-production sample, this is one of the best sounding Philips players yet, even compared with its much more expensive relatives. Combine this with an extremely good set of lab results and an ability to reveal a wealth of information lost to many players and it must be whole-heartedly welcomed as a Best Buy, providing production samples are up to this standard.

TEST RESULTS

	20Hz	1kHz	20kHz
Channel balance	0.06dB	0.05dB	0.08dB
Stereo separation	95dB	96dB	89dB
Channel phase difference	0°	0°	0°
Total harmonic dist, 0dB	–94dB	–93dB	–87dB
Total harmonic dist, –10dB	—	–84dB	—
Total harmonic dist, –60dB	—	–44dB	—
Total harmonic dist, –80dB	—	–15dB	—
Intermodulation, 19kHz/20kHz, 0dB	—	—	–99dB
Intermodulation, 19kHz/20kHz, –10dB	—	—	–94dB
Frequency response, left channel	0.03dB	0	0
Frequency response, right channel	0.03dB	0	0
Signal-to-noise, 20Hz-20kHz unweighted	—	—	105/107dB
Signal-to-noise, CCIR/ARM, 1kHz ref	—	—	101/104dB
Output level, 0dB, left/right	—	—	2.04V
Output impedance	—	—	200ohms
De-emphasis 1kHz, –0.38dB, 5kHz, –4.61dB, 16kHz, –9.08dB	—	—	—
Track access time	—	—	3.5 secs
Error correction capability	—	—	>900µm gap, >800µm dot
Mechanical noise	—	—	low
Spuriae up to 100kHz	—	—	–88dB
Resolution at –90dB	—	—	–100.8/–115.5dB
Headphone socket	—	—	yes, variable, 150ohms
Dimensions (w x d x h)	—	—	42 x 28 x 8.1cms
Estimated typical purchase price	—	—	£250

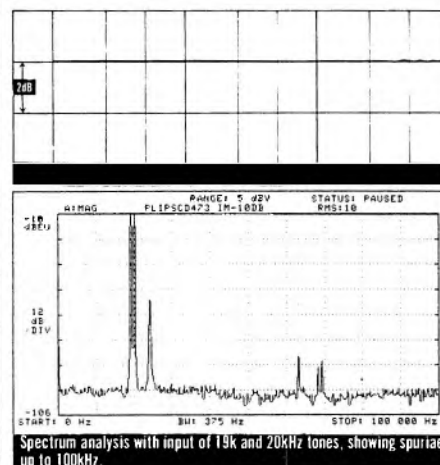

PIONEER PD-6050

PIONEER HIGH FIDELITY GB LTD, FIELD WAY, GREENFORD, MIDDX UB6 8UZ. TEL: 01-575 5757

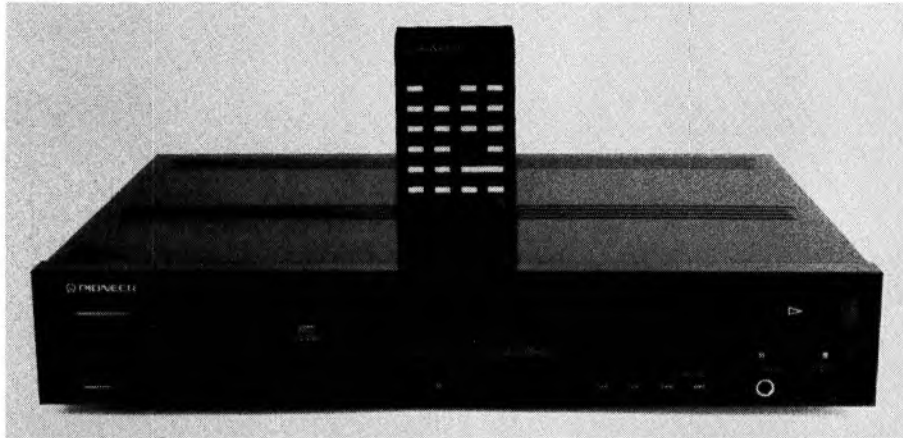

Pioneer may not be one of the largest Japanese electronics companies, but they are known primarily as audio specialists and have long been well established in the UK. Over the years they have come up with some highly rated products, and their ventures into CD have provided some interesting players. As well as leading the market in sophisticated autochangers (as reviewed earlier this year), they also have well specified standard machines.

Such is the CD player sales competition, even budget players are now coming with standard facilities that were reserved for the more expensive end of the range only a year ago. This player is no exception: although lacking a 'digital out' socket, and any form of remote volume control, the PD-6050 has virtually everything else.

Constructed on Pioneer's now familiar honeycomb-pattern pressed steel base with steel cover, this player is very solid and rigid. The inside is neat, and all the major circuit functions are performed on a single, well designed circuit board. Controls are well laid out, and the remote control provides an additional keypad track select function, elsewhere duplicating the player's front panel controls apart from auto programme editing.

As well as the familiar established controls provided on every CD player, Pioneer allow the user to select the programme order with up to 24 steps, which can be edited while a disc is playing. A pause may be specified within the programme, and can then be manually overridden. Auto programme editing allows programmed tracks to be played back within a desired time – a useful feature. A variable output headphone socket is also provided.

LAB REPORT

Typical of Japanese players at this price level, a 2x oversampled time-shared DAC is used, resulting in an unavoidable phase shift at high fre-

quencies. The frequency response is pretty flat, with some ripple at high frequencies which caused the slight fall in measured response at 20kHz; however, this is a very localised phenomenon, and not serious. The impulse showed that ringing was well controlled, and the player preserves absolute phase.

Channel balance was very good; separation was perfectly adequate and maintained up to 20kHz. Output level was slightly high and the output impedance of 1kohm (although higher than most) should cause no problems in normal applications. The de-emphasis circuits worked adequately, mechanical noise was low, and track access times were reasonably fast. As with all the players tested for this issue, it was not troubled by our error correction tests – which now seem almost superfluous. Signal-to-noise ratios were adequate, and could have measured a little better.

Total harmonic distortion figures were very good indeed, and were amongst the best I have ever measured down at -80dB. Intermodulation distortion figures were also good, and linearity was a very respectable 15.8 bits. Spurious above 20kHz were a little on the high side, but being well out of the audio band should not cause any problems. Resistance to shock was a little below average.

SOUND QUALITY

Better than average but not at the top of the class, the Pioneer impressed with a clean, firm, well controlled and extended bass, plus good dynamics which were particularly liked on rock and jazz program. The midrange was a little 'forward' and 'thin'; this showed up particularly on violins which had a tendency towards exuberance in the upper registers. Treble had good clarity, but was a mite exaggerated, though not seriously grainy or extravagant. The soundstage was well focused with better than average depth; images were well formed and a fair degree of ambience was portrayed.

CONCLUSIONS

Although some aspects could be improved, the 6050 rates highly on the value for money quotient. On the whole the lab performance was highly commendable, and the sound quality well liked, so inclusion amongst the Best Buys is mandatory.

TEST RESULTS

	20Hz	1kHz	20kHz
Channel balance	0.03dB	0.02dB	0.06dB
Stereo separation	95dB	96dB	91dB
Channel phase difference	0°	2°	41°
Total harmonic dist, 0dB	-94dB	-96dB	-83dB
Total harmonic dist, -10dB	—	-89dB	—
Total harmonic dist, -60dB	—	-57dB	—
Total harmonic dist, -80dB	—	-26dB	—
Intermodulation, 19kHz/20kHz, 0dB			-87dB
Intermodulation, 19kHz/20kHz, -10dB			-87dB
Frequency response, left channel	0.04dB	0dB	-0.43dB
Frequency response, right channel	0.04dB	0dB	-0.45dB
Signal-to-noise, 20Hz-20kHz unweighted			97/101dB
Signal-to-noise, CCIR/ARM, 1kHz ref			90/94dB
Output level, 0dB, left/right			2.23V
Output impedance			1Kohm
De-emphasis 1kHz, -0.37dB; 5kHz, -4.58dB; 16kHz, -8.37dB			
Track access time			3.5 secs
Error correction capability			>900µm gap, >800µm dot
Mechanical noise			low
Spurious up to 100kHz			-69dB
Resolution at -90dB			-92dB
Headphone socket			yes, variable, 120ohm
Dimensions (w x d x h)			42 x 32.5 x 7.9cms
Estimated typical purchase price			£230

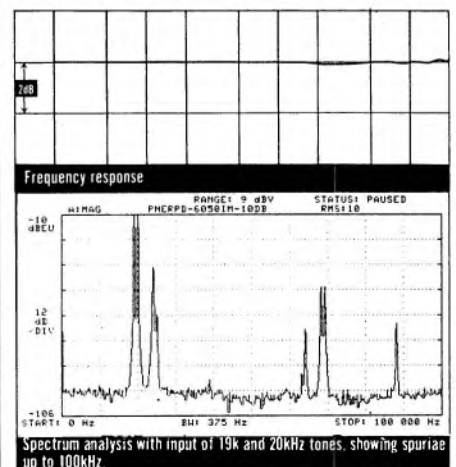

Audio Projects

FOR ALL THE BEST BUYS

WE STOCK A RANGE OF
SELECTED COMPONENTS FROM:
A&R (CAMBRIDGE), AUDIOLAB,
CREEK, DEAN, DENON,
HEYBROOK, LINN PRODUCTS,
MORDAUNT SHORT,
MUSICAL FIDELITY, NAIM AUDIO,
QUAD, REGA.

Home demonstrations our
speciality.

Open 9.30-6.00 Tues-Friday.
2.30-5.30 Saturday.

45 Headingley Lane. Leeds. LS6 1DP. Tel (0532) 789115

“When buying hi-fi you can't afford even one mistake, I promise you won't make any here.”

We are a private business that has been established for over twelve years now. It is run on a very personal basis where you have direct access to the owner.

I'm a professional with a keen interest in music, hi-fi and acoustics. So we are specialists in hi-fi and really know how it will perform best in your home.

You will benefit from a range of free services and comprehensive guarantees.

Major credit cards and personal cheques of any value are accepted. And we provide good finance terms, including interest free credit for that special purchase. Written details are available on request.

You will find us just off the main A34 near the Barclays Bank and be sure of a friendly welcome with a good cup of coffee.

We will also advise by phone, and deliver your new hi-fi by free insured carrier.

My staff and I look forward to being of service to you.

Yours sincerely,

Derek Aston-Dawson



THE HI-FI CONSULTANTS

Aston Audio 4 West Street Alderley Edge Cheshire SK9 7EG Tel: 0625 582704
Open: Tues-Fri 10am-6pm Sat 9am-5pm. Export specialists.



THE MICHELL CONNECTION

"The ultimate connectors for all quality speaker cables"

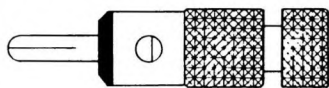

BANANA PLUG

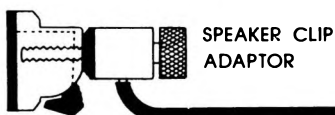
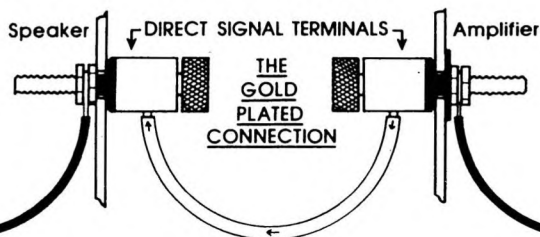

SPEAKER CLIP ADAPTOR

You ain't heard nothin' yet, folks! GET THE CONNECTION!

For details please write:

J.A. Michell Engineering Ltd
Deot. 2HS, 2 Theobald Street, Borehamwood, Hertfordshire, England
Telephone 01-953 0771

STANDENS FOR SOUND

MUSICAL FIDELITY

A&R	GALE	QUAD
ALPHASON	HELIUS	REVOLVER
AR	HEYBROOK	ROGERS
AUDIO INNOVATIONS	INFINITY	RUARK ACOUSTICS
BLQ	LOGIC	SANSUI
B&W	MYST	S.D. ACOUSTICS
CAMBRIDGE	MORDAUNT SHORT	SME
DEAN	MUSICAL FIDELITY	SNELL
DENON	N.V.A.	SONDEX
DIESIS	PINK TRIANGLE	SPENDOR
DUAL	PROTON	THE ROCK
		+ LINX

MUSICAL FIDELITY B200 AMP &
MC4 L'SPEAKERS ON DEM NOW
PLEASE BOOK AN APPOINTMENT AND
LISTEN IN OUR
DEMONSTRATION ROOM



92A High Street, Tonbridge, Kent TN9 1AP
Tel: Tonbridge (0732) 353540

SANYO CP17

SANYO MARUBENI UK LTD, SANYO HOUSE, OTTERSPOOL WAY, WATFORD, HERTS. TEL: (0923) 246363



Sanyo are one of the biggest of the Japanese companies fighting for a share of the growing world compact disc player market. Their *CP17* is a no-frills midi sized package, with neither remote control nor headphone socket. (They also supplied a *CP27*, but as far as I could tell the two were identical apart from a small system remote interface socket on the back of the '17). So if you don't want that feature go for the '17).

Obviously different, a green backlit liquid crystal display conveys all the information required but may not be to everyone's taste, and is difficult to read at a distance. Apart from the open/close button at the bottom right of the drawer, the standard set of controls are grouped in familiar fashion at the right hand end of the player. There are no special functions, just the normal selection - play, stop, pause, track skip and music search, plus repeat and memory facilities (up to 16 tracks played in any order you like). The display has flags for play, repeat and programme, as well as the usual track number, index number and elapsed or total playing time when a disc is first loaded.

The satin-finished steel case has a shiny black, slightly rounded plastic front panel with gold and white lettering, whereas the buttons are matt grey - rather different from the normal.

LAB REPORT

The frequency response showed a slight rise above 7kHz, while channel balance was good except at the high frequency extreme. Channel separation maintained a respectable 94dB in the midband, but fell to a poor -56dB at 20kHz.

The 80° phase difference at 20kHz is typical of a time-shared linear converter - once very popular but now relegated to the budget end of the market. These require a 'brick wall' analogue filter to suppress spurious, but the ringing this filter normally causes on impulse test was fairly well suppressed on this occasion.

Total harmonic distortion was rather high at full level, significantly below the standard set by the vast majority of players. Our *CP27* alternative was checked to see whether this particular sample of the *CP17* was substandard, but very similar results were obtained. However, the significance of distortion below -60dB upon sound quality is rather questionable.

The downband noise for a 20kHz full level tone could have been better suppressed, and the intermodulation distortion results also indicated that the player is likely to be uncomfortable with high frequency, high level signals.

On the other hand, the signal-to-noise ratios were quite good and error correction and de-emphasis functions worked well. Ultrasonic spurious were well suppressed, and low level linearity was well above average. The output impedance was higher than most, whereas output level was on the low side. Mechanical noise was low and the track access time a reasonable 4 seconds.

SOUND QUALITY

The bass was disappointing, sounding 'boomy' and lacking definition, dynamics, extension and power. The midrange was slightly bland but did at times manage to portray some feeling of life, although there was a lack of inner detail and focus. More positively, the top end was not particularly grainy or accentuated. But the treble needed more 'air' and 'sparkle', to compensate for a slightly 'dead' nature which, for instance, would cause the 'ring' of a cymbal to be curtailed early. Consequently boredom set in before fatigue, because the music lost some essence of excitement. Ambience was subdued, and the soundstage was not particularly well portrayed, lacking depth and layering detail. Width was quite good, but images were a little 'defocused', especially on loud passages.

CONCLUSIONS

A little disappointing both in the laboratory and on audition, this player was not up to the normal Sanyo standard, though it was by no means the worst sounding player assessed in *Hi-Fi Choice* this year. The unusual styling may not be to everyone's taste, but it is at least distinctive, and the quality of construction was fine.

TEST RESULTS

	20Hz	1kHz	20kHz
Channel balance	0.04dB	0dB	0.2dB
Stereo separation	112dB	94dB	60dB
Channel phase difference	0°	5°	80°
Total harmonic dist, 0dB	-80dB	-75dB	-37dB
Total harmonic dist, -10dB	—	-65dB	—
Total harmonic dist, -60dB	—	-34dB	—
Total harmonic dist, -80dB	—	-13dB	—
Intermodulation, 19kHz/20kHz, 0dB			-39dB
Intermodulation, 19kHz/20kHz, -10dB			-50dB
Frequency response, left channel	-0.08dB	0dB	-0.63dB
Frequency response, right channel	-0.10dB	0dB	-0.60dB
Signal-to-noise, 20Hz-20kHz unweighted			95/97dB
Signal-to-noise, CCIR/ARM, 1kHz ref			96/102dB
Output level, 0dB, left/right			1.87V
Output impedance			1kohm
De-emphasis	0.41dB, 1kHz,	-4.8dB, 5kHz,	9.28dB, 16kHz
Track access time			4 secs
Error correction capability	>900µm gap,	>800µm dot	
Mechanical noise			low
Spurious up to 100kHz			-92dB
Resolution at -90dB			-88.74dB
Headphone socket			no
Dimensions (w x d x h)			33 x 28.5 x 7.1cms
Estimated typical purchase price			£200

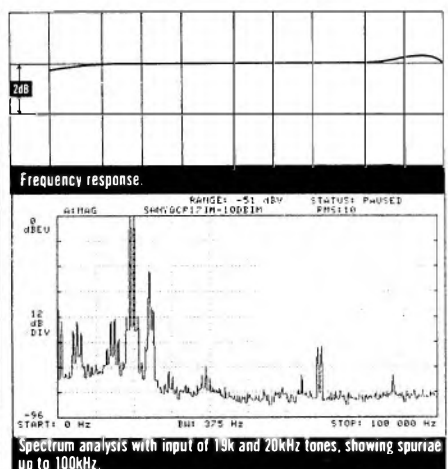

SHARP DX-R700H

SHARP ELECTRONICS (UK) LTD, SHARP HOUSE, THORP RD, MANCHESTER M10 9BE. TEL: (061) 205 2333

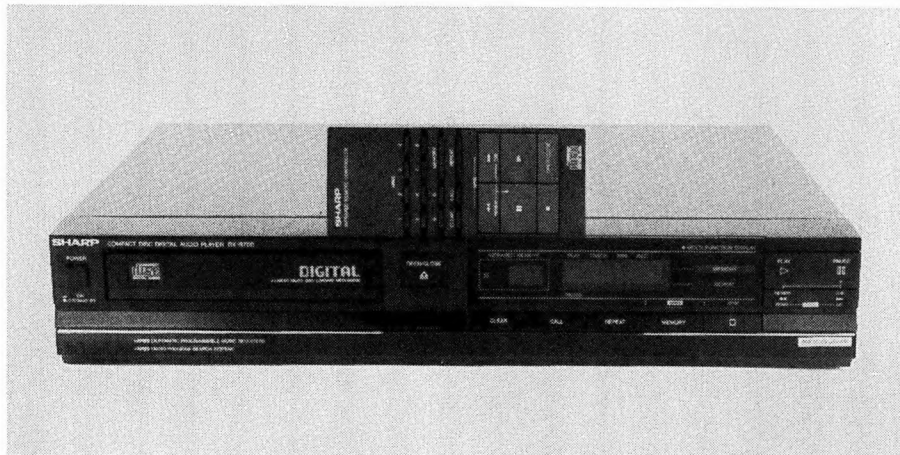

Sharp are one of the 'smaller' Japanese electronics companies, and have a good reputation for producing value for money consumer products. Unfortunately our first sample of the R700H was faulty, delivering a strange set of lab results and a very high noise floor. This caused the background noise to fade in and out with the music – a noise pumping effect – and the measured resolution was only about 11 bits, which is not hi-fi. A fresh sample confirmed the first was substandard, and the rest of the review applies to this second sample.

The player appeared to be well made, using a steel case and a single board construction. The finish is good and looks very smart with a slightly higher gloss paint finish than many. A remote control is part of the package, which interestingly (for reasons not obvious to me) allows remote operation of the loading drawer, but elsewhere mimics the front panel controls and includes an extra track select key pad.

The front panel controls are well laid out and easy to use once you get the hang of the slightly different operating system. Play, stop and pause worked as expected, but Sharp have renamed track skip as APSS (auto program search system – cue and review). Press the pause button first and the cue and review buttons become an audible fast forward or rewind which is locked on until the play button is pressed to resume playback – in some ways similar to the APSS system incorporated in some of their cassette recorders. APMS (automatic programmable music selector) allows you to program the order of play in a sequence of up to nine tracks, and repeat play programming is also available. The orange display is functional and reasonably subdued, displaying track time and track number, with flags for memory and repeat.

LAB REPORT

This player uses a single time-shared DAC with

2X oversampling, which results in an inter-channel phase difference. Considering the output filtering required, ringing was well controlled, while the impulse test also showed the player was phase inverting. Channel balance was good, only deviating slightly at low frequencies, but channel separation could have been better, falling to -64dB at 20kHz .

Distortion measurements were reasonable on the whole, but were mediocre at low signal levels. The frequency response showed a general downtilt across the frequency band, being 0.2dB up at 20Hz and 0.4dB down at 18kHz . The output filter came into effect a little early as the response was down by more than 2dB at 20kHz .

Output impedance was a rather high 3.5Kohm and output level was a high 2.2V . De-emphasis and error correction checks showed no cause for concern. Signal-to-noise ratio was fairly good and spurious were well suppressed. Mechanical noise was average and track access time likewise. The resolution measured at 15 bits which is reasonable enough.

SOUND QUALITY

Falling somewhat below the current average, the sound wasn't unpleasant on first hearing and was generally described as clear. But there was a loss of dynamic speed and attack in the bass, and this continued up into the midrange. People commented that this player either lacked bass or that the bass was soft and indistinct, short of precision and control.

The midrange had a tendency to sound 'congested' and 'thickened', but with a 'hard' upper mid and lower treble which coloured stringed instruments in particular. The main body of the treble was not too aggressive, while showing a hint of grain and lacking 'air' and 'sparkle'. Image focus was fair, as was width, but depth perspectives were below par.

CONCLUSIONS

Once you have interpreted the labelling system, the R700H should perform well in use. Neither offering spectacular sound quality nor exemplary lab performance, this workmanlike player still performed quite well and is rather substantially made, offering a good range of facilities. But in our opinion the price is just a little high.

TEST RESULTS

	20Hz	1kHz	20kHz
Channel balance	0.12dB	0dB	0.04dB
Stereo separation	84dB	90dB	64dB
Channel phase difference	0°	2°	46°
Total harmonic dist, 0dB	-88dB	-90dB	-83dB
Total harmonic dist, -10dB	—	-93dB	—
Total harmonic dist, -60dB	—	-34dB	—
Total harmonic dist, -80dB	—	-10dB	—
Intermodulation, 19kHz/20kHz, 0dB			-86dB
Intermodulation, 19kHz/20kHz, -10dB			-89dB
Frequency response,			
left channel	0.22dB	0dB	-2.16dB
Frequency response,			
right channel	0.21dB	0dB	-2.13dB
Signal-to-noise, 20Hz-20kHz unweighted			96/97dB
Signal-to-noise, CCIR/ARM, 1kHz ref			94/98dB
Output level, 0dB, left/right			2.2V
Output impedance			3.5Kohms
De-emphasis 1kHz, -0.13dB ; 5kHz, -4.49dB ; 16kHz, -9.72dB			
Track access time			4 secs
Error correction capability			$>900\mu\text{m}$ gap, $>800\mu\text{m}$ dot
Mechanical noise			average
Spurious up to 100kHz			-100dB
Resolution at -90dB			-96.5dB
Headphone socket			no
Dimensions (w x d x h)			43 x 31 x 7.8cms
Estimated typical purchase price			£249

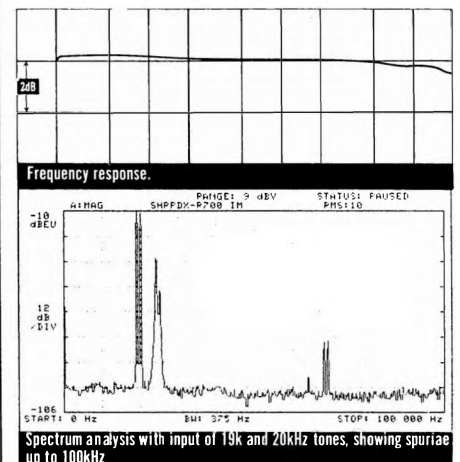

SONY CDP-M50

SONY UK LTD, SONY HOUSE, SOUTH ST, STAINES, MIDDLESEX TW18 4PF. TEL: STAINES 61688

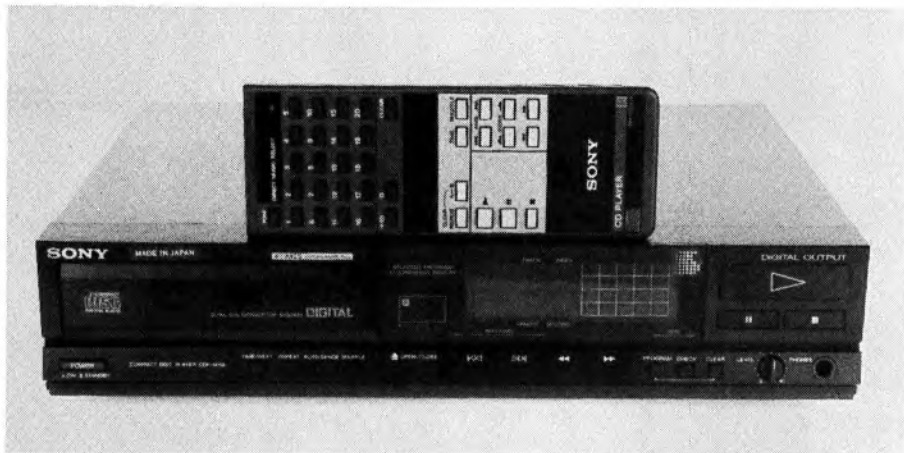

While we tested a host of Sony players in the CD issue earlier this year, including two new budget models, their range is so extensive that there are still plenty more. The *M50* fits at the top end of the budget price range, and is fully specified with many of the latest features of their top models.

This midi size player appears at first sight to be a shrunken version of the successful *CDP-710*, which rated a Best Buy in the CD issue. All is not as it seems, however, and this is in fact a rather different animal, using different components. Although utilising 4x oversampling with a separate DAC for each channel, this design uses those from Burr Brown rather than Philips. The case is predominantly plastic with much internal bracing, plus steel top and bottom covers. A quick internal inspection revealed the odd 'audiophile' component, and good build quality.

The front panel is packed with controls, some of the less important ones being sited under the loading draw. All the usual functions including shuffle, track skip, pause and audible music search are presented in logical order. The large play, stop, and pause buttons are to the right of the display and above the variable output headphone socket, while the rest are grouped on the centre lower front panel. Up to 20 selections can be programmed and played in any order, and programming can be performed while playing. A facility is also provided which allows a blank space of 3 seconds to be inserted between each section.

A comprehensive infra red remote control has a numeric keypad in addition to the other usual facilities; however, the programme mode and auto space functions can only be obtained via the front panel, and no volume control is provided.

The display contains a 20 track matrix, which complements the remote control and acts as an aid when programming. The display also shows track numbers and indexing

together with timing. The user is able to select between remaining time, track time and elapsed time, and a switchable 'digital out' socket is available on the back panel.

LAB REPORT

Channel balance wasn't perfect but remained constant throughout the frequency spectrum, and channel separation was good until high frequencies. Total harmonic distortion measurements were fine at all levels, as were the intermodulation results. There was a slight treble droop above 10kHz but this was minor.

The output impedance was rather high and audio output was a standard 2V. Signal-to-noise ratios were good, the de-emphasis circuits worked well, and mechanical noise was low. Ultrasonic spurious were very well suppressed, linearity was close to ideal, and track access time was fast.

SOUND QUALITY

Listening tests always precede lab testing so that no prejudice is brought to bear by anticipating and listening for any discovered faults or anomalies. But having heard the *CDP-710* earlier in the year, we were expecting something similar from the *M50* - which turned out not to be the case. Still sounding quite respectable, it clearly fell short of the standards set by the slightly more expensive *710*.

Immediately noticeable was a mild softening of transients, manifested in a perceived loss of speed, power and excitement in the bass. The midrange in general was clear and balanced, but the upper mid had a 'hard' quality - not seriously so, but enough to exaggerate and colour violin and female voice. The treble register revealed slight grain and brashness, but the soundstage was well focused with a good measure of depth, whereas width was only average.

CONCLUSIONS

A year or so ago this player would have been highly rated and matched by few at this price, but the advances made over the year now mean that the sound quality is only slightly above average in this group. However, the build quality is fine, the technical performance good, and the features extravagant. All things considered it is, to say the least, a competitive package.

TEST RESULTS

	20Hz	1kHz	20kHz
Channel balance	0.26dB	0.26dB	0.26dB
Stereo separation	113dB	104dB	80dB
Channel phase difference	0°	0°	0°
Total harmonic dist, 0dB	-94dB	-92dB	-83dB
Total harmonic dist, -10dB	—	-84dB	—
Total harmonic dist, -60dB	—	-40dB	—
Total harmonic dist, -80dB	—	-22dB	—
Intermodulation, 19kHz/20kHz, 0dB	—	—	-91dB
Intermodulation, 19kHz/20kHz, -10dB	—	—	-94dB
Frequency response,			
left channel	0dB	0dB	-0.54dB
Frequency response,			
right channel	0dB	0dB	-0.55dB
Signal-to-noise, 20Hz-20kHz unweighted			103/107dB
Signal-to-noise, CCIR/ARM, 1kHz ref			97/101dB
Output level, 0dB, left/right			1.99V
Output impedance			16Kohms
De-emphasis 1kHz, 5kHz, 16kHz,			-9.37dB
Track access time			3 secs
Error correction capability	>900µm gap,	>800µm dot	
Mechanical noise			low
Spurious up to 100kHz			-103dB
Resolution at -90dB			-87.8/-89.8dB
Headphone socket			yes, variable, 220ohms
Dimensions (w x d x h)			35.5 x 27 x 8.5cms
Estimated typical purchase price			£269

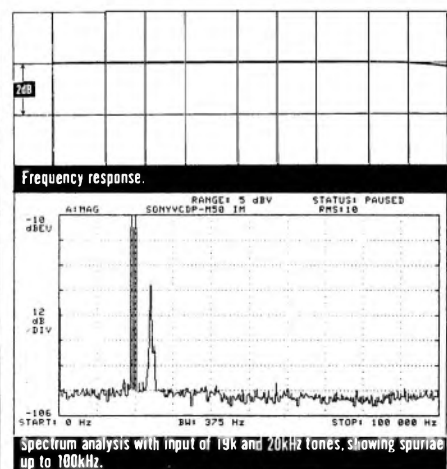

TECHNICS SL-P220

PANASONIC UK LTD, 300-318 BATH RD, SLOUGH, BERKS SL1 6JB. TEL: (0753) 34522

RECOMMENDED

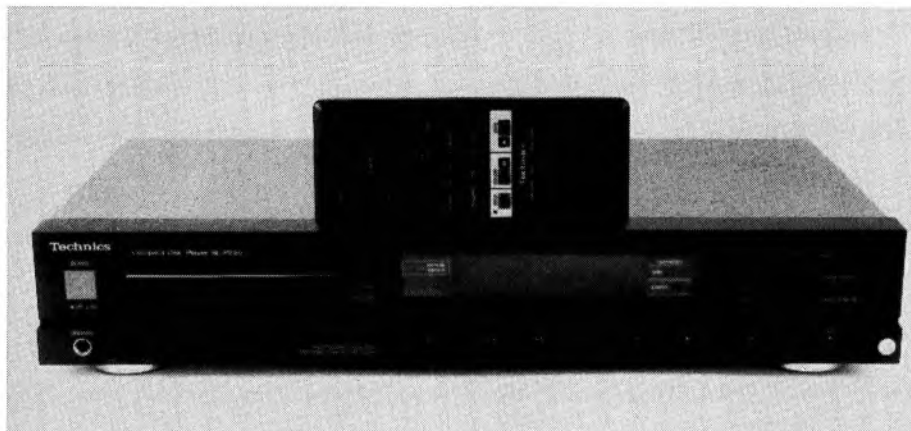

Technics are the hi-fi division of the giant Matsushita organisation, who produce one of the most extensive ranges of audio products available. They have a knack of creating components which provide a fine balance between engineering, styling, sound quality and price in each market sector, and are thus normally very competitive.

The SL-P220 fits neatly into the budget CD market sector and is well specified for the price. The whole player has a quality feel, and the case is made from light steel. The unit is supplied with remote control, which covers all the normal facilities and additionally provides keypad track selection, and a limited digital volume control that allows attenuation in 6 discrete 2dB steps.

The comprehensive front panel has the controls placed in a logical fashion, which makes the player a delight to use. The headphone socket has variable output, and a memory/recall button allows the user to program track numbers, confirm the program and to enter pre-set editing time into memory. Pre-set editing allows the user to specify the duration of play required.

The clear and concise display contains virtually everything you could desire for normal domestic use, showing track number, number of tracks on the disc (in a matrix format which is limited to 20), and 'elapsed time' or 'time remaining' as selected by the user. When the remote volume control is used, the time and track display is momentarily blanked to reveal the amount of attenuation applied. The only missing feature is a 'digital out' socket - which will be no great loss for the vast majority of users.

LAB REPORT

This player performed exceptionally well in the lab. The full level distortion figures were superior to most I have measured at 20Hz and 1kHz, and were still very presentable at low sig-

nal levels. Intermodulation distortion was also highly commendable. The phase error at high frequencies indicates that a single time-shared 2x oversampled DAC is used.

There was a frequency response shelf of about 0.3dB above 1kHz, and this was accompanied by some unevenness, but the channel balance was good, with only a very mild aberration at high frequencies. Mild criticism could be aimed at the -90dB resolution, showing a linearity of 15.4 bits, which could have been better, but this figure appears to bear little or no relationship to perceived sound quality.

De-emphasis worked as it should, output level was close to the standard, and the output impedance of 670ohms should cause no matching problems. Ultrasonic spurious were well suppressed and the error correction tests passed without any trouble. The variable headphone output has a reasonably low source impedance and provided useable levels into 600ohm headphones, but don't expect to be able to drive low impedance types satisfactorily. Track access was very fast and accompanied by low mechanical noise.

SOUND QUALITY

While not in the top rank for its price, the sound was still pleasant, and slightly above average in the context of this group of players. The panel considered that the treble was a little brittle and slightly defocused, but it did have reasonable detail and clarity. The bass had good weight and extension, but there was some loss of 'speed' when compared with the best of the competition. The midrange was detailed with a fine natural balance, and the soundstage was well formed with above average depth and good width. Though the player has a 'forward' presentation, probably caused by the high frequency shelf, this did not detract from its overall merit. On complex passages, however, the image could become confused and there was some loss of transparency.

CONCLUSIONS

Although the sound quality was not the best in the group, the P220 is well constructed, has a host of facilities, a fine technical performance, and is very attractive to boot. This powerful combination should prove hard to resist.

TEST RESULTS

	20Hz	1kHz	20kHz
Channel balance	0.02dB	0.03dB	0.13dB
Stereo separation	95dB	93dB	82dB
Channel phase difference	0°	3°	42°
Total harmonic dist, 0dB	-93dB	-97dB	-86dB
Total harmonic dist, -10dB	—	-93dB	—
Total harmonic dist, -60dB	—	-41dB	—
Total harmonic dist, -80dB	—	-18dB	—
Intermodulation, 19kHz/20kHz, 0dB	—	—	-86dB
Intermodulation, 19kHz/20kHz, -10dB	—	—	-95dB
Frequency response, left channel	-0.27dB	0dB	-0.1dB
Frequency response, right channel	-0.26dB	0dB	-0dB
Signal-to-noise, 20Hz-20kHz unweighted	—	—	96/100dB
Signal-to-noise, CCIR/ARM, 1kHz ref	—	—	90/93dB
Output level, 0dB, left/right	—	—	2.13V
Output impedance	—	—	670ohms
De-emphasis 1kHz, -0.37dB; 5kHz, -4.37dB; 16kHz, -8.85dB	—	—	—
Track access time	—	—	2.5 secs
Error correction capability	>900µm gap, >800µm dot	—	—
Mechanical noise	—	—	low
Spurious up to 100kHz	—	—	-97dB
Resolution at -90dB	—	—	-86.9/-85.8dB
Headphone socket	—	—	yes, variable, 120ohms
Dimensions (w x d x h)	—	—	43 x 25 x 8cms
Estimated typical purchase price	—	—	£229

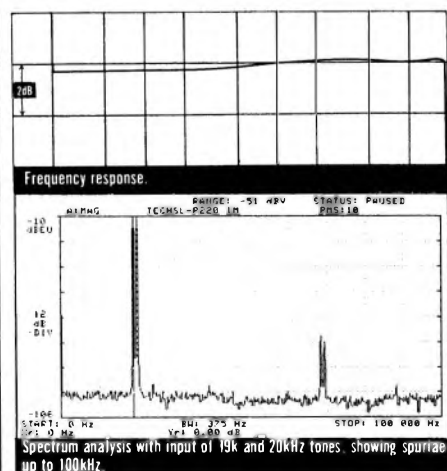

CONCLUSIONS BEST BUYS AND RECOMMENDATIONS

The lowdown on what's hot and what's not on the budget CD scene with our evaluations of value for money in this competitive sector.

Although not the author of the last CD issue, I took part in all the listening tests and was involved in lab testing many of the players. Every effort has been made to maintain consistency, so that the players covered here are assessed to exactly the same standards as before. A complete introduction to our review methodology both technical and otherwise, appeared in the last issue of *Hi-Fi Choice: Compact Disc Players* (No. 51), but its inclusion would be inappropriate in this interim/update report.

It is at the budget end of the market where the greatest strides are currently being made. Prices are stable while sound quality and the feature count continues to increase, so there has never been a better time to buy a CD player. All but one of the players tested here cost under £250, yet five come with some remote control facilities and three of the five have a limited remote control over volume as well. These join 22 sub-£250 players tested earlier in the year, though some are replacements, and this report keeps up to date with the progress made in this hotly contested market sector.

The latest crop of players covers a wide range of technologies. The cheapest simplest machines offer a minimum of facilities and earlier CD technology – 16-bit linear DACs that make 'brick wall' filters necessary. Such filters adversely affect sound quality, so many manufacturers have taken steps to reduce the filter rates as much as possible by using oversampling techniques – it seems that the simpler the filtering, the better the sound.

Next we moved on to 2X oversampling, allowing simpler associated filtering and improved sound, the format still used in the majority of players. Finally, 4X oversampling was initially introduced by Philips, and provides the best sound quality available at this price level.

However, the 4X oversampling

Sony CDP-M50 only managed a Recommended rating. Although the highest priced and one of the best equipped players in the group, it still didn't perform much above average, delivering a sound quality that fell short of the slightly more expensive, full size CDP-710 that did so well in our last CD reviews.

The new Philips and Marantz players may be of lighter construction than most, but both offer exceptional value for money. They are clear winners by a substantial margin on sound quality grounds, and in this price category appear to have stolen a further lead over the opposition. Others also displayed some fine attributes, and are rated Best Buy or Recommended by virtue of their standing within the sub-£250 group as a whole. The standard set by the non-Philips/Marantz players were pretty consistent with the group tested earlier this year.

All listening and measurements were performed at Martin Colloms' facility in North London. His help as one of the listening panel and his advice on technical matters are much appreciated.

BEST BUYS AND RECOMMENDATIONS

All the players we have rated as Best Buy give exceptional value for money together with a fine subjective and lab performance. Recommended status is accorded those players which offer good value for money but fell short of the overall Best Buy attainment.

BEST BUYS

Hitachi DA 7000 (£180)

Well built and easy to use, with the minimum of facilities, providing reasonable sound quality at a very competitive price.

Pioneer PD6050 (£230)

Above average sound quality, with

good finish and construction plus comprehensive features.

Marantz CD873 (£240)

A new well-styled midi player with exceptional sound quality, a good lab performance and fair build quality.

Philips CD473 (£250)

The latest full width remote control Philips player offers a host of facilities and exceptional sound quality.

RECOMMENDED

Technics CD220 (£229)

Well built, with good ergonomics, remote control, and a respectable sound.

ADC CD250X (£230)

Easy to use, this player provides a very good technical performance and reasonable sound.

Sony CDP-M50 (£269)

Includes remote control plus lots of features, and is well built with decent sound quality.

EXISTING BEST BUYS AND RECOMMENDATIONS

The following machines continue as Recommended models, retaining their ratings alongside the 10 players tested in this issue for the first time

BEST BUYS

Ferguson CD-04 (£149)

A stylish manual midi player which gave good sound from Yamaha technology.

Technics SLP-111 (£179)

Simply presented manual midi player with good build and fair sound.

Marantz CD273 (£199)

Fine sounding manual midi-player, though not as ruggedly built as some.

Philips CD160 (£199)

A high quality sound at a

competitive price, if a trifle flimsy in build.

Denon DCD-300 (£210)

Nicely built manual midi player with well balanced sound.

Marantz CD273SE (£239)

Marantz 'tweaks' enhance '73 sound significantly.

Philips CD360 (£249)

An outstanding plastic midi package with remote and FTS, plus exceptional sound for the money

RECOMMENDED

Sony CDP-M20 (£199)

Sony's leading budget midi machine gave a well balanced performance with good build and presentation.

Yamaha CD-X5 (£199)

Fine construction and finish with decent sound quality put Yamaha's budget midi player into the Recommended class.

Denon DCD-500 (£249)

Decent sounding manual full width player with good build quality.

Rotel RCD-820 (£249)

Rotel's Philips clone gives good sound quality, and now remote control too.

Sony CDP-310 (£250)

Full size, full remote plus respectable sound quality makes a competitive combination

Chris Bryant

RELAX IN ONE OF OUR SUPERB DEMONSTRATION ROOMS & COMPLETE YOUR MISSION.



The full range of MISSION products are always available for you to audition in any of our showrooms.

HI-FI EXPERIENCE are stockists for over 40 of the top Hi-Fi manufacturers. So if you are looking for a system or just one item let HI-FI EXPERIENCE help you with your selection.

Demonstration rooms can be booked or just call in.

HI-FI EXPERIENCE

- Hi-Fi Experience at Alfred Place 32/34 Alfred Place, Store Street, London WC1 E7PD Tel. No: (01) 631 4917
- Hi-Fi Experience in Camden 2/4 Camden High Street, London NW1 0JH Tel. No: (01) 388 1202
- Hi-Fi Experience in Leamington Spa 49 Park Street, Leamington Spa, Warks Tel. No: (0926) 881500

ALSO AT:

- 227 Tottenham Court Road, London W1P 0HX Tel: (01) 580 3535
- Erricks, Rawson Square, Bradford BD1 3JR Tel: (0274) 309266







The Crystal Signature with SME V and Koetsu Red. A deceptively slim appearance does not prevent arms like the Well Tempered and Souther being fitted and used with the lid down during play. The roaring fire highlights ProAc's slim but heavy EBS (extended bass) Studios, which use Professional drivers from ATC. The equipment stack consists of DNM Series IIIA/6PS pre-amp, Philips 180 tuner (from obsolete Black Tulip range), and Quicksilver monoblock valve power amps. Be sure to give plenty of warning for the latter to be warmed up if booking a demonstration!

A PHOTOGRAPHIC QUEST IN SEARCH OF THE

Crystal . . .

TV addicts notwithstanding, listening to music remains the cornerstone of relaxation and cultural experience for an enormous number of people. For some, strap-hanging with a Walkman may be enough. For others the passion for music runs close to obsession, and the degree of indulgence is limited only by the depth of the pocket. Then there are those happy individuals who temper passion and self-indulgence with good taste and discrimination; who can afford and are prepared to find out what hi-fi – and what room – suits their particular taste.

The wonderfully catholic nature of music and its appreciation inevitably leads to a similar diversity in the equipment and environments used for its reproduction. Freedom from the tight budgetary constraints of the mainstream mass market affords the opportunity to explore these alternatives –

and is in many senses the essence of hi-fi enthusiasm.

The rules (if any) are loosely defined and debatable, if not downright controversial. The only thing that really matters is the subjective satisfaction of the individual or individuals concerned, in the reproduction of his/her chosen music in congenial surroundings.

For this first in our Aspirations series we travelled to the heart of Oxfordshire, to a delightful village well off the beaten track, rolling up and down hillsides bathed in Autumn sunlight. Bar a slight touch of grey, the creamy stone walls could have been from the heart of the Cotswolds. And as luck would have it, this was one of the last days of Summer, before the Monsoon set in.

Our host's abode nestled next to a pub along an intermittent terrace of cottage-like exteriors. Ducking instinctively beneath an

Doug Brady Hi-Fi

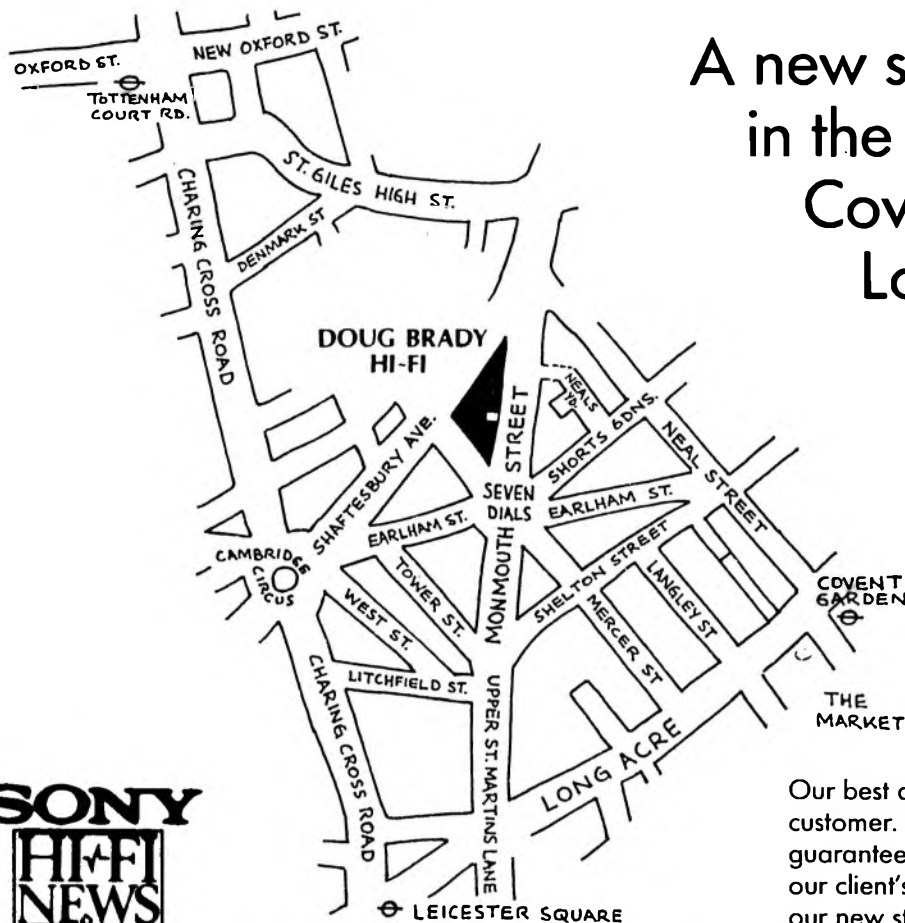

A new store is born
in the heart of
Covent Garden,
London's centre
of leisure.

18 MONMOUTH ST.,
COVENT GARDEN,
LONDON WC2H 9HB
01-379 4010



Winner — Best Hi-Fi Dealer
North West England,
Midlands and North Wales



mission
PCM 7000



are world-famous manufacturers
of high quality loudspeakers and
separates. They offer complete systems comprising the
excellent Cyrus range of amplifiers, matching tuner,
analogue record player and the outstanding PCM
7000 CD player, one of the finest you can buy.

***While stocks last we have a very special
offer on the Mission PCM 4000. Ring for
details.**

A visit to any one of our three stores is an opportunity
to hear, in comfortable demonstration rooms, the best of the world's high fidelity
equipment, including most of the 'Recommended' and 'Best Buys' mentioned in
this issue, or ask for a free copy of OUR OWN Best Buy Guide.

BRADY HI-FI IS A MOST MOVING EXPERIENCE

Doug Brady Hi-Fi
Kingsway Studios,
Kingsway North
Warrington.
(0925) 828009
Closed all day Thursday

W. A. Brady & Son,
401 Smithdown Road,
Liverpool
L15 3JJ
(051) 733 6859
Closed on Wednesdays

Doug Brady Hi-Fi,
18 Monmouth Street,
Covent Garden,
London WC2H 9HB
(01) 379 4010



We Stock AR · A&R · Alphason · Apollo · Apogee ·
Audiolab · Beyer · Celestion · Denon · Foundation
· Fuji · Goodmans · Kef · Krell · Koetsu · Linn ·
Marantz · Meridian · Mission · Monitor Audio ·
Musical Fidelity · Naim · NAD · Nakamichi ·
Ortofon · Philips · QED · Quad · Revolver · Rog rs ·
Rotel · Revox · Sennheiser · Tannoy · Target · TDK
· Wharfedale etc.



Oxford Acoustics Crystal Signature takes the unusual but highly logical step of integrating turntable and stand/plinth. The result is elegant as well as practical, posing the question – why has no-one done it before?

eighteenth century lintel, a vestigial hallway led immediately into the main living and music room. Surprisingly large considering the age of the property, and with no problems over eighteenth century ceiling height, a pair of ProAc *Studio EBS* loudspeakers flanked a massive open hearth at one end, about twelve foot from the comfortably seated listener.

The room itself is L-shaped, the main section for living and listening being about 20 x 16ft, while the adjunct leads to an open wooden staircase and access to other rooms. The massive, unfinished walls reflect the rough-hewn stone blocks of the outside, while the flooring is solid elm. There are no carpets and curtains as such, rugs and shutters, together with the hard stonework ensuring an attractively lively acoustic (to these ears anyway). Yet any unwelcome 'edge' or 'ring' was deftly avoided, partly thanks to the unevenness of the wall surfaces and irregularities of the overall room shape, but particularly decoratively by the antique Turkoman rugs and part rugs on the floor and hanging on the walls.

I am appalled to admit an abysmal ignorance of these exquisite examples of folk art before my visit, yet they were arguably more interesting than the hi-fi and record collection Woven 'on the move' by nomadic tribes

in the desert borderlands of Iran, Turkey and Afghanistan, based on unique patterns specific to tribes and passed down through many generations, their vivid dyes and complex subtleties were a striking feature – lending great character and charm as well as doing a nice job on the acoustics.

Our host is a gifted part-time musician – an amateur violinist who could easily have gone professional if he hadn't decided to earn some money instead. Not surprisingly his taste was almost exclusively for classical music, with much Bach and Mozart but a broad range elsewhere encompassing a few hundred albums (and not a compact disc in sight!).

Pride of place in the hi-fi system goes to the new Oxford Acoustics turntable, the \$2,000 *Reference* version of which had been considerably enhancing our host's listening pleasure for some months. He was in fact upgrading to the sonically similar but aesthetically far superior \$2,500 *Crystal Signature* model at the time of our visit, and this is the model featured in our photographs.

The *Signature* was fitted at the time with SME *Series V* and Koetsu *Red*, though both these components were owned by Oxford Acoustics and it seems likely that our host's Souther Tri-Quartz tonearm and Clear Audio *Pradikat* cartridge would be transferred



from the *Reference* (which we in fact listened to) in due course.

This extravagant but undoubtedly fine 'front end' was expensively van den Hul connected to a DNM Series IIIA/6PS pre-amp (the two-box one with the transparent case and transparent sound to go with it), then on to a pair of Quicksilver mono valve power amplifiers and the ProAc speakers. The tuner was a remarkably nice sounding device from Philips' largely unlamented Black Tulip debacle of a decade ago – so watch out for secondhand Philips 180s he writes, doubling their value at the stroke of a keyboard.

About the only real compromise in this system was the decision not to use spikes (or for the sake of the floor, studs in this case) on the speaker stands. To do so can certainly provide benefits in image solidity and scale, but it also confines the loudspeakers to a single permanent location. The ability to adjust speaker positioning to take sympathetic account of the scale of a work and performance as well as different recording techniques was considered the lesser of two evils in this instance.

The £2,000-£2,500 turntable itself is a genuine 'heavyweight' belt drive model, with 2-speed electronic motor control. It uses an inverted stainless steel 35mm bearing recessed into the 35mm thick, 1.5 per cent dished acrylic top platter, itself running on a substantial phosphor/bronze main platter. The centre weight is also a ph/bronze laminate with acrylic. The MDF/aluminium sandwich subchassis is spike-located into steel bosses set within small rubber decoupling elements, while the plinth base also secretes spikes under its woodwork for levelling and floor-keying.

There are no plans to attempt to review critically the systems which are featured in this series; the intention is merely to present them as interesting solutions to harmonising lifestyle, listening room and 'high end' hi-fi. In this instance the sound seemed particularly well in tune with the predictions of the listener. Majoring on an impressively transparent, informative and dynamically exciting midrange, it gave precise stereo imaging and sounded marvellous on most classical discs, but was clearly not a system for the metal headbanger or Sly and Robbie fan.

Good as the system undoubtedly was, I am sure the room itself played a significant role in the fine end result – confirmed by the thrilling sound of our host's own violin when we persuaded him to show us what it ought to sound like! A well distributed 'live' acoustic with just sufficient damping to avoid harshness almost always seems to provide exciting results. Though I'm not sure what my accountant would say about a collection of tax-deductible Turkoman acoustic treatments.



F R O M F I R S T T O L A S T

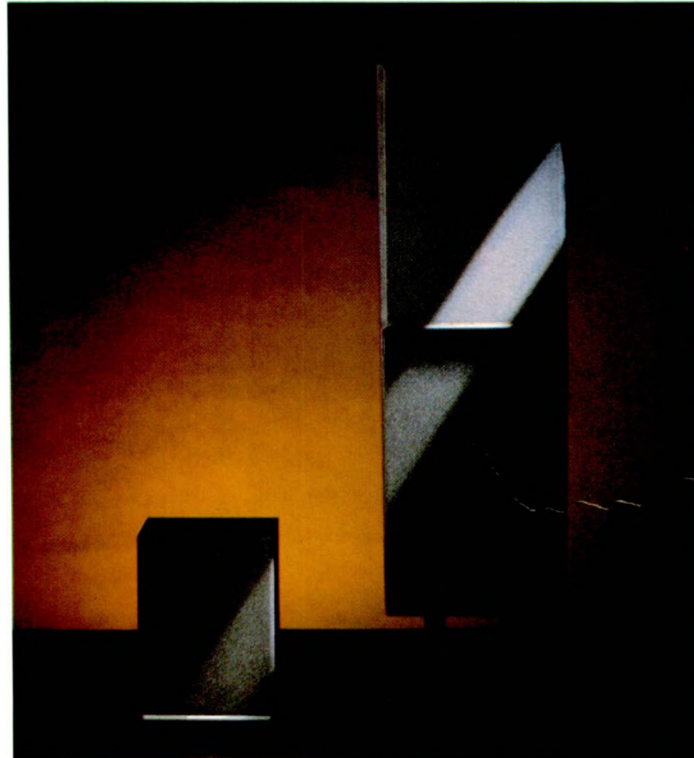

SYSTEM 442

MS10

Whether you are a 'first-time' enthusiast, or a 'long-time' music-lover, whether you aspire to the sensational little MS 10 Series 2 or the magnificent System 442, the superlative products of Mordaunt-Short can always be relied upon to offer outstanding performance, superb craftsmanship and exceptional value for money.

Complete the coupon below, or visit any top 'hi-fi' store, and take the first steps towards the last word.



Mordaunt-Short

C L O S E R T O P E R F E C T I O N

Durford Mill, Petersfield, Hampshire, GU31 5AZ, Great Britain
 Telephone: Rogate (073 080) 721 Telex: 86443 MS HIFI
 Telefax: (073 080) 854

I am interested in affordable quality. Please send me details of your products and a list of your dealers.

NAME

ADDRESS

POST CODE

COSMIC

A world of difference.

MISSION PCM 4000 AND PCM 7000
ON DEMONSTRATION AND IN STOCK

Interest Free Credit (APR 0%) on

PCM 4000

Deposit £39.95

9 Payments of £40

PCM 7000

Deposit £59.95

9 Payments of £60

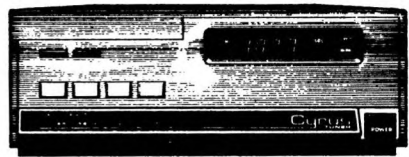
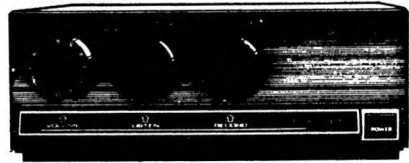
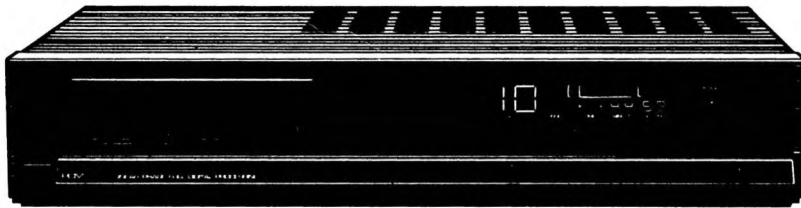

TOGETHER WITH THE
COMPLETE CYRUS RANGE

MISSION
ELECTRONICS



DEDICATED CYRUS ROOM
2 ADDITIONAL DEMONSTRATION ROOMS

COSMIC

244-256 STATION ROAD, ADDLESTONE,
WEYBRIDGE, SURREY.

TEL: (0932) 854522/51753/43769



OPEN SEVEN DAYS A WEEK 9.00AM-6.00PM



CHOOSING AND USING . . . YUPPIE BLASTERS

The term 'yuppie blaster' (possibly coined by Bob Crabtree of ERT) seems curiously apt in describing the new upmarket CD-equipped portables that are appearing on the market at \$250-\$450 or so, double or treble the price of the most pretentious stereo-cassette-radio 'ghetto blaster'.

The latter have been one of audio's success stories in the 'eighties, opening up new markets for second/third systems with holiday/weekend away capabilities, and appealing strongly to young people – as much because of their compactness and transportability as the capacity to run off expensive batteries while annoying the neighbours.

Increasing affluence (amongst the affluent) suggests that the addition of CD playback should expand the portable market still further, particularly in value terms, though it is true to say that the CD medium has not been the portable panacea that many had hoped. However, prices are not that much higher than for a CD-only standalone mains player, so the flexibility of a portable package may present a tempting alternative to customers planning their first CD player. With this in mind we have checked the sound quality of the CD section alone, played through a normal hi-fi system.

This assessment of a batch of 8 Yuppie Blasters has been carried out entirely subjectively – more rigorous lab testing is largely unnecessary, as the engineering constraints in terms of weight and power consumption mean that these portables are comparatively crude compared with mains/domestic hi-fi.

Listening tests were carried out using a domestic system as a reference against which each blaster was compared on CD and cassette sources; the radio element was compared directly with a decent quality portable radio. As all the machines featured CD output sockets, this source was also auditioned independently through the reference system,

which revealed the underlying characters of the players on test.

The listening was initially carried out with the units below ear level and facing the listener. But experimenting with siting revealed that the smaller players provided a better tonal balance off-axis (ie with less direct treble output) and even at floor level (hence boosting the bass).

Record/replay cassette quality was tried using tapes from Agfa and TDK.

Most of the recordings were made from an external line level source like the Meridian *MCDPro* CD player. The recording standard on all models is limited to some degree by automatic level control. *In extremis* this could adjust the record level to make everything the same volume, though in practice the systems used are more 'intelligent' than that, though inevitably some gain-riding and compression effects will mar recordings.

Program material included rock, classical and pop on both formats. The reference system was made up of the following equipment: Meridian *MCDPro* CD player, Yamaha *K-700* cassette deck, Philips *D2924* portable radio, DNM *Primus* preamplifier, Amcron *D-150* power amplifier, Monitor Audio *MA-16* loudspeakers (heavily modified).

CONCLUSIONS

Given the limitations imposed on portable stereo systems, most of the blasters tested managed to come up with fairly reasonable sound quality. The CD medium gives them a substantial sonic advantage over the standard cassette-based machines that have become so prolific this decade, albeit at a significant price increase. However, if used on battery power, the combination of disc drive and laser transport will prove fairly expensive, using even more power than a cassette deck.

However, the players are hardly in the forefront of digital audio technology, and most sound as if they use first generation bit and

oversampling rates. None of the manufacturers specifications volunteered the aforementioned information, which would suggest that it may not be all that impressive.

The practicality of making this medium portable is somewhat debatable to say the least. Being made of soft plastic, compact discs mark quite easily, and contrary to public perception, CD players can get stuck on the grooves much the same way as record players. The units were tested for their ability to operate whilst in motion, and most could withstand light swinging but gave up if jarred, in some cases to the point of taking some time to recover their bearings and reconnoitre play. They would be more comfortable in a domestic situation where space is short, or as a somewhat inadequate substitute for a full blown hi-fi.

Comparing these outfits on sonic grounds, with alternative CD-based systems tends to show them in a poor light, as the standards of conventional loudspeakers and amplifiers can hardly fail to be significantly better. Small built-in speakers have several flaws, not the least of which is their fundamental inability to reproduce the lower registers, resulting in a severely constrained frequency response. The players that featured some sort of extra bass unit were notably more palatable in this respect, but tended to be a bit upper bass heavy when poorly sited, such as on the floor by a wall.

Transmission of vibration from inbuilt loudspeakers to the CD player in particular is not likely to help things either, as this medium will have to work considerably harder than if it was isolated. On half the players tested the sound quality available from pre-recorded cassettes is handicapped by the absence of Dolby noise reduction de-processing, as the encoding is already incorporated during the recording of most commercial tapes. Given the restricted high frequency output of most of the blasters'

loudspeakers, this may not be an impossible situation, but it is a pity nonetheless.

None of the players had the good sense to provide an external aerial socket which could have pulled up the standard of radio reception considerably at little extra cost. Another more serious omission (from all but the Hitachi) is of a vinyl disc input for connecting an external record player. Despite the dreams of marketing men, the vinyl format is still very much alive, and in a domestic set up such an option could undoubtedly be useful.

However, the situation is not all that grim, and there are a variety of advantages to what are after all fairly compact multi-source stereo systems, which can be used off the mains, in the car and even on the beach (assuming it's not a sandy one). They are a lot more robust than most other music sources except perhaps Walkmans – and how else are you ever going to achieve true street credibility?

Of the players included in this test, no single model stands out as far superior to the others – rather some have their strengths concentrated in a particular area.

For CD play the Sharp was considered the most impressive, but it's closely followed by the Sony and the relatively cheap Memorex. However, the best cassette players were the Panasonic and Toshiba. The Sony again, alongside the Fisher provide the better tuners, our radio consultant Norman McLeod expressing a preference for the latter.

Amongst the players so far mentioned only the Toshiba was capable of anything like bass, which could be an important factor depending on taste. If any, I think the \$350 Sony received the best overall rating (and it's certainly the prettiest). But it's also more expensive than all but the Sharp, with its fine compact disc player. That said, I would expect the gadget-laden Hitachi at its recently reduced price to prove the most popular on the market.

Design Council Award Winners 1974
Salone Internazionale della Musica
Premier Award Winners Milan 1977
Gold SIM Award Winner Milan 1978
Design Council Award Winner 1982
FBA Award Winner 1984
FBA Award Winner 1986
Japan HiFi Grand Prix Winner 1986

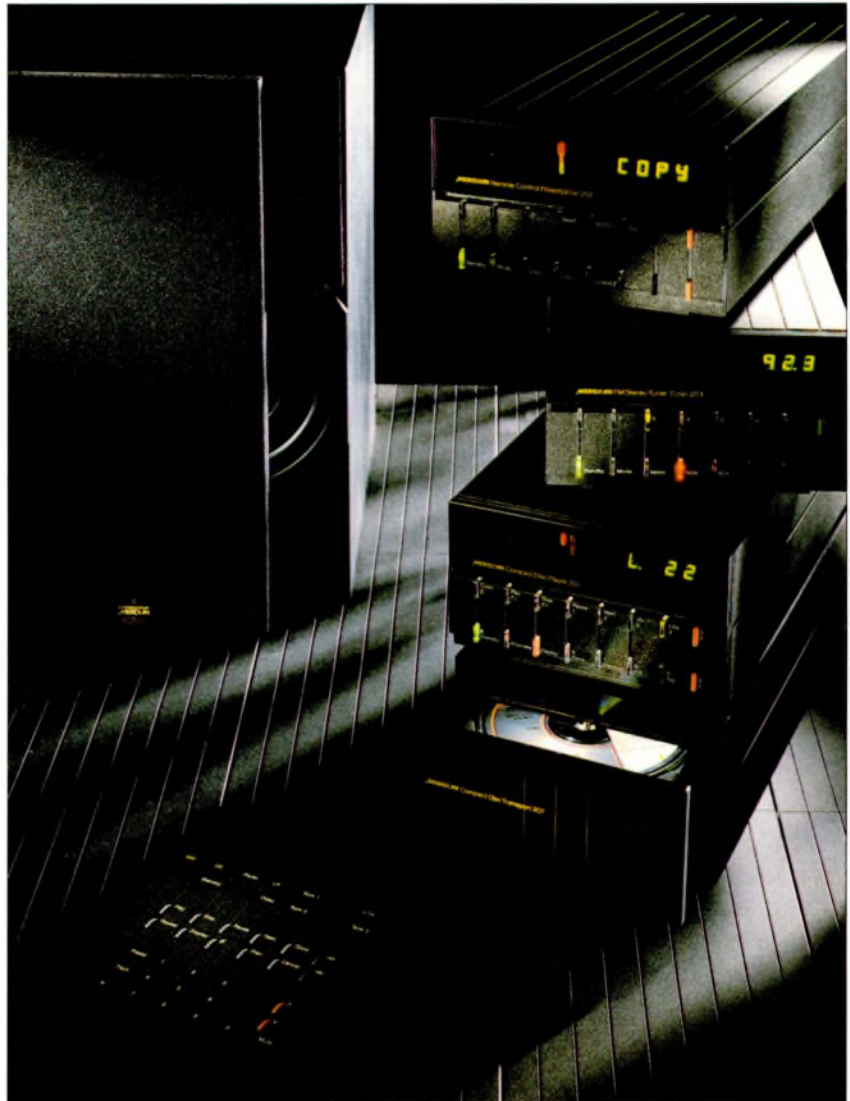

Digital High Fidelity Systems including
Compact Disc, FM Stereo Radio, Amplifiers, Active Loudspeakers,
Full Remote Control and Multi Room distribution systems.

BOOTHROYD STUART
MERIDIAN

Boothroyd Stuart Ltd · Huntingdon · Cambridge · England · 0480 57339

FERGUSON RCD02

THORN EMI FERGUSON, CAMBRIDGE HOUSE, CAMBRIDGE RD, ENFIELD, MIDDX EN1 1UL. TEL: 01-363 5353

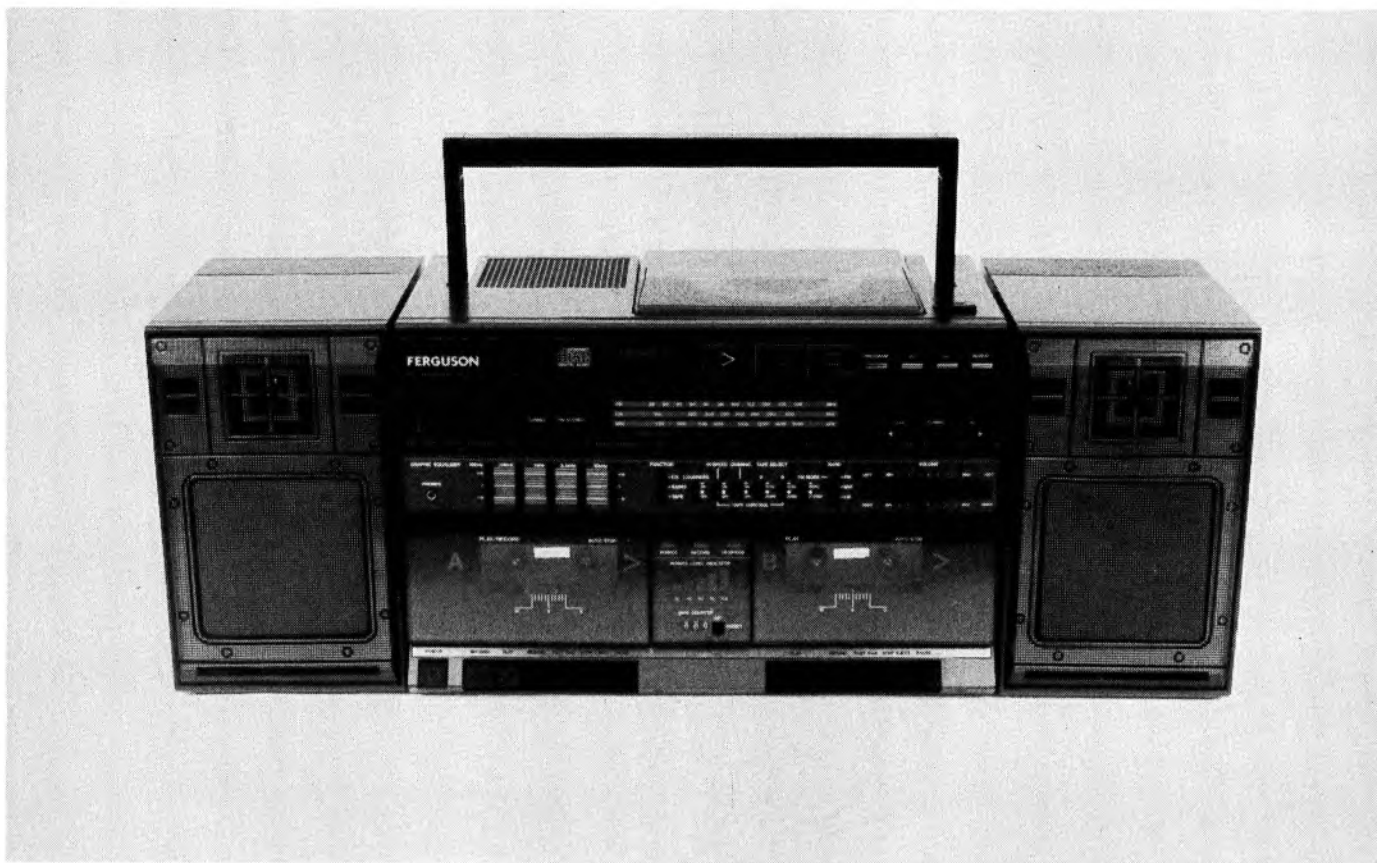

Designed to look – and indeed work – more like a midi system than a portable, this Ferguson is large. The genuine plastic speakers are removable and have captive one metre cables, connecting to the main unit by spring clips. To continue the midi theme the fascia has been divided up to get that all important 'separates' look. Its main concession to portability is a fairly discreet folding handle.

The central control panel features a four-band graphic equaliser, a rather feeble twin ganged volume slider, and a loudness button – the latter applying to all sources, which may appeal to some. Between the twin cassette decks is a power level indicator, with flashing lights marked 20 to 100: I shouldn't like to guess what units these figures might refer to.

With speakers attached this player measures 24 x 64 x 18cm (h x w x d), and weighs a not inconsiderable 8 kilos, to which may be added its complement of nine HP2 batteries. Strolling around Knightsbridge with this could be a viable alternative to working out.

The back of the RCD02 has CD output phono sockets, plus (unusually) a five pin DIN socket for external tape players. Other useful features include twin microphone sockets and a 13.5 volt DC input for sounds on the road.

CD PLAYER

This fairly basic player has only one major flaw, that being a lid which only opens about an inch when the eject button is pressed – in order to insert a disc it's necessary to pull it fully open. However, it does have the largest programmable memory of the group, accepting up to 30 preset tracks. The usual LCD display gives track, time and status, but remains clear after

stop has been pressed. One operating irritation is that one cannot skip tracks without using pause once in the play mode. Repeat and audible track scan functions are also available.

CASSETTE DECK

This twin deck machine has full dubbing facilities and logic controlled transport keys. It even goes so far as to have separate tape type switches for each, and a mechanical counter for the record capable deck. Continuous playback from two tapes is possible but this does not apply to recording. Layout is fairly rational, but control placement does not suit floor siting.

TUNER

The clean simple looks of this tuner should perhaps forewarn one of less-than-user-friendly ergonomics. The bandwidth select switch is fairly easy to locate in the next section down, but tuning with the stiff edgeways knob and chrome cursor is less than fluent, while the FM band scale is half an inch above the cursor and devoid of any guiding lines. That said it does have a basic signal strength indicator and a front mounted stereo/mono button.

HOW IT SOUNDS

Despite the larger than usual, removable loudspeakers, real bass was not in evidence, and mid and treble dominated the tonal balance. A plus point is that even with the speakers fitted onto the main unit vibration transmission was minimal, thus giving the laser a better chance to track discs accurately.

However, CD play sounded brash and mid forward, showing little subtlety. Acoustic instruments had a slightly unnatural tone, but orchestral music was not too unpleasant. On rock material resolution was poor, and following individual instruments was sometimes difficult. If not detailed as such, the sound was quite 'punchy', suiting heavy rhythm-style funk and dub tracks. The sonic presentation was much the same when the player was tried in the reference system: the tonal character seemed 'thick' and rough around the edges, becoming unpleasant at highish levels.

Using pre-recorded tapes the sound was a trifle bland, but quite enjoyable and reasonably informative. Bass performance was a lot better than treble, which is of course a limitation of the format as much as anything else. Recordings onto normal tape sounded a bit messy, the lack of Dolby not helping rather prominent hiss levels. Chrome tapes proved worthwhile, offering a smoother and tonally more accurate copy.

Dial calibration on the tuner seemed rather inaccurate. The rather short FM aerial does not seem to affect the reasonable reception available on this band adversely, and it will sensibly mute into mono on weak stations. Unfortunately there is no AFC, and accurate tuning is very critical. The tuning indicator light works well enough on FM, but on medium wave it came on illogically, producing a strange whooshing noise!

CONCLUSIONS

You get a big box for your £300, and one that will go pretty loud. However, on sonic and build quality grounds it falls somewhat short of recommendation.

FISHER PH-D473F

FISHER SALES UK LTD, FISHER HOUSE, 113 BUSHEY MILL LANE, WATFORD, HERTS WD2 4XN. TEL: (0923) 31974

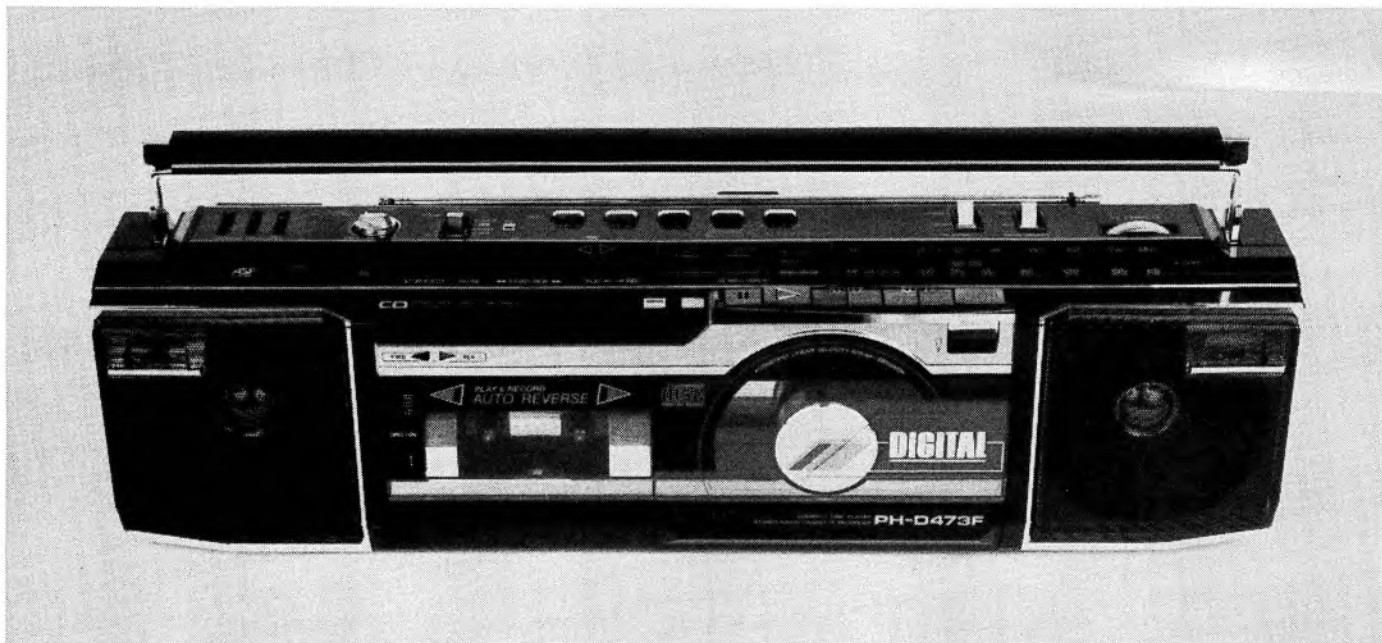

Fisher are the better quality brand of the giant Sanyo operation, the solid feel and reasonable build quality of this £300 portable maintaining that image. Styling is fairly coherent, with a chrome on black theme interspersed with red and blue legends, but the overall effect is a little untidy. A welcome change, this is one of few players to feature a rotary volume control – next to a slightly 'naff' three-band graphic equaliser. Power on/off is part of the source select button.

The player sports line in and out phono sockets, twin headphone sockets, and a mike input. The AM 'beat cut' switch is quite well hidden near the 240 and 12 volt power sockets, and the 1.75m mains lead comes complete with a continental style two pin mains plug and an adaptor for American sockets (I guess 3 pin plugs are too expensive). For sounds on the move you need to increase the 4.5 kilo dry weight with eight HP2 batteries, while dimensions are 15 x 55 x 13cm (h x w x d).

CD PLAYER

Programmable with only up to eight tracks, the CD player's LED display shows track, time, and remaining time. Transport buttons are laid out in typical cassette style, and as such are easy to use. Being located on the top front edge of the box, access is always good. Track skip and audible search have their own keys, and there is a repeat button up amongst the secondary tape controls. Track access is reasonably quick, and on initial insertion of a disc there is no need to wait before pressing play. All in all, a fairly user-friendly player.

CASSETTE DECK

Fitting snugly alongside the CD compartment is the auto-reverse cassette door, its controls set further back and less accessibly than those for the disc player, though still easy enough to use. And I'm glad to say this player features a Dolby switch, alongside the manual tape type select. The latter caters for normal and metal tapes but not chrome – a bad omission. Other facilities include auto search and an automatic space function, but it doesn't have a tape counter and record levels are set automatically (and hence unpredictably).

TUNER

For a pleasant change, the dial, tuning knob and band select are all in the same place on the Fisher. However, its capabilities are limited to FM and AM only, which could be a bane to Radio Four listeners who don't dig *Listen with Mother*. An FM mono/stereo switch is conveniently sited alongside the bandwidth selector, and as previously mentioned a well hidden AM beat cut elsewhere.

HOW IT SOUNDS

Speaker size and construction once again prove a constraint, with all sources sounding lightweight in character. (The above observation is based on comparison with a mains powered domestic system; with careful siting most of these players can be made to give a reasonably acceptable tonal balance.)

The CD player sounds least attractive when

playing acoustic instruments, where tonal inaccuracies are most noticeable – cymbals, for instance, come across more like their electronic imitations. The punchy almost solid character is more at home with rock and pop material, or true street sounds such as hip hop. Even when used in the reference system, it fared poorly against the competition.

Playback of musicassettes doesn't exactly turn heads either, sounding a bit thin and constrained. Resolution and noise were equally unimpressive. Can it really be that bad? Well I guess it's nothing that azimuth correction couldn't have helped put right, as its own recordings evidence. These fared rather better, with good hiss levels and a reasonable musical presentation. Type IV metal tapes proved more informative, and may be a worthwhile investment for the keen listener.

The tuner was one of the few tested that used AFC (automatic frequency control) on FM. Tuning on both FM and AM was remarkably easy, though FM sensitivity seemed a bit below par. AM sensitivity was about average, and sound quality here was particularly decent.

CONCLUSIONS

This is a well built and rationally laid out machine that's let down by below average sound quality. However, it pumps out a reasonable volume for a small box, and looks more expensive than most of the others. If you're not stuck on silver discs it may be worth consideration.

HITACHI CX-W800

HITACHI SALES (UK) LTD, HITACHI HOUSE, STATION RD, HAYES, MIDDX UB3 4DR. TEL: 01-848 8787

RECOMMENDED

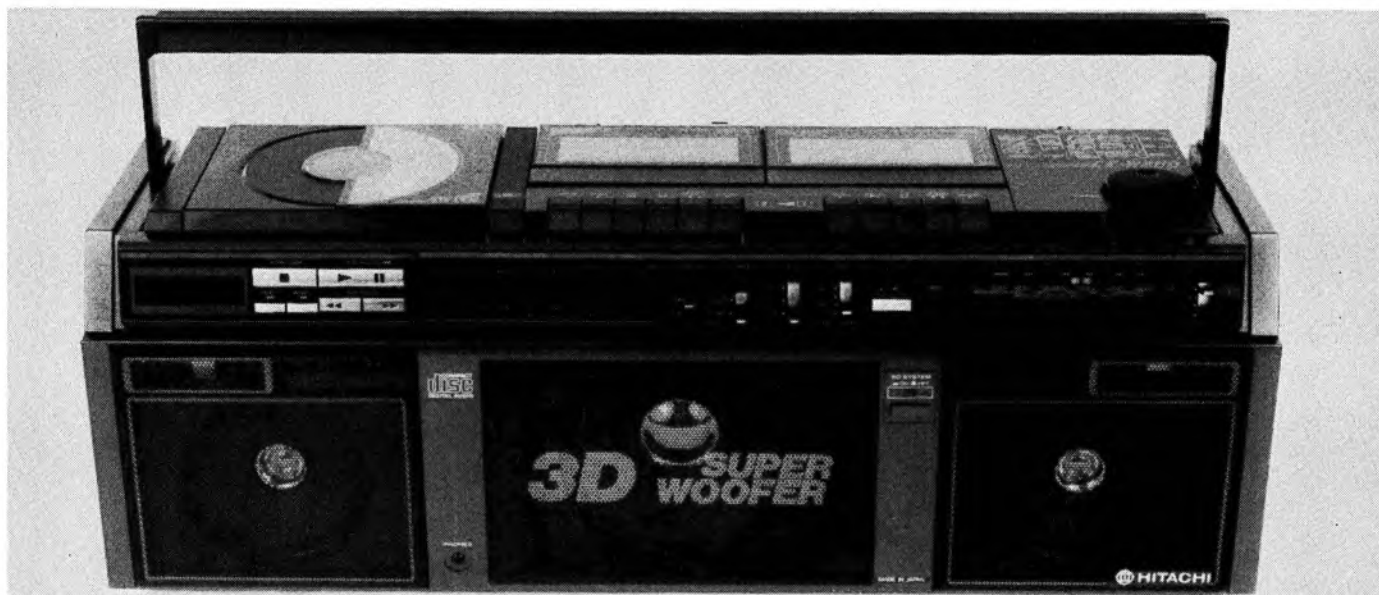

A true street machine in the heavyweight style, Hitachi's *3D Super Woofer* looks as though it could rock the house. Not a player for Bang & Olufsen fans, it is far from discreet, weighing 8 kilos and measuring 23 x 62 x 20cm (h x w x d). You could say it's built to impress.

General features include a central, switchable, third loudspeaker which supposedly crosses over at 150Hz. Inevitably a five-band graphic is fitted, alongside a twin ganged volume slider (which could be easier to use). Remarkably, this CD-based beat box acknowledges the continuing existence of vinyl disc players, by including a line in/phono input with switchable gain.

CD PLAYER

The LED display on this top loading player identifies the track only; other functions such as pause, repeat and memory have lights beside their switches. The memory will accept up to fourteen preset tracks that can be repeated *ad infinitum*. The only (irritating) omission from the controls is audible track scan. The disc door works quite nicely, and features a felt covered disc clamp which probably helps disc stability. The player can cope with gentle swinging, but flips out when jarred. Furthermore, its ability to cope with fingermarked discs at high volume was frankly appalling, producing mistracking along the lines of a Grandmaster Flash scratch mix!

CASSETTE DECKS

In line with the all-singing all-dancing approach there are twin tape decks. One features full record replay facilities with its own

tape type selection switch, the other (replay only) deck is limited to normal tapes. Notably, there is no noise reduction system. General construction and ergonomics are on a par with others in the test, and the dread high speed dubbing is available, for those with very little time to spare.

TUNER

This is the only tuner in the group with a proper face up tuning knob, plus a finger indent for speedy station hopping. The dial itself doesn't warrant the same enthusiasm, as it suffers the all too common cursor/wavelength illegibility: medium wave has been singled out for total obscurity, as the white frequency numerals have been placed on a silver background! Equally irritating is the location of the FM stereo/mono switch, on the back of the machine.

HOW IT SOUNDS

Used without the central bass speaker the *W800* has a similar, maybe lighter tonal balance than average. But at the touch of a red button the *Super Woofer* romps in. The effect is slightly over the top, and bass tends to take over the show – which is fine if your ears are getting maximum treble by being in line with the speakers, but gets a bit much when listening off axis. (The listening tests were conducted with the player facing the reviewer, at close to head height.) One option I couldn't resist trying was the phono input, which sounded rough and ready but full of life (such is vinyl!).

On CD the lower bass lent tonal credibility to

instruments and voices. But a poor top end rather marred the overall performance; it was quite grainy and bright, and pumping up the volume didn't really appeal to my ears. Neither was the resolution of nuance and counterpoint quite up to good reproduction of classical pieces. However, the extra oomph gave rock some solidity and power. Funk (for which such machines are surely designed) really made the grade. The more neutral amplification and speakers of the reference mains set up revealed a slightly smeared and gritty top end, and stereo presentation fell well short of the *MC pro*.

The high treble seemed to be the weakness on cassette playback as well. Pre-recorded tapes suffered badly from the lack of noise reduction, sounding quite raw and messy. Recordings made with normal tapes were no great improvement, offering a 'hissy' rather 'thick' version of the original. Chrome made a small improvement especially at the frequency extremes, and metal logically came out a bit better still – though here the upper treble seemed slightly fragmented, making the extra expense barely worthwhile.

FM reception was above par, and particularly good on weak signals, though it did not automatically mute on weaker stereo signals. The other wavebands were surprisingly bad, medium wave in particular whistling away for all its worth.

CONCLUSIONS

There is something of the AC Cobra in this player's unrefined but powerful character. Street credibility may tip the balance for some, and at £300 it represents fair value for money.

music made live...

MISSION
ELECTRONICS



5% OFF
ANY PURCHASE
OF £99 OR OVER
WITH THIS
ADVERT.
VALID UNTIL
31st Dec. 1987.

Stockists of:

A & R, Aiwa, AR, Ariston, Audio Lab, B & W, Celestion, Dean, Denon, Dual, Exposure, Gale, Heybrook, Hitachi, Inca Tech, KEF, Linn, Logic, Marantz, Musical Fidelity, Mission, Monitor Audio, Myst, NAD, Nakamichi, Quad, Revolver, Revox, Rock, Rogers, Rotel, Ruark, Tannoy, Wharfdale, Yamaha.

GOODS SENT CARRIAGE FREE
(Stands excepted)

TWO YEAR
GUARANTEE



BARTLETTS

175 HOLLOWAY ROAD, LONDON N7 TEL: 01-607 2296/2148
Access, Visa cards accepted. Two Year Guarantee.

Worldwide Export a speciality. Ask for a quotation.

BARTLETTS AUDIO DEALERS ASSOCIATION
BADA



We're now giving chapter and verse every month.

For twelve years, 'Hi-Fi Choice' has been the hi-fi buyer's bible.

No-one else covers so many products in such depth.

No-one else has such a comprehensive directory to the multitude of brands and models on the market.

No-one else carries out such extensive lab tests, to check the truth of manufacturers' claims.

And, now 'Hi-Fi Choice' is appearing monthly, no-one

will be more up-to-date.

Each issue will have 164 pages packed with reviews, group tests, features on every conceivable product category, and advice on buying, up-grading and using your system.

Make sure you get your reading for the month, by placing an order with your newsagent, or by calling the 'Hi-Fi Choice' 24-hour subscription line on 01-360 6797.

HI-FI CHOICE

MEMOREX CD-3300

TANDY UK, TANDY CENTRE, LEAMORE LANE, BLOXWICH, WALSALL, WEST MIDLANDS WS2 7PS. TEL: (09224) 77778



The Memorex name is now used by the fairly huge Tandy Corporation, which might explain why this cassette tape brand is appearing on upmarket hardware. At £280 this player doesn't exactly exude class, and looks slightly tacky amongst the other machines tested, though build quality is fair enough.

Volume control is a twin ganged slider; adjusting level whilst maintaining a given balance is easier than expected. The top of the box also features a three band graphic (or frequency equaliser as they call it), twin mike inputs (facing upwards for optimum dust collection), and separate power and source select switches.

The layout is simple and easy to use, if not giving the tactile feedback one might have liked. The left hand end features the usual line in and out phonos, headphone output, AM 'beat cut', and power inputs for both 12 and 240 volt operation.

Unusually, the Memorex also features external speaker outputs in the form of phono sockets, which I guess is neater and easier to use than spring clips. Its reasonable 4.5 kilo weight needs to be supplemented with eight *HP2* batteries for true portability, and it is reasonably compact at 17 x 58 x 14cm (h x w x d).

CD PLAYER

This is the only player in the group not to have a programmable memory – and control use is much easier for it. The five touch-sensitive buttons cover all the usual functions, including track skip and audible scan. The small but adequate LCD display shows only the track, repeat, and for good measure puts up the word disc when the player is loaded (which is not all

that obvious as there is only a small clear aperture in the door). The door itself opens and closes with a reassuring clunk, at a press of the mechanical release button.

CASSETTE DECK

The *CD-3300* incorporates a fairly run-of-the-mill unidirectional tape deck, which should give it a good chance of performing well by avoiding the inherent problems of head alignment in auto-reverse decks. Transport controls are fully logical, avoiding the need to press stop when changing between fast forward and play modes, for instance. The only other features are Dolby noise reduction and a counter to aid track location. As with the CD player the controls are located at the bottom of the front of the machine which makes access poor when the player is below waist level – especially so if it's on the floor.

TUNER

Continuing the simple theme, the tuner features an edgewise tuning knob and a band select switch that includes FM stereo and mono alongside medium and long wave (omitting short wave). However, the dial layout does leave something to be desired: the FM stereo beacon and wavelength legends are up to a foot away from the actual tuning scale; the cursor itself hardly redeems this by being a quarter of an inch wide and all white, with only a central indent.

HOW IT SOUNDS

Coming across a bit bass shy compared to the others tested, the Memorex failed to deliver

great power, and the amp struggled when high levels were attempted.

The CD managed to stay quite informative and tuneful, only smearing slightly on complex passages. Tonally it sounded a little 'cut off' at top and bottom extremes, but still managed to create an open 'grit free' sound which was quite pleasant. When tried through the reference system its attributes were enhanced; careful listening was required to identify its weak spots when compared to the *MCD Pro* – which is no mean feat in the context of its price.

Replay of pre-recorded cassettes was less wonderful, as the Dolby took off a bit more top end than is necessary. The general character was somewhat coarse, with fair clarity but a 'piercing' treble. Piano sounded unstable which suggests below par speed stability, but on less critical material the overall effect could be quite lively. Recordings, on to normal tape only, came across in the same style, with poor resolution and an 'edgy' treble. However, it does maintain some notion of attack and p'zzaz.

The dial calibration on the tuner was 7MHz out on FM, and sensitivity was about average. The RF side of this tuner is quite clean, but is let down by poor audio quality.

When tried with external loudspeakers (original Wharfedale Diamonds), the sound was bass heavy with restricted treble, but was still preferred to the inboard units.

CONCLUSIONS

Obviously the CD player accounts for the majority of the £280 price tag here, and it works quite well in a domestic system. But it's let down to quite a degree by the ancillary parts of this portable system.

PANASONIC RX-FD80L

PANASONIC UK LTD, 300-318 BATH ROAD, SLOUGH, BERKS SL1 6JB. TEL: 0753 34522



The 'Digital' logo seems to be the essence of this glitzy beat box, which uses chromed plastic like it was going out of fashion (hasn't it?). And unfortunately more space is taken up by unnecessary legends than key function flags, some of which are pretty small. It has the obligatory five-band graphic equaliser, unconventionally set into the cassette door. Large sliding balance and volume controls are accessible as long as the carrying handle is folded down.

The main on/off button is quite well hidden, testing the observation capabilities of the uninitiated. Next to it is the mixing mike input, and an onboard microphone. Also included are line in and out phono sockets, a headphone jack, and the socket for the 1.6 metre mains lead. For use in the great outdoors it can be powered by 10 HP2 batteries and weighs a reasonable 5 kilos without them. It's not too large either, at 16 x 59 x 17.5cm (h x w x d).

CD PLAYER

The FD80L has a fairly well built front loading system, the door opening and closing with a solid reassurance, giving some impression of functional longevity. It is handicapped, however, by the small, closely packed operation buttons, which can hardly be described as ergonomic. The LCD display is also pretty narrow, but does in its own fashion show track number and elapsed time – and at the press of a small chromed bar remaining tracks and time, which is all quite typical. Yet the Panasonic squeezes even more into its 4.8 x 0.8cm window, in the form of ten boxed digits which

reveal the track being played, and the programmed sequence. The usual search, skip and repeat functions are available, plus an eighteen track memory.

CASSETTE DECK

The auto-reverse tape deck has well placed and reasonably marked transport controls, with manual tape type selection switch on playback only. A 90 minute tape was rewound in 2 minutes 39 seconds, which is about par for the group.

TUNER

This four band tuner uses a fairly unconventional but effective rotating dial system, operating under a stationary cursor, and giving an accurate readout of frequency on all bands. A reasonably wide edgways tuning knob makes for fluent dial rotation, and a thinner fine tuning knob helps find stations on the more cluttered wavebands. The FM mono/stereo switch features an ambience position, the dubious effects of which are noted below.

HOW IT SOUNDS

Five and a half inch loudspeakers in plastic cabinets have never been noted for their ability to reproduce bass, and those fitted here are no exception, the sound being notably free of low bass. The ambience function admittedly gives a wider sound spread, but also pushes the mid-range forward and produces an incoherent 'phasey' effect.

CD came across well when playing street style soul and funk music, showing good rhythm and a 'bouncy' feel. Tracks which stretched the top end, however, got grainy and sometimes fierce. Orchestral pieces tended to sound 'congested', with uncomfortable high notes and poor reproduction of brass instruments. When plugged into the reference system things improved all-round, until the volume was pushed up to reveal a 'gritty' top end. With the right material the Panasonic sounded meaty and in control, if lacking the resolution of the Meridian.

Cassette playback was well above average for the group, sounding coherent and musical. Pre-recorded contemporary and classical music both came across well with no glaring inadequacies: even piano sounded quite natural. Recordings, although restricted to normal tapes, didn't muck up the original too much, only adding some hiss and losing a little bottom end 'slam'.

FM radio worked nicely, offering good sensitivity and reasonable sound quality. However, bandwidth on AM seems unnecessarily restricted, and medium wave consequently sounded muffled and bassy.

CONCLUSIONS

At £300 the Panasonic offers a reasonable selection of features, if a somewhat fierce sound quality on compact disc. However, its recording qualities make it a worthwhile proposition, radio was decent, and CD quite adequate on undemanding material.

DEFINITIVE PERFORMER...

Across the world the SME Series V precision pick-up arm is now the standard by which other arms are judged.

Holder of Japan's coveted Hi-Fi Component of the Year Award its performance is not an accident, its reputation not a market whim, but the predictable outcome of innovative design allied with more than a quarter of a century of high quality manufacturing experience.

Ownership of a Series V offers the serious audiophile or professional user deep and lasting satisfaction. Its development and many special features are described in a four-page colour brochure which we shall be happy to send you on request.

Among SME dealers specialising in Series V are:

- Absolute Sound & Video
- Acoustic Arts
- Audiocraft
- Audioscene
- Audio Excellence
- Audio T
- Beechwood Audio
- Doug Brady Hi-Fi
- The Cornflake Shop
- Graham's Hi-Fi
- Hampshire Audio
- Harrow Audio
- Hi-Fi Care
- Hi-Fi Corner
- Hi-Fi Experience
- Horns of Oxford
- Image Hi-Fi
- James Kerr & Co.
- KJ Leisuresound
- Lintone Audio
- Midland Hi-Fi Studio
- The Music Room
- Phonograph
- The Pinewood Music Company
- Radford Hi-Fi
- Reading Hi-Fi Centre
- Sound Organisation
- Sounds Expensive
- Spalding Electrical
- Stafford Hi-Fi Studio
- Studio 99
- Subjective Audio
- Telesonic
- Unilet Products
- Wilmslow Audio
- Zeus Audio



SME

The best pick-up arm in the world

SME Limited
Steyning, Sussex BN4 3GY
Telephone: (0903) 814321
Telex: 877808

SHARP WQ-CD15

SHARP ELECTRONICS (UK) LTD, SHARP HOUSE, THORP RD, MANCHESTER M10 9BE. TEL: (061) 205 2333

RECOMMENDED

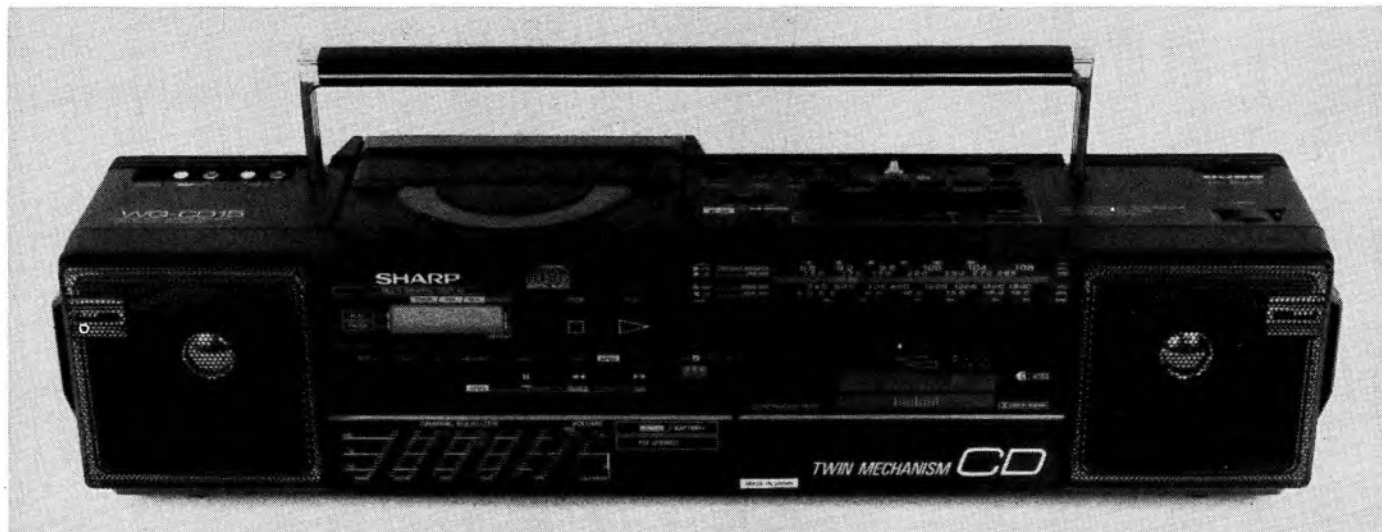

With its reasonably restrained black plastic finish, the *CD15* doesn't create a particularly strong impression for a £400 portable. Styling is lacklustre, but externals are on par with other Japanese plastic boxes. Overall, this is quite a neat machine, with its fairly novel twin cassette layout, and the four band graphic equaliser alongside the matching volume control.

Options available include phono sockets on top of the machine (all the better for absorbing dust) for a line level input and CD output; headphone and mike sockets are of the 3.5mm jack variety. The machine can be powered from the mains *via* its removable lead, or used in the car with optional 16 volt regulator. The street-wise will have to come up with ten *HP2* batteries, and will also have to be fairly fit as this baby weighs in at six and a half kilos dry, though it is also quite compact [15 x 62 x 20cm (h x w x d)].

CD PLAYER

The LCD display is fairly informative, giving track number and elapsed time in minutes and seconds, plus mode indication: play, pause, repeat, and a memory flag. The function buttons are not exactly touch sensitive, however, and the disc compartment door requires a little practise for precise closing in one go. On disc insertion the player needs a few seconds to work out and display the available tracks before it will undertake any commands. Programmable memory accepts a maximum of only nine tracks, which it can repeat in full; track skip and audible scan are also available.

CASSETTE DECK

This is a twin deck with a difference, inasmuch

as it has both cassette slots in the same fairly deep compartment. The door opens slowly (but sexily), for the newcomer to figure out where to put his cassette. The heads are side by side in the top of the cavity, and only the deeper of the two mechanisms has full record/replay capability.

The function buttons are shared by both, but tape 1 has play and stop functions only. Tape 2 is therefore most often used, and incorporates a mechanical counter, plus a programme search system for easier track access. Dubbing at normal or high speed is possible (though the latter is strongly discouraged on sound quality grounds). Manual tape type and Dolby select switches apply to both tapes simultaneously (which may prove a nuisance).

RADIO

Control layout for the radio is hardly rational, with all the function switches kept well away from the tuning dial. Once found, however, it does have a stereo/mono button on top rather than in the back like so many of these units, and an AM 'beat cut' function down amongst the tape switches. The dial itself is reasonably legible, but moving the cursor with the edgeways rotary knob is a slow and imprecise affair. The unit taps the airwaves with a 90cm telescopic extending aerial.

HOW IT SOUNDS

The overall sonic character of this portable is pretty lightweight, and is kept that way by a minimal amplifier (specified as 15 watts RMS but not sounding much like it), and four-inch loudspeakers.

CD proved quite smooth and reasonably informative, though struggling a bit on orchest-

ral transients. On rock programme it maintained good rhythm and an easy, enjoyable presentation; even bass guitar and drums came through, albeit an octave or two too high. Using the CD output to play discs through the reference system proved a revelation, with the Sharp giving surprisingly little away to the Meridian *MCD Pro* used for reference. At higher volumes it sounded slightly grainy in the treble and lacking authority in the bass, but was revealing and musical overall.

Cassette performance was less impressive. Pre-recorded playback sounded a bit rough but was reasonably informative. Orchestral pieces were messy but painless, and Dolby worked reasonably well. Record/replay on normal tapes produced a coarse but lively version of the original, while chrome tapes proved smoother but were still unimpressive. Dubbing at normal speed resulted in a big loss of resolution, and a general musical 'softening'.

Radio reception proved above average for the group, albeit with an annoying hiss in stereo. FM sensitivity was good enough to pull in several foreign stations (from near the South Coast), though not with adequate quality. MW sensitivity was quite good, but the audio bandwidth seemed unnecessarily restricted, with the treble heavily rolled off. Long and medium waves were about average, which translates as pretty poor.

CONCLUSIONS

Only when using the CD player section into a domestic system can one see where the money has been spent on this otherwise rather unexciting machine. However, the Sharp's easy musical character nevertheless merits recommendation in its class.

SONY CFD-66L

SONY UK LTD, SONY HOUSE, SOUTH ST. STAINES, MIDDX. TEL: STAINES 61688

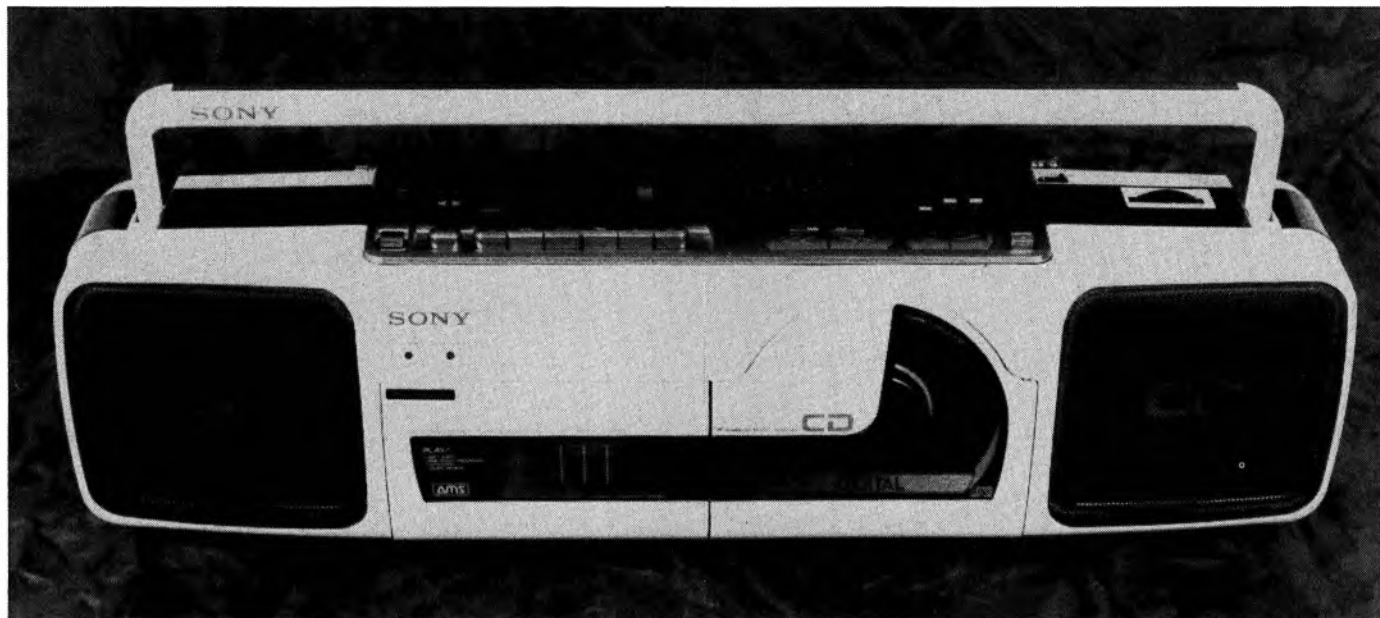

Possibly the definitive Designer Yuppie Blaster, this stylish Sony sets the visual standard by which others must be judged. Its white contoured edges and matt silver controls would look at home on the back seat of any Porsche. The general features include sliding volume and tone controls (which blend rather too well with the background), an appealing green headphone socket, and a power switch which also could have been more obvious. The rear of the machine seems rather too well vented: indiscriminately spilt coffee might cause problems.

The usual line-in and CD-out phono sockets are included, alongside a mixing mike jack. The only notable omission is of a balance control. Size and weight are fairly average at 16 x 58 x 15 (h x w x d), and 4.5 kilos excluding the eight HP2 batteries.

CD PLAYER

This is the only player in the group to feature 'shuffle play', which selects the tracks in a random order and will go on doing so for as long as required. A legible LCD display shows track, time, and player status, with optional remaining time at the press of a small blue button. Transport keys are ergonomic and well placed above the curved door of the disc compartment, though the door itself is a trifle flimsy. This player features all the usual functions, plus a 16-track programmable memory.

CASSETTE DECK

Following the line of the CD door, the deep cassette compartment opens and closes with con-

siderably more aplomb than its neighbour. This auto-reverse unit has neither counter nor (more seriously) Dolby, but a tape search system called AMS will locate individual tracks on appropriately laid out tapes. The manual tape type selector applies to playback only, so presumably only Ferric Type 1 tapes can be recorded accurately (and without Dolby to boot). Also featured are a direction change button which only works in play mode, and record mutef for making AMS-ready recordings.

TUNER

This tuner is unique in the group in having five shortwave bands as well as FM, long, and medium wave, which could be useful on the yacht or down the time-share. Spreading this usually jam-packed spectrum over five bands makes location of individual stations considerably easier. Placement of tuning controls is pretty good, except for the FM stereo/mono switch which is hidden at the back of the unit. The tuning dial is flawed in that the quarter-inch blank cursor is a whole inch away from the long and medium wave bands; this is partly due to the shortwave bands in between, but could have been more rationally arranged.

HOW IT SOUNDS

Stereo presentation is the *forté* of this player, but its shortcoming is a lack of real bass – not unusual amongst four-inch plastic mounted loudspeakers.

Compact disc replay was better than usual. Coherent and informative, if tonally 'light-weight', it was one of too few players to cope

well with the subtlety and detail of some classical pieces. When comparisons were made in the reference system, the Sony sounded slightly 'harder' and less interesting than the *MCD Pro*, but the top end came across nicely (an all too rare trait), and the overall feel was pretty slick. One annoying glitch was the amount of high pitched noise coming from the disc drive, which is quite noticeable at low levels.

Replay of pre-recorded tapes was not too hissy despite the lack of Dolby noise reduction. On operatic material female vocals sounded almost natural, with good air and headroom; more complex passages, however, were less clean cut. Recordings made on the machine were less impressive, being quite hissy and losing a lot of detail.

The tuner gave good RF performance, but was slightly let down on the audio side. However, vocals were only slightly 'plummy', and both classical and pop music sounded fairly clear, though not outstanding. Stereo to mono muting worked well on FM, but skirt selectivity was poor. Medium wave reception is quite clean, sensitivity was average, but the sound was rather boomy.

CONCLUSIONS

If you are style conscious then there is little competition for this very attractive player. If not the strongest musical contender in the bunch, it is a good, competitively priced all-rounder. And I for one won't mind if Sony don't collect it too quickly.

♪ **ADVICE, SERVICE, MUSIC** ♪

for

OVER 50 YEARS

Agents
for:-

A & R CAMBRIDGE
AIWA
AUDIO RESEARCH
AUDIOLAB
CELESTION
CREEK
DENON
DECCA
ELITE
EPOS
EXPOSURE
HEYBROOK
JPW
KEF
LINN
MARANTZ
MISSION
MONITOR AUDIO
MORDAUNT SHORT
MUSICAL FIDELITY
NAIM
QUAD
REGA
ROTEL
SNELL
SYSTEMDEK
TANNOY
WHARFEFALE

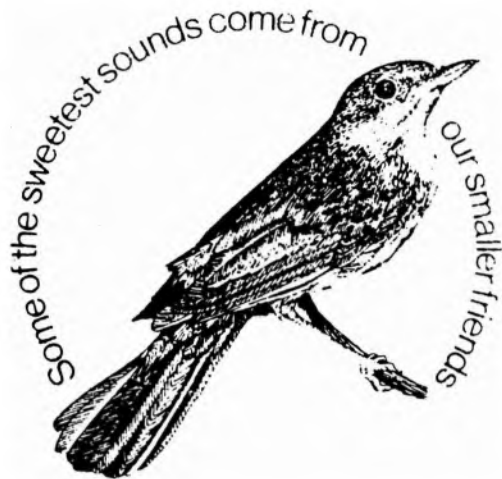

from

**Jeffries
Hifi**

4 ALBERT PARADE - GREEN STREET - EASTBOURNE - (0323) 31336
69 LONDON ROAD - BRIGHTON (0273) 609431

now with 3 separate demonstration rooms at each shop
CLOSED MONDAYS. LATE NIGHT WEDS - 8 p.m.



THE BEST OF THE BEST IN EAST ANGLIA

LEVEL THREE

**AUDIO RESEARCH, COUNTERPOINT,
KOETSU, KRELL, SME, APOGEE, MAGNEPLANAR,
ORACLE, P.S., AUDIO, SICOMIN, SILTECH.**

*Simply ask for
Steve, Alex or Alan*

*Steve
Boxshall*
AUDIO

A MEMBER OF BADA

41 VICTORIA ROAD, CAMBRIDGE : (0223) 68305

setting the standard in loudspeakers.....

Rogers

310 COMMONSIDE EAST, MITCHAM, SURREY CR4 1HX. Tel: 01-640 2172

BRITISH HIGH FIDELITY

Visit one of our dealers listed below to hear the Recommended **LS2** and the Best Buy **LS6** plus our new **LS7t** and **Studio 1A**. Find out why we set the standards.

BRISTOL
CAMBRIDGE
CHANDLERS FORD
CHELMSFORD
CROYDON
EDINBURGH

Radford Hi Fi, 52/3 Gloucester Road
Steve Boxshall Audio, 41 Victoria Road
Hampshire Audio, 8/12 Hursley Road
Rayleigh Hi Fi, 216 Moulsham Street (on the Parkway)
Spaldings, 352/4 Lower Addiscombe Road
Hi Fi Corner, 1 Haddington Place
In Hi Fi, 63 George Street

GLASGOW
HUDDERSFIELD
LEEDS
LEICESTER
LIVERPOOL
LONDON W1
LONDON W1
LONDON W2
LONDON W5
LONDON NW6
LONDON SW19
NEW MALDEN
MANCHESTER
RAYLEIGH
READING
ROTHERHAM
SEVENOAKS
SHEFFIELD
SOLIHULL
WARRINGTON
WATFORD

The Music Room, 221 St Vincent Street
Huddersfield Hi Fi, 4 Cross Church Street
Audio Projects, 45 Headingley Lane
Alpha Electronics, 1 Guildhall Lane
W.A. Brady, 401 Smithdown Road
Telesonic, 92 Tottenham Court Road
K.J. Leisuresound, 48 Wigmore Street
Thomas Heinitz, 35 Moscow Road
Ealing TV & Hi Fi, 4 The Paddocks, Popes Lane
Studio 99, Fairfax Road, Swiss Cottage
M. O'Brien Hi Fi, 95 High Street, Wimbledon Village
Unilet Hi Fi, 35 High Street
The Music Room, 50 Bridge Street
Rayleigh Hi Fi, 44a High Street
Reading Hi Fi Centre, 6 Harris Arcade, Friar Street
Moorgate Acoustics, 2 Westgate
Sevenoaks Hi Fi, 111 London Road
The Audio Centre, 284 Glossop Road
Alternative Audio, 95 Hobs Moat Road
Doug Brady Hi Fi, Kingsway Studios, Kingsway
Acoustic Arts, 101 St Albans Road

SWISSTONE ELECTRONICS LIMITED

310 COMMONSIDE EAST, MITCHAM, SURREY CR4 1HX. Telephone: 01-640 2172

O'BRIEN hi-fi

QUALITY EQUIPMENT ON DEMONSTRATION ON MOST OF THE BEST BUYS



ROYD A711



CASTLE DURHAM



HEYBROOK HB1R

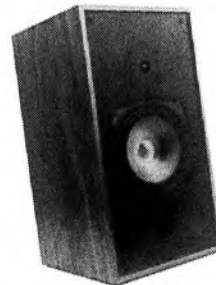

ROGERS LS6

FAMOUS NAMES IN HIGH FIDELITY EQUIPMENT FROM A&R • CAMBRIDGE • AR • BEARD • CAMBRIDGE AUDIO • CELSTION • DENON • DUAL • GLATZ • HADCOCK • HARMON KARDON • HELIUS • HEYBROOK • HITACHI • KEF • LINA • LOGIC • MARANTZ • MICHELL • MORDAUNT SHORT • MERIDIAN • MISSION • MUT. ROSE • NYS • NAKAMICHI • NY TECH • OAK • ORTOFON • PINK TRIANGLE • QUAD • OED • REVOLVER • REVOX • ROGERS • ROTEL • SONY • SUPEX • SYRINX • TECHNICS • THORENS • YAMAHA

95 HIGH STREET, WIMBLEDON VILLAGE, LONDON, S.W.19. 01-946 0331
 • CREDIT FACILITIES (Trinity Finance APR. 38.4%. Written details on request) • SERVICE FACILITIES • ACCESS/BARCLAYCARD
 • FULL ORDER & EXPORT SERVICE • Opening Hours: Tues-Sat 9-5.30.

HI-FI MARKETS
 The place where people care about hi-fi.

TOSHIBA RT-7096

TOSHIBA UK LTD, TOSHIBA HOUSE, FRIMLEY ROAD, CAMBERLEY, SURREY. TEL: (0276) 62222



The sloping top face of this Toshiba gives it some novelty appeal whilst sensibly prohibiting the superimposition of coffee cups and foaming cans. The removable speakers are unusual in featuring upward-facing passive bass radiators, and unique to this group in their chipboard construction. A fair part of the substantial 8.5 kilo weight is attributable to this sonically favourable factor.

General controls include small rotary volume and balance knobs which demand reasonable manipulative dexterity, an even smaller five-band graphic, and a simple function switch. The 1.1 metre speaker cables hook up to the main unit *via* spring clips, which gives the option of using alternative loudspeakers, and line in and CD out phono sockets are also fitted. Main dimensions are 23 x 66 x 19cm, but the sloping top makes for slightly less of a lump than usual.

CD PLAYER

A rather minimal collection of control buttons cover most of the usual functions. However, unless specifically programmed, play will only start on the first track, after which it is possible to skip but not scan tracks. Perhaps more irritating is the need to press stop twice in order to bypass the pause mode. That said, the disc door works well, the LCD display is more informative than usual, while the sixteen track memory and good general layout help make up for the aforementioned inconvenience.

CASSETTE DECK

This fairly innocuous twin deck machine has one record/playback transport and one MQSS deck, the latter a gap searching system which

locates specific tracks on pre-recorded tapes, as well as appropriately spaced home recordings. MQSS itself stands for 'music quick selector system' which has more than a hint of oriental sloganeering about it. Synchronous playback and high speed dubbing functions are available, but Dolby has unfortunately been omitted. Last, but far from least, is the automatic tape type selector – a very rare and convenient facility.

TUNER

The rather cramped vertical dial has been optimised for short and long waves, FM and medium wave bands being placed away from the rather obscure cursor. Tuning by frequency is very vague and easier by ear. However, the tuner does have both its stereo/mono and AM 'beat cut' switches on the front, rather than hidden in the back.

HOW IT SOUNDS

The construction and design of the removable loudspeakers gives this player some bass, and hence a bit of tonal credibility. However, the comments regarding on- and off-axis listening made about the big Hitachi apply even more to this unit. Sat on the floor, the output from the passive bass radiators tends to dominate that from the forward facing fullrange cones. The best tonal balance was achieved with the speakers detached and a little below ear level. The wide stereo function created an increased sound spread at the expense of even worse imaging.

The sound quality available off compact disc failed to make the average grade for this group of players; in other words it was disappoint-

ingly mediocre. Classical material was poorly resolved and very unconvincing, but simpler jazz tracks didn't sound too bad. This player seemed to prefer playing the beat rather than the tune, and is out of its depth with complex passages. Tried through the reference system the acoustic image was a bit clearer and altogether more palatable, though one got the impression it was rolling off quite early in the treble.

The above average quality of the speakers seemed more obvious when playing cassettes, and pre-recorded material fared quite well. Hiss levels were irritating on music with quiet passages, but not so noticeable of course on rock material. Some Kiri te Kanawa tracks came across better than other decks, and the difference in the standard of pre-recorded tapes was also more evident. Playback of recordings made on normal tapes was pretty good, and only slightly 'thinner' than the original. Chrome tapes gave better noise levels but a rather 'smeared', 'shut in' sound, while metal tape made a distinct improvement, sounding open and fairly quiet.

Radio listening revealed no major audio flaws, but FM worked poorly with weak signals and medium wave was dogged by annoying whistling. The overall performance was in the thirty pound wireless ballpark.

CONCLUSIONS

Offering a fair array of features (including some bass) at a well below average £250 price tag, perhaps inevitably the sound quality from CD is also cheap. But the 7096 as a whole is plausible enough if your musical tastes are pop oriented.

ANDREW THOMSON

Specialist in Hi-Fi

97 Shandwick Place, Edinburgh
Tel: 031 2283907

6-8 Bonnar Street, Dunfirmline, Fife
Tel: 0383 724541

3 Whyte Causeway, Kirkaldy, Fife
Tel: 0592 205997

Aylesbury Hi-Fi

Buckingham's specialist for all that is best in Hi-Fi.
Interest free credit — also available for mail order.

Aylesbury Hi-Fi

98 Cambridge St, Aylesbury, Bucks
Tel: 0296 28790



Hi-Fi Specialists

- A&R
- B&O
- Castle
- Dual
- Mission
- Aiwa
- B&W
- Denon
- Marantz
- Monitor Audio

- Mordaunt-Short
- Musical Fidelity
- Nakamichi
- Pioneer
- Philips CD
- Quad
- Rogers
- Rotel
- Revox
- Sony
- Spondor
- Tanhoy
- Technics
- Thorens
- Trio
- Yamaha etc.

Two-year guarantee
Private listening room
Excellent comparator demonstrations

54 Chapel St., Chorley, Lancs.

Telephone (02572) 71935

MANDERS HI-FI LTD

For Nakamichi, Quad, Dual, Hafler, Luxman, Denon, Revox, Sansui, Harman-Kardon, A+R, Thorens, Sondek, QED, Spondor, Technics etc.

2 Edward St, Grimsby, Humberside
0472-51391



Appointed stockists of A&R Cambridge, Denon Castle, Celestion, Creek Audio, Goldring, Kef, Linn, Mordaunt-Short, Naim, Quad, Rega, Rogers, SME, Nakamichi, Ackroyd, Tannoy

40 Little London, Chichester, W. Sussex
Telephone 0243 776402
(Closed all day Monday)



About Sound
Hi-Fi Specialists

MUSICAL FIDELITY THORENS **Sansui** CAM AUDIO Monitor Audio
Yamaha Audio Innovations **AKG** **Carson** **REVOX**
Ortofon **Rogers** **John Bowers** **TOP TAPE DEALER** **MANTRA**
ALPHASON **QUAD** **real British Hi-Fi**

demonstrations by appointment

116 BOLD STREET, LIVERPOOL L1 4JA
Telephone: 051-709 4865

ISLAND COMPACT DISC & HI-FI CENTRE 0624-815521

• WHARFEDALE • CELESTION •
• SUGDEN • HARMON KARDON •
• A&R • JBL •
• LUXMAN • PHILIPS •
• BEYER DYNAMICS • MUSICAL FIDELITY •
• TEAC •

TEL: (0624) 815521

PARLIAMENT SQUARE, RAMSEY, ISLE OF MAN

OPENING TIMES MON-SAT 9-5.00PM

DEM FACILITIES



ROTEL



DENON



Norman H. Field

Hi-Fi

Technics

ALBANY HOUSE,
HURST STREET,
BIRMINGHAM B5 4BJ
Telephone: 021-622 2323

YAMAHA

HI-FI MARKETS
The place where people care about hi-fi.





AR, ADC, AIWA, AKAI, CELESTION, CAMBRIDGE, ARISTON, B&W, BOSE, CASTLE, DENON, DBX, DUAL, ELITE ROCK, HAFLER, HARMON KARDON, HEYBROOK, JBL, JVC, KEF, KENWOOD, LOGIC, LUXMAN, MONITOR AUDIO, MORDAUNT-SHORT, MUSICAL FIDELITY, MYST, MARANTZ, MICHELLE, NAD, NAGAOKA, NAKAMICHI, ONKYO, PIONEER, PROTON, PHILIPS (CD), QED, QUAD, REVOLVER, ROTEL, SPENDOR, TANNOY, T&A, TEAC, THORENS, WHARFEDALE, YAMAHA.

- CREDIT CARDS WELCOME • CAR-PARKING
- MAIL/TELEPHONE ORDERS • INSTANT CREDIT UP TO £1,000

**45 HIGH STREET, HOUNSLOW, MIDDLESEX
TEL: 01-570 7512**

sound advice
RETAILERS OF QUALITY
HI-FI EQUIPMENT



Where the good sounds come from!

SOUND ADVICE THE SOUND FACTORY DUKE ST LOUGHBOROUGH LE11 1ED TELEPHONE: 0509 218254
SOUND ADVICE 162 ALCESTER RD MOSELEY BIRMINGHAM B13 8HS TELEPHONE: 021 449 3328

NAIM LINN ROKSAN A & R REGA MONITOR AUDIO
EPOS ROTEL CAMBRIDGE AUDIO MISSION YAMAHA

OVER 2000 COMPACT DISCS IN STOCK

YAMAHA CAMBRIDGE NVA QED ROGERS REVOLVER DENON B&W TDL ETC



SOUND WAVES

HIGH FIDELITY MUSIC SYSTEMS
3 MARKET PLACE, MACCLESFIELD
Macclesfield (0625) 615740

All Hi-Fi Bought!
We buy or exchange ALL 2nd hand Audio & Video equipment. Everything accepted in ANY condition — absolutely NOTHING refused!

MUSIC & VIDEO EXCHANGE
56 Notting Hill Gate, London W11
Open 7 days 10am-8pm
Tel: 01-727 0424

Public Warning No. 4

THE ONLY HIGH IN HIGH END AUDIO IS THE PRICE

Let's be honest, we don't know why a properly designed moving coil cartridge usually sounds superior to other types (now, there's refreshing candour for you). But it can, and that's why we market no others. Oh, to be sure we can offer a number of hypothesis. We can talk glibly about magnetic hysteresis and much lower susceptibility to loading conditions, which are contributing factors. It all sounds impressive but not very convincing. Frankly, it is impossible to identify one important factor.

But what we are sure of, is that the fancy prices being asked for some m.c. types are outrageous and a waste of your money. Electrically and mechanically, the internal differences between a modestly priced New Mayware MC-7V-111 and those costing up to four figures, are likely to be insignificant.

So before you launch out on a new cartridge, seriously consider our fine range including our high output 2.5 mV model which a £5000 preamplifier, considered the best by the synthetic gurus of the Press would not accept. Astonishingly, the phono stage was not unconditionally stable, that's an essential pre-requisite for any preamp. Our cartridges will sound at their best in our elegant new silicone damped virtually aperiodic FORMULA V unipivot tonearm for minimum record wear. And if you lean towards the low Z cartridge, then you ought to consider also our unique wideband multi-ratio transformer that needs no tapping changes. Mayware products are superbly designed and reproduce sound much like the mastertape, without having to sell the family silver.

SAE please for interesting details, professional review and copies of our other Public Wealth Warnings that some Hi-Fi magazines do not want you to read.

Mayware Ltd., PO Box 58, Edgware, Middlesex HA8 7UE
Telephone: 01-958 9421

Published in the interests of a revival of competence and ethical standards in Hi-Fi.



CELESTION SL6S



MORDAUNT-SHORT 442



ROGERS LS7Ti

Other agencies include:

A&R • AIWA • AUDIOLAB • AUDIO TECHNICA • BEYER • BURMESTER • CELESTION • CREEK • DENON • DUAL • ELITE • EXPOSURE • FOUNDATION • GOLDBUG • GOLDRING • GRADO • GALE • HEYBROOK • KOETSU • KRELL • LINN PRODUCTS • LINX • MAGNEPLANAR • MERIDIAN • MISSION • MICHELL • MONITOR AUDIO • MORDAUNT SHORT • MUSICAL FIDELITY • MYST • NAGAOKA • ONIX • ORTOFON • PHILIPS • PINK TRIANGLE • QUAD • REGA • ROGERS • ROTEL • SENNHEISER • SME • SUPEX • SYSTEMDEK • TANDBERG • TARGET • YAMAHA • WHARFEDALE • ZETA

KEITH MONKS RECORD CLEANING SERVICE AVAILABLE

Reading Hi-Fi Centre

READING HI-FI CENTRE,

6, HARRIS ARCADE, FRIAR ST., READING, BERKS. RG1 1DN.

TEL (0734) 585463

Tues-Sat: 9.30am to 5.30pm. (LUNCH: 2 to 3pm, EXCEPT SAT)

DEMONSTRATION APPOINTMENTS ADVISED!

Closed all day Monday

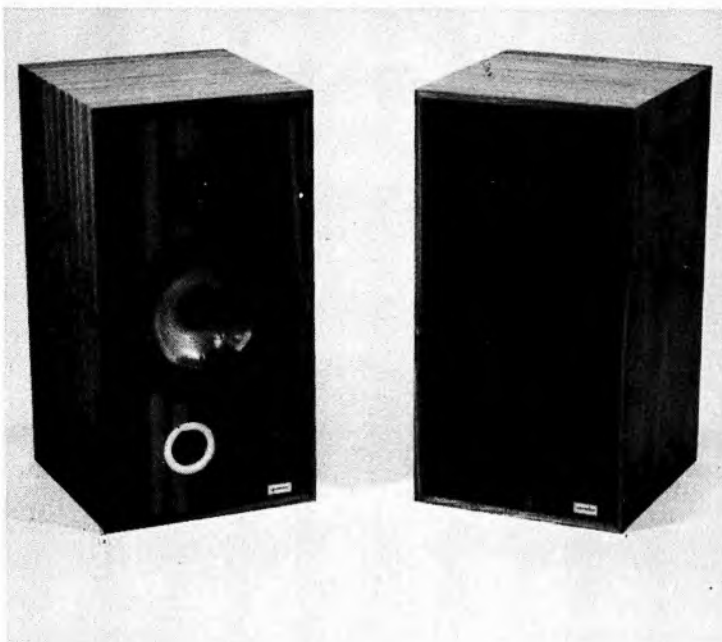

"Spendor now have their compact 30 litre monitor. Offering great consistency and accuracy, it slots in neatly below the SP1, conceding little to that respected larger model. With its natural extended response, low colouration wide dynamic range, easy amplifier loading and very fine stereo, the SP2 is a classwinner and is strongly recommended."

HiFi Choice 1985

"The SP2 is of true monitor quality and does a skilful job in revealing program quality and content, be it good or ill. Furthermore the lab results were highly favourable, particularly in view of the fine forward response uniformity. Its intended sensitivity make it a very good all-rounder, setting, I feel, a new reference standard for this price range."

HIFi News April 1985

spendor
audio
systems

The spendor SP2 compact monitor
'building on success'

Station Road Industrial Estate, Hailsham, Sussex.

tel 0323 843474

SYSTEM BUILDING

Pre-packaged one-make systems have been commercially very successful, with advantages like cosmetic consistency, competitive pricing, and (assumed) technical compatibility. However, despite the mass market clout of the consumer electronic giants, the hi-fi tradition of specialised separate components seems as strong as ever, and certainly represents the route taken by those who place sound quality ahead of other criteria.

Yet those who choose the separates route still have lingering doubts – usually completely unjustified – over the compatibility of components from different manufacturers. Gross incompatibilities are very rare nowadays, only likely to rear their heads amongst the most exotic components such as valve gear or second-hand items, and unusual even here. Meanwhile the subtle 'fine-tuning' of component matching is almost exclusively the preserve of the specialist, and a major reason for the superior sound of the well chosen separates system. Indeed, the delicate art of 'supercompatibility' really takes over the major role at a 'super-fi' level, and might be regarded as the key to 'real' hi-fi.

Superficially the pre-packaged system offers better value, purely in terms of the features available for the price. But the buyer who takes the trouble to analyse his or her needs and preferences will often come to the conclusion that step-by-step building of a separates system will provide greater long-term satisfaction, giving flexibility for future upgrading if so desired.

A QUESTION OF PRIORITIES

The key advantage of separates is the opportunity to choose one's own preferences as priorities. Taking the trouble to try and establish these, leads most people to give up, assuming that they don't know enough even to start. But the process needn't be that difficult.

Begin by establishing whether you like to choose your own music, or have it chosen by someone else. This helps sort out what priority should be given to radio, but bear in mind that the best radio music is live radio music, which is very rare and often quite esoteric;

when radio is merely an alternative source of pre-recorded material, the results will inevitably be inferior to those obtainable directly from the same source in the home, given a reasonably decent hi-fi.

There are now three different pre-recorded music media competing for the attention of the hi-fi user, and to go for all three will either cost a lot of money or involve substantial compromises in the sound quality of each. For this reason many separates purchasers may start with just one source, adding others or a radio tuner when funds permit.

There will always be controversy over the relative qualities of LP, CD and cassette, with earnest protagonists often trying to advance their prejudices by rubbishing rivals. LP is still the choice for ultimate sound quality – particularly for those prepared to spend a substantial sum on a good quality turntable system. Furthermore the vinyl repertoire is still the cheapest, largest and most varied, especially if one acknowledges a secondhand market extending back 30 years. However, LPs remain tied to the home, are prey to warps and surface noise even when purchased new, and do not survive rigorous physical abuse at all happily. Though bulky and heavy to store, the 12-inch cover has been turned to good use for artwork and liner notes, creating a pride of ownership somehow un-matched by CD or musicassette.

Cassette has never really challenged vinyl's potentially superior quality, but it is a multiple role format, offering 'go anywhere' flexibility, a uniquely useful recording capability, plus a broad catalogue of pre-recorded musicassette material. Although there are several potential rivals for recording from radio or pirating copyright material, the cassette still wins on convenience and compactness, though the sudden rise in popularity of double mechanism 'dubbing' decks remains mysterious. As a hi-fi medium cassette suffers from pre-recorded material which has been improving but is still patchy in quality, and can usually be bettered by a home recording, while any such home recording is inevitably poorer than the original. There is also the worry that a tape made on a specific machine

usually replays best on that machine, which may cause aggravation when upgrading a few years hence. Though such opportunities are rarely possible or practical, a live recording onto cassette using good quality microphones can be the hi-fi equal of any other source.

CD is the new challenger to these two established media, using a digital instead of analogue storage format. The sound quality remains controversial, hailed as near perfect by its fans but derided by vinyl freaks, so it is probably fairest to say that CD is fine for most listeners, but may not suit everyone; certainly the lack of background noise, defects and deterioration over time are major strengths. Player prices are still on the high side (typically £200), but dropping. However, disc prices are still nearly twice those of LP and cassette, (they're expected to drop in the New Year) which is a significant disincentive for the music lover who is effectively starting from scratch. A major influence over signal source priority will be how many LPs, tapes and CDs a person already owns. To replace even the key items of a large LP collection with CDs will cost a great deal of money.

A MATTER OF PRECEDENCE

While there will always be arguments about the different music storage and transmission formats available to the hi-fi listener, there is also controversy over the relative importance of the different components which make up the system chain – by which is meant the source, the amplification, and the loudspeakers (and for the pedantic the room itself, though there's often little that can be done).

For many years the 'weakest link' theory proposed that the loudspeakers needed the most attention, that amplifiers merely had to have sufficient power, and that turntables were pretty well perfect. Recently, however, this perspective has become steadily discredited by an alternative 'theory of precedence', which stresses that no subsequent component can make up for the inadequacies of its predecessors – all it can do is supply its own additional degradations. In such a

context it is not uncommon to find more than half the system budget allocated to the record player, with scrimping and saving made on amplifiers and loudspeakers, even though these are used all the time whatever the source. And such an argument applies just as strongly to those who wish to record their LP records on to cassette, for convenience and use elsewhere.

MAXIMISING POTENTIALS

Choosing the components of a system is only part of the task of getting the system as a whole working as well as possible. Good turntables and loudspeakers both benefit to a surprising degree from proper support – from stands that enable them to give their best performance, whether floor-standing or wall-mounted. Just lining the components up along a shelf or sideboard is a recipe for mediocrity, however much has been spent on the individual components themselves.

Siting of components within a room can play a significant role, as can the room itself. Some people may prefer an acoustically more 'live' room than others, but most will agree that the larger it is the better, because this tends to provide smoother and better extended bass reproduction. All rooms create reflections and standing waves, and the effects of these are more severe if all opposing walls are parallel, similar distances apart, and with hard reflective surfaces. Provided that the loudspeakers can be placed fairly symmetrically, slight asymmetry elsewhere in the room is usually helpful. Though it is not really practical to move the walls around (and stud type walls behave differently from brick ones in any case), the odd strategically placed wall-hanging, say above a fireplace, can work wonders in removing an unpleasant 'flutter echo' effect, while a decent carpet is almost mandatory. 'Live' rooms are usually those that are sparsely furnished with hard wall coverings, so the overall live/dead acoustic balance can often be modified according to the furniture (or even the number of people) present.

The loudspeakers are most critical of placement, because it is their job to create the stereo image, and it will be impossible to

do this if the sound from each is not roughly similar at the listening position. Each loudspeaker should operate in a similar immediate acoustic environment, unencumbered by other furnishings and structure, and a similar distance from listener, nearby walls, and corners. Some loudspeakers will be designed to operate close to a rear wall, others a metre or so out into the room, but all loudspeakers seem to benefit from being closely mechanically coupled *via* proper stands to the floor.

There is some debate about the best form of fixing, and in some instances the floor resonances themselves can become excited, particularly if a single concrete casting, and this may cause undesirable side-effects. However, adjustable spikes through to the floor proper or seated into the tops of cross-head screws are generally regarded as the best solution in most circumstances, and seem to give the best rigidity. Some speakers will work best with another set of spikes operating upwards into the loudspeaker itself, but small pieces of Blu-tack are a popular alternative. There is no need for paranoia about using spikes through normal pile carpets

because the holes will be almost impossible to find when the stands are removed, but polished wooden floors do present a problem here, and hard plastic studs may be the only satisfactory solution.

Most decent quality turntables are fairly immune from feedback from loudspeakers, so it should not matter too much if these items are sited fairly close to each other. Indeed it is debatable whether any advantages gained from keeping the turntable well away are not lost through the need to use longer connecting cables. Turntables are usually susceptible to footfall shock, so one solution may be to use a wall bracket, but these do not sound as good as a floorstanding table as a rule. It may sound unlikely, but amplifiers and CD players (and presumably cassette decks too) can also benefit sonically from carefully stand- or bracket-mounting in a high quality system.

Mixing and matching the components of a record player to get optimum results can be something of a black art, over and beyond the fairly simple business of choosing a cartridge of roughly the right compliance to suit the arm effective mass. Certainly the combining of turntables and tonearms is not a simple matter,

and this is where a good specialist dealer will come into his own, both in terms of recommending good combinations from the models he holds in stock, and then in correctly carrying out the sometimes tricky set up procedures which are often required to get the best results.

Getting the best from a cassette deck is usually a question of making sure first of all that your deck does a decent job of replaying a good quality musicassette, and then finding out which tapes in the different price groupings give the best record/replay performance. The most common problem with cassette decks is in their alignment: matters are better than they used to be a few years ago, but both dealer and customer will need to be on their guard against poorly aligned machines. Tuners can occasionally suffer similar problems, though this is even more unusual; most radio difficulties are likely to come from an inadequate or inappropriate aerial, after skimping on the less glamorous part of the budget. CD players have fewer consistency problems than analogue systems, though it is mildly ironic that they too seem to derive some sonic benefit from spiked stands or

tables in a high quality system, and a poorly aligned machine may give poor disc tracking

THE FINAL LINK

The key to getting the best results from a separates system lies in finding an experienced and skilled dealer in the first place. One who takes the trouble to find out what you really want and then demonstrate some likely alternatives, without trying to cram his own particular prejudices down your throat. To some extent the customer's task must be to discover for himself whether the dealer in question is competent or not. Membership of trade organisations like BADA can be a worthwhile pointer to a degree of professionalism, but the bottom line is whether the dealer in question can create a good sound in his own shop. If he can't, there is precious little chance of him doing so in your home. The best dealers should lay on demonstrations so you can hear the differences between components for yourself, and hear the sort of improvements which can be had at different price strata. You can then establish the sort of performance you are prepared to accept within whatever budgetary constraints you have set.

DIRECTORY

TURNTABLES & TONEARMS

The schizophrenic split between consumer electronics and 'real hi-fi' is most obvious amongst turntables. The former are supplied simply as a means of playing vinyl in a system context. Cheaply manufactured in the Far East, these former are complete players with a variety of automatic facilities, sometimes tied into system remote control. But engineering compromises severely limit sound quality, cartridge choice may be P-mount restricted, and such machines are rarely stocked by specialist hi-fi dealers these days.

Specialist turntables offer big sound quality

improvements, but lack so-called convenience features (that practised users often find irksome). Such turntables at the cheaper end of the market (sub-£350) tend to be supplied with matching tonearm, and often include a 'starter' cartridge. Still better quality is found at higher prices amongst the separate motor units and tonearms. Careful partnering and set-up is essential for these individual components, but 'naturally sympathetic' combinations do exist, and the good dealer can help.

Listed separately as integrated players and as turntable motor units and tonearms, our **sound**

quality rating is based on results achieved using a high quality system - but in point of fact the turntable is usually the limiting factor soundwise in any system. **Lab performance** summarises the speed stability, vibration generation and environmental isolation of turntables, along with the friction, alignment and adjustment of tonearms. The tonearm's physical characteristics also define a range of mechanically compatible cartridges (see cartridge listings).

NAME PRICE	LAB SOUND	COMMENTS	FEATURES ARM EFF. MASS	VALUE	BACKISSUE (S=SUMMARY)
Acoustic Research EB101 £220	Good Good+	This genuine high fidelity product offers an impressive package at a competitive price	Subchassis, manual, 13.5g	BB	48
Acoustic Research Legend £260 with arm	Good Good+	Fine all-round performance and good value though somewhat eclipsed in this respect by the cheaper EB101	Subchassis, manual, 13.5g		48S
Akai APA201 £80	Poor Average-	It 'lived down' to our expectations sounding 'dead' and 'smeared', with little depth and poor bass	Solid, auto return, direct drive, 5g P-mount		48
Ariston RD40 Q £295	Average+ Good	Worth considering for stylish appearance and decent performance, but undermined by RD60 in value for money terms	man/electric, belt drive, subchassis 11.5g		48
Ariston RD60 £200	Good Good	With the Enigma arm, this balanced and communicative turntable falls only slightly short of the RD90 on sound quality	Manual, belt drive, subchassis, 11.5g	BB	48
Bang and Olufsen TX2 £288	Average+ Good	Fully automatic, it can interface to B&O's remote control system, is attractively styled and even sounds respectable!	Automatic, belt drive, subchassis, 6g		48S
Dual CS5000 £200*	Average Average+	The rare 78 facility may give grandma's collection a new lease of life but the player did not merit recommendation on price vs sound	Electronic, belt drive, subchassis, 10g		48
Dual CS505-2 £125	Average Average+	A tuneful, lively, punchy sound - a little muddled in mid and treble but well suited to the supplied Ortofon cartridge	Semi-automatic, belt drive, subchassis, 10g	R	48
Dual CS505-2 Deluxe £1449	Average Average+	A small improvement in sound over the standard 505-2 was noticed here attributable to the better plinth	Electronic, belt drive, subchassis, 10g	R	48
Linn Axis £313	Good+ Good++	Setting new performance-for-price standards this cleverly engineered and competent deck has many of the qualities of the Sondek LP12	Electronic, belt drive, semi subchassis, 13g	EB	48/Coil
Logic Tempo/Datum II £240	Good Good++	The general character is lively and exciting, if a little full, with solid, clear open midband, and good stereo staging	Manual/electronic, decoupled plinth, 15g	BB	48
Lux PD290 £167	Average Average+	For the non-critical user who likes Lux styling and who requires a basic turntable	Semi automatic, direct drive, 10g		48S

DIRECTORY

TURNTABLES

NAME PRICE	LAB SOUND	COMMENTS	FEATURES ARMEFF. MASS	VALUE	BACK ISSUE (S=SUMMARY)
Manticore Mantra £300/£330 (Arm)	Good+ Good++	Fitted with a Rega RB250 arm variant and A195E cartridge the Mantra fared very well indeed with a fine midrange and good focus	Subchassis, 12g, manual	BB	48/Coll
Michell Synchro £300	Good Good	Fans of X-ray will like the see-through style of the green-tinted clear acrylic base. Respectable sound was delivered with the Rega RB 300 arm	Manual, belt drive, subchassis 12g		48
Mission 775LCT £200	Average+ Average+	Gives a tidy, coherent and well-integrated sound: a punchy performer if a bit bass light	Solid plinth, manual, 12g		48S
NAD 5120 £89	Average Average+	Offering near "Hi-Fi" quality on a suspended sub-chassis deck fitted with an Ortofon OM10 cartridge can't be bad	Semi-automatic, subchassis, 9g	BB	48
Oak/Moth £175	Average Average-	Despite the excellent Moth tonearm, motor vibration on the Oak makes for a sonically poor performer	Solid, manual, 12g		48
Oracle Alexandria £999	Good++ Good+	Generally supplied with the Prelude arm for the price of a lifetime's issues of Hi-Fi Choice this gave a well-liked sound and high performance	Belt drive, subchassis, 9g		48S
QED R232EM £199	Average+ Average+	A tight and tidy sound, the 232 proved decent and well-balanced, if lacking some weight in the bass	Optional electronic speed change, 12g	R	48
Rega Planar 3 £188	Good Good	A long time leader in its price category, the '3 (with its excellent RB300 arm) sounded nicely "musical" in a balanced and coherent manner	Integrated turntable, manual, 11.5g	BB	48
Rega Planar 2 £135	Average+ Good	A remarkable product at the price, surprisingly articulate and confident	Integrated turntable, manual, 11.5g	BB	48
Systemdek II £199	Good+ Good+	Rating above average for its price the 'II' sounded open and clear, if a bit soft in the bass	Manual/electronic, belt drive, subchassis, 15g	BB	48
Systemdek IIX £199	Good+ Good+	The more conventional appearance of the IIX has made it popular, performing competently, but essentially sounding similar to the II	Manual/electronic, subchassis, 15g	BB	48
Technics SL-DD33 £110	Average Average+	As with the DD33 though better value	Automatic, direct drive, solid plinth, 7.5g, P-mount	BB	48
Technics SL-L20 £115	Poor Average-	A rather lightweight parallel tracker achieving a poor overall rating, with little to recommend it unless you dig facilities	Electronic, solid plinth, 5g, P-mount		48
Technics SL-QD33 £140	Average Average+	The quartz speed controlled version of the DD is short on sound quality but not features. But it did have fair focus and some depth	Automatic, Quartz, direct drive, solid plinth, 7.5g, P-mount	R	48
Technics SLBD-22 £85	Average- Average	Not bad for the price and a great improvement on the L20, it performs reasonably when not stretched	Semi-automatic, solid plinth, electronic, 6g, P-mount	R	48
Thorens TD166III £174	Good Good	Old turntables never die; this revived 166 yet again takes its place near the top of its class	Auto lift, subchassis, 7g	BB	48
Thorens TD280 £155	Average Average+	Not impressive in the context of other Thorens models. The sound was considered lively if somewhat coarse and brash	Electronic, solid plinth, 12.5g		48
Thorens TD316 £219	Good Good+	A competent, well built if not dynamic sounding machine, ably holding its own in its price category	Electronic, subchassis, 4.5g	R	48
Thorens TD320 £314	Good+ Good+	The top of the range and a solid performer providing a stable focused sound, and not critical of siting	Electronic, subchassis 7g (available without)	R	48

MOTOR UNITS

NAME PRICE	LAB SOUND	COMMENTS	FEATURES	VALUE	BACK ISSUE (S=SUMMARY)
Ariston RD90 £300	Good Good+	Giving fairly good depth and focus this is a solid and well-engineered turntable	Manual, belt drive, subchassis		48
Audio Labor Konstant £2560	Good+ Very Good	The space-station-like solid alloy frame needs a substantial shelf, but absolute stability renders a confident, neutral sound	Belt drive, subchassis no arm	R	48/Coll
Heybrook TT2 £279	Good++ Good+	This well constructed and finished design has no great sonic failings but sounds rather conservative	Electronic speed (optional), subchassis, no arm	R	48
Linn Sondek LP12 £471	Very Good Good++	An established favourite. While not necessarily the most neutral, a very musical communicative nature accounts for its deserved popularity	Subchassis, no arm, single speed	R	48/Coll
Logic Gemini £700	Good Good	Innovative twin-motor design but insufficiently developed. Rates good overall but sounds a bit slow and lacking authority	Subchassis, electronic	R	48
Michell Gyrodec £595	Good+ Good+	Heavy engineering, fine finish, well priced	Manual, belt drive, subchassis no arm		48
Oracle Delphi Mk 2 £1500	Very Good Good++	If the enthusiast is looking for a beautifully made and finished (expensive) subchassis turntable he need look no farther than this	Belt drive, subchassis no arm	R	48
Pink Triangle PIT00 £539	Very Good Good++	A substantial improvement on its predecessor, the T00's new outboard power supply and motor gave a neutral sound with fine depth and detail	Electronic, subchassis, no arm	R	48/Coll
Roksan Xerxes £595	Very Good Good++	One of the most creative and innovative designs to emerge for some time, the Xerxes also proved itself to be amongst the best	Electronic, solid subchassis, no arm	—/R	48/Coll
SEE Revolver £127	Average Average	Nively balanced, but unimpressive timing and lightweight bass make this deck rather average for the price	Manual, solid plinth, no arm		48
Systemdek IV £448	Good+ Good+	Clarity and definition in the midrange and treble were outstanding. It was better for firm support; less happy on floor tables	Electronic, belt drive no arm		48S
The Rock £350	Good++ Good+	Clearly worth considering the Rock has its own unique strengths, decent engineering and good sound quality, the turntable itself offering good value	Electronic, belt drive, solid, no arm		48
The Source £849	Good++ Good++	A substantial, extremely well finished turntable with an open bass and easy, relaxed neutrality	Subchassis, belt drive, no arm	R	48
Zaruthustra Soliloquy £1995	Very Good Good++	Attractively designed heavyweight platform, offering very good sound quality but at a hefty price	Electronic, subchassis, belt drive no arm	R	48/Coll

TO NEARMS

NAME PRICE	LAB SOUND	COMMENTS	ARM EFF. MASS	VALUE	BACK ISSUE (S=SUMMARY)
Airtangent £1698	Very Good Very Good	This linear tracking air-bearing tonearm delivers the goods despite its extravagant price	7.5g (vert)	R	48/Coll
Alphason Delta £165	Good Good	A highly competent design from Alphason gives good sound quality but with slight blurring and treble fizz	16g	R	48
Alphason HR100S £359	Good++ Very Good	This S-shaped arm sounds smooth, but nevertheless reproduces transients with fine attack	10g	R	48/Coll
Alphason Opal £110	Average+ Good	The Opal is a well-designed and built tonearm with its own individual interpretation of good sound	10g	BB	48

DIRECTORY

TONEARMS

NAME PRICE	LAB SOUND	COMMENTS	ARM EFF. MASS	VALUE	BACK ISSUE (S=SUMMARY)
Alpha Xenon £210	Good+ Very Good	"...sonically solid overall control with firm sense of image-focus. The treble was clear and finely detailed the bass free from boom"	12.75g	R	48
Ariston Enigma £126	Average Average+	Good but not the best in its class: mid-band sounds a little uneven; treble a trifle "brash"	11.5g		48
Audio Technica AT1120 £132	Good Good+	This low effective mass (5g) arm suits fairly high compliance MM cartridges, gives pleasant tonal balance with good stereo imagery	5g		48S
Decca International £49	Average+ Average+	This uni-pivot design gives a rather rich tonal balance and some bass muddling. Could be good with Decca cartridges, but not well built	12g		48S
Eminent Technology £960	Good+ Good++	One of the best sounding tonearms around, the linear tracking Eminent delivers impressive stereo imagery, focus and transparent sound	9g (vertical)	R	48/Coll
Goldmund T3F arm £3850	Excellent Very Good	This complex parallel tracker created an "ear-opening" experience when tested with a (since updated) Goldmund Studio turntable	16.5g	R	Coll 2
Grace G707 £299	Good Good+	This venerable is still capable, if not competitive with modern alternatives	7g		48
Helius Orion 2 £490	Very Good Very Good	Very expensive but with a performance that merits recommendation	12g	R	48
Kusma £349	Very Good Very Good	A classic performance: solid and dynamic with exceptional bass weight and speed, if a little 'untidy'	14.5g	R	48/Coll
Linn Ittok LVII £399	Very Good Good++	Suitable for many turntables this top-quality arm performs best with the LP12, the combination exceeding the sum of both parts	13.5g	R	48/Coll
Linn LV Plus £129	Good+ Good	The fitted headshell provides an improvement over the LVX resulting in better clarity detail and punch	13g	BB	48
Logic Datum S £230	Very Good Good++	Rated sonically very good with fine depth focus and transparency, good air and life, albeit slightly 'untidy'	15g	R	48/Coll
Mission Mechanic £600	Good+ Good	Our "mechanic" tonearm didn't really make it at its high price, though it is clearly a potentially good performer	16.5g		48
Rega RB300 £90	Good++ Very Good	Despite its modest price this sets exceptional performance standards and could be used on a number of high-quality turntables	10-11g	BB	48/Coll
SME 3009 Series III £216	Good Good	Comprehensively adjustable and very well made, suited to MM and high compliance MC cartridges	5g		48
SME 3009 Series IIIS £156	Good Good	A simplified less flexible (as regards adjustment) Series III with a similarly 'soft' sonic character	5g		48
SME 3009R £272	Average+ Good	A higher mass version of the Series III designed for low compliance MC cartridges	12g		48
SME Series V £1138	Excellent Very Good	Excellent in terms of design engineering and sound quality, this arm arguably sets a new reference standard regardless of price	10.5g	R	48/Coll
Souther Tri-Quartz £850	Good+ Good	A unique parallel tracking arm that makes up for what it lacks sonically in its unusual appearance	3-4g		48
Well Tempered Arm £545	Good++ Good++	The overall performance of this arm "grows" on the listener, justifying the possible mounting complications and radical styling	6.8g	R	48/Coll

CARTRIDGES

Very much the 'slave' of turntable and tonearm, and to some extent undermined by the supply of free 'starter' cartridges on many turntable systems, the cartridge is still worth taking seriously. The quality of both the stylus itself and the cartridge's tracking performance are important in preserving that most important part of the hi-fi system - the record collection - and the cartridge also plays a significant role in determining the overall balance of a system.

Cartridges fall into two groups: high output models, capable of working directly into any amplifier, and more expensive low output models. Stereotypically, low output cartridges use the moving coil principle of operation, have better mechanical integrity and tighter tolerances, and give better performance but at much higher cost. Most under-£150 amplifiers and many valve designs need either an extra head amp or transformer to cope with the low output. **Cartridge/amplifier** interfacing

can be very subtle, but even basic high output moving magnet designs benefit in overall balance from optimised amplifier capacitance loading. Still more important, the mechanical cartridge characteristic of cantilever compliance ('springiness') needs to be considered in the light of the effective mass of the tonearm which will be used (see Turntable & Tonearm entries).

NAME PRICE	LAB SOUND	COMMENTS	ARM AMP MATCHING	VALUE	BACK ISSUE (S=SUMMARY)
A&R P77Mg £47.50	Average+ balance+Average	Cautiously recommended, the P77Mg was preferred to its cheaper partner by virtue of a better tip. Channel balance could have been better	4-9g Normal	R	48
A&R E77Mg £57.50	Average Average	Our sample had a disappointing stylus, but gave a coherent, rich and laid back sound, with good 'scale'	3-8g Normal	R	48
ADC TRX II £69.60	Average Average+	Comments like "fiercely exciting" treble and "plummy" bass made this cartridge seem overpriced, though price reductions now make it more competitive	6-15g Normal		48S
ADC TRX1 £49.90	Average Average	Sounding bright and "tinkly" but with a rich bass this model may endear itself to those who like canaries and gongs. Now quite competitively priced	6-15g Normal		48S
Audio Technica AT 115E £27.95	Average Average	Clear and detailed sound quality although a bit on the "heavy" side. Sonically lagged the cheaper 110E!	5-16g Normal		48S
Audio Technica AT 105 £13.95	Average Average	Tight budget people may enjoy this cartridge whose "overall performance was very good for the price"	6.16g Normal		48S
Audio Technica AT 140ML £99.95	Average Average	Pricey product this. Prefers low-medium mass arms and low capacitance loading, and is sonically unremarkable	6-12g Normal		48S
Audio Technica AT3200XEI £42.95	Average+ Average	This high output MC sounds better than it looks, with a decent 'laid back' sound quality	6-18g Normal	R	48S
Audio Technica AT33ML £238.95	Average+ Good	A little expensive but technically competent, and sonically pretty good, low output MC with rather garish gilt finish	6-16g Low		48S
Audio Technica AT95E £14.95	Average- Average	Clear, dynamic if richly balanced, the magnetic '95E is a definite Best Buy	8.14g Normal	BB	48
Audio Technica ATF3 £70	Average+ Good	Giving a big and generous sound, the ATF3 also has lively pace with good focus and depth, offering a near-ideal balance for the price	4-12g Low	BB	48/Coll
Audionote 102VDH £795	Good Very Good	One of the best, giving 'an extraordinarily relaxing midrange clarity' But it picked up a bit of surface noise and dust and needs a transformer	8-18g Very low (transformer)		48S
B&O MMC5 £21	Average+ Average	Cheapest in the family - smooth treble and good focus, but the bass was left in the wings	5-15g Normal		48S
B&O MMC2 £75	Good Average+	Only a modest improvement on its cheaper brothers (and sisters)	5-15g Normal		48

DIRECTORY

CARTRIDGES

NAME PRICE	LAB SOUND	COMMENTS	ARM AMP MATCHING	VALUE	BACK ISSUE (S = SUMMARY)
B&O MMC3 £50	Good Average	Slightly "laid back" sound quality but a good performer for the price. Best suited to B&O equipment	5-15g Normal		48
Bang & Olufsen MMC1 £97	Very Good Good	Great clarity and detail at high frequencies but a slightly plodding bass. It may appeal more to the classical enthusiast	5-13g Normal		48
Bang & Olufsen MMC4 £33	Good Average+	Solid and well balanced in the midrange, the '4 again lacks bass impact	5-15g Normal		48
Cello Chorale £799	Good Very Good	Looking like a piece of NASA gadgetry the Chorale's transparent treble delicacy was without equal. A serious audiophile choice	4-10g Low o/p	R	48/Coil
Decca Maroon £109	Poor Average+	Utterly different from other cartridges, the Maroon combines Heaven and Hell with good bass and midband but poor top-end control	8-16g + damping Normal		48
Decca Super Gold £248	Average— Good+	Sometimes a bit fierce in emphasising record surface faults, it is perhaps best at revealing the excitement and tension in music	8-20g + damping Normal	R	48/Coil
Denon DL 103 £90	Average Good	This classic spherical stylus model gives lively sound with powerful bass, and is popular in broadcast studios	6-16g Low	R	48
Denon DL110 £60	Good Good	Firmly recommended as a fine all-rounder, this high-output moving-coil model is likely to perform well in nearly all circumstances	6-16g Normal	BB	48
Denon DL160 £80	Average+ Good	Although listeners just preferred the 110 its brother here proved a twin in lab tests and is still "thoroughly competent"	6-16g Low		48S
Dynavektor DV-50X £60	Good Average	A high-output MC model with impressive lab performance, but whose tip and sound quality both disappointed	6-14g Normal		48
Dynavektor DV10X IV £60	Average Average+	Fine sounding and realistically priced; damping is recommended to ensure successful tracking ability	8-18g Normal	R	48
Dynavektor DV23RS £150	Average+ Good	Sound quality was described as "shut-in", lacking energy and sparkle but with some "edginess" in high frequencies	10-22g Low		48S
Glanz MFG 110EX £24	Average Average	A little bright but giving detailed bass and clear treble this was competitive at the price	6-16g Normal	R	Systems
Glanz GMC20E £129	Average Average	You could try haggling but we thought the makers of this number were demanding too much lucre for their product	3-6g Low		48
Goldring Epic £18	Average— Average	An unpretentious "punchy" partner to a budget system, giving decent dynamics and focus	6-14g Normal	R	48
Goldring 1010 £33.95	Average+ Average—	Listening results were a disappointment for a design which "looks right" in many respects	8-16g Normal		48S
Goldring 1020 £49.95	Average+ Average—	Like the 1010 this one strutted finely onto stage but couldn't project to the "gods"	8-16g Normal		48S
Goldring 1040 £74.95	Average+ Average—	High frequency extension was improved by the van den Hul tip; nice looking model — no great actress	8-16g Normal		48
Goldring Electro 111Z Boron £199 complete	Average Average+	Well balanced sound but lacking low frequency authority, midrange focus and "punch"	12-20g Low		48S
Goldring Electro II £135 complete	Average Average+	A pretty decent allrounder that did not excel sufficiently to warrant recommendation	8-16g Normal		48S
Grace F9E II £240	Good Good	For lively presentation, excellent separation and general satisfactory sonic delivery — consider this model	5-10g Normal		48
Highphonic MCA3 £320	Very Good Good+	Exquisitely crafted by a group of ex-Denon engineers, this superb tracker had a sweet and seductive (if rather bright) treble	5-12g Low		48S
Kiseki Purpleheart Sapphire £645	Good+ Good+	Rare, beautiful to look at and sweet to listen to, our review of this high-flyer conjured up images of Japanese art	5-14g Low		48S
Koetsu Black K £550	Good+ Good+	Impressive in scale and dynamics but with some criticism of bass muddling and high treble fizz. Listen before deciding	6-18g Low	R	48/Coil
Koetsu Red £835	Good+ Very Good	Named like a rare, and perhaps dangerous, little oriental fish this famous cartridge sounded "almost larger than life"	10-25g Low	R	48/Coil
Linn Asaka £249	Good+ Good+	Disciples of Linn who are trying to realise their true "Karma" may find that saving money is not a short cut to heaven	9-18g Low	R	48/Coil
Linn Basik £18	Average— Average	This goes much further in delivering the goods than its price tag might indicate	6-14g Normal	BB	48/Systems
Linn K9 £64.88	Average Good	Linn threw this model into the leading pack by beefing up the Basik's bodywork, adding a super stylus, and keeping the price fair	6-15g Normal	BB	48/Coil
Linn Karma £399	Very Good Very Good	A specialist which is strongly recommended for Linn-based systems; results may be less predictable in more general application	9-18g Low	R	48/Coil
Linn Troika £546.25	N/A Very Good	Ex-Karma users have been seen with glazed expressions indicating smug self-indulgence the morning after fitting a Troika	8-18g Low		Coil
Milltek Aurora £198	Good+ Good+	An overall feeling of relaxed ease characterised this clear and atmospheric Kiseki-built cartridge	8-16g Normal	R	48/Coil
Mission 773HC £150	Good Good	A sufficiently well-balanced and competitively priced "old-timer" which still warrants recommendation	6-16g Low	R	48S
Monster Alpha 2 £479	Good Good+	In the final analysis this fine allrounder is insufficiently exceptional in any specific respect to justify fully its high price	6-14g Low		48S
NAD 9100 £12	Average— Average	Clearly a Best Buy model for rock music fans, opera and choral music lovers might do better to avoid its tracking (in)abilities	10-20g Normal	BB	48S
NAD 9200 £26	Average— Average—	Although competent in many respects, overall the 9200 must be considered an undistinguished contender	6-19g Normal		48S
Nagaoka MP10 £17	Average Average	High frequencies sounded "shut-in" with this spherical-stylus model, but mid and bass were energetic, bouncy and punchy	5-13g Normal	R	48
Nagaoka MP11 Boron £38	Average Average+	Responding well overall in PM's equipment and listening room, this model was mildly criticised for low level and dynamic limitations	5-13g Normal	BB	48
Nagaoka MP11 Gold £45	Average— Average+	There were mild criticisms directed at most areas, but in general the sound was clear, open and even	3-8g Normal	R	48
Ortofon MC30 Super £270	Very Good Good+	Beautifully engineered and well-balanced, it was slightly criticised as bland, though some may appreciate the lack of roughedges	5-14g Low		48
Ortofon MC10 Super £65	Average Good	"What a delightfully sweet-sounding cartridge this is..." we said	5-15g Low	BB	48
Ortofon MC20 Super £180	Average+ Good+	An "inviting" sound quality; polite rather than exciting it approaches much more expensive models, but does not better them	6-15g Low	R	48/Coil

THE WORLD'S NO 1 GUIDE TO BUYING HI-FI

DIRECTORY

CARTRIDGES

NAME PRICE	LAB SOUND	COMMENTS	ARM AMP MATCHING	VALUE	BACK ISSUE (S=SUMMARY)
Ortofon OM10 £21	Average Average	One of the leading "cheapies", this gives a fine level of sound quality for the price, with good matching compatibility	5-15g Normal	BB	48
Ortofon MC2000 £450	Very Good Good+	There are few grounds on which to fault the MC 2000, but extremely low output means the expense and aggravation of a transformer	5-10g Very low (transformer)		48S
Ortofon OM20 £45	Average Average+	This turned out to be the listening panel's favourite among Ortofon's moving magnet models	5-16g Normal	R	48
Ortofon OM40 £75	Average Average+	Highly competent engineering, secure tracking and decent sound quality are major strengths. But it's a little cold, a little polite	3-8g Normal		48
Ortofon OM5E £16	Average- Average-	The OM10 is a hi-fi cartridge - the OM5E is not	5-16g Normal		48S
Ortofon VMS 10E II £21	Average- Average-	Some of its stable-mates fared rather better, and showed less evidence of tracking problems to boot	Normal		48S
Ortofon VMS20E II £35	Average Average	One of the most popular cartridges ever, sound quality was a bit laid-back and tracking could have been better	3-10g Normal		48
Ortofon VMS30E II £52	Average+ Average	Rather an old soldier in relation to turntable technology, it will perform undemandingly in demanding circumstances	5-13g Normal		48S
Ortofon VMS5E II £14	Average Average	Sound quality was thought fair for the price, though a little 'untidy'	8-18g Normal		48S
Ortofon X1 £50	Average Average	The cheaper X1 scored higher marks with our listening panel than the X3, but both were a disappointment	6-15g Normal		48
Ortofon X3 £75	Average Average	A lack of bass power, definition and a "zitty" top end makes this competent but uninvolved (see above)	5-15g Normal		48
Pradikal by Clear Audio £1225	Average+ Very Good	Sounded absolutely glorious, creating a full sense of scale and a large well-focused soundstage - but watch for record wear	8-18g		Coil
RATA RP20 £22	Average- Average	Good integration, a clear dynamic midrange and the beginnings of fine stereo imagery merits clear recommendation	6-14g	R	48
Rata RP40 £44	Average Average+	The '40 did a good job of sorting out the layers and complexity of the mix, with good focus, excellent stereo spread and fine scale	6-15g Normal	R	48
RATA RP70 £77*	Average Average+	Clearer and sweeter than the '40 this also seemed heavier and less lively. For £99 you can have a van den Hul stylus	6-14g Normal		48S
Rega RB100 £38	Average Average+	Remarkable mechanical performance in the right system context, but "try before you buy"	5-12g Normal	R	48
Shure M104E £32	Average- Average	Capable in many ways, but giving no substantial improvement over the 92E in our view	5-15g Normal		48S
Shure M105E £45	Average Average-	A slightly 'spitty' sound lacking deep bass and dynamic contrast, but can be used in virtually every system where it will perform "unobtrusively"	5-12g Normal		48S
Shure M110HE £55	Average Average	Sound quality was thought eminently presentable, but not exciting; smooth clear high frequencies, but a loss of bass definition	5-10g Normal		48S
Shure M111HE £67	Average Average	Early reviews of this cartridge complained principally of the price - which has since come down	5-10g Normal		48S
Shure M92E £15	Average- Average	Though lacking depth, the overall sound quality was competent, but treble was not its forte	10-15g Normal		48S
Shure M99E £24	Average- Average-	Sister to the 92E This is a solid but not particularly exciting cartridge	5-10g Normal		48S
Shure ME75ED £24	Average Average-	Rather bright and splashy in the high frequencies but nevertheless a competent model	5-10g Normal		48S
Shure ME97HC £43.95	Average Average+	It won't turn a sow's ear of a turntable into a silk purse, but will at least keep going and produce an acceptable result	8-20g Normal	R	48
Shure ML120HE £95	Average+ Average+	Quite decent sound quality and a generally fine balanced performance	6-18g Normal		48
Shure ML140HE £120	Average+ Good	Qualitatively the treble of this well-balanced moving magnet model was a match for many moving coil cartridges	6-16g Normal		48S
Shure Ultra 500 £452	Good Good	There was no doubting the accomplishments of what could well be the finest moving magnet cartridge around	6-14g Normal		48
Shure V15 VMR £195	Good Average+	Initial listening gave promising results, but extended familiarity gave the feeling of a lack of energy and a "shut-in" sound	5-12g Normal		48S
Supex SD900IV £350	Average+ Good+	The 900 is an inherently fine cartridge, but despite a recent update it is beginning to show its age	10-18g Low	R	48/Coil
Supex SD901IV £375	Average+ Good+	This high output model delivered sufficient subjective and objective performance, plus good compatibility, to justify its price tag	8-18g Normal	R	48
Supex SDX2000 £651 L. £721 H	Good Good+	The high-o/p 2000 was preferred on listening tests to the low-o/p model, which even so has a unique place among the top designs	6-16g Either		48
Supex SMT00E £115	Average Average+	Delivers as much musical information as many moving coils - the bass in particular having an attractive bounce	6-15g Normal		48S
Van Den Hul MC One £799	Good Very Good	This extended all the positive qualities of the '10 but added greater authority and scale - worth it for the extra money	6-12g Low	R	48/Coil
Van Den Hul MC10 £699	Good Good+	A neutral balanced performer giving transparent midrange, fine depth and focus with firm extended bass. Gosh!	5-10g Low	R	48/Coil

AMPLIFIERS

The amplifier sits at the heart of the system, processing the outputs from all the various music sources as necessary and then driving the loudspeakers. These two (quite separate) functions are integrated into a single box at the low-to-middle price points; separated pre- and power amplifiers become increasingly common as one moves upmarket. At the upper end of the specialist market, valve amplifiers provide a popular alternative to the transistor types amongst enthusiasts.

There is a substantial difference between specialist (sound quality oriented) amplifiers and the consumer electronics style models. The former are

bleakly simple, avoiding all unnecessary features to provide the most direct signal path in the interests of best sound quality. The latter range from models with just basic tone controls and tape recorder switching, to those with elaborate facilities such as graphic equalisers, remote control (including volume), surround sound options etc. etc.

Lab measurement provides some useful data, particularly in regard to an amplifier's ability to drive a wide range of different types of loudspeakers, but this is only obliquely related to sound quality. We also include our measured power output (RMS, 8ohm load, 1 channel driven) - but

again, paradoxically, this doesn't necessarily correspond to the loudness capability of the amplifier, and has as much to do with the elegance of the overload characteristics within a given system (valve amplifiers invariably sound more powerful than their rating would suggest). The listing of features provides some indication of the complexity of an amplifier: many users prefer to retain the option of tone controls to 'shape' the overall sound according to taste; many others have found living without tone controls surprisingly easy, with additional benefits in terms of transparency

DIRECTORY

AMPLIFIERS

NAME PRICE	LAB SOUND	COMMENTS	FEATURES	VALUE	BACK ISSUE (S=SUMMARY)
A&R Arcam Alpha £149.90	Average+ Average	This good all-rounder sounds musical if slightly softened. Good build and presentation	5 inputs hdph MM/MC tone controls 30W	R	50
Arcam Delta 90 £329.90	Good Average+	Well balanced and sweet-natured in any given system with MC capability, but pricey	70W MM MC 5 inputs tone controls		50
Audio Research M10 £2850 each	Good+ Excellent	These high end valve mono-block power amps justify their cost by providing near state of the art sound quality. Our reviewer was so excited he bought them	100W	R	50
Audio Research SP11 £5150	Very Good Excellent	Current state of the valve pre-amp art. A reference point	Straight line MM/MC Disc + phase invert	R	50
Audio Research SP8 £1998	Very Good Good++	The sound from this valve pre-amp was good enough to do justice to the finest ancillaries	5 inputs MM	R	48
Audiolab 8000A £325	Very Good Good	A strong contender using high grade circuitry and providing good sound quality on all inputs. Hard to fault at the price	5 inputs MM/MC disc 50W hdph tone controls	BB/R	50
Audiolab 8000C £300	Very Good Good	Bettering the high standard set by the integrated 8000A this pre-amp sounds more tidy and refined, if a little clinical and cold	5 inputs MM/MC Disc Hdph tone controls	R	50
Audiolab 8000P £465	Very Good Good+	A gutsy performer providing high levels into both 8 and 4ohm loads. A power-amp to keep the competition worried	100W	R	50
Beard 506 £995	Good+ Good++	A versatile valve preamp - the bass sounded lively if a touch softened while the treble was detailed but lacked a little sparkle and air.	4 inputs MM/MC	R	50
Beard M70 £1595 pair	Good Good+	A substantial British monoblock power amplifier, but not a great deal more impressive than the P35 at half the price	70W	R	50
Beard P35 £695	Good Good++	A superbly built and engagingly rhythmic valve power amp, sounding sweet and slightly soft in the classic valve style	35W	R	50
Burmester 838 £1490	Very Good Good+	A disc-only minimalist pre-amp, strongpoints include excellent build, extreme neutrality, dry clean bass and notably sharp stereo focusing	MC only, MM option		
Burmester 846 £1599	Very Good Good++	Usually coupled with the 838 this high-level pre-amp provides many and versatile input facilities	6 inputs	R	50s
Burmester 850 £3995	Good+ Good++	Each of these mono power amplifiers contains separate high current 25W amps giving a refined coherent sound over most of the frequency range	100W	R	50s
Cambridge Audio A75 £280	Very Good Good++	This strong power amplifier sounded open and effortless, with fine bass drive and dynamics, albeit a touch grainy and harsh at high frequencies	100W	R	50
Cambridge Audio P40 £200	Good Good	A very fine sounding integrated amplifier with simple facilities and MC cartridge capability	5 inputs 40W MM/MC straight line	BB	50
Cambridge Audio C75 £260	Good+ Good++	Whilst not quite on par with its A75 companion this pre-amp provided excellent stereo imagery but was a touch "heavy" in character	MM/MC disc	R	50
Cello Audio Suite £6000+	Excellent V Good/Excellent	Cello's pre-amp represents a whole new ball game in flexibility and sound quality (or war of attrition on your wallet)	Optional inputs MC etc	R	50
Conrad Johnson Motif MC-8 £2500	Very Good Good++	A cheaper alternative to the '7, this pre-amp is an undoubted success in maintaining the Motif sound but does not compare on sound quality	MM/MC	R	50
Conrad Johnson MV50 £1795	Good+ Good++	Coupled with the PV5, this CJ power amp performed well on audition	50W	R	Coll
Conrad Johnson Premier Four £3900	Good+ Good++	Ambience was the Four's forte - this power amp proved exceptionally revealing of instrumental locations	100W		Coll
Conrad Johnson Premier Three £3775	Good+ Very Good	The Three is a musically accurate and graceful pre-amp which proved versatile on a wide range of inputs	5 inputs MM/MC		Coll
Conrad Johnson PV5 £2010	Good+ Good++	The PV5 is a classy sounding valve pre-amp, and natural partner to the MV50	5 inputs MM	R	Coll
Copland Pre and power amps £649 each	Good+ Good	At £649 each this simple Danish valve pre/power combination is expensive, though the power amplifier sounds very easy on the ear	3 inputs MM, 12 Watts		50
Counterpoint SA12 £1250	Good+ Good+	A real power-house power amp, beefy and load-tolerant although like the SA7 a trifle untidy at frequency extremes	100W	R	Coll
Counterpoint SA7 £747	Average+ Good+	Simple valve Californian pre-amp offering inspiring transparency for the price	4 inputs straight line MM/MC	R	Coll
Creek 4040 £145	Average+ Average	This simple integrated model had a controversial sound, liked by some, plus an acceptable lab performance	4 inputs MM 12W	R	50
Croft Micro £150	Average+ Good+	A real upsetter. This excellent valve pre-amp put the cat among the pigeons proving good sounds can be made at budget price levels	4 inputs MM straight line	R	Coll
Croft Series IVS £730	Good Good++	A lively and 'fast' valve power amplifier, delivering the goods with a pleasing 'classical' tonal quality	40W per channel	R	50
Croft Super Micro £250	Good Good+	With industrial looks and double mono operation, it rated particularly well on disc input, although not so hot on CD	4 inputs MM straight line	R	50
Deftec DPA 100S £1900	Very Good Good++	A top-quality transistor power amp, sounding fast, articulate and well controlled, though maybe a touch clinical for some tastes	80W	R	50
Denon PMA-250 £125	Good Average	As a "budget-plus" integrated amplifier the '250 gave an open sound with lively dynamics and should appeal to a wide range of tastes	25W MM hdph	BB	50
Denon PMA-707 £100	Average+ Average	Originally a budget 'best-buy' the '707 still merits recommendation with a sound quality that sets it apart from "rack-system" standards	25W MM 4 inputs hdph	R	44
DNM 3 £1000	Good+ Good++	The DNM3 in its acrylic case is a remarkably revealing and neutral state of the art pre-amp	5 inputs MC/MM twin vol controls	R	44
Exposure VII £340	Very Good Good	A double mono transistor pre-amp with a notably dynamic and punchy character, though not suited to all tastes	3 inputs MM/MC	R	50
Exposure VIII £310	Very Good Good	This power amplifier created a good impression of speed and power, but was a trifle fierce in the treble	50W	R	50
Haffer DH120 assembled £360	Very Good Good	On sound quality results were substantially good, but this power amp won't set the world on fire at this price	60W		44
Haffer DH120 kit form £295	Good	We didn't build one; see above	60W		44
JVC AX-22 £110	Average Average-	Serves a market that buys on features rather than sound quality. Includes special "flashing light" power meter	55W MM tone controls		50
Kenwood KA-550 £130	Good Average+	Decent sound quality and build at an affordable price, it also has a capable moving coil input - something of a rarity among the competition	40W Hdph Tone controls MM/MC	R	50
Krell KMA-100 II £5900 pr	Excellent Excellent	A genuine reference standard power amp, capable of justifying a wildly extravagant price tag in an appropriate system	100W, Monoblock	R	Coll
Krell KSA50 Mk2 £2495	Very Good Good++	This power amp still holds its own with good depth and ambience and excellent stereo focus	50W	R	50

DIRECTORY

AMPLIFIERS

NAME PRICE	LAB SOUND	COMMENTS	FEATURES	VALUE	BACK ISSUE (S=SUMMARY)
Krell PAM5 £1589	Very Good Good++	Superbly built, the Pam 5 pre-amp gave good definition throughout the frequency range with a good measure of excitement	MM/MC	R	50
Le Tube £585	Good+ Good+	If moving coil sensitivity is not required then this pre-amplifier will offer a clean view with very good stereo	3 inputs (MM)	R	44
Linn LK1 £425	Good+ Good	A durable tolerant power amp, setting a respectable standard on both lab test and audition	60W		50
Linn LK2 £373	Good+ Good	This pre-amp was marginally less successful but the pair (of Linn's) worked well together and are well worth considering	5 inputs MM/MC		50
Linn Stratos £999	Good+ Good+	Facing strong competition in the UK this New Zealand pre-/power combination gives good sound quality... but not exceptional at the price	120W MM/MC straight line		50
Luxman LV-105 £599	Very Good Good	Superbly finished and built, in a sense this model managed to capture the "valve" sound with an easy musical quality and good bass register	85W MM/MC		44
Magnum A100 £1995 pair	Good++ Good+	Given their massive power rating a pair of A100's make a fine stereo power-amp; ideal for high levels and with a wide dynamic range for digital programme	320W	R	50
Marantz PM26 £110	Average Average-	Well built and attractively presented this just manages recommendation, though sonically falling somewhat short of the best examples of its type	30W MM sliding tone controls	R	50
Marantz PM45 £200	Good+ Average	Generally pleasant and polite with above average clarity; there was some softening in the bass, restricting dynamic output somewhat	40W MM/MC tone controls	R	50
Mission Cyrus One £150	Good Good	A reference standard amplifier for its price category the Cyrus 1 attained a high sonic standard. A stylish, neutral performer	5 inputs MM - medium MC 30W straight line	BB	50
Mission Cyrus Two £300	Good+ Good+	A significant improvement on the already competent 'One, the 'Two remained neutral and confident over the whole frequency range	50W 5 inputs MM/MC Disc straight line	BB	50
Mission Cyrus Two with PSX £500	Good+ Good+	Although making the 'Two more powerful, the PSX power supply does not offer significantly better sound quality	A power supply, see above		50
Musical Fidelity A1 £229	Average+ Good	Fine-ranking in terms of overall sound quality for money, the excessive heat output could be hazardous to your vinyl if you're careless	20W MM/MC 4 inputs straight line	R	50
Musical Fidelity A100 £400	Good+ Good+	This is another one recommended for fine sound with which you could keep your Chinese carry-outs warm	50W MM/MC 5 inputs	R	50
Musical Fidelity A370 £2049	Very Good Very Good	Arguably the finest sounding power-amplifier manufactured in the UK	185W	R	50
Musical Fidelity MVT £999	Very Good Very Good	The MVT pre-amp was "simply a knockout in its class", providing competition for £2000-plus amplifier systems	MM/MC 5 inputs	R	50
Musical Fidelity P170 £499	Very Good Good+	Acquitted itself well, later samples showing steadily increasing refinements	85W	R	50
Musical Fidelity P270 £1000	Very Good Good++	If the hot-box aspect is not a deterrent, this is something of a bargain. A big amplifier scale of sound which is just a little rough-edged	135W	R	50
Myst TMA3 £288	Very Good Average++	This excellently-constructed, no-frills, dependable amplifier should offer long life with above average sound quality	35W MM/MC 4 inputs		50
NAD 2200 £339	Good++ Average+	Not recommended on grounds of sound quality, but worth serious consideration for its exceptional power output	100W		44
NAD 3020e £110	Good Average+	A little light in balance and "weight" but superior to run-of-the-mill budget amplifiers	20W MM/MC 4 inputs	BB	50
Naim NAIT £258	Average+ Good	Well built with good load tolerance the NAIT delivered a fully competitive sound in spite of its modest measured power output	15W pc MM 3 inputs	R	50
Naim NAP 250 £966	Very Good Good++	Well-matched to the Naim Pre-amps, and capable of high quality sound levels over the whole dynamic range	70W	R	50
Naim NAC 32 £425	Very Good Good++	A natural partner to the Naim power-amps, with power supply options at different prices	MM/MC, 5 inputs	R	50
Nuance £795	Very Good Good+	A subtle civilised pre-amp though a little lacking in resolution and detail; suited to some tastes but not top-drawer	4 inputs (MC)	R	50
Perreux 1850 £990	Very Good Good	This power amp's musical qualities were disappointing, though powerfully delivered. Build and finish were exemplary	180W		44
Perreux SA3 £690	Very Good Good	This exotic New Zealand-built pre-amp did not really offer the sort of sound quality expected at the price	4 inputs MM/MC		44
Plenitude £795	Very Good Good+	Rating slightly higher than its Nuance partner, this power amp provided a tight, controlled sound, if somewhat lacking in scale and grace	80W	R	50
PS Audio PS4.5 £696	Very Good Good+	Sonically the best pre-amp in its class, but on the bright side, so purchasers should try it with their prospective equipment	MM/MC	R	50
QED A230/240CD/240SA £119/£149/£199	Good Average+/Good	Each model proves a worthwhile step up. The cheaper A230 was civilised, while the '240s were more dynamic with fine resolution of space and depth	4 inputs 40W Hdph (MM) (240 SA MC)	BB	50
Quad 34 £269	Very Good Average+	This well-built durable pre-amp has useful filtering and above average tone controls but was found lacking in sound quality (viz: detail/dynamics)	4 inputs MM/MC tone controls		44
Quad 405 £329	Very Good Average+	Not an impressive power amp but easy on the ear if not pushed and very reliable	100W		44
Quicksilver £1775	Good+ Good++	A remarkable valve power amplifier with little to criticise; fast, articulate bass, neutral midrange and open clear top end	60W	R	50
Radford STA25 Renaissance £977	Good Good++	Offering superb midrange performance if not quite as good at the extremes, the Renaissance valve power amp is a genuine audiophile product	25W	R	50
Robertson Forty Ten £987	Very Good Good+	Here is a neat little power amp (60W) you can fit and forget, it proved most satisfying over long listening sessions	60W		Coil
Rotel RA-820BX II £150	Good Good	Rating very highly for the price, it proved a hard and fast amplifier, easily achieving a best buy rating	4 inputs MM hdph 25W	BB	50
Sansui AU-G11X £139	Good+ Average	Tightly controlled if somewhat congested and lightweight, but a reasonable compromise between features and sound quality	25W MM hdph 4 inputs, tone controls	R	50
Sansui AU-G30X £199	Good++ Average+	A very competent amp with no glaring faults, performing well with phono and compact disc inputs	4 inputs MM 45W tone controls Hdph	R	50
Sansui B2301 £1880	V Good Good	Rating better than the pre-amp and providing generous power output, this amp could not be considered competitive in its price bracket	300W		Coil
Sansui C2301 £2306	Excellent Good	Sansui's flagship pre-amp did not really rate well given its price, but is not short on features	All facilities		Coil
Sony TAF 500ES £349	Good+ Average-	No too hot at the price, lacking in bass action, rating poorly on vinyl, and only marginally improving on CD	75W hdph tone controls MM/MC		50
Sony TAF700ES £500	Good++ Average	Scoring higher than the 500 but still not offering the sort of standards set by the competition. But many buttons to push	100W MM/MC tone controls		50

DIRECTORY

AMPLIFIERS

NAME PRICE	LAB SOUND	COMMENTS	FEATURES	VALUE	BACKISSUE (S=SUMMARY)
Tandberg 300BA £564	Very Good Good	Although featuring comprehensive facilities this pre-amp was considered a little clinical and lacking in musical integration	6 inputs tone controls Hdph		44
Tannoy SR-840 £1713	Very Good Good+	A "muscle" power amp, capable of impressive levels into difficult loads while remaining quite subtle and revealing	250W	R	50
Technics SU-500 £100	Average Average-	Technics have something of a knack in creating models which just border on what we regard as the minimum standards for Hi-Fi. This is an example of that	40W MM Hdph tone controls		50
VTL 50W £1150	Good Good	Rating good on audition and providing complementary characteristics to the minimal pre-amp, these monoblock power amps sounded a little slow and unrevealing	50W 3 inputs	R	50
VTL Minimal £340	Good Good	Providing decent sound quality at the price, this basic pre-amp sounded open and clear in mid and treble	3 inputs (MM)	R	50
Yamaha AX-300 £120	Good Average+	A lively and dynamic performer, offering a credible if bright sound at a competitive price	30W hdph tone controls (MM)	R	50

LOUDSPEAKERS

Last item in the hi-fi chain, to some extent the loudspeaker is merely the slave of what has gone before, capable only of reproducing a signal as good as it is fed. Nevertheless the distortions (colorations and stereo effects) introduced by loudspeakers (and rooms) tend to be more immediately obvious than those anywhere else in the chain, so careful choosing according to taste is very important.

The average loudspeaker consists of a smallish enclosure, much of which may have begun life as

part of a tree, plus a couple of drive units hidden behind a removable grille. Inside the box lurks a simple electrical circuit known as a crossover, which divides the incoming (full range) signal into the right bits for the drivers to handle. Variations on the above formula are specifically identified in the entries. The designer's primary task is to balance the sensitivity of the loudspeaker (how loud it goes for a given electrical input) against the bass extension (how low does it go) for the given box size. After that such subtleties as coloration and

dispersion come into the equation.

Careful placement of the loudspeakers within the room is as important as the initial choice of model. For good stereo they need to be more or less the same distance from nearby walls, and preferably on similar rigid stands. The listener should be about the same distance from and listening angle to each loudspeaker. The ideal placement depends on the way a particular model has been balanced (not to mention a number of other factors), and our recommendation is given in the entries.

MODEL PRICE	LAB SOUND	COMMENTS	SIZE PLACEMENT	SENSITIVITY BASS FROM	VALUE	BACKISSUE FULL REVIEW
Acoustic Research 22BX £160	Average Average	Basically well-engineered with sound "nicely out of the box". Some of our "ears" were less enthusiastic	47 x 29 x 22cm shelf or 50cm stand near wall	89.5dB/W 55Hz	R	This
Acoustic Research 35BX £250	Average Average-	This is quite loud, with some boom and tizz, making it suitable for supine strummers of imaginary guitars perhaps	58 x 26 x 27cm free space on 40cm stands	91.5dB/W 55Hz		This
Acoustic Research 8BX £100	Average Average-	Spacious and informative sound quality with bass well under control. Not that there was much bass to control	40 x 25 x 19cm shelf or 50cm stand near wall	88.5dB/W 70Hz		This
Apogee Scintilla £4950	Good Very Good	These take-me-to-you-leader speakers gave exceptional transparency and can achieve excellent results in a true audiophile system	145 x 88 x 9cm free space on floor	79dB/W 20Hz	R	46/Coil
Arcam One £349.90	Good Average	Some boxiness in the midrange and fizz in the upper treble prevented this from getting the "R" tag	47 x 27 x 33cm open stands, free space	88dB/W 55Hz		46
Arcam Three £150	Average+ Average-	Arcam's baby speaker did not delight our listeners, but it might do better in less expensive systems	34 x 18 x 23cm close to wall at head height	88.5dB/W 95Hz		This
Arcam Two £250	Good Average	Most things to most men this compact is unlikely to disappoint with its lively "bally" character though lacking weight... a bit	38 x 23 x 28cm near wall shelf or 40cm stands	88dB/W 55Hz		This
Audiostatic ES200 £1495	Average Average+	Sounding forward and unbalanced with limited bass power, these excelled in transparency and detail, and might suit some tastes	150 x 53 x 23cm low (10cm) stands away from wall	79dB/W 45Hz		46
Audiostatic ES300 £1995	Average+ Good	Marred by similar problems to its cheaper ES200 stablemate, this line source electrostatic was superb in the upper-mid and treble but lumpy in the bass	44 x 5 x 93cm free standing	82.5dB/W 30Hz		46
Avance 120 £279	Average+ Average	This unusual "after eighties" looking speaker has the recipe for success, but not quite the right seasoning yet	42 x 30 x 30cm 30cm from wall on 40cm stands	86.5dB/W 60Hz		This
B&W DM100 (I) £100	Good Average	This market leader has recently been 'improved' - though the original was good enough	37 x 22 x 22cm open stands near wall	89dB/W 75Hz	BB*	46
B&W DM110 (I) £140	Good+ Average+	Another established favourite, it has recently been 'improved', but not yet checked by us	49 x 26 x 25cm open stands	89.5dB/W 56Hz	BB*	46
B&W LM1 Mk II £199	Average+ Average	Probably one of the best 'micros' ever made, worth considering for special applications (boats or vehicles). Upgraded since our review	24 x 15.5 x 20cm shelf or flush mount	86.5dB/W 80Hz		31
B&W Matrix 1E £595	Very Good Good+	There was enthusiastic and consistent praise for these speakers with their "revealing and seductive" midrange	41 x 23 x 32cm free space on 35cm stands	85.5dB/W 50Hz	R	This
BBC LS3/5A £164	Good+ Average+	As a working tool it does its job but as a piece of value engineering this old-timer is beginning to look a bit grey-haired	30 x 18.5 x 16cm open stands, free space	81.5dB/W 57Hz	R	Coil
Boston A4011 £110	Average Average-	Competent performance for size and price but below average relative to the UK competition	34 x 21 x 20cm on stands near wall	88.5dB/W 63Hz		41
Castle Clyde £112	Average+ Average	A tidy little performer packing punch, but beginning to show its age in the light of new competition	37 x 21.5 x 22cm open space on stands	89.5dB/W 64Hz	R	46
Castle Durham £179	Average+ Average	Listening results were encouraging, well engineered and finished, but lean on treble and a bit weak on bass; still recommended	41 x 21.5 x 25cm near rear wall	89dB/W 67Hz	R	46
Castle Pembroke £269	Good Average+	Comfortably recommended, a sweet smooth sound with good overall balance of engineering-based performance	55 x 37.5 x 30.5cm open space on stands	88dB/W 46Hz	R	31
Celestion 6000 £1470	Very Good Very Good	A genuine fullrange audiophile quality speaker system - with Star Wars styling to suite a high tech environment	Complex, on floor in free space	82.5dB/W	R	Coil
Celestion DL4 (II) £109	Average+ Average+	Strong stereo and controlled bass gave BB status, 'shrill' top end only real criticism. (Now in untested Mk II form)	38 x 21 x 23cm stands near wall	89dB/W 85Hz	BB*	46
Celestion DL6 (II) £139	Average Good+	The control and power sets it well apart from the run-of-the-mill. It has since been updated	45 x 25 x 25cm open space on stands	88.5dB/W 60Hz	R*	46
Celestion DL8 (II) £199	Good Good	An easy speaker to live with that will not 'close up' when driven loud. (Also updated since our review)	50 x 28 x 27cm on stands open space	88dB/W 55Hz	BB*	46
Celestion SL600 £700	Good Very Good	Clearly an exceptional device in terms of design and transparent sound quality. An audiophile miniature	37 x 20 x 25.5cm open space on stands	83dB/W 55Hz	R	46
Celestion SL6S £350	Good Good+	A luxury compact speaker that gives a sweet treble sound with fine musical detail	37.5 x 20 x 27cm free space on 40cm stands	84dB/W 50Hz	R	46
Gale 301 £259	Average Average+	Of unusual, distinctive appearance this produced a mixed response, being lively but lacking depth	44 x 23.5 x 22cm on stands quite near wall	86.5dB/W 63Hz		46
Gale GS402 £599	Average+ Average+	Clean but rich and powerful bass; stereo focus was not a strong point, but it is worth considering	61 x 35.5 x 28cm on matching stands near wall	88dB/W 48Hz		46

DIRECTORY

LOUDSPEAKERS

MODEL PRICE	LAB SOUND	COMMENTS	SIZE PLACEMENT	SENSITIVITY BASS FROM	VALUE	BACK ISSUE FULL REVIEW
Goodmans Maxim Two £80	Average+ Average	More wham-bam-thankyou-mam sound that imitates much bigger speakers when you let these babies yell. (A well-controlled yell)	26 x 17 x 19cm near wall on shelf or stand	86dB/W 85Hz	BB	This
Goodmans Point 3 £90	Average+ Average-	Recommended as good value for money, but our listeners' differing opinions mean your ears should judge for themselves	47 x 25 x 20cm shelf/ high stand near wall	90dB/W 80Hz	R	This
Goodmans Point 7 £170	Average+ Average	Basically competent performance-mix and a lot of speaker for the money, but a certain lack of refinement nonetheless	69 x 33 x 26cm free space on 35cm stand	89dB/W 47Hz		This
Harbeth HL Mk 4 £475	Good+ Good+	Recommended for the good results at its price, and only mildly criticised for heavy bass and a mild 'chestiness'	64 x 33 x 30cm free space on 46cm stand	89dB/W 40Hz	R	This
Heybrook HB1 £169	Good Average+	No longer an over-bright character, a strikingly clear sound and fine transient performance now merits recommendation	47 x 29 x 23cm on stands near wall	88dB/W 61Hz	R	46
Heybrook HB2R £269	Average+ Average	Criticism of the mid and treble balance made this dynamic model less attractive on listening test than was hoped	41 x 23 x 23cm on stands, tilted, near wall	88dB/W 61Hz		46
Infinity Reference Standard IIB £3850	Average+ Good+	Sonically easy to live with, these had areas of truly great performance, but were complicated by many controls	160 x 57 x 30cm free space on low stands	90dB/W 25Hz	R	46/Coll
JBL 18Ti £559	Good+ Good	Beautifully engineered, well finished miniature with many good points, but unexceptional overall. Try the cheaper L20T	34 x 24 x 22.5cm 50cm from wall on rigid stands	85.5dB/W 53Hz		46
JBL 250Ti £3300	Good+ Good+	In general this speaker did not show the required level of dynamic presentation transparency and stereo depth expected of a pricey flagship model	132 x 57 x 36cm free space on floor	89dB/W 53Hz		46
JBL L 60T £370	Good+ Good	Well balanced and offering realistic value for money, the fine treble and extended bass make it suitable for larger rooms	78 x 30.5 x 26.5cm low stands or floor	88dB/W 40Hz	R	46
JBL TLX-3 GI £130	Average Average-	Lively and punchy but also untidy this little speaker may have deviated from the Hi-Fi standard but cannot be summarily dismissed	38 x 25.5 x 22cm free space on stands	87dB/W 55Hz		46
JPW AP2 £145	Good Average+	Few grounds for criticism but purchasers should check out the treble qualities to avoid hammering the ear anvils	46 x 26 x 25cm 40cm from wall on 45cm stands	89dB/W 65Hz	BB	This
JPW AP3 £210	Good Average+	Pretty good stereo and well balanced overall it had its own character which is well suited to vinyl replay	52 x 25 x 29.5cm near wall on stands	90dB/W 57Hz	R	46
JWS Quintet £100	Poor Poor	Poor stereo focus with up to 3dB channel difference, coloration, boom, "sting" and the grille rattled. Oh dear	46 x 19 x 19cm close to wall head height	86dB/W 55Hz		This
KEF 103/3 £630	Good+ Good	Technically impressive, excellent bass/power handling for size, but not for the audiophile system. Better among cheaper components, and good in a large room	56 x 27 x 30cm supplied stands free space	90-95dB/W 35Hz		This
KEF 104/2 (inc KUBE equaliser) £800 (£900)	Very Good Good+	A reference point for dynamics, preferred without KUBE, suited to many rooms Good stereo, high sound levels	90 x 28 x 41.5cm floor standing in free space	92dB/W 50Hz	R	This
KEF 107 £1890	Very Good Good+	A welcome sense of ease and lack of strain at most normal levels. Minor criticisms included a dulling in the extreme treble. Excellent bass extension	116.5 x 33 x 45cm on floor in free space	87.5dB/W 20Hz	R	Coll
KEF C10 £94	Good Average-	Listening panelists gave this a poor reception	30 x 20.5 x 17.5cm stand near wall	87.5dB/W 75Hz		46
KEF C40 £209	Average+ Average-	Criticisms were made of a lack of fine detail and loss of depth and transparency, but it could handle power well!	65 x 24.5 x 26.5cm free space on stands	90dB/W 55Hz		46
Linn Isobarik £1568	Good Very Good	Exceptional capabilities in the dynamic range and bass performance; demands serious consideration as a state of the art contender, but odd stereo	76 x 33 x 41.5cm low stands against rear wall		R	Coll II
Linn Kan £271.95	Average- Average-	The acid test of "blind listening" may dissolve the Kan's high status with strong criticism, but the answer, as always, is: "suck it and see"	30.5 x 19 x 16.5cm back to rear wall on rigid stands	85dB/W 90Hz		41
Magneplanar MG11a £2750	Good Very Good	Another excellent true-audiophile loudspeaker (this American panel speaker helps to convey much of the original character of the music)	180 x 62 x 38cm well clear of walls	84-85dB/W 35Hz		46
Magneplanar SMGa £697	Average- Average	Tonally 'rich', in the right room it proved a satisfactory musical experience	122 x 48 x 4.5cm on floor clear of wall	85dB/W 56Hz		46
Marantz LD20 DMS £130	Average Average	Recommended more for CD users than vinyl keepers, soundly engineered and built but should be heard before bought	36 x 23 x 24cm free space on 45cm stands	86.5dB/W 55Hz		This
Meridian M30 £725	Average+ Average	Pricy but easy on the ears and worth considering especially where space is at a premium	38.5 x 18 x 32cm free space on stands	Active 40Hz		46
Mission Argonaut £700	Good Good	Perhaps not the most subtle or sweet these were recommended for their excitement, drama, power handling and... good looks	95 x 23 x 31cm floor-standing near wall	91dB/W 40Hz	R	This
Mission 700LE £130	Good Average	Mission re-submitted this popular model and again got a positive review - which proclaims their (and our) consistency	38 x 21 x 21cm straight ahead stand near wall	89dB/W 66Hz	R	This
Mission 70 II £100	Good Average	Lively and transparent, the 70 II was favoured for its speed, though the sound had a mildly 'thin' tonal balance	35 x 21 x 21cm on stands or shelf near wall	89dB/W 68Hz	BB	46
Mission 737 £240	Average+ Average	To its credit the 737 was generally articulate and well integrated but stereo was poor and it could sound loud and hard	54 x 25 x 27.5cm low stands near wall	89.5dB/W 58Hz		46
Monitor Audio R352MD £280	Good Average+	Better suited to CD than vinyl perhaps, this is clearly good value for money. But some found it coarse while others praised its cleanliness	64 x 25 x 32cm 25cm stands in free space	89dB/W 42Hz	R	This
Monitor Audio R100 £130	Average+ Average-	Tonally quite neutral, but with small box character, negligible low bass and a rather 'hard' midrange	40.5 x 25 x 21cm free space on stands	87.5dB/W 70Hz		46
Monitor Audio R252 £150	Average+ Average	Rating well for its price this model displayed a rather rough top end and a generally dry character helped by good detail and focus	47 x 25 x 24cm stands quite near rear wall	89dB/W 62Hz	R	46
Monitor Audio R352 £250	Good Average	Well-built and finished, 'sensitive' speaker which is easy to drive and capable of extracting good results from any good amplifier	64 x 25 x 32cm on stands in free space	90dB/W 50Hz	R	46
Monitor Audio R652 MD £369	Average Average+	Mild bass and crossover weaknesses were criticised, but the sound was quite well liked and it is decently built	51 x 20 x 26cm free space on 40cm stands	86.5dB/W 45Hz		This
Monitor Audio R700 MD £269	Average+ Average+	Lively and involving with good, punchy, if rolled off bass. The metal dome speaker gives a clean and open treble	32 x 21.5 x 25cm on stands 0.4m from wall	87.5dB/W 62Hz	R	46
Mordaunt Short 442 £1150	Good+ Very Good	A resounding success with the listening panels. Make sure your room can accommodate the bass	95 x 26 x 38cm floor standing in free space	87.5dB/W 40Hz	R	This
Mordaunt Short 45Ti £220	Good Average	A sensitive tandem-bass number that can be driven loud but loses its balance a bit and can be unsubtle	63 x 26 x 30cm low (20cm) stand near wall	90.5dB/W 52Hz		This
Mordaunt Short MS10 II £90	Average Average-	One of the best miniatures around. A borderline Best Buy because of the bass limitations, which may depend on your taste	29 x 20 x 17cm wall bracket	86dB/W 75Hz	BB	This
Mordaunt Short MS100 £179	Average+ Average+	A mid 'forward' tonal balance is main drawback but other aspects such as ambience, transparency and stereo depth compensate	32.5 x 22.5 x 21.5cm stands near wall	85dB/W 80Hz	R	46
Mordaunt Short MS300 £309	Average+ Average+	Not considered particularly competitive in its class, though it has good power handling and stereo focus	54 x 22.5 x 25cm on stands near wall	89dB/W 65Hz		46
Quad ESL-63 £1458	Good+ Very Good	With its unusual but subtle characteristics this classic electrostatic may not be punchy in the bass, but has strengths that some cannot live without	92 x 66 x 27cm open stand well clear of wall	84dB/W 34Hz	R	46

THE WORLD'S NO 1 GUIDE TO BUYING HI-FI

DIRECTORY

LOUDSPEAKERS

MODEL PRICE	LAB SOUND	COMMENTS	SIZE PLACEMENT	SENSITIVITY BASS FROM	VALUE	BACK ISSUE FULL REVIEW
Rogers LS2 £170	Good Average+	A coherent and polite speaker considered more suited to classical music. Tonally well balanced, neutral and with good power handling	36 x 23 x 22cm on stands near wall	86.5dB/W 51Hz	R	46
Rogers LS6 £240	Good+	Sonically fitting in between the LS2 and 7, the 6 was a consistent success on audition - well balanced with an open and informative nature	51 x 27 x 28cm open stands, free space	87.5dB/W 50Hz	BB	46
Rogers LS7t £360	Good+	A fine combination of classic qualities at reasonable price produces the "R" tag, but try to get a pair home on approval to check for bass 'heaviness'	56 x 27 x 28cm free space on 40cm stands	88.5dB/W 48Hz	R	This
Roksan Darius £1150	Average Wrong but interesting	A controversial speaker which when set up right can deliver impressive performance, but with a far from neutral balance	98 x 31 x 51cm integral stands near side walls	88dB/W 50Hz		This
Rotel RL850 II £120	Average+	Strongly recommended. Well-balanced, clear, with decent focus and fine stereo, but tendency to 'heaviness' needs decent stands and space	44 x 25 x 24cm free space on 40cm stands	86.5dB/W 50Hz	BB	This
Royd A25 £100	Average+	Receiving mixed reactions on audition, the A25 is flawed but offers a lot of speaker for the money	51 x 29.5 x 24cm, stands near wall	87dB/W 52Hz	R	46
Royd A711 £99	Average+	Lively clear sound; good upper bass and dynamics, but treble "ramp" made vocals sound shut in. Try before you buy	31 x 20 x 17cm shelf or 50cm stands near wall	86dB/W 75Hz		This
Ruark Broadsword £700	Average-	Fancy cabinetwork is no real compensation for technical weaknesses which led to three mentions of "suckout" in our review	43 x 23 x 28cm free space on 40cm stands	82dB/W 43Hz		This
Sony APM10ES £100	—	An obvious Best Buy at its highly competitive price point, it can do justice to a good hi-fi system of Sony or specialist origins	40 x 25 x 20cm, 40cm stands 40cm from wall	87dB/W 55Hz	BB	This
Sony APM 20ES Mk II £150	Very Good Average+	A smooth integrated sound with little to criticise at the price. If anything, a little bass forward, but remarkable nonetheless	43 x 25 x 29cm, free space, stand	86dB/W 50Hz	BB	46
Sony APM22ES £249	Good+	Sounding notably clear, the 22ES scored well on listening tests was easy to drive and achieved high sound levels	51.5 x 29 x 30cm free space on 40cm stands	88.5dB/W 46Hz	R	46
Spendor Prelude II £320	Good+	Good clarity and detail were evident everywhere in this speaker. Though a little boxy or muddy in the midrange it is strongly Recommended	50 x 26 x 28cm open stands in free space	88dB/W 52Hz	R*	46
Spendor SA3 Active £2308	Good+	Substantial speakers designed to deliver high sound levels and killer bass. Suited to larger rooms and power hungry ears	85 x 38 x 46cm low rigid stands in free space	89dB/W 32Hz	R	46
Spendor SA3 Passive £1320	—	Same as Spendor SA3 active	ditto	ditto	R	46
Spendor SP1 £640	Very Good Good	A very subtle and musical performer that works particularly well with digital material. An exceptional allrounder	63.5 x 29.5 x 30.5cm stands in open space	87dB/W 41Hz	R	46/Coll
Spendor SP2 £420	Very Good Good+	Conceding little to the SP1, this 30 litre model displayed good tonal balance with a highly articulate midrange, only slightly marred at frequency extremes	50 x 25 x 30cm free space, stands	87dB/W 45Hz	R	46/Coll
Spica TC-50 £595	Average+	These American wedge-shaped-cabinet speakers just merit recommendation at their price and were detailed and clear	40 x 33 x 28cm free space on 50-60cm stands	85dB/W 48Hz	R	This
Tannoy Westminster £3300	n/a Good+	These awesome horn loaded speakers are remarkably controlled and impressive, if only suited to a few pockets and rooms	Huge, flat against rear wall, away from corners	96dB/W (manuf.)	R	Coll
Technics SB-RX50 £500	Very Good Average+	With its unique coaxial drive unit the RX50 proved a smooth and well balanced loudspeaker, its minor weakness being a mildly excessive low bass	48 x 30 x 26cm free space on 40cm stands	86dB/W 40Hz	R	46
Technics SBC 250EK £130	Average+	Despite a fairly even tonal balance, the 250EK sounded muddled in the midrange and dull in character	36.5 x 23.5 x 20.5cm Free space, stands	86dB/W 60Hz		46
Wharfedale 504 £129	Average+	Acquitting itself well on audition, the 504 produced a clear, reasonably balanced sound with above average treble	21 x 18.5 x 20cm stands, near wall	85dB/W 75Hz	R	46
Wharfedale Super Diamond £140	Average	Although there are improvements on the basic "legendary" model, listening panelists did not get airborne about this upgrade	24 x 19 x 19cm close to wall at head height	88dB/W 57Hz		This
Wharfedale Delta 50 £130	Average+	Given the price this was a mild disappointment - there is nothing obviously wrong but it just seemed a bit mundane	48 x 27 x 19cm near wall on 40cm stands	88dB/W 50Hz		This
Yamaha NS 1000M £900	Good Good+	Living up to its monitor label, and tonally well suited to digital material, the NS 1000M is superbly crafted and capable of high levels	67.5 x 37.5 x 32.5cm 30cm from wall, stands	90dB/W 40Hz	R	46

* rating refers to original, tested model.

TUNERS

The radio medium operates at a much lower profile than TV, but in areas outside pop music the BBC service is the envy of the world. Live Prom concerts can rival all other sources from a hi-fi perspective. Only the FM (VHF) bands give stereo hi-fi sound, though AM (MW & LW) are useful for receiving certain transmissions in the UK.

Something of a hi-fi afterthought, tuners are

often selected merely to match a chosen amplifier cosmetically. However, the task they carry out is far from simple (or cheap), combining the skills of RF (reception) and audio (signal processing) engineering. The importance of the former will depend on local reception conditions, but money invested in a high quality outside aerial system is usually well spent.

Tuners come in two basic types. Analogue models tune gradually (and usually manually) across the bands, and can have analogue or digital displays; they are often preferred for sound quality, and are certainly best for AM bands. Digital tuners offer convenient automatic tune facilities and hold many station positions in pre-set memories.

NAME PRICE	LAB SOUND	COMMENTS	FEATURES	VALUE	BACK ISSUE FULL REVIEW
A&R Arcam Alpha £149.90	Good Average+ +	Attractively classic British analogue tuner with sound quality comfortably better than most	FM/AM Analogue	BB	50
Creek CAS3140 £150	Very Good Good+	A true front-rank tuner, excellent ergonomics and audiophile sound quality albeit with the minor handicap of having FM only	FM only	BB	50
Denon TU 45L £130	Average+	Poor AM sound quality may be a deterrent but the FM performance fully merits recommendation	FM/AM Digital	R	50
Harman Kardon TU915 £325	Good Good	This gave good FM performance but was thought "wretched" on AM. (Psst... you don't necessarily buy a tuner for the AM.)	AM/FM 16 presets auto seek		50
Hitachi FT5500 II £250	Very Good Good+	Soundwise highly rated on FM, and on AM basically satisfactory - a versatile all-rounder	Auto and manual tuning. 16 presets	R	44
Mission Cyrus £180	Average Good+	Best Buy material on sound quality but radio frequency performance let it down	FM/AM auto seek tuning	R	50
NAD 4020B £139	Good Average+	Not the quietest or most sensitive tuner tested, it still provided good sound for the money, being "musical and ambient"	Analogue FM/AM	BB	50
Naim NAT 01 £1098	Very Good Very Good	There may be better sounding tuners in the world, but we have yet to hear one	No presets. Two box, flywheel tuning FM only, Analogue	R	50

THE WORLD'S NO 1 GUIDE TO BUYING HI-FI

DIRECTORY

NAME PRICE	LAB SOUND	COMMENTS	FEATURES	VALUE	BACK ISSUE FULL REVIEW
Quad FM4 £289	Very Good Good+	Fine sound, excellent ease of use, good build and finish and a more than satisfactory technical performance	7 presets, Digital	R	50
Revox B261 £1174	Excellent Good+	A sophisticated and well-executed example of modern broadcast design; could be the logical choice for the deep-pocketed radio enthusiast	FM only, twin headphones, 20 presets	R	50
Rotel RT-850L £150	Good+ Good+	Scoring well on listening tests and one of the best sounding tuners at its price level, it was a bit let down on AM but RF performance was good	FM/AM, digital	BB	50
Sansui TU-D99XL £249	Very Good Good+	This slimline compact model gave good FM sound quality and strong RF performance. But the AM sounded unpleasant	16 presets, AM/FM	R	50
Sony ST-S 700ES £299	Very Good Very Good	First class in every respect including FM sound quality. Even AM was well above average	10 presets, FM/AM digital scan	BB	50
Technics ST-500L £100	Average+ Average+	Fine RF performance and fair FM sound at bargain price = Recommended tag. Alas the AM sounded as if it was coming "down a long furry tunnel"	FM/AM 16 station presets, scan	R	50
Technics ST-G7 £400	Very Good Good+	Muffled AM, but fine stereo FM quality and well built	16 presets, digital	R	50
Yamaha TX-500 £150	Average+ Average	Under a gaudy coat, this sensitive tuner gave reasonable stereo results. However, the AM had again been thrown down a well	20 presets (10 buttons) digital		50

CD PLAYERS

This new all-digital music source seems set fair to becoming properly established, despite still high disc prices and the opposition of many hi-fi enthusiasts. Compact Disc's strengths over conventional vinyl are complete freedom from surface noise with automatic and programmable play, plus track skip and fast music scan - frequently under full remote control. However, many

vinyl enthusiasts find CD's sound less involving than top quality vinyl replay.

Introduced five years ago at around £500, CD players now average half that price, and for the main offer improved performance besides. Even cheaper players may have the latest decoding chips and the most useful play features; extra money can buy remote control, remote volume control, audio

'tweaks', plus improved build and component quality control.

Compared with many hi-fi components, CD players give impressive lab performance, though there are differences between players nonetheless. Sound quality variations are even more marked, particularly in a good quality system. As it behaves very like a pre-amp, there are no problems connecting a player to a normal amplifier.

MODEL PRICE	LAB SOUND	COMMENTS	FEATURES	VALUE	BACK ISSUE FULL REVIEW
Acoustic Research CD-04 £290	Good Average+	Stylish but basic player, based on Philips 14-bit 4 x oversampling with respectable sound tweaks and remote control	Remote Control, headphones	R	51
ADC CD-250X £230	Good+ Average	Well made and engineered, and above average soundwise, trumpets could sound 'thin' though violins were liked so it may prefer Stephan Grappelli to Miles Davis	Skip and search, manual, repeat and 16-track programming	R	This
Aiwa DX-500 £179	Average- Average-	Adequate build quality and reasonable features, but this unit did not do very well in the lab and was sonically a disappointing experience	No remote control or headphone socket, but scan, skip, search etc		This
Akai CD-A70 £299	Average Average	A full feature 16 bit 2 x oversampling remote control player with fine presentation and finish and a pleasantly laid back sound quality	Full width rapid access, keypad programming, remote control		51
Cambridge Audio CCI £1500	Good+ Excellent	Advanced design and circuitry give this top class two-box machine exceptional performance, so the intrinsic qualities of CD, (eg. silent surfaces), make themselves felt	No headphones, seven audio filters, skip and scan	R	Coll
Denon DC-500 £250	Average+ Average	Pleasant and lively, offering a fine combination of sound and build quality at a realistic price	Headphones, search, skip	R	51
Denon DCD 1500 £480	Good Good	Rated well with a neutral and dynamic sound though a little forward in character. Good facilities and construction	Fast track skip, keypad programming, timer, remote control, headphones		51
Denon DCD 1700 £599	Good+ Very Good	The overall sound was strong and coherent approaching reference standards. Fine build quality and facilities make this a firm contender	Remote, skip, scan, headphones, programmable	R	51
Denon DCD 300 £210	Average+ Average+	Unspectacular all round competence with remote control can't be bad at the price	Skip, remote control, headphones	BB	51
Denon DCD 700 £290	Average++ Average+	Sound quality is pretty good at the price, and facilities adequate. A competent middle ranking deck at close to budget cost	Remote control, scan, skip, search, programming, headphones	BB	51
Denon DCD-3300 £1200	Good++ Very Good	Sounding tight and coherent though not significantly better than the cheaper 1700. Very well built and comprehensively equipped	Remote control, with volume, keypad programme, scan, search, headphones		51 51
Denon DCD-900 £330	Average++ Average+	Decent sound and build quality and comprehensive facilities. A good but unexceptional performer	Keypad programme, search, skip, headphones, remote control	R	51
Ferguson CD-04 £149	Average+ Average	Could well provide an answer for those appalled by the complexities of many CD players, who seek a low cost, good quality, simple performer	Track skipping, nine track memory	BB	51
Goodmans GCD-500S £160	Average- Average-	User-friendly but flimsy build quality and second class sonics make this poor value even at the price	Audible scan and track skip, programming		51/45
Harman Kardon HD100 £399	Average Average-	With a mixed subjective performance this well built player failed to make the grade in its price class	Skip and scan, programmable		51
Hitachi DA-7000 £180	Good Average	Generally competent, especially considering the price, this was well built and styled if lacking in some facilities - a good budget starter	Memory and repeat, plus the basics	BB	This
Hitachi DA007 £330	Average Average	Unusually fitted with wooden end cheeks and comprehensively kitted out, but only average in sound quality	Full remote control, adjustable headphone output keypad programming		51
JVC XL-M700 £599	Average Average+	An autochanging, twin drawer player offering fair sound quality and the possibility of endless play!	Auto changer, full remote control, random play, intro scan repeat		51
JVC XL-V1100 £659	Average+ Average+	A substantial and very well built flagship model with 16 bit 4 x oversampling, though sound quality was disappointing at the price	Full remote, headphones, scan, skip, intro-scan		51
Kenwood DP990D £299	Average+ Average	A good all-round package, just deserving recommendation, but comparable sound quality can be found more cheaply elsewhere	Headphones, remote control, (manual override)	R	51
Luxman D-100 £449	Average Average-	Sparsely equipped with a slightly old fashioned sonic character, offering little but physical weight for a quite high price	Remote control, skip, scan, headphones (variable)		51
Marantz CD873 £240	Good Good+	Putting many 'audiophile CD's to shame in terms of sound quality this proved another winner, though there was slight criticism of control accessibility at times	No remote control, but the usual skip, scan etc	BB	This
Marantz CD-273SE £240	Good+ Good	The Euro-tweaked version of the standard 273, this model fulfills pretensions to audiophile standards at a budget price	Manual control, skip and scan (audible), 20 track programming, repeat	BB	51
Marantz CD273 £199	Good Average+	An ambitious machine at the price, offering pretty good sound quality but a slightly below average build standard	Skip, scan, programmable	BB	51
Marantz CD65 £250	Average+ Good	Comfortably above average sound quality, this best selling model still represents good value for money	Search and programme, manual control	BB	51
Marantz CD75 £300	Good+ Good+	It delivers a sound quality that can rival machines twice the price even though it may lack some luxury touches	Remote control, search, programmable	BB	51/Coll
Marantz CD94 £800	Good++ Good++	Clearly the best Marantz CD player, with high build quality and good objective and subjective performance	10 digit keypad, headphones, favourite track selection, remote	R	51

DIRECTORY

CD PLAYERS

NAME PRICE	LAB SOUND	COMMENTS	FEATURES	VALUE	BACK ISSUE FULL REVIEW
Meridian 207 £950	Very Good Very Good	A very stylish two box player with onboard pre-amp, providing excellent sound quality and remarkable flexibility	Fully remote, full track search, programming	R	51/Coil
Mission PCM7000 £600	Good Good+	Stylish with a large informative LCD display this deserves recommendation on the basis of sound quality alone	Remote volume control, digital filtering	R	51/Coil
Nakamichi OMS-3E £995	Good Good	Superbly built and presented this expensive machine was a bit of a "stuffed shirt" when it came to sound quality	Remote control, skip and scan, headphones		51
Nakamichi OMS-4E £1200	Very Good Very Good	Solidly controlled and comparatively simple this clearly represents one of the major benchmarks for CD sound quality though the midrange sounded a touch thin	Skip and scan, headphones	R	51
Nakamichi OMS-5EII £1500	Good+	... delivers near state of the art performance and build quality in a deliberately starkly functional package, but at a very high price...	Skip and scan, simple track programming, manual control		51
Nakamichi OMS-7EII £2000	Good+	The only serious criticism here is of the price. And in our not always humble opinion you can get better sound quality for less elsewhere in Nakamichi's range	10 digit track entry keypad programming, headphones		51
Philips CD 160 £200	Good Average+	A little tinny in construction and "plasticky" in feel, this popular model rated well on sound quality despite its budget price	Skip, (20 track) programming, repeat/display	BB	51
Philips CD360 £250	Good+	Fine lab performance and exceptional listening test results, plus the 200 disc favourite track selection makes this modestly priced unit a Best Buy	Remote control, favourite track selection, skip	BB	51
Philips CD473 £250	Good Good+	In the forefront as regards sound quality, this is one of the best sounding Philips players yet; we were unable to catch it out on classical through Jazz program	Favourite track selection, remote control with volume, headphones etc	BB	This
Philips CD960 £700	Good++ Good++	Simple to use with exemplary lab performance, this showed no sign of weakness while sound quality improvements over mainstream models more or less justify the price	Full remote control, favourite track selection, etc	R	51/Coil
Pioneer PD-6050 £230	Good Average+	Much liked on Jazz and rock program this was highly rated in terms of value for money. The midrange sounded a little forward and thin though	Everything but a digital out socket and remote volume control	BB	This
Pioneer PD-M70 £399	Average Average	A remarkable catalogue of features justify the price. Soundwise it rated just above average overall	Remote control, 6-disc autochanger, 8 programme memory, headphones etc		51
Revox B226 £756.70	Good+	The traditional Revox house style is combined with the fine Philips 16 bit chip set, but this player doesn't really offer sound quality to match the price	Infra-red remote control, full search, scan, programming		51/Coil
Rotel RCD 820BX £350	Good Good	A respectable performer with adequate build quality and features, this got the "R" for good musical reproduction	Remote control, repeat, 20 track programming, step	R	51
Rotel RCD-820 £249	Average++ Average+	Though essentially a Philips clone, the 820 does offer a very respectable sound quality for the price, plus remote control	Remote control, 20 track programming, repeat, step	R	51
Sanyo CDP-M50 £200	Average-	A no-frills mid-sized package, this was not up to the usual Sanyo sonic or technical standards but it was well built	Skip, search, repeat, 16-track memory, programmable		This
Sharp DX-R700H £249	Average-	A workmanlike player that does not offer exemplary lab or sound quality but which is well-built with good facilities and should perform well in use	Remote control, track selection keypad, skip, scan repeat programming		This
Shure Ultra D6000 £495	Average+	Ergonomically well thought out with full function remote control, but not really scoring sonically considering its price	Remote control (full function inc volume)		51
Sonographe SOT (by CJ) £799	Good Good++	Distinctive with oak end-cheeks, using Philips based 14 bit x 4 oversampling, Conrad Johnson electronics make this a musically rewarding player	Full search programme and timing	R	51/Coil
Sony CDP 555es £1000	Very Good Very Good	Extravagant build quality, sophisticated features and near state-of-the-art performance, it competes effectively with more expensive models	Remote control, 20 digit keypad, track access, programming	R	51
Sony CDP 710 £299	Good+	One of the outstanding contenders in our 1987 edition. The build was cool; the sound was hot	Remote control, 20 digit direct entry keypad, etc	BB	51
Sony CDP-222ES £449	Good Average+	Exceptional build quality and presentation plus respectably good sound quality merits the "R", but some of its kin were preferred	Remote control, 20 digit keypad, track access, programming	R	51
Sony CDP-310 £250	Average++ Average	Fine build, facilities and healthy enough sound quality - recommended, but look around the range	Remote control (+ usual)	R	51
Sony CDP-M20 £199	Average+	Keeping pace with improvements in the marketplace, it combines decent performance with good build and is competitively priced	20 track programme, skip and scan, repeat and random play	R	51
Sony CDP-M50 £269	Good+	Fine build quality, good technical performance and extravagant features make this a very competitive package	Shuffle, skip, search, remote headphones	R	This
Sony D100 £300	Average Average-	The best all round portable tested, but also the most expensive, and still no substitute for a conventional player	Skip, repeat, 21 track programming, headphones, LCD display		51
Sony D30 £230	Average-	At 50p per hour to run, the sound quality is poor compared to mains machines although reasonably competent overall for a Discman	LCD display, skip, shuffle, and repeat, "in-ear" headphones		51
Teac ZD3000/ZD5000 £899/£999	Very Good Average+	Although achieving a superb technical performance, these players are not competitive on sonic grounds in this price category	Full remote control, keypad, fast track skip, headphones		51
Teac PD-250 £250	Average Average	16 bit 2 x oversampling with fair if lightweight build quality. Sonically falling short of recommendation, but not bad all the same	Remote control, skip, scan, programming		51
Technics SL-P 111 £179	Good Average	An above average sound quality at a well below average price, but this is only most things to most men	Skip, audible scan, programme repeat, preset edit play	BB	51
Technics SP-P1200 £800	Good++ Good+	Looking more like a desk work station than a stackable component, this will appeal to the creative recordist and semi pro user. Sounded pretty good	Headphones, remote control, search dial cueing, etc		51
Technics SL-P220 £229	Average++ Average	Sound quality keeps this out of the top ranks but the facilities (wow) and fine technical performance will make it hard to resist for some	Everything except a digital out socket, which is no great loss to most	R	This
Technics SL-P520 £350	Good+	With features and facilities to satisfy the most eager button pusher, this also produced decent sound quality	High/Low scan ratios, headphones, memory, programming and more	R	51
Technics SL-XP5 £250	Average-	A contender for the "Worlds smallest" title, this beautifully crafted miniature falls short in terms of sound quality	Headphones, "high cut" filter, skip, search		51
Technics SLP 720 £400	Good++ Good	More buttons for sonic pilots - this was the most sonically super of the top Technics models	Search dial cueing, high scan speed optics, disc menu, programming	R	51
Yamaha CD-X5 £200	Average+	Good build quality, respectable lab performance, and decent enough sound delivery for your money	Skip, scan, manual only, etc	R	51
Yamaha CDX-1100 £700	Good+	A pearly king might like the button overkill here... yet despite exceptional lab performance, listeners were not unduly impressed. Its worth considering	Volume handset, random play, space insert, 26 direct track entry keys		51
Yamaha CDX-900 £450	Good Average+	A real button bristler with extensive facilities; well built; but sound quality might suggest a lower price	Programme calendar, remote control, 26 key direct track entry		51

DIRECTORY

CASSETTE DECKS

The bad odour of copyright theft hangs around the compact cassette, but there is no doubt it is the world's most versatile and ubiquitous music storage medium. Hi-fi buffs may wrinkle their noses pointedly, but are still happy to use cassette decks to make up tapes for the car or personal – at the same time complaining loudly about the quality of pre-recorded material. (In fact the very best decks can do a surprisingly good job with musicassettes – see Comments.)

There is no problem in connecting a cassette deck to any normal amplifier, but some care needs

to be taken in choosing the best tapes for a specific machine. (Trial and error is one effective technique, but many decks have manual bias adjustment and some match up to the tape automatically.) Lab performance and sound quality often go hand in hand, and are frequently somewhat dependant upon factory alignment. The mechanical integrity of the mechanism itself is another crucial factor, that is often reflected in the asking price.

All modern hi-fi decks have Dolby B and the majority have Dolby C besides; the very worthwhile HX Pro system is becoming steadily more

widespread. Remote control remains rare though sometimes it is available as a system option.

Three-head recorders allow simultaneous checking of the recording being made. Auto-reverse is a useful convenience feature, but usually with some mechanical compromise, while double-mechanism 'dubbing' decks of dubious quality are fashionable at the bottom end of the market. The welter of different 'music search' systems available is some indication of their frequent ineffectiveness.

NAME PRICE	LAB SOUND	COMMENTS	FEATURES	VALUE	BACK ISSUE FULL REVIEW
Aiwa AD-F26D £90	Good Poor	Well equipped conventional budget recorder measured rather better than it sounded	Dolby B, C, Bias adjust, auto tape select		52
Aiwa AD-R46D £149	Average Average—	Some worthwhile features but sound quality was not especially liked	Auto reverse, Dolby B, C, Track search, Bias adjust		52
Akai GX-6 £329	Good Good	There is a strong sense that someone has really thought this one through; it has an indefinable 'specialness'	Dolby B, C, Bias adjust, Track search	R	52
Denon DR-M07 £140	Average+ Excellent	Despite minor operational and measured shortcomings, sound quality is excellent for the price	Dolby B, C, Record bias adjust	BB	52
Denon DR-M10 £180	Good Good	With the money spent where it counts, this deck rates well at the price. A wide dynamic range and real sense of sonic consistency	Track search, Dolby B & C, Three motor	R	52
Denon DR-M12HX £220	Good Good+	Well constructed and pleasant to use, a lack of true pitch constancy kept it from sounding superb	Dolby B, C, HX Pro, Track search, Bias adjust	R	52
Denon DR-M30HX £319	Good Good+	Ergonomically fine with infra red remote, the M30 fared well on pre-recorded material and was at its best with ferric tapes	Infra Red Remote, Dolby B, C, Hx Pro, 3 Head, bias adjust	R	52
Denon DR-M44HX £400	Excellent Excellent	A well designed deck that also performed fine sonically, working very well with ferric and metal tapes	3 head auto tape set up, real time counter, Dolby B, C, HX Pro,	R	52
Marman Kardon CD491 £695	Good Good+	Excellent audio engineering and tremendous flexibility make this an audiophile cassette deck 'par excellence'	Dolby B, C, MPX Bias/Sensitivity adjust, Track search	R	52
Marman Kardon TD202BL £249	Average Average	A competent middle-ranking performer but lacks sonic incisiveness and is a bit expensive	Dolby B, C, Bias adjust		52
Hitachi D-007 £300	Average— Poor	This double 'dubbing' deck proved a mixed bag – good in parts but disappointing overall	Continuous auto reverse, twin deck, Dolby B & C, dubbing, High Speed		52
JVC TD-V66 £350	Average Average	A user-friendly modern player marred by a 'lazy' undynamic sonic character	Auto Tape Sel., Track Search, Dolby B & C		52
JVC TD-X202 £130	Average Average	A bit of a mixed bag, with rather basic controls and an unimpressive sound quality	Dolby B & C		52
JVC TD-X502 £250	Average— Average	Inconsistent sound quality and lab performance, alongside complex ergonomics and elaborate search facilities	Dolby B & C, Music Search, Intro Scan, Remote Option		52
Kenwood KX550HX £150	Average Average+	This well-laid-out and attractive deck ultimately lacks the edge to stand out in a competitive field	Dolby B & C, HX Pro, Auto tape select, Track search		52
Luxman K-105 £349	Average Average	Rating quite well for an auto reverse deck, and featuring complex track search facilities, it was not sonically competitive on price	Auto Rev, Dolby B & C, Auto Tape Sel.		52
Luxman K-100 £199	Average+ Average+	Poorly laid out but it fared quite well on metal tapes. Commercially recorded tapes sounded bright and cramped, however	Dolby B & C		52
Marantz CP230 £250	Average Average	This is a competitively priced portable recorder though not suited to replay of musicassettes	Dolby B, Bias adjust, Pitch control, Portable	R	52
Marantz SD-35 £160	Good Good+	Rock steady tape transport gives very competitive sound quality for the price. Based on rock steady tape transport, this slightly bright replay may not appeal to some	Auto Select, Dolby B & C	BB	52
Marantz SD-4511 £200	Good+ Good+	Well built and dynamic sounding player, working better as a recorder than with musicassettes	Dolby B & C, Separate MPX, Auto selection	R	52
Nakamichi BX-125E £395	Good Good	This well engineered budget Nakamichi fared very well on all but pre-recorded material. Fundamentally very, very right	Dolby B & C	R	52
Nakamichi BX300E £645	Good Good	Playback of tapes made on the machine is excellent, sounding quite unlike a cassette deck. Musicassettes were not so hot	Optional Remote, B & C	R	52
Nakamichi CR-7E £1500	Excellent Excellent	Remarkably this deck is not only ergonomically but also sonically superior to the Dragon, particularly on record/replay	B & C, Auto Tape Type, 3 Head, Infra Red Remote	R	52
Nakamichi Dragon £1750	Excellent Excellent	Previous to the birth of the CR-7E, this machine stood head and shoulders above the rest. It is still the ultimate for musicassette replay	Dolby B & C, Auto Azimuth Correction, Manual EQ and Bias, Auto Reverse		52
Onkyo TA 2130 £140	Average+ Average+	Rating fairly well on both pre-recorded and record/playback, ergonomics were a little poor but overall performance was generally consistent	B & C, Auto Tape Select, Intro Scan	R	52
Novox B215 £1461	Good Average+	Superb engineering and good sound, but lacking the subjective qualities that characterise the very best hi-fi equipment	Dolby B, C, Remote control, Headphones		52
Rotel RD-B30 £99	Average— Poor	A pretty fundamental if slightly dated design with little sonic merit but an attractive enough price	Dolby B		52
SAE C102 £495	Average+ Good	Looking most unlike a cassette deck designed in the States and proving competitive in its price group. Not sonically that outstanding, however	Auto repeat, Track Skip, Real Time Counter, B & C, Auto Select	R	52
Sony (WMD6C) ProWalkman £249	Good+ Excellent	"One of the finest sounding cassette decks on the market today. A mandatory Best Buy, which also fits in your pocket".	Dolby B, C, Portable, Mic/Headphones	BB	52
Sony TC-FX 150 £90	Average+ Average+	Recording and playing back on this deck itself gave acceptable results, whereas pre-recorded stuff was a joke. But it's a good £90 worth	Dolby B & C	BB	52
Sony TC-K444E SII £349	Good Average	Even the best this deck has to offer is not truly commensurate with the price	Dolby B, C, Memory stop and replay, Headphones		52
Sony TC-K700ES £499	Excellent Excellent	Firmly in the esoteric league, this is easy both to operate and to listen to. Best points: first class imagery, focus and stability	Dolby B, C, Auto tape select, Memory/auto play, Bias/sensitivity adjust	R	52
Sony TC-R502ES £279	Average+ Good	The deck sounded crisp, alive and gave quite good stereo and tonal quality. Wide dynamic range material can be handled with ease	Auto reverse, Dolby B & C, HX Pro, Remote control, Bias adjust	R	52
Teac V-200 £80	Average— Average+	At this price you don't get fireworks, but it offers real value for money and sounds open and honest	Dolby B	R	52
Teac V-210C £99	Poor Poor	It could have been our sample but we found inadequate speed stability and a 'messy' sound	Dolby B, C, Bias adjust		52
Teac W-310C £129	Average— Average—	Dubbing performance is poor, especially using the high speed mode but normal record and replay performance standards are not too bad	Dolby B, C, Twin transports, bias adjust		52

DIRECTORY

CASSETTE DECKS

NAME PRICE	LAB SOUND	COMMENTS	FEATURES	VALUE	BACK ISSUE (S=SUMMARY)
Teac W300 £115	Poor Average-	Sonically a mixed blessing, it does well with pre-recorded tapes but home-made recordings sound a little rough	Twin-deck high speed dubbing, Dolby B		52
Technics RS-B305 £140	Good+ Excellent	Well built and offering excellent sound quality at the price, working well with metal tapes if not so hot on pre-recorded material	Dolby B & C, dbx	BB	52
Technics RS-B705 £250	Average Average-	3 heads for the price of two, but not the sound quality to go with them	3 head, Dolby B & C & HX Pro		52
Technics RS-T22 £150	Excellent Average	Good value for a twin deck machine, and fairly simple to use, but sonically no competition for single transport machines	Twin, Dolby B & C High Speed Dub.		52
Technics RS-T80R £400	Poor Poor	Flexible and pleasant to use but poor transports led to poor sound on our latest sample	Twin Deck Auto Rev, High Speed Dub, Auto Tape select, B & C & DBX		52
Yamaha K-340 £160	Average Average	This deck doesn't make the grade on the grounds of poor speed stability, and an unwelcome degree of record level dependency	Dolby B, C, HX Pro, Auto search/scan, Optional remote control		52
Yamaha K-540 £210	Average Average	Satisfactory but not especially satisfying, and also a bit gimmicky, it failed to match its brothers' good-performance-at-the-price ratings	Auto search/repeat, Dolby B, C, HX Pro, Bias adjust, Remote		52
Yamaha K222 £200	Poor Poor	Beautifully made, but it makes little sense in purist audio terms	High speed dubbing twin deck, Dolby B, C, Auto search, Track sensing		52
Yamaha KX-1200 £500	Excellent Average+	A veritable rats' nest of buttons and dials, albeit well laid-out. This is nearly a great recorder, but lacks simplicity of sound	Dolby B, C, HX Pro, Bias adjust, Auto search/repeat, Remote, headphones		52
Yamaha KX-200 £140	Good- Good	Cheap, well-equipped and workmanlike with the sound quality less obviously processed than most - the whole is more than the sum of the parts	Dolby B, C, Headphones, Track search/scan, Optional remote	BB	52
Yamaha KX-400 £200	Good Good+	A highly commercial package with every widget under the sun. Happily it sounds good too.	Auto reverse, Dolby B, C, Hx pro, Track search/repeat remote control	R	52

CD MIDI SYSTEMS

So you want a hi-fi, but you don't want to make a fuss about it. A pre-packaged system with everything matching up and no aggravation may not rank with carefully chosen separates on **sound quality**, but there's no denying the attractiveness or popularity of this approach - the market for pre-packaged component hi-fi systems is at least as big as that for separate items, even ignoring the vast numbers of low-cost single unit stacker systems.

The arrival of compact disc led to a new fashion

for shelf-standing compact systems, or 'midis' as they are known in the trade, as a replacement for earlier floor-standing rack systems (themselves the upmarket development from music centres). Only some 330mm wide, midis can more or less match full-size (430mm) rack components for performance, and are certainly cheaper to make, ship, sell and buy.

Whereas specialist hi-fi is moving steadily towards ultra-simple 'no-frills' components, midi systems tend to be sold on a feature count at a price

point, usually with little opportunity for demonstration and comparison. Our test programme includes extensive auditioning and lab testing, while making allowance for the different aspirations of designers and expectations of users. Key features valued highly by customers include system remote control, automatic switching, double 'dubbing' cassette decks, and elaborate equaliser tone controls. And the top end of the market is developing with surround sound audio/video-ready packages.

NAME PRICE	LAB SOUND	COMMENTS	FEATURES	VALUE	BACK ISSUE FULL REVIEW
Akai 990 £1400	Average Average+	A gadget oriented expensive system with good compact disc player and remarkable loudspeakers. Let down, however, by the tuner and turntable and not helped by obscure ergonomics	Twin deck cassette, Auto rev., Remote Control, Auto source selection		Systems
Binatone Laser CD System 2000 £270	Bad Bad	A bit of a disaster even at the price. Built to extremely low standard with an appalling turntable. CD and loudspeakers OK, but let down by amp	Twin cassette		Systems
Ferguson HF03 £400	Average+ Good	An all round success with British built speakers and all sources achieving a reasonable standard. Compact disc was weak compared to other units	Twin cassette	BB	Systems
Fisher Midi System M56CD £580	Average Average	Fitted with a pretty good amp, but dire loudspeakers; otherwise a competent combination including a pretty fair cassette deck	Twin cassette, 5-band graphic Equaliser		Systems
Fisher Midi System M46CD £500	Average Average	Somewhat overpriced, the M46 is let down by a poor amplifier and worse speakers. Other elements perform reasonably, CD being its strongest point	Twin transport		Systems
Fisher 2400 £600	Average Average	An ambitious and competent package with a strong amplifier and CD player. Given its new lower price it would have merited recommendation if the loudspeakers hadn't let it down	Twin deck, Graphic eq, 5-band		Systems
Goodmans 5200 £459	Average+ Average+	Offering possibly the best speakers around in this midi system market, the Goodmans wins on a fair standard for the price, though the turntable was not too hot	12 Band Graphic Eq, Twin deck	BB	Systems
Mitsubishi CD51 £429	Average Average-	In some ways a well balanced system, in that the amp and speakers smooth the rougher edges of some sources, but not very satisfactory on the whole	Remote, twin deck		Systems
Mitsubishi 100R £650	Average Average+	A pretty good package, flawed by 'tinny' loudspeakers, but having a fair turntable - a rarity in this category of equipment	Remote, Multidisc CD, Twin	R	Systems
Philips FCD 565 £370	Poor Poor	An unimpressive system. While the compact disc player and tuner were OK, its main tonal characteristic on all sources was a coarse top end	Double deck, 5 band graphic eq.		Systems
Sanyo W36 £550	Average Average	For a change, this outfit comes with excellent loudspeakers and CD player. The main weakness seems to be the amplifier but the turntable was OK, if not fab!	Two H/phone, 5 band graphic, twin deck cass.	BB	Systems
Sony Compact Series 90 £1500	Good Good+	The best of a not too wonderful bunch, the excellent compact disc player and pretty good speakers make for reasonable sound quality, though the tuner wasn't of quite the same standard	Twin deck, auto reverse, timer, extra tape socket	BB	Systems

THE WORLD'S NO 1 GUIDE TO BUYING HI-FI

SELECTED DEALER DIRECTORY

Choosing a good hi-fi dealer is the most vital step in acquiring the system that is right for you. This unique directory gives full information on dealers in your area.

AVON

ABSOLUTE SOUND AND VIDEO, 65 Park St, Clifton, Bristol. (0272) 264975. A&R, Denon, Dual, Linn, Mission, NAD, Quad, Roksan, Rotel, Yamaha, etc. (closed Weds). BADA MEMBER 

PAUL GREEN HI-FI LTD, Kensington Showrooms, London Rd, Bath. (0225) 316197. A&R, Creek, Dual, Heybrook, Linn, Musical Fidelity, Rotel, Systemdek, Wharfedale. Dem facilities available, ring for appointment, car park. Open Tues-Sat, 9-5.30. Home trial facilities, free installation, instant credit up to £1,000. Credit cards: Access, Visa. BADA MEMBER 

BERKSHIRE

READING HI-FI CENTRE, 4-6 Harris Arcade, Friar St, Reading. (0734) 585463. 'The best equipment, advice and service from Berkshire's premier Hi-Fi emporium'. BADA MEMBER 

BUCKINGHAMSHIRE

AUDIO INSIGHT LTD, 53 Wolverton Rd, Stony Stratford, Milton Keynes. (0908) 561551. A&R, Audiolab, Heybrook, KEF, Linn, Mission Cyrus, Musical Fidelity, Nakamichi, Nytech, Rotel. Dem facilities available. Open Tues-Sat. Home trial facilities, free installation, instant credit up to £1,000. Credit cards: Access, Visa. Service dept. BADA MEMBER 

AYLESBURY HI FIDELITY, 98 Cambridge St, Aylesbury. (0296) 28790. Dual, Heybrook, Linn arms, Musical Fidelity, Mission, NAD, Nakamichi, Quad, Rotel. 2 Dem rooms available, ring for appointment. Open 10-6 Mon-Fri, 9.30-5.30 Sat. Home trial facilities, free installation, instant credit up to £1,000. Credit cards: Access, Amex, Diner, Visa. Service dept. BADA MEMBER 

CAMBRIDGESHIRE

CAMBRIDGE HI FI, 1 Hawthorn Way, Cambridge. (0223) 67773. AR, Cambridge Audio, Monitor Audio, Panasonic, Pioneer, Sony ES, Technics, Thorens, Trio, Yamaha. Demonstration facilities. No appointment required. Open 9.30-5.30 Mon-Sat. Free installation. Credit facilities. Up to any amount. Credit cards: Access, Barclaycard. Service dept. available. BADA MEMBER 

STEVE BOXSHALL AUDIO, 41 Victoria Rd, Cambridge. (0223) 68305. Quad, Rotel, Dual, Denon, Krell, Nakamichi, Marantz, Monitor Audio, Tannoy. Demonstration facilities. No appointment required. Open 10.00-6.00, Mon-Sat. Home trial facilities, free installation, credit facilities. Credit up to \$3,000. Credit cards: Access, Barclaycard, Service dept.

CHESHIRE

ASTON AUDIO, 4 West St, Alderley Edge. (0625) 582704. Wide selection of equipment in N.W. Two-year guarantee. Dem facilities: 3 dem rooms, appointment required. Open 10-6 Tues-Sat. Home trial facilities, free installation. Instant credit up to £1,000. Credit cards: Access, Amex, Diners, Visa. Service dept. BADA MEMBER 

DOUG BRADY HI-FI, Kingsway Studios, Kingsway North, Warrington. (Padgate 0925) 828009. 1986 Sony/Hi-Fi News Best Dealer in N.W. England and Wales. 'Largest choice of specialist Hi-Fi in N.W. \$100-\$20K'. All credit cards. 3 Dem Rooms. Dem facilities. BADA MEMBER 

HI-FI CENTRE, Green Lane, Wilmslow SK9 1LQ. Tel: (0625) 522112/524766. B&O, Technics, Sony, Panasonic, Nakamichi, Quad, Revox, Teac, Harman Kardon, Marantz. Demonstration facilities - no appointments required. Open 9-1, 2-5.30 (closed Wed). Open all day Sat. Home trial facilities, free installation, credit facilities. New customers up to \$500 credit. Credit cards: Access, Visa, American Express, Diners Club, Wilmslow Card. Service dept. available.

NEW DAWN HI-FI, 1-3 Castle St, Lower Bridge St, Chester. (0244) 24179. Linn, Quad, Technics, National Panasonic, Denon, Rotel, Dual, Meridian, Aiwa, Philips. Dem facilities: 2 dem rooms. Open 9.00-5.30 Mon-Sat, closed Wed. Free installation, instant credit. Credit cards: Access, Visa, Trustcard. BADA MEMBER 

SWIFT OF WILMSLOW, 4-8 St Annes Parade, Wilmslow. (0625) 526213. A&R, Aiwa, Denon, Dual, Marantz, Mission, Monitor-Audio, Pioneer, Trio, Yamaha, NAD. Dem facilities available. Open Mon-Sat 9.15-5.45. Closed 1-2 Lunch. Home

trial facilities, free installation, instant credit up to £1,000. Credit cards: Access, Visa. Service dept. BADA MEMBER 

CORNWALL

TRURO HI-FI & E.T.S. Ltd, 25 King St, Truro (0872) 79809. A&R, Denon, Dual, Heybrook, Linn, Mission Cyrus, NAD, Quad, Rotel, Thorens. Dem facilities: Single speaker studio. Open Mon-Sat 8.45-5.30. Home trial facilities, credit up to £1,000. Credit cards: Access, ETS Visa. Service dept.

DERBYSHIRE

ACTIVE AUDIO, 12 Osmaston Rd, The Spot, Derby. (0332) 380385. Meridian, Mission, Denon, Yamaha, Rotel, A&R Cambridge, Monitor Audio, Trio, Marantz. Demonstration facilities. Open 9.30-6.00 - early closing Wednesday. Home facilities: credit up to £1,000. Credit cards: Access, Barclaycard, Diners, American Express. Service dept. BADA MEMBER 

DEVON

PETER RUSSELL HI-FI ATTIC, 58 New George St, Plymouth, Devon (0752) 669511. Quad, Linn, Mordaunt-Short, A&R Cambridge, Revolver, Heybrook, Denon, Harmon-Kardon. Dem facilities - no appointment required. Open Mon-Sat 9.30am-5.30pm. Home trial facilities. Free installation. Credit facilities. Credit cards: Visa, Access. Service dept.

ESSEX

AT LABS, 442/4 Cranbrook Rd, Gants Hill, Ilford. (01) 518 0915. Open Mon-Sat, 10-6. Two single speaker dem rooms. Credit cards: Access, Amex, Visa. BADA MEMBER 

BEECHWOOD AUDIO, 6 Market St, Braintree. (0376) 29060. A&R, Ariston, B&W, KEF, Meridian, Musical Fidelity, NAD, Nakamichi, Pink Triangle, Quad, Rotel. Dem facilities: 2 single speaker rooms. Open Mon-Sat, 9.30-6.00. Home trial facilities. Free installation, instant credit up to £1,000. Credit cards: Access, Amex, Diners, Visa.

BRENTWOOD MUSIC & HI-FI CENTRE, 2 Ingrave Rd, Brentwood. (0277) 221210. B&W, Denon, Harmon Kardon, JBL, QED, Quad, Rotel, Tannoy, Trio, Yamaha. Dem facilities available. Open Mon-Sat 9.30-5.30. Home trial facilities, free installation, credit facilities. Credit cards: Access, Visa. Service dept.

GLOUCESTERSHIRE

ABSOLUTE SOUND AND VIDEO, 40/42 Albion St, Cheltenham. (0242) 583960. A-R, Denon, Dual, Linn, Meridian, Mission, NAD, Rotel, Technics, Yamaha, etc. (Closed Wed). BADA MEMBER 

AUDIO EXCELLENCE, 58 Bristol Road, Gloucester. (0452) 300046. Audio Research, Dual, Krell, Linn, Magneplanar, Naim, NAD, Yamaha and lots more. Closed Mon. BADA MEMBER 

ROBBS OF CHELTENHAM, 3 Clarence St, Cheltenham. (0242) 584404. Sansui pure hi-fi, Kenwood, Sony ES, Dual, Technics, QED, Heybrook. Dem facilities. Open 9-5.30 Mon-Sat. Instant free credit. Credit cards: Visa, Access. Service dept.

HAMPSHIRE

HAMPSHIRE AUDIO Ltd, 2-12 Hursley Rd, Chandlers Ford. (0703) 252827/265232. Quality CD and analogue agencies. 5 dem studios. Large free car park. BADA MEMBER 

TRUE-FI SOUND AND VISION, 10/12 Grosvenor Rd, Aldershot. (0252) 26390. Akai, Aiwa, B&W, Nakamichi, Hitachi, JPW, Mission, Mordaunt-Short, Nagaoka, Sony, Technics. Dem facilities available. Open 9.30-6.00 Mon-Sat. Free installation, instant credit up to £1,200. Credit cards accepted. Access, Barclaycard. Service dept.

HERTFORDSHIRE

ACOUSTIC ARTS Ltd, 101 St Albans Rd, Watford, Herts. (0923) 45250. A&R, Audiolab, Denon, Magneplanar, Quad, Rogers, Meridian, TDL, Jadis, Krell. Dem facilities: 2 dem studios, ring for appointment. Open Mon-Sat 9.30-5.30. Home trial facilities, free installation. Instant credit up to £1,000. Credit cards: Access, Visa. Service dept. BADA MEMBER 

THE AUDIO FILE, 40 Hockerill St, Bishops Stortford, Herts.

(0279) 506576. Linn, Roksan, Rega, Naim, A&R (Camb), Heybrook, Rotel, Denon, Epos, QED. Demonstration facilities, no appointment required. Open 9.30-5.30 Mon-Sat. Home trial facilities. Free installation, credit facilities up to £1,000. Credit cards: Access, Visa, Diners, Amex. Service dept. available.

W. DARBY & CO. Ltd, St Peter's St, St Albans (0727) 50961. B&O, Sony ES, Quad, A&R Cambridge, Revox, Denon, Yamaha, Luxman, Ariston, Thorens. Demonstration facilities, no appointment required. Open Mon-Sat 9.00-5.30. Home trial facilities, free installation, credit facilities. Credit cards: Access and Barclaycard. Service dept.

ISLE OF MAN

ISLAND COMPACT DISC CENTRE, Parliament Square, Ramsey. (0624) 815521. Musical Fidelity, Sugden, Celestion, Harman Kardon, Teac, Castle Acoustics, Philips, A&R, JBL, Luxman. Open Mon-Sat 9.00-5.00pm. Dem facilities. Home trial facilities, free installation. Full credit, no limit. Credit cards: Access, Visa, elite. Service Dept.

KENT

JOHN MARLEY HI-FI CENTRES, 2 Station Rd West, Canterbury. (Canterbury) 69329. Also at Dover - (0304) 207562. B&W, Heybrook, Magnum, M.Y.S.T., Nakamichi, Pink Triangle, Rotel, Sansui, Technics, Quad. Dem facilities available. Open Mon-Sat 9.00-5.30 closed Thurs. Home trial facilities, free installation, instant credit up to £1,000. Credit cards: Access, Visa, Creditcharge. Service dept.

LANCASHIRE

CLEARTONE HI-FI, 235 Blackburn Rd, Bolton. (0204) 31423. Best makes, Linn, Creek, NAD, etc. Dem studios. Laser vision and compact disc centre.

BADA MEMBER 

HI-TECH AUDIO, 7 Moor Lane, Clitheroe, Lancs BBY 1BE. (0200) 26563. Mission, Audio Innovations, Rogers, Quad, Rotel, NAD, Elite Rock, B&W, Castle, Wharfedale. Dem facilities, appointment required. Open 9.30-5.00, closed Wednesdays. Home trial facilities, free installation, credit up to £1,000. Credit cards: Access, Visa, Amex, Diners. Service dept. Mail order.

MONITOR SOUND, 54 Chapel St, Chorley. (02572) 71935. A&R, Dual, Mission, Quad, Rogers, Rotel, Spendor, Thorens, Nakamichi, Yamaha, etc. Dem facilities, 2 dem rooms. Open Mon-Sat, closed Weds. Free installation, instant credit up to £1,000. Credit cards: Access, Visa, Service dept.

LEICESTERSHIRE

SOUND ADVICE, The Sound Factory, Duke St, Loughborough LE11 1ED. (0509) 218254. A&R, Creek, Linn products, Epos, Mission Cyrus, Naim, Rega, Roksan, Rotel, Yamaha. Dem facilities, domestic size and furnished studios. Callers welcomed. Demonstrations by appointment. Open 9.30-6.00 Mon-Sat. Free installation. Credit facilities. Credit cards: Access, Visa, Amex. Service dept.

LONDON

A.T. LABS, 159 Chase Side, Enfield, Middlesex. (01) 367 3132. Open Mon-Sat 10-6. Two single speaker dem rooms. Export worldwide. Service dept, car park. Amex, Visa, Access. BADA MEMBER 

AUDIO T, 190 West End Lane, London NW6. (01) 794 7848. Open Mon-Sat, 10-6.00. Two single speaker dem rooms. Access, Amex, Visa. BADA MEMBER 

BILLY VEE, 248 Lee High Rd, Lewisham, London SE13 5PT. (01) 318 5755/852 1321. Aiwa, A&R, Creek, Dual, KEF, Linn, Heybrook, Quad, Naim, Rega. Dem facilities: 2 single system studios ring for appointment. Open Mon-Sat 10-7, closed Thurs. Home trial facilities, free installation, interest free credit up to £750.00. Credit cards: Access, Visa. Service dept. BADA MEMBER 

CORNFLAKE SHOP, 37 Windmill Street (just off Tottenham Court Road), London W1. (01) 631 0472. 10am-7pm, Mon-Sat. Cambridge, DNM, Epos, Koetsu, Naim, PS Audio, Roksan, SME, Van den Hul. Excellent demonstrations, 2 demo rooms, full delivery and installation service. Full credit facilities. Credit cards: Access, Visa.

COVENT GARDEN RECORDS, 84 Charing Cross Road. (01) 379 7635/7427. Quad, B&W, Meridian, Mission, Yamaha, Sony, Philips, A&R Cambridge, Nakamichi, Rotel. Dem

facilities - no appointment required. Open Mon-Sat 10am-7.30pm. Home trial facilities, free installation - to suit the customer. 7.30am-11.30pm weekdays, 9am-9pm weekends. Credit cards: Access, Visa, American Express, Diners Club. Service dept.

DOUG BRADY HI-FI, 18 Monmouth St, London WC2H 9HB. (01) 379 4010. Wide range of top specialist hi-fi from Britain, America and Japan. Dem facilities. 3 Dem rooms. All credit cards. **BADA MEMBER** 

GRAHAMS HI-FI, 86-88 Pentonville Rd, London N1. (01) 837 4412. 'FBA Dealer of the year 1985'. Linn, Naim, Rega etc. £300-£3,000-£13,000. **BADA MEMBER** 

H.L. SMITH & Co Ltd, 287-289 Edgware Rd, London W2 1BE. (01) 723 5891. Aiwa, B&W, Denon, Dual, KEF, Ortofon, Panasonic, Sony, Technics, Yamaha. Dem facilities available. Open Mon-Sat 9.5.30, Thurs 9-1, instant credit up to £1,000. Credit cards: Access, Visa, Diners. Service dept.

K.J. LEISURESOUND, 48 Wigmore Street, London W1. (01) 486 8262/3. Most major brands; 2 dem studios, appointment preferred. Open 10-6 Mon-Sat. Credit cards: Access, Visa. **BADA MEMBER** 

KJ WEST ONE, 26 New Cavendish St, London W1M 7LH. (01) 486 8262. A&R Cambridge, Audio Lab, B&W Audio Res - Krell, Rogers, Gale, Musical Fidelity, Linn, Magnea Pan, Nakamichi. Dem facilities available - appointment required. Open Mon-Sat 10am-6pm. Limited home trial facilities. System Design & Installation. Credit facilities - Credit cards: Visa, Access. Service dept available.

MUSICAL IMAGES, 45 High St, Hounslow, Middlesex. (01) 570 7512. AR, A&R, B&W, Bose, Denon, Dual, Harmon Kardon, Musical Fidelity, Nakamichi, Quad. Single speaker dem room. Open 9.30-6 Mon-Sat. All credit cards.

SUBJECTIVE AUDIO, 12 Park Avenue, Palmers Green, London N13. (01) 886 2650. A&R, Burmester, Krell, Magneplanar, Meridian, Linn, Nakamichi, John Bowers. Dem facilities. 3 single speaker dem rooms, appointment required. 10-6 Tues-Fri, 9-5 Sat. Home trial facilities, instant credit up to £1,000. Credit cards: All Service dept.

TELESONIC Ltd, 92 Tottenham Court Rd, London (01) 636 8177. A&R, B&O, B&W, Hafler, Luxman, KEF, QED, Quad, Nakamichi, Rogers. Dem facilities available. Open Mon-Fri 9-6, Sat 9.30-4. Home trial facilities, free installation, credit facilities. Credit cards: Access, Amex, Diners, Visa. Service dept.

THE SOUND ORGANISATION Ltd, No 1, Cathedral St, London Bridge, London SE1 9DE. (01) 403 2255/3088. Counterpoint, Denon, Exposure, Koetsu, Linn, Naim, PS Audio, Roksan, Rega, SME, and others. Dem facilities available, ring for appointment. Open Tues-Sat, 10-7. Free installation. Credit cards: Access, Visa. Service dept. **BADA MEMBER** 

MANCHESTER

CLEARTONE HI-FI, 52 King St, nr Kendals. (061) 835 1156. Best makes, Linn, Creek, NAD, Naim, etc. Dem studio, Compact Disc centre, video and TV. **BADA MEMBER** 

THE MUSIC ROOM, 50 Bridge St, Manchester. (061) 835 1366. Dem room, service dept. Competitive credit and charge card facilities. **BADA MEMBER** 

MERSEYSIDE

ABOUT SOUND, 116 Bold St, Liverpool L1 4JA. (051) 709 4865. Mordaunt-Short, Musical Fidelity, Myst, Quad, Revox, Sansui, Sugden, Thorens, Walker, Yamaha. Dem facilities, single speaker room. Ring for appointment. Open Tues-Sat 9.5.30. Free installation, instant credit up to £1,000. Credit cards: Access, Diners, Visa. Service dept.

W.A. BRADY & SON, 401 Smithdown Rd, Liverpool. (051) 733 6859. 'Largest choice of specialist Hi-Fi in NW. £100-£20K'. All credit cards. 3 dem rooms. **BADA MEMBER** 

NORFOLK

SOUND APPROACH, 161 Unithank Road, Norwich. (0603) 622833. Ariston, AR, Claymore, Castle, Elite Rock, Haybrook, Matra, Musical Fidelity, Revolver, Yamaha. Dem facilities. Open 9-6.30 Mon-Sat. Home trial facilities. Free installation. Credit up to £1,500. Credit cards: Visa, Access, Diners Club. Service dept available.

WEST MIDLANDS

ALTERNATIVE AUDIO Ltd, 93-95 Hobs Moat Rd, Solihull. (021) 742 0254 (sales), 0248 (service). A&R, Audiolab,

Denon, KEF, Marantz, Meridian, Mission, M.A., The Source. Philips. Dem facilities available, appointment required. 10-6 Tues-Sat, closed Mon. Home trial facilities, 2 dem rooms, service dept, free installation, instant credit. Credit cards: Access, Visa, Amex.

FIVEWAYS HI-FIDELITY Ltd, 12 Islington Row, Edgbaston, Birmingham. (021) 455 0667. A&R, Denon, Dual, KEF, Meridian, Musical Fidelity, Nakamichi, Philips CD, Quad, Revox, etc. Dem facilities. Single speaker dem room. Open 9.30-6 Tues-Sat. Home trial facilities, free installation, credit facilities. Credit cards: Access, Visa. Service dept.

GRIFFIN AUDIO Ltd, 94 Bristol St, Birmingham. (021) 692 1359. Linn, Naim Audio, Rega, Creek, Denon, Nakamichi, Quad, Mission, Monitor Audio, Rotel. Dem facilities. 2 single speaker rooms. Open Mon-Sat 9.30-6. Home trial facilities, free installation, interest free credit up to £1,000. Credit cards: Access, Visa. **BADA MEMBER** 

NORMAN H FIELD LIMITED, 25-27 Hurst Street, Birmingham B5 4BJ. (021) 622 2322/2619. AR, B&W, Denon, Dual, Monitor, Audio, Kenwood, Mordaunt-Short, NAD, Technics, Yamaha. Dem facilities available. Open 9.15-6.00, Saturday 9.00-6.00. Closed Weds. Home trial facilities on selected systems. Credit up to £1,500. Credit cards: Access, Visa. Service dept.

WARSTONES HI-FI STUDIO, 54a Warstones Rd, Penn, Wolverhampton. (0902) 245114. Dem facilities. 2 rooms. Open Mon-Wed 10-6 Thurs-Fri 10-9 Sat 10-6. Home trial facilities, free installation. Credit cards: Access, Visa. Eurocheque. Service dept.

OXFORDSHIRE

ABSOLUTE SOUND AND VIDEO, 19 Old High St, Headington, Oxford. (0865) 65961. A&R, Denon, Linn, Mission, NAD, Rotel, Yamaha. Also 256, Banbury Rd, Summertown. **BADA MEMBER** 

ASTLEY AUDIO LTD, 3 Market Place, Wallingford. (0491) 29206/24249. AR. Dual, Kenwood, Mordaunt-Short, Mission, Monitor Audio, Philips, Technics, Tannoy, Yamaha. Open Tues-Fri 9.5.30, Sat 9-5. Records, tapes and 1000+ CDs. Service dept. Access, Visa, Diners.

WESTWOOD AND MASON, 46 George St, Oxford. (0865) 247783. Linn, Naim, Rega, A&R, Heybrook, Dual, Mordaunt-Short, Spendor, Tannoy, Quad, etc. **BADA MEMBER** 

WITNEY AUDIO, 28 High St, Witney, Oxford. (0993) 2414. A&R, Aiwa, Akai, Dual, KEF, Mordaunt-Short, Pioneer, Philips, Sony, Yamaha. Dem facilities. Open Mon-Sat 9.5.30. Free installation, instant credit up to £1,000. Credit cards: Access, Visa. Service dept.

SHROPSHIRE

AVON HI-FI Ltd, 12 Barker St, Shrewsbury. (0742) 55166. A&R, B&W, JBL, Dual, NAD, Nakamichi, Revolver, Trio, Quad, Yamaha. Dem facilities available. Open Mon-Sat 9.5.30, closed Thur. Home trial facilities, free installation, instant credit up to £1,000. Credit cards: Access, Visa. Service dept.

SOMERSET

WATTS RADIO - THE ENGINEERS, Jim Badman, 1 West Street, Somerton. (0458) 72440. Castle, Dual, Denon, KEF, Mordaunt-Short, Ortofon, Quad, Rogers, Thorens, Yamaha. Dem facilities available. Open Mon-Sat 9-1, 2-5.30, Wed 9-1. Home trial facilities, free installation. Credit up to £1,000. Credit cards: Access, Visa. Service dept.

STAFFORDSHIRE

GRANGE HI-FI LTD, 152 Branston Road, Burton-on-Trent. (0283) 33655. Pink Triangle, Systemdek, Denon, Audio Innovations, A&R, Cambridge, Quad, Rotel, Elite Rock, Snell. Dem facilities - no appointment required. Open Mon, Tues, Thurs, Fri, Sat 9-6.00pm, Wed 9-1.00pm. Free installation. Credit facilities. Credit cards: Visa, Access, Service dept.

SUFFOLK

BEECHWOOD AUDIO, 3 Brentnovo St, Bury St Edmunds. (0284) 68351. A&R, Ariston, B&W, Kef, Meridian, Musical Fidelity, NAD, Nakamichi, Pink Triangle, Quad, Single speaker dem room. Open Mon-Sat 9.30-6. Home trial facilities, free installation. Instant credit up to £1,000. Credit cards: Access, Amex, Diners, Visa.

EASTERN AUDIO, 41 Bramford Rd, Ipswich. (0473)

217217. Quae, Audio Lab, Denon, Dual, Marantz, Mission, Nad, Nakamichi, Technics, Arcam. Dem facilities available. Open Mon-Sat 9.30-6.00pm. Free installation. Credit facilities - Credit cards: Access, Visa. Service dept available.

SURREY

AERCC Ltd, 11 The Broadway, Woking. (04862) 4667. A&R, Ariston, Exposure, HK, AR, Heybrook, JBL, KEF, Magnum, NAD. Pt. Quad, Revox. **BADA MEMBER** 

TRU-FI SOUND AND VISION, 2 Cromwell Rd, Redhill, Surrey. (0737) 66128. Akai, Aiwa, Band W, Nakamichi, Hitachi, JPW, Mission, Mordaunt-Short, Nagaoka, Sony, Technics. Dem facilities available. Open Mon-Sat 9.30-6.00. Free installation, instant credit up to £1,200. Credit cards: Access, Visa. Service dept.

UNILET PRODUCTS Ltd, 25 High St, New Malden, Surrey. KT9 4BY. (01) 942 9567. Mon-Sat 9-6 Thurs 9-7. Credit cards: Amex, Access, Diners, Visa. Dem facilities. Large stock. **BADA MEMBER** 

SUSSEX (EAST)

JEFFRIES HI-FI, 69 London Rd, Brighton, East Sussex. (0273) 609 431. 2 dem rooms, closed Mon, late night Wed. Parking, bus route. Credit facilities. **BADA MEMBER** 

JEFFRIES HI-FI, 4 Albert Parade, Green St, Eastbourne, East Sussex. (0323) 31336. 2 dem rooms, closed Mon, late night Wed. Parking, bus route. Credit facilities. **BADA MEMBER** 

HASTINGS HI-FI, 31-32 Western Rd, St Leonards On Sea. (0424) 442975. A&R, E&W, Mission/Cyprus, NAD, Nakamichi, Quae, Rotel, Systemdek, Tannoy, Yamaha. Dem facilities. 2 single speaker dem studios. Open Mon-Sat 9-6. Home trial facilities. Free installation. Credit facilities. Credit cards: Access, Amex, Visa. Service dept.

SUSSEX (WEST)

BOWERS AND WILKINS Ltd, 1 Becket Buildings, Littlehampstead, Worthing. (0903) 64141. E&W, Dual, JVC, KEF, Nakamichi, Philips, Shure, Quae, Sony, Technics. Dem facilities. 2 dem rooms. Open Mon-Sat 9.5.30, Weds 9-1. Home trial facilities. Free installation, instant credit up to £1,000. Credit cards: Access, Visa. Service dept.

CHICHESTER HI-FI, 40 Little London, Chichester PO19 1PL. Tel: (0645) 774400. Linn, Naim, Rega, Creek, Nakamichi, A&R, Denon, etc. Demonstration facilities available - no appointment required. Open Tues-Sat, 10-1, 2-5.15 (closed Mon.) Free installation. Credit cards: Access + Visa. Service dept. **BADA MEMBER** 

TYNE & WEAR

RED RADIC SHOP AND HI-FI CENTRE, 11 Olive St, (Off Park Lane) Sunderland. (Sunderland) 5672067. Aiwa, Bose, Denon, JVC, Luxman, Michell, Pickering, Spendor, Thorens, Trio. Dem facilities available. Open Mon-Sat 9.5.30. Free installation, interest free credit. Credit cards: Visa. Service dept.

WILTSHIRE

ABSOLUTE SOUND AND VIDEO, 60 Fleet Street, Swindon. (0795) 55222. A&R, Denon, Dual, Linn, Meridian, NAD, Rotel, Technics, Yamaha. (Closed Wed). **BADA MEMBER** 

PR SOUNDS, 5 King St, Melksham. (0225) 708045. Pioneer, Akai, JBC, Dual, Ortofon, Philips, Toshiba, B&W, Celestion. Open Mon-Sat 9.00-6.00pm. Dem facilities, home trial facilities, free installation. Full credit up to £1,000. Credit cards: Access, Service dept.

YORKSHIRE (NORTH)

ELITE HI-FI, 178 Kings Road, Harrogate. HG1 5JG. (0423) 521 831. Voyd, Elite Rock, Systemdek, Celestion, Helius, Audionote, Snell Acoustics, JPW, Nakamichi, Teac. Dem facilities - 2 dem rooms. Open 7 days a week 9-6. Free installation. Service dept. **CARA MEMBER**

THE SOUND ORGANISATION, 26 Gillygate, York. (0604) 27108. Linn, Naim, Rega, Roksan, Epos, Ruark, Gale, Denon, Rotel, Mantra. Dem facilities available. Open Tues-Sat 10-6. Home trial facilities, free installation, instant credit (written details on request). Credit cards: Access, Amex, Visa, Diners. Service dept. **BADA MEMBER** 

SELECTED DEALER DIRECTORY

YORKSHIRE (WEST)

AUDIO PROJECTS, 45 Headingley Lane, Leeds. (0532) 789115. A&R, Audiolab, Creek, Heybrook, Linn, Musical Fidelity, Naim, Quad, Rega, Rogers. Dem facilities available, ring for appointment. Open Tues-Fri 9.30-6, Sat 2.30-5.30. Home trial facilities, free installation, instant credit up to £1,000. Credit cards: Access, Creditcharge, Visa. Service dept. BADA MEMBER 

ERRICKS, Hi-Fi Experience, Fotosonic House, Rawson Square, Bradford. (0274) 309266. Dem facilities. Sales/service agents for A&R, Linn, Quad, Naim, Nakamichi, Mission etc. BADA MEMBER 

HUDDERSFIELD HI-FI CENTRE, 4 Cross Church St, Huddersfield. (0484) 544668. V.W. Loudspeakers, Kenwood, Harman Kardon, Denon, Duo, A&R Cambridge, Musical Fidelity, Quad, NVA, Audio Lab, and many more. Dem facilities - appointment required. Open Mon-Sat 9.00-5.30. Thursday 9.00-8.00. Closed Wednesday. Free installation. Credit facilities. Credit cards: Access, Barclaycard. Extended guarantee facilities.

IMAGE HI-FI Ltd, 8 St Annes Rd, Headingley, Leeds (0532) 789374. 'We stock most of the worlds leading Hi-Fi products'. Demos by appointment please. BADA MEMBER 

IRELAND

CLONEY AUDIO, 34 Main St, Blackrock, Co. Dublin. 0001 889449. Lin, Roxan, Naim, Rega Research, Rogers, Spendor, Musical Fidelity, Cambridge Audio. Open Tues-Sat 10-6.00pm. Thurs & Fri open till 9.00pm. Free installation. Credit cards: Visa, Access. Service dept.

SCOTLAND

ANGUS

ROBERT RICHIE HI-FI, 102 Murray, Montrose, Scotland.

(0604) 73765. A&R, Creek, KEF, Linn, Naim, Quad, Rega, Sony, Technics, Wharfedale. Dem facilities available, ring for appointment. Open 9-1, 2-5 Mon-Sat, Wed 9-1. Home trial facilities, free installation, instant credit. Credit Cards: Access, Visa. Service dept.

GLASGOW

BILL HUTCHINSON Ltd, 43 Hope Street, Glasgow. (041) 248 2857. A.R., Aiwa, Denon, Dual, JVC, Mission, Mordaunt-Short, Omar, Technics, Yamaha. Dem facilities available. Open Mon-Sat 10-6. Free installation, instant credit. Credit cards: Access, Visa. Services dept.

THE MUSIC ROOM, 221 St. Vincent St, Glasgow. (041) 248 7221. Dem room, service dept. competitive credit and charge card facilities. BADA MEMBER 

KIRKCALDY

ANDREW THOMPSON, 3 Whytescauseway, Kirkcaldy. (0592) 205997. Denon, Dunlop Systemdek, KEF, J A Michell, Nakamichi, Quad, Revolver, Tannoy, Yamaha. Dem facilities: 4 rooms. Appointment preferred. Open Mon-Sat 9-5.30 cl. Wed. Home trial facilities, free installation, credit facilities up to £3,000. Credit cards: Access, Creditcharge, Visa. Service dept.

WALES

CLWYD

ACTON GATE AUDIO, 4 Ruabon Road, Wrexham. (0978) 364500. Quad, Rotel, Nad, Onkyo, AR, B&W, Sansui, Revolver, Castle, Target. Opening times: Mon-Sat 9.30-5.30pm, closed Wed pm. Dem facilities available. Home trial facilities, free installation. Full credit, credit cards: Access, Amex. Service dept.

GLAMORGAN

AUDIO EXCELLENCE, 134 Crwys Road, Cardiff. (0222)

28565. Audio Research, Dual, Krell, Linn, Magneplanar, Naim, NAD, Yamaha and lots more. Closed Mon.

BADA MEMBER 

AUDIO EXCELLENCE, 9 High St, Swansea. (0792) 474608. Audio Research, Dual, Krell, Linn, Magneplanar, Naim, NAD, Yamaha and lots more. Closed Mon. BADA MEMBER 

*WE WOULD LIKE
TO HEAR FROM
YOU*

*if you have complaints or
praise for any of the shops
listed here.*

*If you feel your shop should be
included in this directory
please ring*

Hi-Fi Choice on:

01-631 1433

Not for the sheep....

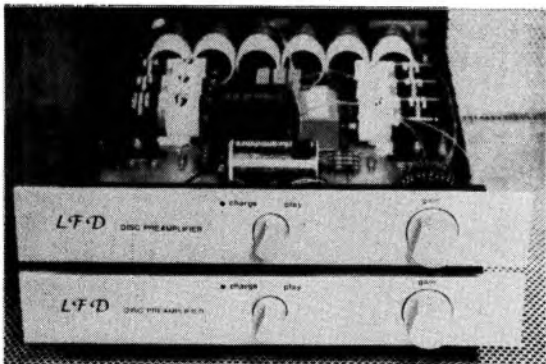

LFD pre amplifier

AIR 2:11

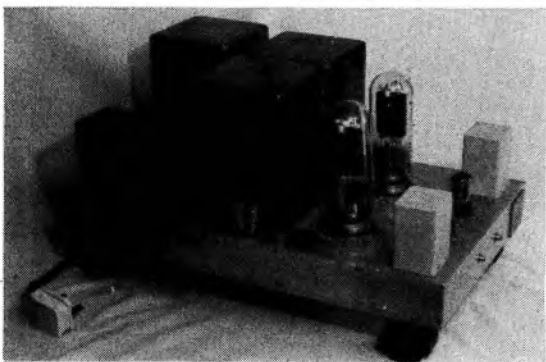

Trade enquiries welcome.

Here at Abbott Audio we pride ourselves in choosing products at our discretion. Never stocking a product simply because of a good review. We let our ears decide. Likewise we believe that you the customer must be the final judge. Whilst offering good, honest, friendly advice and guidance we will never push you into a product simply because we like it. Feel free to disagree.

Two products we do wholeheartedly recommend (for those of an open mind and uncompromising standards) and for which we are UK distributors, are the LFD Pre amp and 'Air' amplifiers. Both are hand crafted units of exceptional sonic merit built by craftsmen who really care and constructed with the finest components available.

The LFD is the latest NO COMPROMISE design from Dr. Malcolm Hawksford and the Essex design team. The pre amplifier is dedicated to vinyl disc reproduction, no other source is selectable. Features include dual mono construction, full 'STAR' grounding, LC, PTFE single strand wiring, high quality switched attenuators, and a sophisticated power supply management system.

We think you will agree with us when you hear this amazing product that the UK is firmly back in control when it comes to state of the art pre amplifier design. Retail price is £3695.

Complimenting the LFD products and offering the same unequalled quality are the 'Air' valve, and mostet power amplifiers. Top of the range is the Air 2:11, a single ended class A design. The unit is built like a battleship, hand



constructed throughout featuring hand wound transformers and the Western Electric 2:11 valve. Power out is 16 watts per channel and in the valve tradition this goes very loud indeed, coupled with the most breathtaking transparency. Units are competitively priced at £4500.

Please phone for a weekend or evening demonstration or to take advantage of our NATIONWIDE demonstration service.

Our range includes: YBA, Kiseki, Vecteur, Stad, Audiosstatic, Beard, Decca, Odyssey, Jecklin, Glanz, Pawel, Nuance, Omega-Point, Audio Innovations, Audio note, Grython, Milltek, Phono Amplifier, Plenitude, Quicksilver, Souther, Snell, SAE, Voyd, Albarry.

Abbott Audio 

THE FARM HOUSE, HOLLY MOUNT, KNEESALL,

NEWARK, NOTTS NG22 0AD

TEL. (0623) 862268



GLOSSARY

The Hi-Fi Choice dictionary of audio terminology, explaining all the weird and wonderful adjectives used by our reviewers, as well as technical abbreviations.

AM: Amplitude modulated; see 'Medium Wave'.

ACOUSTIC BREAKTHROUGH: Sound that gets into the turntable and hence the cartridge from the air and thereby creates a risk of acoustic feedback.

ACOUSTIC FEEDBACK: If any sound in the room can find its way through the body of the record deck to the cartridge stylus, then that sound will be reproduced from the loudspeakers, along with the wanted programme material. If too much of this sound from the loudspeakers is picked up by the cartridge in this way then a vicious circle of acoustic feedback will be created.

ACTIVE: Speaker systems which contain electronic crossovers and where the drive units are connected directly to power amplifiers.

ALIGNMENT PROTRACTOR: A device used to minimise the lateral tracking error of a cartridge/arm combination.

AMPLITUDE: Size or magnitude; hence the amplitude/frequency response, known normally simply as the frequency response, which describes the relative loudness of the system at different frequencies with a constant input voltage.

ANECHOIC: Without echo; a special room or 'chamber' with thick sound absorbing materials on all surfaces to prevent reflections.

ARM MASS: More accurately called *effective* arm mass, because it is *not* the weight of the arm on a pair of scales. It is the mass of the arm and cartridge combination that appears to be concentrated at, and thus felt by, the stylus tip which is tracking a record groove. There is nothing inherently good or bad about arms with light or heavy effective mass; what matters is the manner and choice of their combination with cartridges of different compliance and the low frequency resonance produced by such combination.

AZIMUTH: With reference to tape and cassette recorders, the alignment of head gap to tape path.

BALANCE: 1) The overall relative loudness perceived at different frequencies (eg bass, treble), 2) the accuracy of the match between the two channels of a stereo transducer (eg cartridge or pair of loudspeakers).

BANDWIDTH: A range of frequencies with presumed defined upper and lower limits.

BASS: Lower part of the frequency spectrum.

BELT DRIVE: The motor has its rotational speed geared down to the required platter speed (33 $\frac{1}{3}$ rpm for LP discs) by a rubber or similar resilient belt which runs round a small pulley on the motor shaft and a large pulley attached to or part of the platter.

BEXTRENE: A plastics material frequently used for bass and mid-range cones.

BIAS: (*turntable/arms*) Because the cartridge on a pivotal arm is being drawn across the record surface by the stylus tracking at an angle offset from the pivots, groove friction produces an imbalance of lateral force. Bias is the application of a compensatory lateral force acting in the opposite direction.

BIAS: (*tape*) This refers to a high frequency current passing through the record head which allows the audio current also passing through the head to produce reasonably linear magnetisation of the tape at all levels permitted by the combination of each machine with the tape. The lowest level of bias is

required for ferric cassettes, a slightly higher one for ferrichrome, an even higher one for chrome or pseudochrome, and the highest for metal.

BOTTOMING: The stylus scraping on the distorted rounded bottom of the groove due to incorrect stylus geometry.

CANTILEVER: The thin rod or tube that connects the stylus to the armature and hence the cartridge body.

CAPACITANCE: An element of electrical impedance that is particularly important when matching pickup cartridge, arm leads and amplifier input characteristics to achieve a flat frequency response from discs.

CLIPPING: This is reached when a circuit is overloaded and overdriven, resulting in bad waveform distortion and audibly unpleasant effects.

COLORATION: A general term used to describe the audible effects of distortions, particularly in loudspeakers and record players. These are usually caused by frequency response irregularities and/or resonances.

COMPATIBILITY: The selection of interdependent components to achieve optimum system performance, notably arm/cartridge mass/compliance matching, cartridge electrical loading, or loudspeaker compatibility with amplifiers.

COMPLIANCE: A measure of the springiness of the cantilever/armature seen from the stylus, expressed in compliance units (cu), where 1 cu = 10⁻¹¹ cm/dyne.

CROSSOVER: An electrical circuit which uses combinations of inductors, capacitors and resistors to divide the signal from the power amp into the required frequency bands and with any necessary equalisation for feeding to the individual drive units of the speaker system.

CROSSTALK: The leakage from one channel to the other in a two channel stereo system.

CUTTER: Mechanism used to cut recorded signal onto lacquer master; consists of turntable, lathe, cutting head, cutting and servo amps.

DIN: German standards body, responsible amongst other things for a popular range of standard plugs and socket specifications.

DAMPING: A means of controlling resonances by means of a resistive medium (electrical, mechanical, or acoustic depending on situation).

DECIBEL (dB): A logarithmic unit that is convenient for expressing ratios that span a wide range on a linear scale. For simplicity it can be regarded as a measure of relative loudness.

DISTORTION: Literally this can mean any deviation from the original, but usually refers to harmonic rather than intermodulation distortions when not specified.

DOPING: A technique involving the application of damping to a loudspeaker driver cone in order to assist in controlling resonances.

DOWNFORCE: The weight, measured at the stylus, which holds it down in the groove.

DRIVE UNIT (DRIVER): The term used to distinguish the loudspeaker unit itself, be it bass, mid-range, treble or fullrange in application, from the complete loudspeaker system which combines drive units, cabinet and crossover into a total design.

DROPOUTS: Momentary reductions of programme level due to inadequate head/tape contact caused by oxide particles shedding off the tape onto the head gap, or inadequacies in tape transport or tape.

DYNAMIC RANGE: The ratio in dBs between the quietest sound that can be successfully recorded and the loudest which can be accepted without serious distortion on an average programme.

EFFECTIVE MASS: The inertia, or mass-controlled resistance to movement, of a device, particularly important with regard to tonearms.

EFFICIENCY: The amount of acoustic power delivered for a given electrical input power.

ELECTROSTATIC: A principle employed in some loudspeaker transducers using static electricity effects to set up a polarising field within which the modulated transducer medium moves.

ELLIPTICAL STYLUS: A specially shaped stylus profile that makes the 'plan view' radius along the length of the groove smaller than the 'elevation view' contact radius viewed from the front.

EQUALISATION: (*general*) The deliberate modification of frequency response, usually in response to some engineering limitation or deficiency.

EQUALISATION: (*tape*) This refers to the necessary change in frequency response required of an amplifier so that overall flat frequency response is obtained from a tape medium. Equalisation is required both on record and replay. Any tape recorded on a good cassette recorder should have the same inherent response when played back on another correctly set up machine, since all playback equalisations should have been standardised. These standards are normally specified by the time constants of the circuits involved, eg 70 μ s or 120 μ s (see 'Microseconds').

FM: Frequency modulated; often used to describe radio transmissions of high fidelity potential on the VHF band.

FERRITE ROD: A short rod type aerial used for AM reception; may be fitted internally or externally to tuner or receiver.

FERRO-FLUID: A magnetic fluid which is introduced into the voice-coil gap to provide damping and/or improved cooling.

FILTER: A circuit (normally) used to restrict the bandwidth of a system; may be fixed or switchable.

FREQUENCY RANGE OF SPECTRUM: Can refer to any particular group of frequencies, but commonly applied to the audible band from 20 to 20,000 cycles per second (Hz), extending from the deepest bass to the highest audible harmonics.

FREQUENCY RESPONSE: The variation in output over a frequency range, particularly of a transducer; can be expressed as a range with decibel limits, or depicted graphically.

Hz (HERTZ): 1 Hz = 1 cycle per second and is a measure of frequency which corresponds to musical pitch (the higher the frequency the higher the pitch).

HF: High frequency.

HARMONIC: Harmonics are the whole number multiples of a base frequency called the *fundamental*.

HARMONIC DISTORTION: The addition of unwanted harmonics to a signal.

GLOSSARY

HUM: A low frequency interfering sound produced by break-through or interference from mains wiring or circuitry.

IHF: American Institute of High Fidelity, an important standards body.

IEC: An international standards body.

IMPEDANCE: Measure of resistance (and reactance) in alternating (ie audio) signals; this is of some importance in the compatibility of both cartridges and headphones with amplifiers. For convenience sake is measured in ohms.

INTEGRATION: Used to describe the success with which the output from two drive units combine to give smooth output through the crossover region.

INTERMODULATION (IM): A form of distortion arising from two or more signals producing non-harmonic signals that correspond to the sum or difference of the two frequencies.

KILO (k): prefix meaning one thousand.

LED: Light Emitting Diode; an indicator light.

LF: Low frequency.

LATERAL FRICTION: The resistance to movement of an arm and cartridge combination in the horizontal plane (ie across a record), caused by friction in its bearings.

LINEAR: A transducer that produces an output that exactly portrays its input over the required operating range is described as linear, and is hence distortion free. Hence also nonlinearities (distortions).

LINE-CONTACT: A special stylus profile that extends the ellipse, increasing contact length up and down the sides of the groove.

LOAD OR LOADING: The impedance (including resistive and reactive components, ie ohms, mH, pF) seen by one component looking back to its interconnected component; of importance in compatibility of cartridge/amp, and amp/headphone.

'LOUDNESS': An equalisation circuit frequency switchable on amplifiers which is designed to compensate for presumed hearing characteristics at low listening levels by boosting bass and treble.

MOL: Maximum operating level of tape normally referring to 5% distortion of 315Hz or 3.15kHz.

MEDIUM WAVE: An AM transmission band incapable of high fidelity signals.

MICRO- (μ): Prefix for units meaning one millionth of.

MICROSECONDS (μ s): The time constant of a resistor capacitor combination involving a frequency response change (equalisation).

MIDRANGE, MIDBAND: The central part of the audible frequency range where the ear is most sensitive.

MILLI- (m): Prefix for units meaning one thousandth of.

MODULATION: The audio signal is 'stored' by means of modulations within a medium, eg the 'wiggles' in the groove of a plastic disc, or the magnetic coding on a tape.

MODULATION NOISE: An additional noise added to tape noise, which increases with the degree of modulation of the tape, caused by the properties of the magnetic coating. This noise has most of its energy near the modulation frequency (causatory tone).

MOVING-COIL: A transducer (eg cartridge or

headphone) where the signal is generated by the movement of a coil within a magnetic field.

MOVING-MAGNET: The most common form of cartridge transduction, where the magnet moves while the coils are held relatively stationary.

MULTIPLEX FILTER (MPX): A circuit which introduces severe attenuation at supersonic frequencies to decrease interference encountered with the output from some stereo FM tuners.

NANO (n): Prefix meaning a thousandth of a millionth of.

NOISE: Random unwanted low level signals.

NOISE MODULATION: An unwelcome breathing effect that can be heard on some programme material, produced by poor noise reduction systems, or circuits.

OCTAVE: Two-to-one ratio of pitch or frequency.

OFFSET ANGLE: The angle measured between the centre line of the pickup cartridge and the line which joins stylus and arm pivot point.

OHM: Unit of electrical impedance (including reactance) or resistance; also kohm, where 1 kohm = 1,000 ohms.

OVERHANG: The extent to which the cartridge stylus extends beyond the centre of the platter is critical, and controlled by fore and aft adjustment of the cartridge on the arm.

PASSIVE: The most common type of system, where drivers and crossover are driven from a single power amplifier.

PEAK RECORDING LEVEL: A level above which distortion becomes apparent. This distortion is introduced when the oxide particles almost reach magnetic saturation, and thus will accept no more level.

PHONO: The most commonly used plug/socket combination in audio components.

PICO (p): Prefix meaning one millionth of a millionth of.

PORT: An opening in a cabinet which is tuned to characteristics of the bass driver and the enclosure volume to provide reflex type bass loading.

POWER AMPLIFIER: The part of an amplifier that provides power to drive the loudspeakers; usually integrated, it is sometimes a separate component.

PRE-AMPLIFIER: The part of an amplifier that accepts the input signals, sorts them, applies any necessary equalisation, and then passes the signal to the (normally integral) power amplifiers.

PRESENCE: A quality of forwardness or immediacy in a sound balance, generally related to an upper-middle frequency response boost.

PRINT-THROUGH: A pre- or post-echo of a loud signal created by magnetisation occurring from one layer to an adjacent layer after the tape has spooled or been recorded.

Q: A measure of the magnitude and shape of a resonance; the higher the Q, the sharper and more severe in amplitude the resonance.

REFLEX: A system of bass loading (using port or ABR) which offers improved efficiency and bass power handling at the expense of subsonic control compared to a sealed box.

RUMBLE: The low or medium frequency sound produced mechanically by any moving parts in a turntable, mainly the motor and platter bearings.

SENSITIVITY: The volume of sound output for a

specific electrical voltage input.

SEPARATION: As between the two channels of a stereo pickup; see *cross-talk*.

SHIBATA: A special stylus extending the elliptical to a 'line contact' type of profile.

SIDE-THRUST: A force acting on cartridges in pivoted (ie not parallel tracking) arms, due to the stylus/vinyl 'friction' acting along the line of the offset angle; hence bias or side-thrust compensation.

SIGNAL-TO-NOISE, SIGNAL/NOISE, S/N: The difference in total output when an applied signal is removed.

STYLUS: The specially shaped piece of diamond in contact with the groove and connected to the cantilever.

SUBSONIC: Below the audible range, ie below 20Hz.

SQUARE WAVE: A signal which consists of a fundamental plus a (theoretically infinite) series of odd (3rd, 5th etc) harmonics in a precise phase and amplitude relationship. It is useful for examining transient performance, symmetry, resonance control and 'ringing'.

THD: Total harmonic distortion.

TRACING: The following of the groove modulations by the stylus; hence for example tracing distortion, caused by the inability of a spherical stylus to trace the high frequency inner grooves on a disc.

TRACKABILITY: The ability of the cartridge to cope with large amplitude modulations (or of the arm and cartridge to follow the groove itself properly).

TRACKING ERROR: The discrepancy between the truly tangential angle at which a record is cut and the slightly off-tangential angle at which it is tracked by a stylus on a pivoted arm during some parts of the arm's travel.

TRANSIENT: Signal of very short duration.

TREBLE: Upper part of frequency spectrum, typically above about 3kHz.

TWEETER: A small drive unit designed to operate over the high frequency range.

ULTRASONIC: Frequencies above audibility, ie greater than 20kHz; also *supersonic*.

VERTICAL TRACKING ANGLE (VTA): The angle at which the plane of motion of the stylus is set with respect to the vertical when viewed from a side elevation of the cartridge. Should match the 20° cutter standard.

WEIGHTING: A factor or function that is applied to a measurement to increase its relevance and usefulness.

WOOFER: A drive unit that operates over the bass portion of the audio range.

WOW AND FLUTTER: Low and high frequency pitch variations (from poor tape transport or turntable platters with speed drift).



FROM THE

PERFECTIONISTS
IN SOUND, YOU COULD
ONLY EXPECT THE
GREATEST NAMES
IN SOUND ...

... and at Chew & Osborne, with the best part of 25 years in catering to our customers' discriminating requirements, we make certain that we only stock the names that will live up to these demanding criteria.

LOOK AT THE NAMES

In both our shops you'll find • A&R Arcam • AR • Bang & Olufsen • BLQ • B&W • Cambridge Audio • Celestion • Denon • Dual • Harman Kardon • Harman Kardon Citation • K.E.F. • Kenwood • Logic • Marantz • Mission • Mission Cyrus • Mordaunt Short • Musical Fidelity • NAD • Nakamichi • Pioneer • Quad • Ruark • Spondor • Tannoy • Yamaha — Plus Accessories from • AKG • Audio Technica • Glanz • MIT • Nagaoka • QED • Sennheiser • Siltech • Stax • Target Audio • WBT

LOOK AT THE MUSIC ON
DISC AND TAPE

We've got everything you could ever need, including an extensive range of compact discs at prices to suit everyone, classical and popular naturally!



AND NOW AT SAFFRON WALDEN
THERE'S ABSOLUTE SOUNDS

As the only specialists in Essex appointed by Absolute Sounds, you'll find it well worth a visit to see and hear this truly outstanding equipment. In stock now, you'll find • Apogee • Kinergetics • Krell and Sonus Faber - including cables and interconnects.

LOOK AT THE SERVICE

Professional, helpful, unbiased advice is only part of our service, for true peace of mind we back it with after-sales service which we believe is second to none.

GO Chew & Osborne

EPPING, ESSEX, 148 High Street (0378) 74242
SAFFRON WALDEN, ESSEX, 26 King Street (0799) 23728

simply perfectionists in sound

APPOLO



System
Supports

*Get Your Sound
Off The Ground
With Appolo Hi-Fi Supports*

A complete range of stands and tables to suit all your Hi-Fi requirements

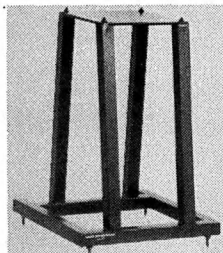

APPOLO STANDS

All stands are fully welded and come complete with adjustable carpet piercing feet. Top plates are threaded for 6mm top spikes, if required. Available as an extra, coated in matt black as standard. The Appolo 10 and 11 have a more substantial 5mm thick top plate. Appolo 10 - 16" Apollo 8 - 12", 16" & 20"

APPOLO HI-FI TABLES

All Appolo Hi-Fi Turntable Tables are fully welded for maximum rigidity. Complete with upturned spikes and discs for top platform. Carpet piercing spikes are included, shelves are Black Ash veneered with Teak on reverse. All shelves are 17 7/8" - 454mm wide and 14 7/8" - 377mm deep.

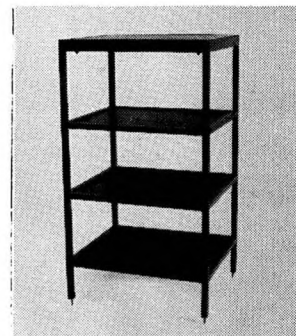

Unit 2, Princes End Industrial Estate,
Nicholls Road, Batmans Hill, Tipton,
West Midlands DY4 9LG
Telephone: 021 520 5070

N. America: 227g Brunswick Boulevard, Pointe Clare,
Quebec, Canada.

Please send me details on the complete range of Appolo stands and tables.

NAME _____

ADDRESS _____

REVIEW INDEX

LOUDSPEAKERS

AR 8BX	26
AR 22 BX	27
AR 35BX	28
ARCAM 2	29
ARCAM 3	32
AVANCE 120	33
BBC LS3/5A	34
B&W MATRIX 1E	35
CASTLE DURHAM	37
CELESTION SL6S	38
GOODMANS MAXIM 2	40
GOODMANS POINT 3	41
GOODMANS POINT 7	43
HARBETH HL Mk 4	44
HEYBROOK HB1	45
JBL 60T	47
JPW AP2	48
JWS QUINTET	49
KEF 103/3	50
KEF 104/2	51
MARANTZ LD20 DMS	53
MISSION 700 LE	54

MISSION ARGONAUT	55
MONITOR AUDIO 352MD	57
MONITOR AUDIO 652MD	58
MORDAUNT SHORT MS10 II	59
MORDAUNT SHORT MS45 II	61
MORDAUNT SHORT MS442	62
QUAD ESL63	64
ROGERS LS6	66
ROGERS LS7T	67
ROKSAN DARIUS	69
ROYD A7 II	70
ROTEL RL850 II	71
RUARK BROADSWORD	73
SONY APM10ES	74
SPENDOR SP2	75
SPICA TC50 II	76
TANNOY MERCURY II	78
WHARFEDALE SUPER DIAMOND	79
WHARFEDALE DELTA 50	80

HITACHI DA7000	101
MARANTZ 873	104
PHILIPS 473	105
PIONEER TD6050	106
SANYO CD17/CP27	108
SHARP DXR700	109
SONY CDPM50	110
TECHNICS SLP220	111

YUPPIE BLASTERS

FERGUSON RCD02	123
FISHER PH-D473	124
HITACHI SUPER WOOFER	125
MEMOREX CD33Q	128
PANASONIC RXFD80L	129
SHARP WQCD15	131
SONY CFD66L	132
TOSHIBA RT7096	135

COMPACT DISC PLAYERS

ADC 250	99
AIWA DX500	100

ADVERTISERS INDEX

A&R CAMBRIDGE	1	FARNBOROUGH HI-FI	65	NAD	19
ABBOTT AUDIO	156	GOODMANS LOUDSPEAKERS	16	ORTOFON	102/103
ABOUT SOUND	136/137	HAMPSHIRE AUDIO	98	O'BRIEN HI-FI	134
AKAI	24/25	HARBETH ACOUSTICS	39	PHILIPS	12
ALTERNATIVE AUDIO	96	HEYBROOK	56	PIONEER HI-FI	IBC
APPOLLO SPEAKER STANDS	159	HI-FI CORNER	89	QED	6
ASTON AUDIO	107	NORMAN HIFIELD	136/137	RAYLEIGH HI-FI	86
AUDIO CONCEPT	81	HI-FI EXPERIENCE	113	READING	138
AUDIO PROJECTS	107	HUNT EDA	65	ROGERS	134
AUDIO T	68/72	BILL HUTCHINSON	77	ROTEL	60
AUTOMATION SCIENCES	92	IN HI-FI	91	SEVENOAKS	84
AYLESBURY HI-FI	136/137	ISLAND COMPACT DISC	136/137	SILVER SERVICE CD	39
BOOTHROYD STUART	122	JEFFRIES HI-FI	133	SME	130
CHEW AND OSBORNE	159	JVC	30	SONY	63
DERBYSHIRE HI-FIDELITY	77	MANDERS HI-FI LTD	136/137	SOUND ADVICE	136/137
STEVE BOXSHALL	133	MARANTZ	10	SOUND WAVES (NW) LTD	136/137
DOUG BRADY HI-FI	116	MAYWARE	137	SPALDINGS	82
BRENTWOODS	39	MICHELL CONNECTION	107	SPENDOR	138
B&W LOUDSPEAKERS	36	MISSION ELECTRONICS	0BC	STANDENS	107
CHICHESTER HI-FIDELITY	136/137	MONITOR AUDIO	IFC	STUDIO 99	77
CORNFLAKE SHOP	42	MONITOR SOUND	136/137	SUSSEX AUDIO	90
COSMIC	120	MORDAUNT SHORT	119	TANNOY	46
COVENT GARDEN RECORDS	94	MUSICAL FIDELITY	22	TDL	62
DARBYS	81	MUSICAL IMAGES LTD	136/137	TECHNICS	4/5
DONNINGTON AUDIO	81	THE MUSIC ROOM	97	ANDREW THOMSON	136/137
CARL DYSON	90	MUSIC & VIDEO EXCHANGE	136/137	WOODSIDE ELECTRONICS	91

The new Pioneer Compact Disc player. Admire its curves.



The Pioneer PD-7050's sleek good looks are enough to set anyone's pulse racing.

But examine its curves, and it becomes even more attractive.

The PD-7050 uses a sampling frequency four times higher than normal. Which means it can produce the kind of low level resolution and high frequency imaging you've only dreamt of.

Add to that these other exciting features and no hot-blooded hi-fi enthusiast will be able to resist it:

- Twin digital analogue converter
- Digital output
- Total remote control
- 4 separate power supplies.

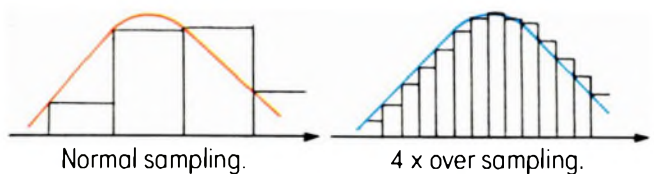

 **PIONEER®**

Wait 'til you hear Pioneer



MISSION ELECTRONICS

MISSION ELECTRONICS HUNTINGDON PE18 6ED PHONE (0480) 57477 TELEX 32333 FAX 413211