

14

2,500 Illustrations in Parts 1-12— (See p. iii of this cover)

1^s/₃^d

HARMSWORTH'S WIRELESS ENCYCLOPEDIA

For Amateur & Experimenter

IVO—LON

CONSULTATIVE EDITOR

SIR OLIVER LODGE, F.R.S.

THIS PART CONTAINS

**207 New Photos & Diagrams with 100
'How-to-Make' & Other Articles**

JACKS AND PLUGS
JOINTS OF ALL KINDS
KNIFE SWITCHES
KNOBS
LATHES FOR THE AMATEUR
LODGE COHERERS & RECEIVERS

Special Article by Capt. Eckersley
THE LONDON B.C. STATION

SPECIAL PHOTOGRAVURE PLATE:
INTERFERENCE ELIMINATOR

*J. LAURENCE PRITCHARD, F.R.Ae.S., Technical
Editor, with expert editorial and contributing staff*

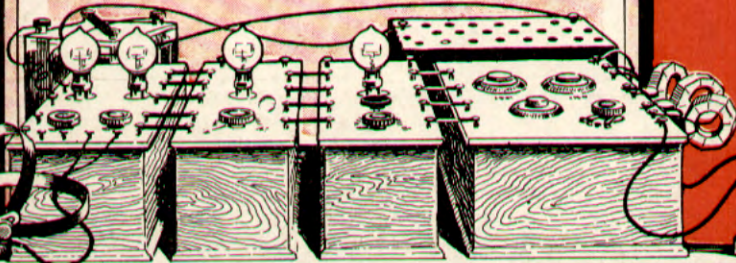

The Only ABC Guide to a Fascinating Science-Hobby

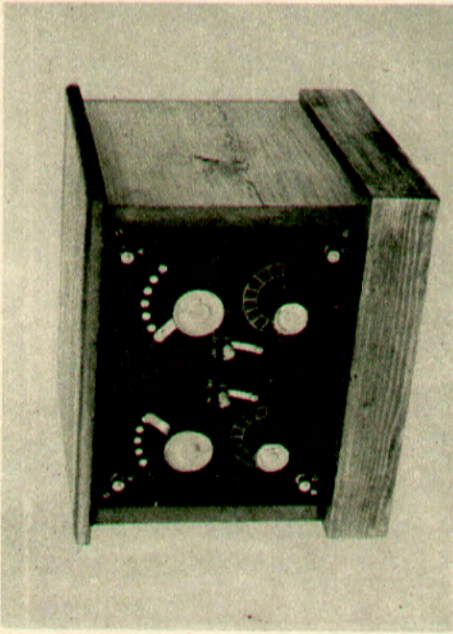

Fig. 12. The complete interference eliminator finished and ready to be connected to the receiver

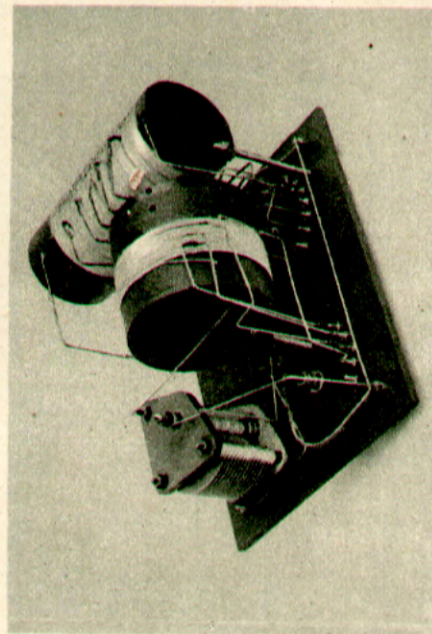

Fig. 16. Wiring is shown completed. Inductances are at right angles to minimize interaction

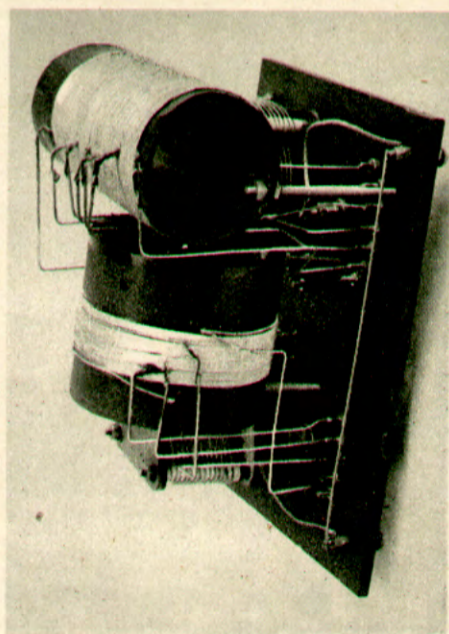

Fig. 17. Tappings are connected to the studs. Note relative positions of the components and use of square wire

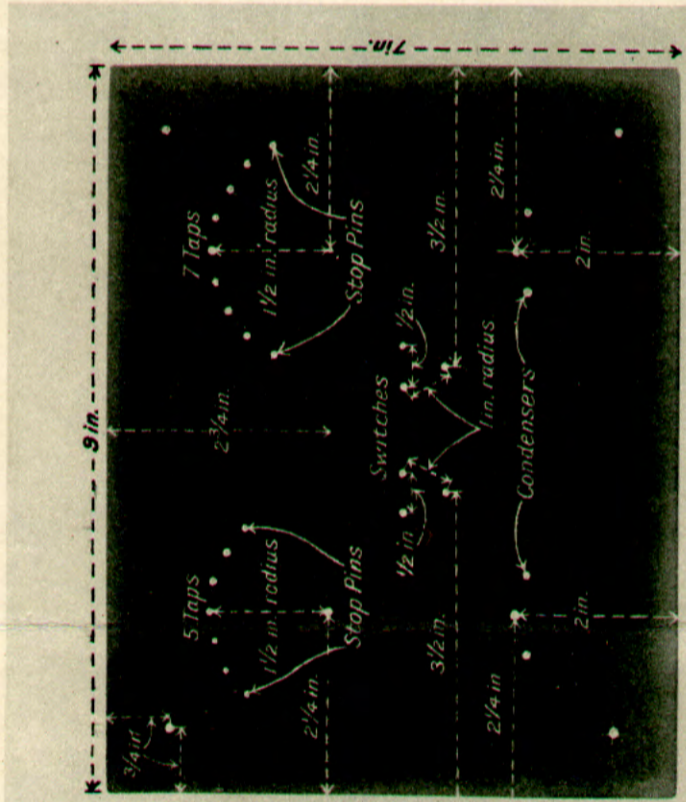

Fig. 13. Dimensions and lay-out for the ebonite panel. Holes for tapping studs, switches, and condenser spindles should be drilled as shown

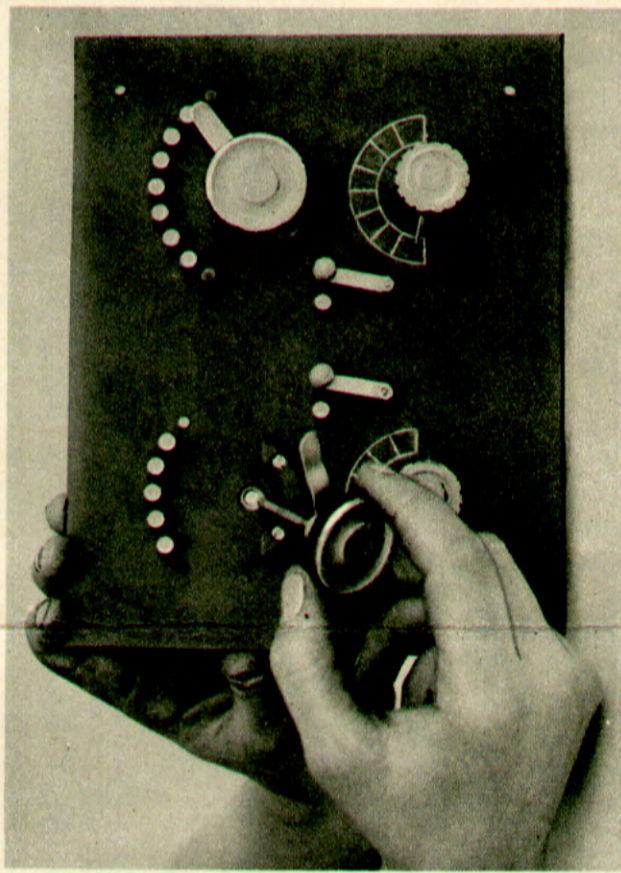

Fig. 18. At the opposite side of each stud-switch contact arm is a metal arm which rests on a balancing quadrant

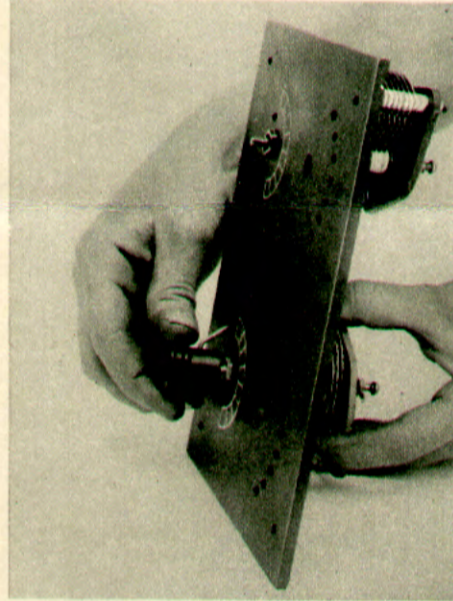

Fig. 14. Both condenser pointers are set at zero before tightening up



Fig. 19. Tightening up nuts on the screw-threaded posts which hold the inductances

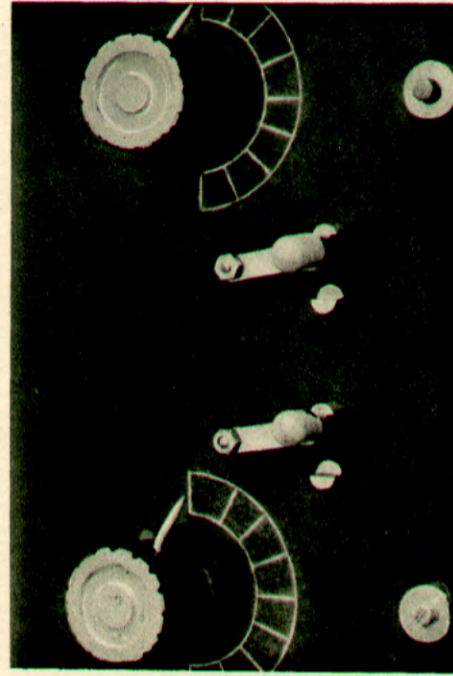

Fig. 15. Between the two condenser knobs are the switches controlling the two rejector circuits

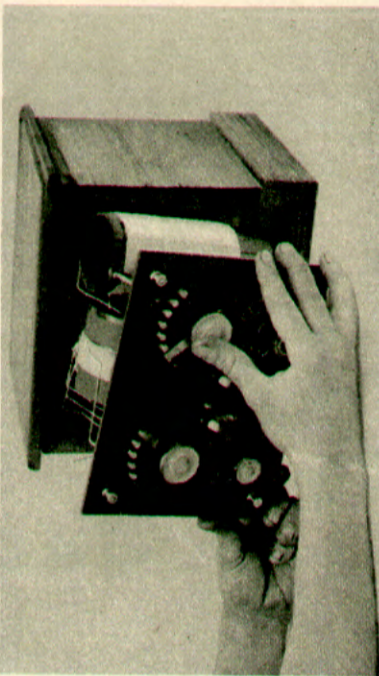

Fig. 20. How the components when mounted upon the panel are fitted into the case

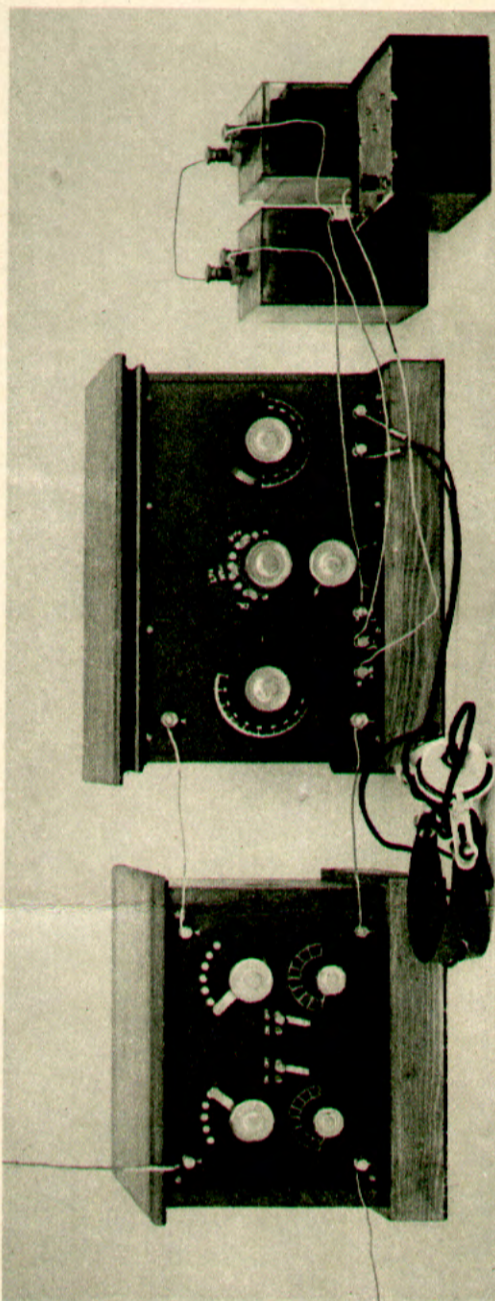
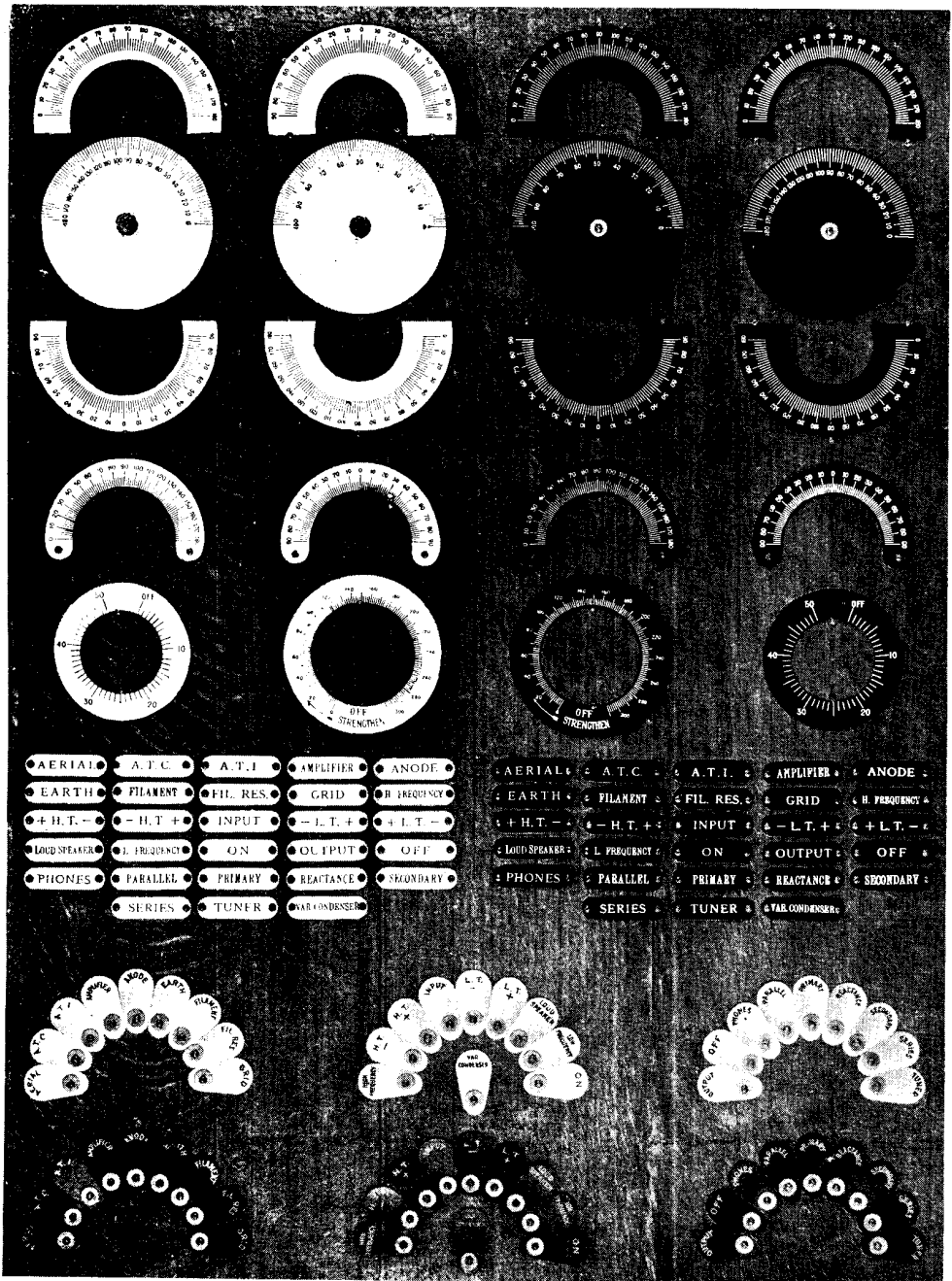

Fig. 21. The interference eliminator is used as a separate unit and is wired up as part of the complete receiving set, as seen in this photograph



IVORINE TABLETS FOR ATTACHMENT TO WIRELESS APPARATUS

Various forms of ionic scales, tabs and disks which are useful to the experimenter are illustrated. Attached to wireless apparatus, the purposes of terminals and turning knobs, switches and plugs are clearly indicated, and mistakes in connecting up obviated

Courtesy Radio Communication Co., Ltd.

Generally these articles are supplied white, with the calibrations and lettering black, but for those who desire a some-

what neater appearance, black plates and white lettering or calibrations are more in keeping with the ebonite panel.

JACKS & PLUGS: HOW TO USE & MAKE THEM

Simple Automatic Switches and Their Uses in Various Circuits Fully Described

Whether for the experimenter who wishes to use any combination of valves in a multivalve circuit, or for the broadcast listener who requires the simplest and most reliable switching arrangements, jacks and plugs, a full account of which is given in this article, have the advantages of simplicity, neatness and efficiency. See also Anti-capacity Switches ; Switch

A jack is a socket forming a terminal or connecting point in an electrical circuit adapted to receive a plug connector. In a simple form the jack or socket may comprise an ebonite or other insulating block, bushed with brass or other conducting material, which is connected to a wire or other conductor. The plug consists simply of an ebonite rod provided, on one part of the exterior, with a brass contact tube which fits snugly in the bush of the jack.

The tube on the outside of the plug is metallically connected with a flexible or other wire which passes through the centre of the ebonite rod, the end of which may form a convenient grip for handling the plug. There are many variations and developments of this simple principle, including several elaborate jacks with a multiplicity of contacts simultaneously operated by a plug with several different steps or diameters, each having a separate contact ring around it and connected to insulated conductors.

A jack itself is not complete, there being two parts, known respectively as the plug and jack. As, however, the plug

portion is always of the same design for all purposes, and the jacks vary in construction and application, it is proposed to outline fully their design and application under the above heading.

For wireless work plugs and jacks are extensively employed for making rapid and easy changes in circuits, as well as for such purposes as automatically lighting the filaments, switching on the high tension, and connecting the telephones in circuit, all in one simple operation of inserting a plug into the jack. Various forms of jack are made to suit different circuit arrangements. A selection of five is shown in Fig. 1. These are the products of the Radio Communication Co., Ltd., and are made specially for use in wireless circuits, both from a view-point of simplicity of panel fixing, and also in the numbers and disposition of contacts.

A jack consists essentially of a heavy brass L-shaped bracket, on the shorter limb of which is mounted a brass bush having a hole of such a diameter that the plug may be a good sliding fit within it. Immediately behind the bush a number of spring strips are disposed. These bear

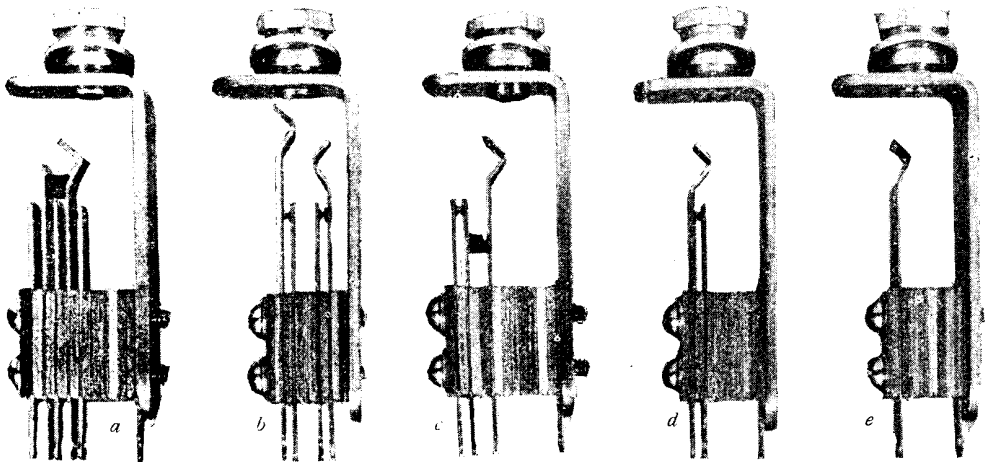

EXAMPLES OF JACKS FOR USE WITH PLUGS

Fig. 1. Five different jacks are shown in this photograph. Their purposes are (from left to right): *a*, double filament; *b*, double closed; *c*, connecting the filament circuit and the telephones, three contact; *d*, single closed; *e*, single open

Courtesy Radio Communication Co., Ltd.

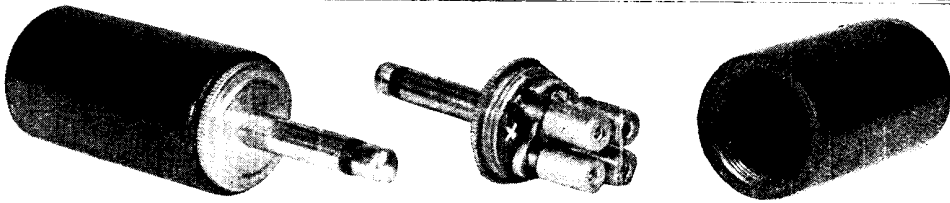

DOUBLE TELEPHONE PLUG FOR USE WITH JACK

Fig. 2. On the left is the plug for insertion in the jack on the extreme right in Fig. 1. On the right are the two parts of the plug shown separately

Courtesy Radio Communication Co., Ltd.

platinum contacts, which open or close as required upon the insertion of the plug.

The simplest type of jack is shown in Fig. 1 (e). It will be seen that this particular form has only one spring contact, and is known as an "S.O." (single, open) type. The insertion of a plug (Fig. 2) causes this spring to be forced away from the brass bracket until the plug is driven right home, when the kink in the spring presses heavily in the groove in the plug, holding the latter firmly in position and making good contact. The plug is in two concentric parts. These parts are insulated from each other by an ebonite bush. The front part is connected to one side of a pair of telephone leads, and the back part to the other side. It will thus be clear that as the front portion makes contact with the spring in the jack, and as the rear portion is in contact with the brass bush, the insertion of the plug makes both connexions. Such a plug as this would be used in any circuit where both sides were wanted to be made or broken at will, such as in the case of telephones.

In a crystal set the jack would be placed between the crystal and earth, as shown in Fig 3. The connexions in a single-valve set would be between anode, or plate, and high-tension positive terminal of the set, a very simple arrangement.

The method of mounting the jack into the panel is perfectly simple, only one hole having to be drilled. The brass bush screws into the bracket, and this must be removed before the appliance is fitted. This bush, having been unscrewed, is fitted into the hole made in the panel. A hexagonal head is fitted to the bush so that a spanner may readily be applied for screwing tightly without damage. It is important that when the jack is fitted the bush be screwed very hard, and that the washer be not omitted between the panel and the hexagonal head.

Fig. 4 indicates how jacks may be used to render a two-valve set, consisting of high frequency and rectifier, capable of being used either as a two-valve set or a one-valve set at will. The first plug is of the S.O. type as previously described,

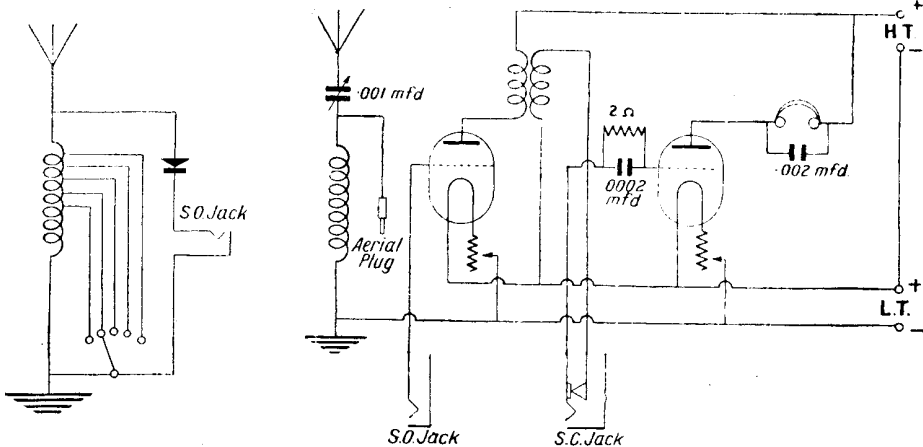

HOW SIMPLE JACKS AND PLUGS ARE USED IN CRYSTAL AND VALVE CIRCUITS

Fig. 3 (left). An S.O. jack is here shown used in a crystal receiving set. Fig 4 (right). Two jacks are employed in this circuit, an S.O. and an S.C., for plugging in the aerial either on to the grid of the high-frequency valve or the grid of the rectifier

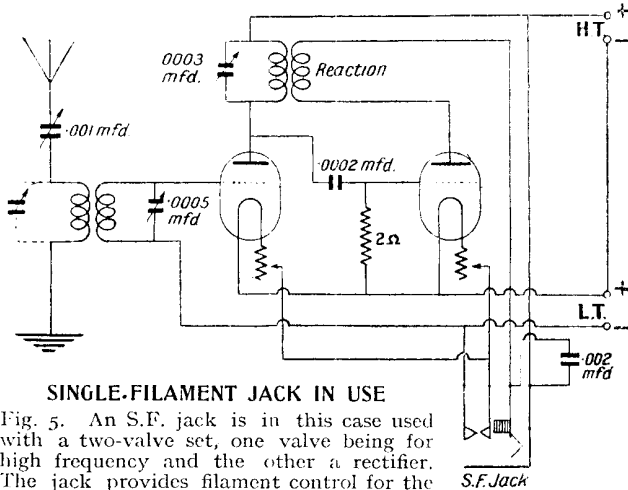

SINGLE-FILAMENT JACK IN USE

Fig. 5. An S.F. jack is in this case used with a two-valve set, one valve being for high frequency and the other a rectifier. The jack provides filament control for the two valves by means of the telephone plug

and the second an S.C. (single closed)—Fig. 1 (d). The latter has a second spring strip bearing a platinum contact which is normally pressing against another platinum contact upon the bent strip. The insertion of the plug causes the platinum contacts to be forced apart.

Fig. 4 shows how the jacks are connected and operated. The plug is connected to the aerial lead, and the first jack to the grid of the high-frequency valve. The second jack performs two functions, and is connected in the grid circuit of the second or rectifier valve. Its first function is to keep this grid circuit

closed when the two valves are in use, and secondly to break that circuit and at the same time allow a second to be made when the plug is inserted. A further S.O. jack might conveniently be inserted in order to plug the telephones in circuit, but this has been left out for the sake of clarity.

A two-valve circuit embodying a filament-control jack is illustrated in Fig. 5. The type of jack used is shown in Fig. 1 (c). This type has three contacts, including that made by the plug as it enters the bush. The two further contacts are disposed each upon a straight

spring strip, and are separated when the plug is out of the jack. The bent strip is not allowed to touch the others metallically, but is separated from them by a small mica block. When the plug is inserted the bent strip pushes the mica block, forces the two platinum contacts together, and thus closes two circuits. The plug itself is connected to the telephone leads and the platinum contact strips in the filament circuit. The result is that on the insertion of the plug the high-frequency circuit is made via the telephone leads, and the filament circuit (hitherto broken) becomes complete and the filament lights.

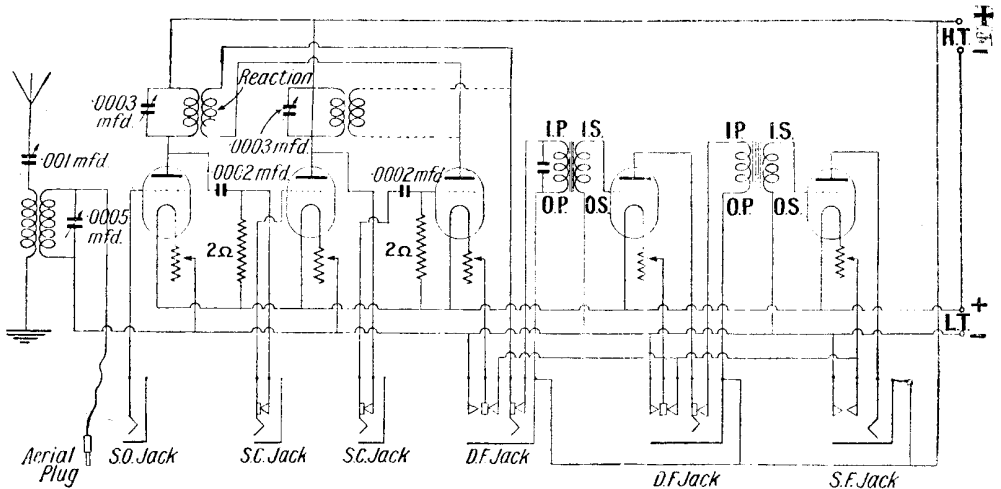

JACKS AND PLUGS IN A FIVE-VALVE CIRCUIT

Fig. 6. Two high-frequency, one rectifier and two low-frequency valves are used in this circuit, and connexions are made by jacks and plugs, as illustrated in Fig. 1. By means of these jacks nine different circuit arrangements may be employed

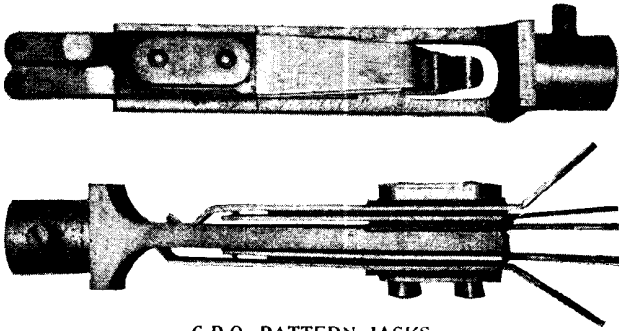

G.P.O. PATTERN JACKS

Fig. 7. Jacks of this pattern are used in G.P.O. apparatus for land lines. They have a somewhat high self-capacity, but may be used in wireless receiving sets if due allowance is made for this fact

Fig. 6 is a circuit employing five valves, two high frequency, rectifier, and two low frequency, and jacks are employed for the aerial and each valve. The arrangement is such that the following combinations of valves are possible:—

- (a) Rectifier alone.
- (b) Rectifier and one high frequency.
- (c) Rectifier and two high frequency.
- (e) Rectifier and one low frequency.
- (f) Rectifier and two low frequency.
- (g) One high frequency, rectifier and one low frequency.
- (h) One high frequency, rectifier, and two low frequency.
- (i) Two high frequency, rectifier, and one low frequency.
- (j) Two high frequency, rectifier, and two low frequency.

A circuit such as this is ideal both for the experimenter and anyone possessing a set with which to reach distant stations, and who desires to save current by using fewer valves when receiving near-by stations. All of the jacks illustrated in Fig. 1 are used, the two which have not previously been described being Fig. 1 (b) and (a). The former is known as a D.C. (double closed) jack, and the latter a D.F. or double filament. Fig. 6 shows how the various jacks are disposed and connected. Two plugs are used, one being connected to the aerial lead and the other to the telephones. The former is used to control the high-frequency valves and the latter the low-frequency valves.

Filament-control jacks are provided for the low-frequency valves, as these will probably be more in use—that is for cutting out—than the high-frequency

valves, particularly if the receiver is used on the telephones rather than the loud speaker.

It will be noticed that if the reaction is to be arranged on the first high-frequency valve, as suggested, it is essential that mechanical means be provided for the coil to be moved conveniently from the first anode coil to the second. This arrangement is suggested by the dotted lines in the circuit diagram.

The type of jack illustrated in Fig. 7 is a G.P.O. pattern instrument, and is designed more particularly for land line

telephony work. It differs from the radio jack in that no use is made of the metallic contact between the plug and the brass bush or jack frame. Furthermore, such a jack has considerably more self-capacity than the proper radio jack, and although this would not be of much account in low-frequency circuits, it would probably reduce efficiency considerably for high-frequency work. Many amateurs use them, however, owing to the cheapness with which they can be obtained at the present time.

Fig. 8 is an illustration of a mounted jack. It is enclosed in a moulded ebonite case, and all connexions are brought to terminals at the top, thus rendering the changing over of circuit arrangements a matter of ease.—*R. B. Hurton.*

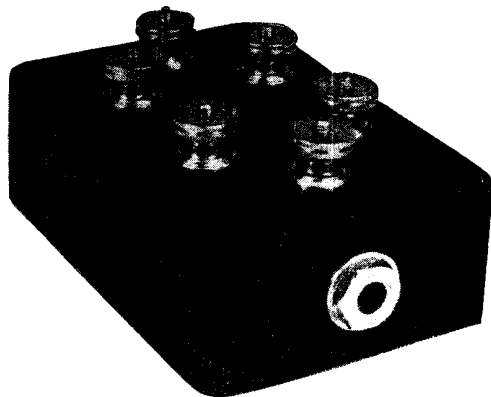

MOUNTED JACK

Fig. 8. In this jack the terminals are all mounted on the top of an ebonite case, thus making it easy to alter the circuit arrangement

Courtesy Radio Communication Co., Ltd

How to Make Simple Jacks and Plugs.

The experimenter interested in home-made apparatus and in possession of a small turning lathe can make up a number of plugs for different apparatus, adapting them to varying requirements. A part sectional drawing of a simple

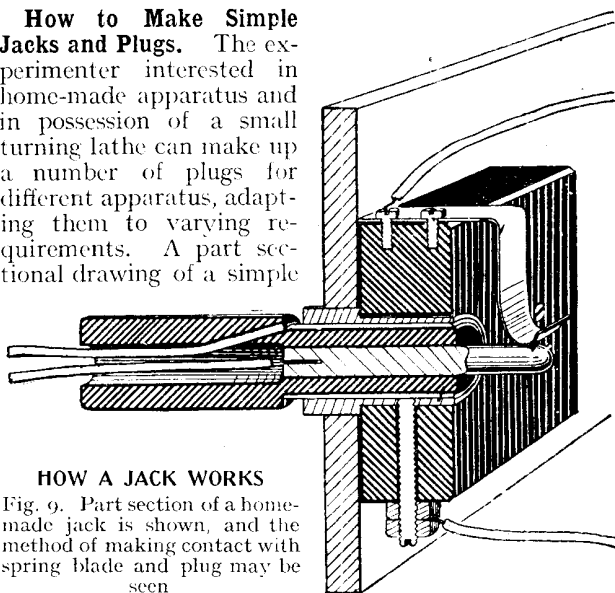

HOW A JACK WORKS

Fig. 9. Part section of a home-made jack is shown, and the method of making contact with spring blade and plug may be seen.

jack is given in Fig. 9, and shows that the jack comprises a substantial block of ebonite, bushed with brass, this bush being metallically connected to a conductor.

A second contact is made by means of a springy brass contact blade screwed to the block, and this also is connected to a second conductor. The contact blade is entirely insulated from the bush, and consequently two circuits can be completed or broken at will. This is accomplished by making the block with a large diameter tubular contact which fits snugly into the bush, and a separately insulated central metal pin which makes contact with the brass contact blade, as is shown more clearly in position in Fig. 10.

The first step is to prepare the ebonite block. This should be at least $\frac{1}{2}$ in. thick, $2\frac{1}{4}$ in. long, and $1\frac{1}{4}$ in. wide. A hole is drilled through the broad part, $\frac{1}{2}$ in. in diameter, and two small holes in line with it for fixing screws, and a third small hole at right angles to the large one, which is drilled and tapped for a 4 B.A. screw. The block should be filed up neat and true and a chamfer formed on one set of edges, as shown in Fig. 11.

The next step is to prepare the brass bush, which may be turned from a piece of thick brass tube. It should be slightly shouldered and slightly tapered, and should be made a tight driving fit into the ebonite. The front of the block will subsequently be fitted to the back of the

panel, and consequently the brass bush should extend by an amount slightly greater than the thickness of the panel, normally $\frac{1}{4}$ in. to $\frac{3}{8}$ in. On the inside of the block the bush is flush.

The next step is to secure it firmly to the block with a piece of 2 B.A. screwed rod, the end of which has been slotted for a screwdriver. This is then screwed into the tapped hole in the block, as shown in Fig. 12, and a couple of nuts screwed on to it, subsequently to receive the connecting wire. Then prepare the brass contact spring. This should measure $\frac{1}{4}$ in. wide and about $\frac{1}{32}$ in. thick. It is more or less L-shaped, one end being bent back slightly, to make a firm spring contact. The actual

shape of this spring may be seen from the photograph Fig. 10, at the top of the ebonite block.

A single one of these contacts can be bent to shape with stout pliers, but if several are to be made, it is preferable to prepare a small bending jig or gauge, such as that shown in Fig. 13. This consists merely of a block of wood to which a smaller block has been screwed or nailed. Two pegs are then driven into the pieces at the point where the contact strip is to be bent, and the first part of the bending performed by bending the brass upwards against the first pin nearest to the wooden block. The larger, thicker pin, seen in Fig. 13, is then put into position, and the blade bent around it as there shown, after which a third pin is put into position, and the contact blade bent backwards again to the position shown in Fig. 14.

Bent in this way, the contacts will be more uniform in size and shape than by attempting to bend them around a metal block. To obtain the exact position for the pin on the small block, the contact blade should be drawn to full size, outlined on the baseboard of the bending jig, and the small block nailed on against the hole which will subsequently be drilled for fixing the blade to the ebonite block. The pins are then driven into the wood in the exact positions where the bends are to be made. After bending, the blade is trimmed up to length and the ends neatly rounded.

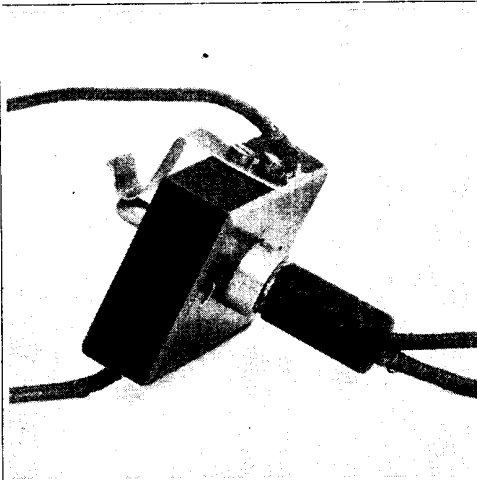

Fig. 10. Connexions are shown in this photograph of the complete plug and jack



Fig. 11. An ebonite block forms the foundation of the jack. Note the position of holes, also chamfered edges

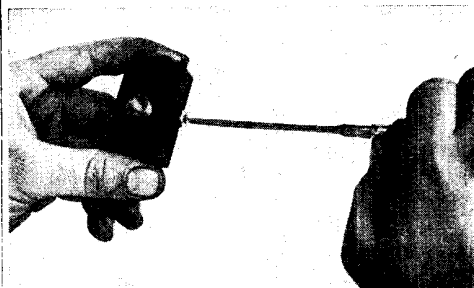

Fig. 12. How the brass bush is secured to the ebonite block is illustrated

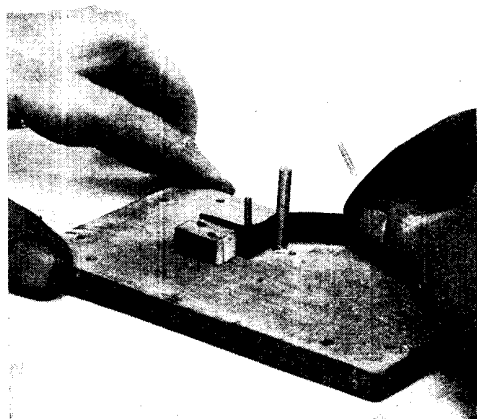

Fig. 13. Contact strips may be bent easily by the means shown in this photograph

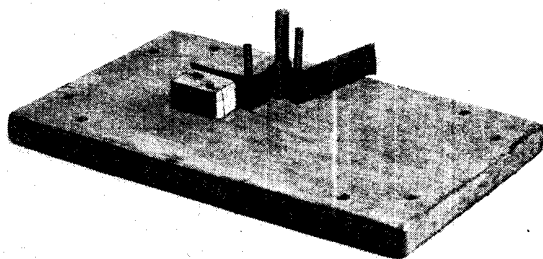

Fig. 14. By means of this simple jig a number of jack contacts may be made accurately

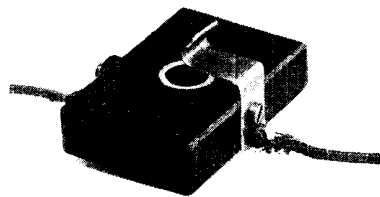

Fig. 15. Connecting wires and spring contact may be seen on the jack

HOW TO CONSTRUCT A SIMPLE HOME-MADE JACK

Two holes are then drilled for 6 B.A. screws, and corresponding holes drilled and tapped into the jack, taking care that they do not pass through and touch the central bush. The blade is screwed into position with these two screws, one of which should be tightened up and the other left slack, being subsequently

tightened up on the connecting wire. The finished jack, with the two connecting wires in place, is shown in Fig. 15, which should make the construction clear.

The next thing is to prepare the plug. The first step is to take a piece of 1/2 in. diameter ebonite rod, chuck it in the lathe, and shoulder down a portion to

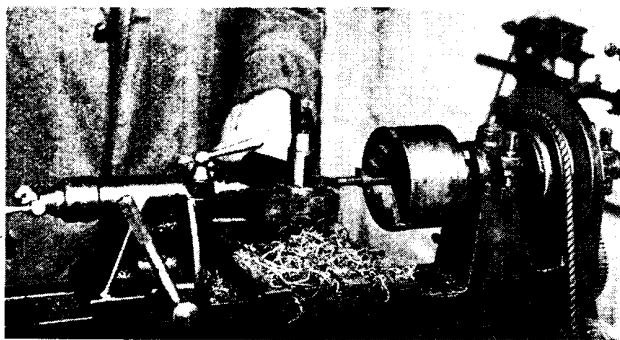

Fig. 16. Ebonite rod of $\frac{1}{2}$ in. diameter is being shouldered down to receive the tubular contact for the plug. It should be slightly tapered to ensure firm attachment.



Fig. 17. Soldering the connecting wire to the pin of the plug

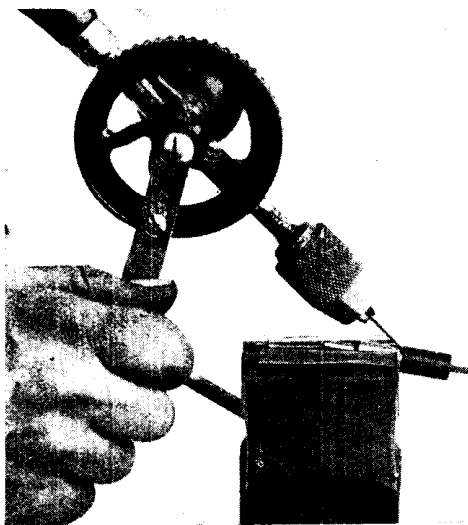

Fig. 18. Drilling the hole in the plug for the connecting wires



Fig. 19. Soldering the connecting wires in position after passing through the hole

Fig. 20. Telephone leads are attached to the complete plug

OPERATIONS IN PREPARING A PLUG FOR THE HOME-MADE JACK

receive the tubular contact, this process being illustrated in Fig. 16. To ensure a firm attachment, the ebonite should be turned very slightly tapered, so that the tube can be driven on or pressed home on to it.

When this part of the work is finished, but before the ebonite rod is taken from the lathe, a central hole is drilled through the ebonite to receive a central brass contact pin. The pin is simply a straight piece of $\frac{3}{32}$ in. diameter brass, rounded off at the outer end. The inner end is drilled with a $\frac{1}{16}$ in. drill for a short distance, and the end of the conducting wire bared and soldered into it, removing as little of the insulation as possible for this purpose.

It should be well soldered, as shown in Fig. 17, after which the conducting wire is passed through the hole in the ebonite rod and the pin pressed home until about $\frac{1}{4}$ in. only is projecting. The outer contact bush is then pressed on to the outside portion of the ebonite by resting the end of the tube on a block of wood on the work bench and pressing the ebonite on to it. A hole is then drilled in the wooden block to allow the central peg to pass and the central tube pressed home.

The next step is to hold the jack in a vice, using a pair of lead or soft copper clamps to prevent bruising the tube, and with the aid of a small drill, inclined at an angle of about 45 degrees, to drill a hole

through the ebonite into the central hole therein (Fig. 18). A thin wire is passed through this hole, in the same direction as it was drilled, and when its end appears beyond the ebonite it is attached to the end of a second conductor from which a small portion of the insulation has been bared, and is carefully drawn through the hole.

The ends of the wires, if flexible wire is used, or the single wire, if only one strand, should then be bent neatly around the end of the tube and securely soldered thereto, as shown in Fig. 19. The insulation should be tested by connecting one end of one of the conducting wires to a battery and trying the other end on a flash-lamp or galvanometer. If the lamp does not light, or the galvanometer pointer does not move, the insulation should be satisfactory for ordinary low-tension work. If used for high-tension purposes, a high voltage should be applied for testing.

If all is correct, the fit of the plug into the jack should be tested. Should this be a little on the tight side, it can easily be remedied by polishing the exterior of the brass tube with the very finest blue-back emery paper. The finished plug is shown in Fig. 20.—*E. W. Hobbs.*

JACKSON, ADMIRAL SIR HENRY BRADWARDINE. British naval officer. Born at Barnsley, January 21st, 1855, Sir Henry Jackson entered the Royal Navy in 1868, and became captain in 1896, chief of the Naval War Staff 1912-14; First Sea Lord, 1915-16; President R.N. College, Greenwich, 1917-19; and chairman of the Radio Research Board, 1920.

Admiral Jackson was early interested in wireless, and in 1893, while commander of H.M.S. Edinburgh, began to make a close study of Hertzian waves, with a view to employing them for signalling work in the Navy. In his early experiments, which he carried out for use with torpedo boats, he used a filings coherer decohered by the hammer of a high-resistance trembling bell. With the advance of wireless, Sir Henry devoted much of his energies to its development and organization in the Navy, and much of its present efficiency in that direction is due to his early efforts. He has been President of the Radio Society of Great Britain.

JAMMING. Term often somewhat loosely used to denote interference (*q.v.*) of any kind, but more particularly applied to that caused by signals from stations

other than those actually in communication with one another.

In radio-telephony, jamming may occur when the wave-length of the interfering station is separated by 30 metres or more, if the station communicated with is a distant one and the interfering station fairly close at hand. But insistent jamming may be caused by Morse signals, especially from high-powered stations, even when the separation of wave-lengths is much wider and the distance of the interfering station considerable.

In the case of transmission and reception between ship and shore stations jamming—owing to the fact that a number of other similar stations may be transmitting on approximately the same if not identical wave-lengths—is often very serious, and the trained ear of a practised operator at the receiving end is needed to establish and maintain communication.

Hitherto no really effective remedy for jamming has been discovered, and such palliatives as have been introduced leave much to be desired. Some success has



ADMIRAL SIR H. B. JACKSON

Wireless developments in the British Navy in the early days of radio communication were largely due to this noted scientist. Admiral Jackson has been chairman of the Radio Research Board and President of the Radio Society of Great Britain

Photo, Russe!

been achieved in the matter of cutting out the local jamming of a near-transmitting station by the careful use of loose coupling, and by the introduction of wave-traps in the form of condensertuned coils interposed in the aerial circuit.

With a loose-coupler inductance, or with a wave-trap tuned to the unwanted signals, a near station can sometimes be tuned out, so that a distant one, working on a wave-length not more than 15 metres lower or higher, can be received satisfactorily. A crystal set connected to the same aerial and earth as the main set has also been successfully employed for the same purpose and in the same manner.

But the most hopeful method of preventing jamming which has so far been brought into common use has been by adopting some directional system whereby only the waves with their superimposed signals proceeding along a certain line are received, to the exclusion of other waves and signals. See Atmospherics; Bellini-Tosi Aerial; Interference; Interference Eliminator; Rejector Circuit; Short Wave; Wave-trap.

JANET, PAUL. French electrical expert. Born in Paris in 1863, he was educated at the Lycée Louis de Grand and the High School there. From 1886-94 he was professor of physics at the University of Grenoble. He is a membre de l'Institut, professor of physics in the University of Paris, and director of the Central Laboratory and of the High School of Electricity. Janet, who is the author of several important works on physics and electricity, is a member of the French Societies of Physics, of Electricians, and of Civil Engineers. In wireless he was the first to make a successful experiment in electric resonance by means of high-frequency currents, in 1892. He is the author of many papers on wireless, including those on the theory of the Duddell singing arc, and on high-frequency alternators.

JAR. A unit of capacity used in the Admiralty service. It equals 10^{11} cm. or $\frac{1}{3000}$ mfd. See Farad; Units.

JERVIS-SMITH MICROPHONE. Name given to a form of microphone due to F. J. Jervis-Smith, and first described as early as 1879. In the liquid microphone a liquid is used in such a way that its resistance is modified by the voice, and the modification is made use of in various

ways to act upon the diaphragm of a microphone. There are many forms of microphone, some of which are described under their respective headings in this Encyclopedia.

The figure is a diagrammatic representation of the method used in the Jervis-Smith liquid microphone. The diaphragm of the microphone is connected to an inclined plate electrode, A. On this plate falls a stream of the conducting liquid. The plate is inclined at an acute angle to the direction of the flow of the liquid, so that a small horizontal movement of the

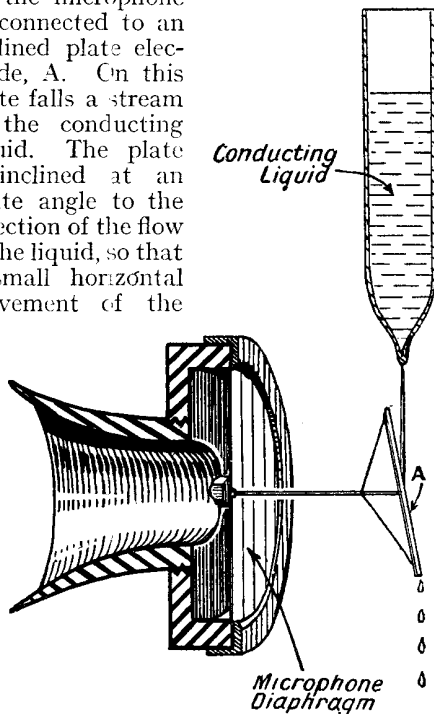

JERVIS-SMITH LIQUID MICROPHONE

Represented in this diagram is the method of working the Jervis-Smith liquid microphone. Modification of the resistance of the liquid by the voice affects the diaphragm

plate causes a relatively large increase or decrease in the length of the liquid path over the electrode A, with a corresponding increase or decrease in the resistance. The second battery connexion is made to the liquid, which is usually a dilute acid, salt, or soda solution. The electrode plate is made of some substance not easily acted upon by the liquid, as platinum. See Microphone.

JIG. An implement that automatically determines the size, shape, or some particular property of a constructed article. Jigs are very extensively used in manufacturing establishments to ensure interchangeable parts, and should be more generally employed by the amateur

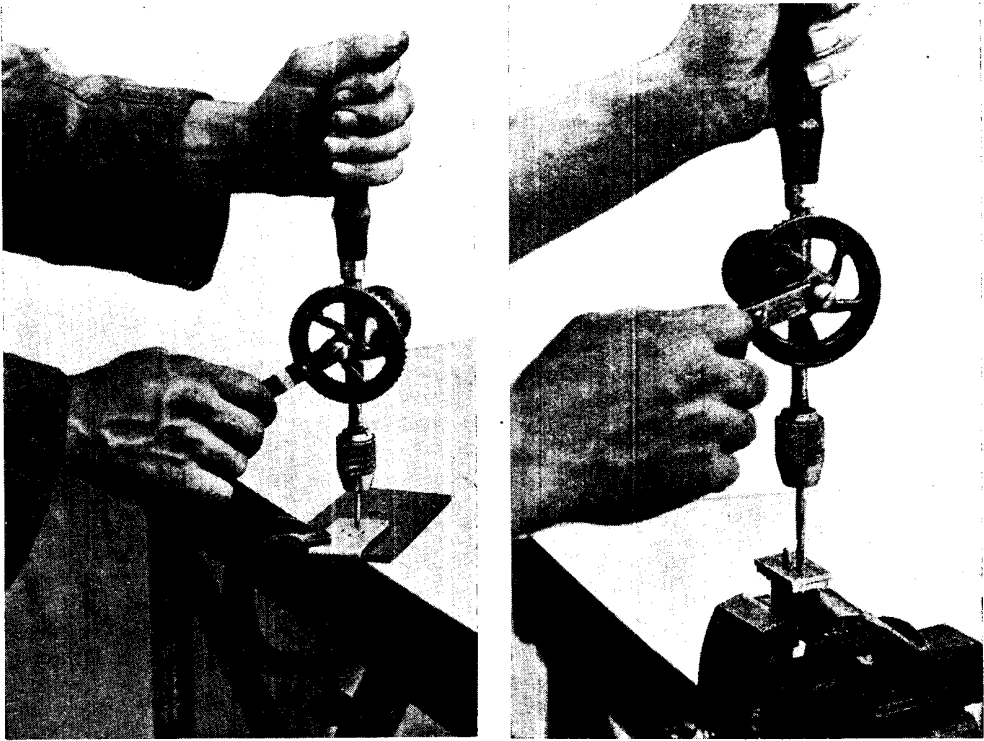

OPERATIONS IN WHICH STEEL JIGS MAY BE USEFULLY EMPLOYED

Fig. 1 (left). Holes are being drilled in an ebonite panel prior to mounting a valve holder, the steel jig acting as a guide to prevent inaccurate spacing. Fig. 2 (right). In this case the jig, which is designed for a coil holder, has a locating peg in place in the first hole while drilling a second hole, which must be exactly a given distance from the first

constructor than is usually the case. There is no such thing as a jig in the sense that it is a tangible article that can be bought at a shop, though there are some components that are purchasable; but in all cases the jig has to be made for a particular purpose. The design and manufacture of modern jigs are such that a small industry has been developed around them by those specially qualified for the work.

The first requirement in any jig is that

it shall possess the requisite degree of accuracy, as obviously it can only turn out results limited by the truth of the jig itself. The simplest type of jig for use by the wireless experimenter is one that is applicable to the operation of drilling the holes in a panel for the reception of the valve legs of a standard valve holder. One example of such a jig is shown in use in Fig. 1, and is composed of a steel plate with one end bent over to act as a guide when placing the jig on the panel.

The jig consists of a flat steel plate with four holes drilled through it at the exact spots where the holes are to come for the valve legs. The distance that these holes are to be from the edge of the panel is determined by the distance from the fence or bent over part of the jig. Consequently, such a jig fixes five dimensions simultaneously and automatically. First it ensures accuracy in the spacing of the four valve leg holes, and also the correct distance from the edge of the panel or some other part of the apparatus.

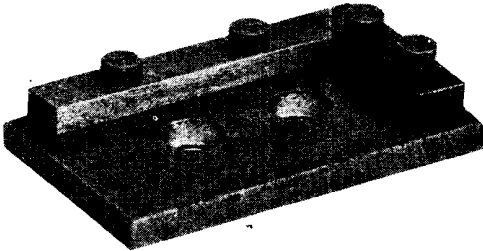

JIG FOR DRILLING COIL HOLDER

Fig. 3. This is a very useful jig for experimenters who frequently construct coils for trying out new circuits

To make the jig, select a piece of mild steel $\frac{5}{16}$ in. thick, bend the end over while hot, and clean up the inner face with a file. Mark out the position for the valve leg holes and drill them carefully. Clean off all burrs and roughnesses, and the jig is ready for use. If intended for much use the steel should be cas hardened or the drilling holes bushed with hard cast steel.

Another very useful jig is that shown in Fig 3, and employed for spacing the holes in a coil holder. The jig in this case comprises a flat steel plate with two pieces of strip metal riveted to the two edges and at right angles to each other. This forms a recess into which the top of the coil holder can be fitted. The spacing of the holes for the socket and peg of the holder is then accurately marked and drilled as before. In use, such jigs are placed flat on the work and secured in some way, as by a clamp, and the first hole drilled. The jig is often held in place afterwards by putting a closely fitting peg into one of the holes to prevent movement while drilling the remainder (Fig. 2).

Numerous developments of the same principle include such items as jigs for drilling the holes in special condenser plates, the spacing jigs for terminal holes, and those used to control the shape of the plates. The basic principle in all is to determine one true line or the relative accuracy of two points, and to work all other dimensions from them. See Jack ; Template.

JIGGER. Another name for an oscillation or coupling transformer or auto-jigger. The photograph shows the $\frac{1}{2}$ kw. covered wire jigger for transmitting such as is used on small passenger liners. The jigger consists of a box in which is the primary winding. Above it appears the secondary winding of the jigger or auto-transformer, tapped by means of plug-socket connexions, which are clearly shown on the top of the box.

In front of the primary winding base box are two plug-socket tapping connexions for the primary, enabling a change over to be made from 300 to 600 metres wave-length. See Auto-jigger ; Oscillation Transformer.

JOINTS. A joint may be defined as the close and maintained contact between two parts or pieces of material. There are two great classes of joint: firstly, those

that are permanent, either flexible or rigid; secondly, demountable joints, as a bayonet joint in the valve holder of some valves. Permanent joints include all those that are made during manufacturing processes, as the welding together of several pieces of material to make one of larger size or substance.

The experimenter is mostly concerned with joints as they apply to constructive work in wood or metal. The simplest joint is the butt, where one part is placed on another and the two nailed, screwed or bolted together, or secured with an adhesive. In woodwork such joints are also effected by planing the two edges to be united and gluing them together. The equivalent process in metal joints is effected by soldering or brazing. Such joints are limited in application, and it is necessary to employ some mechanical means of controlling the joint, as by dowels, as shown in Fig. 1.

The essentials of a dowelled joint are that a hole or holes are drilled in the faces of the two parts to be united, and then a

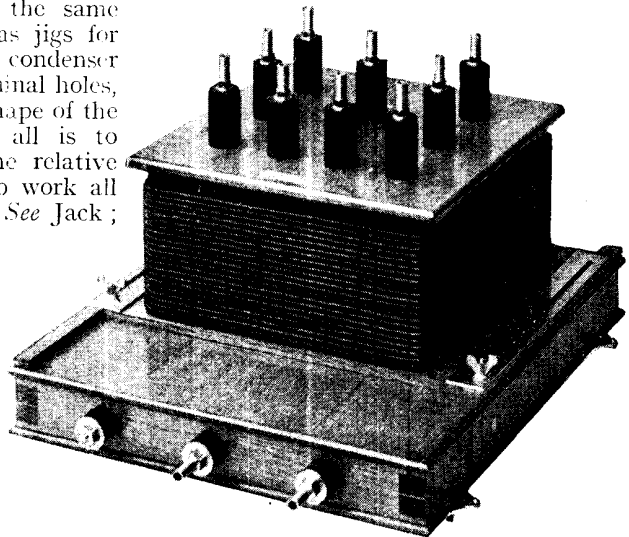

HALF-KILOWATT JIGGER

Transmitting apparatus on small passenger liners use this kind of half-kilowatt jigger or oscillation transformer

Courtesy Marconi Wireless Telegraph Co., Ltd.

peg or pegs are inserted into one set of holes with about half the length projecting, and the other part correspondingly drilled is placed on the pegs and driven home.

The joint at this stage is demountable, and can be taken apart and re-assembled

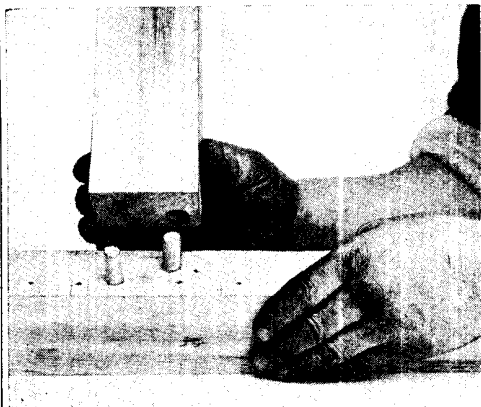

Fig. 1. Dowelled joints permit two parts to be joined without reducing their length or breadth

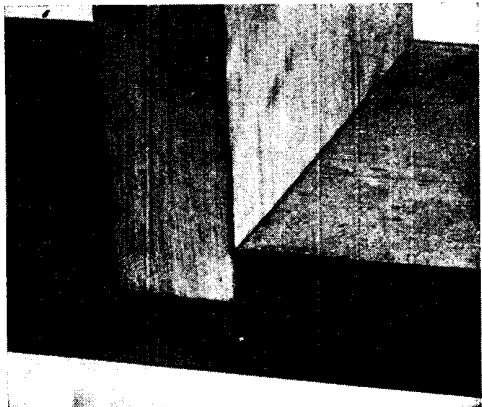

Fig. 2. Simple housing joints are useful for shelving, and very easy to make

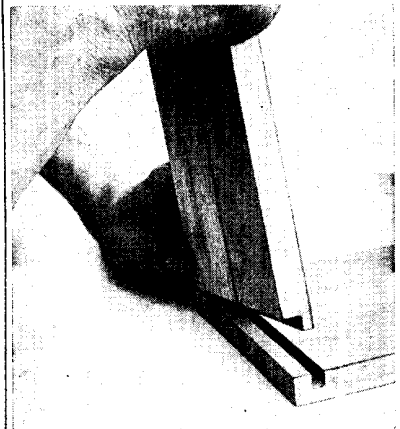

Fig. 3. Square grooved and fingered joints should be used at the end of a piece of board

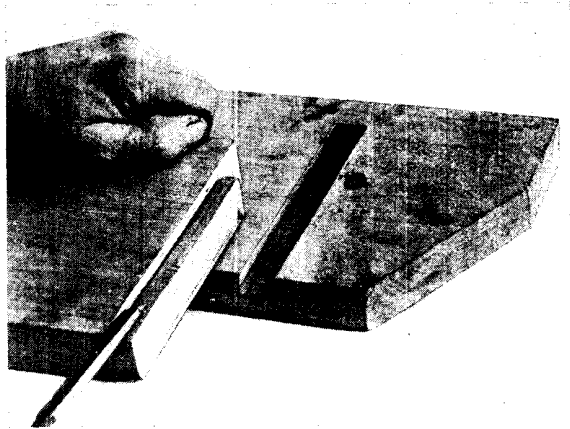

Fig. 4. This is a dovetail, stopped housing joint, and is an improved form of the joints in Figs. 2 and 3, being much more rigid

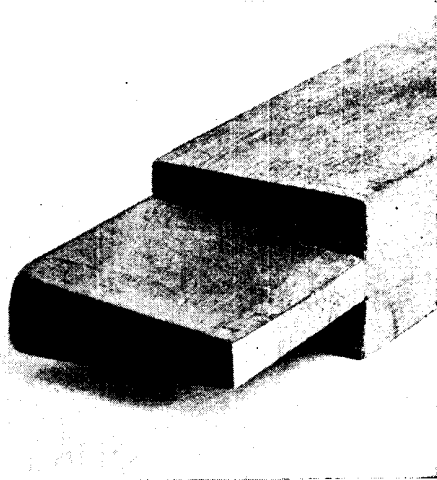
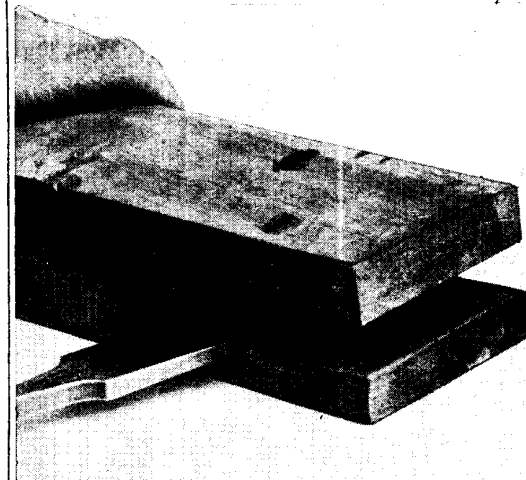

Fig. 5. Simple dovetail joints of this kind are self-locking in one direction. In order to obtain a secure joint the faces of the cut-away portions must be accurately finished and true to measurement

JOINTS TO BE USED IN THE CONSTRUCTION OF WIRELESS ACCESSORIES IN WOOD

readily in the same position as before; it is rendered permanent by gluing, or with nails or screws.

Another serviceable and many-purpose joint is that known as the housing joint, shown in Fig. 2. Here one part is let into a groove cut in the other. This is applicable to the joint between an upright and an horizontal member, such as a shelf and table or bracket.

The joint is easy to make and holds very well. The width of the groove has to be marked accurately across the part to be housed, and the wood between the marks is sawn and chiselled out. The other part should fit accurately and not be tapered at all. It is secured with glue or screws, as desired. When such a joint has to be made at the end of a piece of timber, as when making a case for a wireless set, the method shown in Fig. 3 should be adopted.

The one part has a groove cut across it at a distance from the end equal to one-half the thickness of the part to be fitted to it. The other part is rebated or cut half away to fit into the groove, the joint made secure with glue or fine screws or nails, and subsequently any small projecting portions planed off flush with the surfaces.

How to Make Dovetail Joints

All the foregoing joints have the disadvantage that they do not of themselves prevent displacement in a direction at right angles to the joint. To overcome this the housed joints can be made as shown in Fig. 4. In this case the side of the slot or groove is cut to an angle, thus forming a dovetail. The side of the part to be fitted is cut to a corresponding angle, and accurately fitted by chiselling until it is a close fit in the groove. The groove need not be carried right across the timber, but may terminate at a small distance from one end or edge, and is then known as a stopped housing joint. This avoids the unsightly appearance on the face of the work where the one part fits into the other.

The principle of the dovetail is applied to a great many joints, and a simple example is shown in Fig. 5.

In this case two pieces are to be jointed at right angles, and the joint is to be self-locking in one direction. The right-hand piece has an angular tenon formed on it, and this fits into a tapered hole in the other. The secret of making this or any

other joint is to mark out very accurately the work at the start, and to work to the lines. The bulk of the wood can be sawn away, and the final fitting effected by chiselling with a broad chisel as shown.

The joint faces must fit over the whole of their areas, and not merely jam on one part and be slack in another. When making a structure such as a lattice mast for an aerial, the bulk of the joints are effected with nails and screws or bolts, simply by lapping one part on the other or using a simple butt joint. Scarfed joints are employed to lengthen timber and are simple.

The majority of the joints in metal used in wireless sets are those that are made in wire at the points where two or more conductors unite. An example of the jointing of a single strand wire is shown in Fig. 6, and in this case one wire is bent to a right angle, or at any other desired angle, and placed upon the other or main conductor, good electrical connexion being made by soldering. The strength of this joint is limited by the tensile strength of the solder and the care with which the joint is made.

A better mechanical joint is effected, as shown in Fig. 7, by twisting the wire around the main conductor and then soldering it to make perfect electrical contact and to keep the joint firm. When a joint has to be made in a multi-strand conductor, such as a 7/22 aerial wire, the best plan is to untwist partly the main wires by turning the wire backwards, or against the direction of its twist (Fig. 8).

Jointing Multi-Strand Wires

This will cause the strands to separate, and permit the strands of the joint wire being inserted between them, thus forming an elementary form of splice. The ends are then twisted up and the whole soldered. Three of the strands on the joint wire should be turned to the right of the joint and four to the left, as this increases the area of contact and makes a neater joint.

The attachment of an aerial wire to an insulator is a jointing process that is readily carried out on the same lines as shown in Fig. 9, by untwisting the main part of the wire and interlacing the loose ends into the spaces between the turns, and then twisting the ends around the main part of the wire. If the insulator is supported by a string attached to a convenient point, it will facilitate the work.

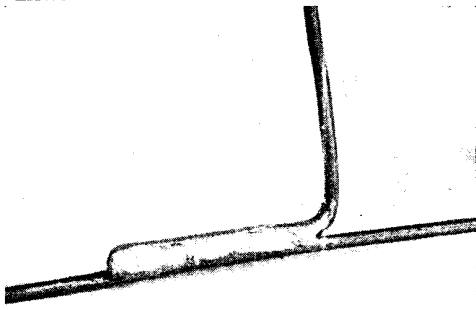

Fig. 6. Soldered wire joints are very common in wireless sets, this method giving the best contact

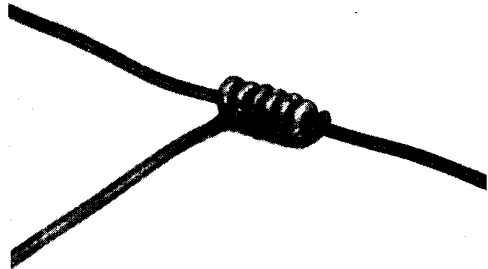

Fig. 7. Two wires may be joined in this way, but it is best to solder in addition in order to make a sound joint

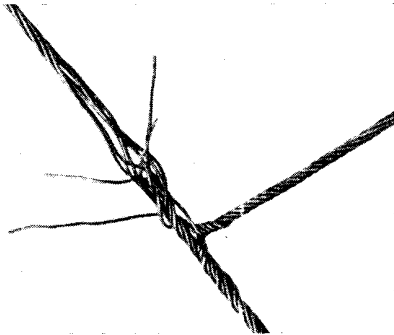

Fig. 8. Multi-strand conductors may be joined by interlacing the strands as illustrated

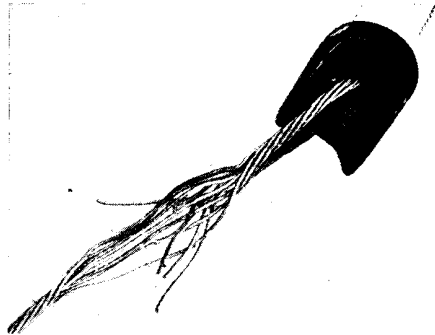

Fig. 9. When a stranded aerial wire ends in a loop it may be spliced upon itself

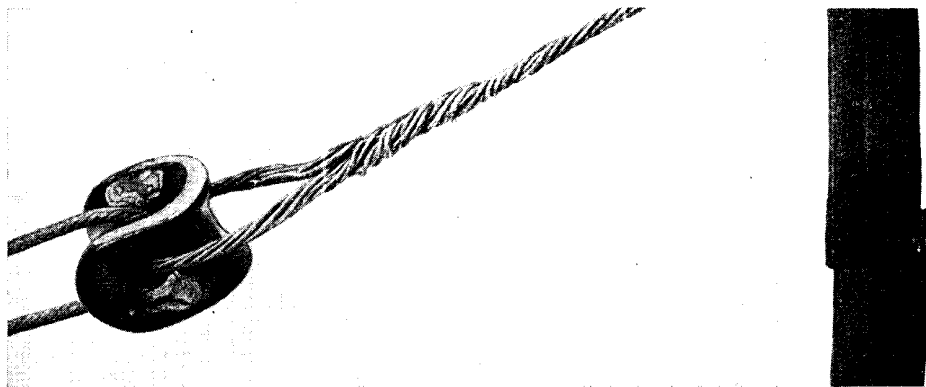

Fig. 10 (left). This photograph shows a stranded aerial wire, as in Fig. 9, after splicing has been completed. Joints of this kind are quite satisfactory electrically. Fig. 11 (right). Sheet metal may be folded over and hammered down to make a lapped joint



Fig. 12. Thick metal plates which cannot be folded and hammered, as in Fig. 11, may be overlapped and riveted, or connected by bolts and nuts, provided good clean contact is made and the plates are very tightly joined

HOW JOINTS ARE MADE IN CONDUCTORS FOR WIRELESS APPARATUS

When the work has been completed to the stage shown in Fig. 10, the joint is finished by whipping with fine copper binding wire, thus making a perfectly secure joint.

Thin sheet metal is usually joined by turning one edge over and inserting it into the correspondingly turned over edge on the other piece and hammering or rolling them tightly into contact, and sometimes finishing by soldering. Such joints are variously known as lapped or seamed, and one example is shown in Fig. 11, where the ends of a metal strip have been joined in this way. The joint is seldom riveted or otherwise secured, as this method is chiefly adopted with thicker metal of some $\frac{1}{16}$ in. in thickness or over. Joints in constructional steel work are usually made by riveting or by bolting, as shown in Fig. 12, and in all cases it is desirable to employ two smaller bolts in preference to one larger, as the load is thereby distributed over a wider area. The bolts must fit securely into the holes, and the nuts be well tightened home.

Such joints are suitable for some forms of metal aerial mast, such as those for experimenters' use, and the bolt holes should be spaced apart about one and one-half times the greatest breadth of the strip.

Most metals can be efficiently joined by soldering, brazing, or welding, these processes consisting essentially of melting an alloy or simple metal and causing it to flow around and on to the parts to be united, thus making a very good joint mechanically and electrically.

In all experimental wireless work it is important to make good joints from the electrical point of view, that is the joint should be made of substantially uniform and continuous cross-section throughout, and not present any increase of local resistance.

Joints in ropes or cords are generally effected by tying a knot or by splicing (*q.v.*). Belts are joined by means of belt fasteners or by splicing the ends and sewing or cementing. Ebonite and fibre can practically only be joined mechanically by screws, rivets, or the like. Many soft materials such as rubber are joined by a solution of the same material applied to the surface and allowed to dry; others by a suitable adhesive, of which shellac varnish is an example. It can be employed

for joining cork to canvas, or canvas to cardboard, and in numerous ways, as for instance, the joining or attachment of an ivory scale to a panel. Mortise and tenon joints are separately described in this Encyclopedia under the headings Mortise and Tenon.—*E. W. Hobbs.*

See Aerial; Bight; Brazing; Cabinet; Soldering.

JOULE. The joule is the practical unit of electrical work or energy. One joule represents the amount of work done or energy expended per second when one ampere of current flows through an electrical circuit between the ends of which there is a difference of potential of one volt.

The mechanical unit equivalent to the joule is "foot-pound per second." This represents the mechanical energy expended in raising a pound weight from the ground in one second of time to a height of one foot.

The calorie is a heat unit often used in electrical engineering, and is equivalent to 4.2 joules, and conversely one joule equals approximately .24 calories. See C.G.S.; International Units; Units. See also under the names of the various units, *e.g.* Ampere; Coulomb; Ohm.

JOULE'S LAW. This a law due to Joule which states that the heat produced in a conductor through which a current is passing is proportional to the resistance of the conductor and the time the current flows, and proportional also to the square of the current strength.

Let E be the potential difference between the ends of a conductor and C the current, both measured in electro-magnetic units (*q.v.*). Then EC is the energy in ergs, which appears as heat when C electro-magnetic units flow for one second, and ECt is the energy in ergs appearing as heat when the same current is flowing for t seconds.

The mechanical equivalent of heat is 4.2 times 10^7 ergs per calorie, and if H be the heat in calories produced, then 4.2 times $10^7 H$ ergs will represent the total energy appearing as heat in the conductor. Or expressing the fact in an equation

$$(4.2 \times 10^7) H = ECt$$

or
$$H = .24ECt/10^7$$

If the potential difference is in volts and the current in amperes, then, since E volts are equal to E times 10^8 electro-magnetic units and C amperes are equal

to C/10 electro-magnetic units, the equations can be written

$$\begin{aligned} H &= .24ECt \\ &= .24C^2Rt \\ &= .24E^2t/R \end{aligned}$$

where R is the resistance of the conductor in ohms. Also since one joule is equal to .24 of a calorie, the heat may be expressed in joules as $ECt = C^2Rt = E^2t/R$, which expressions are the equations of the definition given at the beginning of this article. Joule's law is of great importance in all electrical work, and should be carefully studied by the experimenter.

~~~~~**K**~~~~~

**KATHODE.** This is the alternative spelling of cathode (*q.v.*). So kation, etc., are used instead of cation, etc., which has now become the more usual form.

**KELVIN, WILLIAM THOMSON,** first Baron (1824-1907). British physicist. Born at Belfast, Ireland, June 26th, 1824, he was educated at Cambridge University, where he was second wrangler and Smith's prizeman. In 1846, when he was only twenty-two, he was appointed to the chair of natural philosophy at Glasgow, a post he held for over fifty years, and during which time he was to become world-famous and recognized as one of the greatest physicists of his time.

To every branch of science which Kelvin touched he brought so much original thought that in many instances he entirely revolutionized the then accepted ideas. One of his earliest papers, for example, was on the age of the earth, and here he immediately and successfully attacked the then prevailing theory that the earth's crust was some thousands of millions of years old.

As a result of meeting Joule he proposed his absolute scale of temperature, which is independent of the properties of any particular substance, and followed it with a remarkable paper on the dynamical theory of heat, which he read before the Royal Society of Edinburgh.

But it is to Kelvin's researches in electricity that the wireless enthusiast owes the greatest debt. To Kelvin is due the stranded form of conductor now so widely used in all electrical work; the mirror galvanometer; the siphon recorder; Thomson's electrometer, and many other electrical measuring instruments. In addition there came from his

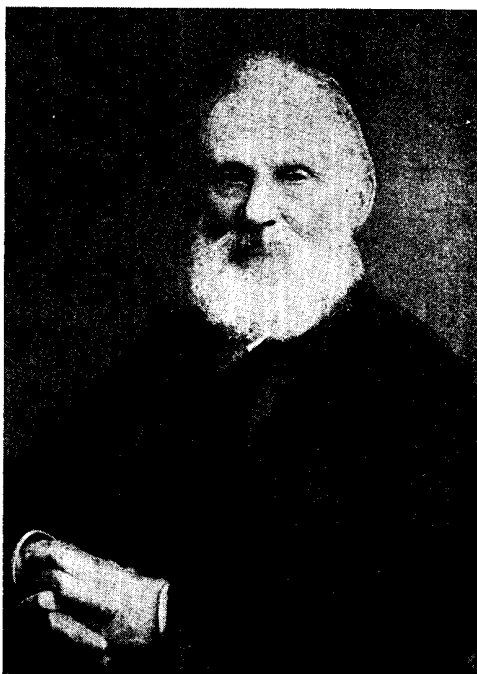

**LORD KELVIN**

Kelvin's name will be handed down to posterity as one of Britain's greatest scientists. He laid some of the most important stones in the foundation of that branch of science which made modern wireless possible

*Photo, Window & Grove*

fertile brain the mariner's compass which swept all previous compasses out of existence; his sounding apparatus for taking soundings rapidly at sea; his tide gauge and tide predictor.

Kelvin wrote more than three hundred papers on scientific subjects, and it was due to him that much of the work of Clerk-Maxwell, Balfour Stewart and other famous electricians was carried out, following Kelvin's suggestion, in the first place, of the formation of the electrical standards committee of the British Association.

During his lifetime Lord Kelvin received nearly every degree and honour which could be bestowed upon a scientist. In 1890 he became president of the Royal Society. His last public address was an analysis before the British Association, only a few months before his death, of the electronic theory of matter. He died December 17th, 1907, at Netherhall, near Largs, Scotland.

**KELVIN.** The Board of Trade unit, the kilowatt-hour, the unit of energy. See Joule; Kilowatt; Units.

**KELVIN'S ELECTROSTATIC VOLTMETER.** In its simplest form this instrument consists of a light metallic vane, supported at its centre on knife edges, and free to move in the vertical plane between a pair of fixed plates. The usual shape and arrangement of the component parts are diagrammatically illustrated in Fig. 2, where only one fixed plate is shown.

Attached to the upper half of the moving vane is a pointer, the zero position of which, as regards the graduated scale, may be adjusted by two small nuts, A and B, on a pair of threaded rods set at right angles to one another. Gravity being the controlling force of the needle, an extension of range is obtained by the addition of a few small weights to the lower end of the moving vane. By a careful calibration of these weights and the scale very accurate results are possible.

The force of attraction exhibited between the electrostatic charges of opposite sign is the factor controlling the operation of the meter. A source of potential connected across the fixed and moving vanes

will communicate unlike charges to them, and the resultant mutual attraction, proportional to the product of the charges and inversely proportional to the square of the distance between them, will be manifested by the movement of the needle over the scale. It should be noted that as the moving vane takes up a position between the stationary quadrants the force of attraction increases, due to the decrease of the distance between the plates and the consequent rise in capacity of the combination.

As the instrument is operated by the mutual attraction of dissimilar charges, it is equally suitable for alternating current, where the effective or vertical voltage is indicated, as it is for direct current. The wide variation between the natural time period of the swing of the needle and that of ordinary A.C. supply allows the needle to remain steady.

Simplicity of construction and insulation are only two of the advantages of this type of voltmeter over the magnetically operated instrument. No metallic circuit existing between the two sets of vanes, no current is consumed on D.C., and only a very small amount on A.C. Stray magnetic fields have no deleterious effects, and no inductive disturbances when used on A.C. render the instrument unstable.

The above type is especially useful when dealing with high voltages, say above 1,000 volts, but at lower potential differences satisfactory results are not possible. An extension occurs in Kelvin's multicellular voltmeter, shown in Fig. 1, which is particularly adapted for measuring the lower voltages. Instead of one movable vane operating between a pair of fixed plates, this meter is built with a number of such vanes, much like a variable air condenser, with the object of increasing the deflecting torque. The essential difference between the multicellular and the simple type lies in the method of suspension of the moving vanes, which are supported by

a fine wire and capable of movement in the horizontal plane. See Combination Meter; Voltmeter.

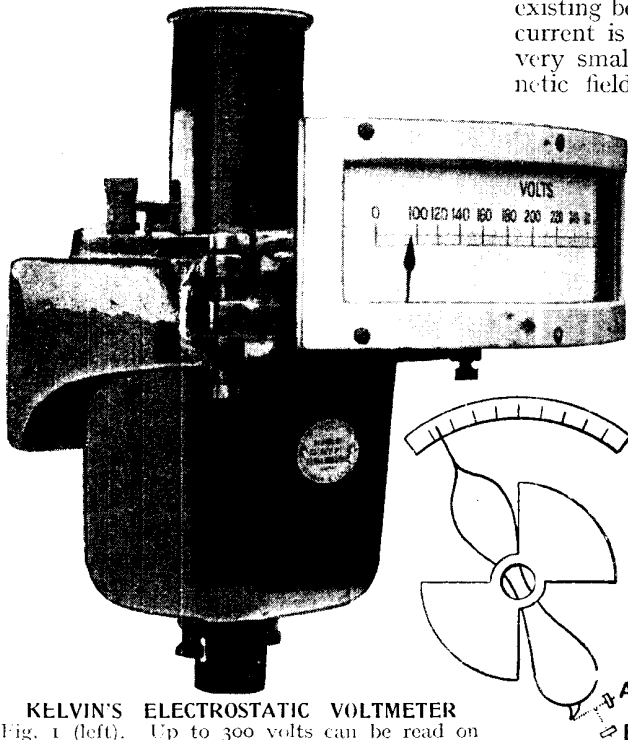

**KELVIN'S ELECTROSTATIC VOLTMETER**

Fig. 1 (left). Up to 300 volts can be read on the multicellular type of voltmeter illustrated. The scale is divided into 2 volt divisions. Fig. 2 (right). The usual shape and arrangement of the metallic vane components are as shown in this diagram

**KENNELLY, A. E.** Anglo-American wireless expert. Born at Colaba, Bombay, December 17th, 1861, he was educated in England, Belgium, France, and Italy. In 1875 he became a telegraph operator in the employ of the Eastern Telegraph Company, and in 1886 became the principal electrical assistant to Thomas Alva Edison in the laboratories at Orange, New Jersey, a post he held until 1892.

He was engineer-in-chief with E. J. Houston, of the Thomson-Houston Company, for the laying of the cables from Vera Cruz to Campeche, 1902. Since 1902 he has been Professor of Electrical Engineering at Harvard University, and since 1914 professor in the same subject at Massachusetts Institute of Technology.

Kennelly has written a large number of books on electricity and wireless, and is the author of one of the standard elementary textbooks on wireless. He has written a very large number of papers on wireless as well, and he is an authority on alternating currents.

He is past president of the American Institute of Electrical Engineers, was president, in 1916, of the Institute of Radio Engineers, and vice-president of the International Electrical Congresses held in Paris and Turin. He is a member of many scientific societies, and has received many honorary degrees. In 1921 he was appointed a delegate to the Inter-allied Radio Technical Committee in Paris.

**KENOTRON.** The name "kenotron" has been given to any valve in which are mounted only two electrodes, *i.e.* a filament and a plate or anode.

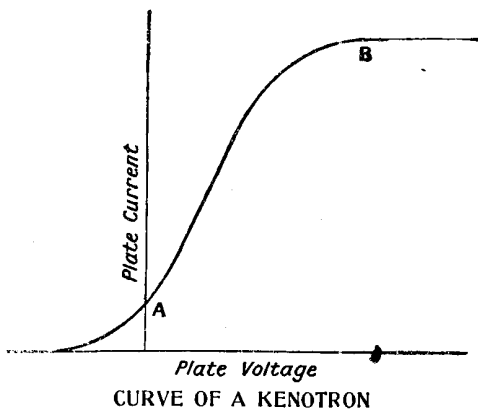
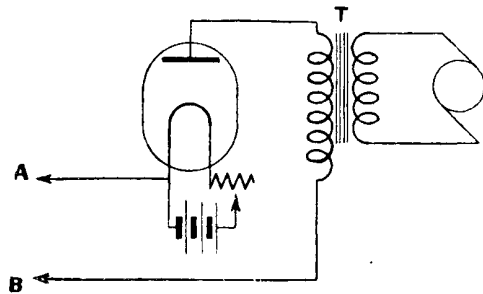

Fig. 1. Rectification point is at A, and saturation at B, in the above curve of a two-electrode or kenotron valve



**KENOTRON IN CIRCUIT**

Fig. 2. Alternating current is converted into direct current by the use of a kenotron or Fleming valve in the circuit illustrated

The original kenotron valve was due to J. A. Fleming in 1904, and it was utilized for the rectification of oscillating currents induced by electro-magnetic waves. When the filament is heated by a current, an electro-motive force applied between the plate and the filament will produce a greater current from the plate to the filament than from filament to plate. Thus, if the potential of the plate is positive with respect to the filament, a greater current will flow through the valve than if the potential of the plate is made negative with respect to the filament. If readings of the plate voltage be plotted against the current flowing in the plate circuit a curve somewhat of the shape shown in Fig. 1 is obtained. It will be seen that above the point A in the lower end of the curve the current increases rapidly with a small increase of plate volts, and above the point B no increase in current occurs with an increase of plate volts. The point A is the "rectification" point, and the point B the "saturation" point.

If the steady potential of the plate is adjusted to the point A, then any increase in voltage, due to one half of the incoming wave, will cause an increase in plate current, while the other half of the wave will cause a decrease of plate current, the increase being greater than the decrease. The incoming signal is therefore rectified, and the rectified impulses affect the telephones and render the signal audible.

Although the two-electrode valve for detection purposes has now been superseded by the three-electrode valve, it is very largely used for converting high-tension alternating currents into high-tension direct currents.

A low-tension alternating voltage is generally transformed to the required high-tension voltage, and is applied to the plate of the valve. When only one valve is used the connexions used are those shown in Fig. 2, the leads marked A, B, being taken to the circuit which it is desired to supply with high-tension direct current.

During one half-cycle the end of the transformer connected to the plate will be at a positive potential with respect to the other end. Under these conditions the valve is conductive, and current will flow into the circuit connected to A and B. During the second half-cycle the plate is at a negative potential with respect to the filament, hence no current will flow into the circuit connected to A, B. The second half-cycle is therefore suppressed, and a series of direct current pulsations is supplied to A, B. These pulsations are shown by the full lines in Fig. 3.

If a steady direct current is desired at A, B, then these pulsations must be smoothed out by means of a combination of capacity and inductance, the inductance being connected in the line A and the capacity across A and B (Fig. 2).

If two kenotrons are used it is usual to connect one end of the transformer to the plate of one valve and the other end to the plate of the other valve. The B lead is then connected to the middle point of the transformer secondary, the A lead being connected as before to the filament. The voltage applied to the plate of each valve will only be half the terminal voltage of the transformer. One valve will now be conductive during one half of the wave, due to the plate potential being positive with respect to the centre point of the transformer, while the second valve will be non-conductive, due to the plate potential being negative with respect to the centre point of the transformer. During the second half-cycle these functions are interchanged, so that the full wave is rectified, and is

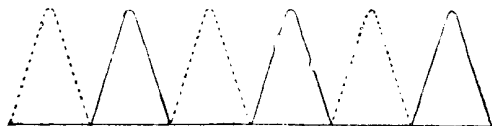

RECTIFICATION BY KENOTRON

Fig. 3. Rectified alternating current is represented. Full lines show half-wave rectification, and dotted lines complete rectification

represented by both the solid and dotted line curves in Fig. 3.

It should be noted that only a small drop in voltage occurs across the valve, and that the filaments and the associated circuit are at nearly the same potential above earth as the transformer terminals. Precautions must therefore be taken to ensure that the rectifier filament circuit is well insulated. It is a general practice to run the filaments off a small step-down transformer from the main alternating current supply.

The kenotrons now in general use for rectifying high-tension alternating current contain a metal wire filament mounted in a comparatively large glass bulb. The anode usually has the form of a flat plate fixed parallel to the filament, or a hollow cylinder symmetrically round the filament. The valve is exhausted to an extremely low pressure, and in order to ensure that as much gas as possible is extracted from the bulb and the internal fittings, the filament is maintained in a state of incandescence and a voltage, gradually increased as exhaustion is nearing completion, is applied between the plate and the filament.—*R. H. White.*

See Fleming Valve; Plotron; Valve.

**KEY.** Form of hand-operated switch, used in Morse transmission, which is inserted in the primary circuit of a transformer, and is designed with the object of enabling the circuit to be opened or closed quickly and conveniently. A simple form of tapping key is shown in Fig. 1. While the construction of this particular key is extremely simple, its general design may be considered typical.

It will be seen that the main essentials are a long, stiff bar pivoted about its centre and normally held down at its back end by a spiral spring. Contacts are arranged at either end of the bar and on the base. The spring normally keeps the back contacts together and the front ones apart, but when the lever is depressed, by pressing the knob, the rear contacts are broken and the front ones come together. An adjustment, consisting of a screw and lock nut, is provided at the rear of the key, so that the distance between the front contacts may be varied to suit the individual operator.

Another adjustment is provided to vary the tension of the spring. These two adjustments are most important for rapidity and ease of operation, if sharp, well-

punctuated Morse is to be obtained. Three terminals are fitted, these being connected to the front contacts and the pivot.

The spring fitted has a hole bored for it through the base, in order that a reasonably long spring may be used. A most essential feature of all keys is that the bearings should be very free in movement, but, at the same time, no shake is permissible, otherwise high-speed working would be rendered inaccurate.

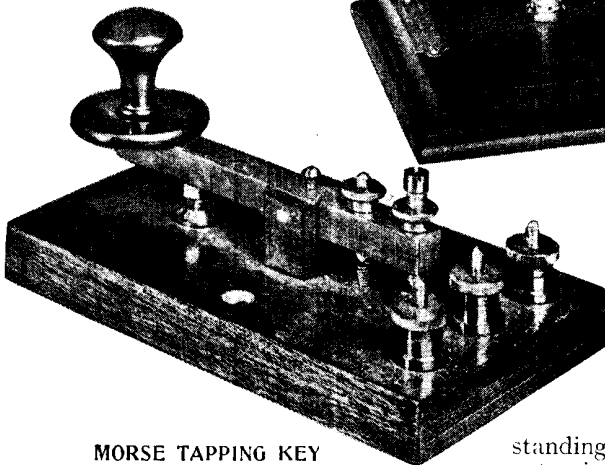

**MORSE TAPPING KEY**

Fig. 1. Morse code signals are transmitted by means of this standard form of tapping key

A key designed to carry heavier currents than that previously described is illustrated in Fig. 2. It will be seen that the contacts are very massive and present a large surface to each other. Provision for removing the contacts for purposes of renewal is fitted. This feature is important, for the passage of relatively heavy

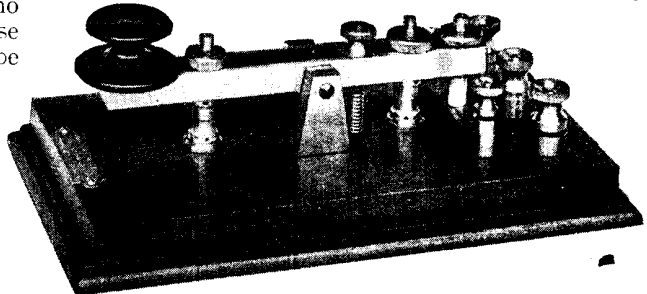

**TRANSMITTING KEY**

Fig. 2. This transmitting key is designed for heavier currents than that in Fig. 1, though the principle and method of operating is the same  
*Courtesy Marconi's Wireless Telegraph Co., Ltd.*

currents causes the formation of arcs and consequent heat at the contact points.

A still more elaborate key is illustrated in Fig. 3, the outstanding feature of which is the long extension lever on the left. This lever may be considered as a safety appliance,

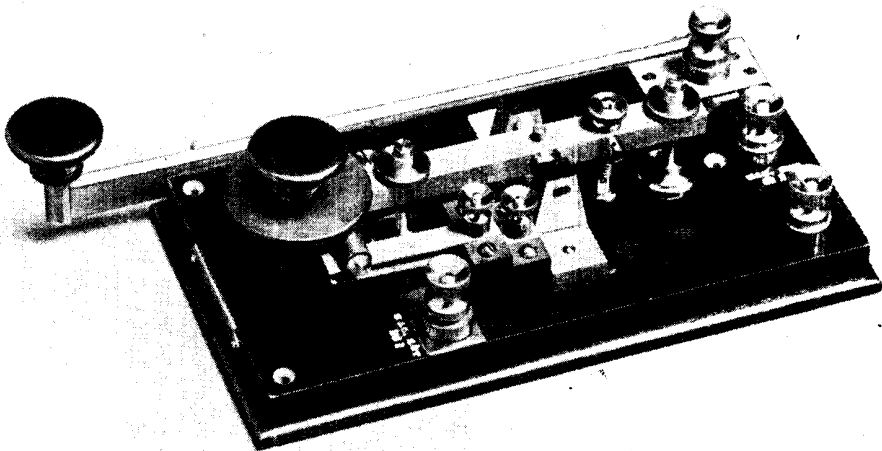

**TRANSMITTING KEY WITH EXTENSION LEVER SAFETY DEVICE**

Fig. 3. In this key the long extension lever shown on the left is a safety device disconnecting the tapping key and preventing any accidental damage being caused to the apparatus through the passing of a high-tension current

*Courtesy Marconi's Wireless Telegraph Co., Ltd.*

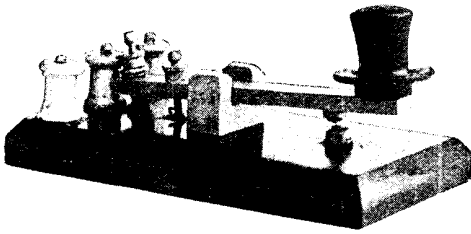

#### TRANSMITTING KEY FOR AMATEURS

Fig. 4. Keys of this kind are suitable for amateur low-power transmission and practice in learning Morse code. This key is easily made

and its application is such that its depression electrically disconnects the other key, so that the depression of the latter by accident cannot cause any damage to the apparatus. This feature is frequently fitted to marine transmitting keys.

The type of key shown in Fig. 4 is easily made by the amateur. It is of the Post Office variety, and consists of a single pair of contacts where the circuit is permanently broken when the operating knob is not depressed. An additional pair of contacts is arranged at the end of the other side of the lever, which makes contact when the knob is released. In this method it will be seen that a single dot is represented at the receiving end by a double click, the first occurring when the back contact is raised, thus breaking the circuit, and the second when the circuit is made by a full depression of the lever.

The base of the key shown in Fig. 4 is made from  $\frac{5}{8}$  in. ebonite or hardwood, measuring  $5\frac{1}{2}$  in. by  $3\frac{1}{4}$  in. To give an improved appearance the top of the base is bevelled. Three terminals of large pattern are arranged in line with each other at one end of the base. The holes for these terminals are countersunk on the underside, so that the clamping nuts do not project under the base.

The pillar on which the lever pivots is made from a piece of brass of  $\frac{1}{2}$  in. thickness and measuring  $1\frac{1}{4}$  in. in width and  $\frac{3}{4}$  in. in height. The centre is cut away to take the lever, which is pivoted between the two posts thus formed. The cut-away portion measures  $\frac{1}{2}$  in. by  $\frac{7}{16}$  in. deep. The pivot consists of a steel pin of  $\frac{1}{8}$  in. diameter, which is driven in a hole in the support pillar, and drilled  $\frac{1}{2}$  in. up centrally from the bottom edge (Fig. 6).

This hole goes through the pillar, and should be carefully drilled, as any inaccuracy will result in throwing the lever out of line with the edges of the base.

The contacts attached to the base consist of two  $\frac{3}{4}$  in. 2 B.A. brass screws, to the ends of which two platinum or silver contacts are soldered. Both are centrally placed on the base, the front one being  $1\frac{3}{4}$  in. from the centre of the brass pillar and the back contact  $1\frac{3}{8}$  in. from the same point. This point is 3 in. from the front edge of the base.

The brass pillar, which may now be assembled, is secured in position with two 2-B.A. screws, screwing to the pillar on the underside. Any small inaccuracy in drilling these holes may be overcome by drilling the screw holes in the base a larger size than actually required, and a small brass plate drilled to take the screw. Before tightening, the pillar can be adjusted to a position sideways or backwards or forwards as necessary.

This brass plate is also useful for connexion of a wire to one of the terminals. The wire may either be placed under the plate, or preferably soldered, as shown in the illustration of the underside of the instrument in Fig. 5. A recess should be cut in the underside of the base in which to sink the screw heads. A  $\frac{1}{4}$  in. hole is required in which to sink the tension spring. This hole is drilled  $\frac{3}{4}$  in. from the centre of the pillar towards the terminal end of the base. The underside of the base has the appearance of Fig. 7 at this point in the construction.

The lever, which now claims attention, is  $4\frac{1}{4}$  in. long, and is made of  $\frac{1}{2}$  in. by  $\frac{1}{4}$  in. brass. The pivot hole, of  $\frac{1}{8}$  in. diameter, is drilled through the lever at a distance of  $2\frac{3}{4}$  in. from the front edge. On the longer side of this hole an ebonite knob is attached by means of a countersunk screw on the underside of the lever. This knob is preferably fitted with a large insulating flange at its lower end.

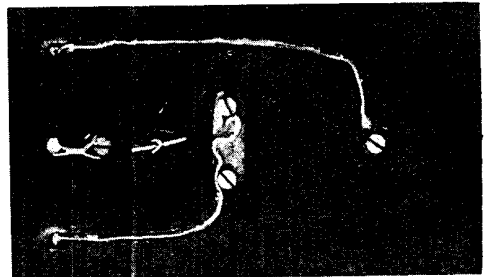

#### UNDERSIDE OF KEY PANEL

Fig. 5. Details of wiring are seen on the underside of the key panel. Note the method adopted for securing the lower end of the spring



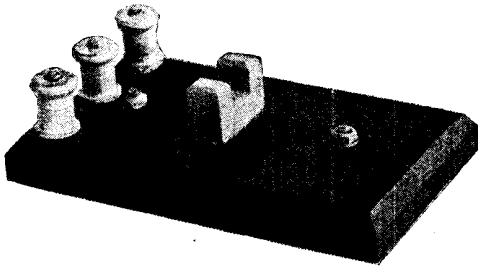

#### KEY BASE AND DETAILS

Fig. 6. Mounted on a base are three terminals and the shoulders of the rocker arm. The lower contacts are also in position

The front contact is soldered to the lever so that it will coincide with the lower contact, and may consist of a circular piece of flat brass, to one side of which a platinum or silver contact is soldered. On the other side of the pivot hole two holes are drilled so that they coincide with the back contact and the spring hole. The hole nearer the end is now tapped 4 B.A. tapping size. The top back contact consists of 1 in. 4 B.A. screwed rod platinum-tipped at one end, and having a knurled knob at the other end.

A knurled locking nut is fitted so that the adjustment of the movement of the

lever may be fixed. The second hole for adjustment of the spring is drilled  $\frac{1}{8}$  in. diameter. A 4 B.A. screwed rod, having a small knurled knob at its top end, is fitted into this hole. The rod has a very small hole drilled at its lower end for attachment of one end of the spring. Adjustment of the spring is effected by a knurled nut screwed to the rod.

The lower end of the spring is secured in position with a pin passed through a loop of the spring at its lower end. The pin is located in position by cutting a trough in the underside of the base into which it will drop. Fig. 7 shows this pin being fitted into position.

The wiring of the instrument is laid in small grooves in order that nothing may project above the base, and is clearly illustrated in Fig. 5.

For wireless signalling only the two outside terminals are required, which are connected in series with the battery and the instrument where the interrupted current is required. See Morse Code.

**KEYING.** The act or process of attaching one part of a device to another by means of an independent part fitting into both the others.

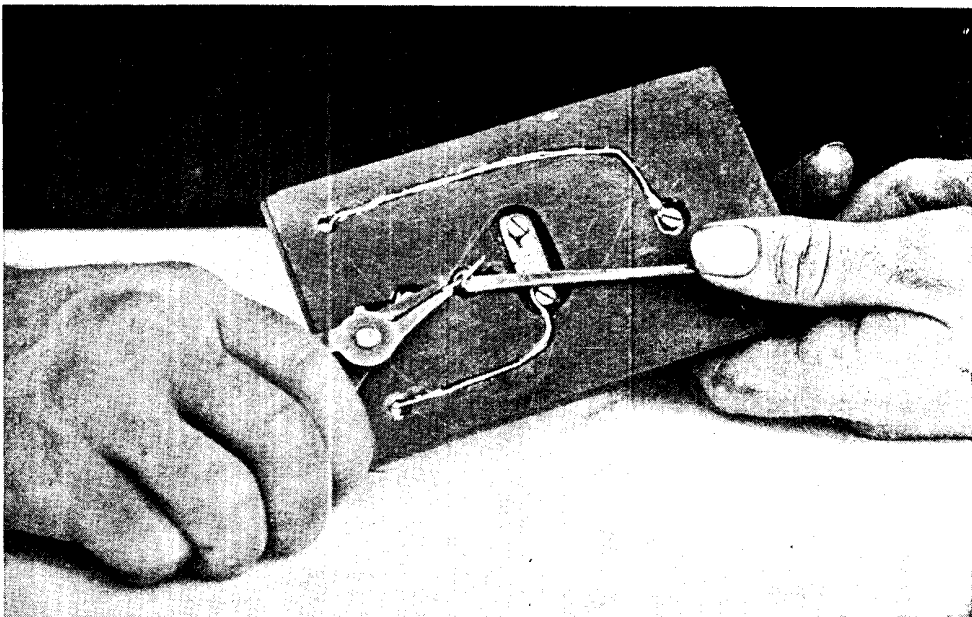

#### METHOD OF SECURING SPRING ON UNDERSIDE OF KEY PANEL

Fig. 7. This photograph shows the method of securing the spring in position by means of a small steel pin held in a pair of pliers. During this operation the spring is held in an extended position with the aid of a screwdriver

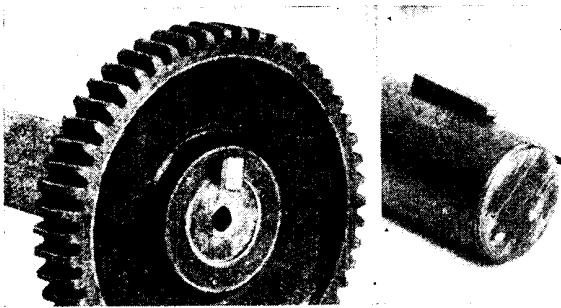

#### KEYING APPLIED TO SHAFTS

Fig. 1 (left). Projecting slightly from the face of the wheel is the key which holds the shaft. Fig. 2 (right). The key on this shaft fits into a recess cut not quite the full depth of the key.

Keys are generally used in metal work, and form the best method of attaching a wheel to a shaft, or an arm or lever to a spindle or other moving member. An example is the attachment of a gear wheel to a shaft, as shown in Fig. 1, where the key is shown projecting slightly from the face of the wheel, and is coloured white for the sake of clearness. Keys of this type are generally known as gib keys, and have a small projecting portion that enables a wedge to be inserted between the key and the face of the wheel for the purpose of withdrawing the key. The keys are made from good grade steel, but ordinary machine or bright mild steel will answer well enough for most amateur wireless purposes. The key is a long, narrow slip of steel, which generally has parallel sides, but may sometimes be tapered on top, giving it a wedge shape. It has to be recessed into the metal of the shaft, as shown in Fig. 2, in such a way that a portion projects from the surface.

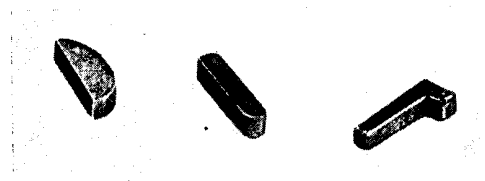

#### KEYS USED IN METAL WORK

Fig. 3. Patterns of key used in metal work are shown. Left to right, they are the woodruff, leather and gib types.

This part fits into a slot or keyway cut in the bore of the wheel, and must be a perfect fit, both on the sides and on the top, as, if the key is a slack fit it will allow a slight movement relative to the shaft, and this will speedily destroy the fit, and the key will ultimately shear or break away.

Three patterns of key are in extensive use in metal-working processes, and these are shown in Fig. 3. One pattern, known as the woodruff, is largely employed, as it is more or less half-round in shape, although made from flat metal. It is easily fitted to a shaft,

as all that has to be done is to mill out a quadrant-shaped slot and fit the key into it. The projecting part is left flat or parallel with the shaft in the usual way, to fit in the keyway provided in the corresponding part of the mechanism.

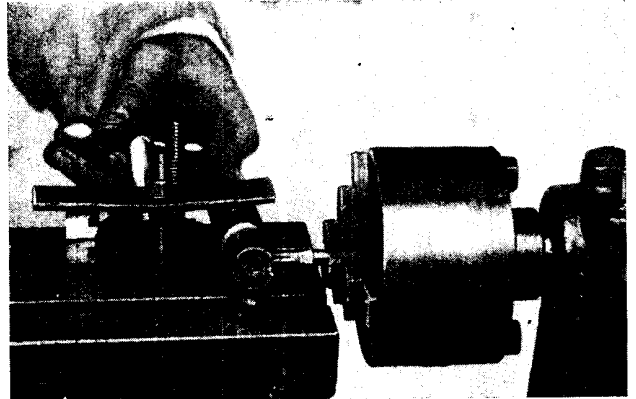

#### CUTTING A KEYWAY IN A LATHE

Fig. 4. Held in position on the milling table is the shaft into which a keyway is being cut with a milling cutter.

The leather key is a long, practically square slip of metal, and has to be fitted to a flat-bottomed slot or keyway cut in the shaft. The gib key is similar, but has an upstanding portion. All of them have to fit a slot cut into the bore of the wheel or other part to be attached to the shaft.

Cutting a keyway by hand is a difficult operation, but most small amateur lathes have available a milling attachment, such as the J.R. shown in use on Fig. 4. On such an attachment the operation is simple, as the shaft only has to be held on the table, a milling cutter of the end mill type mounted in the lathe in a

chuck on the headstock, and the cross slide operated to mill out a slot of desired shape and size.

The exact method varies according to the nature of the work, but an example is illustrated in Fig. 4, where the shaft is clamped to the milling table and the latter adjusted in the usual way to the correct height. The milling cutter is an ordinary straight shank end mill held in the lathe chuck. The cutter should run comparatively slowly, and be well lubricated during the whole of the milling process. Keys are easily filed to shape from ordinary mild steel, but must be kept square and true.

Another application of keying is the use of small pegs fixed to a part of an appliance for the purpose of locating the position of another part which may be added to it. The keys or pegs merely act as locating pins, some other means are provided for the secure fixing of the part.

In plaster and cement work, keying is roughening or scratching the face of a first coat to afford a better grip for a succeeding coat.

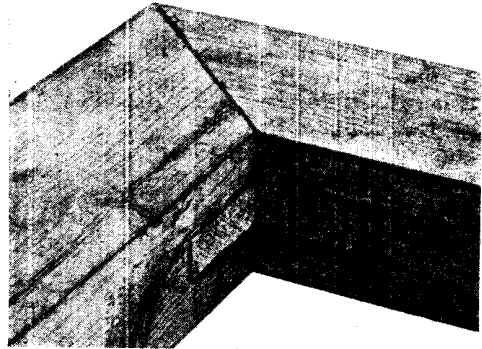

**KEY MITRE JOINT**

Fig. 5. Keying in woodwork is very useful in the case of framing, especially for instrument panels. The illustration shows a keyed mitre joint

Keys are applied in woodwork, as in the keyed mitre joint shown in Fig. 5, and have some applications in wireless, as, for example, the framing for an instrument panel. In these cases the frame is mitred in the usual way, and the joint

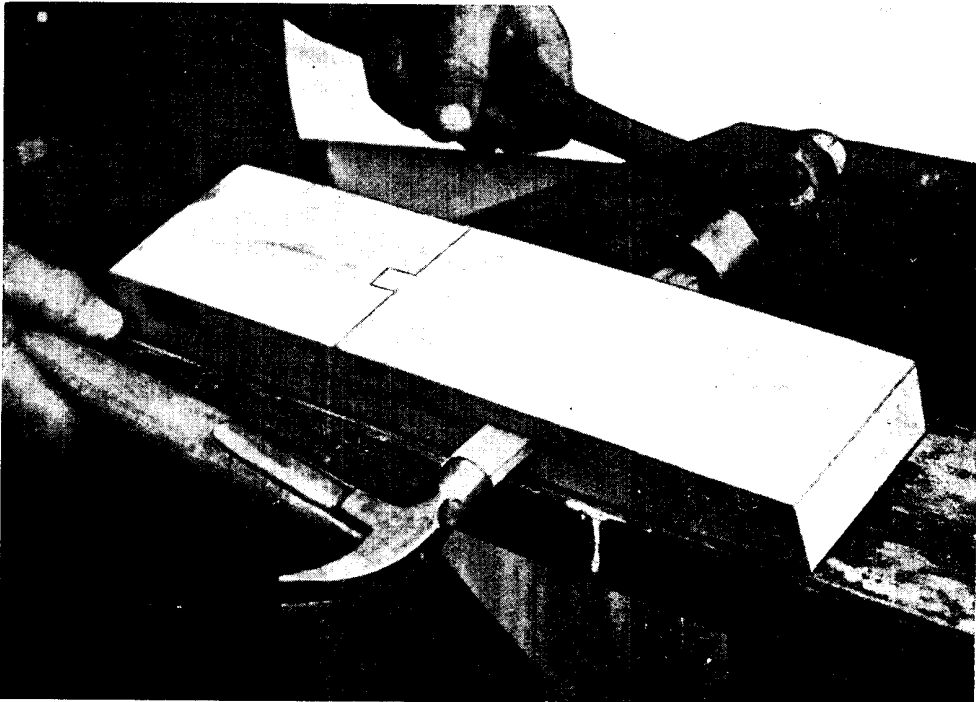

**KEYED JOGGLE HALVING JOINT IN CONSTRUCTIONAL TIMBERING**

Fig. 6. Wooden wedges or keys are here shown being driven home as a means of drawing the jointed parts tightly together. This method is used for heavy timber constructions, such as aerial masts, supporting beams, and other cases where the joint is to take considerable strain and must be kept rigid.

strengthened by the insertion of an angular key in the corner. This usually takes the form of a long, narrow triangular slip of wood, with the grain running across the narrow part. This is inserted into the slot in the inner part of the framework and glued and pinned in place, the projecting portions subsequently being planed off smooth.

Constructional timbering, such as that employed for the heavier types of aerial masts, beams, and the like, is often made with interlocking and keyed joints, such as the keyed joggle halved joint illustrated in Fig. 6, showing the wooden wedges or keys being driven home. The purpose of these keys is to draw the parts tightly together and make the whole a rigid structure.

**KEY SWITCH.** Term applied to any type of switch adapted for operation by a removable portion in the form of a handle or key.

There are numerous patterns on the market adapted to the needs of the electrician, but the construction of a small pattern suitable for the wireless experimenter is not beyond the scope of the amateur, and has the advantage that



INSERTING THE KEY OF A SWITCH

Fig. 1. Key switches are operated by a slotted hollow key. No part of the spindle projects, and it is practically impossible to operate the switch without a proper key

such a switch is a special article and not readily duplicated; consequently as a protection against the unauthorized use of a receiving set it is a real asset.

The general type of switch for such purposes is generally of the single pole

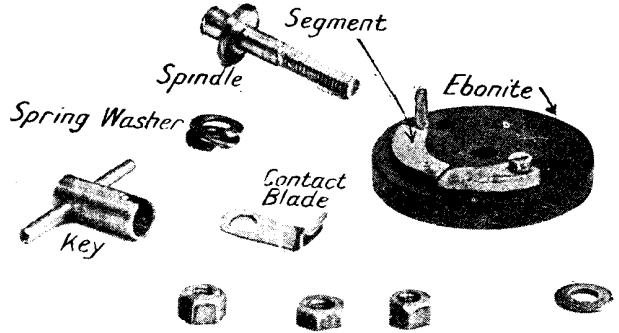

COMPONENTS OF A KEY SWITCH

Fig. 2. Components are shown dissembled to illustrate how the key switch is built up

variety, but a double pole or multi-way switch can be made along similar lines. In fact any switch that is capable of operation by the movement of a central spindle or its equivalent can be actuated by a key, and thus provide the desired security.

For most switches intended for use on a panel the first requisite is that no part of the spindle project beyond the face of the panel, otherwise it could be turned by gripping the spindle with a pair of pliers or the like. In the present example, illustrated in Fig. 1, the spindle is turned by a slotted, hollow key, and no part of the spindle projects.

The components of the switch are shown in Fig. 2, and comprise a circular base made of ebonite  $\frac{1}{4}$  in. thick and  $1\frac{3}{4}$  in. in diameter. Upon this are mounted respectively a segmental piece of ebonite, and next to it a tapered segmental brass plate, both of which are secured to the base with small screws passed through from the underside thereof. The special spindle shown in Fig. 2 is turned up from a piece of  $\frac{5}{16}$  in. diameter brass, a shouldered portion, or collar, being turned from the solid, and this bears against the opposite side of the base to that on which the contacts are fitted.

The screwed part of the spindle is provided with lock nuts, flat washer, and spring washer, the nuts being used to grasp an ordinary type of contact arm, and the spring washer to draw it into

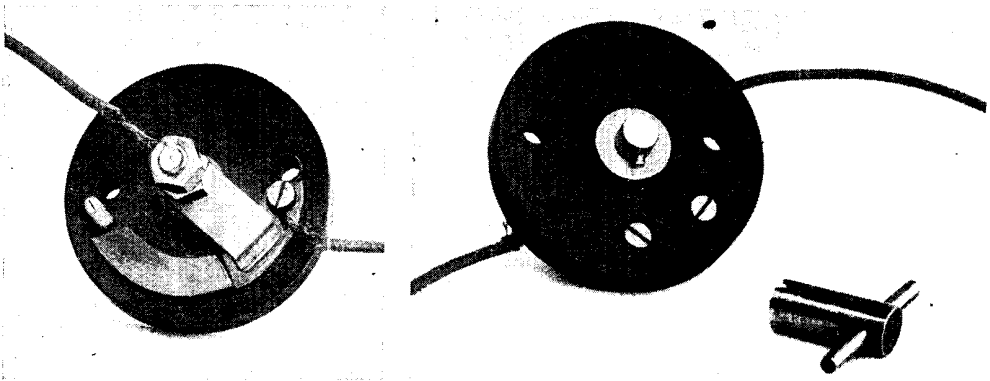

BACK AND FRONT VIEWS OF A KEY SWITCH

Fig. 3 (left). How the conductors of the key switch are connected to the main contact plate is shown, and the assembly of the contact arm and spring washer. Fig. 4 (right). The small brass peg on the spindle is actuated by the switch key

firm engagement with the contact plate. These parts are shown assembled in Fig. 3, which also shows how the conductors are connected to the brass contact plate.

To prevent the contact arm being turned too far, a stop pin is provided at the end of the segmental ebonite plate, its purpose being to prevent the contact arm sticking when it turns off the inclined brass contact piece on to the ebonite, which provides the "off" position.

To actuate the switch the small projecting part of the spindle on the opposite side of the base is provided with a single small brass peg, which projects at right angles to the spindle, as is clearly seen in Fig. 4. The special key actuating the switch

consists of a piece of brass rod  $\frac{5}{16}$  in. in diameter provided with a cross-bar of brass 1 in. in length and soldered to the main part of the same. The opposite end is drilled out and slotted on one side to fit over the end of the spindle.

The result, as shown in Fig. 5, is that by placing the key on the spindle through a sufficiently large hole drilled in the ebonite panel, the switch can be turned on or off. The key, when not in use, can be retained in the pocket or stored in some safe place.

**KICK-BACK PREVENTERS.** Name given to those pieces of apparatus which prevent the surges or kick-backs of high-potential alternating current. A choke coil is placed in the power circuit of a transmitter to prevent the kick-back of high-frequency oscillating currents which rise in voltage and tend to flow back into the transformer and break down the insulation. Oscillations will not take place in a circuit having high resistance; and they can be choked by high inductance. A choke coil is wound on soft iron wire core of high permeability, and it does not allow the high-frequency current to pass.

Condensers in series shunted across the line and earthed between are also used as kick-back preventers. In this case the high-potential current induced in the primary of the transformer charges these condensers, and they discharge by leak. A high-resistance fine iron wire coil is the best surge preventer when it can be used. See Choke Coil.

**KICKING COIL.** This is an alternative name for a choke coil (*q.v.*).

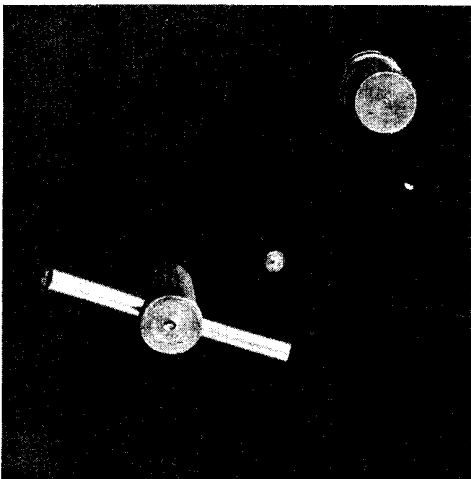

KEY SWITCH PANEL AND KEY

Fig. 5. Behind the panel is the key switch, and the key, when inserted, appears as illustrated

**KILOWATT.** An electrical unit of power used in place of the watt in high power measurement. The wattage of a current is the multiplication of the volts and amperes of the current. The kilowatt represents 1,000 watts, and is often represented by the letters KW. A  $1\frac{1}{2}$  KW. spark transmitter is one where the power of the apparatus is 1,500 watts, for example. *See*, Ampere; Integrating Wattmeter; Volt; Units; Watt; Wattmeter.

**KIMURA, SHUNKICHI.** Japanese wireless authority. Kimura was born in 1866, and educated at the Scientific College of the Tokyo Imperial University, his special study being physics, which he continued to study at Harvard and Yale Universities, United States.

In 1901 Kimura entered the Japanese Navy and first began to study wireless telegraphy, particularly for naval use. In 1906 he was appointed the Japanese delegate to the International Wireless Telegraph Conference, Berlin, and after his retirement from the navy, 1912, he became the director of the Nippon Radio Telegraph and Telephone Company. Kimura has written largely on wireless subjects for various scientific journals.

**KIRCHOFF'S LAWS.** These are two laws concerning the distribution of currents in a network of conductors. They are: (1) the algebraic sum of the currents which meet at any point is zero; (2) in any closed circuit the algebraic sum of the products of the currents and resistances of each part of the circuit is equal to the E.M.F. in the circuit. Thus, if  $C$  is the current entering at one point of a network of conductors and  $C_1, C_2, C_3, \dots$  the currents leaving along various conductors which meet at this point

$$C = C_1 + C_2 + C_3 + \dots$$

and if the resistances of the conductors are  $R_1, R_2, R_3, \dots$  respectively, and  $E$  the total E.M.F. of the circuit

$$E = C_1 R_1 + C_2 R_2 + \dots$$

*See* Electro-motive Force.

**KLEIN, RENE HENRI.** Anglo-French wireless expert. Born at Soultz sous Forêt, France, in 1880, he first became interested in wireless telegraphy in 1908. He was the founder and first honorary secretary of the Wireless Society of London, 1913-20, and became a vice-president of the society. He was one of the inventors, with H. L. McMichael, of the synthetic galena crystal Radiocite, and has written many articles on wireless subjects.

**KNIFE SWITCH.** A type of circuit breaker in which the movable arm or arms wedge, when the circuit is made, between a pair or pairs of parallel spring clips. The knife switch may control any number of circuits, depending on the number of arms. The usual form, however, consists of a single- or double-pole switch. In the latter case both moving arms are rigidly coupled together by an insulated bar, in the centre of which a handle is attached for throwing the arms in or out of the spring clips. A double-pole switch is commonly used to control both positive and negative sides of a circuit, such as the leads from a dynamo or accumulator.

Another type of switch which often takes the form of the knife switch is the single- or double-pole change-over switch.

In this switch spring clips are arranged on either side of the moving arm support, allowing the use of either of two entirely separate circuits. A single-pole switch of this description is commonly used as an aerial to earth switch, as in Fig. 1, where the lead from the aerial is taken to the moving arm support. One of the spring clips is connected by a lead to the receiving set and the other to the earth wire.

The double-pole change-over knife switch is useful where it is desired to use a variable condenser in a series or parallel arrangement; a somewhat similar application of this switch in an aerial tuning circuit is for tuning the receiving set on either an open or closed circuit.

For low-power work a single-pole switch will be found sufficient. Such a device is shown in Fig. 2, and may easily be constructed from workshop odds and ends.

The base is constructed from a piece of  $\frac{1}{4}$  in. ebonite measuring  $3\frac{1}{4}$  in. by 1 in. After cutting to the correct size, the edges should be finished off smooth with a fine file. A  $\frac{1}{8}$  in. hole is drilled in the centre at a distance of  $\frac{3}{8}$  in. from one end. Into this hole the moving arm support is subsequently attached. Two holes of 4 B.A. tapping size are required for securing the spring clips in position, and are drilled  $\frac{5}{8}$  in. apart at a distance of 2 in. from the previous hole and at equal distances from the sides of the base. Two other holes used for holding the switch by screws to a wall or table may be symmetrically placed about the centre of the base. Fig. 3 shows the base with the holes drilled.

The moving arm and its support may now be made, and these features are shown

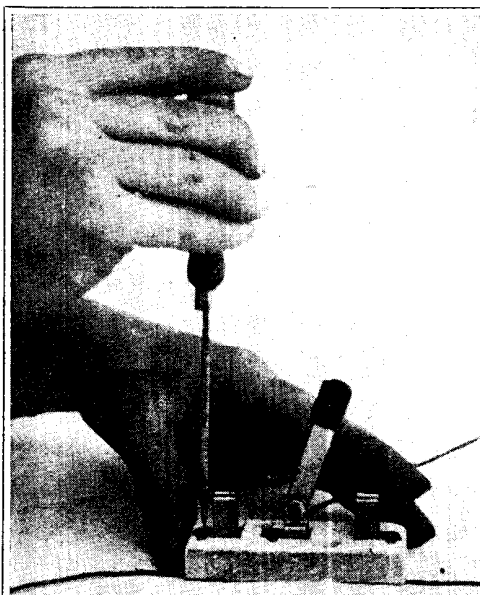

Fig. 1. Knife switches of this kind may be used for aerial-earth connexion. A wire is being connected

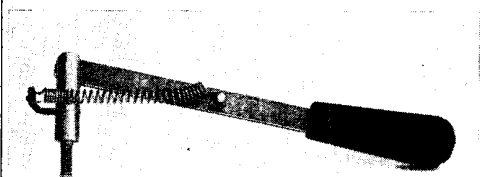

Fig. 4. Details of the knife-switch blade for the switch in Fig. 2 may be seen in this photograph. Note how the spring is held

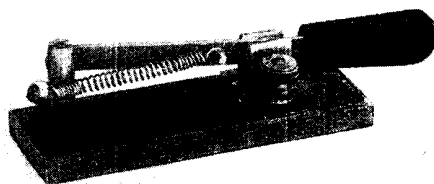

Fig. 2. When complete a single-contact knife switch appears as illustrated. The spring gives quick action

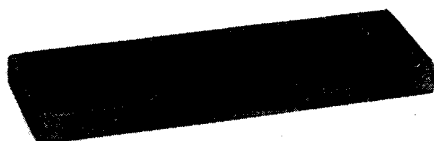

Fig. 3. Ebonite may be used as the base of the knife switch, and holes are drilled as here shown

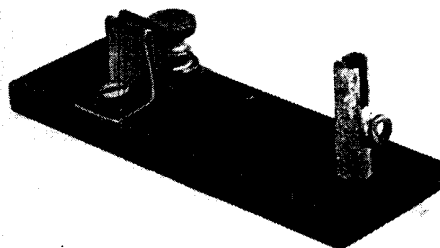

Fig. 5. Spring clips are shown in position on the base. These must be in line with the slot in the blade support

#### KNIFE SWITCHES AND THEIR CONSTRUCTION

in Fig. 4. For the contact arm a piece of  $\frac{1}{4}$  in. brass rod,  $1\frac{1}{4}$  in. in length, is turned down and screwed 4 B.A. for  $\frac{1}{4}$  in. of its length. At the other end a slot is cut to a depth of  $\frac{3}{8}$  in. of sufficient width to permit the insertion and free movement of the moving arm. A small wire hook is soldered in a hole drilled to receive the end of it in the middle of the support. The position of the hook is clearly seen in Fig. 5, and its use is to hold one end of a spring which is designed to keep a tension on the moving arm when it is pressed in its contact clips.

A  $\frac{1}{16}$  in. hole is drilled through the support at right angles to the slot and in the centre of it. The moving arm is made from a 3 in. length of  $\frac{1}{4}$  in. by  $\frac{1}{16}$  in. brass rod. One end of this is filed down to a point, to which an ebonite handle is attached. At the other end a  $\frac{3}{16}$  in. hole

is drilled  $\frac{1}{8}$  in. from the end. A hole of similar size is now drilled at a distance of  $1\frac{1}{2}$  in. from the first hole and a short piece of brass wire is riveted or soldered to the arm through the hole.

This little peg holds the other end of the spring. The moving arm is ready for assembly to its support, and this is done by cutting off a  $\frac{2}{8}$  in. length of  $\frac{1}{16}$  in. brass wire, which goes through the hole at the top of the support and the hole at the end of the moving arm. This piece of wire is lightly riveted over, taking care not to bend the top of the support inwards when tapping. The two spring clips are made of  $\frac{3}{8}$  in. sheet brass, and should be thin enough to bend with the fingers. These are each  $1\frac{1}{4}$  in. long, and are bent as shown in Figs. 5 and 6. Two  $\frac{1}{8}$  in. holes are drilled in the centre of the base pieces for attachment to

the base. They may either be screwed by tapping out the holes in the base to receive the screws, or they may be bolted down.

If the latter alternative is used, the underside of the hole should be countersunk to permit the nut to go below the level of the underside of the base. One of the spring clips is held in position by a terminal, from which connexion is taken.

The underside of the moving arm support is also countersunk to permit the tightening nut to go in under the level of the base.

The other connexion from the switch is taken from a wire fastened underneath this nut. Fig. 5 shows one stage of the assembly, where the spring clips are bolted in position relative to that of the moving arm support.

Further details of the various components may be gathered from Fig. 6, which shows a group of all the parts of which the knife switch is composed.

A very simple form of commercial single-blade knife switch is illustrated in Fig. 7. The switch is mounted upon a rectangular piece of ebonite. The latter is drilled to take the pillars supporting the switch, and has four countersunk holes for fixing purposes. A counterbore has been applied to the underside of the base in order that the nuts which grip the pillars may be flush with the base.

The pillar upon which the switch blade is pivoted is slotted at its upper extremity, there being a circular hole of larger diameter than the width of the slot, which enables a certain amount of "spring" to be given. The end of the blade is pivoted upon a pin, and rotates within the slot,

a stiff movement being obtained by reason of the friction between the sides of the slot and blade.

A second slotted pillar is fitted, identical in shape with the first one, but having no rivet. It is into this slot in this pillar that the knife blade fits in order to connect

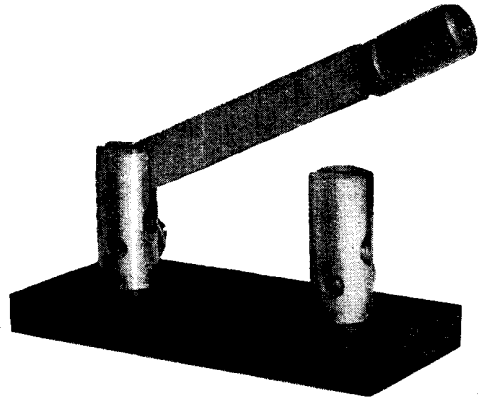

**SINGLE-POLE KNIFE SWITCH**

Fig. 7. Mounted on an ebonite base is a single-pole, single-throw knife switch. This type is small and very useful as an aerial to earth change-over switch

the two pillars together metallically. Connexions to each pillar are made by inserting the wire behind the head of a cheese-headed screw and clamping tightly. The head of the screw on the first pillar may be seen in the illustration.

Switches of this type are capable of carrying quite heavy current, and for this reason are useful in reaction receiving sets for connecting aerial to earth when the set is not in use, as a protection against lightning.

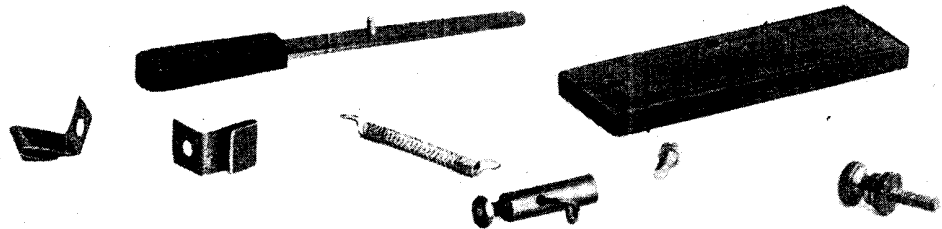

**DISSEMBLED SINGLE-POLE SINGLE-THROW KNIFE SWITCH**

Fig. 6. Components of the knife switch in Fig. 2 are shown laid out. It will be seen that the construction is extremely simple, and the amateur experimenter can easily make his own switch.

All the material required is common to the wireless work-bench



Fig. 8 is an illustration of a form of double-pole knife switch. Here a porcelain base is used, and the pivots, supports and contacts are made of spring brass stampings. The method of bending these in order to give increased grip is worthy of note, as is also the continuation of the base of the stampings in order to form supports for the connexion screws.

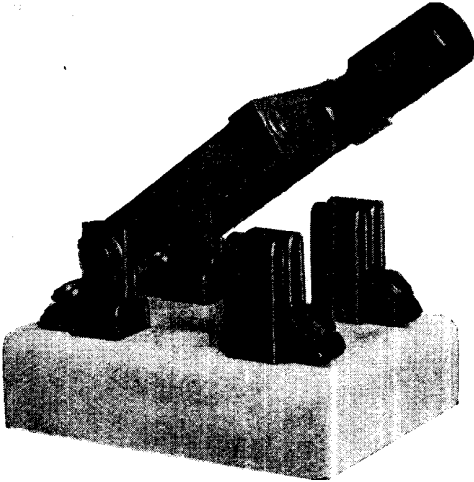

**DOUBLE-POLE KNIFE SWITCH**

Fig. 8. Porcelain forms the insulating base of this double-pole single-throw knife switch

Strip brass is used for the switch blades, and these are joined mechanically to their upper extremities by a piece of ebonite. A

convenient handle of such a length that it projects well away from the point of contact is situated upon the ebonite.

Knife switches of this type should be mounted vertically in such a position that their opening or closing—whichever is the “rest” position—should be assisted by gravity. This will ensure freedom from accidents arising should the pivots become loose in action and thus cause circuit to be broken or made by the blades moving involuntarily.—*R. B. Hurton and W. W. Whiffin.*

See Anti-capacity Switch; Barrel Switch; Cut-out; Lightning Arrester; Switch.

**KNOB.** Term used in wireless for a small, circular-shaped handle, usually made of ebonite or moulded composition. There are many patterns of knobs, such as those shown in Fig. 1, varying in size and shape from a simple cylindrical form to elaborate constructions incorporating an integral extension handle. Much of the external appearance of a panel depends upon the proportioning of the knobs, and therefore, in selecting them, this point should be borne in mind, and at the same time it should be seen that the knob is of adequate size to ensure a good grip, for which reason the rim or handling portion should be neatly serrated, as in Fig. 2, or otherwise shaped to ensure certainty of grip.

The most important feature of a knob is that it should be firmly attached to its

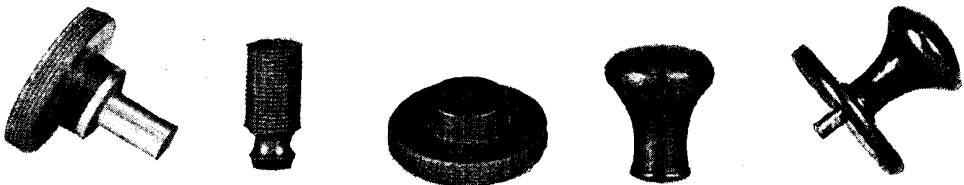

Fig. 1. Five different kinds of knobs are illustrated. They are each designed for particular work, such as turning condenser vanes or filament resistances, or for other controls

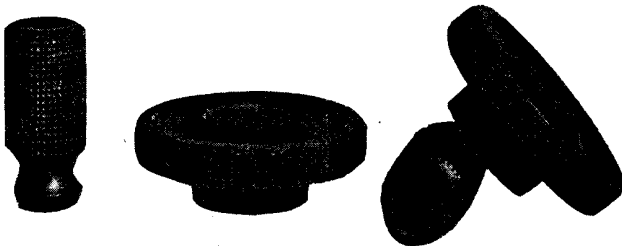

Fig. 2. Serration and knurling enable a grip to be obtained on this kind of knob

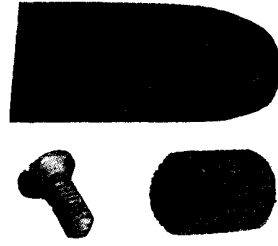

Fig. 3. A moving arm operating knob is shown dissembled

*Courtesy Economic Electric Co., Ltd.*

**TYPES OF KNOBS MADE OF INSULATING MATERIAL USED IN WIRELESS SETS**

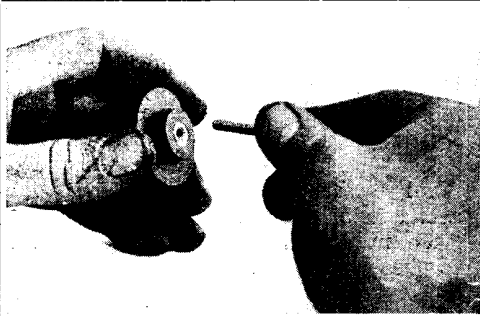

Fig. 4. Embedded in the commonest form of ebonite knob is a brass centre-piece, into which the spindle is screwed

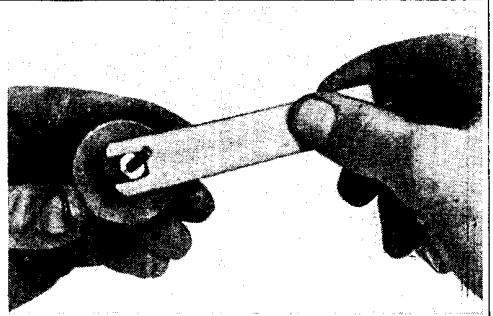

Fig. 5. With a specially made thin screw spanner the tightening nut is screwed up to hold the spindle in the knob

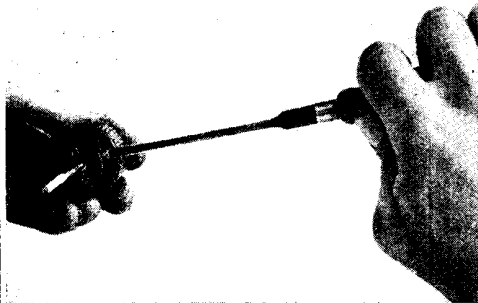

Fig. 6. In this case a grub screw is used to hold the spindle in the knob. The screw is fitted at right angles to the line of the spindle

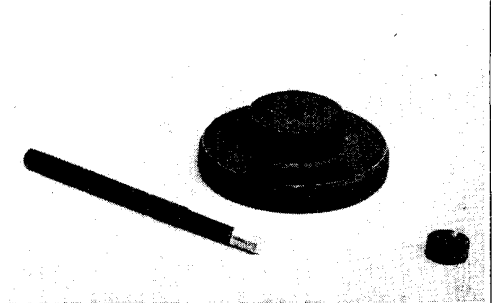

Fig. 7. For this knob a squared shaft is used, and the knob is fixed through a square hole and secured by a nut

#### ATTACHMENT OF A TURNING KNOB TO ITS SPINDLE

spindle or other part of the mechanism which it is intended to rotate or move. In the case of a knob attached to a lever or moving arm, this may usually be accomplished by means of a screw or screws passed through from the underside of the lever into a hole drilled and tapped in the knob, somewhat after the manner illustrated in Fig. 3.

Most of the knobs used in wireless work have to be attached to the end of a spindle, and are fixed by screwing the knob on to the end of a screw thread cut on the spindle, and securing the knob by means of a lock nut. This is placed on the spindle before the knob, and when the latter is in position the lock nut is tightened up, thereby holding the knob by virtue of the frictional grip between the nut, the face of the knob, and the screw thread, as in Fig. 5.

In the better quality knobs a piece of brass is embedded in the centre during the process of manufacture, and this is drilled and tapped to receive the spindle. This method is generally satisfactory

if the article to be turned has very little friction, or offers little resistance to rotation, otherwise the knob is rather likely to come unfastened at the critical moment. This can to some extent be obviated by tightening the lock nut very securely by means of a small spanner, in the manner illustrated in Fig. 5.

The wireless experimenter will find it well worth while to make a small thin-bladed double-ended spanner, preferably with different-sized grips, for tightening such nuts. Such spanners are infinitely better to use than the ordinary pliers, and enable nuts to be tightened up in awkward positions easily. They are easily made out of a strip of thick-gauge brass or thin steel strip.

Another secure method of fastening a spindle and knob is the method illustrated in Fig. 6, where a small grub screw is fitted at right angles to the line of the spindle, and this is tightened up so that its point presses into a little recess or depression formed on the

spindle, thereby fixing it firmly in the hole in the knob and preventing it moving. With such constructions it is important that the knob be bushed with brass, if the grub screw be tapped through this bush, and that the spindle fits tightly into the bushing.

A better plan, especially in cases where the knob is to be fitted to the end of a thin spindle, is to form a square hole in the knob and fit it to a squared portion on the end of the spindle, as is shown in Fig. 7. The other or outer side of the knob is counterbored to receive a circular nut which screws on to a threaded portion on the end of the spindle. The squared portion may be slightly tapered, and should be a very close fit in the square of the knob. The circular knob is then dropped into the recess and tightened up by means of a forked screwdriver, inserting this in the slot in the outer part of the nut. Secured in this way, the knob is most unlikely to work loose or give trouble, and will seldom, if ever, work slack.

For use on a variable condenser with separate vernier control, or in any other form of combination of knobs both turning about the same axis, it becomes necessary to fit the first or larger knob

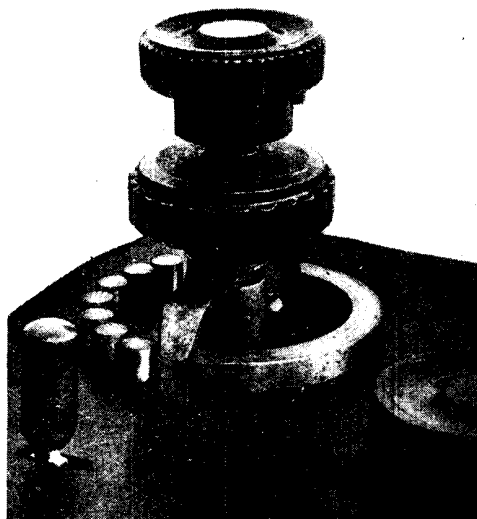

**DOUBLE TURNING KNOB**

Fig. 8. Two separate knobs with independent but concentric shafts are mounted one above the other, forming one double knob. This is useful for a tuned anode circuit, one control operating the condenser and the other the inductance

D 27

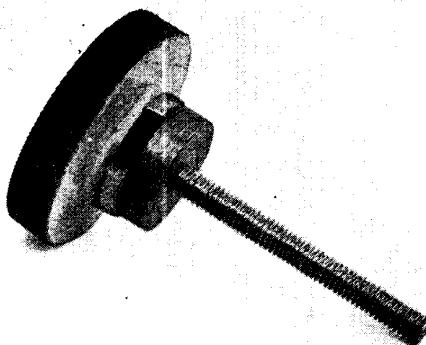

**KNOB WITH SLOTTED DISK**

Fig. 9. Under the ebonite top of this knob is a brass disk slotted to accommodate a contact arm, as for a stud switch

to a hollow shaft. This may be accomplished by any of the before-mentioned plans, except that it is undesirable to use a grub screw, as this would tend to distort the tube.

Possibly the best plan is a long, closely fitting taper, fitted into a tapered hole in the tube and held firm by means of a lock nut. The second or outer knob is fitted by any of the recognized methods to the inner central spindle. This method of arranging two knobs, one in front of the other, tends to reduce the diversity of fittings on the panel and localizes the controls. The arrangement in Fig. 8 provides for the control of a tuned anode circuit, the larger knob rotating the contact arm for the tappings of a tapped inductance, the smaller knob controlling the tuning condenser.

A pointer is often required on a knob, and this may most easily and quickly be fitted by making the base of the pointer equal in diameter to that of the knob, and securing it thereon by two counter-sunk brass screws tapped into holes in the ebonite base. Another plan is to fix a small brass pin into the knob at right angles to the spindle, and finish this with a pointed or rounded end.

When a knob is intended primarily to connect the contact arm, a good plan is to file or mill the slot diametrically across the face of the piece of ebonite. If this is of substantial proportions, it will be satisfactory if a slot is cut in the ebonite, otherwise it should be bushed with brass tube or a separate brass disk should be provided, as shown in Fig. 9.

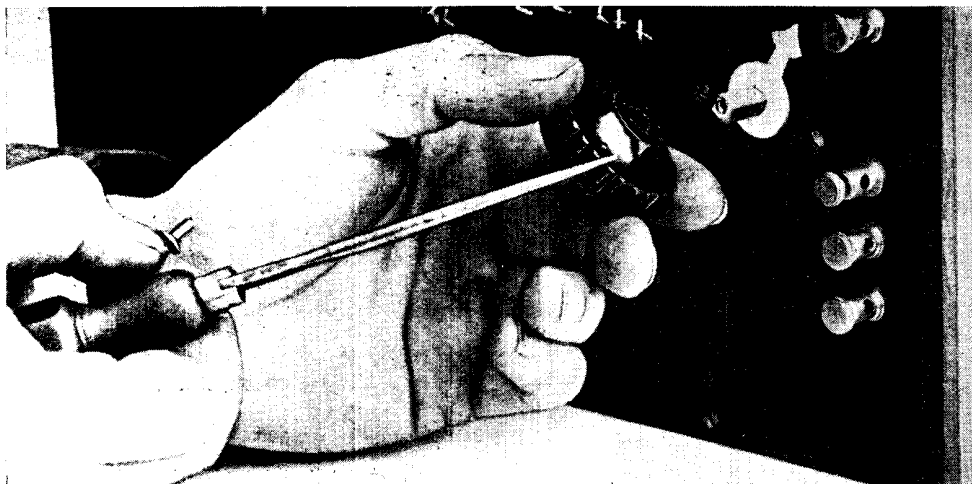

**TURNING KNOB FITTED TO SQUARE SPINDLE**

Fig. 10. Square spindles and holes for turning knobs ensure secure fixing. Such a knob is being fitted. It is held in position by means of a screw and washer fitted into a recess in the outer face of the knob and afterwards covered by an ebonite disk

Another method is to make a separate pointer with a square hole in the centre, slip this over the square of the spindle, as in Fig. 10, and place the knob thereon, the latter having a square hole of corresponding size. This will be firmly held in position by means of a small screw and washer which fit into a recess or counterbore in the outer face of the knob and are subsequently covered with a small disk of ebonite.

Ready-made knobs are easily and cheaply obtainable, but it is often desirable to make a special pattern. An example is shown in Fig. 11 of a knob with a detachable spindle. This allows the knob to be removed when desired, and the setting of the part controlled, such as a variable condenser, is thereby unlikely

to be accidentally altered. The spindle has a small cross pin attached to it to act as a key, and the shank or spindle of the knob is hollow and slotted at the end to fit over it.

The first step in making a knob is to mount a piece of ebonite rod in the lathe

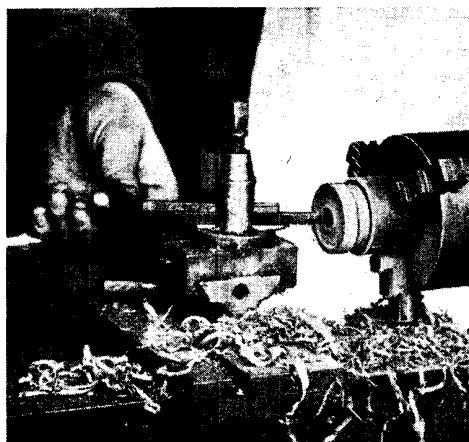

**TURNING THE FACE OF A KNOB**

Fig. 12. Ebonite rod is used as material which is turned in a lathe to make a knob. The unturned part can be seen held in the jaws of the chuck

and turn up the face and rim, as shown in Fig. 12. The next step is to turn the back face and the boss at the same setting by altering the position of the slide rest, as shown in Fig. 13, and using a suitable right-handed side tool. The

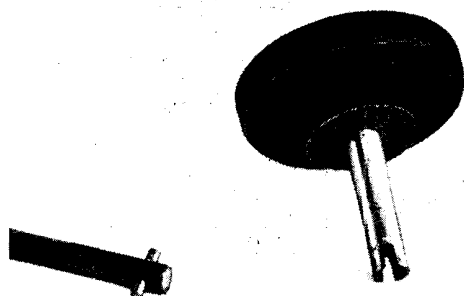

**DETACHABLE KNOB AND SPINDLE**

Fig. 11. On the spindle is a cross pin which fits into the slot of the shank of the knob

central hole is then drilled while the knob is in place in the lathe, and at the same setting, finishing the turning operations by parting off or severing the knob in the usual way from the remainder of the rod. The last step is to grasp the knob in the vice and serrate the edge with a file, as shown in Fig. 14, unless a milling attachment or a knurling tool is available, when this part of the work can be done prior to parting off the knob in the lathe. The spindle is then fitted to the knob by driving it tightly into the central hole and fixing it with a cross pin, passed through the boss from side to side.

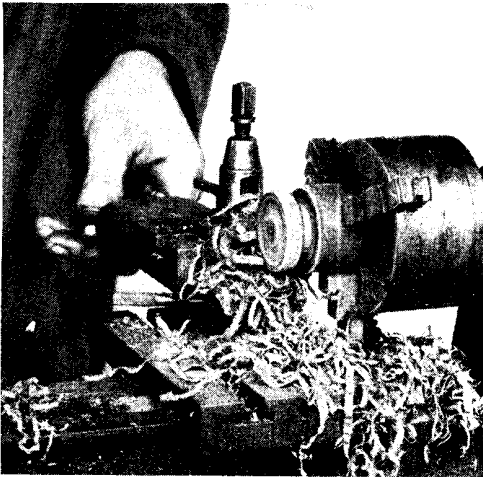

**TURNING THE BACK OF A KNOB**

Fig. 13. After the face is turned the material is not removed, but the back and boss is turned at the same setting. The central hole is drilled after the knob has been turned.

A fine adjustment knob with dial attached is illustrated in Fig. 15. The instrument is cam-operated, all the mechanism being concealed within the ebonite. This device is designed for giving rough and fine adjustments as desired. Rotation of the knob in either direction results in the whole going around solid and taking the spindle on which it is placed with it.

The vernier adjustment comes into play by reversing the knob in either direction. This movement allows a vernier movement through about  $10^\circ$ , and a pointer attached to the underside of the knob, but over the dial, indicates the relative positions of the two components. As soon as the full  $10^\circ$  vernier movement has been given, the



**SERRATING THE RIM OF A KNOB**

Fig. 14. Either a file may be used and the knob held in a vice, or a milling attachment or knurling tool may be used in a lathe for serrating the rim of a knob.

whole instrument locks together automatically and performs as an ordinary fixed knob and dial, provided movement in the same direction is continued.

A feature of this instrument is the method of fitting to any size spindle up to  $\frac{1}{4}$  in. in diameter, by means of a chuck. This ensures concentricity and true

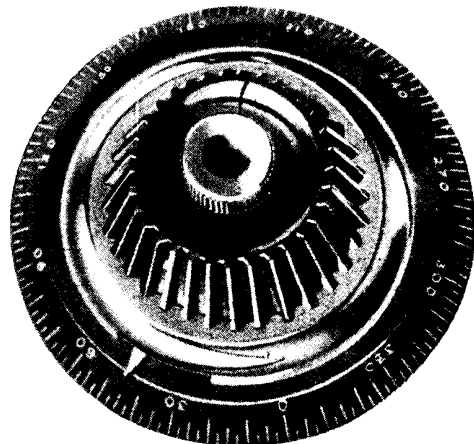

**FINE ADJUSTMENT KNOB**

Fig. 15. Fine adjustment knobs allow a vernier adjustment to be made after coarse movement has been made.

*Courtesy Radio Communication Co., Ltd.*

running upon the spindle, while it simplifies fitting considerably.—*E. W. Hobbs.*

See Ebonite; Handle.

**KOLSTER, FREDERICK A.** American wireless authority. Born at Geneva, Switzerland, January 13th, 1883, he was educated at Cambridge, Massachusetts, and Harvard University. From 1902-8 he was assistant to J. S. Stone, the wireless expert, and from 1909-12 to Dr. M. de Forest. He was appointed chief of the Radio Section of the Bureau of Standards, a post he held until 1921, when he became research engineer to the Federal Telegraph Company.

Kolster has written a large number of articles on wireless subjects, including those on the "Effects of Distributed Capacity in Coils"; "Reinforced Harmonics in Radio Transmission," etc. He is the inventor of the Kolster decrementer, of a radio compass, of directional radio systems, etc., and is a member of the American Institute of Radio Engineers.

**KOOMANS, NICHOLAS.** Dutch wireless authority. Born at Delft, 1879, he was educated there as a mechanical and electrical engineer. In 1908 he received his doctorate for his dissertation "Regarding the Influence of Self-Induction in Telephone Conducting Wires." He was one of the founders of and editor of the "Monthly Review of Telephony and Telegraphy," and was also one of the founders of the Dutch Society for Radio-Telegraphy. Koomans is a member of the International Electro-technical Commission and professor in physics and theoretical electrical engineering at the school of the Dutch Post and Telegraph Administration.

**KORDA FREQUENCY ADDER.** The various types of frequency-raising apparatus can be divided broadly into two classes, namely frequency multipliers and frequency adders. Each group can again be divided into a number of different types of apparatus, and the distinction between the two classes is an important one, since it has a direct bearing on the utility of the apparatus by determining the number of stages that are necessary and the range of application for various frequencies.

To the first group belongs that class of apparatus which

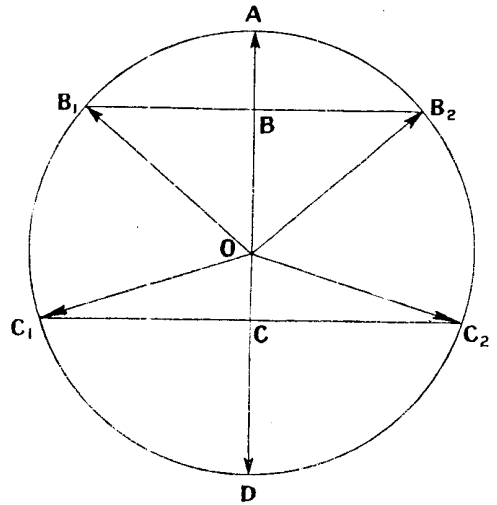

**HARMONIC VECTOR RESOLUTION**

Fig. 1. In the above diagram is plotted a resolution of a simple harmonic vector into two similar but oppositely rotating vectors

utilizes the peculiar magnetic properties of iron referred to in the section dealing with frequency doublers by means of static transformers; while the latter group includes for the most part apparatus which is mechanical in operation, involving rotary or alternator type mechanism.

A means of frequency raising in which the initial frequency is increased three times in the same machine was accomplished by Korda. To follow the principles involved it is first necessary to consider the case of an ordinary single-phase alternating current generator, having its field windings excited by direct current. By rotating the rotor winding an alternating electro-motive force is

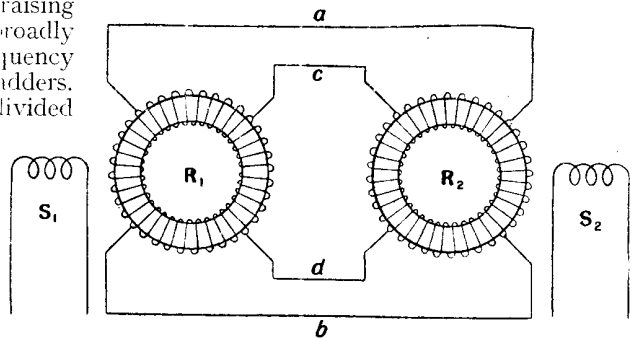

**CONNEXIONS OF KORDA FREQUENCY ADDER**

Fig. 2.  $R_1$  and  $R_2$  are exactly similar rotors mounted together on one shaft.  $S_1$  and  $S_2$  are the stator windings. Connexions are made at  $a, b, c, d$

induced in it according to well-known laws. Imagine this to be a two-pole alternator with a fixed field magnet system, and that the armature windings are arranged upon a revolving rotor. If the rotor is driven at an angular velocity equal to  $p = 2n$ , the armature windings will have induced in them an E.M.F. of frequency  $= n$ . It might in fact be said that this frequency  $n$  has been added to the initial zero frequency of the direct current used to excite the field magnets.

Now let it be supposed that instead of using direct current to excite the field magnets, another alternating current of frequency  $n$  is employed; the magnetic field of the alternator magnets will then be reversing their poles at the rate of  $n$  times per second.

Any harmonic vector quantity can be resolved into two equal vectors of constant magnitudes rotating with equal speeds and in opposite directions. Thus in Fig. 1 the resolution of a simple harmonic vector having a maximum value OA is effected as follows: Let OA, OB, OC, and OD represent successive positions of OA. Then OB may be resolved into  $OB_1$  and  $OB_2$ , OC into  $OC_1$  and  $OC_2$ , etc.; hence OA may be resolved into two equal vectors revolving in opposite directions at identical speeds.

#### Doubling E.M.F. in the Rotor

The periodically varying flux set up in the alternator field magnets by exciting them with alternating current may therefore be resolved in an exactly similar manner, arriving by this means at two revolving fields of constant strength, rotating in opposite directions, with an angular velocity of  $2\pi/T$ , where  $T$  is the periodic time of the alternating field,  $= 1/n$ .

Apart from this, the rotor windings are themselves revolving with an angular velocity  $= 2\pi n$ . Therefore with respect to the stator field components, one of these will be stationary while the other will have a relative angular velocity of  $2\pi n + 2\pi/T = 4\pi n$ , which is double the angular velocity of the rotor. The E.M.F. now produced by the rotor will be doubled as to frequency, since it will have a period of  $4\pi n/2\pi = 2n$ , and will therefore be double the frequency of the initial current used to excite the machine. This apparatus is a true frequency adder, since the angular velocity of the rotor is added to the

angular velocity of the rotating field. In like manner it is also possible to employ the current of frequency  $= 2n$ , obtained above, to excite the field windings of another similar alternator, leading to E.M.F.'s in the second stage of  $2n + n$  and  $2n - n$ , that is,  $3n$  and  $n$ , and so augment this component at the expense of the other. Further stages of frequency adding can be obtained, if desired, in an exactly similar manner.

Korda's frequency adder employs two of the frequency-adding stages just described, combined in one machine. In Fig. 2 an illustration is given of two exactly similar rotors,  $R_1$  and  $R_2$ , mounted together on the same shaft, and each furnished with a field or stator winding,  $S_1$  and  $S_2$ . Both must be finely laminated on account of the high frequency, which would otherwise introduce excessive eddy current losses. The first field system is supplied with alternating current at frequency  $= n$  from any ordinary supply source at the usual commercial frequencies.

#### How Current of Triple Frequency Is Induced

Upon the rotor  $R_1$  being driven round at the correct speed and in the proper direction, it becomes the seat of an E.M.F. having a frequency of  $2n$ , as already shown. Double-frequency two-phase current could, therefore, be taken from circuits  $a, b, c, d$ , if these were joined to four slip rings.

By connecting these leads to four points on the second rotor,  $R_2$ , a rotating magnetic field will be established in the latter revolving with a speed of  $2n$  in one direction or the other relative to the rotor itself, according to the relative order in which the connexions  $a, b, c, d$ , are made. Since, however, rotor  $R_2$  is already revolving at a speed corresponding to the initial frequency  $n$ , it is evident that by arranging the revolving magnetic field to rotate in the same direction it will have an actual relative speed of rotation equal to  $n + 2n = 3n$ .

Current of triple frequency is, therefore, induced in the windings  $S_2$ , and these may be utilized direct, or else raised still further in frequency by another similar stage. They may even be brought back once again to the first stator winding  $S_1$ , thus further tripling the frequency of excitation.

The advantages of the Korda frequency adder are that it requires no slip rings or

other moving contacts, either for collection of the raised frequency current, or for the distribution of the field-exciting current.—*A. H. Avery, A.M.I.E.E.*

See Frequency Doubler.

**KORN, ARTHUR.** German wireless expert. Born at Breslau, Germany, 1870, Korn was educated at Leipsig and Paris,



**PROF. ARTHUR KORN**

Wireless photographs were first introduced by this German scientist, who also invented telautography, and wrote a number of standard works on electricity. He is a noted professor at Munich and Charlottenburg

and became professor of physics at the University of Munich, 1903-8, and afterwards professor at the Polytechnical High School, Charlottenburg, Berlin.

Korn is well known for his experiments on and the invention of a method of transmitting photographs by telegraphy, the first photograph being telegraphed from Munich to Berlin in 1907 by his methods. He is the inventor of a system of telautography and wireless phototelegraphy, and the author of a number of standard books on electricity.

~~~~~ **L** ~~~~~

L. This is the usual symbol in formulae for inductance. Printed in italics it is the symbol suggested by the International Electro-technical Commission for self-inductance.

LACQUER AND LACQUERING. Lacquer is a transparent varnish for metal

surfaces, and is a solution composed of a spirit and some such material as seed-lac, shellac, and occasionally colouring pigments or stain. The usual colours for lacquer are clear or crystal, which is practically colourless, various shades of pale yellow, known under various trade names, but primarily as shell-lacquer, pale gold, deep gold and amber. Various other colours of lacquer are available, including green, red and blue.

Lacquer is generally applied by one of three systems, firstly by brushing the lacquer on to the metal, secondly by dipping the articles, when of small size, into a vessel containing the lacquer, and thirdly by spraying it on with an air brush or similar tool. The latter is seldom available to the amateur, as its use is restricted more to the industries.

There are two general classes of lacquers, the hot lacquers, applied to the metal while it is warm, and the cold lacquers, applied in the form of a thin varnish. The purpose of the lacquer and the lacquering process generally is to preserve and finish the metal work. When properly applied, the lacquer should be uniform in density, evenly distributed, and of uniform colour and texture throughout.

It is important that the amateur should realise that lacquering emphasizes any defects in the finish of the metal work, and will not hide any scratches or blemishes. The first step, therefore, when lacquering is to finish the metal work to the desired state of excellence. The lacquer can be applied to brilliantly polished surfaces, and when properly done will enhance the finished appearance. It can also be applied to a dull or matted finish, or one that is grained or figured:

In most wireless appliances the best finish is either by graining the surface by the application of a very fine grade of emery, or by buffing and polishing, this producing a glossy appearance. In the former case the desired finish is obtained by the use of emery sticks, polishing cloths and the like.

In the case of small terminals, bushes, and the general run of small metal work used in wireless sets, a glossy finish is desirable, and is most quickly obtained by the use of scratch brushes, calico, and wool mops run at a high speed in a small polishing lathe head, the process in each case being similar in that the work is held

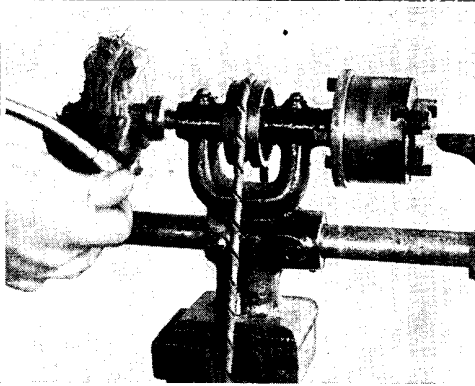

Fig. 1. Before lacquering a glossy finish may be obtained with a wool mop. The surface must be free from scratches

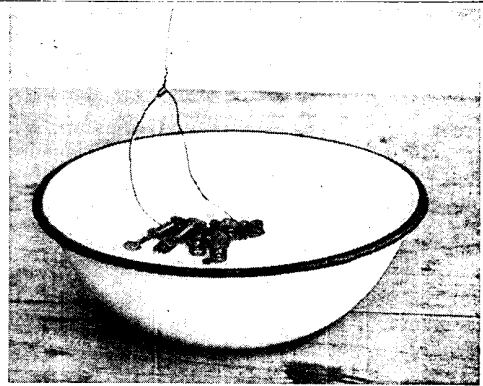

Fig. 2. Small objects, such as terminals, are immersed in hot soda water and afterwards in hot sawdust before lacquering

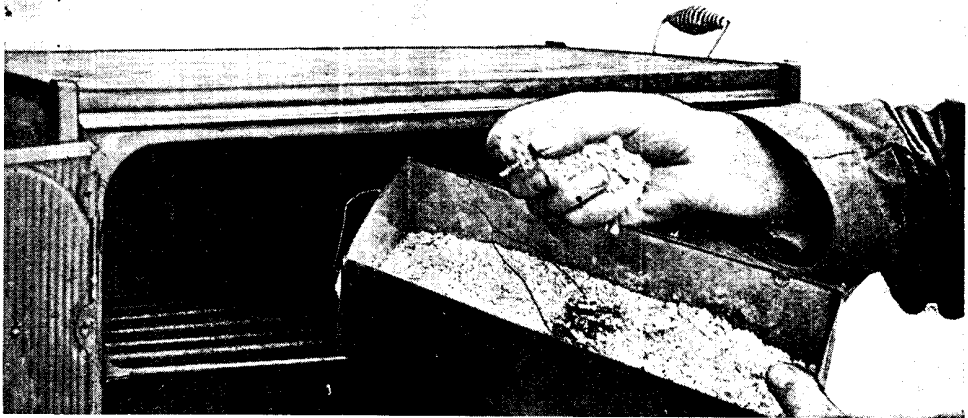

Fig. 3. The cleaned objects are attached to wire before immersing in hot sawdust to bake in the oven, in order to avoid touching by hand, or losing them in the sawdust



Fig. 4. Lacquer is placed in an open vessel and applied to the object being treated with a soft brush. The actual part being lacquered must not be touched by hand

LACQUERING WIRELESS PARTS BY BRUSH AND BATH

in the hands and applied to the surface of the revolving mop, as shown in Fig. 1.

The scratch brush is used first, and is lubricated with soapy water or stale beer, this being followed by the calico mop charged with emery, and the finish effected by means of another calico mop charged with rouge, tripoli, rotten-stone, or other polishing medium. For small parts a wool mop is suitable, especially on long objects. The next and very important step is to clean thoroughly the surface of the parts to be lacquered.

In the case of small items, such as terminals, nuts, and washers, and the like, these may be threaded on a fine wire, as shown in Fig. 2, and immersed in a bowl of very hot soda water, from which they are withdrawn after they are cleansed, and are then immersed in hot dry sawdust, as shown in Fig. 3, placed in an oven, and there left to bake thoroughly dry and hard, after which they are carefully removed and may then be threaded on to a wire, taking care not to touch any part of the surfaces with the hands.

Importance of Perfect Cleanliness

They may either be handled with clean tissue paper, tweezers, or small pliers from which every trace of grease has been removed, or by wearing a perfectly clean pair of leather gloves. The object is to preserve them from any trace of grease. If touched by the fingers the mark will appear on the finished surface in the form of a finger-print.

In the case of the ordinary hot lacquering, the next requirement is a warm room absolutely free from draughts and dust. The work to be lacquered is then warmed, with a gas-stove or other heating medium, to a certain temperature, which can only be determined by experience. As a rough guide, it will be noticed that when the work is held over a gas flame it will turn dull and smeary in parts, and then shortly afterwards assume the clean, dry state. When it is in this state it is usually about the right temperature for the application of the lacquer.

The lacquer is best placed in a shallow bowl, Fig. 4, and applied with a soft camel-hair brush. Useful sizes are flat camel-hair tools about $1\frac{1}{2}$ in. to 2 in. in width and the round, dome-shaped camel-hair brushes about No. 5 size. The brush is dipped into the lacquer and well charged with it. Any surplus that might drop is

wiped away on the edge of the bowl, or against a wire stretched across it, and then applied quickly, carefully, and evenly to the surface to be lacquered. Every effort should be made to flow the lacquer evenly. There must not be too much or too little, or the work will be spoiled.

Immediately the lacquer has been applied the article should be held over the gas flame, or preferably held in an oven and moved about therein by gently moving the hand for a few minutes until the lacquer has set, when it should be placed on a rack and left in the oven about half an hour or so to dry. The oven should be of such a temperature that the hand can just be borne within it without great discomfort.

It is important to keep the brushes perfectly clean. For this purpose they should be washed out in methylated spirit, and then suspended in a tall, large-mouthed bottle. They may be hung from the cork by putting a wire hook in the centre, and making a loop of string on the end of the brush. A small quantity of methylated spirit should be left in the bottle, and the end of the brush should be immersed in this. Kept in this way the brushes will not get hard, and if washed out and then suspended in this manner, they will be clean and soft.

Lacquer should be kept in a small-necked bottle, tightly corked, and in a cool, dry place. Should the first attempt at lacquering prove unsuccessful, the lacquer is easily removed by washing with methylated spirit, when the operation can be repeated as before. Practice alone can give the requisite dexterity, but once the knack has been acquired, the operation is quickly carried out, the resulting appearance being greatly enhanced, improving both the value and appearance of the article.—*E. W. Hobbs.*

See Burnishing.

LADDER. An appliance comprising a set of steps or rungs between two side members, used for climbing purposes. The wireless experimenter will find that ladders are rarely required except for purposes of fixing supports for the aerial system.

The ordinary ladder, as used by builders and contractors, consists of two half-round sectioned side members, generally made of spruce. The rounds, or treads, are larger in diameter in the centre than at the ends, and are fitted firmly into

holes drilled through the side members, and are generally secured with wedges. Two or more iron tie bars are generally fitted to prevent the ladder spreading.

Ladders are generally sold according to the number of rounds, or rungs, and these are usually spaced about 9 in. apart. A 27-rung light ladder is very useful, and will generally reach sufficiently high to give access to the roof for most amateur purposes. It is important when placing such a ladder, for example, against a chimney stack, that the ladder be firmly placed on the ground and be inclined at a small angle to the chimney stack. It should rest fair against the side of the stack, or may be so placed that one of the sides of the ladder is on one face of the chimney stack and the other side of the ladder on the next face, as shown in Fig. 2, as this provides maximum support, and obviates any chance of the ladder slipping sideways.

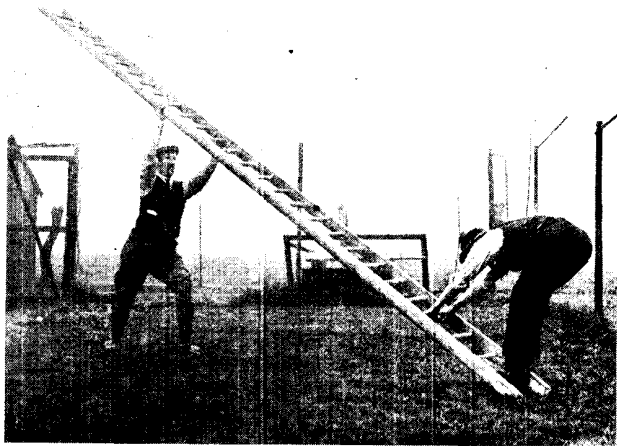

ERECTION OF A LONG LADDER

Fig. 1. Outside wireless work often demands the use of a long ladder, and this photograph shows how to raise the ladder to the erect position. One man stands on the bottom rung, the other walks towards him on the opposite side of the ladder

As an additional precaution a stout cord can be used to steady the ladder while anyone is working on it. In any



Fig. 2. In order to prevent the ladder from slipping sideways the top is placed across the corner of the chimney stack in this case



Fig. 3. The most useful type of ladder for the experimenter is the extension ladder illustrated, which takes up very little room and fulfils all the functions of a long ladder

EXTENSION AND STRAIGHT LADDERS IN USE

doubtful case a second person should stand at the foot of the ladder to steady it.

To erect a ladder, if it is of any length, requires the services of an assistant (Fig. 1). One person should stand on the bottom rung of the ladder. The other should raise the ladder as far as possible and support it with the arms well extended above the head, as is clearly shown in the illustration Fig. 1, and walk towards the first person, who is standing on the bottom rung. Meanwhile, the first person should grasp the third or fourth rung from the bottom, with the arms extended, and continue to endeavour to raise the ladder, the weight of the body thus acting as a counter-weight, thereby enabling a quite heavy ladder to be raised easily.

When placed against an aerial mast the ladder should be held in position and preferably secured with a lashing of cord, as a precaution against accidents.

Probably the most useful type of ladder for the experimenter's use is a variety

known as the extension ladder, such as that shown in Fig. 3. These ladders are made in two or more sections, adapted to slide one upon the other. They can be easily erected, and when in a more or less upright position the extension parts can be hauled up by means of a cord, or raised by hand, according to the exact pattern in use. They do not occupy much space for storage, and can be kept indoors so that they are not always exposed to the weather.

Ladders should be painted or varnished from time to time to increase their durability. In the case of a substantial self-supporting lattice mast, or some forms of pole mast, a ladder is sometimes incorporated, and thus forms a permanent part of the structure.

L AERIAL. Name applied to the horizontal aerial in which the lead-in wire or wires are taken from near one end. This arrangement is clearly shown in the illustration of the Marconi station at Ongar in Essex. The illustration also

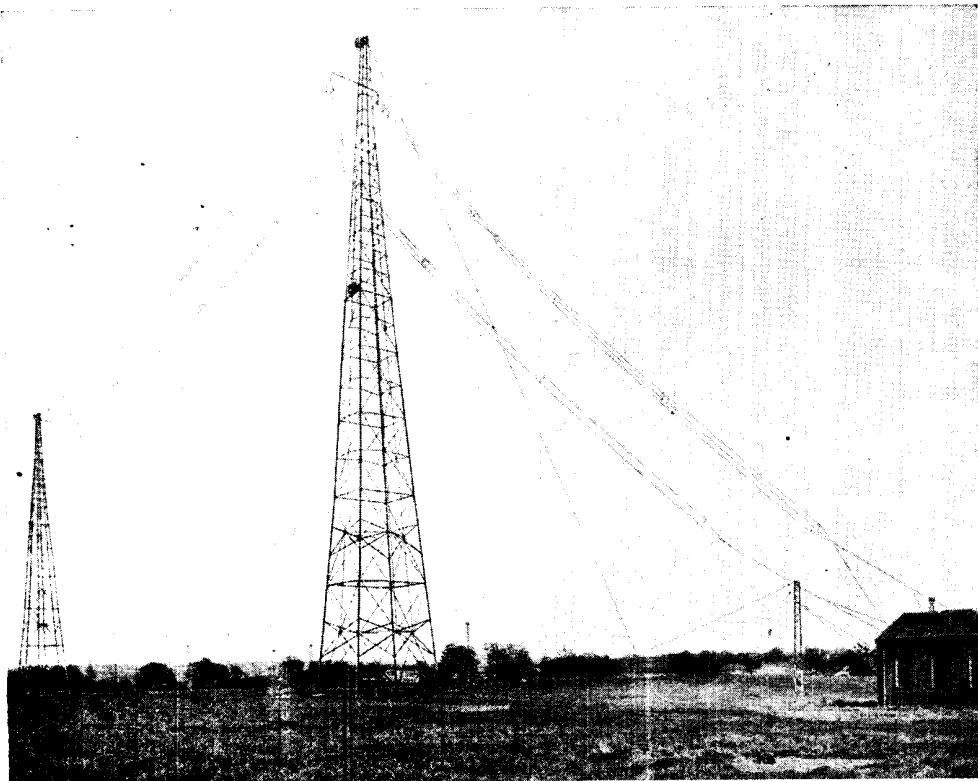

L AERIAL AT MARCONI STATION AT ONGAR

Ongar station of Marconi's Wireless Telegraph Co., Ltd., is equipped with an excellent example of an L aerial on a large scale. This aerial is illustrated in the above photograph. The L is inverted and formed by the horizontal wires and the lead-in wires

Courtesy Marconi's Wireless Telegraph Co., Ltd.

shows the short masts supporting the earth wires, or screen, and the two masts carrying the lower end of the lead-in wires, and the building that houses the wireless apparatus. See Aerial.

LAG. Name given to the property of an alternating current of reaching its maximum value after the E.M.F. has reached its maximum point. When the current reaches its maximum before the E.M.F., it is said to "lead." The extent of the lag or lead of current is known as the phase relation of the two factors, and is measured by the difference between the angles as plotted along a base line, instead of the difference of time between their optimum points. The reason for this is that if lead or lag were measured in terms

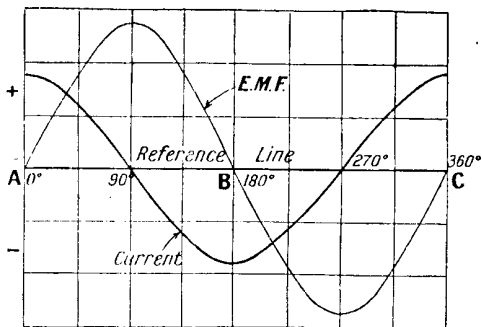

CHARACTERISTIC CURVE SHOWING LAG

This curve shows how an alternating current "leads" the electro-motive force. Maximum current is at A, B, C, when E.M.F. is at zero

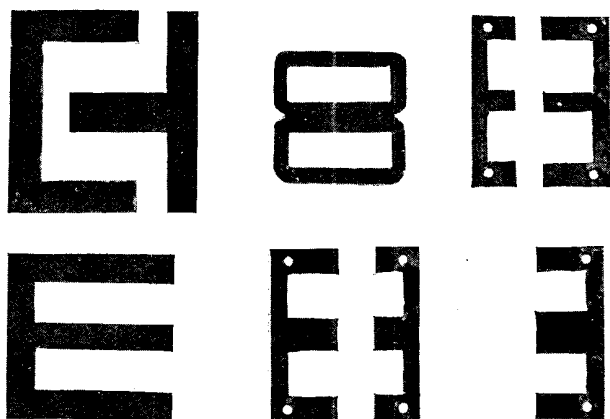

Fig. 1

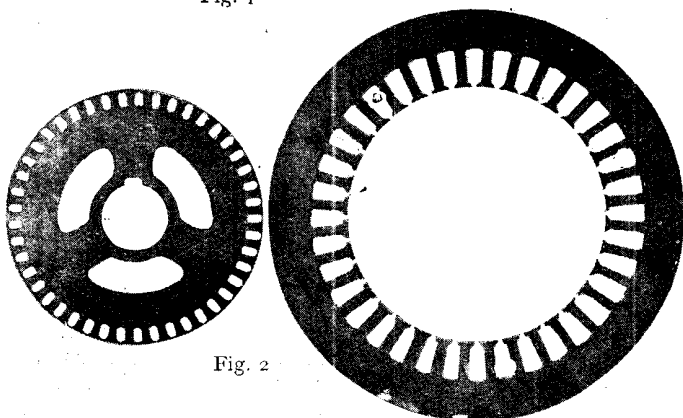

Fig. 2

TRANSFORMER AND ALTERNATOR LAMINATIONS

Fig. 1 (top). Examples are illustrated of the forms of laminations used in building up low-frequency transformers. Fig. 2 (below). Laminations of this kind are used in alternators. The example on the right is for the stator, and the smaller one is used in the rotor. Note the keyway in the latter for holding it to the shaft

Courtesy Joseph Swaney & Sons

of time the figure would be thrown out of truth with a variation in the frequency of the alternations.

The main factors which exercise an influence on lead and lag in an alternating circuit are capacity and inductance. The former has the effect of creating a leading of current, and the latter a lag of current.

In the figure the current is shown leading the E.M.F. If there is no lead or lag, the current and the E.M.F. are said to be in phase with one another.

In the figure, when the E.M.F. is zero, at points A, B, C, the current is at a maximum, and vice versa. The difference between the two is 90°, and this difference remains true, no matter what may be the frequency of the alternations. See Phase.

LAMINATION. A lamination is a thin sheet of metal or other material forming a unit of a composite structure. Generally all the laminations in

the principal part of the structure are uniform in size, shape and thickness. In wireless and electrical work, laminations are generally employed to reduce eddy currents and internal losses of the iron in such

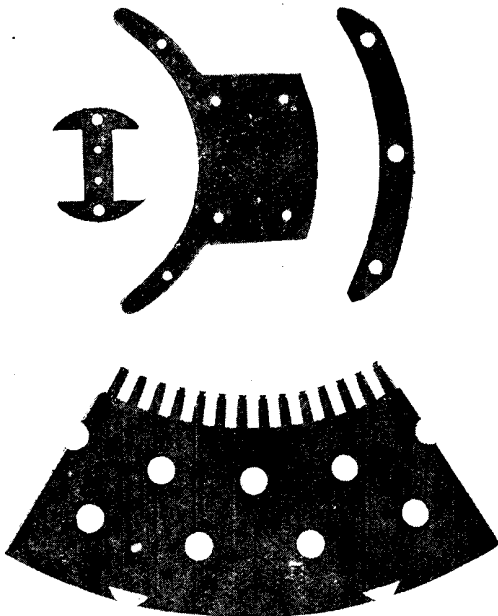

MAGNETO ARMATURE LAMINATIONS

Fig. 3 (top). Left to right are a magneto armature lamination, a pole piece, and a pole shoe. These laminations are used in various magneto machines. Fig. 4 (below). Segments of a large generator stator are shown. The stator is built up of these laminated segments when it becomes too bulky to make complete circular laminations

Courtesy Joseph Sankey & Sons

structures as the cores of transformers or the armature of a generator. Examples of the various forms of laminae suitable for low-frequency transformers are shown in Fig. 1, and are obtainable from a small size, suitable for amateur receiving sets, to the largest and most powerful appliances. Examples of the laminae of an alternator, rotor and stator are shown in Fig. 2. These are generally circular in section, the larger ring being used for the stator, the smaller for the rotor. The bore of the latter is punched out with a small key-way for attachment to the shaft.

Fig. 3 shows a pole shoe, pole pieces and magneto armature laminations. The latter are used for the armature of small magneto machines, the pole pieces in construction of some forms of generator, and the pole shoes for large machines employing separate laminations for the poles.

When the sheets become an unwieldy size it is customary to make up a structure with a series of segments, such as the example illustrated in Fig. 4, which is one of a series for a large generator rotor.

The materials employed are generally of a soft special grade of iron with the requisite magnetic qualities. The amateur will find that the smaller sizes of laminations facilitate the construction of many small parts of wireless apparatus. They can generally be obtained from the regular dealers. *See* Dynamo; Generator.

LAMP, TUNING. A lamp is sometimes used in the Marconi transmitters. One of its functions is to give an indication of the correctness of the tuning of the aerial circuit. *See* Tuning Lamp.

LANGMUIR, IRVING. American wireless authority. Born at Brooklyn, New York, January 31st, 1881, he was educated at the School of Mines, Columbia University, and was for some time assistant to Professor Nerast at the University of Göttingen. In 1906-9 he was instructor in chemistry at the Stevens Institute of Technology, and in the latter year he became a research assistant to the General Electric Company, at Schenectady. Here he has carried out a series of brilliant researches on apparatus used in wireless telegraphy and telephony, on electron discharge apparatus, atomic and molecular structure, etc.

Langmuir has paid particular attention to high-vacuum valves, and is the inventor of the Langmuir valve. To him is due the discovery that by treating the tungstic oxide used in the construction of tungsten filaments with certain compounds of thorium, the filament becomes thoriated tungsten and the electronic emission is enormously increased. These filaments are those used in dull emitter valves, the electrons being given off at comparatively low temperatures. He is the author of many papers to scientific and technical journals, including those on pure electron discharge, thermionic currents in high vacua, etc. Langmuir is also well known for his mercury condensation pump for high vacua.

LANGMUIR VALVE. Name given to a hard vacuum valve due to Dr. Irving Langmuir, and usually known as the plotron. It was described by him before the Institute of Radio Engineers in April, 1915, and it was due to the invention of this valve that Armstrong was able to bring out his super-regenerative circuits. *See* Plotron.

LAP WOUND. A method of winding the armature of a direct current dynamo, in which the wiring between each adjoining

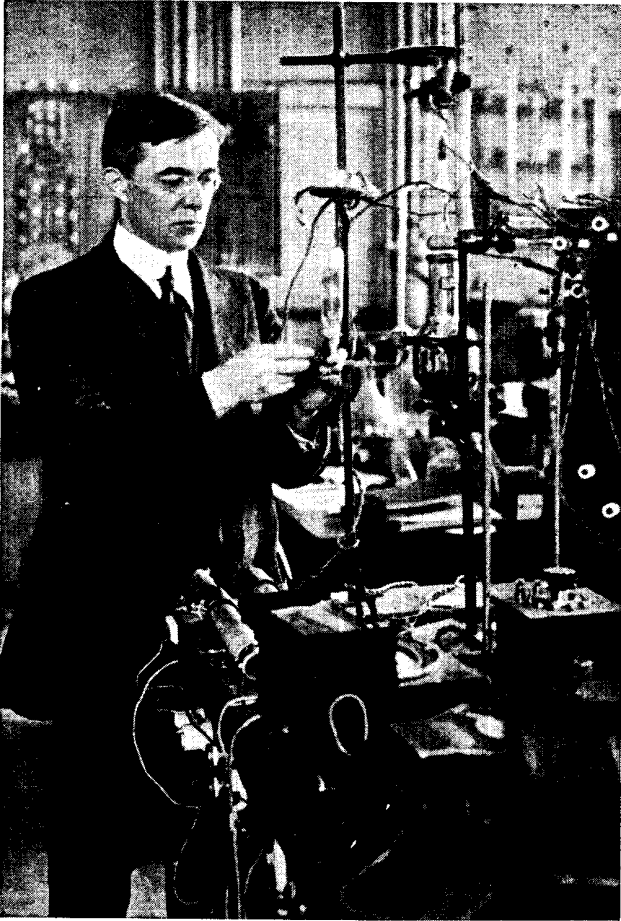

DR. IRVING LANGMUIR

Inventor of the Langmuir valve, this American scientist is noted for his investigations and discoveries, especially with regard to high vacua. He also discovered the means of increasing electronic emission at low temperatures by the thoriated tungsten filament

commutator segment forms a complete loop round a predetermined number of armature poles.

Lap winding is also a method of inductance construction, and consists of a number of layers wound over each other in a special order. By this method of winding the coils of wire are wound on top of one another in a pyramidal form, as shown in Fig. 2, for the first six layers, each turn after the first layer falling in the grooves between the first set of turns. When coiled directly over one another the coils must be supported as in Figs. 3 and 4.

This form of winding has the advantage of saving considerable space, as is shown in Fig. 1. It will be seen that this lap-

wound inductance is more in the form of a ring than a cylindrical coil, the inductance coil shown having an inductive value approximate to a single-wound coil of 4 in. long. The great disadvantage of lap winding lies in its difficulty of construction. There are three common methods adopted for winding this type of inductance. One is shown in Fig. 2, which represents a section of an inductance, each wire being numbered according to the order in which it is wound. It will be seen that the first six turns form a pyramid, against one side of which three successive turns are wound. In this manner all the turns are wound from the bottom upwards.

Another method of lap winding is shown in Fig. 3. The six darkened sections in this illustration represent turns of string or gut, constituting the pyramid made by the first six turns of wire in the first method shown.

The third method requires a thick inductance former, which is turned down through its width, with the exception

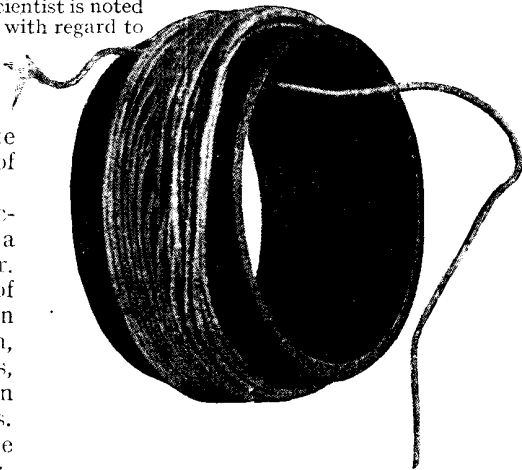

LAP WINDING

Fig. 1. In lap winding the wire is wound in layers over each other, and saves a considerable amount of space

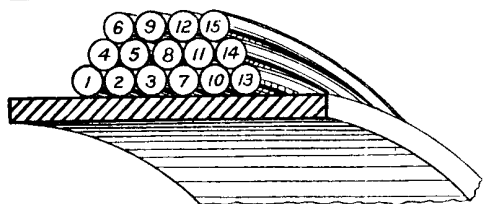

ORDER OF WINDING LAP COIL

Fig. 2. From this sectional diagram will be seen the method of laying on the wire of a lap-wound coil

of a flange at one end. The vertical height of the flange is arranged according to the sum of the number of layers required and the diameter of the wire. The slope of the inside of the flange is at 120° with the turned-down portion of the inductance former. The numbering of the turns of wire indicates the order of procedure in winding.

Lap winding is very similar to bank winding, and the experimenter should refer to that heading for fuller details and alternative methods of construction.

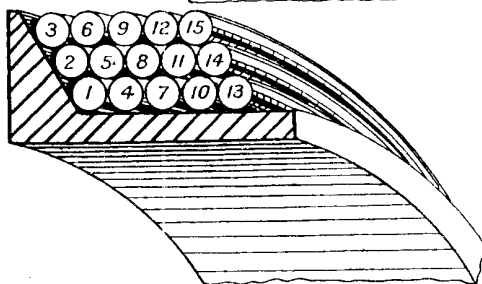
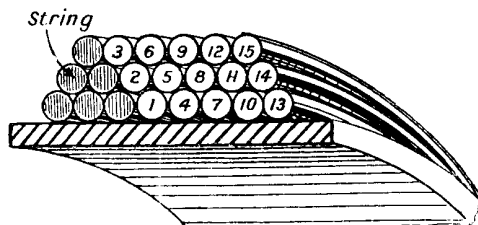

END SUPPORTS OF LAP-WOUND COILS

Fig. 3 (top). This shows another method of lap winding, a pyramid of six turns of thick string being used to form the end support. Fig. 4 (below). Here a flange is made on the end of the former to act as a support

LATHE: THE EXPERIMENTER'S MOST USEFUL TOOL

The Best Varieties of Foot-Power Lathes and their Many Applications Fully Illustrated

Here are fully described the various parts of a lathe and the processes of lathe work. The actual making of a telephone earpiece is shown step by step to illustrate the working. The reader should consult such articles as Aluminium; Brass and Brass Working; Calibrating; Chamfering; Keying; Knobs; Milling, etc., where lathe work is shown in operation

The lathe is an indispensable workshop tool for shaping wood, metal, and other material into circular forms. The wireless experimenter will find that to undertake the construction of any special apparatus, a reasonable lathe is absolutely necessary. With its aid, all manner of special studs, nuts, screws, and circular parts generally can be produced with accuracy and comparative ease.

One of the simplest forms of lathe is shown in Fig. 1, and is known as the C.A.V. It is inexpensive, but is quite capable of a good deal of serious work. It is necessarily limited as regards the size of the parts which can be produced by it, but for a great many operations, such as turning small brass parts, ebonite knobs, bushes and the like, has a real practical usefulness. The other extreme is an elaborate screw-cutting lathe, capable of dealing with work such as the construction of a fair-sized internal combustion engine for driving a dynamo and similar work. These are very expensive and seldom entirely suitable for amateur wireless purposes.

A representative tool that falls between these classes is illustrated in Fig. 2, and is known as the J.R., produced by the Jackson-Rigby Co., Ltd. This is inexpensive, and has an extremely wide range of usefulness for all classes of wireless construction purposes. As illustrated in Fig. 2 it is arranged for a treadle drive, that is to say, a lever or bar known as a treadle is pivoted on a bearing attached to the floor at the back part of the lathe standard. About the middle of the length of this lever is a pivoted flat connecting rod, the upper end of which bears upon a crank attached to a steel shaft turning in long bearings in the lower third of the standard. On the outside end of this crank shaft is mounted a large, heavy flywheel, having three V-shaped grooves turned in its rim.

If this flywheel be given a slight turn with the hand, the treadle will be observed to rise and fall. Instead of turning the wheel by hand, the foot is applied to a corrugated plate at the end of the treadle, and by pressing upon it, the wheel

is given a partial revolution. At the bottom of the stroke of the treadle the pressure of the foot is released and the treadle allowed to rise by the momentum of the flywheel. Immediately the treadle has passed the top of its upward stroke, it is again forced down by the foot, and by this means the flywheel is kept in rotation.

When operating any treadle or foot lathe, it is important to acquire a regular, uniform, and steady action of the treadle, the weight of the body being balanced chiefly on the left foot while the right operates the treadle. The amateur will probably find it preferable to make a special high stool so that a partially sitting attitude can be taken up.

The motion of the flywheel is imparted to a second pulley of smaller size, also provided with three V-shaped grooves on its rim, which is mounted upon a cast steel spindle in a U-shaped casting on the top of the lathe. This pulley is known as the mandrel or cone pulley, and the spindle upon which it is fixed as the mandrel. The U-shaped casting in which it revolves is known as the headstock casting or head, the whole being generally referred to as the headstock. These and the other parts referred to are indicated in Fig. 2.

The object of providing three different diameters on the flywheel and the man-

drel pulley is to obtain a choice of various ratios of the number of turns of the flywheel to that of the mandrel. The proportions of these steps, as they are termed, are such that the same length of belt can be run on either of two of the steps. To obtain the highest mandrel speed, the belt should rest in the largest diameter of the flywheel and the smallest diameter on the mandrel pulley.

More elaborate lathes have four gear wheels, which are disposed on the headstock in such a way that the pulley can be disconnected from the mandrel and driven through the gears, one of which is fixed to the mandrel pulley, the second and third on a shaft, and the fourth on the mandrel itself, this arrangement enabling the mandrel pulley to make three or four turns to the one turn of the mandrel itself, and being known as a back gear.

In the J.R. lathe this gear is omitted, and, instead of it, a very small diameter pulley is formed on the flywheel, so that by using a shorter belt and running it on the large diameter groove on the mandrel pulley, a very slow speed is obtained. For turning wood, a high speed must be used; for turning brass, mild steel, and for most general turning, the intermediate step; and for turning cast iron, or objects of comparatively large diameter, the slowest speed should always be employed.

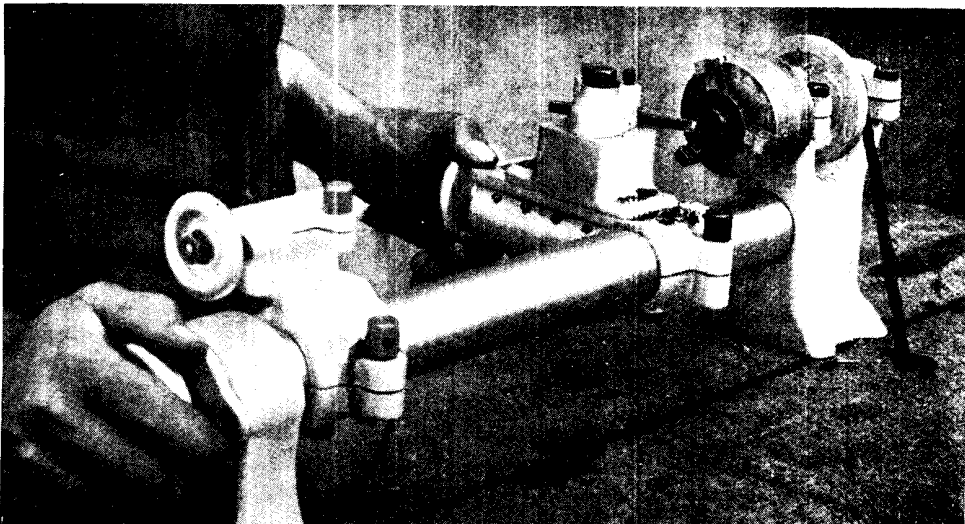

C.A.V. BENCH LATHE IN USE FOR WIRELESS WORK

Fig. 1. One of the simplest and most convenient forms of lathe employed for wireless work by amateurs is illustrated. This is a C.A.V. bench lathe, and is shown turning an ebonite knob for a condenser

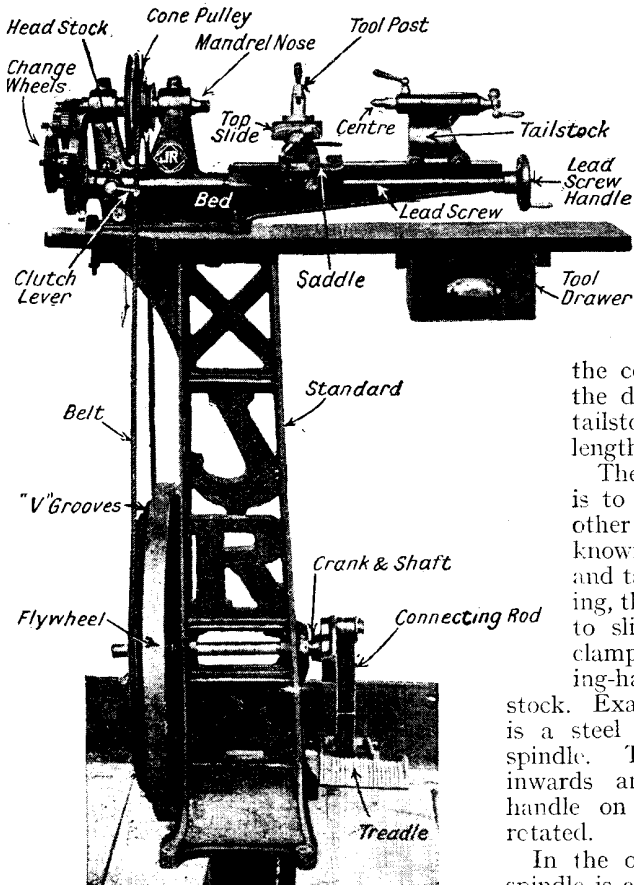

J.R. TREADLE LATHE

Fig. 2. All the principal parts of this lathe, made by the Jackson-Rigby Co., Ltd., are named in the photograph, which may be used as a guide for amateurs who are not well acquainted with the terms used in describing operations on the lathe

A most important point in any lathe is the accuracy of the mandrel and the bearings in which it rotates, and this, to a large extent, governs the accuracy of the resulting work. It is imperative for serious work that means of adjustment be provided on these bearings, and adequate and efficient methods of keeping them constantly lubricated. On the J.R. lathe lubrication is performed by an oil well and small oil pipe located on the top of each bearing. Provision for adjustment is provided by split bearings and by means of a knurled nut at the rear of the mandrel which takes up any end play.

The headstock forms part of a large casting which extends in a horizontal direction and is known as the bed. The

upper surface of this casting is very accurately machined and has two V-shaped edges known as guides or ways. These are exactly parallel with the mandrel and in the same axial line. A small part of the bed is cut away immediately beneath the mandrel nose or screwed part, to permit of larger objects being rotated. The distance of the mandrel above the bed is known as

the centre height of the lathe, and the distance between the head and tailstock as the between centres length.

The purpose of the guides or ways is to control the movement of two other essential features of the lathe, known respectively as the slide-rest and tailstock. The latter is a casting, the bottom of which is machined to slide on the bed, and can be clamped thereto by moving a clamping-handle at the back of the tailstock. Exactly in line with the mandrel is a steel bar known as the tailstock spindle. This is constrained to move inwards and outwards when a small handle on the end of the tailstock is rotated.

In the opposite end of the tailstock spindle is a removable cone-shaped piece of hard cast steel pointed at its outer end, and known as the lathe centre. The tailstock spindle can be securely locked in any position in its bearings by means of a small clamping lever at the front end of the tailstock body. The object of the slide rest is to hold securely a piece of cast steel known as the cutting tool, and to enable the operator to move this tool in any desired direction.

To accomplish this it is necessary to be able to move or traverse the tool holder and its support in a direction parallel to the bed, and also at right angles to it. Both movements are independent of each other, but when both are operated simultaneously curved and angular surfaces can be turned. The lower part of the slide rest, known as the saddle, is caused to slide along the bed by rotation of a long rod having a screw-thread cut upon it, and mounted on bearings on the other part of the bed, this rod being known as the lead screw. It is connected to the front

part of the saddle, which is known as the apron, by a nut, so that when the lead screw is rotated by the lead-screw handle at the right-hand end of the bed, the saddle moves along the bed, an operation known as sliding.

The upper surface of the saddle is accurately machined and has on it two or more T-shaped grooves, for attachment either of the remainder of the slide rest, which is known as the top slide, or for the purpose of clamping a piece of work to be machined. The top slide is virtually a smaller edition of the saddle, and has a somewhat similar lead screw. It can be set to any desired angle to the bed, and carries on its upper part a circular piece of metal with a slot through it which is known as the tool-post or clamp.

The collection of gear wheels on the left-hand end of the headstock is known as change wheels. One is mounted upon the end of the mandrel, another upon the overhanging end of the lead screw, and any suitable number of intermediate wheels connect these two together, with the result that when the mandrel rotates, these gears rotate the lead screw a different

number of turns in relation to that of the mandrel. Consequently, by engaging these wheels and operating the lathe, the slide rest is mechanically driven along the bed.

By properly proportioning the gear wheels, and so the relative movement of the slide rest in respect to a piece of work attached to the mandrel, it is possible to cut a long continuous helix. In other words, the lathe can be used to cut screw-threads. Mounted on top of the standard and clamped between it and the bottom of the bed is a hardwood table, with a drawer in which are stored the spare change wheels and other pieces of apparatus. As it would be inconvenient to move the change wheels whenever it is desired to move the slide rest by hand, a simple dog-clutch is provided and controlled by a small hand lever (shown in Fig. 2), so that the lead screw can be connected or disconnected to the gearing system at will.

Having obtained a lathe, the next item is to ascertain how to use it. The first requirement is the tools with which to turn. A group of those most useful to the amateur is illustrated in Fig. 3, and fall into

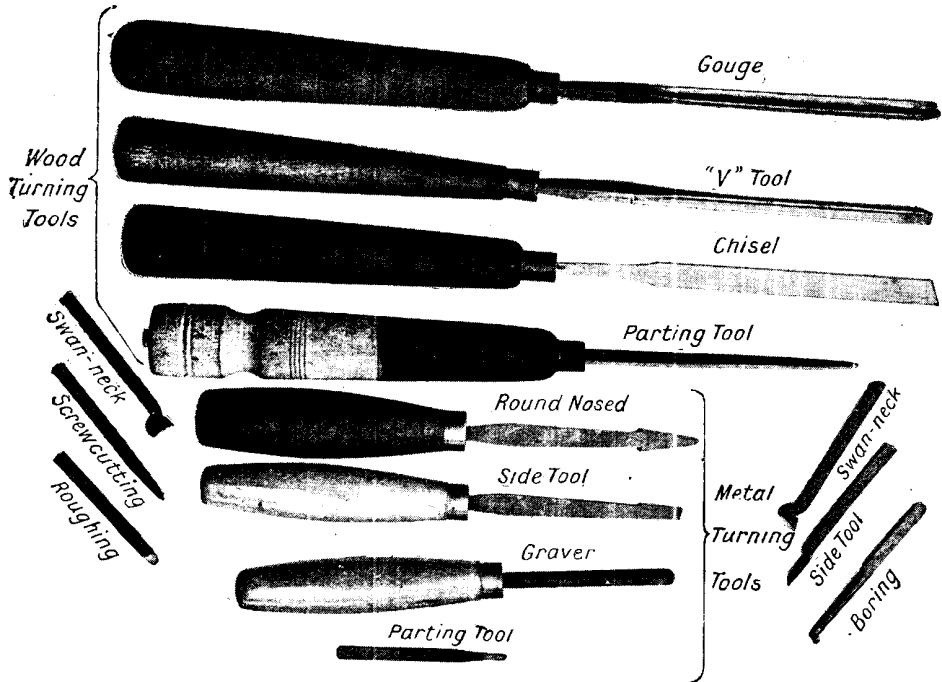

STANDARD TOOLS USED IN CARRYING OUT TURNING OPERATIONS ON A LATHE

Fig. 3. Reference is frequently made to the tools shown in this illustration in the descriptions of how to make wireless components when a lathe is to be employed. The four tools at the top are for working on wood, and the four below in the centre are used on metal. The six small tools at the sides are also used for working on metal with slide rest

two classes, those held in the hand, and known as hand-turning tools, and those which are held in the tailstock of the slide rest, and generally known as turning tools. The latter are made from rectangular cast steel, with variously shaped ends or cutting faces, shaped and named according to the nature of the work and the material to be cut.

The amateur will do well to purchase the regular commercial set of 12 turning tools, and, after gaining experience with them, to develop others. Special combination tool-holders are available in substitution for the ordinary turning tool. Hand-turning tools are of two classes, those intended for turning wood, which consist chiefly of gouges and chisels, and those for turning metal. The former are like ordinary carpenter's gouges, but longer, while the chisels are ground off on each side, and have an angular end which forms the cutting edge.

How the Chuck is Used

Hand-turning tools for metal consist chiefly of the graver, which is a diamond-pointed tool, and side tools, which are flat tools ground to an angle on one side, and round-nosed tools, all of which are illustrated in Fig. 3. The next step is to provide some means of attaching the work to the nose of the mandrel, such means of attachment being generally known as a chuck. A simple example of this is merely a short, coarse screw-thread set in the middle of a flat plate, the latter having a shank which fits into a tapered hole in the mandrel.

It is used for turning wood, the material being screwed on to the chuck as illustrated in Fig. 4. When the wood is only short, no other support is necessary, but when it is long it should be screwed on to the screw chuck and supported by the tailstock, as shown in Fig. 5. In this case the lathe is run at its fastest speed by setting the pulley at the smallest step on the mandrel and the largest on the flywheel.

The first stages of wood turning are effected by the gouge. This is held firmly on the rest or on a rectangular bar supported on the tool post. The gouge is held down by the left thumb and the handle securely gripped with the right hand. The point of the gouge should be exactly on the same line as the centre height of the lathe. Turning is always effected

by working the largest diameter downwards towards the smaller, never uphill. The work is then smoothed with the chisel, which is shown in use, and also the method of holding, in Fig. 6.

The turning of metal requires other chucks. One very useful pattern is known as the collet chuck and is illustrated in Fig. 7. This is a self-centring device, and any circular work gripped in the collet chuck will always run true. The collet is simply a split bush with a hole through its centre, the splits being closed by tightening up a knurled ring on the upper part of the chuck.

The Face Plate and Its Applications

Most lathes are supplied with a large-diameter flat disk of metal screwed in the centre and provided with slots through the surface. This chuck is known as the face plate. It screws on to the thread of the mandrel nose, and is then generally employed in conjunction with short metal posts, which are secured to the face plate by passing the shanks through the slots therein and securing them with a nut and washer on the back of the face plate. Through these posts are passed set-screws, which can be tightened up with a key.

The work is grasped between three or four of these dogs, and the screws adjusted until the work runs true. This can be gauged for ordinary work by holding a piece of chalk in both hands, as in Fig. 8, and slowly revolving the lathe. The higher parts will be touched by the chalk and the lower parts will not exhibit the chalk mark. The screw nearest to the chalk mark should be tightened up and that on the opposite side slackened, thus propping the work across the face plate until, by repeated trials, the work runs true.

Another advantage of the face plate is as a means of holding work in the lathe, as then odd-shaped pieces of work can be gripped tightly by suitably placing the dogs. Fig. 9 shows how a rectangular bar can be held securely and adjusted to any desired position. Another excellent way of supporting some forms of rectangular work, especially castings, and irregularly shaped objects, is to mount them on an angle plate which is bolted to the face plate, as shown in Fig. 10, while one or more dogs are used to grip the work between the angle plate and the end of the dog. When the work is of any

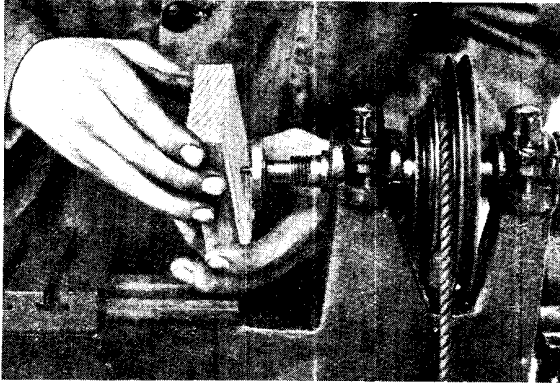

Fig. 4. In this photograph the operator is seen mounting a wood block on the screw chuck

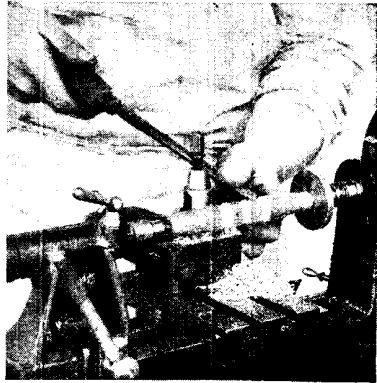

Fig. 5. Here a wooden bar is being turned with the gouge

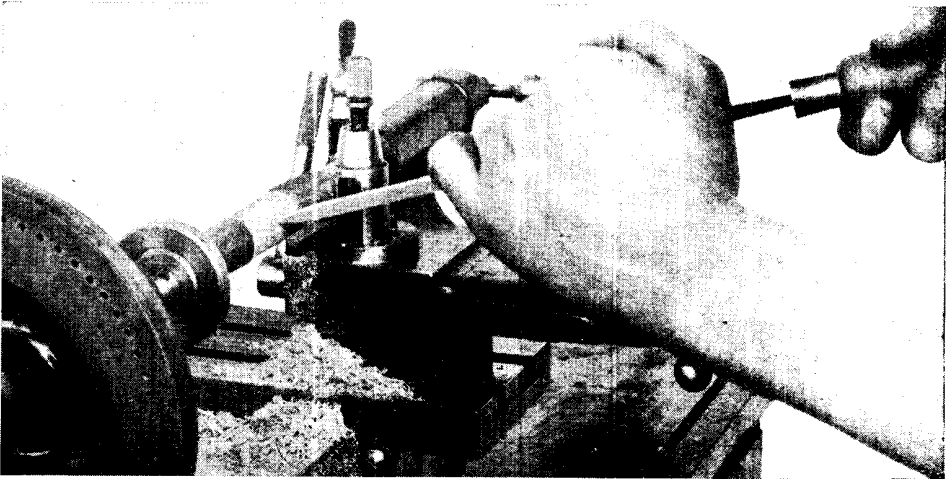

Fig. 6. The operator is here seen carrying out the finishing process in wood-turning. The photograph shows how the chisel should be manipulated

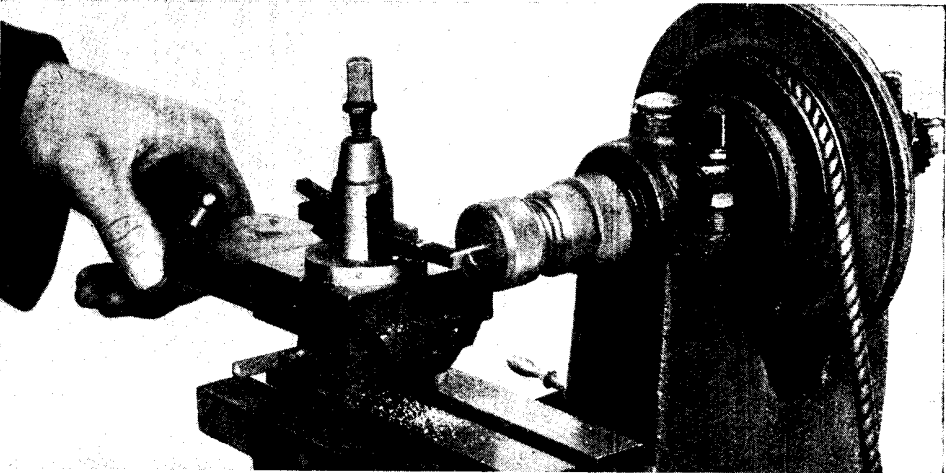

Fig. 7. A chuck which is known as a collet chuck is here seen in use. This type of chuck is self-centring and is used when turning metal parts

SIMPLE FORMS OF WOOD AND METAL TURNING ON A LATHE



Fig. 8. Tracing up is being carried out with the aid of a piece of chalk

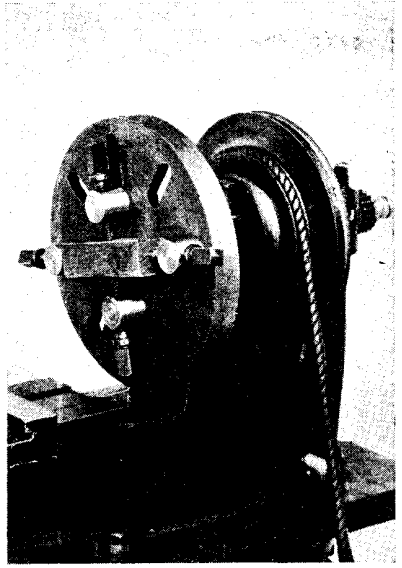

Fig. 9. Work is here seen held in place on a face plate by the use of four dogs

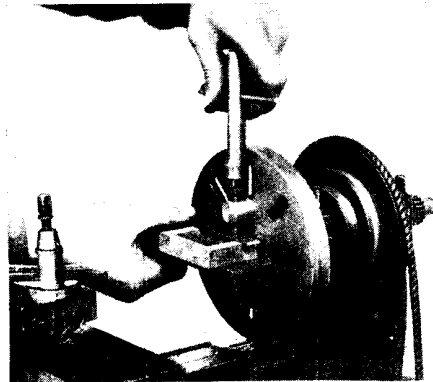

Fig. 10. An angle plate and a dog may be used for fixing the work on a face plate

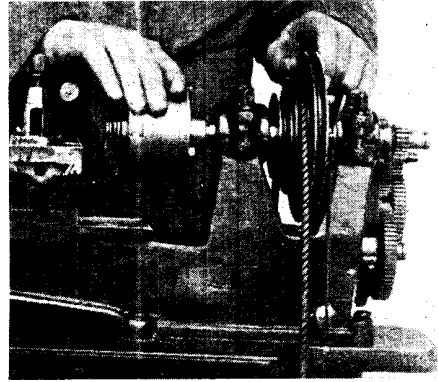

Fig. 11. Here the operator is screwing a self-centring chuck on to the mandrel nose

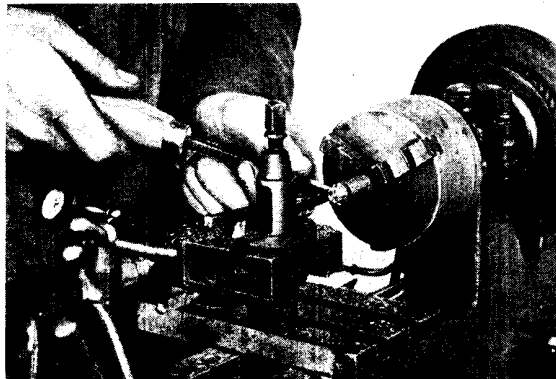

Fig. 12. Turning is being carried out in this photograph. A brass rod is being rotated, and one of the tools seen in Fig. 3 is employed to turn it

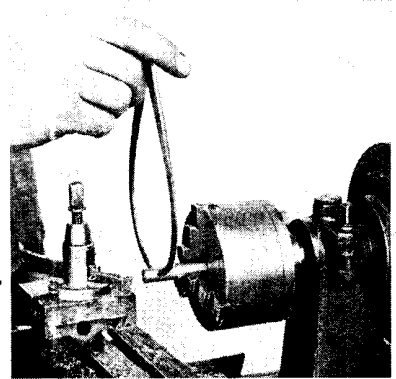

Fig. 13. Calipers are shown in use to ascertain the exact diameter of the turned work

OPERATIONS IN CONJUNCTION WITH A LATHE, CHUCK, MANDREL, AND FACE-PLATE DOGS

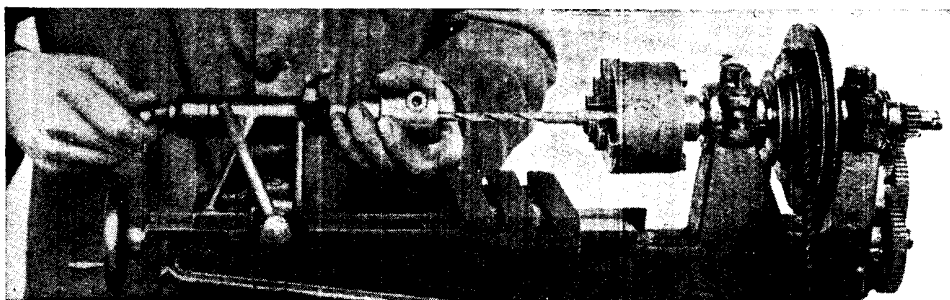

Fig. 14. Drilling is here seen in progress on a lathe. The drill is held in the three-jaw chuck on the mandrel

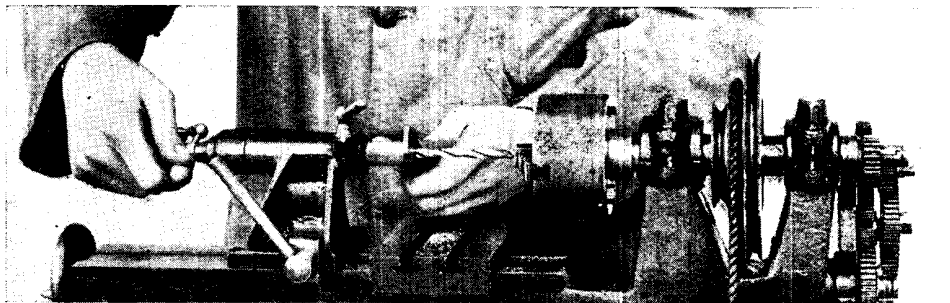

Fig. 15. Drilling on the lathe in this case is carried out by holding the drill in the drill chuck attached to the tailstock

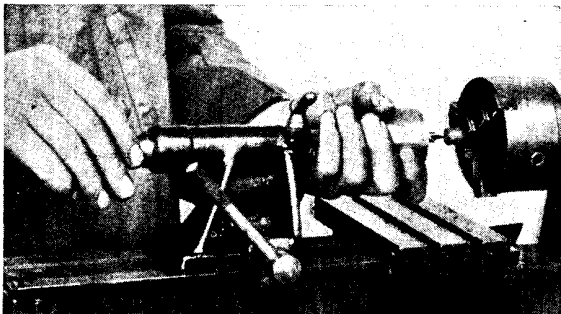

Fig. 16. A Slocomb centre drill is used to form a hollow centre for mounting work in a lathe

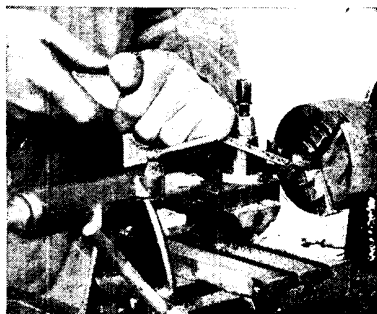

Fig. 17. Preparatory to mounting between centres, a centre is being turned

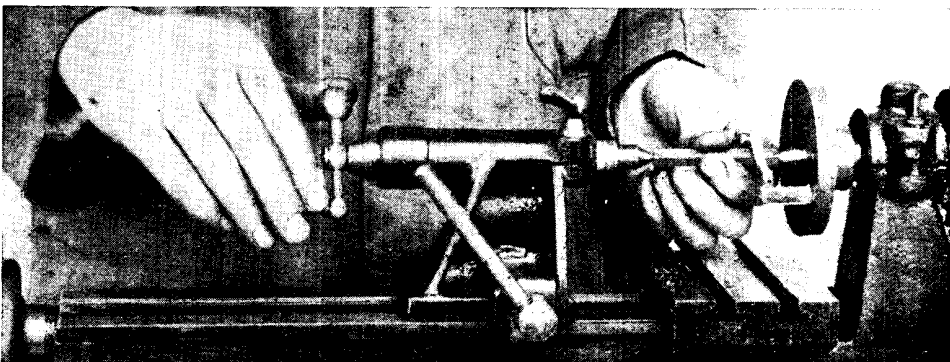

Fig. 18. Two point centres are here seen in their place in a lathe, and between them the work to be turned is mounted

DRILLING AND TURNING METAL IN A LATHE

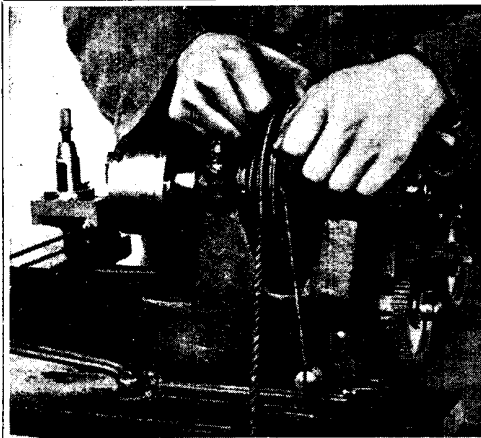

Fig. 19. In the foreground is a pointer for the division plate, by means of which a circle can be divided into any number of equal parts

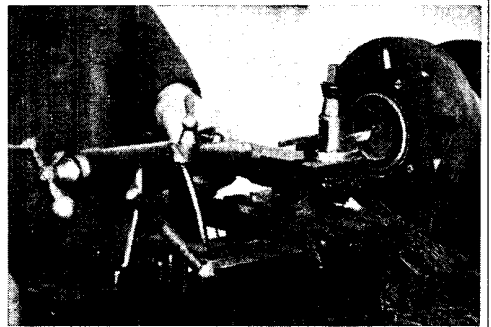

Fig. 22. To form the interior portion of an ebonite telephone ear cap a recess is being turned with a round-nosed tool in the slide rest

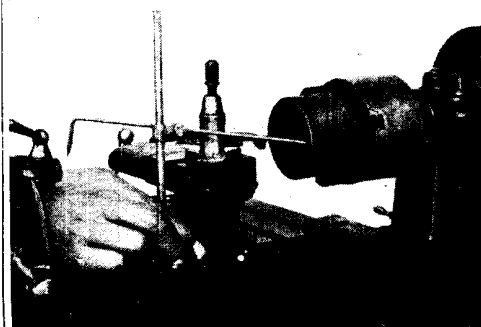

Fig. 20. A surface gauge is being used while dividing work held in the lathe chuck

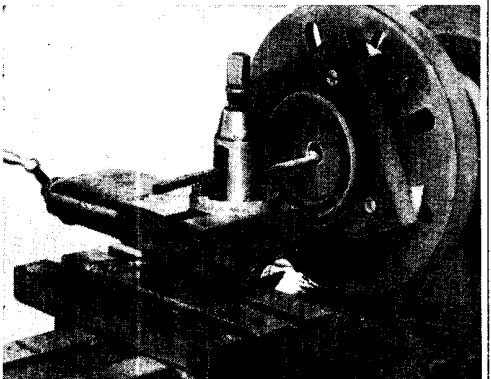

Fig. 23. Enlarging the small central hole by means of a boring tool in the slide rest

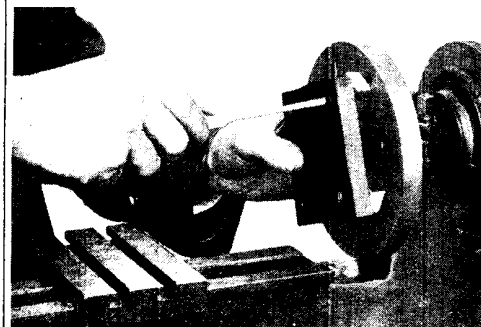

Fig. 21. Mounting an ebonite block preparatory to turning as shown in Fig. 22

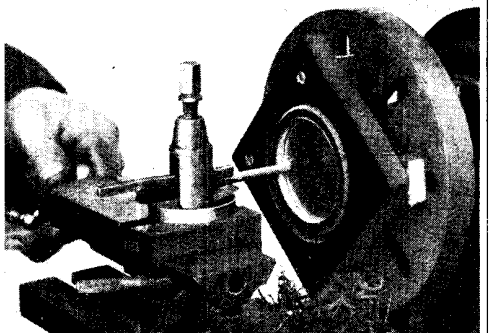

Fig. 24. With a square-ended boring tool the recess or undercut is turned

STAGES IN TURNING AN EBONITE EAR CAP FOR A TELEPHONE RECEIVER

weight and is badly out of centre, a counterweight should be bolted to the face plate so that the lathe will run steadily without undue vibration.

The amateur will find that the most useful form of chuck, and also the most

expensive, is that known as the three-jaw, self-centring chuck. This comprises a system of gearing which operates a scroll or spiral within the chuck. The spiral engages teeth cut in the underside of the three chuck jaws, and the

whole so arranged that when the spiral is rotated by means of a key, the jaws are opened or closed, but their relative position in respect to the centre line of the lathe remains constant. Consequently, any circular or triangular work gripped in the jaws will always run true.

The chuck is bolted to a back plate which is accurately bored and threaded to fit on to the lathe mandrel. When placing such a chuck, it is gripped in the left hand while the mandrel is slowly rotated with the lathe, as shown in Fig. 11. It is imperative that the screw threads on the mandrel and the back plate of the chuck be wiped perfectly clean and free from the slightest trace of dirt or grease, otherwise the chuck will not run true.

A simple example of metal turning with a hand tool known as a graver is illustrated in Fig. 12, where a piece of brass rod, known as stock, is held in a lathe which has a self-centring chuck. The handle of the graver is gripped with the right hand while the left hand presses the upper end of it on to the tool rest or bar held in the tool post on the slide rest.

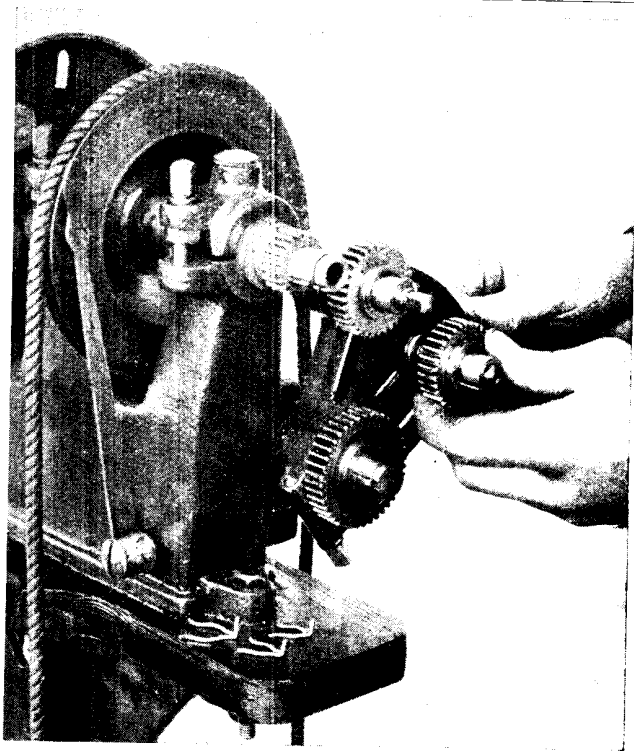

CHANGE WHEELS ON A LATHE

Fig. 25. In order to give the correct ratio between the mandrel and the lead screw the operator is setting up the change wheels

The graver alone is sufficient for almost all classes of external hand turning of metal. Its use can only be acquired by practice. To gauge the diameter of work when it has been turned, outside calipers are

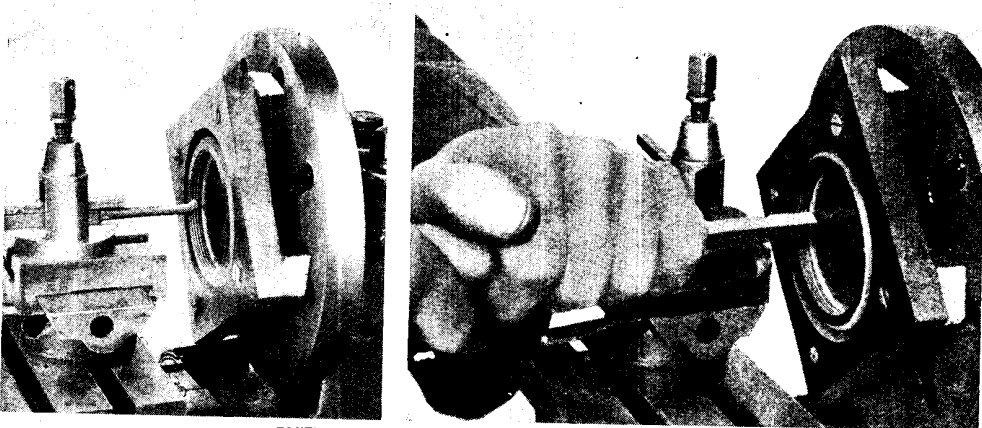

CUTTING AN INTERNAL SCREW THREAD

Fig. 26 (left). Mounted in the slide rest is a tool with a V-shaped cutting point bent at the end. This engages the work at an angle, thus enabling a screw thread to be cut internally. Fig. 27 (right). To finish the internal screw thread a hand chaser is used, which reduces the part cut to the exact size required

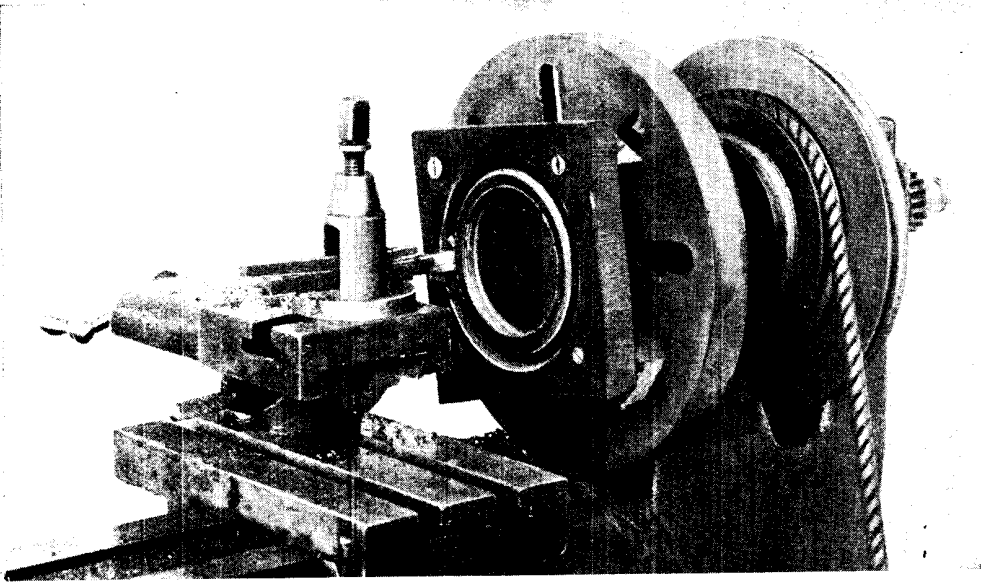

PARTING TOOL IN USE ON A LATHE

Fig. 28. In this photograph a parting tool is being used to cut out a centre part of the ebonite earpiece block, which is subsequently turned up true on a screwed mandrel, as shown in Figs. 29 to 31

applied as shown in Fig. 13, the diameter of the work being determined by applying the jaws of the calipers (*q.v.*) to a rule.

Drilling in the lathe is performed in two ways, first by gripping the drill in a three-jaw chuck, and placing a piece of odd metal or wood behind the work, and pressing it against the drill with the handle of the

tailstock while the lathe is in operation, as shown in Fig. 14. The other method, illustrated in Fig. 15, is to place a drill chuck on the end of the tailstock, hold the drill in this chuck, and grip the work in the lathe chuck.

Much work is turned between centres, for which purpose a small central hole,

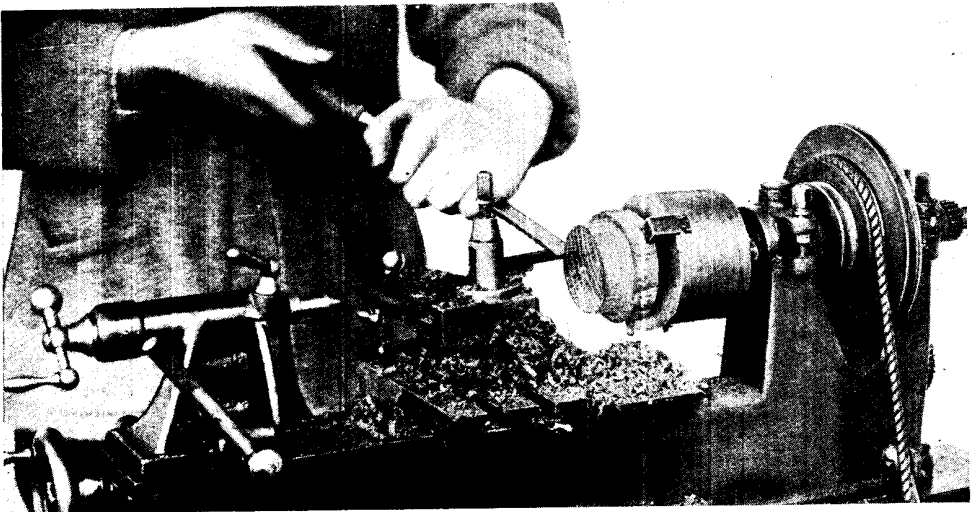

TURNING A MANDREL TO RECEIVE THE TELEPHONE EARPIECE

Fig. 29. By chucking the material in the lathe a hardwood mandrel is made. The exterior is turned before screw-threading it to receive the cap. The outer surface can be shaped with a hand turning tool

properly countersunk, is necessary at each end of the work. This central hole is most easily made by the use of the Slocumb combination drill held in a drill chuck on the tailstock while the work is rotated in the lathe, as shown in Fig. 16. Another method is to turn the centre with a hand side tool, as shown in Fig. 17. After the two centres have been drilled, the work is placed between the lathe centres, fixed, one to the mandrel and the other in the tailstock, as shown in Fig. 18.

The work is made to rotate by fixing a peg or driver in the driver plate screwed to the mandrel nose and engaging with

For instance, if there be 60 holes and the work is to be divided into six, the pointer must be inserted into every tenth hole.

A complete series of lathe photographs is given in Figs. 21 to 31 inclusive, illustrating the stages in the turning of an ebonite ear cap for a telephone receiver, and showing one of the several methods by which this job can be performed. The first step is to screw a rectangular block of ebonite to the face plate, as in Fig. 21, introducing a packing block between it and the underside of the ebonite. The screws bite into the nuts at the back of the face plate.

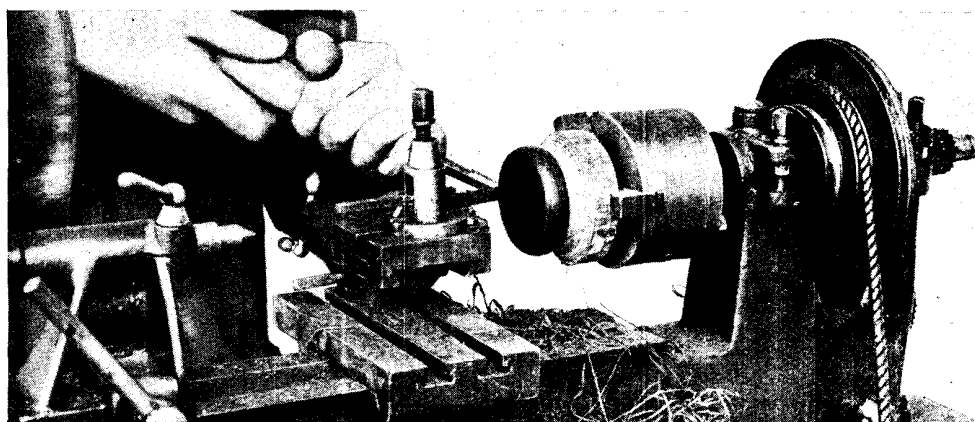

TURNING THE CURVED EDGE OF THE EARPIECE SCREWED ON ITS MANDREL

Fig. 30. With the aid of a hand turning tool the curved edge of the earpiece for a telephone is made on the lathe as illustrated. Note how the tool is held with its engaging end rested on the slide rest tool

the end of a carrier clamped to the work to be turned.

If a lathe is provided with a division plate, it can be used for dividing up a circle into almost any number of equal parts. The first step is to place the pointer in any one of the holes in the division plate, as shown in Fig. 19. The work to be divided is then gripped in the lathe chuck or secured to the face plate and, with the aid of a surface gauge, rested on the bed of the lathe as in Fig. 20, a horizontal line is scribed across the work.

The pointer is withdrawn from the hole in the division plate, the lathe is rotated the desired amount, and the pointer again inserted into a hole in the division plate. Another line is then scribed on the face, and so on until the whole is completed, the space being dependent upon the number of holes in any one ring of holes on the division plate (Fig. 19).

The next step is to use a round-nosed tool in the slide rest and to turn out the centre to form a recess, as shown in Fig. 22. A small hole is drilled in the centre of the ebonite, and this is enlarged with the aid of a boring tool, as illustrated in Fig. 23. The next step is to cut a recess or undercutting at the inner end of the recess, as shown in Fig. 24. The proper change wheels are then placed in position on the lathe, as shown in Fig. 25, and the quadrant adjusted until the wheels are brought into mesh with each other.

A tool like a boring tool, but with a V-shaped cutting point, is placed in the slide rest and a screw thread cut as illustrated in Fig. 26. It may conveniently be finished to exact size with the aid of a hand chaser, as in Fig. 27, a tool having a notched cutting edge corresponding in size and shape to the number of threads per inch to be cut. A parting tool is then

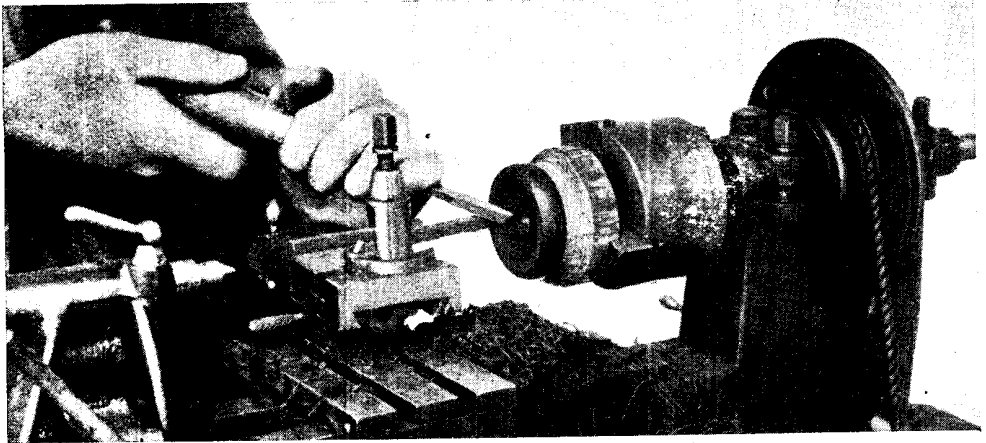

TURNING THE OUTER CURVED FACE OF THE EARPIECE

Fig. 31. For turning the outer curved face of a telephone earpiece a round-nosed hand tool is used as shown in this photograph. The tool is guided by resting the hand against the tool post on the lathe. This is the last operation before polishing

employed to cut out the centre part of the ebonite, as illustrated in Fig. 28, this being gradually fed into the material while the lathe is running.

A hardwood mandrel is then made by chucking the material in the lathe, turning the exterior and screw-threading it to receive a cap, as shown in Fig. 29. The outer surface can be rounded off with the aid of a hand turning tool, as shown in Fig. 30, the hollowing being turned by hand with a round-nosed tool manipulated as shown in Fig. 31. The work is finished by polishing, and is then unscrewed from the mandrel, and is ready for use.

LATITUDE. Term, applied largely to high-frequency transformers and aerial tuning coils of the plug-in variety, to indicate the extent of the wave-lengths on which they are efficient.

A plug-in high-frequency transformer has considerable latitude, as the same transformer may be used efficiently on wave-lengths varying by 300 metres between minimum and maximum. The same may be said of duo-lateral or other plug-in coils forming aerial inductances when used in conjunction with a tuning condenser.

It is important to see that the latitude of a coil is sufficient to tune to the station that it is required to receive, as it frequently happens that the wave-length of a station transmitting is lower than that of the set requiring to tune to it.

The tuned anode method of high-frequency amplification is different from

the transformer-coupling method in this respect. The former requires exact tuning to the aerial wave-length to obtain increased signal strength, and is said to be critical, or having very small latitude.

LATOUR, MARIUS. French wireless expert. Born in October, 1875, he was educated at the University of Paris and the Ecole Supérieure d'Electricité, Paris. He was for many years consulting engineer to the General Electric Company of America, and he specialized in the construction of high-frequency machines. Latour is the designer of the so-called S.F.R. alternator, in which there are a smaller number of stator slots than usual.

During the Great War Latour was engaged in research work under General Ferrie, and he invented a system of elimination of the interference produced in telephone lines by neighbouring high-tension power lines which has been installed throughout the greater part of France. Latour is the inventor of the now widely used system of high-frequency multiplex telegraphy and telephony, using the three-electrode valve for generation and reception. He is a member of many scientific societies, including the Institute of Radio Engineers and of the American Institute of Electrical Engineers. He has written many articles on wireless subjects for scientific and technical journals.

LATTICE MAST. Term used to describe a tall, composite structure for the support of a lofty aerial. This type of construction is carried out both in wood and in metal.

In the latter case a tall mast, such as that at the Berne wireless station, and illustrated in Fig. 2, is made throughout in structural steel, and is a self-supporting construction—that is, it does not require any guy-ropes to give it stability or render it secure.

Another type of lattice mast is illustrated in Fig. 1, and shows a wooden lattice mast by C. F. Elwell Ltd. This

structure is 490 ft. high, and built up of comparatively light timber well supported by insulated guy-ropes. A close-up view of the base of such a mast shows that it is triangular in section, and comprises essentially three upright members held together by tie bars of metal and braced by diagonal bracing of stout timber. The resulting structure is light, strong, and durable, and at the

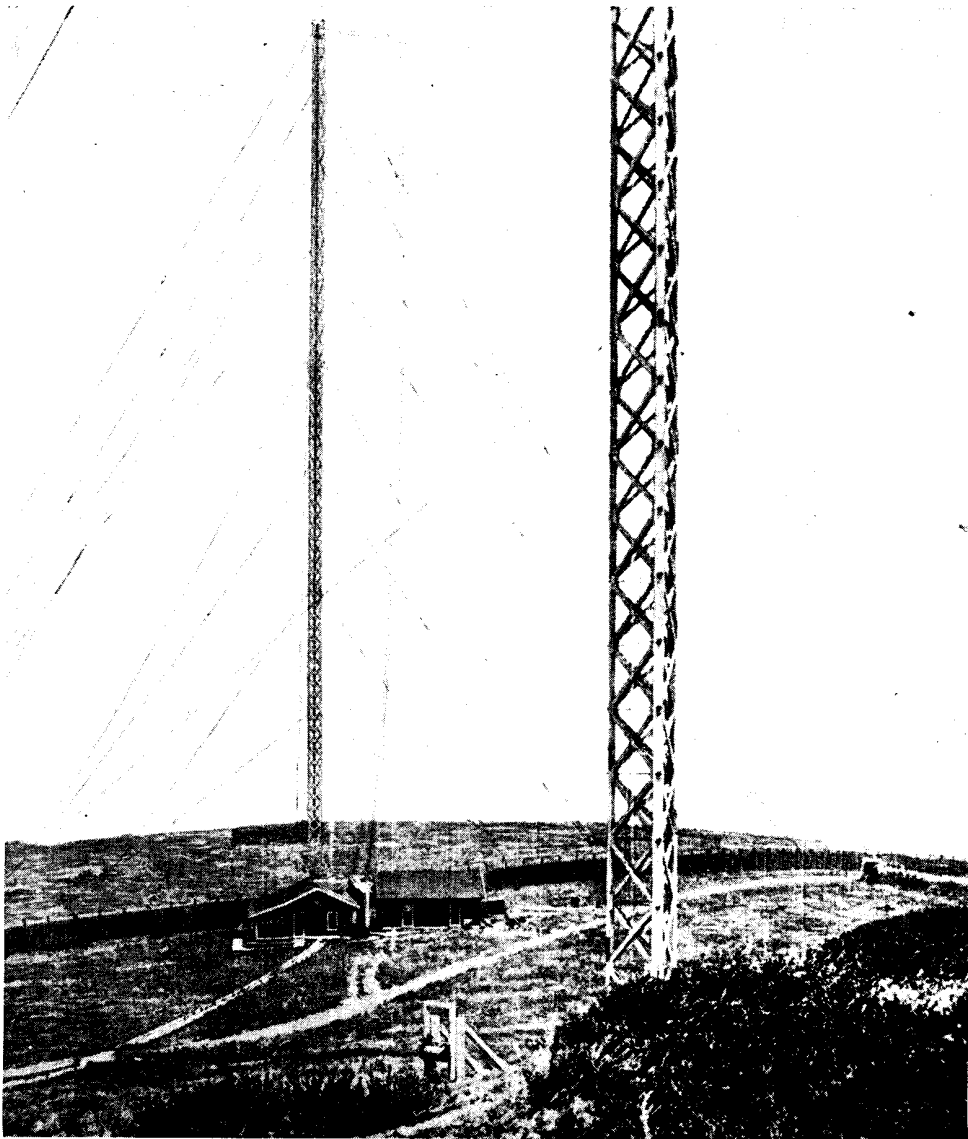

BASE OF AN ELWELL TRIANGULAR SECTION LATTICE MAST

Fig. 1. This wireless station is equipped with lattice masts, of which two are seen. In the foreground is the base of one of them seen at close range. It will be observed that this is triangular in construction and the uprights are held together with iron ties

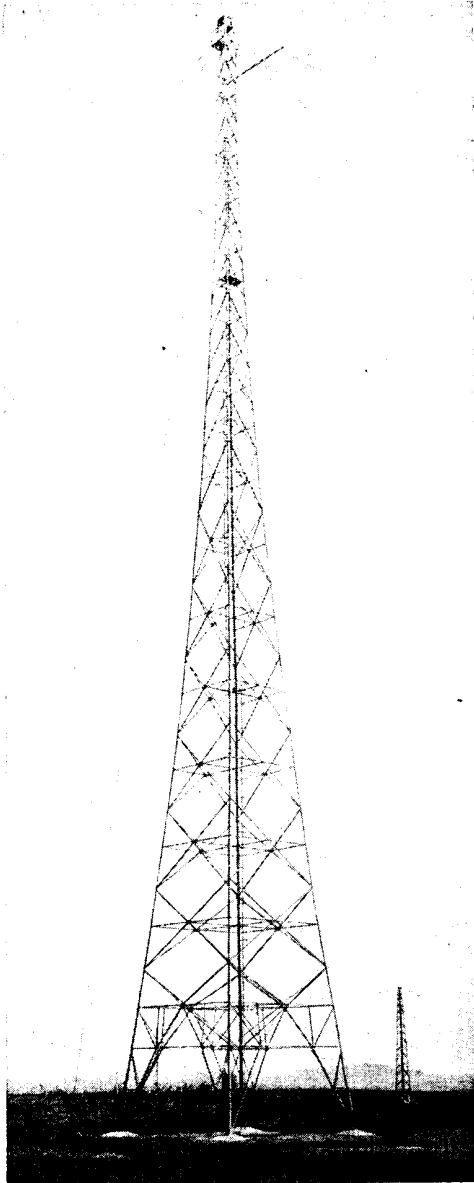

SELF-SUPPORTING LATTICE MAST AT BERNE

Fig. 2. This mast is made throughout of steel and does not require any guying to support it

Courtesy Marconi's Wireless Telegraph Co., Ltd.

same time has sufficient flexibility to allow slight movement due to windage.

A similar structure, but of smaller proportions, can be adopted by the experimenter, the details and construction of which are described under the heading Aerial. See Bamboo Pole; Box Mast; Guy Mast; Pole Mast; Strainer; Tubular Mast.

LATTICE-WOUND COIL. Term applied to a variety of different kinds of inductance coils wound in such a manner that the turns of wire cross one another in a zigzag manner. The chief advantage of lattice-wound coils is that they reduce self-capacity of the inductance by providing ample air space between the turns of the wire. The exact details of the winding, and the method by which it is carried out, vary considerably according to the different manufacturers' processes. In many respects lattice winding is similar to duo-lateral or honeycomb winding, except that the exact arrangement of the turns is sometimes varied between them.

An example of a lattice-wound coil, such as might be applied to a stator of a variometer, is illustrated in Fig. 1. This is a machine-made article, and has the merit that the insulation of the wire itself is sufficient to provide stability without the necessity of impregnating with wax or any other insulating material. The coils are fastened together in a few places with a few turns of ordinary sewing silk. Natural stiffness of the coil is ensured by the method of winding, crossings being made at a considerable angle.

A somewhat similar arrangement is adapted in the case of a movable coil, shown in Fig. 2, mounted on a spindle, thus making it suitable as a reaction coil in a vario-coupler or as a rotor in a variometer. In this case it suffices to fasten the spindle with two nuts and washers to the outer diameter of the winding, and to impart stability to it by

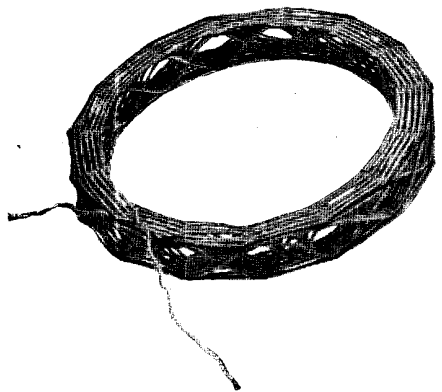

LATTICE-WOUND COIL

Lattice-wound coils are often used in this form as the stators of variometers. Ample air space is allowed between the turns of wire

means of a narrow ebonite cross-bar secured to the spindle with two lock nuts.

The knob is attached in the usual way, and, with a spindle suitably mounted, rotation of the knob necessarily rotates the spindle and, on it, the lattice-wound coil. The methods of winding are described

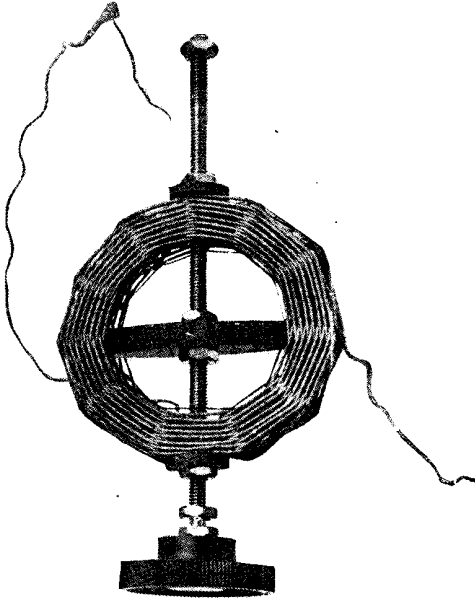

LATTICE-WOUND REACTION COIL

Fig. 2. Coils of this kind may be used as part of a vario-coupler, the rotor of a variometer, or for the purposes of reaction. This example shows how such a coil can be mounted on a spindle

under the headings Coil; Duo-Lateral; Honeycomb Coils. See also Basket Coil.

LAY-OUT. Term used in several senses, but in wireless work generally applied to the lay-out of panels for receiving and transmitting sets.

The expression applies to all the processes of planning out the positions and arrangement of the different parts or components of the set.

The actual lay-out is practically nothing more than a plan of the set with the necessary sectional drawings and elevations to enable the designer to ascertain that the various components can be worked into the desired places and are not likely to cause interference, either electrically or magnetically, or from the point of view of the necessary controls. Such plans are generally quite rough, and are altered from time to time until the best

all-round arrangement has been found. See Panel; Wiring.

LEAD. A metallic element, almost non-elastic, soft and ductile, and bluish-white in colour, darkening on exposure to the air to a dull grey colour. Lead is extensively used in wireless work, and forms the chemical basis of many crystals used as detectors, and is extensively employed in the manufacture of storage batteries. Other applications include linings for acid-proof vessels, coverings for some types of electrical conductors, and as a covering for roofs and other exposed structures.

The chemical symbol for lead is Pb, the melting point is in the neighbourhood of 620° , and the electrical conductivity 8.5 as compared with silver at 100.0. The ultimate tensile strength is about 2,000 lb. per sq. in.

Lead is extensively alloyed, and forms the basis of most of the white metals. It dissolves in nitric acid, but is attacked only slightly by sulphuric acid or by hydrochloric acid.

The principal source of supply of lead is galena, or lead sulphide, which when pure contains some 86 per cent of the metal.

Anglesite or lead sulphate, as well as cerusite or lead carbonate, are oxidized ores and result from decomposing lead sulphide.

Litharge is another compound consisting largely of lead, and is used as the paste filling in some types of storage battery.

Red and white lead in the plastic state are employed as a base for many paints, and also in electrical work in the construction of various apparatus.

Lead wool is metallic lead in the form of long thin strands or threads, and is generally wound or twisted together and supplied in rolls or bundles. It is used as a packing material for making joints in pipes, and for other purposes.

Lead, when alloyed with other metals, forms the base of most of the anti-friction bearing metals, and also of many of the fusible metals used in the safety fuses in electrical work.

Lead pipe is used largely as a conductor of water and is useful as a convenient means of securing a good earth-lead for the amateur receiving-set. Joints are made in lead by a process known as lead burning, the essence of which is that the parts to be united are joined together by melting the edges of the parts or applying

molten lead from a thin strip and thus, as it were, welding the whole into a solid piece. See Accumulator.

LEAD. There are two main meanings of lead in wireless. In one case the word is used to denote a connecting wire from a terminal or piece of electrical apparatus. The use of the word in this sense has a very wide application, and may embrace almost any form of electrical conductor. A common example of lead where the word is almost exclusively used is the lead-in wire from an aerial.

Lead, in another sense, is used in connexion with the lead and lag of an alternating current, where it indicates that the current reaches its maximum value before the E.M.F. Capacity present in a circuit gives an alternating current a lead. The extent of the lead or lag is known as the phase relationship. See Alternating Current; Lag; Phase.

LEAD BATTERY. Name applied to all forms of storage battery employing lead as the chief element or plates. Most of the well-known storage batteries used in wireless work are of the lead type, having perforated or moulded lead plates filled with a paste composed principally of lead in the form of a paste. See Accumulator; Storage Battery.

LEAD-COVERED WIRE. A type of electrical insulated wire in which the wire and its insulation are surrounded in a sheath of lead which forms an entirely watertight tube. Lead-covered wire useful to the experimenter is usually sold with one or two conducting wires, examples of which are shown below. In the case of the twin wire the wires are kept parallel and the outer casing is oval or oblong in section. It is usual also to distinguish between the two wires by making a part of the insulating material of different colour. An alternative plan sometimes adopted is to tin one wire. Thus one

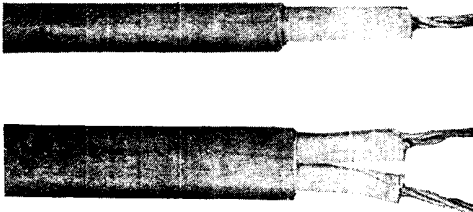

WIRE SHEATHED IN LEAD

Two examples are illustrated of wires with insulation and a covering of lead. The top is a single cable and beneath is a double cable

wire has a copper and the other a silver appearance.

This type of wire is not suitable for aerial or earth leads. Another variety of lead-covered wire differs from that shown in that a single copper wire constitutes the conductor, which in the former case is made up of three strands wound together. The latter type is more suited to requirements demanding greater flexibility.

LEAD-IN. Term used to describe the insulator and other details of that point where the conductors from the aerial enter the building. In the case of large commercial stations the lead-in arrangements are elaborate. One example is shown in Fig. 2, and illustrates the disposition of the lead-in insulators and the leads-in from the aerial at the Berne Marconi Station. In this, the leading-in insulators are large porcelain devices mounted on rectangular panels set into the wall of the building. The smaller insulators on the steel structure in the foreground are the insulators for the earth screen.

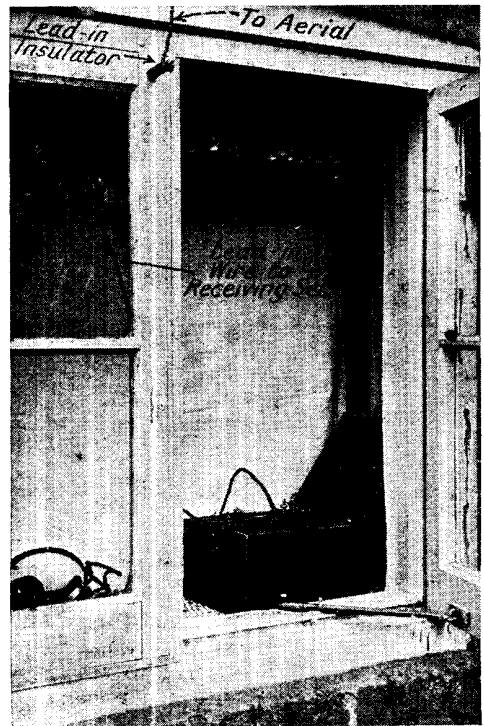

LEAD-IN CONNEXION

Fig. 1. From the aerial to the instrument the lead-in wire usually passes through a window or wall, as in the system illustrated. Connexion is made through an insulated tube, as seen at the top of a window in this case

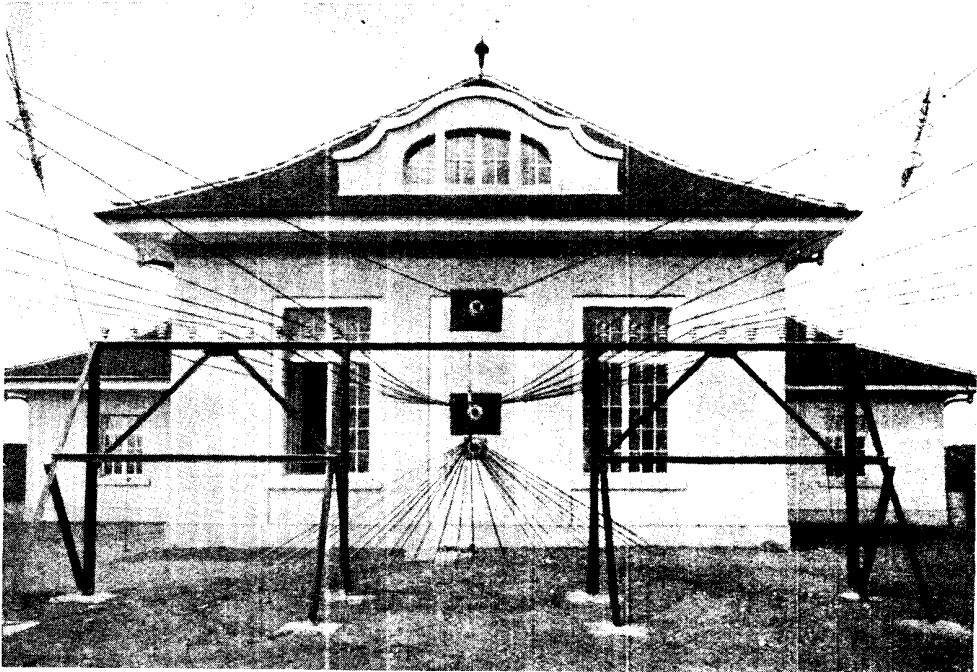

LEAD-IN AT BERNE

Fig. 2. Leading-in insulators and wires at the Berne station are shown. Beneath are the earth screen and earth connectors
Courtesy Marconi's Wireless Telegraph Co., Ltd.

The lower of the three insulated leads-in on the wall is connected to earth. For amateur purposes nothing so elaborate is necessary, and an arrangement such as that shown in Fig. 1 is generally sufficient. This consists of an ebonite or other insulating tube through which passes a stout brass rod provided with terminals at the inner and outer ends. The outer terminal is connected directly to the down lead from the aerial, and the inner may be taken either directly to the instrument or receiving-set, or, better, an arrangement such as that shown in Fig. 3 may be adopted.

In this case the terminal on the lead-in insulator is connected by a short wire to the centre contact of a two-way switch, one terminal of which is connected directly to

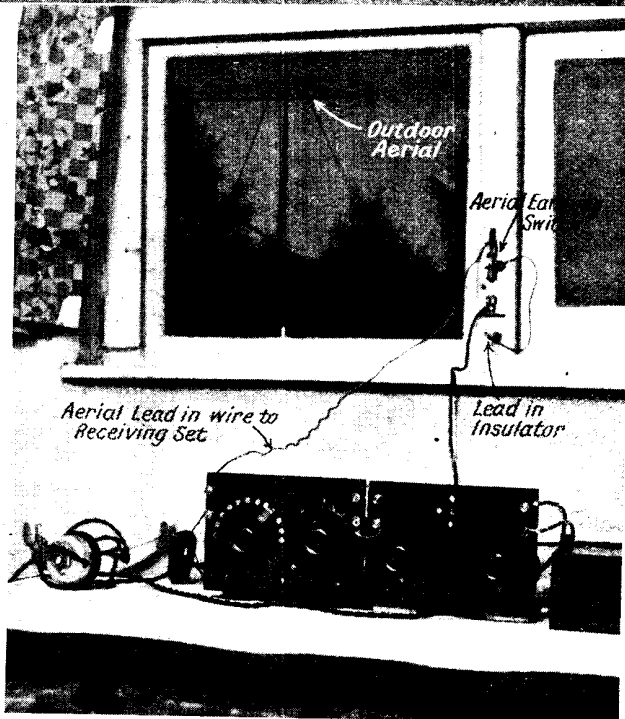

HOW A LEAD-IN APPEARS FROM INSIDE

Fig. 3. After passing through the lead-in tube the wire from the aerial is attached to the terminal of the earthing switch on the wall. The switch arm when engaging the aerial contact, as in the photograph, connects the lead-in from the aerial to the instrument

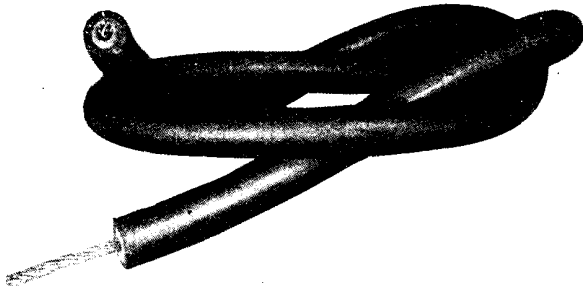

HEAVILY INSULATED LEAD-IN WIRE

Fig. 4. Wire used for lead-in purposes must be carefully insulated, and an example of suitable wire is illustrated

the aerial terminal on the receiving set and the other directly to earth and also to the earth side of the receiving set. Consequently when the lever is in the upright position, as is shown in Fig. 3, the aerial is directly connected to the receiving set. When the switch is in the down position, the aerial is earthed.

The lead-in wire used within a building must be very thoroughly insulated, and is preferably a multi-stranded copper conductor, such as that shown in Fig. 4. The lead-in wire should be as short as possible. See Aerial; Bradfield Insulator; Insulator.

LEAD-IN INSULATOR. Insulator for conducting the down lead from an aerial through the walls or window of a house to the receiving set. A lead-in insulator is generally an ebonite or porcelain tubular body with a central conducting portion composed of copper or brass. A pattern extensively used on shipboard is known as the Bradfield insulator. In large establishments the lead-in and its insulators are extremely important, but for amateur purposes a simple ebonite tube about $\frac{1}{4}$ in. to $\frac{3}{4}$ in. in diameter, and of a length appropriate to the wall or structure through which it has to pass, will answer all requirements.

The ends of such ebonite insulators are preferably capped with metal, and they have a central rod of brass or copper provided with large-diameter terminal nuts, one at each end, whereby to connect the down lead from the aerial to the lead-in wire of the receiving set. To fix such insulators in position it is merely necessary to bore a hole through the wall—and if this is of brick the hole can be made with the aid of a brick borer or jumper—set the ebonite in place, and secure with a mixture of cement and sand gauged in

equal proportions, or preferably with a mixture of pitch and sand worked in hot, especially on the outside of a building.

To protect the lead-in from rain water working down the face of the bricks, a small drip, composed of a small piece of zinc or lead, should be worked into the brick course immediately above the lead-in, to act as a form of miniature roof and divert any rain water from the insulator.

In cases where it is desired to remove the connecting wires at comparatively frequent intervals, the pattern illustrated at the bottom of the photograph has the advantage, as wing nuts are used as terminals, and this facilitates the speedy removal of the connexions. The insulator proper is composed of ebonite in the form of a tube. When possible, the insulator should be set in woodwork, and this can generally be managed by boring a hole through some part of the framework of a window or doorway opening. The insulator should be an easy, push fit in the hole, and may be secured with two or three thick coats of insulating paint, shellac varnish, or the like, to keep it firm.

Various other patterns of lead-in insulators are made, adapted for special purposes, including the type which can pass through a hole drilled through the glass of a window. Other patterns take the form of an L-shaped tube, the bowl part of which is arranged to point downwards, thus minimizing the entry of moisture.

The lead-in insulators should be inspected from time to time to see that they are in good condition, and should also be cleaned of any local dirt or foreign matter which might tend to lessen the signal strength by permitting surface leakage of the high-frequency currents. See Aerial; Bradfield Insulator.



STANDARD LEAD-IN INSULATORS

Lead-in insulating tubes are of various dimensions and patterns. Three examples are shown, and their chief difference is in the design of the terminals

LEAK. Shortened form of grid leak which is occasionally used. See Grid Leak.

LEAK : in Condensers. When a charged conductor is not completely insulated, it is said to leak, and when a condenser is shunted by a megohm or other high resistance, it is called "a leaky condenser." Such a condenser may be charged, but only for a short time; the charge is soon dissipated. Nevertheless, when the condenser is only wanted for rapid oscillations, the leak does not interfere with those oscillations, and it is convenient to have the condenser kept certainly empty, so that its oscillations shall be symmetrical and not perturbed or made one-sided or otherwise troublesome by a residual or initial charge in the condenser.

A condenser short-circuited by a good conductor is in a position to take up oscillations, the frequency of which will depend on the capacity of the condenser and the inductance of the conductor (see Oscillation). But if the conductor is of high resistance, it may be able to check the oscillations and make them dead-beat, a condition which is convenient for a galvanometer needle or other indicating instrument. If the resistance of the conductor is higher than that, the discharge becomes a leak, which may be very slow, and the potential falls down an exponential or logarithmic curve. In other words, it proceeds in a decreasing geometrical progression as time goes on. The rate of leak depends on two things, capacity and resistance. And the equation to a leak is

$$y = y_0 e^{-\frac{t}{RC}}$$

where y is the charge or the potential at any instant, t , and y_0 the initial charge or potential at the initial time, $t=0$. C is the capacity of the condenser, and R the resistance of its leak or slow discharge circuit. RC is a time, and if R is in megohms and C in microfarads, the product is a certain number of seconds.

The curve representing this equation is shown in the figure.

If we take logarithms, we get the equation in this form

$$\frac{1}{RC} = \frac{\log y_0 - \log y}{t}$$

where on the right-hand side we have the decrease of the logarithm divided by the time, which is called "the logarithmic decrement." The reciprocal of the logarithmic decrement may be called "the

time period." It equals RC , and represents the time which must elapse in order that the charge shall be reduced to $\frac{1}{e}$ of its value—that is, roughly, to about $\frac{1}{3}$ of its value; more accurately $\frac{1}{2.7}$. In double the time-period a similar decrease has gone on, and the charge is reduced to $\frac{1}{e^2}$ of its value, or about $\frac{1}{7}$; more accurately $\frac{1}{7.4}$. In three times the time-period the charge is about $\frac{1}{e^3}$ of its original value. And in ten times the time-period—which may be quite a short

time in reality—the charge is insignificant, being $\frac{1}{22000}$ of its original value.

Theoretically, a leak never dies out with absolute completeness. It is said to diminish asymptotically, like a curve which continually approaches a straight line, its zero position, but theoretically takes an

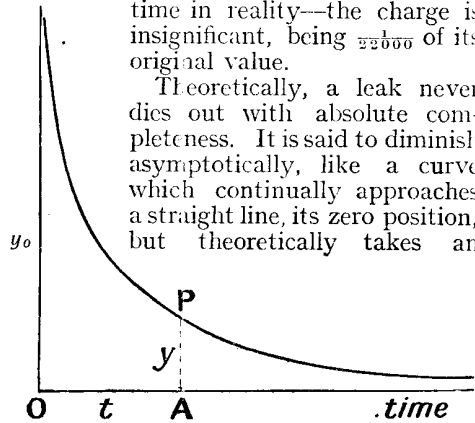

PLOTTING OF A LEAK

Charge is plotted vertically, beginning with y_0 , and at any time, OA , the charge is AP . It keeps on falling asymptotically towards zero, just as the temperature of a cooling body would fall, by the leakage of heat. The point P falls down the curve as time progresses, representing a hot body cooling rapidly at first, and then more slowly

infinite time to get there; though for all practical purposes it gets near enough to make no matter in a second or two, or perhaps in a fraction of a second.

The time-period in the electrical case is equal to the product RC , resistance multiplied by capacity. Thus suppose we have a microfarad shunted by a megohm, the time-period is one second; while 0.1 of a microfarad shunted by a megohm would have a time-period of $\frac{1}{10}$ of a second; and accordingly in $\frac{1}{10}$ of a second it would for practical purposes be completely discharged.—*Oliver Lodge, F.R.S.*

LEAKAGE. The losses in an electric current due to faulty or insufficient insulation or the presence of a conducting path across the insulation.

In the design and construction of a receiving set the possibility of leakage should be closely studied with a view to its elimination. A common cause of leakage

lies in the panel itself. Ebonite is very largely used in this connexion, and it should be well matted on both sides. Glossy-surface ebonite is not to be recommended, owing to the fact that moisture is more prone to condense on it than on a matted one. Only good quality ebonite should be used. Inferior ebonite contains all sorts of materials which may tend to spoil insulation properties.

Terminals should not be placed near the edge of a panel where it touches the cabinet of the set or other medium which is not a good insulator. Apart from possible leakages in the ebonite itself, dirt and dust may collect between the terminals and the case, and bridge the insulation between them.

The use of a pencil should be avoided in marking out wireless panels, as the lead constitutes a conducting path through which currents will leak. In the same way soldering acid or fluxite remaining between contact studs will cause leakages. If not actually conductors in themselves, their sticky surface will collect dust, which is always an enemy to good insulation.

Another type of leakage met with in high-power circuits is the brush discharge. This constitutes a blue sibilant glow at a point or jagged edge of the conductor, and indicates a continuous discharge into the atmosphere, or towards a neighbouring conductor. In condensers at high potential this trouble is lessened or overcome by immersing the plates in a high-dielectric oil. See Dielectric; Fault-finding; Insulation.

LECLANCHE CELL. The Leclanché cell is a primary cell of the one-fluid type, used where intermittent currents of electricity are required, as in bell circuits and telephony. The electro-motive force of a single cell is about 1.5 volts, but, as this soon drops on circuit owing to slow depolarization, it is customary to take 1 volt as the effective electro-motive force unless the current required is very small.

The ordinary pattern of Leclanché cell is shown in Fig. 1. This consists essentially of a zinc rod immersed in ammonium chloride solution and a carbon plate in contact with a depolarizing compound containing manganese dioxide. When an electrical circuit is completed by connecting the terminals of the zinc and carbon poles a continual discharge of ions occurs, as shown diagrammatically in Fig. 2.

The chlorine ion liberates its negative charge of one electron and becomes

nascent (atomic) chlorine. The chlorine in its nascent condition attacks the zinc electrode, the resultant zinc chloride passing into the solution. The ammonium ion is attracted to the carbon plate, where it receives a neutralizing electron therefrom, and then proceeds to break up into ammonia and hydrogen. Hydrogen gas would collect on the surface of the carbon and "polarize" the cell, were it not for

the oxidizing action of the manganese dioxide.

The components of an ordinary pattern Leclanché cell are shown separately in Fig. 3. The outer glass container is a square jar (made in capacities of one pint, quart, and three pints), the upper end of which is dipped in melted paraffin or ozokerite to prevent "creeping" of the electrolyte to the outer surface. This jar has a circular aperture to take the porous cell, with a lip

at one corner for insertion of the zinc rod forming the positive electrode. The porous earthenware pot forming the central negative element of the cell contains a central plate of carbon embedded in a compost of manganese dioxide granules and broken gas carbon. The carbon plate consists usually of ground retort

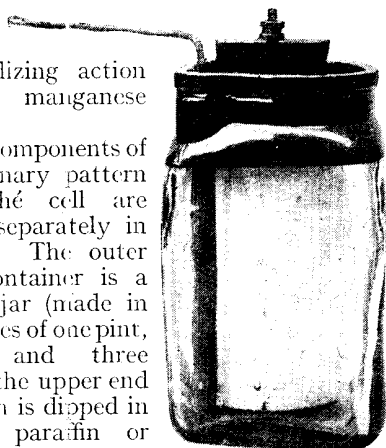

ONE-FLUID
LECLANCHE CELL

Fig. 1. Zinc and carbon electrodes are used in the Leclanché primary cell of the one-fluid type illustrated

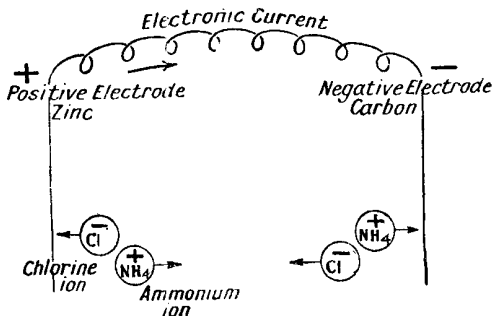

CHEMICAL ACTION IN LECLANCHE CELL

Fig. 2. In the above diagram the chemical action which takes place in a Leclanché cell is represented

carbon mixed with tar and moulded under pressure. The terminal is often screwed directly into this and the head coated with black varnish to stop the salt creeping up to the metal. The pot is sealed up with a mixture of black wax and pitch, two vent holes being left for escape of ammonia gas.

To actuate the cell sal-ammoniac is dissolved in water (3 oz. to one pint being the most satisfactory proportion for general use). This solution is poured into the outer jar, and also down the vent holes if the cell

high value for many months, provided the cell stands for a few minutes between each current pulse. Leclanché cells are therefore largely employed for energizing electric bells, buzzers and other devices calling for an intermittent current.

The following figures relate to ampere-hours of quart-size Leclanché cells with

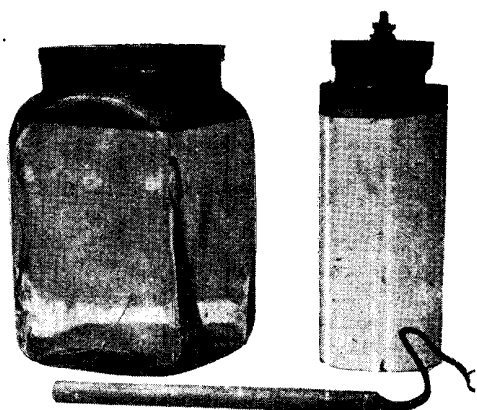

Fig. 3

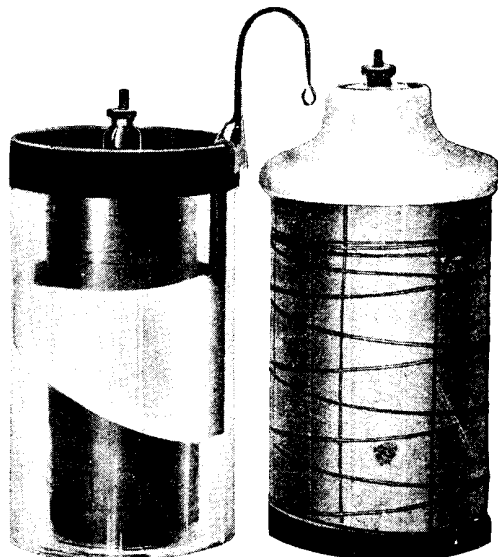

Fig. 4

Fig. 5

EXAMPLES OF LECLANCHE CELLS AND THEIR ELEMENTS

Fig. 3. Components of the ordinary Leclanché cell are shown, comprising the square-shaped jar, porous carbon cell and zinc rod. Fig. 4. This is a Post Office form, known as the sack Leclanché cell, and is more efficient than that in Fig. 1, having about one-eighth of its resistance and nearly three times its amperage. Fig. 5. The negative element of the cell in Fig. 4 is shown. This consists of a central carbon electrode and a canvas cover, between which is packed powdered manganese and string

Courtesy Siemens Bros. & Co., Ltd.

is required for use the same day. Some porous pots have saw cuts at the bottom to ensure quick penetration of the chemical excitant. Undissolved sal-ammoniac reduces the voltaic activity of the cell, as the solution is liable to become supersaturated and deposit crystals on the surface of the zinc electrode. The zinc rod is often amalgamated with mercury.

In more expensive types this electrode may consist of zinc-mercury amalgam throughout, as incrustation takes place less readily thereon. An improved form of porous pot centre is sold which is filled with manganese dioxide powder. The increased cost is more than repaid in better current output and increased life in the cell.

One feature of the usual form of Leclanché cell is the fact that it will yield an intermittent current of comparatively

porous pots $5\frac{1}{2}$ in. by $2\frac{1}{2}$ in., of old and new types respectively. The numbers relate to hours required to reduce voltage to 1 volt and 0.75 volt, the latter being the limit of useful life.

| Type of cell | Amp.-hours to reduce voltage to | |
|------------------|---------------------------------|-----------|
| | 1 volt | 0.75 volt |
| Ordinary pattern | 12.4 | 17.6 |
| Improved pattern | 14.4 | 39.7 |

The ordinary pattern of Leclanché cell has a comparatively high internal resistance. The newer forms of cell overcome this objection and give heavier currents and longer life.

The Post Office form of Leclanché cell with sack centre shown in Fig. 4 gives two to three times the amperage of the

older pattern and has about one-eighth the resistance. The best depolarizing mixture contains, within narrow limits, about 80 per cent of powdered manganese dioxide and 20 per cent of carbon, moistened to permit ramming firmly between the canvas cover and the carbon electrode. The base of the sack element is wood.

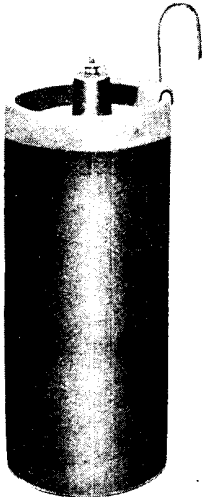
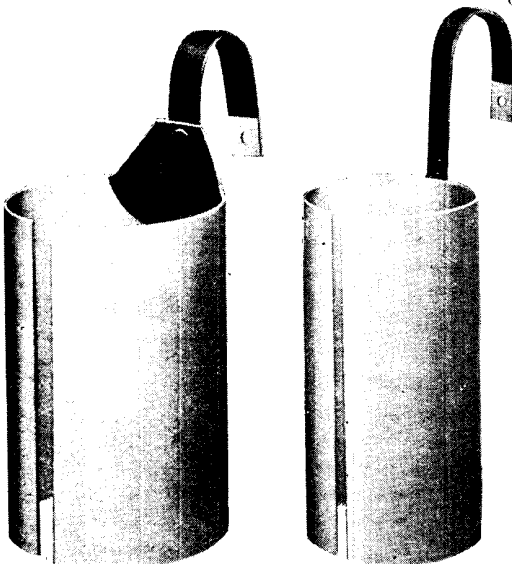

Fig. 6. Siemens sack Leclanché cell of large capacity

The zinc electrode takes the form of a cut-away cylinder with hook suspension from the edge of the cylindrical outer jar. The reason for the shape of the plate is that the zinc dissolves away chiefly at the shank side. A steady large output of current is the object of the Leclanché sack cells of the type shown in Fig. 4.

The agglomerate block cell is a form of Leclanché cell of low resistance (without porous pot), separately described under the heading Agglomerate Leclanché.



CYLINDRICAL LECLANCHE CELL ELECTRODES

Fig. 7. Two types of the cylindrical zinc electrodes used in the Leclanché cell in Fig. 6 are illustrated. A third type is shown in Fig. 4

Courtesy Siemens Bros. & Co., Ltd.

Central zinc Leclanché cells are designed to prevent evaporation of water. The Leclanché Barbier cell is the best known of these. In this the electrolyte is in contact with a central zinc electrode sealed in the stopper and a hollow cylinder of porous agglomerate. The latter is formed by heating a moulded mixture of plumbago, carbon and manganese containing sufficient sulphur to render the mass porous when it gasifies on heating.

So-called dry cells are Leclanché-pattern cells with the electrolyte in paste form for convenient transportation.

A discharged Leclanché cell may be partially revived by adding fresh solution of electrolyte, but its useful E.M.F. is considerably less. A new porous pot is essential if real efficiency is desired. As the zinc rod has generally become rotten also, resuscitation of the cell usually means replacement of all parts except the external jar.

Maintenance of Leclanché cells consists mainly in replacing water lost by evaporation. The zinc rod should be kept free from deposited crystals. In buying sal-ammoniac from the chemist or oil store only white crystals should be accepted, dirty grey or brown-coloured crystals introducing impurities leading to local circuits and impaired efficiency of the cell.—*W. A. Whatmough.*

See Agglomerate Leclanché; Bunsen Cell; Daniell Cell; Dry Battery; Primary Cell.

LEFT-HAND RULE. This is the term often used for Fleming's rule upon the directions of force, current and magnetic lines when applied to motors. The rule may briefly be stated as follows: Let the forefinger of the left hand point in the direction of the magnetic lines of force and the middle finger in the direction of the current sent through the wire. If the thumb is held at right angles to these two directions it points in the direction of the mechanical force acting to move the wire. See Fleming's Rule.

LENGTHENING COIL. A variable inductance used in connexion with an aerial, for increasing its wave-length to that of the transmitting station which it is desired to receive. The lengthening coil is more commonly known as an aerial tuning inductance (*q.v.*). It may comprise any of the types of variable inductances.

LENZ LAW. This is a law which states that in the case of mutual motion of circuits, or circuits and magnets, the induced effects will always be such as to oppose the motion. If an alternating or varying current flows through a coil which is inductively coupled to another coil containing a galvanometer in its circuit, the induced current set up in the latter will be in an opposite direction to that in the primary coil and both coils will be mutually repelled.

If the primary coil is rapidly withdrawn from the other coil, an induced current will be set up in the other coil which will cause mutual attraction and tend to pull the coils together. This also happens if the current is cut off or reduced. See Induction; Mutual Induction.

LEPEL SYSTEM. System of wireless telegraphy due to Baron von Lepele. Fig. 1 shows diagrammatically the Lepele quenched spark gap. A, A are two disks forming the electrodes, usually made of brass, copper or delta metal, and separated by a disk of paper, B. The two electrodes are surrounded by water for cooling purposes. The paper disk has a small hole

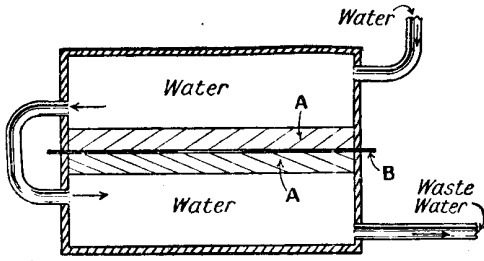

LEPEL SPARK SYSTEM

Fig. 1. Metal electrodes, A, A are separated by a paper disk, B, in the Lepele quenched spark gap

in its centre through which the spark first passes. The spark gradually burns the paper away towards the outside edge, and the paper, therefore, has to be renewed at regular intervals. The paper is impregnated with paraffin, and is from five to ten thousandths of an inch in thickness. Fig. 2 (a) and Fig. 2 (b) show two other forms of the gap, A and B having the same meaning as for Fig. 1.

In all three forms the paper washers used project beyond the edges of the metal electrodes. Fig. 2 (a) shows a spark gap for small power, and is not water-cooled, while Fig. 2 (b) shows the spark gap in the form of two metal cone surfaces separated by paper.

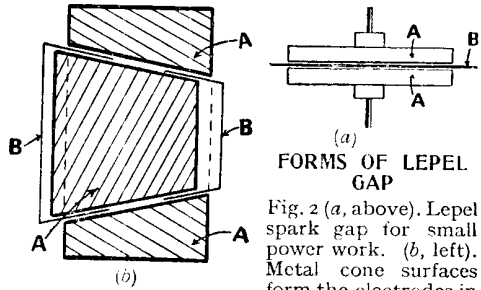

FORMS OF LEPEL GAP

Fig. 2 (a, above). Lepele spark gap for small power work. (b, left). Metal cone surfaces form the electrodes in this type

Fig. 3 shows how the spark gap is coupled directly to the aerial, the auxiliary oscillating circuit being shown dotted. The effect of this auxiliary circuit is to cause the gap to give out a musical note in the same way as the Duddell musical arc. Without the auxiliary circuit, the oscillations in the aerial circuit are not damped.

The aerial in Fig. 4 is inductively coupled to the spark gap, the auxiliary circuit for damping being shown dotted, as in the case of the circuit diagram shown in Fig. 3. The Lepele system, it is clear, therefore, may be used for undamped wave transmission, or damped waves, and the receiving system is usually so arranged that it can receive on either system.

Fig. 5 shows the circuit diagram for the

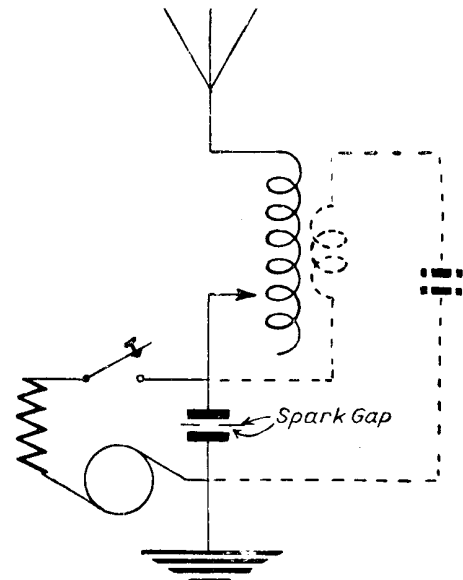

CIRCUIT CONNEXIONS FOR LEPEL GAP

Fig. 3. How the Lepele spark gap is coupled direct to the aerial is shown. The auxiliary oscillating circuit is dotted

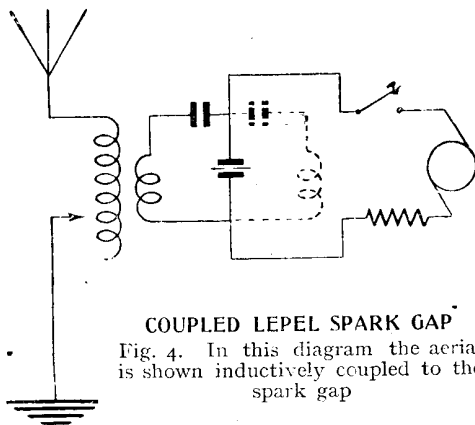

COUPLED LEVEL SPARK GAP

Fig. 4. In this diagram the aerial is shown inductively coupled to the spark gap

transmitter under this system. The spark gap is connected in series with two choke coils, an iron wire resistance, and a manipulating key, to the direct current supply of 500 volts. The arrows show the circulation of the water-cooling system of the spark gap.

The current supply is steadied by enclosing the resistance in a hydrogen-filled glass tube. An inductance coil formed from copper strip wound in a cylindrical shape and a mica condenser form the main oscillating circuit, which is coupled to the aerial circuit. The auxiliary circuit is shown dotted with the usual mica condenser

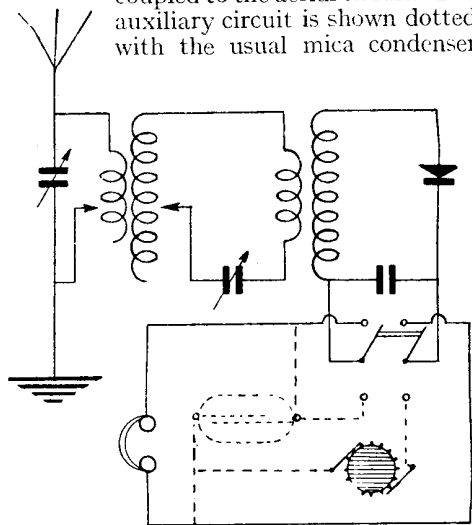

RECEIVING CIRCUIT WITH LEVEL SYSTEM

Fig. 6. For damped waves the crystal detector and telephones are used. For undamped waves a throw-over switch brings in the tinker interrupter and a special condenser

and inductance coil. The latter is tapped to keyboard switch contacts.

A switch, A, enables the auxiliary circuit to be joined across the spark at will, and the transmitter emits the musical note of the Duddell musical arc, a note which may be varied by the keyboard switching arrangement on the inductance coil.

The receiving circuit is shown in Fig. 6. The aerial circuit is inductively coupled to an intermediate circuit, which, in turn, is inductively coupled to the detector circuit. For the reception of damped

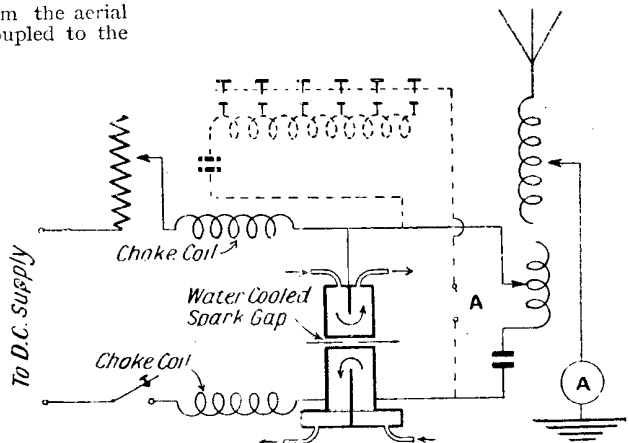

TRANSMITTER EMPLOYING LEVEL SYSTEM

Fig. 5. Included in the above arrangement is a LepeL spark gap used in conjunction with a transmitter. It will be seen that there are two choke coils in series with the water-cooled spark gap

waves the crystal detector and the telephones are used. For the reception of undamped waves a throw-over switch brings in a tinker interrupter in series with the telephones and a specially constructed condenser. This condenser consists of two plates sealed in a glass container, which is filled with an electrolyte. The passage of the current causes a film of gas to form on the plates, and this film acts as the dielectric. The energy stored up by this condenser is discharged by the tinker interrupter. See Duddell Musical Arc; Poulsen Arc; Quenched Spark Gap.

LEVEL. The level is an instrument intended for ascertaining the relative position of an object in respect to the horizontal plane. In the ordinary use of the word the level consists essentially of a glass tube closed at each end, and containing a liquid wherein a bubble of air is imprisoned. The tube is mounted either



Fig. 1. One of the most useful instruments for the wireless experimenter who carries out his own woodwork construction and makes his own cabinets is the carpenter's level here seen in use. This pattern of level is usually 9 in. long and is inexpensive

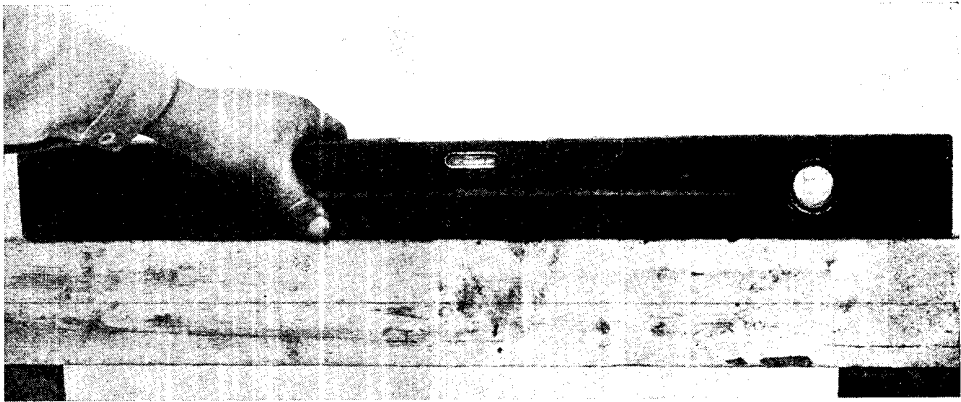

Fig. 2. The builder's level is a larger type than the carpenter's level, and the bubble may be seen from the side or from the top

CARPENTER'S AND BUILDER'S LEVELS AS USED IN GENERAL CONSTRUCTION

on a wood or metal holder or bar, which may be of any convenient size or shape, according to the purpose of the level.

Alternatively, the tube, or bubble, as it is sometimes called, may form an integral part of a piece of apparatus, such as a theodolite or an inclinometer. It is also similarly applied to some workshop tools, such as a breast drill. The experimenter will find the ordinary carpenter's level,

such as that illustrated in Fig. 1, is an indispensable tool. It is inexpensive, and the ordinary 9 in. level will suffice.

The body of the level is usually made of hardwood, the upper surface being strengthened with a plate of polished brass, slotted to permit of inspection of the bubble. A small centre cross mark is located in the middle of the length of the level, and when properly adjusted by the



BUILDER'S LEVEL USED VERTICALLY

Fig. 3. How to use a builder's level to test a piece of wood or upright structure to see whether it is vertically in truth. The position of the bubble is observed in the top circular window

makers, the bubble, when the level is at rest horizontally, should appear an equal amount on either side of this centre piece.

In use it is customary to place the level upon a batten of smooth, straight wood and to raise or lower this while observing the position of the bubble. When the latter is central, the batten is packed up with a wood block, and its surface is then horizontal, and measurements may be taken from it or it may be used in any desired manner, as, for instance, when setting a bench top level. The level only indicates correctly in an axial line through the centre of the length of the level, and, consequently, to get a surface horizontal, the level must be used first in one direction and then in a direction at right angles to it, several tests being necessary to make the surface horizontal.

A larger type of level, shown in Fig. 2, is known as the builder's level and comprises a long, hard-wood body, the bubble being inserted below the level of the upper surface so that it can be inspected from the side as well as the top. A second bubble is set diametrically across a circular hole near one end of the body, and is at right angles to the principal bubble. Such a tool is very necessary for constructional work, as, for instance, making a brick foundation for a small building, such as a workshop or wireless experimenter's room.

If this type of level be inverted and held in an upright position, it can be used to test the uprights by observing the position of the bubble through the circular window. When the bubble is exactly midway between two lines drawn on the tube, the

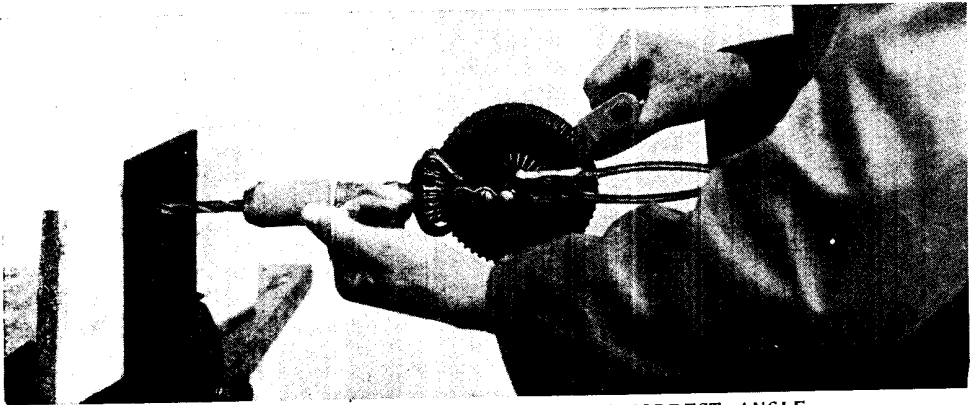

LEVEL USED FOR BREAST DRILLING AT CORRECT ANGLE

Fig. 4. Breast drills are sometimes fitted with a level, and the wireless experimenter will find this arrangement extremely useful for accurate drilling, especially in such a case as that illustrated, where a hole for a bush is being drilled squarely in a panel

upright surface of the level is vertical. This is shown in Fig. 3.

On breast drills a level is often built into the stock, and one such example is shown in Fig. 4. The object in this case is to enable the operator to judge when the drill is in an horizontal position, and thereby improve the accuracy of the drilling. It is comparatively easy to judge whether the drill is square with the work, but impossible to see if it is inclined, except by observation of the level.

LEYDEN JAR. A form of condenser used chiefly in experiments dealing with

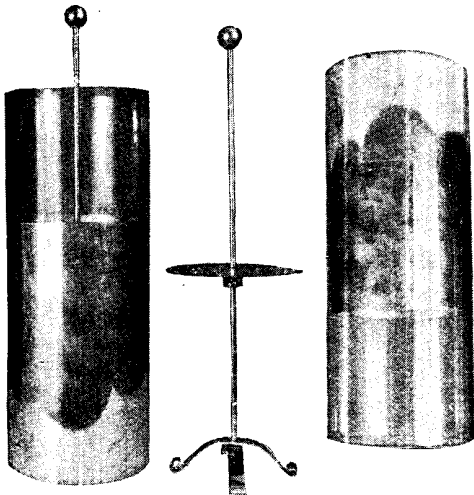

LEYDEN JAR AND COMPONENTS

Fig. 1 (left). Sir O. Lodge used this form of condenser to show that the discharge was oscillatory. Fig. 2 (right). Components of the jar are the metal rod with brass knob at the top, and a tripod base which makes contact with the inner lining of tinfoil.

static electricity and so-called from the town where its properties were originally investigated. The usual type consists of a jar of flint glass, provided with an inner and outer coating of tinfoil up to a certain height, the uncovered portions being varnished with shellac for insulating purposes.

A wooden cover fitted to the top of the jar supports, through its centre, a brass rod terminating externally in a round knob and supplied internally with a metal chain, which hangs down to make contact with the inner coating of foil. In a further type, attributed to Lord Kelvin, this inner foil is replaced by strong sulphuric acid, contact being secured by a leaden foot immersed therein. This form possesses an advantage in that the acid acts as a drying

agent and aids insulation. In the type shown in Fig. 1 an upright metal rod with a tripod bottom stands in the jar. Fig. 2 shows the internal construction.

The charging process is carried out by connecting the terminal in contact with the interior of the jar to the prime conductor of a static machine and the exterior to earth. The safest method of dissipating the charge is by means of discharging tongs, which consist of a pair of metal arms terminating in a brass knob and equipped with an insulating handle. The two coatings of this jar can thus be placed in metallic contact, though this is not usually necessary, as the spark which occurs when the terminal is approached by one arm of the tongs is sufficient to carry out the discharge.

It should be noted that the seat of the charge is in the glass dielectric. See Electrostatic Capacity; Lodge Syntonic Jars.

L.F. This is the standard abbreviation for low frequency. L.F.C. is similarly the abbreviation for low-frequency current, and L.F.I.C.I. that for low-frequency iron-core inductance.

Li. This is the chemical symbol for the element lithium, the lightest known solid.

LICENCE. All holders of wireless apparatus must have a licence of some kind. For the amateur and experimenter three types of licence are obtainable:

1. The experimental licence, which is issued to properly qualified amateurs to enable them to carry out experimental work.
2. The constructor's licence, which is issued to anyone wishing to construct his own apparatus for receiving wireless broadcast.
3. The broadcast licence, which entitles the holder to receive wireless broadcast on a receiver bearing the seal of the British Broadcasting Co.

In order to be entitled to obtain an experimental licence the following regulations are laid down by the Postmaster-General:

1. The applicant shall produce evidence of British nationality and two written references as to character. A certificate of birth should be furnished if possible; but this will not be insisted on if the referees testify of their own knowledge that the applicant is of British nationality. The referees should be persons of British birth and of standing, not related to the applicant.

In the case of a company, society, or other body, application should be made by one of the principals. Any permit granted will be issued in his name, and he will be personally responsible for the observance of its terms.

2. The installation shall be subject to the approval of the Postmaster-General, and shall be open to inspection at all reasonable times by properly authorized officers of the Post Office.

3. Secrecy of correspondence shall be observed.

4. Applicants must satisfy the Postmaster-General that they have in view some object of scientific value or general public utility, and that they are competent to carry out experiments in wireless reception.

5. The apparatus shall be used in such a manner as to cause no interference with other stations. In particular, between the hours of 5 p.m. and 11 p.m. on weekdays and all day Sunday any oscillating valve or valve circuit employing magnetic or electrostatic reaction must not be directly coupled with the aerial or the aerial secondary circuit over the range of wave-lengths between 300 and 500 metres. The use of separate heterodyne circuits coupled with the aerial or the aerial secondary circuit over the range of wave-lengths between 300 and 500 metres is similarly restricted.

That is to say :

(i) Any reactive arrangement or a separate heterodyne oscillator may be used directly coupled with the aerial or the aerial secondary circuit on all waves at all times, with the exception of the range of wave-lengths between 300 and 500 metres, provided no interference is caused with other stations ;

(ii) For the range of wave-lengths between 300 and 500 metres—

(a) The use of reaction or a separate heterodyne oscillator as in (i) is permissible between the hours of 11 p.m. and midnight, and from midnight till 5 a.m., Sundays excluded.

(b) The use of reaction or a separate heterodyne oscillator directly coupled with the aerial or the aerial secondary circuit is not permissible between the hours of 5 p.m. and 11 p.m. on weekdays

and all day Sunday. If the use of reaction or a separate heterodyne oscillator is desired on these waves during these hours, the reaction or separate heterodyne oscillator must be so arranged that a valve is interposed between the aerial circuit or circuits and the circuit with which the reaction or separate heterodyne oscillator is coupled.

6. A fee of ten shillings in respect of each experimental station is payable annually in advance so long as the licence remains in force.

The period covered by the first payment expires as follows :

If the licence is taken out during the three months ended

March 31st.—On Dec. 31st in same year.

June 30th. „ Mar. 31st following year.

Sept. 30th „ June 30th „ „

Dec. 31st „ Sept. 30th „ „

7. AERIALS. Dimensions allowed are as follows: combined height and length not to exceed 100 ft.

8. PORTABLE STATIONS (*i.e.* field stations). General conditions same as for fixed stations.

Use will ordinarily be authorized only within a radius of 10 miles of a fixed point.

A constructor's licence can be obtained at all head and branch post offices and certain sub-offices. An application form must be obtained and filled in. The fee for the licence is 15s. There is no stipulation regarding the use of a set marked "B.B.C.," so that the holder of this licence is at liberty to make his own set from parts. No parts of foreign manufacture are to be used by holders of this licence.

The broadcast licence can be obtained at head and branch post offices on application. The fee payable is 10s. and the licence is only valid for instruments bearing the official stamp of the British Broadcasting Co. See Transmission.

LIEBEN-REISZ VALVE. Soft vacuum valve invented by Lieben and Reisz, and first used by them for low-frequency amplification. The valve, which is here illustrated, was really divided into two parts, separated by a perforated plate which performed the function of the grid in the ordinary three-electrode valve. The plate is in the upper part of the valve, and consists of a helix of aluminium wire, the grid being also of aluminium.

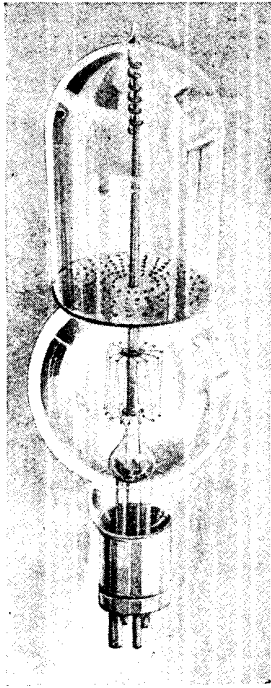

LIEBEN-REISZ VALVE

This is a soft vacuum valve with a perforated plate acting as a grid and filled with mercury vapour

range of colours of the spectrum. Below the red waves are the infra-red waves, and below them the waves used in wireless telegraphy and telephony, the longest waves of all. Above the violet waves of light are the ultra-violet, X, and gamma rays. The only difference between all these rays is that of frequency. See Arc Transmitter; Electricity; Electron; Selenium; Waves.

LIGHTNING ARRESTER. Device for protecting a receiving set from a lightning flash. It usually takes the form of a change-over switch, and several such types are described under the heading Earth Switch.

The lightning arrester illustrated in Fig. 1 is of the vacuum type, and is fitted with a fuse for additional protection. The protector itself is in the centre, and takes the form of a spark gap with a minute space between the elements. Serrations are made on the facing edges of the elements in order to increase the surface area. The gap is supported in an exhausted glass tube having a metal cap at either end. These caps are held in spring clips, which

allow of easy removal when replacement is considered necessary. It is claimed that the vacuum protector will stand repeated discharge before replacement is necessary, and in this connexion is cheaper than the open carbon-block type, which may easily be burnt out after one large discharge.

The cartridge fuse which is shown on the right of the vacuum tube is designed to carry a maximum current of 3 amperes. A knife switch across aerial to earth is fitted, which allows any lightning discharge to run straight to earth without touching the arrester or fuse. This switch may be closed when the set is out of use and must be opened when receiving signals. The arrester then takes up the duty of providing adequate protection.

The internal construction is shown in Fig. 3. The two elements forming the gap are clearly illustrated. It will be seen

A lightning arrester of the metal-carbon gap type is illustrated in Figs. 2 and 3. Fig. 2 shows the whole instrument with its cover in position. The latter is slotted in order that the interior may be accessible to the atmosphere, but at the same time fully protected from mechanical injury and the adjacent apparatus protected from damage by fire.

The internal construction is shown in Fig. 3. The two elements forming the gap are clearly illustrated. It will be seen

The internal construction is shown in Fig. 3. The two elements forming the gap are clearly illustrated. It will be seen

The internal construction is shown in Fig. 3. The two elements forming the gap are clearly illustrated. It will be seen

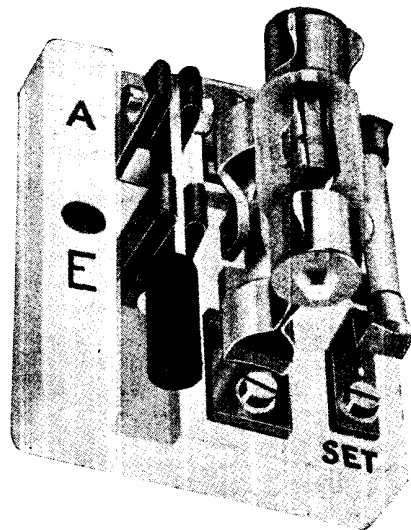

SIEMENS LIGHTNING ARRESTER

Fig. 1. Additional protection is provided in this vacuum type of arrester by the inclusion of a fuse. The knife switch on the left is shown closed, joining aerial to earth. It is opened when the receiving set is in use

Courtesy Siemens Bros. & Co., Ltd.

that the metal part is in the form of a vertically fixed U-shaped formation. This is in close proximity to a block of carbon, the front of which is cut to fit closely to the groove in the metal. In order to ensure that the two elements cannot actually touch they are separated for most of their width by a piece of thin mica.

Porcelain is the material used for the base, and it is on this that the terminals are mounted. One terminal is connected to aerial and the other to earth, and it is best to make these connexions at a point as near to the aerial as possible. If the earth lead to the set is long, and another earth nearer to the aerial is a possibility, it is to that that the arrester should be connected. See Earth Switch; Knife Switch.



Fig. 2. If the earth lead to the receiving set is long, a short earth lead should be provided for this lightning arrester



Fig. 3. With the cap removed, the interior of the metal-carbon gap type of lightning arrester is seen in this photograph, and the two elements forming the gap are clearly visible. The base is of porcelain, and screw holes are provided for attachment to a permanent structure. One of the terminals is connected to earth and the other to the aerial

METAL-CARBON GAP TYPE OF LIGHTNING ARRESTER

LIGHTNING SWITCH. This is an alternative name for earth switch, a switch which enables the aerial and earth of a receiving set to be directly connected without passing through the set, in case of a lightning flash striking the aerial. See previous entry and Earth Switch.

LIME. An oxide of calcium, obtained by burning limestone, chalk or marble, containing a large proportion of calcium carbonate, or carbonate of lime. Its use is chiefly confined to the preparation of mortar for building operations, and as a matrix for making concrete. Its use in wireless work is limited to constructive work, such as the preparation of the foundations for a workshop, erecting brick walls, and work of a similar nature. It is also used for making plaster. Lime can be obtained from builders' merchants

in bags in varying quantities, and when thus procured is a greyish-looking powder. Before it can be used for building operations it is necessary that it be slaked, that is, soaked in water for a considerable time, and used for mixing with sand or other ingredients when in a plastic state. For making concrete it is not so good as Portland cement, and when making beds for lathes and the like, the latter should be used in preference.

LIMITING DEVICE. Any device for limiting the maximum response of a receiver, whatever the strength of the incoming impulse.

The expression is used chiefly in connexion with interference preventers, limiting devices being used to limit those signals which it is not required to hear. One method of imiting or even eliminating

altogether such undesirable signals is by means of balanced crystals, that is, two or more crystals working in opposition to one another. Such a method is described under Balanced Crystals. Two rectifying valves may be used the same way.

Another type of limiter is illustrated, and takes the form of a circular box containing essentially an automatic relay. The purpose of the device is to limit the amount of effective current that can flow at a given time. In practice the appliance is so arranged that when the current supplied for illuminating a number of lamps increases beyond a predetermined maximum the lights burn with a flicker and are rendered valueless as efficient illuminants. This state of affairs is remedied by switching off some of the lights until those left burning give a steady light.

The device operates on the principle of the relay, and when the current exceeds the predetermined amount, the relay partially breaks the circuit, thus giving the intermittent lighting effect. See Bellini-Tosi Aerial; Direction Finder; Frame Aerial; Interference Preventers; Static.

LIMITING VOLTAGE. Low-frequency amplifying, or note-magnifying, is carried out by two separate methods, one involving a capacity-resistance coupling of the valves, and the other employing inter-valve transformers.

The former method is illustrated in Fig. 1. Here valve No. 1 acts as a detector, and rectifies any oscillation set up in the

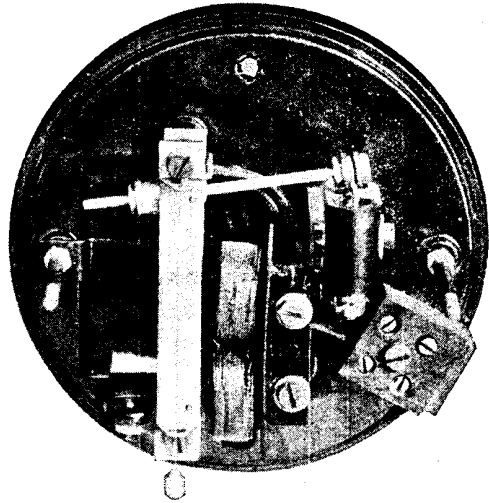

AUTOMATIC LIMITING DEVICE

Acting on the principle of the relay, this automatic device prevents too much current passing
Courtesy Chamberlain & Holtkam

circuit L, C into an audible-frequency rise and fall of the anode current through the resistance R_1 . The grid of No. 2 valve is coupled to the anode of valve No. 1, through a condenser C_1 , and therefore its potential rises or falls at audio-frequency also, and is responsible for causing a similar rise and fall of the anode current through resistance R_2 . In like manner, second and third amplifications are effected through valves Nos. 3 and 4.

The transformer-coupled note magnifier is illustrated in Fig. 2, valve No. 1 acting

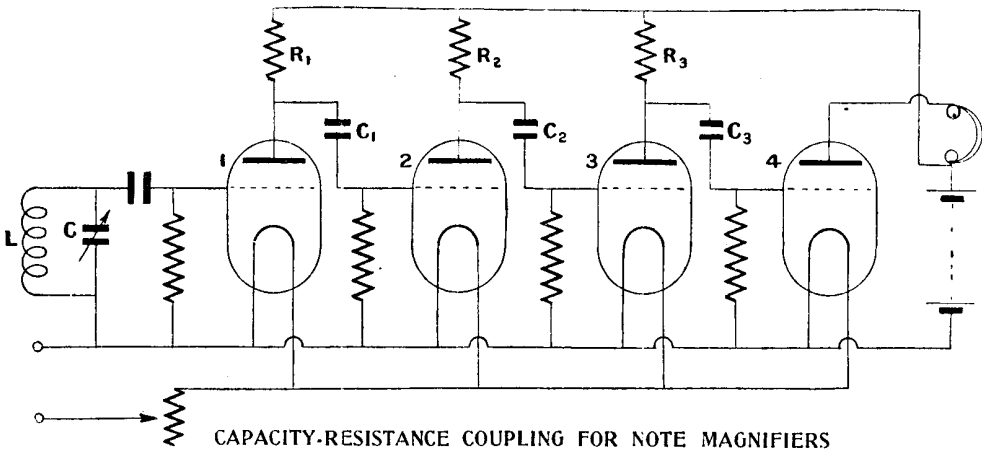

CAPACITY-RESISTANCE COUPLING FOR NOTE MAGNIFIERS

Fig. 1. Capacity-resistance coupling is employed in this circuit, where valve 1 is the detector, with the second valve coupled to its anode, through the capacity C_1 . The remaining valves are similarly coupled. This and the succeeding circuit illustrate the difficulty that arises in amplifiers due to magnification of unwanted signals. Limiting grid voltage affords one means of attacking the problem

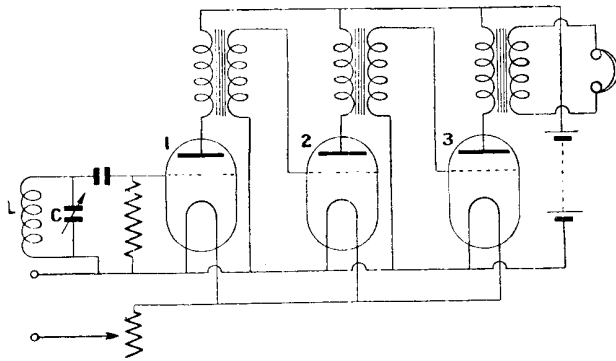

TRANSFORMER-COUPLED NOTE MAGNIFIER

Fig. 2. As in Fig. 1, the first valve is the detector, but instead of the voltage being limited by the resistance coupling method the valves are transformer-coupled.

as a detector in the same way as Fig. 1. In general, it is customary to use transformer coupling for high-frequency amplifying, and capacity-resistance coupling for note magnification by reason of their respective efficiencies.

One of the great difficulties involved in the use of amplifiers, whichever means of coupling is employed, is that atmospherics and other interferences are very liable to amplification also, even to the extent of drowning the required signal.

There are two methods of coping with this difficulty, one depending upon a "balancing" action at the detecting valve, and the other by causing a "limiting" effect to take place. The balancing effect is obtained by adjusting so that the weak signal sought for is rectified and made audible, but any stronger signal is not

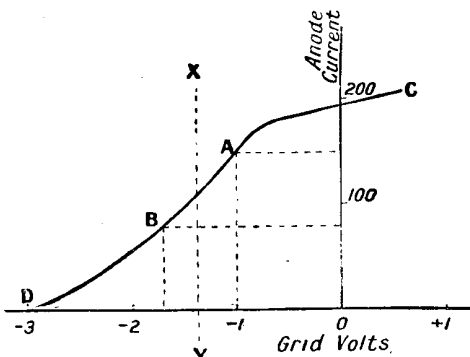

BALANCE METHOD OF INTERFERENCE LIMITATION

Fig. 3. By reducing filament current, variation of grid potential results in greater rectification of wanted signals than of interferences. If filament emission is at a maximum both sets of signals are rectified

rectified, and is therefore more or less inaudible. Referring to Fig. 3, it is possible, for example, to reduce the filament current by means of a rheostat until the maximum filament emission is, say, 200 micro-amperes, the grid potentiometer being adjusted to a negative value of 1 volt, for instance, indicated by the dotted line X, Y. Suppose, now, two waves to be applied to the grid and filament, the first of which varies the grid potential plus or minus 0.4 volt, and the second plus or minus 2 volts. The effect of

the first wave is shown as a variation of grid potential between the points A and B, giving an increase in the anode current

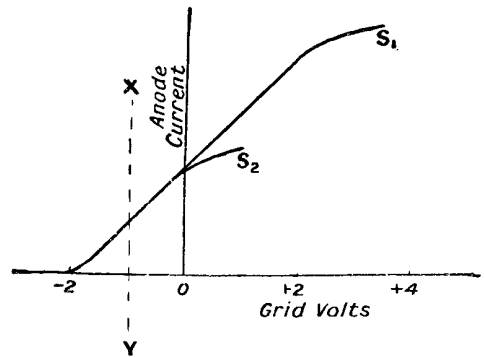

LIMITING INTERFERING SIGNALS

Fig. 4. In this method strong interfering signals are cut down without affecting the strength of a weak signal by limiting the grid voltage

during positive half-cycles of 100 to 150 micro-amperes (which is an increase of 50 micro-amperes) and a decrease during the negative half-cycles of 100 to 70 micro-amperes (a decrease of 30 micro-amperes). This gives a rectification for each cycle proportional to $50 - 30 = 20$ micro-amperes.

The second wave will vary the grid potential between points C and D, giving an increase of 100 to 200, and a decrease of 100 to zero, resulting in no rectification at all, and an inaudible signal.

The alternative method of "limiting" will be understood by reference to Fig. 4, and aims at cutting down a strong interfering signal without affecting the strength of a weak one, by limiting the grid voltage. To accomplish this control, a separate

filament rheostat and grid potentiometer are required for the detecting valve.

If S_1 in Fig. 4 represents the saturation anode current of the detecting valve when burning at normal brilliancy, S_2 may be taken as the performance with the filament current reduced by means of the aforesaid rheostat. It is now evident that no signal, however loud, can be reproduced with a greater strength than that represented by curve S_2 , since this is the maximum amount by which the anode current, and hence the telephone current, can vary. If the notes are distinctive, therefore, the weak signal can be read over the stronger one. See Valve.

LINES OF FORCE. Lines in a magnetic or electrostatic field, whose direction is such that the tangent to any one of them at any point is representative of the resultant direction of the forces acting at that point. The idea of picturing the field of forces and explaining the phenomena occurring therein by means of these lines is due to Faraday, in his endeavour to substantiate the theory that some tangible medium must exist to connect bodies exerting electric forces to the matter on which they act.

To him also is attributed the method of visualizing these lines by iron-filings maps, but in this case the term magnetic curves is often substituted in contradistinction to the abstract mathematical term. Invaluable information regarding these lines may be gathered from such magnetic maps. If a piece of stiff paper or cardboard be placed over a magnet (which may be viewed as a convenient source of lines of force) and iron filings lightly sprinkled thereon, they will be observed to arrange themselves in certain definite curves, each filing, by induction, becoming a small magnet and assuming a position dependent upon the combined action of the forces exerted upon it. Such magnetic maps are illustrated under the heading *Magnetism (q.v.)*.

A very simple means of retaining permanent records of fields thus experimentally procured consists of using ordinary photographic printing-out paper, which can be exposed to daylight until the spaces unoccupied by filings have become dark. The latter may subsequently be removed and the print fixed in the usual bath of a solution of hyposulphite of soda. Such methods must not be taken to give more than approximate results, for reasons

explained later, and it should be remembered that they demonstrate the lines in the horizontal plane only, whereas radiation occurs in all directions.

Similar effects are obtained by the use of a small compass needle, by noting the position it assumes at various points in the field. The simplest case is that of a single pole, obtainable by employing a long bar magnet in a vertical position, the lines of force being merely radial. A more instructive map is that due to a bar magnet placed horizontally. It will be found that the filings finally set themselves in curves passing from one pole to the other, at which points their concentration is greatest.

The direction in which the force of the magnet is exerted is considered to be that in which an isolated north pole would be urged, so that the lines are assumed to pass externally from north to south. Their existence in the form of curves is explained by the fact that like forces display mutual repulsion, with the result that the lines, having the same origin, tend to separate themselves as far as possible. Since they indicate the resultant direction of the forces producing them, no two lines can ever cross.

The magnetic field due to any source, however weak, is presumed to extend to an infinite distance, so that in a field of great strength a higher degree of concentration of lines must exist than in a weaker one. The force available at any point, therefore, may be measured by the density of the lines at that point. A field of uniform intensity is said to exist when the lines of force composing it are parallel.

The mechanical force of attraction and repulsion exhibited by dissimilar and similar forces is usually explained by taking the view that the lines exert a tension along their length, accompanied by a lateral pressure across them.

The effect of the introduction of ferromagnetic substances into the field is to distort the lines of force from their normal position, the extent of their deflection being dependent upon the permeability of the disturbing body. In all cases the lines take the path of least resistance. This will explain why the iron-filings map can only be considered an approximation to the true state of affairs, the presence of iron, a material of high permeability, deflecting the lines from their natural position. Use is made of this property to

screen apparatus from external influences. The polarity acquired by a magnetic substance placed in a field of forces is south where the lines enter, and north at their point of departure.

The lines of force due to a current have their existence in the form of closed loops round the conductor situated in planes perpendicular to it. The relative direction of the lines and the current producing them is given by Maxwell's corkscrew rule, which states that the motion of a current and that of the lines of force due to it are related as the forward movement and rotation of a corkscrew.

A conductor moved in an electro-magnetic field in such a way that the number of lines linked with it is varied will have an electro-motive force induced in it, and the value of this electro-motive force is dependent upon the rate of variation. This is the principle underlying the construction of dynamos, transformers, etc.

The lines of force consequent upon electrostatic charges may also be used to

represent a static field, and may be depicted experimentally, though the process is not so simple as when dealing with magnetic lines.

The latter, however, may be taken as a general guide for the electrostatic field, but whereas they are considered to exist in the body of the magnet as well as in the surrounding medium, the static lines terminate abruptly on the surface of the charged bodies. Their positive direction is that in which a positive point charge is urged, and they are assumed to radiate from a positively charged body to a negatively charged one.—*E. C. Saker.*

See Electricity; Flux; Magnetic Density; Magnetism.

LIQUID BARRETTTER. The liquid barretter, or electrolytic detector, is a form of detector which was much used by Fessenden.

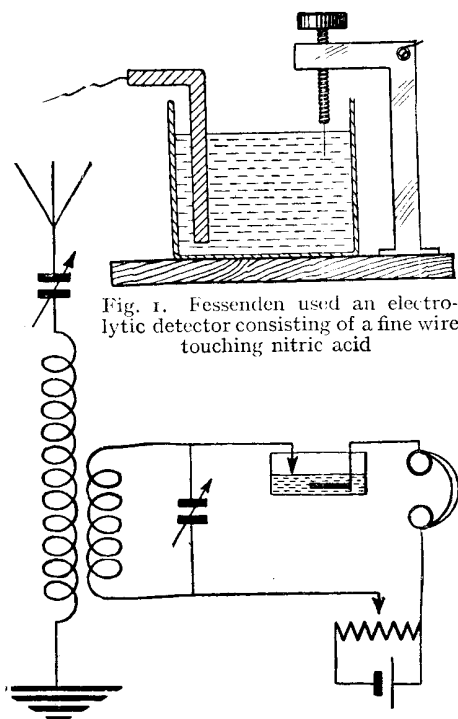
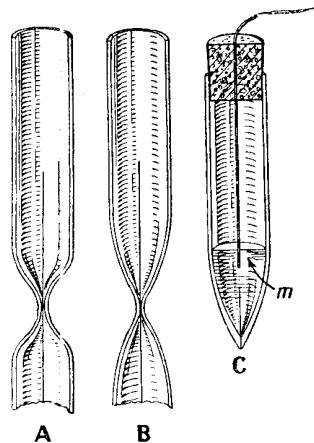

Fig. 1. Fessenden used an electrolytic detector consisting of a fine wire touching nitric acid

LIQUID BARRETTTER CIRCUIT AND DETECTOR

Fig. 2. In this circuit the detector is a liquid barretter, with which is employed a battery with a potentiometer



CONSTRUCTION OF BARRETTTER ANODE

Fig. 3. Glass tubes A and B, being heated, were drawn out and then cut, and the point ground flat. A fine platinum wire in the centre was thus open to contact with the acid, as seen in Fig. 4. A few drops of mercury were placed in the tube at m

In 1903 Fessenden took out a United States patent for an electrolytic detector, consisting of a very fine platinum or Wollaston wire, dipped to a small depth in nitric acid (see Fig. 1).

Two other workers at about the same time independently discovered the electrolytic detector. These were Commandant Ferrie and W. Schloemilch. Fessenden's application for the patent precedes any disclosure by Schloemilch, and it was Fessenden who named this type of electrolytic detector a barretter.

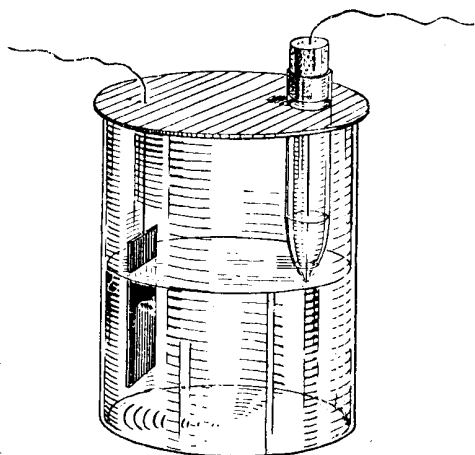

LIQUID BARRETTER COMPLETE

Fig. 4. In the glass jar is the platinum-glass anode, lead cathode, and sulphuric acid electrolyte. The anode is shown separately in Fig. 3

Liquid barretters are stable and reliable detectors, provided they are well constructed. Their success depends on obtaining a microscopically thin wire, or one presenting a microscopical area of surface for contact with the electrolyte.

This has been accomplished in several ways.

Fessenden at first mounted a very fine platinum wire, some $\cdot 001$ mm. in diameter, into a screw (see Fig. 1). This wire became the anode, whilst the cathode was made from a plate of lead or platinum, contained in a glass vessel holding dilute nitric acid.

The detector may be used to replace a crystal in any receiver circuit, and works best when fitted with a small polarizing battery and potentiometer (Fig. 2).

The adjustable screw type of anode, as made by Fessenden, was constructed in an extremely ingenious manner. He required a wire which was far too fine to be drawn. He therefore started with an exceedingly fine platinum wire, $\cdot 002$ in. in diameter, which was plated with silver till its diameter was $0\cdot 1$ of an inch. This wire was then rolled and drawn down till its total diameter had been reduced to the original size of $\cdot 002$ in. This is the wire that was mounted in the screw to form the anode. After mounting the wire was dipped in nitric acid, which dissolved the silver, leaving a microscopically fine platinum wire for use.

A later form of anode was made by sealing one of these exceedingly fine

platinum wires into a glass tube, as at Fig. 3, A. This glass tube was heated and drawn out as at B. The glass was then cut and the point ground off flat, thus leaving a very small surface of the platinum buried in the glass, but open to contact with the acid. A few drops of mercury at *m* (Fig. 3, C) were placed in the tube to make contact with the very fine platinum wire, and a cork with a wire in it was finally inserted, thus closing up the mercury and giving a substantial wire for connecting to the receiver. A barretter of this type does not require adjustment for long periods (Fig. 4).

LIQUID MICROPHONE. Form of microphone which depends upon the variation of resistance of a liquid caused by sound modulation. There are many types of liquid microphone, and in the earliest forms a stream of liquid was varied by means of a needle valve, or some similar valve, connected to a diaphragm. The vibrations of the diaphragm due to sound waves are, by suitable mechanical connexions, transferred to the needle of the needle valve, causing it to allow more or less liquid to pass through on to an electrode. A current passes through the liquid stream, and the resistance depends on the cross-sectional area of this stream. This cross-sectional area being varied by the action of the diaphragm on the needle, the resistance is similarly varied, so transforming mechanical energy due to the sound waves into electrical energy. Dilute acids and salt and soda solutions are the most commonly used liquids.

Liquid microphones are used to modulate alternating currents, so that their uses are confined to the aerial circuit or a circuit coupled to it. One of the drawbacks of the liquid microphone is the great mechanical accuracy which is necessary in the construction of the magnifying levers from the diaphragm to the actuating needle controlling the stream of liquid. If this mechanical accuracy is not obtained distortion inevitably follows, and many vibrations may be completely damped out. Among the better-known liquid microphones are Jervis-Smith's, Vanni's, Majorana's, and Sykes', all separately described in this Encyclopedia.

LITHANODE CELL. The feature of this type of accumulator, manufactured by the Lithanode Company, which calls for special comment is the construction and

method of mounting the positive plate. Instead of the active material being compressed in a raw state into its supporting lead frame and then formed, sections of "lithanode," a porous substance of great durability, are, when electrically complete, cast into a frame, which is then shrunk on to the substance. By this means a good contact is ensured between the active material and the frame, and the possibility of local action, a fruitful source of disintegration, internal shorts, and buckling are to a large extent eliminated.

The hardness of the plates should prove especially advantageous for portable wireless sets, where the cells might be subjected to considerable vibration. The

LITHARGE. Another name for lead monoxide. It is also known as massicot. Litharge is important from the fact that it forms the negative plate paste in the Faure or pasted plate type of accumulator. It is yellowish-brown in colour, and is usually mixed with a small percentage of barium sulphate, carbon, or kaolin to make it assume a spongy nature after formation, and so help the action of the cell. See Accumulator.

LITHIUM. One of the metallic elements. Its chemical symbol is Li, atomic weight 6.94, and specific gravity 0.59. It is the lightest metal known. It is white in colour, and may be pressed into wire and welded at atmospheric temperatures.

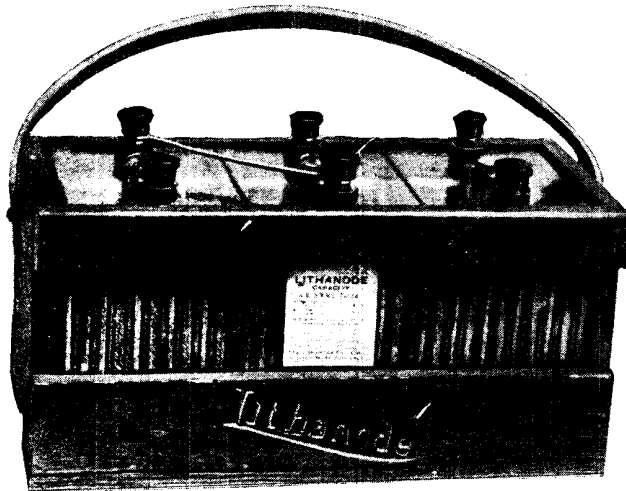

LITHANODE ACCUMULATORS FOR FILAMENT LIGHTING

Fig. 1 (left). This is a 6 volt Lithanode accumulator, which will withstand an accidental short circuit without damage to the plates on account of the special construction. An unusually large area of active material is in use. Fig. 2 (right). An unspillable Lithanode cell designed for dull emitter valves with a high rate of charge and discharge is illustrated

Courtesy Lithanode Co., Ltd.

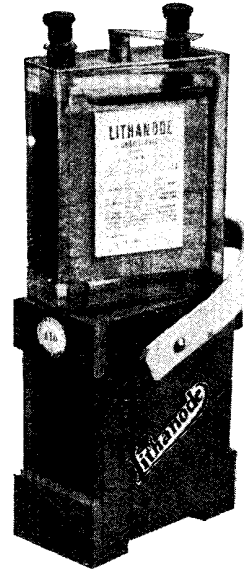

larger surface of active material available, owing to the porosity of "lithanode," permits of a high rate of charge and discharge. It is claimed that these cells may be short-circuited without damaging the plates, and that they will not lose their charge to any appreciable extent when left on open circuit.

Fig. 2 shows a type of lithanode accumulator suitable for use with dull emitter valves. It is of the unspillable kind, and is carried in a specially constructed case, on the top of which it is seen resting. The battery shown in Fig. 1 is a 6 volt accumulator contained in a carrying case.

LITZENDRAHT CABLE. Type of cable made up of many strands of fine wire, each strand insulated from its neighbour, either by enamel or silk covering, and the whole surrounded by a binding of several layers of silk. Various forms of this cable are shown in the photograph. The different varieties may easily be distinguished.

The wire is designed with a view to obtaining as low a high-frequency resistance as possible. This is attained by forming it out of insulated stranded wire, for high-frequency currents tend to travel upon the surface of a conductor rather than the core, and a relatively large surface

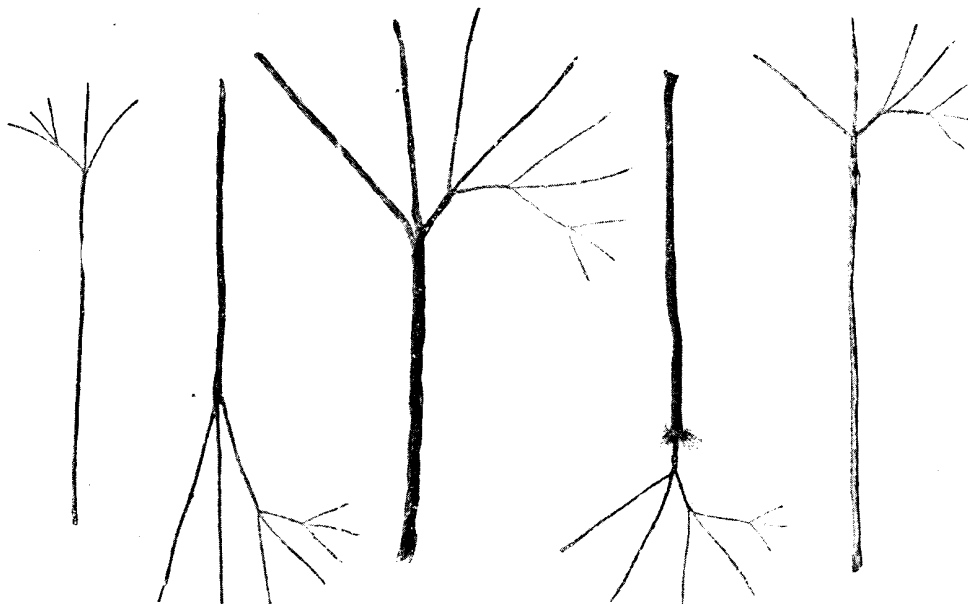

EXAMPLES OF LITZENDRAHT CABLE FOR WIRELESS INSTRUMENTS

Litzendraht cable is made of five strands of wire, each separately insulated, for obtaining as low a high-frequency resistance as possible. The different varieties illustrated may be used for winding inductances

Courtesy London Electric Wire Co.

is, of course, obtained. For fuller explanation of this fact reference should be made to the heading Skin Effect.

Litzendraht is particularly suited to the making of inductances, either of the single-layer type or pile wound. To obtain the best results, however, it is very important to see that every wire is connected, otherwise serious losses will be obtained. It has been estimated that by missing one strand in a joint with litzendraht the efficiency is lowered to a value below that of ordinary single-stranded insulated copper wire. Careful attention must also be given while making joints to see that the insulation between each strand is well maintained.

LIVE WIRE. This expression is used of a wire which is actually carrying an electric current.

LOAD. A term used to denote the useful resistance offered to the motion of a machine, representing the work being done. It is important for the safety of a machine to ensure that the load is not greater than that for which the machine is designed. The result of overloading an electric dynamo or motor shows in excessive heating and sparking at the collectors, and may even result in the wiring of the armature or field magnets being burned out.

For this reason the great majority of motors are fitted with an overload release, which automatically stops the motor when the load becomes excessive. This is accomplished by a device fitted to the motor starter. It consists of a light iron armature pivoted at one end and bearing two springy contacts at the other end. The armature is arranged close to an electro-magnet, and is only attracted when the current passing through the motor is too high. When attraction takes place, the contact pieces on the magnet armature short circuit the magnet holding up the switch arm. This causes the switch arm to be released and thus stops the motor.

The load of a dynamo is the amount of current drawn from it, and the device for protecting the machine from the generation of excessive currents is usually called an auto-cut-out.

The fuses in a dynamo or motor circuit may be called upon to function in the case of an overload, but this necessitates considerable loss of time in replacing the burnt-out fuses.

Where automatic overload devices are used they should be periodically inspected to ensure that they are in working order. See Auto-cut-out ; Cut-out ; Fuse.

LOADED AERIAL. An aerial the inherent capacity, or inductance, or both capacity and inductance, of which has been artificially added to. The most familiar instance is the interposition of a condenser or a coil in series with the lead-in from the aerial. It is also frequently desirable to load a transmitting antenna in order to tune it for resonance at the desired frequency. For efficient radiation the antenna should not be so loaded as to decrease its resonance to less than one-quarter that of the unloaded aerial. See Capacity; Electrostatic Capacity; Inductance; Loading Coil.

LOADING COIL. One used for the purpose of adding inductance where required in either an open or closed circuit.

In the aerial circuit a loading coil (see Loaded Aerial) may be used to increase the wave-length of the aerial, being simply interposed, in series, in the lead from the aerial to the receiver. In the case of a transmitting aerial it may be employed to tune the aerial for resonance at a desired frequency.

A loading coil may also be added to an existing tuning coil in order to increase the wave-length for the reception of which the existing coil has been wound. In this way an important improvement may sometimes be effected in apparatus originally of very restricted usefulness. Thus receivers only

built for the reception of broadcasting may, by the addition of a loading coil or coils—which may take the form of easily inserted blocks—be altered to receive signals from stations using a much higher wave-length. To some forms of variometer, again, a loading coil may be added for the same purpose and with the same result, but usually with a certain loss of efficiency.

In a closed circuit a coil may be similarly loaded, some degree of precision as regards the calculation of the result being afforded by the methods indicated under the separate headings Coils and Inductance.

One example of the use of a loading coil on a commercial receiving set is shown in Fig. 1, where a plain basket coil has been added to increase the range of reception of an Oracle crystal receiving set. On this set, and many others, there is a pair of terminals provided to permit the introduction of a loading coil.

The ends of the windings are simply attached to the terminals, and virtually increase the length of the aerial tuning inductance.

When not required the terminals are shorted or connected together. Another method is illustrated in Fig. 2, showing a plug-in loading coil in place, while in Fig. 3 the coil is shown removed.

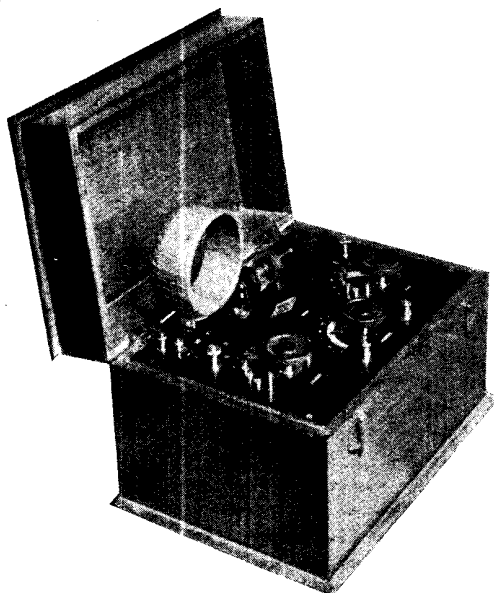
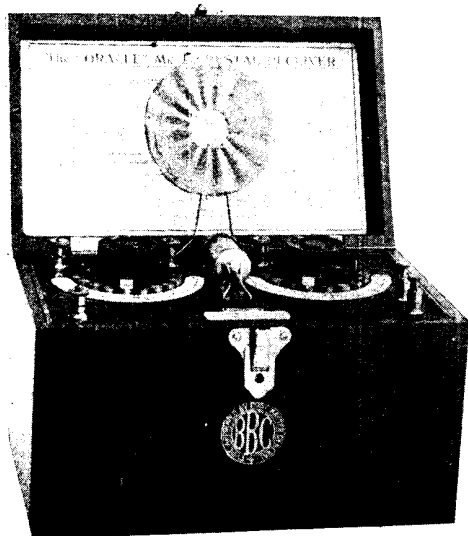

LOADING COILS ADDED TO RECEIVING SETS

Fig. 1 (left). Here a plain basket coil has been used to increase the range of reception of a crystal receiving set. Fig. 2 (right). Plugged in on a Peto-Scott receiver is a loading coil, to enable Paris time signals to be received in London

The advantage of such plug-in coils is that the value of the coil can be selected to suit the desired conditions for reception.

For example, by the use of appropriate coils the set may be used for broadcast reception and also for the reception of long-wave signals.

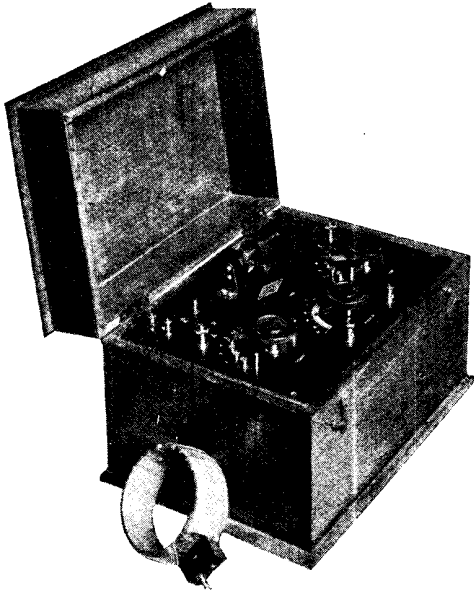

LOADING COIL CONNEXION

Fig. 3. With the loading coil removed the connexions can be seen in the crystal set which is shown in Fig. 2. The coil is only added when the higher wave-lengths are required

Courtesy Peto-Scott, Ltd.

There is another method of applying a loading coil to a circuit, that is by the use of a loading inductance (*q.v.*).

LOADING INDUCTANCE. A coil of wire arranged as a unit and applicable to the purposes of adding to the receptive range of a receiving set.

An example is shown in Fig. 1, and takes the form of a case made of polished hardwood, the upper surface composed of ebonite. At the back part of the top of this panel are two ebonite bushed terminals for the aerial and earth sides of the circuit, respectively. In the centre is a movable contact arm brushing over a number of contact studs. These studs are connected on the

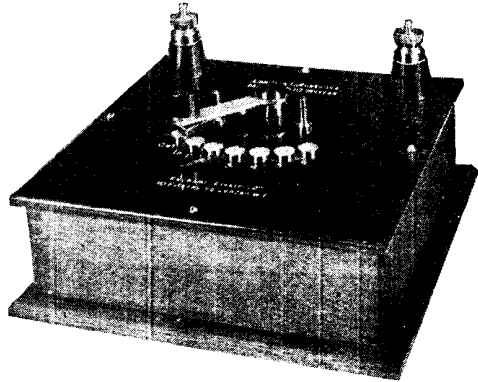

LOADING INDUCTANCE

Fig. 1. Terminals at the back of this instrument are for the aerial and earth. The inductance is tapped by stud switch contacts

underside of the panel to taps taken from the inductance windings.

These are shown in Fig. 2, an underside view of the panel as removed from the case and inverted to show the interior. The inductance takes the form of a lattice-wound coil mounted on an ebonite plate supported by an ebonite bushing attached to the panel. Connexions are effected by soldering. The appliance is used in the same way as a loading coil, but has the additional advantage that different wave-lengths can be tuned by the mere moving of the contact arm from one stud to another. The final tuning is obtained in the receiving set by whatever method is employed in it. An item of importance is to protect the inductance from surface leakage, and this has been accomplished in the case illustrated by mounting the coils on an independent platform beneath the panel. *See Loading Coil.*

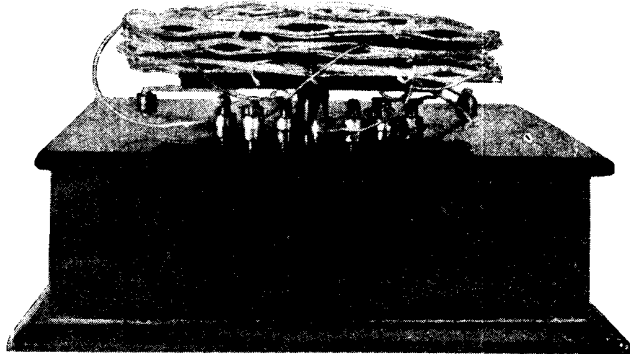

COILS OF A LOADING INDUCTANCE

Fig. 2. With the panel turned upside down the coils may be seen in the loading inductance shown in Fig. 1

Courtesy Economic Electric Co., Ltd.

LOCAL ACTION. This is another name usually given to polarization in a cell, due to impurities in the metal plates, which are generally amalgamated with mercury to check the action. See Accumulator; Depolarizer; Polarization.

LOCAL BATTERY. An expression denoting the battery used in various forms of relay work, where its application is to supply a more powerful current, as, for example, the operation of a tape machine or other telegraph instrument. The circuit to which the local battery is connected is sometimes called the local circuit, and the current from the local battery flowing through this circuit is called the local current.

When a telegraph message is sent over a land-line it is usually found more practicable to use a local battery to operate the receiving instruments. To enable this to be accomplished, an instrument called a relay is used. The relay takes various forms according to the types of work to which it will be put, but in general the principle is the same. It consists of a delicately adjusted armature which is attracted to an electro-magnet capable of being energized by the signal current from the distant station. The armature controls the current from the more powerful local battery by a system of contacts on the armature.

The local circuit will thus be seen to comprise the local battery, a part of the relay, and the receiving instrument, such as a tape machine. See Relay.

LOCAL OSCILLATIONS. The term local oscillations is applied to any oscillations that may be directly or indirectly generated in a closed circuit.

The oscillations may be generated for a specific purpose, or they may be caused by a secondary and undesired action of oscillatory currents in some other circuit, thus entailing a loss of efficiency.

A closed oscillatory circuit is, in contradistinction to an open oscillatory circuit, a very inefficient radiator of energy. Hence the radiated energy of the oscillations in a closed circuit is very limited and,

generally speaking, can only be utilized for local purposes.

The generation of oscillations for local purposes is required for the reception of continuous wave signals. In this system of reception, oscillations from a local oscillation generator are superimposed on the incoming continuous waves to produce a beat frequency. The local oscillations are introduced into the particular circuit in which their effect is required, and measures can be adopted to prevent the oscillations from influencing any other circuit. Since the electrical constants of the circuits of the local oscillation generator can be adjusted by the receiving operator, he is enabled to adjust the beat frequency produced in the receiver circuit.

A local oscillation generator used for continuous wave reception generally consists of a three-electrode valve, the anode and grid circuits of which are coupled together by a variable coupling coil. A closed oscillatory circuit, the natural period of which can be adjusted, is included in the circuit of the valve, and leads are taken to a small coil coupled to one of the tuning circuits of the receiver.

Local oscillations can be set up in any circuit in which inductance and capacity are associated. Any inductance coil has a certain inherent capacity, depending on the dimensions of the coil and the method of winding. Hence the capacity of the winding can be considered to act as a condenser connected across the coil and, under certain conditions, local oscillations can be set up in this circuit, which oscillations would have no useful effect.

This is particularly seen in the "dead end" effect of an inductance in which only a small part is actually used in a circuit while the remaining unused part is open-circuited. If the figure represents a coil with a condenser across the points A and B, then between B and C the idle turns of wire, in conjunction with their capacity to one another, represented by the condenser K, will form a local circuit in which oscillations will be induced to reduce the efficiency of the tuned circuit A, B, C. See Closed Circuit; Dead-end Switch.

LOCAL OSCILLATOR. An oscillating circuit used in conjunction with a receiving set for beat reception. Beat reception consists of superimposing a local wave on the oscillations from the incoming signals, the local oscillations being tuned to a slightly different frequency.

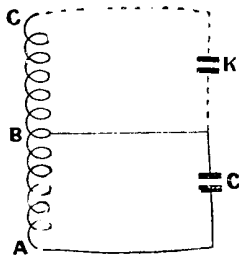

DEAD-END EFFECT

Local oscillatory circuit set up in inductance, only part of which is in circuit

Fig. 1 shows a wiring diagram of an oscillating circuit capable of producing sustained oscillations for the purpose of beat reception. An inductance and a variable capacity are shown in the diagram wired across the anode and grid of the valve. A tapping is taken from the middle of the inductance to the positive terminal of a high-tension battery, the negative side of which joins the low-tension positive terminal. A grid leak and condenser are inserted between the grid and the grid side of the inductance and capacity. The object of these is to avoid the strong positive potential on the grid which would otherwise occur and prevent the operation of the valve on its effective point.

The method of reception employing a local oscillator may be used on any wave-length, but will be found to be most efficient on the higher wave-lengths.

A simple but effective type of local oscillator is shown in Fig. 2, and may be constructed easily and at a small cost.

The components required include: ebonite panel, 7 in. by 5 in. by $\frac{1}{4}$ in. thick; 1 valve holder; 1 two-coil holder; 3 terminals; 1 dull emitter valve (or other valve); 2 duo-lateral coils; box, 7 in. by 5 in. by 4 in. deep; a number of screws and wire, 18 gauge tinned is best; and 1 Polar variable condenser of .001 mfd. maximum capacity.

A group of these components is shown in Fig. 3, and will assist in the selection

of suitable materials. No size is given for the duo-lateral coils, as these depend on the wave-lengths on which it is desired to receive. For British broadcasting, No. 50 and No. 35 Igranic coils will be found suitable for the anode and grid coils respectively. The Polar condenser may be substituted by any other of different pattern if desired, providing provision is made in the case to receive it.

The panel is cut out and finished to the size stated, and it should be well

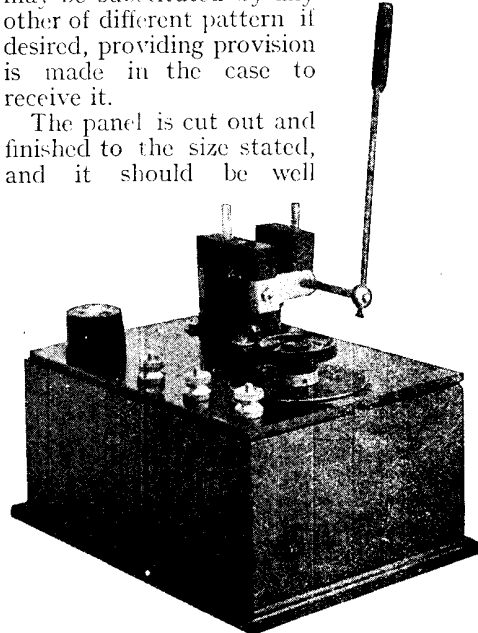

HOME-MADE LOCAL OSCILLATOR

Fig. 2. To the right of the valve holder are two coil holders. The turning knob operates a tuning condenser

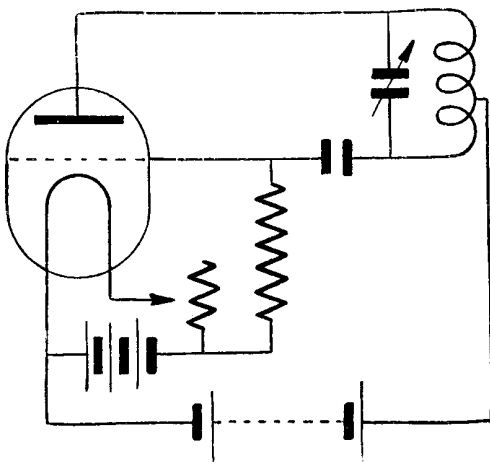

SUSTAINED LOCAL OSCILLATIONS

Fig. 1. For the purpose of beat reception oscillations are sustained by a circuit of which the above is wiring diagram

matted to avoid surface losses. The condenser is mounted, as shown in the panel lay-out, towards the front of the panel. The dial of this condenser is attached to the panel by three small bolts with holes in the dial set radially. These holes will be found to be indented slightly, and in order to secure a flush fit to the panel, the panel holes are countersunk slightly. Fig. 4 shows the operation of fixing the dial. The dial is used as a template.

The setting of the condenser pointer must be arranged so that it registers with the correct condenser setting. This is done by rotating the spindle until it reaches the stop on the left of the condenser. While in this position the pointer, with circular nut attached, is placed to the zero mark on the dial. Taking care not to move these positions, the set-screw is tightened. This operation is shown in Fig. 5. The valve holder is placed at the top

left side of the panel, to the right of which is the two-coil holder. The former is secured by means of the nuts on the valve legs. The coil holder may be fixed with 4 B.A. nuts and bolts, or, according to the type of component used, other methods may be adopted.

Wiring is best carried out with bare wire soldered straight from point to point. Where two wires cross sufficient space must be left between them to ensure that they will not touch or interact.

Lighting flex is used to the coil holder connexions and is taken underneath the panel by means of holes drilled close to the points of connexion. The wiring diagram is shown in Fig. 6. The use of a filament resistance is not necessary if a suitable valve and battery are procured. A suitable valve for the purpose of the local oscillator is the V24 valve. It has a low self-capacity, but requires, however, characteristic fittings, which may give trouble if not correctly mounted.

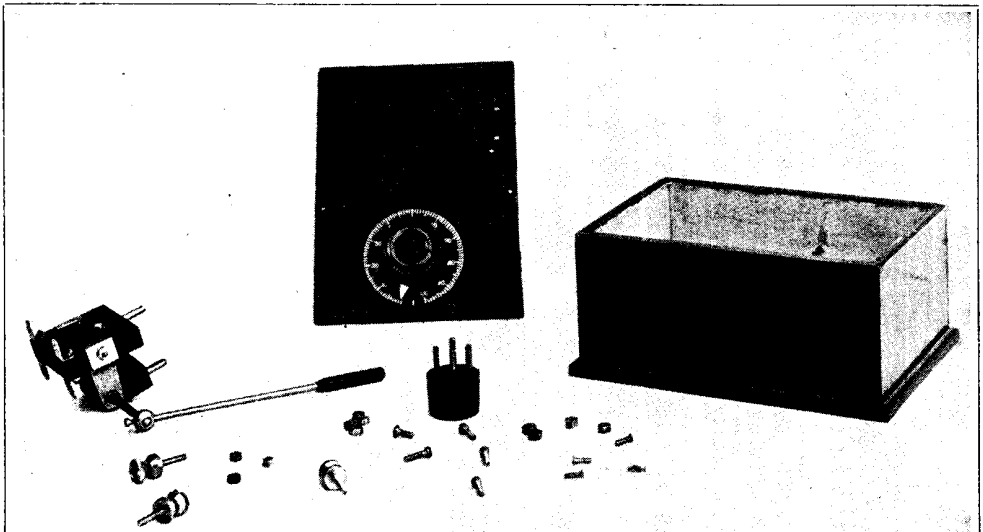

Fig. 3. Collected together are the parts used in the construction of the local oscillator. The condenser is not shown disassembled, but the turning knob and dial can be seen on the panel

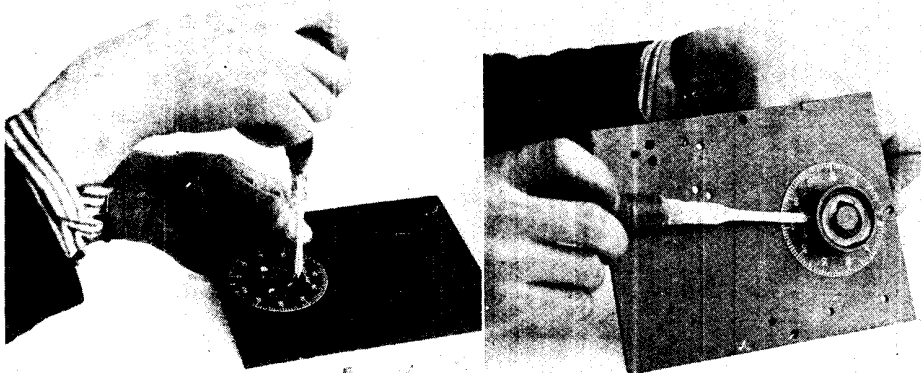

Fig. 4 (left). Illustrated in this photograph is the method of fixing the condenser dial to the panel by small countersunk screws and bolts. Fig. 5 (right). Unless care is taken the condenser pointer may be found out of adjustment with the condenser setting. This illustration shows the method of locking the pointer in position

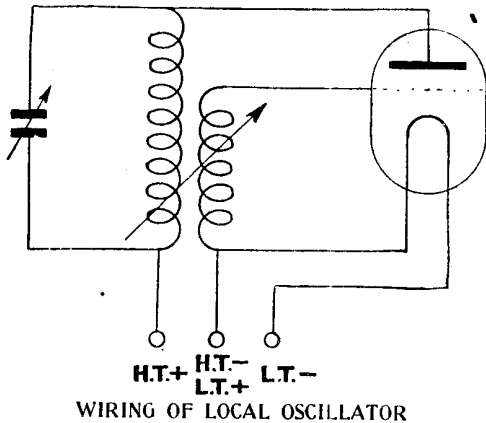

Fig. 6. In this diagram is shown the method of wiring the local oscillator. The valve should be of the hard variety, or a V24 may be used

For general purposes any hard receiving valve will be found suitable.

Fig. 7 shows the application of the local oscillator to a valve receiving set seen to the right. The distance of the local oscillator from the set will depend on the strength of the oscillations from the former. In general practice a distance up to four feet will be found about correct. The instrument can be used with a crystal set, and enables signals or continuous waves to be received. It will be found in tuning the local oscillator that when it is tuned to a frequency nearly approaching that of the incoming oscillations the note in the telephones is low, its pitch increasing as the difference of frequency increases either above or below that of the signals being received—*W. W. Whiffin.*

See Beat Reception ; Heterodyne.

LOCUS. Curve or surface traced out by a point or line which moves according to given conditions. Thus the circumference of a circle is the locus of a point in a plane which moves in such a way that it is always equidistant from a given fixed point. See Alinement Chart ; Curve ; Graph ; Sine Curve.

LODESTONE. Popular name for the natural magnet. The lodestone is a variety of iron ore, consisting chiefly of ferric oxide (Fe_3O_4). It was originally found in Magnesia, Asia Minor, and so originated such terms as magnetism. The mineral is also found in Scandinavia, America, and other parts of the world, and has the usual property of a magnet of pointing north and south when suspended freely. It is an iron-black in colour, and contains also magnesium, nickel, and other elements. See Magnet ; Magnetism.

LODGE, SIR OLIVER. British physicist and wireless pioneer. Born at Penkhill, near Stoke-upon-Trent, June 12th, 1851, Sir Oliver Lodge went to the Newport Grammar School at the age of eight, but at fourteen was taken into business to help his father. He worked in the evenings for the intermediate examination in science at the University of London, and eventually took first-class honours in physics. In 1872 he went to University College, London, and in 1877 took his D.Sc. in electricity and became demonstrator, and afterwards assistant professor in physics at University College.

In 1881 he was appointed first professor of physics at Liverpool, and in 1887 he was made a Fellow of the Royal Society. In

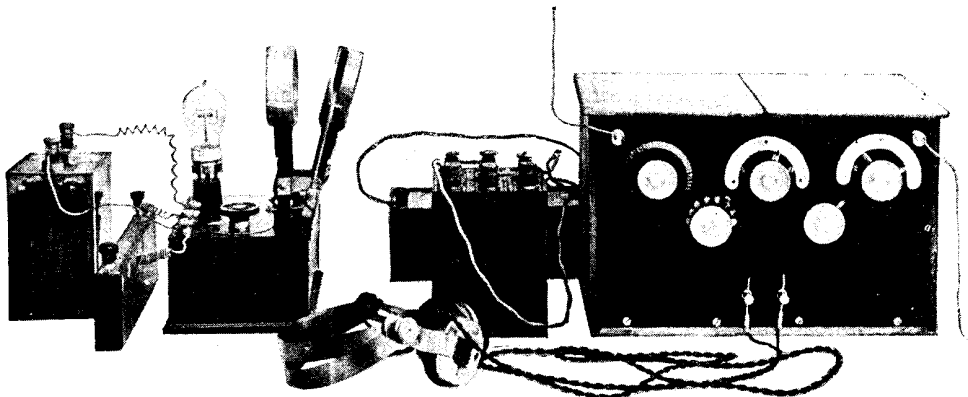

GENERAL LAY-OUT OF A LOCAL OSCILLATOR AND RECEIVING SET

Fig. 7. Complete with batteries is a receiving set which is laid out to show the method of including the local oscillator in the system for beat reception. The wiring of the oscillator unit and its batteries is given in Fig. 6. The local oscillator is on the left, and the receiver on the right

1888 he received the honorary LL.D. of the University of St. Andrews, the first of a long series of such distinctions. In 1900 he was appointed the first principal of the University of Birmingham, a post from which he retired in 1920. In 1902 he was knighted.

Sir Oliver Lodge is one of the foremost physicists of his time, and his brilliant series of researches into electrical phenomena, which he has made his special study, have had a profound effect in all branches of this subject. To him, indeed, wireless owes as much as to any man, for he dealt with fundamentals when the whole subject of electro-magnetic radiation was in its infancy. He was led to study the surging and oscillating character of an electrical discharge along wires as a result of his investigations as to the best means of protection against lightning.

One very remarkable experiment of his is now well known under the name of Lodge's resonating jar, now used as a measurer of wavelength. In these experiments Lodge was really dealing with the electro-magnetic waves discovered by Hertz in 1888. Lodge early recognized the vast importance of the discovery by Hertz, which so brilliantly confirmed the theories of Clerk-Maxwell, and he threw himself into the work of investigating these waves with an energy which made him the foremost British physicist on the subject at the time. All this was pioneer work before Marconi and others came along and built upon the solid foundations which Lodge had prepared.

It was during this early period that Lodge discovered his coherer, separately described in this Encyclopedia, and with this detector devised the first practical wireless telegraph, sending signals over a distance of several hundred yards. In May, 1897, Lodge took out his fundamental patent for tuning, a patent that was successfully upheld in the law courts, and extended for seven years by Lord

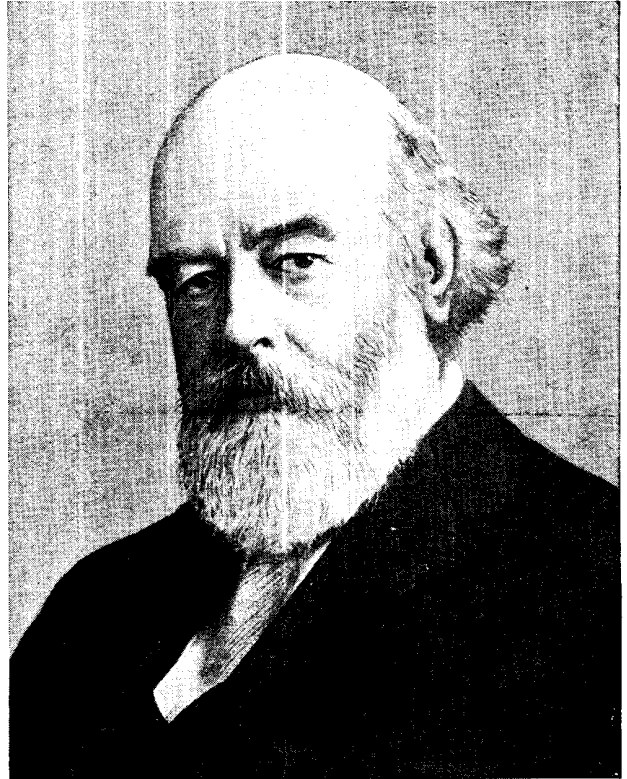

SIR OLIVER LODGE, D.Sc., F.R.S.

One of the most distinguished scientists of modern times, Sir Oliver Lodge commenced a business career at the age of 14 and rose to fame by personal diligence. His brilliant and original studies in electrical phenomena have had far-reaching results in all branches of science, while his pioneer work in the infancy of electro-magnetic radiation laid the solid foundation on which the substantial fabric of practical wireless communication has been built.

Sir Oliver has acted as Consultative Editor to this Encyclopedia

Photo, Elliot & Fry, Ltd.

Parker. The patent was acquired by the Marconi Company in 1911.

Sir Oliver Lodge has been a pioneer in many other directions. His theories and experiments in connexion with the ether, of which he is the leading exponent, are well known, and he has carried out a number of interesting researches on the passage of electricity through liquids. Sir Oliver was the first to devise a simple and direct experiment to show the speed and direction of travel of the constituents of a salt in solution when broken up by a current of electricity. For his researches on electric waves and the passage of light through a moving medium, Sir Oliver Lodge received in 1898 the Rumford Medal of the Royal Society, one of the highest honours the society bestows.

Sir Oliver Lodge has won a well-deserved reputation for the clearness and simplicity with which he is able to explain many of the difficult and fundamental truths of physics, and this clarity of expression is well shown in the many articles he has written for this Encyclopedia. The more important of these articles include Electrostatic Capacity; Electrons; Ether; Ohm's Law; Potential; Units, and Waves. He is the author of many books, including "Modern Views of Electricity"; "Signalling through Space without Wires," first published as long ago as 1894; "Electrons," etc. Sir Oliver Lodge has acted as Consultative Editor of this Encyclopedia.

LODGE COHERER. The term "coherer" is now applied to any device for detecting electric waves or surgings by the breaking down of an infinitesimal film of nearly non-conducting material and the establishment of conducting contact by the cohesion of metals on either side of the gap. Its commonest form is the Branly filings tube, as modified by many experimenters. But the name was originally given by Oliver Lodge to a single contact between a spring wire and a plate, as depicted by him in 1894. (See "The Electrician," vol. 33, page 189, and illustration here reproduced.)

But this was an outcome of previous experiment made in 1889. Lodge then noticed that two knobs sufficiently close together, *i.e.* in ordinary but not effective contact, could, with the slightest electric stimulus, become short-circuited, so as to close a battery circuit and deflect a galvanometer or ring an electric bell. This made an extremely sensitive detector of Hertz waves, and in the spring form could easily be used with a telephone without special tapping back or de-cohering.

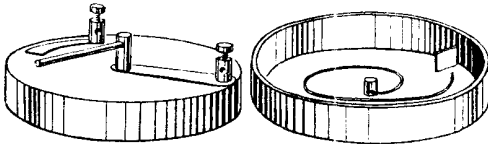

LODGE COHERER FOR LABORATORY SIGNALLING

In 1894 the first Lodge coherer was used for wireless laboratory signalling. This consisted, as illustrated, of a spiral of thin iron wire mounted on an adjustable spindle and an aluminium plate. When the lever was moved clockwise the tip of the iron wire pressed gently against the aluminium plate. A telephone in circuit readily gave Morse responses. This was based on the observations of the coherer principle made in 1889

On showing this effect to the Institution of Electrical Engineers in April, 1890 (*see* Journal Inst. E.E., Vol. 19, pages 352-354), Professor David Hughes gave the information that he had noticed a somewhat similar thermo-electric effect at a joint, though he had not noticed cohesion and had not followed it up.

An experiment of Lord Rayleigh's illustrates the principle very well. If a mercury globule on a flat plate is cut with an oily knife, the two halves remain separate until about a couple of volts is applied, when the separating film breaks down and the globules reunite.

This idea also was applied by Lodge and Robinson to the invention of a wheel coherer, where a steel disk about the size of a threepenny bit was revolved slowly by Morse clockwork, with its edge dipping into oiled mercury. Momentary cohesion sets in between the disk and the mercury whenever a wave is received by the collector, and is immediately broken by the revolution. In this way wireless signals could be recorded with great precision on a Morse tape, as Alexander Muirhead showed, with a syphon recorder; the signals being long and short, instead of right and left as in cable signalling.

For the transmission of speech and music, coherers are useless. But as Major Phillips has found, they still have practical importance for wireless control of moving objects.

LODGE RECEIVER. When practical wireless telegraphy was first introduced by Senatore Marconi in 1896, though Morse signals could be received from a fair distance, there was no means of discriminating between one station and another. Nor at first was there any need for such selection, since stations did not exist. Oliver Lodge perceived that the principle of resonance or syntonny would greatly increase the sensitiveness, and would also make selection possible, so that a desired station could be tuned in and others tuned out. He realized that the way to do that was to introduce extra self-induction into the aerial, thereby conferring upon the oscillations a property analogous to inertia. Their radiating power would be diminished; but the conserved energy would be available for prolonged oscillation, so that instead of dealing with something analogous to a whip crack, the experimenter would be dealing with something more analogous to a

musical note. And the receiver, by a similar use of self-induction, could be tuned to respond, just as one tuning-fork is able to respond to another at a distance if they are precisely alike, but not otherwise.

Lodge took out a patent for this syntonic or tuned telegraphy in May, 1897. Fourteen years later the importance of this patent was recognized by Mr. Justice Parker—afterwards Lord Parker—after

represented by the inductance in every aerial. But this earliest form of tuned wireless may be illustrated in modern fashion in the diagrams (Figs. 1-3).

LODGE SYNTONIC JARS. Leyden jar experiment due to Sir Oliver Lodge, now used in wave measurers.

The inside and outside coatings of two Leyden jars are connected to wires, and the first jar has a spark gap, while the

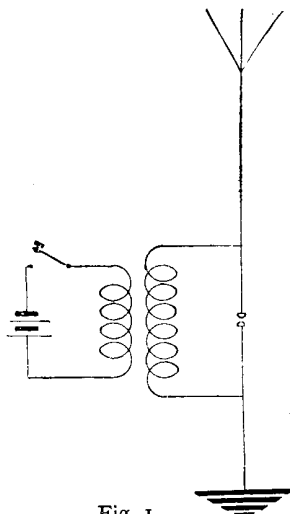

Fig. 1

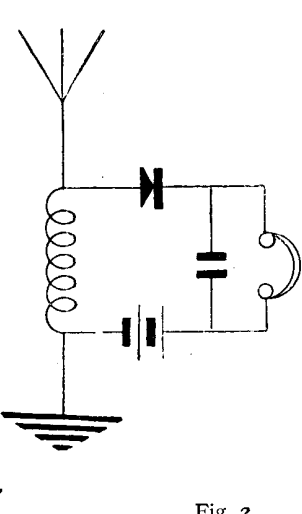

Fig. 2

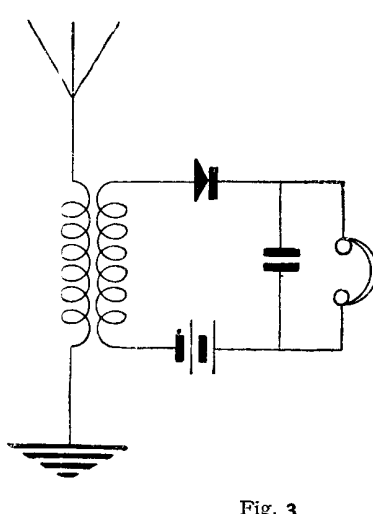

Fig. 3

INTRODUCTION BY LODGE IN 1897 OF TUNING INDUCTANCE

These diagrams represent in modern form Lodge's inductance for tuning introduced in 1897. Tuning existed only between sending and receiving aeriels. Closed circuits were not tuned, nor could they be, as illustrated, because of high coherer series resistance. Oscillations started violently in the transmitting aerial, Fig. 1, whenever a spark was produced. Oscillations worked up from zero in the receiving aerial, Fig. 2, till they broke down the resistance of the coherer, shown here as a crystal with boosting battery, these diagrams being modern versions of Lodge's original circuits. The condenser was merely a by-path allowing the induced E.M.F. to reach the coherer without choke by the telephone, and was not really necessary. A pair of capacity areas were often used as an alternative to earth connexion. In Fig. 3 the modern method is shown of inductive coupling

several days' trial, and he extended it for seven years. It was then acquired by the Marconi Company. Later its validity was called in question by the Admiralty, and was ultimately submitted to the arbitration of Lord Moulton, who, after twelve days' trial, decided that it was perfectly valid, and had been infringed by every spark system of telegraphy from the very beginning up to May, 1918, when its extended period came to an end.

This Lodge patent, 11575 of 1897, also showed the use of magnetic coupling by a transformer to connect the receiving circuit to the aerial. But the tuning of such a transforming or coupled circuit, and its use for sending, were reserved for Senatore Marconi's patent, 7777 of 1900.

There is no need to depict the special feature of the Lodge system, since it is

circuit of the second is closed. The second jar has a sliding link or bridging piece along the rectangle of wire joining the outer and inner coatings, enabling its inductance to be altered. It has only an overflow gap.

Sir Oliver Lodge found that if the first jar is charged until a spark passes, then by moving the bridging piece in the second circuit to a suitable position a spark will jump from one coat to the other if they are brought together by a tinfoil strip over the lip, or even across the knobs, as shown. This position Sir Oliver Lodge called the position of syntony, the position where the two circuits were tuned to one another. Hence the name syntonic jars. The second jar is a resonating responder, and was one of the earliest experiments in accurate tuning.

LOFTIN, EDWARD HILL. American naval wireless authority. Born at Deatesville, Alabama, 1885, and educated at Pensacola, Florida, he entered the U.S. Naval Academy, 1904. In 1912 he was appointed to the command of the torpedo boat *Bailey* for special wireless experi-

which the base must be raised to equal the number. As an example, $10^2 = 100$; 10 is called the base, and 2 is the logarithm of 100 to that base. So, since $2^5 = 32$, 5 is the logarithm of 32 to the base 2, and 3 is the logarithm of 27 to the base 3, since $3^3 = 27$, and so on.

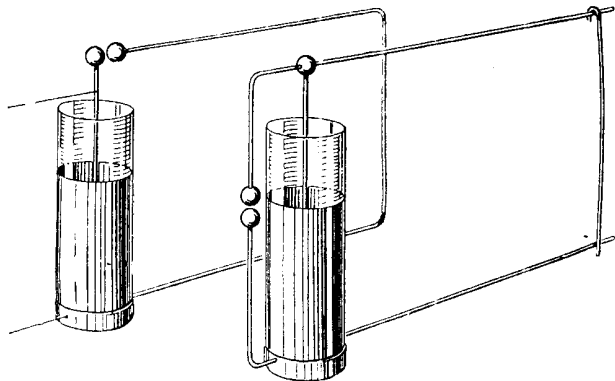

SYNTONIC JARS USED IN LODGE'S EXPERIMENTS

This is an experiment, due to Sir Oliver Lodge, to exhibit electric resonance or tuning. The second Leyden jar has a closed circuit with an adjustable slider, and the remarkable thing is the jar can overflow at the spark gap on the left when a spark occurs in the gap on the first jar in spite of its being completely short-circuited

mental work for the navy, and in 1916 was the district wireless communication superintendent of the Eighth Naval District, with special duties in connexion with wireless on naval aircraft.

In 1917 Loftin became the wireless officer for the battleship division of the American Atlantic fleet, and afterwards for the American naval air forces. He was the special liaison officer between America and France during the construction of Lafayette high-power radio station, and a member of the Inter-allied Radio Conference, and of the Inter-allied Code and Signal Conference. After 1918 he was in charge of research and patents in connexion with wireless in the Navy Department.

LOGARITHM. Name given by Napier of Merchiston to a system of dealing with numbers devised by him.

The importance of Napier's discovery lies in the fact that the ordinary processes of multiplication and division are replaced, with the aid of logarithms, by those of addition and subtraction. This follows from the definition of a logarithm. If $a^x = n$, then x , the power, is called the logarithm of n to the base a . In other words, the logarithm of a number to a given base is the index of the power to

2 is the logarithm of 81 to the base 9. It is also the logarithm of 144 to the base 12. But if we ask what is the logarithm of 144 to the base 10, the answer can only be given approximately; for it is incommensurable (*q.v.*). It can be calculated, but not easily. The ordinary plan is just to look it out in the tables, which have been made by those who can readily calculate these things. It is no more difficult to look it out than to look out a word in a dictionary, as soon as you know the simple rules which the designer of the tables has made in order to simplify them and make them ready for practical use.

These rules are usually contained in a preface to the tables, and will not be given here. Only practice makes them quite familiar.

The advantage of logarithms is that multiplication is turned into addition, and division into subtraction. For instead of multiplying or dividing the numbers, you can add or subtract the indices, that is to say, the logarithms.

Similarly, involution and evolution can be turned into multiplication and division. This is especially useful in extracting roots. For if 2^3 had to be raised to the fourth power, we should have to multiply the indices 3×4 , and say that the result was 2^{12} , which is 4,096. And if we wanted to find the cube root of 10^{39} , we should have to divide 39 by 3, and say that the result was 10^{13} , that is, 1 followed by thirteen 0's.

Many numbers have no exact root. You cannot multiply similar numbers together to make 2 or 3, or 5 or 7. They have not even any factors, and are called prime numbers. 12 is not a prime number, but it has no root, 9 has a square root, 8 has a cube root. Only a few numbers have both; 64 is an example. It has a sixth root as well: that is why it has both.

Suppose you want to multiply 16 by 32. One is 2^4 , the other is 2^5 . Therefore the

result is 2^9 , and that is 512. The common base, however, employed in practice is 10, because of our decimal system of notation.

Suppose you had to multiply 144·1 by 37. You look out the logarithms, and find them to be 2·1587 and 1·5682. Add these together, and you get 3·7269. You now have to refer back to the tables to find what number has this logarithm. You find it to be 5332, which, therefore, is the answer, not quite exact, but correct to three significant figures, and nearly correct to four. Correctly it is 5331·7.

Suppose, now, you had to divide 144·1 by 37. You would then subtract the same two logarithms, with the answer ·5905. Looking out the number which has this logarithm, you find it to be 3·895, again with approximate accuracy. This amount of accuracy would not suffice if you were working in the theory of numbers, or dealing with really commensurable quantities which could be counted. But as the numbers are presumably the result of experiment, and not themselves precisely accurate, the amount of error in the arithmetic is unimportant, provided always that it is smaller than the necessary errors of experiment. It is no use pretending to be accurate beyond the really significant figures.

The errors to avoid in logarithmic work are errors due to carelessness; taking out the wrong numbers, or using them wrongly. The tables are sure to be accurate enough for all practical purposes, if used rightly and with care. In physics, one nearly always has to deal with incommensurable quantities, and, accordingly, decimals in practical use do not either terminate or circulate. A terminating or circulating decimal is a vulgar fraction, and is precisely accurate. Accuracy of that kind is unobtainable in laboratory measurements. The only accurate observation in that sense is counting; and it is seldom that one has to deal with things that can be counted.

The ordinary base used in tables of logarithms is 10; but, oddly enough, there is a base of logarithms which occurs in nature, though a full account of this is too complex for treatment here.

The base of this logarithm is called e ; and it is an incommensurable number.

The value of e can only be stated approximately, and is 2·71828. For practical purposes we need not remember that number. The best thing to remember

is the logarithm of 10 to the base e , that is, the number x when we write $e^x = 10$. And this number is 2·3028, or approximately 2·3. Consequently, when you want a natural logarithm—as you do in calculating the capacities of wires—you can look out a tabular logarithm to the base 10 and multiply it by 2·3. That will give you the natural logarithm, or a sufficient approximation thereto. The logarithm of e to the base 10 is the reciprocal of 2·3, and is ·4343.—*Oliver Lodge.*

See Incommensurables; Units.

LOGARITHMIC DECREMENT. When the amplitude of an oscillation decreases in geometrical progression, the Napierian logarithm of the ratio of the maximum displacement of any oscillation to the maximum displacement in the same direction of the immediately succeeding oscillation is known as the logarithmic decrement. See Decrement; Oscillations; Wave.

LOHYS. A patented special form of very low carbon steel, very much used for laminations for dynamos, generators and motors. Its chief electrical characteristics are a very low power loss and a high permeability. A typical example of a stamping in this material is given in the figure. This is an armature stamping of the cogged-ring type. The radial slots are for ventilation, and another slot for the shaft key is made. The usual thickness of such laminations ranges from ·012 to ·023 in., according to the size of the machine and the discretion of the designer.

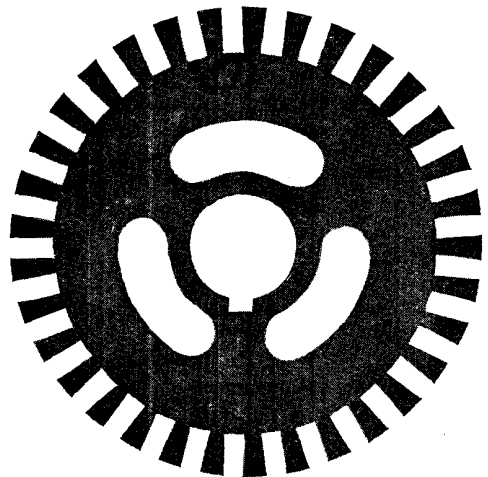

ARMATURE STAMPING IN LOHYS STEEL

This cogged-ring armature stamping is made of special low-carbon steel known as lohys

Courtesy Joseph Sankey & Sons

THE LONDON BROADCASTING STATION AND ITS WORK

By Captain P. P. Eckersley

The chief station and headquarters of the British Broadcasting Company developed within a comparatively short period into one of the best-run and most enterprising stations in the world. Here an outline of its activities is given by the Chief Engineer of the B.B.C. Other stations of the company are described under their own headings.

See also Broadcasting ; Relay ; Transmission

This article necessarily describes the London station in partial anticipation of its completion. It will be realized that British broadcasting is unique, and that as no other country has developed the art in, at any rate, the same way, there has been no standard of comparison by which to measure development, and the service has been largely run on experimental lines in order to build up the best system. Thus as the apparatus stands at the time when this article is written, it is largely "lash up." All plans are, however, complete for its concentration into a concrete whole, designed on the basis of past experience. It is the final form of apparatus that is described here.

Let me deal first with ordinary "studio" work, where performances are broadcast from the premises at 2, Savoy Hill. The studio (Fig. 2) is a room some 40 by 30 ft., about 15 ft. high, draped by a single layer

of grey material, lighted in the cornice by indirect lighting, the decorative scheme being carried out by the inclusion of four false windows, electrically lit to give the effect of golden sunlight. Here will be found the pianos, drums, bells, and other musical apparatus ; but centrally disposed on a dark-stained wooden stand, slung on a sponge-rubber suspension, is the heart of broadcast, the microphone.

The microphone consists of a fine wire coil free to move in a magnetic field. Wires run from it, and take the feeble currents which copy the sound waves, and another pair of wires carries the magnetizing current. These wires terminate in male plugs, which fit into female plugs let neatly into the floor of the studio. Wires run beneath the floor into a little room just outside the studio, where will be found a bank of accumulators and their associated charging motor. A switch in this room serves to switch on

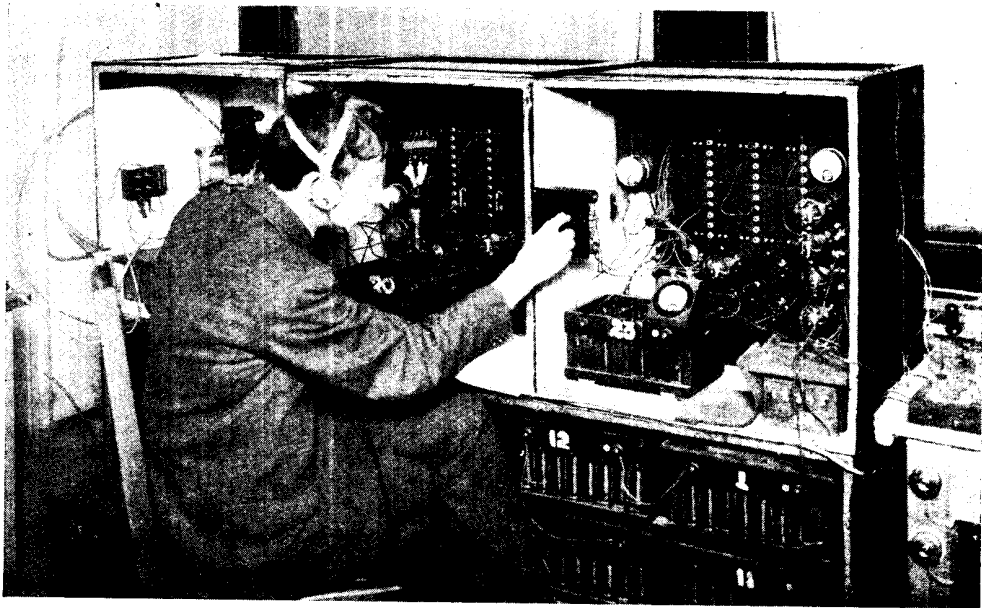

STUDIO AMPLIFIERS AT THE LONDON STATION 2 LO

Fig. 1. Two amplifying instruments are used at the studios of the London station of the British Broadcasting Company for the purpose of controlling the transmissions. These instruments have eight stages of amplification, and the operator is shown in the act of adjusting the very delicate control whereby the output is corrected from the studio for which it is used



INTERIOR OF STUDIO AT 2 LO, THE LONDON BROADCASTING STATION

Fig. 2 After a great deal of experimenting, the arrangement of drapery seen in this photograph was found the most satisfactory for eliminating undue echo. The microphone is seen in front of the clock. While transmission is in progress the announcer is in this room, and when the microphone is required to be sensitized the signal is given by an electric bell which sounds in the control room

and off the magnetizing current at the beginning and end of a performance. The sacred feeble currents, which are the embryo of the broadcast, are carried by a lead-covered cable away upstairs to the input of the amplifier.

The amplifier room contains two amplifiers (Fig. 1), one for each of the two studios, before which sit the operators, 'phones on ears, their hands glued to the sensitivity control, and their eyes fixed upon the blasting indicator. The amplifier has eight stages of amplification, resistance-capacity connexion being mostly employed. The three, two, or one stage can be cut out by the movement of one plug. The first three stages contain the tone adjustment, whereby the "pitch" of the broadcast may be adjusted to its best value, and the "first-stage amplifier" is separate from the main amplifier, transformer connexion being arranged between microphone input and the input and output of the first-stage amplifier and the main amplifier. The main amplifier has

two handles for sensitivity adjustment, and these vary the point of tap off a grid resistance; thus, since the grid circuit carries no current, the adjustment is absolutely silent.

The output of the amplifier is through a transformer, and is passed to an ordinary land wire which terminates at the transmitting station.

In parallel with the output from the amplifier is another transformer, with its secondary connected across grid and filament of a small valve. In the anode circuit of this valve there is a small direct current instrument. The grid of the valve is biased just so much negative as to allow the impulses of the broadcast output only to cause a reading on the direct current instrument when over-control and blasting occurs. It is thus the object of the control operator to prevent his meter wobbling. The operator wears 'phones which are connected to a good single-valve wireless receiving set, enabling him thereby to judge quality and strength to a fine

BACK NUMBERS OF ALL PARTS ARE STILL ON SALE

Harmsworth's Wireless Encyclopedia

CONTENTS OF PARTS 1-12

The first 12 parts, principal contents of which are listed below, include the striking total of 900 articles and nearly 2,500 photographs and diagrams, all of which have been specially prepared for "Harmsworth's Wireless Encyclopedia" and are now published for the first time

Part 1

WIRELESS AND OTHER WAVES
By Sir Oliver Lodge, F.R.S., D.Sc.
WIRELESS THEORY FOR AMATEURS
By Dr. J. A. Fleming, F.R.S.
RADIO WONDERS OF THE FUTURE
By Dr. N. W. McLellan
ACCUMULATORS: CHOICE, CHARGING & REPAIR
with 36 photos and diagrams.
AERIALS: TYPES, THEORY & CONSTRUCTION
with 50 photos and diagrams, and photogravure plate

Part 2

AMPLIFIERS: PURPOSES & CONSTRUCTION
with 51 photos and diagrams, and photogravure plate
ANODE CIRCUIT: PRINCIPLES & COMPONENTS
with 20 illustrations
ANTI-CAPACITY SWITCHES: HOW TO MAKE
with 15 illustrations
ARMSTRONG CIRCUITS & RECEIVERS
with 27 illustrations

Part 3

AUDIO-FREQUENCY TRANSFORMERS
with 15 illustrations
BANK-WOUND COILS: HOW TO WIND
illustrated by "action" photographs
BASKET COILS, FORMERS & HOLDERS
with 37 photos and a photogravure plate
BATTERIES & BATTERY SWITCHES
with 18 illustrations

Part 4

BOX MAST: HOW TO MAKE
with 8 "action" photographs
BROADCASTING: PRINCIPLES & PROBLEMS
by Richard Twelvetrees and Captain P. P. Eckersley
with large broadcasting map in three colours
CABINETS FOR WIRELESS SETS
with 67 new "action" photos and diagrams
CALL SIGNS: PUBLIC & AMATEUR
comprehensive lists covering the world's important stations and British amateur transmitters

Part 5

CAPACITY: THEORY & CALCULATION
a series of 6 important articles
CHARGING BOARDS: HOW TO USE AND MAKE
with 12 photos and diagrams
COCKDAY CIRCUIT: A REMARKABLE RECEIVER
with 13 photographs and diagrams
COILS: TYPES, USES & THEORY
with 16 photos and diagrams

Part 6

COILS: HOW TO MAKE AND WIND
with 43 photos, including a three-folder plate
COIL HOLDERS: USES & CONSTRUCTION
with 24 photographs
CONDENSERS: THEORY & CONSTRUCTION
74 photos and diagrams, and a photogravure plate
CONTROL BY WIRELESS
by Major Raymond Phillips, I.O.M.

Part 7

Special "Crystal" Number
CRYSTALS: TYPES & HOW TO USE THEM
CRYSTAL CIRCUITS: PRINCIPLES & PRACTICE
with 14 diagrams
CRYSTAL DETECTORS: THE BEST TYPES
with 21 photographs
CRYSTAL DETECTOR UNIT
with 5 illustrations
CRYSTAL RECEIVERS: (1) STANDARD SETS
with 15 photographs
CRYSTAL RECEIVERS: (2) HOW TO MAKE
with 66 "how-to-make" photographs
CRYSTAL RECEIVERS: (3) ADDING AMPLIFIERS
with 54 illustrations, including three-fold plate in full colours

Part 8

DEAD-END SWITCH: HOW TO MAKE
with 10 photos
DETECTOR PANELS & DETECTOR UNITS
with 30 illustrations, including plate in photogravure
DIRECTIONAL WIRELESS
with 20 special photographs and diagrams
DISK CONDENSER
with 10 new photographs
DISTORTION PROBLEMS IN RADIO RECEPTION

Part 9

DRILLS & DRILLING
with 18 photos
DUAL AMPLIFICATION: THEORY & PRACTICE
with 17 photos and diagrams
DULL EMITTER VALVES & A RECEIVER
with 18 photos, including a photogravure plate
DUPLEX WIRELESS TELEPHONY
with 13 special photos
EARTHS: CAPACITY, CONNEXIONS, LEADS & SWITCHES
series of 7 articles with 20 photos
EBONITE: HOW TO WORK AND USE IT
with 21 "action" photos
EIFFEL TOWER STATION
special description, with 10 unpublished photos
ELECTRICITY: ITS CHARACTERISTICS
By F. H. T. Roberts, D.Sc., F.Inst. P. An extraordinarily clever and simple article with remarkable illustration

Part 10

THE ELECTRON IN THEORY & PRACTICE
by Sir Oliver Lodge, F.R.S., D.Sc.
ELECTROSTATIC CAPACITY
by Sir Oliver Lodge, F.R.S., D.Sc.
THE ETHER: MODERN THEORIES
by Sir Oliver Lodge, F.R.S., D.Sc.
FAULTS IN RECEIVERS & HOW TO FIND THEM
with special three-fold photogravure plate

Part 11

FLEMING VALVE: A PIONEER INVENTION
By Professor J. A. Fleming, F.R.S., D.Sc.
FOUR-VALVE SET: A SIMPLE LONG-RANGE RECEIVER
with 17 illustrations
FRAME AERIALS: THEORY, TYPES & MAKING
with 18 photographs and diagrams
FRAME AERIAL RECEIVING SET
with 28 photos and diagrams, and photogravure plate
GALVANOMETERS: USES & CONSTRUCTION
with 16 illustrations, including a series of "how-to-make" photos
GENERATORS FOR TRANSMISSION & OTHER PURPOSES
by A. H. Avery, A.M.I.E.E., with 25 descriptive photos and diagrams

Part 12

GRID LEAKS: FUNCTIONS, VARIETIES & HOW TO MAKE
with 15 illustrations
HANGING SET: A SET FOR THE DINING-ROOM
with 38 illustrations, including photogravure plate
HIGH-FREQUENCY AMPLIFICATION: THE BEST METHODS
with special photographic lay-out diagrams
HIGH-FREQUENCY AMPLIFIERS: HOW TO USE AND MAKE
with 27 photos and diagrams, including photogravure plate
HIGH-FREQUENCY TRANSFORMERS
with 8 illustrations

PART 15 ON SALE EVERYWHERE TUESDAY, MAY 20

Wonders of the Past

in 3 Sumptuous Volumes

Edited by J. A. Hammerton

THE Romance of Perished Civilizations is portrayed for you in these three wonderful volumes. You are led by the world's foremost archæological experts to the scenes of their life labours. They show you the wonderful monuments of antiquity that survive in imperishable stone—they tell you the meaning of the weird inscriptions chiselled by hands of craftsmen dead for sometimes thirty centuries or more—they describe the forgotten civilizations of which these monuments are the relics—they reconstruct for you the cities and empires at the time when these empty streets and deserted temples were thronged by hustling crowds and devout worshippers—they roll back for you the curtain of time and cause to live again the world as it existed before Abraham tended his flocks on the plains of Chaldea. The photographs of existing monuments and the reconstructed pictures of what they were in the height of their glory invest these pages with a vivid interest that gives this great work a fascination unapproached by any former attempt to deal with the great subject of which it treats.

Read what some subscribers to "Wonders of the Past" say about it

Prof. A. H. Sayce, late professor of Assyriology at Oxford University, writes

"If the British public refuses to listen to the voice of the charmer, nothing will ever make it interested in the history of the past. Archæology owes you a great debt."

Sir J. Balfour Paul, Lyon-King-of-Arms, writes

"Allow me to congratulate you on the 'Wonders of the Past,' which you have edited with much skill and judgment."

Joseph Kenworthy, Deepcar, Sheffield, writes

"Allow me to congratulate you on the work you are doing in placing before the public such a treasure-house as 'Wonders of the Past.' I am thankful to have lived to see and revel in such a book in my old age, and thank you for bringing into reality the dream of my youth and manhood."

Mirza Muhammad, Khan Bahadur, Punjab, writes

"If there are people in civilized countries who cannot thank you adequately for your 'Wonders of the Past'—what can be said by us, who live in this semi-civilized country, where literature is not quite accessible to all."

You will be equally delighted if you allow these experts to lead you in the pages of "Wonders of the Past" to the scenes of their labours and listen to the stories of dead ages revealed by their discoveries.

For a first payment of only 5/- the three volumes are sent to your home carriage paid, and while you are enjoying the books and their wonderful revelations of the dim past, you pay the remainder of the price by monthly subscriptions of a few shillings.

First, send for the booklet describing the work in detail. It will cost you nothing, and it is well worth having. It will commit you to nothing, and after you receive it, you can decide if the volumes are worth acquiring. Therefore send TO-DAY a postcard, asking for a Booklet about "WONDERS OF THE PAST" as described in the Wireless Encyclopedia, and address the postcard to

The Educational Book Co., Ltd., 17, New Bridge Street, London, E.C.4.

Printed and Published every alternate Tuesday by the Proprietors, The Amalgamated Press (1922), Ltd., The Fleetway House, Farringdon Street, London, E.C.4. Sole Agents for South Africa: Central News Agency, Ltd.; for Australasia: Messrs. Gordon & Gotch, Ltd.; and for Canada: The Imperial News Co. (Canada), Ltd.
Subscription Rates: Inland and Abroad, 1s. 5d. per copy. May 6th, 1924.

D/R

Carriage Paid

to your home
on payment of

only 5/-

as a first
instalment