

WIRELESS ENGINEER

The Journal of Radio Research and Progress

Managing Editor : HUGH S. POCOCK, M.I.E.E.
Editor : W. T. COCKING, M.I.E.E. Technical Editor : Professor G. W. O. HOWE, D.Sc., LL.D., M.I.E.E.

Editorial Advisory Board:

P. A. T. BEVAN, B.Sc., A.M.I.E.E. (British Broadcasting Corporation); F. M. COLEBROOK, B.Sc., A.C.G.I. (National Physical Laboratory); Professor E. B. MOULLIN, Sc.D., M.I.E.E.; A. H. MUMFORD, O.B.E., B.Sc. (Eng.), M.I.E.E. (G.P.O. Engineering Department); R. L. SMITH-ROSE, D.Sc., Ph.D., M.I.E.E. (Department of Scientific and Industrial Research).

NOVEMBER 1951

Vol. XXVIII

No. 338

CONTENTS

EDITORIALS : Reduction of Skin-Effect Losses	321
Electrical and Magnetic Units	322
RECEIVERS FOR USE AT 460 Mc/s. By E. G. Hamer, B.Sc.(Eng.) (Hons.), and L. J. Herbst, B.Sc.	323
TRANSIENT RESPONSE. By I. F. Macdiarmid	330
IONOSPHERIC CROSS-MODULATION. By I. J. Shaw, Ph.D.	335
LINEAR DIODE VOLTMETER. By R. E. Burgess, B.Sc.	342
RC-COUPLING NETWORK FOR PULSE TRANS- MISSION. By Hilary Moss, Ph.D., B.Sc.(Eng.)	345
NEW BOOKS	349
CORRESPONDENCE	350
ABSTRACTS AND REFERENCES. Nos. 2608-2884. A.203-A.224	

Published on the sixth of each month

Annual Subscription: Home and Overseas, one year £2 4s. 6d., six months, £1 2s. 3d. Canada and U.S.A. \$7.00

Editorial, Advertising and Publishing Offices

DORSET HOUSE, STAMFORD STREET, LONDON, S.E.1

Telephone : WATerloo 3333 (60 lines)

Telegrams : Wirenger, Sedist, London

BRANCH OFFICES AT COVENTRY · BIRMINGHAM · MANCHESTER AND GLASGOW

Cathode Ray Tubes

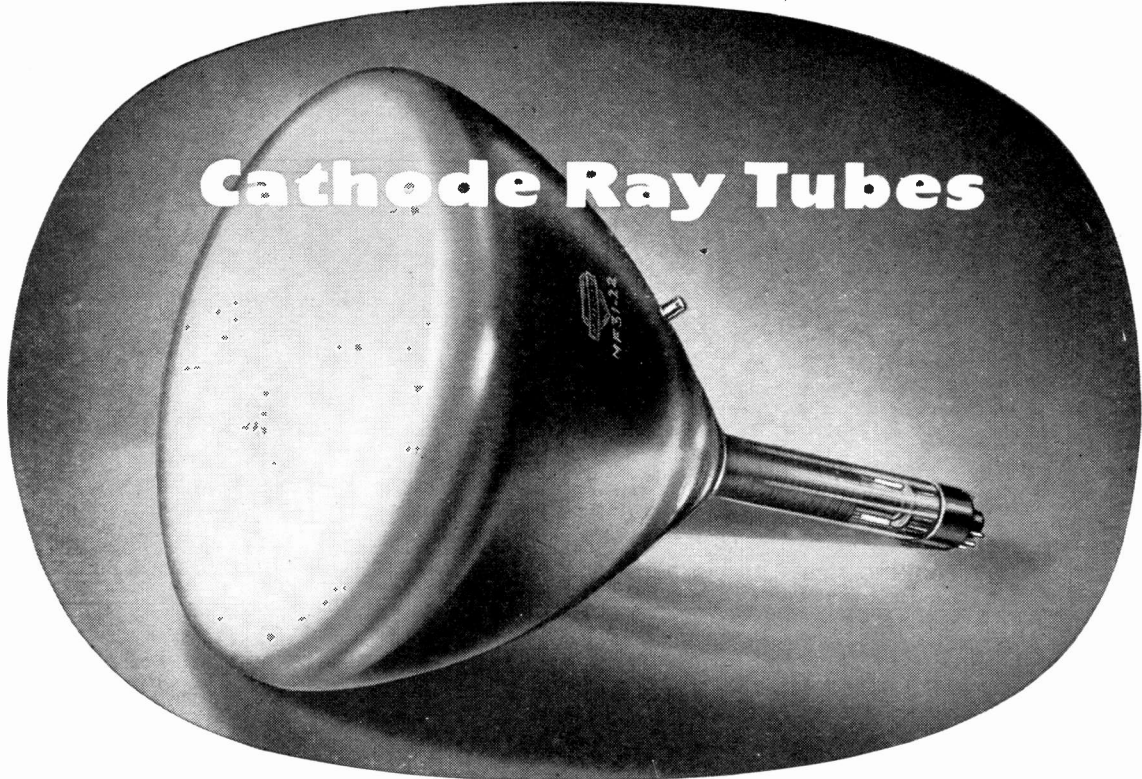

for Radar, Research and Industrial Applications

The cathode ray tube is now accepted as an essential component in all electronic equipments where it is required to obtain a rapid indication or display of physical phenomena. As such it forms the basis of oscilloscopes, test apparatus, monitors, flaw detectors and numerous other research, industrial and communications equipments. The Mullard range of cathode ray tubes has now been extended to meet all these applications.

TUBES FOR RADAR DISPLAYS.

Of particular importance among this range are the Mullard C.R. Tubes MF31-22 (12-in.) and MF13-1 (5-in.) both of which are designed to meet the continuous operation and arduous conditions of service encountered in marine radar applications. Having long-persistence aluminised fluoride screens, these tubes are suitable for use in P.P.I. systems.

SMALL TUBES FOR INSTRUMENTS

A variety of 1 $\frac{1}{4}$ -in. and 2 $\frac{1}{4}$ -in. electrostatic C.R. Tubes with green, blue or persistent screens are also available. These tubes are all characterised by low inter-plate capacitances and are designed for operation with voltages from between 800 and 1,000 volts. These features, coupled with the fact that the tubes are fitted with standard B9C bases and have a seated length of less than 6 ins., make them suitable for use in small, compact oscilloscopes, and in a variety of industrial, communications and research testing and measuring equipments. All these tubes can be obtained in versions suitable for either symmetrical or asymmetrical deflection.

For larger equipments, a high-grade electrostatic 5-in. tube is also available.

Abridged technical details on the tubes for radar displays are listed below. Full data on the complete range of cathode ray tubes is available on request.

Type	Description	Base	Max. Screen Diameter (mm.)	Max. Overall Length (mm.)	V _h (V)	I _h (A)	Va1 max. (V)	Va2 max. (KV)
MF13-1	5" radar tube with metal-backed magnesium fluoride screen	Octal	127.5	292	6.3	0.3	450	11
MF31-22	12" radar tube with metal-backed magnesium fluoride screen	B12A	308	471	6.3	0.3	400	11

Mullard



MULLARD LTD., CENTURY HOUSE, SHAFTESBURY AVENUE, LONDON, W.C.2

MVT106

WIRELESS ENGINEER

Vol. XXVIII

NOVEMBER 1951

No. 338

Reduction of Skin-Effect Losses

IN the July number of the *Proc. Inst. Radio Engrs.*, and also of the *Bell System Technical Journal*, there is an article by A. M. Clogston describing a new method of reducing skin-effect losses. The method is so novel and the claims made so striking that we feel justified in drawing the attention of our readers to the article. The method consists in laminating the surface of the conductor; in a coaxial cable the central conductor consists of a number of thin concentric cylinders of slightly different diameters, separated by layers of dielectric. It is claimed that, in such a conductor, under certain conditions the penetration is so much greater than in a solid conductor of the same size that it more than compensates for the fact that the cross-section is only partly conducting, and thus reduces the losses and the resulting attenuation. Although the mathematical development, starting from Maxwell's equations, is very thorough, the physical explanation is much less satisfactory, but other papers are promised in which the practical and experimental aspects of the problem will be discussed.

In an ordinary conductor at high frequencies the so-called 'skin depth' δ , as the author says, is the depth at which the amplitude has fallen to $1/e = 0.367$ of its surface value, but it is so called because the loss is exactly what it would be if the total current were uniformly distributed over a layer of this depth. Since $\delta = \sqrt{2/\omega\mu\sigma}$ the loss is proportional to the root of the frequency, of the permeability, and of the conductivity.

If the conductor is made up of alternate layers of conducting material of thickness W and insulating material of thickness t , its average or effective dielectric constant in a transverse or radial direction will be

$$\bar{\epsilon} = \epsilon \left(1 + \frac{W}{t} \right)$$

and its average conductivity in the axial or longitudinal direction will be

$$\bar{\sigma} = \sigma \frac{W}{W + t}$$

A surprising result of the mathematical treatment of the problem is that the depth of penetration into the laminated conductor depends on the dielectric constant of the space between the inner and outer conductors (that is, of the main dielectric of the cable) upon which the velocity of wave transmission depends. To obtain the increased depth of penetration it is necessary that this dielectric constant be practically the same as the value $\bar{\epsilon}$ given above for the transverse value of the laminated conductor; quite a small difference causes a considerable decrease in the depth of penetration. It is also essential that the thickness W of the laminations be small compared with the normal depth of penetration δ into the ordinary conductor. If W were equal to δ very little of the energy would get beyond the outer lamination and it would be practically equivalent to a solid conductor.

If $W = t$ no advantage is gained unless the depth is more than doubled because the average conductivity is halved. If there is ample space between the inner and outer conductors and this space is filled with a dielectric of constant $\bar{\epsilon}$, and if $W \ll \delta$, then it is shown that the effective skin depth is given by the formula

$$\delta_w = \sqrt{3} \left(\frac{W + t}{W} \right) \left(\frac{\delta}{W} \right) \delta$$

The conductance of the cable will be proportional

to $\bar{\sigma}\delta_w$, whereas for a solid conductor of the same size it would be proportional to $\sigma\delta$, and since the attenuation constants will be inversely proportional to the conductances, the attenuation constant of the laminated line will be to that of the solid line as

$$\frac{\sigma\delta}{\bar{\sigma}\delta_w} = \frac{\sigma\delta}{\left(\sigma \frac{W}{W+t}\right) \left[\sqrt{3} \left(\frac{W+t}{W}\right) \left(\frac{\delta}{W}\right) \delta \right]}$$

$$= \frac{W}{\sqrt{3}\delta}$$

This emphasizes the importance of making W small compared with δ .

At very low frequencies the skin effect is negligible and the attenuation would be increased by laminating the conductor but, as the frequency is increased, a value will be reached at which the gain due to lamination exactly balances the reduction of cross-section and the laminated and solid conductors will have the same attenuation. Over a wide range of frequency the laminated conductor will have the smaller attenuation, until at a very high frequency for which the penetration is smaller than W , the attenuation will be the same for the laminated and solid conductors.

If one regards the laminated conductor as a medium through which energy is transmitted longitudinally the velocity of transmission will depend on the value of ϵ in a radial direction (that is, on $\bar{\epsilon}$) and if this is equal to the dielectric constant of the main dielectric of the cable, the

longitudinal velocities will be the same in both. This seems to be the essential condition; viz., that the value of $\bar{\epsilon}$, and therefore the velocity of propagation, should be the same in both the dissipative medium (i.e., the laminated core) and in the non-dissipative medium beside it, which has to supply its losses. It is shown that with very thin laminations the reduction of ϵ_x , the longitudinal value of ϵ on passing through a lamination is largely restored on passing through the dielectric layer, so that it enters the following lamination with its value almost restored to its original value. By slowing down the main energy transmission by increasing the value of the main dielectric constant to $\bar{\epsilon}$, one allows it to spread into the laminated core and pass along the dielectric layers and thus into the successive laminations. One has in effect increased the active surface of the conductor.

The most striking novelty in the paper follows from this. The author considers the laminated material as a new kind of transmission medium and fills the whole space between the two conductors with it. Calculation shows that the attenuation is thereby decreased. There is a certain amount of waste current flowing in the laminations but this is more than counterbalanced by the enormous increase in the conductor surface and the resulting decrease in current density.

There is much in the paper to which we have not referred, but the above will indicate that it deals with a very novel and interesting subject and deserves careful study.

G. W. O. H.

Electrical and Magnetic Units

WHEN reviewing recent German textbooks we have on several occasions remarked on the absence of any reference to Giorgi or the m.k.s. system. Even when a rationalized practical system is employed, the unit of length is still the centimetre, which is undoubtedly more convenient than the metre in many applications; an ampere per square metre is admittedly not a very convenient unit in which to express the current density in a wire. To maintain the practical units, the ampere, volt, etc., it is necessary, however, to adopt as the unit of mass, 10^4 kg) i.e., 10 tons) which is, perhaps, more inconvenient than the metre, except that it enters very little into electrical units. This system is usually associated with the name of Mie.

In the *Elektrotechnische Zeitschrift* of 1st August there is an 8-page article by O. Löbl entitled "Memorandum on Electrical and Magnetic units", in which the author reviews the

general situation, discusses the Gauss, Giorgi and Mie systems, and then advocates a return to an assumption that we regarded as obsolete: viz., that in both the electric and magnetic fields, cause and effect have the same dimensions, and that consequently permittivity and permeability are both mere numbers, their relative and absolute values being one and the same thing. In the proposed system the unit of H and B is the A/cm and that of E and D the V/cm; consequently the values and dimensions of the electric and magnetic fluxes Ψ and Φ and their densities D and B differ from those in the present system. Two constants are introduced, $c_e = 10^9/4\pi c^2$ where $c = 3 \times 10^{10}$, and $c_m = 4\pi/10^9$, and then, instead of the electric flux Ψ being equal to Q , we have $Q = c_e \Psi$, and similarly, instead of the magnetic flux Φ being equal to the pole strength P , we have $P = c_m \Phi$. These constants appear in many formulae and it is interesting to note that

$1/(c_e c_m) = c^2$ and $\sqrt{(c_m/c_e)} = 377 \Omega$, which is the intrinsic impedance of space (see Editorial of September 1949). For the force between two electric charges or two magnetic poles the formulae become

$$F = \frac{1}{c_e \epsilon} \cdot \frac{Q_1 Q_2}{4\pi r^2} \text{ and } F = \frac{1}{c_m \mu} \cdot \frac{P_1 P_2}{4\pi r^2}$$

and for the energy density in the fields $0.5c_e \epsilon \mathcal{E}^2$ and $0.5c_m \mu H^2$ respectively.

The principal advantage (?) of this suggested system appears to be that, instead of writing $\mu\mu_0$, where $\mu_0 = 4\pi/10^9$, one writes μc_m , where $c_m = 4\pi/10^9$, and similarly for the permittivity but, seeing that the leading German electrotechnical journal devotes eight large pages to the subject, we thought it advisable to draw attention to the proposal, which the author suggests should be brought before the international standardization organization.

G. W. O. H.

RECEIVERS FOR USE AT 460 Mc/s

By E. G. Hamer, B.Sc.(Eng.)(Hons.), A.M.I.E.E., Ass.Brit.I.R.E.,
and L. J. Herbst, B.Sc.

(Communication from the Staff of the Research Laboratories of The General Electric Co., Ltd., Wembley, England)

THE increasing use of frequencies below 200 Mc/s for communications between fixed and mobile stations necessitates the use of higher frequencies for fixed-link services. The bands of frequencies 235–328.6, 335.4–420 and 460–470 Mc/s have been allocated by the International Telegraph Union for fixed and mobile services. For frequencies up to 500 Mc/s standard types of valves and components may be used, but above these frequencies, for example the 1700–2300 Mc/s band of frequencies, special types of valves and circuit elements are required, and these entail a much greater initial and maintenance cost.

In the case of communication circuits requiring up to, say, six speech channels over one radio link, it is important that the cost of the radio equipment shall be as low as possible consistent with reliability and the required minimum of technical performance. On these grounds the lowest permissible frequency would be chosen to obtain as large a transmitter power as possible when using inexpensive valves, also to reduce the propagation losses to a minimum. With the relatively low transmitting powers available (2–5 W) and the maximum economic aerial gain, one of the factors limiting the maximum distance for a link is the behaviour of the receiver in regard to thermal noise generated in the input circuits.

At high frequencies the limitation on the overall gain of a receiver is the amount of thermal noise in the first stage of the receiver, this thermal noise being produced by the aerial input circuit, and the first circuit components. A designer has little control over the amount of thermal noise

contributed by the aerial circuit, but the remainder may be reduced to a minimum by careful choice of valves and circuit elements in the early stages of the receiver. The efficiency of the receiver design may be expressed by the noise factor of the receiver, and this is defined as the ratio of the noise-power output produced by the actual receiver to the noise-power output produced by the input source only, the remainder of the receiver being assumed to be perfectly noiseless.

The final signal-to-noise ratio at the output of the receiver depends on its noise factor, and an improved receiver noise factor will enable either a better signal-to-noise ratio to be obtained, or enable an increase of range or a reduction of transmitter output power for the same performance.

In an actual receiver the design of the first and second stages determines the noise factor, and this article is confined to the problems involved in this stage of the design. Considering the various sources of noise in detail, we have first the aerial itself. Neglecting any effects due to static or ignition noise, the aerial itself is a source of thermal noise, and it can be shown that the thermal-agitation noise produced is the same as that produced by a resistance equal to the radiation resistance of the aerial, and at the same mean temperature as the aerial. The thermal agitation noise produced by a resistance R due to the random motion of the conductor electrons may be represented by a voltage of magnitude \bar{E}

$$\text{where } \bar{E} = \sqrt{4kTBR}$$

k = Boltzmann's constant

T = absolute temperature

B = bandwidth of circuits following R .

MS accepted by the Editor, September 1950

This value of \bar{E} is really a root-mean-square value, as the noise voltage is random in phase and magnitude.

A certain amount of noise is generated by the valves due to the random motion of the electrons which leave the cathode, resulting in random variations of the anode current, and producing what is known as shot noise. This effect is particularly noticeable when the valve is operated under temperature-saturated conditions, and is used in the diode noise generator. In the case of a multi-electrode valve there is an additional noise effect known as partition noise, and this is due to the random division of the cathode current among the various electrodes, thus causing further fluctuations of the anode current. All these effects can be simulated by placing a hypothetical resistance in series with the grid of the perfect valve, the value of the resistance being such as to generate the same amount of thermal noise as would be generated by the actual valve. This noise resistance is simply a convenient way of expressing a generated noise voltage, and does not exist as a physical ohmic resistance in the ordinary sense. Various formulae have been derived for giving the noise resistance of a valve, and these formulae differ slightly with various authors^{1,2,3}.

Using the expressions given by F. E. Terman for noise resistance:

$$R_n = 3/g_m \text{ ohms for a triode valve} \quad \dots (1)$$

$$R_n = \frac{I_a}{I_a + I_{g2}} \left\{ \frac{2.5}{g_m} + \frac{20I_{g2}}{(g_m)^2} \right\} \text{ ohms for a pentode} \quad (2)$$

where I_a = anode current (A)

I_{g2} = screen current (A)

g_m = mutual conductance (mA/V).

It will be seen from (1) and (2) that a triode valve will generate less noise than a multi-electrode type, and is normally to be preferred. Other conditions must, however, be taken into account. For example, the input capacitance of the valve determines the efficiency of the input circuit; grid current causes additional shot noise, and transit time effects may render a valve unusable unless it has been designed for high-frequency operation. Another factor to be borne in mind when triode valves are used is that the high input to output capacitance makes neutralization usually essential, and this may cause further difficulties.

General Design Considerations

The receiver design factors to be discussed in this article are broadly divided into two sections: receivers not using r.f. amplifiers, and those where the mixer is preceded by one or two stages of r.f. amplification. In the u.h.f. bands of frequencies

the deciding factor between the two types may be cost or the availability of suitable valves. Up to 500 Mc/s suitable simple based valves are available for use as r.f. amplifiers. Between 500 and 2000 Mc/s disc-seal type valves may be used together with the necessary mechanically elaborate circuits. Above 2000 Mc/s it is possible that special types such as travelling-wave valves could be used. At the higher frequencies it may be more economical to use a direct mixer followed by an i.f. amplifier, and in this case the overall noise factor will be determined mainly by the noise factor of the i.f. amplifier, and the conversion loss of the mixer. The use of an i.f. amplifier with a low noise factor is essential in this latter case.

Considering in more detail the requirements for a low-noise i.f. amplifier for carrier frequencies of 460 Mc/s, and taking into account the stability of circuits and the bandwidth required for the intelligence to be transmitted, an intermediate frequency of between 30 and 40 Mc/s would probably be chosen. From equations (1) and (2) it is seen that a triode valve is less noisy than a pentode; hence, triode valves should be used in preference to multi-grid types. The usual methods of connecting a triode amplifier are either as an earthed-cathode, earthed-anode, or earthed-grid circuit, and considering the earthed-anode or, as more commonly known, cathode-follower circuit, we have the advantage of a high input and low output impedance. This means that although there is a considerable power gain the voltage gain is less than unity. At high frequencies, however, there will be feedback between the input and output circuits due to the grid-to-cathode capacitance and transit-time effects. Cathode followers are mainly useful where it is required to match the output into a coaxial cable, say, where part of the receiver is mounted close to the aerial and the remainder of the i.f. amplifier at some distance away. The noise performance of the cathode-follower circuit can be shown to be the same as the earthed-cathode circuit³, but the performance at 40 Mc/s is doubtful without further circuit elaboration to neutralize the effect of the grid-to-cathode capacitance.

Considering the earthed-cathode circuit, this has reasonably high input and output impedances, and usually gives a voltage and power gain. At high frequencies there is feedback between the input and output circuits due to the grid-to-anode capacitance and transit-time effects. Over a reasonably wide band of frequencies this effect may be nullified by suitable neutralization circuits.

The noise factor of an earthed-cathode circuit is

$$N = 1 + T_c \cdot \frac{R_a}{R_c} + \frac{R_n}{R_a} \left\{ 1 + \frac{R_a}{R_c} \right\}^2 \quad \dots (3)$$

(See Appendix I)

For the earthed-grid circuit the input impedance is low and the output impedance is high. This makes it useful for matching to the output from a coaxial cable. The coupling between the input and output circuits is very low, depending on the cathode-to-anode capacitance, and by suitable construction of the valve and circuits it can be reduced to a very low value.

The noise factor for an earthed-grid circuit is:—

$$N = 1 + \frac{2}{R_L} \left[\frac{1}{g_m} + \sqrt{R_n R_L + \left(\frac{1}{g_m}\right)^2} \right] \quad (4)$$

(See Appendix 2)

if transit-time effects are neglected.

At frequencies of the order 40 Mc/s the noise figures obtained for the two circuits are nearly identical, and the choice of circuit is largely determined by the circuit bandwidth required. The input impedance of the earthed-grid amplifier is of the order $1/g_m$, and in consequence of this low value is very suitable where large bandwidths are required. The earthed-cathode stage is to be preferred for smaller bandwidths due to its higher input impedance.

The overall noise factor of the i.f. amplifier is mainly determined by the noise factor of the first two stages, and with the circuits discussed the contribution of the second stage to the overall noise factor is approximately 10% of the total (see Appendix 3). The earthed-cathode stage followed by a pentode amplifier is difficult to neutralize due to the large voltage gain. If, however, the earthed-cathode circuit is followed by an earthed-grid circuit, the power gain is considerable although the voltage gain is reduced and the circuit is more stable; also the second

stage noise is reduced. If both valves have the same conductance, the input impedance of the earthed-grid circuit is $1/g_m$ and the voltage gain from the input grid to the cathode of the second valve is $g_m \times 1/g_m = 1$. A considerable power gain has occurred in the first stage and this circuit makes the major noise contribution. The overall noise factor of this circuit is the best obtainable theoretically and practically with present techniques⁴, and provided a suitable mechanical layout is chosen, the earthed-cathode circuit is easy to neutralize. In many cases the first stage is found to be stable without neutralization, although in this case a worse noise factor is obtained.

Performance of Valves and Circuits

To estimate the noise factor of a circuit a knowledge of the resistive component of the input impedance of the valve is required, as the merit of any given valve for low-noise applications depends on its input impedance and its mutual conductance. The resistive component of the input impedance was measured for various valves at a frequency of 40 Mc/s. The mean results of several samples were taken in each case. Table 1 gives the measured input resistance of the various valves, and the calculated noise resistance and noise factor when used in an earthed-cathode circuit.

Fig. 1 shows the circuit diagram of a complete low-noise i.f. amplifier; various valves were used in the first two stages and the overall noise factor was measured by using a diode noise generator. Table 2 gives the measured overall i.f. noise performance for various valve types.

TABLE 1

Valve type	EC91	A1714	CV408	*Z77	12AT7	12AU7	EAC91	DH77	177	ECC91	6N4
g_m (mA/V)	8.5	7	7	8	5.5	2.2	2.9	1.2	2.2	5.3	5.3
Mean input resistance (Ω)	12,000	58,900	57,200	16,800	37,100	68,900	82,900	36,000	22,000	15,000	19,200
Noise resistance (Ω) ..	400	400	400	400	460	1,140	860	2,100	1,400	470	470
Noise factor (40 Mc/s)	2.02	1.57	1.57	1.90	1.76	2.01	1.8	4.15	2.77	2.0	1.93
Noise factor (db) ..	3.0	2.0	2.0	2.9	2.3	3	2.6	6.3	4.4	3.9	2.8

* Triode connected.

TABLE 2

Valve type	EC91	A1714	12AT7	ECC91	Z77(1)	Z77(2)
Overall noise factor to be expected (db) ..	4	3	5.5	5.5	4	4

(1) and (2) valves were triode connected. In (1) suppressor to anode, in (2) suppressor to cathode.

Using Z77 valves for V_1 and V_2 in Fig. 1, the noise factor was found to be 2.35 (3.7 db).

Particulars of the input circuit were:

$$R_n = 400 \Omega$$

$$R_e = \text{Input resistance of valve} = 17 \text{ k}\Omega$$

$$R_g = \text{Resistance of generator} = 375 \Omega$$

$$\omega_0 = 2\pi \times 40 \times 10^6$$

$$C = \text{total tuning capacitance of first stage} \\ = 18 \text{ pF}$$

$$Q_0 = \text{natural } Q \text{ of } L_1 \text{ and } C = 130$$

$$Z_0 = \text{dynamic impedance of first tuned circuit} \\ = 40 \text{ k}\Omega$$

$$R_c = \frac{Z_0 R_e}{Z_0 + R_e} = 12 \text{ k}\Omega$$

$$n = \text{aerial transformer ratio} = 2\frac{1}{2}$$

$$R_a = n^2 R_g = 2.4 \text{ k}\Omega$$

Using equation (10), Appendix 1 and equation (22), Appendix 3:--

$$N_1 = 2.1$$

Also, as the input impedance of the earthed-grid stage is approximately 200 Ω , and from equation (22)

$$\frac{N_2 - 1}{G_1} \approx \frac{1}{10}$$

hence $N = 2.1 + 0.21 = 2.31$ (3.65 db).

It will be seen that this figure is in good agreement with the measured value of 3.7 db.

The addition of a mixer valve before the i.f. amplifier will worsen the noise performance of the receiver (Appendix 2). In the case to be considered, the mixer is a silicon-crystal valve with a conversion power gain of 0.25, and an output impedance of 375 ohms. An i.f. amplifier designed to match the output impedance of the crystal will have a noise factor of 4 db, and due to the conversion loss of 6 db the overall noise factor of the receiver will be 10 db.

Fig. 2 shows the circuit diagram of a complete silicon-crystal mixer head, which, when used with the i.f. amplifier of Fig. 1, gave a noise factor of 9 db measured at a frequency of 465 Mc/s using a thermionic diode noise generator. The effect of varying the tapping position of the crystal along the top-capacitance loaded coaxial line is to vary the circuit Q , and causes a small change of conversion gain. This enables the r.f. selectivity to be adjusted to the required value.

As previously mentioned, for frequencies up to 460 Mc/s simple based valves are available which will behave satisfactorily as r.f. amplifiers. These valves are on glass bases, are of the triode type, and due to their physically-small size and short leads are eminently suitable. The valves are usually constructed with duplicate pin connections, and arranged for earthed-grid operation. By using earthed-grid circuits the difficulties of neutralization are generally avoided, and effective screening is obtained between the input and output circuits.

The use of r.f. valve amplifiers also adds con-

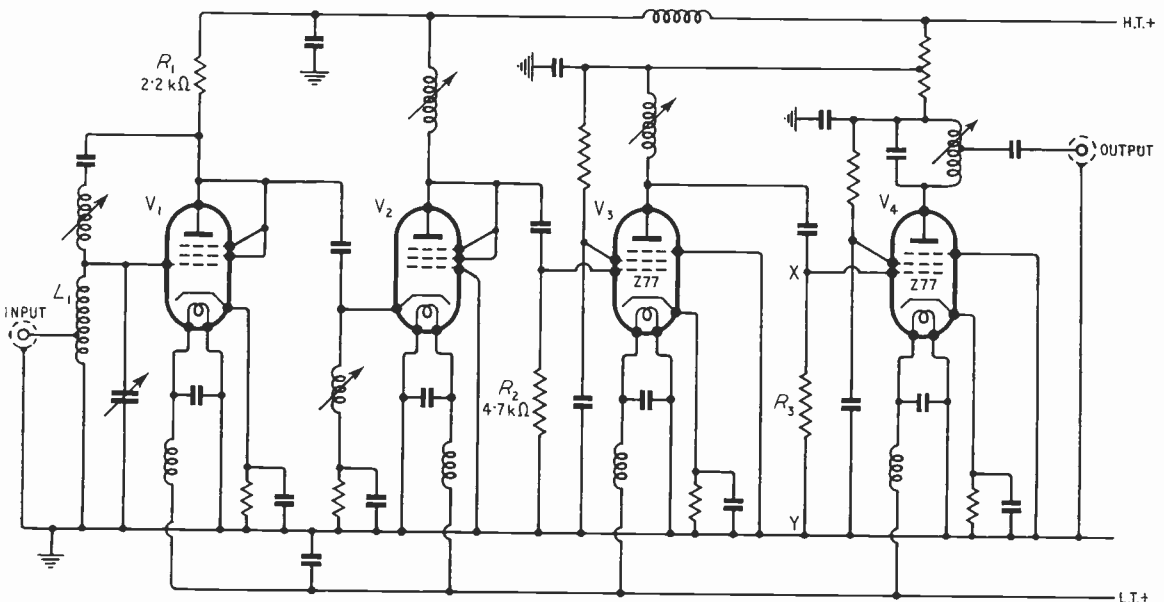

Fig. 1. Low-noise i.f. amplifier: $R_1 = 2.2 \text{ k}\Omega$, $R_2 = 4.7 \text{ k}\Omega$, $V_3, V_4 = \text{Z77}$, $V_1, V_2 = \text{valves under test}$.

siderably to the r.f. selectivity of the receiver, and this added selectivity is also accompanied by an improved noise performance. The noise factor of an r.f. amplifier valve in an earthed-grid circuit is

$$\text{Then } R_{kmin} = 1,100 \text{ ohms}$$

$$\text{and } N_{min} = 2.3 = 3.5 \text{ db.}$$

This takes no account of the noise contribution of the second stage r.f. amplifier or mixer circuit, and also neglects transit-time effects.

Fig. 3 shows the circuit of a typical receiver comprising an earthed-grid r.f. amplifier, and an earthed-grid mixer. When using EC91 or 12AT7 valves, a noise factor of 7 db was measured using a thermionic diode noise generator at a frequency of 465 Mc/s. The addition of a second r.f. stage would give a small improvement as the second-stage noise would be reduced from that caused by a mixer to that caused by an r.f. stage, but it enables an extra tuned circuit to be used and gives increased r.f. selectivity.

Noise figures of between 6 and 10 db may be expected for receivers used at frequencies of 460 Mc/s, depending on the type of circuit used.

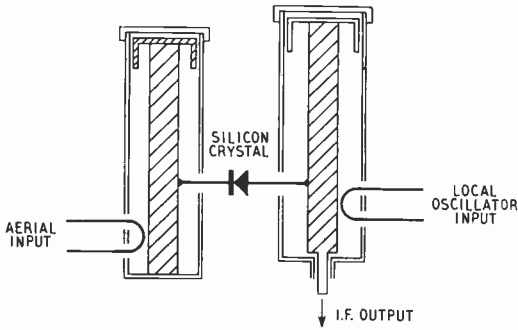

Fig. 2. Crystal mixer head.

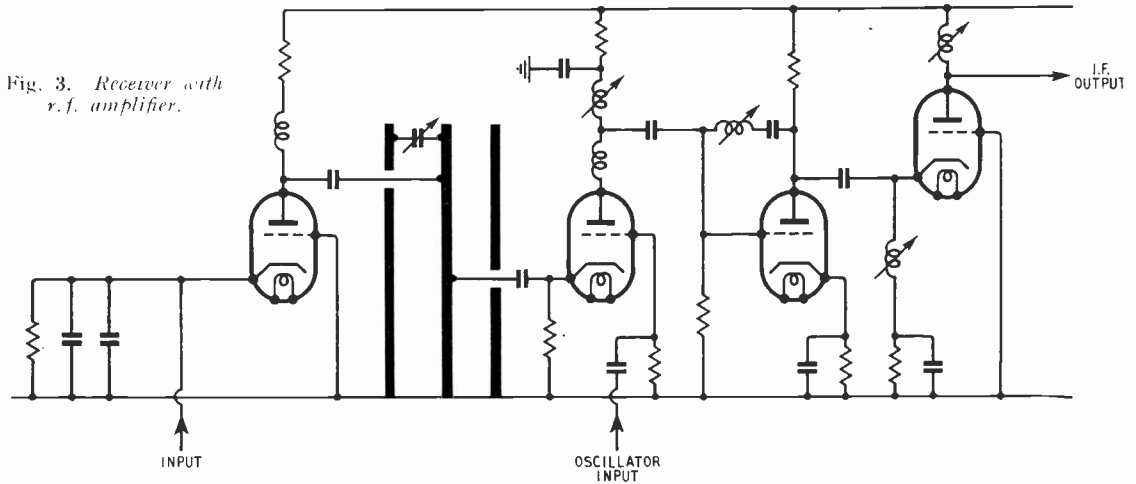

Fig. 3. Receiver with r.f. amplifier.

derived in Appendix 2 and the noise factor is seen to depend on the cathode load of valve. For optimum noise performance (neglecting transit-time effects)

$$N_{min} = 1 + \frac{2}{R_L} \left[\frac{1}{g_m} + R_{kmin} \right] \dots \dots (5)$$

where the cathode impedance R_{kmin} for this condition is

$$R_{kmin} = \sqrt{R_n R_L + \left(\frac{1}{g_m} \right)^2}$$

where R_n = equivalent noise resistance of valve

R_L = anode load resistance

g_m = mutual conductance

and in a typical case, if $g_m = 5 \text{ mA/V}$

$$R_n = 600 \text{ ohms}$$

$$R_L = 2,000 \text{ ohms}$$

Simple based cheap valves give an improved noise factor at this frequency, and can be used without requiring elaborate mechanical circuits. There is little to be gained in noise performance by using more than one r.f. amplifier, but extra stages may be required on the grounds of r.f. selectivity.

APPENDIX 1

The noise factor of a receiver may be defined by

$$N = V_2^2 / V_1^2$$

where V_2 = fictitious r.m.s. voltage which, inserted in series with the real noise generator, the aerial R_a , produces the actual noise output of the amplifier.

V_1 = r.m.s. noise voltage developed across R_a due to thermal noise in R_a .

R_b = bias resistance

C_b = by-pass capacitor.

R_n = noise resistance of valve at operating frequency.

R_c = input resistance of valve at operating frequency.

From Fig. 4 the equivalent noise resistance of the grid circuit is

$$\left\{ \frac{R_a R_c}{R_a + R_c} + R_n \right\}$$

the corresponding noise voltage at the grid is V_g where

$$V_g = \sqrt{4kTB \left\{ \frac{R_a R_c}{R_a + R_c} + R_n \right\}}$$

hence V_2 , the equivalent noise voltage in series with R_a

$$V_2 = \frac{R_a + R_c}{R_c} V_g = \frac{R_a + R_c}{R_c} \sqrt{4kTB \left\{ \frac{R_a R_c}{R_a + R_c} + R_n \right\}}$$

$$\begin{aligned} \text{hence } N &= \frac{V_2^2}{V_1^2} = \left\{ \frac{R_a R_c}{R_a + R_c} + R_n \right\} \left(\frac{R_a + R_c}{R_c} \right) \frac{1}{R_a} \\ &= 1 + \frac{R_n}{R_c} + \frac{R_n}{R_a} \left(1 + \frac{R_a}{R_c} \right)^2 \dots \dots \dots (7) \end{aligned}$$

APPENDIX 2

Fig. 7 shows the basic circuit of the earthed-grid connection.

R_n = noise resistance of valve.

$$e_g = \sqrt{4kTBR_n}$$

e_k = noise voltage developed in cathode load,

$$= \sqrt{4kTBR_k}$$

R_a = a.c. resistance of valve. e_2 = noise voltage developed in anode load = $\sqrt{4kTBR_L}$. R_k, R_L are resistances of cathode and anode loads at resonance.

Then $V_g = e_g + e_k - iR_k$

$$= \sqrt{4kTBR_n} + \sqrt{4kTBR_k} - iR_k \dots \dots \dots (13)$$

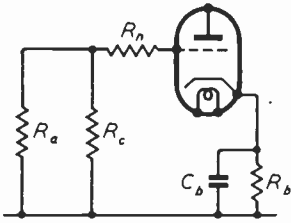

Fig. 4

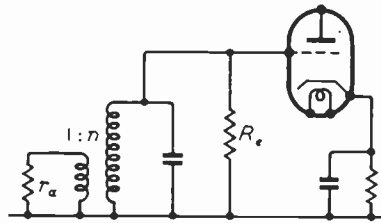

Fig. 5

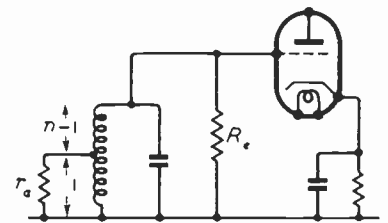

Fig. 6

Figs. 4, 5 and 6. Basic earthed-cathode circuits; (Fig. 5) transformer coupled; (Fig. 6) autotransformer coupled.

For a minimum value of N , it is found by differentiating

$$(7) \text{ that } R_a = R_c \sqrt{\frac{R_n}{R_n + R_c}} \dots \dots \dots (8)$$

$$\text{and the value } N_{min} = 1 + 2\frac{R_n}{R_c} + 2\frac{R_n}{R_c} \sqrt{1 + \frac{R_c}{R_n}} \dots (9)$$

The resistance of the source is generally unequal to the value given by (8), and a matching transformer is required to step up the source resistance.

Figs. 5 and 6 show the most popular circuits. In Fig. 6 the inductance of the tuned circuit serves as an autotransformer, and in Fig. 5 the two windings are closely coupled. In both Figs. 5 and 6 $R_a = n^2 r_a$.

R_c = damping resistance of valve at operating frequency.

The effect of transit time on the noise factor has been investigated by various authors². We assign an arbitrary noise temperature constant T_c to R_c and $T_c \approx 5$ at a frequency of about 40 Mc/s. R_c is then replaced by $T_c R_c$ and equations (7), (8) and (9) modified, giving

$$N = 1 + T_c \frac{R_a}{R_c} + \frac{R_n}{R_a} \left(1 + \frac{R_a}{R_c} \right)^2 \dots \dots \dots (10)$$

$$\text{for } N_{min}, R_a = R_c \sqrt{\frac{R_n}{R_n + T_c R_c}} \dots \dots \dots (11)$$

$$N_{min} = 1 + 2\frac{R_n}{R_c} + 2\sqrt{\frac{R_n}{R_c} \left(T_c + \frac{R_n}{R_c} \right)} \dots \dots \dots (12)$$

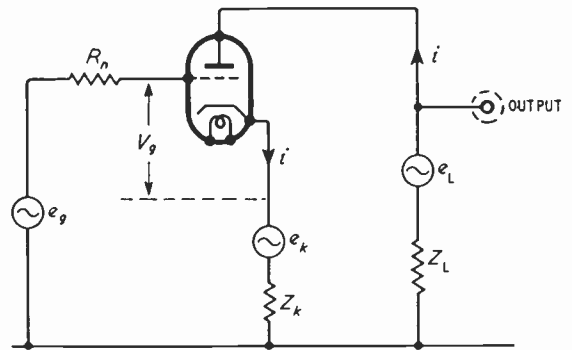

Fig. 7. Basic earthed grid circuit.

Considering the anode loop

$$e_k + e_L + \mu V_g = i(R_k + R_a + R_L) \dots \dots \dots (14)$$

(13) and (14) give

$$i = \frac{(\mu + 1) \sqrt{4kTBR_k} + \sqrt{4kTBR_L} + \mu \sqrt{4kTBR_n}}{(\mu + 1)R_k + R_a + R_L} \dots \dots \dots (15)$$

The noise output voltage

$$\begin{aligned} V_n &= iR_L - \sqrt{4kTBR_L} \\ &= \frac{(\mu + 1)R_L \sqrt{4kTBR_k} + \mu R_L \sqrt{4kTBR_n} - \{(\mu + 1)R_k + R_a\} \sqrt{4kTBR_L}}{(\mu + 1)R_k + R_a + R_L} \end{aligned}$$

To get the mean noise voltage, we take the squares of the various components, giving

$$V_{n2} = \text{mean-square-noise voltage} \\ = 4kTB \frac{(\mu + 1)^2 R_L^2 R_k + \mu^2 R_L^2 R_n + \{(\mu + 1)R_k + R_a\}^2 R_L}{\{(\mu + 1)R_k + R_a + R_L\}^2}$$

In the case of an ideal amplifier we neglect the noise generated in valve and anode load;

$$\text{i.e., } e_g = e_L = 0$$

We then have

$$V_g = \sqrt{4kTBR_k} - iR_k \quad \dots \quad (16)$$

$$\sqrt{4kTBR_k} + \mu V_g = i(R_k + R_a + R_L) \quad \dots \quad (17)$$

and

$$V'_n = \frac{R_L(\mu + 1)\sqrt{4kTBR_k}}{(\mu + 1)R_k + R_a + R_L}$$

hence

$$N = \frac{V'^2_2}{V'^2_1} = \frac{R_k R_L^2 (\mu + 1)^2 + \mu^2 R_L^2 R_n + \{(\mu + 1)R_k + R_a\}^2 R_L}{(\mu + 1)^2 R_k R_L^2}$$

$$= 1 + \frac{R_n}{R_k} + \frac{R_L}{R_k} \left\{ \frac{R_k}{R_L} + \frac{R_a}{\mu R_L} \right\}^2 \quad \dots \quad (18)$$

for $\mu \gg 1$

Differentiating (18) with respect to R_k to find the minimum value of N , we find that

$$R_k = \sqrt{R_n R_L + \left(\frac{1}{g_m}\right)^2} \quad \dots \quad (19)$$

Substituting this expression for R_k in (18)

$$N_{min} = 1 + \frac{2}{R_L} \left\{ \frac{1}{g_m} + \sqrt{R_n R_L + \left(\frac{1}{g_m}\right)^2} \right\} \quad (20)$$

The effect of transit time has been neglected in the above treatment.

Consideration of transit-time effect leads to rather cumbersome expressions, which do not readily lend themselves to a solution for minimum noise factor⁵.

APPENDIX 3

The noise factor of a receiver consisting of networks (1), (2), (3), . . . (r) in cascade is

$$N = N_1 + \frac{N_2 - 1}{G_1} + \frac{N_3 - 1}{G_1 G_2} + \dots + \frac{N_r - 1}{G_1 G_2 \dots G_{r-1}} \quad (21)$$

where G_1 is the power gain from the input terminals of (1) to (2),

G_2 is the power gain from the input terminals of (2) to (3), etc.

$\frac{N_3 - 1}{G_1 G_2}$ and the following terms can generally be neglected in the above expression, and for all practical purposes

$$N = N_1 + \frac{N_2 - 1}{G_1} \quad \dots \quad (22)$$

Hence, from (22), we can allow for the contribution of the second stage noise to the overall noise factor.

V.h.f. and u.h.f. receivers often consist of a silicon-crystal mixer followed by an i.f. amplifier. Equation (22) is then modified.

Rewriting it as it stands

$$N = \frac{1}{G_1} \{ N_1 G_1 + N_{if} - 1 \} \quad \dots \quad (23)$$

where G_1 is the power gain from mixer input to i.f. input terminals.

N_1 = noise factor of crystal mixer.

N_{if} = noise factor of intermediate frequency amplifier.

$N_1 G_1$ is defined as the noise temperature t_r of the crystal and equation (23) written in the usual form.

$$N = \frac{1}{G_1} \{ t_r + N_{if} - 1 \} \quad \dots \quad (24)$$

The performance of silicon-crystal mixers has been investigated thoroughly in recent years.

For v.h.f. and u.h.f. silicon-crystal mixers operating with 1 milliwatt local oscillator injection

$$t_r \approx 1$$

and

$$N = \frac{N_{if}}{G_1} \quad \dots \quad (25)$$

Finally, an expression will be derived relating to the noise factor and the pre-detector signal-to-noise-power ratio S of a receiver.

Let R_a be the resistance of the generator (this will normally be the aerial radiation resistance).

Let V be the strength of the received signal in volts r.m.s. Then signal power developed across $R_a = V^2/R_a$.

Noise power developed across $R_a = 4kTBN$. Hence the signal-to-noise power ratio S is given by

$$S = \frac{V^2}{4kTBN R_a} \quad \dots \quad (26)$$

It must be stressed that the above formulae take only thermal receiver noise into consideration. External noise, such as static, will be part of V in equation (26).

REFERENCES

- ¹ F. E. Terman, "Radio Engineers Handbook," McGraw-Hill Co.
- ² L. A. Moxon, "The Noise Characteristics of Radar Receivers," *J. Inst. elect. Engrs*, Radiolocation Convention, Pt. IIIA, pp. 1130, 1946.
- ³ R. E. Burgess, "Signal/Noise Characteristics of Triode Input Circuits," *Wireless Engineer*, 1945, Vol. 22, p. 56.
- ⁴ Van Voorhis, "Microwave Receivers," M.I.T. Radiation Laboratory Series, Vol. 23.
- ⁵ M. Dishal, "Theoretical Gain and Signal to Noise Ratio of the Grounded Grid Amplifier at Ultra-High Frequencies," *Proc. Inst. Radio Engrs*, 1944, Vol. 32, p. 276.

TRANSIENT RESPONSE

Conditions for Monotonic Characteristics

By I. F. Macdiarmid, A.M.I.E.E.

(Post Office Research Station)

SUMMARY.—The necessary and sufficient conditions for a monotonic transient response when a network is stimulated by a unit step of current are considered, and it is shown that the location of the zeros of the impedance function on the complex-frequency plane is as important as the location of the poles.

Conditions for monotonic transient response are derived for networks having two poles and two zeros in the complex-frequency plane, and an example is given of a compensated anode load fed by a triode valve.

1. Introduction

WHEN a network is stimulated by a step-function of voltage or current the response is usually either oscillatory or monotonic (i.e., free from overshoot or other turning points). Typical examples are sketched in Fig. 1(a) and (b). For many applications the monotonic form of response is desirable or even essential, and a common design problem is to find a network with the shortest rise-time and a monotonic response. The present paper is concerned with the problem of obtaining a transient response of monotonic form.

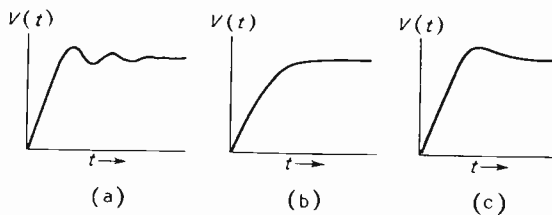

Fig. 1. Typical transient responses.

The study of the transient response of a network can best be carried out by means of the Heaviside Operational method or the allied Laplace Transform method, the latter being used here. The first step in either method is to write down the 'operational impedance' or 'impedance function' of the network. Practically, this is done by replacing ' $j\omega$ ' in the ordinary steady-state impedance by a new variable ' p ' which can take real or complex values in addition to the purely imaginary values of $j\omega$. This process is equivalent (in the most common case where the initial conditions are zero) to transforming the real variable ' t ' in the homogeneous differential equations of the network to the complex variable ' p ' by means of the Laplace Transformation. The formal mathematics of the procedure can be found in a textbook on operational calculus (e.g., reference 3) and an excellent discussion has been given by

Bode⁵ on the physical significance of ' p ' as a complex frequency and its relation to network behaviour.

The impedance function of a network, being derived from the network differential equations, contains information about both the transient and steady-state responses. It can be shown⁵ that for a physically-realizable network the impedance function is always a rational function; i.e., the ratio of two polynomials in p . The numerator and denominator of the function can be separately factorized out and each factor in the numerator will give a value of p (generally complex) for which the function is zero; similarly each factor in the denominator gives a value of p for which the function is infinite. These 'singular' values of p are respectively known as the zeros and the poles of the function. Owing to the restricted form of the impedance function a knowledge of the positions of the poles and zeros in the complex p -plane is all that is required to reconstruct the function (apart from a numerical scaling factor). Therefore the position of the poles and zeros of the impedance function contains all the information about both the transient and steady-state responses.

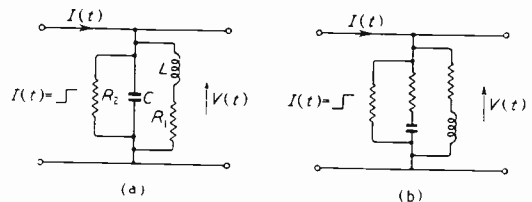

Fig. 2. Networks with one pair of poles.

It has been suggested that the necessary and sufficient condition for a monotonic transient response is that the poles of the network transfer impedance should lie on the negative real axis of the complex frequency plane (p -plane).^{1,2} However, it appears that this condition is not sufficient even for a simple network such as a valve anode load.

MS accepted by the Editor, August 1950

In the case of such a network, Fig. 2(a), the transfer impedance has a zero at infinity and two poles and one zero in the left-hand half of the complex p -plane. Even when all these lie on the negative real axis it is possible to obtain a transient response of the type shown in Fig. 1(c) which has an overshoot although it is not oscillatory in the normal sense.

The conditions necessary to obtain this form of response are studied in the next section for the case of a network with two poles and two zeros.

2. Conditions for Overshoot without Oscillation

When the transient response of a network of known impedance function is being studied two alternative types of stimulus are commonly used, viz.: the step function (or unit step)

$$U(t) = \begin{cases} 0, & t < 0 \\ 1, & t > 0 \end{cases}$$

and the impulse function (or unit impulse or Dirac δ function)

$$\delta(t) = \begin{cases} 0, & t < 0 \\ \infty, & t = 0 \\ 0, & t > 0 \end{cases} \text{ while } \int_{-\infty}^{+\infty} \delta(t) dt = 1$$

There is a relationship between the responses to the two forms of stimulus which will now be developed as it is used in the later sections of this paper.

The Laplace Transforms of the functions $U(t)$ and $\delta(t)$ can be shown to be³

$$\mathcal{L}U(t) = \int_0^{\infty} U(t) e^{-pt} dt = 1/p$$

and $\mathcal{L}\delta(t) = 1$ respectively.

The Laplace Transform of the transient response of a network whose impedance function is $Z(p)$ and which is stimulated by a current whose transform is $I(p)$, is given by the transform equation

$$V(p) = I(p) \cdot Z(p),$$

and when the stimulus is a step function or an impulse function the equation respectively becomes

$$V(p) = \frac{1}{p} Z(p)$$

$$\text{or } V(p) = Z(p),$$

and the appropriate time response can be found by taking the Inverse Laplace Transform of $V(p)$.

Now there is an important theorem which states that if

$$V(p) = \mathcal{L}V'(t),$$

$$\text{then } \mathcal{L}V''(t) = \mathcal{L}d \frac{[V(t)]}{dt} = pV(p) + V(0+).$$

$V(0+)$ is the limiting value of $V(t)$ as $t \rightarrow 0$ from the positive side, and for any real network stimulated by a step function, $V(0+) = 0$ because of the capacitance which must exist across the terminals under consideration. Consequently if the response of a network to a unit step is $V(t)$ then the first derivative of this response with respect to time, $V'(t)$, is also the response of the network to a unit impulse.

In the three sub-sections which follow, this property is used to study the form of the transient response of a network whose impedance function has two poles and two zeros; in the first two, one zero is at infinity and the other zero and the two poles are on the negative real axis of the p -plane; in the third both zeros and both poles are on the negative real axis.

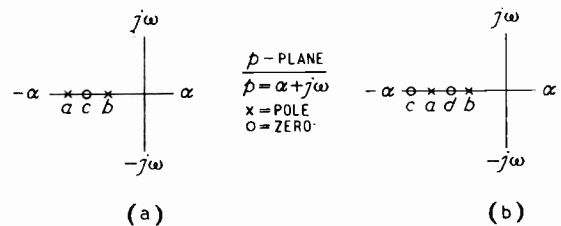

Fig. 3. (a), A possible pole-zero pattern for the network in Fig. 2(a); and (b) for the network in Fig. 2 (b).

2.1. Separate Poles, 1 Zero

If the pole-zero pattern of the transfer impedance is as shown in Fig. 3 (a) then the network function is

$$Z(p) = \frac{p + c}{(p + a)(p + b)} \quad \dots \quad (1)$$

The voltage response to a unit impulse of current is given by

$$V'(t) = \mathcal{L}^{-1} \frac{p + c}{(p + a)(p + b)} \quad \dots \quad (2)$$

where

$$\mathcal{L}^{-1} f(p) = \frac{1}{2\pi j} \int_{\sigma - j\infty}^{\sigma + j\infty} f(p) e^{pt} dp \quad \dots \quad (3)$$

From tables of Laplace transforms³ (Gardner and Barnes No. 1.107).

$$V'(t) = \frac{(c - a) e^{-at} - (c - b) e^{-bt}}{b - a} \quad \dots \quad (4)$$

In this a , b and c are all positive real numbers. The presence of overshoot in the response to a unit step is indicated by part of the impulse response being negative, since the impulse response is the time derivative of the step

response.* Thus there will be an overshoot if at a finite time

$$V'(t) = 0$$

Therefore if $b \neq a$ (i.e., the poles are not coincident) the condition for overshoot is:—

$$(c - a)e^{-at} - (c - b)e^{-bt} = 0$$

$$\text{i.e., } e^{-(a-b)t} = \frac{c - b}{c - a}$$

but $0 \leq e^{-(a-b)t} \leq 1$ for all finite time, thus for overshoot

$$0 < \frac{c - b}{c - a} < 1 \quad \dots \quad (5)$$

This can only be satisfied for $c < b < a$; i.e. overshoot is produced only when the zero lies between the origin and the first pole on the negative real axis of the p -plane.

2.2. Coincident Poles, 1 Zero

In the case where the poles are coincident at $(-a, 0)$ the network function is

$$Z(p) = \frac{p + c}{(p + a)^2} \quad \dots \quad (6)$$

and the response to an impulse of current is

$$V'(t) = \mathcal{L}^{-1} \frac{p + c}{(p + a)^2} \\ = [(c - a)t + 1]e^{-at} \quad \text{from Gardner and Barnes}^3 \text{ No. 2.120.}$$

For an overshoot this must pass through zero, as before, i.e.,

$$[(c - a)t + 1]e^{-at} = 0 \text{ for some finite value of } t.$$

$$\therefore 1 = (a - c)t$$

Since t must be positive, this can only be satisfied for $a > c$.

Thus overshoot occurs only when the zero lies between the origin and the double pole on the negative real axis.

2.3. Separate Poles, 2 Zeros

In a more general circuit where the zero at infinity is moved on to the negative real axis along with the other zero and the two poles, Fig. 3 (b), the network function is

$$Z(p) = \frac{(p + c)(p + d)}{(p + a)(p + b)} \quad \dots \quad (7)$$

The inverse transform of this is not listed by Gardner and Barnes, but that of the step-function response is given (1.111)³,

* Strictly speaking this indicates a turning point in the curve which does not necessarily imply that there will be an overshoot. However, in cases where a monotonic response is important any turning point will be just as undesirable as an overshoot, so there is no loss of usefulness in taking the impulse response as a criterion.

$$\text{i.e., } V(t) = \mathcal{L}^{-1} \frac{(p + c)(p + d)}{p(p + c)(p + b)} \\ = \frac{cd}{ab} + \frac{a^2 - (c + d)a + cd}{a(a - b)} e^{-at} \\ - \frac{b^2 - (c + d)b + cd}{b(a - b)} e^{-bt} \quad \dots \quad (8)$$

The response to an impulse of current can be obtained by differentiation (provided $t > 0$):

$$V''(t) = \frac{a^2 - (c + d)a + cd}{(a - b)} e^{-at} \\ + \frac{b^2 - (c + d)b + cd}{(a - b)} e^{-bt} \quad \dots \quad (9)$$

For an overshoot $V''(t) = 0$ for finite t , so that, provided the poles are not coincident, i.e., $a \neq b$:

$$(a - c)(a - d)e^{-at} = (b - c)(b - d)e^{-bt}$$

$$\therefore e^{-(a-b)t} = \frac{(b - c)(b - d)}{(a - c)(a - d)}$$

\therefore For overshoot

$$0 < \frac{(b - c)(b - d)}{(a - c)(a - d)} < 1 \quad \dots \quad (10)$$

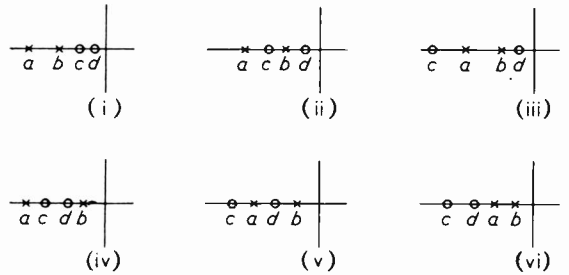

Fig. 4. Alternative arrangements of 2 poles and 2 zeros on real axis of p -plane.

A number of possible conditions arise with different arrangements of the poles and zeros. These are listed below and illustrated in Fig. 4.

$$(i) \quad d < b, c < b$$

The condition (10) is satisfied; i.e., there is overshoot.

$$(ii) \quad d < b, b < c < a$$

$$\frac{(b - c)(b - d)}{(a - c)(a - d)} < 1$$

i.e., the condition (10) is not satisfied, thus there is no overshoot.

$$(iii) \quad d < b, c > a$$

For c slightly greater than a the expression in (10) is greater than 1 and there is no overshoot.

For $c \gg a$ the expression becomes less than 1. The limiting condition is

$$\frac{(c - d)(b - d)}{(c - a)(a - d)} = 1$$

$$\therefore cb - cd - b^2 + bd = ca - a^2 + ad - cd$$

which gives $c = \frac{a(a-d) - b(b-d)}{a-b}$

Thus for $c > \frac{a(a-d) - b(b-d)}{a-b}$ there is an overshoot, while for

$$\frac{a(a-d) - b(b-d)}{a-b} > c > a$$

there is no overshoot.

(iv) $b < d < a, b < c < a$

The expression in (10) is positive and can be greater or less than 1 according to the positions of the zeros. Any particular case would have to be tested to determine whether or not there is an overshoot.

(v) $b < d < a, c > a$

The expression in (10) is negative, therefore there is no overshoot.

(vi) $d > a, c > a$

The expression in (10) is greater than 1, therefore there is no overshoot.

3. Example

As an example of the importance of the foregoing let us consider the circuit of Fig. 2(a), which is a circuit that sometimes occurs in practice, for instance, as a compensated anode load fed by a triode valve.

The impedance of the circuit can be written as

$$Z(p) = \frac{1}{\frac{1}{R_2} + pC + \frac{1}{R_1 + pL}}$$

Making the substitutions

$$m = L/CR_1^2$$

$$R = \frac{R_1 R_2}{R_1 + R_2}$$

$$k = R_2/R_1,$$

normalizing the impedance by expressing it relative to R , and normalizing the frequency and time scales by putting $CR = 1$, gives

$$Z(p) = \frac{p + \frac{k-1}{mk}}{p^2 + p \left(\frac{k-1+m}{mk} \right) + \frac{k-1}{mk}} \quad (11)$$

The 'critical damping' condition, previously believed to be sufficient to ensure a monotonic response with the shortest rise-time, is that the two poles of the impedance function are coincident on the negative real axis of the p -plane. This means that the denominator of $Z(p)$ must have coincident real roots, which gives

$$\frac{1}{m^2 k^2} (k-1+m)^2 = \frac{4(k-1)}{mk}$$

This equation is a quadratic and can be solved for m to give

$$m = \{1 \pm 1/\sqrt{1-1/k}\}^{-2} \dots \dots (12)$$

We therefore have two real finite values of m which give $Z(p)$ a double pole on the negative real axis.

Substituting these values of m into equation (11) and simplifying, gives

$$Z(p) = \frac{p + \{1 \pm \sqrt{1-1/k}\}^{-2}}{[p + 1 \pm \sqrt{1-1/k}]^2} \dots \dots (13)$$

In the notation of Section 2.2

$$Z(p) = \frac{p+c}{(p+a)^2} \dots \dots \dots (14)$$

so that

$$c = \{1 \pm \sqrt{1-1/k}\}^2 \dots \dots (15)$$

$$\text{and } a = \{1 \pm \sqrt{1-1/k}\} \dots \dots \dots (16)$$

The factor under the radical lies between 0 and +1 so $a < c$ where the positive sign is used and $a > c$ where the negative sign is used. Thus from Section 2.2 the positive sign must be used for a monotonic transient response. This means that for the shortest rise-time with monotonic response

$$m = \{1 + 1/\sqrt{1-1/k}\}^{-2} \dots \dots (17)$$

and $Z(p)$ is given by equation (13), taking the positive sign.

The response of the circuit to a step function of current is given by

$$V(p) = I(p) \cdot Z(p) = \frac{p+c}{p(p+a)^2}$$

$$\text{and } V(t) = \mathcal{L}^{-1} V(p)$$

$$= \frac{c}{a^2} + \left\{ \frac{(a-c)^t}{a} - \frac{c}{a^2} \right\} e^{-at}$$

from tables³ (Gardner and Barnes No. 2.138).

On substituting the alternative values for a and c from Eqs (15) and (16) and simplifying, we get

$$V(t) = 1 - [\pm t\sqrt{1-1/k} + 1] e^{-(1 \pm \sqrt{1-1/k})t} \quad (18)$$

The step response, for both values of m , has been evaluated using equation (18) for the case where $k = 2$ (i.e., $R_1 = R_2$), and is shown in Fig. 5. It can be seen that in this case the use of the

wrong value of m , resulting from a neglect of the location of the zero, would give a response with about 59% overshoot.

It is worth noting that the value of m given by equation (17) is always less than that required for the case where the compensated anode load is driven by a pentode valve. This value can be obtained by letting $R_2 \rightarrow \infty$, which makes $k \rightarrow \infty$, and from (17)

$$m \rightarrow 1/4$$

This is the value previously obtained for the case where a pentode is used.^{1,2}

Fig. 5 Transient response of circuit whose transfer function has coincident real poles and one real zero.

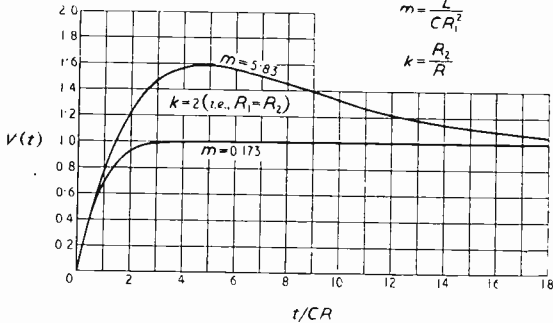
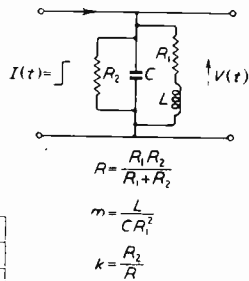

4. Conclusions

When the transfer impedance of a network has only two poles a necessary condition for a monotonic transient response is that the poles shall lie on the negative real axis of the p -plane. If they do not they must form a conjugate complex pair, and then the circuit has only a single normal mode which is a damped sine wave; in this case the transient response is necessarily oscillatory.

That the poles should lie on the real axis of the p -plane is a necessary condition for a monotonic transient response, but it is not a sufficient one, as the transient response now depends on the location of the zeros as well as the poles. If one of the zeros is at infinity then the other must lie on the negative real axis and a sufficient condition for a monotonic transient response is that one at least of the poles should lie nearer the origin than this zero.

If the zero at infinity is moved down the negative real axis the foregoing conditions are no longer sufficient; e.g., Section 2.3 (iv) gives a case which meets these conditions and where the transient response may not be monotonic. Also Section 2.3 (ii) and 2.3 (iii) give cases which do not satisfy the foregoing conditions and yet they can have a monotonic transient response. It therefore appears that if a network has two zeros and two poles on the negative real axis, no firm conditions can be stated for a monotonic transient response. Fortunately this case is less common than the previous one, as it corresponds to circuits of the type shown in Fig. 2(b). Strictly speaking this circuit is not physically realizable since, in a practical case, there must always be capacitance across the terminals of a network. This would introduce a zero at infinity and an extra pole into the impedance function which then comes into a class which has not been studied in the present paper.

More general impedance functions having any number of poles have been studied in a recent paper by Mulligan.⁴ In it he is only able to state in general terms one condition where the transient response cannot be monotonic, and another condition which is necessary for a monotonic response when a pole lies on the real axis at the projection of the first conjugate complex pair. However, he gives a valuable method of finding the amount of overshoot, if any, from the locations of the poles and zeros on the p -plane.

While only a very restricted type of network has been studied in the present paper, the results obtained, when taken in conjunction with Mulligan's, suggest that except for such simple networks, no general conditions can be specified which are both necessary and sufficient for a monotonic transient response. Nevertheless the frequent use in practical circuits of the network with two poles gives some value even to the present restricted results.

REFERENCES

- ¹ Elmore, W. C., "The Transient Response of Damped Linear Networks with Particular Regard to Wideband Amplifiers." *Journal of Applied Physics*, Jan. 1948, Vol. 19, pp. 55-63.
- ² Thomson, W. E., "Transient Response of V.F. Couplings." *Wireless Engineer*, Jan. 1947, Vol. 24, pp. 20-27.
- ³ "Transients in Linear Systems." Vol. 1. Gardner, M. F., and Barnes, J. L., John Wiley and Sons, New York, 1942.
- ⁴ Mulligan, J. H., "The Effect of Pole and Zero Locations on the Transient Response of Linear Dynamic Systems." *Proc. Inst. Radio Engrs*, May 1949, Vol. 37, No. 5, pp. 516-529.
- ⁵ "Network Analysis and Feedback Amplifier Design," Chapter 2. Bode, H. W., D. Van Nostrand and Co., New York, 1945.

IONOSPHERIC CROSS-MODULATION

By I. J. Shaw, Ph.D.

(Formerly of the Cavendish Laboratory, Cambridge)

1. Introduction

THE phenomenon of the Luxembourg Effect, or, as we now prefer to call it, ionospheric cross-modulation, was first reported as long ago as 1924. In the last few years it has been the subject of a large amount of study, both theoretical and experimental. To the broadcasting engineer, ionospheric cross-modulation is a nuisance which will increase with the advent of high-power stations; to the research physicist, on the other hand, it provides a very useful tool with which he can gain information about the ionosphere which is otherwise unobtainable.

A. G. Butt, in 1924, seems to have been the first to draw attention to the effect. Listening in England to a transmission from Radio Paris, he heard in the background the programme being radiated by Radio Luxembourg on an entirely different frequency. Once attention had been drawn to it, many other observations of the effect were made in the next few years, and notable experiments were carried out by Grosskopf of the German Pst Office, and by van der Pol of Holland. It was soon established that the effect was not due to cross-modulation in the receivers nor to rectifying contacts in nearby metallic structures. Since the cross-modulation occurred only at night, it was suspected that it had its origin in the ionosphere.

Professor V. A. Bailey and Dr. D. F. Martyn were the first to put forward a theory of the effect, and experiments have shown that their theory was, in its essentials, correct. In this country within the last few years many experiments have been made with the co-operation of the B.B.C. and the Post Office, and the results of some of these experiments will be described here. A certain amount of theory will also be presented, as far as possible in a non-mathematical way, and a description will be given of the experimental technique employed in the automatic measurement of the amplitude and phase of the transferred modulation.

2. Experimental Technique

The basis of most of the experiments was the measurement of the amplitude of the modulation transferred to the wanted carrier, and of its phase referred to a standard, which was in fact the phase of the modulation received by the ground wave from the disturbing station. A study of the

variation of these two quantities as the modulation frequency is changed provides us, as will be shown later, with enough information to deduce both the collision frequency of the electrons with neutral molecules in the ionosphere, and the level in the ionosphere at which cross-modulation occurs.

With disturbing stations of about 100 kilowatts power, the percentage modulation transferred to suitable wanted stations is of the order of 5% at a modulation frequency of 60 c/s, and about 0.25%, or less, at 2,000 c/s. The difficulty of measuring the amplitude and phase of such small signals in the presence of atmospheric noise, adjacent-channel interference, and receiver noise, may well be imagined.

It is a matter of greatest importance in these experiments that the receivers used for the reception of the wanted and disturbing stations should not introduce any shift in the relative phases of the audio envelopes of the carriers. It was found that type C.R.100 receivers, with re-designed audio sections, were very suitable. When two signal generators set to widely different radio-frequencies were modulated from a common source, and used to drive the two modified receivers, it was found that the audio signals after detection were shifted in phase by about 5° at 50 c/s and were in phase from about 100 c/s to 2,000 c/s.

The wanted signal, being reflected from the ionosphere, was always subject to fading. This was overcome to a great extent by the use of an amplified automatic-gain-control circuit, which was capable of holding the output constant to about 5% for an input range of $10^5:1$.

It is obvious that the strictest precautions must be taken against any cross-modulation occurring in the receivers themselves. The two channels, handling the wanted and disturbing stations, were driven from separate power-packs, electronically stabilized, and careful screening and decoupling was used throughout. Stringent tests showed that the precautions were successful, and that there was no cross-modulation between the two channels.

Originally, the audio outputs of the two receivers were displayed on the two traces of a Cossor double-beam oscilloscope, the phase of the transferred modulation relative to the reference signal calculated by noting the displacement of the sine-waves, and its amplitude measured directly. The more usual ellipse method of

MS accepted by the Editor, September 1950

measuring the phase difference between the two sine-waves could not be employed on account of the large amount of noise on the transferred modulation signal. Some 14 different audio modulation frequencies were used, between 60 c/s and 2,000 c/s, each being sustained for two minutes to enable the adjustment of the oscilloscope time base and the readings to be made. Thus each experiment took about half-an-hour to complete.

It was soon realized that, in order to obtain consistent results, a much more accurate and rapid method of measurement would have to be employed, and an automatic apparatus was constructed which made about twelve readings of the phase and amplitude of the transferred modulation in 30 seconds at each modulation frequency, thus greatly increasing the accuracy of the observations and decreasing the time needed to make them.

The fundamental circuit of the automatic apparatus is the phase-sensitive rectifier or ring modulator. This is a ring circuit of four rectifiers all connected the same way round. When fed across the ends of opposite diagonals with centre-tapped transformers with two signals $a \cos \omega t$ and $b \cos (\omega t + \phi)$, a d.c. output is obtained between the centre-taps of the transformers which is of the form $f(a, b) \cos \phi$. If the amplitude of one of the signals is made very large, then that signal becomes merely a switching voltage, which turns the various rectifiers on and off. In this case, the output is independent of the amplitude of the switching or reference signal, and is of the form $f(b) \cos \phi$, depending only upon the amplitude of the small signal and upon the phase difference between the two. It was in this condition that the circuit was used in the apparatus.

If the phase of the reference signal $a \cos \omega t$ is shifted by 90° and the signals $a \cos (\omega t + 90^\circ)$, $b \cos (\omega t + \phi)$ are applied to a second phase sensitive rectifier, the d.c. output is now $f(b) \sin \phi$. The two signals, $f(b) \cos \phi$ and $f(b) \sin \phi$ applied the X and Y plates of an oscilloscope will cause the spot to move a distance proportional to $f(b)$ from its rest position, at an angle ϕ to the horizontal.

Although simple in theory, there were difficult problems to be overcome. The most difficult one was the production of the quadrature signal $a \cos (\omega t + 90^\circ)$ from the reference signal $a \cos \omega t$. The phase shift was accomplished by the use of a Miller integrator. The phase-shifted signal has an amplitude which is inversely proportional to frequency, and therefore varies by a factor of 40 over the working range 50 c/s-2,000 c/s. After much experiment, the most satisfactory amplitude control was obtained by using a servo-mechanism. The shifted signal was rectified and matched

against a fixed potential. If any difference voltage existed, it was used to drive a servomotor which was coupled to a gain potentiometer, the output being thus adjusted until the two signals were accurately equal.

With the aid of relay circuits, a cycle of switching operations was arranged thus. Initially, the oscilloscope beam was blacked out. The first relay brightened the spot to a brilliance suitable for photographing. Almost immediately, the two signals $f(b) \cos \phi$ and $f(b) \sin \phi$ were applied, through d.c. amplifiers and equal time constants, to the X and Y plates of the oscilloscope. The spot moved, rapidly at first and then more slowly as the capacitors charged up, towards its final position. When the capacitors had charged up to about 0.9 of the final voltage, the spot was blacked out again. This cycle of operations was repeated automatically every two seconds.

The camera film moved continuously past the screen, and upon development showed a series of straight-line vectors, the lengths of which were proportional to the amplitude of the transferred modulation, and the directions of which were equal to the phase angle between the transferred modulation and the reference signal. The speeds of movement of the oscilloscope spot and the film were such that there was no distortion of the straight-line vector. (The reason for blacking out the spot before the end of its movement will now be clear.)

At the end of a run from 60 c/s to 2,000 c/s, the servo-motor controlling the amplitude of the quadrature signal automatically set itself to be in a position nearly correct for the 60-c/s signal at the beginning of the next experiment.

The phase-sensitive rectifier is a device which discriminates strongly against signals which are not coherent in phase with the reference signal. Thus it discriminates against noise and extraneous modulation from interfering stations, and it was possible to measure the amplitude and phase of transferred modulations of the order of 0.25% in the presence of noise. Fig. 1 shows a typical record obtained, and Fig. 2 is a schematic diagram of the apparatus.

3. The Theory of Ionospheric Cross-modulation

A radio wave in its passage through the ionosphere loses some of its energy to the electrons. The process of absorption may be explained, in a physical manner, thus. The electrons, acted upon by the electric field of the wave, are accelerated and thus increase their energy. Were their motion undisturbed, this energy would be re-radiated later in the cycle and the total resultant effect on the wave would be zero. But, in fact, the motion of the electrons is disturbed by the collisions which they make with the molecules of the gases

in the ionosphere, and the return of energy from the electrons to the wave does not take place. Thus it is clear that the amount of absorption of energy from the wave will depend upon the number of electrons, and on the number of collisions they make during one cycle of the radio frequency.

It can be shown that a wave in the ionosphere is attenuated according to a law of the form

$$E = E_0 e^{-\kappa x}$$

where E is the amplitude of the emergent wave, E_0 the amplitude of the incident wave, κ is the absorption coefficient per unit distance, x the distance travelled in the absorbing medium, and e the base of the Napierian logarithms.

The coefficient of the absorption κ is of the form

$$\kappa = \frac{2\pi e^2}{\epsilon_0 m c} \cdot \frac{N \nu}{p_E^2 + \nu^2}$$

- where e is the charge on the electron
- m the mass of the electron
- ϵ_0 the permittivity of free space
- c the velocity of light
- N the number of electrons per cm^3
- ν the collision frequency of the electrons per second
- p_E is a function of p , the angular frequency

of the wave, of p_H , the local angular gyro-frequency and of θ , the angle between the directions of propagation of the wave and the earth's magnetic field.

(The angular gyro-frequency is the angular frequency with which electrons, under the combined action of an electric field and a magnetic field, gyrate about the direction of the magnetic field. If the magnetic field has a value H , the angular gyro-frequency is He/mc . In this part of the world, this corresponds to an actual frequency of about 1.3 Mc/s. The passage through the ionosphere of radio waves of about this frequency is markedly influenced by the existence of this natural frequency of oscillation.)

In general $p_E > \nu$ and the coefficient of absorption may be written

$$\kappa = \frac{2\pi e^2}{\epsilon_0 m c} \cdot \frac{N \nu}{p_E^2}$$

We have seen how the absorption of energy from a radio wave increases the energy of the electrons in the ionosphere. The manner in which the energy thus gained from the wave by the electrons is shared between them and the molecules in the ionosphere is somewhat complicated. In collisions between the electrons and molecules there is certainly a sharing of energy, but it is



Fig. 1. A typical record obtained with the automatic apparatus. The vectors represent the phase and amplitude of the cross-modulation at frequencies of 60, 120, 300, 500, 700, 1,000, 1,250, 1,500 and 2,000 c/s.

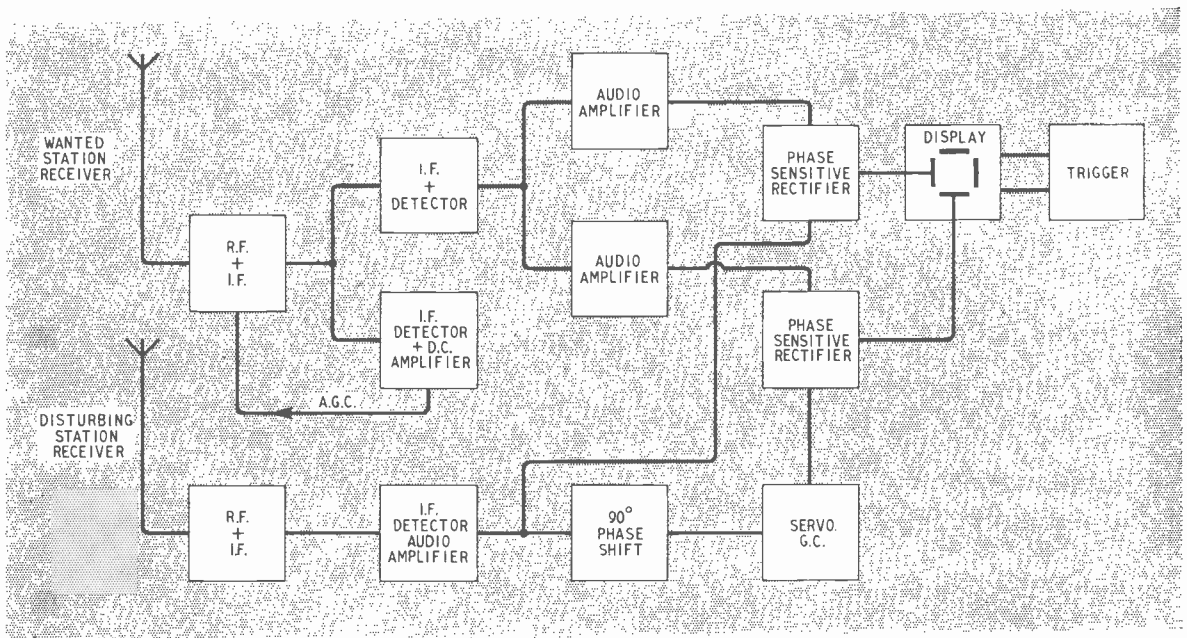

Fig. 2. Block schematic diagram of the automatic apparatus.

not the usual type of energy division between two perfectly elastic bodies in collision. It seems fairly certain that quantum changes occur in the molecules, but the detailed consideration need not concern us. It can be shown experimentally that, provided the extra energy acquired by the electron from the wave between collisions is not too great, it will pass about 1.3×10^{-3} of its excess energy to the molecule. After its first collision, therefore, the electron will have slightly greater energy than it had before the action of the incident wave; and it will go on increasing its energy until such time that the amount of energy lost per collision is just equal to the energy gained from the wave between collisions. There is then set up a state of dynamic equilibrium, with the electrons at a slightly higher energy level than that of the surrounding gas molecules.

Now the velocity of an electron and its energy are related by the usual formula

$$\text{energy} = \frac{1}{2} m v^2$$

and furthermore its velocity, collision frequency, and the length of path between collisions (the mean free path) are also related.

$$v = \nu l$$

$$\therefore \text{energy} = \frac{1}{2} m \nu^2 l^2$$

The mass and mean free path are constant, and we see that the collision frequency is proportional to the square root of the energy. Thus when a radio wave is being absorbed in the ionosphere, the collision frequency of the electrons is increased. Referring now to the equations for the absorption coefficient, it is seen that an increase of the collision frequency results in an increase of the coefficient of absorption.

Consider now two transmitters, the wanted station and the disturbing station, and imagine that the wave from the wanted station is received by a reflection from the ionosphere. When the disturbing station is switched on and energy is absorbed from this wave in the ionosphere, the collision frequency is increased, and so is the absorption of the wanted wave. Thus when the disturbing station is switched on, the received field-strength of the wanted wave will decrease. When the disturbing wave is switched off, the electrons return exponentially to their normal energy value. The 'time constant' of the return to normal energy conditions is governed by the amount of energy lost per collision and the number of collisions suffered per second. The time constant τ is, in fact, $1/G\nu$ where G is the Townsend energy loss factor, 1.3×10^{-3} , and ν the collision frequency.

Suppose now that the disturbing station is amplitude modulated at a low audio frequency. This amplitude modulation may be regarded as

a rhythmic variation of power. If the time constant of the electrons in the ionosphere is small enough, their collision frequency will follow the variation of the signal from the disturbing station, and the carrier from the wanted station, originally unmodulated, will now suffer a rhythmically varying absorption, and will appear as a modulated signal. When the disturbing wave reaches maximum amplitude at the crest of the cycle of modulation, the absorption of the wanted wave will be a maximum, and the amplitude of the wanted wave a minimum. Thus the transferred modulation and the disturbing modulation are anti-phased at low frequencies.

As the modulation frequency increases, the electron collision frequency can no longer follow the modulation cycle to the full extent, and the amplitude of the transferred modulation decreases. It can be shown that the amplitude T of the cross-modulation is governed by a law of the form

$$T = T_0 / \sqrt{1 + \left(\frac{\omega}{G\nu}\right)^2}$$

where T_0 is the amplitude at a very low modulation frequency, and ω is the angular modulation frequency in radians per second.

At the same time, the anti-phase relation mentioned above no longer holds, and it is possible to show that the phase difference ϕ between the transferred and disturbing modulation at a frequency $f = \omega/2\pi$ cycles per second is

$$\phi = \tan^{-1} (\omega/G\nu) + 180^\circ$$

This law of phase variation shows how the phase of the transferred modulation at the region of the cross-modulation is related to the phase of the disturbing modulation at that point. In the experiments we use as a phase reference the signal received along the ground from the disturbing station, and we measure the phase of the transferred signal when it reaches the ground at the receiver. There will thus be an additional phase shift due to the difference of length of the two paths, (1) disturbing station to receiver along the ground and (2) disturbing station to point of cross-modulation and thence to the receiver along the trajectory of the wanted wave. If this path difference is d kilometres, the total phase difference, as measured at the receiving station, is

$$\phi = \tan^{-1} \left(\frac{\omega}{G\nu} \right) + 180^\circ + \frac{\omega d}{3 \times 10^5}$$

Thus, by measuring the amplitude of the transferred modulation as a function of frequency, we should be able to determine $G\nu$, and knowing G , to find the electron collision frequency ν . Furthermore, if we measure the phase of the transferred modulation as a function of frequency, we should be able to determine both $G\nu$ and d , the

path difference. And when d is found, it is merely a matter of geometry to determine the height of the region of cross-modulation if we know the height of reflection of the wanted wave.

The full theoretical treatment of cross-modulation put forward by Bailey and Martyn is very complicated, but when the physical basis of the effect, outlined above, is fully understood, it is fairly easy to deduce the equations relating to it from the well-known formulae of the magneto-ionic theory. The coefficient of cross-modulation has been developed in this manner by Mr. J. A. Ratcliffe, of the Cavendish Laboratory, in the following form

$$T_o = \frac{\alpha(p_w)}{3Gk\theta} (P_1 - P_2)$$

where $\alpha(p_w)$ is a function of p_w , the angular radio-frequency of the wanted wave, of p_H , the angular gyro-magnetic frequency and of θ , the angle between the direction of propagation and the earth's magnetic field

- G is the energy loss factor, 1.3×10^{-3}
- k is Boltzmann's constant, 1.37×10^{-16} ergs per degree K
- θ is the temperature of the ionosphere, about $300^\circ K$
- P_1 is the power flux in ergs per second per square centimetre of the incident disturbing wave
- P_2 is the power flux in ergs per second per square centimetre of the emergent disturbing wave.

The term $\alpha(p_w)$ is fairly easily determined. It is given by

$$\alpha(p_w) = \frac{2\pi e^2}{\epsilon_0 m c} \cdot \frac{1}{(p_w \pm p_L)^2 + v^2}$$

or
$$\alpha(p_w) = \frac{2\pi e^2}{\epsilon_0 m c} \cdot \frac{1}{p_w^2 + v^2}$$

depending upon the conditions of propagation. The term p_L is given by

$$p_L = \frac{eH_L}{mc}$$

where $H_L = H \cos \theta$ is the resolved part of H , the earth's magnetic field along the direction of propagation.

The term $(P_1 - P_2)$ is not necessarily the total power lost by the disturbing wave in its passage through the ionosphere, for any power absorbed in a region where there is no absorption of the wanted wave, does not, of course, produce any cross-modulation. In the majority of cases, however, where a low-frequency station is used as the disturbing station, and a medium wave station as wanted, $(P_1 - P_2)$ is actually the total power lost by the disturbing wave.

This equation is simple to apply, and Table 1

gives the calculated percentage cross-modulation for many different pairs of B.B.C. stations, all received at Cambridge. As a point of interest, the measured cross-modulation also is given. This

TABLE 1

Wanted Station	Disturbing Station	Calculated	Observed
(kc/s)	(kc/s)	%	%
Westerglen 767	Ottringham 167	5.6	6.0
Lisnagarvey 1050	Ottringham 167	1.6	1.0
Droitwich 1050	Ottringham 167	1.4	3.0
Ottringham 1122	Ottringham 167	0.7	0.5
Stagshaw 1050	Ottringham 167	1.8	2.0
Lisnagarvey 1050	Droitwich 200	4.3	4.0
Droitwich 1050	Droitwich 200	1.1	1.5
Washford 804	Droitwich 200	2.6	2.0

table shows that when the equation is correctly applied it is possible to calculate to a fair degree of accuracy the cross-modulation to be expected in any practical case.

4. Fundamental Test of the Theory

It was pointed out in Section 3 that the field strength of the wanted wave should decrease when a disturbing station is switched on, increasing the collision frequency of the electrons responsible for the absorption of the wanted wave. This is a fundamental consequence of the absorption theory of ionospheric cross-modulation, and it is therefore a matter of some importance to decide experimentally whether such an effect exists.

Using as wanted station a B.B.C. transmitter at Westerglen in Scotland, and as a disturbing station the long-wave transmitter at Ottringham, it can be calculated that the decrease in the field strength of the wanted wave when the disturbing station is switched on should be about 6%. The wanted wave, received via an ionospheric reflection, fades to a much greater extent than this, and it was a matter of some difficulty to demonstrate the small change of 6% in the field strength of the fading carrier. The effect was finally shown by feeding the output from the wanted-station receiver through a resistance-capacitance combination to a sensitive galvanometer. The resistance-capacitance circuit was equivalent to a high-pass filter, so that the slow fading of the signal was not transmitted to the galvanometer, while any rapid changes were. The disturbing station was keyed on and off as sharply as possible at 2-second intervals. There was a clear indication of the decrease in the received signal when the disturbing station was switched on. Fig. 3 shows a photographic record of the effect.

5. Measurement of Collision Frequencies

From many experiments carried out in 1947 with the two pairs of stations, Westerglen 767 kc/s wanted and Ottringham 167 kc/s disturbing, and Lisnagarvey (Northern Ireland) 1,050 kc/s wanted and Droitwich 200 kc/s disturbing, an estimate has been made of the collision frequency of the electrons with the molecules in the ionosphere.

Unfortunately, both these wanted stations are situated a considerable distance from Cambridge, and no ground wave from them reached the receiver. It was therefore impossible accurately to determine the height of reflection of the wanted wave. From the path difference d (mentioned in Section 3) deduced from a phase-frequency curve, the height of reflection of the wanted wave, and the geometrical arrangement of the transmitters and receiver, it is possible to determine the height at which the cross-modulation takes place. In these experiments, however, the level of reflection had to be assumed, and it was taken as 100 km. Using a value of 1.3×10^{-3} for G , the energy loss factor, it was found from the year's observations that the collision frequency of the electrons at a height of 86 km is 10^6 per second.

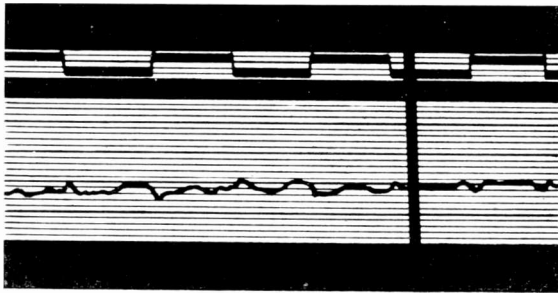

Fig. 3. Effect of keying the disturbing transmitter. The top trace is high when the transmitter is on. The lower trace shows the field strength of the wanted wave, increasing upwards.

6. Variation of Cross-modulation with Frequency

The law of variation of the cross-modulation with the modulating frequency

$$T = T_0 / \sqrt{1 + \left(\frac{\omega}{G\nu}\right)^2}$$

is found to be obeyed quite well for audio frequencies up to about 700 c/s. Above this frequency the cross-modulation often decreases more rapidly than theory predicts. This effect can be explained by making the plausible assumption that there are two points on the trajectory of the wanted wave where modulation is transferred to it, one point as the wave passes upwards through the ionosphere and the other on its downward path after reflection. As the modulation fre-

quency increases, the phase difference due to the path difference between the two centres becomes more important, and the contributions from the two centres slip out of phase.

7. Variation of Cross-modulation with Time

It might be considered that the cross-modulation should be a maximum at the time of maximum absorption of the disturbing wave; i.e., during the day when the term $(P_1 - P_2)$ reaches its maximum value (P_2 equal to zero, for total absorption of the disturbing wave). It is, however, practically impossible to measure cross-modulation on medium wavelengths during the day, as these waves are so strongly absorbed that there is generally no signal received via the ionosphere. Experiments have been carried out over the period of sunrise, and there is no doubt that, contrary to our expectations, the cross-modulation decreases rapidly at sunrise. The decrease begins about the time that the sun's rays first strike the ionosphere at 100 km above the ground (i.e., about 80 minutes before sunrise in the summer time) and by the time of sunrise at the ground, the cross-modulation has practically disappeared.

With some arrangements of wanted and disturbing stations, this decrease can be explained on the assumption that the regions of absorption of the wanted and disturbing waves drift apart, due perhaps to a decrease in the ionization density gradient on the lower side of Region E. But with the other pairs of stations this explanation is not tenable, and the reason for the decrease in these cases is not yet completely understood.

8. Variation of Cross-modulation with Power and Modulation Depth of Disturbing Station

The full theory predicts that the cross-modulation should be directly proportional to the power of the disturbing station, provided that this power is not so high as to cause an increase in the energy of the electrons which is comparable to their mean thermal energy. Using disturbing stations of up to 520 kW power, it has been found that the cross-modulation is still accurately proportional to the power.

A direct proportionality to the depth of modulation of the disturbing station required by the theory was also shown in experiments.

9. Variation of Cross-modulation with Radio Frequency

The variation of cross-modulation with the radio-frequency of the wanted station is contained in the term $\alpha(p_w)$. The form of $\alpha(p_w)$ shows that, generally speaking, $\alpha(p_w)$ decreases as the radio-frequency increases. Experiments with different wanted stations have shown that the cross-

modulation certainly does decrease as the radio-frequency increases. Wanted stations on frequencies up to 4 Mc/s have been used. No cross-modulation was observed on this frequency, nor have any well-authenticated cases of cross-modulation on short-wave broadcasts been reported. On the other hand, as the frequency of the wanted station decreases, the cross-modulation does not increase continuously. Cross-modulation has been observed on frequencies down to 167 kc/s, but experiments with a wanted wave on a frequency of the order of 100 kc/s gave negative results.

As far as the disturbing station is concerned, the manner in which $(P_1 - P_2)$ varies with frequency controls the way in which the cross-modulation varies with the frequency of the disturbing station. If the region of cross-modulation is at all extended, the disturbing wave will be almost completely absorbed, whatever is its absorption coefficient per unit distance, and hence it is not to be expected that the term $(P_1 - P_2)$ will vary much with frequency. We should not expect, therefore, that the cross-modulation would depend very strongly upon the radio frequency of the disturbing wave. This is the case, and cross-modulation has been observed with disturbing stations on frequencies from 167 kc/s to 1,355 kc/s. For disturbing stations of high frequency, it is likely that the level of reflection of the disturbing wave will be above the level of reflection of the wanted wave. In this case, all the power absorbed from the disturbing station between these two levels will not be effective in producing cross-modulation. In such cases the cross-modulation is likely to be small.

With disturbing stations on very low frequencies, of the order of 100 kc/s or less, the amount of cross-modulation decreases very markedly—an effect which is not easily accounted for.

10. The Position of the Region of Cross-modulation

The equation $T = \frac{\alpha(p_w)}{3Gk\theta} \cdot (P_1 - P_2)$ shows

that the position of the region of cross-modulation is that region where the loss of power from the disturbing wave per unit distance is a maximum. The loss of power per unit distance is governed by two factors: first, the absorption coefficient at the particular height, and secondly, the amount of power left in the wave when it reaches that height.

An experiment with two wanted stations at the same position but of different frequencies, proved the correctness of this idea. The two wanted stations were situated at Westerglen, and radiated on frequencies of 767 kc/s and 1,149 kc/s, while

the disturbing station in both cases was at Ottringham. The average value of the collision frequency measured over alternate half-hour periods on two nights did not differ by more than 0.5%, and this, of course, means that the level of cross-modulation is the same in the two cases; and does not depend upon the frequency of the wanted wave.

11. Self-distortion

Throughout this discussion we have always considered that the extra energy given to the electrons came from the disturbing wave. But, of course, the original source of this energy is of no fundamental importance; it may just as well be provided by the wanted wave itself. This leads us to a consideration of an effect which has been called 'self-distortion'.

Let us consider the passage through the ionosphere of a modulated wave from a powerful transmitter. Suppose first that the modulation frequency is low. As the wave reaches a crest of a modulation cycle, the power reaches a maximum, and consequently the electrons attain their highest collision frequency. This causes the maximum absorption of the wave. As the wave reaches a minimum in the modulation cycle, on the other hand, the collision frequency of the electrons and the extra absorption will be a minimum. Thus the effective depth of modulation is decreased. For instance, for a 100-kW transmitter at a distance of about 500 km, if the original depth of modulation is about 70%, the depth of modulation measured on the wave reflected from the ionosphere will be about 65%.

At higher modulation frequencies, the effect is not so pronounced for, as has been seen, the electrons are not able to attain the fullest extent of variation in collision frequency. Moreover, the change in collision frequency does not remain in phase with the modulation cycle (the $\tan^{-1}\left(\frac{\omega}{Gv}\right)$

law mentioned previously). For the conditions considered above, for instance, at 2,000 c/s, the decrease in the depth of modulation will be only about 0.5% or less.

This effect is directly proportional to the power of the transmitter, and thus it can be seen that a programme received from a very distant powerful transmitter may be considerably deficient in low modulation frequencies.

Since cross-modulation is proportional to the power of the disturbing station, which is itself proportional to the square of the amplitude, we should expect the second harmonic of the modulation frequency to appear in the cross-modulation. In the self-distortion effect also, the harmonic of

the modulation frequency appears. For the above case, again, about 1% of the harmonic appears at low modulation frequencies.

In ordinary broadcast engineering, we know that the field strength is proportional to the square root of the power of the station. For a distant station received by reflection from the ionosphere this law does not hold, an effect due again to self-distortion.

Suppose, for instance, that a transmitter of 10-kW power gives a field strength of M millivolts per metre at a distant point. Now suppose that the power of the transmitter is increased 100 times to 1,000 kW. We know that a 100-kW transmitter causes a change of about 5% in the absorption of a wave passing through the ionosphere. A 1,000-kW transmitter would therefore increase the absorption by about 50% and the received field strength at the distant point will be only about $5M$ millivolts/metre instead of $10M$ millivolts/metre.

Conclusion

A more detailed survey of the work done in England in the last few years and a good bibliography has been published recently by L. G. H. Huxley and J. A. Ratcliffe (*Proc. Instn elect. Engrs*, Pt. III, Vol. 96, p. 433, 1949). The reader is referred to this publication and to the papers mentioned therein if he desires to investigate the subject of cross-modulation in greater detail.

The experimental and theoretical investigations discussed in this paper were carried out during the past three years at the Cavendish Laboratory as part of a programme of radio research supported by the D.S.I.R. Many people have contributed to their success. In particular, thanks are due to the British Broadcasting Corporation, the Admiralty and the Post Office for providing transmissions, to Mr. J. A. Ratcliffe of the Cavendish Laboratory for his help and guidance, and to Mr. S. W. Falloon for help with the equipment.

LINEAR DIODE VOLTMETER

Response to Randomly-Recurrent Impulses*

By R. E. Burgess, B.Sc.

(Communication from the National Physical Laboratory)

SUMMARY.—The response of an ideal linear diode voltmeter to randomly-recurrent impulses is evaluated in terms of the parameters of the impulses and the time constants of the voltmeter. The rectification efficiency is shown to be slightly greater than that for regularly-recurrent impulses of the same average recurrence frequency.

1. Statement of the Problem

THE response of a linear voltmeter to single and to regularly-recurrent impulses has already been discussed.¹ It seems of interest to extend the analysis to impulses which are randomly distributed in their time of recurrence. The condition of randomness may be stated as follows: the probability dP that an impulse occurs in an element of time dt is proportional to dt . That is

$$dP = k \cdot dt \quad \dots \quad (1)$$

where k is a constant independent of the previous history of the series of impulses. It is well known that this assumption leads to the Poisson distribution for the probability that n impulses occur in a time t , namely

$$P(n) = \frac{(kt)^n e^{-kt}}{n!} \quad \dots \quad (2)$$

The expectation of n is kt and thus k can be identified with the average rate of recurrence of the impulses.

The other important distribution associated with such a random sequence is the probability that the spacing between successive impulses lies between s and $s + ds$, and is given by

$$W(s) \cdot ds = ke^{-ks} \cdot ds \quad \dots \quad (3)$$

This can be interpreted as the product of the probability that no impulse occurs in the time s [i.e., $P(0)$ from equation (2)] and the probability that an impulse occurs in the successive interval ds , these two probabilities being independent as a consequence of the postulate of randomness.

We now wish to determine the output from a linear diode voltmeter when randomly-recurrent impulses are applied to it (Fig. 1).

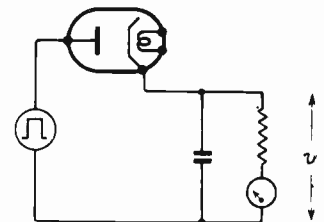

Fig. 1. Diode-voltmeter circuit.

* Submitted to the meeting of the International Special Committee on Radio Interference (C.I.S.P.R.) in Paris, July 1950.

MS accepted by the Editor, December 1950

It will be assumed that the voltmeter has a charge time constant of $1/\alpha$ which is small compared with the discharge time constant $1/\beta$ and that the impulses are rectangular, of uniform amplitude A and of duration T which is small compared with the average pulse spacing $1/k$.

2. Analysis

Let the rectified voltage appearing across the load circuit capacitor $v(t)$ have the values U_n just before, W_n just after the n th impulse (Fig. 2).

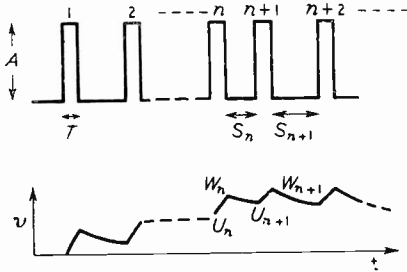

Fig. 2. Randomly-recurrent pulses and the rectified voltage.

Then by definition of the charge time constant

$$\frac{A - W_n}{A - U_n} = e^{-\alpha T} \quad \dots \quad (4)$$

and from the definition of the discharge time constant

$$U_{n+1} = W_n e^{-\beta s_n} \quad \dots \quad (5)$$

where s_n is the interval between the end of the n th impulse and the start of the $(n+1)$ th impulse. In general the rectified voltage at any time t after the end of the n th impulse and before the start of the $(n+1)$ th is

$$v(t) = W_n e^{-\beta t} \quad \dots \quad (6)$$

From the above equations the following recurrence relations are obtained:

$$\left. \begin{aligned} U_{n+1} &= [A(1 - e^{-\alpha T}) + U_n e^{-\alpha T}] e^{-\beta s_n} \\ W_{n+1} &= A(1 - e^{-\alpha T}) + W_n e^{-\alpha T} e^{-\beta s_n} \end{aligned} \right\} \quad (7)$$

Since we are considering statistically uniform impulses (i.e., a sequence for which A , T and k are constant) we can average these last equations by inserting the mean values for U , W and $e^{-\beta s}$:

$$\left. \begin{aligned} \bar{U} &= \frac{mA(1 - e^{-\alpha T})}{1 - me^{-\alpha T}} \\ \bar{W} &= \frac{A(1 - e^{-\alpha T})}{1 - me^{-\alpha T}} \end{aligned} \right\} \quad \dots \quad (8)$$

where, by virtue of equation (3)

$$m \equiv e^{-\beta s} = \frac{k}{k + \beta} \quad \dots \quad (9)$$

The quantity which determines the meter indication for repetitive impulses is the average

value of the rectified voltage. In the present analysis it is assumed that the impulse duration is short compared with the impulse spacing and consequently it is sufficiently accurate for the voltage to be averaged over the discharge period between impulses. Thus

$$\left. \begin{aligned} \bar{v} &= \bar{W} \frac{1}{S} \int_0^S e^{-\beta t} dt \\ &= \bar{W} \left(\frac{1 - e^{-\beta S}}{\beta S} \right) \\ &= \bar{W} \frac{k}{\beta} \log \left(1 + \frac{\beta}{k} \right) \end{aligned} \right\} \quad \dots \quad (10)$$

The rectification efficiency, defined as the ratio \bar{v}/A thus has the following value for random pulses:

$$\eta = \frac{\bar{v}}{A} = \frac{c(x+1)}{xc+1} x \log \left(1 + \frac{1}{x} \right) \quad \dots \quad (11)$$

where $c = 1 - e^{-\alpha T}$ is the charging parameter, $x = k/\beta$ is the average number of impulses occurring during the discharge time constant.

It is useful to compare this expression with the rectification efficiency for regularly-recurrent impulses having a steady recurrence rate of k :

$$\eta_o = \frac{c}{1 - e^{-1/x}(1-c)} x(1 - e^{-1/x}) \quad \dots \quad (12)$$

When x is large compared with unity the rectification efficiency tends to unity for both random and regular pulses in very nearly the same manner since as the asymptotic expansions show, the expressions are identical to the term in $1/x$:

$$\left. \begin{aligned} \eta &\approx 1 - \frac{1}{x} \left(\frac{1}{c} - \frac{1}{2} \right) + \frac{1}{x^2} \frac{6 - 3c - c^2}{6c^2} \dots \\ \eta_o &\approx 1 - \frac{1}{x} \left(\frac{1}{c} - \frac{1}{2} \right) + \frac{1}{x^2} \frac{11 + 4c - 4c^2}{6c^2} \dots \end{aligned} \right\} \quad \dots \quad (13)$$

The term in $1/x^2$ is always greater for random pulses than for regular pulses. When x is small compared with unity (pulses not frequent in relation to the discharge time constant) the rectification efficiency for the random pulses is appreciably greater than for regular impulses:

$$\left. \begin{aligned} \eta &\approx cx \log \frac{1}{x} \\ \eta_o &\approx cx \end{aligned} \right\} \quad \dots \quad (14)$$

However, this result is not very relevant to the conventional technique of impulse interference measurement since the meter time constant is usually small compared with the discharge time constant and thus the indication follows the discharge of the rectified voltage between widely-separated pulses. In this case the infrequent

impulses would be regarded as single impulses and the peak indication on each impulse would be noted. An analysis has been made in an earlier paper¹ of the maximum indication of a critically-damped meter to the rectified voltage arising from a single impulse and the result can be expressed as the product of the peak rectified voltage at the end of the impulse and a factor which is a slowly decreasing function of the ratio of the meter time constant to the discharge time constant.

Fig. 3 shows the dependence of the rectification efficiencies γ and γ_0 on x for values of charge parameters equal to 1, 0.1 and 0.01.

The analysis presented above is for the relatively simple case of rectangular d.c. or video impulses, whereas radio noise is often measured at the intermediate-frequency output of a receiver. Without complicating the analysis by considering the response to r.f. impulses it may be noted that the mathematical fiction of an "equivalent charge

Fig. 3. Rectification efficiency for random and for regular pulses; $c = 1 - e^{-\alpha\tau}$ = charging parameter.

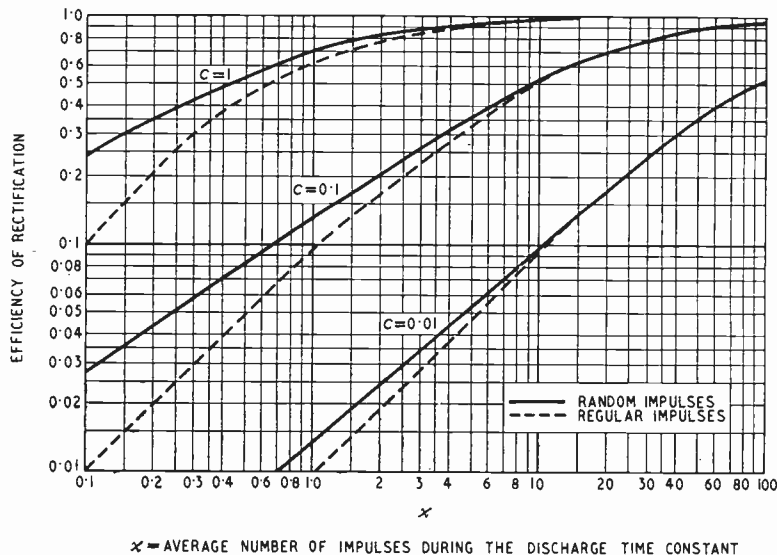

time constant" discussed in the earlier paper may well prove to be valid in the present problem.

Although the results are presented with the problem of radio interference in mind it is interesting to realize that they are particularly applicable to the measurement of the impulses from a counter used in the measurement of radio-active radiation in which the impulses are truly random.

In this case the instrument would be used as a counting-rate meter which would be supplied with impulses of constant amplitude and duration

such as would emerge from an amplifier with a limiting stage connected to the counting tube. Reference to equation (11) and to Fig. 3 then shows that x should not exceed $1/(5c)$ for the indication to bear a sensibly linear relation to the average pulse-recurrence rate. Thus a choice of discharge time constants should be provided which can be selected according to the pulse rate being measured. The appropriate selection can be readily made during use by noting that it corresponds to the condition that the efficiency of rectification should not exceed 0.2.

Acknowledgment

The work described above was carried out as part of the programme of the Radio Research Board. This paper is published by permission of the Director of the National Physical Laboratory, and the Director of Radio Research of the Department of Scientific and Industrial Research.

REFERENCE

¹ "The Response of a Linear Diode-Voltmeter to Single and Recurrent R.F. Impulses of Various Shapes," by R. E. Burgess. *J. Instn. elect. Engrs*, March 1948, Vol. 95, (Part 111), pp. 106-111.

I.E.E. MEETINGS

8th November: "The London-Birmingham Television Cable System," by T. Kilvington, F. M. Laver and H. Stanesby.

14th November: "The Life of Oxide Cathodes in Modern Receiving Valves," by G. H. Metson, S. Wagener, M. F. Holmes and M. R. Child.

20th November: Four papers on Digital Computers, by F. C. Williams, T. Kilburn, G. C. Tootill, G. E. Thomas, J. C. West and A. A. Robinson.

26th November: Discussion on "Should Broadcasting be Superseded by Wire Distribution?" opened by P. P. Eckersley.

5th December: "An Investigation into the Mechanism of Magnetic Tape Recording," by P. E. Axon.

All meetings are to be at the Institution, Savoy Place, London, W.C.2, at 5.30 p.m.

BRIT. I.R.E. MEETING

21st November: "Development of High-Frequency Transmitter Cables," by R. C. Mildner.

At the London School of Hygiene and Tropical Medicine, Keppel Street, Gower Street, London, W.C.1, at 6.30 p.m.

RC-COUPLING NETWORK FOR PULSE TRANSMISSION

Criteria for Maximum Pulse Sharpness

By Hilary Moss, Ph.D., B.Sc.(Eng.), M.Brit.I.R.E., A.M.I.E.E.

SUMMARY.—A resistance-capacitance differentiator is analysed when it is acting in conjunction with a normal form of intervalve-coupling network. The analysis leads to expressions defining the conditions for maximum pulse sharpness. An experimental check shows agreement with theory.

Statement of the Problem

IN the generation of sharp pulses for television and radar purposes the network of Fig. 1 finds frequent use. The valve V_1 is being heavily overdriven, often from a sinusoidal source, and is periodically cut-off—virtually instantaneously. The steep rise in anode potential is then differentiated by R and C to form a pulse which is subsequently sharpened by V_2 . (This latter valve also serves to suppress the negative-going pulse produced by the differentiation of the trailing edge of the approximately square wave at the anode of V_1). The problem we present and solve is this: what are the optimum values of R , r and C to feed the sharpest pulse to the grid of V_2 ? In this analysis we shall assume V_1 to be cut off instantaneously. C_1 and C_2 are the inevitable stray output and input capacitances respectively associated with V_1 and V_2 . It is self-evident that these capacitances should be made as small as possible, but it is equally clear that they can never be reduced to zero. Having made them as small as possible, we seek to establish the optimum values of R , r and C in terms of C_1 and C_2 to produce the sharpest pulse.

Previous Literature

If we split the circuit of Fig. 1 into two portions by a line XY, the right-hand portion can be considered as a normal differentiator shunted by stray capacitance C_2 and fed from an integrator which delivers a voltage of the form

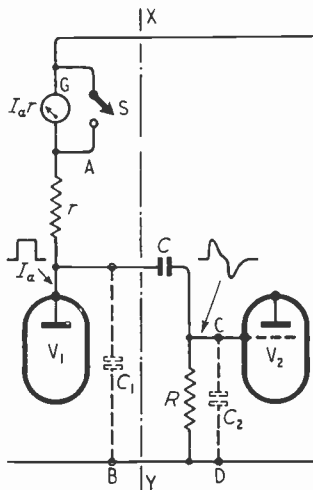

Fig. 1. Basic pulse coupling network.

$v = V_o(1 - \exp -t/C_1r)$. The response of this network to such a pulse-form has been studied in detail by Ohman¹. Unluckily, however, Ohman assumes that the right-hand differentiating element exerts no loading reaction on the left-hand driving integrator. Since this condition is not in general true, it is difficult to deduce the answer to our problem from his analysis which is more concerned with other aspects of differentiators working into capacitive loads.

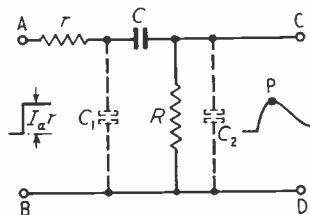

Fig. 2. Derived equivalent network.

Reduction of the Problem to a Linear Passive Circuit

We suppose the valve V_1 to be carrying a steady anode current I_a , which is instantaneously reduced to zero by the cut-off pulse applied to its grid. Because of the charge on C_1 , the anode voltage cannot change instantly, and so the current in r is diverted from the valve into C_1 . Thereafter, the voltage to earth rises and the voltage across r and the current in r fall as C_1 charges. This is equivalent to opening a switch S across the fictitious generator G , which delivers a square pulse of amplitude $I_a r$, while leaving the valve current I_a unchanged; assuming the value to have an infinite a.c. resistance. The coupling capacitor C blocks steady voltages and for transient conditions we are interested only in changing voltages. Therefore, the circuit can be reduced to the equivalent of Fig. 2, in which a Heaviside Unit Pulse of amplitude $I_a r$ is injected across AB. The first part of our problem is to compute the resulting response across the output terminals CD to which the valve V_2 is connected. We must then discuss the criteria defining its

MS accepted by the Editor, November 1950

sharpness, and finally use these criteria to deduce the relationships sought to achieve maximum sharpness.

Response of Circuit to Heaviside Pulse

An analysis of the network of Fig. 2 is given in Appendix 1 and leads to the following indicial equation for the output voltage v_o across CD

$$v_o = \frac{\rho CR}{\rho^2 \{ \overline{CrC_2R} + \overline{C_1rCR} + \overline{C_1rC_2R} \} + \rho \{ \overline{CR} + \overline{C_2R} + \overline{Cr} + \overline{C_1r} \} + 1} (I_a \cdot r) \quad (1)$$

Setting

$$A = CrC_2R + C_1rCR + C_1rC_2R$$

$$B = CR + C_2R + Cr + C_1r$$

leads by use of the Heaviside expansion theorem to the following expression for the output voltage v_o

$$v_o = \frac{CRrI_a}{\sqrt{B^2 - 4A}} \left\{ e^{p_1 t} - e^{p_2 t} \right\} \quad (2)$$

where

$$p_1 = \frac{-B + \sqrt{B^2 - 4A}}{2A} \text{ and } p_2 = \frac{-B - \sqrt{B^2 - 4A}}{2A}$$

Equation (2) is exact. The form of this well-known transient is sketched across CD in Fig. 2. It is sharpened by applying it to the grid of V_2 , which is normally cut off, as indicated in Fig. 3. This suppresses all the pulse except the tip around P.

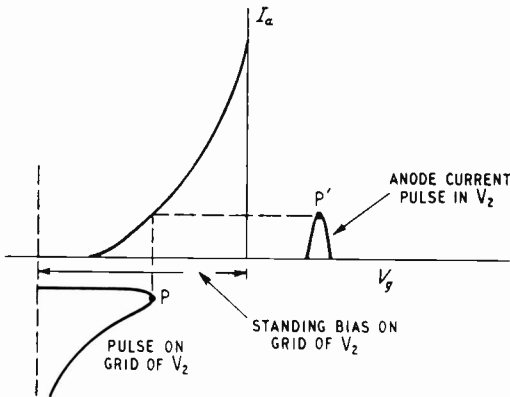

Fig. 3. Use of back-biased V_2 to sharpen pulse.

Criterion of Maximum Sharpness

'Sharpness' might be defined in a variety of ways, but the definition which is easiest to manipulate mathematically, and the one which is probably also most reasonable on physical grounds, makes use of the concept of pulse curvature at the crest P. Mathematically, we shall

in fact define the sharpest pulse as the one having the largest value of $\rho = \left. \frac{d^2 v_o}{dt^2} \right|_p$ where this denotes the value of $\frac{d^2 v_o}{dt^2}$ at the maximum value of v_o . This definition, on account of the smooth nature of the function (2), is

consistent with another very obvious criterion of sharpness—namely, that the amplitude of the extreme crest of the pulse lying between two closely adjacent times, shall be a maximum.

It is proved in Appendix 2 that

$$\rho = \frac{-CRrI_a \{ \frac{B - \lambda}{B + \lambda} \}^{\frac{B}{2\lambda}} \sqrt{(B - \lambda)(B + \lambda)}}{2A^2} \quad (3)$$

where $\lambda = \sqrt{B^2 - 4A}$

We must regard I_a as a fixed parameter, since some restriction must be imposed on the power dissipation in valve V_1 . We then seek to maximize the remainder of the expression (3).

Equation (3) is not easy to treat rigorously, and the maximization problem is best attacked by putting in special values and then using some variational methods to make more general deductions.

Fig. 4 shows values of the pulse sharpness ρ plotted against C for stated values of C_1 , C_2 , R and r . We now establish the following theorems which enable important *general* deductions about the maximization of (3) to be made.

Theorem 1

"If C , C_1 and C_2 are held constant and r and R are each multiplied by k , then the sharpness ρ is multiplied by $1/k$ and the pulse amplitude is multiplied by k ."

Proof.

Since $A = CrC_2R + C_1rCR + C_1rC_2R$

and $B = CR + C_2R + Cr + C_1r$

when r and R are both multiplied by k , then A is multiplied by k^2 and B is multiplied by k . It immediately follows that λ is also multiplied by k . Direct substitution in (3) then shows that ρ is multiplied by $1/k$. Similarly, equation (2) shows that the pulse amplitude is multiplied by k .

Conclusion 1

The values of C shown on Fig. 4 which maximize (3) for the specific values of C_1 and C_2

are independent of the absolute values of r and R , provided their ratio is unchanged.

Conclusion 2.

Pulse sharpness can be increased indefinitely by reducing the values of r and R , but a practical limit is set by the necessity of having some minimum pulse amplitude (see Fig. 5).

Theorem 2

"If r and R are fixed, and C_1 , C_2 and C are all multiplied by k , then the pulse sharpness ρ is multiplied by $1/k^2$ and the pulse amplitude is unchanged." This theorem may be re-stated thus. "If r and R are fixed, and C_1 , C_2 and C are all multiplied by k , then the pulse is entirely unchanged in shape, but is redrawn on a time scale k times as long."

This is readily proved after the manner of Theorem 1.

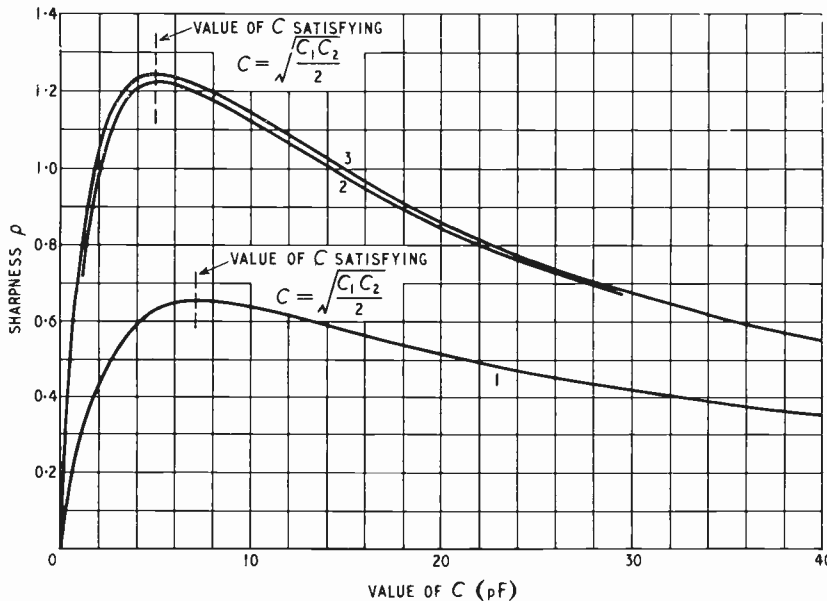

Fig. 4. Computed values of ρ against C from equation (3) for the following conditions: Curve 1, $C_1 = 10 \text{ pF}$; $C_2 = 10 \text{ pF}$; $r = 10^3 \Omega$; $R = 10^3 \Omega$; Curve 2, $C_1 = 5 \text{ pF}$; $C_2 = 10 \text{ pF}$; $r = 10^3 \Omega$; $R = 10^3 \Omega$; Curve 3, $C_1 = 5 \text{ pF}$; $C_2 = 10 \text{ pF}$; $r \times R = 10^6$ and r and R individually adjusted to satisfy equation (4).

Conclusion 3.

If the value of C shown on Fig. 4 which maximizes (3) for the specific values of C_1 and C_2 quoted is $f(C_1, C_2)$, then the value of C which maximizes (3) for values of kC_1 and kC_2 is $kf(C_1, C_2)$.

Conclusion 4.

By scaling up the values of the capacitances by some large multiplying factor, we may check the theory more easily, since the time constants and circuit parameters become more convenient. (This has been done in the experimental check.)

Theorem 3

"For maximum pulse sharpness the following equation should be satisfied"

$$\frac{r}{R} = \frac{C + C_2}{C + C_1} \quad \dots \quad (4)$$

Proof

Examination of (3) will show that for a given value of the product rR , A and B should be minimized to achieve the sharpest pulse.

Now the value of A is independent of the individual values of r and R , but depends only on their product.

But B may be re-expressed in the form

$$B = R(C + C_2) + r(C + C_1) \quad \dots \quad (5)$$

and it is easy to show that (5) is a minimum for rR fixed when equation (4) is satisfied.

However, it is also easy to show that provided $\frac{1}{3} < C_1/C_2 < 3$, then the improvement in pulse sharpness effected by satisfying (4) as compared with setting $r = R$ is never greater than about 5%. The very slight improvement effected by satisfying (4) when $C_1/C_2 = \frac{1}{3}$ is shown in curve (3), Fig. 4.

Theorem 4

"If $r = R$ then the values of C shown on Fig. 4 which maximize (3) are unchanged by reversing the values of C_1 and C_2 ."

This is immediately obvious by consideration of the expressions for A and B .

Criteria for Maximizing Pulse Sharpness

From Fig. 4 we find that a very good approximation for the optimum value of C in the three cases specifically worked out is given by

$$C \approx \sqrt{\frac{C_1 C_2}{2}} \quad \dots \quad (6)$$

Theorems 1, 2, 3 and 4 then show that this result must have wide generality. Therefore we can summarize the rules for achieving maximum sharpness thus

- (i) Set C according to equation (6)
- (ii) Set $r = R$ and reduce both together until the minimum useful pulse amplitude is obtained.
- (iii) Then readjust r and R according to (4) keeping rR constant.

Operation (iii) is hardly worth while, especially when C_1 and C_2 are nearly equal. This can be seen by examining curve (3), Fig. 4.

Experimental Check

Figs. 5 and 6 show some oscillographic studies which confirm the above theory. The experimental check was greatly simplified by the 'time scaling' operation (Theorem 2) achieved by setting up the circuit of Fig. 2 with values of the capacitors far larger than those normally obtaining in an interval coupling network. In the latter case, using for example a CV 138 for V_1 and V_2 , we might expect $C_1 = 5$ pF and $C_2 = 10$ pF as fairly typical given due care in wiring. The pulse crest conducted by V_2 would then occupy perhaps $0.5 \mu\text{sec}$. In the experimental circuits, capacitors of about 4×10^5 times as large were used, and the transient duration was correspondingly longer.

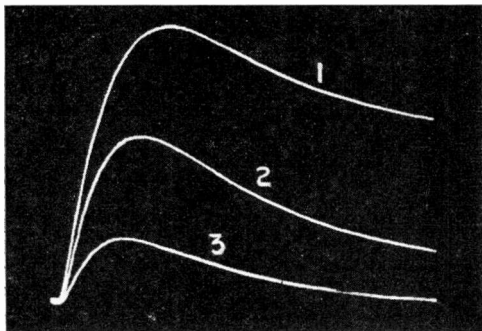

Fig. 5. Oscillograms showing effect of reducing r and R . Curve 1, $R = r = 10^4 \Omega$ input square-pulse amplitude ($I_a \cdot r$) = 800; Curve 2, $R = r = 5 \times 10^3 \Omega$; $I_a \cdot r = 400$; Curve 3, $R = r = 2 \times 10^3 \Omega$, $I_a \cdot r = 160$; Curve 4, $R = r = 10^3 \Omega$, $I_a \cdot r = 80$. $C_1 = 2 \mu F$, $C_2 = 4 \mu F$, $C = 2 \mu F$ throughout.

A single-stroke triggered time base with a sweep time of approximately 0.15 second was employed for the recording. The delay between the initiation of the time-base stroke and the transient was achieved very simply by relying on inertia in an auxiliary Post Office type relay. Separate records were superimposed on one film to aid comparison of the effects of circuit-constant adjustments.

The great advantages of the time-scaling operation are (1) ready attainment of adequate trace brightness without the complication of repetitive time bases, and (2) elimination of effects of unwanted stray capacitances since the latter are 'swamped' by the large circuit values used.

Fig. 5 shows the trivial solution illustrating the effect of progressive reduction of r and R . The input square wave to the network was reduced in proportion to the value of r , so as to simulate the assumption of constant anode current I_a .

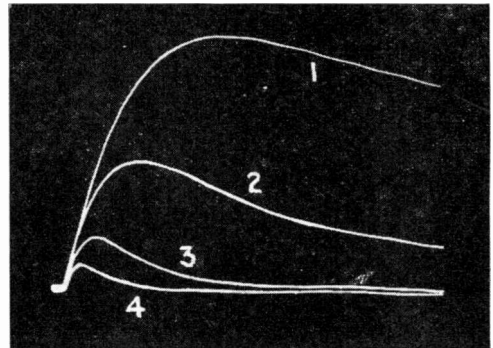

Fig. 6. Oscillograms showing value of $C = \sqrt{C_1 C_2} / 2$ giving sharpest pulse. Curve 1, $C_1 = 2 \mu F$, $C_2 = 4 \mu F$, $C = 6 \mu F$; Curve 2, $C_1 = 2 \mu F$, $C_2 = 4 \mu F$, $C = 2 \mu F$; Curve 3, $C_1 = 2 \mu F$, $C_2 = 4 \mu F$, $C = \frac{1}{2} \mu F$. $r = R = 5 \times 10^3 \Omega$ throughout.

Fig. 6 verifies the criterion (6). The central trace has a value of C satisfying (6) and this trace also possesses the sharpest crest, as required by the theory.

Acknowledgment

The author wishes to thank Mr. J. R. W. Smith for helpful discussions.

APPENDIX 1.

Referring to Fig. 2, the impedance of C_2 and R in parallel is $\frac{R}{1 + pC_2R}$

\therefore the impedance in parallel with C_1 is $\frac{1}{pC} + \frac{R}{1 + pC_2R}$

\therefore impedance in series with r is

$$\frac{1}{pC_1 + \frac{pC(1 + pC_2R)}{1 + pR(C + C_2)}} \equiv Z_1$$

\therefore voltage appearing across C_1 is $\frac{Z_1}{Z_1 + r} (I_a \cdot r)$ 1

\therefore output voltage v_o across CD is

$$v_o = \frac{Z_1}{Z_1 + r} \cdot \frac{R}{\frac{1}{pC} + \frac{R}{1 + pC_2R}} (I_a \cdot r) \quad 1$$

On substituting the value of Z_1 and after some reduction we find

$$v_o = \frac{pCR}{p^2\{C_1rC_2R + C_1rCR + C_1rC_2R\} + p\{CR + C_2R + Cr + C_1r\} + 1} \cdot (I_a r) \dots (1)$$

APPENDIX 2.

The output voltage v_o is given by

$$v_o = \frac{CRrI_a}{\sqrt{B^2 - 4A}} \left\{ e^{p_1t} - e^{p_2t} \right\} \dots \dots \dots (2)$$

$$\rho = \left. \frac{d^2v_o}{dt^2} \right|_p = \frac{CRrI_a}{4A^2\lambda} \left[(\lambda - B^2) \left\{ \frac{B + \lambda}{B - \lambda} \right\}^{\frac{\lambda - B}{2\lambda}} - (B + \lambda)^2 \left\{ \frac{B + \lambda}{B - \lambda} \right\}^{-\frac{(B + \lambda)}{2\lambda}} \right]$$

Setting $\lambda = \sqrt{B^2 - 4A}$ and differentiating yields

$$\frac{dv_o}{dt} = \frac{CRrI_a}{\lambda} \left\{ p_1 e^{p_1t} - p_2 e^{p_2t} \right\} \dots \dots (7)$$

$$\text{and } \frac{d^2v_o}{dt^2} = \frac{CRrI_a}{\lambda} \left\{ p_1^2 e^{p_1t} - p_2^2 e^{p_2t} \right\} \dots \dots (8)$$

Now at the crest of the pulse $\frac{dv_o}{dt} = 0$ whence from (7)

$$p_1 e^{p_1t} = p_2 e^{p_2t}$$

so that the time which elapses from the start of the transient to its crest is

$$t = \frac{A}{\lambda} \log_e \frac{B + \lambda}{B - \lambda} \dots \dots \dots (9)$$

Putting this value in (8) then gives us the value of ρ sought, viz :

and after expansion and rearrangement this yields

$$\rho = \frac{-CRrI_a}{2A^2} \left\{ \frac{B - \lambda}{B + \lambda} \right\}^{B/2\lambda} \sqrt{(B - \lambda)(B + \lambda)} \dots (3)$$

The negative sign indicates, of course, that the crest corresponds to a maximum value of v_o ; i.e., a pulse curve which is convex upwards.

REFERENCE

¹ G. P. Ohman. "Differentiating Circuit Analysis." *Electronics*, August 1945.

NEW BOOKS

Fundamentals of Acoustics

By LAWRENCE E. KINSLER and AUSTIN R. FREY. Pp. 509+xiii, with 166 illustrations. Chapman & Hall, Ltd., 37 Essex Street, London, W.C.2. Price 48s.

Written by two joint professors of physics at the U.S. Naval Postgraduate School, Annapolis, this textbook is well fitted to impart a comprehensive knowledge of the subject of acoustics to those with a general grounding in physics and mathematics.

Without preamble we are launched on a consideration of simple harmonic motion, first as a general physical concept and then as a mathematical abstraction. On page 3 we find "... replacing the ratio of the two constants of the system s/m by a new single constant ω_o^2 we obtain ... an important second-order linear differential equation whose solution is well known ... " It is necessary to wait until the next page, or to turn up the list of symbols at the back of the book to find that ω is angular velocity, and that ω_o is the angular velocity at resonance.

Happily after this rather estranged start the physical and mathematical concepts settle down to a closer partnership and in the first nine chapters the fundamentals of vibration, wave propagation and absorption are firmly and clearly laid down. The succeeding seven chapters deal with selected applications of these principles under the headings, Direct Radiator Loudspeakers, Horn-type Loudspeakers, Microphones, Psychoacoustics, Architectural Acoustics, Underwater Acoustics and Ultrasonics.

Throughout, the treatment is straightforward and unequivocal, as a classroom textbook should be, and for anyone who wants either a quick answer to a specific problem or a rapid revision of any aspect of the subject of acoustics, this book could hardly be bettered. It is difficult to select sections for special mention, but one might cite the treatment of the concept of loudness and the comprehensive analysis of the transfer of energy

from a vibrating piston to the surrounding medium as being much above the average.

Since the book is of American origin the terminology is naturally American also and there are some things which appear odd to British eyes; notably, the use of 'g', which we have so long associated with the acceleration due to gravity, as an abbreviation for grams. The use of 'ultrasonic' instead of 'supersonic', when referring to frequencies above audibility is not, of course, confined to the U.S.A., but is none the less to be deprecated. The restriction of the general term 'dynamic' (i.e., of power or force) to one particular principle of loudspeaker or microphone operation is surely bad practice in a scientific book even if the word is so used in popular language. There is confusion of dimensions with units, e.g., page 21, "The units of mechanical impedance are the same as those of mechanical resistance, i.e., grams per second". Does this mean that matter is created? The alternative statement, a few lines lower that "the mechanical ohm has the dimensions of a force divided by a velocity" fortunately provides the clue which students of graduate or advanced undergraduate standing, to whom this book is addressed, will be quick to spot.

These points are minor ones which do something to mar an excellent book, but which will not hold up the reader once he has become accustomed to them.

F. L. D.

Guide to Broadcasting Stations (6th Edition)

Pp. 94. *Wireless World*, Dorset House, Stamford Street, London, S.E.1. Price 2s. (postage 2d.).

Includes frequencies and other details of some 350 authorized European broadcasting stations and some 200 others operating on unauthorized frequencies. Details of over 1,400 short-wave broadcasting stations operating in 117 countries are included as well; among them are nearly 50 European v.h.f. stations.

CORRESPONDENCE

Letters to the Editor on technical subjects are always welcome. In publishing such communications the Editors do not necessarily endorse any technical or general statements which they may contain.

Television Waveform Display

SIR, A statement by Dr. Sturley in a recent *Wireless Engineer* article (September 1951) would appear to be sufficiently misleading to warrant further discussion. Dr. Sturley states that in his waveform display using the receiver timebase to generate a 50-c/s timing reference, "it is only necessary" to superpose the waveforms of successive frames to check the receiver interlace.

It is known that interlacing in a receiver depends not only upon the correct timing of the frame timebase, but also on the relative amplitudes of successive flybacks and forward scans being equal to within very fine limits (see, for example, W. T. Cocking in *Wireless Engineer* Editorial, May 1951 and *Wireless World*, April 1947, p. 124). Since the waveform display described can take account of the frame-timebase timing only, it seems clear that the check described is not sufficient to determine an accurate interlace.

A method of checking interlace which has been found quite useful is to obtain a flat-topped 25-c/s square wave, and apply it to the modulator or cathode of the c.r. tube via an amplitude-controlling potentiometer. On turning the potentiometer up and down one frame only will be blacked out, and if this operation is performed fairly rapidly it becomes comparatively easy to estimate the degree of interlace.

H. B. S. BRABHAM.

Research Laboratories of
The General Electric Co., Ltd.,
Wembley, Middlesex.
24th September, 1951.

Resonance Curve of Two Coupled Circuits

SIR,—In *Wireless Engineer*, August 1928, Prof. E. Mallett has given the well-known parabolic representation of the double-hump resonance curve of two coupled circuits. Another diagram can be made as follows, expressing the double-hump curve by a simple trigonometric function:—

The impedances of circuits 1 and 2 are written as

$$Z_1 = r_1 + j\omega L_1 + \frac{1}{j\omega C_1} \text{ and } Z_2 = r_2 + j\omega L_2 + \frac{1}{j\omega C_2}$$

If the circuits are unequal the geometric mean is written as $\sqrt{Z_1 Z_2} = Z = r + j\omega L = \frac{1}{j\omega C} = r - jx$.

If the circuits differ much from each other, r , L and C are not physically realizable fixed quantities but may be regarded as calculation quantities only.

The steady-state equations for circuits 1 and 2 are written as:

$$e = Z_1 i_1 - j\omega M i_2 \text{ and } 0 = Z_2 i_2 - j\omega M i_1$$

Solving with regard to i_2 as a function of e and ω , we find the general transformer equation valid for any linear 2-circuit transformer network:

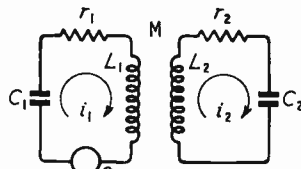

Fig. 1.

$$i_2 = \frac{e \cdot j\omega M}{Z_1 Z_2 + \omega^2 M^2}$$

Substituting Z for $Z_1 Z_2$ this equation becomes:

$$i_2 = \frac{e \cdot j\omega M}{Z^2 + \omega^2 M^2} = \frac{e \cdot j\omega M}{(Z - j\omega M)(Z + j\omega M)} = \frac{e \cdot j\omega M}{(r + jx + j\omega M)(r + jx - j\omega M)}$$

Drawing the two factors of the denominator as vectors in the diagram, Fig. 2, the first as OB, the second as OC, the numerical value of i_2 may be written as:

$$|i_2| = \frac{|e| \cdot \omega M}{OB \cdot OC} = \frac{|e| \cdot \omega M \cdot \sin \alpha}{OB \cdot OC \cdot \sin \alpha} = \frac{|e| \cdot \omega M \cdot \sin \alpha}{r \cdot 2\omega M} = \frac{e \cdot \sin \alpha}{2r}$$

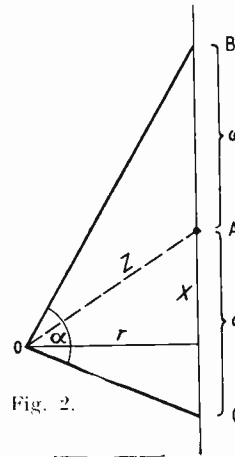

Fig. 2.

since the area of triangle BOC can be expressed as both $\frac{1}{2} \cdot OB \cdot OC \cdot \sin \alpha$ and $\frac{1}{2} \cdot r \cdot 2\omega M$.

The secondary current i_2 is therefore seen to be directly proportional to $\sin \alpha$.

If ω is varying about resonance, x will vary and the base $BC = 2\omega M$ of the triangle BOC which is practically constant will move up and down. As $\sin \alpha$ is maximum for $\alpha = 90^\circ$, the secondary current i_2 can only be maximum for $\alpha = 90^\circ$. The diagram shows that this condition, which is fulfilled for

$$Z = \omega M \text{ or } r = \omega L = \frac{1}{\omega C}$$

$\pm \sqrt{\omega^2 M^2 - r^2}$, can only be satisfied for $\omega M \geq r$ (equality corresponding to critical coupling).

From the distance x , the angular frequency distance $2 \cdot d\omega$ between the two secondary current peaks can be calculated as follows, the triangle BOC being right-angled:

$$x = \sqrt{\omega^2 M^2 - r^2} = \omega L = \frac{1}{\omega C} \approx 2L \cdot d\omega \text{ and, therefore, } 2 \cdot d\omega = \frac{\sqrt{\omega^2 M^2 - r^2}}{L}$$

The double-hump curve can be drawn directly from the diagram by computing or measuring the angle α corresponding to a number of positions of the centre A of the triangle base BC.

Sonofon Radiofabrik,
Gentofte, Denmark.
9th August, 1951.

KJ PRYTZ.

ERRATUM

In the Editorial on "The Velocity of Light" in our April number, the first sign at the top of the second column on page 100 should be \times not $+$. We are indebted to Mr. J. W. Jenkins, of A. C. Cossor, Ltd., for drawing our attention to this.

ABSTRACTS and REFERENCES

Compiled by the Radio Research Organization of the Department of Scientific and Industrial Research and published by arrangement with that Department.

The abstracts are classified in accordance with the Universal Decimal Classification. They are arranged within broad subject sections in the order of the U.D.C. numbers, except that notices of book reviews are placed at the ends of the sections. U.D.C. numbers marked with a dagger (†) must be regarded as provisional. The abbreviations of the titles of journals are taken from the World List of Scientific Periodicals. Titles that do not appear in this List are abbreviated in a style conforming to it.

	PAGE	
	A	
Acoustics and Audio Frequencies	203	of an experimental generator. An excitation coil is enclosed in a vessel fitted at one end with a sound-transmitting plate and filled with a suspension of carbonyl iron powder in insulating oil. The circuit of a pulse generator of this type is shown. Qualitative tests have proved satisfactory.
Aerials and Transmission Lines	205	
Circuits and Circuit Elements	207	
General Physics	209	
Geophysical and Extraterrestrial Phenomena	210	534.321.9 : 537.228.2 2613
Location and Aids to Navigation	211	Magnetostrictive Ultrasonic Apparatus. —H. Thiede. (<i>Funk u. Ton</i> , Jan. 1951, Vol. 5, No. 1, pp. 32-42.) Illustrated description of the construction and applications of ultrasonic transducers for the frequency range 15-200 kc/s. The electroacoustic efficiency, resonance and attenuation factors of different forms of oscillator are discussed and the advantages of nickel as the magnetostrictive element are reviewed. The circuit of a valve-operated drive unit providing a modulated h.f. excitation voltage is shown.
Materials and Subsidiary Techniques	212	
Mathematics	214	
Measurements and Test Gear	214	
Other Applications of Radio and Electronics	216	
Propagation of Waves	217	
Reception	219	
Stations and Communication Systems	220	
Subsidiary Apparatus	221	
Television and Phototelegraphy	221	
Transmission	222	534.373 2614
Valves and Thermionics	223	The Absorption of Sound in Fog. —Y. Rocard. (<i>Rev. sci., Paris</i> , Jan. March 1951, Vol. 89, No. 3309, pp. 42-43.) Measured values of the absorption of sound in fog are very different from theoretical values, particularly at high frequencies. It is tentatively suggested that the discrepancy may be due to resonant vibration of drops of moisture excited by the sound wave.
Miscellaneous	224	

ACOUSTICS AND AUDIO FREQUENCIES

016 : 534 2608	534.373 : 534.213.4 2615
References to Contemporary Papers on Acoustics.—R. T. Beyer. (<i>J. acoust. Soc. Amer.</i> , July 1951, Vol. 23, No. 4, pp. 484-489.) Continuation of 2309 of October.	Wall Viscosity and Heat Conduction Losses in Rigid Tubes. —R. F. Lambert. (<i>J. acoust. Soc. Amer.</i> , July 1951, Vol. 23, No. 4, pp. 480-481.) Expressions are derived for the attenuation constant and <i>Q</i> of rectangular and round acoustic tubes for various modes of excitation.
534.213.4 : 534.373 2609	534.64 2616
Boundary Layer Attenuation of Higher Order Modes in Rectangular and Circular Tubes. —R. E. Beatty, Jr. (<i>J. acoust. Soc. Amer.</i> , July 1951, Vol. 23, No. 4, p. 481.) Correction to paper noted in 1045 of May.	Principle of and Apparatus for Measurement of Sound Transmission through Partitions. —M. Kobrynski & A. Neyron. (<i>Ann. Télécommun.</i> , Feb. 1951, Vol. 6, No. 2, pp. 34-42.) Description of a c.r.o. installation designed to record automatically the transmission coefficient of panels 1 m square, over the frequency range 50-10 000 c/s. The test panel is fixed between two microphones at one end of a sealed echo-free chamber, and a uniform sound pressure is applied to the external face of the panel. Voltage proportional to the logarithm of the instantaneous frequency is applied to the timebase plates of the c.r.o. while voltage proportional to the decibel difference at the two microphones, obtained by use of logarithmic-sensitivity amplifiers, is applied to the deflecting plates.
534.231 2610	534.75 2617
On the Acoustical Radiation of an Emitter Vibrating Freely or in a Wall of Finite Dimensions. —J. Pachner. (<i>J. acoust. Soc. Amer.</i> , July 1951, Vol. 23, No. 4, p. 481.) Correction to paper noted in 1816 of August.	The Frequency Selectivity of the Ear as determined by Masking Experiments. —S. de Walden. (<i>J. acoust. Soc. Amer.</i> , July 1951, Vol. 23, No. 4, p. 481.) Comment on 2692 of 1950
534.24 2611	
Sound Scattering by Solid Cylinders and Spheres. —J. J. Faran, Jr. (<i>J. acoust. Soc. Amer.</i> , July 1951, Vol. 23, No. 4, pp. 405-418.) The theory of the scattering of plane sound waves by isotropic circular cylinders and spheres is extended to take into account shear waves which can exist as well as compression waves within solid scattering bodies.	
534.321.9 : 534.232 2612	
Generation of Ultrasonic Oscillations by means of Volume Magnetostriction. —H. H. Rust. (<i>Z. angew. Phys.</i> , Jan. 1951, Vol. 3, No. 1, pp. 9-14.) Description	

534.75 : 621.39.001.11

2618

Information and the Human Ear.—H. Jacobson. (*J. acoust. Soc. Amer.*, July 1951, Vol. 23, No. 4, pp. 463-471.) Calculations of the capacity of the human ear to handle information are made by computing the number of sound patterns per second that can be discriminated and applying the Shannon information theory. A maximum of 10^4 bits/sec is found. This is compared with corresponding values for other sound channels and with the observed rate of perception of information from speech and music. A capacity of 5×10^4 bits/sec is necessary for high fidelity. The brain is able to use < 1% of the information transmitted by the ear.

534.78

2619

The Influence of Interaural Phase on Masked Thresholds: Part 1—The Role of Interaural Time-Deviation.—F. A. Webster. (*J. acoust. Soc. Amer.*, July 1951, Vol. 23, No. 4, pp. 452-462.) The masking of a tone or narrow-band noise—the signal—by wide-band noise is discussed with particular reference to the interaural phase differences for signal and noise respectively. Audibility is best when the interaural phase difference for the signal is 180° and that for the masking noise is zero. Experimental results are discussed in terms of the interaural phase- and time-deviations produced by the superposition of the signal on the noise.

534.78

2620

A Phoneme Detector.—C. P. Smith. (*J. acoust. Soc. Amer.*, July 1951, Vol. 23, No. 4, pp. 446-451.) Description of a device in which an incoming speech signal is compared with a set of stored energy-distribution reference patterns, and the best fit among the reference patterns is selected. Contiguous band filters covering the range 100 c/s-7 kc/s are used to dissect the incoming signal, and special arrangements are incorporated to provide improved selectivity and discrimination against noise.

534.851

2621

Intermodulation Distortion in Gramophone Pickups.—S. Kelly. (*Wireless World*, July 1951, Vol. 57, No. 7, pp. 256-259.) A special test record is used having negligible intermodulation components. The frequencies are 60 c/s and 2 000 c/s on one side and 400 c/s and 4 000 c/s on the other. The output from a pickup playing this record is observed either on an intermodulation test set or visually on a c.r.o.

534.861 : 621.396.61

2622

Justification for raising the Standard of Broadcast Transmissions.—M. Beurtheret. (*Onde élect.*, April 1951, Vol. 31, No. 289, pp. 184-187.) Improvements in the quality of broadcast transmissions can improve reception for a large number of listeners. Conventionally accepted criteria of quality do not take adequate account of the worst faults, viz., frequency distortion due to intermodulation and transient distortion. Use of a high degree of negative feedback in the transmitter is recommended to improve quality. Perfect linearity of the a.f. amplitude/frequency characteristic of the transmitter is essential only in the range 50-2 500 c/s; the production of high-quality broadcast transmitters is simplified if it is not attempted to extend the linear range unnecessarily.

621.395.61 + 534.321.9

2623

On the Possibility of a True Mechanical Transformer.—Y. Rocard. (*Rev. sci., Paris*, Oct./Dec. 1950, Vol. 88, No. 3308, pp. 236-238.) A rod whose cross-section varies exponentially has the properties of an impedance transformer for longitudinal, transverse and torsional vibrations. Practical applications of the device in transducers, etc., are described.

621.395.616 : 534.612.4

2624

Condenser Microphone Sensitivity Measurement by Reactance Tube Null Method.—H. E. von Gierke & W. W. von Wittern. (*Proc. Inst. Radio Engrs*, June 1951, Vol. 39, No. 6, pp. 633-635.) The capacitance variations produced by energizing voltages in the frequency range 20 c/s-200 kc/s are balanced against corresponding capacitance changes produced in a calibrated reactance-tube circuit. The capacitance variations are arranged to modulate the amplitude of a 3-Mc/s carrier; balance is observed by means of a c.r.o. to which the demodulated signal is applied.

621.395.623

2625

The Transmission Factor and Distortion Factor of an Electrodynamical Sound Receiver.—G. Haar. (*Funk u. Ton*, Jan. 1951, Vol. 5, No. 1, pp. 17-26.) Description of measurement circuits and procedure for determination of the characteristics of a headphone designed for acoustic tests in the range 50-5 000 c/s. Its advantages over a loudspeaker are outlined; its low inherent distortion factor makes it specially useful for investigation of nonlinear distortion in an a.f. system.

621.395.623.7

2626

Loudspeaker Diaphragm Control.—J. Moir. (*Wireless World*, July 1951, Vol. 57, No. 7, pp. 252-255.) Loudspeakers of current designs are critically damped by an amplifier having an output impedance > 10-20% of the d.c. voice-coil resistance. The use of loudspeakers in small rooms prevents any advantage being obtained from over-critical damping. The use of an exponential horn is recommended to increase damping of the cone oscillation at high frequencies and to flatten the voice-coil impedance curve.

621.395.623.7 : 534.13

2627

Growth of Subharmonic Oscillations.—W. J. Cunningham. (*J. acoust. Soc. Amer.*, July 1951, Vol. 23, No. 4, pp. 418-422.) The conditions necessary for the excitation in a resonant system of oscillations at half the driving frequency are discussed. An experiment is described, using a suitably energized LC tuned circuit. The mode of production of subharmonic vibrations in a direct-radiator loudspeaker is also discussed and experimental data are given.

621.395.623.7 : 534.231

2628

Sound-Field Regulator.—P. Riety. (*Ann. Télécommun.*, Feb. 1951, Vol. 6, No. 2, pp. 43-48.) Description of a system providing a sound field of constant strength over the range 20 c/s-15 kc/s. The input to the loudspeaker amplifier is fed through a regulating circuit to which is applied a control voltage corresponding to the e.m.f. developed by a 'pilot' microphone in the sound field of the loudspeaker, so that the input to the latter is inversely proportional to its acoustic efficiency. The time lag of the regulation is discussed. Amplification range is > 30 db.

621.395.625.3

2629

A Professional Magnetic-Recording System for use with 35-, 17½- and 16-mm Films.—G. R. Crane, J. G. Frayne & E. W. Templin. (*J. Soc. Mot. Pict. Televis. Engrs*, March 1951, Vol. 56, No. 3, pp. 295-309. Discussion, p. 309.) Description of portable equipment for producing a high-quality sound track for motion pictures.

621.395.625.3

2630

A.C. Magnetic Erase Heads.—M. Rettinger. (*J. Soc. Mot. Pict. Televis. Engrs*, April 1951, Vol. 56, No. 4, pp. 407-410.) Various ring-shaped heads for erasing magnetic records are compared. Measurements were made of the degree of erasure obtained and the tem-

perature rise of the head as the 70-kc/s erase current was varied. Best results were obtained with two heads in cascade.

621.395.625.3 **2631**
A German Magnetic Sound Recording System in Motion Pictures.—M. Ulner. (*J. Soc. Mot. Pict. Televis. Engrs*, April 1951, Vol. 56, No. 4, pp. 411-422.) For economy, magnetic tape (6.5 mm) is used for all original sound records in German film studios, film being used only in re-recording on the final negative. A description is given of the magnetic recorder and play-back amplifier and the method of synchronization with the picture.

621.396.645.029.3 **2632**
Extended Class-A Audio.—Sterling. (See 2680.)

AERIALS AND TRANSMISSION LINES

621.315.212 **2633**
The Behaviour of Curved Uniform Lines at High Frequencies.—H. H. Meinke. (*Arch. elekt. Übertragung*, March 1951, Vol. 5, No. 3, pp. 106-112.) The case of a line bent into an arc of a circle is considered. An equation is derived giving the change of characteristic impedance introduced for a line of arbitrary cross-section. A formula giving a very close approximation is derived for the coaxial line, and some other cross-sections are discussed. The effective length of the line is given by the circumference of a circle whose radius is equal to the mean radius of curvature as particularly defined. For the sake of simplicity, the discussion is restricted to cases in which axial field components may be neglected.

621.315.212 : 621.3.09 **2634**
The Effect of Connectors on the Properties of a Cable.—M. Cotte. (*Câbles & Transmission*, Paris, Jan. 1951, Vol. 5, No. 1, pp. 84-87.) The effect on the propagation characteristics of discontinuities introduced by connectors between lengths of cable is discussed. The levels of parasitic echo signals so introduced are calculated for transients and for steady-state conditions. Phase distortion due to differences in group velocities is estimated. To keep these distortion effects within given limits the product of the reflection coefficient between a cable length and a connector, multiplied by the length of the connector, must be smaller than a predetermined value. In practice, with typical cables and connectors, it is found that echo-effect distortion is more important than phase distortion; the requirements for good transmission are met by correctly designing the connectors.

621.315.212 : 621.392.43 **2635**
Coaxial Stub Filter.—J. A. Craig. (*Electronics*, June 1951, Vol. 24, No. 6, pp. 132, 134.) Describes the use of correcting stubs for coaxial transmission lines.

621.392.09 **2636**
Single-Conductor Surface-Wave Transmission Lines.—G. Goubau. (*Proc. Inst. Radio Engrs*, June 1951, Vol. 39, No. 6, pp. 619-624.) General information and design data relating particularly to the dielectric-coated conductor. See also 281 of February and 812 of March.

621.392.21 **2637**
Note on the Variations of Phase Velocity in Continuously-Wound Delay Lines at High Frequencies.—I. A. D. Lewis. (*Proc. Instn elect. Engrs*, Part III, July 1951, Vol. 98, No. 54, pp. 312-314.) "The effect of the self-capacitance of the winding on the velocity and on the characteristic impedance is here determined by a simple method. A direct treatment is given of the decrease in the inductance per unit length which occurs when the wavelength along the coil is not very large compared with the

winding diameter. The two effects have opposite influences on the velocity, and a fair degree of cancellation can be obtained if a certain relationship between the parameters is satisfied."

621.392.26† **2638**
On the Representation of the Electric and Magnetic Fields produced by Currents and Discontinuities in Wave Guides.—N. Marcuvitz & J. Schwinger. (*J. appl. Phys.*, June 1951, Vol. 22, No. 6, pp. 806-819.) The calculation of the fields produced by prescribed and induced currents at a discontinuity is treated by representing the fields in terms of a complete set of vector modes characteristic of the possible transverse field distributions in the waveguide cross-section. This representation transforms the field problem into one-dimensional modal problems of conventional transmission-line form. The eigenvalue problem of finding the characteristic modes is discussed in detail for the case of a uniform guide with perfectly conducting walls. A typical modal analysis and synthesis are presented for infinite and semi-infinite waveguides of arbitrary cross-section.

621.392.26† : 621.39.09 **2639**
The Significance of the Transmission-Line Equations and Characteristic Impedance for Waves of Arbitrary Type in Cylindrical Lines.—F. Borgnis. (*Arch. elekt. Übertragung*, April 1951, Vol. 5, No. 4, pp. 181-189.) The familiar transmission-line equations expressing the spatial distribution of current and voltage along a Lecher line apply also to the propagation of an arbitrary electric wave in a cylindrical line (e.g. a waveguide) provided it is possible to excite a single electric or magnetic mode in the line. The special interpretation to be attached to the concepts 'current', 'voltage' and 'characteristic impedance' in this case is discussed.

621.392.26† : 621.39.09 **2640**
The Velocity of Propagation of H_{0n} Waves in a Multi-layer Waveguide.—N. N. Malov. (*Zh. tekh. Fiz.*, Dec. 1950, Vol. 20, No. 12, pp. 1509-1510.) A discussion of the possibility of using waveguides filled with two or three layers of dielectrics as phase changers, with comments on a paper by Fox (1255 of 1948).

621.392.26† : 621.396.67 **2641**
Application of Array Theory to Nonresonant Slotted Waveguides.—J. B. Tricaud. (*Onde élect.*, March & April 1951, Vol. 31, Nos. 288 & 289, pp. 122-132 & 188-200.) The directive properties of halfwave dipole arrays, fed by a waveguide, are compared with those of a slotted guide. The slotted guide is discussed in detail as a particular class of linear array. Schelkunoff's space-factor theory is developed to give the amplitude-distribution function; approximate sinusoidal solutions are worked out and the usefulness of the method, permitting the expression of results as asymptotes, is emphasized, with examples. The theory is applied to consideration of the radiation from a single slot, the matching of impedance along a slotted guide and the relation between amplitude distribution and load. The characteristics of a typical low-radiating-angle radar aerial, using a nonresonant slotted guide, are given.

621.396.67 **2642**
U.R.S.I.-I.R.E. Spring Meeting, Washington, D.C., April 16-18, 1951.—(*Proc. Inst. Radio Engrs*, June 1951, Vol. 39, No. 6, pp. 716-720.) Summaries are given of the following papers:

15. Low-Frequency Antennas.—P. S. Carter.
16. Antenna Systems for Radio Direction Finding.—E. C. Jordan.
17. Electrically Small Antennas and the Low-Frequency Airborne Antenna Problem.—J. T. Bolljahn.

18. Antennas in Conducting Media.—R. K. Moore.
 29. On the Theory of Antenna Beam-Shaping.—A. S. Dunbar.
 30. Beam Shaping in Doubly Curved Reflector Systems employing Quasi-Point Sources.—A. E. Marston.
 31. Lack of Uniqueness in Antenna Pattern Synthesis Methods and the Related Energy Storage Considerations.—T. T. Taylor.
 32. Feed Problems in Broad-Band Antenna Arrays.—W. R. LePage & R. F. Gates.
 33. Second-Order Beams of Slotted Waveguide Arrays.—H. Gruenberg.
 42. Aperture Phase Errors in Microwave Optics.—K. S. Kelleher.
 43. Review of Spherical Reflector Research at A.F.C.R.L.—J. E. Walsh.
 44. Review of Recent Metal Lens Research at A.F.C.R.L.—J. Ruze.
- 621.396.67 2643
Wrotham Aerial System: Part 2 — The Main Transmission Line and the A.M./F.M. Combining Filter.—C. Gillam. (*Wireless World*, July 1951, Vol. 57, No. 7, pp. 279–282.) The transmission line which conveys r.f. power to the multiple-slot radiator and distribution system (see part 1: 2340 of October) is described. F.m. and a.m. transmissions can be radiated simultaneously from the single aerial system.
- 621.396.67 2644
Improved Anti-Fade Transmitting Aerial.—H. Brückmann. (*Funk u. Ton*, Jan. 1951, Vol. 5, No. 1, pp. 5–16.) Full paper of which a shorter version in English was abstracted in 1863 of 1950.
- 621.396.67 2645
Impedance Characteristics of Thick Cylinders.—S. Zisler. (*Onde élect.*, March 1951, Vol. 31, No. 288, pp. 133–143.) The input impedance of cylindrical aeri-als, and in particular of thick cylinders, is calculated by an extension of two-wire transmission line theory. The equivalent coaxial line is assumed to have damping resistance and reactance uniformly distributed along its length, to account for power loss due to radiation from the aerial and to provide the same current distribution in the line as is found in the aerial. Results are quoted, with curves and diagrams, for cylindrical $\lambda/4$ and $\lambda/2$ aeri-als for a length/diameter ratio between 2 and 50.
- 621.396.67 2646
Aperiodic Aeri-als: Use with Vertical-Incidence Ionospheric Recorders.—R. Bailey. (*Wireless Engr.* July 1951, Vol. 28, No. 334, pp. 208–214.) An analysis is made of the performance of several types of simple resistance-terminated travelling-wave aeri-als, of practical height and shape, for transmission and reception in a vertical direction above a perfectly flat earth. The results are used to find the conditions for best signal interference ratio for ionospheric echoes between about 0.5 and 20 Mc/s, using the minimum number of aeri-als to cover the whole range. The results may also have application to short-distance sky-wave radio communication.
- 621.396.67.014.1 2647
Current Distributions on Helical Antennas.—J. A. Marsh. (*Proc. Inst. Radio Engrs.*, June 1951, Vol. 39, No. 6, pp. 668–675.) Measurements were made over the frequency range 600–1 700 Mc/s on two uniform circular helices, of diameter 8.61 cm, pitch angle 12.6°, and different lengths, using a sampling probe. The distributions of current amplitude and phase are shown graphically, and a satisfactory interpretation is given in terms of three travelling-wave modes. The relative phase velocities in the modes are deduced. When the T_1 mode predominates there is good agreement between measured and calculated velocities and the value required for optimum end-fire directivity.
- 621.396.671 + 621.396.11 2648
Application of the Compensation Theorem to Certain Radiation and Propagation Problems.—G. D. Monteath. (*Proc. Instn elect. Engrs.*, Part III, July 1951, Vol. 98, No. 54, pp. 319–320.) Digest of I.E.E. monograph. The compensation theorem is extended to deal with a continuous system in which a solution of Maxwell's equations must satisfy certain boundary conditions. In particular, the change in mutual impedance between two aeri-als is considered when changes are made to other parts of the system, e.g. the surface of the earth. The result is expressed in terms of the change in surface impedance.
- 621.396.671 2649
The Patterns of Antennas Located near Cylinders of Elliptical Cross Sections.—G. Sinclair. (*Proc. Inst Radio Engrs.*, June 1951, Vol. 39, No. 6, pp. 660–668.) The patterns of small dipole and loop aeri-als mounted on or near a perfectly conducting cylinder of elliptical cross-section are calculated by determining the open-circuit terminal voltages of the aeri-als when receiving plane waves. The aeri-als are assumed to be such that they cause negligible distortion of the field when they are open-circuited, thus reducing the problem to that of calculating the diffraction of a plane wave around the cylinder. The results have applications in the design of aircraft aeri-als and slotted-cylinder aeri-als.
- 621.396.671 : 778.3 2650
Photo Radiation Patterns.—G. W. Goebel. (*Electronics*, May 1951, Vol. 24, No. 5, p. 89.) A simple and economical method is described for exhibiting two-dimensional patterns of two or more interfering radiators of the same frequency and polarization.
- 621.396.676.029.6 2651
A Very-High-Frequency-Ultra-High-Frequency Tail-Cap Antenna.—L. E. Raburn. (*Proc. Inst. Radio Engrs.*, June 1951, Vol. 39, No. 6, pp. 656–659.) An account of the development of an omnidirectional zero-drag aircraft aerial for vertical polarization. By insulating the vertical stabilizer from the remainder of the tail structure, a suitable radiator was obtained, covering the frequency band 100–400 Mc's. The principal radiation patterns are illustrated, and some details of mechanical design are included.
- 621.396.677 2652
Wide-Angle Metal-Plate Optics.—J. Ruze. (*Proc. Inst. Radio Engrs.*, June 1951, Vol. 39, No. 6, p. 697.) Correction to paper abstracted in 1345 of 1950.
- 621.396.677 2653
Factors affecting Performance of Directional Antennas.—A. E. Cullum, Jr. (*Broadcast News*, March/April 1951, No. 63, pp. 43–51.) The horizontal and vertical radiation patterns for various phase and space relations of a 2-element aerial show the distribution of the radiation between sky and ground waves. The influence of the shape and bonding of the towers, guy layout and insulation and ground screens on the radiation pattern is considered. Methods of sampling the radiated fields are given.
- 621.396.677.3 2654
On the Response of a Directive Antenna to Incoherent Radiation.—F. W. Schott. (*Proc. Inst. Radio Engrs.*, June 1951, Vol. 39, No. 6, pp. 677–680.) A general expression is derived for the power gain of a directive

aerial over a nondirective aerial, when receiving radiation comprising components with various directions of arrival and random phases. The usual method of expressing signal strength in db relative to a particular $\mu\text{V/m}$ level may give rise to error in this case; only the received power can be stated. Results obtained by measurement with parabolic aerials at 9.375 kMc/s show that for widely scattered radiation the aerial aperture has little effect on received power.

CIRCUITS AND CIRCUIT ELEMENTS

621.3.015.7 **2655**
Improved Pulse Stretcher.—J. F. Craib. (*Electronics*, June 1951, Vol. 24, No. 6, pp. 129–131.) A delay line charged by crystal rectifiers in parallel is used to stretch pulses up to 25 times their original length. The effects produced by superposing pulses within the stretch time are discussed. Design equations are presented.

621.316.729 **2656**
Synchronization of Relaxation Oscillations at Fundamental and Subharmonic Frequencies of an Applied Electromotive Force: Part 4.—V. V. Vitkevich. (*Zh. tekh. Fiz.*, Oct. 1950, Vol. 20, No. 10, pp. 1245–1256.) In continuation of previous papers (see *Elektrosvyaz*, 1940, No. 11; *Zh. tekh. Fiz.*, 1944, Vol. 14, Nos. 1/2 & 1945, Vol. 15, No. 11), a general case is considered in which several electromotive forces are applied to the oscillator and, in addition, the critical voltage value of the non-linear element is affected by these forces. Formulae are derived for determining the amplitudes and synchronization bandwidths at the fundamental and subharmonic frequencies of the complex applied e.m.f., and a general theory of the synchronization of asymmetrical and symmetrical oscillators is presented. A geometrical interpretation of the conclusions is given.

621.316.8 **2657**
The Problem of a Non-ohmic Resistor in Series with an Impedance.—E. B. Moullin. (*Proc. Instn elect. Engrs*, Part I, March 1951, Vol. 98, No. 110, pp. 87–96.) An experimental determination of the r.m.s. voltage required to maintain a given current through a silicon-carbide resistor in series with an ohmic resistor or a reactor. An appendix shows how the observed results can be predicted from the static characteristic by simple algebraic methods. The observed waveforms are also discussed.

621.318.4.042.13 **2658**
Cylindrical-Coil Theory applied to Calculation of Reluctance or Resistance between the End of a Straight Core and Infinity.—P. M. Prache & R. Cazenave. (*Câbles & Transmission, Paris*, Jan. 1951, Vol. 5, No. 1, pp. 60–67.) A theoretical study is made of the reluctance along a tube of force through an air-cored cylindrical coil. An expression for the reluctance between the end of the coil and infinity is obtained as the difference between the total reluctance of the tube of force and that of its part inside the coil; its value is nearly independent of the flux distribution within the winding. The expression is useful in the calculation of discontinuous magnetic circuits. The results obtained for reluctance may be translated into terms of resistance for estimating the value of resistance between the end of a cylindrical body and infinity.

621.318.42 **2659**
Design of Input (Regulation Control) Chokes.—N. G. Crowhurst. (*Electronic Engng*, May 1951, Vol. 23, No. 279, pp. 179–181.) A design chart is presented for determining the optimum specification for a choke to cover a given range of current and output voltage. It is intended to be used in conjunction with the charts noted in 1096 of May.

621.318.572 **2660**
The Cascaded Binary Counter with Feedback.—G. F. Montgomery. (*J. appl. Phys.*, June 1951, Vol. 22, No. 6, pp. 780–782.) A cascade of binary counters having arbitrary feedback arrangements introducing additional pulses is analysed; for a given count, or scale, a feedback arrangement requiring a minimum number of connections can be found.

621.318.572 : 621.385.3 : 546.289 **2661**
Some Transistor Trigger Circuits.—P. M. Schultheiss & H. J. Reich. (*Proc. Inst. Radio Engrs*, June 1951, Vol. 39, No. 6, pp. 627–632.) A survey of possibilities. Each of 5 circuits shown has operated successfully with at least one transistor. Difficulties encountered in reproducing results with other transistors or altered parameters are discussed.

621.385.3 : 546.289 **2662**
Duality, a New Approach to Transistor Circuit Design.—R. L. Wallace, Jr. (*Proc. Inst. Radio Engrs*, June 1951, Vol. 39, No. 6, p. 702.) Outline of principles applied. See 2369 of October.

621.385.3 : 621.385.5 **2663**
Valve Operating Conditions.—(*Wireless Engr*, July 1951, Vol. 28, No. 334, pp. 195–196.) A triode with capacitive load and without feedback may be cut off by a negative-going input voltage which can be amplified when no capacitance is present. The operation of triodes and pentodes under these conditions is discussed, and the case of an inductively-loaded pentode is also considered.

621.392 **2664**
A Network Theorem and its Application.—F. W. Bubb, Jr. (*Proc. Inst. Radio Engrs*, June 1951, Vol. 39, No. 6, pp. 685–688.) The theorem here proved is useful in analysing the response of a h.f. circuit to an a.m. signal by relating it to the response of an equivalent l.f. circuit to the signal envelope. The cases of a single-tuned circuit and a two-stage stagger-tuned amplifier are calculated as examples.

621.392.5 **2665**
Generalized Impedance Circle Diagrams in the Analysis of Coupled Networks.—C. Ghosh. (*Indian J. Phys.*, May 1950, Vol. 24, No. 5, pp. 223–231.) A practical method of developing circle diagrams for a representative 'T' network is described for cases in which the circuit parameters vary.

621.392.5 **2666**
Generalized Representation of a Valve Circuit by an Iterative Matrix.—U. Kirschner. (*Arch. elekt. Übertragung*, April 1951, Vol. 5, No. 4, pp. 190–196.) The circuit is considered as an active quadripole, and matrix methods are developed enabling its performance to be predicted. In illustration, the calculation is carried out for four different pentode circuits. See also 837 of April.

621.392.5 **2667**
Constant-Resistance Networks of the Linear Varying-Parameter Type.—L. A. Zadeh. (*Proc. Inst. Radio Engrs*, June 1951, Vol. 39, No. 6, pp. 688–691.) Explicit expressions are derived for the transfer function of such networks. See 834 of April.

621.392.5 **2668**
Initial Conditions in Linear Varying-Parameter Systems.—L. A. Zadeh. (*J. appl. Phys.*, June 1951, Vol. 22, No. 6, pp. 782–786.) The response of the initially excited system to a given input is considered. Mathematically, the problem involves the solution of a linear

differential equation, with time-dependent coefficients, subject to prescribed initial conditions. These conditions may be satisfied by superposing upon the given input a linear combination of delta functions and treating the system as if it were initially at rest. Using the concept of a system function, a simple general expression for the response is developed. The result is similar in form to that obtained by the use of conventional Laplace transformation techniques in the case of a linear differential equation with constant coefficients.

621.392.52 **2669**
Input Admittance, Output Admittance and Voltage Transformation at the Centre of the Pass Band in Variable Three-Stage Filters.—W. Pfost. (*Arch. elekt. Übertragung*, Feb. 1951, Vol. 5, No. 2, pp. 77–80.) General theory for the electrical design and construction of these filters was given in 843 of 1950. Formulae are now derived for the input and output admittances and for the voltage transformation ratio at the centre of the pass band. The values found are shown graphically and discussed. As required by the theory, the amplification is independent of direction of operation, and is nearly independent of bandwidth.

621.392.52 **2670**
The Double-T RC Filter.—J. Thouzéry. (*Radio franç.*, Jan.–April 1951, Nos. 1–4, pp. 6–11, 17–20, 20–22 & 19–22.) The theory of the double-T filter is discussed at length, after a preface on tensor analysis. The relation between the ratio volts-input volts-output and the constants of the network, i.e. the transfer equation, is investigated for the general case and for practical parameters; expressions are derived for the resonance frequency of the network for both general and particular cases, and frequency response curves are shown. Practical examples are discussed to illustrate applications of the theory.

621.392.6 **2671**
Representation of a Network or Transmission System by a Number of Superposed Balanced Circuits.—L. J. Collet. (*Câbles & Transmission, Paris*, Jan. 1951, Vol. 5, No. 1, pp. 3–24.) Following on an earlier paper on superposed circuits (592 of March) a generalized treatment is given of the problem of balanced a.c. circuits. In any network those circuits which can be defined by real coefficients are designated as real; in this sense it is shown that a network having a number of terminals exceeding by n the number of its component loops can always be resolved into n real and mutually balanced circuits, and hence that a network including two sets of terminals, each characterized by the same number n , can generally be resolved into n electrically independent quadripoles. Thus a transmission line constituted by n wires and the ground can be resolved into n balanced circuits.

621.396.6 : 061.4 **2672**
1951 Components Exhibition, Paris.—J. Rousseau. (*T.S.F. pour Tous*, March & April 1951, Vol. 27, Nos. 269 & 270, pp. 100–102 & 162–167.) Short illustrated review of exhibits. For other accounts see *Radio prof., Paris*, Feb. 1951, Vol. 20, No. 192, pp. 16–19, *Télévision, Paris*, March April 1951, No. 12, pp. 75–78, *Radio franç.*, Feb. 1951, No. 2, pp. 13–15, and *Toute la Radio*, March April 1951, No. 154, pp. 99–107.

621.396.611.1 **2673**
The Influence of Initial Phase Angle on the Excitation of Subharmonic Oscillations in a Nonlinear Circuit.—G. J. Elias, S. Duinker & Tan Soen Hong. (*Tijdschr. ned. Radiogenoot.*, March 1951, Vol. 16, No. 2, pp. 69–84.) Report of an experimental investigation of oscillations excited in a circuit comprising capacitor and iron-cored

inductor by a sinusoidal-voltage input. Graphs are used to show the initial values of phase and amplitude for which relaxation and subharmonic oscillations occur, for various values of capacitance. The effect on subharmonic response of additional resistance is considered. The phase-angle control-switch circuit used is described in an appendix.

621.396.611.3 **2674**
The Pull-in Effect in Coupled Circuits.—W. Herzog. (*Arch. elekt. Übertragung*, Feb. 1951, Vol. 5, No. 2, pp. 81–84.) To provide a physical picture of the pull-in effect, the simple case is considered of a bridge oscillator with two resonator circuits in parallel, the capacitance in one circuit being variable. The reactances of the two circuits are plotted on the same graph against frequency, and the dependence of the oscillation on the difference between the two reactances is demonstrated.

621.396.615 **2675**
Oscillators.—W. Herzog. (*Arch. elekt. Übertragung*, April 1951, Vol. 5, No. 4, pp. 169–180.) A comparative survey is given of the most useful oscillator circuits. Formulae determining amplitudes and frequencies are established.

621.396.619.13.018.78+ **2676**
Distortion in Linear Passive Networks.—L. Rieblman. (*Proc. Inst. Radio Engrs.*, June 1951, Vol. 39, No. 6, pp. 692–697.) A development of the theory of distortion in a f.m. system, based on a series solution of the superposition integral, provides a method of calculating the distortion produced by practical receiver circuits when the circuit transfer function is known in pole-zero form.

621.396.622.63 **2677**
The Diode Rectifier.—D. Geist. (*Z. angew. Phys.*, Jan. 1951, Vol. 3, No. 1, pp. 32–35.) A theoretical treatment of the crystal-diode-capacitor circuit. The current-voltage characteristic is taken as linear, with different slopes in the forward and reverse regions, a finite value of resistance being assumed in the reverse region. The time constant, efficiency, etc., can be calculated from the formulae derived. In the special case of infinitely high reverse resistance, the formulae apply also to the valve rectifier.

621.396.645.018.422+ **2678**
Simplified Q Multiplier.—H. E. Harris. (*Electronics*, May 1951, Vol. 24, No. 5, pp. 130–132, 134.) A narrow-band amplifier incorporating a negative-resistance circuit and having high stability and ease of control is described. The parallel-tuned circuit whose Q is to be increased is connected to the grid of a cathode follower. The cathode is connected via a variable resistance to a tap on the tuned circuit. A stable Q of 30 000 can be obtained.

621.396.645.018.424+ **2679**
Notes on Wide-Band Amplifiers.—L. Bernardi. (*Poste e Telecomunicazioni*, July 1950, Vol. 18, No. 7, pp. 261–274.) Practical design data for amplifiers used in carrier-frequency telephony or television are presented. Phase shift and amplification loss in voltage amplifiers at low and high frequencies are considered, and suitable compensating networks discussed. At h.f. various two- and four-terminal networks are available. Cathode coupling of power amplifiers to coaxial cable is considered. A worked example illustrates the method.

621.396.645.029.3 **2680**
Extended Class-A Audio.—H. T. Sterling. (*Electronics*, May 1951, Vol. 24, No. 5, pp. 101–103.) Description of a push-pull a.f. power amplifier using a triode and tetrode connected in parallel in each half, and delivering nearly

50 W from four Type 807 valves. At low levels the tetrodes are cut off and class-A triode operation is obtained with low distortion and power consumption. At high levels the tetrodes conduct and deliver the full output required.

621.396.645.029.3 **2681**

Amplifier of Variable Output Impedance.—R. Vorke & K. R. McLachlan. (*Wireless Engr.*, July 1951, Vol. 28, No. 334, pp. 222–225.) Positive and negative feedback are used to provide an output impedance variable from -10 to $+20\Omega$. The amplifier characteristics were investigated experimentally and the principal results are outlined.

621.396.645.215 **2682**

Improvement of the Frequency Response of Output Transformers by use of Filter Coupling.—R. Seidelbach. (*Funk u. Ton*, Jan. 1951, Vol. 5, No. 1, pp. 27–31.) The leakage inductance of the transformer is incorporated in a π -type filter, and a selective L-type network is coupled directly to this. This system provides a high-frequency cut-off at a frequency below 25 kc/s and is useful in an anode-modulation circuit in which frequencies of 25–60 kc/s give rise to distortion. Frequency attenuation figures are tabulated for a typical set of component values.

621.396.645.3 **2683**

Maximum Permissible Value of Grid-Leak Resistance.—O. Schmid. (*Arch. elekt. Übertragung*, Feb. 1951, Vol. 5, No. 2, pp. 85–88.) The value of the grid-leak resistance for an amplifier valve is required to be the smaller the nearer the valve is worked to the zero-grid-voltage point and the longer the grid remains at low values of negative potential. Hence care is needed in fixing the value of this resistance for d.c., a.f. and pulse amplifiers, in order to avoid nonlinear distortion. Where the grid voltage is changing rapidly there is no danger of distortion if the value of the grid-leak resistance is fixed according to the mean values of grid current and grid voltage.

621.396.645.35 **2684**

D.C. Amplifiers.—J. Schérer. (*Toute la Radio*, March/April 1951, No. 154, pp. 93–96.) Traces the evolution of d.c. amplifiers, and indicates modern practice.

GENERAL PHYSICS

537.311.5 + 538.569.4 **2685**

U.R.S.I.-I.R.E. Spring Meeting, Washington, D.C., April 16–18, 1951.—(*Proc. Inst. Radio Engrs.*, June 1951, Vol. 39, No. 6, pp. 716–720.) Summaries are given of the following papers:

8. Validity and Limitations of the Van Vleck-Weisskopf Equation for Atmospheric Microwave Absorption.—T. F. Rogers.

41. Current Distributions on Large Reflecting Cylinders.—H. J. Riblet.

537.523.3 + 537.525.3 **2686**

Starting Potentials of Positive and Negative Coronas with Coaxial Geometry in Pure N₂, Pure O₂, and Various Mixtures at Pressures from Atmospheric to 27 mm.—C. G. Miller & L. B. Loeb. (*J. appl. Phys.*, June 1951, Vol. 22, No. 6, pp. 740–741.)

537.525.6 : 538.561 : 621.396.615.142 **2687**

Electron Plasma Oscillations.—Wehner. (See 2875.)

537.528 : 621.315.61 **2688**

The Formation of Conducting Bridges in Suspensions of Conductors and Semiconductors in Dielectrics: Part 2.—L. G. Gindin, L. M. Moroz, I. N. Putilova & Ya. I.

Frenkel. (*Zh. tekh. Fiz.*, Feb. 1951, Vol. 21, No. 2, pp. 143–148.) The behaviour of 0.1% suspensions of Al in benzene under strong electric fields was investigated, and in particular the formation of conducting 'bridges', made up of Al particles, between the electrodes. The effect of various factors on the formation of these bridges is discussed.

538.221 **2689**

Ferromagnetism: Magnetization Curves.—E. C. Stoner. (*Rep. Progr. Phys.*, 1950, Vol. 13, pp. 83–179. Bibliography, pp. 180–183.) In this report, which is complementary to that abstracted in 3395 of 1948, an account is given of experimental and theoretical work over a period of about 16 years, on the behaviour of ferromagnetic materials in low and medium fields. The complex of behaviour represented by the magnetization curves of ferromagnetics is regarded as arising from small perturbations. The investigations selected for consideration are those providing quantitative information about these elementary processes, or exemplifying general methods of attacking the problems, or illustrating general principles.

538.3 : 530.145 **2690**

The Reciprocity Theory of Electrodynamics.—H. S. Green & K. C. Cheng. (*Proc. roy. Soc. Edinb. A.*, 1949, 1950, Vol. 63, Part 2, pp. 105–138.) Application of the principle of reciprocity to problems of classical and quantum electrodynamics. The first step is the formulation of a reciprocally invariant Lagrangian function for a system of electrons in interaction with the e.m. field. A study of the unaccelerated motion of an electron is extended to the case of arbitrary motion. The Hamiltonian energy of electron and field is determined and this makes it possible to express the theory in a quantum form which avoids the usual divergence difficulties.

538.311 : 513.647.1 : 621.318.423 **2691**

Waves Guided by Helical Circuits.—É. Roubine. (*C. R. Acad. Sci., Paris*, 7th May 1951, Vol. 232, No. 19, pp. 1748–1750.) A more general analysis than that presented in 1350 of June, applicable to any circuit whose limiting surface is generated by the helical motion of a curve. The electric field may be expressed in terms of a function ϕ which is the solution of an equation bearing to the Goldstein equation the same relation as the wave equation bears to the Laplace equation. The theory is applicable to (a) delay lines, (b) travelling-wave valves, and (c) helical aerials.

538.56 : 535.13 **2692**

On the Nonspecular Reflection of Electromagnetic Waves.—V. Twersky. (*J. appl. Phys.*, June 1951, Vol. 22, No. 6, pp. 825–835.) The nonspecular reflection of plane electromagnetic waves of arbitrary polarization by perfectly conducting surfaces composed of either semi-cylindrical or hemispherical bosses on an infinite plane is analysed. Solutions for the problem of the single boss are given and extended to cover patterns of bosses. The results for the various cases are compared and expressions are obtained for the ratios of the components of the reflected wave.

538.56 : 535.42 **2693**

Diffraction of Centimetre Electromagnetic Waves by Metal and Dielectric Disks.—H. Severin & W. v. Baeckmann. (*Z. angew. Phys.*, Jan. 1951, Vol. 3, No. 1, pp. 22–28.) The field distribution in the axial region of a metal disk was investigated experimentally. Methods using a fixed disk and a movable disk led to similar results. The latter method, applied in the case of a dielectric disk, showed that the diffracted wave differs from that for a metal disk only by a constant factor which is identical with the optical reflection coefficient.

538.56 : 535.42 **2694**
Theory of the Diffraction of Electromagnetic Waves.—H. Severin. (*Z. Phys.*, 2nd April 1951, Vol. 129, No. 4, pp. 426–439.) Green's tensors are used to derive boundary-value formulae for electromagnetic diffraction, by means of which the field in the space can be calculated from the tangential components of the electric or magnetic field-strength over the boundary.

538.566 **2695**
Huyghens' Principle for an Electromagnetic Wave.—R. de Possel & C. Pouget-Michel. (*C. R. Acad. Sci., Paris*, 16th May 1951, Vol. 232, No. 20, pp. 1819–1821.) Huyghens' principle is expressed in terms of electric and magnetic doublets similar to those used by Larmor for the general solution of Maxwell's equations in a vacuum. Love's potentials are introduced. The method of deducing from the derived expression the classical formulae involving charges and currents is indicated.

538.566 **2696**
Wave Packets, the Poynting Vector, and Energy Flow: Part 2 — Group Propagation through Dissipative Isotropic Media.—C. O. Hines. (*J. geophys. Res.*, June 1951, Vol. 56, No. 2, pp. 197–206.) A theoretical paper. For pulses propagated in infinite media or through slabs having appreciable absorption, the speed of transmission to be expected is $c/(dkn_1/dk)$, where n_1 is the real part of the refractive index at frequency $kc/2\pi$. Part 1: 1881 of August.

538.566 **2697**
Wave Packets, the Poynting Vector, and Energy Flow: Part 3 — Packet Propagation through Dissipative Anisotropic Media.—C. O. Hines. (*J. geophys. Res.*, June 1951, Vol. 56, No. 2, pp. 207–220.) "Formulae are developed giving the velocity of packet propagation in dissipative anisotropic media, for both homogeneous and inhomogeneous waves." Part 2: 2696 above.

GEOPHYSICAL AND EXTRATERRESTRIAL PHENOMENA

523.72 + 523.85] : 621.396.822 **2698**
Radio Astronomy.—M. Ryle. (*Rep. Progr. Phys.*, 1950, Vol. 13, pp. 184–245. Bibliography, pp. 245–246.) A survey, complementary to those of Hey (91 of 1950) and Pawsey (104 of January). Details of experimental observations are dealt with relatively briefly, while discussions at greater length are devoted to the fundamental limitations of the various experimental techniques and to some of the theoretical implications of the observations already made.

523.72 + 523.85] : 621.396.822 **2699**
Radio Astronomy.—(*Wireless World*, July 1951, Vol. 57, No. 7, pp. 275–278.) A brief survey of modern equipment and techniques developed for the study of radio stars, meteors in the upper atmosphere, and solar and galactic noise.

523.72 : 621.396.822 **2700**
Radio Emission from the Sunspot of Central Meridian Passage 1950 June 14.—A. Maxwell. (*Observatory*, April 1951, Vol. 71, No. 861, pp. 72–74.) Observations made at Jodrell Bank indicated that the radiation intensity on a wavelength of 3.7 m (10^{-19} W/m² per c/s) was unusually high for a sunspot group of this area (600 millionths of the sun's disk) which was, according to optical observations, declining. The magnetic field of the spot (3 600 gauss) was insufficient to account for this intense r.f. radiation. The high intensity persisted for 6 days, being asymmetrical about the time of central meridian passage, but coinciding in time with a brighter-than-normal patch of flocculi in the spot.

523.74 **2701**
A Forecast of Solar Activity.—W. Gleissberg. (*J. geophys. Res.*, June 1951, Vol. 56, No. 2, pp. 294–295.) Earlier predictions (1121 of 1944) are vindicated; new predictions indicate that the next sunspot cycle will probably again be one of intense activity, with an unusually shallow minimum.

523.746 "1951.01 .03" **2702**
Provisional Sunspot-Numbers for January to March 1951.—M. Waldmeier. (*J. geophys. Res.*, June 1951, Vol. 56, No. 2, p. 288; *Z. Met.*, May/June 1951, Vol. 5, Nos. 5/6, p. 192.)

523.85 : 621.396.822 **2703**
Some Observations of the Variable 205 Mc/s Radiation of Cygnus A.—C. L. Seeger. (*J. geophys. Res.*, June 1951, Vol. 56, No. 2, pp. 239–258.) U.R.S.I. Sept. 1950 General Assembly paper. A report on observations made between October 1948 and May 1950. Contrary to the results of Bolton & Stanley (2514 of 1948), the intensity of the radiation was found to vary with a mean period of about $\frac{1}{2}$ minute, which agrees with observations at lower frequency. Strong variations occur at all altitude angles of the source; these may be caused by ionospheric scattering.

550.38 : 621.396.11 **2704**
Relation between the Earth's Magnetism and the Propagation of Radio Waves between Washington and Bagneux.—Lejay, Ardillon & Bertaux. (See 2806.)

550.38 "1950.10/.12" **2705**
International Data on Magnetic Disturbances, Fourth Quarter, 1950.—J. Bartels & J. Veldkamp. (*J. geophys. Res.*, June 1951, Vol. 56, No. 2, pp. 283–287.)

550.38 "1951.01/.03" **2706**
Cheltenham [Maryland] Three-Hour-Range Indices *K* for January to March, 1951.—R. R. Bodle. (*J. geophys. Res.*, June 1951, Vol. 56, No. 2, p. 288.)

550.384.4 **2707**
The Daily Magnetic Variations in Equatorial Regions.—A. T. Price & G. A. Wilkins. (*J. geophys. Res.*, June 1951, Vol. 56, No. 2, pp. 259–263.) A new analysis of the *S_q* field for the Polar Year 1932–1933 indicates that the maximum daily variation of *H* in equatorial regions occurs between the magnetic and dipole equators in South America and Africa, but to the south of both these equators in the Far East. The line of maximum variation swings seasonally in the opposite direction to the sun.

550.385/.386 **2708**
Sudden Commencements and Sudden Impulses in Geomagnetism: their Hourly Frequency at Cheltenham (Md), Tucson, San Juan, Honolulu, Huancayo, and Watheroo.—V. C. A. Ferraro, W. C. Parkinson & H. W. Unthank. (*J. geophys. Res.*, June 1951, Vol. 56, No. 2, pp. 177–195.) During the period 1926–1946 the local time variations in the hourly frequency of sudden commencements appeared to be small; their frequency may be greatest around 1300 local time. The hourly frequency of sudden impulses was minimum at around 0800 and 2000 local time. The diurnal variations in frequency of sudden commencements and sudden impulses with a preliminary movement in the opposite direction exhibit a local time effect with an afternoon maximum; their frequency may depend on longitude. The curves for the annual mean number of sudden commencements and sudden impulses combined and for annual mean sunspot numbers show striking similarities.

550.385 2709
Principal Magnetic Storms [Sept. 1950–March 1951].—
(*J. geophys. Res.*, June 1951, Vol. 56, No. 2, pp. 289–
291.)

550.385 : 551.594.52 2710
**The Southward Shifting of the Auroral Zone during
Intense Magnetic Storms.**—T. Nagata. (*J. geophys. Res.*,
June 1951, Vol. 56, No. 2, pp. 292–294.) Author's reply
to comment noted in 873 of April (Ferraro).

551.510.5 : 621.396.9 2711
**Observation of Radar Echoes coming from a Cloudless
Region.**—J. Broc. (*C. R. Acad. Sci., Paris*, 28th May
1951, Vol. 232, No. 22, pp. 2034–2036.) With radar
equipment operating on a wavelength of 3.2 cm and a
peak power of 30 kW, echoes of unexplained origin were
observed on 20th March 1951 at Monaco. The echoes
came from an apparent distance of 15–20 km and from a
height > 1 km, the sky being clear.

551.510.535 + 551.594.5 2712
**U.R.S.I.-I.R.E. Spring Meeting, Washington, D.C.,
April 16-18, 1951.**—(*Proc. Inst. Radio Engrs.*, June 1951,
Vol. 39, No. 6, pp. 716–720.) Summaries are given of the
following papers:

2. Martyn's Theory of Magnetic Storms and Auroras.
—H. G. Booker.
9. On the Definition of Virtual Height.—J. Shmoys.
11. Fluctuations of F_2 Region between Stations
separated by 100 to 150 Miles.—H. W. Wells.
24. The Experimental and Theoretical Study of
Ionospheric Absorption at 150 kc s.—A. H.
Benner.
35. Southern Extent of Aurora Borealis in North
America.—C. W. Gartlein & R. K. Moore.
36. A V.H.F. Propagation Phenomenon associated with
the Aurora.—R. K. Moore.
38. Magneto-ionic Multiple Splitting determined with
the Method of Phase Integration.—W. Pfister.

551.510.535 2713
**Evidence for Ionosphere Currents from Rocket Experi-
ments near the Geomagnetic Equator.**—S. F. Singer, E.
Maple & W. A. Bowen, Jr. (*J. geophys. Res.*, June 1951,
Vol. 56, No. 2, pp. 265–281.) Two rockets carrying total-
field magnetometers were fired from sites 60 miles apart.
In one case the recorded magnetic field at distances
between 20 and 105 km decreased according to expecta-
tions for a simple dipole field. In the second case a
discontinuity was observed in the altitude range 93–105
km. The results establish the existence of a current
system in the E region, causing the diurnal variation of
the earth's magnetic field at sea level, and support the
dynamo theory of the daily magnetic variation proposed
by Balfour Stewart & Schuster. A brief report of the
same work is given in *Phys. Rev.*, 15th June 1951, Vol.
82, No. 6, pp. 957–958.

551.510.535 2714
The Theory of Magneto-ionic Triple Splitting.—
O. E. H. Rydbeck. (*Chalmers tekn. Högsk. Handl.*,
1951, No. 101, 40 pp. In English.) The coupling
coefficients between the magneto-ionic modes of propa-
gation are calculated and the method of excitation of
the z mode analysed in detail. The transformation and
reflection coefficients of the modes are deduced as func-
tions of the collisional frequency. Poeverlein's graphical
method is applied to determine the refractive indices and
ray paths. Data from Kiruna are used to illustrate the
main results of the theory. Meek's results (3221 of 1948)
are also explained. The possibility that scattering
discontinuities can excite the z mode at lower latitudes is

discussed briefly. See also 1147 of May, and *Onde élect.*,
Feb. & March 1951, Vol. 31, Nos. 287 & 288, pp. 70–81 &
153–156.

551.510.535 : 621.396.11 2715
**Change in the Nature of Medium-Wave Propagation at
Sunset.**—Houtsmuller. (See 2809.)

551.594.5 : 621.396.11 2716
**Radio Observations of the Aurora on November 19,
1949.**—N. C. Gerson. (*Nature, Lond.*, 19th May 1951,
Vol. 167, No. 4255, pp. 804–805.) Using amateur reports
of aurorally maintained reception, the position of the
auroral reflecting belt is calculated assuming that the
height of reflection is 100 km and that the ray paths are
tangential to the earth. Possible causes of the 'auroral
modulation' are discussed. It is probable that this effect
is due to changes of ionization density with position and
time.

551.594.6 : 621.317.7.087 : 621.396.821 2717
An Atmospheric Waveform Receiver.—W. J. Kessler.
(*Proc. Inst. Radio Engrs.*, June 1951, Vol. 39, No. 6,
p. 676.) The waveform is displayed on a c.r.o., the
horizontal sweep being triggered by the signal. This is
delayed by 18 μ s so that the leading edge is not lost. 50- or
100- μ s markers are displayed on a separate sweep to
avoid confusion with the signal. The display rate is
limited to about 8 waveforms per sec; 3 sample waveforms
showing multiple echoes are reproduced.

551.594 2718
The Flight of Thunderbolts. [Book Review]—B. F. J.
Schonland. Publishers: Clarendon Press, Oxford &
Oxford University Press, London, 1950, 152 pp., 15s.
(*Nature, Lond.*, 19th May 1951, Vol. 167, No. 4255, pp.
787–788.) "An elementary but authoritative account"
covering the development of knowledge regarding
lightning discharges, methods of protection against
lightning, the mechanism of electrification of thunder-
clouds, radio atmospherics and their use in locating
thunderstorms.

LOCATION AND AIDS TO NAVIGATION

621.396.9 2719
Port Approach and Berthing in Fog.—F. J. Wylie.
(*J. Inst. Nav.*, April 1951, Vol. 4, No. 2, pp. 156–164.)
A discussion of the role of shore-based radar in the berth-
ing of ships in fog, and of the manner in which information
obtained from radar or other aids should be presented to
the master of a ship.

621.396.9 : 621.396.616 2720
Optimum Operation of Echo Boxes.—W. M. Hall &
W. L. Pritchard. (*Proc. Inst. Radio Engrs.*, June 1951,
Vol. 39, No. 6, pp. 680–684.) The dependence of the
optimum Q and maximum ring time of an echo box
system on coupling method, pulse length, unloaded
cavity Q and transmitter-receiver properties is examined
theoretically. The results are shown graphically; the
power taken by a direct-coupled box is also plotted as a
function of pulse length and the ratio of loaded to
unloaded Q .

621.396.93 : 621.396.67 2721
**U.R.S.I.-I.R.E. Spring Meeting, Washington, D.C.,
April 16-18, 1951.**—(*Proc. Inst. Radio Engrs.*, June 1951,
Vol. 39, No. 6, pp. 716–720.) A summary is given of the
following paper:
16. Antenna Systems for Radio Direction Finding.—
E. C. Jordan.

621.396.933 2722

Description and Evaluation of 100-Channel Distance-Measuring Equipment.—R. C. Borden, C. C. Trout & E. C. Williams. (*Proc. Inst. Radio Engrs.*, June 1951, Vol. 39, No. 6, pp. 612–618.) By combining the principles of operation of two separate earlier schemes for 50-channel equipment, a 100-channel system has been developed using only 20 distinct frequency channels (10 for interrogation and 10 for reply), occupying a total bandwidth of 50 Mc/s in the region of 1 kMc/s, together with 10 coded temporal relations between the interrogation and reply pulses. Possible identification schemes are discussed and flight tests are described.

MATERIALS AND SUBSIDIARY TECHNIQUES

535.215 2723

Photoconductivity of Caesium-Antimony Films.—P. G. Borzyak. (*Zh. tekh. Fiz.*, Aug. 1950, Vol. 20, No. 8, pp. 923–927.)

535.215 2724

Preparation of Photoconducting Cadmium Sulphide.—R. E. Aitchison. (*Nature, Lond.*, 19th May 1951, Vol. 167, No. 4255, pp. 812–813.) Uniform layers of photoconducting CdS having any desired area, with thicknesses up to 5×10^{-4} cm, can be prepared by the slow evaporation in vacuo ($p \leq 10^{-6}$ mm Hg) of CdS precipitated from an aqueous solution.

537.226 2725

Present-Day Theories of Ferroelectricity.—H. Lumbroso. (*Rev. sci., Paris*, Oct. 1950, Vol. 88, No. 3308, pp. 239–247.) A general discussion, with particular reference to the properties of Rochelle salt and BaTiO_3 ; a bibliography of 18 items is appended.

537.311.33 2726

Transistors: Part 1.—J. Malsch. (*Arch. elekt. Übertragung*, March 1951, Vol. 5, No. 3, pp. 139–148.) A survey paper, discussing the fundamental physical processes of conduction in semiconductors such as Si and Ge.

537.311.33 2727

Valence Semiconductors.—F. Stöckmann. (*Naturwissenschaften*, April 1951, Vol. 38, No. 7, pp. 151–154.) A survey paper, with numerous references, in which the conduction mechanism in semiconductors is considered from the point of view of developing materials with properties suitable for practical applications. Mixed-crystal (valence) semiconductors have the advantage that the concentration of impurity centres depends only on the composition of the material, and is thus controllable and thermally stable.

537.311.33 : 061.3 2728

The Seventh All-Union Conference on the Properties of Semiconductors.—(*Zh. tekh. Fiz.*, Feb. 1951, Vol. 21, No. 2, pp. 231–242.) Report on a Conference held by the Academy of Sciences of the U.S.S.R. and by the Academy of Sciences of the Ukrainian S.S.R. in Kiev on 14th–21st October 1950. 39 papers were read, under the following headings: general; theory of semiconductors; photoelectric phenomena in semiconductors; new types of semiconductors; surface and contact phenomena; thermal properties of semiconductors; technical application of semiconductors. Summaries of the papers and of the discussions are given.

537.311.33 : 546.3 2729

The Formation of Barrier Layers with the aid of Chemical Combinations in Welds.—S. G. Kalashnikov & L. N. Erastov. (*Zh. tekh. Fiz.*, Feb. 1951, Vol. 21, No. 2, pp. 129–134.) A simple method is described for obtaining

a barrier layer by welding two metals which form a layer of high specific resistance in the weld. In this way barrier layers were obtained between Sb and Mg and between Sb and Zn. The technique is described and the results of an experimental investigation, including the voltage, current characteristics, are presented. A theoretical interpretation is given of the rectification produced. It is not suggested that the method is suitable for practical applications, since the rectifying properties of the welded pairs apparently deteriorate rapidly.

537.311.33 : 546.841-3 2730

Semiconductor Properties of Thoria in a Vacuum.—G. Mesnard. (*C. R. Acad. Sci., Paris*, 7th May 1951, Vol. 232, No. 19, pp. 1744–1746.) Experiments were carried out on thoria cylinders, deposited by electrophoresis on pairs of parallel tungsten wires serving as heater and electrode systems. Properties investigated included electrical and thermal conductivity and the rectification at the tungsten thoria interface. The observed variation of conductivity with temperature gives support to the views of Loosjes & Vink (3208 of 1950) on the electronic processes involved, while the values obtained are comparable with those of Danforth & Morgan (2539 of 1950). Departure of the observed thermoelectric effect from values given by existing semiconductor theory are explained by an interface p.d. which increases with rise of temperature. Rectification occurs as a result of the interface p.d. and the greater abundance of electrons in regions of higher temperature.

538.221 2731

International Conference on Ferromagnetism and Antiferromagnetism, Grenoble (3rd–7th July 1950.—(*J. Phys. Radium*, March 1951, Vol. 12, No. 3, pp. 149–508.) Full text of 49 papers presented at the conference.

538.221 2732

The Origin of Intermittent Activation in Ferromagnetic Materials.—R. Forrer. (*C. R. Acad. Sci., Paris*, 7th May 1951, Vol. 232, No. 19, pp. 1746–1748.)

538.221 2733

The Magnetic Structure of High-Coercivity Alloys: Part 4—Magnetostriction Hysteresis in Alnico and Vicalloy Alloys.—D. A. Shturkin & Ya. S. Shur. (*Zh. tekh. Fiz.*, Nov. 1950, Vol. 20, No. 11, pp. 1393–1399.) The results of an experimental investigation are analysed on the assumption that these ferromagnetic materials consist of finely dispersed plate-formations insulated from one another, and that there is only one region of spontaneous magnetization within each formation.

538.221 2734

Magnetic Viscosity of Permalloy in Sinusoidally and Aperiodically Varying Fields.—R. V. Telesnin & S. Z. Ushakov. (*Zh. tekh. Fiz.*, Nov. 1950, Vol. 20, No. 11, pp. 1366–1371.) Magnetic viscosity, i.e., the time delay of variations in magnetization with respect to variations in the intensity of the magnetic field, has previously been investigated by a number of authors separately for sinusoidally and for aperiodically varying fields. The present paper reports measurements made on the same sample for both types of field. A number of conclusions regarding magnetic viscosity are drawn.

538.221 2735

The Ferromagnetism of the ϵ_1 Phase of Co/Zn Alloys.—A. J. P. Meyer & P. Taglang. (*C. R. Acad. Sci., Paris*, 21st May 1951, Vol. 232, No. 21, pp. 1914–1916.) An experimental study of a series of alloys in which the proportion of Zn was varied from 42% to 60%.

538.221

Results of Measurements on High-Permeability Ferrite Cores.—M. Kornetzki. (*Z. angew. Phys.*, Jan. 1951, Vol. 3, No. 1, pp. 5-9.) The permeability characteristics of ferrite cores are discussed and compared with those of high-permeability stacked and wound cores. The ferrite cores may have a μ up to 3 500, nearly independent of frequency up to the gyromagnetic limiting frequency, between 1 and 6 Mc s; above this frequency μ falls. Due to capacitive eddy currents a resonance occurs which may lead to an apparent increase in μ . The Curie point is lower the higher the permeability.

538.221 : 539.382

Measurement of the Young's Modulus of Ferrites.—L. Weil & L. Bochirol. (*C. R. Acad. Sci., Paris*, 16th May 1951, Vol. 232, No. 20, pp. 1807-1809.) The method used depends on finding the resonance frequency of magnetostrictively excited mechanical oscillations in annular specimens.

539.23

Thin Films of Hydrocarbons formed by Electron or Ion Bombardment.—H. König & G. Helwig. (*Z. Phys.*, 28th April 1951, Vol. 129, No. 5, pp. 491-503.) The mechanism by which films of solid hydrocarbons are formed from gas on the walls of experimental vacuum tubes is described. Disturbing effects and useful applications of the films are discussed.

539.234 : 546.59

The Crystallization of Very Thin Gold Films.—A. Colombani & G. Ranc. (*C. R. Acad. Sci., Paris*, 2nd April 1951, Vol. 232, No. 14, pp. 1344-1346.) Report of an experimental investigation of films deposited by evaporation on to an amorphous (e.g., plexiglas) or crystalline (e.g., NaCl) support. The nature of the film at different stages of development was deduced from the variations of its conductivity. Results are presented in graphs and discussed briefly.

546.287 : 537.533.8

Silicone Oil Vapour and Secondary Electron Emission.—A. Lempicki & A. B. McFarlane. (*Nature, Lond.*, 19th May 1951, Vol. 167, No. 4255, pp. 813-814.) Measurements of the 'sticking' potential of a fluorescent powder and of the secondary-emission coefficient for various surfaces lead to the view that silicone oil vapour, currently used instead of mercury vapour in diffusion pumps, will produce obnoxious results on any surface bombarded by electrons.

549.514.51 : 621.396.611.21

Temperature Dependence of Quartz Resonators.—R. Bechmann. (*Arch. elekt. Übertragung*, Feb. 1951, Vol. 5, No. 2, pp. 89-90.) A note complementing earlier papers (3332 of 1942 and 2187 of 1943) and giving values of oscillation coefficients, piezoelectric coefficients and capacitance constants and their temperature coefficients for some bar and plate resonators.

621.3.011.5 : [546.131 + 546.131.02

The Dielectric Properties of Solid HCl and DCl.—C. S. E. Phillips. (*C. R. Acad. Sci., Paris*, 21st May 1951, Vol. 232, No. 21, pp. 1924-1927.) Measurements made at frequencies ranging from 80 c s to 6 Mc s are reported.

621.314.63

The Theory of Direct-Current Characteristics of Rectifiers.—P. T. Landsberg. (*Proc. roy. Soc. A*, 22nd May 1951, Vol. 206, No. 1087, pp. 463-477.) Image force can be taken into account very simply by making minor adjustments in the diffusion and diode theories.

Expressions are obtained enabling detailed comparisons to be made with experimental data of the d.c. reverse characteristics of Cu_2O , Se and Ge rectifiers assuming (a) a Mott barrier, (b) a Schottky barrier; agreement is satisfactory. The effect of the image force on the charge-carrier distribution is illustrated and a general relation between the two theories is established.

621.314.63

Contributions to the Theory of Heterogeneous Barrier-Layer Rectifiers.—P. T. Landsberg. (*Proc. roy. Soc. A*, 22nd May 1951, Vol. 206, No. 1087, pp. 477-488.) Assuming an arbitrary distribution of space charge in the barrier layer, the general form of the current/voltage relation is derived from both diode and diffusion theory. A connection, valid for most barriers, between this characteristic and the capacitance voltage curve is pointed out. The Sachs breakdown voltage can be deduced from the latter characteristic. Assumption of a barrier in which the distribution of impurity centres is established by a diffusion process leads to more likely values for the rectifier parameters.

621.314.63

Theory of the Contact between Two Semiconductors with Different Types of Conductivity.—A. I. Gubanov. (*Zh. tekhn. Fiz.*, Nov. 1950, Vol. 20, No. 11, pp. 1287-1301.) Various phenomena observed when a voltage is applied between two semiconductors with different types of conductivity (hole and electron) are discussed. To explain these phenomena it is suggested that a barrier layer of a type different from that considered by other investigators is formed at the contact. The theory of this layer is presented and it is shown that it must possess high resistivity and exert considerable rectifying action. A formula is derived for determining the current through the contact. IV characteristics, for both forward and backward directions, plotted from this formula show good agreement with experimental results.

621.315.61

Dielectrics Made to Order.—A. R. von Hippel. (*Electronics*, June 1951, Vol. 24, No. 6, pp. 126-128.) Study of the synthesis of dielectric materials based on investigation of dielectric breakdown.

621.315.61 : 621.3.015.5

Electrical Breakdown over Insulators in High Vacuum.—P. H. Gleichauf. (*J. appl. Phys.*, June 1951, Vol. 22, No. 6, pp. 766-771.) Account of a practical investigation, in continuation of previous work (2454 of October). Breakdown voltage was measured for various electrode and insulator materials; data establishing the relation between insulator length and breakdown voltage were obtained. The effect of the degree of roughness of the insulator surfaces in contact with the electrodes was investigated, and experiments were made in which one of the electrodes was separated from the insulator.

621.315.616.9 : 621.3.015.5

The Intrinsic Electric Strength of Polyvinyl Alcohol and its Temperature Variation.—I. D. L. Ball. (*Proc. Instn. elect. Engrs*, Part I, March 1951, Vol. 98, No. 110, pp. 84-86.) Measurements were made at temperatures from -195°C to 90°C . Comparison with observations made on other high polymers [see 1696 of 1949 (Bird & Pelzer) and 764 of 1947 (Austen & Pelzer)] suggests that the temperature variation of the intrinsic electric strength of these materials is determined by the dipoles present rather than by the physical structure.

621.318.4.042.15

Investigations into the Possibility of using Suspensions of Ferromagnetic Particles in Liquid Dielectrics in place

of Powder Cores.—H. H. Rust. (*Arch. elekt. Übertragung*, Feb. 1951, Vol. 5, No. 2, pp. 67-76.) Plastic suspensions of e.g. carbonyl iron in insulating oil were investigated. Coils were embedded in the suspension, and determinations were made of the resistance of the suspension with and without addition of a dipolar substance to the dispersive medium, and of the Q and self-inductance of the coil as a function of temperature and sedimentation time; the results are compared with corresponding values for powder-core coils. Variation of the effective permeability of the suspension due to thixotropic effects resulting from mechanical stress was investigated and a number of practical applications are indicated.

621.319.45 2750

The Oxide Layer on Aluminium and the Temperature Dependence of the Capacitance of the Electrolytic Capacitor.—S. S. Gutin. (*Zh. tekhn. Fiz.*, Feb. 1951, Vol. 21, No. 2, pp. 135-142.) A report on an experimental investigation, the main conclusions of which are as follows: (1) the oxide layer is of porous structure; (2) the temperature dependence of capacitance is determined by the action of the electrolyte in the pores; (3) covering the layer with a thin film of a solid dielectric reduces the temperature dependence of capacitance and ensures linear variation within the working range of temperatures.

669.018 2751

Resistance Alloys.—H. Thomas. (*Z. Phys.*, 13th Feb. 1951, Vol. 129, No. 2, pp. 219-232.) Measurements were made on Ni/Cr, Fe/Al, Ni/Al, Fe/Si, Ni/Cu/Zn and Ni/Cu alloys. The resistivity/temperature curve is S-shaped, and the resistance is increased by heat treatment at low temperatures and is decreased by cold working. A physical explanation is advanced.

MATHEMATICS

517.94 2752

U.R.S.I.-I.R.E. Spring Meeting, Washington, D.C., April 16-18, 1951.—(*Proc. Inst. Radio Engrs.*, June 1951, Vol. 39, No. 6, pp. 716-720.) A summary is given of the following paper:

40. Asymptotic Solution of Maxwell's Equation.—M. Kline.

518.3 2753

The Smoothing of Experimental Curves.—P. Vernotte. (*C. R. Acad. Sci., Paris*, 21st May 1951, Vol. 232, No. 21, pp. 1897-1899.)

518.3 : 514.6 2754

Nomogram and Slide-Rule for Solution of Spherical Triangle Problems found in Radio Communication.—D. V. Dickson. (*J. geophys. Res.*, June 1951, Vol. 56, No. 2, pp. 163-175.)

681.142 2755

The Diagnosis of Mistakes in Programmes on the EDSAC.—S. Gill. (*Proc. roy. Soc. A*, 22nd May 1951, Vol. 206, No. 1087, pp. 538-554.) Description of methods applicable generally to high-speed computers, for rapid diagnosis of mistakes due to faulty programming, including details of checking routines applicable particularly to the EDSAC.

517.53 2756

Équations Intégrales et Transformation de Laplace. [Book Review]—M. Parodi. Publishers: Ministère de l'Air, Paris, 1950, 125 pp. (*Ann. Télécommun.*, Feb. 1951, Vol. 6, No. 2, p. 60.) Addressed primarily to

mathematicians, but of interest also to engineers and physicists concerned with manipulating integral equations or using the symbolic calculus.

MEASUREMENTS AND TEST GEAR

529.786 2757

Accurate Time for Broadcast Studios.—J. H. Greenwood. (*Electronics*, June 1951, Vol. 24, No. 6, pp. 97-99.) Details of a system using a 60-c/s standard frequency controlled by a 240-c/s tuning fork to drive up to 10 synchronous clocks. Indications may be adjusted to agree with WWV signals to an accuracy within ± 0.1 sec.

621.316.726.078.3 2758

Frequency Stabilization: Ultra-High-Frequency Discriminator.—G. Pircher. (*Onde élect.*, March 1951, Vol. 31, No. 288, pp. 144-152.) Methods of stabilizing u.h.f. oscillators and various types of discriminator are outlined. A detailed description is given of a simple discriminator, based on modifications of the amplitude and phase of the stationary wave pattern in a guide terminated by a load tuned approximately to the resonant frequency to be controlled. Figures are given of an actual equipment, using a klystron oscillator, covering the waveband 30-36 mm, and applications in the field of u.h.f. measurements are indicated.

621.316.8 : 621.317.3.029.55 2759

A Resistor for High-Frequency Measurements.—F. Lappe & K. B. Westendorf. (*Z. angew. Phys.*, Jan. 1951, Vol. 3, No. 1, pp. 29-32.) The resistor consists of a large number of thin parallel wires stretched along the surface of a cylinder and connected in parallel. The return path is provided by a coaxial metal cylinder inside or outside the wire cage. The time constants for such arrangements are calculated and details are given of suitable constructions for particular applications.

621.317.32 2760

Arrangements for the Compensation and Measurement of Small Direct Voltages.—G. Paldus. (*Arch. elekt. Übertragung*, March 1951, Vol. 5, No. 3, pp. 135-138.) A device suitable for balancing out the steady component of an applied voltage, and thus making the whole of the galvanometer scale available for measuring the variable component, consists basically of oppositely connected thermocouples with separate heaters connected for differential control by a potentiometer circuit. Variants of the basic arrangements are described.

621.317.32.029.63 2761

Modern Methods of High-Frequency Voltage Measurement up to about 10 000 Mc/s.—M. J. O. Strutt. (*Arch. tech. Messen*, March 1951, No. 182, pp. T32-T33.) Discussion of sources of error in a diode voltmeter, and description of this and other measurement systems, the latter depending on current variations.

621.317.324 : 621.396.611.1 2762

Methods of Measuring Adjacent-Band Radiation from Radio Transmitters.—N. Lund. (*Proc. Inst. Radio Engrs.*, June 1951, Vol. 39, No. 6, pp. 653-656.) Three methods are described, using respectively two modulation tones of equal amplitude, normal modulating signals, or thermal-noise modulation. Good agreement between the last two methods shows the usefulness of thermal noise measurements, which require considerably less equipment. The first method normally gives only a qualitative estimate, but distortion measurements can be used to calculate the adjacent-band radiation, which is in reasonable agreement with the values found by the other methods.

- 621.317.335.3.029.63† 2763
The Measurement of Permittivity and Power Factor of Dielectrics at Frequencies from 300 to 600 Mc/s.—J. V. L. Parry. (*Proc. Instn elect. Engrs*, Part III, July 1951, Vol. 98, No. 54, pp. 303–311.) A resonance method developed from that of Hartshorn & Ward (351 of 1937) for use at higher frequencies is described. The variable capacitive elements are mounted in a re-entrant cavity, which serves as a wavemeter for capacitance calibration. The accuracy for permittivity measurement is estimated to be within $\pm 1\%$, and for power-factor measurement to within $\pm 2 \times 10^{-5}$ for values below 0.01 and $\pm 5 \times 10^{-4}$ for higher values.
- 621.317.336.029.62/63 2764
U.R.S.I.-I.R.E. Spring Meeting, Washington, D.C., April 16-18, 1951.—(*Proc. Inst. Radio Engrs*, June 1951, Vol. 39, No. 6, pp. 716–720.) A summary is given of the following paper:
 3. Impedance Measurements in the 50 to 1 000 Mc/s Range.—F. J. Gaffney.
- 621.317.42 2765
The Electron Multiplier as an Indicator of Weak Magnetic Fields.—N. V. Krasnogorskaya. (*Zh. tekh. Fiz.*, Oct. 1950, Vol. 20, No. 10, pp. 1257–1266.) Experiments were conducted which show that an electron-multiplier tube with permanent magnets can be used as a magnetometer. It can be easily connected to an oscillograph and, being practically inertialess, it follows rapid variations of weak magnetic fields.
- 621.317.42 2766
Magnetic Field Measurements with Peaking Strips.—J. M. Kelly. (*Rev. sci. Instrum.*, April 1951, Vol. 22, No. 4, pp. 256–258.) The method is based on the oscillographic observation of voltage pulses induced in a coil wound round a length of high-permeability wire (i.e. a 'peaking strip') arranged parallel to the magnetic field. Field strengths of the order of a kilogauss can be measured accurately to within ± 0.02 gauss.
- 621.317.725 2767
The Theory and Design of the Reflex Voltmeter.—A. E. Budarov & L. E. Leykhter. (*Zh. tekh. Fiz.*, Jan. 1951, Vol. 21, No. 1, pp. 77–91.) Range and scale-linearity of valve voltmeters are improved by the use of negative feedback. A detailed theoretical discussion of the operation of the voltmeter is presented, followed by a report on an experimental investigation confirming the theoretical findings. Two alternative circuits are described and design details are considered. The various advantages of this type of voltmeter are enumerated. In addition to those already mentioned, they include: all-mains supply; great stability; very high input impedance; very long life of the measuring valve, owing to the considerable reduction in the filament voltage; simplicity in production and operation; small weight and overall dimensions.
- 621.317.755.087.5 2768
The Speed of Recording of Cathode-Ray Traces by External Photography.—V. P. Shasherin. (*Zh. tekh. Fiz.*, Jan. 1951, Vol. 21, No. 1, pp. 92–103.) An attempt is made to provide a theoretical basis for determining the maximum speed of recording. The main factors involved are the conditions under which the oscillograph is used, the conditions under which the photographs are taken, the inertia of the c.r.o. screen, the method of scanning, and the characteristics of the photosensitive layer of the negative. Each of these factors is discussed in detail and formulae are derived taking them into account. Some experimental data are also given.
- 621.317.763 : 621.396.615 2769
Two 'Grid Dip' Oscillators.—C. Guilbert. (*Toute la Radio*, March/April 1951, No. 154, pp. 82–87.) Description, with full constructional details, of two small valve-oscillator wavemeters. One uses a single 'magic-eye' valve for both oscillator and indicator and covers the range 3.3–95 Mc/s. The second has a normal indicating instrument and covers the range 3.4–250 Mc/s.
- 621.317.772.089.6 2770
Precision Calibrator for L.F. Phase-Meters.—M. F. Wintle. (*Wireless Engr*, July 1951, Vol. 28, No. 334, pp. 197–208.) The calibrator provides a fixed-phase reference output and a calibrated variable-phase output; to improve accuracy, the phase shifting is performed at a harmonic of the output frequency and the output is taken after frequency division. Details are given of the master oscillator, the main phase-shifting control, the frequency dividers and selective amplifiers, together with examples of calculation of typical component values.
- 621.317.784 2771
Absolute Measurement of Microwave Power in Terms of Mechanical Forces.—A. L. Cullen. (*Nature, Lond.*, 19th May 1951, Vol. 167, No. 4255, p. 812.) A radiation-pressure method is described for measuring the power in a low-loss cavity. Fox's rotary phase shifter (1255 of 1948) can be adapted to measure power absolutely without introducing reflection effects in the cavity.
- 621.385.001.4 2772
Valve Testing Methods and Apparatus of the French P.T.T. Administration.—M. Ganet. (*Câbles & Transmission, Paris*, Jan. 1951, Vol. 5, No. 1, pp. 68–75.) A description of factory test methods and apparatus ensuring the reliability and uniformity of valves supplied in bulk for use in telephone and telegraph line repeaters.
- 621.385.001.4 2773
Radio Valve Life Testing.—R. Brewer. (*Proc. Instn elect. Engrs*, Part III, July 1951, Vol. 98, No. 54, pp. 269–274.) Valve failure may be due to emission failure or to mechanical or electrical defects. The prediction of life is usually based on sample testing. The tests made may be for the purpose of quality-control, pilot-production, type establishment or special applications, and vary accordingly. Sampling and test procedures and suitable equipment are described. Evidence from life-tests is summarized, and possible ways of speeding up procedure are outlined.
- 621.396.611.21 2774
The Measurement of the Amplitude of Oscillation of Quartz Crystals by the Interference Method.—L. N. Borodovskaya & A. E. Salomonovich. (*Zh. tekh. Fiz.*, Feb. 1951, Vol. 21, No. 2, pp. 221–224.) The method was used for measuring the oscillation amplitude of quartz crystals oscillating longitudinally, and for determining the relation between this amplitude and the voltages applied to or taken from the crystal. The theory of the method and the experimental results are discussed.
- 621.396.612.7.029.64 2775
A Spark Transmitter for Lightly Damped Centimetre Waves of Continuously Variable Frequency.—H. Anders. (*Z. Phys.*, 29th Jan. 1951, Vol. 129, No. 1, pp. 45–55.) A Hertzian dipole oscillator inside an almost closed cavity resonator is used as a continuously tunable generator over the 1–3-cm waveband. Since this arrangement produces a spectrum of oscillations, the radiation is passed through a second resonator whose spectrum coincides with that of the first at only one frequency. A nearly monochromatic radiation results, with intensity

adequate for measurement purposes and a logarithmic decrement of the order of 0.01.

621.396.615.015.7 **2776**
Narrow-Pulse Generator.—S. F. Pearce & D. C. G. Smith; C. S. Fowler. (*Wireless Engr.*, July 1951, Vol. 28, No. 334, pp. 225–226.) Further discussion of the difference between the measured and theoretical pulse lengths as described in 694 of March (Fowler). The discrepancy is ascribed to the finite operating time of the thyatron.

621.396.645.35 : 621.383 **2777**
A High-Sensitivity All-Mains Amplifier for Photocell Measurements.—H. Tronnier & H. Wagener. (*Funk u. Ton*, Jan. 1951, Vol. 5, No. 1, pp. 1–4.) Modifications which improve the stability of the Etzold-type circuit (1324 of 1948) are discussed. The circuit described includes additional voltage stabilizers and two barretters, one to prevent overloading the main stabilizer, the other in the heater supply to the measurement circuit.

621.397.6.001.4 **2778**
Simple Test Generator for Television Sets using 441 and 819 Lines.—J. Bergonzat. (*TSE pour Tous*, March 1951, Vol. 27, No. 269, pp. 120–122.) Apparatus providing a test signal for adjusting and demonstrating television sets consists of a Colpitts oscillator generating frequencies from 40 to 60 Mc/s. The various signals required to give a square-grid display are formed in four multivibrators. The circuit diagram, with component values, is given.

OTHER APPLICATIONS OF RADIO AND ELECTRONICS

522.615 : 522.2 **2779**
Servo Guider for Solar Telescopes.—F. E. Fowler & D. S. Johnson. (*Electronics*, May 1951, Vol. 24, No. 5, pp. 118–122.) Circuits incorporating photocells are used to correct the telescope direction for both hour-angle and declination errors.

538.563 : 621-526 **2780**
Phase-Sensitive Detector Circuit having High Balance Stability.—N. A. Schuster. (*Rev. sci. Instrum.*, April 1951, Vol. 22, No. 4, pp. 254–255.) High stability of the detector balance, of great importance, e.g., in measurements of nuclear resonance, where signal noise ratio is low and an hour or more is required for signal measurements, is here achieved by using only one valve for the signal input, and switching its plate load by means of the reference signal.

621.316.7.076.7 **2781**
Improving Industrial Control Design.—E. H. Vedder. (*Electronics*, May 1951, Vol. 24, No. 5, pp. 104–106.) Based on a paper given in full in *Proc. Nat. Electronics Conference, Chicago, 1950*, Vol. 6, pp. 471–479. Differences between requirements for industrial electronic apparatus and those for receivers are indicated; long valve life and high reliability are important.

621.316.7.076.7 **2782**
The Electro-analogue, an Apparatus for Studying Regulating Systems: Part 1—Components and Functions.—J. M. L. Janssen & L. Ensing. (*Philips tech. Rev.*, March 1951, Vol. 12, No. 9, pp. 257–271.) A universal model, constituted by a network, representing the process to be regulated is combined with another model for the automatic controller, which may act continuously or discontinuously. Oscillograms of typical response functions are given.

621.317.083.7 : 621.396.621 **2783**
Linear Discriminator for F.M. Telemetering.—G. S. Sloughter & R. T. Ellis. (*Electronics*, June 1951, Vol. 24, No. 6, pp. 113–115.) An asymmetrical flip-flop circuit is used to provide a stable f.m. discriminator for deviation ratios from zero to $\pm 20\%$, with subcarrier frequencies between 400 c/s and 70 kc/s. The discriminator is linear to within 1% over a deviation range of $\pm 7.5\%$. The particular application described is for the ground recording of flight characteristics of aircraft.

621.317.083.7 : 621.396.621.015.7 **2784**
Pulse-Width Discriminator.—A. A. Gerlach & D. S. Schover. (*Electronics*, June 1951, Vol. 24, No. 6, pp. 105–107.) Description of a simple high-stability pulse-width discriminator, handling pulses between 20 and 100 ms wide, used for channel identification at the receiving end of a 3-channel telemetering system with pulse-width channel coding. Using pulse widths of 30, 60 and 90 ms respectively a tolerance of ± 5 ms was satisfactory in the presence of noise.

621.365.029.63 : 537.523.5 **2785**
The Electronic Torch and Related High Frequency Phenomena.—J. D. Cobine & D. A. Wilbur. (*J. appl. Phys.*, June 1951, Vol. 22, No. 6, pp. 835–841.) Description of an electronic torch operating at 1 kMc/s, and of some of the characteristics of the gaseous discharge produced. Power from a magnetron is coupled into a cavity, in turn coupled to a coaxial line through which gas is passed and which is terminated by the torch section. The flame produced by polyatomic gases is capable of melting many refractory materials, due to the heat of association of the dissociated molecules. For a shorter account see *Electronics*, June 1951, Vol. 24, No. 6, pp. 92–93.

621.365.54+ **2786**
R. F. Induction Heating of Materials.—M. Krüger & A. Koppenhöfer. (*Elektron Wiss. Tech.*, Feb./March 1951, Vol. 5, Nos. 2/3, pp. 35–44.) A survey of the principles and apparatus used, with indication of specific applications.

621.383.001.8 : 621.798.4 **2787**
New Photoelectric Register Controls.—G. M. Chute. (*Electronics*, May 1951, Vol. 24, No. 5, pp. 92–97.) Description of three circuits for controlling packaging machinery. Thyratrons are used for feeding the correcting motor, and a three-photocell arrangement for obtaining high accuracy of register control.

621.384.6 **2788**
An Electronic Ram.—W. Raudorf. (*Wireless Engr.*, July 1951, Vol. 28, No. 334, pp. 215–221.) A simple method for accelerating electrically-charged particles is suggested, based on the transfer of the energy of a moving electric charge to a small fraction of that charge. A tubular arrangement is described in which the axial velocity of an electron beam is controlled by a longitudinal magnetic field. An extremely short and powerful e.m. pulse is generated.

621.384.6 **2789**
Cyclic Accelerators.—J. H. Fremlin & J. S. Gooden. (*Rep. Progr. Phys.*, 1950, Vol. 13, pp. 295–349.) A review of the development of the more important particle accelerators requiring magnetic fields to control the particle orbits, with a discussion of the applications for which each is economically best suited.

621.384.612.2+ **2790**
The Synchrocyclotron at Amsterdam.—F. A. Heyn. (*Philips tech. Rev.*, March 1951, Vol. 12, No. 9, pp. 241–

256.) General description of the installation, with its oscillator and modulator, which produces, in continuous operation, deuterons with an energy of 28 MeV.

621.385.3 : 578.08 **2791**
Wide Range Mechano-Electronic Transducer for Physiological Applications.—S. A. Talbot, J. L. Lilienthal, Jr., J. Beser & L. W. Reynolds. (*Rev. sci. Instrum.*, April 1951, Vol. 22, No. 4, pp. 233-236.) A modified version of the RCA 5734 triode described in 3413 of 1947 (Olson) is used to measure forces of 100 mg 25 kg.

621.385.83 **2792**
Energy Loss from Fast Electrons on passing through Foils (Multiple Scattering).—W. Schultz. (*Z. Phys.*, 28th April 1951, Vol. 129, No. 5, pp. 530-546.)

621.385.833 **2793**
Theory of the Independent Electrostatic electron Lens with Elliptical Central Electrode.—E. Regenstreif. (*C. R. Acad. Sci., Paris*, 21st May 1951, Vol. 232, No. 21, pp. 1918-1920.) Explicit formulae are established for the gaussian trajectories in such a lens.

621.385.833 **2794**
Trajectories of Charged Particles Deflected Slightly from the Original Direction by an Electrostatic Field.—B. M. Rabin & A. M. Strashkevich. (*Zh. tekhn. Fiz.*, Oct. 1950, Vol. 20, No. 10, pp. 1232-1240.) Equations are derived determining the trajectories of the particles. Using these equations it is possible to investigate the electrooptical properties of focusing and deflecting systems in three dimensions.

621.385.833 **2795**
The Optical Strength of Short Electron Lenses.—O. I. Seman. (*Zh. tekhn. Fiz.*, Oct. 1950, Vol. 20, No. 10, pp. 1180-1193.) It is shown that in determining the focal length of an electrostatic electron lens from the usual formula (1) an error as large as 100% may be introduced. More accurate formulae (8) and (21) are derived. The error introduced in determining the focal length of a magnetic lens from the usual formula (2) is also estimated.

621.385.833 : 537.533.72 **2796**
The Significance of the Concepts 'Focus' and 'Focal Length' in Electron Optics, and Strong Electron Lenses with Newtonian Image-Formation Equation: Part 2.—W. Glaser & O. Bergmann. (*Z. angew. Math. Phys.*, 15th May 1951, Vol. 2, No. 3, pp. 159-188.) Continuation of 2505 of October.

621.387 : 621.396.645.35 **2797**
Improved D.C. Amplifier for Portable Ionization Chamber Instruments.—N. F. Moody. (*Rev. sci. Instrum.*, April 1951, Vol. 22, No. 4, pp. 236-239.) The requirements of zero stability, adequate overall gain and low battery consumption are reconciled by the use of a two-stage reflex amplifier circuit. The anode load of the first (electrometer-valve) stage is returned to the screen grid of the second valve, a pentode cathode follower. The two stages are effectively cascaded, and a voltage gain > 100 can readily be attained.

621.398 : 621.396.61 **2798**
A General-Purpose Remote Control System for Radio Transmitters.—V. J. Tyler. (*Marconi Rev.*, 2nd Quarter 1951, Vol. 15, No. 101, pp. 61-81.) The general requirements of remote-control systems using land-lines are discussed and the advantages of a standard design having wide applicability are indicated. A brief description is given of a system which has been adapted for the

control of three widely different transmitters, viz. a small communications transmitter, a pair of large broadcasting transmitters, and an aircraft navigation aid beacon transmitter.

PROPAGATION OF WAVES

- 538.566 + 621.396.11 **2799**
U.R.S.I.-I.R.E. Spring Meeting, Washington, D.C., April 16-18, 1951.—(*Proc. Inst. Radio Engrs.*, June 1951, Vol. 39, No. 6, pp. 716-720.) Summaries are given of the following papers:
1. Recent Mathematical Developments in the Theory of Tropospheric Propagation.—B. Friedman.
 4. Air-to-Air Tropospheric Radio Propagation.—G. B. Fanning & F. P. Miller.
 5. The Effect on Propagation of an Elevated Atmospheric Layer of Nonstandard Refractive Index.—L. H. Doherty.
 6. Experimental Discrimination of the Factors in V.H.F. Radio Wave Propagation.—A. W. Straiton & C. W. Tolbert.
 7. Some Characteristics of 92.9-Mc/s Propagation observed at a Distance of 127 Miles.—R. J. Wagner, Jr.
 10. Dispersion of F_2 -Layer Critical Frequencies.—M. L. Phillips & H. S. Moore.
 11. Fluctuation of F_2 Region between Stations separated by 100 to 150 Miles.—H. W. Wells.
 12. Angle of Arrival and Polarization at Fort Chimo.—J. E. Hogarth.
 13. Use of Long-Distance Back-Scatter to Determine Skip Distance and Maximum Usable Frequency.—W. Abel.
 14. Application of Punch Cards to the Analysis of Multipath Ionospheric Pulse Propagation Records.—W. C. Moore.
 19. Wave Propagation over Rough Surfaces.—W. S. Ament.
 20. Simultaneous Mobile Measurement of the Field Strengths of Two V.H.F. Radio Stations over Irregular Terrain.—R. S. Kirby.
 21. Suppression of Waves by Zonal Screens.—H. E. Bussey.
 22. The Effect of Low-Level Atmospheric Conditions on Overwater Interference Patterns at Microwave Frequencies.—V. R. Widerquist & J. E. Boyd.
 23. V.H.F. Tropospheric Recording Measurements of Plane and Circular Polarized Waves in the Great Lakes Area.—J. S. Hill & G. V. Waldo.
 25. The Measurement of the Polarization of Ionospheric Reflections at Low Frequencies.—R. A. Helliwell, A. J. Mallinckrodt, D. A. Campbell & W. Snyder.
 26. Theoretical and Experimental Investigation of the Polarization of Long Waves reflected from the Ionosphere.—J. M. Kelso & H. J. Nearhoof.
 27. Polarization Measurements of Low-Frequency Echoes.—E. L. Kilpatrick.
 28. A Method for obtaining the Wave Solutions of Ionospherically Reflected Long Radio Waves, including All Variables and their Height Variation.—J. J. Gibbons & R. J. Nertney.
 34. Very-High-Frequency Propagation in the Equatorial Region.—O. P. Ferrell.
 36. A V.H.F. Propagation Phenomenon associated with the Aurora.—R. K. Moore.
 37. Phase Velocity of Vertically Polarized Electromagnetic Waves in the Diffraction Region at the Surface of a Sphere.—H. Lisman.
 39. Electromagnetic Energy Density and Flux.—C. O. Hines.

538.566

The Radiation from a Magnetic Dipole in a Spherically Stratified Atmosphere.—G. Eckart. (*Arch. elekt. Übertragung*, March 1951, Vol. 5, No. 3, pp. 113–118.) German version of 2009 of 1950.

2800

621.396.11 + 621.396.671

Application of the Compensation Theorem to Certain Radiation and Propagation Problems.—Monteath. (See 2648.)

2801

621.396.11

The Diurnal Variation of Signal Propagation [time] and Frequency between America and Europe.—A. Stoyko & N. Stoyko. (*C. R. Acad. Sci., Paris*, 16th May 1951, Vol. 232, No. 20, pp. 1817–1818.) A study involving 6 000 recordings was made of the reception at Paris of time signals from Annapolis (NSS, 23.75 m) over the period 1944–1949. Variation of propagation time with hour of day was observed, signals arriving in the morning and evening taking less time than those in the middle of the day. Recordings of signals from WWV show diurnal variations of received frequency with higher values during the hours 0500–1500 U.T. than during the rest of the day. The contradiction between these two sets of results is removed if it is assumed that the number of hops in the propagation path changes suddenly when the F_1 layer reaches a certain height; this assumption is supported by angle-of-arrival observations.

2802

621.396.11

Variation of the Velocity of Propagation of Radio Waves.—A. Stoyko. (*C. R. Acad. Sci., Paris*, 21st May 1951, Vol. 232, No. 21, pp. 1916–1918.) Recordings of time signals from Annapolis at Paris, and from Pontoise at Washington, during the period 1944–1949 yield a value of 271 317 km/s for the apparent velocity, as against the value of 290 000 km/s deduced from observations of round-the-world signals. The relation between propagation time and sunlit length of path is investigated, and observations of s.w. reception recorded during 1931–1939 are re-examined, taking this relation into account; another mean value of 273 000 km/s is obtained for the apparent velocity. It is concluded that the apparent velocity of s.w. signals in the ordinary case is less than for round-the-world signals, and is variable.

2803

621.396.11 : 531.74

A Phase-Comparison Method of Measuring the Direction of Arrival of Ionospheric Radio Waves.—W. Ross, E. N. Bramley & G. E. Ashwell. (*Proc. Instn. elect. Engrs*, Part III, July 1951, Vol. 98, No. 54, pp. 294–302.) The apparatus described uses two pairs of spaced, coaxial loop aerials at a separation of 100 m. "The signals from the aerials in a pair are amplified by means of matched receivers. The phase difference between the output signals from these receivers is displayed direct on a c.r. tube as the angle of inclination of the trace. With pulsed signals emitted from a suitable transmitter and with corresponding timing equipment in the receiver, the individual rays making up the total ionospheric signal may be separated from each other. The apparatus covers the frequency band 4–15 Mc/s, and the r.m.s. error of phase measurement is about 1°. Site errors, however, set a more severe limit to the accuracy of the directional measurements than do instrumental errors, and in practice it is found that, for example, over an oblique path corresponding to a range of 700 km, bearings can be measured with an accuracy of about 1° while the angle of elevation can be measured with an accuracy better than about 1½° so long as it exceeds 30°. These limitations mean that angles of elevation of E-layer reflections cannot be measured accurately at long range; it is possible, however, to obtain measurements of useful accuracy of

2804

the angle of elevation of F-layer reflections at ranges up to 1 000 km or more. Bearings can be measured accurately at all ranges and for all reflections."

621.396.11 + 538.566] : 550.38

The Effect of the Earth's Magnetic Field on Short-Wave Communication by the Ionosphere.—G. Millington. (*Proc. Instn. elect. Engrs*, Part III, July 1951, Vol. 98, No. 54, pp. 314–319.) Digest of I.E.E. monograph. A re-presentation of the magneto-ionic theory for oblique transmission through the ionosphere. The quartic equation of the theory is solved graphically, and simple expressions are derived, by the method of stationary phase, for the differential coefficients for the group time, lateral deviation and specific attenuation of the ray path. Numerical integration along the path is discussed with special reference to the relation of oblique to vertical transmission, and some preliminary results are given.

2805

621.396.11 : 550.38

Relation between the Earth's Magnetism and the Propagation of Radio Waves between Washington and Bagnaux.—P. Lejay, J. M. Ardillon & G. Bertaux. (*C. R. Acad. Sci., Paris*, 28th May 1951, Vol. 232, No. 22, pp. 1975–1976.) Records of reception from WWV made at the Laboratoire National de Radioélectricité have been studied in conjunction with records from the magnetic observatory at Chambon-la-Forêt; close correlation is established between received field strength and magnetic activity. Graphs for February and July 1950 show that the ionospheric disturbances, as indicated by reduced field strength, last for several days after the end of the magnetic disturbances, both in winter and summer. For weak magnetic disturbances the field-strength fluctuations on 15 and 20 Mc/s are parallel in winter but opposed in summer; this difference is attributed to a reduction of m.u.f. The results are supported by observations of WWV 10-Mc/s transmissions made at Turin.

2806

621.396.11 : 550.385

Enhanced Trans-equatorial Propagation following Geomagnetic Storms.—O. P. Ferrell. (*Nature, Lond.*, 19th May 1951, Vol. 167, No. 4255, pp. 811–812.) Radio-amateur reports of abnormal communication in the 6-m band during 1949 show that maximum usable frequencies are abnormally high during or immediately following the longer magnetic storms. The equatorial positive phase (891 of 1950) may continue for up to one day after the end of the storm.

2807

621.396.11 : 551.510.535

The Mechanism of F-Layer Propagated Back-Scatter Echoes.—A. M. Peterson. (*J. geophys. Res.*, June 1951, Vol. 56, No. 2, pp. 221–237.) U.R.S.I.-I.R.E. 1950 Meeting paper. The results of multifrequency observations agree with theory if scattering is assumed to occur at the earth's surface rather than in the E region. The leading edge of the scatter echo corresponds to energy returned from beyond the edge of the skip-zone, while energy from the skip-zone edge returns with greater delay, the time-difference becoming larger as the F-layer vertical-incidence critical frequency is approached. The rapid build-up of echo amplitude which follows a sharply defined minimum time-delay is explained as a focusing phenomenon.

2808

621.396.11 : 551.510.535

Change in the Nature of Medium-Wave Propagation at Sunset.—J. Houtsmuller. (*Tijdschr. ned. Radiogenoot.*, March 1951, Vol. 16, No. 2, pp. 85–114. Discussion, pp. 115–116.) Investigations made under the auspices of the International Broadcasting Organization during the latter part of 1947 are reported; they provide important information regarding the influence of soil conditions at

2809

transmitter, receiver and—in the case of double-hop transmissions—earth reflection point, and regarding the dependence of ionosphere properties on the sun's position. The observations indicate that electrons recombine not only with positive ions but also with neutral atoms and molecules.

621.396.11 : 551.594.5 **2810**
Radio Observations of the Aurora on November 19, 1949.—Gerson. (See 2716.)

621.396.11.029.6 **2811**
A Study of Tropospheric Scattering of Radio Waves.—A. W. Straiton, D. F. Metcalf & C. W. Tolbert. (*Proc. Inst. Radio Engrs*, June 1951, Vol. 39, No. 6, pp. 643–648.) The following results substantiating the scattering theory of Booker & Gordon (1757 of 1950) were observed at frequencies in the neighbourhood of 100 Mc/s: (a) at great distances, for horizontal polarization, energy was received over a considerable range of elevation angle for weak signals but was restricted to the horizontal direction for strong signals; (b) while for vertically polarized waves attenuation with distance agreed with the refracted-wave theory, for horizontally polarized waves attenuation was less than expected. At about 9 kMc/s the cone of received energy was restricted to a few degrees above the horizon, again in conformity with the scattering theory.

621.396.81 **2812**
Prediction of Short-Wave Propagation Conditions based on Ionosphere Observations.—K. Rawer. (*Arch. elekt. Übertragung*, April 1951, Vol. 5, No. 4, pp. 154–167.) A survey is given of methods practised by the French government service. The upper and lower propagation frequency limits, as determined respectively by ionosphere penetration and D-layer absorption, are discussed and their relation to propagation path examined. The methods of ionosphere prediction take account of geographical position, daily and seasonal variations, and sunspot cycle. 40 literature references are included.

621.396.81 **2813**
Sunspots or Position of the Sun?—R. G. Sacasa. (*Rev. Telecomunicacion, Madrid*, June 1950, Vol. 5, No. 20, pp. 11–22.) N.B.S. predictions are compared with those made by the method of 2614 of 1950. Graphs of field strength at Madrid of 10-, 15- and 20-Mc/s transmissions from Washington for Jan. 1949 and Jan. 1950 are given.

621.396.81.029.6 **2814**
Predicting Performance of U.H.F. and S.H.F. Systems.—E. A. Slusser. (*Electronics*, June 1951, Vol. 24, No. 6, pp. 116–121.) Aids provided to simplify signal-strength calculations for u.h.f. radiating systems, for a wide range of conditions, include nomograms for (a) the power gain of aerial systems, (b) field strength as a function of distance, frequency and aerial constants, (c) spatial attenuation between given aerials, (d) effect of ground reflections, (e) calculation of optical and radio horizons, Fresnel zone radii and shadow losses. Receiver noise and atmospheric absorption are considered and a detailed example of the calculations for a complete system is given.

621.396.812 : 551.510.535 **2815**
Fading of Short Wireless Waves due to the Interference between the Magneto-ionic Components.—S. N. Mitra. (*Indian J. Phys.*, May 1950, Vol. 24, No. 5, pp. 197–206.) Periodic fading of a downcoming wave may be due to interference between the two magneto-ionic components when the difference between their equivalent heights of reflection is changing at a uniform rate. A twin-loop aerial system that accepts only one of the components is described. Its use in investigations of this type of fading

is illustrated, and the effect of ionospheric irregularities with random motion and with steady drift is discussed. See also 442 of 1950.

621.396.812.3 **2816**
Comparison of Field-Strength Fluctuations of the Swiss Broadcasting Stations in the First Fading Zone.—C. Glinz. (*Tech. Mitt. schweiz. Telegr.-Teleph. Verw.*, 1st Jan. 1951, Vol. 29, No. 1, pp. 1–25.) The measurements made at St. Gall on transmissions from Beromünster, reported in 2036 of 1949 (Gerber & Werthmüller), are compared with measurements for the Sottens and Monte Ceneri stations over the period 1936–1950. The seasonal variations of amplitude for Sottens are in phase with those for Beromünster, while those for Monte Ceneri are opposed in phase. For all three stations the amplitude of fluctuation varies inversely as sunspot activity. The results are used to calculate the absorption in the D layer, shown in graphs. Stratification of the E layer is discussed. Correlation of the results with variation of the s.w. attenuation/frequency curve for different values of sunspot activity is attempted, but cannot be accomplished without knowledge of the nocturnal critical frequencies of the lowest ionosphere layers. After March 1950, when the wavelength of Monte Ceneri was changed from 257 m to 339 m, the field-strength fluctuations for this station resembled those for Beromünster.

RECEPTION

621.396.621 **2817**
Up-to-Date High-Fidelity Receiver: Cathode-Coupled Frequency Changer.—J. Kousseau. (*TSF pour Tous*, March 1951, Vol. 27, No. 269, pp. 112–113.) Certain modifications to the receiver described earlier (982 of April) are explained and the advantages of using separate valves for frequency changer and oscillator, with cathode coupling, are discussed in detail; circuits and component values for use with various valves are given.

621.396.621 **2818**
The T.R.153 [receiver].—B. Morisse. (*Toute la Radio*, Feb. 1951, No. 153, pp. 56–59.) Description of a high-quality broadcast receiver, incorporating the cathode-amplifier circuit [78 of January (Parry)] in the audio amplifier.

621.396.621 : 621.396.615 **2819**
A High-Stability Directly-Calibrated Oscillator.—G. L. Grisdale. (*Marconi Rev.*, 2nd Quarter 1951, Vol. 15, No. 101, pp. 89–96.) The oscillator described was designed for use in a series of communication receivers, and covers the frequency range 2–4 Mc/s. It is hermetically sealed and has a frequency/temperature coefficient $< 5 \times 10^{-6}$ per °C. A direct-reading frequency scale allows accuracy of tuning to within ± 1 kc/s, and the frequency changes by < 1 part in 10^6 for a 1% change in valve anode or filament voltage.

621.396.621 : 621.396.619.13 **2820**
F.M. Demodulation in U.S.W. Broadcasting Receivers.—A. Nowak. (*Telefunken Ztg.* Dec. 1950, Vol. 23, No. 89, pp. 139–153.) Three different methods of demodulation are considered, the discussion being illustrated by reference to the basic circuits of a series of receivers produced by the Telefunken company. The operation of the ratio detector is studied in detail. An expression is derived for the optimum amplitude limiting on which the design of the diode coupling circuit can be based. The effect of adding resistance to the h.f. and d.c. circuits to stabilize the output is discussed. The simpler demodulation method of using an a.m. detector with operating point on the side of the resonance curve is applied in the cheaper receivers.

621.396.621 : 621.396.619.13 **2821**
Commercial U.S.W. Receivers.—G. Vogt. (*Telefunken Ztg.*, Dec. 1950, Vol. 23, No. 89, pp. 155–166.) Requirements for l.f. fidelity, h.f. selectivity and sensitivity in different f.m. receivers for use in re-broadcasting stations are discussed. Performance figures and details are given for four types of receiver. A monitor receiver with frequency range 87–110 Mc/s has an intermediate frequency of 10.7 Mc/s. A general-purpose unit for reception of programmes for relaying has two intermediate frequencies of 16 Mc/s and 4 Mc/s respectively, giving improved selectivity and general performance. Other receivers on this principle are used for multichannel reception, operating on a fixed carrier frequency and incorporating f.m. feedback to the second detector through a phase-equalizing network.

621.396.621 : 621.396.65 **2822**
Design Considerations for a Radiotelegraph Receiving System.—J. D. Holland. (*Proc. Instn elect. Engrs*, Part III, July 1951, Vol. 98, No. 54, pp. 253–262.) Difficulties encountered in the reception of frequency shift and a.m. telegraph signals over radio links are discussed; greater transmission efficiency can be obtained by the former system. Fading and interference affect both systems and give rise to distortion; the three main components of distortion are defined, and bandwidth requirements before and after demodulation discussed. The need for exceptional frequency stability is stressed in relation to the reduction of errors for both methods. Diversity operation is considered, and an a.m. diversity method is described.

621.396.621.5 **2823**
A Dual-Diversity Frequency-Shift Receiver.—D. G. Lindsay. (*Proc. Inst. Radio Engrs*, June 1951, Vol. 39, No. 6, pp. 598–612.) Reprint. See 1761 of 1950.

621.396.622 **2824**
Sensitivity and Operating Condition of Mixing Circuits using Diodes.—H. F. Mataré. (*Arch. elekt. Übertragung*, Feb. & March 1951, Vol. 5, Nos. 2 & 3, pp. 57–66 & 119–124.) Mixing problems in the decimetre-wave region are discussed. On the assumption that the noise is determined mainly in the i.f. stages, a simple circuit is derived for the equivalent noise source, from which the operating condition and corresponding sensitivity can be found. The inherent feedback of the diode is taken into account. The equivalent conversion noise resistance is introduced to explain the behaviour when using harmonics for the mixing step. Transit-time effects are considered. A method is presented for predicting the sensitivity. Calculated values are compared with results measured at a wavelength of 55 cm, and good agreement is found.

621.396.6.8 **2825**
Réception Radiophonique, Parasites (Broadcast Reception, Interference). [Book Review]—Y. Angel. Publishers: Eyrolles, Paris, 1950, 166 pp., 880 fr. (*Ann. Télécommun.*, Feb. 1951, Vol. 6, No. 2, p. 59; *Rev. gén. Élect.*, March 1951, Vol. 60, No. 3, p. 88.) Complementary to an earlier work on broadcast receivers (738 of 1950). This volume deals with interference and its suppression, and aerials and long-distance reception.

STATIONS AND COMMUNICATION SYSTEMS

621.3.015.7(083.7) **2826**
Standards on Pulses: Definitions of Terms — Part I, 1951.—(*Proc. Inst. Radio Engrs*, June 1951, Vol. 39, No. 6, pp. 624–626.) Reprints of this Standard, 51 IRE 20 S1, may be purchased while available from the Institute of Radio Engineers, 1 East 59 Street, New York, at \$0.50 per copy.

621.39.001.11 **2827**
Adaptation of Message to Transmission Line: Part 2 — Physical Interpretation.—B. Mandelbrot. (*C. R. Acad. Sci., Paris*, 28th May 1951, Vol. 232, No. 22, pp. 2003–2005.) A cybernetically reversible complex transmission process is investigated by breaking it down into elementary differentiation and integration processes, corresponding to the quantization of the message into words, followed by its reconstruction. The operation of the system is considered in terms of entropy variations.

621.39.001.11 **2828**
A Functional Equation of Information Theory.—J. Ville. (*Câbles & Transmission, Paris*, Jan. 1951, Vol. 5, No. 1, pp. 76–83.) To estimate the quantity of information delivered by a given source of independent signals of unequal probabilities of occurrence, the 'transmission cost' of each signal is considered. An expression is obtained for the 'transmission cost' of a signal as a function of the number of messages transmitted. The frequencies of occurrence of the signals being known, a minimum 'transmission cost' will be attained when the signals are actually transmitted at these frequencies; the functional equation thus permits calculation of transmission-cost deviation and of its lower limit. For a given occurrence frequency, the amount of information delivered is closely related to its 'transmission cost'; hence an estimate may be obtained which depends not upon the number of possible values ascribable to the signal, but only upon the relative frequencies of these values.

621.39.001.11 : 621.396.619 **2829**
Limited-Spectrum Signals and Modulation Theory.—J. Oswald. (*Câbles & Transmission, Paris*, Jan. 1951, Vol. 5, No. 1, pp. 54–59.) Amplitude modulation may be defined by means of linear 'commutation' operators, which are associated with the product of any function having an integrable square, multiplied by a periodic function of limited bandwidth. By the use of these operators the spectral composition of a signal may be defined for any modulating function of finite bandwidth. Analogous but nonlinear operators may be defined for the case of frequency modulation. See also 210 of January.

621.395.43 : 621.395.822.1 **2830**
Crosstalk in Amplitude-Modulated Time-Division-Multiplex Systems.—J. E. Flood & J. R. Tillman. (*Proc. Instn elect. Engrs*, Part III, July 1951, Vol. 98, No. 54, pp. 279–293.) Mathematical analysis of the crosstalk occurring when energy proper to one channel arrives during the time allocated to another. This may arise from coupling and decoupling circuits, stray capacitance, the use of cable links and low-pass filter networks. Both Fourier analysis and operational calculus are used, and experimental results confirming the analysis are presented. Improvements in crosstalk ratio may be obtained by inductance compensation in amplifiers. When many distorting networks are present, improvement may result from the use of non-rectangular pulses.

621.395.64 **2831**
Portable Repeater used for Broadcast Programmes.—F. A. Peachey, G. Stannard & C. Gunn-Russell. (*Electronic Engng*, May 1951, Vol. 23, No. 279, pp. 162–166.) Describes the principles and details of apparatus used by the B.B.C. for relaying over G.P.O. lines. Equalizers are connected at the input to the repeater amplifier and in its negative feedback path. The complete assembly comprises two equalizer-amplifier units (one spare), one switching, telephone and d.c. testing unit, and batteries.

621.395.66 **2832**
Level Regulation and Telesignalling on the Paris-Brive-Bordeaux-Toulouse Coaxial Cable.—R. Sueur, F. Job &

F. Le Guen. (*Câbles & Transmission, Paris*, Jan. 1951, Vol. 5, No. 1, pp. 40-53.) The system includes both automatic and tele-regulated repeaters, the equipment comprising temperature compensators, voltage-actuated distortion regulators, telecontrol and telesignalling apparatus. Circuit diagrams and explanations of operation are given.

621.396.41

2833

Note on the Coding of a Multiplex Transmission.—F. H. Raymond. (*Ann. Télécommun.*, Feb. 1951, Vol. 6, No. 2, pp. 55-57.) Rules are formulated for deriving arithmetically a series of code numbers corresponding to given combinations of signals in m channels. It is shown that the simplest procedure is to derive the code signals for the m channels of a time-division multiplex system.

621.396.619.13 : 621.317.35

2834

The Component Theory of Calculating Radio Spectra with Special Reference to Frequency Modulation.—N. L. Harvey, M. Leifer & N. Marchand. (*Proc. Inst. Radio Engrs.*, June 1951, Vol. 39, No. 6, pp. 648-652.) To find the response of a filter to a f.m. signal, a vectorial representation of phase is used. On a plane rotating at the filter response frequency a fixed 'filter-response' vector is drawn. The f.m. signal vector rotates relative to this. The instantaneous angular difference between the vectors being θ , it is assumed that the filter current is proportional to the signal and to $\cos \theta$, and that the 'filter-response' vector will adjust its phase to extract maximum energy from the signal during each modulation cycle. The filter current is then calculable, and the results for sinusoidal modulation agree with previous methods of analysis.

621.396.619.13 : 621.396.813

2835

Nonlinear Distortion in Frequency Modulation.—E. Kettel. (*Telefunken Ztg.*, Dec. 1950, Vol. 23, No. 89, pp. 167-174.) Analysis particularly of amplitude distortion in different demodulator circuits and of frequency distortion in the transmission and reception circuits handling the f.m. signal. Theoretical distortion factors for harmonics of different orders are calculated in these cases. The actual distortion effects occurring in practice are due to combination tones, and their relative magnitudes are often measured instead of distortion factor. In f.m. systems the relation between these two factors varies. Methods of distortion measurement for f.m. systems are outlined.

621.396.65

2836

Telecommunication Networks using U.H.F. Radio Links.—L. U. Marin & J. J. R. Moral. (*Rev. Telecommunicacion, Madrid*, June 1950, Vol. 5, No. 20, pp. 23-44.) Part 1 critically surveys the evolution and present-day state of radio-link technique, giving, in tabular form, brief details of 23 existing or projected links. Part 2 makes concrete proposals for the establishment of four links, branching from Madrid, to connect the 20 principal Spanish towns. Frequency modulation is advocated. The method of determining the sites and calculating signal/noise ratio is outlined, with numerical examples in illustration. An estimate is made of the equipment required and the cost of the installation and maintenance of the system.

621.396.65 : 621.394.3

2837

Teletypewriter System using Radio Links (Tor).—H. C. A. van Duuren. (*Tijdschr. ned. Radiogenoot.*, March 1951, Vol. 16, No. 2, pp. 53-67.) A two-way system is described in which, on reception of a mutilated character, the receiver stops operating and the local transmitter signals the fault back to the remote station, the remote receiver actuating its associated transmitter to repeat the message

starting with the mutilated character. A 7-unit code is used for the transmission, with conversion from and to the usual 5-unit code.

621.396.712.029.6(43)

2838

U.S.W. Broadcasting.—H. Bredow. (*Telefunken Ztg.*, Dec. 1950, Vol. 23, No. 89, pp. 123-126.) Advantages of u.s.w. technique are outlined and details of the German network operating in the 90-Mc/s band are shown.

654.01

2839

Optimum Junction Points in Telephone and Communication Networks.—K. Dörr. (*Arch. elekt. Übertragung*, March & April 1951, Vol. 5, Nos. 3 & 4, pp. 125-134 & 197-201.) Vector analysis is used to determine the location of junction points in star and mesh systems so as to give the most economical arrangements. Mechanical projection apparatus is described for dealing with particular problems. Several examples are considered, including the broadcasting of television from aircraft and the location of relay stations in u.s.w. radio link systems.

SUBSIDIARY APPARATUS

621.314.63

2840

Measurement of Characteristics of Rectifier Disks for Different Harmonic Contents.—F. Jerrentrup. (*Z. angew. Phys.*, Jan. 1951, Vol. 3, No. 1, pp. 14-21.) The behaviour of dry rectifiers under different operating conditions is investigated experimentally. Measurement circuits used for operation with steady d.c., pulsed a.c., etc., are shown and the conductance characteristics of Cu_2O , Fe-Se and Al-Se disks are compared. Forward and backward conductance are treated separately. Typical parameters for the 3 types are tabulated.

TELEVISION AND PHOTOTELEGRAPHY

621.397.24

2841

Television Transmission in Local Telephone Exchange Areas.—L. W. Morrison. (*J. Soc. Mot. Pict. Televis. Engrs.*, March 1951, Vol. 56, No. 3, pp. 280-294.) The use of lines for transmitting video signals over short distances between pickup camera, local studio and points on intercity networks is discussed. The physical and electrical properties of the various types of cable and the design and performance of video amplifiers and equalizers now in use are described.

621.397.3.083 : 621.392.53

2842

Storing Video Information.—A. L. Hopper. (*Electronics*, June 1951, Vol. 24, No. 6, pp. 122-125.) A fused silica bar operating on 54 Mc/s is used to provide a delay of 63.5 μs , the time required to scan one television line, thus making possible a comparison of signal amplitudes along adjacent lines. Inclusion of a filter with a frequency response inverse to that of the bar enables the effective pass band to be doubled; a bandwidth of 14 Mc/s at the 3-db points is obtained, the signal/noise ratio exceeding 54 db.

621.397.5 : 535.62

2843

The Physiological Basis of Colour Television.—Y. Le Grand. (*Onde élect.*, April 1951, Vol. 31, No. 289, pp. 173-177.) Physiological considerations suggest that the seeing of colour television depends on the fact that the ability of the human eye to distinguish detail is less when the colour of the picture alone changes than when the level of illumination varies, rather than on the possibility that the resolving power of the eye may be lower in the blue than in the other parts of the visible spectrum.

621.397.5 : 535.623

2844

Field-Sequential Color Companion.—E. Cohen & A. Easton. (*Electronics*, May 1951, Vol. 24, No. 5, pp. 110-

114.) An adapter unit for connection by a lead and plug to the video-stage valveholder of a black-and-white-television receiver, for reception of the C.B.S.-system colour transmissions. Scanning is at 144 frames/s, interlaced, and a three-colour rotating disk is arranged in front of the tube face. Timebase generators, power supplies and motor synchronizing circuits are incorporated.

621.397.5(083.74) **2845**

Conversion of Television Standards.—A. Cazalas. (*Onde élect.*, April 1951, Vol. 31, No. 289, pp. 178-183.) The possibility of using television signals conforming to a first standard to provide a service conforming to another standard is examined. Difficulties arising from modification and mixing of the signals generated, and those due to interlaced scanning and phasing effects are set out. The technique is suggested of using the transmission by the first standard to produce an electrical image on an auxiliary screen, which is then used to produce the transmission conforming to the second standard. Apparatus for achieving this is described.

621.397.6 **2846**

Rack-Mounted Flying-Spot Scanner.—R. L. Kuehn & R. K. Seigle. (*Radio & Televis. News, Radio-Electronic Engng Supplement*, April 1951, Vol. 16, No. 4, pp. 7-9.) Description of self-contained scanning equipment designed for 2 in. \times 2 in. standard slides. Circuit details and block diagrams of the c.r. tube scanner and associated amplifier and photomultiplier units are given.

621.397.6 : 535.88 **2847**

The RCA PT-100 Theater Television Equipment.—R. V. Little, Jr. (*J. Soc. Mot. Pict. Televis. Engrs*, March 1951, Vol. 56, No. 3, pp. 317-331.) Description of commercial equipment.

621.397.6.001.4 **2848**

Simple Test Generator for Television Sets using 441 and 819 Lines.—Bergonzat. (See 2778.)

621.397.61 : 621.396.615.142.2 **2849**

Five-kW Klystron U.H.F. Television Transmitter.—H. M. Crosby. (*Electronics*, June 1951, Vol. 24, No. 6, pp. 108-112.) Description of the G.E. Type Z 1891 klystron, which has an output > 5 kW at frequencies between 475 and 890 Mc/s, and its use in a high-power u.h.f. television transmitter. Using this klystron as video amplifier, a power gain of 50 is obtained, with low noise, over a band of 5 Mc/s with a response flat to within 1 db.

621.397.621.2 : 535.62 **2850**

Constructing the Tricolor Picture Tube.—D.G.F. (*Electronics*, May 1951, Vol. 24, No. 5, pp. 86-88.) The c.r. tube for receivers using the R.C.A. colour-television system is described. Details are given of photoengraving processes suitable for the manufacture of the apertured metal mask and of the method of preparing the stencil for the phosphor-dot screen in accurate alignment with the mask so as to ensure that only the appropriately coloured dots are scanned by any one gun.

621.397.621.2 : 535.88 **2851**

Projection Kinescope 7NP4 for Theater Television.—L. E. Swedlund & C. W. Thierfelder. (*J. Soc. Mot. Pict. Televis. Engrs*, March 1951, Vol. 56, No. 3, pp. 332-342.) The features of this 7-in. 80-kV kinescope include (a) high-efficiency, low-colour-shift, white fluorescent screen; (b) adequate high-voltage insulation; (c) electrostatically focused high-current beam; (d) magnetic deflection through a narrow angle to conserve deflection power and maintain focus over the picture area.

621.397.621.2.001.4 **2852**

Picture-Tube Performance.—K. A. Hoagland. (*Electronics*, May 1951, Vol. 24, No. 5, pp. 123-125.) The current required in the focusing coil of television-receiver c.r. tubes under given pattern conditions is discussed. It is found that wide tolerances are necessary for this current if the position of the aid is defined relative to the tube neck instead of relative to the gun. Corresponding considerations apply in the case of tubes with e.s. focusing. The vertical resolution of picture tubes is also investigated, and on the basis of subjective tests an optimum value is found.

TRANSMISSION

621.316.726 : 621.396.61 **2853**

Communications Technique in French Aviation.—Babin. (*Onde élect.*, April 1951, Vol. 31, No. 289, pp. 161-172.) An account of the methods used for frequency stabilization, both for continuous ranges and for fixed frequency channels. Three distinct techniques for using the stable frequencies generated by quartz oscillators are indicated: the quartz may be used directly, or with the interposition of a discriminator, or with locking of the controlled circuits, as in a multivibrator. Several types of equipment actually in use are described.

621.396.61/62 **2854**

Army Walkie-Talkie in Mass Production.—R. J. (*Electronics*, May 1951, Vol. 24, No. 5, pp. 98-100.) A portable 16-valve f.m. v.h.f. transmitter-receiver giving speech communication over a range of five miles. By use of subminiature valves and Ge diodes the weight and size have been reduced to half that of the equipment used in the 1939-1945 war.

621.396.61 : 534.861 **2855**

Justification for raising the Standard of Broadcast Transmissions.—Beurtheret. (See 2622.)

621.396.61 : 621.396.615.16 **2856**

Specification for U.S.W. F.M. Broadcasting Transmitters set up by the Broadcasting Corporations of the [Western German] Federated Republic.—F. Gutzmann. (*Telefunken Ztg*, Dec. 1950, Vol. 23, No. 89, pp. 127-130.) General discussion of harmonics, interference, modulation, audio frequency range, carrier-frequency constancy, and distortion.

621.396.619.13 : 621.396.615 **2857**

A Simple Method of Producing Wide-Band Frequency Modulation.—H. Rakshit & N. L. Sarkar. (*Indian J. Phys.*, May 1950, Vol. 24, No. 5, pp. 207-222.) Full description of the principles and experimental arrangement including a phase-discriminator a.f.c. system for carrier stability. See 2362 of 1949.

621.396.619.13 : 621.396.615.16 **2858**

The Series of Transmitters for U.S.W. Broadcasting.—W. Burkhardtmaier. (*Telefunken Ztg*, Dec. 1950, Vol. 23, No. 89, pp. 131-138.) Illustrated description of the construction, design and operating characteristics of various transmitter units developed for the German f.m. broadcasting service. The complete installation provides an output of 10 kW in the frequency range 87.5-100 Mc/s. Frequency swing is 75 kc/s at 100% modulation, distortion factor about 1%. The two self-contained preamplifier stages are designed to feed a 60- Ω asymmetric load and can be coupled to an aerial for radiation at powers of 250 W or 3 kW. Specially designed valves are used [see 2872 (Rothe et al.) below]; details are given of the completely enclosed, single-valve construction of the 10-kW stage.