

EXPERIMENTAL WIRELESS & The WIRELESS ENGINEER

VOL. V.

MARCH, 1928.

No. 54.

Editorial.

Potential Difference and Capacity in A.C. Problems.

THE capacity of any conductor is defined as the ratio of its charge to its potential under certain conditions as to other neighbouring conductors; the capacity of a condenser is usually defined as the ratio of its charge to the P.D. between its electrodes.

Both these definitions involve a definition of potential and a rigorous meaning can only be given to them in so far as a rigorous meaning can be given to the definition of potential. Now the P.D. between two points is defined as the work done in transferring unit quantity of electricity from one point to the other. Nothing is said about the path to be followed in making the transfer, because it is assumed that the work done is independent of the path. This assumption is justified in an electrostatic field or in the case of a steady direct current; in such cases the work done in transferring unit charge from one point to another is quite independent of the path followed. This follows from the fact that in such a field, where magnetic fields are either non-existent or unvarying, the resultant work done in moving an electric charge around any closed path, back to the point from which it started, is zero. In other words, the line integral of the electric force around any such closed path is zero. Hence so

long as we are dealing with electrostatic problems or steady current problems, the definitions of potential and capacity are rigorously definite.

As soon as we try to apply these definitions to A.C. problems, however, we get into difficulties. A varying current produces a varying magnetic field, and in such a field the line integral of the electric force around a closed path is not necessarily zero, but is proportional to the rate of change of magnetic flux through the closed path. The result of this is that the work done in transferring unit charge from one point to another—which by definition is the P.D. between the two points—is no longer independent of the path followed by the unit charge. Strictly speaking, the term "Potential Difference" is not applicable to A.C. circuits; it is a term based upon conditions which do not hold in A.C. circuits, and defined in a way which leads to indefinite results when applied to them. This may come as a surprise to many readers, but it is true, and its realisation is of great importance to a proper understanding of the difficulties confronting one in attempts to apply low-frequency methods and formulæ to high-frequency problems. But surely—a reader will object—when it is stated that the P.D. between the terminals of an A.C. generator

is 200 volts, the statement has a definite meaning. To a very high degree of approximation, yes, but rigorously, no, unless the definition of P.D. can be modified.

The reason for the lack of absolute definiteness can perhaps best be appreciated from a consideration of Fig. 1, which represents a portion of an overhead single phase transmission line. To measure the P.D. between the lines at the points *A* and *B*, an electrostatic voltmeter may be connected between the points. In the figure it is shown in three alternative positions, and in a D.C. circuit the reading on the voltmeter would be identically the same in each position. Very accurate observations would show, however, that in the A.C. case the voltmeter reads differently in the three positions, and the reason is obviously due to the E.M.F. induced in the voltmeter wires by the magnetic flux produced by the current in the transmission lines. An attempt to read the P.D. at a distant point on a voltmeter in the power station by means of pilot wires, as is done on D.C. systems, might lead to very wrong results when applied to an A.C. system, unless special precautions were taken. Some reader may say that the obvious thing to do is to connect the voltmeter between the two points by the most direct route. True, but our definition of Potential Difference will then

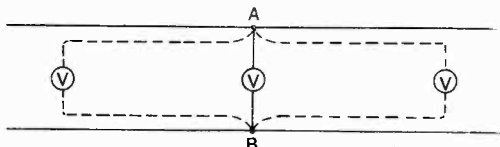

Fig. 1.

have to be modified and defined as the work done in moving unit charge from one point to the other *by the most direct route*. This is good enough for most low-frequency cases, because the differences introduced by any reasonable departure from the most direct route, or by any difference of opinion as to which is the most direct route, are practically negligible.

This is no longer true, however, when applied to radio frequency circuits and the higher the frequency the more indefinite becomes the meaning of the potential difference between any two points.

Fig. 2 represents a circuit in which some A.C. generator *G* is maintaining a high-frequency current. *AB* and *BC* represent inductive coils, and *CD* a piece of wire of negligible resistance. Three alternative positions are shown for a voltmeter connected across *A* and *C* with the object of measuring the P.D. between these two points. Similarly

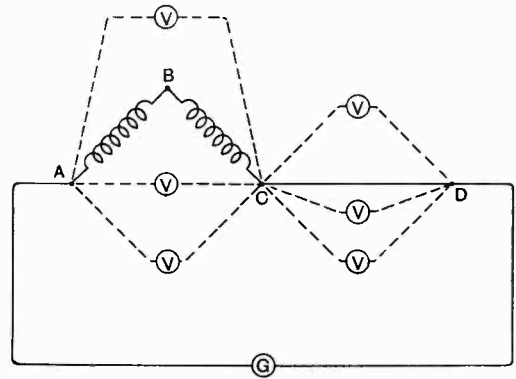

Fig. 2.

three positions are shown for a voltmeter across *C* and *D*. Which route one regards as the most direct in each case is a matter of taste. If the coils are very inductive the reading on the voltmeter across *AC* will vary very little with the position of the voltmeter; it will vary to some extent, however, and no rigorous definite value can be assigned to the P.D. In the case of the voltmeter across the points *C* and *D*, matters are much worse, since large variations in the reading are caused by the movements of the voltmeter, and the closer the voltmeter leads are brought to the most direct route—that is, lying alongside the wire—the nearer will the reading approach zero.

If Fig. 3(a) represents a single phase overhead transmission line on which the points *AB* are a mile distant from the points *CD*, then the fall of potential or the drop per mile is the difference between the P.D. across *AB* and that across *CD*. This would be determined by connecting a voltmeter across *AB* and another across *CD*, in each case by the most direct route. If, for the sake of convenience, however, one were to put the two voltmeters together somewhere midway between *A* and *C* and run long voltmeter wires to the four points, the route followed by the wires would be a

matter of vital importance. This has nothing to do with any current taken by the voltmeters, and we may assume that electrostatic instruments of negligible capacity are employed.

Again, if one assumes that the drop per mile is equally divided between the two wires *AC* and *BD*, whatever that may really mean, we should expect a voltmeter across *AC* to read half the difference between the voltmeters across *AB* and *CD*, but this could only be managed by running the voltmeter leads along a certain route, and that hardly the most direct route.

Fig. 3(b) shows the correct route, and Fig. 3(c) shows a route which would give entirely different results. All these difficulties, which are non-existent in dealing with direct current, arise through the application of the idea of potential difference to cases to which it is, strictly speaking, inapplicable.

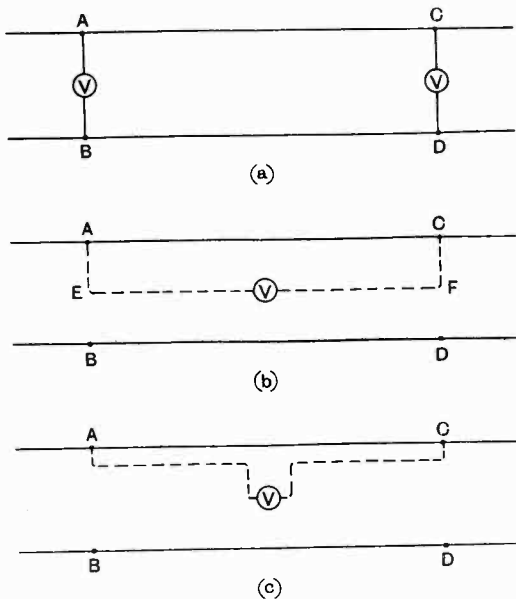

Fig. 3.

In the theory of A.C. transmission lines, one designates by *C* the capacity of the line per unit length. This is by definition the ratio of the charge per unit length to the P.D. between the wires. Is this to be determined under electrostatic conditions or under working conditions? We have seen

that only under electrostatic or steady current conditions can a rigorous meaning be attached to the P.D. between the wires. Even then, however, the P.D. will depend not only on the charge on the unit length considered, but on the charge on the rest of the line, and therefore on its distribution along the line. The usual assumption made is that the line is infinitely long compared with the distance between the wires, and that the charge is uniformly distributed along it. In practice the length of the line is usually very great compared with the distance apart of the wires, and the charge per unit length changes very little over considerable lengths, so that these assumptions are justified. If we attempt to define the capacity under A.C. conditions we immediately meet the difficulty of defining the P.D. between the lines, when they are carrying an alternating current, and although we can get over the difficulty as indicated above by adding the words "by the most direct route" to the definition of P.D., we should not forget that we have thereby done something very different from what we did when we assumed that the line was infinitely long and uniformly charged; those were justifiable assumptions, but this is playing fast and loose with one of the fundamental definitions of electrical theory.

In our opinion it is better to avoid this difficulty by defining the capacity per unit length as that determined under electrostatic conditions from an assumed distribution of charge corresponding as closely as can be predicted to the distribution actually occurring in normal A.C. operation.

In Figs. 1 and 3(a) we agreed that in the presence of alternating currents we should take as the P.D. the work done in moving the unit charge from one point to the other over the most direct route, whereas in Fig. 3(b) we saw that to obtain a consistent result for the P.D. between the points *A* and *C* it was necessary to follow a path which could not be called the most direct. Is there perhaps not something common to both these cases which may throw light on the question as to the proper path to follow in every case? Yes. If the vector potential be found at every point, it will be noticed that the path followed in both cases lies entirely in planes at right angles to the direction of the vector potential or in planes

of zero vector potential. For those not familiar with vector potential we may explain that just as a charge dq produces at a point at distance r a scalar potential dq/r , so an element of conductor of length dl carrying a current i produces at a point at distance r a vector potential $i \cdot dl/r$ in a direction parallel to the current. Just as

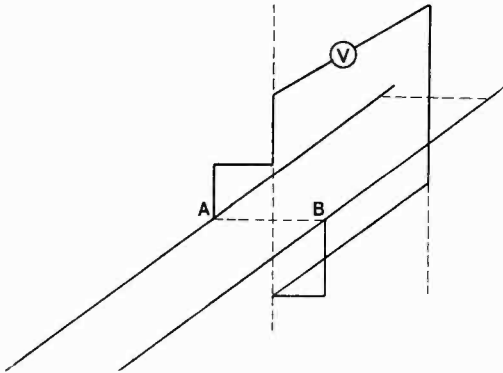

Fig. 4.

the total scalar potential at a point is the algebraic sum of all the component scalar potentials, so the total vector potential is the resultant of all the component vector potentials. In the case of the two parallel wires carrying currents in opposite directions, the vector potential will be necessarily parallel to the wires and will therefore have no component in planes normal to the wires; it will also be zero in the mid-plane all points of which are equidistant from the two wires. In Fig. 1 the voltmeter reading is unaffected by the path followed by the voltmeter leads so long as they remain in the plane through AB normal to the transmission line or in the midplane. Such a path is shown in Fig. 4, in which the voltmeter will read exactly the same as in the mid-position in Fig. 1.

It will be seen that the path followed in Fig 3(b) conforms to this rule; the path can be as long and tortuous as one likes, the voltmeter reading will be unaffected so long as the paths from A to E and C to F remain in their normal planes, and that from E to F in the midplane.

This leads us to modify the definition of the P.D. between two points as the work done in moving unit charge from one point to the other, by adding the proviso that

in the presence of varying currents or varying magnetic fields, the path followed should be either at right angles to the vector potential at every point or in planes of zero vector potential. This is not absolutely essential so long as the resultant line integral of the electric force due to the vector potentials is zero over the total path followed; that is to say the sum total of all the errors introduced by departing from the ideal path must be zero.

This rigorous definition replaces then our rough working rule of following the most direct route, which we found of very limited application.

By calculating the vector potential at every point of the circuit of Fig. 2 one could map out a path from C to D , normal at every point to the vector potential at that point, and then by calculation or measurement could determine the work done in moving unit charge along the path from C to D . This gives us what we must presumably regard as the P.D. between the two points.

The path—or paths, for there are an infinite number of them—gives the position of the voltmeter wires, in order that the instrument may correctly record the P.D. This path encircles just that part of the total magnetic flux which can be regarded as linked with the wire CD . We say advisedly “can be regarded as linked with the wire CD ,” for the whole procedure appears very arbitrary when applied to such a case; it is, however, a necessary corollary to the conception of a P.D. between the points C and D utilised partly in overcoming the ohmic resistance of the wire CD , and partly in overcoming a back $E.M.F$ induced in the wire by a certain fraction of the total magnetic flux which links the circuit.

Since we assume that the path followed is such that the line integral of the electric force due to the vector potential is zero, the

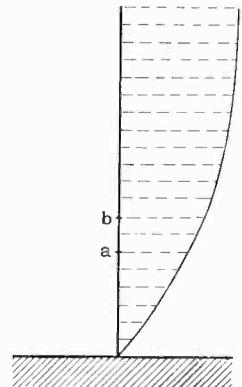

Fig. 5.

P.D. so determined is due entirely to the distribution of electric charge around the circuit at the moment considered. It is the value which would be found whatever the path followed, if we imagine the current to cease, but the charges to remain unchanged, that is, it is the P.D. corresponding to a fictitious electrostatic case.

We now turn to an example of special radio interest. The transmitting aerial is often considered as an example of an A.C. transmission line and an attempt is made to apply the ordinary telephone transmission formulæ to it.

To do this it is necessary to give a value to the capacity per unit length of the aerial wire, and the question arises as to what meaning can be attached to the term in this special case. Let Fig. 5 represent a plain vertical transmitting aerial oscillating at its fundamental frequency, *i.e.*, with a wavelength a little more than four times its height. What do we mean by the capacity of the piece of wire ab , or rather, of this length of the equivalent transmission line? Certainly not the capacity of this piece of wire in the absence of the rest of the aerial.

There are several alternative electrostatic interpretations; for instance, if the aerial were disconnected from the earth and charged to unit potential the charge on the portion ab would be one measure of its capacity; again, if the wire is assumed to be charged uniformly its potential will vary from point to point, and that at ab could be used to calculate its capacity. In operation, however, the aerial is not uniformly charged, nor is it charged to the same potential, but its charge is distributed somewhat as indicated in Fig. 5.

Assuming such a distribution of charge to be possible electrostatically, the potential distribution along the aerial could be calculated, or, on the other hand, assuming the curve in Fig. 5 to represent, as it does approximately, the distribution of potential, the distribution of charge might possibly be determined; either of these purely electrostatic methods would give a result for the capacity of the element ab , but it must not be overlooked that the assumptions are far removed from any possible electrostatic condition. The only way in which the aerial could be given such a charge would be by dividing it up into a number of short

pieces of wire each insulated from the neighbouring pieces.

Any attempt to define the capacity of the element ab under working conditions leads one into great difficulties. One may simplify the problem by assuming a plane earth of infinite conductivity and considering the combination of the aerial and its image as

the two wires of a transmission line with the transmitting station at the earth's surface. The P.D. between a and a^1 will differ from that between b and b^1 , the difference being the drop along the length ab of the combined line, and half the difference the drop along the length ab of the aerial wire. This sounds very simple until one tries to give a definite meaning to the P.D. The work done in moving a unit charge from a to a^1 will differ enormously, depending upon the path followed, due to the

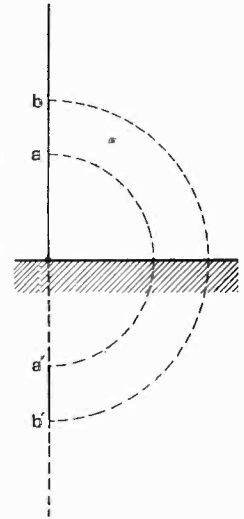

Fig. 6.

rapidly changing magnetic field in the surrounding space. A further difficulty meets us in this case which we have not yet mentioned, and that is due to the fact that the force on the unit charge at any moment is not that calculated from the charges and currents in the aerial at that moment, but allowance must be made for the time taken for the electromagnetic effects to travel from the various parts of the aerial to the point where the unit charge is situated at the moment. This effect, which enormously complicates the problem, is negligible in the cases previously considered, but is by no means negligible in the present case.

After much consideration we have come to the conclusion that it is advisable not to attempt any A.C. definition of the capacity per unit length of the aerial, in the application of the transmission line formulæ, but to calculate the electrostatic capacity on the assumption of a distribution of charge such as shown in Fig. 5, or other distribution, depending on the wavelength employed.

When the capacity per unit length is thus determined for all points along the aerial, the inductance per unit length follows at once from the formula

$$v = \frac{1}{\sqrt{CL}}$$

where v is the velocity of light.

From the assumed distribution of charge the distribution of current can be determined, and from this and the distribution of inductance the voltage along the aerial can be determined by ordinary A.C. methods. This should agree with the voltage distribution calculated electrostatically from the assumed charge. If it does not, the assumed distribution of charge needs correction and the calculation must be repeated.

We have then replaced the actual aerial by a system of inductances and condensers, as shown in Fig. 7, in which the magnetic fields are confined within the inductance coils.

Unfortunately, the magnitude of the condensers and inductances depends on the electrical conditions of the system.

This may not appear to some a very satisfactory method, but it has the important advantage that the capacities, inductances, and potentials involved are all defined in a perfectly definite manner.

The result can only be regarded as an approximation, since the method uses simple devices to solve a very complex problem.

The field of the electrostatically charged aerial would extend indefinitely into space,

whereas in operation the field travels outwards with the velocity of light, and at the moment of maximum charge is confined, so far as it emanates from that charge, to a limited space around the aerial. No method which ignores the finite velocity of

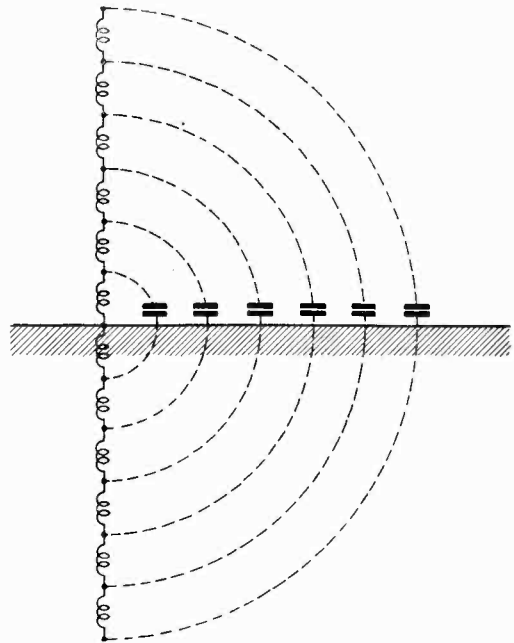

Fig. 7.

the field from the aerial into space can be regarded as more than a rough approximation to the actual problem.

G. W. O. H.

Generalised Theory of Antennæ.

By *Raymond M. Wilmotte, B.A.*

Definitions.

IN the issue of last November there is published a very interesting paper on antennæ by F. M. Colebrook. It was after discussing with him the problems which he had set himself that I tackled them also, freeing them as far as possible from the assumptions of which both he and Moullin* were conscious. The few experiments that I have made justify the theoretical conclusions. In this respect I hope to have completed, or at any rate partly completed, the gaps which Colebrook noted at the conclusion of his paper.

The general problem can be stated as follows: It is required to find how far the effective constants of antennæ used as transmitters and receivers are equal. By constants is meant the reactance, ohmic resistance, radiation resistance, effective height, etc. All these constants need careful definition.

In all forms of electrical measurements it is necessary to have a very clear idea of what is being measured; sometimes the meaning of the quantity being measured is obvious and its value can safely be used for other arrangements of the apparatus or conditions. Very often, however, this is far from being the case. When dealing with antennæ, the exact meaning of a measurement is not usually immediately clear. It becomes necessary, therefore, to define the terms used with considerable care.

In ordinary electrical circuits, the current is usually constant throughout, or very nearly so; this is not the case for antennæ. The circuit appears remarkably simple, being in the main a number of straight lengths of uniform wire. The difficulty arises owing to the fact that the current is not constant, but is continually varying from one end of the antenna to the other.

This being so, the results of any measurement will depend on the position on the antenna of the apparatus used in making

the measurement. That is why the word "effective" was used in connection with the constants of the antenna. It may be generally assumed, unless otherwise stated, that the point at which measurements are made is at the foot, between the antenna and the earth or counterpoise. The values obtained are then stated as though they applied to a simple circuit, in which the current was constant throughout, and equal to the current at the point of measurement; such values are usually called "effective" values. Thus, if the power dissipated in an antenna were found to be W and the current at the base I , the effective resistance would be given as W/I^2 . The same applies for reactance, but in this case there is a further complication, since the reactance of a simple circuit can be made to vary with frequency by suitably adjusting the relation between the inductance and the capacity. The "effective" inductance and "effective" capacity are, therefore, chosen so that the variation of reactance with frequency in the immediate neighbourhood of the frequency used is the same for the equivalent simple circuit and the antenna. It may be of interest to some readers to consider this more fully, and in Appendix I a more detailed consideration is given to this question.

Returning now to the papers of Colebrook and Moullin, we must investigate what were the assumptions made therein. They are quite straightforward and were stated by the authors themselves. They assumed that an antenna behaved as though it had uniformly distributed constants; that is, that the resistance, capacity and inductance were the same per unit length at all points of the antenna. Both Colebrook and Moullin supposed, rightly as I now believe, that in simple antennæ the deviation from this was likely to be small, except perhaps in certain very localised parts of the antenna, such as near the earth end. The assumption cannot, however, be expected to hold for complicated constructions of antennæ.

The first question is: What is meant by capacity and inductance per unit length? The answer to this question is by no means

* "On the Currents induced in a Wireless Telegraph Receiving Antenna," by E. B. Moullin, *Proc. Camb. Phil. Soc.*, Vol. 22, pp. 567-578, 1925.

obvious. We are now dealing with alternating currents; let us, therefore, consider the meaning of these terms from the alternating current point of view only, without any consideration for the present of their electrostatic meaning.

Consider an apparatus *A* at a potential *v* (Fig. 1). Let it have a capacity *C* to earth, then the current *i*₁ entering it will be different from the current *i*₂ leaving it. Using symbolic vector representation, this difference is given by

$$i_1 - i_2 = jvC\omega$$

where $\omega/2\pi$ is the frequency and $j = \sqrt{-1}$.

Hence, as far as alternating currents and potentials are concerned, a capacity is characterised by a change in the current. If the apparatus consists of a unit length of wire, then the admittance of the capacity *C* will be the ratio between the difference in

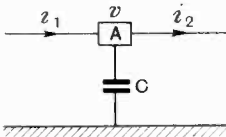

Fig. 1.—Effect of capacity to earth explaining the meaning of capacity per unit length.

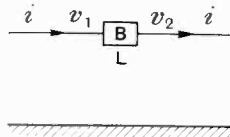

Fig. 2.—Effect of self-inductance explaining the meaning of self-inductance per unit length.

the currents entering it and the potential of the wire. To put this into more mathematical language, the capacity per unit length is given by

$$jC\omega = - \frac{di/dx}{v} \dots \dots (1)$$

From this we can see that the greater the capacity per unit length, the greater the rate of change of current along the wire at the point considered.

With exactly similar reasoning, we can find the meaning of self-inductance per unit length. Suppose the apparatus *B* (Fig. 2) has a self-inductance *L* and no capacity. There will be a difference of potential between one end and the other of the apparatus, and this difference is given by

$$v_1 - v_2 = jiL\omega,$$

where *i* is the current through the apparatus.

A self-inductance is therefore charac-

terised by a change in potential. If the apparatus consists of a unit length of wire, then the reactance of the self-inductance will be the ratio between the difference of potential across it and the current flowing through the wire. Mathematically, this can be written

$$jL\omega = - \frac{dv/dx}{i} \dots \dots (2)$$

This shows that the greater the self-inductance per unit length, the greater the rate of change of potential along the wire at the point considered.

It will be noticed that in the above definitions resistances have been neglected. This has been done purposely in order not to confuse the issue. If there is a resistance from the element of length considered to earth, it should appear on the left-hand side of equation (1). Its effect can, however, be differentiated from the rate of change of the current due to the capacity, since the latter effect is in quadrature to the former. The same applies to the resistance in the element itself, which should appear in the left-hand side of equation (2).

This, however, is not the whole story. In equations (1) and (2) there are two terms whose meaning have been tacitly assumed, namely, the conduction current *i* and the potential *v*. The instantaneous conduction current is not difficult to define as the rate of flow of electricity, but the potential is not so simple.

In electrostatics, the potential at a point is defined as the work done against the electric forces in the medium in bringing a unit electric charge from infinity up to the point considered, and it is found that this is a circuital function, that is, the work done is independent of the path chosen. When, however, there are alternating currents (or currents varying with time in any manner), the electric forces in the medium are no longer only dependent on the distribution of charge, and the work done will depend on the path chosen; it is, therefore, necessary to seek a variation on the electrostatic definition of potential to fit the case when alternating currents are present.

The electric forces in a medium can be considered as the sum of two terms, one due to the distribution of charges and the other due to the distribution of the alter-

nating currents.* It is only the work done against the latter that depends on the path taken; it is, therefore, convenient to define potential as the work done in bringing a unit charge from infinity up to the point considered against the electric forces due to the distribution of charge only.

Neglecting for simplicity the effects of resistance, let us suppose that we know the value of the rate of change of current and potential at any given point as well as the actual value of the current and potential. From equations (1) and (2) we can calculate the value of the "effective" capacity and self-inductance at that point. Consequently, any distribution of current and potential along an antenna will correspond to a certain definite distribution of capacity and self-inductance per unit length. (Any variation in the phase of the current or potential will correspond to resistances.)

The meaning of self-inductance and capacity per unit length should now be clear. This meaning does not necessarily have any relation to the meaning of the terms used in electrostatics, and what this relation is we shall now consider. These definitions may appear to be very artificial and the terms do not lend themselves to our minds for pictorial representation. If, however, their conception is useful, it is sufficient reason for retaining them.

Unfortunately, however, the solution of equations (1) and (2), whatever distribution of capacity and self-inductance per unit length is chosen, will give a result for both the current and the potential distribution, which will depend on the frequency. The values of the constants per unit length cannot, therefore, be expected to be the

same for the electrostatic and the alternating current cases. By how much they differ is the next question to be investigated.

If we consider any element of a conductor, the reason, why the conduction current entering it is different to the conduction current leaving it, is that there is a component of the electric force which is normal to the surface of the element in contact with the dielectric. This component produces what is known as a displacement current and this is equal to the difference between the conduction current entering and leaving the element of the conductor under consideration. Moreover, if this normal component of the electric force were the same in the alternating as in the electrostatic case, the capacity per unit length would also be the same in the two cases.

In the case of an antenna, where the conductor consists of very long thin wires, the electric force due to the alternating currents alone (not the charges) will be mainly parallel to the wires; those components that are normal to the wires will be produced by currents flowing in directions also normal to the wires. It is true that such components may not be negligible, but at points not in the very immediate neighbourhood of bends, since the wire is comparatively thin, the normal electric force due to the conduction current in the direction from the dielectric to the conductor will be negligibly different from that from the conductor to the dielectric. The result is zero and it can be taken that the conduction current produces a negligible displacement current from the surface of the conductor. (This is not true in the neighbourhood of bends, but the effect will be very local.) We can therefore assume that the displacement current from the surface of the conductor is due to the distribution of charge only. There remain two reasons why the capacity per unit length may differ appreciably in the alternating and electrostatic cases. The first is that the reaction of one part of the system of conductors on another does not take place instantaneously, but with the velocity of light, and the second that the distribution of charge is different in the two cases. The first of these reasons will only become of importance at extremely high frequencies as it will only apply to those parts that are at an appreciable fraction of a wavelength away

* It will be evident that an alternating current distribution produces a distribution of charge. Thus, if a current having an instantaneous value i enters an element of length δx and a current $i + \delta i$ leaves it, the charge per unit length δq accumulated in the time δt is given by

$$\delta q = \delta i \cdot \delta t / \delta x.$$

If, now, the current and charge per unit length vary sinusoidally with respect to time and have maximum values I and Q respectively, we can write in vector notation

$$Q = -\frac{I}{j\omega} \frac{dI}{dx} \quad \dots \quad (3)$$

From this equation the charge distribution can be calculated from the current distribution.

from the point considered. The second reason can be discounted only if the distribution of charge in the neighbourhood of the point considered is very nearly the same in the two cases. (It will be noted that it is the distribution and not necessarily the actual value of the charge that must be the same.) This again will hold except at extremely high frequencies. We can assume, therefore, that the capacity per unit length is not equal to but is approximately that measured electrostatically for all cases except at such high frequencies as are not to be encountered even in radio.

Turning our attention to the self-induction per unit length, we know that the difference between the electric force due to the distribution of charge and that due to the distribution of alternating current is equal to the resistance drop Ri . Since the difference of potential has been defined as due to the distribution of charge only, and since for simplicity we are neglecting the effect of resistance, we deduce that the difference of potential along a conductor is due to the electric forces (resolved along the conductor) due to the conduction currents. That is, the potential difference between two points on a conductor is equal to the work done by a unit charge against the electric force due to the conduction currents alone when that unit charge is moved from one point to the other (neglecting the effect of resistance). According to this the self-inductance per unit length will depend only on the distribution of the conduction currents and will be independent of frequency so long as the distribution of current in the neighbourhood of any element considered is sensibly the same at all frequencies. As in the case of charges, this will be approximately so except at extremely high frequencies.

We conclude, therefore, that the self-inductance and capacity per unit length have nearly the same distribution irrespective of the frequency for all practical cases. Moreover, in all cases an antenna, by suitably choosing the distribution of its constants per unit length, can be exactly represented by a system having self-inductances and capacities per unit length as defined by equations (1) and (2), although these self-inductances and capacities will vary slightly with frequency.

It is of interest to note in passing that the

above arguments apply to the ordinary transmission line theory, but in this case the difference between the distribution of the constants in the electrostatic and alternating cases is even closer than in the case of an antenna. The reason for this is that not only is the frequency very much lower, but also the return circuit is very close to the outgoing wire and the two shield each other from the effects of the more distant portions of the line.

Distribution of the Constants in a Simple Antenna.

We shall now consider why the distribution of capacity and self-inductance per unit length cannot be considered rigorously as constant even in a simple antenna consisting of a straight vertical wire.

There are several reasons for this; the first will be obvious from the explanation that has been given in the previous paragraph. If the wire were infinitely long, its static charge per unit length would, from symmetry, be constant, so that its capacity per unit length would also be constant. When the frequency is high, however, the

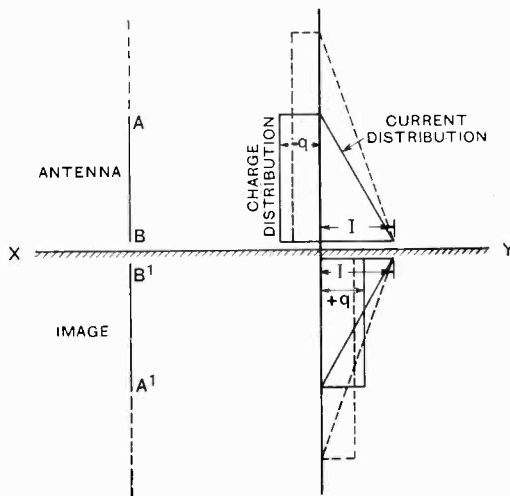

Fig. 3.—Current and charge distribution of a simple antenna.

capacity per unit length will no longer be rigorously the same as the electrostatic capacity; moreover, since the distribution of potential is slightly different with respect to different elements of length, the capacity per unit length will also vary along the wire.

The second reason is that even the electrostatic capacity is not constant per unit length when the length of wire is finite.

Let AB be the antenna (Fig. 3). Let it be given an alternating charge of R.M.S. value $-q$ per unit length as shown. This, from equation (3), is equivalent to an alternating current distribution uniformly decreasing from the value $+I$ at the bottom end B down to zero at the end A . If the earth XY is perfectly conducting, it will be an equipotential surface of zero potential. It is therefore possible to replace the earth by a charge distribution $+q$ per unit length from B' to A' , where $A'B'$ is the exact image of AB in the earth. It only means that the charges induced in the earth by AB are equivalent to the charges on $A'B'$. This representation is a very convenient mathematical dodge known as the "Theory of Images."

The theory of images can be applied to the alternating current in an antenna, for the charge distribution in $A'B'$ corresponds to a current distribution which decreases uniformly from $+I$ at B' to zero at A' . That is, the field and potentials due to the eddy currents in the earth are exactly equal to those induced by the current in $A'B'$.

Let us first consider the end B and find whether the electrostatic capacity is large or small. The effect of the image in the earth is to induce a more positive potential near the end B than near the end A , and this potential will vary rapidly as the end B is approached. In order to keep the potential constant over the whole antenna (as it would be, if the capacity were measured electrostatically) the charge near the end B must be made more negative. This is equivalent to an increase in the rate of change of current and, by definition, to an increase in the capacity per unit length. Hence, near the bottom end B the capacity per unit length is greater than near the centre for low frequencies.

This result may appear obvious, but it gives us the clue for finding the effect near the top end A . Suppose the antenna were continued upwards as shown dotted, the potential at A would be unaffected by the end effects, so that the capacity per unit length would be the same as in the centre. Now, this added portion is inducing a greater

negative potential at A than at B . If, therefore, this portion is removed, in order to retain uniform potential, the charge at A must be made more negative, which, as before, is equivalent to an increase in the capacity per unit length.

The arguments used for both ends are essentially similar. At the end A a negative charge is removed, while at the end B this charge is turned into a positive one. The capacity at B will, therefore, be greater than at A . Qualitatively, therefore, the distribution of current and capacity per unit length will be as shown in Fig. 4.

From this argument it will have become evident that the distribution of capacity is not only dependent on the geometrical shape of the antenna, but also on the frequency.

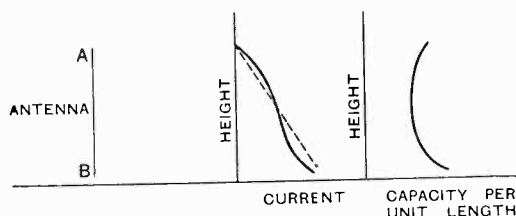

Fig. 4.—Current and capacity distribution in a simple antenna at low frequencies deduced qualitatively.

It would not be difficult to obtain similar conclusions with regard to the distribution of self-inductance, but as the argument is essentially similar to that applied to the distribution of capacity it will not be given.

The Effective Constants of Receiving and Transmitting Antennæ.

These considerations will have shown the importance of obtaining theoretical results which are independent of assumptions regarding the distribution of capacity and self-inductance per unit length along an antenna.

The mathematics is straightforward, but for convenience it is put in Appendix II.

The only assumption made in comparing the constants of an antenna used for transmission and reception is that the distribution of capacity, self-inductance and resistance is the same in both cases. It is therefore necessary to inquire how far such an assumption is justified.

The essential difference as far as the antenna is concerned between reception and

transmission is that the distribution of E.M.F. is different in the two cases. One could expect that the effective constants of a complicated circuit (to which an antenna corresponds) measured at any point might depend on the manner in which the E.M.F. is applied. In Appendix II this is proved not to be so, but only so long as the distribution of E.M.F. does not affect the distribution per unit length of capacity, self-inductance and resistance along the circuit. In an antenna the distribution of the constants per unit length could hardly be expected to be a sharp function of the current distribution; that is, unless the current distribution were totally altered by the change in E.M.F. distribution, the distribution of the constants along the antenna would not be expected to vary very much. (For it is only the variation in the current distribution in the immediate neighbourhood of any point under consideration which will cause an appreciable variation in the constants per unit length at that point.)

Now, since in practice the resistance of any elementary part of an antenna is small compared to the reactance, the potential differences between the various parts will be produced mainly by the reactance, and only to a very small extent by the applied E.M.F., when the antenna circuit is tuned, for the current is then comparatively large. It is not to be expected, therefore, that the current distribution will greatly depend on the distribution of the applied E.M.F., while the distribution of capacity and self-inductance will depend on the E.M.F. distribution to very much smaller extent. The assumption made leaves only second order effects out of consideration, and is a very much closer approximation to the assumption made by Colebrook and Moullin that the constants are uniformly distributed.

In the analysis given in Appendix II, the general case of an antenna having an E.M.F. V applied at the foot as well as a distributed E.M.F. along it is considered. By putting $V = 0$ we obtain the case of a receiving antenna, while, if the E.M.F. distributed along it is put equal to zero, the antenna becomes a transmitting antenna.

If i_0 is the current at the foot of the antenna and there is an impedance Z between the foot of the antenna and the earth, equation (9) of Appendix II shows that we

can write

$$i_0(Z + Z_0) = V + E_0,$$

in which Z_0 is independent of the applied E.M.F.'s and E_0 is independent of the impedance Z .

The antenna circuit can therefore be represented by a circuit such as that shown in Fig. 5. The "effective" impedance of the antenna Z_0 is independent of the applied E.M.F.'s and is, therefore, the same for transmission as for reception. E_0 will be the "effective" E.M.F. of the applied field.

Incidentally this result applies equally well to any form of transmission line.

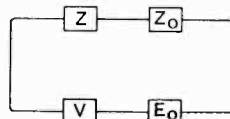

Fig. 5.—Equivalent circuit of an antenna circuit.

The next problem is the comparison of the effective height of the same antenna transmitting and receiving.

The definition of the effective height of an antenna is by no means simple. On Hertz's simple doublet theory, the field strength at any point at a large distance from the antenna is proportional to the strength of the doublet, and inversely proportional to the distance.

Now, an excited antenna can be considered as a series of doublets, and the field strength at any point will be proportional to the sum of the radiations due to the doublets, taking into account the relative phases at which these radiations arrive at the point considered. When the antenna is small compared with the wavelength, the radiations from the various parts of it will arrive substantially in phase,* but when it is comparable or large compared with the wavelength, that will not be so. In this latter case directive effects occur, so that even at large distances from the antenna the radiation will not be the same in all directions; moreover, these directional effects are not necessarily confined to the horizontal plane. Nevertheless, the effective height must bear some relation to the signal strength. There are further difficulties that

* This is not rigorously correct, but few exceptions to this rule are met with in practice.

enter this question which arises from the absorption of the electromagnetic radiation by the earth, due to its resistivity and also the effect of the radiation reflected from the conducting layers of the atmosphere.

The most convenient method of representing these effects is to use a separate factor for each. Thus, there would be a factor for the law of propagation of the waves, another factor for the absorption of the ground and intervening objects, another factor for the directivity, and, finally, a factor for the distribution of current and the shape of the antenna. It is this last factor which is called the "Effective Height."

Unfortunately, most of these factors interact to a greater or less degree on one another, especially that of directivity and of effective height, so that the latter has no very definite meaning unless referred to the field strength of the radiation at some definite point. Such a point could conveniently be on the surface of the earth in the direction of maximum radiation.

Over a perfectly conducting plane earth, the image in the earth is the exact reproduction of the antenna itself, and the sum of the radiations on the earth's surface due to the series of doublets forming the antenna will be proportional to the integral of the current over the antenna resolved in the vertical plane, making a suitable allowance for the phase difference of the radiations from the various parts. This difference in phase will only occur if the antenna stretches in a horizontal plane over a distance comparable with the wavelength, as in a beam station, for example. The general formula for the effective height of a transmitting antenna is given by equation (14) of Appendix II.

It may be noticed that if the earth is not perfectly conducting it will not be rigorously an equipotential surface, and a correction should be applied. However, until more is known on this point we must be content with the above definition.

The effective height of a receiving antenna is apparently more easily defined. If an electromagnetic wave having a uniform electric intensity E approaches the antenna, a current I is obtained at the foot of the antenna. If an E.M.F. V applied at the foot were alone able to produce the same current I , we obtain at once for the definition of the

effective height R of a receiving antenna

$$R = V/E$$

It is necessary to assume a uniform electric field, otherwise the definition becomes meaningless. The value of R is given by equation (16) of Appendix II and comes out to be identical with the value found for the effective height of a transmitting antenna. We thus obtain the following proposition:—

"If the distribution of the constants along an antenna is unaffected by the applied E.M.F.'s, the effective height is the same for transmission as for reception."

The final point for theoretical consideration is that of radiation resistance.

This is proportional to the total energy radiated, which energy, for a given current and radiation polar diagram, will depend largely on the effective height of the antenna defined as for a transmitting antenna. That is, if this effective height is large, so will the radiation resistance be expected to be large.

For a transmitting antenna this effective height is independent of the impedance between the foot of the antenna and earth. [See equation (14) of Appendix II.] For a receiving antenna, however, the effective height due to the re-radiation does depend on this impedance [equation (18) of Appendix II]. The radiation resistance will not, therefore, be the same for transmission and reception.

In the special case considered at the end of Appendix II of an antenna having uniformly distributed constants, the values of the effective height are given for both transmission and reception [expressions (19) and (20) of Appendix II]. In the case of reception this effective height is a measure, not of the effect of the received signal, but of the strength of the re-radiated field. When the antenna is tuned it will be seen that the value of the effective height of the antenna considered as a transmitter and, therefore, the radiation resistance, is smaller for transmission than for reception, the difference depending on the value of Z of the impedance between the foot of the antenna and earth.

In fact, when Z is infinite, the difference in the radiation resistance is also infinite. The physical interpretation of this is easily found. If Z is infinite, the current I at the foot of the antenna will be zero. Thus, in the case of transmission there will be no

current whatever in the antenna, while, owing to capacity and inductance effects, some current will flow on reception; this current will produce a re-radiated field. On reception, therefore, some power is re-radiated, although the current at the base may be zero. This will evidently give rise to an infinite radiation resistance, since the measurements normally refer to the effective value at the foot of the antenna.

Experimental Verification.

In order to test the theoretical conclusions outlined above, the following experiments were carried out.

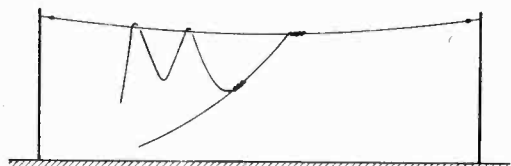

Fig. 6.—Shape of antenna used in experiments.

To ensure that the antenna under measurement did not possess uniformly distributed inductance, capacity and resistance, loops of wire were added to it until its shape was as shown in Fig. 6. A counterpoise earth was used.

The measurements were carried out by inserting the antenna in a circuit (Fig. 7) consisting of an inductance *L*, a condenser *C* and an ammeter. The circuit was measured with and without the antenna, keeping the counterpoise permanently connected to the point *A* during all the measurements.

The resistance was measured by the variation of reactance method by varying a small accurately calibrated condenser in parallel with the condenser *C*.

For transmission a small power set inducing directly into the coil *L* was used, while

another antenna excited by a larger power set was used for testing the antenna as a receiver. The two antennæ were about fifty yards apart. A large army hut running the whole length of the antenna under measurement and within a few feet of it between the receiving and transmitting antennæ, ensured that the field at the receiving antenna was not uniform.

It was ascertained that the direct induction from the transmitting antenna into the coil of the measuring circuit was negligibly small. The two power sets were adjusted to the same frequency by means of the same wavemeter, without alteration of the setting, so as to eliminate small errors due to frequency adjustments.

Since the differences were only to be expected at high frequencies, as short a wave length as was conveniently possible (compatible with accurate measurement) was used. Table I gives the results of the measurements. The figures for the reactance and resistance refer to the antenna alone, without the rest of the circuit. They were obtained by subtracting the values for the circuit with and without the antenna.

The last result at a wavelength of 114 metres is interesting, for it represents the antenna beginning to act as a rejector circuit. Owing to its shape, the down-coming lead is for a long portion of its length quite close to the earth screen, thus acting as a large capacity. The rest of the antenna acts as a positive impedance at that frequency, so that a rejector circuit is formed. This is the reason for the sudden rise in the value of the resistance. This condition could be altered by changing the shape of the lead-in wire. This was done and, though no very accurate measurements were made, the effective resistance decreased to the value of the order of 15 ohms.

TABLE I.

Wavelength in Metres.	RECEPTION.			TRANSMISSION.		
	Setting of Condenser <i>C</i> .	Reactance in Ohms.	Resistance in Ohms.	Setting of Condenser <i>C</i> .	Reactance in Ohms.	Resistance in Ohms.
208.5	119.8	- 297.0	4.2	120	- 297.0	4.2
140.0	283.0	- 74.0	5.0	283	- 74.0	4.9
127.0	186.0	- 7.8	7.2	186	- 7.8	7.0
114.0	215.0	+ 89.0	64.0	215	+ 89.0	70.0

From the table we see that the natural wavelength of the antenna is slightly below 127 metres. This, incidentally, is a very accurate method of finding the natural wavelength of an antenna without having instruments liable to alter the value searched for. The process consists in exciting the

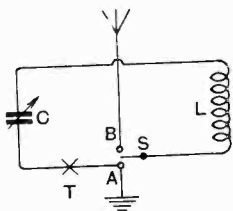

Fig. 7.—Circuit for measuring the natural frequency of an antenna.

circuit by inducing an E.M.F. from a local source into the coil L (Fig. 7). The reading C_1 of the condenser is taken when the circuit is tuned to the frequency of the source, as seen by the deflection of the ammeter, with the switch S connected to A , so that the antenna is not in the circuit. The switch S is now connected to B and the new capacity C_2 , for which the circuit is now tuned, is noted.

Obviously, if $C_1=C_2$, *i.e.*, when there is no change in the tuning conditions produced by the insertion of the antenna in the circuit, the antenna must be acting as a pure resistance, and the frequency of the source is its natural frequency, which is what we are endeavouring to find. The most convenient way of doing this is to find C_1 and C_2 for a number of frequencies in the neighbourhood of the natural frequency of the antenna, and plot C_1-C_2 against the wavelength of the source. A typical curve is shown in Fig. 8. Where this curve cuts the axis is the natural wavelength searched for. It may be noted that the result will not be affected if the source is inducing an E.M.F. directly in the antenna, for we have seen that the effective impedance of an antenna is independent of the distribution of the E.M.F.'s.

It was not possible to take measurements at higher frequencies owing to the increasing difficulties that were met; in particular because, with the antenna used, the resistance attained very high values, rendering the deflection of the ammeter too small to be

useful for accurate resistance measurements (and these are already inherently uncertain at much higher frequencies).

The values obtained are seen from Table I to confirm the theoretical deductions. No differences in the condenser settings were detectable, while the resistance appears to be slightly greater for reception than for transmission, which difference increases with increasing frequency. At 114 metres wavelength the resistance was very difficult to measure, but the resistance for transmission appears to be greater than for reception. This is probably due to the action of the antenna as a rejector circuit, for in that case the greater the resistance within the circuit the smaller the effective resistance.

Too great reliance, however, should not be placed on the small differences shown in the table, as they are within the limits of experimental error. The fact that the errors of measurement due to the arrangement of the circuit are similar for transmission and reception gives, however, greater weight to the reality of the observed differences.

To test this further, measurements were made near the natural frequency of the antenna ($\lambda=127$ metres) using thermoammeters having different resistances. From our previous theoretical considerations we saw that the radiation resistance for recep-

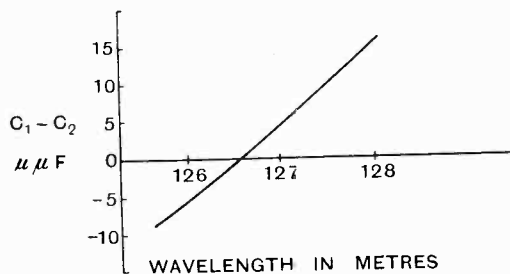

Fig. 8.—Curve for finding the natural wavelength of an antenna.

tion was greater than that for transmission and was dependent on the impedance between the foot of the antenna and the earth. It was also found that the greater this impedance, the greater would be the difference between the resistance for transmission and reception. It is to be expected, therefore, that the resistance for reception minus

that for transmission would increase as the resistance of the thermo-ammeter was increased. This was actually found to be the case as is shown in Table II.

TABLE II.

Resistance of Thermo-ammeter.	(Resistance for Reception) - (Resistance for Transmission).
1 ohm	0.2 ohm
5 ohms	0.3 "
30 "	0.7 "

The resistance of the rest of the circuit was of the order of 8 ohms.

It was found that measurements became increasingly difficult as the resistance of the thermo-ammeter was increased, owing to the effect of the observer on the large capacity via the earth between the screen of the condenser and the counterpoise, and also owing to the capacity of the coil to earth.

The differences shown in the table are small and within the limits of experimental error for absolute values, but probably not for the differences themselves. It should be further noticed that any error caused by the reaction back on the source is greater the greater the coupling of the circuit to the source, and always causes the measured resistance to be too high. Now, with the antenna used as a transmitter the coupling is comparatively large, while it is very low when the antenna is used as a receiver. Any error of measurement due to this cause would, therefore, make the value of the resistance larger for transmission than for reception, whereas the reverse was always found to be the case.

Summary.

The intention of this investigation is to amplify the important theoretical work of Moulain and Colebrook, who have considered the case of antennæ having uniformly distributed constants. The reasons for doubting the rigid validity of this assumption is explained at some length, although in many cases it can probably be taken as a first approximation.

As an example a simple vertical antenna is considered qualitatively in order to discover what would be the likely distribution of capacity along it at low frequencies.

In this connection the meaning of the terms capacity and self-inductance per unit length are considered and defined as regards their application to alternating current. The definitions given do not bear necessarily any relation to their meaning in electrostatics, but it is shown that the electrostatic value and the alternating current value are very nearly equal when the frequency is low. This does not only apply to antennæ, but also to transmission lines, for which the problem is essentially similar. In this case, however, the approximation of taking the values of the constants as equal to the corresponding values for the electrostatic case is amply sufficient; the frequency is usually low and the return circuit is close to the outgoing wire, so that they effectively screen each other from the outside conductors and the more distant points on the same conductors.

In the mathematical analysis, which for convenience is given in an appendix, one assumption is made. This is that the distribution of the constants along an antenna is the same for transmission and reception. It is explained why this is not strictly correct, but the error caused by this assumption should be quite negligible.

It is then shown that an antenna having an E.M.F. V and an impedance Z at its base, between the foot and the earth, and a distributed E.M.F. along it can be represented by a simple circuit consisting of an impedance Z in series with another impedance Z_0 , an E.M.F. V and another E.M.F. E_0 . Z_0 and E_0 can, therefore, be termed the effective impedance and the effective E.M.F. of the distributed E.M.F. of the antenna respectively. Z_0 is shown to be independent of the distributed E.M.F. and of V , so that its value will be the same whether either the distributed E.M.F. or V is put equal to zero. That is, the effective impedance of the antenna is the same whether it is transmitting or receiving, and this holds irrespectively of the distribution of the constants along the antenna.

Incidentally this proposition holds equally well for any form of transmission line.

After defining the term "effective height" for a transmitting and a receiving antenna, and explaining briefly the difficulties inherent in the definitions, the following proposition is proved.

“ If the distribution of the constants of an antenna is unaffected by the distribution of applied E.M.F.’s the effective height is the same for transmission and reception.”

The next point to be considered is the radiation resistance. This is found to be different for transmission and reception, being in general greater for the latter. In fact, for a receiving antenna it is dependent on the impedance between the foot of the antenna and the earth and increases with it. It becomes infinite when this impedance becomes infinite. For a transmitting antenna the radiation resistance is independent of the impedance of the apparatus at the foot of the antenna.

The experimental results, which were carried out on an antenna built to have non-uniform distribution of constants, are in accord with the theoretical conclusions reached. The effective reactance and the effective resistance of the antenna were measured for reception and transmission and found to be identical except for a small difference in the value of the resistance, as was foreshadowed by the theory.

Incidentally, an accurate method of finding the natural frequency of an antenna is given. In this method no instruments likely by their reactance to affect the result are used.

APPENDIX I.

THE SEPARATION OF REACTANCE INTO ITS CAPACITY AND INDUCTANCE COMPONENTS.

Let the effective impedance of a circuit be Z_0 , being composed of a resistance R_0 and a reactance X_0 . It is required to find a capacity C_0 and an inductance L_0 , which will represent X_0 as nearly as possible. Since there are only two quantities at our disposal, we can only hope to satisfy two conditions. These are that the reactance of the combination of C_0 and L_0 be equal to X_0 at the frequency considered, and the other that the rate of change in reactance with frequency be the same for X_0 as for the combination of C_0 and L_0 .

When measuring the reactance of a circuit it is usual to measure directly the inductances or capacities which have the same reactance at the required frequency. Let these be L and C respectively

$$(i.e., L\omega = -\frac{I}{C\omega} = X_0).$$

Let us take the case in which L_0 and C_0 are put in series, so that

$$jL\omega = jL_0\omega + \frac{I}{jC_0\omega}$$

Differentiating with respect to ω , we have for

the second condition

$$\frac{dL}{d\omega} = -\frac{I}{jC_0\omega^2}$$

From these two equations we can find L_0 and C_0 . They are

$$C_0 = \frac{2}{\omega^2} \frac{dL}{d\omega}$$

and

$$L_0 = L + \frac{\omega}{2} \frac{dL}{d\omega}$$

In the case of an antenna, when the frequency is low, it is more usual to measure the capacity C . In this case, the initial equation is

$$\frac{I}{jC\omega} = jL_0\omega + \frac{I}{jC_0\omega}$$

Proceeding as before, differentiating with respect to ω and solving the two equations for L_0 and C_0 , we obtain

$$L_0 = \frac{I}{2C^2\omega} \frac{dC}{d\omega}$$

and

$$C_0 = \frac{2C^2}{2C + \omega \frac{dC}{d\omega}}$$

Hence by plotting L or C against ω and finding the differential (*i.e.*, the gradient of the curve), we can find the effective self-inductance and effective capacity at any required frequency.

Near even multiples of the natural frequency of an antenna, $dL/d\omega$ becomes small and the effective impedance of the antenna then resembles more that of a parallel tuned circuit as regards the variation with frequency. Near these frequencies, the usual representation of a self-inductance and capacity in series becomes very unsatisfactory, for the values of L_0 and C_0 will vary rapidly with frequency.

APPENDIX II.

Consider an element of length δr of an antenna. Let its direction cosines be l, m, n . Suppose the components of the electric intensity of an approaching wave have instantaneous values E_x, E_y, E_z , and that an E.M.F. of instantaneous value V be applied at the foot of the antenna, the frequency of the E.M.F.’s being the same.

We shall write R, L, C for the resistance, self-inductance and capacity per unit length respectively of the element δr of the antenna.

If v and i are the potential and the current respectively at any point r of the antenna, then the differential equations for the electric conditions at any point are

$$-\frac{dv}{dr} = (R + jL\omega)i - (lE_x + mE_y + nE_z) \dots (1)$$

$$\text{and } -\frac{di}{dr} = jC\omega v \dots \dots \dots (2)$$

where $j = \sqrt{-1}$ and $\omega = 2\pi$ (frequency).

It should be noticed that in the two equations R, L, C, E_x, E_y, E_z are functions of r .

Eliminating v from equations (1) and (2), we have

$$\frac{d^2i}{dr^2} - \frac{I}{C} \frac{dC}{dr} \frac{di}{dr} - (R + jL\omega) jC\omega i = -jC\omega (lE_x + mE_y + nE_z) \quad (3)$$

To solve this, suppose s is a solution of the equation

$$\frac{d^2s}{dr^2} - \frac{I}{C} \frac{dC}{dr} \frac{ds}{dr} - (R + jL\omega) jC\omega s = 0 \dots (4)$$

It may be noted in passing, that s is a current distribution which is possible when there is no distributed E.M.F., *i.e.*, it is a possible distribution for a transmitting antenna. If s were the complete solution of equation (4) and the constants were adjusted to satisfy the correct boundary conditions, s would be the current distribution of the antenna acting as a transmitter.

Writing $i = u \cdot s$, we obtain

$$\frac{d^2u}{dr^2} + \frac{du}{dr} \left(2 \frac{ds}{s} - \frac{I}{C} \frac{dC}{dr} \right) = -\frac{jC\omega}{s} (lE_x + mE_y + nE_z).$$

This is a linear equation in du/dr , and the solution is

$$u = \int \frac{C}{s^2} \int (lE_x + mE_y + nE_z) sj\omega \, dr \, dr + A \int \frac{C}{s^2} \, dr + B$$

where A and B are constants of integration.

Let $Q = \int \frac{C}{s^2} (lE_x + mE_y + nE_z) sj\omega \, dr \, dr \dots (5)$

and $P = \int \frac{C}{s^2} \, dr$, so that $\frac{dP}{dr} = \frac{C}{s^2} \dots (6)$

Hence we can write

$$i = (Q + AP + B)s \dots (7)$$

We shall also find the following formula useful

$$Q = \int \frac{dP}{dr} \int E_r sj\omega \, dr \, dr = \left[P \int E_r s \, dr - \int P E_r s \, dr \right] j\omega \dots (8)$$

where $E_r = lE_x + mE_y + nE_z$.

In these equations it should be noticed that the variables P and s are functions of the antenna constants only, while Q is a function of both the antenna constants and of the approaching field.

There now remains to insert the boundary conditions. Let the impedance of the apparatus between the foot of the antenna and earth be Z , and let i_0 be the value of the current at the foot of the antenna, then

$$\text{when } r = 0, v = V - Zi_0 \text{ and } i = i_0$$

$$\text{and when } r = h, i = 0.$$

On substituting these boundary conditions, we obtain

$$i_0 \left\{ Z - \frac{I}{s_0 C_0 j\omega} \frac{ds_0}{dr} - \frac{I}{(P_0 - P_h) s_0 j\omega} \right\} = V - \frac{Q_0 - Q_h}{s_0 (P_0 - P_h) j\omega} + \frac{s_0}{jC_0 \omega} \frac{dQ_0}{dr} \dots (9)$$

where s_0, C_0, P_0, Q_0 are the values of s, C, P, Q when $r = 0$ and P_h, Q_h are the values of P, Q when $r = h$.

Let us examine equation (9). It will be seen that the right-hand side is a function of the applied electric intensities and the units are those of an E.M.F. Also the coefficient of i_0 is independent of the applied electric intensities and its units are those of an impedance.

Now, comparing equation (9) with the equation

$$i_0(Z + Z_0) = V + E_0 \dots (10)$$

where Z_0 is the effective impedance of the antenna and E_0 is the equivalent E.M.F. at the base, which produces the same current i_0 as the approaching wave, we obtain at once

$$Z_0 = -\frac{I}{s_0 C_0 j\omega} \frac{ds_0}{dr} - \frac{I}{(P_0 - P_h) s_0^2 j\omega} \dots (11)$$

and $E_0 = \frac{s_0}{jC_0 \omega} \frac{dQ_0}{dr} - \frac{Q_0 - Q_h}{s_0 (P_0 - P_h) j\omega} \dots (12)$

The effective height of a transmitting antenna is defined as

$$T = \int_0^h \frac{I}{i_0} n i \, dr \dots (13)$$

Substituting relation (7), we have

$$T = \frac{\int_0^h n(P - P_h) s \, dr}{s_0 (P_0 - P_h)} \dots (14)$$

In the case of a receiving antenna, suppose the current produced at the foot by a vertical approaching field is i_0 and that the same current is produced by an E.M.F. V of the same frequency applied at the foot of the antenna, then the effective height R can be defined by the relation

$$R = V/E \dots (15)$$

In this case the approaching field must be uniform, otherwise the effective height will depend on the distribution of this field and becomes meaningless.

From equation (9) we can find i_0 in the two cases by first putting $V = 0$ and then $E_r = 0$. On substituting in equation (15), we have

$$R = \frac{\int_0^h n(P - P_h) s \, dr}{s_0 (P_h - P_0)} \dots (16)$$

It will be seen that equations (14) and (16) are identical.

In considering the radiation resistance, the integral given in equation (13) is of interest. For a receiving antenna it can be shown to be

$$\frac{I}{i_0} \int_0^h n i \, dr = \frac{I}{i_0} \int_0^h n s (Q - Q_h) \, dr - \frac{s_0}{i_0} (Q_0 - Q_h) R + R \dots (17)$$

The integral on the left-hand side of this equation will to a large extent govern the radiation resistance. If this integral is large, so can the radiation resistance be expected to be large.

For a transmitting antenna the value of this integral is equal to the effective height. It will be seen, therefore, that the radiation resistance is not in general the same for transmission and reception.

We shall now consider a special case, in which

the constants are uniformly distributed along the antenna, and apply the equations obtained above.

An obvious solution of equation (4) is

$$s = e^{Kr}$$

where $K^2 = (R + jL\omega)jC\omega$

Therefore
$$P = -\frac{Ce^{-2Kr}}{2K}$$

and
$$Q = -\frac{jC\omega e^{-Kr}}{K^2} E_r$$

Substituting in equation (11) we have

$$Z_0 = \frac{K}{jC\omega} \coth(Kh) \dots \dots (18)$$

which is the well-known formula for a uniform transmission line.

Expanding, this becomes

$$Z_0 = R\frac{h}{3} + \frac{I}{hjC\omega} + \frac{hjL\omega}{3} + \dots$$

From equation (13), we readily find the effective height to be

$$T_z = \frac{I}{K} \tanh\left(\frac{Kh}{2}\right) \dots \dots (19)$$

$$= \frac{h}{2} I + \frac{h^2 LC\omega^2}{12} + \dots$$

as obtained by Moullin.*

* *Loc. cit.*

To compare the radiation resistance in the two cases of transmission and reception, we must evaluate

$$\frac{I}{i_0} \int_0 i dr$$

For transmission this is equal to the effective height and is given by equation (19). For reception the integral, assuming E_r to be uniformly distributed along the antenna, is

$$\frac{I}{K} \tanh\left(\frac{Kh}{2}\right) + \frac{jC\omega E_r}{K^2 i_0} \left[\frac{2}{K} \tanh\left(\frac{Kh}{2}\right) - h \right]$$

that is

$$\frac{I}{K} \tanh\left(\frac{Kh}{2}\right) - \frac{jC\omega}{K \tanh\left(\frac{Kh}{2}\right)} \left[\frac{2}{K} \tanh\left(\frac{Kh}{2}\right) - h \right] (Z_0 + Z)$$

We should, therefore, expect the radiation resistance to be slightly different in the two cases. If $(Z + Z_0)$ is a pure resistance, that is, if the antenna circuit is tuned, the resistance will be greater for reception than for transmission. It is interesting to note that the difference in the radiation resistance in the two cases is dependent on the value of the impedance Z of the apparatus between the foot of the antenna and earth and is greater the greater that impedance.

A New Range of Meters.

The accompanying illustration shows two examples of a range of small precision meters recently

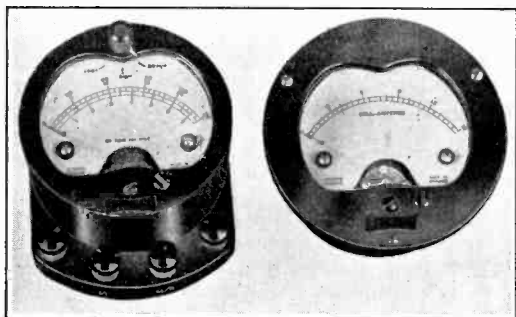

Ferranti Combined Portable Instrument, Type PR3a, Ranges 0-15 Milliamps, 0-7.5 volts, 0-150 volts, and the Flush Pattern, Type RIFa, 0-15 Milliamps.

produced by Ferranti's. The meters are particularly suitable for general laboratory work and the price is very reasonable. Tests carried out on one of the milliammeters (0-15 range) showed that for over half the scale readings coincided with those of a sub-standard milliammeter (accuracy 1/2 per cent.) and at no point was the reading more than 1 1/2 per cent. different from the sub-standard.

A replaceable safety fuse incorporated in the case is a most useful refinement because accidents are always liable to happen and, with this arrangement, instead of having to send the instrument away for repair a new fuse can be easily fitted in ten minutes. We had some doubt as to whether a fuse could actually be a sufficiently certain protection to an instrument taking so small a current. To satisfy ourselves we applied an overload current of about 100 per cent. and watched the needle carefully. The fuse went before the pointer had traversed one-third of the scale, so that the pivots were not called upon to withstand the shock of a full scale deflection.

Good Quality in H.F. Amplifiers.

By C. C. Inglis, A.M.I.E.E.

WITH the advance in the design of low frequency amplifiers for good quality reproduction, it has been questioned whether the frequencies let through by a tuned anode arrangement for high frequency amplification, using the new screened valve, are consistent with the flat characteristics of the low frequency resistance-coupled amplifier.

It is obvious that it is useless providing a flat characteristic in the low frequency amplifier up to say 6,000 cycles, if the high frequency end does not pass them.

The average low loss coil *per se* has much too narrow a resonance curve to do this, but as until now valves of about 20,000 ohms have been used in conjunction with these coils, the resonance curve has been effectively broadened so as to allow the necessary band to pass.

The following analysis was made to arrive at the width of a resonance curve at a large fraction of its height:—

Consider the impedance of a coil of inductance L and resistance R when shunted by a condenser of capacity C .

It can be shown that if $Z =$ impedance at ω frequency

$$\text{then } \frac{1}{Z^2} = \omega^2 C^2 - \frac{2\omega^2 LC - 1}{R^2 + \omega^2 L^2}$$

at resonance

$$\omega = \sqrt{\frac{1}{LC} - \frac{R^2}{L^2}}$$

giving

$$Z = \frac{L}{CR}$$

Consider the values of ω which would reduce the impedance to some fixed fraction $1/n$ of this maximum resonant value. Then to find the two values of ω for this condition put

$$\frac{n^2 C^2 R^2}{L^2} = \omega^2 C^2 - \frac{2\omega^2 LC - 1}{R^2 + L^2 \omega^2}$$

Now, if $\omega_A \cdot \omega_B$ are the two real roots of this

equation it can be shown that

$$\begin{aligned} \omega_A^2 - \omega_B^2 &= 2 \frac{R}{L} \sqrt{n^2 - 1} \left[\sqrt{\frac{1}{LC} + \frac{(n^2 + 1)^2}{L(n^2 - 1)} \cdot \frac{R^2}{L^2}} \right] \end{aligned}$$

(See appendix I.)

For all ordinary values of L, C, R , and provided n is small, the expression in the bracket is approximately equal to the resonant angular frequency ω of the circuit since R^2/L^2 is very small compared with $1/LC$ (about 1 in 10^7);

$$\text{or } \omega_A^2 - \omega_B^2 = 2 \frac{R}{L} \sqrt{n^2 - 1} \cdot \omega$$

$$\therefore (\omega_A - \omega_B)(\omega_A + \omega_B) = 2 \frac{R}{L} \sqrt{n^2 - 1} \cdot \omega$$

$$\text{but } \omega_A - \omega_B = 2\omega.$$

Hence

$$\omega_A - \omega_B = \frac{R}{L} \sqrt{n^2 - 1}$$

This is not quite true, as a resonance curve is not quite symmetrical about its maximum ordinate.

For small values of n , however, the error is inappreciable.

In other words the width in cycles per second of a resonance curve at $1/n^{\text{th}}$ of its height is

$$\frac{R}{2\pi L} \sqrt{n^2 - 1}$$

cycles on the above assumptions.

Consider a circuit of $183\mu\text{H}$, $.0002\mu\text{F}$, and 5 ohms, which is representative of a good low loss coil tuned to 830kC (2LO).

$$\text{Let } n = 1.05.$$

That is the condition when the impedance of the circuit is 5 per cent. less than its maximum.

Then width—

$$= \frac{R}{2\pi L} \sqrt{n^2 - 1} = \frac{R}{2\pi L} \cdot .346 \text{ cycle}$$

$$= \frac{5}{2 \cdot \pi \cdot 183 \times 10^{-6}} \times .346 = 1,500 \text{ cycles.}$$

This value is much too small for good quality.*

Valve Damping.

It can be shown that the equivalent resistance of a valve of ρ A.C. resistance which can be inserted in a circuit L, C, R , is $\omega^2 L^2 / \rho$ provided that R is small compared with ωL . (See appendix II.)

This is always the case, except in that of resistance wound H.F. transformers. Consequently with the coil under consideration and a valve of 20,000 ohms, the equivalent resistance to be inserted is

$$\frac{(2\pi \cdot 830,000)^2 \times (183 \times 10^{-6})^2}{20,000} = 45 \text{ ohms.}$$

This makes a total coil resistance of 50 ohms.

Now with $R = 50$ ohms at $n = 1.05$ width becomes

$$.346 \cdot \frac{50}{2\pi L} = 15,000 \text{ cycles.}$$

A satisfactory value.

This is the band that would be passed with a maximum reduction of 5 per cent. provided there was no reaction or feedback in the circuit, but no doubt in practice the band is reduced by these causes.

Turning now to the effect of the new high impedance valve of, say, 100,000 ohms.

The equivalent resistance is $\omega^2 L^2 / 100,000$.

$$\begin{aligned} L &= 183 \times 10^{-6} \text{H} \\ \omega &= 2\pi \cdot 830,000 \\ &= 9 \text{ ohms} \end{aligned}$$

making a total of 14 ohms in the coil.

This gives a band width with $n = 1.05$ of 4,200 cycles, or only 2,100 cycles either side of the maximum.

It is therefore seen that to pass a band of frequencies of only 4,000 the station will have to be tuned to one side of the peak, so as to pass one sideband correctly instead of two sidebands partially.

This is found to be necessary in super-heterodyne circuits, where feedback produces very sharp response curves at the intermediate frequency.

* [The author regards decrease of 5 per cent. in the current as the limiting factor in fixing the width of the band. In our opinion this is far too stringent.—EDITOR.]

In fact, the alteration in tone is very noticeable as the oscillator is slightly varied.

The results of the above remarks show that care must be taken not to use a valve of too high impedance with a tuned anode circuit, if good quality is to be maintained.

If a transformer is used, it is clear that the damping action of the valve is considerably reduced, and that good quality cannot be attained with this arrangement.

Assuming that a resonance peak of 12,000 cycles (at 5 per cent. maximum reduction) is required, then equivalent coil resistance of 22 ohms is required.

With a coil of 5 ohms resistance, this results in a resistance, due to the valve, of 17 ohms or a valve resistance of, say, 53,000 ohms.

It must be pointed out that all the above calculations are based on a 5 per cent. cut off, and naturally with a higher cut off, say 10 per cent. ($n = 1.11$) the band of frequencies passed are broader, enabling a higher impedance valve to be used.

APPENDIX I.

$$\frac{n^2 C^2 R^2}{L^2} = \omega^2 C^2 - \frac{2\omega^2 LC - 1}{R^2 + \omega^2 L^2} \quad (\text{See text})$$

by rearrangement

$$n^2 C^2 R^4 + n^2 C^2 R^2 L^2 \omega^2 = L^2 \omega^2 C^2 R^2 + \omega^4 L^4 C^2 - 2\omega^2 L^3 C + L^2$$

$$\therefore \frac{\omega^4 L^4 C^2}{\omega^2 (2L^3 C + (n^2 - 1)C^2 R^2 L^2)} - (n^2 C^2 R^4 - L^2) = 0$$

$$\text{or } \omega^4 - \omega^2 \left(\frac{2}{LC} + (n^2 - 1) \frac{R^2}{L^2} \right) + \left(\frac{1}{L^2 C^2} - n^2 \frac{R^4}{L^4} \right) = 0$$

Let

$$\frac{2}{LC} + (n^2 - 1) \frac{R^2}{L^2} = 2\omega R^2 \quad \dots (1)$$

and

$$\frac{1}{L^2 C^2} - n^2 \frac{R^4}{L^4} = \omega_r^4 \quad \dots (2)$$

Then

$$\omega^4 = \omega^2 2\omega R^2 + \omega_r^4 = 0$$

and

$$\omega^2 = \frac{2\omega R^2 + \sqrt{4\omega R^4 - 4\omega_r^3}}{2} = \omega R^2 \pm \sqrt{\omega R^4 - \omega_r^4}$$

If ω_A^2, ω_B^2 are roots.

Then

$$\omega_A^2 - \omega_B^2 = 2\sqrt{\omega R^4 - \omega_r^4} \quad \dots (3)$$

Now from (1)

$$\omega R^4 = \frac{1}{4} \left(\frac{2}{LC} + (n^2 - 1) \frac{R^2}{L^2} \right)^2 = \frac{1}{L^2 C^2} + \frac{(n^2 - 1) R^2}{LC L^2} + \frac{(n^2 - 1)^2}{4} \cdot \frac{R^4}{L^4}$$

(from 2)

$$\omega_r^4 = \frac{1}{L^2 C^2} - n^2 \frac{R^4}{L^4}$$

$$\therefore \omega_R^4 - \omega_r^4 = \frac{(n^2 - 1)R^2}{L^3 C} + \frac{n^4 - 2n^2 + 1}{4} \frac{R^4}{L^4} + \frac{4n^2}{4} \frac{R^4}{L^4}$$

or

$$\omega_R^4 - \omega_r^4 = \frac{(n^2 - 1)R^2}{L^3 C} + \frac{(n^2 + 1)^2}{4} \frac{R^4}{L^4} \\ = \frac{R^2}{L^2} (n^2 - 1) \left[\frac{1}{LC} + \frac{(n^2 + 1)^2}{4(n^2 - 1)} \cdot \frac{R^2}{L^2} \right] \dots (4)$$

From 3 and 4 we get

$$\omega_A^2 - \omega_B^2 = 2 \frac{R}{L} \sqrt{n^2 - 1} \left[\sqrt{\frac{1}{LC} + \frac{(n^2 + 1)^2}{4(n^2 - 1)} \cdot \frac{R^2}{L^2}} \right]$$

APPENDIX II.

Consider the circuit as shown in the figure with V volts applied.

In practice since R is very small compared with ωL the current through an inductive branch of the tuned circuit is sensibly $V/\omega L$.

\therefore Power lost in R is $(V/\omega L)^2 R$.

Now power lost in $\rho = V^2/\rho$

Making a total of $V^2 \left(\frac{R}{\omega^2 L^2} + \frac{1}{\rho} \right) \dots (1)$

Let the equivalent circuit to the above arrangement be L, C, S , where S is the combined value of ρ and R .

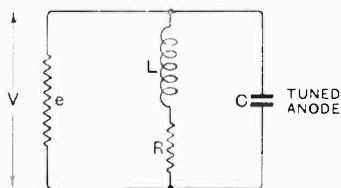

Power lost in this case $\left(\frac{V}{\omega L} \right)^2 \cdot S \dots (2)$

If 1 and 2 are equal,

then

$$\frac{V^2}{\omega^2 L^2} \cdot S = V^2 \left(\frac{R}{\omega^2 L^2} + \frac{1}{\rho} \right)$$

$$\text{or } S = R + \frac{\omega^2 L^2}{\rho}$$

So that coil resistance is increased by $\omega^2 L^2/\rho$

Holland's Short Wave Station.

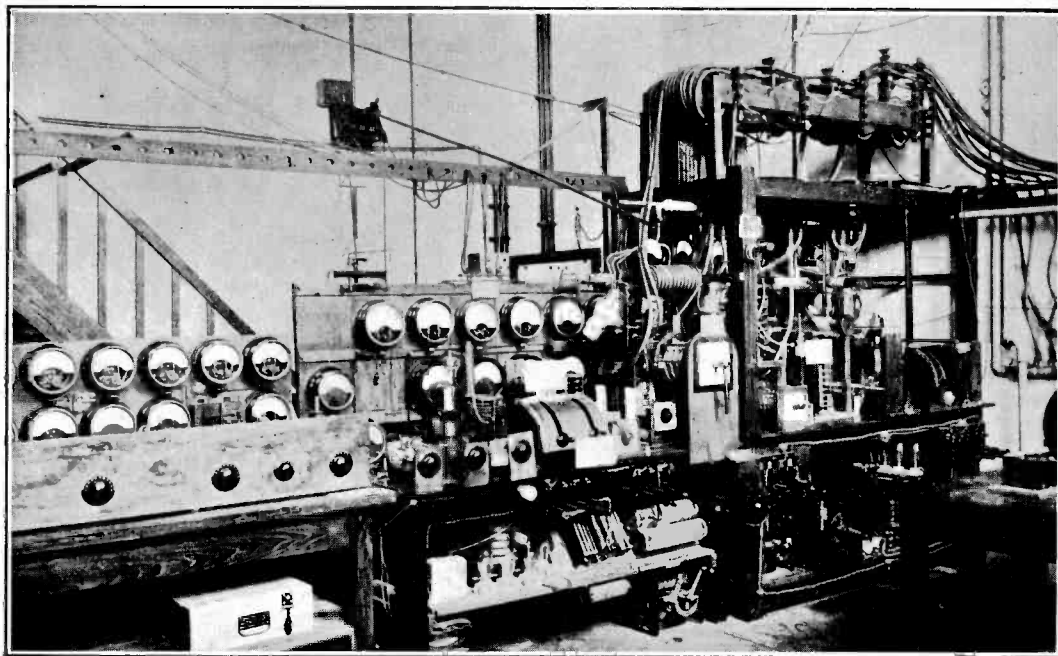

The first photograph to be taken of the Dutch Short Wave Station PCJJ, which has been conducting world-wide broadcast transmissions for some months past with such remarkable success.

Parasitic Oscillations in the Case of a Tuned-Anode Oscillator.

By M. Reed, M.Sc., A.C.G.I., D.I.C.

IN a previous article* the subject of Parasitic Oscillations was treated quite generally. In this article a particular case of Parasitic Oscillations is considered, and it is shown how these Oscillations were encountered in actual practice.

Introduction.

During the course of an ordinary laboratory test, it was desired to obtain a curve between the value of the mutual induction required

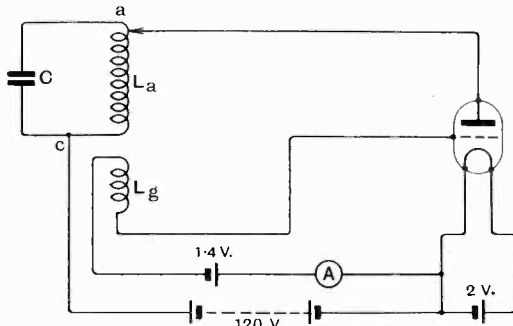

Fig. 1

to start oscillating a tuned-anode valve oscillator and the position of the anode tapping point. To obtain this curve a tuned-anode oscillator with anode tap was connected up as shown in Fig. 1. The particulars of the circuit were as follows:—

- Capacity of condenser $C = 0.0567 \mu\text{F}$.
- Inductance of coil $L_a = 0.480$ henry.
- Resistance = 25 ohms.
- Inductance of coil $L_g = 0.08$ henry.
- Frequency of oscillatory circuit = 965 cycles/sec.

It was found that in this case the curve between the mutual induction required to bring the valve to the point of oscillating and the position of the anode tapping point was as shown by the curve marked "Position

B" in Fig. 3. For positions of the tapping point below 0.9 it was found that for values of the mutual induction lower than those required to produce audible oscillations the micro-ammeter A gave a fairly large reading, thus indicating that an oscillation above audio-frequency was present. The presence of a higher frequency oscillation was further proved by means of a wavemeter.

When the connections to both the grid and anode coils were reversed, the corresponding curve between mutual induction and position of tapping point was as shown by the curve marked "Position A" in Fig. 3.

This curve will be recognised as the one which is obtained for a tuned anode oscillator with anode tap under normal conditions. In this case it was found that no deflection was obtained in the micro-ammeter for values of the mutual induction below those required to start the audio oscillation, nor could an oscillation be detected by means of a wavemeter.

Since in the second case the connections to both the grid and anode coils were reversed, it would be expected that the behaviour of the oscillator would be the same in this as in the first case.

In the following a full investigation of the two cases is given and the curious behaviour of the oscillator is explained.

Description of the Mutual Inductance Used.

Fig. 2a gives an elevation and side view, and Fig. 2b a photograph, of the inductance.

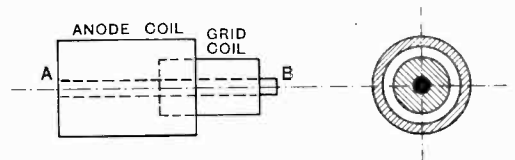

Fig. 2a.

The anode coil is wound in ten equal sections, each section being brought out to a pair of terminals, thus giving the anode tapping

* "The Suppression of Parasitic Oscillations," E.W. & W.E. of Dec., 1927, p. 725.

points. The grid coil is wound in four equal sections whose ends are brought out to terminals. The latter slides coaxially inside the former on a graduated rod. The inductance was calibrated against a standard so that the value of the mutual induction corresponding to any reading on the graduated rod was known.

Reference to Figs. 1 and 2a will show that the ends marked A and B in Fig. 2a correspond in Fig. 1 to opposite ends of the coils. Thus in the case of "Position B" the connections to the anode and grid respectively are as far apart as possible.

The Investigation.

In this section the tests carried out are described as briefly as possible. In all the tests except Test 1, the position of the

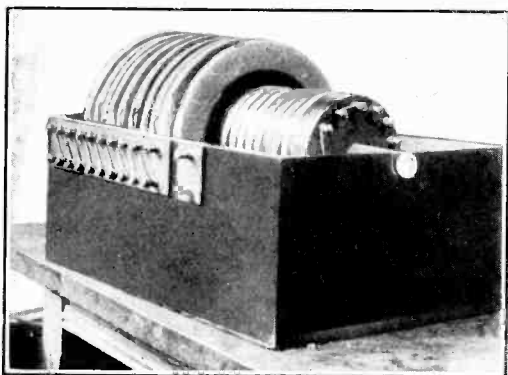

Fig. 2b. Photograph showing the Mutual Inductance used.

tapping point was kept fixed at 0.8 of "all in" because Fig. 3 shows this position to give the worst result.

The valve used was of the ordinary D.E.R. Type, having an amplification factor of 9 and an internal resistance of 22,000 ohms.

TEST I.

The Effect of the Audio Oscillatory Circuit on the Parasitic Oscillation.

In this test the circuit of Fig. 1 was used and the peak voltage between the end of the coil marked c and each of the tapping points was measured.

The "Peak-voltmeter" shown in Fig. 5 was used for this purpose; the peak voltage being indicated by the electrostatic voltmeter.

TABLE I.

Peak Voltmeter connected between the Point c and :	Peak Voltages.	
	Using Anode Tap of 0.8.	Using Anode Tap of 0.6.
All in	0 volts	0 volts
0.9	25 "	10 "
0.8	62 "	55 "
0.7	75 "	70 "
0.6	72 "	80 "
0.5	70 "	85 "
0.4	66 "	84 "
0.3	55 "	70 "
0.2	30 "	50 "
0.1	5 "	10 "

From the readings given in Table I it is seen that when the parasitic oscillation is present the effect of the condenser C in the audio oscillatory circuit is to connect the two portions of the anode coil which are separated by the anode tap, in parallel.

The audio oscillatory circuit therefore represents, as far as the parasitic oscillation is concerned, an inductance consisting of two coils in parallel.

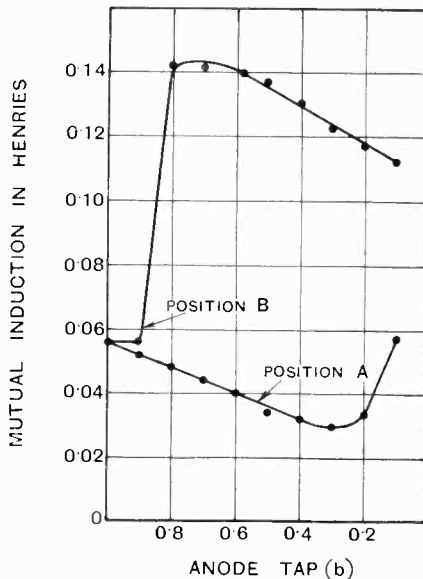

Fig. 3

The condenser C can therefore be replaced by a piece of copper wire, and the parasitic oscillations can be investigated without interference from the audio oscillation.

TEST 2.

The Strength and Frequency of the Parasitic Oscillations.

Measurements of frequency were made by means of the circuit shown in Fig. 4. The coil *L* was loosely coupled to the oscillator under investigation, and resonance was indicated by means of the galvanometer *A* placed in the anode circuit of the rectifying valve *V*. The reading of the galvanometer at resonance was taken as a measure of the strength of the detected oscillation.

The connections of Fig. 1 were used, the condenser *C* being replaced by a piece of copper wire as explained in Test 1. The voltage on the anode was kept constant at 120 volts, and the tapping point was kept fixed at 0.8 of "all in." The position of the grid coil was varied and the corresponding frequency and amplitude were recorded.

TABLE II.
AMPLITUDES AND FREQUENCIES FOR POSITION B.
Zero Reading of Galvanometer = 9 divisions.

Position of the Grid Coil.	Amplitude of the Oscillation.	Frequency of the Oscillation.
cms.	Divisions.	Cycles/Sec.
24	18.5	4.0×10^4
22	12.8	4.2×10^4
20	12.5	4.16×10^4
18	12.0	4.08×10^4
16	12.0	4.02×10^4
14	12.0	4.00×10^4
13	12.0	3.93×10^4
12	12.0	3.90×10^4
11	11.8	3.875×10^4
10	8.0	3.85×10^4
9	2.6	3.83×10^4
8	1.7	3.83×10^4
7	1.4	3.84×10^4
6	1.4	3.87×10^4
5	1.3	3.885×10^4
4	12.5	3.90×10^4
2	12.0	4.00×10^4
0	11.0	4.08×10^4

Table II gives the measurements obtained in the case of "Position B" and Fig. 7 shows the frequency curve obtained. In this case the harmonics were neglected, and the amplitude measurements refer to the fundamental.

From the measurements given in Table II it is seen that there is a sudden change in

amplitude somewhere near 10 cms. There is no jump in the frequency, which changes quite slowly.

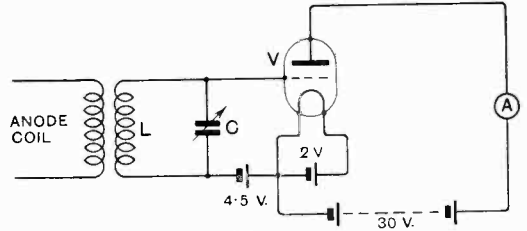

Fig. 4.

The measurements of frequency for "Position A" are given in Table III.

TABLE III.
FREQUENCIES FOR POSITION A.

Position of Grid Coil.	Frequency of Oscillation.
24 cms.	22.0×10^4 cycles/sec.
	18.1×10^4 "
	14.5×10^4 "
	10.95×10^4 "
	7.45×10^4 "
	3.80×10^4 "
22 "	8.85×10^4 "
21 "	4.30×10^4 "
17 "	4.85×10^4 "
17 "	8.96×10^4 "
16 "	17.20×10^4 "
	8.60×10^4 "
15 "	17.00×10^4 "
	8.60×10^4 "
14 "	17.00×10^4 "
	8.74×10^4 "
13 "	9.20×10^4 "
12 "	9.20×10^4 "
11 "	9.20×10^4 "
10 "	9.20×10^4 "

From the measurements of Table III it is seen that at 24 cms. six harmonics could be detected. From 17 cms. and onwards the frequency of the fundamental is much higher than that of the fundamental at 24 cms. to 21 cms.

From 21 cms. to 17 cms. exclusive no oscillation could be detected. Similarly at 10 cms. and downwards.

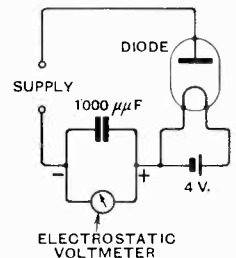

Fig. 5.

TEST 3

The Effect of a Condenser Connected Across the Anode and Grid.

The circuit of Test 2, "Position B," was used, and in addition a variable condenser was connected across the anode and grid terminals of the oscillator. The tapping

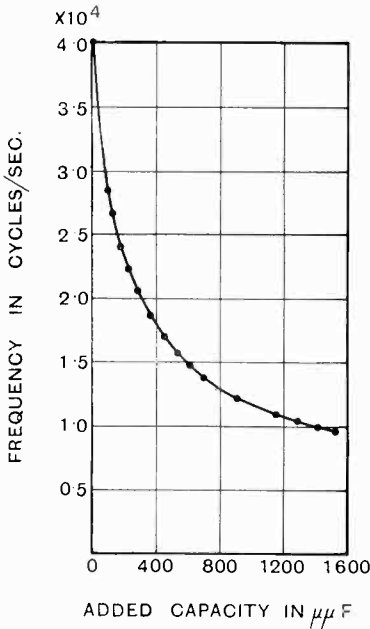

Fig. 6.

point was kept fixed at 0.8 of "all in" and the value of the mutual induction was kept constant.

The change in frequency with variation of the added capacity was recorded, and the resulting curve is shown in Fig. 6.

The above test was repeated for "Position A." It was found that small capacities connected across the anode and grid enabled an oscillation to be detected during the interval of 21 cms. to 17 cms., although no oscillation could be detected if this capacity was removed (see Table III).

The following test was therefore carried out. The tuned circuit of the frequency indicator (Fig. 4) was kept at a fixed value, and the condenser connected across the anode and grid of the oscillator was varied until a resonance point indicated by the galvanometer in the anode circuit of the frequency indicator was obtained. This was

repeated for different positions of the grid coil, and, as seen from the measurements given in Table IV, the effect of the added capacity was to start an oscillation from 21 cms. to 17 cms. which appears to be the same as the oscillation at 24 cms. to 21 cms. The effect of this capacity is also to stop the valve from oscillating for positions of the grid coil below 18 cms.

TABLE IV.

Position of the Grid Coil.	Capacity required to start the Oscillation.
24 cms.	115 μμF
22 "	120 "
20 "	120 "
19 "	140 "
18 "	160 "
17 cms. and onwards.	No oscillation could be detected.

TEST 4.

From the results of the previous test it is seen that in the case of "Position B" a condenser connected across the anode and

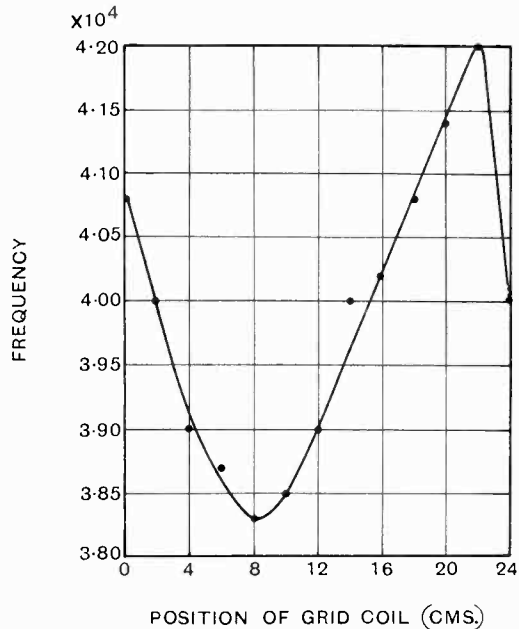

Fig. 7.

grid has the effect of reducing the frequency of oscillation. It therefore seems that the capacity which may exist between the

anode and grid, *i.e.* the inter-electrode capacity, or the capacity between the coils of the mutual inductance, or both these capacities in parallel, forms part of the oscillatory circuit. If this is so then the complete oscillatory circuit would consist of the grid coil, the anode coil (consisting of two parts in parallel) and the stray capacity between the grid and the anode. This will be recognised as the Hartley circuit.

It is possible, however, that the introduction of the condenser across the anode and grid in Test 3 caused the oscillation to be established in the Hartley circuit, and that previous to the introduction of the condenser the oscillation was confined to a different circuit.

To verify this point a megohm was connected between the negative end of the filament and the terminal of the grid coil which was not connected to the grid. This resistance was thus in the Hartley circuit, and it therefore prevented any tendency that this circuit might have to oscillate. An oscillation was, however, detected, and its frequency was found to be 5.6×10^4 cycles/sec. This frequency did not alter appreciably with the position of the grid coil, but the oscillation ceased for positions of the grid coil below 6 cms.

TEST 5.

Determination of the Natural Frequency of the Components of the Oscillator.

The natural frequency of the grid coil was first determined. The method employed is indicated in Fig. 8a. The frequency of the oscillator was varied by means of condensers C_1 and C_2 until a "kick" curve was obtained as indicated by the thermo-ammeter. Such a curve is shown in Fig. 8b.

The natural frequency of the coil was then calculated by determining the value of the capacity C and substituting in the formula:—

$$f_0 = \frac{1}{2\pi \sqrt{LC}}$$

where f_0 = natural frequency of grid coil.
 L = inductance of grid coil.

Since only an approximate value of f_0 was required the value of C was assumed to be given by $\frac{Ca + Cb}{2}$.

[The theory of this method is fully explained in *J.I.E.E.*, Vol. 63, p. 397.]

The natural frequency of the grid coil was found to be 5.4×10^4 cycles/sec.

As far as the anode coil is concerned, we have to determine its natural frequency when it consists of two portions in parallel

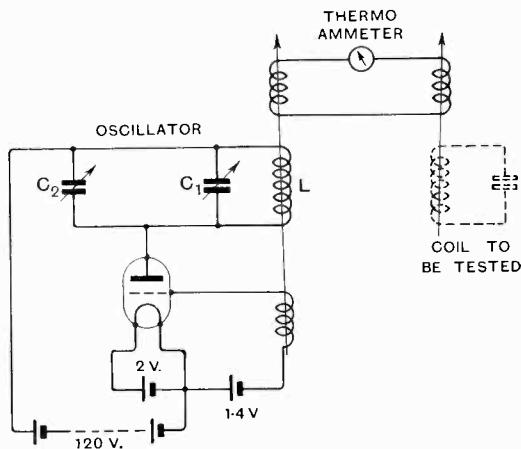

Fig. 8a.

and separated by the tapping point. To obtain this, the method indicated in Fig. 8c was used. The two ends of the anode coil were shorted, and one section of the coil (corresponding to a particular tapping point) was connected to the grid and filament terminals of the valve voltmeter (see Fig. 4) which has been used for the frequency measurements. C_1 and C_2 (see Fig. 8c) were then varied until an indication of resonance was obtained. The value of the capacity at resonance gave the means of calculating the natural frequency of the anode coil for the particular tapping point.

The frequency of the anode coil for the 0.8 tapping point was found to be 9.8×10^4 cycles/sec.

The natural frequency of the Hartley circuit was calculated as follows:—

Consider first the value of the stray capacity between the anode and grid.

From the curve of Fig. 6, the following values can be taken:—

Added capacity =	Cycles/sec.
1. 200 $\mu\mu\text{F}$ frequency	= 2.25×10^4
2. 300 $\mu\mu\text{F}$..	= 1.95×10^4
3. 400 $\mu\mu\text{F}$..	= 1.725×10^4
4. 600 $\mu\mu\text{F}$..	= 1.475×10^4
5. 1,200 $\mu\mu\text{F}$..	= 1.075×10^4

Let the stray capacity between the anode and grid be denoted by C . Then, since the same inductance was used in all the cases, we have from 1 and 3:—

$$\frac{400 + C}{200 + C} = \left[\frac{2.25}{1.725} \right]^2 = 1.7.$$

$$\therefore C = 86 \mu\mu\text{F}.$$

Similarly from 2 and 4: $C = 105 \mu\mu\text{F}$
and from 4 and 5: $C = 82 \mu\mu\text{F}$.

The average of these three results gives
 $C = 90 \mu\mu\text{F}$

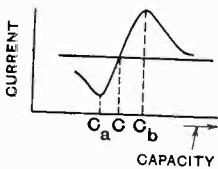

Fig. 8b.

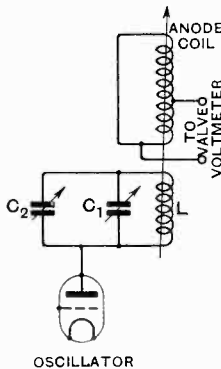

Fig. 8c.

Consider next the anode coil. This consists of two portions in parallel, and for a tapping position of 0.8 the value of each portion is:—

Larger part = $0.48 \times 0.8 = 0.384$ henry.

Smaller „ = $0.48 \times 0.2 = 0.096$ „

Inductance of these two portions in parallel = 0.077 henry. The mutual induction between the two parts is neglected. The inductance of the grid coil will remain unaltered, its value being 0.08 henry.

The Hartley circuit is therefore as shown in Fig. 9.

For the sake of simplicity we shall consider the case when the position of the grid coil is at 0 cm.; the mutual induction between the anode and grid coils is then extremely small, and the inductance of the anode and grid coil in series is then equal to 0.157 henry.

▶ The natural frequency of the Hartley circuit is then 4.18×10^4 cycles/sec.

The Parasitic Oscillatory Circuits.

From the knowledge of the natural frequencies it is now possible to give the values of each of the possible parasitic oscillatory circuits.

Consider the grid coil. Its natural frequency has been estimated as 5.4×10^4 , therefore its effective self capacity is practically 100 $\mu\mu\text{F}$.

Consider now the anode coil. For a tapping position of 0.8 the natural frequency is 9.8×10^4 and the inductance is 0.077 henry; therefore the effective self capacity is about 30 $\mu\mu\text{F}$.

The components of the Hartley circuit have already been estimated. A complete diagram is shown in Fig. 10, and from this figure it is seen that the possible oscillatory circuits are:—

Frequency =

1. The anode coil. 9.8×10^4 cycles/sec.
2. The grid coil. 5.4×10^4 „
3. The Hartley circuit. 4.18×10^4 „

From the frequency measurements of Test 2 it is seen:—

(a) The Hartley circuit oscillates for all positions of the grid coil in the case of "Position B."

(b) In the case of "Position A," the Hartley circuit oscillates at 24 cms. to 17 cms., and the anode coil oscillates at 17 cms. to 10 cms.

From the measurements of Test 4 it is seen that the grid coil will oscillate in the case of "Position B" if the Hartley circuit is prevented from oscillating by the insertion of a megohm in its circuit.

It is now necessary to explain why the oscillations change from one circuit to another, and to account for the measurements of Tables II and III.

The Effective Mutual Induction between the Anode and Grid Coils.

From the foregoing tests it is seen that the position of the grid coil influences the nature of the parasitic oscillation. Since the anode coil consists of two parallel portions during the presence of a parasitic oscillation, therefore the value of the mutual induction between the anode and grid coils is different from the value that it has when the valve is oscillating at the normal audio frequency.

The diagram, Fig. 9a, shows how the

current through the anode coil divides into two parts C_1 and C_2 .

These currents flow in opposite directions, and hence the mutual induction between each part of the anode coil and the grid coil must be of different sign. In the case of "Position B" for a tapping position of 0.8 the sign of the mutual induction between the larger portion of the anode coil, *i.e.*, the portion carrying C_1 and the grid coil is negative. The reason for this

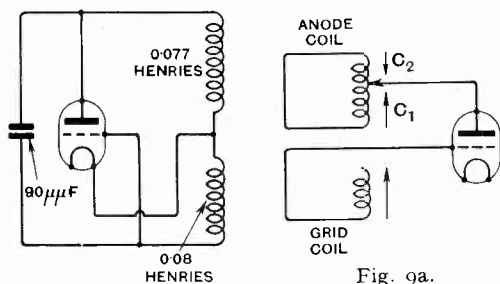

Fig. 9.

Fig. 9a.

will be seen when it is considered that the connections to the anode and grid coils are such that under normal conditions the audio oscillation would be maintained, *i.e.*, the sign of the mutual induction between the whole of the anode coil and the grid coil is negative.

Appendix I shows how the effective mutual induction between the anode and grid coils can be calculated when the Hartley oscillation is present, *i.e.*, when the anode and grid coils are in series.

The component mutual inductances given in the final equation for the value of the effective mutual induction between the anode and grid coils were measured. Table V gives the values of the effective mutual induction for all positions of the grid coil for both "Position A" and "Position B" for an anode tapping position of 0.8.

From the measurements given in Table V it is seen that whereas the sign of the mutual induction is negative for all positions of the grid coil in the case of "Position B," it is only negative after about 18 cms. in the case of "Position A."

The values of effective mutual induction given in Table V will only be true when the Hartley circuit is oscillating. Since the anode coil will consist of two portions in parallel if either the grid or the anode

TABLE V.
VALUES OF EFFECTIVE MUTUAL INDUCTION.
Position A.

Position of the Grid Coil.	M_2	M_3	M_a	M_g	Effective Mutual Induction.
0	0.01184	0.0093	0.00038	0.0038	0.0021
4	0.0186	0.01625	0.0079	0.0094	0.0087
8	0.0312	0.01754	0.00815	0.0071	0.0075
12	0.053	0.0304	0.0224	0.007	0.015
16	0.0822	0.03667	0.0178	-0.0136	0.0021
20	0.109	0.02835	0.0051	-0.0388	-0.0165
22	0.120	0.0224	-0.00115	-0.0531	-0.026
24	0.126	0.017	-0.0065	-0.049	-0.028

Position B.

0	0.0200	0.00145	-0.00665	-0.0032	-0.0049
4	0.03325	0.0020	-0.0079	-0.0078	-0.0079
8	0.0563	0.0029	-0.0102	-0.0144	-0.0123
12	0.08545	0.0042	-0.0136	-0.0296	-0.0216
16	0.1130	0.00717	-0.0143	-0.0468	-0.0305
20	0.1260	0.0123	-0.0112	-0.0592	-0.0352
22	0.1260	0.01595	-0.00765	-0.0532	-0.0304
24	0.1210	0.0220	-0.0010	-0.0510	-0.026

circuit oscillates, it can be assumed that Table V still gives an indication of the sign of the mutual induction if either of the latter two circuits oscillates, although the actual values of the mutual induction will not hold.

Explanation of the Results obtained in "Position B."

Table V has shown that the sign of the effective mutual induction between the anode and grid coils is negative for all positions of the grid coil in the case of "Position B." It is therefore possible for only the Hartley circuit or the grid coil to oscillate. The anode coil cannot oscillate because its natural frequency is above that of the grid coil, and hence the sign of the mutual induction must be positive for the anode coil to oscillate.*

The frequency measurements of Table II show that the Hartley circuit oscillates. The valve probably prefers to maintain this circuit in oscillation because it is the one which is most closely coupled to it.

* *Loc. cit.*, p. 731.

Test 4 has shown that the grid coil will oscillate if the Hartley oscillation is prevented.

The changes in frequency that take place as the position of the grid coil is varied (see Table II) can be explained as follows. If L_a is the effective inductance of the anode coil, L_g the inductance of the grid coil, and M the effective mutual induction between

will tend to lower the frequency of oscillation. Hence, while the increase of capacity is greater than the decrease in inductance, the frequency will fall, and on the latter predominating the frequency will rise. Fig. 7 shows this to be the case, the decrease in inductance predominating from 9 cms. to 22 cms. The low frequency at 24 cms. is probably due to the low value of effective mutual induction for this position of the grid coil (see Table V).

The changes in amplitude (see Table II) for this position can be explained as follows. The natural frequency of the grid coil was found to be 5.4×10^4 cycles/sec., when the inductance of the grid coil was at its normal value of 0.08 henry. When the grid coil is part of the oscillator its effective inductance is given by $L_g - M$, and its value changes as the position of the grid coil is varied. From Table V it is seen that the effective inductance of the grid coil is a minimum at 20 cms. The natural frequency of the grid coil will therefore be highest at 20 cms. and lowest at 0.2 cm. From Fig. 10 it is seen that the grid coil acts as a rejector circuit to an oscillation existing in the Hartley circuit; and, since the value of the natural frequency of the grid coil is near to the frequency of the Hartley oscillation, the grid coil will introduce a fairly high resistance into the Hartley circuit. The value of this

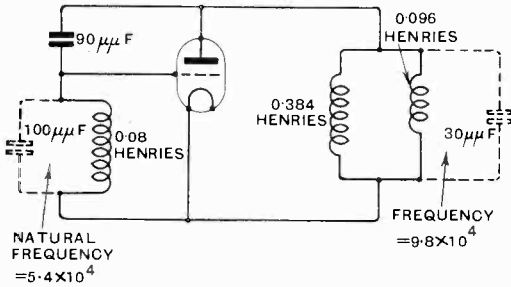

Fig. 10.

them, then, since the sign of M is negative, the effective inductance of the anode and grid coils in series is $L_a + L_g - 2M$. Therefore as the coupling between the anode and grid coils is increased, the effective inductance will be decreased. At the same time, since the grid coil is being moved nearer to the anode coil, therefore the

TABLE VI.

Position of the Grid Coil.	$Mg.$	$= \frac{L_{eff}}{Lg - Mg.}$	$\frac{I}{\omega L_{eff.}}$	$\frac{I}{R_{eff.}}$	R_{eff} in Ohms.	Theoretical Amplitude.
0.2 cms.	0.0036	0.0764	5.22×10^{-5}	2.71×10^{-5}	3.7×10^4	3.4 cms.
4 "	0.0063	0.0737	5.40×10^{-5}	2.90×10^{-5}	3.45×10^4	3.9 "
8 "	0.0147	0.0653	6.10×10^{-5}	3.60×10^{-5}	2.78×10^4	6.0 "
12 "	0.0294	0.0506	7.88×10^{-5}	5.37×10^{-5}	1.86×10^4	23 "
16 "	0.0486	0.0314	12.7×10^{-5}	10.2×10^{-5}	0.98×10^4	48 "
20 "	0.0570	0.0230	17.3×10^{-5}	14.8×10^{-5}	0.68×10^4	100 "
22 "	0.0560	0.0240	16.6×10^{-5}	14.1×10^{-5}	0.71×10^4	91 "
24 "	0.0510	0.0290	13.3×10^{-5}	11.2×10^{-5}	0.925×10^4	54 "

$L_g = 0.08$ henries.
 $c = 100 \mu F.$

$\omega = 2\pi \times 10^4 \times 4.$

$\omega C = 2.51 \times 10^{-5}.$

capacity between these coils, which has been shown in Test 4 to be part of the Hartley circuit, is increased. The decrease in effective inductance will raise the frequency of oscillation, whereas the increase in capacity

resistance will increase as the natural frequency of the grid coil approaches the frequency of the Hartley oscillation—that is, as the effective inductance of the grid coil is increased.

The effective resistance introduced into the Hartley circuit is given by:—

$$\frac{I}{R_{eff}} = \frac{I}{\omega Lg_{eff}} - \omega C.$$

Where C = self capacity of the grid coil.

= 100 $\mu\mu\text{F}$.

Lg_{eff} = effective inductance of the grid coil.

ω = $2\pi \times$ frequency of Hartley oscillation.

= $2\pi \times 4 \times 10^4$.

4×10^4 cycles/sec. is taken as a mean value for the frequency of the Hartley oscillation. The resistance of the grid coil is neglected.

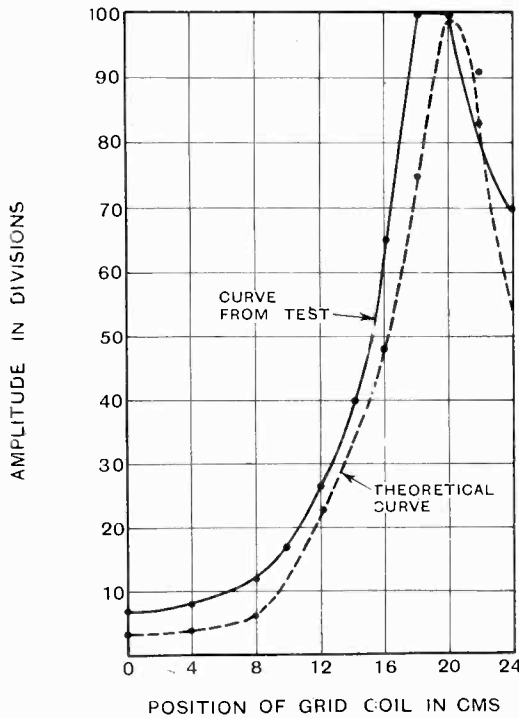

Fig. 11.

In Table VI the values of the effective resistance for different positions of the grid coil are given. Now the strength of the Hartley oscillation will decrease as the rejector resistance increases. It is assumed that in the method employed to measure the strength of the oscillation (see Test 2) the curved position of the detector valve characteristic was employed (this is prac-

tically true), then the galvanometer deflection is proportional to the square of the oscillation strength, and therefore proportional to

$$\frac{I}{R_{eff}^2}$$

In Table VI the column giving the theoretical amplitude was calculated on this basis, the amplitude for 20 cms. being used as the standard. The results are shown in Fig. 11, and from this figure it is seen that the theoretical amplitude changes in practically the same manner as the amplitude measured.

The changes in the frequency and amplitude as the position of the grid coil is varied can therefore be accounted for by considering the alterations in the effective mutual induction between the anode and grid coils.

Explanation of the Results obtained in "Position A."

The measurements of Table V show that the sign of the effective mutual induction is positive from 0.2 cm. to about 16 cms., and negative from about 16 cms. to 24 cms. for "Position A." For the first part it is therefore possible for the anode coil or the Hartley circuit to oscillate, and for the second part it is possible for the grid coil or the Hartley circuit to oscillate. The frequency measurements of Table III show that the anode coil oscillates from 10 cms. to 17 cms. and that the Hartley circuit oscillates from 17 cms. to 24 cms.

The absence of an oscillation from 17 cms. to 21 cms. (see Table III) can be accounted for as follows. In Test 3 it was shown that an oscillation could be detected during this interval if a condenser was connected across the anode and grid of the valve. This oscillation seemed to be confined to the same circuit as the one which oscillated from 24 cms. to 21 cms., i.e., the Hartley circuit (see Table IV): Now if, under normal conditions, the Hartley oscillation stops at 21 cms. owing to the fact that the resistance introduced by the rejector action of the grid coil has become excessive, then the oscillation can only be restarted if this resistance is reduced. This can be accomplished by increasing the difference between the frequency of the Hartley circuit and that of the grid coil. The effect of connecting a condenser across the grid and anode terminals

is to reduce the frequency of the Hartley circuit, and hence to reduce the rejector effect of the grid coil. This results in the Hartley circuit commencing to oscillate and continuing to oscillate until 17 cms.

In connection with this interval another point arises. When the Hartley circuit ceases to oscillate at 21 cms. it should be possible for the grid coil to oscillate. Reference to Table V shows that between 20 cms. and 16 cms. the mutual induction changes sign. Now the figures in this table cannot be regarded as very accurate, since to obtain them it has been assumed that the same current flows in the grid and anode coils. Actually these currents will differ owing to the fact that each coil has a self-capacity, and these self-capacities are not of the same value. Therefore it is quite possible that the actual value of the effective mutual induction is less than that given in Table V, and hence it will be too small to maintain an oscillation in the grid coil. It is also possible that the change in the sign of the mutual induction actually takes place before 20 cms., and hence it would be impossible for the grid circuit to oscillate. The positive value of the mutual induction at this point would probably be too small to maintain an oscillation in the anode circuit (see below).

The absence of an oscillation after 10 cms. must now be accounted for. It is probable that the anode circuit ceases to oscillate after 10 cms. because the magnitude of the mutual induction has become too small.

Now when the frequency of the anode circuit is above that of the grid circuit, the greater the difference between these two frequencies the greater is the value of the mutual induction required to maintain an oscillation in the former circuit.*

Therefore, to maintain an oscillation in the anode circuit for the given value of the mutual induction, the frequency of the anode circuit must be reduced.

It was found that if a condenser of about 25 $\mu\mu\text{F}$ was connected across the anode coil, an oscillation of frequency corresponding to that of the altered anode circuit could be detected. From this we can deduce that the oscillation ceases at 10 cms. because of the low value of the effective mutual induction.

* *Loc. cit.*, p. 732.

The Hartley circuit does not oscillate after 10 cms. because the value of the effective resistance introduced into its circuit is sufficiently high to stop the Hartley oscillation.

Relation between Parasitic Oscillation and Position of Tapping Point.

So far we have been mainly concerned with the behaviour of the oscillator for a particular tapping position, *i.e.*, 0.8 of "all in." The nature of the oscillations for this position have been considered without reference to the other positions of the tapping point. It was therefore determined to see what effect the other tapping points had on the parasitic oscillations.

The circuit of Test 2 was used, the position of the grid coil was varied, and for each tapping position the presence of a parasitic oscillation was determined by means of the detector shown in Fig. 4.

The tuning circuit of this detector was capable of covering a wide range of frequencies; hence, if an oscillation was present, there was little chance that it would be missed.

TABLE VII.
BEHAVIOUR OF THE PARASITIC OSCILLATIONS.
Position A.

Position of Tapping Point.	Behaviour of the Parasitic Oscillations.	
	Stops at :	Then continues from :
0.9	20.0 cms.	16.0 to 10.2 cms.
0.8	21.0 "	17.0 " 10.0 "
0.7	20.5 "	16.5 " 9.0 "
0.6	20.0 "	14.5 " 7.2 "
0.5	20.4 "	
0.4	21.0 "	
0.3	21.6 "	14.5 " 5.8 "
0.2	21.7 "	15.6 " 3.5 "
0.1	22.0 "	16.2 " 1.5 "

Position B.

0.9	} Present for all positions of the grid coil.	Start at :	24.0 cms. and continue to the end.
0.8			
0.7			
0.6			
0.5			
0.4			
0.3			
0.2			
0.1			

Table VII shows the behaviour of the oscillator for both "Position A" and "Position B" for the different tapping positions. From this table it is seen that in the case of "Position A" there was an interval during which the parasitic oscillation disappeared. Also the parasitic oscillation ceased at some definite point for each position of the tapping point. It is the last point which accounts for the difference in the shape of the curves shown in Fig. 3, for from Table VIII given

TABLE VIII.

Position of Tapping Point.	Value of Mutual Induction at which Parasitic Oscillation Stops.	Value of Mutual Induction at which Audio Oscillation Stops.	Theoretical Value of Mutual Induction required.
	Henries.	Henries.	Henries.
0.9	0.053	0.052	0.049
0.8	0.060	0.048	0.045
0.7	0.046	0.043	0.040
0.6	0.054	0.039	0.036
0.5	0.136	0.034	0.032
0.4	0.138	0.031	0.029
0.3	0.045	0.029	0.027
0.2	0.033	0.0325	0.029
0.1	0.025	0.057	0.040

The theoretical value of the Mutual Induction required was obtained from the formula :—

$$M = \frac{RRaC}{mb} + bL$$

where *b* = position of tapping point and *R*, *C* and *L* refer to the resistance, capacity and inductance, respectively, of the audio circuit.

above it is seen that in the case of each tapping position (excepting 0.1) the parasitic oscillation ceases before the audio oscillation. Hence, as far as the "tap-mutual induction" curve is concerned, the parasitic oscillation will not interfere with the shape of that curve. With reference to the 0.1 tapping position, reference to Table VIII shows that in this case the difference between the actual and theoretical values of the mutual induction is greatest for this position, thus indicating that the presence of the parasitic oscillation does interfere with the audio oscillation.

From Table VII it is seen that in the case of "Position B" the parasitic oscillation once started continues for all positions of the grid

coil and for all tapping positions. Therefore the parasitic oscillations will interfere with the shape of the "tap-mutual induction" curve.

Effect of Preventing the Parasitic Oscillation in the Case of "Position B."

It has been shown that the parasitic oscillation is confined to a Hartley circuit in the case of "Position B." Now this oscillation can be prevented by the insertion of a suitable condenser and resistance in its circuit. The value of the condenser and resistance required can be calculated as follows :—

The condition for the maintenance of oscillations in a Hartley circuit is given by :—

$$CRRa(L_1 + L_2 \pm 2M) < (L_1 \pm M) [m(L_2 \pm M) - (L_1 \pm M)]$$

Where *L*₁ = inductance of anode coil = 0.077 henry.

*L*₂ = inductance of grid coil = 0.08 henry.

M = mutual induction between the coils.

C = capacity of Hartley circuit.

R = resistance of Hartley circuit.

Ra = internal resistance of the valve = 22,000 ohms.

m = amplification factor of the valve = 9 ohms.

Therefore, for a given valve and a given *L*₁, *L*₂ and *M*, the Hartley oscillation can be prevented by increasing *C*, *R*, or their product.

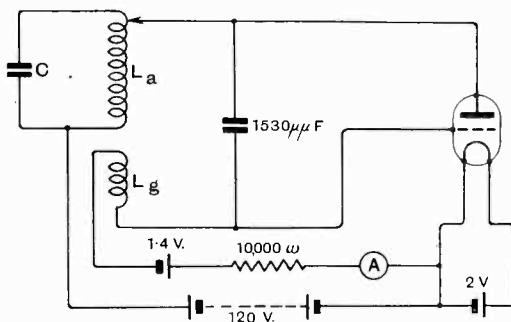

Fig. 12.

For a capacity of 1,530 μF and zero mutual induction, the resistance required to stop the Hartley oscillation is 10,000 ohms.

The circuit of Fig. 1 was therefore used with the addition of a 10,000 ohms non-inductive resistance which was placed in the grid circuit, and a condenser of 1,530 $\mu\mu\text{F}$ placed between the grid and anode. These modifications are shown in Fig. 12.

The curve marked "Position B" in Fig. 13 shows the effect of adding this resistance and condenser.

In addition it was found that for all values of the mutual induction below that required to produce audio oscillations no deflection was obtained in the grid ammeter, thus indicating that there was no parasitic oscillation present.

Conclusions.

1. The difference in the behaviour of the oscillator for "Position A" and "Position B" is due to the presence of parasitic oscillations.

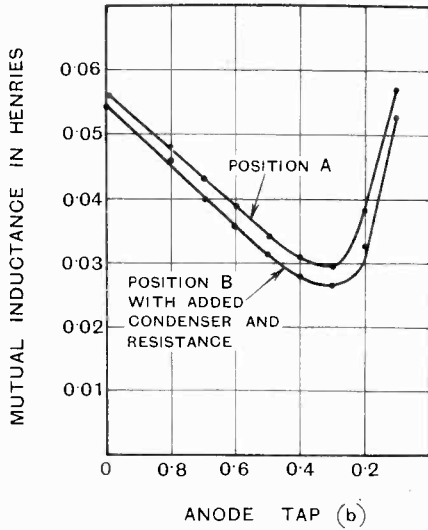

Fig. 13.

2. In the case of "Position A" these oscillations are confined to the anode circuit for some positions of the grid coil, and to a Hartley circuit for other positions of the grid coil. Also the parasitic oscillations stop at some definite position of the grid coil for each tapping point. In all cases (except the 0.1 tapping point) the parasitic oscillation stops before the legitimate audio oscillation.

3. In the case of "Position B" the Hartley circuit oscillates for all positions of

the grid coil and it is not until this oscillation is prevented by the addition of a suitable resistance and condenser that the "tap-mutual induction" curve becomes the same for this position as for "Position A."

APPENDIX I.

TO DETERMINE THE EFFECTIVE MUTUAL INDUCTION BETWEEN THE ANODE AND GRID COILS.

The figure given below shows the arrangement of the anode and grid coils when they are connected in series.

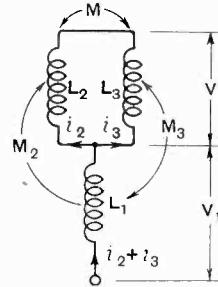

In this figure :

- L_2 and L_3 = inductance of the respective portions of the anode coils separated by the anode tap.
- L_1 = inductance of grid coil.
- M = Mutual induction between the portions of the anode coil separated by the anode tap.
- M_2 = Mutual induction between the grid coil and L_2 .
- M_3 = Mutual induction between the grid coil and L_3 .

The signs of all the quantities are assumed positive.

Assume that a voltage V is applied to the anode coil, and that a voltage V_1 is applied to the grid coil, and let the resulting currents be as shown in the diagram.

Neglecting resistance, we have for the anode coil :—

$$V - j\omega M_2 (i_2 + i_3) - j\omega M i_3 = j\omega L_2 i_2 \quad \dots 1$$

$$V - j\omega M_3 (i_2 + i_3) - j\omega M i_2 = j\omega L_3 i_3 \quad \dots 2$$

Adding 1 and 2, we have :—

$$2V = j\omega [(i_2 + i_3)(M + M_2 + M_3) + L_2 i_2 + L_3 i_3] \quad \dots 3$$

Subtracting 2 from 1, we have :—

$$i_2(M - M_2 + M_3 - L_2) = i_3(M + M_2 - M_3 - L_3) \quad \dots 4$$

∴ from 3 and 4 we have :—

$$\frac{V}{i_2 + i_3} = j\omega \left[\frac{M_3(M - L_2) + M_2(M - L_3) + M^2 - L_2 L_3}{2M - L_2 - L_3} \right]$$

∴ the effective inductance of the anode coil is given by :—

$$L_{eff} = \frac{M_3(L_2 - M) + M_2(L_3 - M) - M^2 + L_2 L_3}{L_2 + L_3 - 2M}$$

$$= \frac{L_2 L_3}{L_2 + L_3 - 2M} + \frac{M_3(L_2 - M) + M_2(L_3 - M) - M^2}{L_2 + L_3 - 2M} \quad \dots 5$$

Now $\frac{L_2 L_3}{L_2 + L_3 - 2M}$ is the normal inductance of L_2 and L_3 in parallel. Therefore expression 5 may be written :—

$$La_{eff} = La + Mg \quad \dots \quad 6$$

Consider now the grid coil. As before :—

$$V' - j\omega(M_2 i_2 + M_3 i_3) = j\omega L_1 (i_2 + i_3) \quad \dots \quad 7$$

From 4 and 7 we have :—

$$\frac{V'}{L_2 + L_3} = j\omega \left[\frac{L_1(L_2 + L_3 - 2M) + M_2(L_3 - M) + M_3(L_2 - M) - (M_2 - M_3)^2}{L_2 + L_3 - 2M} \right]$$

$$\therefore Lg_{eff} = L_1 + \frac{M_2(L_3 - M) + M_3(L_2 - M) - (M_2 - M_3)^2}{L_2 + L_3 - 2M} \quad 8$$

which may be written :—

$$Lg_{eff} = Lg + Mg \quad \dots \quad 9$$

From 6 and 9 :—

$$La_{eff} + Lg_{eff} = La + Lg + 2 \left(\frac{Ma + Mg}{2} \right)$$

\therefore the effective mutual induction between the anode and grid coils is given by :—

$$M_{eff} = \frac{Ma + Mg}{2} = \frac{M_2(L_3 - M) + M_3(L_2 - M)}{L_2 + L_3 - 2M} - \left[\frac{M^2 + (M_2 - M_3)^2}{2(L_2 + L_3 - 2M)} \right]$$

In the oscillator under consideration M_2 is negative (see p. 141)

$$\therefore M_{eff} = \frac{2[M_3(L_2 - M) - M_2(L_3 - M)] - M^2 - (M_2 + M_3)^2}{L_2 + L_3 - 2M}$$

$$\text{also } Ma = \frac{M_3(L_2 - M) - M_2(L_3 - M) - M^2}{L_2 + L_3 - 2M}$$

$$\text{and } Mg = \frac{M_3(L_2 - M) - M_2(L_3 - M) - (M_2 + M_3)^2}{L_2 + L_3 - 2M}$$

ERRATA.

“ THE STABILITY OF THE TUNED-GRID TUNED-PLATE H.F. AMPLIFIER.”

Equation 19 should read :—

$$k/H = g[1 - G \cdot \sigma_v/g]/G^2 \cdot C_0 \cdot \Omega \quad \dots \quad (19)$$

and Equation 21 should read :—

$$[k/H] [C_0 \cdot \Omega \cdot g/\sigma_v^2] = [1 - G \cdot \sigma_v/g] [g/G \cdot \sigma_v]^2 \quad \dots \quad (21)$$

What is the Correct Characteristic for a Variable Condenser?

By *Lieut.-Col. K. E. Edgeworth, D.S.O., M.C., A.M.I.E.E.*

THEORETICALLY the resonant frequency of a tuned circuit may be adjusted either by varying the capacity or by varying the inductance, but for practical reasons the employment of variable condensers in wireless receivers is almost universal.

In the earliest variable condensers the shape of the moving plates was semi-circular, so that the capacity in circuit was approximately proportional to the angular movement of the dial over the greater part of the working range. Of recent years condensers have been designed so as to give other characteristics, and the shape of the plates has been varied accordingly. There have been plates designed to give a straight line relationship between wavelength and angular movement, or between frequency and angular movement, and plates giving an exponential characteristic, and plates giving no obvious characteristic at all.

With this variety of types to choose from it is natural that the user should ask himself what type is really the best, and the object of the present paper is to assist him in arriving at a correct answer.

The dial of a wireless receiver is usually calibrated in degrees, and the user of the instrument is expected to interpret the readings by means of a calibration chart. It is to be hoped, however, that this very cumbersome expedient will soon be abolished. There is no serious difficulty in calibrating the dials of a receiver directly in metres, and the advantages of doing so are obvious.

The construction and use of a calibration chart is facilitated if the characteristic which is being plotted is approximately linear. Not only are fewer calibration points required, but the curve itself will possess a higher degree of accuracy.

In Europe the metre is the unit which is most commonly employed, and it is therefore convenient to use condensers having a straight line wavelength characteristic. For the same reason condensers with a straight line frequency characteristic would be con-

venient in America. The argument has not very much force, however, since it is open to wireless engineers to describe transmissions by means of either unit.

The allotment to transmitting stations is governed by the need for avoiding interference, and the interval between the wavelengths allotted is usually fixed at some definite number of cycles, say, 20,000 cycles for telephony, and 2,000 cycles for telegraphy.

When stations are tuned in on a receiver there is usually a tendency for the stations to crowd together at the shorter wavelengths, the intervals between stations being somewhat as shown in Table I.

TABLE I.

Kilo-cycles.	Metres.	Interval between Stations.		
		A.	B.	C.
1,200	250.0	1.85°	2.1°	4.6°
1,180	254.2			
560	535.7	12.4°	9.9°	4.6°
540	555.5			

- A. Semi-circular plates.
- B. Straight line wavelength.
- C. Straight line frequency.

It is argued on behalf of the straight line frequency condenser that various transmitting stations should be equally spaced on the dial of the receiver, and it will be observed that the straight line frequency condenser possesses this characteristic.

The validity of this contention is open to question, however, and it is desirable to look into the matter a little more closely.

The fundamental purpose of the variable condenser is to enable the receiver to be adjusted in such a manner that the distant station is received at maximum strength, and it is necessary that the instrument should be capable of being adjusted to a certain specified degree of accuracy at all points of the scale.

The degree of accuracy required may be defined by saying that it must be possible to adjust the condenser so that the signals are within 90 per cent. of maximum strength, or any other desired percentage may be selected. For our present purpose it is sufficient to agree that some standard is desirable, but it is not necessary to fix any particular standard except for purposes of illustration.

The ease with which the receiver can be adjusted depends upon the selectivity, the size of the dial, the ratio of the gearing (if any), and so on; but it is evident that any desired standard of accuracy can be most readily secured when the facilities for accurate adjustment are equal at all points of the scale.

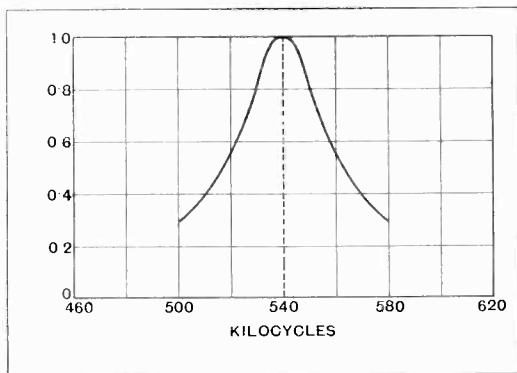

Fig. 1.—Selectivity at 550 metres.

The question of selectivity has been analysed in *E.W. & W.E.* in a paper by P. K. Turner,* and the analysis shows that the selectivity of the tuned circuit varies inversely as the tuning capacity or nearly so.

This is illustrated in Figs. 1 and 2, which show the selectivity of the same amplifier at 550 and at 250 metres respectively. With a multi-stage amplifier the curves would be different, but the relative selectivity at the two different settings would remain unchanged. In either case the instrument is more than four times as selective at 550 metres as it is at 250 metres.

Assume that the receiver comprises a single tuned circuit having a tuning capacity

of $500\mu\text{F}$. at 555.5 metres, and that the valve has an anode A.C. resistance of 20,000 ohms. Then the error in setting which will reduce the desired signal to 90 per cent. of the maximum is given in Table II.

TABLE II.

Kilo-cycles.	Metres.	Allowable Error in Tuning.		
		A.	B.	C.
1,200	250.0	3.1°	4.1°	4.5°
540	555.5	3.1°	2.3°	1.0°

- A. Semi-circular plates.
- B. Straight line wavelength.
- C. Straight line frequency.

At 555 metres it will be observed that the adjustment on the straight line frequency condenser is more than twice as critical as it is on the straight line wavelength type and three times as critical as it is on the condenser with semi-circular plates. Judged according to this standard the condenser with the semi-circular plates is the best and the straight line frequency condenser is the worst.

In order to reach a perfectly logical conclusion it would be necessary to estimate the relative importance of equal spacing of stations on the one hand and equal facility of adjustment on the other, and this seems hardly possible. It is interesting to observe, however, that the use of gearing increases the ease of adjustment and makes it less neces-

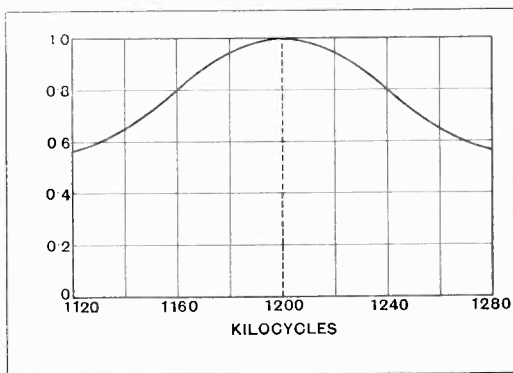

Fig. 2.—Selectivity at 250 metres.

sary to provide uniformity in this respect. On the other hand it may be argued that the provision of a large dial accompanied

* *E.W. & W.E.*, October, 1925.

by uniform or nearly uniform facility of adjustment may render the use of gearing unnecessary.

The usual solution to a problem of this sort is a compromise, and attention is naturally directed to the straight line wavelength condenser which is seen to occupy an intermediate position between the other two.

The position may be summed up by saying that the straight line wavelength condenser possesses the following advantages:

(i) It avoids the very close crowding of stations which occurs on short wavelengths with condensers having semi-circular plates.

(ii) It avoids the very critical tuning

adjustment which is necessary on long wavelengths with condensers having a straight line frequency characteristic.

(iii) In Europe, where the unit employed is the metre, the calibration curve is a straight line, and the construction of instruments reading directly in metres is facilitated.

It is perhaps desirable to add a warning that many of the condensers advertised as square law condensers do not give a straight line relationship between wavelength and angular movement. The correct curve, to a first approximation, has been given by W. H. F. Griffiths in *E.W. & W.E.* for January, 1926.

Book Reviews.

THE PROPAGATION OF RADIO WAVES ALONG THE SURFACE OF THE EARTH AND IN THE ATMOSPHERE. By P. O. Pedersen. Pp. 244+19. Published by G. E. C. Gad, Vimmelskaftet 32, Copenhagen. 15 Kr.

This is a most important publication. Although written by a Dane and printed and published in Denmark, it is written in perfect English. Anyone acquainted with Prof. Pedersen's work on the Poulsen Arc and other subjects will expect to find the subject dealt with in a thoroughly scientific and accurate manner. Their expectations will be amply fulfilled, for the book represents a masterly analysis of the subject. It is dedicated "to my friend Dr. Valdemar Poulsen who twenty years ago and first of all demonstrated perfect radio telephony." The book is really in two volumes, as a number of curves and nomograms are bound separately in a 19-page appendix. The book is divided into 11 chapters and each chapter is subdivided into a number of sections, each section dealing with a definite subject and giving references to the various authorities on that subject. The author has attempted to give a connected physical theory of radio wave propagation; as he says in the preface, "the main basis of such a theory must be the state of ionisation and the electrical and optical properties of the atmosphere and it has therefore been necessary to discuss such questions as air pressure at high altitudes, mean values of free path for the electrons and ions, sources of radiation, etc." In working out the necessary formulæ for the influence of electrons and ions, and of the magnetic field of the earth on the propagation of waves, the author says that he has not aimed at mathematical elegance and brevity but has tried to carry out the calculations in such a way that the physical aspect of the question is never lost sight of.

The work is quite up to date, although, as the author says, the development has been so rapid that many of the most important papers bearing on the subject have appeared during the printing

of the book. We noticed a reference to a paper which appeared in *E.W. & W.E.* as recently as May, 1927, and all the recent work of Appleton and Barnett, Breit and Tuve and others is discussed in detail.

It is a book which no one interested in the subject can afford to be without.

THE INTERACTION OF PURE SCIENTIFIC RESEARCH AND ELECTRICAL ENGINEERING PRACTICE. By Prof. J. A. Fleming, F.R.S. Pp. x.+235, with 64 Figs. Constable. 15s.

"In the following pages we shall attempt to show the manner in which the electrical industry is based essentially on, and advanced by, pure scientific research, and also the manner in which technology repays its debt to pure science by providing new materials or appliances or larger opportunities for experiment, and so advances our knowledge of the processes at work in Nature." This quotation from the introduction indicates the object of the book, which is an expansion of a course of eight public lectures delivered by the author in the spring of 1926. "As it would be difficult to deal with the subject apart from specific instances, the objects in view can best be attained by discussing a limited number of branches or special departments of electrical engineering and endeavouring to show in each and all of them that technical advances have, in general, been due to previous or contemporary scientific investigations, which have, at the time they were made, no other aim than that of a disinterested advancement of scientific knowledge." The eight lectures are represented by eight chapters dealing with: (1) insulation and conduction, (2) ferromagnetism, (3) thermionics, (4) glow and arc discharges, (5) telephony, (6) surges and pressure rises, (7) electrochemistry and metallurgy, (8) electrical measurements. The book is what one would expect from a lecturer and writer of Dr. Fleming's calibre and reflects his long and intimate acquaintance with the various branches of electrical science. A reader

with a certain amount of scientific knowledge will obtain a very good idea of the history of the various branches of electrical engineering dealt with in the book, and it can be unreservedly recommended to any reader of *E.W. & W.E.* The chapter on ferromagnetism includes a very interesting illustrated account of Mr. Mordey's wonderful and puzzling research on the separating of magnetic ores by means of alternating currents. In the chapter on thermionics we think that the author might have been a little more generous in his references to Dr. de Forest's share in the invention of the three-electrode valve. The chapter on glow and arc discharge describes the various vacuum tubes now so popular for illuminated signs and also the mercury arc rectifiers now so largely used for power purposes. Under surges and pressure rises the author describes the various devices for protecting apparatus from their effects. The subject of electrochemistry and electrometallurgy provides many examples of the application of research to commercial problems, various electric furnaces being described. The final chapter describes the development of accurate units and standards of measurement of the various magnitudes involved in electrical engineering, the most recent piece of pure science to be harnessed being the piezoelectric effect. Prof. Fleming is to be congratulated on making these lectures accessible to those who were denied the pleasure of hearing them.

A STUDY OF RADIO DIRECTION FINDING—SPECIAL REPORT NO. 5 OF THE RADIO RESEARCH BOARD. Prepared by R. L. Smith-Rose. 37 pp. Published by H.M. Stationery Office. Price 1s. 6d.

Several reports have already been issued dealing with the work of the Committee on Directional Wireless. The present one summarises the progress made during the last five years and gives a comprehensive survey of the subject. A theoretical discussion is also given, indicating the contribution which the study of direction finding has made to the solution of the problem of wave propagation. On the practical side one of the most important results of the research was the discovery at a late stage that Adcock had patented a system in 1919 which completely eliminates the night effect and gives practically correct bearings under all circumstances. The report concludes with the statement that the practical development of this system is now being pursued. A bibliography gives 60 references to publications dealing with direction finding. Anyone wishing to obtain a good knowledge of the history and present position of the subject could not do better than study this report.

THE THERMIONIC VALVE. By Fred Goddard. Pp. 192. Mills & Boon. Price 3s. 6d. net.

This is a popular non-mathematical book in which the valve is described in clear, simple language. After an introduction, the manufacture of a valve is described step by step, then the action of a valve in detection and amplification; this is followed by a description of the ways in which valves are used in different circuits. The last 50 pages are devoted to a number of valve circuit diagrams. On the whole, the book is clearly written,

but it is not always so clear as it might be. We wonder if there is any evidence that the magnesium mirror on the inside of the bulb absorbs gas liberated during the life of the valve. It may be so. On page 34 the temperature coefficient of resistance of tungsten is given as 0.400; it should be 0.004. "Anode impedance" is always employed and designated by "R" in spite of a table giving "Z" as the symbol for impedance. The statement on page 75 that "the usual method of producing a valve with a high M value is to set the grid . . . near the filament and the anode a comparatively long distance away. The effect of this facilitates filament current flow while retarding anode current flow" is very strange. How it can affect the filament current flow is difficult to understand. On page 77 the numerical example is far from clear, while on page 80 the statement that "the number of electrons emitted per second is proportionate to the temperature of the filament—in other words, the amount of current passing through it" makes one wonder what meaning the author attaches to the word "proportionate." The same applies to the term "overall efficiency" on page 91, where we are told that "the best valves to procure are those which possess the highest overall efficiency. This is a combination of several efficiencies. The most important of these are (1) thermal efficiency, (2) characteristic efficiency, (3) life efficiency, (4) microphonic efficiency." A useful word is "efficiency." We will conclude with a good example of Mr. Goddard's style: "Signals launched into space at a point round the periphery of the earth antipodal to the receiver are constantly recorded, and even in the attenuated atmosphere which some of our high-climbing aviators have reached the thermionic valve has proved susceptible to impulses from the earth over hundreds of miles."

LES FILTRES ÉLECTRIQUES: L'ALIMENTATION DES POSTES RÉCEPTEURS. By M. Veaux. Pp. 242 with 227 Figs. Librairie del enseignement technique. Paris.

A better title would be "The power supply to receivers, with special reference to filters or smoothing devices." Of the four chapters, the first is devoted to primary cells and secondary batteries; the second to the theory of filters; the third to battery charging devices; and the last to the supply of filament and anode current from D.C. and A.C. mains.

The treatment of the subject of filters is very clear, with just sufficient mathematics to enable one to design a filter of given approximate characteristics, without going into the more complex aspects of the question. For battery charging from A.C. mains various rectifiers are described, including gas, electrolytes, colloidal silver and mercury vapour, as well as several of the mechanical type; we could not find any reference to the copper oxide type. The final chapter deals with the various methods of supplying anode and filament currents from D.C. and A.C. mains. The book is clearly written and numerical values are given in nearly every case considered. It is a book which can be recommended.

G.W.O.H.

The Effect of Weather Conditions on Long-Distance Reception.

By S. K. Lewer.

Introduction.

IT is intended in this paper to give an outline of the further investigations carried out along the lines of the experiments described in the writer's "Notes on the Conditions Governing Transatlantic Reception."¹ After the end of 1925 several experimenters commenced systematic observations on long-distance reception and its variations, in an attempt to connect these variations with changes in the weather. The general practice was to observe the changes in the *local* atmospheric pressure, temperature, etc. The writer compared the curve showing the variations in the *local* atmospheric pressure for every day during 1924 and 1925 with the curve showing the variations in the conditions for transatlantic reception, as obtained from the log-books. For isolated periods of three or four weeks the two curves took the same shape, but the resemblance was too vague to allow any definite conclusions to be formed. Attempts to connect the variations with the changes in the temperature, cloud and wind, have similarly proved fruitless. In fact, there is every reason to believe that the changes in local conditions are of no interest whatever, when dealing with long-distance reception. The connection, if any, must be looked for in the changes in the space between the transmitting and receiving stations. We have evidence,² but very unreliable evidence, of an apparent connection between reception conditions and the phases of the moon. It must be borne in mind, however, that if the experiments dealing with the subject in general are to be of any practical or theoretical use, particularly in connection with the phases of the moon, they must be carried out over long-continued periods. The evidence drawn from experiments covering periods of one or two months is not sufficiently reliable. The period must be

long enough for generalisations to be made. While dealing with the effect of the moon, the writer wishes to repeat here that from all the experiments he has made he has not found any connection between the phases of the moon and reception conditions. From the experiments it was found that the moon may vary in coincidence with the reception conditions for about one month, but later in the year it may be completely out of step. This is not evidence to show that the moon has no effect on reception: its effect, if any, may be masked at certain

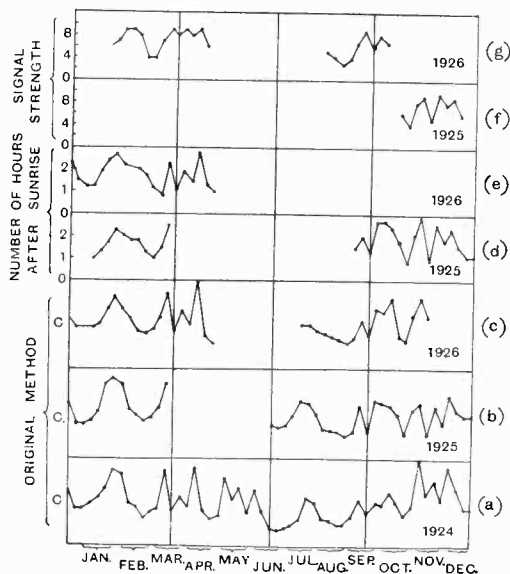

Fig. 1

periods by some other more potent factor. The moon probably affects reception by the tidal movements of the atmosphere which would result in changes in the refracting and reflecting properties of the ionised regions.

Variations in the Reception Conditions.

As stated in the article mentioned above,¹

¹ E. W. & W.E., Dec., 1925, p. 958.

² E.W. & W.E., July, 1926, p. 429.

the curve showing the variations in radio conditions (for transatlantic reception) throughout the year 1924 was followed in the first part of 1925 by a curve coinciding in shape with the curve for 1924. Much will be said about this curve, so it is repeated here for convenience in comparing it with the other curves to be described (see Fig. 1 (a)).

For the sake of brevity, the measure of conditions for long-distance reception will, for present purposes, be called C ; that is to say, when long-distance reception is particularly good the value of C is high, and conversely, when conditions are poor C is low.

As the result of continued investigations it can be said with some certainty that the curve is similar every year, that is, the periods of good and bad conditions recur in the same sequence every year. The considerations by which this conclusion was reached will be given later. From Fig. 1 (a) it appears that the second half of the curve is similar (in the fluctuations up and down, but not in the absolute values of C) to the first part of the curve; in other words, the curve is repeated every six months. However, the writer does not wish to lay too much stress on this apparent six-monthly repetition. It may be a mere accident, an error incurred in some way, or it may be an aid in solving these problems. On considering the *annual* repetitions it appears that the variations are caused by some solar influence, direct or indirect (assuming that the position of the earth relative to the solar system has no effect on the value of C). The sun may be held responsible for the usual gradual change in C from summer to winter. There is no doubt about this. The very much more abrupt changes represented in the curve are very irregular throughout each half of the year, and it is improbable that these changes are caused *directly* by the sun. More probably the changes are due to some complex cyclical change. This cycle of changes, whatever its nature may be, and however complex, must be repeated annually. Other variable factors, quite independent of the sun, may be responsible for the particularly low and high values of C . It must be pointed out here that although the curve takes the same *shape* every year,

in the sense that the maxima and minima of one year coincide as regards the time of the year with the maxima and minima of any other year, yet the respective values of C may not be the same in any two years. In practice the determination of the absolute value of C is much more difficult than the determination of the changes in the value of C , or, in other words, it is more difficult to say whether the conditions on any given night are good or bad for the time of the year, than it is to say, whether the conditions are improving or deteriorating. Hence, too much attention must not be paid to the actual values of C . If the exceptionally high and low values of C are due to experimental errors, then it is possible that there are *no* factors which are *independent* of the sun, that is, that all the variations are caused (directly or indirectly) by the sun. At any rate, in this paper only the changes which are repeated annually will be dealt with, and irregular effects, if any, will be disregarded. Before proceeding further it would be advisable to give the detailed evidence the writer has for believing that the changes in C represented by the curve in Fig. 1 (a) are repeated annually.

Evidence for Annual Repetition of Changes in C .

For the greater part of 1925 the writer continued observations on the signals from amateurs in North America and Brazil. The observations consisted mainly in determining the number of stations audible in a given period of time (generally one hour). This was the original method used by the writer in drawing the curve in Fig. 1 (a). The curve obtained for 1925 by this method is shown in Fig. 1 (b). It is remarkably similar to the curve for 1924, the only real difference being that on one or two occasions a maximum or minimum value of C on one curve would occur a week before or behind the corresponding maximum or minimum on the other curve. The corresponding values of C were not always the same, but, as explained above, it is not the *absolute* values of C but the *changes* of C which are important.

Another method of observation used by the writer was the determination of the length of time after sunrise of the "moment"

when the signals at last became inaudible. This "moment" was generally of about 10 minutes' duration, and yielded fairly definite results, since the length of time after sunrise was, on the average, about two hours. It may be seen that the curve obtained by this checked very closely with the other curves. See Fig 1 (d). The writer outlined this method in the description of the original experiments¹ and offered four objections to it, but in the light of further evidence it appears to be a fairly satisfactory and convenient method.

A third method was used for a short period: this was the determination of the signal-strength of one particular station at the same time each night. The station in this case was WIZ, the R.C.A. station at New Brunswick, working with high power on 43.02 metres. The signal-strength was estimated aurally by the familiar "R" standard. This is usually considered to be a very unsatisfactory method, but as the signal-strength variation was large (from R3 to R9) the results were not regarded as being quite useless. The curve produced is shown in Fig. 1 (f), and it can be seen that as far as it continues it checks closely with all of the other curves. The "shunted-phones" method of measuring the signal-strength was given a trial, but, due to various causes, it was found to be no more accurate than the method of estimation by the "R" standard. Since the station was sending in morse, all ballistic or dead-beat galvanometers were out of the question; in either case the deflection would depend upon the speed of sending. These methods were continued to some extent during a part of 1926, and the curves obtained all checked with the original curve with a considerable degree of accuracy. The curves for 1926 are shown in Fig. 1 (c, e, g). These, and the 1925 curves, correspond to the wavelength band of 35-40 metres, whereas the 1924 curves correspond to the wavelength bands of 150-200, 100-110, and 35-40 metres. Here are several curves obtained by three different independent methods. Apart from occasional discrepancies, all the curves are of the same shape, indicating maximum and minimum values of C on approximately the same dates in three successive years. The evidence given here is considered to be

¹ *E.W. & W.E.*, Dec., 1925, p. 958.

sufficient to show that the changes are repeated annually.

Possible Causes of the Variations.

It is very interesting to note that similar variations in C for very long waves have been observed. L. W. Austin has produced curves³ showing the variations during 1922-3-4 in the field-strength received in North America from LY, Lafayette, France, the wavelength being 18,900 metres. Only monthly changes are given, but for the greater part of the three years the curves correspond to the curve shown in Fig. 1 (a) which was drawn from observations on waves of under 200 metres. The extent of the variations in the field-strength observed on the 18,900 metre wave was as much as 50 per cent. reduction from the maximum during some months. The characteristics of these long waves are much more stable than those of waves of less than, say, 300 metres. If these long waves are affected throughout the year in a manner similar to that in which the short waves are affected it may be assumed that the cause is the same in each case. The percentage variations in field-strength in the two cases do not differ by a very large figure. Now there must be very drastic changes in this factor to cause large changes in C for long waves, whereas, since the changes in C for short waves are so very frequent and variable, it seems that even slight changes in this factor cause large changes in C for short waves. This is an important point.

It has been shown mathematically by Eccles⁴ and Larmor⁵ and others that the long waves are returned from the ionised medium at lower altitudes than the shorter waves. Let the height be H for the short waves (this is the *effective* height since short waves are refracted over, not reflected) and h for the long waves, which are truly reflected.⁶ Then the relatively drastic changes referred to above in the case of long waves must occur in regions below the height h . It is unreasonable to suppose that the path of the wave will be influenced by any changes which occur only in the

³ L. W. Austin, *Proc. I.R.E.*, June, 1925.

⁴ W. H. Eccles, *Proc. Roy. Soc.* (87A), 79, 1912.

⁵ J. Larmor, *Phil. Mag.*, Vol. 48, 1924.

⁶ E. V. Appleton, *Nature*, 9th Oct., 1926.

medium *above* the path. The changes in this factor need only be slight in the case of short waves at a height H , that is, at a height above h . The conclusion to be drawn is that the magnitude of the changes for which we are looking decreases as the height above the earth increases. Now there are several things which vary by smaller amounts as the altitude increases. Probably the most important of these is the intensity of ionisation, about which, unfortunately, very little is known. The temperature varies most at ground level, and is constant at about 200° abs. in the isothermal layer which extends from about 10 kilometres to about 55 kilometres above the earth's surface. Above this layer the temperature rises to about 300° abs. at 150 kilometres (Lindemann and Dobson). Precisely what happens to the temperature above the isothermal layer is at present a subject of much discussion. There seems to be no definite evidence relating to winds in the upper atmosphere. According to some investigators, the atmospheric pressure at an altitude of 20 kilometres is practically constant throughout the year, but from the results of some experiments⁷ commenced in 1909 there appears to be a maximum deviation of about 8 per cent. from the mean pressure at an altitude of 20 kilometres throughout the year, which is about twice the deviation from the mean pressure at sea-level. The evidence, however, is far from being conclusive, and the deviation at 20 kilometres may be much less than 8 per cent., and still less at greater altitudes. These questions of pressure and temperature, and those of humidity, density, chemical constitution, intensity of ionisation, etc., at high altitudes are for the meteorologists and astrophysicists to settle, and, unfortunately, at present there seem to be no definite conclusions.

In comparing long and short waves, it must not be forgotten that the long waves are truly reflected from the medium, since the change in conductivity with height is sharp compared with the wavelength, whereas the short waves are refracted from the medium. Ordinary reflection of short waves may occur if, for some reason, there happens

to be an exceptionally sharp change in the conductivity with height. The distinction between reflection and refraction adds one more difficulty to the problem. The variable factors may influence the reflection without affecting the refraction, or *vice versa*, or they may influence one more than the other.

Here is an effect which appears to vary, for both long and short waves, in the same way during the year (and perhaps every year), and to have a comparatively greater influence on long waves than on short waves. Is this because long waves are *reflected* and short waves *refracted*? Or is it because the short waves penetrate to a higher altitude than the long waves? The writer makes no attempt to answer these questions, but offers them as lines for further investigation.

It should be noted that the monthly changes in the long waves are of the same magnitude as the monthly changes in the short waves, but the diurnal changes in the long waves⁸ are much smaller than the diurnal changes in the short waves: it has been shown that on a wavelength of about 17,000 metres the signals are practically constant throughout the day and night. An investigation of this effect might possibly throw some light on the problem.

Leaving the subject of long waves, we have the suggestion by Pickard, and Nichols and Schelling⁹, that diffraction effects may occur on short waves due to space irregularities in the medium. These effects would be more frequent, and of greater importance, as the wavelength decreases, since smaller irregularities in the medium are more likely to occur than large irregularities. Diffraction effects may occur more largely at one period of the year than at another period, but at present it seems impossible to investigate them. At any rate, the diffraction would probably be very erratic (possibly accounting for fading and audio-frequency distortion), and it may reasonably be set down as one of the *irregular* factors.

The vertical motion of masses of heated air has been suggested by Baeumler¹⁰ as

⁷ L. H. G. Dines, *Meteorological Mag.*, Sept., 1926, p. 190.

⁸ Espenschied, Anderson, Bailey, *Proc. I.R.E.*, Feb., 1926.

⁹ Nichols and Schelling, *Bell Syst. Tech. Journ.*, April, 1925.

¹⁰ M. Baeumler, *Proc. I.R.E.*, Feb., 1925.

field is predominantly horizontal, the vertical component probably being too weak for investigation.

According to Prof. E. V. Appleton⁶, when the waves are deviated below about 70 or 80 kilometres no abnormal polarisation is produced. If the waves are deviated above this height, both Kerr and Faraday effects will be produced. This will depend upon, among other things, the atmospheric pressure at different altitudes. If the pressure in the ionised regions changes, then the polarisation effects will change. This provides a probable connection between atmospheric pressure and signal-strength.

Changes in the polarisation due to changes in the earth's field are, in all probability, too small to be detected.

Prof. W. H. Eccles¹² suggests that diffraction effects due to the diminution of density of the atmosphere with height should be considered, and that the variations in signal-strength may be due to variations in, or movements of, the *lower* atmosphere. This is possibly another way in which atmospheric pressure can affect the signal-strength, though in this case the variations in the pressure at *lower* altitudes would have some effect. The diffraction effects on the shorter waves, however, may be too small to be appreciable. It should be noted that these effects, if appreciable, would not vary in the same way as the diffraction effects of Pickard, and Nichols and Schelling, one being due to changes in the atmospheric density at low altitudes, and the other being due to occasional space irregularities in the medium, *i.e.*, the temporary banking-up of ions.

In the considerations mentioned above, the variations in the atmospheric pressure appear to be the most important factor which may influence long-distance reception. This is the factor which the writer has investigated, and the results will now be described.

Variations in Atmospheric Pressure.

The writer obtained all the information concerning the pressure distribution across the North Atlantic from the weather charts kindly supplied by the Air Ministry Meteorological Office. As an example, the chart for

14th April, 1924, is reproduced in Fig. 2. On this date conditions for transatlantic reception were exceptionally favourable. Unfortunately, these charts are sometimes incomplete, no observations being received from North America. The pressure readings over the sea are supplied voluntarily by ships; when very few readings are received from ships the pressure distribution becomes doubtful, and in these cases the isobars are drawn as dotted lines. The full lines are the isobars when the pressure distribution is known with a greater degree of certainty. Also, there may be cases of an exceptionally deep depression, or a region of exceptionally high pressure, inside a particular isobar. For example, the pressure may rise to a very high value near the south coast of Greenland or in the "high" region just west of Florida. These remarks are intended to show that

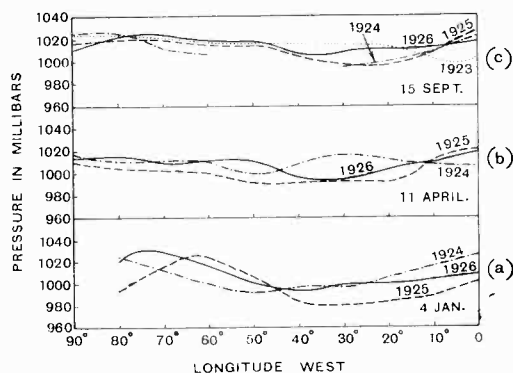

Fig. 3.

the charts are not absolutely accurate, and that it may be justifiable to alter the curves to a slight extent to suit the purpose in question. The weather charts are issued at about midday from the readings taken during the morning, but since the pressure distribution does not usually change a great deal in 24 hours, each chart may be taken to represent the state of the pressure during the previous night without incurring much error.

The method of drawing the pressure distribution curve from these charts will now be described. A curved line is drawn to join London to a point in the centre of the eastern side of the United States. This need not be any particular point, since the signals were received from practically the

⁶ E. V. Appleton, *Nature*, 9th Oct., 1926.

¹² *Proc. Roy. Soc.*, 757A, May, 1926.

whole of the eastern half, and not from any particular station. It would, of course, be better to examine the isobars drawn on a great-circle map with London at the centre. A straight line drawn on this map would then represent the shortest distance between London and any other point. If the straight line between London and the eastern side of the U.S. on this map is transferred on to a map with the North Pole at the centre, as in the weather chart (Fig. 2), it becomes slightly curved, the North side being convex. Consequently, the line on the weather chart must be curved upwards to approach Iceland and Greenland. For each chart, the pressure as indicated by the isobars at points separated by 10 degrees of longitude along this curved line is noted. This is continued to 80 or 90 degrees west. These figures are then plotted on a separate chart against the longitude, and each curve thus obtained gives the pressure distribution along the line for one particular day.

Now, if there is any connection between the pressure distribution across the Atlantic and transatlantic reception, it is reasonable to expect the pressure distribution curve for any particular day to be the same as for the same day in any other year, if the receiving conditions are the same on any given date for any year. That is, the pressure distribution curve for, say, 5th May, 1924, would have to be the same as the curve for 5th May, 1925, or any other year. To see whether this relation holds true, the writer drew the pressure distribution curves for parts of January, April, and September, of the years 1923-4-5-6. Unfortunately, many of the charts for 1923 were unobtainable; and it would seem to be impossible to attempt to trace any resemblance between the curves for periods before 1923, owing to the lack of material. Altogether, over 100 curves were drawn, and to reproduce them here would occupy too much space. An example, which represents the general appearance of the curves fairly well, is shown in Fig. 3 (a, b, c). Fig 3(a) shows how the pressure varied across the Atlantic on 4th January, 1924-5-6. It may be seen at the first glance that in each year, on this date, there was a depression over the Atlantic between longitudes 30 and 50 degrees west. The depression did not occur in exactly the same place each year, and similarly the

pressure did not rise to a maximum at exactly the same place in the eastern part of the U.S. each year. This sort of discrepancy occurs in most of these curves. In many cases, however, a closer resemblance could be seen if the curve for, say, 5th May, 1924, was compared with the curve for 4th May, or perhaps 6th May, 1925. This seemed to show that the pressure distribution might be repeated annually, though perhaps a day too early or a day too late. In some cases it was two days too early or too late, but a discrepancy of this order can be permitted since the conditions for reception are at times as much as a whole week out. By drawing curves to represent the mean pressure distribution for three or four consecutive days of each year, such discrepancies would be eliminated. If the mean curves are drawn for, say, more than

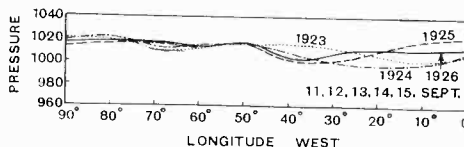
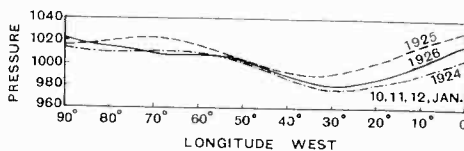

Figs. 4 & 5.

a week there is a tendency for the minor variations to disappear, in which case no comparisons could be effected. The writer drew the 3-day mean curves for January and the 5-day mean curves for September. (During September the pressure was much more stable, and the use of the mean curves for as many as five days was therefore considered justifiable.) As was expected, there was a much closer resemblance between these curves. Examples of these are shown in Figs. 4 and 5. It is remarkable to note how very closely the 5-day mean curves for 11-15th September (Fig. 5) agree, particularly over the U.S. between 50 and 90 degrees west. The observations over land are made at special meteorological stations, and those readings can be trusted to have a greater accuracy than the readings

taken voluntarily by ships. This may account for the discrepancies over the Atlantic (between 0 and 50° west). On the other hand, it may be that the pressure over water is naturally more variable than it is over land.

It is difficult to decide whether the resemblances are merely due to chance or whether they are due to any real repetition of pressure distribution. It may be argued that if there were any repetition of the pressure conditions, then there would necessarily be a similar repetition of the weather conditions. There is ample evidence to show that the weather conditions at any given point are not repeated annually in this way. It must be pointed out, however, that although the pressure *distribution* may be repeated annually with discrepancies (such as a 300-mile displacement of a depression), the *actual* pressure at any given point along the line may be quite different from year to year. It would, perhaps, be more accurate to say "distribution of weather" may be repeated every year. It can be seen directly from the weather charts as supplied by the Air Ministry that the high and low pressure regions occur in approximately the same place on corresponding dates in successive years, but obviously this method of representation is out of the question.

Connection between Pressure Distribution and C.

The actual connection between pressure distribution and the receiving conditions is a little obscure. The best way in which the general conclusions may be shown is

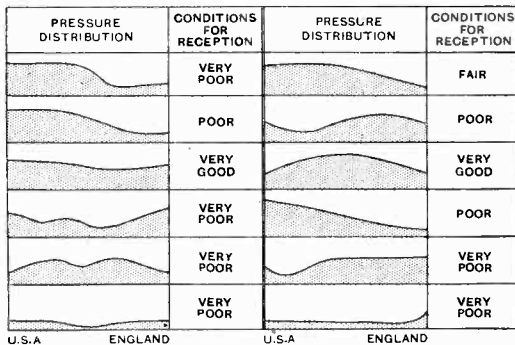

Fig. 6.—General relations between pressure distribution and conditions for reception of signals from U.S.A. in England.

by the diagrammatical representation of the relation in Fig. 6. It is seen that reception conditions may be either good or bad when the pressure is the same all the way across the Atlantic, depending on whether the pressure is high or low. A dip in the pressure when it is high seems to result in poor

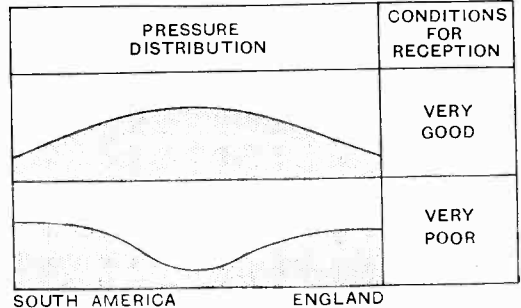

Fig. 7.—General relations between pressure distribution and conditions for reception from Brazil.

signals. A region of high pressure, provided it is confined to a small range, also results in poor signals. If the high-pressure region covers the greater part of the distance between the transmitter and receiver, then strong signals will be received. Fig. 7 shows the relation between the pressure distribution from England to South America and the signals received from Brazil. The same connection as for North America is seen to hold good here. Over a period of several weeks last winter the signals from North America were very poor, while signals from South America were good. At that time there was a deep depression, more or less stationary, between England and North America, whereas the pressure between England and South America was high. The writer has found that when the signals from South America are weak, there is always a depression in the path of the signals, and that the same relation applies to signals from North America.

Observations on signals from New Zealand and Australia would, of course, be useless owing to the great distance and, therefore, the complexity of the effects. The distances traversed by European signals received in England are considered by the writer to be too short for the effect of the weather to be investigated satisfactorily.

The relation between pressure distribution and the received signals just described, and

the probable effect of the atmospheric pressure on long-distance reception described under "Possible causes of the variations," led the writer to suggest the following theory.

In the first place, the assumption is made that, at altitudes of 50 kilometres or more, the atmospheric pressure varies in a manner similar to that in which it varies at sea-level. At present there seems to be no direct evidence for or against this, and the only experiments relating to this subject, as far as the writer is aware, are those referred to above, and they dealt with the pressures at altitudes of only 20 kilometres. It may seem probable that the pressure at an altitude of, say, 50 kilometres is practically constant throughout the year, and yet, on the other hand, when it is remembered that a depression may cover an area as much as 500 kilometres in diameter, it appears possible that owing to a depression at sea-level, the pressure at 50, or perhaps 100 kilometres above that area may similarly be reduced, though, of course, the percentage deviation from the mean pressure might be expected to decrease as the altitude increases. If the pressure changes in this way, it would, in all probability, follow the variations observed at sea-level. On this assumption the pressure distribution curves would represent, though on a different scale, the pressure distribution across the Atlantic at high altitudes.

Now if the pressure changes at these altitudes, then the intensity of ionisation will also change. Thus if, during the day, the pressure at sea-level is decreasing, the pressure above that region will, it is assumed, also be decreasing, and consequently the absorption of the ultra-violet radiation from the sun will decrease, resulting in the formation of ions at a lower altitude. In other words, there would be an increasing dip in the ionised medium over the region where the pressure is decreasing. Conversely, if the pressure at sea-level is high, the ionised medium above this region will, in effect, be raised. It should be noted that if the pressure decreases during the night, there will not be any dip formed in the medium, since the source of ionisation is then removed, and no more ions will be formed at a lower altitude. The effect of a decrease in pressure would be to decrease the rate of recombina-

tion of the ions, *i.e.*, the rate of rise of the lower boundary of the medium. An increase in pressure during the night would result in an increased rate of rise of the lower boundary. These effects during the night would probably be noticeable only when the pressure is changing rapidly. The result would be, in any case, however, that the medium, or rather a layer of any given intensity in the medium, would follow the shape of the pressure distribution curve. This is the basis of the theory. It depends on an assumption which may, or may not, be justifiable.

Now, what will be the effect of the curvature of the "layer" on the path of a wave? Again, an idea of what is likely to happen according to this theory can best be conveyed by means of a diagram. In Fig 8(a) the pressure at the transmitter *T* and the receiver *R* is high, and between them there is a depression. On the assumptions pointed out above there will be a dip in the "layer" in the region of the depression. This dip will be of the form shown in Fig. 8(a), and *not* of the form shown in Fig. 8(b), since the power of the ultra-violet radiation of producing an increased number of ions here will decrease as it travels downwards, due to absorption, and probably the lower boundary of the medium will remain unaffected. Consider a wave-front travelling upwards from *T*. As soon as it gets into the medium, the upper part of it will be accelerated, and the wave will be refracted over and returned to earth, but, due to the depression, the curvature of the "layer" is increased, so that the wave is deflected downwards before it has travelled to any great distance. Although only one path has been considered, it is clear that the effect is practically the same for various angles of propagation. Thus, a depression between the transmitter and the receiver will prevent waves from reaching the receiver, unless the depression is very close to the receiver. The dip is most marked at high altitudes, and since it is the very short waves which penetrate to the higher altitudes, the effect of the dip will be most marked on the very short waves. As the wavelength is increased, the height to which the wave penetrates will decrease, and the effect of the dip will also decrease. There is ample experimental evidence to show that the shorter the wave the

more variable it is in its behaviour. This is in accordance with the theory. If, however, the wave is very long, say, several thousand metres, it will be reflected at low altitudes; but here the pressure varies more than at

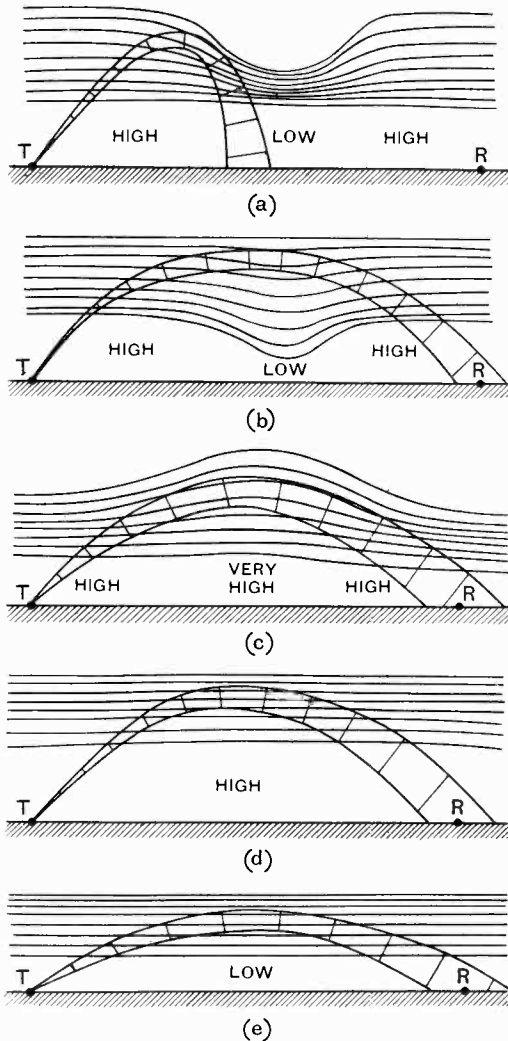

Fig. 8.—Showing the path of a wave in the ionised medium. The lines in the medium represent layers of equal intensity of ionisation. The intensity increases upwards from the earth.

higher altitudes where the shorter waves are refracted. This will result in a large variation in the absorption of the wave-energy by the atmosphere, since the absorption depends upon the pressure. This agrees with L. W. Austin's experiments described in an earlier part of

this article. It appears that for long waves it is the *pressure* variations which are important (being greater here than for short waves), and for short waves it is the *ionisation* variations which are important (being greater here than for long waves). If the pressure at T and R is low, and high between them, as in Fig. 8(c), the waves will be able to travel to greater distances: this corresponds to good conditions. Again, in Fig. 8 (d), where the pressure is high everywhere between T and R, conditions will be good, but if, as in Fig. 8 (e), the pressure is *low* everywhere, conditions will be poor, for this reason: due to the low pressure, the "layer" will have descended to a low altitude, and the wave will be forced to travel at low altitudes, but even here the pressure is low, and the result should be the same as in the case of a uniform pressure. Whenever there is a large area of low pressure, however, it seems to be generally accompanied by cyclones (which may not be recorded on the weather charts). Consequently, if the pressure appears to be uniformly low, there will almost certainly be a depression somewhere in the region, which corresponds to the case in Fig. 8(a). A comparison of Figs. 6, 7, and 8, shows that the conditions suggested by the theory are in accordance with experimental facts.

The writer submits this theory with some reserve, and in the hope that it will lead to a better understanding of the effect of the weather. He is convinced, however, that out of all the factors connected with the weather, which can affect long-distance reception, the atmospheric pressure is the most important. There is no hard and fast rule that can be made to apply to the changes either in pressure distribution or in long-distance reception: discrepancies occur in both of them, and these may be due to other effects such as temperature, or winds. However, evidence shows that the conditions for reception and the pressure distribution across the Atlantic are repeated annually in a complex but definite manner, and that there is a connection between them.

Information on transatlantic reception and atmospheric pressures for periods before 1923 is very difficult to obtain, and time only will show whether there is any real repetition as there appears to be at present, after three years of investigation.

Abstracts and References.

Compiled by the Radio Research Board and reproduced by arrangement with the Department of Scientific and Industrial Research.

PROPAGATION OF WAVES.

COMPTE RENDU DES OBSERVATIONS FAITES PENDANT L'ECLIPSE DE SOLIEL DU 29 JUIN, 1927 (Report of the observations made during the sun's eclipse, 29th June, 1927).—H. S. Jelstrup. (*L'Onde Electrique*, 6, 69, pp. 445-460.)

The observations were made at Nordre Langen in East Norway, which was about in the middle of the zone of totality. The transmitting station observed was at Hamar, on the opposite side of the zone of the Heaviside layer suffering eclipse. A Marconi 7-valve receiver was employed, which is described in detail; the wavelength was 566 metres. The results are tabulated at length; a simultaneous series of astronomical and radio observations having been made. The following conclusions are drawn:—

1. The effects of the eclipse on the transmission of radio waves of medium length are similar to those ordinarily found at sunset: namely, increased intensity and increased fading; the intensity rising to its maximum a moment after the actual totality.

2. The intensity is strongly influenced when the moon passes over a spot situated near the sun's edge, as shown in the accompanying figure, with the occurrence of an extremely powerful and peculiar "atmospheric."

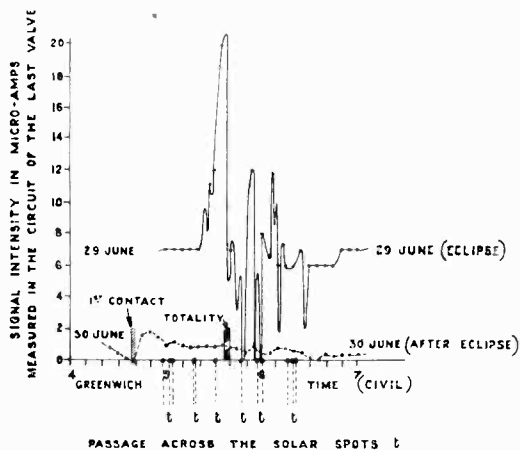

3. From the fact that the day and night before the eclipse audibility was mediocre while the evening afterwards it was excellent (and also some other considerations), the question is raised whether the moon approaching the sun has not some deviating action on the solar corpuscular radiation, emanating more particularly from the spots, and whether these variations, engendered by the moon in conjunction, may not manifest themselves by analogous variations in the ionisation of the

Heaviside layer, and affect radio reception accordingly. In this way the author concludes, disturbed radio reception should be expected at the new moon.

DEVIATION OF WIRELESS WAVES AT A COASTAL BOUNDARY.—(*Nature*, 7th January, 1928, p. 35.)

A record of evidence in support of the suggestion that wireless waves are reflected at a coastline, mentioned by Dr. Smith-Rose in a letter to *Nature* of 9th September, 1925, p. 426.

Major Worledge reports that during the calibration of a direction-finding station, last year, it was noted that the bearings on certain stations, using more than one wavelength, showed abnormal variations accompanied by sudden shifts of as much as 4 or 5 degrees on wavelengths in the neighbourhood of 1,000 metres: on systematic observation, it was found that the change in bearing was related in a harmonic manner to the frequency of the waves received, the period of this harmonic relation being consistent with the explanation that the change in bearings was due to the reflection of waves from the landward side of the neighbouring coastline. Directional error is a maximum when the wavelength is such that direct and reflected waves arrive in the same phase, while at intermediate wavelengths, blurred minima are observed as a result of the phase difference.

INFLUENCE DE LA NATURE DU SOL SUR L'EMISSION ET LA RECEPTION RADIOELECTRIQUES (Influence of the nature of the ground on wireless transmission and reception).—L. Boutillon. (*L'Onde Electrique*, 6, pp. 533-553, November, 1927).

Paper presented at a meeting of the S.A.T.S.F., 8th February, 1927.

All ground behaves as a perfect conductor for waves sufficiently long (above 133 metres for sea water and 833 metres for damp earth), and as a perfect dielectric for waves sufficiently short (less than 33 metres for dry sand and 13 metres for fresh water), while cases in practice range between these two extremes. Recent experiments with short waves have complicated the problem, showing that the inclination of the waves and their polarisation have also to be taken into account. The complex problem is investigated for the four most simple systems: a vertical and a horizontal antenna and a vertical and a horizontal frame. The consequences of the investigation are pointed out: interpretation of certain results of experience (reception with horizontal antennæ or frames, polarisation of waves, small influence of the shape of the aerial in the case of short waves); the connection with Zenneck's theory; and lastly, the possibility of new methods of measuring the characteristics of electromagnetic fields.

DIE ANWENDUNG VON KURZEN WELLEN IM VERKEHR MIT FLUGZEUGEN (The employment of short waves for communication with aircraft).—H. Plendl. (*Zeitschr. f. Techn. Physik*, 8, pp. 456-464).

Description of an investigation on the usefulness of short waves for aircraft communication (although certain writers have declared short waves of no value for this purpose on account of zones of silence and also the shaking of an aeroplane in flight and noise from the engine). Circuit-diagrams of the transmitting and receiving apparatus employed on the aeroplane in these experiments are shown in the figures.

The experiments showed that for distances

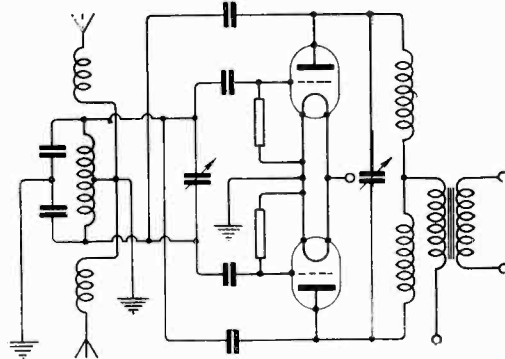

Circuit arrangement for reception on short waves.

greater than 1,000 km., short waves are probably a sure means of communication for aircraft, as good reception was obtained from foreign short-wave stations 1,500-20,000 km. distant; and that for distances less than 100 km., within which the so-called silent zones should occur, though there certainly was very considerable attenuation for some wave ranges, this nevertheless was never sufficient to entirely prevent communication.

The author concludes that nothing definite about the silent zones of a wave can be stated until a large number of repeated observations on that wave at different times have been made; further, the whole waveband of 10-150 metres must be investigated, and quantitative field-strength measurements carried out. He adds that research is also required on the optimum form of antenna, means of drive, and transmitter energy to employ.

POLARISATION OF RADIO WAVES.—J. Hollingworth and R. Naismith. (*Nature*, 4th February, 1928, p. 171.)

A letter describing interesting results recently obtained in connection with the propagation of long waves (14,350 metres).

In the course of simultaneous observations over a period from one hour before until one hour after sunrise of the same transmission from St. Assise by two stations, Slough and Aberdeen, roughly 400 and 1,000 km. from it and approximately on the same great circle, it has been found that in the period preceding sunrise the wave arriving at the nearest station is plane polarised, with its plane of polarisation rotated in a clockwise direc-

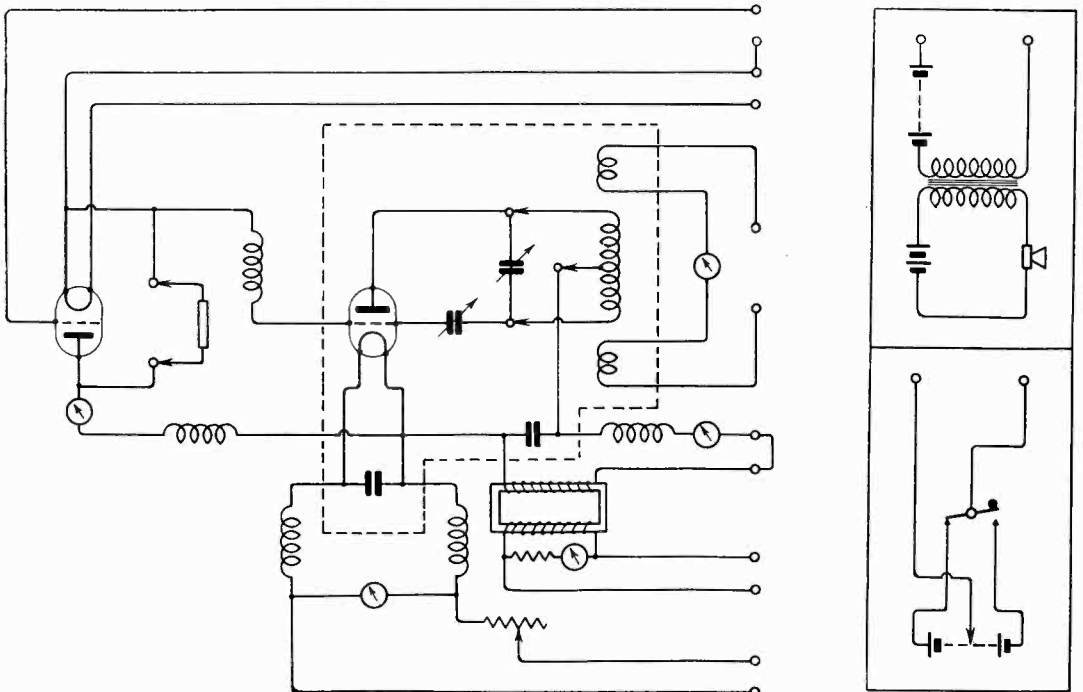

Transmitting circuit with separate keying or microphone arrangement.

tion when looking in the direction of propagation, whereas at the more distant station the rotation is anti-clockwise. By the time of sunrise both these abnormal polarisations have gradually decreased and disappeared, and in some cases at the nearer station the space wave appears to have entirely vanished also. About half an hour later, however, the space wave reappears at the nearer station, but this time with left-handed polarisation. This persists with varying intensity throughout the day, again disappearing about 15.00 G.M.T., when the right-handed polarisation returns for the night. It has also been shown that the wave reaching the far station has started from the transmitter at practically the same angle of elevation as the wave to the near station, and that its downcoming angle at the far station is comparatively steep.

From the evidence the authors believe it highly probable that we are here dealing with some form of doubly refracted ray of which one element is being received at each station. Further experiments on the subject are in progress.

ON THE ANOMALOUS DISPERSION AND ABSORPTION OF ELECTRIC WAVES.—S. Mizushima. (*Sci. Papers Inst. Phys. and Chem. Research, Tokyo*, 5, pp. 201-248.)

It is highly probable that the longer the wavelength of an electromagnetic oscillation, the greater will be the mass of the oscillator. Thus the spectroscopic phenomena of shorter waves are ascribed to the inter atomic oscillation and those of the longer waves to that of molecules or their conglomerates. Assuming the existence of a permanent dipole in a molecule; Debye proposed a theory for the anomalous dispersion and absorption of electric waves, which hitherto has not been confirmed by experiment. In the present investigation systematic measurement is made of the anomalous dispersion and absorption at various temperatures and wavelengths, and the results are discussed from the view-point of the dipole theory.

ATMOSPHERICS.

METHODS OF REDUCING THE EFFECT OF ATMOSPHERIC DISTURBANCES.—E. H. Armstrong. (*Proc. Inst. Radio Engineers*, 16, pp. 15-29, January, 1928.)

Description of a method of reducing the effects of atmospheric disturbances by selective means as distinguished from directional reception. The method is based on the establishment of a difference between the natural and the signalling waves by imparting to these latter a characteristic not found in the former. This difference is effected by producing at the transmitter two waves of closely adjacent frequency and radiating them alternately. Details of the working out of the method are given. Discussion on the paper is appended.

PROPERTIES OF CIRCUITS.

ZUR THEORIE DER ENDVERSTÄRKUNG (Theory of last stage amplification).—M. von Ardenne. (*Zeitschr. f. Hochfrequenz.*, 30, pp. 116-123, October, 1927.)

Formulae are found for the least anode battery tension and the negative grid tension required,

for distortionless reproduction, when inductive loud-speakers are working at their maximum output with high emission valves. It is shown what circumstances result when several loud-speakers are connected in series or parallel, or when several valves in parallel are used to drive the loud-speaker. Numerical and graphical solutions of the problem are shown by means of examples, also curves giving the dependence of the useful output of the loud-speaker on the internal resistance of the valve and the frequency.

DREI BEITRÄGE ÜBER SCHWINGUNGSERZUGUNG (Three contributions on the generation of oscillation).—G. Jobst. (*Telefunken-Zeitung*, 47, pp. 11-38, October, 1927.)

The first contribution deals with exceptional sources of emission in transmitting valves: considering secondary emission from the grid, its influence upon the operation of transmitting valves, the elimination of undesired and strengthening of desired effects; discussing also thermic emission from the grid due to rising of its temperature, leading to reversal of the grid current and reduction in efficiency; and just mentioning secondary emission from the anode which is of little practical importance.

In the second contribution determination is made of amplitude and frequency in oscillation generators with non-linear characteristics, a method being developed from a calculation of oscillation problems.

The third contribution considers dynatron oscillations of the first, second and third variety, and aperiodic changes in its condition, applying the method previously described, a modification being made for ambiguous functions.

APPARATE FÜR VERSTÄRKUNGS-MESSUNGEN AN MEHRFACHRÖHREN ODER ANDEREN IN KASKADE GESCHALTETEN RÖHREN-ANORDNUNGEN (Apparatus for amplification measurements on multiple valves or other valve-arrangements connected up in cascade).—F. Gabriel. (*Zeitschrift f. Hochfrequenz.*, 30, pp. 95-100 and 123-126, September and October, 1927.)

After explaining the necessity for measuring the amplification obtained from valves in cascade with alternating current, the author gives at length the theory of the measurements, and describes the apparatus, showing circuit connections and the method of constructing input and output instruments, with illustrations.

DER ABGESTIMMTE HOCHFREQUENZVERSTÄRKER (The detuned high-frequency amplifier).—W. Runge. (*Telefunken-Zeitung*, 47, pp. 50-63.)

Description of some fundamental calculations and methods of measurement that have originated in the Telefunken receiving laboratory when working out the detuned high-frequency amplifier.

GEKOPPLETE KREISE (Coupled circuits).—W. Kummerer. (*Telefunken-Zeitung*, 47, pp. 63-69, October, 1927.)

For the mathematical treatment of coupled circuit problems, one proceeds from the differential

equation. By limiting oneself, however, to the stationary condition of a forced oscillation, it is simpler to make use of the symbolic method of calculation customary in heavy current technique, and to explain the action of coupled circuits on one another by the introduction of transferred resistance. The relations holding good generally are deduced and with their help the frequency of a self-excited intermediate circuit valve transmitter is found.

A VECTOR LOCI METHOD OF TREATING COUPLED CIRCUITS.—E. Mallett. (*Proc. Roy. Soc., A*, 117, pp. 331-350, January, 1928.)

KEEPING H.F. OUT OF THE L.F. AMPLIFIER.—A. L. Sowerby. (*Wireless World*, 1st February, 1928, pp. 117-118.)

The theory of the series grid resistance.

RECTIFICATION AS A CRITERION OF DISTORTION IN AMPLIFIERS.—M. von Ardenne. (*E.W. & W.E.*, 5, pp. 52-55, February, 1928.)

TRANSMISSION.

ÜBER DIE ZIEHERSCHEINUNG BEIM LICHTBOGEN-GENERATOR (On oscillation hysteresis phenomena in the arc generator).—H. Poleck. (*Zeitschr. f. Hochfrequenz.*, 30, pp. 109-116, October, 1927.)

The author explains that when this paper was being printed, one on the same subject by Winkler appeared in the July *Zeitschrift* (these Abstracts, November, 1927, p. 695), but that while the starting point of both investigations is the same, they lead in different directions. Experiments are described in which oscillation hysteresis figures are obtained for both the fundamental wave and harmonics and compared with those of the valve transmitter. The detection of beats after a jump to the shorter coupling wave, between the longer wave, is mentioned, which has not been observed with valves, and there is a discussion of the influence of the arc capacity.

ÜBER DIE FELDER DER WECHSELSTROMLEITUNG MIT ERDE UND DER HORIZONTALANTENNE (On the fields of alternating current wires with earth and the horizontal antenna).—F. Pollaczek. (*Elekt. Nachr. Technik*, 4, pp. 515-525, December, 1927.)

Concluding part of a mathematical discussion begun in the July number of *E.N.T.*, pp. 295-304.

NEUERE ANWENDUNGEN DER MODULATIONS-DROSSELN (Recent applications of modulating chokes).—L. Pungs and F. Gerth. (*Zeitschr. f. techn. Physik*, 11, pp. 471-473, November, 1927.)

THE DESIGN OF CHOKE COILS AND TRANSFORMERS WHICH CARRY A DIRECT CURRENT.—G. W. O. Howe. (*E.W. & W.E.*, 5, pp. 49-52, February, 1928.)

THE RADIATION RESISTANCE AND ENERGY CAPACITY OF HALF-WAVE AERIALS.—E. Green. (*E.W. & W.E.*, v, pp. 82-84, February, 1928.)

RECEPTION.

LOCATING AND CORRECTING PROPAGATED RADIO INTERFERENCE.—C. Evans. (*Electrical World*, 90, p. 1300.)

Description of an investigation to locate a source of radio interference found on the system of the San Antonio Public Service Company, which manifested itself as a low-frequency hum. It was discovered that one of the blades of a gang-operated disconnecting switch failed to make complete contact, resulting in a small arc between blade and jaw. It was this arc that had set up the oscillations of radio frequency, which were propagated throughout the city over the 13-kV. system. The basic frequency of the power current, 60 cycles, modulated the arc oscillations, resulting in the characteristic "60-cycle hum" that had complicated the investigation.

TRACING RADIO INTERFERENCE.—J. Hanly (*Electrical World*, 14th January, 1928, p. 101.)

Details are given of routine method of locating various kinds of trouble. Test set proves value of audio-radio selective arrangement.

AUTOMATIC VOLUME CONTROL FOR RADIO RECEIVING SETS.—H. A. Wheeler. (*Proc. Inst. Radio Engineers*, 16, pp. 30-39, January, 1928.)

A receiving set is described in which the radio frequency amplification is automatically controlled to give a nearly constant radio-frequency voltage at the detector, independent of differences in antenna signal voltage. This results in nearly uniform response at the loud-speaker from nearby and distant broadcasting stations and also reduces the effect of fading. The method employed consists in using the rectified carrier voltage to adjust the grid bias of the radio-frequency amplifier valves. Solutions of special problems that arise in carrying out this method are indicated.

A NEW METHOD OF USING RESISTANCE AMPLIFICATION WITH SCREENED GRID VALVES.—J. J. Dowling. (*E.W. & W.E.*, 5, pp. 61-62, February, 1928.)

A NOVEL VALVE DETECTOR.—H. J. Neill. (*E.W. & W.E.*, 5, pp. 74-76, February, 1928.)

VALVE CURRENT FROM A.C. MAINS.—J. K. Jennings. (*E.W. & W.E.*, 5, pp. 77-82, February, 1928.)

QUALITY AND THE ANODE RECTIFIER.—A. L. Sowerby. (*Wireless World*, 25th January, 1928, pp. 87-90.)

LOW-FREQUENCY OSCILLATION.—U.I.G.P. (*Wireless World*, 4th January, 1928, p. 17.)

Some notes on recent investigations by the Ferranti research laboratories.

THE DANGERS OF DETUNING.—A.L.M.S. (*Wireless World*, 18th January, 1928, pp. 69-70.)

VALVES AND THERMIONICS.

ON THE EMISSION OF POSITIVE ELECTRICITY FROM HOT TUNGSTEN IN MULLARD RADIO VALVES.—P. Kumar Mitra. (*Philosophical Magazine*, 5, pp. 67-79, January, 1928.)

An account of the variation of positive emission with temperature and with applied potential difference, and of the growth and decay of positive emission current with time under various conditions. The results are tabulated and shown graphically.

ÜBER DEN EMISSIONSMECHANISMUS VON OXYDKATHODEN (On the mechanism of emission from oxide cathodes).—W. Espe. (*Wiss. Veröffentlich. a.d. Siemens-Konzern V*, 3, pp. 29-45; Abstract in *Zeitschr. f. Hochfrequenz.*, 30, pp. 126-128, 1927.)

The paper is a systematic investigation of the mechanism of emission from cathodes containing barium, strontium and calcium oxides; there still existing some obscurity as to the process of emission from oxides as distinct from cathodes of pure metal.

DIE AUSTRITTSARBEIT VON ELEKTRONEN AUS ERDALKALIOXYDKATHODEN (The work of emission of electrons from cathodes with alkaline-earth oxides).—W. Espe. (*Wiss. Veröffentlich. a.d. Siemens-Konzern V*, 3, pp. 46-61; Abstract in *Zeitschr. f. Hochfrequenz.*, 30, p. 128, 1927.)

INVESTIGATION OF THE THERMIONIC PROPERTIES OF THE RARE-EARTH ELEMENTS.—E. Schumacher and J. Harris. (*Journ. Am. Chem. Soc.*, 48, pp. 3108-14.)

MEASUREMENTS AND STANDARDS.

GERÄTE ZUR MESSUNG VON EMPFANGSFELDSTÄRKEN IN DER DRAHTLOSEN TELEGRAPHIE UND TELEPHONIE (Instruments for measuring field-strength in wireless telegraphy and telephony).—G. Anders. (*Zeitschr. f. techn. Physik*, 8, pp. 464-471, November, 1927.)

Apparatus for measuring large and small field-strength is described, and in particular an instrument constructed by A E G. Reliability tests are explained. The recording of field-strength is possible.

A NEW METHOD FOR THE CALIBRATION OF AMMETERS AT RADIO FREQUENCIES.—H. C. Hazel. (*Proc. Inst. Radio Engineers*, 16, pp. 70-74.)

Description of the construction and operation of a thermionic vacuum tube designed for the measurement of radio-frequency currents. The input circuit consists of a filament whose cross section is small enough for the "skin effect" to be negligible at the frequencies used. The filament is heated first by currents of known magnitude (at a low frequency) and again by radio-frequency currents to be measured. Electrons emitted by the heated filament are drawn to an anode sealed into the tube and a comparison of the resulting

space currents indicates, if the necessary precautions are taken, the amount of current in the input circuit.

DIAGRAMME DES CHAMPS ELECTRIQUES MESURÉS À MEUDON PENDANT LE PREMIER SEMESTRE, 1927 (Graphs of the electric fields measured at Meudon during the first half of 1927).—(*L'Onde Electrique*, 6, pp. 603-605.)

The field-strengths measured at Meudon of Bordeaux, Nantes, Rocky Point, Rome and Leafield are shown graphically, for the first six months of 1927.

LE QUARTZ PIEZO-ÉLECTRIQUE COMME ETALON DE FRÉQUENCE (Piezo-electric quartz as frequency standard).—R. Jouaust. (*L'Onde Electrique*, 6, pp. 513-532 and 580-588, November and December, 1927.)

"Conférence de documentation" given before the S.A.T.S.F., 10th May, 1927.

Description and theory of the properties of quartz utilised in its employment as a standard of high-frequency, followed by some particulars of different methods of realising such a standard.

THE ACCURACY AND CALIBRATION PERMANENCE OF VARIABLE AIR CONDENSERS FOR PRECISION WAVEMETERS.—W. H. Griffiths. (*E.W. & W.E.*, 5, pp. 17-24 and 63-74, January and February, 1928.)

SUBSIDIARY APPARATUS AND MATERIALS.

THE VACUUM TUBE RECTIFIER: OSCILLOGRAPHIC AND VACUUM TUBE VOLTMETER (Study of its Application to B-Voltage Supply for Radio Receivers).—J. Kuhlmann and J. Barton. (*Jour. Amer. Inst. E.E.*, 47, pp. 17-24, January, 1928.)

The paper covers investigations made in undertaking the design of a rectifier for use as the B power supply for radio receivers. It determines the most satisfactory type of filter circuit and the appropriate values of inductance and capacitance to give a D.C. output delivered with the least practical voltage drop and having no fluctuations of sufficient magnitude to interfere with the proper operation of the set. A vacuum-tube peak voltmeter used to detect very small fluctuations is described.

ÜBER DIE NICHTLINEARE VERZERRUNG VON LAUSPRECHERN UND FERNHÖRERN (On the non-linear distortion of loud-speakers and telephones).—E. Meyer. (*Elekt. Nachr. Technik*, 4, pp. 509-515, December, 1927.)

DIE ANWENDUNG DER QUECKSILBERDAMPFRÖHRE ALS SCHALTORGAN (The employment of the mercury vapour tube as a switch).—H. Schuchmann. (*Zeitschr. f. techn. Physik*, 8, pp. 489-491, November, 1927.)

FURTHER NOTES ON THE REFLEX VOLTMETER.—W. B. Medlam and U. A. Oswald. (*E.W. & W.E.*, 5, pp. 56-60, February, 1928.)

PANOLIN.—W.I.G.P. (*Wireless World*, 11th January, 1928, pp. 29-32.)

A survey of the properties of this support for inductances carrying H.F. currents, and its manufacture.

STATIONS : DESIGN AND OPERATION.

Radio in Sweden.—(*Electrician*, 20th January, 1928, p. 76.)

Swedish broadcasting in 1927 yielded a net profit of about 600,000 kronor, as against 400,000 the previous year. According to the statistics published by the Royal Telegraph Department, the number of radio licences per thousand inhabitants in European countries is now highest in Sweden, with 53.6, next comes England with 53, and then Denmark, 44.8; Austria, 43; Germany, 28.1; Norway, 22.1; Switzerland, 15.9; Czechoslovakia, 15.2; Hungary, 9; Finland, 8.8; and Belgium, 4.6. At the Geneva Conference, Sweden was allotted five exclusive short wavelengths, varying between 200 and 600 metres, now used by six different broadcasting stations in Sweden. The increased demand for new stations has led to experiments in running two or several broadcasting stations on the same wavelength, but this problem has not been fully solved, and therefore at present it has been decided to raise the power of the Gothenburg and Malmo stations from 0.5 kW to 10 kW, and so increase their range.

RADIO IN FRANCE.—(*Electrician*, 13th January, 1928, p. 49.)

Broadcasting in France is in process of reorganisation. Three national and eighteen regional broadcasting stations are to be created. The first regional station will be constituted by the present station at the Postal Telegraph and Telephone School, known as the P.T.T., with its power increased and the programmes improved. The other two will be established by the resources of the "Syndicates of Users," and it is expected that the eighteen district stations will be constructed in two or three years. In order to meet the expense which will fall upon the State by this reorganisation, the licence fee will be increased from one to ten francs.

EGYPT : RADIO TELEGRAPHY.—(*Electrical Review*, 20th January, 1928, p. 108.)

Further extensions of Marconi wireless telegraph services are announced. A high-speed duplex service was inaugurated directly between London and Constantinople on 1st January, and from 15th January the Egyptian service hitherto operated by the British Post Office will be operated by the Marconi Company in London and by the Marconi Radio Telegraph Company of Egypt in Cairo. The Abu Zabal station has been acquired by the latter company and in future will be used only as a transmitting station, while a new receiving station has been constructed at Meadi, a few miles to the south of Cairo, in order to provide a high-speed duplex service in place of the present simplex service. Both transmitting and receiving stations are connected by special landlines to a new central telegraph office in Cairo, where all operating processes will be carried out.

UNITED STATES : RADIO TELEGRAPHY.—(*Electrical Review*, 3rd February, 1928, p. 197.)

The lease of the high-power transoceanic radio station at Sayville, Long Island, by the Postal Telegraph Company, the Commercial Cable Company, and the newly-formed Mackay Radio Company is an important step in ship-to-shore communication to compete with the existing organisations. The Sayville station was originally operated by the German Telefunken Company, who built it in 1912, its chief purpose being to communicate with Nauen. It was taken over by the U.S. Navy radio service in July, 1915. World-wide communication such as is planned will mean combination of cable and radio services, each supplementing, but not necessarily supplanting, the other.

WIRELESS EQUIPMENT OF THE MOTOR SHIP "BERMUDA."—(*Electrician*, 30th December, 1927, p. 828.)

Brief account of the Marconi equipment on the new liner, involving a departure from standard ship installation.

A SUPER-RECEIVING STATION.—A. Dinsdale. (*Wireless World*, 18th January, 1928, pp. 68-69.)

Some details of the new transoceanic relay station at Belfast, Maine, U.S.A.

GENERAL PHYSICAL ARTICLES.

NEW RESULTS ON COSMIC RAYS.—R. A. Millikan and G. H. Cameron. (*Supp. to Nature*, 7th January, 1928, pp. 19-26.)

Substance of the discourse, with additions, delivered by Prof. Millikan on 2nd September, at Leeds, during the B.A. meeting.

Cosmic rays are defined as that small portion of the "penetrating radiation" which is of cosmic origin. The main purpose of this paper is to present a preliminary report of very recent work on these rays, which throws new light on their properties.

The writers trace each step in the work on cosmic rays from the time when the presence of very penetrating radiation was first detected by Rutherford and McLennan in 1903, owing to its getting through the thick screens of their electroscopes; down to Millikan's latest results, revealing the existence of cosmic rays so hard that they are able to penetrate about 5 metres of lead before being completely absorbed.

For the most penetrating of the cosmic rays, the experiments indicate a wavelength of only 0.00021A, which is far shorter than the shortest of the γ -radiations from any known radio-active material and corresponds to a generating potential of nearly 60,000,000 volts. Magnitudes of this order require change taking place within the nucleus itself, since no extra nuclear changes are associated with anything like such energy. Although the fact that cosmic rays are non-directional means that they must come chiefly from beyond the Milky Way, either from the spiral nebulae or from the very attenuated matter that pervades all space, the numerical value of the energy at present found for

the rays is not such as to justify their being regarded, as yet, as providing direct experimental evidence of the transformation of matter into radiation in outer space. The total energy flowing into the top of the earth's atmosphere in the form of the cosmic rays is computed to be 3.1×10^4 ergs. per sq. cm. per sec., or just one-tenth the total energy coming into the earth's atmosphere in the form of starlight and heat.

THE TEMPERATURE COEFFICIENT OF OSCILLATING QUARTZ PLATES.—R. Strout. (*Physical Review*, 31, p. 156, January, 1928.)

Abstract of a paper presented at the Chicago meeting of the American Physical Society, November, 1927.

The change of frequency with temperature of a quartz crystal plate, $1.8 \times 1.8 \times 0.11$ cms., vibrating in a direction normal to its faces with a frequency of 2,700 kc., was determined at various temperatures. A second oscillating plate was used as a fixed frequency, while the heterodyne note was heard with a receiving set. This second plate was maintained at or near room temperature, and was reground to an appropriate frequency for each determination. The change of frequency with temperature was found to decrease linearly from 61.3 cycles per degree at 65°C . to 4.3 cycles per degree at -189°C .

PREFERRED ORIENTATION IN TUNGSTEN CRYSTALS CAUSED BY MECHANICAL WORKING.—H. De Vore and W. Darcy. (*Physical Review*, 31, p. 160, January, 1928.)

Abstract of a paper presented at the Chicago meeting of the American Physical Society, November, 1927.

VEKTORDIAGRAMME BEI STROMRESONANZ (Vector diagrams in the case of current resonance).—E. Roessler. (*Elekt. Nachr. Technik*, 4, pp. 525-533, December, 1927.)

When all losses are taken into account, this case appears very complicated. For practical purposes, however, the relations can be very considerably simplified, the vector diagram of the apparent resistance as a function of the frequency becoming a circle, and the current diagram a straight line.

GENERAL CONSIDERATIONS ON THE PHOTO-ELECTRIC EFFECT.—P. W. Bridgman. (*Physical Review*, 31, pp. 90-100, January, 1928.)

It is suggested that the considerations of this paper enable another significance to be attached to the argument of Lawrence that photo-electric and thermionic emission are identical.

ON A PHOTO-ELECTRIC THEORY OF SPARKING POTENTIALS.—J. Taylor. (*Proc. Roy. Soc.*, A, 117, pp. 508-516.)

A paper describing a photo-electric theory of sparking potential, according to which the latter is a function of the photo-electric emissivity of the cathode for the radiations accompanying the neutralisation of the positive ions at the cathode surface. It is assumed that no ionisation by collision is produced by the positive ions in the gas.

RESONANCE RADIATION IN EXCITED NEON.—Y. Fujioka. (*Sci. Papers Inst. Phys. and Chem. Research*, Tokyo, 7, pp. 27-34.)

ELECTRODELESS DISCHARGES.—J. S. Townsend. (*Philosophical Magazine*, 5, pp. 178-191, January, 1928.)

A REPLY TO THE PAPER, "IONISATION BY COLLISION."—J. Taylor. (*Philosophical Magazine*, 5, pp. 445-446, February, 1928.)

THE BOLTZMANN-HOPKINSON PRINCIPLE OF SUPERPOSITION AS APPLIED TO DIELECTRICS.—F. D. Murnaghan. (*Journ. Amer. Inst. E.E.*, 47, pp. 41-43.)

A paper showing that the principle of superposition, shown for some time in experiment, is a necessary consequence of Maxwell's theory, and further, that the principle is valid for any theory leading to a system of linear differential equations with constant coefficients.

EINE NEUE METHODE DER KLANGANALYSE (A new method of sound analysis).—M. Grütz-macher. (*Elekt. Nachr. Technik*, 4, pp. 533-545. *Zeitschr. f. techn. Physik*, 11, pp. 506-509 (abridged).)

EIN REGISTRIEVENDER SCHALLMESSER UND SEINE ANWENDUNGEN (A recording sound-meter and its applications).—E. Gerlach. (*Zeitschr. f. techn. Physik*, 8, pp. 515-519.)

Description of an electro-acoustic measuring arrangement with photographic recording, which can be employed for the measurement of loud-speakers, microphones, amplifiers, filter-chains, gramophone writers, etc. It can also be used to investigate sound absorption and reflection as well as for harmonic analysis.

THE RESULTS OF CLASSICAL WAVE MECHANICS OBTAINED BY USING THE METHODS OF RELATIVITY MECHANICS.—T. Lewis. (*Philosophical Magazine*, 5, pp. 408-416, February, 1928.)

MISCELLANEOUS.

RÉCEPTIONS RADIOTÉLÉPHONIQUES SUR TRAINS EN MARCHÉ (The reception of radio telephony on moving trains).—R. Saglio. (*L'Onde Electrique*, 6, pp. 589-602.)

An account of tests made by the Orleans Railway Company as to the possibility of the reception of broadcasting by passengers during long journeys. While it is found that the reception of waves emitted by a distant antenna leaves much to be desired, this apparently is no longer the case when the waves are guided by a carrier wire close to the line. A note is added by M. Lange in which he testifies to the good quality of the reception he found last year on the Berlin-Hamburg line, where a combination of guided wave and radio is employed, an antenna being erected on the roof of the train to pick up the communication from the wire alongside the line.

SIGNALÜBERTRAGUNG AUF FAHRENDE ZÜGE MITTELS WECHSELSTROMINDUKTION UND RESONANZ (Signal communication on moving trains by means of alternating current induction and resonance).—P. Tätz. (*Telefunken-Zeitung*, 47, pp. 70–78, October, 1927.)

UNITED STATES: TELEVISION.—(*Electrical Review*, 20th January, 1928, p. 109.)

The first demonstration of broadcast radio television arranged by the Radio Corporation of

America is reported to have been successfully carried out on 13th January before groups of engineers, scientists and newspaper men, who, standing before home television sets, saw moving images and heard voices of a man and woman transmitted from the General Electric Co.'s laboratories several miles distant. The receiving sets were installed in three different homes, and all functioned equally well. Transmission was on a 37.8 metre wavelength, while the voice was simultaneously conveyed on 379.5 metres.

D.E.H.

Esperanto Section.

Abstracts of the Technical Articles in Our Last Issue.

Esperanto-Sekcio.

Resumoj de la Teknikaj Artikoloj en Nia Lasta Numero.

PROPRECOJ DE CIRKVI TOJ.

LA DESEGNADO DE ŜOKBOBENOJ KAJ TRANSFORMATOROJ, KIUJ PORTAS KONTINUAN KURENTON.

Redakcia artikolo pritraktanta la modifon de induktanco, kiu okazas kiam Kontinua Kurento ĉeestas en ferkerna bobeno. La ciklo de magnetigo kaj la histereza kurvo estas unue konsiderita, sekvita de la kampo de magnetigo, kaŭze de malgranda Alterna Kurento surmetita sur ekzistantan Kontinuan Kurenton. La efekto de aera interspaco en la magneta cirkvito estas tiam pritraktita, kaj oni montras, ke ĉi tio eble havas la efekton igi, ke la malgranda kurvo de A.K. magnetigo estu pli krute klinita, tiel ke, la efektiva A.K. induktanco estas pligrandigita. La aera interspaco por optimumaj kondiĉoj estas pliposte diskutita laŭ la laborado de T. Spooner kaj C. R. Hanna (Usono). Esprimoj estas donitaj por la fluo en diversaj okazoj, kaj kurvoj estas montritaj por faciligi desegnadon, kun rimarkigoj pri praktikaj metodoj de desegnado rilate al aera interspaco, nombro da turoj, k.t.p.

RICEVADO.

VALVA KURENTO PERE DE ALTERNKURENTAJ ĈEFTUBOJ.—J. K. Jennings.

La artikolo priskribas metodon uzitan de la aŭtoro por havigi filamentan kaj anodan provizojn pere de A.K. ĉeftuboj. La senfadena aparato havas konvenciajn konektaĵojn. Transformatoro kun kvar vindaĵoj konsistas el la bobenoj:—(1) Primario por konekto al la A.K. ĉeftuboj, (2) por filamenta provizo al la aparato, (3) por filamenta provizo al la rektifikatoro, (4) por A.T. provizo al la rektifikatoro. Sekvas priskribo pri l'aparato de l'aŭtoro, inkluzive la dimensioj de la fero, la diversaj vindaĵoj, k.t.p. Notoj estas ankaŭ donitaj pri la ĝeneralaj aranĝoj kaj kunmetado.

REKTIKADO KIEL KRITERIO PRI DISTORDADO ĈE AMPLIFIKATOROJ.—M. von Ardenne.

Ĉi tiu artikolo pritraktas la fakton, ke miliampermetro povas esti uzita en la anoda cirkvito de amplifa valvo por indiki distordadon, kies ĉeesto estas evidentigita per iu ajn movo de l'instrumento, kaŭze de rektifado je foriro for de rekta parto de l'anoda kurvo. La efekto de transpaso al kurba parto de l'kurvo estas konsiderita, kun esprimoj por la permesebla krada migro, kaj la diferenco de kurveco inter la statika kaj dinamika karakterizoj estas ilustrita kaj diskutita. La "distorda faktoro" estas derivita, kaj oni deduktis, ke miliampermetro en la anoda cirkvito de potenca valvo devus ne varii pli ol 0.05 de sia konstanta cifermetro por obteni bonan ricevadon per laŭtparolilo.

NOVECA VALVA DETEKTORO.—H. J. Neill.

La detektoro priskribita estas laŭ la formo de ekvilibrata de-modulatoro, funkcia laŭ la konversa maniero de l'ekvilibrata modulatoro de transatlantika sendada praktiko. La kradoj de du valvoj estas konektitaj al kontraŭaj finaĵoj de fermita oscila cirkvito, kun krada potencio aplikita pere de centra konektaĵo, dum la anodoj estas provizitaj per komuna rezistanco kun kupla kondensatoro el la kuniĝo de rezistanco kaj anodo. La karakterizoj de ambaŭ valvoj devus esti preskaŭ identaj, kaj la aŭtoro donas notojn pri diversaj tipoj de valvoj provitaj. Oni diras, ke konsiderinde malpliigita valoro de altatensia vultkvanto povas esti uzita.

NOVA METODO POR UTILIGI REZISTECAN AMPLIFADON PER SKRENITAJ VALVOJ.—J. J. Dowling.

La aŭtoro unue konsideras la ekzemplon de rezisteca kapacita kuplado per triodo, ilustrante la rezonadon per familio de anodvoltaj/anodkurentaj

kurvoj. La rezonado estas etendita al skrenita valvo, kun interrespondaj kurvoj. Li poste montras, ke se la laboro estas limigita al la regiono de la anodvolta/anodkurenta kurvo, kiu klinas mal-supren (super regiono de ĉirkaŭ 30 anodaj volttoj) tre granda amplifado estas obtenebla super etega enmeta amplekso (proksimume po centonoj da voltto). Eksperimenta kontrolado de ĉi tiu rezulto estas priskribita, pligrandigo de 150-oblo estante citita.

SENDADO.

LA RADIADA REZISTECO KAJ ENERGIA KAPACITO DE DUONONDAJ ANTENOJ.—E. Green.

La aŭtoro unue aludas al opinio, ke estas mal-facile havigi percepeblan potencon en anteno por mallongaj ondoj, pro ĝia malgranda kapacito. Ĉi tio, li diras, estas malprava, kaj estas efektive la kontraŭo de la vero.

Li poste deduktas tipajn ciferojn por duonondlonga anteno uzita por mallongaj ondoj, kaj kompilas tabulan komparon inter tia anteno kaj la Rugby'a anteno, laŭ la ciferoj de S-ro. E. H. Shaughnessy (vidu *E.W. & W.E.*, Majo, 1926a). Ĉi tiu komparo montras 80% da efikeco por la duononda anteno, komparite je 26.5% por la Rugby'a anteno.

Mallonga matematika diskutado estas poste donita pri la radiada rezisteco kaj pri la proporcio de maksimuma tensio kontraŭ maksimuma kurento por la duonondlonga anteno.

HELPA APARATO.

PLUJAJ NOTOJ PRI LA REFLEKSA VOLTMETRO.—W. B. Medlam & U. A. Oswald.

La aŭtoroj larĝe pritraktas la priskribon pri la "Reflekso" tipo de termiona voltmetro (priskribita de ili en *E.W. & W.E.*, Novembro, 1926a), en kiu rezistanco inter la alttensia kaj mal-alttensia baterioj estas komuna ĉe krada kaj anoda cirkvitoj, tiel ke la potenco diferenco naskita trans ĝi, kaŭze de anoda kurento, agas kiel krada potencialo. La efiko de kondensatoro trans ĉi tiu rezistanco estas poste diskutita, kaj oni diras, ke estas preferinde normigi kaj utiligi la voltmetron kune kun tia kondensatoro. Poste pritraktitaj estas valoroj de rezisteco kaj de alttensia volt-kvanto, la efiko de ilia variado estante montrita per serio de normigaj kurvoj.

La aŭtoroj tiam diskutas la forekvilibrigon de komenca kurento per mekanikaj rimedoj kaj elektraj rimedoj, kaj priskribas la aranĝon de du-skala voltmetro, kun specimenaĵoj kaj notoj pri funkciigo.

Laste priskribita estas reflekso tipo de voltmetro kun seria krada kondensatoro, permesanta ĝian uzon en la ĉesto de kontinua kurento.

LA KOREKTECO KAJ NORMIGADA DAŬRECO DE VARIEBLAJ AERKONDENSATOROJ POR PRECIZECAJ ONDOMETROJ.—W. H. F. Griffiths.

Findaŭrigita el antaŭa numero, priskribinta novan formon de precizeca aerokondensatoro, ĉe kiu la apudaj dielektrikaj interspacoj estas elektre en serio, kaj estas ankaŭ komplementaj. En ĉi tiu parto la aŭtoro unue konsideras la amplekson de l'eraraj enkonduktitaj de la kapacito inter

apudaj movaj platoj, ilustrante amplekse la efekton je diversaj gradoj de rotaciado. Detaloj estas donitaj pri la skrenaj arandoj, por korekti ĉi tion, enkorpiĝitaj en la fina desegno; ankaŭ pri la kompletaj skrenarandoj de la tuta kondensatoro. La proporcio de maksimuma/minimuma kapacito estas poste diskutita, kun esprinoj por la kompleta kapacito de la kondensatoro. Notoj pri aliaj detaloj de desegnado estas ankaŭ donitaj, kaj la aŭtoro finas per priskribo pri l'utiligo de la kondensatoro ĉe malalta dekrementa ondmetra cirkvito, traktante ankaŭ pri tre sentema metodo de rezonanca detektado. Nerigide kuplita kristala cirkvito estas uzita, kune kun du galvanometroj, unu kiel proksimuma indikato por serĉi, kaj la alia kiel sentema indikato permesanta tre precizan alĝustigon, la pliboniĝo de precizeco estante ilustrita.

DIREKTA SENFADENO.

ROTACIANTAJ-KADRAJ RADIO-SENDILOJ.

Oni presigas resumojn de tri prelegoj pri la ĉi-supra temo, legitaj ĉe la Senfadena Sekcio de la Instituto de Elektraĵ Inĝenieroj, Londono, je 4a Januaro, 1928a.

(1) Rotaciantaj-Kadraj Radio-Sendiloj kaj ilia aplikado al Direkto-Trovado kaj Navigado.—de T. H. Gill kaj N. F. G. Hecht, M.I.E.E.

(2) Kelkaj Eksperimentoj pri l'Aplikado de la Rotacianta-Krada Sendilo al Mara Navigado.—de R. L. Smith-Rose, D.Sc., Ph.D., A.M.I.E.E., kaj S. R. Chapman, M.Sc., A.M.I.E.E.

(3) Teoria Diskutado pri Diversaj Eblaj Antenarandoj por Rotacianta-Kadraj Sendiloj.—de R. L. Smith-Rose, D.Sc., Ph.D., A.M.I.E.E.

DIVERSAĴOJ

RESUMOJ KAJ ALUDOJ.

Kompilita de la Radio-Esplorada Komitato (*Radio Research Board*), kaj publikigita laŭ arando ĉe la Brita Registara Fako de Scienca kaj Industria Esplorado.

LA EKSPOZICIO DE LA FIZIKA SOCIETO.

Rakonto pri aferoj de senfadena kaj laboreja intereso ĉe la Dekoka Ĉujara Ekspozicio de la Fizika Societo kaj la Optika Societo, tenita ĉe la Imperia Kolegio de Scienco kaj Teknologio, South Kensington, Londono, je la 10a, 11a, kaj 12a de Januaro, 1928a.

La revuo diskutas la aparaton montritan sub la rubrikoj "Elektraĵ Mezuraj Instrumentoj," "Laboreja Ekipaĵo," "Senfadenaj Akcesoraĵoj, Partoj kaj Aparatoj," "Esplora kaj Eksperimenta Sekcio," kaj estas ilustrita per fotografiaĵoj, unu kun aparta intereso, estante pri la nova tipo de precizeca kondensatoro priskribita en *E.W. & W.E.*, de Januaro kaj Februaro, 1928a.

LIBRO-RECENZO.

Recenzo de D-ro. R. L. Smith-Rose estas donita pri la verko "*Wireless Directional Finding and Directional Reception*" (Senfadena Direkto-Trovado kaj Direkta Ricevado), de R. Keen, B.Eng., A.M.I.E.E., dua kaj pligrandigita eldono, eldonita de la posedantoj de *E.W. & W.E.*

Some Recent Patents.

The following abstracts are prepared, with the permission of the Controller of H.M. Stationery Office, from Specifications obtainable at the Patent Office, 25, Southampton Buildings, London, W.C.2, price 1/- each.

THE TORUSOLENOID.

(Convention date (U.S.A.), 15th March, 1926. No. 267474.)

The form of winding shown in the Figure has been christened the Torusolenoid in America, presumably because it combines the "closed-field" advantage of the ordinary Toroid with the special feature that the input and output terminals are spaced widely apart as in a solenoid coil.

The wire is laid around a magnetic core in two symmetrical halves which are wound in opposite senses, so that the output terminal *N* lies diametrically opposite the input *P*. When a current passes through the two windings in parallel, the adjacent ends develop magnetic poles of opposite sign so that a closed magnetic field exists inside the core.

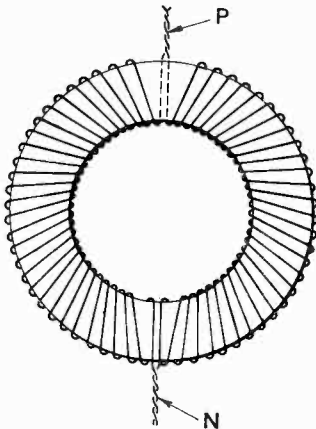

Owing to the wide separation of the terminals' capacity coupling such as is liable to arise in the ordinary Toroid, when used for very high frequencies, is avoided. In addition the standard Toroid with closely adjacent terminals forms, in effect, a single-turn winding which sets up a corresponding small external field. In the Torusolenoid the two windings form two single half-turns, each carrying current in the same direction, so that the external field is completely neutralised.

Patent issued to The Dubilier Condenser Co.

A DUAL-SUPPLY RECTIFIER.

(Convention date (Germany), 31st March, 1926. No. 268764.)

The rectifier tube shown in Fig. (a) is designed to supply a comparatively heavy charging-current at a low voltage, simultaneously with a relatively small charging-current at a high voltage, so that the same installation can be used for recharging

both a filament accumulator and a wet-cell type of H.T. battery. The glowing cathode *C* co-operates with two anodes *A* and *A*₁. The anode *A* is of large surface and practically surrounds the cathode, so that it absorbs the bulk of the electron discharge stream. The second anode *A*₁ is a mere point of wire which protrudes from an insulating sleeve *S* of quartz.

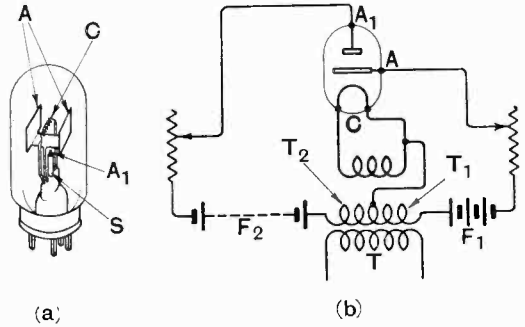

The circuit arrangement is shown in Fig. (b). The main secondary winding of the supply transformer *T* is in two parts, one *T*₁ consisting of a few turns of relatively thick wire, whilst the other *T*₂ comprises a larger number of turns of thinner gauge. A large amperage at low voltage is drawn from the main anode *A* to charge the filament accumulator *F*₁, whilst a smaller current at higher pressure is supplied from the point anode *A*₂ to the H.T. battery *F*₂.

Patent issued to Accumulatoren-Fabrik.

MECHANICAL PIEZO EFFECTS.

(Convention date (Germany), 8th April, 1926. No. 276037.)

When a piezo crystal is set into vibration by the application of an alternating E.M.F., it is known that the resulting molecular deformations react upon the air in the immediate vicinity of the crystal, and set up a train of compression waves.

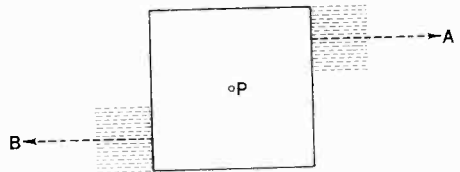

By cutting the crystal asymmetrically, the inventor arranges that these air currents are located at definite points such as *A* and *B* so that they produce a torque tending to rotate the crystal

bodily about a pivot *P*. The effect is used to indicate and measure the intensity of electric oscillations.

Patent issued to the Telefunken Co.

STABILISING CIRCUITS.

(Application date, 6th July, 1926. No. 281740.)

One drawback of certain known methods of preventing inter-electrode capacity coupling is that when the adjustments are such as to prevent self-oscillation on the higher frequencies, regeneration on the lower frequencies is *ipso facto* reduced to a point lower than is really necessary, so that the overall amplification is not constant. Another defect is a loss in the true quality of distant reception owing to excessive selectivity and consequent "trimming" of the side bands.

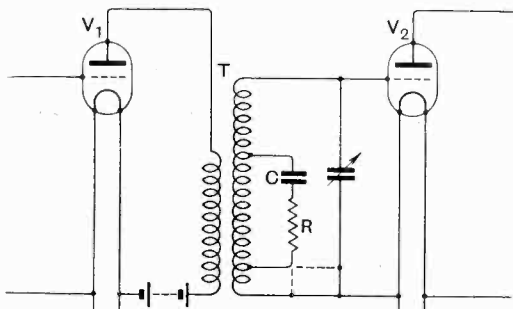

The Figure shows a circuit arrangement for ensuring stability without introducing either of these drawbacks. The coupling transformer *T* is so arranged that part of the primary winding is more closely coupled to one portion of the secondary than to the remainder of the same. To avoid excessive regenerative effects, a load is associated with certain of the secondary windings and is of such a nature that the voltage induced into the secondary is maintained constantly out of phase with the inducing currents; or conversely the induced current is kept in phase-opposition with the inducing voltage.

The load consists of a condenser *C* inserted in series with a resistance *R* across a number of turns on the secondary. The value of the load, and the number of secondary turns shunted, depend upon the impedance of the valves *V*₁, *V*₂, and upon other circuit constants. Definite values are given in the specification, together with a vectorial analysis of the various voltage which may exist, at any one instant, in a typical amplifying circuit.

Patent issued to the Gramophone Co., Ltd.

AERIAL SYSTEMS.

(Application date, 8th September, 1926. No. 281762.)

An antenna is energised from the power house by a single-wire feeder of any length, the effective resistance of the antenna being made equal to the surge impedance of the wire by the insertion of suitable loading resistances at distances corresponding to odd quarter-wave lengths along the

wire, together with inductive or capacitive impedances to neutralise the inherent inductance or capacity of the wire at the working frequency. Under these conditions energy flows along the wire from the generator to the loaded point, and is then completely absorbed by the resistance and by radiation from the point beyond, without creating any back-reflection effects.

If the loading point is located some considerable distance away from the power house, the system is equivalent to a Beverage or wave aerial, but since no physical "earth" is required, the antenna may be erected vertically. On the other hand, if the loading point is situated relatively near the power house, then the intervening line functions simply as a feeder to the main radiating portion, which may be expanded into any desired form (for example to give directional effects) and erected at a considerable height above the ground.

Patent issued to C. S. Franklin.

VALVE FILAMENTS.

(Application date, 3rd September, 1926. No. 281401.)

In order to reduce the internal impedance or A.C. resistance of a valve, the filament *F* is made of strip material, and the various legs forming the complete M- or W-shaped filament are all kept in the same plane relatively to the anode, care being

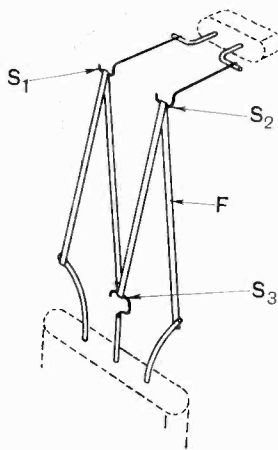

taken to see that no out-of-plane twist is introduced at the bight portion where the strips pass over the supports *S*₁, *S*₂, *S*₃. In this way the active or electron-emitting surface of the entire filament is maintained substantially equidistant from the flattened anode.

Patent issued to E. Y. Robinson and the Metropolitan Vickers Co.

HIGH-FREQUENCY GENERATORS.

(Convention date (U.S.A.), 17th October, 1925. No. 259937.)

In order to generate oscillations of very high frequency, the effective circuit inductance and capacity is exclusively located inside the bulb of the valve. The grid and filament are enclosed by

the plate structure *P*, which is supported by an insulating bridge-piece *B* carried at the extremity of elongated lead-in conductors *L—L₃*. The lead *L* from the high tension battery to the plate, and the lead *L₁* to the grid, are respectively bent outwards to form an inductive loop as shown.

The corresponding tuning capacity is contributed in part by the inter-electrode or grid-plate capacity, and in part by a small condenser *C* mounted as shown near the stub end of the valve, which also serves to keep the high-tension voltage from the grid. The lead-in conductors are connected to a

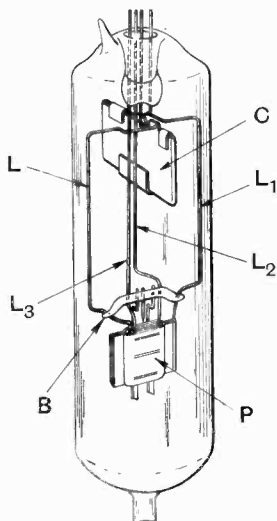

node in the oscillatory circuit, and are bent back into a plane at right-angles to the inside loop, so as to minimise undesirable inductive effects.

Patent issued to the British Thomson Houston Co.

PIEZO-CONTROLLED VALVE GENERATORS.

(Application date, 1st October, 1926. No. 281810.)

In order to generate sustained oscillations, the voltage variations across the grid and filament of a valve must be out of phase with those existing across the plate and filament. In this connection a piezo crystal oscillating at its natural frequency behaves as though it were a pure resistance of the order of, say, 20,000 ohms, whilst at other frequencies the crystal is equivalent to a high impedance, introducing a positive or negative phase-angle according to whether the circuit frequency is above or below the fundamental crystal frequency.

Accordingly if the grid and plate circuits of a single valve are back-coupled through a piezo crystal, oscillations at the fundamental crystal frequency will not be maintained, because at that frequency the crystal functions as a pure resistance and tends to keep the plate and grid voltages in phase. However, by using two resistance-coupled valves, *V, V₁*, and inserting the crystal *C* as a back-coupling link between the grid of the first and the

plate of the second, the correct phase-relations are ensured, and the system can be made to oscillate at the fundamental crystal frequency. An ad-

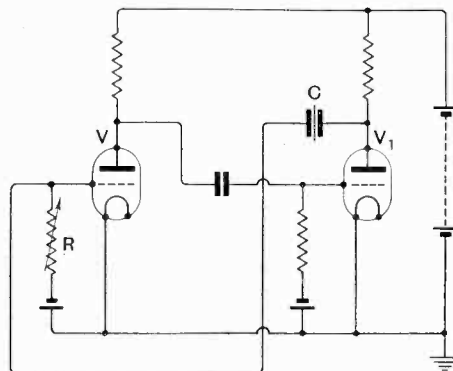

justable resistance *R* in the grid circuit of the first valve provides a critical control of the regenerative action.

Patent issued to H. L. Kirke.

GAS-FILLED RECTIFIERS.

(Convention date (Germany), 10th July, 1926. No. 274026.)

A gas-filled thermionic rectifier is characterised by the feature that the distance between the anode and the glowing cathode (or an element connected thereto) is substantially equal to the mean free path of the gas molecules at the working pressure.

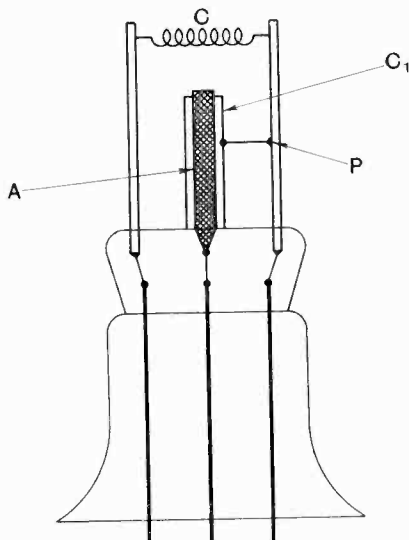

As shown in the Figure, the glowing cathode *C* is connected through a lead from the point *P* with a metal cylinder *C₁* closely surrounding the anode *A*. The latter is in the form of a thin rod.

The containing vessel is preferably of metal, or,

if of glass, is provided with a mirrored interior which is electrically connected to the cathode in order to stabilise the discharge. It is stated that a rectifier of this type will resist a back pressure of from 500 to 1,000 volts depending upon the enclosed gas, helium giving the best results.

Patent issued to F. Meyer, H. J. Spanner and C. von Wedel.

MAINS-SUPPLY UNITS.

(Application date, 10th September, 1926. No. 281776.)

The combined plate-current taken by, say, the first three stages of a four-valve set, is only a fraction of that consumed in the last or power stage. Moreover, any voltage fluctuations that may persist after the plate supply has been passed through the usual filter circuit will have a much greater effect on the earlier valve stages, where they undergo subsequent amplification, than if they only reach the plate of the power valve.

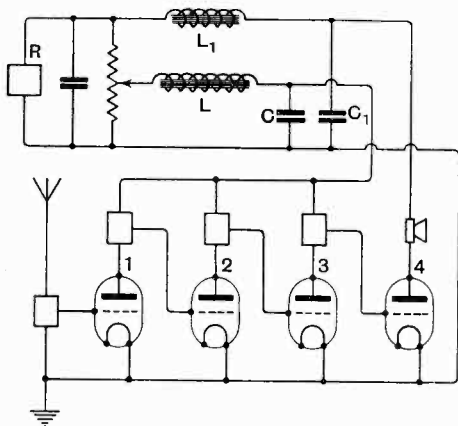

In order to effect an economy in the design of a filter circuit suitable for feeding a multi-valve set, the filter circuit is accordingly divided into two sections, one of high attenuation to carry the supply to the first valves, and the second of lower attenuation to supply the power valve. For instance, the plates of the valves 1, 2 and 3 are fed from the rectifier R through a choke L consisting of a very large number of turns of fine wire shunted by a condenser C. The supply to the plate of the

power valve 4, on the other hand, passes through a choke L₁ having fewer turns of heavier-gauge wire, shunted by a condenser C₁.

Patent issued to W. J. Brown and the Metropolitan Vickers Co.

NEUTRALISING SPACE CHARGE.

(Application date, 19th July, 1926. No. 280617.)

The effect of the crowd of electrons normally surrounding the heated cathode of a valve is

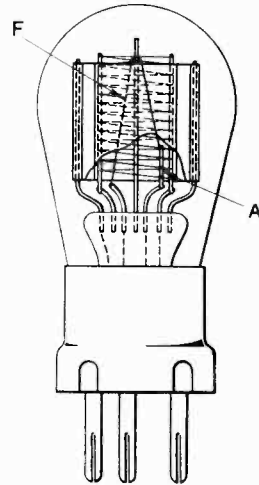

counterbalanced by deliberately introducing a substance which liberates positive ions under the influence of heat. A suitable material for this purpose is a fused mixture of iron oxide with a small percentage of an alkali or alkaline earth metal, a discovery due to C. H. Kunsman.

As shown in the Figure, a part A of the ordinary hair-pin filament F is coated with the ion-emitting substance which becomes active under the influence of the filament heating current. The coated leg A is connected to the positive terminal of the filament battery, so that the ions, when freed, naturally drift towards the more negative parts of the filament, and thus automatically counterbalance the stagnant electrons accumulated there.

Patent issued to L. J. Davies.

Catalogue Received.

GETTING THE MOST OUT OF RADIO. An educational catalogue of Quality radio components and accessories, distributed by Claude Lyons, Ltd., 76, Old Hall Street, Liverpool. A booklet of 72 pp., price 1s.

This booklet is mainly a detailed catalogue of apparatus handled by Claude Lyons, Ltd. It is prefaced by eight pages of advice on getting the most out of radio by Mr. Claude Lyons.

The bulk of the catalogue section of the book is devoted to the products of General Radio Co., of Cambridge, Mass., U.S.A., the remainder dealing with a selected range of components, mostly of American manufacture. It is interesting to have the information so detailed on a number of important products of the General Radio Co., which specialises in the manufacture of testing sets and laboratory equipment to meet the requirements of the wireless trade.