

EXPERIMENTAL WIRELESS & The WIRELESS ENGINEER

VOL. II.

OCTOBER, 1925.

No. 25.

Editorial Views.

Selectivity.

IN view of the increasing tendency (due to the very small current consumption of modern valves) to use multi-valve sets for reception except on ultra-short waves, there is considerable interest attached to the article on selectivity in this issue. At first sight, one might wonder why the question is connected with multi-valve sets; why, in fact, it has not been the practice to use several tuned circuits coupled together to get selectivity apart from the amplifier. The reason, however, is simple. A set of several coupled circuits has several natural frequencies, even if all the circuits are tuned alike. It is, in fact, a filter, and must be designed as such.

But the same circuits connected to one another by valves behave in a radically different manner, because they do not react on one another—except, of course, to a small extent *via* the valve capacity, in sets not neutralised.

The great selectivity which may be obtained in multi-stage sets makes it necessary to adopt a special point of view; one must be on one's guard against *excessive* selectivity. Consideration of this point, in connection with the methods developed in the article, throw into prominence a curious point in the case of multi-stage receivers designed to tune over a considerable range;

that if it is desired to maintain constant selectivity, the condensers should be practically fixed, and the inductances should be varied. Otherwise the set must be more selective on long than short waves.

As far as the writer remembers, this is a point not previously brought out.

Directional Reception.

We publish also in this issue an article on the methods adopted at certain commercial stations to diminish interference from atmospherics and unwanted stations by getting sharp directional effects. It is unfortunate that the most effective of these methods are hardly practicable for amateur working. But simplified versions of them may be very useful. For example, during the recent pan-European broadcast tests, we were working on a high power set and frame, in order to cut down interference and also to get help from the directional effect in identifying stations. In several cases it was found that the use of either a rather long earth wire or a small indoor aerial connected to the set as well as the frame gave a quite useful approximation to a "heart-shape" diagram, and was of great assistance. By connecting both to the set by untuned transformers with variable coupling even better results are obtainable, though with reduced signal strength.

Supersonics.

We were impressed, on our various visits to the Albert Hall Show, with the comparative absence of "freak" sets. On the other hand, the supersonic has undoubtedly come into its own. Naturally, the sets exhibited are exclusively for broadcast work. But it appears to us that the possibilities of this set for long-distance short-wave work are not yet fully recognised. After all, straight H.F. amplification is not so very difficult at 300 metres, and yet the supersonic is getting more and more popular for that work. On 50 or 20 metres, where (at present) straight H.F. amplification seems impracticable, it should have even greater claims for notice.

Many readers, we believe, are rather frightened of the supersonic, perhaps owing to the weird terms ("filters," for example) used by our Transatlantic cousins in describing it. But if one just sits down and starts to design out, on one's own, a combination of a I-valve receiver, a separate oscillator for short waves, a long-wave amplifier, and a long-wave oscillator for the beat note, one can go ahead very comfortably.

Although it is not our usual practice in E.W. & W.E. to give detail designs of sets, we are thinking of doing so in this instance, and giving particulars of a fairly successful set with which we have been working lately. At the same time we should be very glad to use similar descriptions of sets built by readers. It should be noted that we want above all the *principles and methods used in the design* rather than a bald description of the final set.

Why we give Space to Esperanto.

From time to time a few British readers of E.W. & W.E. complain because we devote some space to material in Esperanto. They suggest that those who wish to learn this

language are provided for elsewhere; and this is undoubtedly true.

But we should like readers to realise that (although we began with an Esperanto dictionary of wireless technical terms and a sketch of Esperanto grammar) the articles and abstracts now appearing are not primarily intended as Esperanto lessons for British readers, but are provided for their wireless interest to our many foreign readers.

It is, in fact, possible that in the future there will be an international arrangement by which leading wireless technical journals will publish Esperanto abstracts of their own contents, so that readers in other countries may derive benefit from them.

Lest it may be thought that this is just some personal fad, it may be mentioned that the use of Esperanto for such purposes has just been exhaustively investigated by a strong conference in Paris. We give just a few of the persons and institutions represented—those whose names are familiar to us: d'Arsonval, Berthelot, de Broglie, Gen. Ferrié, Lebesgue, Lumière, Painlevé, Perrin; British Association for Advancement of Science ("B.A."); French Association for Advancement of Science; American Association for Advancement of Science; American Mathematical Society; French Mathematical Society; Physical Society of London; Zoological Society of London; British Medical Association; French Society of Electricians; Carnegie Institute; Franklin Institute; Messrs. Gaumont; Messrs. Michelin.

In all, there were 130 societies and institutions and 120 well-known scientific individuals, belonging to 19 countries.

All agreed in recommending the use of Esperanto for expressing the results of scientific work, so as to make the information available to all countries; and we ourselves recommend readers, who are interested in learning what work is being done in other countries, to follow the lead of the Conference.

Selective Amplifiers.

A short review of the question of Correct Selectivity, with simple graphs and charts for design purposes.

By P. K. Turner.

[R342'6

A POINT on which the user of receiving apparatus has as a rule rather vague ideas, is the best means of getting the correct selectivity in H.F. amplifier circuits. We say the "correct" selectivity, for it must be realised clearly that excessive selectivity is quite possible. In telephony there is the well-known effect of loss in high notes due to "cutting" the side-bands. In telegraphy—especially high-speed work—there is trouble due to "rounding off," the dots and dashes no longer having sharp outlines.

It may be of interest, then, to show a quite easy way to design the coupling circuits to get just what is wanted. A fundamental point (mentioned not long ago in E.W. & W.E.) is the difference in the type of resonance curve obtained by (A) using one highly-selective stage and several quite untuned, or (B) by the same overall selectivity given by several equal fairly "flat" circuits. This point will be considered in due course.

The fundamental circuit to be considered is that of Fig. 1a, that known as "tuned anode." It should be noted that any "bridge" or "neutrodyne" methods of

"transferred to the primary." This means that if S is the turns ratio, a condenser C' across the secondary is treated as one of capacity S^2C across the primary, and a resistance R_e across the secondary treated as one of R_e/S^2 across the primary.

Now the effect of an alternating voltage E_{g1} on the grid of the first valve is to apply a perfectly definite alternating voltage μE_{g1} (where μ is the voltage amplification factor of the valve) to the anode circuit, in addition

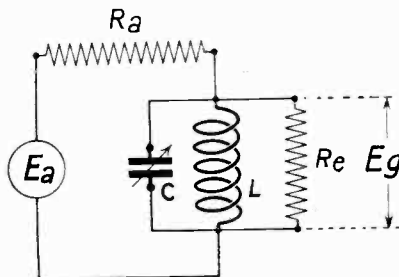

Fig. 1b.

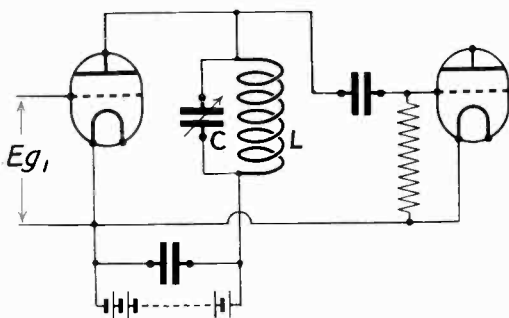

Fig. 1a.

stabilising will in no way affect our calculation, provided that the two items L and C are understood to be the coil and condenser actually forming the anode "rejector." The case of the transformer-coupled amplifier is essentially similar, provided that any capacity or resistance across the secondary is

to the D.C. voltage from the battery. Some of this voltage is used to drive the alternating anode current through the valve's own resistance; the rest to drive this current through LC . It is only this latter voltage that is transferred to the next grid.

Therefore, the measure of efficiency of the coupling is the fraction E_{g2}/E_{a1} —or, as we shall call it for simplicity, E_g/E_a —where E_a is the same as μE_{g1} , and is the alternating voltage put out by the first valve.

For purposes of calculation (which is carried out in the Appendix) we re-draw Fig. 1a in the form of Fig. 1b, where E_a is a generated voltage, R_a the anode impedance of the valve itself, and R_e the resistance of the grid circuit of the next valve. The resistance of the H.T. battery is neglected: it is supposed to be shunted by a condenser of reactance negligible at the working frequency.

In order to give the result of analysing the circuit in the simplest and most general form, we shall denote some of the important

relationships in the circuit by letters. First, let ψ be the phase difference of the coil, which is its resistance divided by its reactance at the working frequency. We elected to

affected by tuning, while the second is. To get selectivity we want A to be small, so that B shall have as large an effect as possible on the value of η . For this purpose

the first thing is to make R_c large, which means a well-designed grid circuit. (Note that we have not allowed for the capacity of this, because it is included with C .) In practice, R_a/R_c will almost always be considerably smaller than 1. Next, we should keep ψ small. But if m is going to be small this will not be so important, for then the product $m\psi$ will almost certainly be only quite a small factor compared with 1.

It is important to note that changes in A have the greatest effect on currents to which the circuit is tuned, while changes in B effect others more. It is therefore bad practice to control excessive selectivity by increasing ψ (as by using bad

coils, or "lossing"), because this increases A without affecting B . An increase of m increases A also, but in addition effects a greater increase in B , and therefore decreases the selectivity without such a large loss of efficiency.

It will be the general rule, then, to get the correct selectivity by adjusting the value of m : small m , i.e., large coil (and small condenser), for flatness; large m , i.e., small

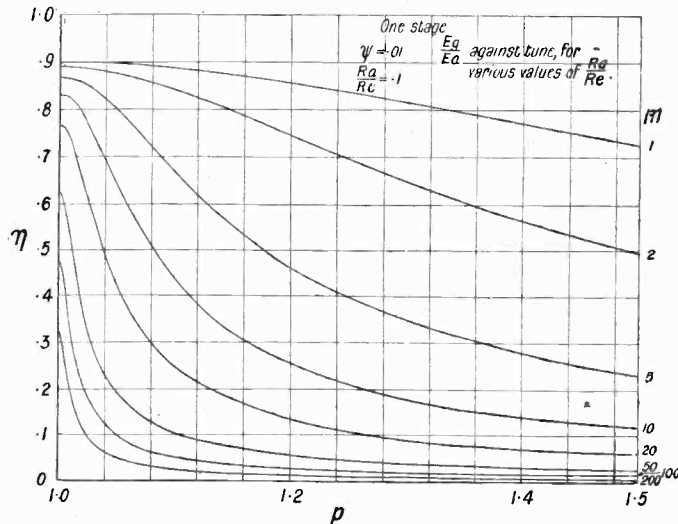

Fig. 2.

base our calculation on ψ rather than on the actual resistance of the coil because, although both vary with frequency, the phase difference is usually the more nearly constant of the two. Next, let m be the ratio of the anode resistance of the valve to the reactance of the coil at the working frequency: it will be seen later that this is the controlling factor for selectivity. Next, let p be the "tuning ratio" of any frequency, i.e., if λ_0 is the wave length to which the circuit is tuned, and λ any other wave-length, then $p = \frac{\lambda_0}{\lambda}$. Lastly, let η be the "efficiency," i.e., the ratio E_g/E_a already mentioned. Then (as shown in Appendix I.) to a close approximation

$$\frac{1}{\eta^2} = \underbrace{\left(\frac{R_a}{R_c} + 1 + m\psi \right)^2}_{(A)} + \underbrace{m^2 \left(p - \frac{1}{p} \right)^2}_{(B)} \quad (1)$$

Before going on to give detailed results from this equation, it is interesting to note some general features. First, it must be remembered that to get selectivity we do not want η to be always large or always small. We want it to be large for tuned signals ($p=1$) and small for untuned ones. Now the expression for $1/\eta^2$ comprises two parts, A and B , of which the first is not

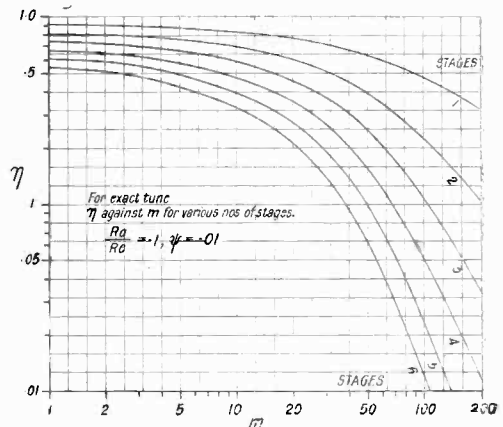

Fig. 3.

coil (and large condenser) for sharpness. High magnification valves usually have high anode impedance, and hence call for larger coils and smaller condensers.

Any attempt to show actual effects in typical circuits is rather handicapped by the large number of variable factors: R_a , R_e , L , λ , and ψ , might all vary. We decided therefore to investigate only one value of R_a/R_e and one value of ψ . The value chosen for R_a/R_e was .1. It is by no means easy to assess the real value of this, for R_e varies according to the type of the second valve and the load in its anode circuit, and depends also on frequency. It is probable that at short wave-lengths R_a/R_e is really quite considerably larger than .1. But, as stated above, a change in its value causes a much smaller change in η , and, further, does not greatly affect selectivity. The same consideration, luckily, hold as regards ψ , so we selected for ψ a fixed value of .01. This is a reasonable value for good plug-in coils of medium inductance value—"50 to 200 turn" coils: smaller ones are likely to be better and larger ones worse. But, as we have stated, any divergence in ordinary practice from our chosen values of R_a/R_e and ψ will not greatly affect the results as regards selectivity.

From now onwards, then, we adopt as fixed

$$\frac{R_a}{R_e} = .1, \psi = .01.$$

Our first step was to calculate out and draw the resonance curves for one stage of such an amplifier for various values of m . These will be seen in Fig. 2, where η is plotted against p for values of m from 1 to 200. Both the outstanding features are very clearly shown here. There is a drop in efficiency, from .9 for the largest coil ($m=1$) to .32 for the smallest ($m=200$); and at the same time there is a very large change in selectivity. In Fig. 3 we show how, for exactly tuned signals, the strength falls off as the selectivity is increased by using large values of m . The reduction is shown for varying numbers of stages.

But it is not quite easy to see in Fig. 2 just how one curve compares with another; a much truer comparison is got by first multiplying each curve by a factor which brings the efficiency at exact tune ($p=1$) up to one fixed value; and secondly by using a logarithmic scale for η . These two changes have been made in Fig. 4. In this diagram the steepness of any curves at any point is a true measure of the selectivity; also, this type of curve is especially useful in dealing with multi-stage amplifiers.

Fig. 4 lays bare a very unfortunate difficulty in set design. Suppose, for example, we have found that in order to get the side-bands we must include signals "5 per cent. off tune," i.e., $p=1.05$, and that we wish to get them at not less than .8 of the strength of the carrier wave. Then we see from Fig. 4 that the highest permissible value of m is 10. This means that signals 20 per cent. off tune ($p=1.2$) will come in at a strength of about .31. If we wish for better selectivity we must sacrifice part of the side-band.

The difficulty is avoided by using several stages each one of the same moderate selectivity, instead of one highly-selective stage and several untuned ones. That this is so is seen from Fig. 5. It is fairly obvious that if one stage cuts a certain signal down to .8 of its original value, two stages will cut this down again, making it $.8 \times .8 = .64$. With the logarithmic scale, this means simply that every point on the "2-stage" curve

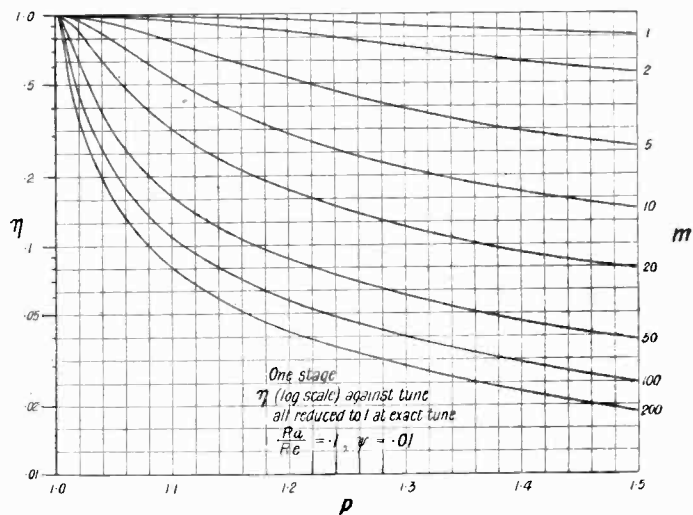

Fig. 4.

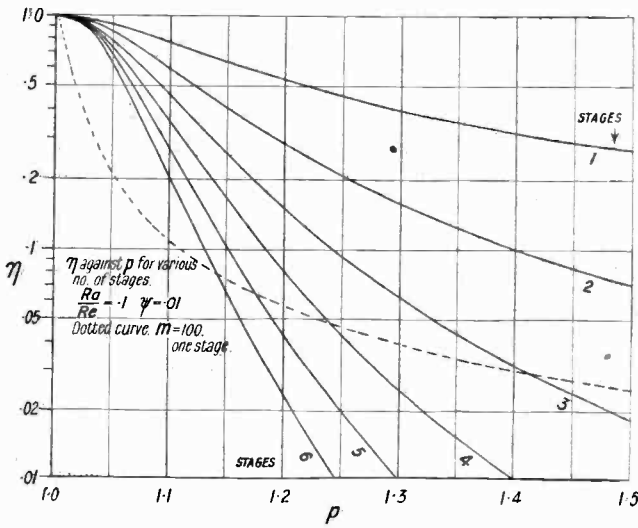

Fig. 5.

will be twice as far from the top of the sheet as the corresponding point on the "1-stage" curve, and thus we get Fig. 5.

Note, that in saying that a stage of amplification "cuts down" a signal, we really mean that the coupling does so. The accompanying valve will then magnify the remainder. Thus: strength of original signal 1. After first valve (of $\mu=5$, say), the strength is $1 \times 5 = 5$. After first coupling (giving a reduction to .8, say), strength is $5 \times .8 = 4$. After second valve, strength is $4 \times 5 = 20$; after second coupling, $20 \times .8 = 16$.

Let us tabulate these values for efficiencies of .1, .8, and .6 respectively:—

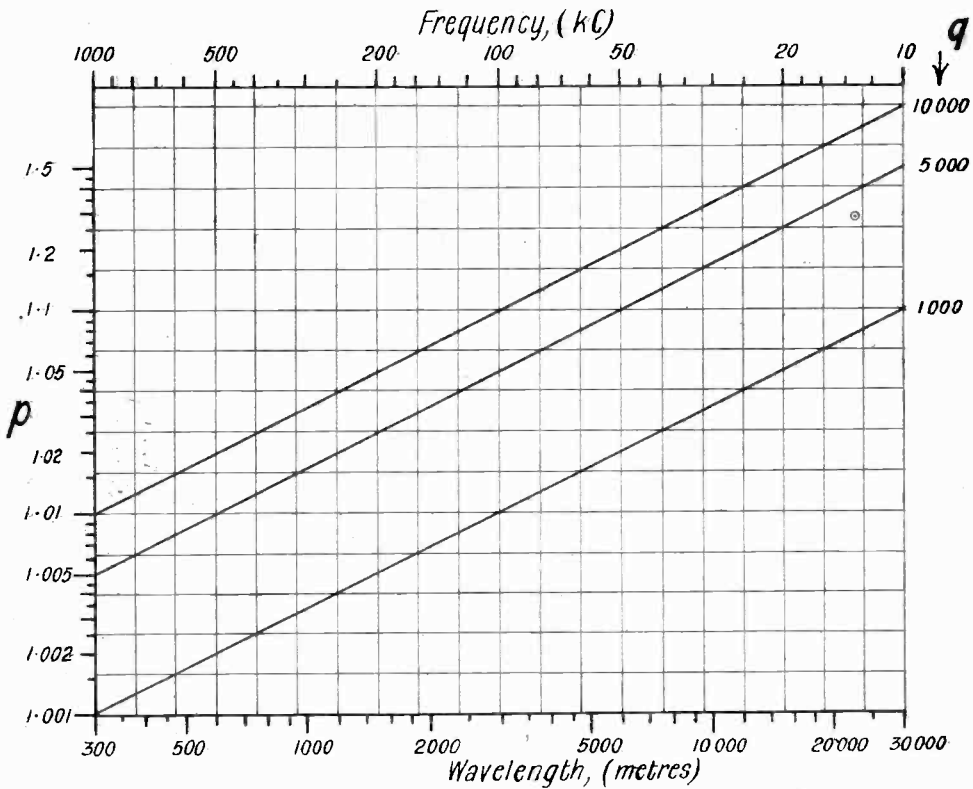

Fig. 6.

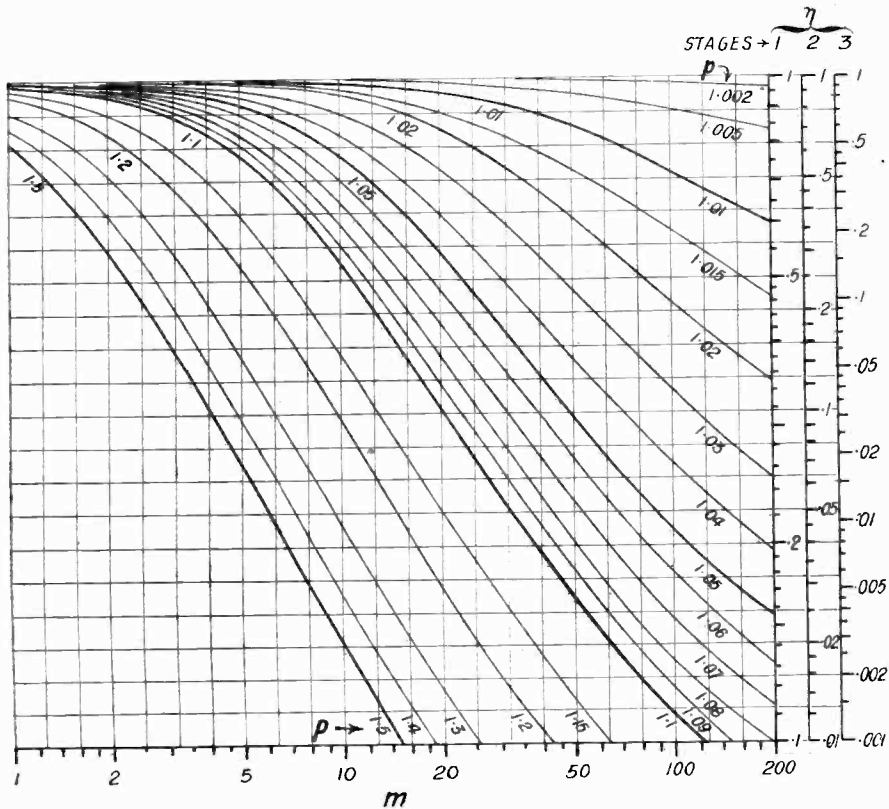

Fig. 7.

Efficiency	Signal	After 1st valve	After 1st coupling	After 2nd valve	After 2nd coupling
1	1	5	5	25	25
.8	1	5	4	20	16
.6	1	5	3	15	9

Comparing the initial and final results, we see how the reduction in the coupling increases selectivity.

The multi-stage curves in Fig. 5 are all for a circuit of rather low selectivity ($m=5$), except the dotted one, which is that of a single selective circuit ($m=100$) introduced from Fig. 4 for contrast. It is hardly necessary for us to point out the increased admission of nearly tuned "side-bands" of the multi-stage curve, combined with its better elimination of signals considerably off tune.

It will be appreciated, of course, that this

is not necessarily an advantage. For telephony, it is of course a necessity. But for amplifying a single unmodulated frequency before allowing a local heterodyne to beat with it, the curves of Fig. 4 are more suitable, and it will be best to get the required selectivity by a few extremely selective circuits rather than by many moderate ones—additional stages, if required for strength, being aperiodic.

Now as to the design of an amplifier. We assume that the question to be solved is something like the following: "I want to amplify at 3 000 metres, to include side-bands given by audio frequencies up to 5 000 cycles; permissible drop not below .8; anode impedance of valves, 30 000 ohms."

The first question, then, is as to the amount of de-tuning (*i.e.*, value of p) required by a given modulation frequency on a carrier of given wave-length. This is solved by Fig. 6. Here wave-length is read along the bottom or radio frequency along the top, and lines are given for 1 000 cycle modulation for

telegraphy, and 5 000 and 10 000 for telephony, the latter being preferable if it can be managed. This modulation frequency we are calling q , and from Fig. 6 we can find p for any given q and λ : in our example $p=1.05$.

The next task is to find the value of m which, for signals of given " p ," will give not less than the requisite strength of signals. For this purpose we have prepared Figs. 7 and 8. Fig. 8, it may be noted, is simply the upper part of Fig. 7 to a larger scale. In order to deal with amplifiers of various numbers of stages, we have provided each of these figures with several scales of η , each for a given number of stages.

In the case of our chosen example, we have $p=1.05$, $\eta=.8$; and we wish to find m . We can find different values of m for each number of stages; they are as shown in the table at the head of the next column.

The choice between these alternatives depends on the desired reduction of signals further off ture. There are, of course, many

Stages	m	η for $p=1.2$	η for $p=1.5$
From Fig. 7	1	.34	.16
	2	.22	.05
	3	4.5	.025
From Fig. 8	4	.14	.012
	5	3.5	.007
	6	.12	.004 5

other considerations, such as the cost of many stages, difficulty of handling, required final strength of signals, etc.; but these are problems apart from the one we are considering at the moment. It may be that the number of stages is already fixed by other considerations, in which case m is now settled. Assuming that we are not limited by any such other considerations, let us take it that we are faced with jamming which is at a difference of wave-length given by $p=1.2$ or 1.5. Then the third and fourth columns of the table above show what is the comparative strength of this jamming.

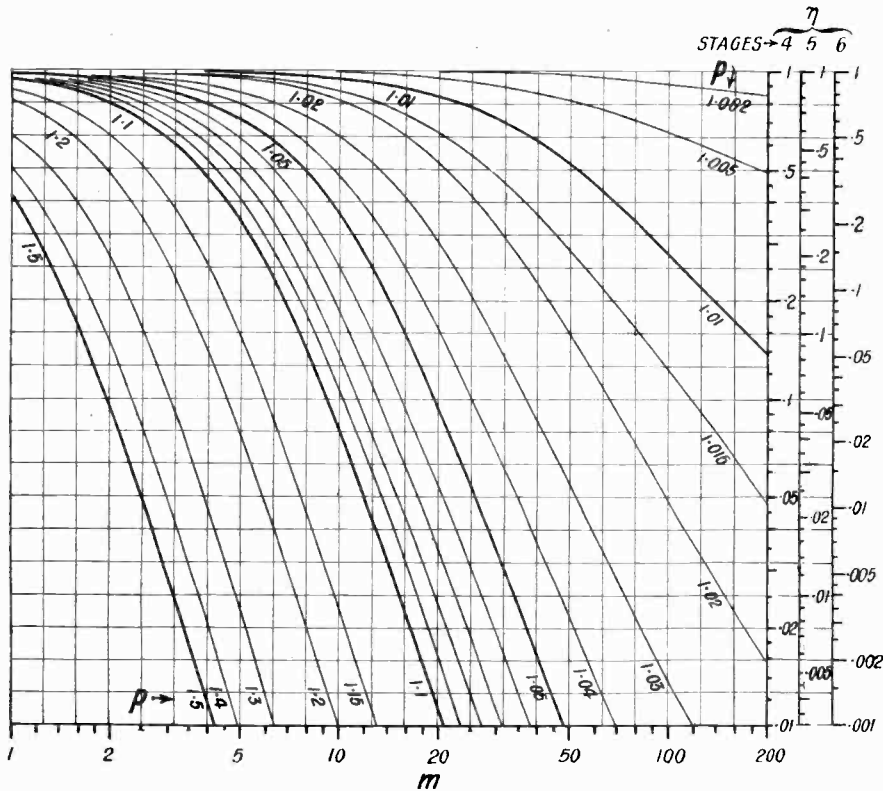

Fig. 8.

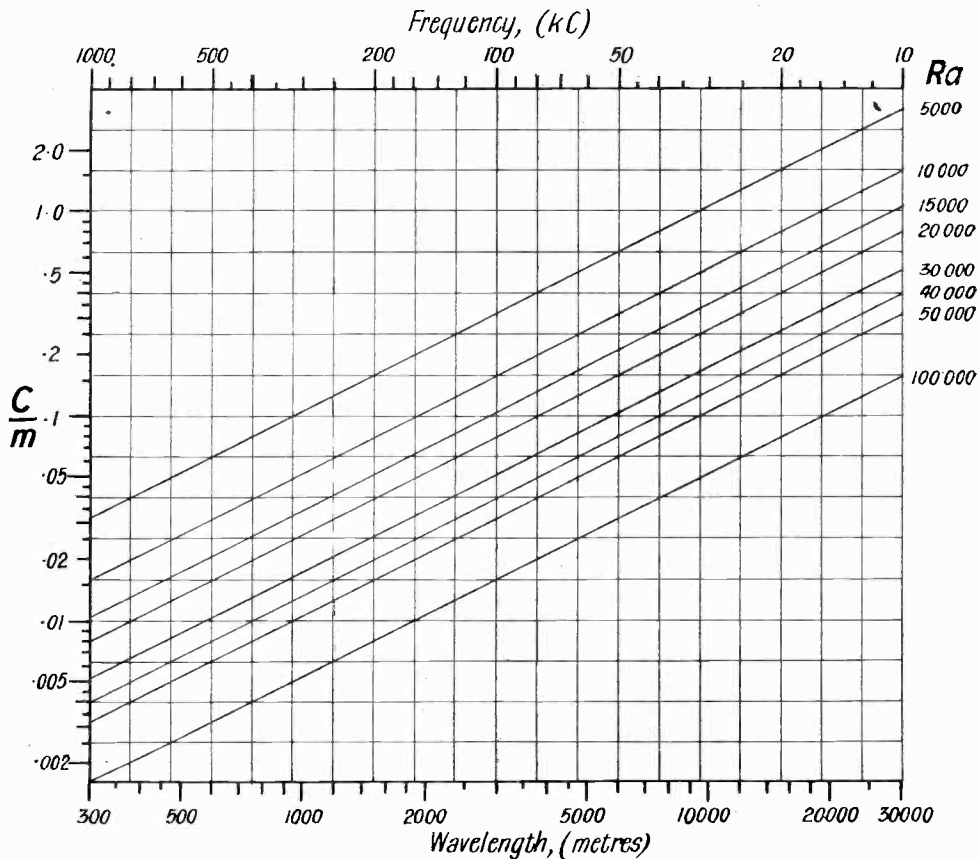

Fig. 9.

It would appear that three stages, $m=4.5$, would be the best compromise between economy and efficiency in the first case.

Having found m , we are in a position to evaluate the required inductance of our coil. But here a most interesting point crops up.

It is well known, and is confirmed by Fig. 6, that for a given q (modulation frequency), ϕ increases as the wave-length goes up. Figs. 7 and 8 show that, for a given minimum of η , m must decrease as ϕ goes up, and therefore as λ goes up. But $m = R_a/X_o$, where X_o is the reactance of the coil at the tuned frequency. Now, at the tuned frequency, the reactance of coil and condenser are equal—that is the definition of resonance. The reactance of a condenser is $1/2 \pi fC$, so we have $m = 2\pi fR_aC$. Now, we have just shown that m must increase as f goes up (this is the same as a decrease as λ goes up). If m and f increase exactly together, we see that, if R_a does not change, C will not either: in fact,

the same condenser value will be right for all frequencies: only the coil should be changed. In actual practice m does not vary exactly in proportion, so that the required capacity is not exactly the same for all frequencies. But a change of wave-length from 300 to 30 000 metres may only cause a change of 30 or 50 per cent. in the capacity. For this reason we shall give details as to how to find C , and not L , from the data we have already got together. L can always be found from C and λ .

It will be remembered that we have already shown how to find m . Fig. 9 gives a means of finding C/m , and on multiplying this by m we have C at once. Fig. 9 has lines for values of R_a from 5 000 ohms, for power valves of fairly low μ , up to 100 000 for valves such as the "Q." As a rule, it will be from 20 000 to 40 000.

Fig. 10 shows capacity required against frequency, for three random cases, worked

out in this way. It will be noted that practical working conditions, most happily, nearly always lead to a capacity of convenient value. As was stated above, the

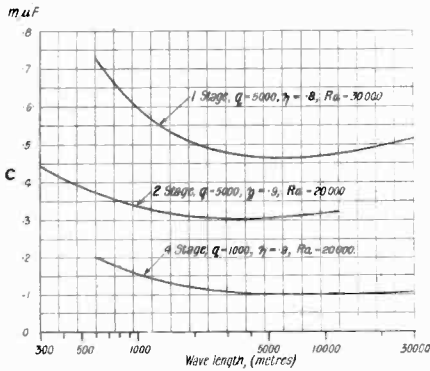

Fig. 10.

frequency effects nearly cancel out, the largest condenser for any one case being only twice that of the smallest throughout the whole range of frequency.

Lastly, before we repeat and summarise the working instructions, we feel inclined to say a few words on the cases where this question of correct selectivity may be really important. The outstanding example, of course, is in the supersonic set for telephony, where its effects are very obvious, and in fact act as a definite limit on the selectivity. But this is by no means the only case. A carefully stabilised H.F. amplifier of high power may show the effect quite distinctly on short waves.

An interesting point crops up in connection with heterodyne reception. If an H.F. or supersonic amplifier is being used, it is obviously best to defer the introduction of the heat supply to the latest possible point; for before its introduction we are dealing with a single pure frequency without side-bands, and can get extreme selectivity. Afterwards, this is not the case.

SUMMARY.

Given λ , the wave-length to be received; q , the modulation frequency; η , the minimum permissible strength of the edge of the side-band, compared with that at the carrier; and R_a the anode impedance of the valve:—

Turn to Fig. 6, and from λ and q find p ; then turn to Figs. 7 or 8, and from p and η find m : decide on the number of stages,

which will affect m . Last, turn to Fig. 10, and from λ and R_a find C/m . C is got by multiplying these two results, and will be given in $m\mu F$ ($1m\mu F = .001\mu F$). L can be got from the well-known formula

$$\lambda = 59.7\sqrt{CL}$$

or

$$L = \frac{\lambda^2}{3550C}$$

which gives it in microhenries.

APPENDIX I.

Referring to Fig. 1b of the article, reproduced here for reference; if the coil L has a resistance R_e and the losses in condenser C are neglected, let Z be the operator impedance of the circuit comprising C , L , R , and R_e .

Then

$$\frac{I}{Z} = j\omega C + \frac{I}{R + j\omega L} + \frac{I}{R_e} \quad \dots (1)$$

$$= j\omega C R R_e - \omega^2 L C R_e + R_e + R + j\omega L \quad \dots (2)$$

$$\text{or } Z = R_e \frac{R + j\omega L}{R_e(1 - \omega^2 LC) + R + j(\omega L + \omega C R R_e)} \quad \dots (3)$$

Now the total impedance of the circuit is

$$Z' = Z + R_a \quad \dots (4)$$

$$= \frac{R R_e + j\omega L R_e + R_a R_e(1 - \omega^2 LC) + R R_a + j R_a(\omega L + \omega C R R_e)}{R_e(1 - \omega^2 LC) + R + j(\omega L + \omega C R R_e)} \quad \dots (5)$$

from this, if Z' is the magnitude of Z' ,

$$Z'^2 = \frac{A^2}{B^2}$$

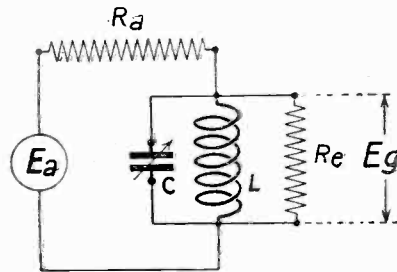

where

$$A^2 = [R R_a + R_a R_e + R_e R - \omega^2 L C R_a R_e]^2 + [\omega L(R_a + R_e) + \omega C R R_a R_e]^2 \quad (6)$$

$$\text{and } B^2 = [R_e(1 - \omega^2 LC) + R]^2 + [\omega L + \omega C R R_e]^2 \quad (7)$$

Now A^2 reduces to

$$R_a^2 R_e^2 \left[(R^2 + \omega^2 L^2) \left(\frac{R}{R_e} + \frac{R_a}{R_e} \right)^2 + 2R \left(\frac{R}{R_e} + \frac{R_a}{R_e} \right) + (1 - \omega^2 LC)^2 + \omega^2 C^2 R^2 \right] \quad (8)$$

and the corresponding numerator for Z^2 is

$$R_e^2 [R^2 + \omega^2 L^2] \quad \dots (9)$$

and if we neglect R^2 by comparison with $\omega^2 L^2$,

then

$$\frac{Z'^2}{Z^2} = \frac{1}{\eta^2} = R_a^2 \left[\left(\frac{1}{R_e} + \frac{1}{R_a} \right)^2 + \frac{2R}{\omega^2 L^2} \left(\frac{1}{R_e} + \frac{1}{R_a} \right) + \frac{(1 - \omega^2 LC)^2}{\omega^2 L^2} + \frac{C^2 R^2}{L^2} \right] \quad (10)$$

$$= \left(\frac{R_a}{R_e} + 1 \right)^2 + \frac{2RR_a}{\omega^2 L^2} \left(\frac{R_a}{R_e} + 1 \right) + \frac{R_a^2}{\omega^2 L^2} (1 - \omega^2 LC)^2 + \frac{C^2}{L^2} R^2 R_a^2 \quad (11)$$

now let $\omega_0^2 = \frac{1}{LC}$, and $\omega_0 L = \frac{1}{\omega_0 C} = X_0$,

also let $\frac{\omega}{\omega_0} = p$, so that $\omega^2 LC = p^2$,

$$\omega L = pX_0, \quad \omega C = \frac{p}{X_0}, \quad \frac{C}{L} = \frac{1}{X_0^2},$$

and lastly, let $\frac{R}{\omega L} = \psi$ and $\frac{R_a}{\omega L} = m$,

then

$$\frac{1}{\eta^2} = \left(\frac{R_a}{R_e} + 1 \right)^2 + \frac{2m\psi}{p^2} \left(\frac{R_a}{R_e} + 1 \right) + m^2 \left(\frac{1}{p} - p \right)^2 + m^2 \psi^2 \quad (12)$$

Now it will be noticed that of the two terms in p , the second is symmetrical in p and $1/p$, while the first is not, thus the "resonance curve" obtained

by plotting η against p is asymmetrical. For our purpose, however, a mean value of η for p and $1/p$ is useful, and the equation is much simplified by substituting 1 for p in the first term. It may be noted that the resulting error is quite negligible for all values of p that are important. Making this substitution, (12) reduces to

$$\frac{1}{\eta^2} = \left[\frac{R_a}{R_e} + 1 + m\psi \right]^2 + \left[m \left(\frac{1}{p} - p \right) \right]^2 \quad (13)$$

as stated in the body of the article.

APPENDIX II.

Derivation of Fig. 6.

This is a simple graph with logarithmic scales, to solve the equation

$$r = \frac{q}{f} = \frac{q\lambda}{3 \times 10^8} \quad \dots \quad (14)$$

where $r = p - 1$. The vertical scale is, of course, logarithmic in r and not in p .

Derivation of Fig. 9.

Since $m = \frac{R_a}{X_0} = R_a \omega C \quad \dots \quad (15)$

$$\frac{C}{m} = \frac{1}{2\pi f R_a} = \frac{\lambda}{6\pi R_a \times 10^8} \quad \dots \quad (16)$$

and Fig. 9 is a logarithmic scale graph to solve this.

Measuring Small Changes of Anode Current. [R384·6

IN many uses of the valve for radio measurement we are interested, not in the steady current in the anode circuit, but in small changes of that current due to a voltage applied to the grid as the result of some phenomenon under observation. As a particular case may be quoted the drop of anode current on rectification—a change which is frequently utilised in laboratory measurements either with locally assembled gear or in the Moullin H.F. voltmeter arrangement.

In the former case the high value of the steady anode current (relative to the very small changes to be observed) is sometimes inconvenient, especially if a multi-range

instrument is available with a scale value suitable for the small changes, but much too sensitive for the steady current.

Ordinary methods of shunting are inadmissible since they simply reduce the sensitivity of the instrument, and we are compelled to look for an arrangement which balances out the relatively large steady current in the sensitive galvanometer or microammeter, while still leaving it responsive to the small changes.

A very simple arrangement to give this effect has been shown by Moullin and Turner.* It is illustrated in Fig. 1, where it will be seen that the galvanometer is shunted by a high resistance R and that the potentiometer P can be set to give a current through the GR circuit in the opposite direction to the current already traversing the galvanometer due to its position in the anode circuit. The potentiometer can thus be set to zero the galvanometer or microammeter, which will then show the change under observation (correction being made for the shunting effect of R).

This arrangement is convenient in that it

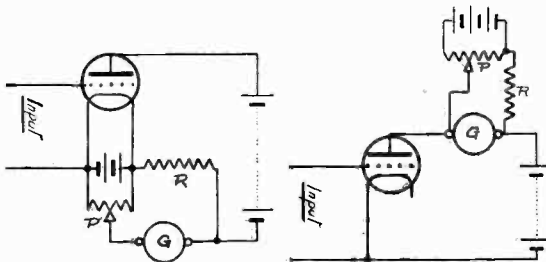

Fig. 1.

Fig. 2.

* Journal I.E.E. Vol. 60, No. 310, June, 1922.

utilises the already existing filament battery as a source of the balancing current, but it involves non-commoning of the filament

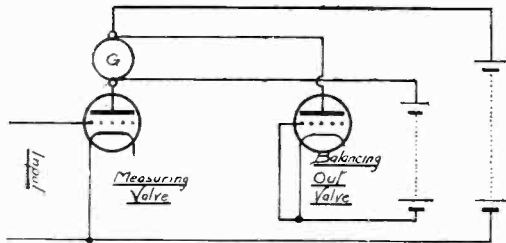

Fig. 3.

and anode batteries. In some cases where this commoning already exists and cannot

conveniently be broken, it may be more convenient to use a separate battery with the potentiometer, as shown in Fig. 2. This is exactly similar in principle to the arrangement in Fig. 1.

Another convenient arrangement is that of a balancing out or "backing-off" valve, as shown in Fig. 3. The filament of the balancing out valve is then adjusted to zero the galvanometer. This has the advantage of effectively shunting the galvanometer (in so far as its position in the measuring valve is concerned) by a resistance which is the anode impedance of the balancing valve and will therefore be so large compared with the resistance of the galvanometer that its shunting effect can be ignored. J. F. H.

Meters for Valve Transmitters.

[R 384

THERE are probably quite a number of transmitting amateurs who, for reasons of economy, have failed to invest in the milliammeter and H.T. voltmeter necessary for determining the input power, and it is proposed to show how an ordinary moving-coil ammeter may be modified to serve the purposes of both these instruments.

The moving-coil type ammeter, reading up to about 20 amps, is quite cheap, and to convert it into a milliammeter it is only necessary to disconnect the low resistance shunted across the winding. To calibrate it the meter should be joined in series with a high resistance (such as a high resistance ear-piece) and a battery of 6 volts. The current passing through the circuit is found from Ohm's law. If the needle points to, say, 4 amps, when the actual current is 6 milliamps, it may be assumed that 10 amps would indicate 15 milliamps, and so on.

The next step is to use the meter for the measurement of H.T. up to about a 1000 volts. In this case a resistance of something in the neighbourhood of 50 000 ohms is required. The anode resistance used in the receivers is altogether out of the question; similarly, to wind one by hand is beyond the patience of most of us. This leaves the liquid resistance, which is quite suitable if it is not overworked.

A glass tube about 5 inches long and 1/2 inch diameter should be fitted with two corks, through which pass two thick wires to act as electrodes. The tube must be nearly

filled with distilled water and joined in series with the meter and a source of H.T. of about 200 volts' pressure. Dilute sulphuric acid should then be admitted into the water, drop by drop, until the meter registers about a fifth of the highest desired reading; that is to say, until the applied voltage is 200, when the meter is required finally to 1000 volts. The same method of calibration as that used previously may also be employed here, but, of course, the instrument may be calibrated against standard meters if they are available.

The tube containing the dilute acid solution should be placed in a vertical

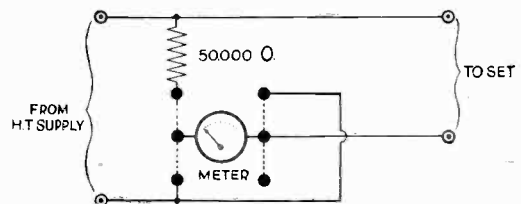

Fig. 1.

position, and the upper cork should have a vent to allow the gases caused by electrolysis to escape.

If this meter, now a combined milliammeter and H.T. voltmeter, is joined up with the resistance and a D.P.D.T. switch to the circuit shown in Fig. 1, the change from one instrument to the other will be a simple matter and the input to the set may be determined easily and quickly. S. K. L.

Distortion in Wireless Telephony, and Related Applications of the Cathode Ray Oscillograph.

By E. K. Sandeman and N. Kipping. [R135-R388

Part II.

APPLICATION OF THE CATHODE RAY OSCILLOGRAPH.

A. INTRODUCTORY REMARKS.

SINCE the Cathode Ray Oscillograph has only recently reached the stage of development where it is within easy reach of the ordinary research laboratory, a good deal yet remains to be learnt of the uses to which it can be applied. There are, however, several cases in which it has been of service where other means of investigation have proved either cumbersome or totally inadequate.

Amongst the latter cases may be included the study of atmospheric, of dynamic valve characteristics and of the process of modulation.

It has been found very useful also in comparison of frequencies with great accuracy and the plotting of circuit characteristics generally.

Perhaps it should here be remarked that the great advantages of the Cathode Ray Oscillograph over other types are that, being free from inertia, it is capable of dealing with radio frequencies; that it plots in rectangular co-ordinates the characteristic under examination; and that the curves plotted may be visually examined, without the necessity for recording photographically.

For the benefit of those who are not familiar with the function of the Cathode Ray Oscillograph, a description was included in last month's issue.

In oscillographic investigations, it frequently happens that data are required of the way in which oscillating currents or voltages vary with time, rather than of the way in which they vary with some other dependent variable. It is consequently necessary to establish a means of procuring a time scale with the cathode ray oscillograph. The method which the authors have used is described in Appendix II.

B. APPLICATION.

The Study of Atmospheric.—This matter has been the special study of the Radio Research Board, established under the Department of Scientific and Industrial

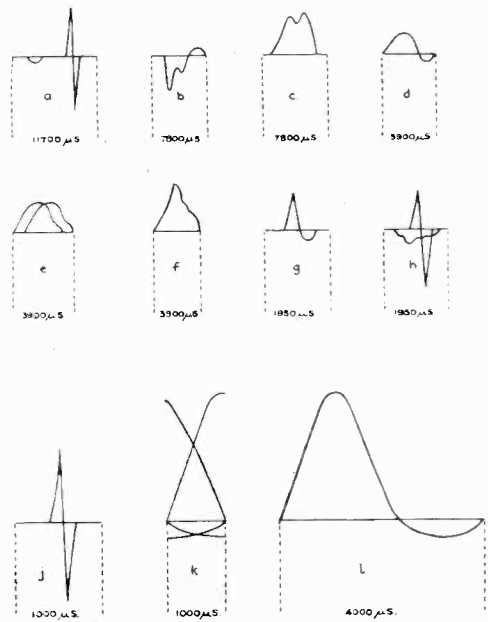

Fig. 13.

Research, by whose kind permission we are able to publish Fig. 13. In this figure are seen direct tracings from the oscillograph screen of some selected samples from the wave forms of atmospheric. These strays were observed visually on the oscillograph screen, and delineated by the Radio Research Board with the help of a linear time base developed for the purpose by Appleton, Herd and Watt, who have been responsible for this important investigation.

The duration of the forms traced in the figure is shown below each one in micro-

seconds (μ s). The duration is, of course, known from the frequency of operation at which the time-base was working.

The forms shown are typical. Form *k* is an excellent example of the use of the linear time base, for in this figure the complete form lasted four times the duration of the base. The known linearity of the base permits one to reconstruct the form on a continuous base, and this is done in 1.

Dynamic Valve Characteristics.—With such an arrangement as that shown in Fig. 14, the oscillograph may be employed for the plotting

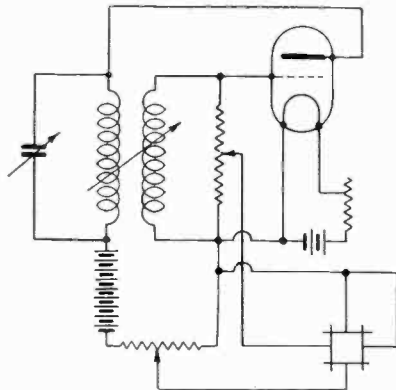

Fig. 14,

of dynamic valve characteristics. It will be seen that the deflecting plates are so connected that the curve charted will represent the relation between variations in grid potential and anode current.

Assuming that the grid is always maintained sufficiently negative with respect to the filament to prevent any convection current flowing between filament and grid, then with oscillations sufficiently feeble to ensure that the valve is working on the

straight part of its characteristic, approximately simple oscillation is obtained. By a simple oscillation is meant an oscillation in which all the A.C. currents and voltages associated with the circuit are sinusoidal waves of the same frequency. This condition involves that all the impedances of the circuit should be linear—a condition never obtainable in practice. It is, however, possible to approximate very closely to this requirement, when oscillation is very feeble.

The above conditions for simple oscillation do not necessarily mean that the anode current and grid voltage are in phase; the condition for phase coincidence is that the inductances of the plate and grid coils shall be resistanceless, for if they are not a phase difference between the anode current and grid voltage is introduced. It follows that, in all practical cases, this phase difference exists.

When plotting dynamic valve characteristics of anode current against grid volts, it is therefore to be expected that the figure will not take the form of a straight line, but of an ellipse, whose dimensions will depend upon the amount of phase difference existing.

(It should be remembered that if two equal sine waves are plotted together in rectangular co-ordinates on equal scales, they produce a straight line sloping at 45° if they are in phase or 180° out of phase, and a circle if they are 90° out of phase. Intermediate phase relations produce some sort of ellipse.)

Fig. 15A shows the dynamic characteristics of an oscillator operating in approximately the simple manner described. The phase difference mentioned may be noticed in this figure.

In considering the characteristics to be expected when oscillations are more violent, it is convenient to neglect for a moment the

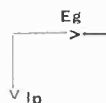
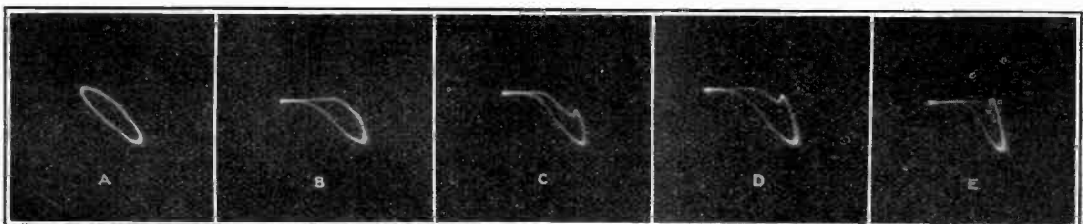

Fig. 15. The direction of the plate current (I_p) deflection in these photographs is the reverse of that usually shown in figures. This was done to simplify circuit arrangements, but of course makes no difference to the results.

question of phase difference. The ellipse of Fig. 15A might then become the line BC in Fig. 16. On increasing the violence of the oscillations, this curve would first stretch out towards A and D, and subsequently might extend to A and E. The flattening of the curve towards A is due to the zero limitation of the anode current, while the flattening and dropping of the curve on the portion CDE is due to the dropping of the anode voltage and possibly, in some measure, to the saturation limitation of anode current. The oscillations may in some cases reach such violence that the anode actually becomes negative, and for the second time in the cycle no anode current flows. This state is a form of "impulse excitation." It is well to bear in mind that the anode potential varies approximately sinusoidally in an efficient oscillating circuit, no matter what the shape of the anode current, since the potential of the anode is governed by the potential across the oscillatory circuit.

The drop over the section DE of Fig. 16 is probably augmented by the flowing of convection grid current, which increases as the anode current decreases. This reduces

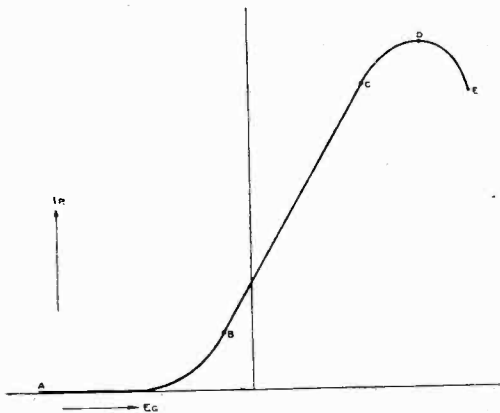

Fig. 16.

the potential of the grid, so that the anode current becomes still further decreased.

These effects combine to produce Fig. 15, C, D and E in which the oscillations are becoming successively more violent. These figures, of course, suffer the same phase dis-

placement as Fig. 15A. In Fig. 15E, conditions have combined to cause the anode current to reach zero twice in the cycle.

This may perhaps indicate the way in which the dynamic valve characteristic may

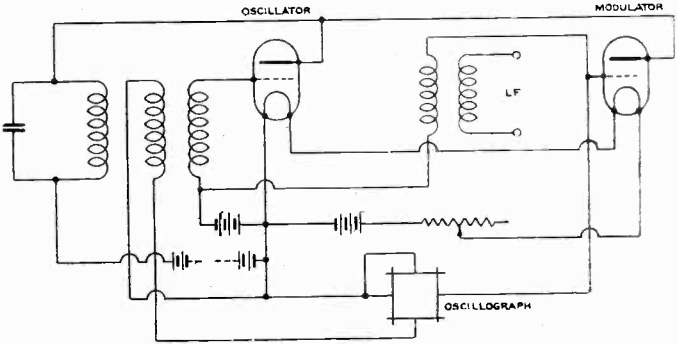

Fig. 17.

be used to examine the function of an oscillatory circuit. It is, of course, entirely practicable to observe changes in the shape of the characteristic while circuit adjustments are being made.

Determination of Percentage Modulation.—

The cathode ray oscillograph may be used for the simultaneous study of both the percentage modulation and the quality reproduction characteristics of a radio transmitting set.

In Fig. 17 is shown a type of anode modulation circuit, whose working is so inefficient as to emphasise those points which the oscillographic records obtained will show up. The circuit depends for its modulation on a change in resistance of the modulator valve, which is a shunt on the carrier oscillatory circuit. These resistance variations are brought about by the audio frequency wave, when the modulator valve is working on the curved part of its characteristic. Were it working on the straight part of its characteristic, the oscillatory circuit would only be shunted by the characteristic impedance of the modulator valve, the audio frequency wave then having no modulating effect.

In order to make it possible for modulation to be so complete as to reduce the carrier oscillations to zero amplitude (for peak values of the audio frequency), it is necessary to devise coupling arrangements in the carrier oscillator which are so loose that zero amplitude may be reached when the oscillator

is shunted by the minimum obtainable shunt resistance—that is to say, by the characteristic impedance of the modulator tube.

This unstable working of the oscillator has the effect of making the oscillations slow in building up and, to some extent, in dying

frequency amplitude. If modulation were incomplete, the triangle would have no true apex, and would become a trapezium in which the length of the shorter parallel side would indicate the minimum radio frequency amplitude. Then if the longer parallel side

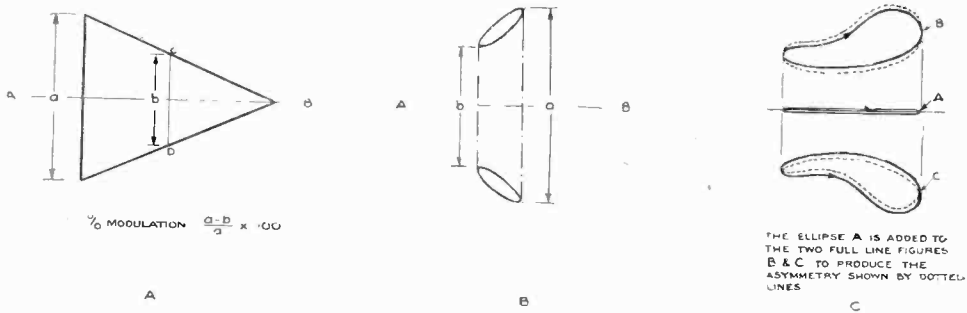

Fig. 18.

down. There is in fact a critical value for the damping resistance at which the oscillations build up very rapidly, and by no means proportionally with the damping resistance—that is to say, with the instantaneous voltage applied to the modulator grid. This, of course, produces inherent distortion. Another possible source of trouble is that the audio frequency potential may exceed the limits of the curved part of the modulator characteristic in either direction, which is analogous to the ordinary case of overloading.

The oscillograph is connected to this circuit in such a manner that in one direction it indicates the audio frequency voltage, and at right angles the radio frequency output. Were modulation complete and without distortion, it is clear that a figure of the shape of an isosceles triangle would be produced, as shown in Fig. 18A; the base of this triangle would represent the maximum radio frequency amplitude, and its height the audio

be called (*a*), and the shorter (*b*), the expression:—

$$\frac{a-b}{a} \times 100$$

will give a measure of the percentage modulation obtained. Modulation of 100 per cent. will then produce Fig. 18A.

The photographs shown in Fig. 19, showing figures produced from the circuit of Fig. 17, do not in any case show exactly the trapezium or triangular form which should be theoretically obtainable. In Fig. 19A, a symmetrical figure of general trapezium shape is bounded on the unparallel sides by two ellipses instead of by two straight lines. It will be seen from Fig. 17 that the connections made to the oscillograph are of necessity from opposite sides of the modulator valve. The presence of inductance and capacity in the input and output circuits of this valve are responsible for a phase difference between the input

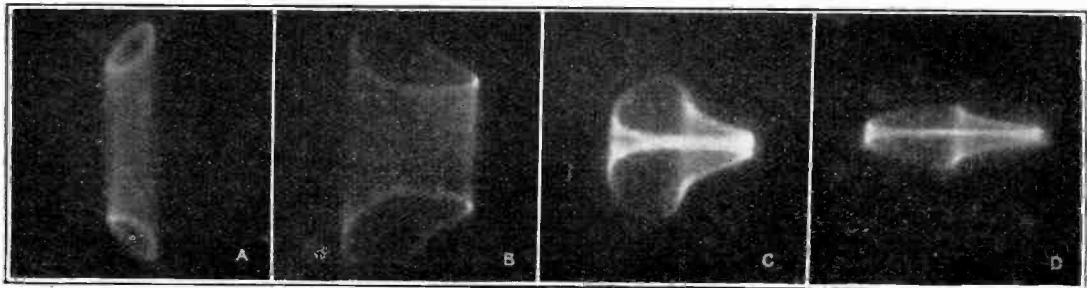
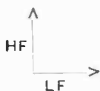

Fig. 19.



audio frequency and the envelope of the output radio frequency wave. This phase difference causes the elliptical boundaries to the photograph of Fig. 19A. It is clear that the maximum and minimum amplitudes of the radio frequency wave are, in this case, represented by the lengths a and b respectively in Fig. 18B.

In Fig. 19B and C, however, the boundaries to the trapezia do not take either straight line or elliptical form.

Their shape is the result of the inherent distortion of the system which has already been mentioned. In Fig. 19B, the percentage modulation is about 60 per cent., while in Fig. 19C it is practically 100 per cent. In Fig. 19D, the radio frequency has zero amplitude for a large portion of the cycle, so that over-modulation has occurred. The critical building up of the carrier oscillator is marked in Fig. 19D, in which the envelope of the figure shows a steep slope about the centre, just when the oscillator finally builds up to its maximum amplitude.

With more efficient types of modulation than that chosen above, it might be possible to avoid any phase difference between the audio frequency and the changes in radio frequency amplitude, so that the boundaries to the oscillographic figures produced would be single lines, rather than types of ellipses. Also if there were no distortion these boundaries would be straight lines, so that the shape of the envelope of the figures will in all cases give a measure of the quality reproduction characteristics of the system.

It will be appreciated that audio frequency distortion is extremely likely to occur if mean modulation is allowed to exceed a small percentage, as peak values of voltages will cause over modulation. It is as a rule impracticable to modulate so weakly, as power output would be correspondingly

reduced. We should repeat that the great variations in intensity which have to be dealt with in average broadcasting, coupled with the need for high power output, make it difficult to select a degree of modulation which is satisfactory from both standpoints.

It will be noticed that Fig. 19A, B, C and D are more or less asymmetric about a horizontal axis.

It has been suggested by Mr. A. D. Blumlein that this is caused by the audio frequency variations in anode current flowing in the anode circuit of the oscillator, and from there being induced into the coil used for obtaining the vertical deflection on the oscillograph. This deflection will be nearly 90° apart in phase from the voltage producing the horizontal deflection, and considered apart from the carrier frequency deflection would produce an ellipse. This ellipse then becomes added to the normal deflection which would be obtained were this effect not present, in the manner shown in Fig. 18C.

General Investigation of Asymmetric Distortion.—The introduction in, for example, an amplifier of frequencies not present in the input wave, may be detected by a simple plotting, and subsequent comparison of input and output waves.

The time base which the authors have used for wave-form examination is described in Appendix II.

For a thorough examination of a circuit for asymmetric distortion, it would be advisable to make such a comparison of input and output waves throughout a range of frequencies where the input is a sine wave. A potentiometer arrangement will in many cases enable an output wave to be brought to the same dimensions on the oscillograph screen, as the input wave, so that comparison of the two is facilitated. This was done in the case of Fig. 20, where A was the

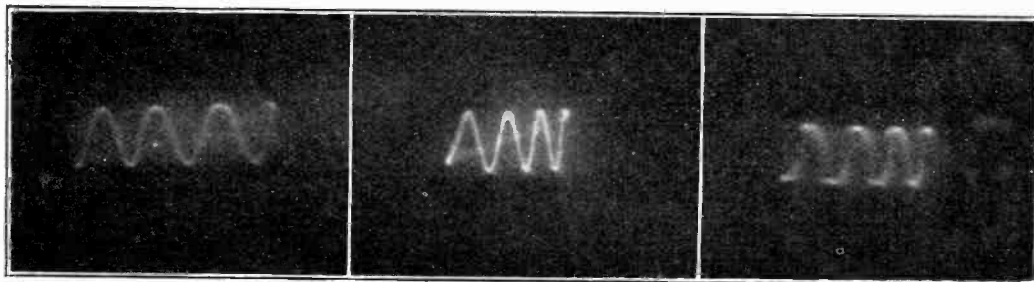

A

B

C

Fig. 20.

input to an amplifier, B the output where A was about 0.05 milliamperes, and C the output where A was about 2.0 milliamperes. The distortion due to the overloading of the amplifier in the case of C is obvious. The frequency of the wave in these cases was about 10 000 p.p.s.

A slight unevenness of the time scale will be noticed in Fig. 20, especially in B and D. The reason for this, and a means of avoiding it, are mentioned in Appendix II. The figure shows, however, that absolute linearity is unnecessary when only a comparison of waves is required, as in this case, and the refinement of more complete linearity in time scale may be omitted.

The examination of the wave-form in this manner may be made in any part of the circuit concerned, and a source of trouble may often be tracked down by progressive

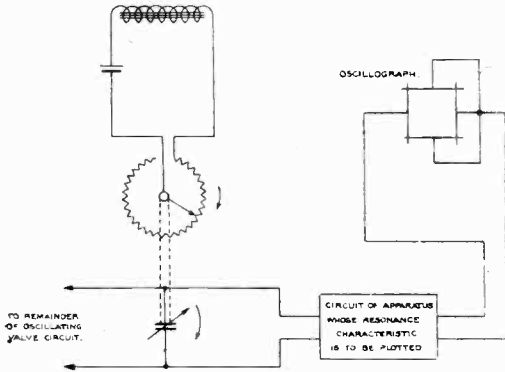

Fig. 21.

examinations through the apparatus. The nature of the wave distortion found will frequently suggest a clue as to the source of the trouble. For example, a wrong grid bias in an amplifier might be responsible for flattening the top of a wave, the peak voltage value being such as to extend over the limits of the characteristic of the amplifying valve. Overloading of the valve will also tend to produce a second harmonic, especially when grid current is permitted to flow. Again, transformers are a fruitful source of odd harmonics, frequently producing the characteristically pointed wave caused by the presence of a third harmonic.

It will in general probably be found that overloading is the most usual source of trouble to be found in amplifying circuits. The output wave form may in such cases be observed at the same time as adjustments of the

damping or coupling, etc., are made, so that the maximum or minimum safe values, as the case may be, may be quickly determined.

Frequency Resonance Curves.—The resonance characteristics of circuits have been studied by the arrangement shown in Fig. 21.

In this arrangement alternating current is supplied to the circuit to be studied, the potential difference across which is applied to that pair of the oscillograph plates which controls vertical deflection. The frequency of the A.C. is controlled by a variable condenser rotated synchronously with a circular potentiometer, the latter being arranged to control the current passing through an iron core induction coil. The coil is placed in such a position adjacent to the oscillograph that the varying field exerted by it, causing a correspondingly varying flux in the iron core, deflects the ray horizontally. The

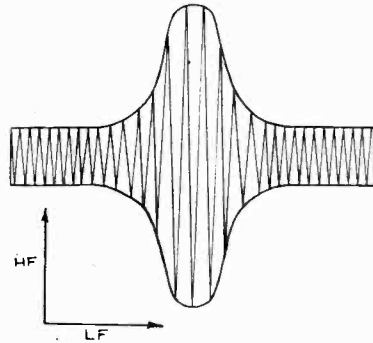

Fig. 21a.

figure produced is of the type shown in Fig. 21a. The amplitude of the oscillations in the circuit being studied clearly increases as the resonance frequency is reached, and the range of frequencies covered by one revolution of the controlling condenser being known, an accurate idea may be gained of the resonance frequency found. As the condenser and rheostat are rotated synchronously, the vertical and horizontal deflections of the ray are also synchronous, so that a steady picture is obtained.

This arrangement may, of course, be used for the study of amplifying circuits, or for mechanical parts, such as loud speakers or receivers.

Some other Related Applications.—Two simple methods of comparing frequencies with great accuracy depend upon the use of the cathode ray oscillograph.

In the first, a source of known frequency is applied to one pair of deflecting plates, and the uncalibrated source to the other pair of plates. If the relation in frequency is $1 : 1$, the figure produced is a straight line or a circle, or a form of ellipse depending on the phase relation between the two sources. If the relation is not exact, the figure appears to revolve, going from the straight line condition to the circular condition through the various stages of an ellipse: the figure revolves once per second if the two frequencies differ by one cycle per second. If the frequency relation is some other simple ratio, the figure obtained is a form of the appropriate Lissajou figure, which again revolves when the relation is inexact. As very slow movement

can be seen, it is possible to adjust the unknown frequency with great accuracy.

The disadvantage of this method is that the figures become complicated and difficult to recognise when the frequency relation is complicated. The second method, due to Mr. D. Dye, of the National Physical Laboratory, does not suffer to the same extent from this trouble, and is, apart from other considerations, of interest because it makes use of the fact that the sensitivity of the oscillograph increases as the anode potential decreases.

A circle is produced on the screen by means of the circuit shown in Fig. 22, in which

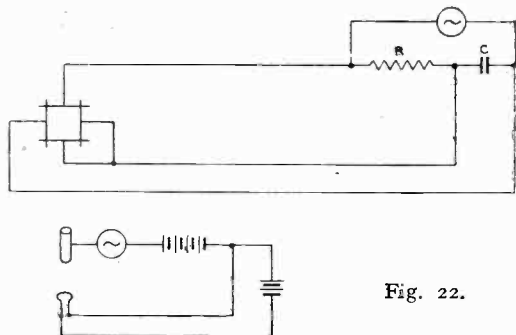

Fig. 22.

$R = 1/\omega C$, the source of A.C. used for obtaining the circle being of known frequency.

The source of unknown frequency is connected in series with the anode battery, and has the effect of making the net anode potential vary between limits controlled by its own A.C. voltage. Suppose the fixed anode battery to be V volts, and the A.C. source to vary between $+v$ and $-v$ volts. Then the anode potential varies between $V-v$ and $V+v$ volts. The circular trace on the screen is biggest when the anode potential is $V-v$ volts and smallest when the anode potential is $V+v$ volts. Suppose the frequency of the unknown source to be five times that of the known source, then the diameter of the circle will be at its

greatest and at its least each five times per cycle of the known source. If the relation is exact, the figure produced is of a cart-wheel type. This rotates if the relation is inexact. The type of figure produced with various frequency relations is shown in Fig. 23, in which the system will be seen to be quite clear. Even quite complicated relationships may be examined in this way, and the method is of considerable accuracy.

Valve characteristics may be plotted with the cathode ray oscillograph by means of the

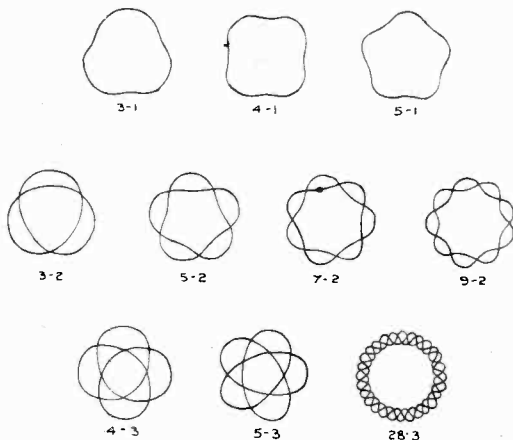

Fig. 23.

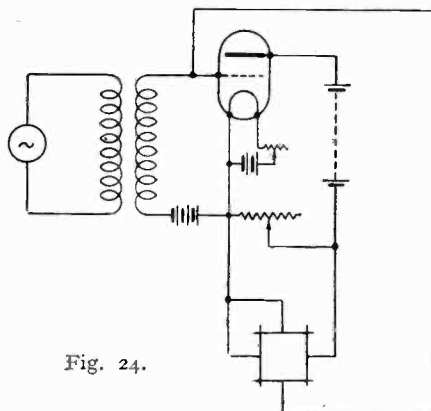

Fig. 24.

type of circuit shown in Fig. 24. With this arrangement, the horizontal deflection is controlled by the sinusoidal input to the grid of the valve, while the corresponding plate current variations control vertical deflection. The grid bias and applied A.C.

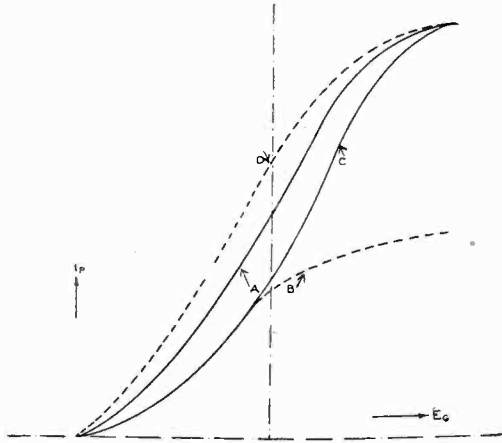

Fig. 25.

potential are adjusted so that the net grid potential at least reaches the zero and saturation limitations of the valve being tested.

The circuit shown is arranged to chart grid voltage-plate current curves, and in Fig. 25 tracings of the type of figure obtained

are shown. It is, of course, possible to observe changes in the shape of the curves obtained, when alterations are made to battery voltages and filament current. Thus in Fig. 25, for A the filament current was 1.25 amps and the plate voltage 150 volts. In B, the filament current was reduced to 0.95 amps. In C the plate potential has been reduced to 100 volts, while the filament current remains at 1.25 amps, and in D the plate voltage is 200.

When the characteristics of a number of valves are required, this method is extremely quick and useful, but for a single tube, of course, the time taken in setting up the apparatus would probably not justify any departure from the slower point by point method.

Conclusion.—In concluding, the authors would like to thank Messrs. J. Collard and P.R. Thomas for their very able assistance in photographing the oscillographic records. It will probably be of interest to record that most of the photographs were taken with an exposure of one minute, with a lens operating at $f/4.5$ and using plates of speed 700 H & D. Fig. 20A, however, was exposed for only fifteen seconds, the other conditions remaining the same.

Photographs of the cathode ray oscillograph are published by the courtesy of the Western Electric Co.

APPENDIX II.

A LINEAR TIME-BASE FOR EXAMINING WAVE FORMS WITH THE CATHODE RAY OSCILLOGRAPH.

Wave forms are most familiar when plotted on a linear time-base, and the provision of a means of obtaining this is a valuable adjunct to any oscillograph. The vibrating strip type of oscillograph usually employs the rather cumbersome rotating mirror device for providing a linear time scale for visual working, while a falling or projected photographic plate is used for photographic recording. The latter is, of course, impossible with the cathode ray oscillograph, as the fluorescent spot is insufficiently intense to permit instantaneous photography. The rotating mirror could be used, but is by no means an ideal system, as well as having a rather low limit in the speed at which it can be worked satisfactorily.

The cathode ray oscillograph, however, permits the use of an entirely different type of time-base—one brought about by means of suitable potential variations across one pair of the deflecting plates.

An ordinary sine wave connected in this way would, of course, give figures in the form of ellipses, with various superposed loops, when plotted against the wave to be examined, but for most work a subsequent mathematical translation from this sinusoidal base to a linear base would be necessary.

The authors have used the time-base, whose method of production is illustrated in Fig. 26.

When the battery is switched on in this circuit, the neon lamp may be said to be on open circuit. The condenser *C* in parallel with the neon lamp charges up through the high resistance *R* until the discharge potential of the lamp is reached, and at that moment the condenser discharges through the lamp until the failing potential of the lamp is reached, after which the cycle of operations is repeated. (The neon lamp, being a discharge device, "strikes" and "fails" at critical potentials, approximately 170 and 145 volts respectively.) Thus the lamp "blinks" at a frequency governed by the values of the battery potential *B*, the resistance *R*, and the condenser *C*. The condenser charges, and therefore the lamp blinks at intervals of time *t* according to the expression—

$$e = B (1 - e^{-t/RC})$$

where *e* is the striking potential of the lamp. Now the current flowing through the resistance *R* is the condenser charge current, which in this circuit follows a slightly curved saw-tooth wave shape. The period of discharge of the condenser is very short, so that by connecting one pair of the oscillograph deflecting

plates across a convenient portion of the resistance R , the spot is made to travel slowly across the screen, returning almost instantaneously, and repeating the movement at a frequency which may be controlled. Potential variations arranged to deflect the spot at right angles to the time-base are therefore spread out on a time-base which, although not exactly linear, is for comparative and many other purposes of great value. Far greater linearity may be obtained by substituting a saturated diode for the resistance R , for under these conditions it is clear that the current flowing through the diode is constant, and therefore that the quantity of electricity in the condenser becomes a linear function of time. Consequently, the potential across the diode becomes a linear function of time, and is made use of for obtaining the time-base for the oscillograph. The only requirement for this device to produce a truly linear time-base is that the current flowing through the diode must always be sufficient to saturate it.

Normally, it is found to be extremely quick and simple to control the frequency by adjusting C , but alterations in R , or the filament current of the diode, may in some cases be found more convenient. It is usually best to arrange the frequency of the

time-base deflection to be one-third or one-fourth of the frequency of the second deflection so that three or four complete waves of the second deflection are traced out before the falling potential of the neon lamp is reached and the figure is retraced. The photographs of Fig. 20 show how accurately it is possible to tune the frequency of the neon lamp, as in these the figures were kept stationary for periods of one minute.

The device works satisfactorily until the charge time of the condenser is equal to or less than the discharge time. This occurs at about 6 000 p.p.s. and as wave forms may still be examined when, say, 10 complete waves are traced on the screen the system is good for the examination of waves of frequencies up to about 60 000 p.p.s.

In Fig. 20 (B & C), the circuit shown in Fig. 26 was used for the time-base, while in Fig. 20A the saturated diode arrangement was used. The latter will be seen to be far more linear than the former, although complete linearity is seen to be unnecessary for comparative purposes. Indeed, except where actual measurement of harmonics, etc., is to be attempted, complete linearity is of no particular use, provided the crowding of the time-base is as small as that obtained in this device.

BIBLIOGRAPHY.

Acoustics.

- "Collected Papers on Acoustics." By W. C. Sabine, 1922.
 "Acoustics of Buildings." By F. R. Watson.
 "The Acoustics of Room Reverberations." By E. A. Eckhardt.—*Journ. Franklin Inst.*, p. 799, June, 1923.

Atmospherics.

- "Observations on Atmospherics." By R. A. W. Watt.—*Wireless World and Radio Rev.* 12, pp. 601-612, August 1, 1923; pp. 636-637, August 8, 1923; *Elec. Rev.* 93, pp. 266-7, August 17, 1923.
 "Directional Observations of Atmospherics." By R. A. W. Watt.—*Phil. Mag.* 45, pp. 1010-1026, May, 1923; *Roy. Soc. Proc.* 102, pp. 460-478, Jan. 1, 1923.
 "On the Nature of Atmospherics." By R. A. W. Watt.—*Roy. Soc. Proc.* 103, pp. 84-102, April 2, 1923.
 "The Simultaneous Origin of Atmospheric Disturbances." By M. Baumlér.—*Jahrb. d. drahtlos. Tele.* 22, pp. 2-8, July, 1923.
 "The Origin of Atmospherics." By R. A. W. Watt.—*Nature* 110, pp. 680-1, November 18, 1922.
 "Energy of Atmospherics." By T. L. Eckersley.—*Electrician* 93, pp. 150-151 and 155, August 8, 1924.
 "Atmospherics." By L. W. Austin.—*Nat. Res. Council Bulletin* 7, No. 41, pp. 127-130, Washington, 1924. *Monthly Weather Rev.* 52, pp. 220-221, April, 1924.
 "Atmospherics and their Effect on Wireless Receivers." By E. B. Moullin, M.A.—*Journal I.E.E.*, p. 353, April, 1924.

Cathode Ray Oscillograph.

- Phys. Soc. Proc.* 35, pp. 109-124, November, 1922, and p. 127, November, 1922.
 "A Low Voltage Cathode Ray Oscillograph." By J. B. Johnson.—*Journal of Optical Soc. of America*, September, 1922.

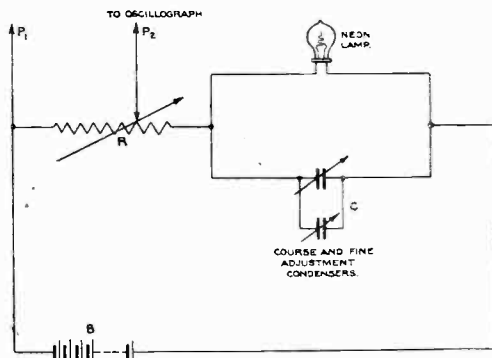

Fig. 26.

- "A Practical Demonstration of Some Applications of the Cathode Ray Oscillograph." By N. Kipping.—*Wireless World and Radio Rev.*

Distortion.

- "Transmission Maintenance of Telephone Systems." By P. E. Erikson and R. A. Mack.—*Journal I.E.E.*, August, 1924.
 "Faithful Reproduction in Radio Telephony." By L. C. Pocock.—*Journal I.E.E.*, September, 1921.

"The Development of Simultaneous Broadcasting." By E. K. Sandeman.—*Wireless World and Radio Rev.*, p. 521, June 23, 1924.

Electromagnetic Screening.

"Electromagnetic Screening." By R. W. Watt and J. F. Herd.—*Wireless World and Radio Rev.*, pp. 532-539, January 1, 1923.

General.

"Problems in Telephony Solved and Unsolved." By Prof. J. A. Fleming.—*Journal I.E.E.*, June, 1923.

"Electrical Vibration Instruments." By A. E. Kennelly.

Interference.

"Trans-Oceanic Wireless Telephony." By H. W. Nicholls.—*Journal I.E.E.*, July, 1923.

"Auditory Masking of One Pure Tone by Another." By R. L. Wegel and C. E. Lane.—*Phys. Rev.*, February, 1924.

"Elimination of Interference."—*Wireless World and Radio Rev.* 12, pp. 693-695, August 22, 1923.

Loud Speakers.

"Zur Theorie des Lautsprechers."—*Wissenschaftlichen Veröffentlichungen aus den Siemens Konzern*, Vol. III., p. 62.

"Discussion on 'Loud Speakers for Wireless

and other Purposes' with Introductory Papers"—*Journal I.E.E.*, p. 265, March, 1924.

"Loud Speakers." By E. K. Sandeman.—*Wireless World and Radio Rev.*, p. 225, May 21, 1924.

Measurements.

"Radio Instruments and Measurements."—*Bureau of Standards Circular No. 74.*

Modulation and Detection.

Proc. Inst. Radio Engineers, 1919.

Telephone Receivers.

"Theoretical and Experimental Study of Telephone Receivers." By A. E. Kennelly.—*P.O.E.E. Journal* 16, Part 2, July, 1923.

Telephone Transmitters.

"The Sensitivity and Precision of the Electrostatic Transmitter for Measuring Sound Intensities." By E. C. Wentz.—*Phys. Rev.*, Vol. XIX., No. 5, p. 498.

Vacuum Tubes.

"On the Form of Free Triode Vibrations." By E. V. Appleton and B. van der Pol.—*Phil. Mag.*, August, 1921.

"Experimental Determination of the Fundamental Dynamic Characteristics of a Triode." By Eijiro Takagishi.—*Proc. Inst. of Radio Engineers*, pp. 609-622, October, 1924.

The Sterling Anode Reaction Unit. [R382'5

WE have recently tested one of the above components manufactured by the Sterling Telephone & Electric Co., Ltd., of 210-212, Tottenham Court Road, W.1.

The unit provides a simple means of coupling H.F. valves by the tuned anode method, with the introduction of reaction; if desired, it could also be used as the aerial coil, with reaction. A knob controls the reaction coil, which is mounted at an angle of 45 degrees to the spindle so that a rotation of 180 degrees of the knob moves the coil from its position of maximum to minimum coupling.

The device is really in two parts, the knob and adapter (which are permanently mounted in the set) and the actual tuning units which are interchangeable, so that various wave-length ranges may be covered.

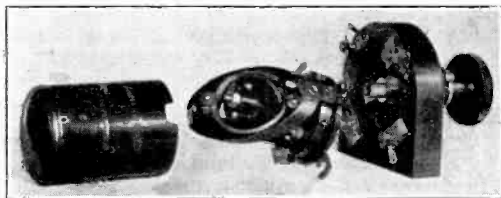

Ingenious construction is coupled with electrical efficiency in this unit. It is also most compact.

The two coils in the tuning unit are of silk-covered copper wire wound in wave form and waxed, and mounted on formers of insulating material.

A moulded cover is fitted over the coil unit so that the coils are protected when in use. Connections between the coil unit and adapter are made by means of four spring clips, which also serve to fix the two portions of the component together.

We measured the self-inductance of each coil of the unit sent to us, which is intended for the lower broadcast range.

Neglecting the self-capacity, the inductance of the anode coil was $332\mu\text{H}$ and that of the reaction coil $116\mu\text{H}$.

These values correspond to standard plug-in coils of approximately 75 and 50 turns respectively. The maximum coupling coefficient was 46 per cent. and the minimum 0.5 per cent. Thus, though there is no negative coupling, the positive coupling can be reduced almost to zero.

We noticed that the coupling of this unit with external coils was very small, which is a good point, since stray couplings, particularly in an H.F. amplifier, are to be avoided.

The units are made in eight sizes, lettered from A to H; that tested was D, with a nominal range of 280-550 metres when used in a tuned anode circuit with a .00025 μF condenser in parallel.

The adapter with one coil unit costs £1, and extra coil units are obtainable, price 12s. 6d.

Filters:

A Supplementary Note.

[R386

By P. K. Turner.

IT has been pointed out to the writer that in his recent notes on filters,¹ he omitted to deal with band filters with regard to controlling the width of the band passed or stopped.

This is an extremely simple matter, and to avoid waste of space will now be dealt with as an extension of the previous article,

and dance continually increases. That is, the filter "passes" for $-s < 4$ and "stops" for $-s > 4$.

The value of s is a function of the frequency. If ω_0 , f_0 and λ_0 refer to the frequency for which all the sections of the filter are tuned, then we gave originally for a BAND PASS FILTER

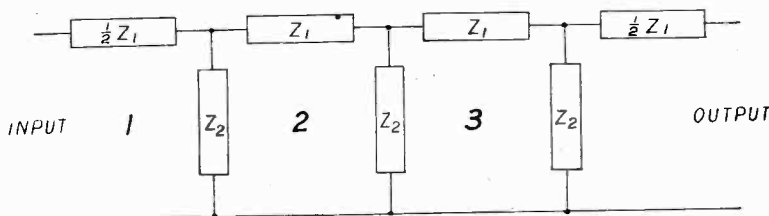

Fig. 1.

The most general type of filter; Z_1 and Z_2 represent impedances of some kind.

to which reference should be made for explanation of symbols, etc.

It will be remembered that the curves which gave the "filter impedance" of the filter (*i.e.*, input volts over output current) were drawn in terms of a quantity " s ," defined as Z_1/Z_2 (see Fig. 1, reproduced from the original article). It may also be restated that for $s=0$ to $s=-4$, the filter impedance is low, while for $-s > 4$ the impe-

$$s = -\left(\frac{\omega - \omega_0}{\omega}\right)^2 = -\left(\frac{f - f_0}{f}\right)^2 = -\left(\frac{\lambda_0 - \lambda}{\lambda}\right)^2 \quad (1)$$

NOTE.—In the original article, the second term was, by a printer's error, shown as $\left(\frac{\omega}{\omega_0}\right)^2$.

and for a BAND STOP FILTER

$$s = \frac{-I}{\left(\frac{\omega - \omega_0}{\omega}\right)^2} = \frac{-I}{\left(\frac{f - f_0}{f}\right)^2} = \frac{-I}{\left(\frac{\lambda_0 - \lambda}{\lambda}\right)^2} \quad (2)$$

¹ P. K. Turner, "Filters," E.W. & W.E., Aug., 1925, p. 673.

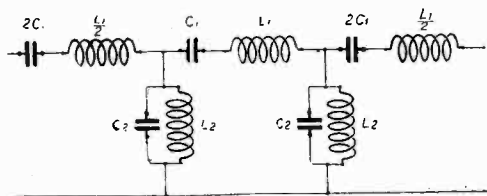

Band Pass
Fig. 3a

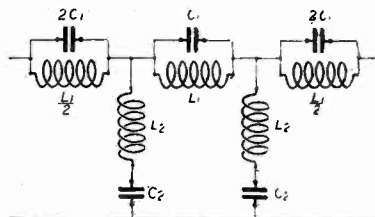

Band Stop
Fig. 3b

In arriving at these values, however, a certain assumption was made with regard to the values of coils and condensers to be used. Fig. 2 shows the types of filter being considered, and hitherto we have assumed $C_1=C_2$ and $L_1=L_2$. It is by variation here that we control the width of band.

It should be noted first that the "width of band" is quite distinct from the "sharpness of cut." Fig. 3, for example, shows

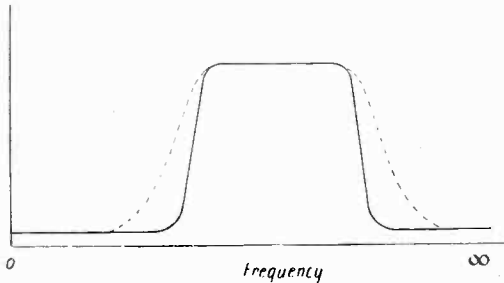

Fig. 3.

the type of curve for two-band pass filters of which the width of band is the same, while the dotted curve shows a less sharp cut-off. How to get any required sharpness was dealt with in the original article.

If now we draw curves of s against f_0/f for the two types of filter already dealt with we get the curves of Fig. 4, from which we see that for the pass filter — $s < 4$, i.e., the filter "passes," for any frequencies between .4 times and 2.5 times f_0 , while the stop filter "stops" for frequencies between .8 times and 1.25 times f_0 , and these proportions are fixed.

But if now we put $L_1 = kL_2$, and $C_1 = \frac{1}{k}C_2$,

so that L_1C_1 still equals L_2C_2 , then it will be found that the values of s are k times what they were before: in fact we have

$$s = -k \left(\frac{\omega}{\omega_0} - \frac{\omega_0}{\omega} \right)^2 = -k \left(\frac{f}{f_0} - \frac{f_0}{f} \right)^2 = -k \left(\frac{\lambda_0}{\lambda} - \frac{\lambda}{\lambda_0} \right)^2 \quad (3)$$

BAND STOP

$$s = \frac{-k}{\left(\frac{\omega}{\omega_0} - \frac{\omega_0}{\omega} \right)^2} = \frac{-k}{\left(\frac{f}{f_0} - \frac{f_0}{f} \right)^2} = \frac{-k}{\left(\frac{\lambda_0}{\lambda} - \frac{\lambda}{\lambda_0} \right)^2} \quad (4)$$

It is readily seen from this that the effect of using values of k greater than 1 is to decrease the width of band.

An Example.

For example, suppose that we wish to design a band pass filter to pass wavelengths of 2700 to 3300 metres, i.e., frequencies of (say) 90 to 110kC, f_0 will obviously be 100kC, and we want s to be somewhat above 4 for $f/f_0 = .9$.

Straightforward calculation shows that for

$$\frac{f}{f_0} = .9, \left(\frac{f}{f_0} - \frac{f_0}{f} \right)^2 = .045.$$

Therefore, if s is to be, say, 4.5 at this point, k must be 100, i.e., $L_1 = 100L_2$, and $C_1 = C_2/100$.

From this point the design can be carried on exactly as in the original article, which, it will be remembered, led to finding Z_2/Z_c , which is either a constant or is found as a

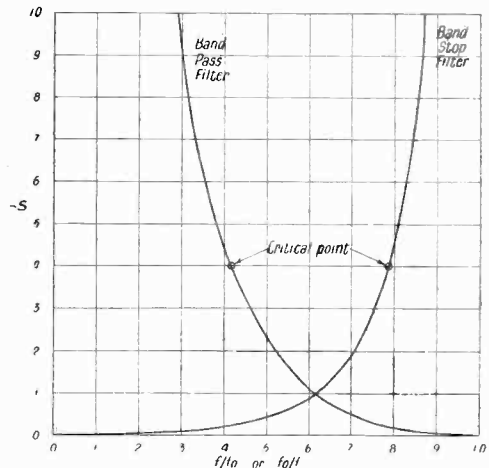

Fig. 4.

function of frequency. Z_e being the known load, Z_2 is thus found for some frequencies, and as we know its form (it is a coil either in series or in parallel with a condenser), we can find quite easily the separate values of L_2 and C_2 , whence, knowing the value of k , we can find L_1 and C_1 .

Naturally, the design of band filters of this type is not such a perfectly simple matter as that of simple high pass and low pass filters; but it will still be found not to present any serious difficulties if tackled on these lines.

5JX.

*An Amateur Station.**By Marcus G. Scroggie, B.Sc.*

[R625

General Description.

UNTIL recently the call 5JX has been known to many radio experimenters as one of the few assigned to Scottish stations, having worked from Edinburgh for a period of two years; but it has now been removed to the neighbourhood of London. The fact that transmissions from this station are fewer and feebler does not indicate that experimental work has ceased, and it is owing to the experiments arising out of the change of supply current from D.C. to A.C. that it is thought that an account of some of the experience gained in connection with the working of the station would be of interest, particularly to those who are new to transmitting.

The principal work in view when transmitting was contemplated was the investigation of fading and similar effects experienced with short waves. Owing however to the necessity for economy in expenditure, a large part of the time was taken up in working out schemes for the provision of a cheap H.T. supply. A machine which was developed for this purpose has already been fully described in this journal¹ and elsewhere.

The First Apparatus.

When the licence was received in October, 1922, the 440-metre wave was the one commonly used, and a trial set was rigged up from Mark III. tuning coils, an R valve, and the 230-volt supply directly applied. This involved practically no expense, as all the components were ready to hand in connection with receiving. The power was limited to about 2 watts, but otherwise the arrangement was very satisfactory, as there was no noise nor moving machinery

to start up, and no elaborate smoothing system was required to produce a wave free from ripple. It might be mentioned that this convenient form of H.T., with or without the addition of a supplementary dry battery, was frequently used for low power work and for this purpose was ideal. The input was later increased to 7 watts at 230 volts by the use of a Mullard 0/20 valve, which, by the way, is the only transmitting valve which has been used.

Early Duplex Work.

Some very interesting experiments in duplex telephony were carried out, using this form of H.T., preferred on account of the absence of interference with the receiver. In the first arrangement the wave used for transmitting was 200 metres, while the replying station (2TF) used 440 metres. This wide spacing of wave-length was used partly because of the waves allotted and partly because duplex could be carried on without special apparatus or tuning systems, except that separate aerials were used for sending and receiving. The results obtained in this way over a short distance were perfectly satisfactory, and there is no reason why it should not work over a much greater distance, as no excessive "side tone" was produced, even when amplification was used for working a loud-speaker.

This system was improved by abolishing the extra aerial, the receiver being connected to the same aerial as the transmitter through a rejector circuit *LC* tuned to the latter, as shown in Fig. 1. This method enabled the stations to work on more nearly equal wave-lengths; 130 and 150 gave more than ample spacing. The circuit diagram shows the system of modulation which (after trial of dozens of methods) proved the best. The results were very nearly,

¹ E.W. & W.E., February, 1924.

if not quite, as good as with choke control, and the apparatus is much simpler, as only an R valve is required as modulator, and no extra H.T. supply or speech amplifier.

In looking about for some other source of power, two old 1/6th h.p. motors which had broken down at an engraver's works were picked up, the field coils of one and

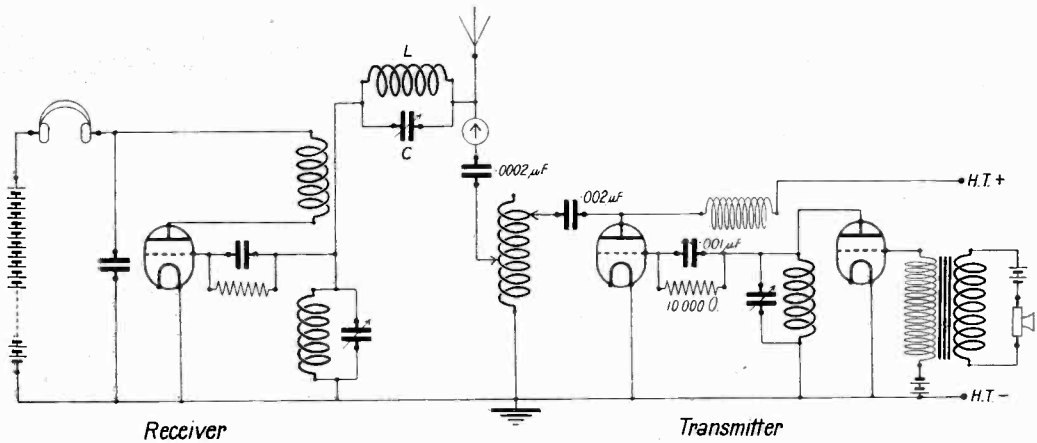

Fig. 1.

This system of duplex working is less complicated than those generally described, and for the powers ordinarily used by amateurs is very effective.

Experiments with A.C. Supply.

It has been mentioned that the 230-volt supply was used pending the development of a more powerful arrangement, and experiments were commenced using A.C. A small fan motor was adapted by fitting two slip rings on the shaft, and connecting these to an opposite pair of commutator segments. This improvised rotary converter delivered slightly less than the theoretical 163 volts A.C., which was stepped up by a very well designed and crudely constructed transformer, consisting of 1½ lbs. of 36 wire, ¾ lb. of 24, about 3 lbs. of banding iron, and a roll of insulation tape—nothing else. This worked quite well, supplying 800 volts, which agreed almost exactly with that designed for. At the time (1922) the use of chemical rectifiers for high tension supply for transmitting was unknown to the writer, so these were tried. Many attempts were made to produce a satisfactory rectifier, but the chemical tubes were finally given up in disgust as ineffective and messy. Others appear to have obtained quite good results with this type of rectifier, owing no doubt to the greater amount of experience which has been gained with them.

the armature of the other rewound, the two machines connected up by a mechanical coupling and used as a booster; one machine being driven off the mains and the output of the other connected in series with the mains, giving a total of 400 volts. (Fig. 2.)

Both field circuits were run off the mains. When this was brought into use the wavelength employed was brought from 440 to 200, a primitive counterpoise was put up, and two R valves used in parallel, so that an input of 100 watts and an aerial current of 0.4 amp was obtained. That evening a test call was made, and great excitement was caused when a reply was immediately picked up from 2DF, 340 miles away, which was no small distance at the beginning of 1923, so great has been the advance in amateur communication since then.

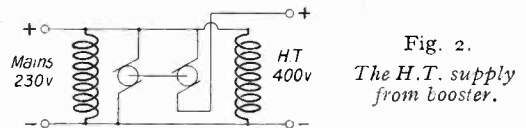

Fig. 2.

The H.T. supply from booster.

A Further Improvement.

Just at this time it occurred to the writer that if a number of condensers were connected in series and each charged to 230 volts by the house supply, a high voltage would be obtained. Various types of commutators for effecting this charging as frequently as possible were thought of, and

as a radial one with rotating brushes seemed to be the simplest, a number of switch contact studs were mounted on a small ebonite panel, these being connected to fixed condensers of about $3\mu\text{F}$, four in series. It was seen that the design would require to prevent short-circuiting of the brushes or condensers at any point, and yet the former could not be allowed to rub over the ebonite between metallic contact, or metal dust would soon cause leakage and flash-over. The studs were, therefore, mounted well clear of the panel by condenser spacing washers, and dead studs were placed between the live ones. Two phosphor bronze brushes connected to the 230-volt input were rotated by means of the old fan motor previously mentioned, and great was the joy at seeing a voltmeter at the output end jump up to 800. After improvements, such as larger condensers, a commutator cut out of sheet copper, and laminated brushes, the device took the form illustrated in *The Wireless World and Radio Review*, 15th August, 1923. This machine gave 18 months' constant service without alteration.

Some Results.

A plug switch was used for connecting the condensers so as to obtain various voltages and it was commonly used at 400-600 volts. Shortly after first working, SBF, 600 miles distant, reported good reception. This showed that the middle of summer was not against getting good results on low power.

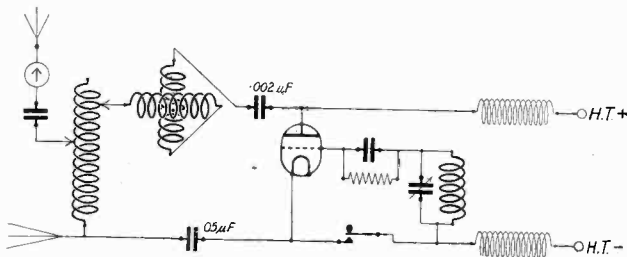

Fig. 3.

A regular schedule of fading tests was arranged, which enabled curves of signal strength to be obtained simultaneously at a number of stations, thus showing whether fading took place in a similar manner at different positions. Results indicated that even at stations whose distance apart was

only about 1 per cent. of the distance from the transmitter, no similarity in fading could be traced.

Unfortunately much further information could not be obtained owing to the difficulty in securing a sufficient number of simul-

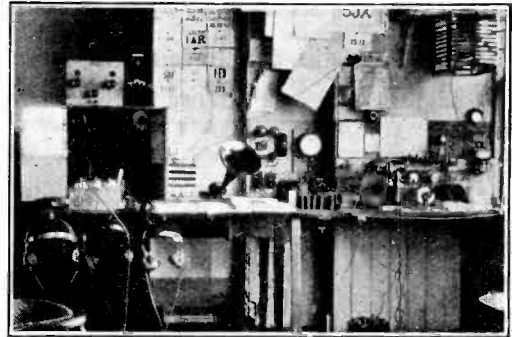

Fig. 4.

taneous reports. The system used, however, was shown to be quite sound, as any moment of time, within about a second, was definitely traceable on all the records obtained.

The winter 1923-24 saw the commencement of transatlantic communication on the part of British amateurs. 5JX was out of action during most of the time, but in the spring several attempts were made using the newly popular 115-metre wave, and we finally succeeded in "getting over." The circuit used is shown in Fig. 3, which will be recognised as the so-called 1DH circuit. Attention is drawn to the method of keying, which has the advantages of absence of chirp, absence of sparking even if used on higher powered sets, and the total cut off of anode current except when actually radiating, thus less heating of the valve. The aerial was not very satisfactory, being only about 30 feet high and consisting of a single stranded wire, with a 3-wire counterpoise which was not properly under the aerial. The aerial current was 0.7 amp with 25 watts input.

The layout of the apparatus is shown in Fig. 4, in which the A.T.I., built of 10 turns of copper strip, is to be seen in the top right-hand corner, the rest of the transmitter below it, and the receiver on the left. The

latter uses what is essentially the same circuit as was in use five years ago—a simple single valve reaction circuit with an optional L.F. valve. A heterodyne wave-meter is also incorporated. This receiver gets anywhere and so no elaborate arrangement has been required, and a large band of waves can be searched with one knob.

A Long-distance Transmitter.

A slightly improved transmitting circuit which gave wonderful results in the way of consistent long-distance working is shown

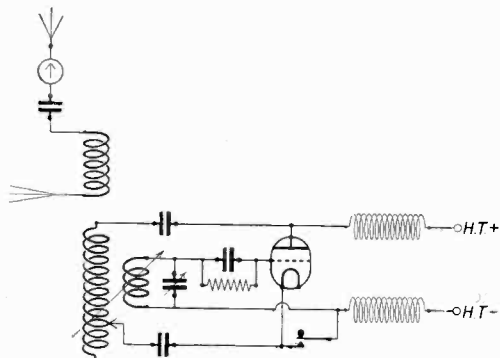

Fig. 5.

in Fig. 5. This is the one now used. The A.T.I. consists of two turns of copper strip 13 inches in diameter, and tightly coupled to 10 turns (variable) on the same skeleton former. The reaction coil has 4 turns, 8 inches diameter, and as this is insufficient in itself a .0005 μ F condenser is used for tuning it. The idea of this is to provide a relatively large tuning capacity so that small variations in capacity of the aerial, etc., will have the minimum effect.

Reference has been made in this journal to a Canadian member of the A.R.R.L. who spent the summer of 1924 in the middle of the Atlantic. The writer first heard of this on returning from holiday, and knocked together the transmitter just described in two days for the express purpose of working him. This was done at the very first attempt, and in a period of four successive days, the Atlantic, the English Channel, France, Belgium, Luxembourg, Denmark, and Finland were worked, many of them several times, all were raised by the first call, all reported R7 or R8, and very favourable comments were made on steadiness of wave, Finland going so far as to say 5JX

was the best of over 20 British stations worked to that date. This good working in midsummer, on low power from the original voltage raiser, is largely attributed to the circuit and method of keying, both of which are recommended to DX men.

The Move to London.

On moving to London the supply was found to be 200 volts A.C., so the D.C. voltage raiser was useless. In the article in E.W. & W.E. referred to, an A.C. voltage raiser is described similar to the D.C. type but necessitating a synchronous motor. It was seen, however, that a much simpler arrangement could be used if the number of condensers in series was reduced to two, as then a simple contact arm vibrating between two fixed contacts would, if in correct phase with the supply voltage, charge the two condensers alternately. The cheapest way of bringing this about was by means of a Weston moving coil relay, which was connected up as in Fig. 6. As the peak voltage of a 200-volt A.C. supply is 280, theoretically 560 volts could be obtained by this method, but in practice this is reduced to about 450 volts, partly because the contact extends beyond the moment of maximum alternating voltage, and partly due to the partial discharge of the condensers in between charges.

The cost of this system is extremely small, as no transformer or rectifier is required, and the noise is negligible—an important point when working at night. Some people must needs have their generators in the cellar for this reason. The best

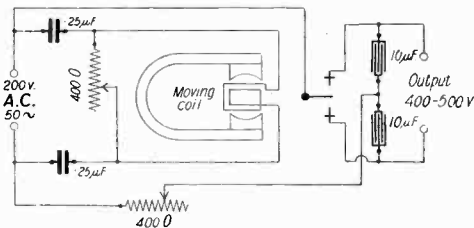

Fig. 6. H.T. from A.C.

values of capacity and resistance and the best distance apart of the fixed contacts is found by experiment.

Charging Accumulators.

An almost exactly similar system is used for charging accumulators, and an old

G.P.O. relay and a D. Mark III. buzzer* have both been used successfully for this purpose. Two Bell transformers, price 12/6, step down the A.C. to a suitable value (Fig. 7). In order to prevent damage being done by any failure of the apparatus when left on charge a reverse-current relay was constructed. The contact to battery and mains is made when a current coil A acts in a direction to assist a pressure coil B, the latter not being sufficient in itself to hold over the contacts. Any failure or reversal of the charging current therefore completely disconnects the gear. The contacts have to be made by hand when starting up. The same transformers as are used for charging are switched into parallel for L.T. supply to the transmitter.

Finally, the writer hopes that this account of the development of a transmitting station

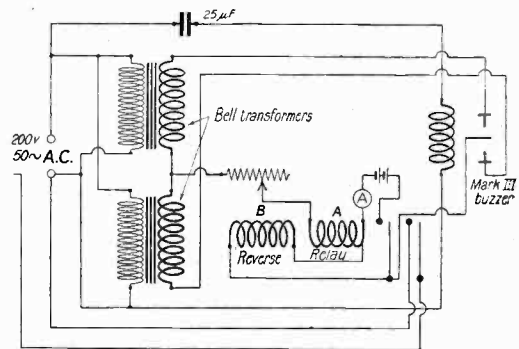

Fig. 7. L.T. from A.C.

* E.W. & W.E., September, 1924.

at the minimum cost may offer suggestions to other experimenters.

The "R.I." Tuner.

[R 3822

AN interesting component recently submitted to us for test is the new R.I. "Aerial Tuning Reactance Unit." This has been designed to replace plug-in coils which are normally used for aerial and reaction coils. With a .001µF condenser in parallel, the wave-length range covered is stated to be 175-4 000 metres.

The unit consists of a single-layer tapped winding of D.S.C. wire on a Paxolin cylinder 3½ in. in diameter. Inside this, at one end, is pivoted the reaction coil. This is also a single-layer winding on a tube, and operated by a knob which appears on the panel, in conjunction with a well-made bevel gear.

The aerial coil is tapped in eight sections, at 11, 22, 33, 44, 55, 66, 128, and 250 turns respectively. With the object of eliminating "dead end" losses, a special shorting switch is fitted so that the section adjacent to that in use is short circuited.

The construction and finish are all that could be desired, all the mechanical parts being extremely smooth in action. The two knobs project through an ebonite dial, which is suitably engraved, and the sections are lettered A to H.

Connections to the two coils are made by four terminals fixed to the back of the component. The aerial winding was covered by a sheet of thin celluloid, which we removed in order to measure the exact size of the wire.

To test the component, we measured the inductance, H.F. resistance, self-capacity and power factor of several sections.

On stud A we found an inductance of 18µH. (The other quantities in this case were not measured.) On stud C the inductance was 119µH (corresponding to a 40-turn plug-in coil), the self-capacity being 8µµF, which is quite good. The H.F. resistance here was about 16 ohms.

We then took a measurement with the shorting arrangements removed. The inductance rose to 153µH, the self-capacity became 18µµF, and the H.F. resistance dropped slightly to 12 ohms. Finally, we made tests on stud H, getting a value of 3 483µH for the inductance, corresponding roughly to a 250 turn plug-in coil. The self-capacity here was only 7µµF and the H.F. resistance 47 ohms. Compared with plug-in coils, these results are quite good.

The power factor, on calculation, proved to be .016, .017 and .014 respectively for the three sets of tests, which is about the same as the average plug-in coils now on the market.

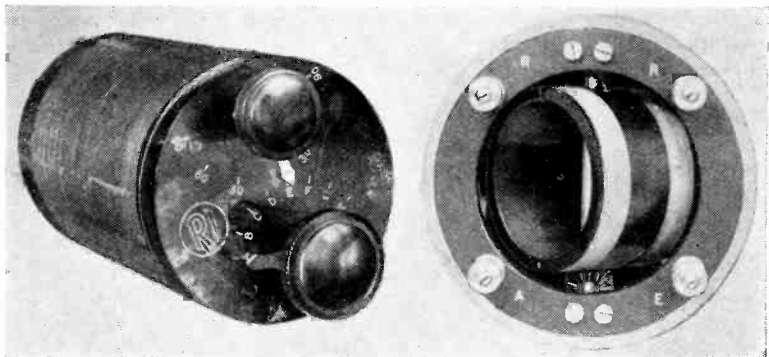

Two views of the "R.I." Tuner.

The Polar Curves of Reception for Spaced Aerial Systems.

By E. Green, M.Sc.

[R125·1

The systems to be described are due to Mr. C. S. Franklin, of Marconi's Wireless Telegraph Company, Ltd.

THE first experiments with polar curves were begun at Broomfield in 1913, but were discontinued on account of the war. The experiments were continued at Letterfrack and Towyn during 1919-20. The completed systems have been in continuous use there since that time until these stations were closed down, and have proved their marked superiority over open aerials or single frame aerials.

They provide a receiving system with marked directional properties, resulting in the reduction of atmospheric disturbances, as compared with the signal, and the elimination of possible jamming stations.

It is not proposed to give here a detailed description of the circuits used, or of their actual performance, but only an outline, so as to bring out clearly the fundamental principles, and we shall confine the study to signals on the horizontal plane.

2. The best way of showing the directional effect of a receiving system is by polar curves. These are constructed as follows: a point *O* is taken and lines drawn from it in all directions, of lengths proportional to the

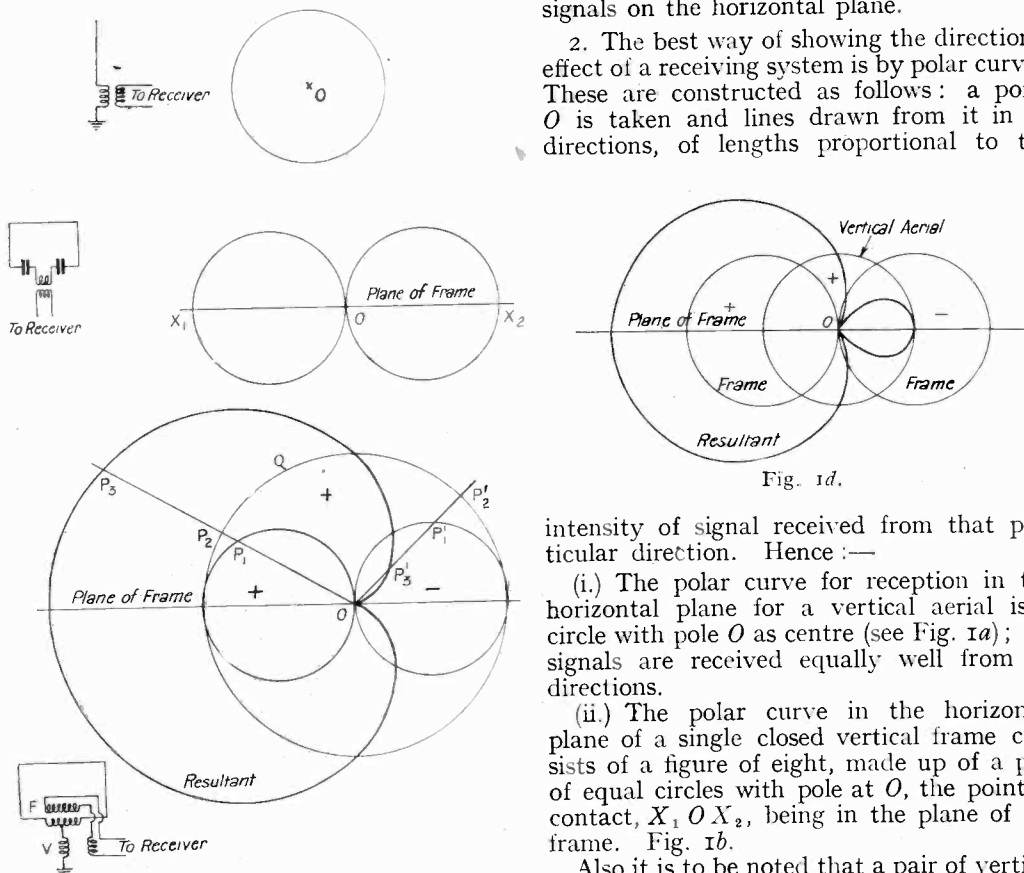

Figs. 1a, b and c.

Fig. 1d.

intensity of signal received from that particular direction. Hence:—

(i.) The polar curve for reception in the horizontal plane for a vertical aerial is a circle with pole *O* as centre (see Fig. 1a); *i.e.* signals are received equally well from all directions.

(ii.) The polar curve in the horizontal plane of a single closed vertical frame consists of a figure of eight, made up of a pair of equal circles with pole at *O*, the point of contact, $X_1 O X_2$, being in the plane of the frame. Fig. 1b.

Also it is to be noted that a pair of vertical frames fixed at right angles properly coupled

to a radiogoniometer are equivalent to a single rotatable frame.

(iii.) By adding a vertical aerial E.M.F. to the E.M.F. derived from the frame a heart-shaped polar diagram is obtained, provided this vertical component is equal in magnitude to the maximum E.M.F. from the frame, and is in (or opposite in) phase to the frame E.M.F.¹ These conditions can be fulfilled

vertical aerials, their distance apart being some fraction of the wave-length to be received, usually somewhere between $\frac{1}{6}$ and $\frac{1}{10}$ of a wave-length (call it λ/n).

These aerials are connected through tight-coupled transformers T_1, T_2 and underground cables U_1, U_2 to a central receiving station, indicated by the dotted line.

The aerial systems can be tuned to the wave to be received by means of condensers K_1, K_2 . B_1, C_1 and B_2, C_2 are two similar tuned circuits of low decrement. D is a circuit coupled equally to B_1 and B_2 , and from D the resultant signal comes through a coupled circuit to the amplifier.

4. Owing to the spacing between the aerials A_1 and A_2 there will be a phase difference in the E.M.F.s induced in them which will depend on the direction from which the signals come.

If A_1, A_2 were half a wave-length ($\lambda/2$) apart, the E.M.F.s due to signals from direction A_1, A_2 would be exactly opposite in phase; *i.e.* that in A_2 would be $\pi = 180^\circ$ behind that in A_1 . For a spacing between A_1 and A_2 of λ/n the E.M.F. in A_2 would be $360^\circ/n$ behind A_1 . For signals coming from the direction $P A_1$ (Fig. 2a) making an

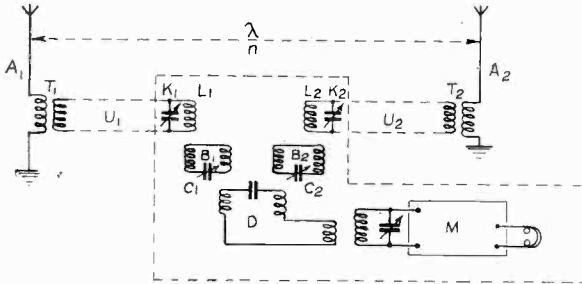

Fig. 2.

with suitable circuits. A skeleton diagram of the connections is shown in Fig. 1c. The frame component of E.M.F. is derived from the transformer F , and the vertical component from the transformer V , which utilises the frame as an open vertical aerial. Fig. 1c also shows how the heart diagram can be constructed graphically. The two circles of the frame diagram are marked positive and negative because the phase of the E.M.F. is reversed when the direction of the signal is reversed. The circle $P_2 O P_2$ shows the signal derived from the vertical aerial taken as positive in phase for all directions.

Then for signals from a direction, such as $P_1 O$, the frame and vertical aerial E.M.F.s are added. \therefore Resultant E.M.F. = $O P_1 + O P_2 = O P_3$, while for signals from direction $P_1' O$ the resultant E.M.F. is the difference of the two = $O P_1' - O P_2' = O P_3'$.

If this construction is performed for various directions the heart-shaped figure shown in Fig. 1c is obtained.

Fig. 1d gives the polar curve obtained if the vertical component is too weak.

Spaced Aerials.

3. Fig. 2 shows the simplest form of spaced aerial system. A_1, A_2 are two similar

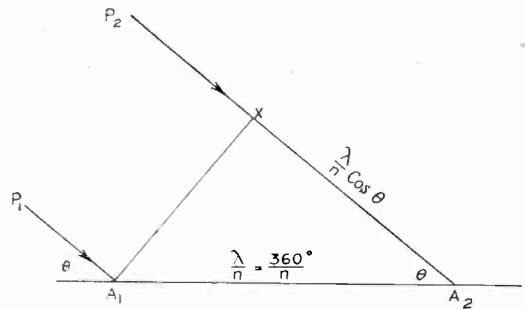

Fig. 2a.

angle θ with A_1, A_2 , the phase difference will be that due to $X A_2 = \lambda/n \cos \theta$ and will be $360^\circ \cos \theta$.

5. Fig. 3a (next page) shows the phase relations of the E.M.F.s induced in the aerials for eight different directions.

The couplings of B_1 and B_2 are opposed, which is equivalent to reversing one of the E.M.F.s, so that signals from directions perpendicular to A_1, A_2 will cancel out, if there is no phase shift in the circuits.

¹ G. M. Wright and S. B. Smith—"The Heart-Shaped Polar Diagram." *Radio Review*, August, 1921.

A spacing of 1/6th of a wave-length has been assumed, this makes the maximum phase difference 60° . The positive direction of rotation of the vectors is counter-clockwise. The straight arrows at the top show the direction of the signal. The resultant signal obtained by combining the two E.M.F.s is given by OR . The resultant E.M.F. is a maximum for the directions A_1A_2 and A_2A_1 , and zero for the directions perpendicular to A_1A_2 . It is therefore a figure eight diagram, the two loops of which are approximately circles (as shown in Fig. 3a) and will be assumed to be so.

In fact the system is equivalent to a closed frame with sides at A_1 and A_2 .

receiving circuits themselves, in a way to be described, and is therefore independent of the direction from which the signal comes. Hence the phase relations of the E.M.F.s are now as drawn in Fig. 3b. The resultant polar curve is the heart-shaped figure on the right. Its shape is practically identical with that of Fig. 1c, and it can be constructed graphically in the same way.

7. The required phase shifts of the E.M.F.s from A_1 and A_2 are obtained by mistuning the low decrement circuits B_1 and B_2 by a slight alteration of the capacities C_1 and C_2 (Fig. 2).

Fig. 4 shows the variations in magnitude

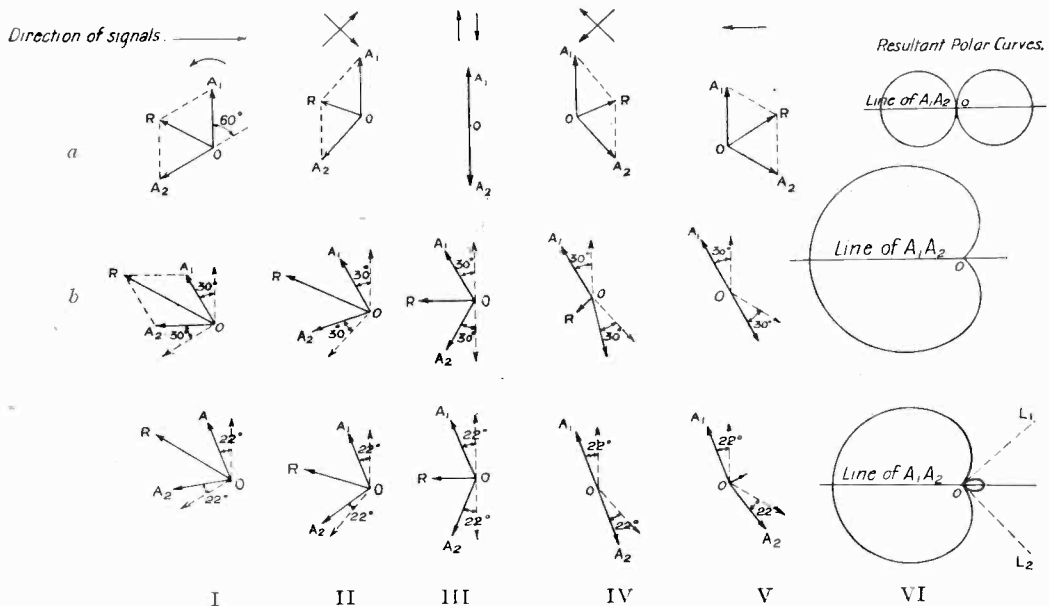

Figs. 3a, b, and c.

6. A more useful polar diagram however would be one which gave a maximum strength of signals for the direction A_1A_2 , and zero strength for signals from the opposite direction A_2A_1 .

From Fig. 3a (V) we see that to achieve this we must alter the phase relation of the two E.M.F.s as shown in Fig. 3b (V). That is, we must advance the phase of OA_1 30° and lag OA_2 30° . The dotted lines indicate the original positions of OA_1 and OA_2 whilst the full lines give the new positions.

This phase shift is performed in the

and phase of the current in a circuit as the capacity is varied. The decrement of the circuit is taken as .008.

It will be noticed that to obtain the 30° advance on OA_1 capacity C_1 must be decreased by .3 per cent. and to get the 30° lag on OA_2 , C_2 must be increased by .3 per cent.

This mistuning reduces the currents to .866 of their resonance values, but this is inevitable.

The phase shift by mistuning can only be performed for wave-lengths which are very close to the wave-length to be received. For

wave-lengths well outside this range, the small alterations of C_1 or C_2 hardly affects the phase. But these wave-lengths are not important as they can be tuned out in the

and the maximum is obtained with spacing between $1/5$ and $1/6$ of a wave-length.

Although these diagrams only apply strictly to undamped wave signals, they are approximately true for spark signals, and to a considerable extent for atmospheric disturbances.

In practice it is found that the combination of two spaced aerials is more free from atmospheric disturbances than a single aerial. At some times the effect is much more marked than at others, *i.e.*, if a large proportion of atmospherics are coming from the same direction as the signals to be received, *i.e.*, $A_1 A_2$, not much reduction is to be expected, while if they are coming from the opposite direction, the reduction will be marked.

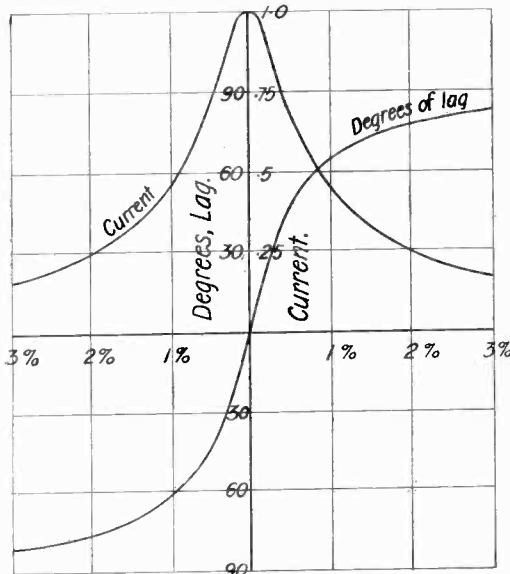

Fig. 4.

ordinary way, by low damped intermediate circuits.

We shall therefore take it that the polar curve is approximately a heart shape for wave-lengths likely to affect the receiver.

8. If the misphasing is given an intermediate value, say $O A_1$ advanced 20° and $O A_2$ lagged 20° , we get the vector diagram shown in Fig. 3c and the resultant polar curve is also shown. It has minima in directions $O L_1$ and $O L_2$, and such an arrangement can be used to cut out jamming from these directions.

It is similar to Fig. 1d and can be constructed in the same way.

The most important case, however, is that giving the heart-shaped curve dealt with above.

9. As the spacing between the aerials is increased the resultant signal strength on the maximum will increase as shown in Fig. 5, where allowance is made for the weakening due to the mistuning of B_1 and B_2 . The E.M.F. given by one aerial alone is taken as the unit of signal strength.

The increase of strength with spacing is rapid up to about $1/10$ th of a wave-length,

10. So far we have dealt with the results that can be obtained from the combination of two spaced plain aerials, as this is the most simple case. But in actual practice the plain aerials are replaced by pairs of D.F. frames connected through underground cables to radiogoniometers in the receiving hut. (See Fig. 6a and 6b, next page.) In 6a each pair of D.F. frames will give a figure eight diagram, whilst in 6b extra connections are made so that a vertical component can be obtained to produce a heart diagram from each individual set of frames. The frames A_1 and A_1' are a pair of D.F. frames and are shown separately on the figure for convenience of drawing the connections, similar remarks also apply to A_2 and A_2' .

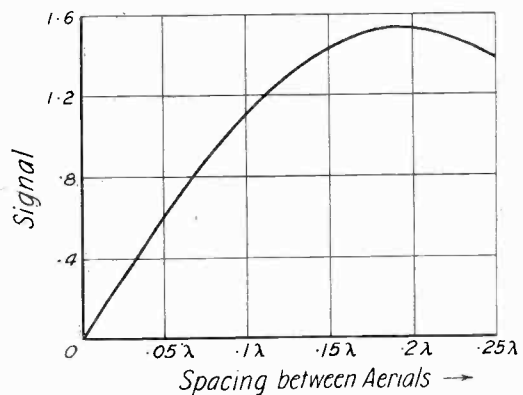

Fig. 5.

In 6a we have two twin cables from each pair of frames. $L_1 L_1' L_2 L_2'$ constitute the fixed coils of the radiogoniometers, S_1 and S_2 the rotating search coils.

In 6b we have extra circuits made up of $T_1 U_1 V_1$ and $T_2 U_2 V_2$ to provide the vertical components for the heart diagram.

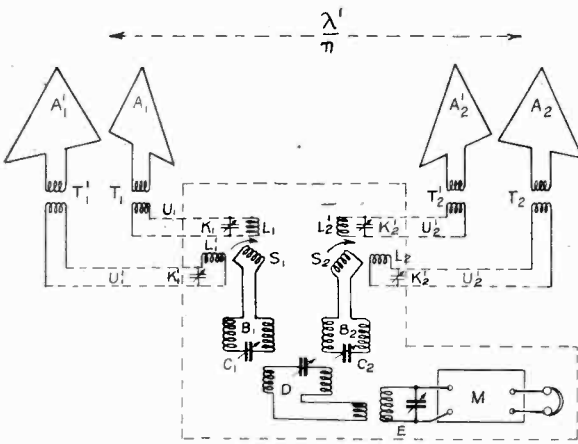

Fig. 6a.

For the rest the circuits are identical with those of Fig. 2 for open aerials and have been similarly lettered. $B_1 C_1$ and $B_2 C_2$ are the misphasing circuits as before.

11. We have now to show how to find the resultant polar curves, obtained with systems such as 6a or 6b. We may regard each pair of frames, as $A_1 A_1'$ with its associated radiogoniometer, as equivalent to a single rotatable frame. Take the case of 6a: each pair of frames gives a figure eight diagram which rotates as the search coils are rotated. Suppose the search coils are set so that the equivalent frames lie along $A_1 A_2$ and therefore the figure eight curves for each set of frames are as shown in Fig. 7a. Also let the misphasing circuits $B_1 B_2$ be set so as to give a minimum from the direction $A_2 A_1$: i.e., if we had simple open aerials at A_1 and A_2 the combination would give us the heart diagram of Fig. 3b, shown dotted in 7b. The polar diagrams of Fig. 3 we shall refer to as the open aerial combination diagrams or spacing and phasing diagrams. Then it is obvious that with the search coils set as above no signals are received on either set of frames from directions at right angles to $A_1 A_2$. Therefore the heart diagram due to the misphasing must be pinched in to zero in these directions.

The resultant polar curve is shown in Fig. 7b, which is derived as follows: If we had open vertical aerials at A_1 and A_2 instead of frames, giving E.M.F.s, equal to $O_1 M_1 = O_2 M_2$ (Fig. 7a), the resultant is OM (Fig. 7b). For any other direction, such as $P_1 O_1$, with open aerials, the individual E.M.F.s would still be equal to $O_1 M_1 = O_2 M_2$ but the resultant would be OP on the heart diagram. But with the frames at A_1 and A_2 the individual E.M.F.s for the direction $P_1 O_1$ are reduced to the value $P_1 O_1$. Therefore the resultant E.M.F. for the combination will be reduced in the same ratio, and is equal to $OP \times \frac{O_1 P_1}{O_1 M_1}$ i.e., it is proportional to $OP \times O_1 P_1 = OQ$ say, since $O_1 M_1 = O_2 M_2 = \text{constant}$.

12. Hence the following construction will give us the resultant diagram of the combination of spaced frames: The figure eight diagram of the individual frames is superimposed on the spacing and phasing diagram for the open aerial combination in its proper relative position as in Fig. 7c.

Then for any direction, such as XO , the

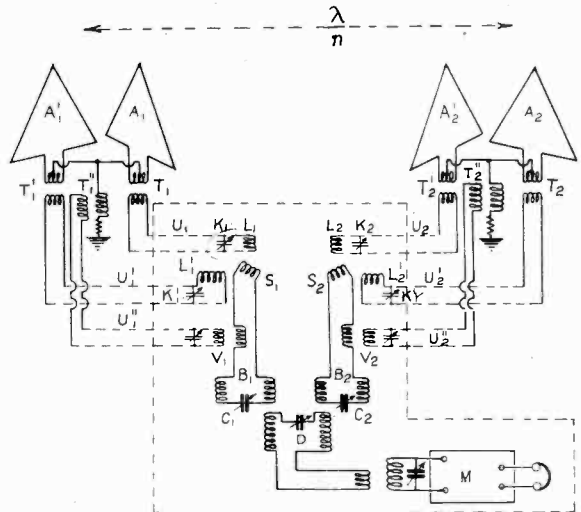

Fig. 6b.

resultant vector for the frame combination will be $OP \times OP_1 = OQ$.

This process may be termed multiplying one polar diagram by the other.

The scale on which the two diagrams are drawn will not affect the shape of the resultant diagram which is also shown in Fig. 7d.

The table below gives the relative values of the vectors in the figure eight and heart diagrams at intervals of ten degrees, starting from the maximum values. The third column gives their product, which is the value of the vector on the resultant diagram for the same direction. Fig. 7c is constructed from these figures. This table will be found of use in constructing the later diagrams.

13. As might be expected, the resultant diagram is much better than that obtained with open vertical aerials, and will give correspondingly better results in practice as regard freedom from jamming and atmospherics.

14. By the above method we can easily determine what happens when we vary one of the two main factors, e.g. :—

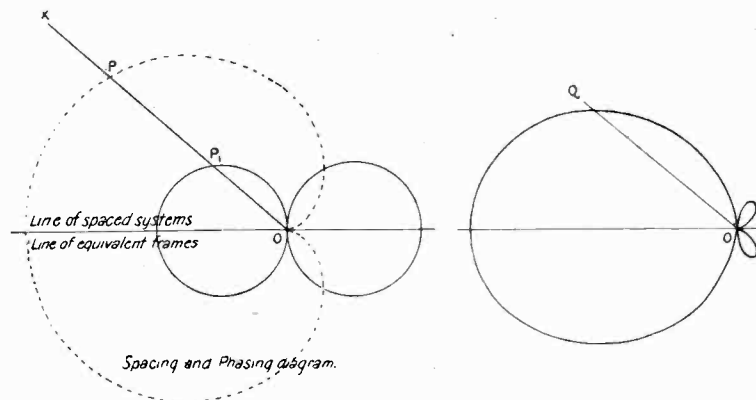

Figs. 7c and d.

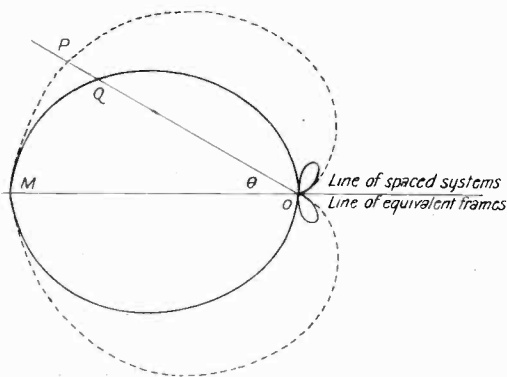

Figs. 7a and b.

(1) Rotation of the search coils of the radiogoniometers. In practice these will always be moved through equal angles so that the equivalent frames remain parallel.

(2) Alteration of the amount of mis-phasing in B_1 & B_2 .

Take as an example of (1); the search coils of the radiogoniometers are rotated through an angle of 30° in the counter clockwise direction, so that the equivalent frames and the individual polar curves are

Angle θ degree.	Vector of Fig. 8 diagram = $\cos \theta$.	Vector of Heart diagram = $(1 + \cos \theta)$.	Vector for Combination = $\cos \theta (1 + \cos \theta)$.
0	1.0	2.0	2.0
10	.985	1.985	1.96
20	.94	1.94	1.82
30	.866	1.866	1.60
40	.766	1.766	1.35
50	.643	1.643	1.06
60	.500	1.500	.75
70	.342	1.342	.46
80	.174	1.174	.205
90	0	1.00	0
100	-.174	.826	.143
110	-.342	.658	.244
120	-.500	.500	.25
130	-.643	.357	.238
140	-.766	.234	.179
150	-.866	.134	.116
160	-.94	.06	.056
170	-.985	.015	.015
180	-1.00	0	0

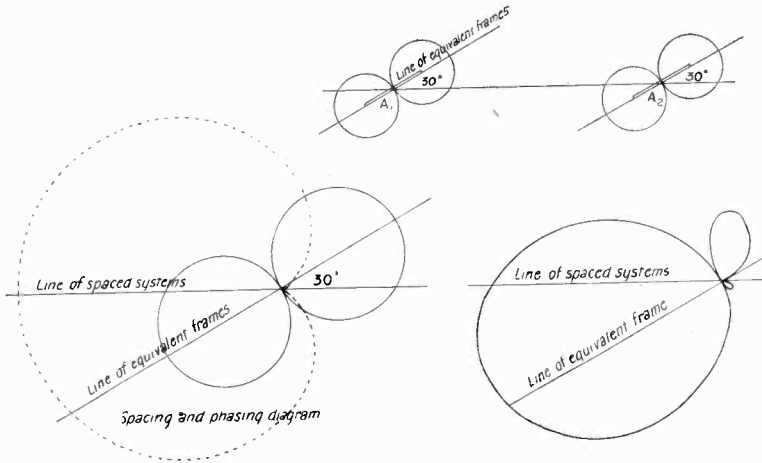

Fig. 8a (above), 8b (left) and 8c (right).

axis, Fig. 10a. If B_1 and B_2 are in tune, i.e., no misphasing, the open aerial combination diagram is a figure eight as in 10b. Superposition gives the resultant curve shown in 10c. It is identical with that of 7b, although its derivation is so different.

17. If now B_1 and B_2 are misphased so as to give a minimum behind A_2 the open aerial combination diagram is a heart, so

as shown in Fig. 8a. The misphasing, and therefore the heart combination diagram, is unaltered. Superposition gives Fig. 8b with the resultant polar curve shown in Fig. 8c. One of the back loops is enlarged and the other is reduced in size, and the strength in direction A_1, A_2 is reduced. The figures for this calculation are given below. Those for the figure eight diagram have been moved up 30° compared with those in the previous table, whilst the figures for the heart are unchanged. As the figure is unsymmetrical it is necessary to make out the table for the whole 360° .

15. Next with the search coils in their original position so that the equivalent frames are along A_1, A_2 , let the misphasing be reduced. The open aerial combination diagram is now that of Fig. 3c (VI) and superposition of the diagrams as in 9a yields the resultant of 9b. Figs. 9c and 9d give the superposed and the resultant diagrams when the misphasing is less than in 9a and 9b.

Many such varying combinations can be worked out.

16. The same method can be applied to any combination of two or more similar spaced aerial systems. Consider the system outlined in Fig. 6b, where each pair of D.F. frames is connected so as to give a heart diagram (by obtaining a vertical component from the frames through the transformers T_1 and T_2). For example, let the equivalent frames lie along A_1, A_2 so that the individual heart curves have A_1, A_2 as

Angle θ degree.	Vector of Fig. 8 diagram. = $\cos(\theta + 30^\circ)$	Vector of Heart diagram. = $(1 + \cos \theta)$	Vector of resultant diagram. = $(\cos(\theta + 30^\circ) + 1 + \cos \theta)$
0	.866	2.0	1.73
10	.766	1.985	1.52
20	.643	1.94	1.25
30	.500	1.866	.933
40	.342	1.766	.605
50	.174	1.643	.286
60	0	1.500	0
70	-.174	1.342	.234
80	-.342	1.174	.402
90	-.500	1.0	.50
100	-.643	.826	.53
110	-.766	.656	.50
120	-.866	.500	.433
130	-.94	.357	.335
140	-.985	.234	.23
150	-1.00	.134	.134
160	-.985	.06	.06
170	-.94	.015	.014
180	-.866	0	0
190	-.766	.015	.011
200	-.643	.06	.038
210	-.5	.134	.067
220	-.342	.234	.08
230	-.174	.357	.062
240	0	.5	0
250	+.174	.656	.114
260	.342	.826	.282
270	.5	1.0	.5
280	.643	1.174	.755
290	.766	1.342	1.03
300	.866	1.5	1.3
310	.94	1.643	1.54
320	.985	1.766	1.74
330	1.0	1.866	1.866
340	.985	1.94	1.91
350	.94	1.985	1.87
360	.866	2.0	1.73

that the resultant diagram is also heart shaped, but the minimum behind is wider. This is shown in Fig. 11 (next page).

The signal strength on the maximum will be almost twice that of Fig. 10c.

Now keeping this degree of misphasing we might swing the search coils round 30° to minimise atmospheric disturbances from a particular quarter. The indivi-

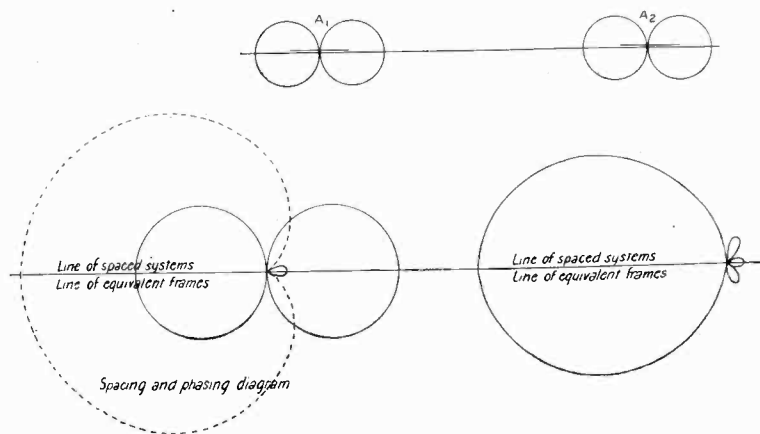

Figs. 9a (left) and 9b (right).

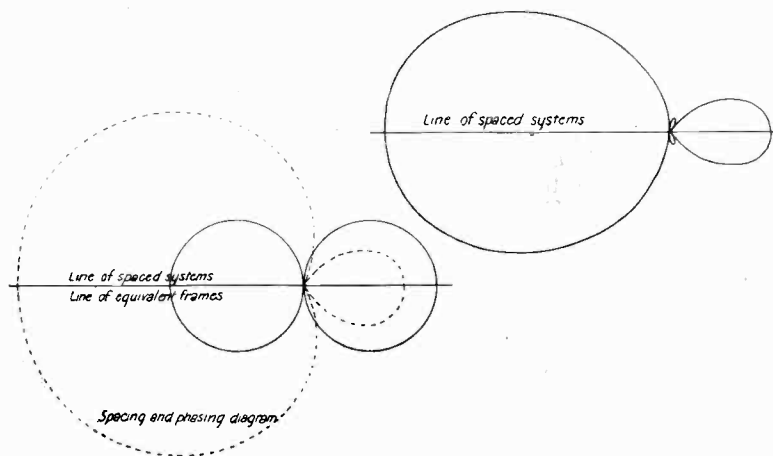

Figs. 9c (left) and 9d (right).

diagram is wider than the two minima on the figure eight. Hence, if you are working on one pair of frames, and swing the search coil round, you can usually find a position that gives a very definite minimum of atmospheric disturbance.

When using plain frames this effect is not at all marked. Secondly, the minimum of the heart diagram remains good under night conditions, in which the minima

dual hearts are now as 12a (next page), the superimposed diagrams as 12b and the resultant diagram as 12c.

18. In practice the system outlined in Fig. 6b, (i.e., a vertical aerial component combined with the frame E.M.F.s so that each pair of frames gives a heart diagram) gives better results than one using plain D.F. frames. The single minimum on the heart

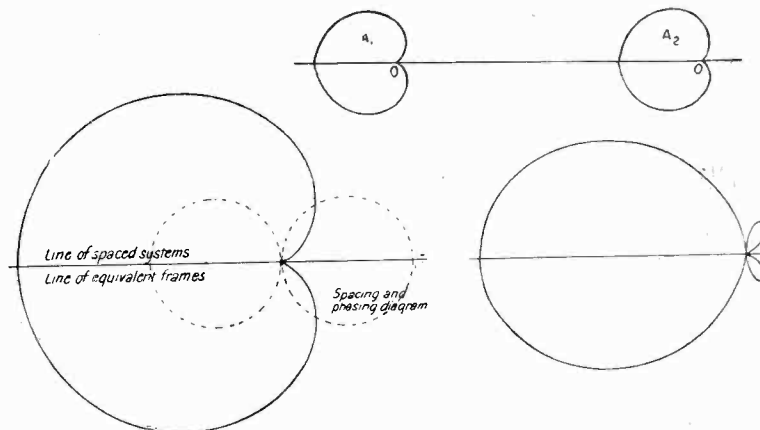

Figs. 10a (above), 10b (left) and 10c (right).

on plain frames may disappear entirely.* Thirdly, there is no ambiguity of sense when locating the direction of jamming.

19. The way in which the two E.M.F.s from the two sets of frames will be combined by misphasing will depend on circumstances. In the first place the line of the frames, *i.e.*,

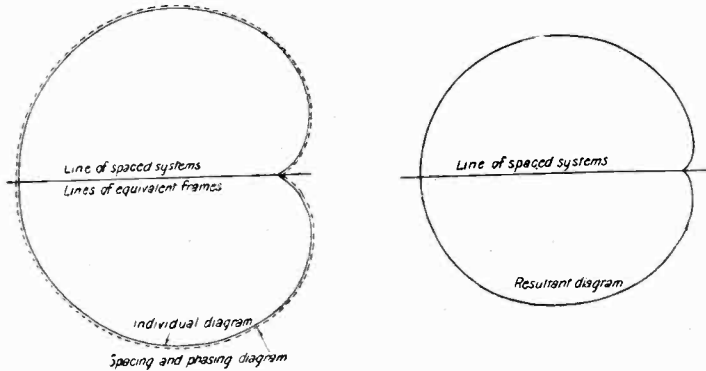

Fig. 11.

$A_1 A_2$, should point toward the station to be received, and as far as possible all jamming stations should lie behind A_2 . The search coils can then be set to give minimum atmospheric disturbance from each frame. Then B_1 and B_2 are mistuned to get maximum signals from the front. Such a case is shown in Fig. 12, where Xs are supposed to be coming from the direction OX. Or, if there is a particularly strong jamming station not quite directly behind, the misphasing is decreased to give a minimum in its direction.

Fig. 13a and 13b show the superposed and resultant diagram for this case.

20. It is not suggested that all these different diagrams should be constructed accurately to scale. The method is chiefly useful in that it enables us to draw the diagram for the individual sets of frames, and the misphasing diagram, quite roughly in their proper relative positions, and to derive from them by rapid inspection a good general idea of the resultant diagram.

Note that there will be minima on the resultant

polar diagram for the same directions that there are minima on either the spacing and phasing diagram, or the individual diagrams.

It is hoped that the method outlined will assist readers to obtain a clear mental picture of what is happening when such circuits are being adjusted.

We can now give the general rules for finding polar diagrams (for reception in the horizontal plane) obtained by combining any number of similar and similarly oriented spaced aerial systems. These are as follows:—

(1) Consider each individual system replaced by a vertical aerial, and find the polar diagram obtained

by combining the currents from all these vertical aerials, any misphasing being exactly as for the individual system that the vertical aerial replaced. This diagram is called the "combination," or "spacing and phasing" diagram.

(2) Find the polar diagram for each individual system.

(3) Superpose the spacing and phasing diagram obtained in (1) on the individual polar diagram obtained in (2) pole on pole and with the proper orientation.

(4) The resultant polar diagram for the complete set of spaced systems is obtained

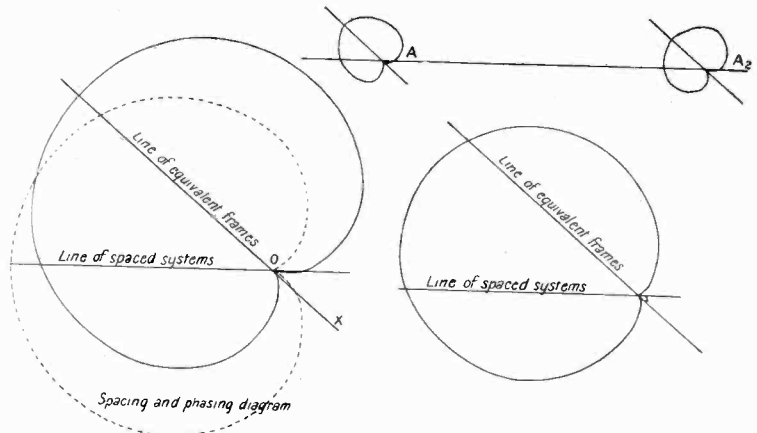

Figs. 12a (above), 12b (left) and 12c (right).

* See previous reference.

by "multiplying" one of these two diagrams by the other, as described in this article.

The same method can be applied to find the polar diagram for transmission

If we wish to find the polar figure in three dimensions instead of in two only (the horizontal plane) in (I) we must replace each individual system by a hypothetical receiver that receives equally in all directions instead of by a vertical aerial. The spacing and phasing diagram must then be obtained in three dimensions. Similarly, the polar figure for each individual system must be found for three dimensions. The resultant polar figure is found by superposing one of these on the other in their correct relation and "multiplying" one by the other.

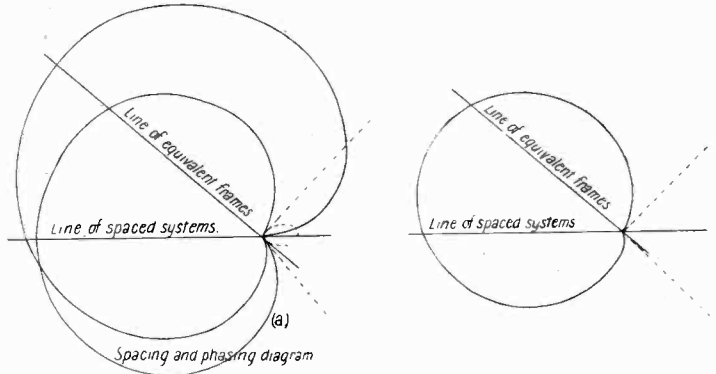

Figs. 13a and b.

for any set of similar and similarly oriented spaced aerial systems, though these have not been specifically referred to in this article.

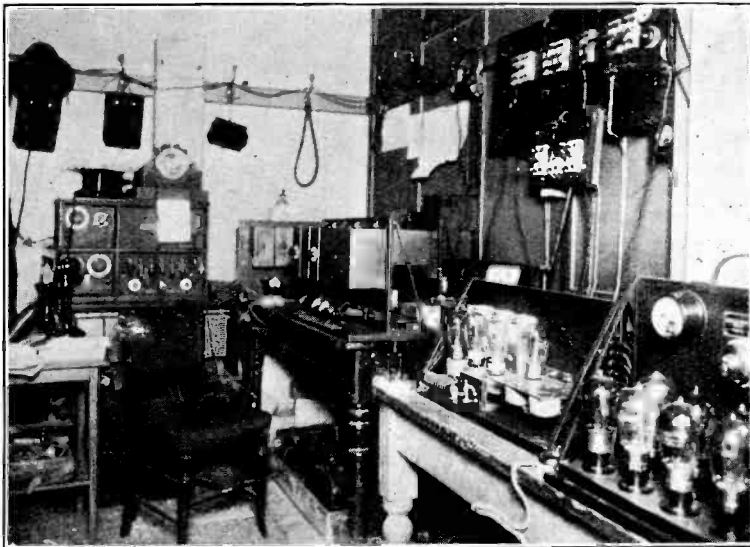

An exclusive picture of the Marconiphone and B.B.C. amplifying apparatus for broadcasting by means of loud-speakers the speeches, etc., made at the recent Wireless Exhibition at the Albert Hall.

The Albert Hall Exhibition. [R064

A Brief Review of some of the more Interesting Exhibits.

THOUGH the recent successful exhibition staged at the Albert Hall, London, did not bring to light any very startling novelties in apparatus and equipment, it was of interest in that it indicated clearly the improvements in design and construction which have recently taken place, as well as the lines upon which manufacturers are now working.

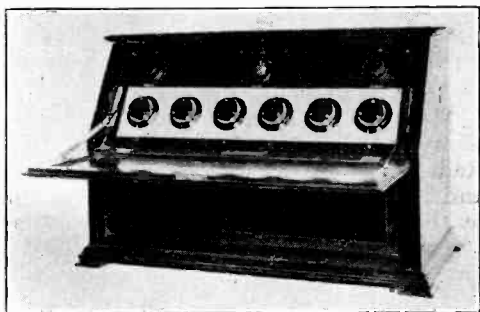

The "straight eight" receiver developed by the Marconiphone Company. At the moment specification and circuit details are not available.

With one or two exceptions, the trend seems to be towards the detailed improvement of standard design, both from the point of view of mechanical and electrical efficiency, and in the case of broadcast receivers and equipment, from considerations of an æsthetic nature.

In the following pages we propose to give a brief description of such of the exhibits as will be likely to interest our readers, and in doing so we propose first to deal with the receivers which were on view.

Leaving out crystal receivers, of which many ingenious designs were to be seen, we found that valve receivers could be broadly divided into three classes. First, there were sets employing one or two valves. In these, no vast changes were apparent, and in many cases last year's designs had been more or less adhered to. There were several examples of two valve sets, employing a detector valve and one L.F. amplifier with

direct aerial reaction, intended for working a small loud-speaker at short ranges from the local station. We cannot help thinking that the quality of the results obtainable from two valves would have been vastly improved by re-designing these sets to have one H.F., crystal detector and one L.F. valve.

The second class of valve sets noticed was what we may call the "luxury" class. In most cases, receivers of this class employed four valves (H.F., detector and 2 L.F.); and were housed in cabinets of excellent construction and finish. Many were available in different "period" designs, and most of them contained all batteries and accessories. In many cases loud-speakers were built in, making the set almost self-contained.

Most of the large firms had sets of this type on view, and almost each set had some distinguishing feature in design or construction. Thus the De Luxe Pedestal set made by the British L. M. Ericsson Manufacturing Co., Ltd., incorporated a simple wave-trap. The Chakphone No. 7, by the Eagle Engineering Co., Ltd., employed a coupled aerial circuit, both primary and secondary being tuned. This set was said to give excellent selectivity.

The Cosmos 5-valve cabinet sets have, of course, been on the market for some time. They make use of special plug-in units for different wave-length ranges, the units containing the aerial and reaction coils and the H.F. transformer. A lever is provided which couples the reaction coil either to the H.F. transformer or to the aerial coil. In a 3-valve amplifier made by this firm, resistance coupling is employed, and the last two valves may be switched in series or in parallel. The first position results in the usual circuit, and maximum amplification is obtainable when receiving weak signals. If strong signals are being received, the valves are switched in parallel, when they are capable of dealing with more power, and risk of distortion due to overloading is eliminated.

The Radio Communication Co., Ltd., were showing an interesting set in the "Polar Four." This set employs a double tuning system, so that a set can be tuned to a short wave and a long wave station, the change-over from one to the other being easily performed. The most interesting point is, however, that a system of remote control is incorporated. This consists of a control box attached to a long cable which can be plugged into the set by a special plug and socket. In the control box (which is placed in the room where the loud-speaker is situated) is a switch which operates relays in the set, bringing either the long or short wave tuner into action. In addition, the control box contains a rheostat which varies the filament voltage of the detector valve, thus controlling the degree of reaction. Such a device is necessary, otherwise on switching over it might be found that the reaction coupling was too great, resulting in oscillation, which must be avoided at all costs.

So far we have only mentioned sets of the "straight" type with conventional circuits. A rather unusual receiver was the Marconiphone "Straight Eight." As its name implies, it employs eight valves,



The new "Radiosun" receiver designed by Auto-Sundries, Ltd. The loud-speaker is a fixture.

5 H.F., detector and 2 L.F., and was designed by Captain Round. It has some novel method of neutralisation of which, up to the present, we have not been able to obtain

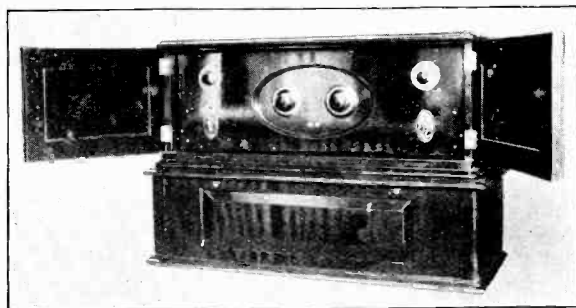

The handsome de luxe model Burndept supersonic receiver. It costs £84.

details. Incidentally, each of these receivers is calibrated in metres.

Almost the only other neutralised receiver we noticed was that produced by the British Radio Corporation. This employs 5 valves and has a range of 200-3000 metres, obtained by the use of suitable interchangeable tuners. There seems to be no doubt that this essentially American circuit is finding very little favour over here.

The Ediswan Company were showing a novel 4-valve set, the W.L. 449, employing capacity reaction. The method of manufacture has been so standardised that all instruments are sent out with the tuning condenser calibrated in metres, and individual calibration is not needed.

Perhaps the most novel receiver which we saw was that shown on Messrs. Auto Sundries' stand. This, the "Radiosun," is claimed to operate on an entirely new principle. It employs 5 valves, which are specially manufactured for the firm by a well-known valve manufacturer, and the *total* filament current consumption is only 0.1 ampere. The plate current required is in the neighbourhood of one or two mA at 60 volts. The set is intended for loud-speaker reception at distances up to 25 miles from the local station.

So far we have not been able to obtain full particulars as to the circuit employed, or the special properties of the valves. The set employs a frame aerial concealed at the back, and the only other components visible are a variable condenser and one or two fixed condensers. No L.F. transformers are

employed, and the makers say that distortion is thereby practically eliminated. Lest it should be thought that this set (which is quite cheap—£18 10s., including loud-speaker and all accessories) is another of the "wildcat" schemes of which there are so many prevalent at the present time, we should in fairness say that the inventor of the circuit is a man who has had a good deal of useful experience, and it is quite possible that he has hit upon some revolutionary idea. At this we will leave it, until we have had opportunity of verifying the claims put forward.

We now come, by a process of elimination, to a class of receiver which, during the last year, has made great strides towards popularity—we refer to the supersonic receiver, or, as some call it, the superheterodyne. This time last year the use of this type of receiver was confined almost exclusively to experimenters, and all parts in use were of American origin. To-day, many types of British made supersonic receivers are on sale, and sets of parts are also available. There is no doubt this is largely due to the increasing efficiency of dull-emitter valves. Few members of the general public could manage to run, say, eight bright emitters consuming about 6 amps in all.

At the Exhibition, the number of supersonic receivers was surprising—there were not many of the larger manufacturers who

did not show at least one type. In most cases, the parts for building one's own set could be obtained.

Messrs. Beard & Fitch were showing several supersonic sets and a complete range of their supersonic components. These included the "Superforma" (an intermediate-frequency transformer) and an oscillator coupler. The sets are specially designed for simplicity of control. Apart from the filament resistance and a potentiometer the only controls were the oscillator coupler and the tuning condenser.

Messrs. Bowyer-Lowe were showing no less than six models, all employing their sets of components, which are obtainable separately. The "Popular" model employs 8 valves, and is self-contained except for a frame aerial.

The British Thomson-Houston Co. were showing 6-valve models of both portable (with loud-speaker) and pedestal types.

The Ethodyne, by Messrs. Burndept, is a handsome set, and employs 7 valves: an oscillator, first detector, 2 intermediate frequency, second detector, and 2 L.F. valves. The latter can be switched out if desired. The first detector employs anode rectification, a suitable grid potential being applied for this purpose. The intermediate-frequency amplifiers operate on a wavelength of 6000 metres. Separate frame aerials are provided for the lower and upper broadcast band.

The General Electric Company were showing two Gecophone supersonic receivers, one 6-valve and one 8-valve. The latter is

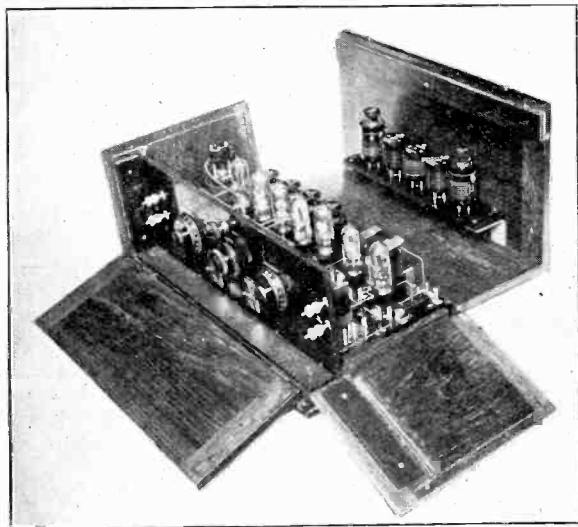

An interesting interior view of Messrs. L. McMichael's supersonic set.



One of the "Amplion Radiolux" loud-speakers, which came as a great surprise to most people at the Show.

similar to the former, but has two additional L.F. valves, Three intermediate-frequency amplifiers are employed, and work on a wave-length of 5 000 metres. The tuning range is from 175 to 3 000 metres by the use of suitable plug-in units. The only controls are two tuning condensers, and a volume control.

Messrs. L. McMichael have recently produced a set of supersonic components, and on their stand was a 7-valve set employing these. This will shortly be on the market. The first valve is a combined detector and oscillator, which is rendered possible by the centre-tapped "Autodyne" unit. Then follow 3 L.F. amplifiers, the second detector, and 2 (optional) L.F. amplifiers. The first of these is transformer coupled, the second employing resistance-capacity coupling. As an example of compact and neat wiring, this set would be hard to beat.

Finally, we should mention the R.I. 6-valve supersonic, which employs the units made by this firm. The oscillator couplers are of a flat circular shape, and the layout and wiring of the set are very well disposed. Two of the new geared R.I. condensers are employed for tuning purposes.

Having now dealt at some length with the various types of sets which were on view, we will consider the accessories to such sets, under which heading we include loud-speakers, batteries (and other devices intended to replace them), and valves.

The tendency in loud-speaker design was, on the whole, towards the production of instruments of the hornless or concealed

horn type; though many of the standard horn models were to be seen improvements in which had been confined to details in the design and construction.

The most unexpected innovation in loud-speakers was probably the new Amplion "Radiolux." This, in appearance, resembles the old English bracket clock, the dial of which is replaced by a bulged grille. The electro-magnetic movement is of an improved type, the active dimensions of the diaphragm being increased, and the area of the pole faces of the magnet system being reduced to allow of a high flux density through them. The acoustic system is novel, and is stated to be the result of much research. The sound waves are first led along a gently tapering curved sound conduit and are then reflected at a "bowl" of double hyperbolic section. The orifice of the sound conduit is placed at the focus of the hyperbolic reflector. We hope to have an opportunity of testing this instrument shortly.

Several other novel types of loud-speakers were also to be seen. The British Thomson-Houston type E is of the conical diaphragm type. Over the front of the cone is an open grille, behind which is stretched a panel of silk to diffuse the sound. The A. J. Stevens pedestal instrument consists of a solid mahogany case, in which is a cast straight horn, with a solid reflector which reflects the sound horizontally through the grille at the top. Messrs. S. G. Brown have produced several new models, including a cabinet instrument, and the "H.Q.," a model similar to the well-known "Q," but

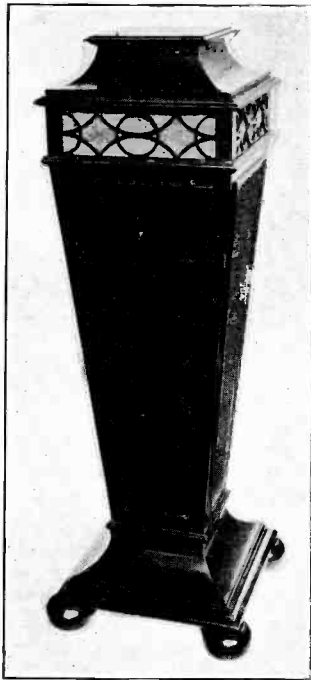

This pedestal loud-speaker by A. J. Stephens, Ltd., is as much an ornament as an efficient instrument.

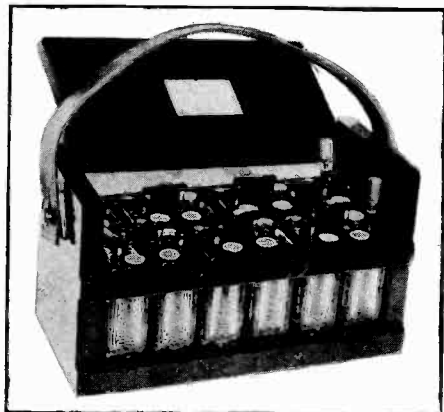

The "Hymeg" H.T. accumulator unit made by Ediswan's.

much less costly. The cabinet model is similar in appearance to a "hornless" gramophone, and contains an internal horn. Messrs. C. A. Vandervell and the Radio

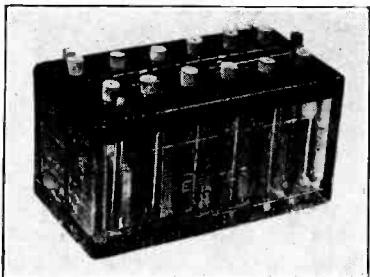

This Exide "W.H." H.T. battery is a development of the well-known "D.T.G." type cells.

Communication Company are also showing some novel instruments on these lines.

As to batteries and other sources of supply, there were no startling developments. Several firms, notably the Chloride Electrical Co., the Hart Accumulator Co., and Edison Swan Electrical Co., were showing new types of H.T. accumulators. On the stand of the first of these companies, a new glass-cell type W.H. was to be seen, similar in construction to the well-known D.T.G. types. This is stated to hold its charge for six months without damage. On the Hart stand was noticed a new experimental type, the cells of which are placed in a metal container, and are then completely oil-immersed. The oil floats on the acid, and trouble due to spraying and evaporation is eliminated.

Several battery chargers and mains supply units, both for H.T. and L.T. supply, were to be seen, but they appeared to be constructed on conventional lines.

Messrs. S. Smith & Sons, who now deal with the well-known M-L products, were showing a range of M.L. anode converters, small H.T. generators and two-voltage boxes.

The anode converters are, of course, small motor generators which derive their input supply from 6 or 12-volt accumulators. Three types are available, Types N, C and D. They give respectively 120, 300 and 500 output volts, with input voltages of 6, 12 and 12 respectively. When two different H.T. voltages are required, a two-voltage box must be used. This contains an inductively wound resistance with tappings. It also contains a $2\mu\text{F}$ condenser and thus

serves as an additional smoothing unit. It is also possible to buy the generators with the two-voltage device built in. Two types are available, giving voltages of 120 and 60, and 300 and 60.

Machines can also be supplied with a single winding only, suitable for driving from an external source, and wound for any voltage

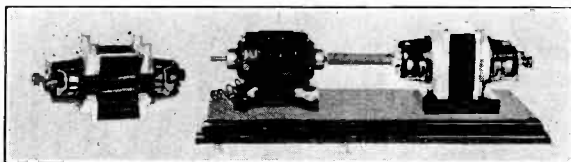

The "M.L." anode converter, by S. Smith and Sons (M.A.), Ltd.

up to 600 volts. A standard machine is available, giving 30mA at 550 volts at 2500 r.p.m. This would be suitable for amateur transmitting stations of small power.

We come next to the consideration of the valve exhibits. Messrs. Burndep have now entered the circle of valve manufacturers and are making a complete range of valves for receiving purposes, including power valves. We are glad to note that they have adopted what is, in essence, our own method of classification.

We noticed especially the L550, which is a "super" power valve. The filament current is 0.5 amp at 5.0 volts, and the emission is 60mA. The makers advise the following combinations of H.T., and grid voltages.

H.T.	150 volts,	Grid - 15 volts.
	200 volts,	Grid - 30 volts.
	250 volts,	Grid - 45 volts.

The Cossor Valve Co., were showing two new power valves—the W3 and P3, the former being a "250" and the latter a "425."

The Mullard Radio Valve Company were showing the new P.M.4, which is a "410" power valve, with a specially coated "N" shaped filament, the electrodes being arranged horizontally. A large range of transmitting valves was also to be seen, ranging in power from a "5-watter" to the large silica-cased valves which are features of this firm's products.

The M.O. Valve Company are now making valves for both the General Electric Company (Osram) and the Marconiphone Company (Marconi). Several new types are available. The old D.E.R. is now superseded

by two forms, the D.E.2 H.F. and L.F., with amplification factors of 12 and 7 respectively. The old D.E.6 has now been slightly modified, the impedance being reduced and the amplification factor slightly raised. This has involved increasing the filament consumption from 0.4 to 0.5 amp, the valve thus becoming a "250."

Two entirely new valves by this Company are the D.E.8 H.F., and L.F. both being of the "612" class. The H.F. model is claimed to be a very efficient detector; the D.E.8 L.F. meeting the demand for a low current consumption power valve.

A comprehensive display of obsolete types of valves, showing the growth of the present models, was a feature of this stand.

A range of transmitting valves was also shown, including the high power water or oil-cooled types as used at Daventry. The usual amateur transmitting types were also to be seen, together with one which promises to be of interest to many of our readers. This is the D.E.T.1 and it is said to be the first dull-emitter transmitting valve to be produced. It is rated at 40 watts, the filament current being 1.9 amps, at 6 volts, the normal anode voltage being 1000. The valve is fitted with a special low-capacity cap, consisting of a bakelite base, with four pins, one at each corner of the base.

On Messrs. Autoveyer's stand were to be seen samples of many types of Western Electric valves, including the well-known power valve. The cathode ray oscillograph (described in our issue of September) was also exhibited.

The Dubilier Condenser Co., apart from the usual broadcast apparatus,

were showing many types of transmitting condensers, including new types suitable for amateur transmitters. These are in porcelain cases, about 5 in. high and 3 in. in diameter.

Some well-made standard variable condensers were also to be seen, together with banks of standard fixed condensers which are intended for laboratory use. On this stand we noted also a buzzer wavemeter, using plug-in coils, and supplied with calibration charts.

Other firms showing buzzer wavemeters were Messrs. Burndept and Messrs. Bowyer-Lowe. That produced by the former is known as the "Ethophone" buzzer wavemeter.

The Bowyer-Lowe precision wavemeter is fitted with interchangeable coils for different ranges, and a Weston thermometer is incorporated for the purpose of indicating resonance.

The Marconiphone Co. have now produced a cheaper model of the "Ideal" L.F. transformer, known as the "Junior Ideal" and priced at 25s. It is said to give a very good amplification curve. Good curves are also shown by the new Pye and B.T.H. transformers.

The tendency in the case of variable condensers has been to produce geared or slow motion models, and almost every firm is showing either an actual geared condenser or a "vernier" dial intended for use on an ordinary condenser.

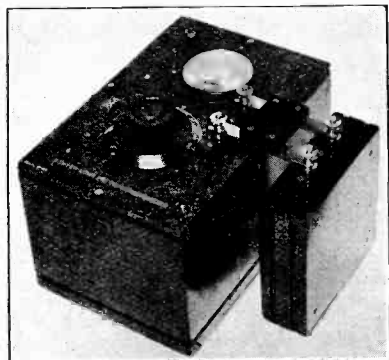

The Bowyer-Lowe wavemeter which is provided with separate coils for various ranges.

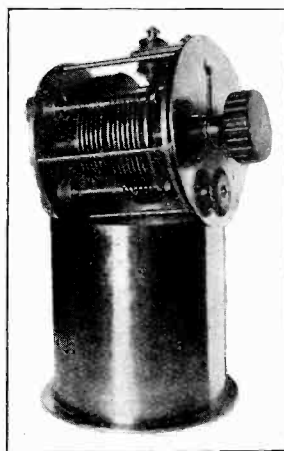

One of the Dubilier standard laboratory variable condensers.

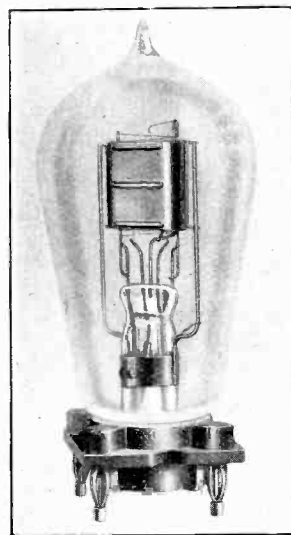

Of interest to all transmitters—the new "Osram" dull-emitter transmitting valve being made by the M.O.V. Company. The price is £5 5s.

Rectifiers for High-Tension Supply.

Part III: Rectification by Gas Conduction.

By R. Mines, B.Sc.

[R355·5

The present instalment deals with Gas-Conduction Rectifiers of atmospheric-pressure type.

I.—The Electrical Nature of a Gas.

OUR atmosphere (or in fact any gas in a chemically inactive state) consists of a crowd of molecules—and according to the Kinetic Theory of Gases these molecules are continually moving about, hitting each other and rebounding, with what is known as “thermal agitation,” to an extent depending on the temperature of the gas. This is the normal condition, there being in general no changes in the chemical or electrical state of the molecules.

The latest theories concerning the structure of the atom (the unit, of different kinds, from which molecules are built) indicate that it consists of a positively-charged “nucleus” (which contains practically the whole mass of the atom) surrounded by a number of electrons (*i.e.*, unit negative charges) revolving around it in various orbits. These “orbital electrons” are thus bound to the nucleus by electrostatic attraction, just as the planets, while revolving in their orbits, are bound to the sun by gravitational attraction. This analogy is strikingly close—for the relation between the size of an electron and the size of its orbit (or in fact the “size” of, or space occupied by, the atom) is of the same order as in the case of the planets in the solar system.

When two atoms in their motions approach each other, their outermost electrons come the nearest to each other, and because of their like charges experience an electrostatic repulsion; and, subject to exceptions to be described, this repulsion is communicated to the atomic systems by the internal forces that make these systems stable. The result is an “elastic collision” (the rebounding mentioned above), similar to that which takes place between two billiard balls. In a like manner a single electron may collide elastically with an atom, rebounding with its original kinetic energy but with an alteration in its direction of travel.

II.—The Gas as an “Insulator.”

It is evident from the above description that in its normal state a gas is composed of neutral molecules, and that unless by some means “carriers” of electricity are brought into existence a permanent gas behaves as an insulator.

Actually, however, this statement is not strictly true (neither is it for liquid or solid “insulators”) for Coulomb in 1785 showed that a charged body gradually lost its charge even when supported by the best solid insulator procurable, due to conduction of the electricity through the surrounding air (later C. T. R. Wilson repeated this result while eliminating any possibility of leakage due to the solid support by means of a guard-ring device. This phenomenon, known as the *dark discharge*, is now attributed to the continuous generation of “ions” or carriers of both signs by ionising radiations from radioactive substances in the earth. But the magnitude of the effect is very small—it is calculated that about six ions are generated in each cubic centimetre of the atmosphere in every second due to this cause; whereas a current of one ampere consists of a flow of electronic charges at the rate of about 16×10^{18} per second.

III.—Origin of Positive Ions.

We have said that an electron may make elastic collision with an atom; this holds true as long as its velocity of approach does not exceed a certain critical value. Above this point, however (which is known as the “resonance potential”* for the gas in question) the stabilising forces of the atomic

* The velocity, or rather the kinetic energy, of a moving electrified particle is most conveniently expressed in terms of the potential difference though it would have to fall to acquire this velocity if starting from rest, *i.e.*, in terms of the amount of *potential energy* that is converted into the kinetic form.

The kinetic energy is equal to $\frac{1}{2}mv^2$, where m is the mass of the particle and v is its linear velocity,

system can no longer stand up to the impact—the moving electron is capable of disarranging the atomic structure, causing one of the electrons in the atom to change its orbit.

A further increase in the velocity of an electron may cause it to disrupt the atom with which it collides, expelling one or more of the orbital electrons from the parent atom. In this condition the atom is said to be "ionised," since it is positively charged (having *lost* some *negative* charge) and will therefore behave as an "ion" or carrier of electricity.

For every gas there is a series of "ionisation potentials"* corresponding to the detachment of one, two, etc., electrons; the first one only need concern us here, since the removal of only one electron from an atom constitutes it an effective carrier.

The sudden change in position of an orbital electron, either from one orbit to another or in complete expulsion, involves a change in its potential energy—this accounts for the absorption of kinetic energy from the impacting electron arriving from outside. After an inelastic collision there is always a tendency for the atom to return to its original condition, by the return of the displaced electron to its original orbit, or by the "recapture" of any free electron that may come within the sphere of influence of the ionised atom—there will always be an electrostatic attraction between the two. Such process is called "recombination."

When such a return of an electron takes place, its newly-acquired potential energy is given out in the form of electromagnetic radiation. The return is frequently accomplished in a number of steps, the electron falling into a succession of possible orbits—thus the radiation occurs in pulses. It is the frequency of this radiation, not its intensity, which is determined by the amount of energy transformed at each step: and this is dependent on the orbits concerned, and therefore on the atom's structure; hence it is characteristic of the kind of matter.

The frequency of the radiation is often

and the potential energy is equal to Ee , where e is the charge on the particle; then if E is the P.D. as defined above, these quantities may be equated, from which we discover that $E = \frac{1}{2e} m v^2$; and e being constants for the same kind of particle.

* The first ionisation potential of air is 17 volts, and of helium 25 volts.

within the limits of visibility, so that regions where ionisation and recombination are taking place may be seen by the light emitted. (By the use of a spectroscope, which analyses the frequencies present in this light, it is possible to determine what kinds of matter are taking part in the process.)

IV.—The Gas as a "Conductor."

Evidently the first effect of establishing a potential difference across a space between two electrodes filled with gas (*i.e.*, applying an electric stress to the gas) will be to cause all positive ions to fall down the potential gradient towards the negative electrode, and also negative ions to "fall" up the gradient, to the positive electrode.

Thus an electron, for example, will accelerate until a collision takes place, either with a gas molecule or with the positive electrode—in the latter case it is merely absorbed, but in the former if the electric stress is sufficiently great it may cause ionisation. In this event there result at least two electrons (in general having now only a small velocity), and a positive ion; and if the electric field where these two electrons find themselves is still high enough the process will be repeated for each of them. The action is thus cumulative, and if the field is of fairly uniform strength over the path between the electrodes (as between two parallel plates or between two spheres of somewhat the same size) an unstable condition results and a *spark* snaps across. We shall presently see that the spark discharge is actually a little more complex in nature than the description so far given would indicate.

On the other hand when the surface of one electrode has a radius of curvature very small compared with the distance between them (for example a fine wire, or a sharp edge or point), a stable form of discharge may be produced. The effect of thus shaping the electrode surface is to cause an excessively strong field in the immediate neighbourhood of this surface, at the expense of that over the remainder of the space. It must be remembered, though, that the effect of the motion of ions in such a field is to even it up. Thus with a moderate-sized wire, say 0.02 in. in diameter, mounted centrally in a tube about 1 in. in bore, sparking will take place more readily than any other form of discharge (excepting of course the "dark" type—provided, however, that the distribution of

potential remains sufficiently uneven, then, although cumulative ionisation may take place in the vicinity of the fine wire or point beyond this region the ions produced can proceed only relatively slowly—the conduction here being of the dark type. The ionised region is usually visible by the emission of light—from this follows the name *Glow Discharge*.

V.—The Brush Discharge.

We have considered so far the effect of accelerating only the electrons. The positive ions, being also charged particles, are accelerated by the same electric field, but the velocity they acquire is several thousand times smaller in proportion in fact to their greater mass. It is proved, however, that they too can produce ionisation when their velocity is high enough—to achieve this result in air at atmospheric pressure requires an electric stress of about 30 kilovolts per cm. They also possess this other useful property—that when they bombard a metal surface with sufficient energy they release electrons from it, though they themselves may become buried in it.

Therefore, if the over all P.D. is further increased with the sharply curved electrode arrangement we find a sudden increase in the current carried by the discharge, and this latter assumes an appearance of bright lines of light radiating from the sharp electrode (generally tending to fix on irregularities of its surface)—the appearance reminds one of brush bristles, and from this resemblance it is named.

VI.—The Corona Rectifier.

It will be obvious that if the sharp electrode is made positive, then positive ions will have their direction of motion away from it; whereas if it is negative they will be able to bombard the electrode surface. Hence, whether or no the critical potential at which positive ions can release electrons from a metal surface is less than that at which they can ionise gas molecules, the fact stands out that with the sharp electrode negative the positive ions have two chances of assisting the ionisation, whereas with it positive they have only the one. In other words current will pass more easily in one direction than in the other, and this asymmetry can be used for rectification.

The usual form of apparatus for this purpose consists of a hollow cylindrical

conductor, with a fine metal wire stretched as accurately as possible along its axis. An alternating P.D. is applied between these two electrodes, and when it is adjusted to a suitable value, it is found that an appreciable current will flow *via* the brush discharge, at the peak of that half wave during which the wire is negative, but not during the other half wave.

The rectification is not “perfect,” but the efficiency obtainable is good considering the nature of the phenomena on which it depends. Davis and Breese,¹ using a tube nearly 2 in. in bore and a wire 0.008 in. in diameter, obtained rectified currents up to 0.12 amp, but the alternating P.D. used was 8 kilovolts. Thus the apparatus is not likely to be of much interest to radio workers other than in connection with the higher-powered transmitting stations.

VII.—The Spark Discharge.

It has been noted earlier that the processes of ionisation by collision are cumulative; and that when the electric stress between two electrodes is fairly uniform over the intervening space, if it is high enough to cause ionisation at all, the discharge grows very suddenly into the spark form. Such uniformity of field exists between parallel plates for example, or between any electrodes for which the radius of curvature is not very small compared with the distance between them.

The condition is also set up in the Corona Rectifier, or with a sharp point and a plate, if the P.D. across the apparatus is raised too far; for as the value increases, the region wherein ionisation is taking place extends over more and more of the available space, and when it reaches the second electrode the discharge changes to a spark or even to an arc.

VIII.—The Air Blast Rectifier.

The establishment of a spark means an increase in the current many hundredfold—there being a plentiful flow of ions of both kinds, travelling, of course, in opposite directions. For it must be remembered that the positive ions are material particles; and it found that a discharge of the heavier kind may be prevented by a strong blast of air, for any positive ions formed have the motion of all surrounding air particles in

¹ *Journ. Amer. I.E.E.*, Vol. 36, p. 153, 1917.

addition to that due to the electrostatic force, and so may be carried away from the path of the discharge and prevented from contributing to the ionisation.

Rectification may be effected by use of this "blowing out" effect in the following way:—

The air-blast or jet is directed so that the direction of motion of the air is *along* the path that would be followed by the discharge. The tendency then is for positive ions to travel with the jet, and as long as this direction coincides with that of the electrostatic force upon them, they are able to ionise by collision in the manner described; the negative ions have to travel against the blast, but since they are mostly electrons this is an easy task, both on account of their higher acceleration under the electric force and on account of their minute size which enables them to pass easily among the relatively cumbersome atoms.

When the relation between the directions of the air blast and of the electric stress is opposite to that described above, no current can pass (other than a slight leak or dark discharge of electrons) because any positive ions formed are blown back on to the positive electrode.

Thus if an alternating P.D. is applied to such a system, a relatively heavy discharge will pass in one direction but not in the other.

IX.—A Practical Form of the Apparatus.

A form of apparatus developed by some American workers consists of a metal rod $\frac{1}{16}$ in. diameter with the end coned, facing a flat plate, the gap being adjusted to about $\frac{3}{8}$ in. The diameter of the plate is made relatively large (*e.g.*, 4 in.) to preclude the possibility of the discharge travelling to its edges; preferably the edges are rounded. The rod electrode is arranged to project concentrically a short distance from a hole about $\frac{3}{16}$ in. diameter in an air chamber; the air jet emerges from this hole as a nozzle, a blower being connected to the chamber which will supply air at pressures up to 10 lbs./in.².

It is found experimentally that the pressure of air supplied to the chamber controls the completeness of the rectification obtained—this is to be expected, since it determines the velocity of the jet and therefore the effectiveness with which positive ions are prevented from travelling from the

plate to the point. In one case a pressure of about 1 lb./in.² was sufficient to produce maximum rectification of the current; excess over this amount, besides being unnecessary, caused irregular operation.

This form of rectifier is at a greater disadvantage even than the corona type in that it is not possible to work it on lower alternating P.D.s than a few kilovolts—since a P.D. of this order of magnitude is necessary to jump the gap before any power is available for output. With a reservoir condenser

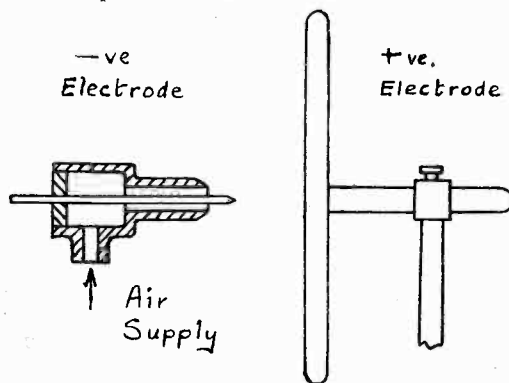

The arrangement of electrodes in the air-blast rectifier.

(capacity about $0.001\mu\text{F}$) connected across the load, $100\mu\text{A}$ of rectified current was obtainable, the D.C. output pressure being 15 kilovolts.

X.—Effect of Gas Pressure.

Experiments have been conducted with the electrodes enclosed in an air-tight vessel; different gases were used, and the blast pressure was raised in some instances as far as 200 lbs./in.². With air a maximum efficiency of rectification (this includes the H.T. transformer) of 75 per cent. was reached at about 160 lbs./in.². Ammonia gave 85 per cent. at 100 lbs./in.²; with this gas continuous operation of the rectifier for 10 hours without attention was attained. It is supposed that under the action of the discharge the gas is chemically decomposed into nitrogen which is inert, and nascent hydrogen which is a powerful reducing agent that effectively prevents burning of the electrode faces.

AUTHOR'S NOTE.—A great deal of space in this article has been taken in attempting to give a clear explanation of the mechanism of gas conduction, because this is an essential introduction to an understanding of the operation of rectifiers that are to be described in future articles.

Apparatus Tested.

[R-009]

Two Dubilier Components.

The "Vanicon" Square Law Condenser. [R3813]

MESSRS. THE DUBILIER CONDENSER CO., LTD., of Ducon Works, Victoria Road, North Acton, London, W.3, are now making a series of "Vanicon" square law variable condensers with verniers. We have recently tested one of these, having a nominal maximum capacity of .0005 μ F.

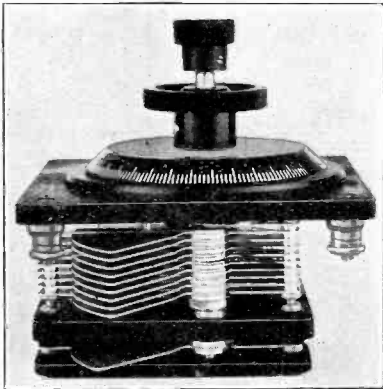

The compact and well-designed "Vanicon" condenser.

The condenser is built up with ebonite end-plates, and the vanes are of aluminium. The spacing between the plates is quite small, with the result that the component is very compact, the depth below the panel being only 2½ in., which, it must be remembered, includes the vernier. The instrument can be used either for panel or table mounting, the latter being facilitated by the use of squared ebonite end-plates.

The moving spindle is of ¼ in. brass, with adequate bearings, and the movement of the plates is very "sweet."

Positive contact to the moving plates is made by means of a phosphor-bronze spiral, so that trouble due to intermittent contact is eliminated. Two large terminals, mounted underneath the upper end-plate, serve for purposes of connection.

On test we found that the minimum capacity was 16 μ F, the vernier added another 30 μ F, and the total capacity was .000567 μ F, being thus slightly over the rated capacity. The power factor, although not actually measured, appeared to be normal to good.

The condenser is evidently of sound design and construction. The prices for nominal capacities of .00025 μ F, .0005 μ F and .001 μ F, are 17s. 6d., £1 2s. 6d., and £1 7s. 6d. respectively.

We understand that another model, embodying several new features, is being designed, and it will probably be reviewed in due course.

The Dubilier-Mansbridge Variometer. [R3827]

Another Dubilier product which we have recently tested is the Dubilier-Mansbridge variometer.

This variometer has been designed with a view of increasing the compactness without sacrificing efficiency. To this end the coils are of the flat "D"-shaped type, two being fixed, and two moving, the latter being rotated by a standard knob and dial.

The makers have certainly succeeded in making the instrument compact, for the depth behind the panel is barely 1½ in., and the overall diameter is only 3¾ in.

The coils are completely enclosed in a moulded case, and three feet are provided for use if it is not desired to mount the variometer behind a panel.

The ends of the fixed and moving sets of coils are brought out to four terminals, and straps are provided so that the coils may be connected in series or parallel. Connection to one end of the moving set is made by a spiral of phosphor-bronze. For the other connection, a spring washer rubbing on a plate is relied upon.

For our tests we connected the coils in series. We found that the inductance varied from 65 μ H at the minimum to 300 μ H at the maximum. Shunted with a .0003 μ F condenser, this would result in a range of about 265 to 565 metres (neglecting the self-capacity of the coils). This range might be expected when used with a full size P.M.G. aerial, without an additional condenser in parallel.

We found the self-capacity over the whole range to be about 5 μ F, which is a good low figure. The resistance at the minimum was 11 ohms, and that at the maximum 19 ohms, in each case at a frequency

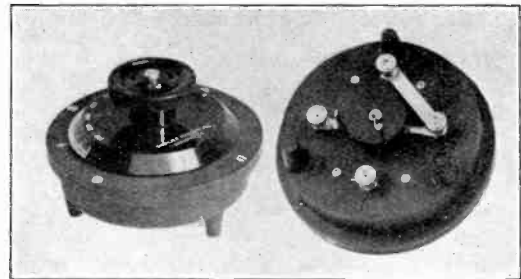

This novel variometer contains coils of the flat "D" shaped type.

corresponding to 400 metres approximately. This is rather higher than that of some of the coils now on the market, though not to any considerable extent.

On calculation, the power factor was found to be .03 and .02 at the minimum and maximum respectively. This again is somewhat greater than many coils, but not seriously so.

Considering the extreme compactness of the component, the electrical efficiency is good.

The component is supplied in a box, complete with drilling template and a leaflet of diagrams, price 12s. 6d.

The Marconiphone Variometer.

[R382'7

The Marconiphone Company, Ltd., of Marconi House, Strand, W.C.2, are selling a rather novel variometer, which covers a wide wave-length range. For this purpose the windings of the variometer are used in parallel for the lower range, and in series for the higher. The change-over from the parallel to the series position is effected without a separate switch, and is quite automatic.

The dial is engraved from 0° to 360° . From 0° to 180° the windings are in parallel, but as the 180° position is reached, an ingenious cam and leaf contact switch (seen in our illustration) comes into action and switches the windings, so that from 180° to 360° they are in series. It is not practicable to obtain an absolutely smooth change-over at the 180° position. There is bound to be some break in the wave-length at this point. The great advantage is the automatic switching.

The two windings are on moulded formers, and very close coupling is obtained, which gives a good wave-length range, although the power factor is likely to be increased to some extent.

The variometer was tested in our laboratory, and following is a résumé of the results obtained. The inductance ranged from about $75\mu\text{H}$ (microhenries) to $2430\mu\text{H}$, so that with a full-size P.M.G. aerial a wave-length range from less than 300 metres to just over 1600 metres is obtained, and thus both the lower broadcast band and the high-power station's wave-lengths are covered.

The H.F. resistance varied from 10 to 30 ohms, and the self-capacity from 25 to $30\mu\text{F}$. The power factor as obtained from these results ranged from .011 to .024.

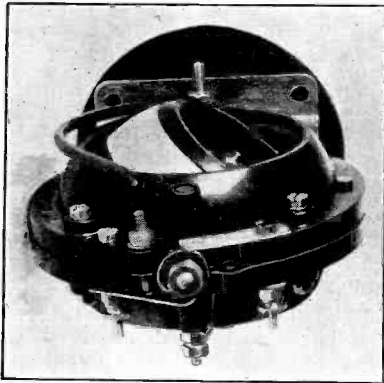

By means of a cam switch, the coils of the Marconiphone variometer are switched in series and parallel.

Needless to say, the component is particularly good from the point of view of mechanical strength and finish, the movement of the rotor being very smooth, and the electrical connections between the two coils being quite sound. Connections to the instrument itself are made to two small terminals.

For those who use variometer tuning and wish to cover a wide wave-length range without trouble, this variometer should prove particularly serviceable. The price is 16s.

A Standardised Buzzer Wavemeter.

[R384'1

Messrs. Burndept Wireless, Limited, of Aldine House, Bedford Street, Strand, W.C.2, have just produced a wavemeter known as the Burndept Ethophone Wavemeter. It is of the well-known buzzer type, with two ranges—200 to 500 metres and 800 to 2000 metres. Two coils are provided,

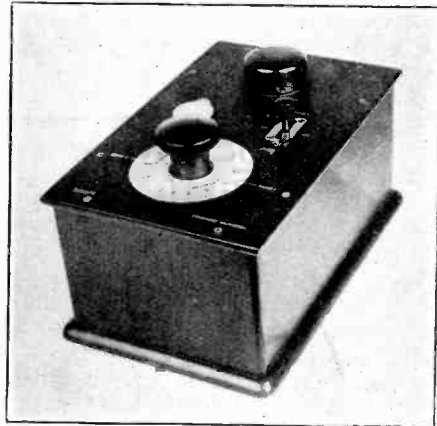

The two-range buzzer wavemeter described herewith.

wound on ebonite tubes and waxed, and tuning is performed with a Burndept standard precision condenser of .0005 μF capacity. A switch which places the condenser across either coil at will is provided, thus giving the two ranges. An "Off" position is also available.

The buzzer, which is of a well designed and substantial pattern, is operated by a small 1.5 volt dry cell, which is easily replaceable. The instrument is mounted on an ebonite panel, which is fitted to a polished mahogany cabinet, the overall measurement being approximately $10\frac{1}{2}$ ins. by 6 $\frac{1}{2}$ ins. by 6 $\frac{1}{2}$ ins.

The problem which had to be faced by the makers in producing these instruments was to combine accuracy with low cost. Individual calibration had thus to be abandoned; instead, the scales of the condensers are all similarly engraved to read directly in metres. To make this possible, all component parts have to be manufactured and adjusted by precision methods.

On test, against one of our standard wavemeters, the sample submitted to us showed up well. At the lower end of the scale we found the error to be about 3.5 per cent. in the case of the lower range and about 5 per cent. for the higher range. Further up the scale, the accuracy was within 2 per cent.

The price of the wavemeter is £6 6s., and considering the good finish and accuracy, it is to be recommended to those who are requiring an instrument of this type.

Long-Distance Work.

By Hugh N. Ryan (5BV).

[R545·009·2

UNTIL last year, the "active" and "inactive" periods for DX work were clearly defined, and recurred annually. The work was ruled almost entirely by weather conditions, and so the division was simply that in winter DX work was done and in summer it was not.

Nowadays, however, summer no longer disrupts long-distance contact, and we have just reached the end of our first year's continuous work. It is therefore of interest to notice whether there is still a slack period, and if so, when.

I think there is no doubt that, as far as this country is concerned, work falls off somewhat about September. It is not easy to say whether this is due to purely wireless conditions, or whether it is just because the average amateur takes his holiday at this time. Perhaps the reason is a psychological one, in that the amateur forsakes wireless to get the best out of the departing summer, and will return as soon as it has departed; whatever the cause, all reports this month indicate a falling off in quantity of work, although contact with all countries is easily being maintained.

The only difference in conditions which I have myself been able to notice is that the Americans (north and south) report bad QRN more often than usual, and slightly more is sometimes noticeable here.

I do not think that any new country has been worked during the month, but communication with South American countries and the MacMillan ships has been more frequent than hitherto.

In response to my last month's request for further observations on 45-metre fading phenomena, many stations have reported exactly similar results to those I mentioned, and an extremely interesting addition comes from 5NJ (Belfast). He finds that powerful London stations can hardly be read in Belfast at 6 a.m. and remain extremely weak until 7.15 or later. He can hardly hear any English stations between midnight and sunrise. Reinartz, operating WNP, tells me that American signals fade out about 2 a.m. (G.M.T.) for two hours, while British signals are still OK. WNP's own signals become somewhat weaker soon after this time.

Mexican 1B says that my own signals become much weaker to him just after sunrise in England, coming back to their usual strength as soon as the sun is well up.

The more powerful London stations are working quite regularly. 2KF works New Zealand most mornings, often on phone. 5LF works nearly every morning from 5 to 6.30 (G.M.T.), and has worked Mexican 1B and a number of A's and Z's during the month.

6LJ is in fairly regular operation, mostly working Americans, and has also worked 24AR. 6TM has worked 22CM, and a number of New Zealanders, including one (4AS) who had not worked Great Britain before. 5BV's broken mast has been replaced, and a number of new stations worked, including WNP and Mexican 1B, as well as New Zealand.

6RM has conducted some interesting work with NKF, the American Navy's experimental station, in addition to working with other more distant countries. 6QB has reduced his power to 1.8 watts, and has been working chiefly with home stations. He has heard, among other New Zealand stations, one (22AQ) who has not, I think, been heard here before. 6YK has been working on very low power, and has been reported as R6 in Stuttgart, with $\frac{3}{4}$ watt input, on 96 metres. 6VP is now using his full 10 watts, and has been received strongly in most parts of Europe on 90 metres.

Mr. N. Guy, of Pinner, a keen receiver and prospective transmitter, has carried out some extremely fine reception on a very simple receiver. He has received 40-metre New Zealand signals in the evening, a feat shared, I believe, only with d7EC, and he has heard 23JU, a station not hitherto reported here.

2CC has a new 45-metre set working now. He has worked all American districts except 6 and 7, as well as NKF and both the MacMillan ships, WNP and WAP. 5KO has worked a number of American stations from his new station at Newcastle, but he is not using the power of his old Bristol days.

I understand that 2OA is working more on paper than "on the air" at present, but

2TF is keeping the Scottish end up, working with U.S.A. on 23 metres.

6TD is still the leading station in Wales, though 6US is shortly returning to the work. 6TD works U.S.A. regularly, and at the time of writing has, I think, just got through to New Zealand. 6US is to be expected back as soon as he has succeeded in drilling the requisite number of glass panels without breaking them.

Two stations are now working in Northern Ireland, both in Co. Antrim. 5NJ has worked with u1PL, this being the first Irish-American contact. 5NJ was using under 20 watts, and QRN was very bad in America at the time. The first communication between Ireland and Norway was accomplished by 6MU, who has worked LA1A with 4 watts.

The Cambridge Society's scheme, which I have mentioned before, should be in working order soon after this appears. They hope to establish a listening centre, which will listen to and report upon tests from any station who desires it. The listening will be done by competent amateurs who are thoroughly *au fait* with our work, although not themselves transmitters.

Many conflicting reports have reached this country concerning the amateur position in the Irish State Free. It appears that no amateur transmitting permits have yet been granted. There are many competent, but isolated, experimenters there who feel that they would be in a better position if they could get together. I hope that readers in Saorstát Eireann, who are interested in the question, will unite, as we should all like to have transmitters in every part of the British Isles.

The most interesting item of foreign news is the work of our nearest Continental

neighbours with the Antipodes. The leading French station in this work is 8WAG, who has been working Australia and New Zealand for some time. He recently worked 22AE when the latter was only using 28 watts input. This is probably a record for low-power trans-world work.

Belgian 4YZ has worked with 22AC, using 65 watts input. This is the first B-Z contact. 7EC is the only Danish station working. He still works Porto Rico 4SA to schedule, and has also worked Brazil 1AB. A station signing y7XX has been working for some time in Jugo-Slavia, and has worked a number of British stations.

I have received from Major Raven-Hart, the pioneer Chilean amateur (ch9TC), an interesting account of amateur activities in Chile. 9TC was until recently the only station working there, but several more have started recently. ch2LD has worked U.S.A. and New Zealand with 5 watts, and ch1EG has worked China and Britain on 50 watts. (These powers are American "tube" ratings, and not actual input powers, which are probably about four or five times as much.) 9TC himself works mostly on 275-metre phone, but tests with Argentine MA1 from 21.15 to 21.45 (G.M.T.) on about 85 metres on Tuesdays and Fridays. He has been heard in this country, and would welcome further reports.

Next month, when there are more stations working and American QRN has lessened, there will probably be more to report. Perhaps we shall soon work the American West Coast and the inland parts of Canada, which work is certainly overdue.

Please let me have next month's reports by the 10th.

Round the World by British Wireless.

By Major Wm. Coates Borrett (C1DD).

[R545:009:2

THIS old Empire of ours, on which the sun never sets, can now claim to be the Empire on which amateur DX wireless never ceases.

For years it has been the hope of the Canadian amateurs that some day they would be able to relay messages and make tests completely round the world by British amateur wireless. And, having that idea in

view, the Division Managers of the five Canadian Divisions of the American Radio Relay League, when they met in conference in the city of Winnipeg during the month of December, 1924, made plans to hold Trans-Canadian tests every Wednesday night, in order to get all Canadian stations linked up, so that eventually the Maritime Division could get in touch direct with Great Britain

and the Vancouver Division with the New Zealanders, who, in turn, could establish contact with the home country *via* Australia and India—thus making an "all red" route round the world to handle British messages.

We already knew that the English stations were making world's records every morning by working direct with our brother "hams" in New Zealand, but our idea was to organise the whole Empire into a series of small jumps, which should be more reliable.

To start the thing going we set aside the wave-length of 125 metres for Trans-Canada and inter-Empire amateur communication. We have had Trans-Canada tests every Wednesday night on this wave, with the great majority of stations in every district taking part; and now it is a simple matter to pass messages back and forth from East to West. These Wednesday night tests take place at nine-thirty Pacific coast time, which is five-thirty A.M. Thursday, G.M.T. It is a splendid time for British stations to do some good DX work and link up with our western stations direct. Although we all send in the vicinity of 125 metres, we listen from 100 to 135 metres in case any other British stations happen to be on at the time.

While the Division Managers were speeding home by train (Winnipeg is four days' run by train from the writer's home at Dartmouth, Halifax, Nova Scotia), the rest of the boys were "digging in" for all they were worth; and to my great joy I found that on 4th December Mr. Joseph Fassett (1AR, of Dartmouth, Nova Scotia) had been in direct touch with NZ4AA, and had won the honour of being the first Canadian to work New Zealand direct—in spite of the fact that he is the greatest possible distance in North America from New Zealand.

This was just the thing to spur the rest to greater efforts to get QSO New Zealand to further our scheme, especially as 1AR was on the east coast. On 10th December Mr. Arthur Crowell of 1DQ, again of Dartmouth, N.S., also reported having been in touch with NZ4AA. Next the west coast got in, and station 5BA, of Vancouver, operated by H. T. Libby, got in touch with NZ4AG and 2AC on 11th December. The east coast again linked up when the writer (1DD) worked NZ4AG for over an hour on 15th December. It is also believed that 5GO of Vancouver has since worked NZ.

It may interest British readers to know that 5GO is operated by Mr. Chang, a Chinese

boy in Vancouver, who is one of the leading amateurs in Western Canada. It is understood that he is in Canada for the special purpose of studying wireless and soon is to return to his native country to take an important part in wireless development there.

In addition to this super-DX of over nine thousand miles from our east coast and over six thousand miles from our west coast, we have been keeping in touch with the Mother Country, so that our scheme is working itself out very well. The only drawback has been the fact that most of the English stations, after calling "ARRL," listen in that terrible band of QRM 75-80 metres, and in most cases we have been forced to QSY down from 125 to get them to answer us. However, this is doubtless through not knowing where we are calling and also on account of the New Zealand and Australian stations working around 85-90 metres.

One step farther was made in the world-wide relay by British radio on the night of 7th January when G2NM, working on about 100 metres, took part in our regular weekly relay, and test messages were handled from London, Eng., to Halifax, through the Maritime Division and in relays right across Canada to Vancouver, B.C.

Another relay, which took short cuts, but was really along the lines of our scheme, took place on 16th December or thereabouts, and, as usual, that gentleman who is always doing things ahead of schedule—Mr. Joseph Fassett of 1AR—had the honour of showing the rest of us how it should be done. He took a message from NZ4AG and passed it to G5MO, who, in turn, passed it to G2NM, to whom the original message was addressed. G5MO got the surprise of his life when 1AR handed him the message, and if only it had come from Australia in the first place, our entire object would have been accomplished: communication round one side of the earth.

On behalf of the Canadian amateurs the writer invites all British stations to take part in these relay tests, and would suggest that the English stations undertake the organisation of the eastern route from England to Australia *via* as many British countries as possible; and some day we will be able to start a message from London and pass it right around the world and back to London within twenty-four hours.

The Canadians are ready: QTC?

“Wipe Out.”

[R147]

Some notes on a popular fallacy with regard to the effect of induced local oscillations on incoming signals.

THIS article is written in the hope that it will help to clear up some of the misconceptions which at present seem to be prevalent on the question of “wipe out.” For those who are interested and require further mathematical or experimental proof of what is contained in this article (and considerably more besides), I would refer them to a paper by Dr. E. V. Appleton in the *Proceedings of the Cambridge Philosophical Society* (Vol. 21, p. 231), “Automatic Synchronisation of Triode Oscillators.”

The general view of some writers would appear to be that if a weak C.W. signal is being received in a wireless receiver, and if a strong local heterodyne be used, then the induced local oscillations will “wipe out” the incoming signal. This is entirely at variance both with practice and theory, as shown in the above-mentioned paper. Of course, if the local oscillations are strong enough to sweep over the complete range of the receiver’s first valve characteristic there would, to put it loosely, be no further room for the incoming signal; but this is a special case which we need not consider here.

That “wipe out” exists is undoubted; it has been observed by many, but what actually takes place is not so widely known. Suppose two triode oscillators, A and B, are coupled together and that a detector circuit be placed near by. Let the frequency of A be made to approach that of B and gradually varied through the resonant point of B, and let A be the stronger oscillator. Let the frequency of A be n_a , and that of B be n_b . As n_a approaches n_b a very high note will be heard in the detector telephones. This note gradually becomes lower as n_a gets nearer n_b , until finally the note suddenly disappears altogether. When n_a has passed n_b the note again appears, low in tone, and rising as n_a departs from n_b . This is the well-known heterodyne reception.

The “silent space” (when n_a is very close to n_b) is not due simply to the note in the telephones being below the audible limit, but is due to the fact that the *stronger oscillator draws the weaker oscillator into step with itself*. This becomes readily apparent if the two oscillators are strong and are fairly tightly coupled, for the beat note

in the telephones disappears noticeably before the audible limit is reached. This phenomenon is termed “automatic synchronisation,” or, more loosely, “wipe out.”

Now the crux of the matter is that this effect is not directly due to any property of the two oscillatory circuits, but is due to the fact that the triodes associated with these oscillatory circuits cause them to have varying decrements. Thus, if in an oscillatory circuit there are two oscillations present, “wipe out” can only occur due to the interaction of the sources of these two oscillations.

Let us apply this to the case of signals received from a distant transmitter. In the receiver there are two oscillations present, one due to the distant transmitter and another due to the local heterodyne. Let the local oscillations be of large amplitude compared to the distant—as is usually the case in heterodyne reception. Then, at first sight, it would appear that there would be “wipe out,” but this is not the case. Remember that it is the interaction of the sources of oscillation that produce “wipe out.” Thus it is the interaction between the local oscillator and the source of the signal—*i.e.*, the transmitter—that we must consider.

Now, the transmitter is obviously much more powerful than the local oscillator, and will have much more effect—*via* the receiver—on the local oscillator than will the local oscillator on it—also *via* the receiver. Hence the signal can draw the induced local oscillations into step with itself, but the reverse process is out of the question.

As a matter of fact, the measurement of the region over which synchronisation, or “wipe out,” takes place is a direct measurement of signal strength, since the width of the silent space is directly proportional to the signal strength and inversely proportional to the strength of the local oscillations. In this case, experiment coincides with theory to within 15 per cent.

Thus, there need be no fear when receiving very weak signals that a relatively strong local oscillator will “wipe out” the incoming signals, and the local oscillator can be kept relatively strong, optimum heterodyne reception being ensured.

For the Esperantists.

Distordado.

[R800

Pritraktante la demandon pri rezistanca (aŭ ŝoka) kupleco, kontraŭ transformatora intervalva kupleco, ni penas eksplodigi popularan—kaj seriozan—sofismon.

PARTO III.

AVERTO DE FABRIKISTO.

EN la du antaŭaj partoj ni pritraktis la elekton kaj utiligon de valvoj. Nia nuna tasko estas trakti pri intervalva kupleco.

Sed antaŭ ol tion fari, estas necese dediĉi ankoraŭ pli da spaco pri la valva demando, pro letero kiun ni ricevis de la *General Electric Company*. Esence, la letero estis averto de la fabrikisto de la valvoj (kiu supozeble *devus* ja scii), ke la agado de ni rekomendita, kiu ofte postulas la uzon de altatensia voltkvanto supernorma, povus efiki malbone la valvan vivon.

Ni treege bedaŭras sciigi pri tio, sed ni tute ne ŝanĝas nian opinion. Nia celo estas montri, *kiel eviti distordon*, kaj ni montris, ke estas necese uzi altpotencan valvon por la lasta ŝtupo. Se la valvo-fabrikistoj avertas nin, ke ne estas eble funkciigi iliajn valvojn ĝis la plena kvanto de ties filamenta emisio, pro tio, ke la bezonata altatensia voltkvanto damaĝos ilin, la sola kuraco estas uzi eĉ pligrandajn valvojn; ekzemple, L.S.5 anstataŭ 625, 625 anstataŭ 606, k.t.p.

Efektive, tamen,—ni ĝojas diri—ni *ne* trovis, ke la anodaj voltkvantoj sugestitaj de ni, almenaŭ por transformatora kuplo, naskos ian malbonon.

LA INTERVALVA KUPLECO.

Oni ordinare parolas pri tri ĉefaj specoj de malaltfrekvenca intervalva kuplo: transformatora, ŝoka, kaj rezistanca. Tamen, rilate al distordado, estas efektive nur du: tiuj sen krada kondensatoro, kaj tiuj kun.

Treege bedaŭrinde, ĉar ni deziras esprimi nian honestan opinion tiurilate, ni devas defaligi idolon, kiun oni nunmomente adoras tra la lando.

Estas nuntempa modo supozi, ke rezistanca kuplo estas ja la plej uzinda, pro tio

ke, malgraŭ la perdo de forteco, oni tute certe ne ricevos distordadon. *Laŭ nia opinio, tio estas absoluta sofismo.*

Certe la plimulto de transformatore-kuplitaĵoj tute ne estas perfekta; sed kaj teorie kaj praktike estas kaŭzoj kial la rezistance aŭ ŝoke-kuplita aparato estas eĉ plimalbona, krom se ĝi estas treege lerte desegnita.

La necesega diferenco estas, kiel ni jam sugestetis, la ĉesto de la krada kondensatoro. Kiam ajn la krado ricevas pozitivan ŝarĝon, estas elektrona kurento, kiun ni povas konsideri kiel ordinaran kurenton de krado al filamento. Ĉi tiu kurento povas kompletigi sian cirkviton nur pere de la krada rezistanco; tial, post haltigo de la dumtempa impulso (kiu envenis pere de la krada kondensatoro), la afero staras kiel ĉe Fig. 1, kun kurento fluanta tra la rezistanco, kaj negativa ŝarĝo ĉe la krado.

Tio daŭras ĝis ekvilibro estas laŭgrade restarigita per fluo de la kurento tra la rezistanco. Dumtempe, la kontrolo de la valvo estas renversita; eble la krado estas tiom negativa, ke ĝi ne funkcias ĉe rekta parto de sia karakterizo, kaj distordo okazas.

Distordo ja okazos, se oni permesos, ke la krado fariĝu pozitiva en amplifikatoro sen krada kondensatoro, sed ĝi ne estas tiel severa. Memoru, ke ĉi tia distordo estas ĝuste sama esence kiel la rektifa ago de valvo. Ĝuste kiel la krada rezistanco kaj kondensatoro instigas al efika detektado, tiel ĝi produktas distorditan amplifadon, escepte se oni treege zorgas.

DEFINITIVAJ BEZONOJ.

Ekzemple, antaŭnelonge ni eksperimentis je amplifado laŭ pligranda skalo, ol ordinare. Ni uzis 300 voltajn anodajn kaj 30 voltajn kradaĵojn ĉe L.S.5¹ a valvo. La kvalito estis tutbona, kvankam iomete distordita

ĉe akra orelo; la miliampermetro estis meze, kvankam ne tute, trankvila. Konforme al ies sugesto, oni anstataŭigis la lastan transformatoron per rezistanca kuplo, altigante la altan tension ĝis 400 voltoj, je kiu ĝi emisiis ĉirkaŭ 25 miliamperojn.

Je ĉiu laŭta tono, la miliampermetro resvingiĝis al 15 miliamperoj, kaj (kiel oni atendis) la kvalito estis aĉa. Ĉar ni posedis nur baterion 450-voltan, ni ne povis kontroli praktike la teorion indikon ke—40 voltoj kradaj kaj 600 altatensiaj estas bezonataj.

Resume, ŝajnas ke, dum por transformatora kuplo krada potencialo de nur duono de la meza modulo sufiĉas por tre bonaj rezultoj, kun ŝoka aŭ rezistanca kuplo, oni devas aranĝi por la maksimuma modulo ĉe laŭta tono, kun konforma altigo de alta tensio. Plue, oni devas zorgi pri la valoroj de la kradaj kondensatoro kaj rezistanco kaj anoda rezistanco, kiuj ofte estas malĝustaj en aparatoj kaj kupliloj vendataj nuntempe.

Konsiderante unue la anodan rezistancon, ni devas kompromisi inter malmulta efikeco, se ĝi estas tro malgranda, kaj troa alta tensio, se tro granda. Ŝajnas ke valoro de duoblo de la anoda impedanco de la valvo estas justa kompromiso, sed oni devus klare scii, kio ja estas la anoda impedanco. Kelkaj el la pli popularaj Britaj valvoj havas valorojn proksimume jenajn:—

	Omoj.
"R" kaj aliaj valvoj por ĝenerala uzado (helaj aŭ malhelaj)	20 000
Malaltfrekvencaj (malhelaj kaj duonhelaj)	15 000
Altfrekvencaj (malhelaj kaj duonhelaj)	25 000
625 kaj similaj altpotencaj valvoj	5-10 000
625b kaj similaj "alt- μ " altpotencaj valvoj	20 000
625a kaj similaj "malalt- μ " altpotencaj valvoj	20 000

Rilate al ŝok-kuplita aparato, estas grave ke la impedanco de la ŝoko, eĉ por la plej malaltaj aŭdfrekvencoj, estu granda, kompare kun tiu de la valvo. Oni bezonas proksimume 100 henriojn; tio estas, induktanco kiel tiu de la sekundario de bona intervalva transformatoro. La mem-kapacito devus esti malalta.

La kondensatoro devus esti granda; sed ĉar, kiam la krado neatendite pozitivigas, la rezultanta distordo pligrandiĝas laŭ la grandeco de la kondensatoro, estas kutime, ke ĝi ne estu tre granda. Tamen, ĝi certe ne estu malpligranda ol $.05\mu\text{F}$, kaj se la krada rezistanco estas malalta, kiel priskribota en la proksima paragrafo, estus plibone.

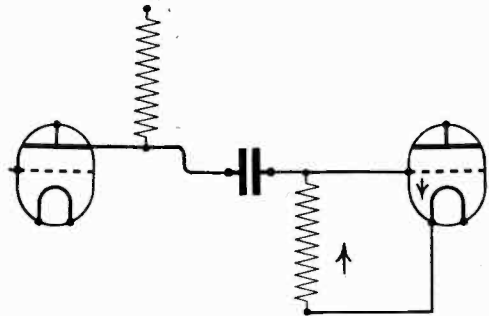

Fig. 1.

Kiel ĉi-supre sugestite, la kutima kradrezistanco estas treege tro granda. Altvalora kradrezistanco treege pligrandigos la eblecon de distordo. Same, tro malalta rezistanco kaŭzas perdon de fortco. Ĉi tiu gazeto jam pritraktis la problemon laŭ teknika vidpunkto. Sufiĉas diri, ke la plej bona valoro estas ĉirkaŭ 250 000 omoj.

RESUMO.

Per ĉi tiaj antaŭzorgoj—malgranda anoda rezistanco kaj krada rezistanco; grandaj kondensatoro, altatensio, kaj krada potencialo—oni povas ricevi superbonan kvaliton per rezistanca amplifikatoro. Kiel ĝi komparas kun transformatora kupleco? La sola avantaĝo estas, ke la rezistanca amplifikatoro funkcios de 50 cikloj supren; dum, ĉe la plej bonaj transformatoroj, la transformatora amplifikatoro kredeble ne funkcios ĝis 200 cikloj. Sed nun venas alia punkto. Ĉu nuntempa stacio de la Brita Brodkasta Kompanio sendas tiujn ĉi malaltajn frekvencojn (50 ĝis 200 cikloj) je preskaŭ plena fortco? Se jes, ĉu la nuntempa laŭt-parolilo reproduktos ilin? La aŭtoro opinias mem, ke oni devas respondi "ne" al ambaŭ demandoj, kaj ke tial la rezistanca aŭ ŝoka amplifikatoro ne havas veran avantaĝon nunmomente por kompensi sian malefikecon.



Letters of interest to experimenters are always welcome. In publishing such communications the Editors do not necessarily endorse any technical or general statements which they may contain.

Proposed Institute of Radio Engineers.

The Editor, E.W. & W.E.

SIR,—Allow me to concur with your remarks in "Editorial Views," in the September issue. Wireless has become a large family and must have a house of its own. It must cease to be a lodger under the roof of the I.E.E. if real progress is to be made. The I.E.E. are to be congratulated on fostering wireless in its infancy, but I feel that to label a wireless engineer as a "chartered electrical engineer" will falsify the status of electrical engineering and bring blushes to the cheeks of the purely wireless man.

That the new Institute should consist of qualified wireless engineers is a highly important feature. A fundamental education up to matriculation standard, backed by a good knowledge of higher mathematics such as algebra, analytical geometry, differential and integral calculus and differential equations, with a thorough drilling in electricity and magnetism—high-frequency A.C. work being most important—and wireless telegraphy and telephony should meet the case. Acoustics and other sciences kindred to wireless should also be considered, and practical experience must, of course, play an important part.

We must not, however, overlook the fact that most wireless men are self-taught and many men holding high positions in the wireless world commenced as amateurs.

H. GAMBRELL.

36, Manor Road,
Rugby.

American Science—A Reply.

The Editor, E.W. & W.E.

SIR,—On page 521 of your issue of May last appears a letter by Mr. D. V. Onslow, under the heading "Power Factor Measurements." Mr. Onslow states amongst other things that "the British spend £50 on research apparatus and £1 000 on thinking, and get results, while Americans spend £1 000 on apparatus and £50 on thinking, and get lost."

From the tone of Mr. Onslow's letter I am inclined to think that he knows very little about American research; has he heard of the U.S. Bureau of Standards? And does he know that the results obtained in this national laboratory are embodied in publications which are sold to anyone

by the U.S. Stationery Office at the bare cost of printing?

Speaking about methods of making measurements, has Mr. Onslow ever heard of the American society for testing materials, or seen the results of their researches, which are published annually?

Again, does Mr. Onslow know that the results of all U.S. Government research departments, including those in agriculture, engineering, meteorology, and many other branches of science, are available to the public; and that the various scientific societies always have their material available for use by the engineers of the world?

It is to be hoped for the sake of the Electrical Research Association, of which presumably Mr. Onslow is a member, that this gentleman obtains more facts before writing his reports than he did before writing the letter now under reply.

As an engineer trained in England and America, I am glad to know that leading engineers of England, as evidenced by their own statements, do not hold the same opinion as your correspondent, but give credit ungrudgingly to our American cousins for the very fine work which they produce.

Is it too much to ask that Mr. Onslow spends one shilling in gathering facts before he spends a penny stamp in disparaging the work of his brother engineers?

C. R. RUSSELL, M.Sc., M.I.R.E., A.M.I.E.E.
162, Heaton Street,
Christchurch,
New Zealand.

The "R.I." Transformer Curve.

The Editor, E.W. & W.E.

SIR,—On principle I rather take exception to the "R.I." advertisement on page iii. in EXPERIMENTAL WIRELESS, September issue.

Surely the transformer that amplifies all frequencies equally is the perfect transformer? There have been lengthy articles on this very subject in E.W. & W.E. from time to time.

Again, it has come as a shock to me to learn that the reason why "the 'R.I.' curve is right" is because the "transformer amplifies overtones more than the fundamental." Surely it is best to amplify all frequencies equally! Unless there was some new factor discovered by "R.I.," one would be inclined to think the "R.I." curve was far from right; and, in any case, the lower curves shown at least get down to about 1 000 p.p.s., and even at a loss of amplification would be the more pure.

Whilst I am anxious and willing to purchase and am proud of British wireless goods that are good, I consider this advertisement not only misleading, but unfair to transformers that do more nearly approach perfection.

Portseton.

E. A. ANSON (20A).

Station News.

The Editor, E.W. & W.E.

SIR,—Will readers please note that my address is now changed from 10, Lake Road, Lytham, to "Highcroft," Park Lane, Burnley, Lancs. All QSL cards and reports of any kind are answered and are very welcome.

In addition, some of your readers may desire to send a card or a report to the following French stations—STOK, 8ROR or 8ZEB.

If they do, they may send them *via* the above address. There is no necessity to enclose a stamp. The three stations referred to always reply to QSL cards and to reports of any kind.

Burnley.

J. C. HARRISON (5XY).

The Editor, E.W. & W.E.

SIR,—The P.M.G. has allocated to me the call sign 6CI in place of my old one, 2APG, which was issued with my licence for an artificial aerial. I would be very pleased to receive any reports on my transmissions which at present are on 90 metres.

19, Melville Road,
Coventry.

BRIAN W. WARREN.

The Editor, E.W. & W.E.

SIR,—I shall be glad if you will publish my call sign and address in your next issue.

They are 6KA and 58, Ulverston Road, Upper Walthamstow, E.

KEITH HARDIE.

The Editor, E.W. & W.E.

SIR,—I should be grateful if you would publish the following:—

My call sign is 2UD; wave-lengths 150-200 metres and 440 metres; power 10 watts; C.W. and telephony.

I shall be using an underground aerial, and will welcome very much all reports, which will be answered.

"Kenwell,"

Boxley Road,
Chatham, Kent.

A. ACLAND (2UD).

The Editor, E.W. & W.E.

SIR,—I should be very glad if G2NU and G5ZHC would communicate with me at the address below, as I have cards for them from NoPM.

R. A. WEBBER (G2BDQ).

8, Theresa Avenue,
Bishopston, Bristol.

The Editor, E.W. & W.E.

SIR,—Will you insert in your journal a notice to the effect that I transmit almost daily on 23 metres (C.W.) and should be glad of reports. All cards answered.

PERCY BRIAN, M.Sc. (G6GW).
79, Lakey Lane,
Hall Green, Birmingham.

The Editor, E.W. & W.E.

SIR,—The call sign 2VS, formerly the property of a transmitter in the Norwood district, has now been allocated to me. Telephony and C.W. transmissions will be carried out on wave-lengths of 23 and 150-200 metres.

Detailed reports will be greatly appreciated, and all QSL cards acknowledged.

JOHN D. R. HAMMETT.
88, Fairlop Road,
Leytonstone, E.II.

The "Red Seal" Loud Speaker.

[R376·3

WE have recently tested the above loud-speaker, which is manufactured by Sexton Barnes, Ltd., of 61, Borough Road, London, S.E.1. It is known as the "Red Seal" model No. 10. In size it is intermediate between the "baby" and the full-sized instrument, and is designed for use in an average-sized room.

As will be gathered from our illustration, it is very graceful in design, the finish being crystallised black, the terminals, etc., being nickelled.

Before we tested the instrument it appeared to us that the sound conduit was on the small side and that the makers had apparently sacrificed efficiency to the graceful appearance of the instrument. On test, however, we found that our expectations were entirely unfounded. The strength of signals was only slightly (*i.e.*, about 10 per cent.) below our standard, which, considering the size of the instrument under test, is particularly good. We found that it was not easily overloaded and would deal with at least twice the power which would be required an average-sized room.

The tone was all that could be desired providing the instrument was not overloaded.

The price of this efficient little instrument is 45s.

The "Red Seal" loud-speaker described herewith is graceful in appearance, and gave surprisingly good results on test.



[R050

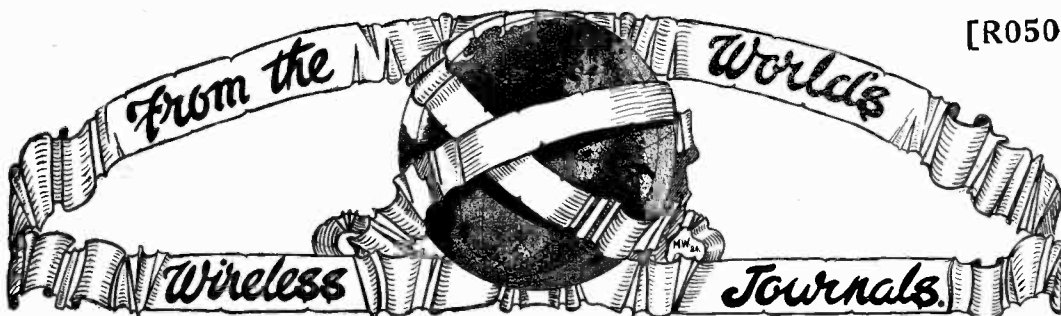

R300.—APPARATUS AND EQUIPMENT.

R344.—UN POSTE D'EMISSION DE 200 KW POUR ESSAIS DE TRIODES.—Dr. Balth. van der Pol and K. Posthumus (*Onde Elec.*, Aug., 1925).

A description of an experimental plant for work with water-cooled oscillator valves up to 200 kilowatts. The type of valve used has a cylindrical anode of chrome-iron alloy which also constitutes the envelope round which water may flow for cooling purposes. The upper part of the valve is of glass which is sealed to the metal part. Filament and grid leads to external connections are sealed through the glass portion. The cathode consists of two parallel hairpin-shaped filaments taking a heating current of 80 amperes at 17-18 volts. The valve has an internal resistance of 3 000 ohms, a μ of 40 and operates on anode voltages of 8 000 to 12 000. The high-tension supply is derived from 3-phase A.C. fully rectified by six water-cooled diodes of similar construction to the oscillator. The oscillator circuit supplies H.F. energy to an artificial aerial consisting of a loose-coupled inductance, a condenser and a resistance. The latter has to be capable of dissipating some 150 kW as heat and is composed of a number of carbon bars in a rack. Carbon has the advantage of showing comparatively little skin-effect and obviates the necessity for corrections on this account when calculations are made on the electrical energy dissipated in heating it up. A large part of the paper is given up to theoretical analysis of the conditions for efficiency in a valve generator. As is generally known, a triode excited about the mid-point of a substantially straight characteristic cannot have an efficiency exceeding 50 per cent. as a D.C.-to-H.F. converter. Greater efficiencies are obtained by biasing the grid negatively, so that normally no anode current would flow, and by giving the grid a series of positive pulses each lasting a small fraction of a cycle. As analogy to this method of excitation the case of a pendulum is considered where the pendulum is kept swinging by correctly-timed pulses of short duration. The relation of efficiency and power output to the phase angle θ during each cycle over which the excitation persists is worked out. As θ varies from 0 to 2π the theoretical efficiency varies from 100 per cent. to 50 per cent. while the input power varies from 0 to 50 per cent. An efficiency of 100 per cent. cannot be attained in practice but with the apparatus described efficiencies up to 87.5 per cent. have been obtained. It is interesting to note that the grid biasing was effected by a grid condenser and leak, the latter consisting of carbon lamps to the value of 1 800 ohms. The grid current is stated to be 1.5 amps, giving a negative

bias of 2 700 volts. The expenditure of 4 kilowatts in grid-current seems high even for so large an installation, but these are the figures clearly stated in the paper.

R100.—GENERAL PRINCIPLES AND THEORY.

R131.—ÜBER ELEKTRONENBAHNEN IN TRIODEN.—Balth. van der Pol, jr. (*Zeitschr. f. Hochfrequenztechnik*, Vol. 25, No. 5).

An article dealing with the electronic paths in triodes. In the first part of the paper the distribution of potential and charge are compared in the cases of a heated and unheated diode with plane electrodes. It is shown that at a certain potential-difference between cathode and anode the field at the anode remains the same as at the cold cathode if the heated cathode is removed further from the anode by about a third of the original distance. Next the electrostatic field in a cylindrical triode is examined more closely. The amplification factor μ is defined as the ratio of the filament-grid and filament-anode capacities. It is shown further that the total current $i_a + i_g$ which the incandescent filament loses is entirely a function of $V_a + \mu V_g$, where V_a and V_g are the potentials of anode and grid, there being two exceptions, however. The first occurs at very small values of space-current when the grid lies within the cloud of electrons surrounding the filament, this space-charge distorting the electrostatic field. The second marked distortion of the field occurs in a certain region where V_a is less than V_g ; the explanation offered is that a secondary space-charge of primary electrons is formed in the vicinity of the cathode by electrons which have passed twice through the meshes of the grid. Characteristic surfaces for i_a and i_g and a complete set of V_g, i_a , curves are discussed with the aid of stereoscopic models. Irregularities of the characteristics become apparent when the triode sends out the very short waves first noticed by Barkhausen and which are attributable to the double space-charge. The phenomenon of secondary emission, which plays an important role in three-electrode valves, is then studied. The ratio of the number of secondary electrons per primary electron is found by suitable interpretation of the characteristics with the aid of the law which holds for the case when no secondary electrons occur. Special oxide-coated anodes were constructed which released 20 and more secondary electrons per primary electron. Lastly, the total heating up of the electrodes was investigated and it was found that the electrode with the higher potential was less heated and that with the lower potential more heated than would follow from the product of current and voltage for the electrode considered.



(The following notes are based on information supplied by Mr. Eric Potter, Patent Agent, Lonsdale Chambers, 27, Chancery Lane, W.C.2.)

[R008

A CRYSTAL-VALVE CIRCUIT.

(Application date, 14th March, 1924. No. 232,390.)

A very useful combination of a crystal and valve is described in British Patent No. 232,390 by A. W. Sharman. The object of the invention, it is stated, is to obtain the maximum sensitivity from a crystal detector. The inventor states that

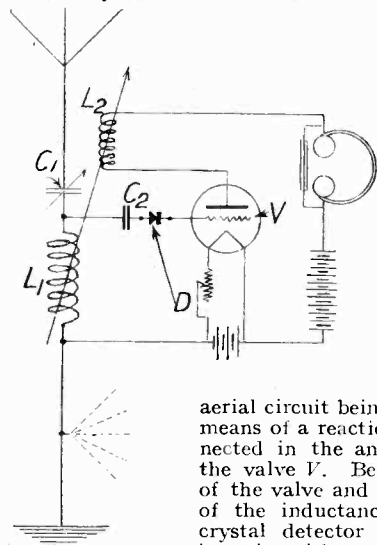

the efficiency of a crystal detector is considerably lowered by the current passing through it. Accordingly the scheme shown in the accompanying illustration is adopted.

An ordinary tuned aerial circuit $L_1 C_1$ is shown, reaction on the

aerial circuit being obtained by means of a reaction coil L_2 connected in the anode circuit of the valve V . Between the grid of the valve and the upper end of the inductance there is a crystal detector D , connected in series with a small condenser

C_2 . It is stated that the capacity of this condenser should be very small, and that the insulation should be exceedingly high, thus preventing any steady direct current from flowing through it. The inventor states that the detector functions by virtue of variation of electrostatic potential, which is conveyed to the grid of the valve and amplified. This is, of course, the case of "pure potential rectification" described by Colebrook in his recent series in E.W. & W.E., and shown by him to be quite effective.

A THERMO-ELECTRIC BATTERY.

(Application date, 26th February, 1924. No. 233,810.)

A rather interesting invention is described in the above British Patent by Fullers United Electric Works, Limited, and A. P. Welch. The thermo-electric junction has been known for many years,

and hitherto its applications have been in connection with the measurement of minute voltages or temperatures. Recently the "thermo-former" has been placed on the market with the idea of providing a direct current supply of low voltage suitable for operating valve filaments, the initial supply of energy being obtained from the domestic lighting supply.

The above invention relates to one such device, and a particular form of construction is represented diagrammatically in the accompanying illustration. It is well known that if certain dissimilar metals be placed in intimate contact and the point of contact heated, a certain potential difference will be developed. Thus, if two strips of dissimilar metals, such as iron and constantin, be welded together, and the junction heated, a voltage of the order of 0.02 volt will be produced.

A combination of metals of this description is made use of in the particular example illustrated, and it will be seen that a number of junctions consisting of strips of iron F joined to strips of constantin C are joined at X . A number of such pairs are radially disposed around an asbestos disc D . A number of these discs are arranged as shown in the lower half of the illustration, each disc of elements being separated by another disc K of asbestos or similar material.

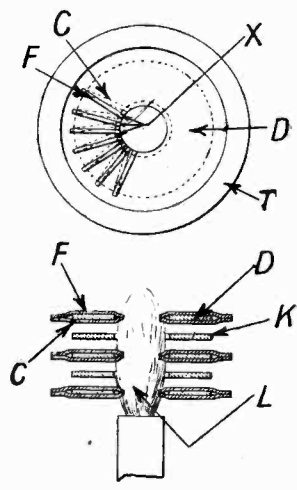

Thus it will be seen that if a flame L passes through the centre of the discs all the junctions will be heated, and the voltages produced at each junction will be added together, since the junctions are arranged in series. One hundred junctions would give a voltage of about 2 volts, and by using strips about an inch wide it is possible to obtain a current as great as 1 ampere. It is essential however that a temperature difference should exist between the opposite ends of the strips, and for this reason the outer ends of the thermo-junctions are arranged in a tube T through which

water may be circulated, in order to cool the strips.

We should imagine that the device would be extremely useful where only gas is available.

OSCILLATING CRYSTALS.

(Application dates, 9th April, 1924, and 24th July, 1924. No. 236,648.)

The above British Patent, No. 236,648, granted to H. J. Round and N. M. Rust, contains some very interesting details. The invention relates to a method of obtaining negative resistance effects

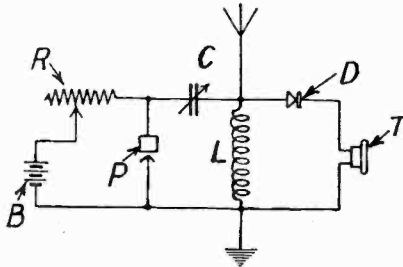

with a crystal combination as well as actual oscillations. The specification includes very comprehensive instructions, giving actual values of the components, which will be quoted later, but no suggestion is given to account for the manner in which the scheme functions.

Referring to the accompanying illustration, it will be seen that the aerial is tuned by an inductance *L*. An ordinary crystal detector *D* and telephones *T* are provided, which are connected across the inductance in the usual manner. The negative resistance device consists of another crystal detector *P*, which is connected through a variable condenser *C* across the aerial inductance, a variable resistance *R* and a battery *B* being shunted across the detector *P*. The ordinary aerial and detector circuit are quite normal, the variable condenser *C* being of the order of about 0.0008 μ F, though under working conditions the value of this condenser may be between 0.0001 μ F and 0.00025 μ F. The resistance *R* can be varied between 1 000 and 12 000 ohms, and the 50-volt battery *B* is tapped every 1½ volts, the negative pole being connected to the contact point.

It is stated that the best results are obtained with the highest value of the resistance and about 50 volts from the battery, higher voltages tending to burn the point. The best results so far as the crystal is concerned were obtained with "arsenite," which is the trade name for a crystal which is practically a pure zinc oxide. Other crystals, such as silicon, zincite, tellurium, magnetite and iron pyrites may be employed. The negative resistance effects can be increased if a spot is fused on the arsenite crystal by connecting the positive pole of a 100-volt supply main and forming an arc between it with a pointed carbon electrode. Instead of the crystal detector *P*, a combination consisting of a catwhisker and an oxidised film can be used. The film can be produced by forming an arc with the plate as one electrode. Thus a zinc plate can be coated with white zinc oxide. It has been found, however, that by subjecting a coated zinc plate to a subsequent treatment with

the arc a reddish-brown oxide is formed, and at the point marking the junction of the two oxides it is possible to obtain oscillations on wave-lengths as short as 600 metres, whereas with an ordinary coated plate it is only possible to obtain oscillations with the longer wave-lengths. With an ordinary crystal, however, it is possible to get the device to function on broadcast wave-lengths, and the scheme as outlined should be of particular interest to experimenters.

THE MAGNESIUM "GETTER."

(Convention date, France, 22nd March, 1924. No. 231,194.)

A method of evacuating a valve or similar discharge tube is claimed in the above British Patent by the Compagnie Générale de Telegraphie Sans Fil, and relates to the use of magnesium. The patent deals essentially with methods of igniting magnesium. When the valve is assembled a small piece of magnesium is included in the vicinity of the plate, and the valve is then exhausted.

The magnesium is ignited by passing a current through the grid sufficiently intense to heat it to the required temperature, and in another modification the magnesium is attached to the plate and ignited by the heat radiated from the grid to the plate.

The advantage of the method, of course, lies in the fact that no high voltage has to be used between the filament and the plate.

SHORT WAVE TRANSMISSION.

(Convention date, U.S.A., 22nd January, 1924. No. 228,159.)

A rather interesting short wave transmission circuit is described in the above British Patent by the Westinghouse Electric and Manufacturing Company, and R. L. Davis. The circuit shown, it will be noticed, is an ordinary choke control or constant current modulator system, connected to two oscillators. It is stated that the object of the

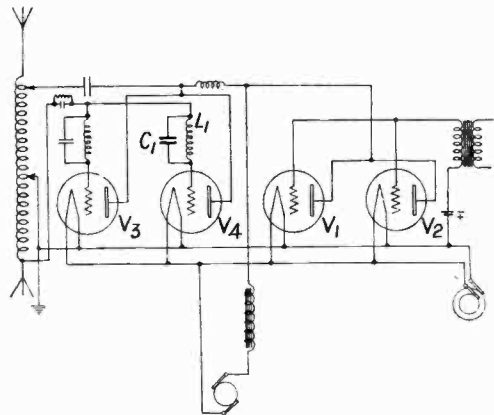

invention is to overcome some of the troubles which are associated with the centre tap type of coupling, in which, it is stated, it is usually found necessary to employ a large number of turns in the grid circuit in order to produce oscillations, resulting

in very high grid voltages being produced, and general instability of the system. Referring to the illustration it will be seen that the valves V_1 and V_2 are ordinary modulators, while the valves V_3 and V_4 are the two oscillators connected across an inductance L , a centre tap filament connection being employed.

Instead of taking the grid lead direct to the grid, each grid is connected through a trap consisting of an inductance L_1 and a condenser C_1 . It is stated that the introduction of a filter in this position is found to increase the stability of the system, avoids parasitic oscillations, and, in addition, enables a very much lower grid voltage to be employed.

No explanation is given to account for the manner in which the scheme operates, but we should imagine that it is somewhat comparable with the use of a tuned circuit in place of the usual high frequency choke which is employed in the anode circuit of a shunt feed supply to an oscillator system.

DIRECT CURRENT SUPPLY.

(Application date, 21st May, 1924. No. 236,702.)

Another system for utilising the domestic supply for broadcast receivers is described in British Patent No. 236,702 by P. B. Frost. The scheme utilises direct current mains, and the voltage for the filaments is obtained from resistive chokes L_1 and L_2 . The filament current is further reduced

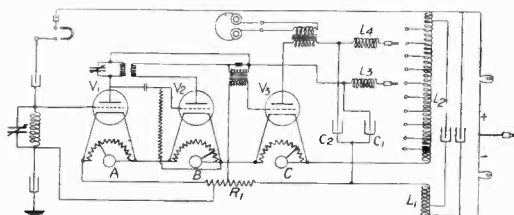

by a resistance R_1 , which is also utilised for obtaining grid bias for the valve V_3 . The filaments are run in series, and are controlled by variable resistances A , B and C . The choke L_2 from which the high tension supply is obtained is tapped. Further smoothing for this purpose is obtained by means of chokes L_3 and L_4 and condensers C_1 and C_2 .

The specification is very detailed, and describes the particular arrangements of the chokes and resistances as shown in the diagram. There is nothing particularly novel about the whole idea, and the invention really lies in the actual combination and arrangement of the device shown, the particular values of which, together with the method of arrangement, are described in great detail.

FILAMENT LEAD SUPPORTS.

Convention date, U.S.A., 15th December, 1923. No. 226,196.)

The British Thomson-Houston Company, Ltd., and R. B. Prindle describe in the above British Patent a method of supporting the filament leads

in a high power valve. Referring to the accompanying illustration, which shows one of the supporting devices, it will be seen that two filament

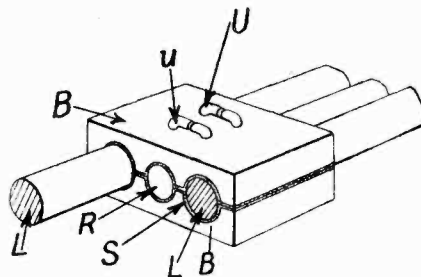

leads are held between clamps consisting of two rectangular portions provided with grooves.

The two filament leads L are clamped between the two blocks B provided with longitudinal grooves. The blocks may be of metal and an insulating sheathing S is included to prevent the two leads from becoming short-circuited.

It will be noticed that there is a third rod. This rod R is for the purpose of supporting the filament leads. The two blocks are held together by means of "U"-shaped staples U . The rod R is provided with two transverse grooves or slots, through which the "U"-shaped pins can pass. It will be obvious that these transverse slots prevent the rod from rotating, and the pins maintain the clamp secure in position.

ELECTRODE SUPPORTS.

(Application date, 3rd May, 1924. No. 236,692.)

A method of supporting the electrodes in high power transmitting valves is described in the above British Patent by The Mullard Radio Valve Company, Limited, C. F. M. Hayes and L. Grinstead.

Referring to the accompanying illustration it will be seen that the electrodes are supported by means of a metal band B , which is placed around a re-entrant tube T . The two edges of the band are bent up as shown at X , and are welded together at G . It will be noticed that the band is a very easy fit over the re-entrant tube, and is held in position by means of wedges W , which are pushed between the collar and the tube, and are then spot-welded to secure them in position.

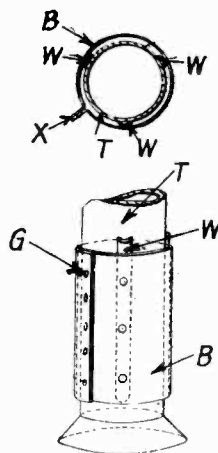

In another modification of the invention, the wedge may actually constitute the legs supporting the electrodes. This arrangement is shown in the lower half of the illustration.

“E.W. & W.E.” Calibration Department.

Valve Wavemeters.—Between 60 and 20 000 metres.

Fees.—For a single range, 2s. For each additional range, *i.e.*, swing of condenser over its full scale, add 1s.

Valve wavemeters must be accompanied by the actual valve to be used.

Information required.—Filament, anode, and grid volts to be used; minimum and maximum wave-lengths expected on each range.

Buzzer Wavemeters.—Between 100 and 6 000 metres.

Fees.—For the first range, 1s., each additional range, 6d. (For “range,” see above under valve wavemeters.)

Information required.—Voltage required for buzzer if battery not enclosed in meter; minimum and maximum wave-lengths expected on each range.

Fixed Condensers, not more than .002 μ F, 9d., tested at R.F. Larger, tested at audio-frequency, 1s.

Variable Condensers, 1s. plus 3d. for each position tested.

Inductors, Fixed, Air Core (we do not test iron-core coils). Coils between 50 and 50 000 μ H tested for inductance and self-capacity, 2s. 6d.

Inductors, Variable.—Each tapping or position on a variometer will be tested as a separate coil.

Fees.—As above.

Condensers and Inductors can be tested for H.F. Resistance. For further particulars see pages 276 and 277 of our February issue.

Resistance, D.C., measured to the following

accuracy; below 1 ohm, 1 per cent.; 1 to 10 000 ohms 0.1 per cent.; above 10 000 ohms, 1 per cent.

Fee.—9d.

Resistance, H.F.—Resistors of 1 to 30 ohms, approximately non-reactive, can be tested at any one desired radio-frequency between 2 000 and 15kC (150 to 20 000 metres).

Fee.—2s. 6d.

Voltmeters, D.C., of maximum reading 2 to 250 volts. If the scale is blank, only light pencil graduations will be put on.

Fee.—6d. plus 3d. for each reading.

Information required.—Approximate maximum voltage.

Ammeters, D.C., of maximum reading 10 microamps to 5 amps. Conditions as for voltmeters.

Voltmeters, H.F., Moullin type, complete with plate ammeter, can be tested at any one radio-frequency between 2 000 and 20kC. Limits of voltage, .1 to 10 volts.

Fee.—1s. plus 3d. per reading.

Information required.—Exact steady voltage to be applied to anode and grid, reading on plate ammeter with no applied H.F. voltage, whether voltmeter is of grid-leak type or not.

Milliammeters, H.F., complete, or thermo-junctions. Limits of current 1 to 500 milliamps.

Fees.—As for H.F. voltmeters.

Information required.—Approximate maximum current. In case of separate thermo-junctions, D.C. resistance of indicating instrument to be used with them.

**EXPERIMENTAL
WIRELESS**
& The WIRELESS ENGINEER.

COUPON

for

OCT., 1925.

Calibration Department.

139-140, Fleet Street, London, E.C.4.

Sender's Name

Address

Apparatus sent

Date

DETAILS OF TESTS.

For fuller particulars of the tests and information we require, attention is drawn to pages 276 and 277 of the February issue of E.W. & W.E.

In spite of our previous requests, apparatus continues to come in insecurely packed. The packing case should be *screwed*, not nailed, since this enables the same case to be used when returning the instrument.

All remittances should be large enough to cover the cost of returning apparatus by registered post.