

One Shilling net.

# EXPERIMENTAL WIRELESS

A JOURNAL OF RADIO RESEARCH & PROGRESS

Vol. I. No. 1.

October, 1923.

1s. net.

## Principal Contents.

### EXPERIMENTAL TOPICS.

THE MAINTENANCE OF HIGH FREQUENCY OSCILLATIONS

*By E. W. B. Gill, M.A., B.Sc.*

THE FADING OF SIGNALS

*By O. F. Brown, M.A., B.Sc.*

NEON LAMPS AND THEIR USE FOR WIRELESS PURPOSES

*By E. H. Robinson.*

ANTENNA CONSTANTS

*By H. Andrewes, B.Sc., A.C.G.I., D.I.C.*

EFFICIENT TRANSMISSION

*By F. L. Hogg.*

THE DESIGN AND OPERATION OF TUNED ANODE RECEIVERS

*By Capt. St. Clair-Finlay, B.Sc.E. (Laus).*

AN ARMSTRONG SUPER-HETERODYNE RECEIVER.

*By E. J. Simmonds.*

CRYSTALS AND CRYSTAL TESTING

*By A. V. Ballhatchet, M.J.I.E.*

AN ULTRA-SELECTIVE CIRCUIT  
THE TREND OF INVENTION.

DISTORTIONLESS AMPLIFICATION.  
RECENT WIRELESS PUBLICATIONS.

THE SEVENTH  
"Model Engineer"  
EXHIBITION

Will be held at the

ROYAL HORTICULTURAL HALL,  
Vincent Square - - - London, S.W.1,

from

JANUARY 4th to 11th, 1924  
(Both days inclusive).

WIRELESS SECTION.

A strong wireless section has always been a special feature of this popular exhibition. The wireless trade exhibitors meet an enthusiastic buying public, and the wireless visitors find much to interest them in the other exhibits of tools, workshop equipment, and scientific apparatus.

---

*There are only a few spaces now vacant. An illustrated prospectus giving full details and floor plan will be sent post free to any trade firm on request.*

Organisers :—

Percival Marshall & Co., 66, Farringdon Street, London, E.C.4.

---

"THE MODEL ENGINEER" EXHIBITION IS THE EVENT  
OF THE YEAR—DO NOT MISS IT.

## “NEW LAMPS FOR OLD.”

Long, long ago in the Eastern fable this cry was raised in the narrow streets; to-day, to a wider public, we raise as its modern equivalent the cry of “New Valves for Old.”

To none of us it may befall to share the fabled joys of Aladdin, but through the medium of wireless we may all, in fact, share the joys of listening-in; when, daily and with most generous hand the treasured stores of fact and fable, art and science, music and literature are poured out for our delight. This, of course, is within the knowledge of all, but what is not so generally known and what is of immediate interest to *you* is that you may have your worn-out valves repaired and made in all respects equal to new at a cost of 7/6 each.

By our Revalco process we undertake to repair wireless valves, and we guarantee them when repaired to withstand a high plate voltage, to be of hard vacuum, to detect and amplify; and in tone, clarity and volume to afford you the fullest satisfaction.

### WHY THROW AWAY YOUR WORN-OUT VALVES?

Having executed repairs for thousands of delighted clients, and having received from technical experts most eulogistic reports on repaired valves which have been submitted to them for test purposes, we now confidently solicit your patronage.

**EQUAL TO NEW—7/6 EACH—EQUAL TO NEW.**

APPLY TO AGENT IN YOUR DISTRICT OR TO US DIRECT.

**REVALCO LIMITED,**  
**15, GRAPE STREET**

(Behind Princes Theatre),

**SHAFTESBURY AVENUE, LONDON, W.C.2.**

TEL. : Regent 2704.

# HULLO!! C.Q., WILL DAY CALLING you to inspect a new selection of Wireless Accessories!

A NEW ROTARY CONVERTER for charging your own Accumulators from any main supply of Electricity, for use on either D.C. or A.C. A thoroughly reliable and greatly simplified Instrument ... £5 12s. 6d. each.  
**CHARGING BOARD** for above, fitted with Amperemeter and Rheostat ... £1 2s. 6d. each.  
**VARIABLE GRID LEAK.** New Rotary Pattern, always constant and thoroughly reliable, 0-5 Megs...5/6 each.  
**HEADPHONES**—Brown's Featherweight, 4,000 ohms ... .. 25/- pair.  
 Ericsson's British make do. ... .. 26/6 "  
 Western Electric ... .. 25/- "  
 Ericsson's Continental, stamped B.B.C.... .. 18/6 "  
 Special cheap line of 4,000-ohm Headphones ... .. 15/- "  
**SHEET EBONITE.** Grade A. Cut to any size ... .. 5/- lb.

*Write for our new  
Catalogue. Now  
ready, sent post  
free. Postage and  
Carriage on all  
goods extra.*

When you are tired of wasting both time and money on so-called Wireless Crystals, secure one of the New Super Marvel Crystals **DAYZITE (REQD.)** and put an end to all your troubles. Sold only boxed with Silver Cat's Whisker, 2/6 each, postage 3d. extra.

**WILL DAY, LTD.,** 19, LISLE STREET,  
LEICESTER SQUARE, LONDON, W.C.2.

Phone: Regent 4577.

Telegrams: "Titles, Westrand, London."

## RADCOM H.T. BATTERIES.

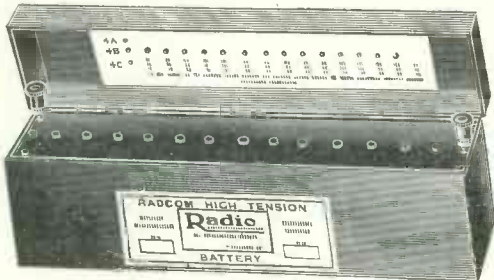

By our new Patented system of connecting these batteries, they have an advantage over all other types of High Tension Dry Batteries, which enables tapings to be made at every 1½ volts, thus giving a variation rendering the finest possible adjustments.  
 Approximate voltage, 18. ... Price (complete with plugs), 4/-;  
 Ditto, '36—Price, 8/- Ditto, 63—Price, 13/6 Ditto 126—Price 27/-

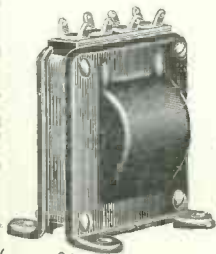

**RADCOM SHROUDED  
INTERVAL TRANSFORMER.**  
Eliminating howling & distortion

Price 21/-  
**Radio**  
COMPONENTS. LTD

19, Rathbone Place,  
LONDON, W.1.

Telephone: Museum 3485.  
Telegrams: Radponents Westcent, London.

## Advertisements in "EXPERIMENTAL WIRELESS."

□ □ □  
NOTICE.

The regular tariff for advertising in these pages will not be fixed till the circulation has been fully developed. A limited number of advertisements are now accepted on a provisional basis, particulars of which will be furnished to any advertiser who is interested, on application to the Advertisement Manager.

# EXPERIMENTAL WIRELESS.

A Journal of Radio Research and Progress.

General Editor: PERCIVAL MARSHALL, C.I.Mech.E.

Technical Editor: PAUL D. TYERS.

VOL. I. NO. I.

OCTOBER 1st, 1923.

MONTHLY.

## CONTENTS OF THIS ISSUE :

|  | PAGE |
|--|------|
| EXPERIMENTAL TOPICS .. .. .                              | 1    |
| THE MAINTENANCE OF HIGH-FREQUENCY OSCILLATIONS .. .. .   | 5    |
| By E. W. B. Gill, M.A., B.Sc., Fellow of Merton College. |      |
| THE FADING OF SIGNALS .. .. .                            | 9    |
| By O. F. Brown, M.A., B.Sc.                              |      |
| NEON LAMPS AND THEIR USE FOR WIRELESS PURPOSES .. .. .   | 12   |
| By E. H. Robinson.                                       |      |
| ANTENNA CONSTANTS .. .. .                                | 20   |
| By A. H. Andrewes, B.Sc., A.C.G.I., D.I.C.               |      |
| SOME NOTES ON DISTORTIONLESS AMPLIFICATION .. .. .       | 23   |
| EFFICIENT TRANSMISSION .. .. .                           | 27   |
| By F. L. Hogg.   |      |
| THE DESIGN AND OPERATION OF TUNED ANODE RECEIVERS.. .. . | 33   |
| By Capt. St. Clair-Finlay, B.Sc.E. (Laus.)               |      |
| AN ARMSTRONG SUPER-HETERODYNE RECEIVER .. .. .           | 43   |
| By E. J. Simmonds.                                       |      |
| CRYSTALS AND CRYSTAL TESTING .. .. .                     | 46   |
| By A. V. Ballhatchet, M.J.I.E.                           |      |
| AN ULTRA-SELECTIVE CIRCUIT .. .. .                       | 51   |
| By "2 SH."   |      |
| THE TREND OF INVENTION .. .. .                           | 53   |
| RECENT WIRELESS PUBLICATIONS .. .. .                     | 55   |

THE EDITOR will be pleased to consider for publication articles of interest to readers of this journal, more especially those relating to original experimental work, novel applications of existing apparatus, and also details of quantitative investigations. Although every care will be taken of authors' manuscripts and illustrations, the Editor cannot accept responsibility for their safe custody. Contributions should be addressed to: The Editor, EXPERIMENTAL WIRELESS, 66, Farringdon Street, London, E.C.4.

## Subscription Rates.

"Experimental Wireless" is published on the first of each month.

Single copies 1/- net; post free 1s. 3d. Annual subscription 15/-, post free anywhere.



EDITORIAL, PUBLISHING, AND ADVERTISEMENT OFFICES:

PERCIVAL MARSHALL & Co., 66, Farringdon Street, LONDON, E.C.4.

Telephone - - - - - CENTRAL 9071.

# THE "EXPERIMENTAL WIRELESS" LABORATORY.

A Unique FREE Service.

As announced in the early pages of this issue, we are placing the facilities offered by our laboratory and experimental station in the hands of our readers. In order that experimenters may be better able to conduct their investigations, we have formulated a system whereby we enable the reader to be the possessor of accurately calibrated instruments and electrical standards. To this end we have arranged to calibrate without charge any instrument, or determine various constants of any material or piece of apparatus. We set forth below the conditions upon which the determinations are made.

### CONDITIONS OF SERVICE.

Each instrument or piece of apparatus must be accompanied by a Calibration Form cut from the current issue of EXPERIMENTAL WIRELESS, duly filled in as indicated. To each instrument must be attached a label bearing the sender's name and address. The instruments or apparatus, which must be adequately packed, should be addressed to the Editor, EXPERIMENTAL WIRELESS, 66, Farringdon Street, London, E.C.4, and marked "Calibration." Delicate instruments should be forwarded in wooden boxes, with screw-down lids. A remittance to cover the return postage must be enclosed. All instruments will be dealt with in strict rotation. Although every precaution will be taken to ensure their safety, the safe transit of the apparatus cannot be guaranteed, but full responsibility will be taken during the period between acknowledgment of receipt and advice of despatch.

Amongst others, the following calibrations will be undertaken :—

|   |  |   |
|---|--|---|
| <i>The Measurement of :—</i><br>Resistance.<br>Inductance.<br>Capacity. | <i>The Determination of :—</i><br>Insulation Resistance.<br>Transformer Constants.<br>Valve Constants. | <i>The Calibration of :—</i><br>Variable Capacities.<br>D.C. or A.C. Voltmeters, Ammeters<br>(to sensitivities of micro-volts and<br>micro-amps), Wavemeters. |
|---|--|---|

-----  
*To be sent, with apparatus, to The Editor, "Experimental Wireless," 66, Farringdon Street, E.C.4.*  
 -----

### CALIBRATION FORM.

[October, 1923.]

*Instrument* .....

*Maker* .....

*Calibration Required* .....

|                   |  |  |
|-------------------|--|--|
| Leave this Blank. |  |  |
|                   |  |  |

*Return Postage Enclosed* .....

*Name* .....

*Address* .....

*Date of Despatch* .....

# Experimental Wireless

A JOURNAL OF RADIO RESEARCH AND PROGRESS

---

VOL. I, No. 1.

OCTOBER, 1923.

1s. NET.

---

## Experimental Topics.

### About Ourselves.

WE make no apology for adding one more to the list of wireless publications already in the field. The development of wireless achievement during the past two or three years has been so rapid and so extensive that it has become increasingly difficult for any one paper to cater adequately for each and every section of the varied interests concerned. In wireless, as in other spheres of technical interest, the need for specialised papers is bound to arise. We enter the field in no competitive spirit in regard to our contemporaries, and, as will be seen in a subsequent Editorial note, we gladly acknowledge the good work they have done. But we believe that there is now not only room, but a distinct need, for a specialist paper dealing exclusively with the interests of the serious experimenter. This is the gap which we aim to fill with EXPERIMENTAL WIRELESS. A glance through the pages of this number will indicate the general lines on which we propose to work, and in subsequent issues our programme will be more fully developed as space permits. It will be observed that we confine our contents strictly to subjects of experimental interest. The exclusion of more general matters, such as broadcasting news, elementary theory, the construction of simple home-made sets, and society reports, enable us to give the experimenter an unusual number of articles of direct interest and service to him, and this will be the main justification for our existence.

We ask our readers to reserve a final judgment on the fulfilment of our programme till they have seen our further development during the next few months.

### An Independent Policy.

An essential feature of any journal which takes for its platform the advancement of experimental science is that it should preserve a complete independence. Independence does not mean antagonism, it means freedom to help every legitimate project for the advancement of the science of wireless. By being the official organ of no society we can help all; by owing no allegiance to any trade interests we can contribute freely to the advancement of the whole industry. Incidentally we may, perhaps, emphasise the importance of the experimenter to the industry. No branch of scientific research to-day is so full of possibilities as is wireless, and the future of the industry is largely wrapped up in the improvements and new discoveries which will result from experimental work during the next decade. It is of the utmost importance to the trade that not only should they carry out research work themselves, but that they should encourage and follow the work of the skilled amateur.

### The Field for Experimental Work.

In spite of the enormous strides which have been made in recent years, wireless is, to use a hackneyed phrase, "still in its infancy." Wireless telegraphy and tele-

phony are naturally the best known and most widely used examples of the radio-transmission of energy, but the future holds many developments in its keeping. Wireless control of mechanism at a distance is a branch of the science in which steady progress is being made. The wireless transmission of pictures will be followed by the transmission of scenes from life, and the wireless distribution of light and power are dreams of the engineer which are well within the bounds of possibility. The field for experiment is boundless, and though the experimenter of to-day may, in general, be content to limit his research to improvements in the transmission of speech, his horizon will steadily grow broader and broader as the years go on. The outlook and the scope of EXPERIMENTAL WIRELESS will expand in like degree.

#### A Word to Societies.

We have already remarked on the absence of reports of the doings of wireless societies from our pages. We exclude them in no feeling of unfriendliness; we are staunch believers in the good work societies are doing, and we wish them all an increasing measure of usefulness and strength. But their doings already receive such a generous share of space in the columns of our contemporaries that we feel they have no real need of a like hospitality from us. While, however, we do not feel called upon to report the ordinary comings and goings of society life, it is more than possible that here and there papers will be read, or demonstrations will be given, of great interest to the experimenter. Such matter when forthcoming will, we need hardly say, always receive a warm Editorial welcome from us.

#### Experimental Work Abroad.

Arrangements have been made whereby our readers will be kept in touch with experimental practice in all parts of the world, since we have a number of foreign representatives who will forward from time to time a summary of the march of progress in their own specific areas. Month by month we shall publish a bibliography of the more important articles which have appeared in British and foreign publications. The "Trend of Invention" will summarise the progress of wireless at home, particularly in relation to the work of the experimenter, and we

shall duly record the advent of any inventions of importance which may be made abroad. By observing the directions in which patentees are working, our readers may find valuable hints for the guidance of their own efforts.

#### Mathematics and Wireless.

The introduction of mathematics into an article relating to wireless subjects seems to have the effect of frightening many experimenters whose mathematical qualifications are not very high. It is unnecessary to point out that little advance can be made in many directions without the aid of mathematics, but in order that the non-mathematical reader may not be unduly alarmed, we propose, as far as possible, to place all mathematical proofs and determinations in an appendix to each article where such proofs are required. There are, however, certain articles—such, for example, as "The Maintenance of High-Frequency Oscillations," by Mr. E. W. B. Gill, appearing on page 5 of this issue—which will not lend themselves to this treatment. Mr. Gill has much to say that is of direct interest to the experimenter, apart from the calculations he gives, and we hope, therefore, that the non-mathematical reader will give his important contribution the careful attention its subject warrants.

#### How Readers Can Help.

The large section of the wireless public engaged in experimental and research work includes people of a very widely varying degree of experience and technical attainment. For this reason it is impossible to make the contents of EXPERIMENTAL WIRELESS of equal interest to every reader, but we have endeavoured to provide in our first issue a sufficiently varied range of matter to please the majority. We shall, however, appreciate the friendly co-operation of our readers in making our journal as useful as possible to the serious experimenter, and shall be grateful for any criticisms or suggestions which will help in this direction. The first issue of any paper is never completely representative of its intended scope. We have several additional features of interest we propose to incorporate as time progresses, but meanwhile we shall be glad to receive and to consider very carefully any comments



our readers may be good enough to send us. We hope also that readers will avail themselves of our columns for the discussion of subjects and the contribution of information of immediate interest to all experimenters. A most interesting feature, for example, both to the transmitter and the receiver, will be the publication of lists of calls which have been logged. There is little use, however, in considering those of which the distance of transmission is less than about 60 miles, and in order that the lists may be of some practical value they should bear the date, time and strength of reception, together with data concerning the receiver. Records of long-distance or "DX" work is obviously of very great value, and it is hoped that readers will co-operate by compiling useful logs and sending them to us.

#### The Press and the Industry.

Having outlined our own policy as a new arrival in the field of wireless publications, it may not be out of place if we say a few words about the relationship between the wireless press generally and the industry. We are prompted to do this because one manufacturing firm has intimated to us that there are already too many wireless papers, and some of them "would have to be eliminated in the near future." We say unhesitatingly that publicity is the life-blood of any industry. By the word publicity we do not mean merely advertising. We mean that every industry must have a press to record the progress of discovery and invention, to disseminate the news of the industry, to focus opinion and experience, and to provide a common forum where the thousand and one problems of the industry, commercial as well as technical, may be ventilated and discussed. Moreover, every industry needs a press to tell the world what it is doing, to arouse new and increased interest in its products, and to expand its markets. This is true of any industry, but it is especially true of a new industry, as in the case of wireless. Where would the wireless industry have been to-day if it had had no press to broadcast the wonders of wireless achievement, and to bring home to hundreds of thousands of people the possibilities of practical service, as well as of private entertainment, which wireless equipment could give them? The wireless industry

has been peculiarly fortunate in the enthusiastic and enterprising press which has grown up with it, and we confidently assert that all firms who are engaged in the manufacture and sale of wireless equipment owe a debt of gratitude, possibly greater than they realise, to those publishers and editors of wireless and other papers who during the past few years have done so much to make wireless communication a subject of national interest and enjoyment. Whether there are too many papers, and whether any papers need "eliminating" is a question which will automatically settle itself. When any paper fails to hold its public it will die a natural death, because no publisher can afford to continue to produce a paper which the public will not buy. But so long as any paper can maintain its reader-interest it is doing good work for the industry it represents, and should be regarded as a valuable asset rather than as a parasite to be "eliminated."

#### The Need for Greater Amateur Co-operation.

That the condition of the amateur movement is critical is, unfortunately, only too true. A brief survey of the correspondence columns of the various wireless periodicals reveals a vast amount of dissatisfaction in all directions. Members are not in agreement with their societies, and one society is antagonistic to another. In many cases the trouble is due to nothing more than petty jealousy, on which we need not comment; but, on the other hand, there are undoubtedly reasonable grounds for complaint in some directions. Dissatisfaction seems to arise owing to the great variation in the technical knowledge of the members of the various societies. The more advanced experimenter is too prone to forget that there was once a time when his own knowledge of wireless was very slight, and because his society is not able to provide a programme of an advanced nature he becomes discontented. The obvious remedy is for experimenters to associate themselves according to their qualifications, and we should be glad to see some effort made in this direction. Societies and associations, too, would do well to consider their relationship with others of a greater or less degree of importance, and endeavour to co-operate rather than compete with each other, to the

benefit of the amateur movement in general. It must be remembered that every amateur experimenter, whatever may be his qualifications, is dependent upon the Post Office for authority to continue his investigations. Nothing can be more prejudicial to the granting of his requests than great diversity of opinion amongst experimenters in general. There is no more convincing argument than that of a large majority, and until all amateurs are agreed it is unreasonable to expect the Postmaster-General to listen to their requests. Agreement can only result from co-operation, and it is to be hoped that the amateur movement will take steps to place itself on a firmer and more united basis in the very near future.

### The "Experimental Wireless" Laboratory.

Many experimenters find themselves frequently handicapped in their investigations by the lack of accurate apparatus and instruments, and in order that we may assist amateur readers who experience this difficulty we have undertaken the equipment of an experimental station and laboratory. The laboratory is at present situated in London, but as soon as the necessary arrangements have been made it will be transferred to a country site, free from screening and local interference. Plans have also been made for the erection of a test station, and as soon as our negotiations for a suitable site have been completed we shall announce further details of this part of our service programme. For the moment it is the laboratory which will be of immediate interest to all readers. We are now prepared to give what we may best term "A Calibration Service," whereby any reader may send for calibration any instrument or piece of apparatus. On receipt of the apparatus it will be immediately passed on to our laboratory, where it will be tested against accurate standards without any obligation on the part of the reader other than payment of the sum necessary to cover the cost of return postage. Should readers avail themselves of this offer in numbers beyond all expectations it may be found necessary to make some nominal charge to meet the additional expenditure involved, but for the time being the service is free. There would seem to be no limit to the

nature of the calibrations and determinations which we may be asked to make for our readers, but amongst those of primary importance which we are now prepared to undertake are the following:—The measurement of resistance, inductance, and capacity; the determination of insulation resistance, transformer constants, and valve constants; and the calibration of variable capacities, variable inductances, wavemeters, and direct- and alternating-current meters to sensitivities of milli- or micro-volts or amps., according to the nature of the instruments. We refer those of our readers who are interested in this service to the fuller details given on page vi of this issue, but may add that the service will be available from October 8th onwards.

### The Price of Components.

The summer slump in the sales of apparatus was attended by marked reductions in prices, not only of complete receivers, but also of components. There is little doubt, however, that the prices demanded by certain dealers for some components are still too high, but while we should like to see reductions in these instances, we would warn our readers against the purchase of exceedingly cheap components without examining them thoroughly as to their electrical and mechanical capabilities. As an instance of this we may mention some apparatus which we recently examined. A so-called grid leak had an almost infinite resistance, while two variable condensers were finally thrown aside as useless after many hours had been spent in re-assembly. In endeavouring to meet the demands of the public by the production of a really cheap article the manufacturer will find that, unless he maintains a useful standard of quality, he is really doing his trade more harm than good. Unsatisfactory products not only damage the reputation of the individual maker or dealer, but they are hurtful to the industry as a whole by reason of the dissatisfaction and disappointment they produce in the ranks of wireless workers. What the experimenter needs is apparatus which is both electrically and mechanically efficient, and usually he has little interest in other details. The experimenter will pay a fair price if he is sure of getting an efficient article, for efficiency means cheapness in the long run.

# The Maintenance of High Frequency Oscillations by Valves.

By E. W. B. GILL, M.A., B.Sc., *Fellow of Merton College, Oxford.*

Most experimenters are, no doubt, familiar with the methods employed in the production of extra high frequency oscillations corresponding to wave-lengths of the order of several metres. Wave-lengths of the order of 50cms. can be produced with an ordinary R type valve by virtue of a new principle which has recently been developed, and the general outline of the mode of operation will be found below.

IF an oscillatory circuit consisting of an inductance and capacity be connected to a valve, in which currents are passing, by joining the condenser terminals to two of the electrodes of the valve and if an oscillation is by some means or other set up in the circuit one of two things may happen. Either the alternating potential of the oscillation does work on the electrons moving across the valve in which case the effect of the valve is to abstract energy from the oscillations and damp them, or the electrons by virtue of their motion do work against the alternating potential, in which case the tendency of the valve is to put energy into the oscillating circuit and sustain the oscillations.

The latter alternative is the underlying principle of the modern methods of maintaining continuous wave oscillations by the use of three-electrode gas-free valves.

As an example, in the ordinary valve generator the oscillatory circuit is connected between the filament and the plate, a battery or other source of high potential being inserted in the plate lead, while a reaction coil is placed between the filament and the grid. This coil is inductively coupled with the inductance of the oscillatory circuit.

If no oscillations are occurring a current  $i$  passes through the valve from the filament to the plate, this current consisting of electrons emitted from the hot filament. The size of the current, the filament temperature being kept constant, depends on the voltage  $V_G$  between the grid and filament, and also on the voltage  $V$  between the plate and filament.

For suitable values of  $V$  the plate current is little affected by small variations in  $V$ , but is chiefly determined by the value of  $V_G$ , the change in the plate current being directly

proportional to the change in  $V_G$  over a fair range. If, now, a small oscillation is started in the oscillatory circuit (whose resistance will be regarded as very small), the voltage across the condenser may be taken as  $V_0 \sin pt$  (where  $V_0$  is a constant,  $t$  represents time, and  $2\pi/p$  is the periodic time of the oscillation), and the potential difference between the filament and the plate becomes  $V + V_0 \sin pt$ .

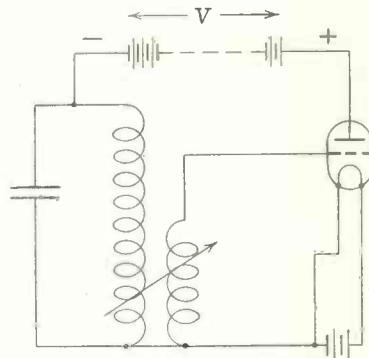

Fig. 1.—In the ordinary valve generator, the oscillatory circuit is connected between the plate and the filament, the plate being maintained at a positive potential.

The effect of the oscillating current in the main circuit inductance is to induce an alternating E.M.F. in the reaction coil, that is, between the filament and grid, which E.M.F. will be practically  $180^\circ$  out of phase with and proportional to the E.M.F. across the condenser if the reaction coil is properly placed with regard to the main inductance.

The net result is that the plate current, which varies linearly with the grid voltage, also varies linearly with  $-V_0 \sin pt$ , and at time  $t$  will be equal to  $i - k V_0 \sin pt$ ,  $k$  being a constant.

At time  $t$  an element of charge  $(i - k V_0$

$\sin pt$   $dt$  reaches the plate under the voltage  $V + V_0 \sin pt$ .

The work thus done per cycle on the electrons in the valve as they move from filament to plate is :

$$\int_0^{2\pi/p} (V + V_0 \sin pt) (i - k V_0 \sin pt) dt$$

$$\text{which} = \frac{2\pi}{p} Vi - \frac{\pi}{p} k V_0^2.$$

The second term is the work done by the alternating E.M.F., and as this work is negative, it means that work is got from the electrons which goes to maintain the oscillations.

This can also be seen in another way. The current running through the main battery at time  $t$  is  $i - k V_0 \sin pt$ , and the work done per cycle by the battery is therefore

$$\int_0^{2\pi/p} V (i - k V_0 \sin pt) dt$$

which reduces to  $\frac{2\pi}{p} Vi$ , but the work absorbed by the valve is seen above to be less than this by the amount  $\frac{\pi}{p} k V_0^2$ , and this amount

represents, therefore, a balance of work from the main battery which goes to maintain the oscillation.

The physical explanation is easy to see. If no oscillations occur all the work done by the main battery on the electrons is expended in the valve and appears in the heating of the plate by electronic bombardment. When oscillations occur, the electrons on the average hit the plate with a lower velocity and the heating of the plate is less. The main battery does the same work per unit time in the two cases, and thus part of the work wasted in heating in the first case is used to sustain oscillations in the second. The electrons take energy from the high-tension battery and give out a portion to the oscillatory circuit.

2.—In the above calculation it has been tacitly assumed that the time the electrons take to cross the valve is negligible in comparison with the time of oscillation. The variation of grid voltage operates on the electrons between the filament and the grid, causing a variation in the number which ultimately reach the plate; in assuming,

therefore, as was done, that the plate current follows the grid voltage instantaneously the time of passage must be neglected. If, on the other hand, the time of passage is an appreciable fraction of the time of oscillation, the element of charge  $(i - k V_0 \sin pt)$   $dt$  does not move across the valve under an E.M.F. of  $V + V_0 \sin pt$ , but under an E.M.F. which varies from  $V + V_0 \sin pt$  to  $V + V_0 \sin p(t+T)$ ,  $T$  being the time of passage.

It is of importance to note that in such a case the work done on the electrons cannot be deduced solely from the potential of the plate at the time when the charge reaches it, and that to go through the argument of paragraph 1, putting in a phase angle to allow for the lag of current behind plate voltage on arrival would be incorrect, though the actual effect is similar to what would be produced by such a lag.

Independently of the question of the time that the electrons take to cross the valve, it is doubtful how far the current is controlled by the grid if the oscillations are very rapid. Without, however, trying to apply exact calculation to the case where the time of oscillation is comparable to the time taken by the electrons to cross the valve, it is fairly evident that as the wave-length of the oscillatory circuit is reduced, the valve becomes less and less efficient as a generator owing to the "lag-equivalent" effect.

With ordinary sized transmitting valves, using the ordinary voltages, the time factor begins to become of importance when the wave-length is of the order of 10 to 20 metres. If the valve is of the size of the usual French type, it is difficult to sustain oscillations of much less than two metres.

So far as the time factor is concerned, the production of still shorter waves by the usual methods might be attained by a decrease in the radial dimensions of the valve and an increase in the plate voltages, as each of these changes would make the electrons cross the valves faster; but no very considerable diminution in wave-length can be expected as the fundamental wave-length of the circuit consisting only of the leads inside the valve and the valve capacity, without any external circuits at all, is of the order, for a French valve, of about one metre.

3.—An entirely novel method of producing short waves was announced by Barkhausen

and Kurz in the *Physikalischer Zeitschrift* of January, 1920, by which wave-lengths of from 50 cms. upwards can readily be obtained, though the oscillations are not very strong. In their arrangement the grid of a gas-free valve is charged to a high positive potential  $V$  above the filament, and the plate is put at about the same potential as the filament. The oscillatory circuit consisted of two long equal straight wires. If these wires are placed near and parallel to each other they form a so-called Lecher wire system, which has a distributed inductance and capacity. These wires are joined to the plate and grid, and are thus loaded with a small capacity at the end.

This system can oscillate on a fundamental wave-length or on harmonics, which are shorter waves.

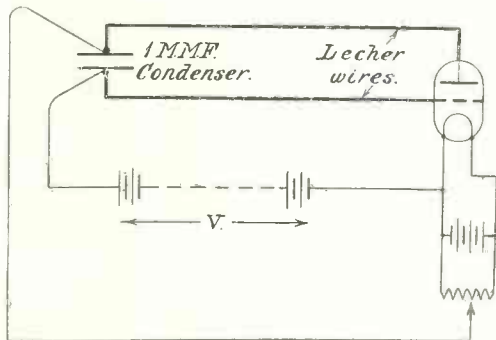

Fig. 2.—The oscillatory circuit comprises a Lecher wire system connected between the grid and the filament, the grid being held at a high positive potential, while the plate is made slightly negative.

It is outside the scope of this article to give in detail the actual experimental arrangements, and we shall concern ourselves merely to indicate that such a system will maintain very short wave oscillations.

The electrons which leave the filament are accelerated up to the grid, and those which pass through are retarded from the grid to the plate. It is only necessary to apply the elementary principles of electrostatics to see that the electrons will just fail to reach the plate, if it is very slightly negative in potential to the filament (provided there are no oscillations); for the electrons having negative charges cannot move from a body of higher potential to one at a lower.

All the velocity they attain under the accelerating force from filament to grid will be lost under the retarding force after passing

the grid when they reach a place where the potential is the same as that of the filament, that is, a point just before the plate. The electrons, therefore, turn back near the plate and return to the grid either directly or after one or two more passages backwards and forwards through the grid. It will simplify things to assume the grid spaces are very small compared to the area of the grid wires, in which case the electrons return direct to the grid and do not pass through it a second time.

Thus all the electrons which leave the filament ultimately reach the grid after moving through a potential  $V$  and hit it with the same velocity. The work done by the high-tension battery being all devoted to heating the grid by bombardment, the plate receiving no current.

If, however, there is a very small oscillation in the circuit attached to grid and plate the state of affairs is different.

Instead of the old arrangement of potentials

Potential of Filament     $O$  say  
 Potential of Grid         $V$   
 Potential of Plate         $O$

they become at time  $t$

Filament  $O$   
 Grid       $V - \frac{V_0}{2} \sin pt$   
 Plate      $V + \frac{V_0}{2} \sin pt$

the alternating potential between grid and plate being  $V_0 \sin pt$ .

It is very easy to see the effect of this if the electron's time of passage is negligible compared to the time of an oscillation.

In the first place, the average grid potential  $V$  being high, the current from the filament to the grid can be taken as the saturation current and is unaffected by small alterations in the grid voltage. Grid control, in other words, does not operate, and a uniform current  $i$  flows through the grid towards the plate.

In the second place, the plate now receives current intermittently, for when  $\frac{V_0}{2} \sin pt$  is positive the plate potential is higher than that of the filament and the electrons, therefore, reach it, while when  $\frac{V_0}{2} \sin pt$  is negative the electrons stop just before reaching the plate and return to the grid. Thus plate and grid receive current alternately.

Considering a complete oscillation from  $t=0$  to  $t=2\pi/p$ , from  $t=0$  to  $t=\pi/p$ , the current  $i$  passing the grid goes direct to the plate, and from time  $t=\pi/p$  to  $t=2\pi/p$  the current  $i$  goes back to the grid. This would be repeated in succeeding oscillations. In addition there is a current  $i$ , going direct from the grid to the filament all the time.

The question of whether this arrangement of currents will damp or sustain the oscillations can be answered from the chief principle enunciated that it depends on whether the oscillating potential does work on the electrons or whether the electrons do work against the oscillating potentials.

The work done per cycle by the alternating potential can be divided into three parts:

(A) On the current  $i_x$  going direct from filament to grid the work is

$$\int_0^{2\pi/p} -i_x \frac{V_0}{2} \sin pt \, dt \quad \text{which is zero.}$$

(B) On the current carried by the electrons which go through the grid, as they go from filament to plate (whether collected on the plate or not), the work is

$$\int_0^{2\pi/p} i \frac{V_0}{2} \sin pt \, dt \quad \text{which is also zero.}$$

(C) On the current which returns from just outside the plate to the grid during the time  $t=\pi/p$  to  $t=2\pi/p$  the work is

$$\int_{\pi/p}^{2\pi/p} -i V_0 \sin pt \, dt \quad \text{which is equal to } \frac{2iV_0}{p}$$

Hence the total work done per cycle by the oscillating potential is  $\frac{2iV_0}{p}$  and as this is positive the electrons gain energy at the expense of the oscillating system, and the oscillations are damped out and not sustained. Thus this arrangement will not act as a valve generator for long waves.

But if the time the electrons take to go across the valve becomes comparable to the time of oscillation things may be very different.

The electron which passes the grid at time  $t$  when the plate potential is  $\frac{1}{2}V_0 \sin pt$  does not reach the plate till a time  $T$ , say, later,

when the plate potential has become  $\frac{1}{2}V_0 \sin p(t+T)$ . The electron has, therefore, moved under a potential varying between these limits.

There are two main consequences of this:

1.—The electrons which pass through the grid from time  $t=0$  to  $t=\pi/p$  no longer all reach the plate. The new criterion for reaching the plate is not whether the plate is positive to the filament when the electron starts, but whether the work done by the varying field on the electron during its passage to the plate is positive. The electrons still run alternately to the plate and back to the grid for time intervals  $\pi/p$ , but these intervals are, so to speak, out of phase with the oscillation, the amount of which they are out of phase depending on the ratio of the time of passage to the time of oscillation.

The net effect of this is to change the limits of the integral in (c) above, and it is clear that if the form of (c) were still correct an appropriate change in the limits would make the value of the integral negative and change the damping of the valve into a regenerative action.

But the form of (c) is no longer quite correct, owing to the second consequence.

2.—That in calculating the work done on an electron, allowance must be made for the variation of potential during its motion.

The full calculations are rather lengthy and tedious, and can be found in the *Philosophical Magazine* for July, 1922, in an article by J. H. Morrell and the author. It will suffice here to give a few calculated numerical results for cases where the work done by the oscillating potential is negative—that is, where the valve maintains the oscillation.

If the ratio of the time of oscillation to the time the electron takes to go from the grid to the plate is 4, then the work done by the oscillating potential is  $-.47$  in certain units

|                               |             |        |
|-------------------------------|-------------|--------|
| If the ratio is $\frac{4}{2}$ | the work is | $-.85$ |
| " "                           | " "         | $-.36$ |
| " "                           | unity       | $-.32$ |

For values of the ratio larger than about 8, the work is positive, and oscillations cannot be maintained.

The result is interesting as showing that the work will reach its largest negative value and regeneration will, therefore, be strongest

for a particular ratio somewhere about 3 of the time of oscillation to time of passage.

The time of passage can fairly easily be seen to be inversely proportional to the square root of  $V$ , and hence there is a species of tuning between the voltage used and the wave-length.

This last explains why this method will give shorter waves than the natural wave-length of the valve, and its connections (which limits the wave-length obtained with the ordinary circuit), for if the voltage appropriate to the wave-length of one of the harmonics is applied the set will oscillate

on this in preference to oscillating on the fundamental. With ordinary circuits the tendency is for the set always to oscillate on the fundamental.

To give an idea of the sort of wave-length obtained, a French valve with about 200 volts on the grid gives strongest oscillations on a wave-length of about 60 cms. The wave-length is inversely proportional to the square root of the voltage, so that 50 volts would give 120 cms., 800 volts (if the grid would stand it) would give 30 cms., and so on. Valves with larger distances from grid to plate would give longer wave-lengths.

---

## The Fading of Signals.

BY O. F. BROWN, M.A., B.Sc.

(*Technical Secretary to the Radio Research Board.*)

The effects of fading of short wave signals are too apparent to the experimenter to need discussion, while on the other hand little is known of the cause. The Radio Research Board is at the present time conducting an investigation, and have asked for the co-operation of the amateur. In the following pages the factors determining the received signal strength are considered.

FROM the earliest days of radiotelegraphy it has been known that radio signals may vary in strength quite apart from faults or lack of adjustment of the apparatus at the transmitting or receiving station. An operator may be listening to good signals from a distant station when these may gradually decrease in strength, until sometimes they become too weak to read, and then increase again until they become stronger than they were originally. Such phenomena are described as "fading effects," and their explanation is to be sought in the factors influencing the propagation of the wireless waves in the intervening space between the transmitter and receiver.

Fading effects are more commonly met with in the reception of short waves (*i.e.*, waves of the order of 600 metres and below) received by night over long distances. The increase in the numbers receiving broadcast signals, and also the increase in amateur communication over long ranges (as, for example, the reception of American amateur

stations in this country), have brought these effects recently into great prominence.

The growing interest in short wave communication is to be welcomed by all interested in the scientific aspects of wireless communication, because the study of transmission on such waves is likely to lead to the collection of valuable data bearing on the solution of problems of the propagation of waves, the explanation of which are at present matters of conjecture.

Fading effects are closely allied to other phenomena of wireless transmission, such as the fact that the range of a wireless station using short waves is always greater by night than by day, or the occurrence of freak ranges when signals from a station usually inaudible at a particular spot can be heard occasionally by night. Any general hypothesis advanced to explain any one of these effects must be capable of explaining the others.

The hypothesis which is generally accepted to-day is that the upper rarefied regions of the atmosphere contain a large quantity of

minute dust particles charged with electricity which have been driven out from the sun and caught in our atmosphere. Such particles have the effect of making the portions of the atmosphere in which they occur semi-conductors of electricity. The physical constitution of the upper atmosphere makes it probable that these particles are sorted into more or less definite layers, the lowest of which may be supposed to be about 100 kilometres from the surface of the earth. At night time these layers, encircling the earth as a semi-conducting shell, may be expected to have fairly sharply defined under surfaces. Under the direct influence of sunlight, however, it is probable that the rarefied gases of the atmosphere are directly ionised; that is, the atoms which compose them are broken up into positive and negative particles called ions. These ions will penetrate into the atmosphere to distances considerably below the permanent semi-conducting layers already described.

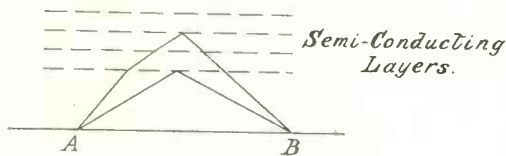

Fig. 1—By night, waves from the point A, reach B, by the path shown.

After sunset, when the direct action of the sun is removed, the positive and negative ions recombine, leaving the space below the lowest permanent semi-conducting layer practically free from ions, and therefore an insulator.

Several years ago a classic series of experiments carried out by Austin and Cohen led to a somewhat complicated empirical formula being evolved giving the strength of the voltage to be expected at a receiving aerial at various distances from the transmitter. Recently Prof. G. N. Watson has shown mathematically that, assuming wireless waves are conducted round the earth in an insulating shell between a semi-conducting earth and a semi-conducting layer in the atmosphere, a formula exactly of the same form as the Austin-Cohen formula is obtained, and this result lends very strong mathematical support to the supposed existence of such layers in the atmosphere.

We may now consider the effect of the

ionisation on the propagation of wireless waves. When a medium is a semi-conductor the effect is to increase the velocity with which a wave passing through the medium travels. In the daytime, therefore, when the under surface of the lowest semi-conducting layer is ill-defined, the upper portions of a wave from a transmitting station will pass through an ionised portion of the atmosphere. These portions of the wave will travel faster than the lower portions which travel along the earth's surface, and the wave will therefore be tilted over or refracted towards the earth and will be absorbed in the ground. Also, when the waves are passing over dry soil, which is not a good conductor of electricity, the foot of the waves will be pulled backwards, so that absorption by the ground will take place more quickly than if the wave were passing over sea water, for example. There is in addition probably an absorption and scattering of the actual energy of the wave by the charged particles in the medium, and this absorption is greater for short waves than for long waves. The general effect of these factors is to make the day range of short waves comparatively small.

At night the lower portions of the atmosphere are clear of ions and the surface of the semi-conductive layers more sharply defined. Thus, instead of the waves entering a charged medium and being refracted, they will encounter charged layers which can act as semi-reflecting surfaces, just as the surface of water acts as a partial reflector for light waves. As the short waves are more easily absorbed so, from the physical principles involved, they may be expected to be more easily reflected than longer waves. The layers are semi-transparent to the waves, and part of the energy in the waves will be transmitted and refracted by each layer and part will be reflected. The amount of energy reflected depends on the angle at which the waves meet the surface. If this is a large angle most of the energy will pass through the layer; as the angle gets smaller more energy is reflected.

By night, then, waves from a point A may be supposed to reach B by paths such as are shown in Fig. 1. Although the layers at night are moderately well defined, it is to be expected that the shape of the layers is continually varying, and the paths by



which waves may reach B from A will be affected by the changes in the surfaces of the layers. The signals received, therefore, will be by no means constant in strength; in other words, "fading" effects will certainly occur at night either through changes in the constitution of the semi-reflecting surface or through changes in the direction of the layers, both of which factors will affect the paths taken by the waves. Figs. 2 and 3 illustrate roughly how the variation in signal strength may arise through alterations in the arrangement of

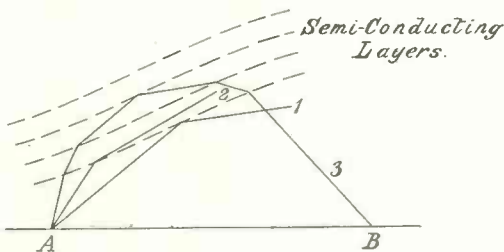

Fig. 2.—If the layers become bent, waves travelling along paths (1) and (2) are reflected and refracted and are lost by absorption in the upper atmosphere, while those travelling more vertically reach B by the path (3).

the layers. Should the layers be bent as shown in Fig. 2, then waves travelling along paths (1) and (2) are reflected and refracted so as to be lost and absorbed in the upper atmosphere. The waves following path (3) which reach B are those radiated in a more vertical direction than those reaching B in Fig. 1. As very little energy is usually radiated vertically from an ordinary aerial the signal strength at B will be decreased. Similarly from Fig. 3 it is seen that if the layers lie in the other direction the strength of signals at B will be increased.

It thus appears that the strength of signals received especially on short waves, will be influenced by the condition, as regards conductivity, of the portions of the atmosphere through which the waves pass. The paths which the waves take will depend on the sharpness of the ionised layers, and the number of charged particles in the layers from moment to moment, and even on the varying arrangement of the particles in the layers.

The strength of the signals may also depend on the nature of the ground between the receiver and the transmitter, and may be influenced by changes in its electrical conductivity produced by the presence or

absence of rain. The signals may, in addition, vary through the changes in the electrical state of the lower atmosphere. For example, the presence of thunder clouds may cause local absorption or deflection of the waves.

In particular, just at sunset and sunrise the changes taking place in the conductivity of the atmosphere will be very great, as the direct ionising effects of the sun will cease and begin at those times. Fading effects may, therefore, be expected to be very pronounced, and experience fully supports this expectation.

The only way in which these complicated phenomena can be investigated is by carefully organised simultaneous observations carried out over a long period. The Radio Research Board established under the Department of Scientific and Industrial Research has taken a step towards the investigation of the problem along these lines by enlisting the co-operation of amateurs through the Radio Society of Great Britain and its affiliated societies. In many districts arrangements have been made for several observers to record the strength of the signals from the Broadcasting Stations, whose transmissions are on wave-lengths likely

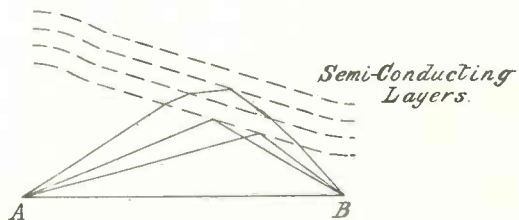

Fig. 3.—Here, the layers lie in the opposite direction, thus causing the signals to be increased in the direction of B.

to show fading effects, and to forward their observations monthly to the Secretary of the Board for analysis. The measurement of signal strength, unfortunately, is a matter of the greatest difficulty if accurate results are desired, and it is impossible outside a fully-equipped laboratory. Isolated observations may, therefore, not always be reliable. Nevertheless, if the variation of signals are observed simultaneously by several independent observers reliable qualitative data at least are likely to be collected, which will be of great value in the elucidation of the problems of wireless transmission.—Published by permission of the Radio Research Board.

# Neon Lamps and Their Use for Wireless Purposes.

By E. H. ROBINSON.

Gas discharge devices have occupied the attention of the experimenters for some considerable time, the Geissler tube, for example, being many years old. The neon tube is very convenient for experimental work in that it requires an ionising potential of only a few hundred volts. The recent appearance of the neon tube as a commercial article for the purpose of illumination is most opportune as it provides the experimenter with a suitable discharge device at a reasonable price. Below will be found much information relating to the use of neon lamps for reception, transmission and other purposes.

NEON lamps have been attracting the attention of experimenters for some time past, and it seems that they may in the near future find several useful applications both in wireless transmission and reception. Perhaps it would be more correct to say that already they have, in the hands of a few amateurs who have taken the trouble to experiment with them, proved successful for certain purposes which formerly could only be served by the much more costly thermionic valve. The following remarks may help to give the reader an idea of the properties of neon lamps and the sort of thing they may be expected to do.

## The "Osglim."

At the time of writing the most familiar type of neon lamp on the market is the "Osglim," made by the G.E.C. These lamps are similar to the old Geissler tubes, in that a luminous ionised-gas discharge takes place between metallic electrodes in a rarified atmosphere, with the difference that the ordinary Geissler tube requires a potential of several thousand volts across its terminals as against only about 200 volts in the case of the neon lamp. This difference is chiefly due to the abnormally low ionising potential of neon gas, and its high electrical conductivity when ionised. The electrodes of the "Osglim" lamp, which, by the way, are made of iron, are much closer together than in the older type of "vacuum tube." The space within these lamps contains nearly pure neon\* under a pressure corresponding to several millimetres, or even a centimetre or two, of mercury. Thus, judging by modern standards, the vacuum is an ex-

\* One of the five completely inert gases that are present in small quantities in our atmosphere.

tremely "soft" one. The neon usually contains a small percentage of helium, and sometimes a trace of hydrogen may be added by the makers, as this tends to prevent disintegration of the electrodes. The writer believes that a little mercury vapour is also present. Certain impurities, however, such as water vapour, must be religiously excluded during manufacture as they are detrimental to the proper action of the lamp.

Before experimenting with a commercially made neon lamp it is advisable to remove the safety resistance which lies hidden in the brass cap of the lamp, as it may seriously modify the action of the lamp, especially where H.F. currents are involved. The most obvious way of removing the resistance is to cut round the brass cap with a small pair of scissors so that part can be removed, allowing one to get the resistance out and to take leads direct from the electrodes. It is, however, much more convenient to preserve the cap intact so that the lamp can be inserted in standard bayonet holders for subsequent experiments. This can be done by the following procedure. The lamp is held by the bulb, as shown in Fig. 1, and the brass cap is carefully heated by a small bunsen flame applied to the end where the contacts are, special care being taken that the flame does not play on the glass. This heating has the double effect of melting the solder which secures the lead-in wires to the contact lugs, and of softening the cement which holds the bulb in the cap, so that the cap can be readily removed by grasping with a pair of tongs or pliers and pulling gently. The cap thus removed reveals the resistance which usually takes the form of a quantity of fine insulated wire wound on

a piece of cardboard or an earthenware bobbin. The removal of the resistance now presents no difficulty, and the brass cap may be fixed on again with elastic glue or similar cement after suitable connection has been established between the lead-in wires and the contact lugs.

When the safety resistance has been removed it is not safe to put a neon lamp straight across the lighting mains, as excessive pulses of current are likely to run through it and blow the fuses. When working off the mains some external limiting

such as the star type or certain of the letter-lamps. The lighting-up and extinction voltages of a neon lamp are not the same; that is to say, there is a certain minimum potential below which the discharge will not start, but once the discharge has been started by applying this potential (or a higher one) the glow may be maintained by a potential appreciably below that required for starting. In this respect the neon lamp resembles an arc lamp, though the effect is more pronounced in an arc lamp. Another property of neon lamps is that if the electrodes are

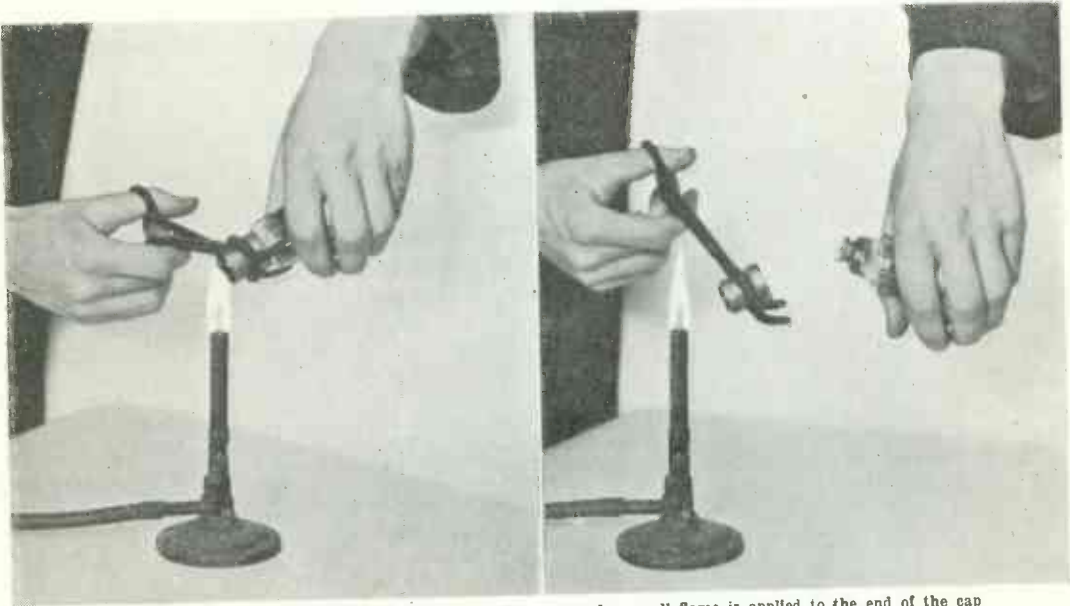

Fig. 1.—On the left the Osglim is held with a pair of tongs, and a small flame is applied to the end of the cap until the solder securing the leads melts, when the cap can be pulled away, as seen on the right, exposing the resistance.

device, such as a lamp, should be used in series.

#### Characteristics of the Neon Tube.

Most of the interesting properties of the neon lamp depend on the fact that as a conductor of electricity it does not obey Ohm's law. Fig. 2 is the characteristic curve of a typical lamp. Hardly any two lamps appear to have exactly the same characteristics, and the curves of some neon lamps show abrupt kinks where the discharge suddenly spreads to another part of the electrodes or alters its whole distribution. Such kinks are particularly common in lamps having irregularly-shaped cathodes,

of unequal size the conductivity is not the same both ways, the lamp conducting best when the largest electrode is the cathode. It will be born in mind that in the "Osglim" lamps the glow appears at the cathode, which is the fancy electrode, and which has a much greater surface area than the anode. Thus, if the lamp is put in its socket the wrong way round, the glow appears at the smaller electrode and less current will be found to pass through the lamp than when it is connected in the normal way. A certain lamp of the "Beehive" type when tested in this way on a voltage of about 200, passed 15 milliamperes in the normal direction and 13 in the reverse direction. In many lamps,

however, this uni-directional effect is much more marked. Not only is the conductivity of neon lamps different when they are connected with different polarities, but the minimum ignition potentials are different, a lamp lighting up on a lower voltage when the smaller electrode is made the cathode.

It might be as well to mention here that neon lamps should not be run on voltages much in excess of the rated value if it is desired that they should retain their original properties. If a 220-volt lamp is run for about a quarter of an hour on four or five hundred volts it glows with abnormal brilliancy and heats up considerably, the electrodes, especially the smaller one, becoming red hot and the bulb becoming too hot

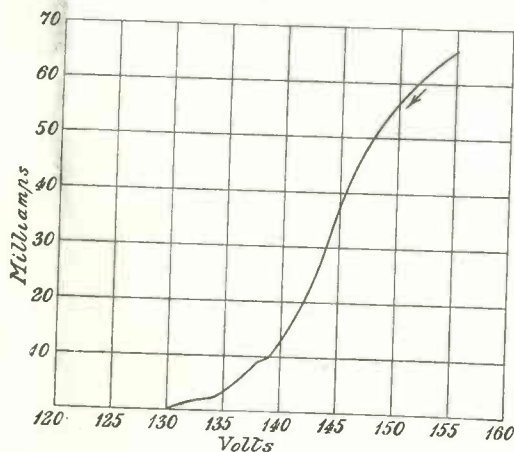

Fig. 2.—Showing the general form of the characteristic curve of a Dutch double spiral neon tube, as taken by the author. The arrow indicates that it is an extinction curve.

to touch. After a few minutes of this treatment the glow changes from the original pinkish-orange colour to a pale lilac fringed with blue or green. Once a lamp has been over-run to this extent it requires a higher voltage than the rated value to work it afterwards, and it will always light up the pale lilac colour. Over-running spoils a lamp for many purposes, but the writer finds that the oscillatory properties referred to below are often improved to a great extent.

### Rectification.

Owing to the partial uni-lateral conductivity a certain amount of rectification can be obtained with a neon lamp, although the rectification obtained is very incomplete

and probably will not in itself find a very extended application. Fig. 3 shows how a neon lamp may be used as a detector to receive sufficiently loud signals. The neon lamp V is connected across the A.T.I. in series with a pair of 'phones, a high variable resistance R and a 200-volt H.T. supply. C is a large bye-pass condenser, which is not absolutely essential. By means of R the potential across the lamp is adjusted until the lamp glows feebly. This arrangement, using an "Osglim" lamp, is rather insensitive and is inferior to a good crystal detector, very little being audible in it other than a local broadcasting station. Nevertheless, the writer can receive 2LO very clearly if not very loudly, in this manner. It might be of use, however,

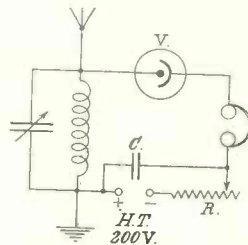

Fig. 3.—Method of using the neon tube as a detector.

for a separate "side-tone" receiver for those who experiment with the transmission of radio-telephony. A difficulty that one usually meets in trying to listen to one's own transmission is that most detectors, including valves, tend to be paralysed by the powerful local oscillations of the transmitter. A neon lamp used as a detector is practically free from paralytic effects.

### Production of Oscillations.

One of the most interesting properties of neon lamps is their capability of converting a direct-current supply into regularly pulsating current. If a lamp is shunted, as in Fig. 4, by a variable condenser C fed through a resistance R from a D.C. supply of 200 volts or more a rapid series of pulses will pass through the lamp when R is increased until the lamp is just on the point of extinction. This is due to the arc-like property of the lamp previously referred to. The number of discharges per second through the lamp depends upon the rate at which the supply current through the resistance R can charge the condenser C up to the ignition potential of the lamp. Thus by decreasing R the frequency of the pulses is increased, and also the smaller C is made the higher will be the discharge frequency. By suitable

adjustments of  $R$  and  $C$  the frequency may be made such that the lamp only flashes once every few seconds, or it may be made of any desired musical pitch. It is necessary to have the potential drop in  $R$  about equal to that in the lamp—that is to say,  $R$  must be of the same order of resistance as the lamp. A simple water resistance is convenient for experimental purposes. With

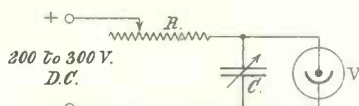

Fig. 4.—The neon lamp is shunted by a condenser supplied through a high resistance, the frequency being determined by the values of  $R$  and  $C$ .

most neon lamps the frequency can be carried just above the limit of audibility, but it is not usually possible to carry the pulsations much further into the radio frequencies, the average lamp ceasing to function at about 25,000 per second, after which the glow is continuous and not interrupted. Owing to the fact that these pulsations are detached uni-directional surges, as shown in Fig. 5, and are not sinusoidal oscillations, an enormous number of harmonics are present. If we make a neon lamp pulsate in the manner described above at a frequency of about 15,000 and listen in a heterodyne receiver close to the lamp we hear a strong C.W. note due to the fundamental pulsations on a long wavelength of 20,000 metres or so, and as we tune the receiver down to shorter wavelengths we come to harmonics of two, three, four, five, and so on, times the fundamental frequency, and it follows that the higher the frequency we tune to the more crowded together these harmonics will be. This is, indeed, no case of "the higher you go the fewer." On the shorter wavelengths below 400 metres the harmonics become extremely feeble, but follow each other in rapid succession as the tuning condenser of the heterodyne receiver is varied.

The harmonics of a neon lamp, far from being a disadvantage, make it possible to generate low power C.W. on short wavelengths in spite of the fact that the lamp itself will only pulsate on frequencies corresponding to very long wavelengths. By tuning an oscillatory circuit associated with the neon lamp circuit to one of the short-

wave harmonics, this harmonic is made to stand out very much more strongly than the rest, and will produce loud heterodyne effects in an adjacent receiver. The writer has found the connections shown in Fig. 6 best for this purpose. Suppose that it is desired to produce oscillations of a frequency of 1,000,000 (corresponding to a wavelength of 300 metres) in the circuit  $L_2C_2$  (Fig. 6). The neon lamp  $V$  is connected up to produce pulsations, as in Fig. 4, except that an inductance  $L_1$  is included in series with the lamp.  $R$  and  $C_1$  are adjusted to make the lamp pulsate at as high a frequency as possible; the higher this fundamental frequency can be made the stronger and purer will be the C.W. produced at the desired

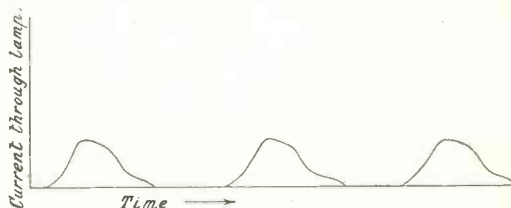

Fig. 5.—The wave form of pulses produced by a neon lamp, showing their non-sinusoidal nature.

harmonic frequency.  $C_1$  may be a .001 mf. variable condenser at about half-way setting. The inductance  $L_1$  must be of such a value that in conjunction with  $C_1$  it would tune approximately to the same frequency as  $L_2C_2$ —that is to say, 1,000,000 per second in this case. The circuit  $C_1L_1V$  is not a tuned circuit in the ordinary sense of the word, owing to the inclusion of the lamp  $V$ , but the adjustment referred to ensures a maximum transference of energy on the harmonic frequency from the lamp circuit to the tuned circuit  $L_2C_2$ . Once the circuit  $L_2C_2$  has been tuned to the desired frequency a slight adjustment of  $C_1$  or  $R$  will serve to bring a harmonic into exact synchronisation with  $L_2C_2$ , in which case the C.W. produced is at its strongest and purest. The coupling between  $L_1$  and  $L_2$  requires a certain amount of adjustment, and should be made quite tight. H.F. chokes may be put in the supply leads, as shown in Fig. 6, but they are not always necessary as the resistance  $R$  is usually very high, and is sufficient in itself to keep H.F. currents out of the supply leads. If the arrangement is used for low power

transmission the closed circuit  $L_2C_2$  is replaced by a tuned aerial circuit. The whole action of the arrangement is that of impact excitation, each aperiodic discharge pulse through the lamp giving a kick to the circuit  $L_2C_2$ , which continues to oscillate in its own free period until the next pulse comes to keep it going. The process of tuning  $L_2C_2$  to a harmonic simply amounts to making the lamp circuit give the circuit  $L_2C_2$  a kick at intervals of an exact number of oscillations. Thus, if the lamp is discharging at 20,000 per second and  $L_2C_2$  is tuned to a frequency of 1,000,000, the circuit  $L_2C_2$  receives a kick exactly every 50 oscillations, and if this circuit is one with low H.F. losses practically undamped oscillations are sustained in it. The principle is exactly the same as that used in the Chaffee, Ditcham, and T.Y.K. systems of producing C.W., with the difference that these systems used a highly-quenched spark-gap in place of the neon lamp, and were capable of dealing with powers of 100 watts or more.

### The Neon Tube as an Oscillator.

The first difficulty that one encounters when one tries to use the neon lamp oscillator for transmission is the minuteness of the power obtainable. Although the standard "Osglins" are intended to consume 5 watts normally, most of them will only pulsate when they are on the point of extinction and consuming considerably less than 1 watt. Many lamps are capable of great improvement in this respect by over-running on about 400 volts until the glow changes to a pale lilac colour. This not only makes it possible for the lamp to pulsate subsequently on greater power, but enables it to pulsate on a somewhat higher fundamental frequency and to give much more powerful harmonics.

When a neon lamp is being used, as in Fig. 6, to produce continuous oscillations it is highly important to have the supply current absolutely constant. It will be born in mind that the fundamental frequency is not determined as in a valve transmitter by a tuned circuit, but is chiefly a function of the supply current and the condenser in the neon lamp circuit. Thus small variations in the supply current cause corresponding variations in the fundamental pulsation frequency of the lamp which are enormously exaggerated in the harmonic selected by

the circuit  $L_2C_2$  (Fig. 6). For example, the writer was making a neon lamp oscillator give C.W. on 400 metres, rectified A.C. being used as the source of current. Although the smoothing arrangements were such that absolutely pure C.W. would have been given on a 10-watt valve transmitter, the oscillations from the neon lamp sounded in a heterodyne receiver as if entirely unsmoothed A.C. were being used. It was not until a smoothing system consisting of two inter-valve transformers and condensers amounting to 10 mf. was used that pure C.W. was obtained, and this in spite of the fact that only about 5 milliamperes were being drawn from the H.T. supply. When once the supply has been made sufficiently smooth the C.W. note is as pure as that obtained from a valve transmitter.

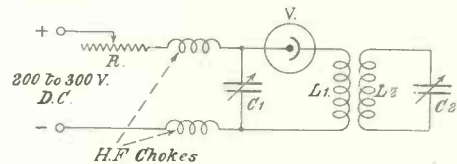

Fig. 6.—Here a harmonic from a pulsating neon lamp is selected by a tuned circuit  $L_2C_2$ .

The susceptibility of the oscillations to variations in the supply current has one advantage, in that very sensitive telephonic modulation can be obtained by simply inserting the secondary of a modulation transformer in series with the H.T. supply.

### The Effect of other Gases.

So far reference has been made only to the use of neon lamps as oscillators, but the writer has found that the properties referred to above are by no means confined to vacuum tubes employing neon gas. Neon lamps are convenient simply because of the low voltages required to work them, and because they are readily obtainable at a moderate price. Other gases and vapours give similar and even greatly improved results. A simple air vacuum will work after a fashion, while ammonia gas is quite good. Very good results are obtainable from lamps containing a mixture of phosphorus and mercury vapour. In one set of experiments the pip of an "Osglim" was removed so as to let the air in, and to let the neon escape. A glass exhausting tube was now sealed on to the bulb, and a drop of mercury, along with a

few grains of red phosphorus, was introduced; connection was made by rubber pressure tubing to an ordinary filter pump working on a water tap at full mains pressure. This pump was capable of exhausting to a pressure corresponding to about 1 cm. of mercury. During exhaustion a potential of 500 volts A.C. was applied to the electrodes, this causing a bluish-violet glow to take place between them, and making them red-hot. At the same time the lamp was shaken so that some of the red phosphorus fell on to the hot electrodes, and became converted into yellow phosphorus, which vaporised and combined with any residual oxygen in the bulb. The exhaustion was continued for about five minutes, and the exhaustion tube was sealed off near the bulb with the lamp still glowing. Several lamps were prepared in this way, and though they did not all behave in exactly the same manner, they were nearly all much better oscillators than the ordinary neon lamp. One tube in particular gave very good results, as it would pulsate on a power of over three watts at a fundamental frequency as high as 50,000 (*i.e.*, 6,000 metres wave-length). The writer has not been able to obtain such a high frequency with a neon lamp. The tube in question was rather difficult to start up, and required about 400 volts to work it, but it was capable of putting  $\cdot 1$  amp. into an average aerial on 440 metres, the arrangement in Fig. 6 being used with the aerial circuit in place of the closed circuit L2C2. The C.W. heterodyne note was as pure as that from a valve transmitter. These phosphorus vapour lamps might very well be developed into a practical article for regular use, and they can be constructed at a negligible cost by anyone with a little experience of glass working. Much better results could probably be obtained by using specially designed electrodes made of some more suitable metal than iron.

### Early Discharge Devices.

The idea of using a discharge in a partial vacuum to produce C.W. is by no means new, and was brought to the stage of practical utility in 1916 by Japanese radio engineers in the form of the T.Y.K. vacuum discharger. The T.Y.K. discharger consisted of two circular parallel electrodes sealed into a glass bulb evacuated to a pressure of a

centimetre or two of mercury. The anode was of copper, the cathode of aluminium, and the distance between the electrodes was about half a millimetre. The discharger really amounts to a Chaffee gap in a partial vacuum. The atmosphere in the discharger may be air; but ammonia gas was found to give greatly superior results. The T.Y.K. discharger dissipated about 100 watts, and was fed from a 500-volt supply, the circuit used being almost identical with Fig. 6.

The whole subject of using neon lamps and similar devices is an interesting and extensive one, and we hope to be able to publish further accounts of it in future issues of this journal.

It is possible to use a neon lamp as a modulating device in a radio-telephone transmitter. The writer does not at present claim that a neon lamp gives better results

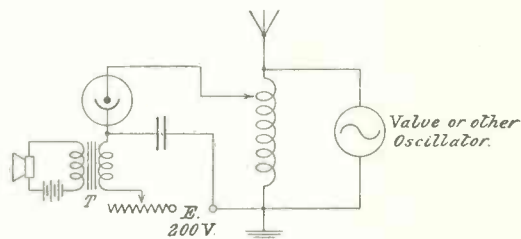

Fig. 7.—The lamp is shunted in series with the modulation transformer across the A.T.I. of the transmitter. A source of polarising potential should preferably be included in series with the lamp.

as a modulator than as an ordinary thermionic valve, but it is a very inexpensive substitute, has no filament, and is certainly capable of giving quite good results. The simplest modulation scheme using a neon lamp is shown in Fig. 7; it amounts to the converse of the receiver in Fig. 3. Shunted across the aerial circuit is the lamp in series with the secondary of a step-up modulation transformer T, and a source E of polarising potential. By means of a resistance R the potential across the lamp is adjusted until it glows feebly; a certain amount of glow is also caused by the H.F. potentials, derived from the aerial inductance. When the microphone is spoken into, the potentials set up across the secondary of the transformer T vary the conductivity of the lamp (owing to its non-linear characteristic), causing a varying damping effect on the aerial circuit. This system of modulation can be applied to a 5-watt valve transmitter with satis-

factory results, but the writer prefers the arrangement shown in Fig. 8. Here the ordinary electrodes of the lamp do not constitute an absorption path in themselves, but a third electrode is made by placing an insulated metallic coating round the outside of the bulb. This may consist of tinfoil neatly stuck on to the glass with shellac varnish or other adhesive. The tinfoil should cover nearly the whole of the bulb, but on no account should it touch the brass cap or any other conductor at earth potential. A piece of copper wire is bound round the bulb so as to make good contact with the tinfoil, and connection is made thereby to the grid of the transmitter valve. One of the leads to the internal electrodes of the lamp is connected to the filament lead, the two internal electrodes being connected in series with the secondary of a step-up modulation transformer, and a source of variable polarising potential. When the lamp glows its interior becomes semi-conductive, and its capacity effect with the tinfoil outside forms quite a good conducting path for H.F. currents. The arrangement may be used as a shunt control across either the grid circuit or the plate circuit of the valve transmitter. Most effective modulation can be obtained by using a tuned grid circuit and shunting the absorption modulator across this. Similar circuits, using valve modulators, are quite well known to most experimenters. By

lamp if necessary, to cut down the voltage across the lamp to the right value. In the figures a separate H.T. supply is shown for simplicity.

**Other Uses of the Neon Lamp.**

Other uses for neon lamps have suggested themselves, and have been put successfully into practice. Fig. 10 shows how a neon lamp may be used to obtain rectified high-tension

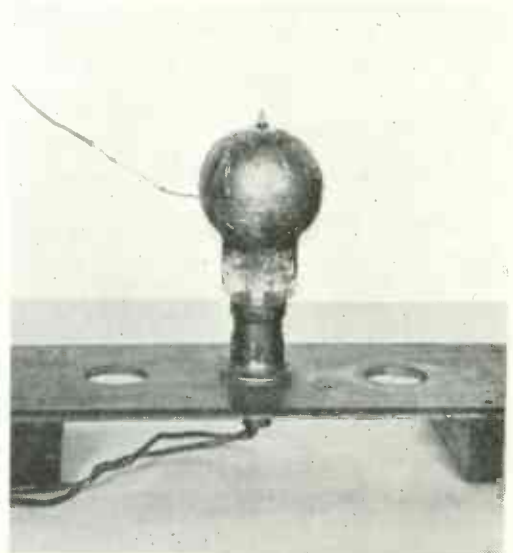

Fig. 9.—Tinfoil is fixed to the glass with shellac to form the third electrode.

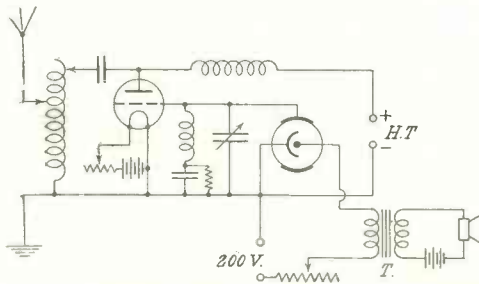

Fig. 8.—The internal electrodes are connected across the secondary of the modulation transformer, the auxiliary electrode being taken to the grid of the transmitting valve.

adjustment of the tuning condenser across the grid circuit one can obtain a flexible control of the extent of modulation. In either of the systems shown in Figs. 7 and 8, the polarising potential for the neon lamp may be derived from the same H.T. source as is used to supply the oscillator, a suitable resistance being inserted in series with the

currents from a spark coil suitable for C.W. and telephony valve transmitters; PS is an induction coil, preferably of the type with a high speed interrupter and capable of giving comparatively heavy currents in the secondary at a voltage of a thousand or so. The neon lamp V is placed in series with secondary S as shown, C1 and C2 being smoothing condensers whose necessary value will be determined chiefly by the interruption frequency in the primary P. These condensers, especially C1, should be built to withstand fairly high peak voltages. The fact that a rectified output is obtained from the condenser C2 does not depend so much upon the unilateral properties of the lamp itself as upon the peculiar wave-form of the secondary voltage of an induction coil. When the interrupter in the primary "makes" the circuit, only a low voltage of certain polarity is set up across the secondary, and this is



insufficient to drive any current through the lamp. On "break," however, a very high potential surge of opposite polarity is set up in the secondary, and this passes through the lamp easily, and charges the condensers  $C_1$  and  $C_2$ . Since only the break surges get through the lamp, and since these are always of the same polarity, it follows that the condensers will charge up, and D.C.

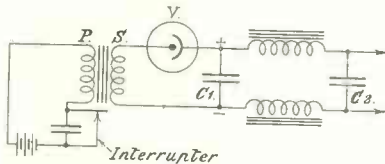

Fig. 10.—A neon lamp in series with the secondary of the induction coil allows only pulses due to the break to pass into the output.

can be drawn from them. Only one lamp is shown in Fig. 10, but it will usually be necessary to use two or three neon lamps in series, as one will not stand a back voltage greater than about 200. This method of using neon lamps is particularly applicable to H.T. units of the well-known "T.V.T." type.

An example of the useful application of neon lamps to wireless reception is to be found in the Anson Relay. As this device

has already been described in the technical press, it will not be dealt with at length here. The broad principle consists in placing a neon lamp in the plate circuit of a three-electrode valve and adjusting the H.T. supply so that the lamp works near its extinction point. The input-output characteristic can be steepened in this way so that the current through the plate circuit when no signal is arriving is negligible compared with the current that is set up when a signal does arrive. This enables a relay in the plate circuit to work cleanly and precisely. Also the extra resistance due to the neon lamp reduces the time constant of the relay circuit and allows a higher working speed.

A variety of miscellaneous uses will, no doubt, occur to the experimenter. Long-wave oscillations produced directly by a neon lamp may be used for heterodyne reception of stations like Carnarvon. Also a lamp pulsating near the limit of audibility might be applied to the Armstrong super-regenerative receiver. The object of this article will have been accomplished if it has helped to give an idea of the possibilities in neon lamps and to stimulate some of the readers of this journal to make further experiments for themselves in this direction.

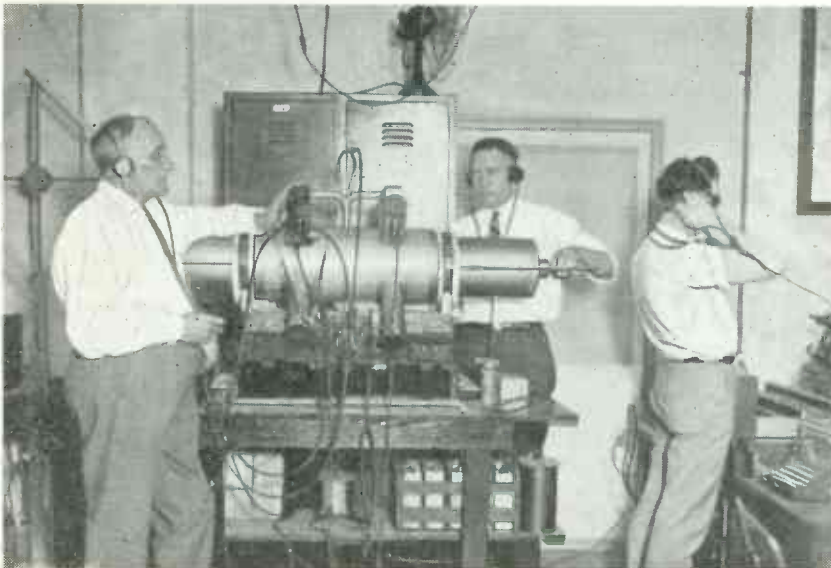

The above photograph, of American origin, shows another attempt at static elimination. Being dissatisfied with radio and audio frequency eliminators, attention has been turned to acoustic methods, and the photograph should form excellent subject-matter for amateur experiments in this direction.

# Antenna Constants.

By H. ANDREWES, B.Sc., A.C.G.I., D.I.C.

It is impossible to bring a transmitter to a state of efficiency without a knowledge of the aerial constants, particularly the effective resistance. The following article explains how the radiation resistance may be measured, and is, perhaps, the best method for the experimenter, as it involves little calculation and practically no additional apparatus.

THE aerial, or, more correctly, the antenna system, of an amateur transmitter is very often a much neglected-portion of the station. Not so much, perhaps, from the point of view of putting up a large, high elaborate aerial, but owing to the fact that the actual efficiency of the system as a radiator is not known. Without careful measurement it is impossible even to estimate the radiating efficiency, and only a poor idea of the efficiency of the oscillator can be obtained from the anode current and the aerial current. It is not, perhaps, generally realised that the measurement of the "so-called" constants of an antenna is not really such a difficult problem, and that most of the apparatus is available to the average transmitting licence-holder.

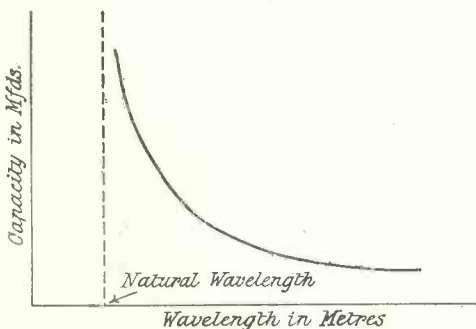

Fig. 1.—The capacity of an aerial varies with the wave-length, and the general form of the curve showing the relation can be seen from the above figure.

Now, every aerial system has inductance, capacity and resistance, and hence a natural wave-length at which it will oscillate when unloaded. With small antennas, such as are usually used, at any rate, for 200-metre work, the inductance is usually neglected, as it is fairly small. This, of course, introduces an approximation, and hence we must remember this if the capacity is to be measured by substitution.

The two most important properties of the antenna are the capacity and the resistance. By resistance is meant the effective resistance. Later it will be shown how this may be split up into its three components.

The first thing we must do is to measure the natural wave-length of the system. Then, knowing this, we may measure the capacity and resistance above this for a series of wave-lengths and hence obtain curves showing us the variation of these "constants."

## Variation of Capacity with Wave-length.

It is not, perhaps, always realised that the capacity of the antenna varies with the wave-length, and hence it is only true to say that a certain antenna has a capacity of, shall we say, .0005 mfd. for a certain fixed wave-length. The general shape of the capacity-wave-length curve is shown in Fig. 1.

The easiest way to describe how to make these measurements will be to describe, briefly, the apparatus and method used to obtain resistance and capacity curves at the author's station.

The general method is to obtain a small current in the antenna at a given wave-length, and then switch the oscillator on to an artificial aerial consisting of capacity and resistance, and adjusting the capacity for resonance and the resistance to give the same current. Then, approximately, the capacity and resistance of the antenna are given by the values in the artificial circuit for the given wave-length. To prevent reactions between the artificial and oscillating circuits, and to keep the conditions the same for aerial and artificial circuits, it is essential to use extremely loose coupling between the oscillator or "driver," as it is often called, and the A.T.I. For this reason it is usual to set up the driver about 10 ft. away from the lead-in and A.T.I. and

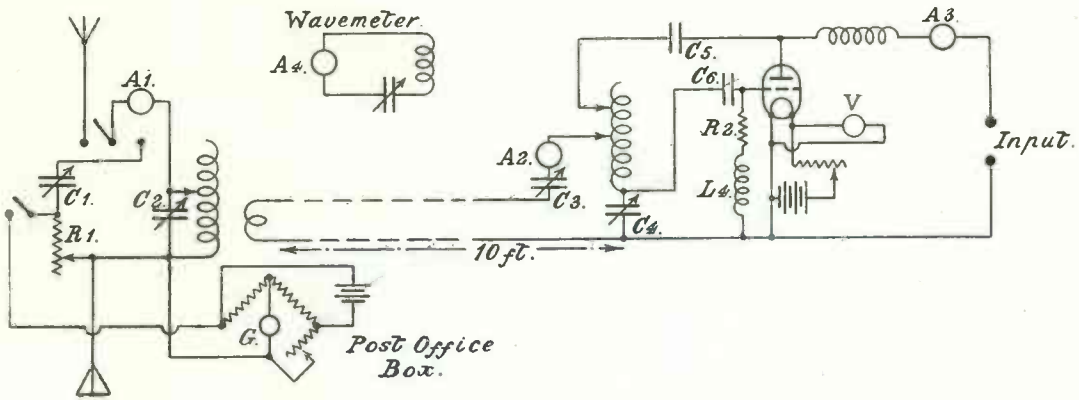

Fig. 2.—The oscillator on the right produces a small current in the aerial circuit, which is then substituted by the artificial circuit adjusted to give the same aerial current. The oscillator, or driver, must be at least 10 ft. from the artificial circuit in order to prevent capacity and reaction effects.

then run long straight wires or flex from the driver to a coupling coil coupled to the A.T.I.

**The Driver.**

For the driver any ordinary oscillatory circuit may be used. In the general circuit diagram (Fig. 2) the Colpitts is shown. One essential point about the driver is that it should be of sufficient power. In the case in question a French 60-watt tube was used, with 1,200 volts "raw" A.C. on the anode. Owing to the nature of the oscillatory circuit employed a "phantom" circuit was placed where normally the aerial circuit would be connected and the coupling coil to the A.T.I. included in this circuit. This was found to be advantageous, as up to 5 amps. could be obtained in this circuit, allowing loose coupling to the aerial, and at the same time it was possible to change the wave-length by altering the "phantom" circuit condenser without shutting down the circuit, as changing the clips necessitated.

The following are details of the apparatus shown in Fig. 2 :—

- A<sub>1</sub> = aerial hot-wire milliammeter.
- A<sub>2</sub> = "phantom" circuit hot-wire ammeter, 0—7 amps.
- A<sub>3</sub> = anode input ammeter, 0—150 D.C. milliamperes.
- A<sub>4</sub> = wavemeter hot-wire milliammeter, 0—250.
- C<sub>1</sub> = 1 jar Navy variable.
- C<sub>2</sub> = .0005 mfd. variable.
- C<sub>3</sub> = .001 mfd. variable; high insulation.
- C<sub>4</sub> = .001 mfd. variable; high insulation.
- C<sub>5</sub> = anode stopping, .01 fixed.
- C<sub>6</sub> = grid, .01 fixed.
- I<sub>r</sub> = ordinary helix to be used on transmitter.
- I<sub>2</sub> = three-turn coupling coil (about 1 ft. diam.).

- L<sub>3</sub> = "driver" helix (bare wire, good insulation).
- L<sub>4</sub> = grid H.F. choke (any fairly large inductance).
- L<sub>5</sub> = anode feed H.F. choke (any fairly large inductance).
- R<sub>1</sub> = Artificial aerial resistance. A straight Eureka wire with sliding clip.
- R<sub>2</sub> = water grid leak, variable.

In order to take a reading the procedure was as follows :—The driver was started and the wave-length adjusted to a suitable value by means of C<sub>3</sub> and C<sub>4</sub>, and as large a current as possible obtained in A<sub>2</sub>. The wave-length was then accurately measured

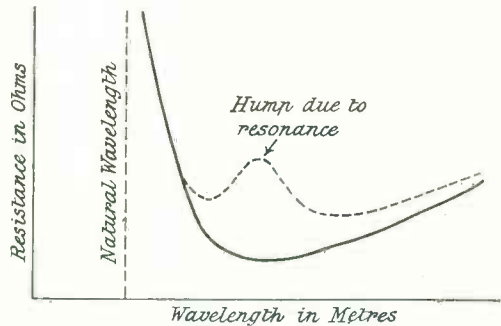

Fig. 3.—The variation of resistance with wave-length can be easily seen from the above curve. The peculiar shape is brought about by resonance with some near conductor.

by means of the wavemeter. The change-over switch was then placed on the aerial side and the aerial circuit brought into resonance with L<sub>1</sub> and C<sub>2</sub>, and the coupling between L<sub>1</sub> and L<sub>2</sub> adjusted to give from 50—100 milliamperes in A<sub>1</sub>.

With a fairly large value, for safety, in R<sub>1</sub> the switch was thrown over and the

artificial circuit brought into resonance by means of  $C_1$  and the current in  $A_1$  brought to the previous value by altering  $R_1$ . The value of  $R_1$  is then obtained from the P.O. box.

It is advisable to test at the beginning for reaction by moving the change-over switch backwards and forwards and noting if there was any change in  $A_2$  or  $A_3$  readings.

#### A Low-Loss Condenser.

The following important points should be noted. The condenser  $C_1$  in the artificial circuit must be a good low-loss one. This is absolutely essential, as the author has found by experience. At first an ordinary receiving condenser was used immersed in paraffin to increase the capacity. This gave a resistance for the antenna at a certain point of about 5 ohms; on replacing this by a good condenser the value of  $R$  rose to 20 ohms. This may have been due largely to the paraffin, but still indicates the necessity for a good condenser.

The coupling between  $L_1$  and  $L_2$  should not be too loose, as otherwise it was found that the artificial circuit was difficult to manage and absurd results were obtained. By using a P.O. box to measure the value of  $R$  any errors due to loose contact, etc., to the resistance wire were avoided, but, of course, by careful construction, this could be avoided, and the P.O. box is not an essential. The condenser  $C_2$  need not be a low-loss one, as its resistance does not enter into the measurements.

With the above apparatus, and with careful measurements, it will be seen that curves may be drawn from the readings obtained of the capacity and effective resistance of the aerial system with varying wave-length. Fig. 3 shows the theoretical shape of such curves. As a rule, the capacity curve follows in practice the theoretical shape, but very often the resistance curve has serious humps in it. These are usually due to resonance in some object near the aerial, such as another aerial, telephone wires, etc. These can only be remedied by the removal of the object, a possible cause of friction if your neighbour is a "broadcast listener-in"! If by luck you get a curve such as Fig. 3 it is then possible to split up the effective resistance into its components. There are three losses in the

aerial system which appear as resistance in their curve, namely: (a) Radiation resistance; (b) dielectric losses; (c) ohmic resistance. These may be represented as shown in Fig. 4. The radiation resistance is a curve as shown. The dielectric losses increase with the wave-length, while the ohmic losses remain constant.

It can be seen, then, that by geometry the various components may be determined.

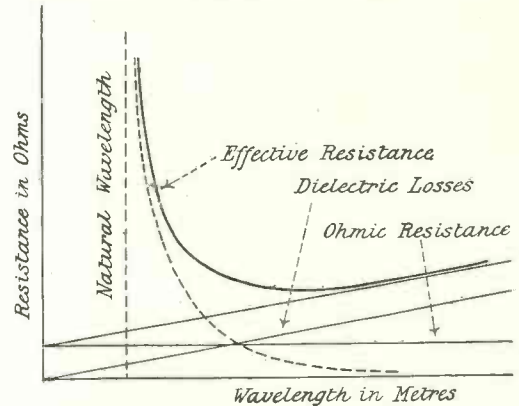

Fig. 4.—The components of the effective resistance of the aerial are clearly demonstrated by the above curves.

The important point is that, in this way, we may find the efficiency of the antenna system at different wave-lengths, *i.e.*, watts radiated to watts in the aerial, and it is easy to see that the point of maximum aerial current is not necessarily the best working point. It should be noted that if an oscillating circuit such as the Colpitts be used for the transmitter the curves obtained do not hold as a series aerial condenser is introduced. This may be obviously remedied by taking the curve with the condenser in circuit at various settings.

#### Trans-Atlantic Signals Coming Over Again.

Experimenters report the reception of quite a number of American amateur stations during the last few weeks. Broadcasting stations can also be heard on wave-lengths from 300 and 400 metres between the hours of 00.30 and 3.30 G.M.T. Although the carrier-waves of several of these stations are usually fairly easy to detect, and the modulation is readable at times on a good receiver, the strength of the signals is not yet up to what may be expected at the most favourable times during the winter.

## Some Notes on Distortionless Amplification.

The following article shows where distortion is likely to occur in power amplifiers, and gives interesting data for the production of pure speech and music from loud speakers.

IT is a regrettable fact that, perhaps, not more than five per cent. of the broadcast receivers fitted with loud speakers give results approximating to clear speech and music. A recent examination of a number of installations, both amateur receivers and demonstration models, showed that the results were absolutely deplorable, the speech, in some case, being absolutely unintelligible. Such a condition must necessarily have a very malign effect upon broadcasting, and in the interests of wireless it is surely the duty of the experimenter to demonstrate that the faithful reproduction of speech is no mere hypothesis, but is, on the other hand, an assured fact. It is the object of these short notes to indicate the most usual causes of distortion, and explain how the original quality of the

progressively, dealing with each individual component very briefly. It will be assumed that the carrier wave is modulated as perfectly as possible, and it may, therefore, be considered as distortionless. The quality of a modulated wave is dependent upon the percentage modulation, which, in the case of a broadcast station, is considerably smaller than that used by the average amateur experimenter, resulting in better quality of speech.

### Crystal Rectification.

The first component of the receiving apparatus is the tuning system, and calls for no attention. Following this is the rectifier, unless radio-frequency amplification is employed, which will be considered later. It will be seen that if any distortion takes place here its effect will be greatly magnified by the subsequent low-frequency amplifiers, and consequently it is of vital importance to obtain distortionless rectification. Most receivers employ cumulative grid condenser rectification, which functions by virtue of the change in grid current. This method is undoubtedly the most efficient, but is likely to produce more distortion of the original wave form than other systems. The value of the grid leak is a very critical factor, and is determined by the constants of the circuit. It is essential, therefore, that it should be found by trial. The writer is in favour of connecting it between the grid and the positive side of the filament battery. It will probably be found that the value of the leak which gives the clearest speech does not give the greatest volume of sound. It is, no doubt, advisable to sacrifice strength at the expense of quality, thereby giving a somewhat lower efficiency per valve.

Crystal rectification is a far simpler problem, and there is little to choose between a good crystal and a valve rectifier without reaction. The crystal rectifies owing to the asymmetrical nature of the contact resistance, and it can be shown that less distortion is likely to be produced than with a valve. The next part of the receiver is the low-

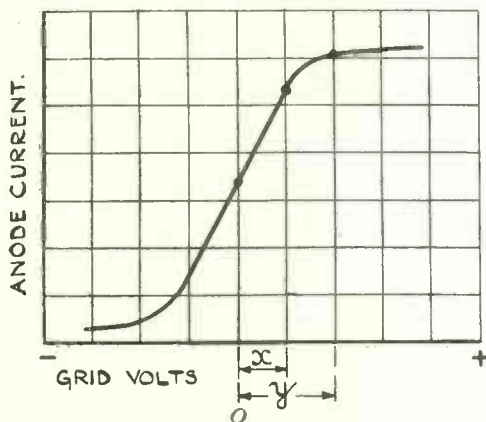

Fig. 1.—When the potentials reach a value of "y" distortion occurs.

speech may be retained by the correct adjustment of the apparatus.

The idea seems to be prevalent that the distortion is invariably due to bad design of the low-frequency transformers and the loud speaker. In the majority of cases nothing could be more erroneous, the trouble usually being associated with conditions under which the valves are functioning. In order to examine all the possible causes of distortion the whole system will be examined

frequency amplifier, and is responsible for a good proportion of the bad quality of the speech.

### Linear Amplification.

The magnitude of the potentials applied to the first amplifier will be dependent upon the strength of the rectified oscillations, which, in the case of broadcasting, will be fairly large. In order to obtain proper amplification the change in anode current must be directly proportional to the applied potentials, which in this case are fairly large. This means that the portion of the curve over which the valve is being used must be represented by a straight line. This condition can be fulfilled by arranging the steady grid potential so that the operating point is brought to the middle of the straight part of the curve. This adjustment alone is not sufficient. It will be seen by referring to Fig. 1 that as long as the applied potentials do not exceed a value of "x" linear amplification occurs, but when they reach a value of "y" the operative point moves to the upper bend of the characteristic. The obvious remedy is to lengthen the curve, which simply necessitates increasing the filament emission, by brightening the filament or substituting a valve having a greater emissivity. This may produce saturation at the particular anode voltage. In order to restore normal working conditions it will be necessary to increase the voltage on the anode to some extent.

It will be seen, then, that the filament must be fairly bright, and that a large voltage should be used on the anode. For an ordinary R-type valve about 80 to 100 volts should be used on the first amplifier. The voltage on the anode has an effect upon the normal working point on the curve. Increasing the voltage has the effect of moving the whole curve to the left, which thus determines the correct steady grid potential. From Fig. 2 it will be seen that when the anode voltage is 50 the grid potential should be about zero. When the voltage is increased to 100 the necessary grid potential would be about 3 volts. It has been shown that, owing to the magnitude of the applied potentials, it is necessary to use a long curve, which further necessitates a steady negative potential on the grid. In practice this is best obtained by the introduction

of grid cells, and will be referred to later. There is an additional advantage obtained by the use of the negative potential, since, if of sufficient magnitude, the strongest positive potential applied by the incoming signal can never give the grid an absolute positive potential. This means that no grid current will flow which would produce distortion.

### Increased Power in each Stage.

The above reasoning holds good in the case of the next stage of amplification, only in this case the applied potentials are considerably greater. Thus, if the first amplifier is working at the maximum

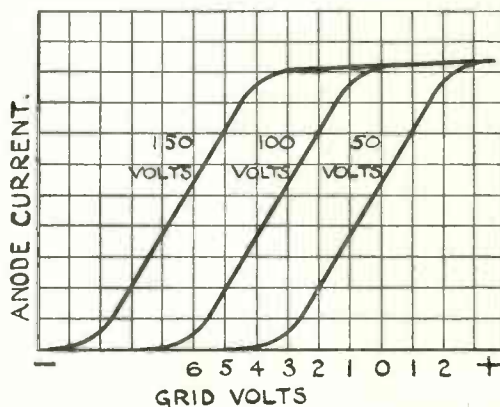

Fig. 2.—As the anode voltage is increased, the curve moves to the left.

efficiency it follows that the available power in the next stage must be increased. This means that a greater anode voltage must be used, and a greater negative grid bias will also be required. Similarly a third stage will require even greater values. It is impossible to give absolute values without the various constants of the circuit, but they should be determined as follows. The first stage of amplification should be connected, making the filament fairly bright, and using about 70 volts on the anode. If signals are at all strong a loud speaker must be used in place of telephones, as it is impossible to judge the quality with an over-loaded telephone. It is advisable also to use a crystal as the rectifier. The grid bias should then be adjusted in conjunction with the anode voltage. As the grid is made negative the strength and quality of the signal will

improve, and will continue to do so until a critical value at which maximum amplification will be obtained. When this point is reached it is advisable to see if increasing the anode voltage will give a further increase in signal strength. The same procedure is then carried out with the subsequent stages. As a rough guide, the following table shows the comparative values of the voltages required for successive stages of amplification:—

| Valve.    | Grid Bias. | Anode Voltage. | Valve.            |
|-----------|------------|----------------|-------------------|
| 1st Stage | — 2        | 100            | R type.           |
| 2nd Stage | — 6        | 150            | Very hard R type. |
| 3rd Stage | —12        | 300            | Small power valve |

Another cause of distortion is sometimes due to excessive radio-frequency amplification. Too many stages of radio-frequency amplification build up such big potentials that they are not only distorted in the last

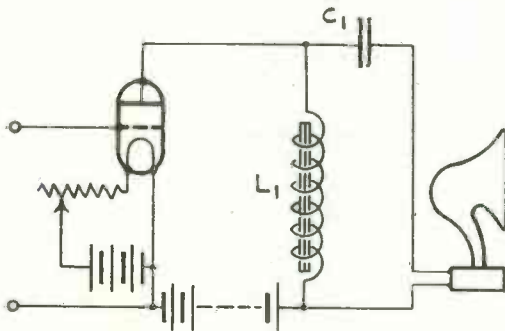

Fig. 3.—The loud speaker is connected across a choke  $L_r$  through a condenser  $C_1$ .

stage of radio-frequency amplification, but are not properly rectified, the peak voltages being lost which are responsible for the quality of the speech. The resulting speech is "tinny" and "rusty." The remedy is obvious, it being merely necessary to cut out the unnecessary stages of amplification.

**Loud Speaker Connections.**

With regard to the loud speaker, it must be remembered that it is by means of this that the quality of the speech is judged, and it must be assumed that there is nothing wrong with it. If another type is available it is useful to make all tests with each of the

loud speakers. It will probably be found that a small condenser of about 0.002 mfd. in shunt will improve the quality to some extent. An arrangement sometimes employed with very satisfactory results is shown in Fig. 3. It will be seen that the loud speaker is connected across a large choke of the order of 2 Henries through a condenser of about 1 mfd.

If bad speech and music are still obtained the trouble probably lies in the instruments, or more often in their arrangement. A tendency to howl and a muffled sound is generally due to low-frequency reaction, which should always be avoided. Adjustment of the filaments will usually remedy this, or it may be necessary to try a different arrangement of the transformers. Many transformers have a large magnetic leakage, and interaction between the fields giving rise to a form of trouble which is best remedied by screening or alternatively the substitution of another transformer. A number of transformers have a ratio as large as 1 to 5, and are rather liable to give trouble by oscillating at an audible frequency, especially when there is a large negative grid bias. This can sometimes be rectified by experimenting with small condensers connected across the primary windings and elsewhere. The writer is in favour of ratios not greater than about 1 to 3.5, but it should be remembered that a transformer should really be made to suit the circuit and not the circuit to suit the transformer, as is unfortunately the case.

There is one form of distortion which is very hard to eliminate. Speech and music constitute a very large band of audible frequencies, the higher harmonics approaching radio frequencies. It is obviously very hard to arrange two or three transformers and a loud speaker so that they will respond proportionally to applied potentials at all frequencies from several hundreds to several thousands. The transformers are best suited for middle frequencies. The very low frequencies require a very large reactance value for the transformers. If this is provided the secondary reactance must be increased proportionally in order to keep the transformation ratio constant. The additional winding increases the self-capacity of the secondary enormously, with the result that it has a by-passing effect, especially on the

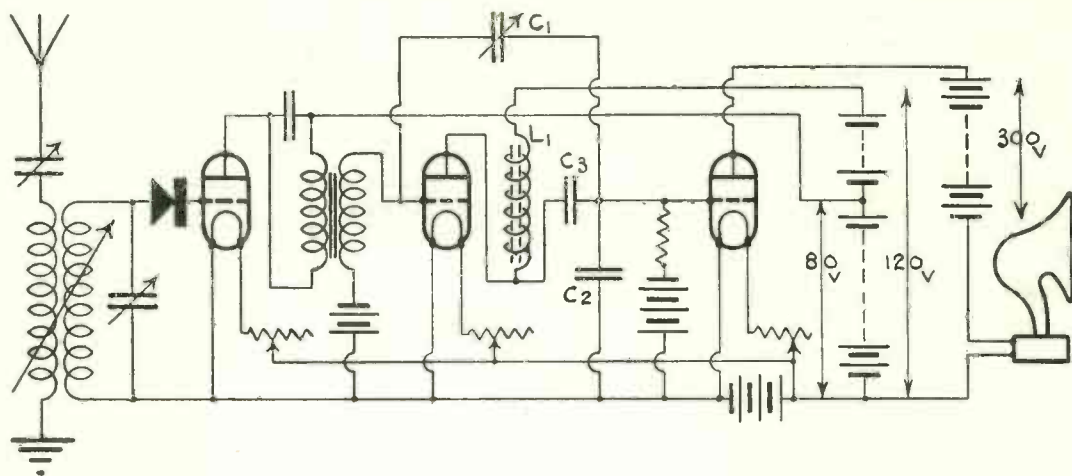

Fig. 4.—A novel circuit embodying several interesting features. The condenser  $C_1$  is used to obtain negative audio frequency reaction and  $C_2$  is used to by-pass high audio frequencies which are amplified too much by the second valve.

higher speech frequencies. It is obvious, then, that if an unequal amplification occurs, more particularly with music, that the original timbre and colour can never be faithfully reproduced. The resistance coupled amplifier, being aperiodic, is more perfect in this respect, but requires very careful adjustment, and, of course, no voltage step up is obtained with successive stages of amplification.

#### An Interesting Circuit.

Much time and experiment can be devoted to distortionless amplification, and, in conclusion, some details of a circuit which has a moderately high efficiency will, no doubt, be of interest. Rectification is obtained by a crystal, which is connected directly to the first valve, the anode voltage being about 80. This is coupled to the next valve by a 1 to 3 transformer, shunted by a condenser of about 0.002 mfd., the anode voltage being about 120. The second valve is coupled to a Marconi Osram T15 by a large choke, the secondary winding of an old motor spark coil being suitable. The coupling condenser is 0.25 mfd., and the grid leak is about one megohm connected to an 8-volt grid cell. Owing to the large emission from the filament the grid normally assumes a large negative potential, and the grid cell can sometimes be dispensed with, depending upon the actual conditions of the circuit. It will be seen that a separate anode supply of the order of 300 volts is used for the last valve.

In order to keep the loud speaker at earth potential it is included in the negative lead, the positive going direct to the anode. This particular circuit was found to amplify the higher frequencies too much, and this was overcome to a certain extent by shunting the grid and filament of the last valve with a 0.002 mfd. condenser. If low-frequency reaction is present to any extent a condenser of about 0.0003 mfd. can be placed between the grids of the last two valves. The value, of course, is rather critical. Experimenters who are interested in pure reproduction will find the subject of distortionless amplification very fascinating if they care to approach it by what the writer has termed "constructive amplification," which if not a truly scientific method, is both instructive and interesting. Having rectified the incoming oscillations as purely as possible, they are amplified by several low frequency stages, various devices being included to control the degree of amplification of various bands of frequencies. It will be seen from the foregoing notes that distortion is chiefly due to the working conditions of the instruments and not to the apparatus itself, and consequently any experimenter who is pleased to allow his loud speaker to emit anything but perfectly intelligible speech and music rich in tone and colour is doing little else but demonstrating his unfamiliarity with wireless apparatus, and is at the same time prejudicing his friends against broadcasting.

P. D. T.



# Efficient Transmission.

By FREDERIC L. HOGG.

Many experimenters interested in transmission are content to connect an ordinary valve oscillator to a receiving aerial and expect good results. The following article, by an experimenter who has been heard in America, will show that many special circuits and arrangements are necessary for efficient transmission.

THE subject of efficiency in transmission has not had much attention paid to it by radio amateurs in this country. Perhaps this is due to the lack of information about transmission in radio journals, and it is hoped that many will now give their experiences and information to others through this magazine.

The usual procedure in making a transmitter is to build up a nice set in a box, using the conventional reaction circuit—or "reversed feed back"—and to fiddle with this till the ammeter moves a bit. Having got a reading on the ammeter the input is pushed up to an unmentionable value till there is an appreciable aerial current. Most people affirm that it is impossible to have more than, say, .8 amp. in the aerial on 10 watts, and that .5 is a good average. This is absolutely incorrect. On any ordinary aerial a current of at least 1 amp. should be obtained, and more under good circumstances.

How many amateurs who have really good receivers have found it possible to build their receivers without a considerable amount of experimental work? Of course, anyone can make a receiver work, but what is meant is the kind of receiver which will give good transatlantic results.

Considering the fact that in a receiver one can allow a considerable amount of loss which will be counteracted by reaction, and that in a transmitter such losses must be made up by input power, it is obvious that far more care must be taken over the transmitter. The usual receiving aerial and earth are generally no use at all for transmission, but when they are made suitable for transmission a difference in reception will be noticed. This is a point very few realise; it is far harder to make a really successful transmitter than it is to make a good receiver. The remarks I propose to make on this subject will refer to 200-metre work in the

main, although they will apply to a certain extent to the higher waves as well.

## The Aerial System.

First of all, let us take the aerial system. It is well known that a curve can be drawn showing the resistance of the aerial at different wave-lengths. A typical curve is shown in Fig. 1. The total resistance  $R_a$  is made up of three separate components, *i.e.*, the true radiation resistance of the aerial (representing the actual energy used usefully) —  $R_r$ ; the losses due to ground resistance and wire resistance, etc., —  $R_g$ ; and the dielectric losses due to houses,

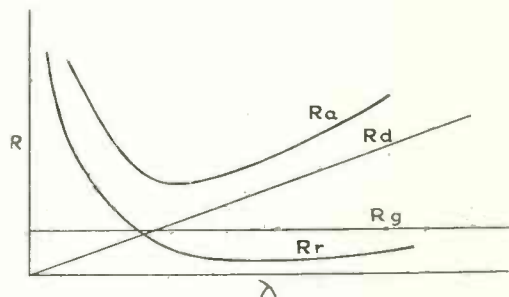

Fig. 1.—Illustrating the three components of the radiation resistance curve of a typical aerial.

trees, etc., —  $R_d$ . These three components are shown in the figure. For the moment this will be assumed, but possibly may be discussed at length in a future article. It will be seen that near the fundamental the total  $R_g$  and  $R_d$  are least and that  $R_r$  is greatest. From this it has been assumed that the best point at which to work an aerial is at its fundamental, as here  $R_r$  is theoretically infinite. This view is particularly popular in the U.S.A., but, while I agree as regards theory, in practice things appear very different. However, whether the reader agrees or not, he will grant this point: Given any particular wave, the higher the radiation

current on that wave and aerial the more efficient the transmitter.

Before proceeding a note on fundamentals would not be out of place. We all know that the fundamental of an L aerial is approximately  $4\frac{1}{4}$  times its length in metres or 1.5 times its length in feet. But this is usually quite wrong when applied to amateur aerials, for not only must we count the length of aerial, but also the lead-in and earth lead. As an example, my own aerial, which is an exaggerated case, will be quoted. Length of top, 60 ft.; length of down lead to roof, 15 ft.; length from lead-in to set, 10 ft.; length from set to level of counterpoise, 45 ft.; total, 130 ft. This gives a natural wave-length of about 195 metres. The actual natural wave-length is 192 metres. Most people would say such an aerial would have a natural wave of about 90—100 metres. I have found by trial on quite a number of aerials that 1.5 times the length in feet of

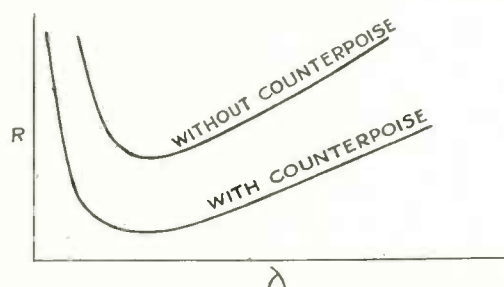

Fig. 2.—It will be seen that the use of a counterpoise lowers the radiation resistance of the aerial to a considerable extent.

all leads from earth or counterpoise level to free end of aerial gives a very good approximation. Now this explains why people have difficulty in getting down to short waves.

We see, then, that we can get greater aerial currents by eliminating the wasteful  $R_d$  and  $R_g$  losses.  $R_d$  is, unfortunately, usually fixed for any particular location, though if the operator can remove all trees, houses, etc., in the neighbourhood so much the better! Often a noticeable difference is made by carefully breaking and insulating all guys, etc., and keeping the aerial well away from the masts. However, in most cases  $R_g$  is the factor which counts most. The usual water pipe earth has a colossal resistance, and buried plates have too small an active area to be any use for transmitting.

### The Counterpoise.

The only thing to do is to use a counterpoise under the aerial. This should be as large as possible, and perfectly insulated, about 6 ft. above the ground in the ideal case, although in practice a couple of wires 10 or 12 ft. above the ground under the aerial are often far better than the usual earths. Also the capacity and natural wave-length fall, which is, in many cases, an advantage, as a bigger inductance can be used in the aerial circuit, with better transference of energy. This, of course, only applies in some cases. Anyhow, the first thing to do is to put up as large a counterpoise with as many wires as possible. The smaller the amount of the sky visible from the ground the better. The whole must be insulated just as carefully as is the aerial. With quite a small counterpoise of six wires spaced a foot apart, and 12 ft. high, the resistance of my own aerial was reduced from 38 to 5 ohms on 200 metres, which is certainly an extreme case, but I have heard of worse cases. It is safe to say that in every case of an average amateur station a counterpoise will improve results. Having now a counterpoise, we have reduced  $R_g$  considerably, which is a considerable advantage. We have also altered our fundamental a little if the counterpoise is small, but this is not of great significance. As to the aerial itself, a larger number of wires than are used for reception are probably an advantage—three or four are generally suitable. A cage has a very slight theoretical advantage in some circumstances, but is not always worth the trouble of building. A well-spaced (4 or 5 ft.) four-wire flat top is as good as anything to begin with. The usual wire is quite suitable, but it should preferably be enamelled. The insulation must be far better than usual. The ordinary small shell or egg insulators are no good unless they are cleaned every few days. They are quite useless for large aerial currents also. If nothing better can be obtained a string of at least three insulators should be placed at each end of each wire. The best insulators to use are 12-in. or 18-in. glazed porcelain rods of best quality. Composition and ebonite insulators should invariably be avoided. The importance of insulation is still greater on high powers, say 100 watts and over; the ordinary types will brush

over and the composition ones melt. The lead-in is of equal importance. A large porcelain tube should be used, or, if possible, no lead-in tube at all.

**Aerial Current.**

Having now a good aerial, we can proceed to other parts of the set. But first let us consider what aerial currents we should get on 10 watts input. We all know that—

$$\text{watts input} \times \text{efficiency} = \text{watts output.}$$

$$\text{And watts} = (\text{current})^2 \times \text{resistance of circuit.}$$

$$\therefore \text{watts input to anode} \times \text{efficiency} = (\text{aerial current})^2 \times R_a.$$

Now the efficiency and  $R_a$  are both unknown, but if we can tabulate  $\frac{R_a}{\eta}$ , where  $\eta$  is the efficiency, we can get an idea of what is taking place. The smaller this figure the better our transmitter. It is usually assumed that  $\eta$  is .5 for a valve, but this figure can be easily exceeded. Many commercial stations have efficiencies of .85 to .9, and .75 should be obtained by any amateur. The efficiency is governed largely by the

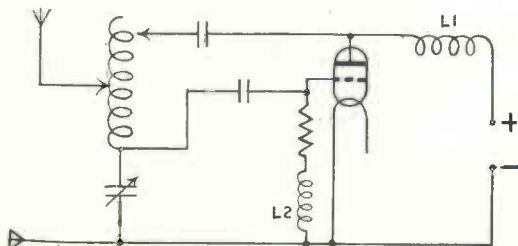

Fig. 3.—Colpitt's Oscillator. Here the grid coupling is capacitive. The choke (L2) in series with the grid leak should always be used when the leak is connected to the filament.

anode tap, grid leak and H.T. voltage. To a certain extent the greater the values of these three the greater the efficiency, though, of course, there are many other factors. Now, at its lowest point the resistance of an average amateur aerial with counterpoise is below 10 ohms. If it is not, there is something wrong somewhere. The number of aerials with a higher resistance is very small indeed, and many fall as low as 5 ohms or less. Now, if we have an input of 10 watts in a 10-ohm aerial at .75 efficiency we get an aerial current of .87 amp. With a little care the 10 ohms can be reduced to 5 ohms and the efficiency increased to .8, which gives us a current of 1.26 amps. These figures

show us there is something wrong with the average .5 or .6.

If the aerial resistance is above 5 ohms at its lowest point the trouble is probably due to ground resistance and can be reduced, but this subject will be dealt with later. We will consider the subject of efficiency inside rather than outside the station. If we have any sort of an aerial we should be

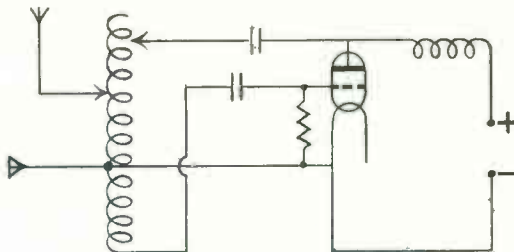

Fig. 4.—The Hartley circuit is somewhat similar to the Colpitts, and is better suited to low impedance valves.

getting somewhere about 1 amp. of aerial current.

An important point to consider is the earth-counterpoise arrangement. To start with, at any rate, it is best to use only a perfectly insulated counterpoise. Later, earths can be added, tuned by condensers. This will prevent certain difficulties arising. If an earth and a counterpoise are connected together to a set the aerial current usually goes down, for the currents in the two will be out of phase because of their different capacities and resistances. Each separate earth must be tuned, which, of course, is a complication, and should only be attempted when results on counterpoise alone are efficient. If an earthed H.T. supply is used an R.F. choke should be placed in series with each lead, which will eliminate the trouble.

**The Aerial Ammeter.**

The next point to consider is one of the utmost importance, which is usually neglected, *i.e.*, the aerial ammeter. Most people get a hot wire 0—5 instrument, and try to get it off the scale before proceeding further. But if we have an aerial whose resistance is, say, 10 ohms, and put in an instrument with a resistance of 5 ohms—which is the resistance of such a meter—we are losing a third of our aerial power. The 0—1.5-amp. type has a resistance of 1—1.5 ohms, which is

an enormous difference in practice. As an example, on a certain set with a 0.5 ammeter of 4.58 ohms resistance and a 6-ohm aerial a current of .45 amp. was obtained. On substituting a 0-1.5 of 1.29 ohms resistance the current was .82 amp. Here, of course, the efficiency altered, but especially when using a fairly low H.T. voltage a slight decrease of resistance will increase the efficiency when other adjustments fail. I have known of several cases where the whole trouble of seemingly poor

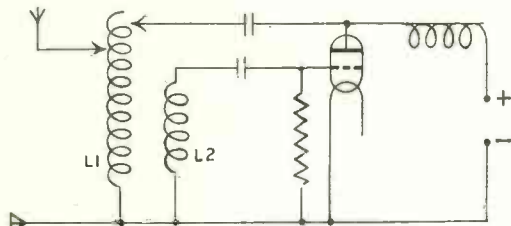

Fig. 5.—The Reversed Feedback or reaction circuit is most familiar, and is suitable for general work.

results was due to the aerial ammeter. An ammeter should always be checked, if possible, against a standard instrument. They will read fairly accurately on D.C., as the inductance is very small. If no standard is available a lot can be done with a 2-volt accumulator and an accurate D.C. voltmeter or ammeter. If an ammeter is obtainable the procedure is obvious. If a voltmeter is used a small known series resistance must be used, and the current can be calculated by the volt drop across the resistance. The inaccuracy can often be corrected to a great extent by altering the tension of the wire and re-setting the pointer, but it should be checked over the whole range if possible. A thermocouple is, of course, better, but is usually out of the question for most amateurs on account of the high price. They can be depended upon for years, while a hot-wire ammeter needs checking every few months.

#### Transmission Circuits.

Now as to the circuit to use. There are seven main types of circuits to use, *i.e.*, Colpitts, Hartley, Meissner, reversed feed back (direct or loose coupled), master oscillator, and ratio tap. These are illustrated in Figs. 3 to 9. Most of these names are American, I know, but it is much easier

to have a name than to describe the circuit each time. Let us consider these one by one.

The Colpitts circuit is the easiest circuit to get satisfactory results from, and gives, as a rule, a greater efficiency than any other circuit. It is ideal for rapid wave-changing, only two adjustments being necessary to cover a band of, say, 100 metres. Also the series condenser enables a larger aerial to be used than is possible on other circuits, as a certain amount of inductance must be in the aerial circuit to get a transfer of energy from valve to aerial. But, you may say, one can use a series condenser on any circuit. This is quite true, but for some obscure reason the Colpitts series condenser and other series condensers have not the same effect. It is possible to use quite a high loss condenser in the Colpitts circuit without effect, whereas this is fatal in any other case. This is not a particular experience, but is the result of tests at a number of stations. There is as yet no explanation forthcoming for such behaviour as this, but the fact remains that in the ordinary case a series condenser is inefficient, whereas on a Colpitts it is anything but. The aerial inductance should be larger than usual, and the series condenser should be about .001 mfd.

The Hartley circuit does not appear to be very successful in England. In America it is used a great deal for high-power work,

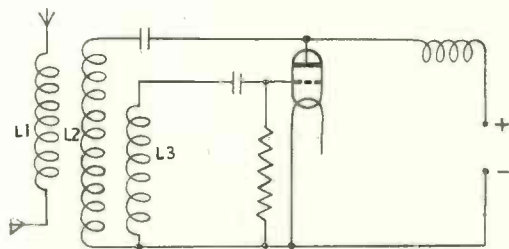

Fig. 6.—Illustrating the loose-coupled reaction circuit. Here again a choke is placed in the anode circuit, which is always necessary when the anode is supplied in shunt.

but it does not appear to suit our valves. The aerial coil again needs to be of very large inductance. This circuit is of more use for artificial circuits, drivers, etc., than for ordinary work. It will not give results on a high-resistance aerial, nor on high impedance valves, which last accounts for its prominence in the States and not here, as American valves are of much lower impedance than ours.

The reversed feed back circuit is our usual two-coil reaction circuit, which nearly everyone uses. This is a very straightforward circuit, and works very well if care is given to the value of anode tap.

The loose-coupled reversed feed back is sometimes used, but has little advantage for amateur work.

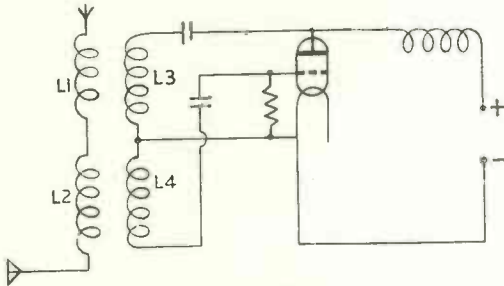

Fig. 7.—In the Meissner oscillator, the aerial inductance is split and the anode and grid coils are each coupled to one half.

The Meissner circuit is really the loose-coupled reversed feed back circuit rearranged. The aerial coil is split into two parts, and the plate and grid coils are each coupled to one part, but not to each other. This is supposed to lead to simple wave-changing, but whether this is so is a matter of opinion.

The master oscillator is really the ideal circuit, but it requires very careful handling, and an extra valve. On high-power work, also, the power valve has to be of larger size than usual in case it should stop oscillating, which is more likely with this circuit than any other. The grid of the power

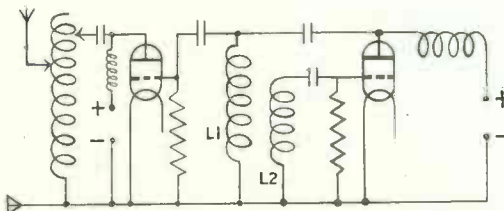

Fig. 8.—The oscillations are produced by L1, L2, and control the grid of the power valve.

valve is connected to an oscillator tuned to the required wave, and so the plate output frequency is independent of the aerial tuning, resulting in a perfectly constant wave-length, however much the aerial may swing. A receiving valve will control a 30-watt transmitter if about 200 volts are

put on the plate, and a 50-watt valve will control a 250 transmitter.

The "ratio tap" circuit is due to Capt. P. P. Eckersley, well known to all British amateurs. The anode coil has a very large number of turns of fairly thin wire, and the aerial coil is wound right on top of this. The grid coil is coupled in the usual way. This circuit enables an aerial to be worked on a wave nearer its fundamental than any other circuit not using a series condenser. The anode coil for 200-metre work should have a natural wave-length of 400-600 metres.

**The Aerial Inductance.**

We now have a choice of circuits to select from. Personally, I would recommend the Colpitts for simplicity and efficiency, followed by the master oscillator, whose advantages are very great, although it is hard to work. However, the choice must be left to the individual experimenter. As regards the

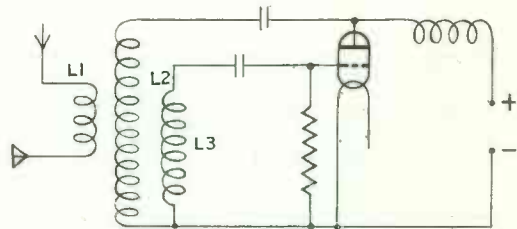

Fig. 9.—In the ratio tap circuit, the aerial coil L1 is wound over the anode coil L2, consisting of many turns of fine wire.

set, the best procedure is to build it up on a large table, keeping the wiring spaced very well—far more than in a receiver. The aerial coil should, if possible, be of very large diameter—up to 18 ins.—and wound with aerial wire, turns spaced half an inch or so. Twenty-five turns on a hexagonal frame of ebonite rod, spaced 1/8 in. on an 18-in. diameter is a suitable size to commence with. The grid leak is another important thing. This must be variable. It may conveniently be a small column of water in a glass tube with movable electrodes. The careful adjustment of the grid leak is a great aid to efficiency. The anode tap is also of vital importance. The anode coil will, on 200 metres, be larger than the aerial portion, and must be adjusted for best results. The more anode coil in circuit the lower the input falls, but, of course, at a

certain point the aerial current falls as well. Just before this point is the most efficient position of working. At this position we have the aerial impedance and the anode circuit impedance equal, which means we have the best transfer of energy. It is an advantage to use as high an H.T. value as possible, and a consequently small current. An ordinary 30-watt valve will stand 1,500 volts comfortably on a 10 to 20-watt total input with astonishing efficiency if carefully adjusted, although theoretically the maximum allowable anode voltage is 1,000 volts.

The most important points are these:—

- (1) Use a counterpoise.
- (2) Use a high H.T. voltage.
- (3) Use a variable grid leak, as high a value as possible.
- (4) Use a variable anode tap, as high a value as possible.

I hope these notes will enable many to make their sets more efficient and so obtain greater ranges than before. If we get to Holland, Scotland and Spain on 3 to 5, we can look forward to getting to the U.S.A. on our efficiently radiated 10 watts in the winter.

At some future date I hope to discuss some of these points more fully than is possible here. Experiments, such as the measurement of radiation resistance, should be carried out by every amateur, and many would be considerably surprised to see their aerial curves.

Finally, I would emphasise the need of a great deal of experimenting before good results can be expected. Your first receiver was not the last word in efficiency, so don't expect your transmitter to be so the first time you fit it up.



The accompanying photograph illustrates the new antenna system which has just been erected at the WGY broadcasting station. The aerial contrasts greatly with those of our own broadcasting stations which employ a cage type. The flat top aerial seems to be used more in America than here, although many experimenters now employ the flat top for transmission purposes.

# The Design and Operation of Tuned Anode Receivers.

BY CAPTAIN ST. CLAIR-FINLAY, B.Sc.E. (Laus.),

*Late Chief Experimental Officer Research Commission, Technical Adviser Inter-Allied Technical Council.*

THE following notes upon a practical receiving circuit for general amateur use deal primarily with a system of radio-frequency amplification, the principle of which is, of course, well known and widely used in one form or another, and the particular form about to be described, first used by the writer in connection with short-wave work in the relatively early days of valves, is now given in no sense as a novelty, but as an outcome of more recent development along these earlier lines towards a really practical and efficient receiver for medium and short-wave work, which it is hoped may be of interest to experimenters, to whose purposes it is particularly suitable.

It is termed by the writer a duo-regenerative circuit, and the principle upon which it is based is the reactance-capacity—or, as it is, perhaps, better known, the tuned anode—method of radio-frequency coupling, one that has been the subject of much booming, use, and, unfortunately, ill-use of late in connection with broadcast reception; but if readers of the present article will try to forget its “barrel organ” guise, and will consider it for a moment from the scientific standpoint, they will—if they have not already done so—find in it much of at least potential interest and use to them.

To begin with, it is one of the most efficient known methods, and probably the most practical method, of radio-frequency coupling for medium and short wave-lengths below, say, 2,000 metres (*i.e.*, the band with which amateur experimenters are chiefly concerned), though this by no means represents the limits of its utility; and over this band, down to very short waves, and particularly including short waves, possesses properties of special value, the degrees of amplification and selectivity obtainable and the general practicability of the system being of a high order, whilst the instability commonly attributed to it is largely a chimera due for the

most part to imperfect application of the principles involved; and it is the purpose of these notes, firstly, to discuss these principles in general terms and to suggest how best they may be applied for the avoidance of such pitfalls; secondly, to describe a particular form of circuit that has proved particularly satisfactory in practice; and, thirdly, to indicate the results obtainable with such circuit.

The principle of operation of the tuned anode is probably well known to the majority of readers of this journal, but, to make what follows the clearer, it may be well—without entering into unnecessary technicalities—to touch upon this briefly first of all.

The “tuned anode” is simply a resonant rejector circuit excited by incoming high-frequency currents, just like the aerial circuits itself, except that the currents have first been amplified by passage through the valve to which the anode belongs and are, therefore, able to excite this second tuned circuit more strongly than the aerial circuit was excited by the original unamplified currents.

The strong excitation of this second circuit gives rise to increased potential differences across the inductance therein, which are passed on to the grid of another valve for repetition of the process or for rectification or both, the function of the valve thus being current amplification and of the tuned circuit, the conversion of this into voltage amplification, the inductance acting as an auto-transformer. In fact, this arrangement is sometimes known as auto-transformer coupling, and the difference between it and transformer coupling is the same as that between choke and transformer couplings in audio-frequency circuits, and the principles involved are the same, both forms of auto-transformer or “choke” operating on the principle of self-induction.

Now a comparison between tuned anode and transformer coupling will show them to be identical, except that the actual intervalve coupling itself is in the latter case inductive or magnetic, whilst in the former it is static, and herein lies the great practical difference that, whereas in the one case an extra tuned circuit is necessitated for full efficiency, in the other it is not, and this is where the tuned anode method particularly scores. In fact, transformer coupling is nothing more nor less than a tuned anode to which is added another circuit simply for intervalve coupling purposes, some break in the electrical continuity of the intervalve circuit being, of course, necessary so far as the continuous current component therein is concerned so that the high-tension battery potentials shall not be impressed directly upon the grid of the valve, and, in view of the popularity of transformer coupling amongst amateurs, it may be as well to examine both systems in order that their relative advantages may be compared.

The simplicity of the tuned anode as compared with transformer coupling is obvious and will not be questioned, and it remains, therefore, to consider whether or not the extra complexity of the latter is justified by attendant advantages.

First, there is the question of amplification, as to whether the addition of the extra circuit should result in any material increase in this. Since the potentials across the secondary circuit will, other things being equal, depend (a) upon those in the primary; (b) the induction ratio between primary and secondary; and (c) the transformer losses, it follows that a step-up effect will be obtained only if the secondary-to-primary induction ratio is made large enough to overcome the transformer losses without the primary potentials being at the same time reduced; and since in a tuned circuit the available induction is governed by the resonance frequency, and this will, of course, be the same in both circuits, it is evident that no material step-up effect between them can be looked for.

It might be thought that this could be arranged by reducing the induction in the primary circuit and increasing the capacity therein to arrive at the same frequency, whilst doing the reverse in the secondary circuit, but, unfortunately, electricity refuses

to be "wangled" like this, and the plan does not answer in practice because reducing the primary induction also reduces the initial potentials, and this completely discounts the step-up effect gained, on the principle that  $1 \times 4$  has the same result as  $2 \times 2$ ; and, in fact, the result in this case is not even quite "as you were," since, whilst the reduction of induction and increase of capacity reduces the efficiency of the primary circuit as shown, the reverse process reduces that of the secondary also by reducing its periodicity and thereby flattening out its potential peak, this aperiodicity moreover making strict resonance of the circuit impossible and thereby impairing its selective properties.

In practice, therefore, no material gain in amplification is obtained by the addition of a secondary intervalve circuit, tuned or otherwise.

Then there is the question of selectivity. A tuned anode constitutes, as has been shown, a resonant high-frequency choke, *i.e.*, an efficient rejector of the desired oscillations which produce excitation of the circuit and are shunted off in their entirety and in amplified degree to the grid of a following valve, and a more or less efficient acceptor of undesired oscillations which do not produce excitation of the circuit and are not shunted, but pass through the circuit and away to earth. A certain proportion of these do, of course, reach the grid of the next valve together with the desired oscillations, but, whereas these latter have been amplified by the action of the circuit, the former have not, so are comparatively greatly suppressed. The percentage of undesired signals that will reach the grid of the following valve, other things being equal, will depend upon the high-frequency resistance or damping of the rejector circuit, and will only approach zero if the damping is zero, a condition which does not naturally obtain, but which can fortunately be approached in practice by the introduction of reaction into the circuit, which counteracts the effects of damping therein and enables the selectivity of the circuit to be greatly increased.

Now, in considering the question as to whether the addition of a secondary circuit—*i.e.*, the conversion of the simple tuned anode into transformer coupling—may be



expected materially to increase this selectivity, it must be appreciated that the currents flowing in the primary will be not only those due to the desired signals, but also those due to the undesired signals on their passage through the circuit in its function of acceptor thereof, so that transference of the desired signals from primary to secondary will, to some extent, be accompanied by transference of undesired signals also, the extent depending chiefly upon the degree of aperiodicity of the circuits. If the aperiodicity of either or both circuits is at all considerable, as is the case when neither or one only of them is closely tuned, the proportion of undesired signals reaching the grid of the next valve will be considerable also, and the selectivity of the arrangement proportionately poor, whereas if both circuits are in strict resonance the selectivity will be good because neither will respond at all readily to undesired oscillations and the transference of these will be small. But here, again, the effects of resistance in the circuits must be taken into consideration, as unless the damping be reduced by the introduction of reaction neither circuit will be sharply resonant, the selectivity in this case being certainly not superior, if as good, and the amplification considerably inferior to that obtainable with the tuned anode with reaction, which is the simpler arrangement.

It will, therefore, be clear that transformer coupling has for our purposes no real advantage to offer over the tuned anode method unless reaction is applied, in which case a material—though not enormous—improvement in selectivity is certainly to be expected. But the introduction of this, of course, still further complicates the arrangement as compared with the tuned anode, and it is questionable whether, from the experimenter's standpoint, the resultant gain is at all worth the loss of handiness involved.

Practicability is, after all, one of the first and foremost essentials of the "standard" receiver of an experimental station where the wave-lengths received are continually varying. Complex arrangements involving a multiplicity of tuned circuits, etc., are all very well in the case of commercial or other stations operating on fixed wave-lengths, but are of little practical use in experimental stations where continual searching and tuning are the rule. Here conditions

are quite different, and it does not suffice for a receiver to be highly sensitive and selective if its tuning arrangements are so involved as to make searching with it a labour of frightfulness.

There is, of course, much interesting and useful experimental work to be done in the field of reception, but this concerns the present article only inasmuch as the more this is done at any given station, the more need will there be at that station for a practical "standard" receiver against which results may be compared, and with which ordinary tests and receptions may conveniently and reliably be carried out; and for this purpose the best type of receiver will manifestly be that which best combines the essential qualities of practicability, efficiency and dependability.

This the tuned anode undoubtedly does—or, at least is capable of doing—and it is the purpose of these notes to show not only why this should be so, but how it may be made so.

The actual circuit proposed will presently be described, but first of all it is desirable to deal with the pitfalls so that these may be avoided from the start and success be assured.

The most far-reaching of these lie in capacity-effects, upon which too much emphasis cannot be laid. Applicable as this, of course, is to all radio-frequency circuits, it is—as the very name implies—particularly so to reactance-capacity circuits, the success or otherwise of which are virtually bound up with this issue.

The golden rule is, in a nutshell—from beginning to end and throughout, from antenna to earth, and particularly in the receiver itself, avoid stray capacities as you would the plague.

This will, of course, be a matter chiefly of careful wiring arrangements and the avoidance of overcrowding of parts and circuits, and will be made clear by reference to Fig. 1, showing the capacities and couplings inherently existent in a valve and its associated circuits.

These may be said to comprise three separate but interacting capacities: X between the plate and grid of the valve and any leads attached thereto; Y between grid and filament and leads; and Z between plate and filament and leads. (See Fig. 1.)

Y and Z are small so far as the electrodes themselves are concerned, but begin to become appreciable where the leads come close together at the pinch, legs and sockets of the R-type of valve, and may become considerable if the wiring concerned is allowed to run close together or close to any other conductor, earthed or otherwise, in the receiver, the effects being to cause high-frequency losses in the plate and grid circuits and to reduce the natural frequency of these circuits so that, to counterbalance this, the inductance thereof has to be cut down for any given wave-length until for short waves insufficient induction will remain to produce the required potential differences in the circuits, the result being both loss of efficiency and limitation of the effective wave-band range of the receiver.

But more important still is the plate-grid capacity X, which, unfortunately, owing to the proximity and comparatively large size of the electrodes concerned, is the largest of the capacities within the valve itself, and is, of course, also subject to aggravation at the pinch and legs of the valve before we even get to the wiring of the receiver.

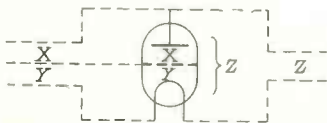

Fig. 1.—Illustrating the various capacities existing between the electrodes.

It is this capacity or coupling that is the most prolific source of trouble unless specially guarded against, as not only can it cause range limitations and high-frequency losses like Y and Z, but is also chiefly answerable for the bugbears of uncontrollable self-oscillation and general instability in such circuits for which, woefully common as they are, there is, in reality, no necessity at all.

Fig. 2, showing the tuned anode circuit with two forms of regenerative coupling, one of which will be recognised as inherent to it, should make this clear, in that it shows it to be nothing more nor less than a straightforward and fully-fledged self-oscillation or generative valve circuit adapted to reception instead of transmission purposes, requiring only a sufficiency of either capacity (Fig. 2A) or inductive (Fig. 2B) coupling between

the plate circuit  $L_2 - C_2$  and the grid circuit  $L_1 - C_1$  to become an active generator of continuous oscillations when these two circuits are in resonance; and since in practice they will, of course, be tuned to resonance, and an appreciable degree of coupling between them will exist inherently within the valve itself, it is not difficult to see where the danger lies or how it arises. It lies, of course, in any stray couplings the sum of which may so increase the inherent coupling as to give rise to persistent self-oscillation or an uncontrollable tendency thereto, thus making the receiver unstable and spoiling it for the reception at least of telephony, and arises (if allowed to do so) from mal-arrangement—from the scientific standpoint—of the receiver in general and of any wiring concerning the plate and grid circuits of the radio-frequency and rectifying valves in particular.

But the danger need not arise and its prevention is not difficult, although, strange to say, it does seem to be allowed to arise in more or less unnecessary degree in four cases out of five, frequently unknown to the operator, or at least unrecognised by him, because it is insidious and may not openly declare itself unless so extreme as to be obvious. In that case self-oscillation troubles, etc., will make their existence painfully evident, but up to that point the little instabilities, wave-range limitations, amplification, selectivity, sensitivity and general efficiency losses that are really going on *sub-rosa* may not be realised, and the operator may believe his receiver to be working quite well, simply because it functions without obvious shortcomings to open his eyes and he has no standard whereby to gauge its true capabilities. But let him compare it against such a standard, *viz.*, a similar receiver really scientifically designed and constructed, and what a tale will be unfolded!

The secret—if such it can be called—lies in *designing* the receiver before constructing it, in such a manner that stray capacities and couplings of any kind shall rigorously be reduced to a minimum, to which end particular attention should be directed to:—

(1) Arrangement of the wiring so that all leads—particularly those concerning plate and grid circuits—shall be as short and as widely separated as possible, both from one

another and from all other conductors, and the terminals, etc., concerned as far apart and isolated as possible.

(2) The use of coils, fittings, etc., of minimum self and incidental capacities.

(3) The use of low-capacity skeleton (air-spaced) type valve sockets and small nuts or threaded sleeves of ebonite, fibre or prepared wood in place of the usual metal nuts for their attachment to the panel; or preferably valves and holders of the anti-capacity type (not merely adapters plugged into ordinary sockets) if short-wave work is contemplated.

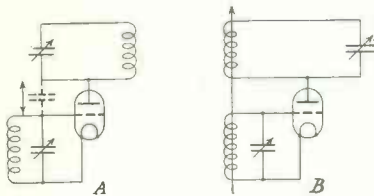

Fig. 2.—Illustrating the coupling between the grid and anode circuit.

(4) The use of low self-capacity and low resistance wire for all wiring and windings, such wire being preferably stranded, of reasonably generous gauge, and either air-spaced or covered only with cotton or other suitable insulator of low specific inductive capacity.

(5) The judicious use, particularly for short-wave work, of screening of any parts of the radio-frequency circuits likely to be subject to body or other stray capacities difficult of avoidance—such, for example, as tuning condensers, which should be earth-screened and provided with anti-capacity control handles.

And now for two important *don'ts* and a corollary:—

(6) Don't incorporate a complex system of jacks, plugs, switches, etc., on the radio-frequency side of the receiver—even of so-called "anti-capacity" type. These are all very well for audio-frequencies, and it may be very neat and convenient to be able to throw valves, etc., in and out of circuit by mere touch of a switch, but where radio-frequencies are concerned such conveniences invariably have to be paid for—often dearly paid for—in terms of far more important stability and general efficiency. It is an axiom in radio-frequency circuits that all wiring and connections therein should be as simple and straightforward as possible.

(7) Don't attempt to make a tuned anode receiver of the waistcoat-pocket type; do not squeeze it into a small space or cramp it in any way, but allow plenty of room for adequate spacing and proper arrangement of everything.

(8) Finally, and in fine, do not in any way sacrifice *efficiency* for mere neatness of appearance or convenience; reconcile all three as far as possible—a well-designed receiver usually will look workmanlike—but let this be quite an incidental consideration and efficiency always the foremost.

In fact, give to the design and construction of the receiver the same meticulous care and consideration that you would to a low-power transmitter in which little leakages and inefficiencies cannot be afforded. They can still less be afforded in a receiver, and all trouble taken for their avoidance will be amply rewarded.

It may here be remarked that all recommendations and the majority of comments made in these notes in reference specifically to tuned anode coupling apply equally—in some cases even more vitally—to transformer coupling, and, indeed, to radio-frequency circuits of any kind, the tuned anode not being specially more delicate or susceptible—with certain reservations mentioned—than most other systems.

It is not, of course, suggested that observance of the few simple rules given is all that is necessary to ensure complete success with reactance-capacity or any other system; but it will be so great a part of the battle that the foundations at least of a thoroughly efficient and satisfactory receiver will have been laid, and we can now go on to discuss the proposed circuit itself without doubt as to its complete success in practice.

The basis of this circuit is shown in Fig. 3, and will be seen to be a straightforward tuned anode circuit with reaction (shown coupled to the A.T.I. for simplicity) arranged in a not unorthodox but, in practice, somewhat unusual way, the whole constituting, as it stands, an autodyne receiver for C.W. and simple regenerative receiver for telephony which should be regarded for the present purposes as one unit, the reason for which will presently become clear.

The considerations underlying the reaction arrangement shown are:—

(1) That since the tuned anode or plate

circuit of the first valve  $V_1$  will in any case include an inductance  $L_2$  and condenser  $C_2$  for tuning purposes, it may as well be utilised to furnish the desired regeneration on the aerial circuit simultaneously with its ordinary functions, which it is able to do without loss of efficiency in any respect, thus saving an extra reactance and, perhaps, tuned circuit for this purpose, and considerably simplifying the arrangement both as to construction and operation.

(2) That the reactance thus constituted, being tuned, is of the most efficient type.

(3) That regeneration is by this means introduced directly into the aerial circuit and the grid circuit of the second valve  $V_2$  simultaneously, which is not fully possible with the usual arrangement in which the reaction onto the aerial circuit is derived from the plate circuit of the detector, although it does, of course, benefit to some extent indirectly through being in train.

(4) That for heterodyne reception it is preferable that the oscillating valve be, if possible, purely a radio-frequency valve and should not combine a different function such as rectification, whence it is better that regeneration should, for this purpose, be as derived from the H.F. valve  $V_1$  itself, and not from  $V_2$ .

Now such a circuit, although its use with an outside aerial is not permissible during broadcasting hours owing to the fact that oscillation of  $V_1$  will, of course, energise the aerial, constitutes a very efficient receiver for both C.W. and telephony, and has the advantage of extreme simplicity; in fact, there being but the two tuned circuits  $L_1-C_1$  and  $L_2-C_2$  and the coupling between them to consider, it is as simple to operate as the majority of single-valve and even crystal receivers, though its sensitivity is, of course, much greater, whilst for heterodyne reception of short waves it could scarcely be bettered, being quite as efficient as a normal separate heterodyne.

For the reception of telephony in particular, however, this circuit, good as it is, is capable of improvement in certain respects, the first of these being selectivity. It will be found, as it stands, quite selective enough for most practical purposes where relatively weak signals are concerned, the tuning, in fact, being decidedly sharp with such, thanks to the rejector circuit  $L_2-C_2$  and the

regeneration introduced thereby, but for very strong signals, such as those from broadcasting or nearby transmitting stations, there is certainly room for improvement. Secondly, its sensitivity can be still further increased to a very material and useful extent. And, thirdly, provision can be made to permit of its use with regeneration during broadcasting hours. And all three of these important improvements can be obtained without materially complicating the arrangement in any way.

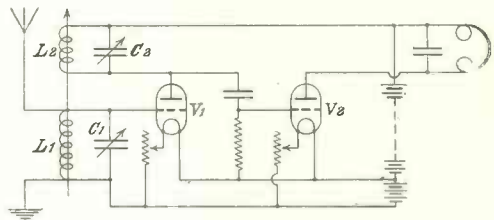

Fig. 3.—The basic regenerative tuned anode circuit.

This development is shown in Fig. 4, and will be seen to consist of the introduction of an additional (untuned) reaction circuit  $L_3$  from the plate of the detector  $V_2$  on to the anode circuit  $L_2-C_2$  of the first valve, by means of which the high-frequency component in the former—otherwise useless—is utilised to introduce reaction into its own grid circuit, thus completing the regeneration train and causing the detector  $V_1$  to function also as a second radio-frequency amplifier with considerable efficiency, and enabling reaction to be applied to the aerial and rejector circuits  $L_1-C_1$  and  $L_2-C_2$  independently.

The objects of this are threefold, *viz.* :—

(1) To permit of intervalve reaction during broadcasting hours, when, of course, the aerial reaction provided by the first valve cannot be used.

(2) To enable *both*  $V_1$  and  $V_2$  to be brought to that point immediately preceding self-oscillation where, owing in effect to steepening of the normal characteristic curve, abnormal sensitivity obtains.

(3) To provide against unbalance of the two circuits which, owing to inequality of their inherent damping, ordinarily results in the damping in one of them being reduced to zero before an equal condition is obtained in the other, self-oscillation thus setting in considerably before maximum sensitivity

can be attained, this being an inherent weakness in most reaction circuits. Now the introduction of reaction independently on to both  $L_1-C_1$  and  $L_2-C_2$  enables the damping in both parts of the circuit to be reduced to zero or thereabouts simultaneously and the full benefits of regeneration to be obtained in either or both circuits independently or simultaneously as desired up to the point of self-oscillation of either valve, thus enabling maximum efficiency to be obtained.

The increase of sensitivity resulting from this arrangement may be in the neighbourhood of as much as 50 per cent. over that obtainable with the single reaction circuit of Fig. 3, whilst the improvement in selectivity is such that a closed aerial circuit becomes for most practical purposes quite unnecessary, and is therefore dispensed with in Fig. 4, thus maintaining the simplicity of operation of the circuit as a whole. In fact, it will be seen that, since  $L_3$  need not be tuned, little or no extra complication is introduced thereby, and there remain only the two tuned circuits  $L_1-C_1$  and  $L_2-C_2$  and their couplings to consider.

Some doubt may be felt concerning the absence of a closed aerial circuit, but it should be borne in mind, firstly, that the use of such with direct reaction is just as restricted under P.M.G. regulations as is a similar arrangement with open circuit, and secondly, that loose coupling is merely one way of obtaining selectivity—neither the only nor necessarily the most efficient way.

The arrangement of Fig. 4 will, in practice, be found fully as effective in this and all other respects as a closed reaction circuit, the use of which is, in fact, not recommended with it, owing, firstly, to the unnecessary extra complication involved; and, secondly, to its liability to cause a tendency to instability and undesirable self-oscillation in this connection.

And now we have touched upon the one weakness of the Fig. 4 circuit, *viz.*, a slight tendency to instability and consequent trickiness in operation which may in practice sometimes prevent full realisation of its virtues in other respects, and the overcoming of this in a simple and effective manner is a further and last improvement which our quest for efficiency and practicability calls upon us to make.

This final development is shown in Fig. 5, which shows the complete receiver advocated in the present article, and will be seen to consist of provision for control of the plate voltage and grid potentials of  $V_1$  and  $V_2$  in a simple and straightforward manner, which has the further advantages, as compared with the usual potentiometer methods, that neither is undesirable resistance introduced into the circuits, nor is any extra drain imposed upon the filament battery.

By this means the respective and relative plate, grid, and filament potentials are readily adjustable, so that any tendency to instability disappears and the maximum sensitivity, amplification and general efficiency become reliably obtainable; and there now remain to be given only a few general hints as to the practical working of such a receiver which may prove useful.

The complete circuit of Fig. 5 is that actually installed at the writer's station, and is shown with one stage of note-magnification  $V_3$  and one stage of power amplification  $V_4$ ; but for clearness, without switch-gear, the actual arrangements and number of stages used on the audio-frequency side will,

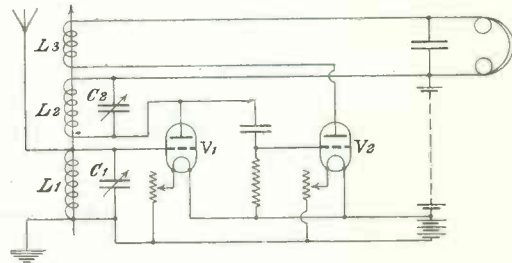

Fig. 4.—This circuit enables both valves to be brought to the point of self-oscillation.

of course, depend entirely upon individual requirements. Certain constants are, however, given, which, it is recommended, be followed reasonably closely.

With regard to inductances, for short-wave work with this receiver the writer rather favours variometer tuning for  $L_1$  and  $L_2$ , preferably shunted by vernier condensers of about .001 mfd., provided the variometers are really well designed and constructed, and for medium wave work above 500 metres plain cylindrical coils of about  $2\frac{1}{2}$  to 3 ins. diameter, tuned with variable condensers of about the values shown in Fig. 5, and preferably untapped for the avoidance of

dead-ends. Basket coils will be found very efficient similarly employed, and, where it is desired to cover a considerable wave-band conveniently, duolateral or honeycomb inductances of the plug-in type will be found quite suitable, though scarcely as efficient as the foregoing owing to their somewhat greater self-capacity due to their coverings and their plugs and sockets. Similar coils with gimbal mounting are better, and can be used very satisfactorily. Slab and such-like coils are not recommended owing to their relatively high self-capacity. The reactance  $L_3$  may be of any desired type, according to circumstances, the plug-in type being very convenient owing to the ease with which the size of coil may be changed, and this will be found of considerable importance in practice.

As to valves, the R type may be used quite satisfactorily down to about 150 metres, but below this anti-capacity valves, such as the Ora B. or V.24 are desirable—and for really short waves essential—on the H.F. side (including detector), though the four-pin type may, of course, always be used for L.F. amplification. A Mullard P.A. type is suitable for power amplification, as it works well on a 6-volt filament battery.

A special rectifier, such as the R.4B., whilst not essential to good results, is capable of markedly increasing the sensitivity of the receiver, and is recommended; whilst if grid-leak rectification is employed a variable compound leak, as shown in Fig. 5, will be found of advantage, though by no means essential.

Low-temperature valves may be used very satisfactorily with this receiver.

The A.T.C. will usually be found best in parallel with the A.T.I. above about 300 metres and in series below, though this will, of course, largely depend upon the size and type of aerial in use.

The loading ratio is of considerable importance, and should preferably be not less than .5 nor much greater than 5, *i.e.*, the natural wave-length of the antenna should be somewhere within the limits of about .2 and .7 of the wave-lengths to be received, and this is usually within the bounds of feasibility where short waves are concerned, but is, unfortunately, not so, particularly with restricted amateur aerials, on the longer waves, which provides one

reason for the falling off in efficiency of reactance-capacity circuits where the latter are concerned.

For this reason single-wire aerials up to maximum P.M.G. dimensions are to be recommended for short-wave reception below, say, 400 metres and multi-wire aerials for the higher lengths, a sound general rule being the higher the wave-length the greater the number of wires permissible and of advantage in the antenna, always maintaining due regard to other considerations which will be known to readers of this journal.

Now the operation of such a receiver will be found quite simple, and really no more difficult or tricky than an ordinary closed-circuit single-valve reaction set, though the results obtainable will, of course, be immeasurably superior. The number of tuned circuits and couplings—two only—is the same, the necessary adjustments are neither many nor unduly critical, and the set will be found easily manageable and highly efficient throughout its range. In fact, in the writer's considered opinion, it is questionable whether, valve-for-valve and adjustment-for-adjustment, any circuit now in common use can offer much real general advantage over that of Fig. 5 for amateur use.

Compared with transformer coupling, for example, the sensitivity will be found about 25 per cent. greater, valve-for-valve, than fully-tuned transformers with reaction, the selectivity quite comparable, whilst the simplicity of operation is, of course, much greater.

For reception during broadcasting hours on an outside aerial it is necessary only to loosen the coupling between  $L_1$  and  $L_2$  and to tighten that between  $L_2$  and  $L_3$  somewhat to obtain a form of intervalve reaction which is effective but innocuous (so far as any form of reaction can really be innocuous), whilst at other times full dual regeneration is available simply by using both couplings at once, or for the reception of C.W.  $L_3$  is loosened somewhat and  $L_1$  and  $L_2$  tightened until  $V_1$  oscillates.

The regeneration due to  $L_3$  is, of course, variable both by the degree of coupling and by the size of coil used, and it will usually be found that for short waves  $L_3$  may be somewhat the largest of the three, whilst for longer waves it may be the smallest, or about the same size as  $L_1$ . Self-oscillation

of  $V_2$  should be avoided, though it will be found possible to receive C.W. in this manner, for example, during broadcasting hours when the signals are coming in on a length adjacent to the broadcast band.

The best way to tune in telephony signals will usually be to start with fairly loose average couplings between the three coils until the signals have been brought in by adjustment of the two tuning-condensers and then to tighten first one coupling and then the other, slightly resetting the condensers meanwhile, until the desired signal strength is attained, the same applying

selectivity is obtained by loosening the couplings generally to the accompaniment of reduced signal strength, in that it is here obtained by increasing the degree of regeneration and resultant resonance, e.g., tightening the couplings, which results in increasing the strength of the desired signals to the suppression of those that are not desired—a more efficient principle.

Should any tendency to undesired self-oscillation occur when the couplings are not particularly tight, this may be corrected by adjustment of the grid-potential tap, so that this is made somewhat more positive—

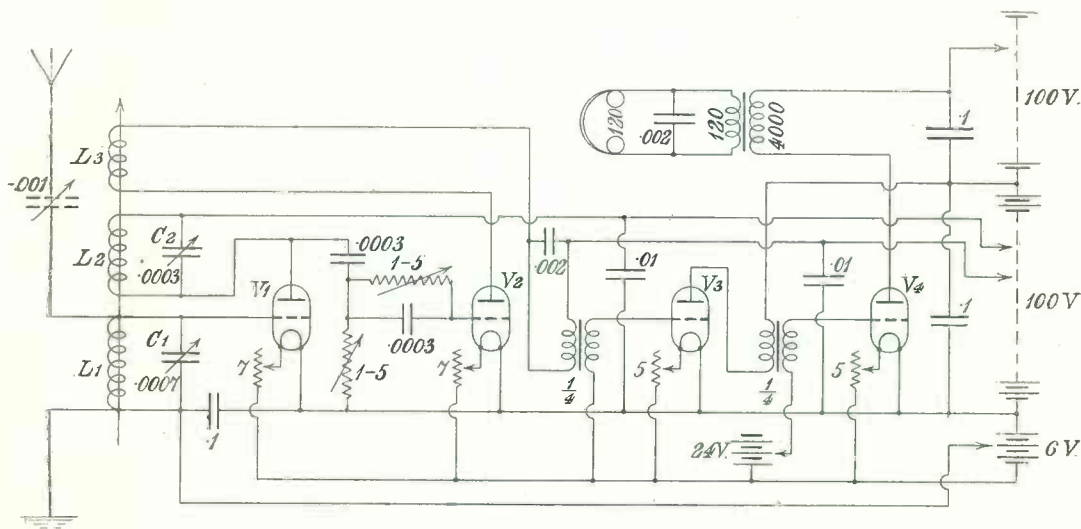

Fig. 5.—A practical regenerative receiver providing critical control of all variable factors. The last valve functions as a power amplifier.

when variometers are used, except that the initial tuning should be done on the variometers themselves and the subsequent fine tuning on the vernier condensers. Vernier condensers may, of course, be employed with advantage no matter what tuning system is used, and are actually included on the writer's set (though not shown on the diagram), but are not essential.

A useful feature of the circuit is the way in which undesired signals can be eliminated merely by variation of one or other or both of the couplings and subsequent re-tuning of the condensers, or *vice-versa*, without necessarily loosening the couplings or losing signal strength at all; and in this respect the circuit is quite different from the usual loose-coupled arrangement in which extra

or, rather, less negative—of the anode voltage tap, and also, if necessary, of the variable grid-leak arrangement, if such is used, should the seat of the trouble be in the second valve.

Should a more marked tendency of this kind arise—as it sometimes may when the receiver is used towards the upper limit of its useful wave-range, or when a frame is used for reception above about 400 metres—it may be corrected by the use of a small stabilising plate on the common inductance  $L_2$ , which may conveniently take the form of a ring or cylinder of spring brass or copper made to slip in and out of the inductance at will, and should preferably be earthed for maximum effect, the *modus operandi* of this arrangement being the closer equalisation

of damping in the aerial and first plate circuits, the latter of which is, of course, normally minus the stabilising action of the antenna-earth system, and is, moreover, subject to a double regeneration effect; and this will be found quite effective without resulting in loss of signal strength, since L<sub>2</sub>-C<sub>2</sub> will now accept more regeneration without self-oscillation, and this can readily be provided by tightening the coupling.

The condition to be aimed at for best reception of telephony with this circuit is a nice regenerative balance between the three circuits L<sub>1</sub>-C<sub>1</sub>, L<sub>2</sub>-C<sub>2</sub>, and L<sub>3</sub>, so that the two valves V<sub>1</sub> and V<sub>2</sub> shall be as nearly as possible equidistant from the sub-oscillation point, and this may readily be obtained by judicious use of the adjustments provided. It is scarcely necessary to add that care must be taken in the first instance to make the connections to the three inductances the right way round, otherwise a degenerative effect will result and nothing will work to plan.

In conclusion, some indication as to the results obtainable with such a receiver may be found useful as a guide.

In the matter of selectivity it may suffice to say that Glasgow at 330 miles can always be received through Birmingham at 85 miles without interference from the latter, notwithstanding the considerable "jamming" power in use and the fact that their wavelengths are no more than 5 metres, or 1.2 per cent., apart; also the fact that Birmingham, being in a direct line immediately between Glasgow and the writer's station, reception is literally "through" him and directional methods are out of the question.

As to sensitivity and amplification, using two valves only the broadcasting stations can be brought in quite comfortably on the loud speaker up to a range of about 30 miles, the addition of one note-magnifier enabling this to be done on a frame, or increasing the range to about 50 miles. Three valves enable most of our 10-watt transmitters up to 40 miles or more, many of the more powerful Continental amateurs, and most of the British and Continental broadcasting stations to be brought in well on 'phones—some of them on the loud speaker—whilst some of our more powerful amateur trans-

mitters come in quite strongly on the latter up to 30 to 40 miles. American broadcasting stations are often strongly audible on 'phones even in summer with three valves, whilst the volume obtainable with that number on our own broadcasting stations is sufficient to fill a good-sized hall up to about 30 miles.

Four valves do not often prove necessary except for long-distance and loud-speaker work, and as an instance of what may be done on this number may be mentioned the reception recently—in August—of W.G.Y., New York, at loud-speaker strength sufficient to fill a largish room; whilst, as further examples of the sensitivity of the circuit may be cited the reception during a recent low-power test of quite readable telephony on 180 metres from 5 BT at 30 miles when his input was stated as 2 milliampères at 30 volts only (0.75 watt) and radiation unmeasurable, and of speech on 200 metres from 8 BF at 300 miles, radiation 1.2 ampere, strength R 3-4 on an indoor aerial. And it should here be mentioned, firstly, that the circuit of Fig. 5 with one high-frequency valve only was used in each of these instances (the writer has not touched upon the question of additional H.F. stages in these notes simply because such are so very rarely necessary with this circuit, but, in view of the forthcoming transatlantic tests, etc., will hope to do so in a future article upon this subject); secondly, that the outdoor aerial used is of standard P.M.G. dimensions—60 ft. in length and 40 ft. in height; and, thirdly, that the reception conditions in each case were ordinary average summer conditions and in no way exceptional, the results given being probably reproducible on at least four days out of five throughout the year.

But perhaps the most convincing guide that the writer can give is the simple statement of fact that, whilst his own station—which is some distance out in the country, and therefore requires an efficient receiver—is equipped for short-wave work with a seven-valve super-heterodyne receiver, with which, of course, remarkably fine results are obtainable, quite three-quarters of his reception other than purely experimental work is carried out on the circuit of Fig. 5, the extra valves of the "super" being usually unnecessary, and therefore frankly wasteful.



# An Armstrong Super-Heterodyne Receiver.

By E. J. SIMMONDS.

Super-Sonic amplification is, no doubt, the simplest and most efficient method of short wave reception. Not only does the circuit become easily manageable, but the selectivity of the receiver is increased considerably. In the following article will be found full data for the construction of a super-sonic amplifier.

THE theory of the super-heterodyne is simple, and the operation has many advantages. The principle difficulty in high-frequency amplification at short wave-lengths, namely, valve capacity, is overcome by the simple solution of reducing the frequency to some predetermined fixed value, when a radio-frequency amplifier designed for efficient long-wave working can deal with the signals.

instability of ordinary receivers below 200 metres wave-length, it is thought that the description of a receiver embodying high efficiency, sharp tuning, absence of body capacity effect, and ease of adjustment will be particularly useful.

It is proposed to describe a modification of the well-known Armstrong super-heterodyne as made by the writer for the Transatlantic tests of 1922, and used continuously

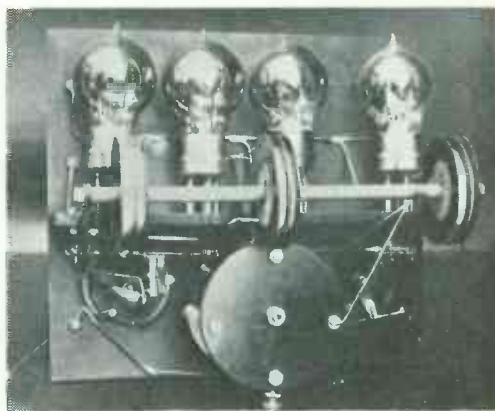
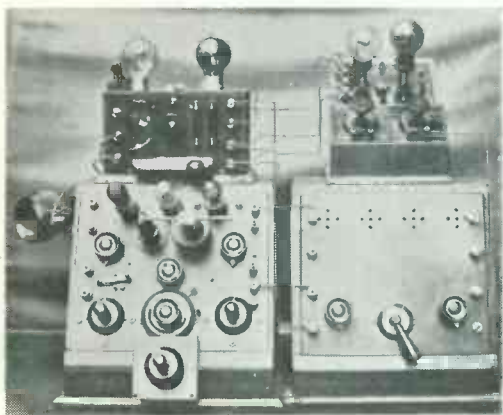

Fig. 1.—The left panel of the complete receiver contains the H.F., detector and oscillator valve and coupling device with the tuned anode coil. The right panel contains the three-stage long wave amplifier and detector. Above these are the H.F. and the detector (tuned anode, resistance or choke capacity) and two note magnifiers. On the right is seen the rear of the super-sonic amplifier.

The original signal is transferred to the closed circuit, and amplified at the original frequency. The local source of oscillations is coupled to the anode coil of the first high-frequency valve, and adjusted to such a value that a suitable beat frequency is formed, and impressed on the grid of the detecting valve. The resulting reduced radio-frequency oscillations are then passed to the long wave amplifier. By this method all the advantages of high frequency amplification at low radio frequency are obtained.

Now that increasing attention is being given to comparatively short-wave working, and in view of the difficulty and

since. It is worthy of mention that the instrument was only completed three days before these tests, and that, although unskilled in the adjustments, nearly 100 log entries were made, and 24 different U.S.A. amateurs scheduled complete with code words, in individual periods.

It should also be mentioned that no receptions were possible before 3.15 a.m. owing to "hash" from Northolt Radio, which source of short-wave interference is doubtless too well appreciated to call for more than passing comment.

The amplifier may consist of two units, the first of which is the ordinary one-stage

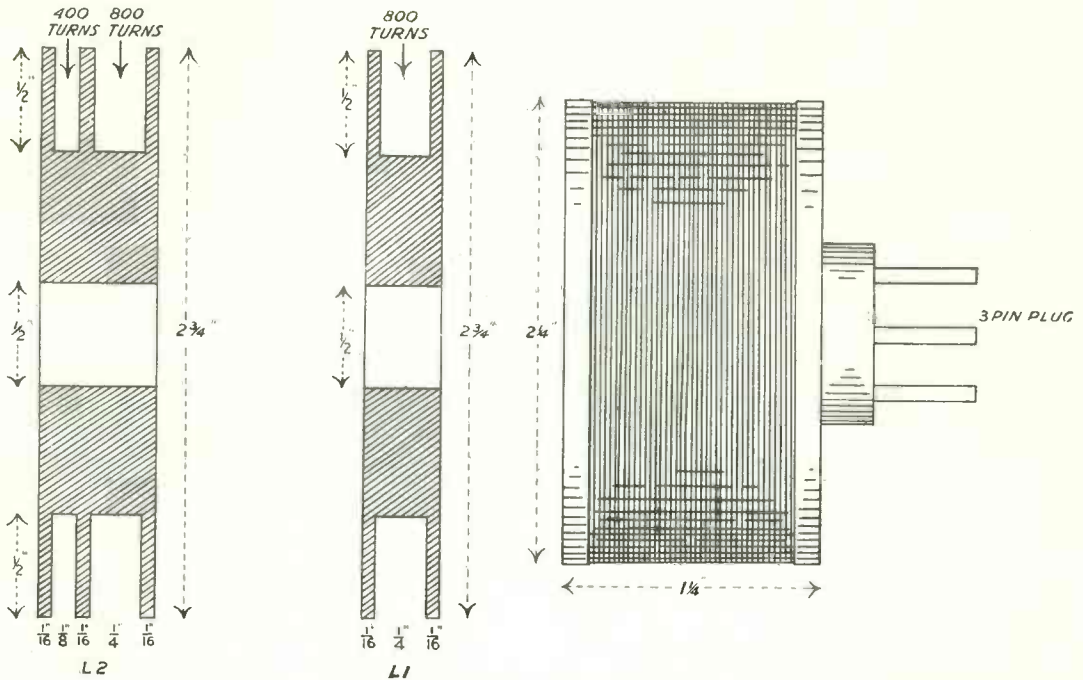

Fig. 2.—On the left are the coupling transformers. Three are required to the dimensions of  $L_2$  and two as  $L_1$ , coupled closely together. On the right is the oscillator coil, two being required. One is wound with 30 turns of 24 D.C.C. and works from 140 to 450 metres, and the other is wound with 60 turns, the length being  $2\frac{1}{2}$  ins.

H.F. and detector, plus the heterodyning valve and necessary coupling.

It is suggested that the tuned anode coil be of the air-spaced type to reduce self capacity, and for the same reason V.24 or other low-capacity valves may be used. In practice it is found convenient to use a separate H.T. battery of 36 volts with taps for the oscillator valve, and by varying this H.T. voltage it is possible to control the amount of energy transferred to the tuned anode without mechanically altering the coupling; there is also the additional advantage that this method does not affect the tuning. The oscillator coils are of the three-prong plug-in type, with centre tap to negative filament, a variable coupling being arranged between these coils and the tuned anode coil.

Those who have resistance-coupled amplifiers available may use these for the long-wave component with excellent results, but it is strongly advised that the inductively-coupled amplifier be used, as the efficiency of same is so much higher; the resistance-

coupled type has also the disadvantage of requiring a higher voltage H.T.

The inductively-coupled type, however, requires more care in adjustment, and, if compressed into too small a cabinet, has the tendency to "couple back."

For those who contemplate making such an amplifier it is suggested that the valve holders be mounted about 6 ins. apart on a board, and then wired up temporarily.

When satisfactory operation is obtained, the question of compression into a cabinet can be taken up. Such step will, undoubtedly, have effects quite unforeseen. All necessary data can be obtained from the diagrams.

The formers for the H.F. transformers may be turned to dimensions out of hardwood, well dried, and paraffin waxed, or may be built up from waxed cardboard.

They should be mounted on a common shaft of wood, all the coils being wound in the same direction. In connecting up, the two inside leads go to +H.T. and potentiometer slider respectively. Using windings indicated, the amplifier will be resonant at

about 4,000 metres, but the exact wave-length is immaterial so long as the frequency is not too high.

The plate circuits are aperiodic, but it is necessary to tune each grid circuit to the wave-length of the preceding grid circuit. It will be found that if the condensers are adjusted for uniform capacity, and the bobbin turns carefully counted, very little final adjustment will be necessary. This correction should be made after the amplifier is

it necessary to damp the grids, although the amplifier cabinet is only 12 ins. long.

This type of amplifier, when once properly adjusted, will continue to function perfectly as long as the H.T. and L.T. batteries are kept in good condition.

For all internal wiring use bare tinned copper wire bent to shape, solder all joints, and consider well the wiring scheme, especially with reference to the relative grid and anode circuits; small changes in

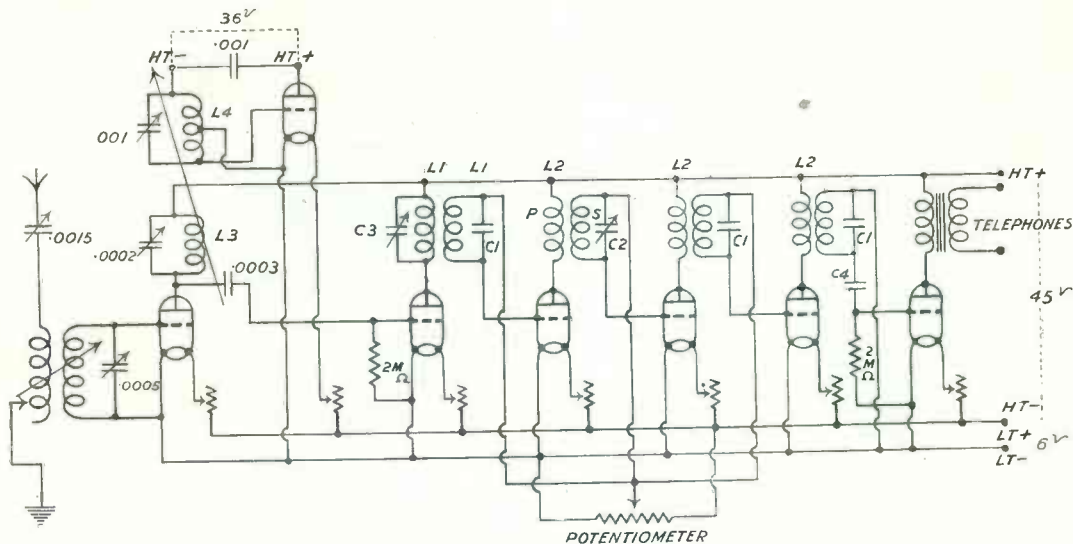

Fig. 3.—The complete circuit of the receiver in which the values are as follows :—C1 0.0001 mfd., C2 0.0005 mfd., C3 0.0002 mfd., C4 0.0003 mfd., L1 890 turns 36 D.S.C., L2 Primary 400 turns, Secondary 800 turns, 36 D.S.C., L3 Tuned anode coil, L4 Threepin plug-in oscillator coil.

assembled and wired up. Slight changes then necessary may be made by varying the number of turns of the grid circuit transformers. The condenser  $C_2$  is in the grid circuit of second valve, and should have a maximum capacity of .0005. This condenser controls the regenerative action of the amplifier, and, as this capacity is reduced from maximum, the amplification will be increased up to the point of self-oscillation. This action will be found to be very smooth, with no "overlap," and under perfect control. It is advisable to try the grid leaks connected to +L.T. as well, as shown, as certain valves function better when connected to +L.T.

Any undesirable tendency to self-oscillation can be effectively controlled by the potentiometer, but the writer seldom finds

wiring have far-reaching effects on all high-frequency amplifiers. Most of the receptions are done on a loop or small indoor aerial. If considered necessary, one or two note magnifiers may be used after the last detecting valve.

After completion the set should be calibrated. Connect up to aerial and earth as usual, and loosely couple a wavemeter to the aerial circuit. Now adjust aerial condenser, closed circuit, and tuned anode condensers, also heterodyne condenser for maximum signals. (Signals will be heard at two different settings of heterodyne condenser.)

Note should be made of the wave-length as indicated on wavemeter, and a chart should be prepared with columns for various condenser adjustments.

This should be tabulated to cover the whole range of the receiver. By this means the maximum results may be obtained on any setting with ease.

It should be noted that the instrument so calibrated may be operated on any aerial

suitable for short-wave reception, the only unknown factor being the tuning of the aerial. Although the adjustment appears to be complicated, in practice it is not so, and the writer finds the circuit particularly adapted to quick search.

## Crystals and Crystal Testing.

BY A. V. BALLHATCHET, M.J.INST.E.

The introduction of the thermionic valve had the immediate effect of diverting the attention of the experimenter from the crystal, and since that time little investigation has been conducted. Below will be found a brief summary of the properties of various crystals and the methods used in testing.

THE enormous development of wireless telegraphy and telephony during the last two years or so has brought the crystal as a rectifying detector into great prominence. The crystal, in common with other examples of scientific achievement, suffered the fate of eclipse by a more brilliant rival, and that before its possibilities were fully determined. How many of my readers recall the Nernst electric lamp? This, a wonderful development in artificial lighting, when just reaching popularity, was eclipsed by the metal filament lamp. So the crystal as a rectifier of oscillatory energy has suffered partial eclipse by the thermionic valve. To many amateurs in wireless reception the crystal is a new thing, discovered simultaneously with the perfection of wireless telephony and broadcasting. Yet some of the older amateurs who, like the writer, experimented with coherers will remember what a revelation was their first reception with a crystal detector.

In spite of the wonderful things accomplished by the thermionic valve, and the promise of yet more wonderful things, it must be remembered that, as a detector, the crystal is in some respects vastly more efficient than the valve; and it is the fact that so little of the action of the crystal is known with certainty that renders it an object well worthy of prolonged and patient investigation by the seriously-minded amateur. It is largely the object of these few notes to awaken the interest of amateurs to the study of the crystal.

*The Action of a Crystal.*—It is held, generally, by those who have read a little

of the theory of the subject that a crystal functions as a rectifier by reason of its unilateral conductivity; in other words, it possesses the property of allowing electrical energy to pass through it in one direction only. This is hardly correct, however, for practically all crystals will allow current to pass either way, only that the conductivity in one direction is very much greater than that in the other. So great is this difference that we may regard the lesser as being negligible. Careful experiments have shown that the half oscillations passed by a crystal are very distorted when compared with those passed by a valve when functioning as a rectifier. But the unexplained fact remains that a good specimen of crystal, properly adjusted, produces louder signals than the valve, and in many cases these signals are of purer tone. In this direction, then, the crystal is more efficient than the valve. Again, before a valve can function it must be supplied with current, and this is not by any means a negligible quantity—several watts even in the latest forms. But what percentage of this applied energy is returned? The crystal passes practically all the energy applied to it from the aerial circuit, the only loss being that due to its natural resistance. So that here again the crystal is far more efficient than the valve, for economy is surely a large factor when determining efficiency. Most readers who have studied the action of their crystal detector will admit that the most difficult matter in its adjustment is the *pressure* at the point of contact. This leads to the supposition that it is a matter of thermal effect which causes

the crystal to function. It is quite possible to take two pieces, say of galena, from the same large lump. One will act splendidly, while the other is either very poor indeed or absolutely worthless. Yet chemical analysis will show no difference; the optical properties of the two pieces are identical, and other physical examinations will show no difference. Where, then, lies the difference in their behaviour when used for rectification? This is the one great question yet to be answered.

*The Nature of Crystals.*—The majority of crystals used are crystalline specimens of natural metallic ores. In the early days of crystal detectors relatively few substances

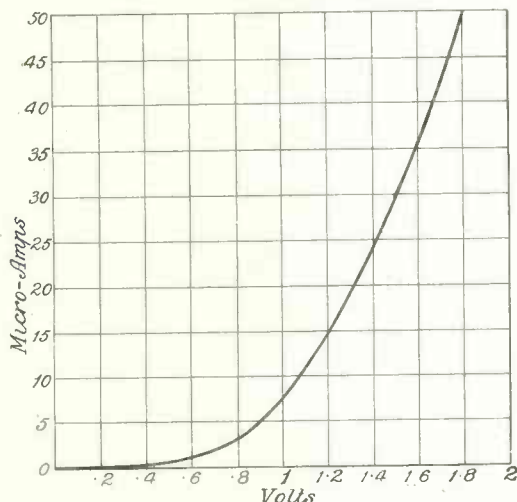

Fig. 1.—Characteristic curve of carborundum and steel combination.

were employed, and search for further suitable material was checked by the development of the valve. The recent boom in wireless reception has stimulated experiment and search, and it is now possible to compile a long list of crystals, and it is also perfectly safe to say that this list is far from complete. The following list comprises some of the specimens with which the writer has experimented, and the names given are the usual mineralogical terms. When a substance is known by more than one name the synonym is given in brackets. The chemical composition assigned to each is that of a chemically-pure specimen. The substances are arranged alphabetically, and those marked with an asterisk are artificial, while those with a double asterisk have undergone

preparation. These latter are elements, and, with the exception of tellurium, are not found in an elemental state in nature:—

|                                   |   |
|-----------------------------------|---|
| Argentite (Silver glance) ...     | Ag <sub>2</sub> S.  |
| Blende (Sphalerite) ...           | ZnS.  |
| Bornite (Erubescite) ...          | 3Cu <sub>2</sub> S <sub>3</sub> .Fe <sub>2</sub> S <sub>3</sub> . |
| *Carbon Silicide ...              | CSi.  |
| *Carborundum ...                  | SiC.  |
| Cassiterite (Tinstone) ...        | SnO <sub>2</sub> .  |
| Cerrusite ...                     | PbCO <sub>3</sub> .   |
| Chalcocite (Copper glance) ...    | Cu <sub>2</sub> S.  |
| Copper pyrites (Chalcopyrite) ... | Cu <sub>2</sub> S <sub>2</sub> .FeS <sub>2</sub> .                |
| Corundum ...                      | Al <sub>2</sub> O <sub>3</sub> .                                  |
| Domeykite ...                     | Cu <sub>2</sub> As.   |
| Galena ...                        | PbS.  |
| Graphite (Plumbago) ...           | C.  |
| Hessite ...                       | Ag <sub>2</sub> Te.   |
| Hæmatite ...                      | Fe <sub>2</sub> O <sub>3</sub> .                                  |
| Iron Pyrites (Mundic) ...         | FeS <sub>2</sub> .  |
| Malachite ...                     | CuCO <sub>2</sub> .CuH <sub>2</sub> C <sub>2</sub> .              |
| Molybdenite ...                   | MoS <sub>2</sub> .  |
| Niccolite (Kupfernickel) ...      | NiAs.   |
| Octahedrite (Anatase) ...         | TiO <sub>2</sub> .  |
| Pyrrhotine (Magnetic pyrites) ... | FeS.  |
| Siderite (Chalybite) ...          | FeCCO <sub>3</sub> .  |
| **Silicon ...                     | Si.   |
| Stromeyerite ...                  | Ag <sub>2</sub> S.Cu <sub>2</sub> S.                              |
| **Tellurium ...                   | Te.   |
| Zincite ...                       | ZnO.  |
| **Zirconium ...                   | Zr.   |

The reader will be quite well aware that there are a score or more of crystals to be obtained from dealers and which are not included in the above list. Many of these crystals are nothing more than galena. It is quite possible they may be selected and have been tested for sensitiveness, but that is all. There may be some specimens which have undergone some form of treatment, but so far the writer has handled but one specimen only which is entirely artificial and prepared definitely for wireless work.

*Crystal Combinations.*—Crystals may be divided into two classes:—(1) Those which must be in contact with another crystal, the two forming what is often called a "perikon" detector; (2) those which require a metal contact. Chief among those of the first group are the following:—

- Zincite with tellurium, copper pyrites, chalcocite, or bornite.
- Galena with tellurium or graphite.

In the second group the following are prominent:—

- Carborundum with steel.
- Galena with silver, brass, copper, or gold.
- Silicon with gold or steel.
- Iron pyrites with gold.
- Molybdenite with silver.

*Notes on Crystals.*—A few remarks on these combinations may be useful. In the perikon combinations it is most essential that the pressure at the point of contact be most

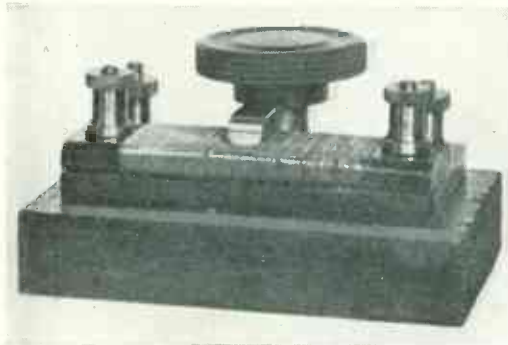

Fig. 2.—A potentiometer for use with carborundum.

carefully adjusted. Zincite, tellurium, and galena are very brittle and friable. Copper pyrites and bornite are relatively hard, and will soon grind away the fine points of the softer crystals. It is also important that the points making contact are bounded by natural angles. Any filing or grinding to shape is useless. When points need renewing it is best to chip away the old faces with a needle point. Carborundum—a product of the electric furnace—sometimes offers difficulties to the amateur who uses it for the

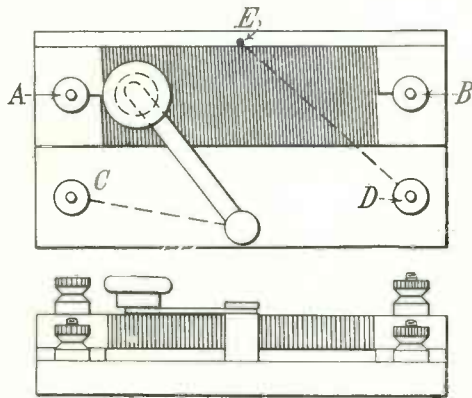

Fig. 3.—Connections of the potentiometer.  
 A and B — To Battery.      C — To Inductance.  
 D — To Detector.          E — Central Tapping.

first time. It may be obtained in pieces of varying structure and colour. The very hardest varieties, which show well-defined crystals, and have usually a brilliant display

of iridescent colours, is worthless for detectors. The two best kinds are the steel-grey, glassy variety, and the somewhat fibrous, greenish-grey variety. The former is slightly more sensitive than the latter, but not so stable in action. The steel contact is best in the form of a flat strip—a piece of clock-spring being excellent. The pressure may amount to as much as 2 or 3 lbs. It is necessary for best results to apply a small potential across the detector. The rectifying action of crystals is often improved in this way, though usually the improvement is so small as to make the employment of the extra apparatus hardly worth while. Carborundum will function without applied potential, but its addition makes a most marked improvement. Fig. 1 is the characteristic curve of carborundum showing how its resistance varies as the applied potential rises. If the potential is adjusted so that

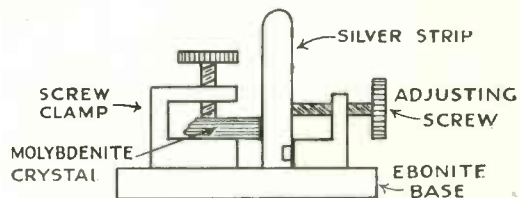

Fig. 4.—Design for a molybdenite detector.

the crystal functions just at the bend in the curve it will be in its most sensitive condition. Fig. 2 shows a simple potentiometer for this purpose. It consists of a small slab of ebonite wound with about 20 yards of No. 40 Eureka wire (enamelled or silk covered). A tapping is taken from the centre of the winding, and a spring contact sweeps across the top of the winding. A battery of three small dry cells (a flashlamp refill) is joined across the winding and forms the source of potential. Fig. 3 shows the connections of battery, potentiometer and detector.

The silver contact for molybdenite is also best in the form of a flat strip bent in the shape of a U spring. Molybdenite is a substance much resembling graphite. It is, however, brighter in colour, and makes a greenish-grey streak when rubbed on paper. It is lamellar in structure, and in use should be cut at right-angles across the laminae, the surface being made smooth with very fine emery paper. Fig. 4 gives a suggestion for

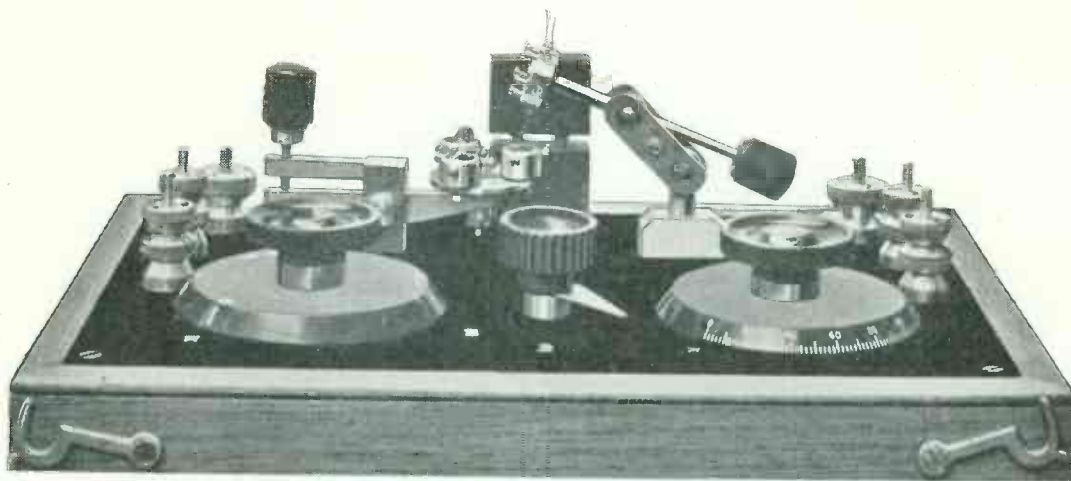

Fig. 5.—View of the top of the crystal testing set, showing the universal movement of the detector mountings.

a suitable arrangement. All other metal points are best in the form of wire—about 30 gauge being suitable. The artificial crystal mentioned before works very well with gold, silver or brass, but better as a perikon with bornite or copper glance, the latter being the better of the two.

*Mounting Crystals.*—Some diversity of opinion exists as to the best method of mounting crystals. The original method was to set the crystal in a brass cup, using Wood's metal as a cement. It is now common practice to use a brass cup fitted with one or more set-screws. Some affirm that the heat of the melted Wood's metal has an injurious effect on the crystal. The writer does not altogether agree with this except, perhaps, in the case of molybdenite. Wood's metal is an alloy of lead, tin, bismuth, and cadmium, and, if of correct composition, melts at 66° C. Another alloy—Lipowitz's—contains the same constituents in slightly different proportion, and melts at 60° C. These temperatures are well below that of boiling water, and will not damage a crystal. Many samples of fusible metals sold for the purpose are not Wood's metal, and require a much higher temperature to make them fluid. In these cases there is some risk in spoiling a delicate crystal. There would seem to be just as much risk of spoiling a brittle crystal in using set-screws, because these must be screwed up really tight in order to secure good contact. For the experimenter who wishes to change his

crystals frequently the screwed cup has its advantages, perhaps, but for permanent use there is much in favour of setting the crystal in Wood's metal—only it must be the right grade.

*The Detector.*—For really good results the mechanical side of the detector requires some care in design. While freedom of movement must be provided to the metal contact, for instance, there must be no slackness or shakiness. As before mentioned, the pressure at the point of contact is extremely important, and this seems in a great many detectors difficult to arrange with certainty. Electrical continuity in the moving metal parts is, of course, vital, and just as vital is the question of insulation in the mounting. Dust is a most insidious enemy, and it is a sign of advancement to see types of protected detectors now appearing in dealers' lists and windows. Some of these protected types would be better if the glass or celluloid covers were a little larger; movement of the metal point seems a little cramped and restricted.

*Some Suggestions.*—Some small observations will now be given from the writer's experience. The question is often asked, "Which is really the best detector?" This is not quite easy to answer. Personally, the writer believes that for all-round efficiency, simplicity in adjustment, and constancy in action under all conditions there is nothing to beat the carborundum-steel with its battery and potentiometer. When a crystal

is used in conjunction with a valve for either high- or low-frequency amplification, carborundum is preferable to any other crystal. It also stands up well against atmospheric disturbances, and it is the only crystal that will survive the proximity of high-tension discharges such as are used in spark transmission.



Fig. 6.—The inductance selector switch, mounted beneath the panel.

Beyond the metal points mentioned earlier, phosphor-bronze or german silver will sometimes give good results with certain crystals. Certain combinations, such as silicon and gold, give very good results when L.R. 'phones are used. This is, no doubt, because such a combination has a much lower resistance than others. It will be found, too, that while it is better to use two or more pairs of H.R. 'phones in parallel, L.R. 'phones are best joined in series. The writer has noticed on more than one occasion that, using silicon on 2LO broadcasting, distant spark signals are very faint; yet, changing over to galena, these distant signals become much stronger, while 2LO is weaker. Finally, in the writer's opinion, many amateurs use crystals far too large in size. Given a good specimen, there is not the slightest advantage in using a large piece.

*Testing Crystals.*—To test out a crystal thoroughly one must work on a definite system, and the matter requires some little patience. The writer has done a fair amount of crystal testing for commercial purposes. The specimens come in small bags, numbered, but generally un-named, and are usually in pieces about the size of a cherry stone and larger. Broadcast transmission is generally used for test purposes in order that purity of

tone may be judged, and reception is taken on both Brown's "A" type 'phones, and also the usual diaphragm pattern. Pieces are first taken from each sample and mounted up in screwed cups. The plan generally adopted is first to test each specimen with various metal points, assigning so many marks of a possible ten to each test. If required the specimens are tested with others in a perikon combination. Having found the best combination, this is used to find the total area of sensitivity and also the uniformity of sensitivity over the whole area, assigning marks as before. All this takes time, but it is the only way in which a satisfactory report can be rendered. The question of the effective life of a crystal can only be settled by periodical tests over a length of time.

*A Tuner for Crystal Testing.*—In order that the procedure mentioned above may be carried out expeditiously and as thoroughly as possible, the writer has designed and constructed a receiver which embodies several features not usually found in a crystal set. Fig. 5 shows the general appearance of the set. On the left is the selector switch from the tapped inductance. This is wound on a paxolin tube  $3\frac{1}{2}$  ins. diameter. The winding is 130 turns of No. 28 s.s.c. wire. Tappings

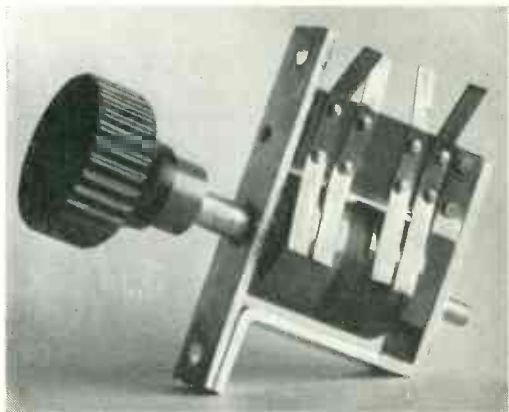

Fig. 7.—Illustrating the construction of the dead-end switch.

are taken from the tenth turn and then from every three. The winding is divided into three sections, which are isolated by a dead-end switch, the control knob of which is seen in the centre. The first section finishes at the eighteenth stud of the switch, and the second at the thirty-second stud.



This gives ranges of, approximately, 500 metres, 900 metres and 1,200 metres. If longer ranges are required a loading coil can be plugged into the holder at the back of the panel. This holder is of the standard pattern to take the plugs usually fitted to lattice coils, and, normally, is short-circuited by a plug. On the right is a variable condenser with total capacity of 0.0005 mfd. Between the three control knobs and the loading coil socket is the detector. On the right is a capstan head which will carry five wire contacts. It is mounted in a double ball-and-socket fitting so that movement in all directions is provided and any wire contact can be selected at will. The fitting on the left carries three removable crystal cups mounted capstan fashion, and the screw on the extreme left provides a micrometer rise and fall to the crystal cups, the arm on which they are mounted being a first order lever. Good contact and smoothness in action is secured by a phosphor-bronze spring thrusting the arm against the adjusting screw. In this fitting the difficulty of providing that delicacy of pressure which is so essential has been overcome, and the detector proves entirely satisfactory in action. The selector switch is mounted below the panel so that it is protected from

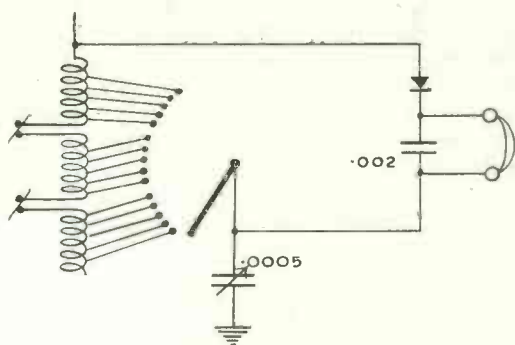

Fig. 8.—The circuit employed on the testing set.

dust, Fig. 6 giving a close-up view of it. The dead-end switch shown in Fig. 7 is simply a short cylinder of ebonite carrying two brass plates which make contact with two pairs of bronze fingers.

Altogether, the set has well repaid the time taken in its construction, as not only is really good reception obtained with accurate tuning, but crystal testing is greatly facilitated and can be done with certainty. Fig. 8 is the wiring diagram of the set. It might be mentioned, perhaps, in closing, that when crystals of the perikon group are being tested a separate detector of special design is used.

## An Ultra-Selective Receiver.

By "2SH."

Below will be found some details of a new circuit embodying several new features. Readers who test out the scheme will, no doubt, be surprised at the results obtainable.

NOW things are returning to normal after the upheaval caused by the advent of broadcasting in the experimental world, many amateurs are finding the problem of selectivity a very pressing one. The ordinary single-valve reaction set, when used at a distance of less than 5 or 6 miles from a broadcasting station, will not cut out that station entirely on any wavelength. This can be greatly improved by loose coupling the aerial circuit, but such circuits are not easy to handle while getting good signals in searching. In the U.S.A.

where anyone can get a transmitting licence for 1 kw. this problem has been of importance for many years. If you have a neighbour with 1 kw. of I.C.W. on 200 metres you have rather a thin time near his wave. The solution over the other side has been the "three-circuit regenerator," which consists of a loose-coupled set with a tuned plate circuit. The primary coil is the fixed winding of a vario-coupler, and the secondary is the vario-coupler rotor in series with a variometer. The plate is tuned with another variometer (see Fig. 1). The primary is

tuned by tappings and sometimes a series aerial condenser. The secondary has no condenser. This type of set is very selective, but it needs, as someone once said, "three hands and a foot" to tune it properly. Every change in the secondary circuit necessitates a critical readjustment of the plate variometer. In consequence of this difficulty many American experimenters have been attempting to find a good selective

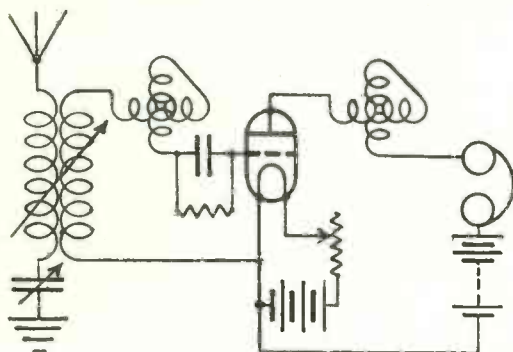

Fig. 1.—An ordinary regenerative circuit in which the selectivity is increased by tuning the closed circuit and the anode circuit with variometers.

single-valve circuit with few adjustments. A year or so ago the Reinartz tuner was brought out, and this circuit (Fig. 2) certainly gives great selectivity with simple adjustment, but, unfortunately, the signal strength is much reduced. It will be seen that this circuit uses a small untuned aerial coil and "shunt" reaction coil. The secondary coil is excited by shock.

However, within the last few months a new circuit has been evolved by Mr. L. M. Cockaday, which he calls the four-circuit tuner. This sounds worse than before, but is not!

In an ordinary regenerative circuit by increasing reaction coupling we decrease the positive resistance of the circuit by increasing the negative resistance, until at length the latter exceeds the former and the set begins to oscillate. In this new circuit we use the reverse process. An easily oscillating valve circuit is used, and the positive resistance is increased until the oscillations are manageable. In this set the aerial coupling is as loose as possible for good strength of signals, and the reaction control varies very little with quite a large change of wave-length. Owing to the circuit arrangement the aerial

need not be accurately tuned, so that our only controls are the grid tuning condenser and reaction. Instead of the usual circuit we use the De Forest Ultraudion circuit for our oscillating valve. Usually this circuit cannot be easily stopped oscillating and is not manageable. Here we arrange it to oscillate as it wishes, and we subtract energy from the grid circuit until the desired state is reached. This is done by the "fourth circuit," which is a small tuned trap coupled to the grid coil. Note that this circuit is not tuned to the working wave, but usually well below it. This distinguishes between this circuit and a freak type of multiple tuner. The circuit is shown in full in Fig. 3. The aerial circuit is made up of the two coils A and B. A is tapped every few turns. B consists of one turn of thick wire. C, the trap, consists of a small coil with .0005 condenser, wound close to the tuning coil D on the same former. B is coupled to the end of C farthest from D. This coupling can be adjusted on test, and when the best value is found it may be left. It will be found that no appreciable strength is gained by tuning the aerial accurately. As for correct sizes for coils, all should be wound with at least 20 D.S.C. wire. A may

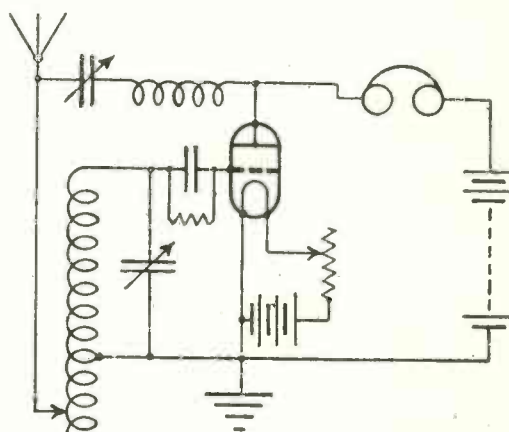

Fig. 2.—In one type of the Reinartz circuit, the aerial coil is untuned, and the reaction coil is connected in shunt.

be 5 ins. diameter, turns spaced  $\frac{1}{8}$  in., tapped every five for thirty turns. B should be about 14 S.W.G. C and D should be on a 4-in. former, and of 30 and 50 turns respectively, close wound, with  $\frac{1}{4}$  in. between coils. D should be tapped at 25 turns. The method of operation is as follows:—

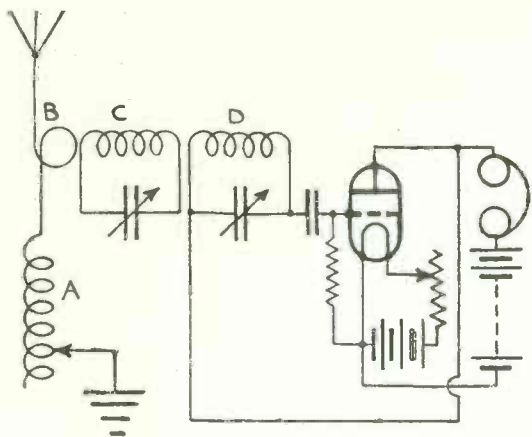

Fig. 3.—The aerial is coupled by a single turn to the trap circuit, which is not tuned to the desired frequency.

Put the condenser across C to zero, and adjust the valve until it oscillates vigorously.

Then increase condenser C and so stop oscillations. Set A to approximately the correct value, and search with condenser D. C will be found to need little adjustment. A few minutes practice will show the simplicity and extraordinary selectivity. Unfortunately, it is not legal to use this set for broadcasting, but the radiation is extremely small owing to the loose coupling. It would be found possible, however, to receive any station at will, which is quite impossible with an ordinary set.

I hope these notes will interest some sufficiently to test out this circuit, for it is well worth while. It will be found that all signs of broadcasting will be cut out on slightly shorter waves, which is not usual with one-valve sets. If desired the filaments may be earthed. This will help to eliminate any body capacity effects.

## The Trend of Invention.

We summarise below the more important wireless inventions which have been disclosed during the month, special reference being made of those of immediate interest to the experimenter.

### Tuning Devices.

Fig. 1 illustrates a rather ingenious method of simultaneously decreasing the capacity and inductance of a tuned circuit. A moveable plate 9 acts partly as a variable condenser in conjunction with a fixed plate 5, and partly as a means for varying the effective inductance of the tuning coil 3. The disc 9 acts as a closed circuit variably coupled to the coil 3, so that as it is moved towards the coil the mutual inductance between the two circuits decreases the effective self-inductance of the coil 3; at the same time the capacity between 9 and 5 is decreased. (A. H. S. MacCallum, Brit. Pat. 202,115.)

Another tuning device recently patented, primarily consists of a condenser having vernier and main elements mounted on separate but coaxial shafts with an inter-locking device which permits the vernier section to act alone over a certain range, after which the main section is brought into play. The condenser can therefore be used over a wide range of tuning. (H. Saville and C. H. Thornton, Brit. Pat. 201,816.)

### Smoothing Device.

Fig. 2 is rather a novel departure in smoothing circuits; it is intended to fatten out pulsating D.C. such as may be obtained from a rectifier. The pulsating input is applied at A and is fed into an electrolytic cell or a number of cells in series at F

which become polarised. From F the current passes to the output B through a loose contact device C, whose resistance varies with the pressure on the diaphragm D. Across the cell F is an electro-magnet E, fluctuations in which cause a varying pull on the diaphragm D, thereby tending to neutralise fluctuations in current passed to the output B.

### Signalling by High-Frequency Mechanical Vibrations in Material Media.

Apparatus for transmitting sound waves of audible or super-audible frequency through water or similar media is described in British Patent 200,709. Oscillations generated by an arc, alternator or commutator are applied to a special electrostatic condenser device which may be submerged in the water surrounding a ship or other vessel. Owing to the varying electrostatic attraction between the plates of the device they vibrate in response to the applied alternations, thus imparting a vibratory disturbance to the water, which is propagated to a distance, and may be detected by some suitable submersible responsive device. Instead of immersing, the electrostatic vibrator in the water outside the vessel a vibrator may be installed inside in such a manner as to impart its vibrations to the wall of the vessel which in turn sets up the requisite compression waves in the water. It is stated that the device

works well with high frequencies and lends itself to telephony. Its most important use is in submarine communication.

**Atmospheric Elimination.**

In designing circuits to discriminate between atmospherics and signals, we have taken into account the fact that atmospherics are aperiodic impulses which kick any tuned circuit into oscillations of its own natural frequency; hence the difficulty of eliminating the effects of atmospherics with ordinary selective circuits. A new system has recently been patented by H. J. Round (Brit. Pat. 200,857). Coupled to an aerial, preferably one having the best directional properties, are two tuned circuits in cascade; these circuits are so

by the atmospherics themselves in the absence of a signal.

**Sealing Leading-In Wires for Heavy Currents into Glass.**

One of the chief difficulties in constructing lamps, valves or enclosed arcs to handle large powers is that of producing a satisfactory metal-to-glass seal. Thick leading-in wires, even if made of platinum or other metal with the same co-efficient as glass, present serious difficulties when it is attempted to make a robust and permanently gas-tight seal. The Dutch firm of Philips, which holds a large number of lamp and valve patents, has developed a seal in which the lead-in is made by means of a chrome-iron disc,

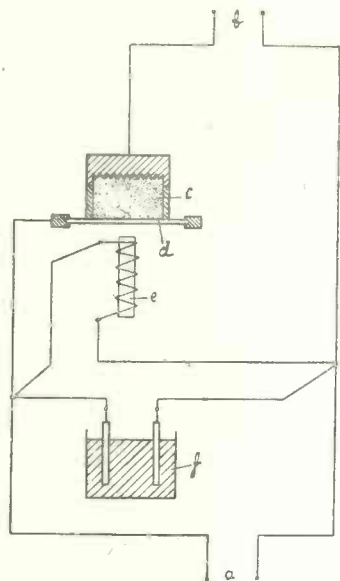

Fig. 2.

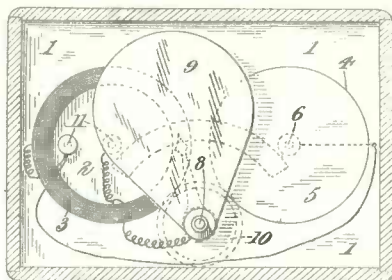

Fig. 1.

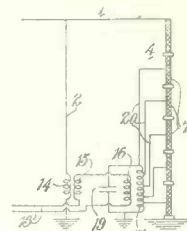

Fig. 5.

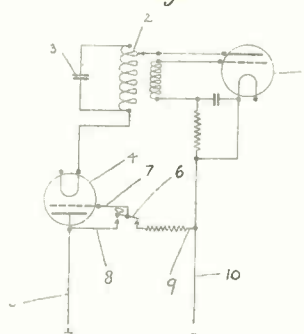

Fig. 3.

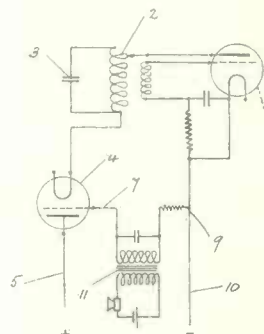

Fig. 4.

Fig. 1.—A method of simultaneously varying inductance and capacity. Fig. 2.—An arrangement to smooth pulsating D.C. Fig. 3-4.—A system of keying or modulating the output of a valve oscillator. Fig. 5.—The mast is divided into a number of insulated sections, supplied with graded potentials.

adjusted that their respective resonance curves are as near together as possible without overlapping, one being exactly tuned to the signals to be received. At the end of these circuits are connected two detectors, so balanced that only the difference between the currents set up in the two circuits affects the indicating device. Thus an atmospheric impulses both tuned circuits equally into their own free periods, and the effects therefore cancel in the indicating device. The tuned signal, however, materially affects only one circuit and is recorded. What is actually recorded by, say, a syphon recorder is the difference between the signal and atmospheric amplitudes. This difference may be large, small, positive or negative according to the phase relation between signal and atmospheric, but in any case nothing is recorded

the circumference only of which is fused into the glass. (Chrome-iron can be made to have the same co-efficient of expansion as glass.) The heavy current leads are attached to the centre of the chrome-iron disc on either side. (Brit. Pat. 198,322.)

**A System of Modulation.**

Numerous patents have been filed for modulating the output of valve transmitters for telephony and keying them for Morse. Figs. 3 and 4 illustrate a scheme recently patented by N. F. S. Hecht (Brit. Pat. 201,276). A control valve is placed in series with the positive H.T. lead as shown. When the key (Fig. 3) is up, the grid of the control valve 4 is connected to the negative H.T. lead and is thereby maintained at a sufficiently great negative potential to cut the current through the

valve down to a low value. When the key is down the grid is connected straight to the plate, and thus brought to full positive H.T. potential under which circumstance the control valve passes its full saturation current. The modulation scheme in Fig. 3 should give good results, but it is not quite clear where the novelty lies, other than the use of the control resistance 9.

#### Aerial Improvements.

The Telefunken Co. describe in Brit. Pat. 180,673 a system in which the aerial is broken up into a number of elements, each fed from the transmitter, so arranged that the energy is utilised equally. The system is comparable with the Alexanderson multiple-tuned aerial.

E. Y. Robinson gives details in Brit. Pat. 201,264 of a system of breaking up the aerial mast into insulated sections, a tapped inductance supplying graded potentials to the various sections. The disturbing effects of the metal mast are thus eliminated, as shown in Fig. 5.

#### Microphone Singing.

The singing effect between a microphone and telephone receiver is well-known, and the Telefunken Co. have devised a method of eliminating the effect. The microphone is connected in a form of bridge circuit, of which one arm is equivalent to the line in use and the whole is so balanced that currents from the transmitter do not effect the local receiver. Full details will be found in Brit. Pat. 178,860.

## Recent Wireless Publications.

Figures after the title of each publication indicate Volume and Number of Publication containing the article. Where only one number is given, this indicates the serial number of the publication.

#### ABBREVIATIONS OF TITLES OF JOURNALS USED IN THE BIBLIOGRAPHY.

- |  |  |
|--|--|
| Amer. Acad.—American Academy of Arts and Sciences.                     | Mod. W.—Modern Wireless.   |
| Am.I.E.E. J.—Journal of American Institute of Electrical Engineers.    | Nature—Nature.   |
| Ann. d. Physik—Annalen der Physik.                                     | Onde El.—L'Onde Electrique.  |
| Boll. Radiotel.—Bolletino Radiotelegrafico.                            | Phil. Mag.—Philosophical Magazine.                                     |
| Elec. J.—Electric Journal.   | Phil. Trans.—Philosophical Transactions.                               |
| El. Rev.—Electrical Review.  | Phys. Rev.—Physical Review.  |
| El. Times—Electrical Times.  | Phys. Soc. J.—Journal of Physical Society of London.                   |
| El. World—Electrical World.  | Q.S.T.—Q.S.T.  |
| Electn.—Electrician.   | R. Elec.—Radio Electricité.  |
| Frank. Inst. J.—Journal of the Franklin Institute.                     | Roy. Soc. Proc.—Proceedings of the Royal Society.                      |
| Gen. El. Rev.—General Electric Review.                                 | Sci. Abs.—Science Abstracts.   |
| Inst. El. Eng. J.—Journal of the Institute of Electrical Engineers.    | T.S.F.—Telegraphie sans fils, Revue Mensuelle.                         |
| Inst. Rad. Eng. Proc.—Proceedings of the Institute of Radio Engineers. | Teleg. without Wires, Russia—Telegraphy without Wires, Nijni Novgorod. |
| Jahrb. d. drahtl. Tel.—Jahrbuch der drahtlosen Teleg. etc.             | W. Age—Wireless Age.   |
|  | W. Trader—Wireless Trader.   |
|  | W. World—Wireless World and Radio Review.                              |

### 1.—TRANSMISSION.

- DIRECTIVE RADIO TRANSMISSION ON A WAVELENGTH OF 10 METRES.—S. R. Winters (*W. Age*, 10, 11).
- VOLTAGE RAISER FOR VALVE TRANSMITTERS.—Marcus G. Scroggie, B.Sc. (*W. World*, 290).
- THE TRANSMISSION OF PICTURES BY WIRELESS.—J. H. T. Roberts, D.Sc., F.Inst.P. (*Mod. W.*, 1, 8).
- A HIGH-POWER WIRELESS VALVE CAPABLE OF BEING DISMANTLED.—(*El. Rev.*, 93, 2387).
- RADIO BROADCASTING STATION, W.G.Y. (U.S.A.).—W. R. G. Baker (*Gen. El. Rev.*, 36, April, 1923).
- A 30-KILOWATT 15,000 VOLT RECTIFIER FOR THE UNITED STATES NAVY.—A. Schmidt, Jr. (*Gen. El. Rev.*, No. 26, May, 1923).
- BROADCASTING STATION AT SCHENECTADY, NEW YORK.—W. R. G. Baker (*Inst. Rad. Eng. Proc.*, 11, 4).
- VACUUM TUBES AS POWER OSCILLATORS, PART 2.—D. C. Prince (*Inst. Rad. Eng. Proc.*, 11, 4).

- IL CENTRO RADIOTELEGRAFICO DI COLTANO (*Boll. Radiotel.* 2, 22).
- THE NODAL POINT EXPLAINED.—H. F. Mason. (*Q.S.T.*, 7, 2).
- THE BEST DIMENSIONS FOR AMATEUR ANTENNAS.—Ross Gunn (*Q.S.T.*, 7, 2).

### 2.—RECEPTION.

- STATIC ELIMINATION PHANTASIES.—Carl Dreher (*W. Age*, 10, 11).
- AN ARMSTRONG SUPER RECEIVER.—5HZ (*W. World*, 209).
- DISTORTION IN VALVE RECEIVING CIRCUITS. Part 1.—S. O. Pearson, B.Sc. (*W. World*, 211).
- HINTS ON BETTER RECEPTION.—W. James (*W. World*, 211).
- MY NEW CIRCUIT.—E. T. Flewelling (*Mod. W.*, 1, 8).
- RADIO ATMOSPHERIC ELIMINATION. THE MARREC SELECTIVE RECEIVING APPARATUS (*El. Rev.*, 93, 2388).

LONG DISTANCE RADIO RECEPTION IN INDIA.—P. J. Edmunds, B.A. (*Electn.*, 2361).

SUPER-REGENERATION.—P. David. (*Onde El.*, No. 2, April, 1923).

ON SUPER-REGENERATION.—E. O. Hulburt (*Inst. Rad. Eng. Proc.*, 11, 4).

LOOP UNI-DIRECTIONAL RECEIVING CIRCUITS FOR THE DETERMINATION OF THE DIRECTION OF ATMOSPHERIC DISTURBANCES.—L. W. Austin (*Inst. Rad. Eng. Proc.*, 11, 4).

THEORIE DER BEVERAGE-ANTENNE, 2.—H. Busch (*Jahrb. d. drahtl. Tel.*, 21, 6).

EXPERIMENTALUNTERSUCHUNG ÜBER DIE VERGLIMMLICHVERSTÄRKERRÖHRE.—E. Marx (*Ann. d. Physik*, 70, 4).

### 3.—MEASUREMENT AND CALIBRATION.

PRACTICAL TABLES FOR INDUCTANCE AND COIL CALCULATIONS (*W. Age*, 10, 11).

NOTE ON THE CALIBRATION OF A HETERODYNE WAVEMETER.—E. Mallet, H. Andrewes, and E. T. A. Rapson (*Electn.*, 2363).

RECEIVING MEASUREMENTS AND ATMOSPHERIC DISTURBANCES AT THE UNITED STATES NAVAL RADIO RESEARCH LABORATORY, BUREAU OF STANDARDS, WASHINGTON, MARCH AND APRIL, 1923.—L. W. Austin (*Inst. Rad. Eng. Proc.*, 11, 4).

STANDARDS OF CAPACITY PARTICULARLY FOR RADIO FREQUENCY CURRENTS.—J. B. Dempster and E. O. Hulburt (*Inst. Rad. Eng. Proc.*, 11, 4).

ANLEITUNG ZUM SELBSTHERSTELLEN EINES TRAGBAREN WELLENMESSERS FÜR KURZE WELLENLÄNGEN FÜR AMATEURE.—Bureau of Standards (H. Eales) (*Jahrb. d. drahtl. Tel.*, 21, 6).

MESSUNG DER KAPAZITÄT DÜNNDRÄHTIGER SPULEN VON HOHER WINDUNGSZAHL UND DIE ABHÄNGIGKEIT DES FACTORS DER THOMSONSCHEN GLEICHUNG VON DER GRÖSSE DER ZUSATZKAPAZITÄT.—Erich Marx and August Karolus (*Physikal. Zeitschr.*, 24, 3).

EXPERIMENTELLE UNTERSUCHUNGEN UNTER DIE BEUGEN UNGEDÄMPFTER ELEKTRISCHER WELLEN AN DIELEKTRISCHEN ZYLINDER UND ÜBER DIE EIGENSCHWINGUNGEN DIELEKTRISCHER ZYLINDER.—C. Schaefer and J. Merzkirch (*Zeitschr. für Physik*, 13, 3).

### 4.—THEORY AND CALCULATIONS.

ETUDE DES ANTENNES EN NAPPE.—R. Villem (*R. Elec.*, 4, 11).

LONGEUR D'ONDE OPTIMUM.—Léon Bouthillon (*R. Elec.*, 4, 11).

PROPAGATION OF ELECTROMAGNETIC WAVES OVER THE SURFACE OF THE EARTH.—Léon Bouthillon (*Journ. Tél. graph.*, 47).

BERECHNUNG DER KOPPLUNGSKOEFFIZIENTEN FÜR EINIGE BESONDEREN FÄLLE DER GEGENSEITIGEN INDUKTION.—D. Wicker (*Jahrb. d. drahtl. Tel.*, 21, 6).

VEKTORANALYSIS IN IHREN GRUNDZÜGEN UND WICHTIGSTEN PHYSIKALISCHEN ANWENDUNGEN.—A. Haas (reviewed in *Jahrb. d. drahtl. Tel.*, 21, 6).

DER AUFBAU DER ATOME AUS URATOMEN.—L. Zehnder (reviewed in *Jahrb. d. drahtl. Tel.*, 21, 6).

EINFÜHRUNG IN DIE IONEN- UND ELEKTRONENLEHRE DER GASE.—H. Greinacher (reviewed in *Jahrb. d. drahtl. Tel.*, 21, 6).

MATHEMATISCHE EINFÜHRUNG IN DIE GRAVITATIONSTHEORIE EINSTEINS NEBST EINER EXAKTEN DARSTELLUNG IHRER WICHTIGSTEN ERGEBNISSE.—H. Bauer (reviewed in *Jahrb. d. drahtl. Tel.*, 21, 6).

VALVE PERFORMANCE.—P. K. Turner (*W. Trader*).

### 5.—GENERAL.

NOTES ON VACUUM TUBES.—M. L. Snyder (*W. Age*, 10, 11).

THE NEW SIGNAL CODE.—Louis Cohen, Ph.D. (*W. World*, 209).

SOME EXPERIMENTS ILLUSTRATING THE ELECTRICAL PROPERTIES OF NEON LAMPS.—Demonstration by Philip R. Coursey before the R.S.G.B. (*W. World*, 210).

DUPLEX RADIOTELEPHONY ON CONTINENTAL RAILWAYS.—Nicholas Langer (*W. World*, 211).

A LOW-VOLTAGE CATHODE RAY OSCILLOGRAPH.—N. V. Kipping (*W. World*, 212).

LA RADIOÉLECTRICITÉ ET LA TÉLÉPATHIE.—Henri Aubert (*R. Elec.*, 4, 10).

L'INVENTION DE LA T.S.F.—J. Guinchant (*R. Elec.*, 4, 10).

A PROPOS DE LA RADIOGONIOMETRIE (*R. Elec.*, 4, 10).

A PROPOS DE COLLOIDES.—Joseph Roussel (*R. Elec.*, 4, 11).

LES TUBES THERMOIONIQUES À VAPEUR MÉTALLIQUE.—Michel Adam (*R. Elec.*, 4, 11).

THE CRYSTALS USED IN WIRELESS.—E. H. Chapman, M.A., D.Sc. (*Mod. W.*, 1, 8).

COMMERCIAL WIRELESS TELEGRAPHY IN SOUTH AMERICA (*El. Rev.*, 93, 2388).

INTERFERENCE.—Robert H. Marriott (*Inst. Rad. Eng. Proc.*, 11, 4).

DIGEST OF U.S. PATENTS RELATING TO RADIO TELEGRAPHY AND TELEPHONY ISSUED APRIL 24, 1923—JUNE 19, 1923.—John B. Brady (*Inst. Rad. Eng. Proc.*, 11, 4).

ATLAS DER FUNKTELEGRAPHIE UND SEEKABEL IM WELTVERKEHR.—H. Behner (reviewed in *Jahrb. d. drahtl. Tel.*, 21, 6).

ÜBER VERSTÄRKUNG DER PHOTOELEKTRISCHEN UND IONISATIONSTRÖMER MITTELS DER ELEKTRONENRÖHRE.—G. de Prel (*Ann. d. Physik*, 70, 3).

THE MOTION OF ELECTRONS IN GASES UNDER CROSSED ELECTRIC AND MAGNETIC FIELDS.—Rabindra N. Chaudhuri, M.Sc., Ph.D. (*Phil. Mag.*, 46, 273).

ELECTRICAL DISCHARGES IN GEISSLER TUBES WITH HOT CATHODES.—W. H. McCurdy, M.A. (*Phil. Mag.*, 46, 273).

THE MOTION OF ELECTRONS IN HYDROGEN UNDER THE ACTION OF CROSSED ELECTRIC AND MAGNETIC FIELDS.—R. N. Chaudhuri, M.Sc., Ph.D. (*Phil. Mag.*, 46, 273).

THE APPLICATION OF A REVOLVING MAGNETIC DRUM TO ELECTRIC RELAYS, SIPHON RECORDERS AND RADIO TRANSMITTING KEYS.—N. W. McLachlan (*Inst. El. Eng. J.*, 321).

THE DESIGN OF INDUCTANCES FOR HIGH FREQUENCY CIRCUITS.—Prof. C. L. Fortescue (*Inst. El. Eng. J.*, 321).

THE BEST DIMENSIONS FOR AMATEUR ANTENNAS.—Ross Gunn (*Q.S.T.*, 7, 2).

# "THE WIRELESS WORLD AND RADIO REVIEW"

FOURPENCE

— Every Wednesday —

FOURPENCE

The First  
Radio

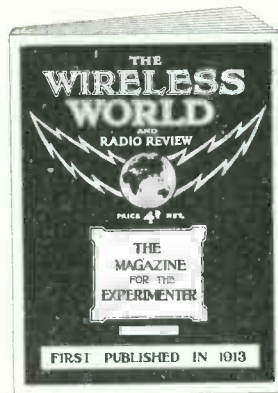

And Best  
Weekly

**THE FIRST** to describe the Armstrong Receiver.  
**THE FIRST** to describe the Neutrodyne Receiver.  
**THE FIRST** to describe the Flewelling Receiver.  
**THE FIRST** to describe Double Magnification Receivers.  
**THE FIRST** to give 32 pages for fourpence.  
**THE FIRST** for latest developments.

**THE BEST** list of contributed articles.  
**THE BEST** type of circuits only are given.  
**THE BEST** for solving your difficulties.  
**THE BEST** for genuine experimenters.  
**THE BEST** for quantity and quality—therefore  
**THE BEST** that you can buy.

Since 1913 "THE WIRELESS WORLD AND RADIO REVIEW" has catered regularly for the amateur, and has continuously maintained the high standard for which it is noted.

"THE WIRELESS WORLD" is universally recognised as the Leading Weekly Journal for all who take a serious interest in wireless matters. Its articles contain new ideas—not a re-hash of old ones. Our purpose is to help you, therefore, a special department devotes its whole time to the answering of readers' questions.

"THE WIRELESS WORLD" gives you Theory and Practice.

In the course of remarks on wireless, the "Daily Chronicle" stated that "Volumes of the 'WIRELESS WORLD' since the Armistice probably contain more actual constructional advice than all the British Wireless text-books."

**"THE WIRELESS WORLD" IS THE LEADING RADIO WEEKLY.**

*We shall be pleased to send you a free specimen copy and our catalogue of over seventy books on wireless upon receipt of a post card.*

**The Wireless Press, Ltd.,** Dept. E. W.,  
12-13, Henrietta St., London, W.C.2.



**IT IS A WELL-KNOWN FACT THAT EVERY**

TRADE **Grelco** MARK

**PRODUCT IS JUST A LITTLE BETTER THAN THE PURCHASER EXPECTS. THAT'S OUR POLICY;** and yet in the long run you pay less than the unknown "orphan" lines which are offered by firms who have only taken up the sale of wireless goods since the broadcasting.

**BE ON THE SAFE SIDE AND SEND NOW FOR OUR 100-PAGE CATALOGUE, POST 3d. FREE.**

**GRAFTON ELECTRIC COMPANY,**  
54, GRAFTON ST.,  
Tottenham Court Rd.,  
LONDON, W.C.1.

Telephone: Museum 241. Works: Slough.

Low Prices. Highest Quality.

**Experimenters Need RELIABLE Equipment**

We make our appeal to you on quality goods—goods you may safely rely upon to do the work for which they are designed, and which will really assist you in the work in which you are interested. Good instruments and good components vitally concern you if you are serious in your experimental endeavours. For twenty-three years we have carried out research in wireless; the result is shown in the high standard, everywhere acknowledged, as being characteristic of Bowyer-Lowe manufactures.



Take, for instance, our Mark I Wavemeter, which covers from 150 to 600 metres. This is a most useful instrument, and is supplied complete for sending and receiving. The price is £4 12s. 6d., or for sending only, £4 4s. Full descriptive leaflet will be sent on application. Both electrically and mechanically the quality of our workmanship, inside and out, is beyond reproach. Our prices are the lowest on the market for the quality we give.

**AN INVITATION.**—We invite your correspondence on any question relating to wireless, and if you will send us your name and address on a p.c. marked "Experimenter," we will keep you posted about all new apparatus we introduce. Write now.

**The Bowyer-Lowe Co. Ltd.**

Manufacturers and Suppliers of High-grade Wireless Instruments,

**Radio Works, Commerce Av., Letchworth**

Telephone: LETCHWORTH 246.

Telegrams: "BOWYER-LOWE CO., LETCHWORTH."



Wholesale Distributor for Scotland:

F. M. Milligan, 23-25, Rentfrew Street, Glasgow

**ALL 'ATHOL' GEAR**

is supplied under a guarantee of "ENTIRE SATISFACTION."

**SWITCH ARMS. 4-leaf.**  
1/3 each, post free.

**SWITCH CONTACTS.**  
1d. each, post free.

**FILAMENT RESISTANCES.**  
2/9 each, post free.

**ENAMELLED AERIALS**  
100 ft. 7/22. 4/9, post free.

**SCREWED RODS, 12".**  
4 B.A. 4d. 2 B.A. 5d. each.

**INSULATING TUBING.**  
6d. per yard, post free.

**PANEL LABELS.**  
1 1/2d. per sheet (19 labels).

**RECEPTACLES**  
1/3 each.  
Postage 1d.

**TERMINAL PLUGS**  
As above, but with Terminals,  
1/6 each.  
Post 1d.

**SEND A P.C. FOR LIST.**

**Athol Engineering Company,**  
9, PERU St., Hr. Broughton, MANCHESTER.

**"GUARANTEED" SERVICE**

Our Guarantee accompanies every article sold, and anything not thoroughly approved will be willingly exchanged or credited. Service is prompt—every letter having attention within 24 hours. Lists are free, and will be sent post free on receipt of your name and address. Send a P.C. to-day.

**ELECTRICAL SUPPLY STORES,**  
"WIRELESS SPECIALISTS,"

11, FOUNTAIN STREET, HALIFAX.  
Telegrams: "Terminals, Hz." Phone: 1062.

**A USEFUL BOOK FOR WIRELESS EXPERIMENTERS.**

**Maintenance and Repair of Electrical Measuring Instruments.**  
By H. G. Yarrill.

The object of this handbook is to set down in as simple a form as possible the general principles of the various types of commercial instruments in everyday use, and to give some practical hints on installing, maintaining in service, and the performance of minor repairs.

Eight Chapters, including Common Defects: Causes and Remedies; and Repairs and How to Carry Them Out.

Well Indexed. : : 7 Plates and 14 other Illustrations.

Price 2/6 net, through your bookseller, or 2/8 post free from

**PERCIVAL MARSHALL & CO.,**  
66, FARRINGTON STREET, - - LONDON, E.C. 4.



All the advantages  
of experimenting  
with a 2-Valve Set  
are yours  
for half-a-crown

if you have

**PHILIPS' MODEL  
OF  
WIRELESS RECEIVING SET**

DESIGNED BY

W. H. DERRIMAN, B.Sc., A.C.G.I., and N. COX-WALKER.

Of immense value to the amateur who desires to gain knowledge of the functioning of valves—a subject which is often so difficult to understand without the aid of expensive apparatus.

The model will appeal strongly to those who hold or contemplate holding an experimental licence.

The model is of stout cardboard folded to size 10 x 7½ inches, and is contained in a strong manilla envelope. Price 2/5 net (post free 2/8).

Obtainable from all Booksellers, Stationers, and Apparatus Dealers, or direct from—

GEORGE PHILIP & SON, LTD., 32, Fleet St., London, E. C. 4.

NO LISTENER-IN should be without—  
Philips' Wireless Map of Great Britain  
Price 2/6 net (Post free 2/8).

**EQUIPMENT FOR  
EXPERIMENTERS**

**PRELIMINARY SAFETY**

No matter what type of circuit you intend using in your receiving set your results are wholly dependent upon the quality of your preliminary component purchases. Modern Radio experience and research is embodied in all WEBBER PRODUCTIONS. They ensure preliminary safety in outlay, and are supremely neat, compact and economical. The WEBBER COMPLETE SAFETY VALVE PANEL W53 is illustrated. This panel is fitted with a POLAR FUSE to protect the valve and an Igranic Rheostat to give smooth control. The Rheostat terminal is clearly marked to enable positive and negative lead changes during experiment.



Size complete 4" by 4".

With ordinary Rheostat .. .. . Price 16/6  
With vernier .. .. . " 19/6

Approved by The Radio Communication Company, Ltd., and on view at demonstration Rooms, 35, Norfolk St., Strand, W.C.2.

Write for descriptive list (post free.)

**N. V. WEBBER & CO., Radio Engineers,**  
WALTON HOUSE, WALTON-on-THAMES,  
SURREY. ARKS 2

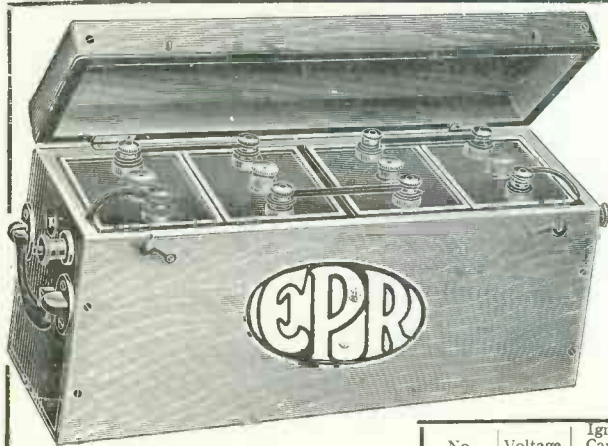

**GREAT SALE OF  
LONDON  MADE  
ACCUMULATORS.**

**"Popular" Type.**

High Quality Cells at low competitive prices. Clear Celluloid cases. Well finished.

**"C" Type.**

Special Features: Extra Stout Cases (Celluloid). Specially Formed Lattice Grid Plates. Absolutely the finest Cell yet produced.

**ALL CELLS GUARANTEED.**

| VALVES.     |       |                      |       |
|-------------|-------|----------------------|-------|
| PHILLIPS, R | 10/6  | DUTCH (Det).         | 8/6   |
| XTRUDION    | 13/11 | EDISWAN              | 13/11 |
| MARCONI     | 13/11 | GOSSOR               | 14/9  |
| MULLARD     | 15/-  | (Postage 6d. extra.) |       |
| PHONES.     |       |                      |       |
| BRUNET      | 17/11 | N.&K. (Genuine)      | 18/11 |
| STERLING    | 24/6  | SIEMENS              | 24/6  |
| FEDERAL     | 24/11 | FRENCH               | 14/11 |
|             |       | (Postage 1/- extra.) |       |

| VOLTMETERS |             |             |            |
|------------|-------------|-------------|------------|
| Ditto      | Flange Type | 5/11 & 7/11 | 8/11 10/11 |

Accumulator charging done on the premises Day and Night.

| No.  | Voltage. | Ignition Capacity Amps. | Price. | Extra for Carriage. | No.  | Voltage. | Ignition Capacity Amps. | Price. | Extra for Carriage. |
|------|----------|-------------------------|--------|---------------------|------|----------|-------------------------|--------|---------------------|
| 1310 | 4        | 20                      | 11/9   | } 1/6               | 1710 | 4        | 22                      | 13/11  | } 1/6               |
| 1315 | 4        | 30                      | 12/11  |                     | 1720 | 4        | 44                      | 19/9   |                     |
| 1320 | 4        | 40                      | 15/6   |                     | 1730 | 4        | 66                      | 24/9   |                     |
| 1330 | 4        | 60                      | 20/3   | } 2/-               | 1740 | 4        | 88                      | 31/6   | } 2/-               |
| 1340 | 4        | 80                      | 26/11  |                     | 1750 | 4        | 110                     | 37/6   |                     |
| 1350 | 4        | 100                     | 29/11  | } 2/6               | 1820 | 6        | 44                      | 29/11  | } 2/6               |
| 1420 | 6        | 40                      | 24/11  |                     | 1830 | 6        | 66                      | 37/11  |                     |
| 1430 | 6        | 60                      | 30/9   |                     | 1840 | 6        | 88                      | 46/11  |                     |
| 1440 | 6        | 80                      | 35/6   |                     | 1850 | 6        | 110                     | 55/-   |                     |
| 1450 | 6        | 100                     | 41/-   |                     |      |          |                         |        |                     |

**RICHFORD & Co. (Est. 1876), 153, FLEET ST., LONDON, E. C. 4.**



**SCIENTIFIC SUPPLY STORES,**  
126, Newington Causeway, LONDON, S.E.1.

**A FEW OF OUR COMPONENTS. ALL POST EXTRA.**

- Lapped Coil, tens and units 2/6
- '001 Variable Condenser 10/6
- Two-Coil Tuning Stand ... 5/6
- Three-Coil Tuning Stand ... 7/6
- Coll Holder for same, as shown 1/6
- H.F. Transformers:
  - A. 150-235 m. ... 1/3
  - B. 320-490 m. ... 1/3
  - C. 550-810 m. ... 1/8
  - D. 790-1800 m. ... 2/-
  - E. 1650-2900 m. ... 2/6
- Variometer, 385 to 800 m. 8/9
- Filament Rheostat, with dial ... 2/9
- Variometer, 250-000 m. 2/6
  - Ball only, unwound ... 9d
  - Ball only, wound ... 1/6
  - Complete Set of Parts, wound ... 5/6
- Double Headphones, adjustable ... 19/6
- Double Headphones, non-adjustable 15/6
- L.F. Transformer, 12/6
- Experimental Panel, 1 valve ... 8/6
- Rasket Coils, 180-4000 m. D.M. set ... 2/8

Phone: HOP 4177

To READERS.—“EXPERIMENTAL WIRELESS” may be obtained to order through any Newsagent or Bookstall, but for the convenience of those who prefer to subscribe direct we print this form.

Per Issue,

1/3

post free to any part of the World.

## Subscription Order Form

Annual Subscription,

15/-

post free to any part of the World

To PERCIVAL MARSHALL & CO.,

66, Farringdon Street, LONDON, E.C.4.

Please supply me with “EXPERIMENTAL WIRELESS” regularly as published, commencing with the issue for.....

Herewith I beg to hand you 15/-, being payment in advance of my Subscription for 12 issues.

(Name).....

(Address in full).....

Date.....

Please write Distinctly.

Head Office: 19, FITZROY SQUARE, LONDON, W.1.

# ECONOMIC ELECTRIC LTD.

TELEPHONE MUSEUM 1055.

Showrooms: 303, EUSTON ROAD, N.W.1

Branch Showrooms: TWICKENHAM.

## CATERING FOR THE ELECTRICAL EXPERIMENTER

has been our speciality for 7 years, and we can promise you value and efficiency. Write for our 40 page RADIO LIST, sent post free ad.

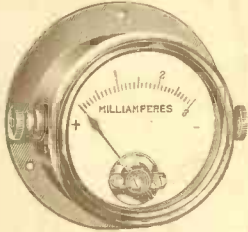

MOVING COIL MILLIAMPERE METERS.



VALVE LEGS.



SPADE TERMINALS.

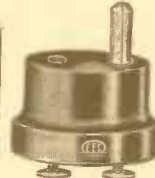

HONEYCOMB COIL SOCKETS.

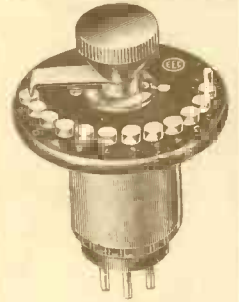

TUNED ANODE.

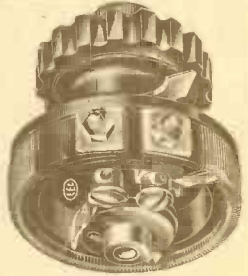

FILAMENT RHEOSTAT With Vernier.

## "XTRAUDION" VALVE

15/-



"A real mechanical job." — *Amateur Wireless.*

"The 'Xtraudion' is a marvellous silent amplifier." — *Bazaar, Exchange and Mart.*

"On the S.T. 100 circuit it gave a fine roar with 2 L.O.'s Dance Music, audible at the end of a large suburban garden." — *Wireless Weekly*, July 25.  
"Preference should be given to a valve using little current. The 'Xtraudion' using only .4 amps, fills the bill." — *Motor Cycling*, Aug. 8.

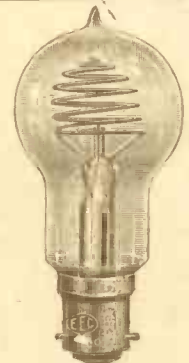

NEON TUBES.

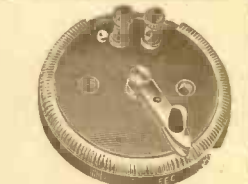

FILAMENT RHEOSTAT.

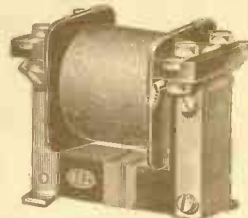

L.F. TRANSFORMERS.

## THIS FAMOUS LOW-CONSUMPTION VALVE

Is recognised as a great advance in valve-construction. Two "XTRAUDIIONS" use practically no more current than one of most other types. Amplification is enormous, the factor being 12. Silent working, due to the wonderful grid construction. Elements supported on two sides. Should filament sag, it cannot touch the grid. The anode is immensely strong and rigid. Send for our 40-page Radio Book and read all about it. Mailed post free for 4d.

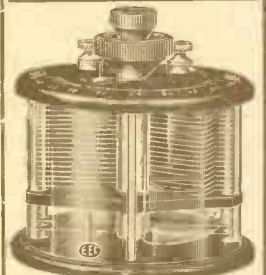

VARIABLE AIR CONDENSER With Vernier.

## THE FINEST RECTIFIER OF RADIO FREQUENCY CURRENTS IS OUR SYNTHETIC CRYSTAL "RECTARITE."

A specimen of this fitted into a good detector holder used in conjunction with our "Unisector" circuit will operate a

LOUD SPEAKER 5 miles from a Broadcasting Station! We will help you to test this statement

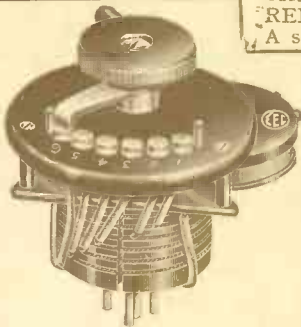

TUNED ANODE WITH REACTANCE.



LOOSE COUPLED INDUCTANCES.



VARIOMETERS.