

**EVERYDAY**

JANUARY 1994

WITH **PRACTICAL**

# **ELECTRONICS**

INCORPORATING ELECTRONICS MONTHLY

FULLY S.O.R. £1.95

**10 PLUS 10 STEREO AMPLIFIER**

TIMER AND NiCAD CHECKER

**AUTOMATIC NIGHT LIGHT**

CALCULATION CORNER 1

**FREE  
INSIDE**

**DISPLAY  
ELECTRONICS  
CATALOGUE**

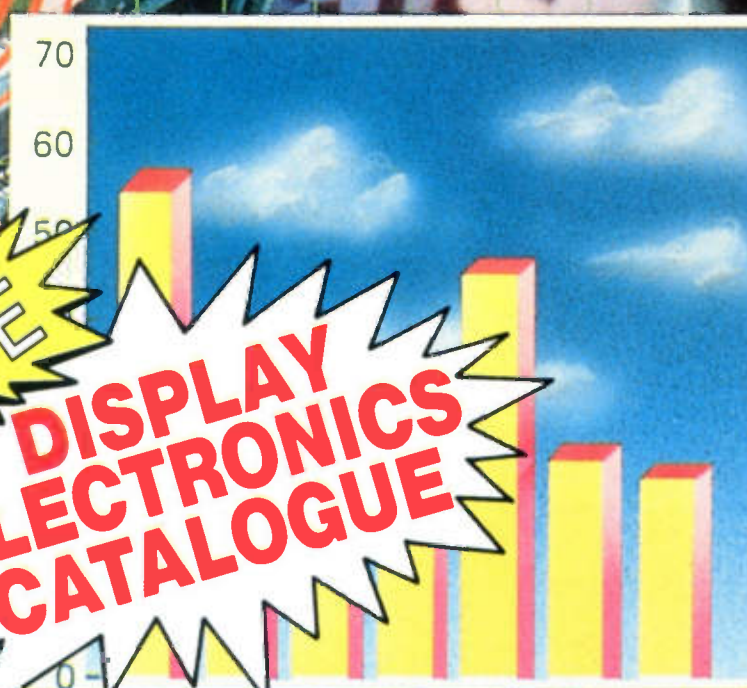

THE No. 1 INDEPENDENT MAGAZINE for **ELECTRONICS, TECHNOLOGY** and **COMPUTER PROJECTS**



**AMSTRAD DMP4000** Entire printer assemblies including printhead, platen, cables, stepper motors etc. Everything bar the electronics and case. Good stripper!! Clearance price just £5 REF: MAG5 or 2 for £8 REF: MAG8

**VIEWDATA SYSTEMS** Brandnew units made by TANDATA complete with 1200/75 built in modem, infra red remote controlled keyboard, BT approved, Prestel compatible, Centronics printer port, RGB colour and composite output (works with any TV) complete with power supply and fully cased. Price is just £20 REF: MAG20 Also some customer returned units available at £10 each REF: MAG10

**PPC MODEM CARDS.** These are high spec plug in cards made for the Amstrad laptop computers. 2400 baud dial up unit complete with leads. Clearance price is £5 REF: MAG5P1

**INFRA RED REMOTE CONTROLLERS** Originally made for hi spec satellite equipment but perfect for all sorts of remote control projects. Our clearance price is just £2 REF: MAG2

**TOWERS INTERNATIONAL TRANSISTOR GUIDE.** A very useful book for finding equivalent transistors, leadouts, specs etc. £20 REF: MAG20P1

**SINCLAIR C6 MOTORS** We have a few left without gearboxes. These are 12v DC 3,300 rpm 6"x4", 1/4" OP shaft. £25 REF: MAG25

**UNIVERSAL SPEED CONTROLLER KIT** Designed by us for the above motor but suitable for any 12v motor up to 30A. Complete with PCB etc. A heat sink may be required. £17.00 REF: MAG17

**VIDEO SENDER UNIT.** Transmits both audio and video signals from either a video camera, video recorder, TV or Computer etc to any standard TV set in a 100' range! (Tune TV to a spare channel) 12v DC op. Price is £15 REF: MAG15 12vps is £5 extra REF: MAG5P2

**\*FM CORDLESS MICROPHONE** Small hand held unit with a 500' range! 2 transmit power levels. Reqs PP3 9v battery. Tuneable to any FM receiver. Price is £15 REF: MAG15P1

**LOW COST WALKIE TALKIES** Pair of battery operated units with a range of about 200'. Ideal for garden use or as an educational toy. Price is £8 a pair. REF: MAG8P1 2 x PP3 req'd.

**\*MINIATURE RADIO TRANSCEIVERS** A pair of walkie talkies with a range of up to 2 kilometres in open country. Units measure 2x2x1.55mm. Complete with cases and earpieces. 2xPP3 req'd. £30.00 pair REF: MAG30.

**COMPOSITE VIDEO KIT.** Converts composite video into separate H sync, V sync, and video. 12v DC operation. £8.00 REF: MAG8P2

**LQ3600 PRINTER ASSEMBLIES** Made by Amstrad they are entire mechanical printer assemblies including printhead, stepper motors etc etc In fact everything bar the case and electronics, a good stripper! £5 REF: MAG5P3 or 2 for £8 REF: MAG8P3

**PHILIPS LASER 2MW** helium neon tube Brand new full spec £40 REF: MAG40. Mains power supply kit £20 REF: MAG20P2. Fully built and tested unit £75 REF: MAG75.

**SPEAKER WIRE** Brown two core. 100 foot hank £2 REF: MAG2P1

**LED PACK** of 100 standard red 5mm leds £5 REF: MAG5P4

**JUG KETTLE ELEMENTS** good general purpose heating element (about 2kw) ideal for all sorts of heating projects etc. 2 for £3 REF: MAG3

**UNIVERSAL PC POWER SUPPLY** complete with flyleads, switch, fan etc. Two types available 150w at £15 REF: MAG15P2 (23x23x23mm) and 200w at £20 REF: MAG20P3 (23x23x23mm)

**OZONE FRIENDLY LATEX** 250ml bottle of liquid rubber, sets in 2 hours. Ideal for mounting PCB's, fixing wires etc £2 each REF: MAG2P2

**\*FM TRANSMITTER** housed in a standard working 13A adapter! the bug runs directly off the mains so lasts forever! why pay £700? or price is £26 REF: MAG26 Transmits to any FM radio!

**\*FM BUG KIT** New design with PCB embedded coil for extra stability. Transmits to any FM radio. 9v battery req'd. £5 REF: MAG5P5

**\*FM BUG BUILT AND TESTED** superior design to kit, as supplied to detective agencies etc. 9v battery req'd. £14 REF: MAG14

**TALKING COINBOX STRIPPER** originally made to retail at £79 each, these units are designed to convert and ordinary phone into a payphone. The units we have generally have the locks missing and sometimes broken hinges. However they can be adapted for their original purpose or used for something else?? Price is just £3 REF: MAG3P1

**100 WATT MOSFET PAIR** Same spec as 2SK343 and 2SJ413 (8A, 140v, 100w) 1N channel and 1P channel, £3 a pair REF: MAG3P2

**VELCRO** 1 metre length of each side 20mm wide (quick way of fixing for temporary jobs etc) £2 REF: MAG2P3

**MAGNETIC AGITATORS** Consisting of a cased mains motor with lead. The motor has two magnets fixed to a rotor that spin round inside. There are also 2 plastic covered magnets supplied. Made for remotely stirring liquids! you may have a use? £3 each REF: MAG3P3 2 for £5 REF: MAG5P8

**TOP QUALITY SPEAKERS** Made for Hi Fi televisions these are 10 watt 4R Jap made 4" round with large shielded magnets. Good quality general purpose speaker. £2 each REF: MAG2P4 or 4 for £6 REF: MAG6P2

**TWEETERS** 2" diameter good quality tweeter 140R (would be good with the above speaker) 2 for £2 REF: MAG2P5 or 4 for £3 REF: MAG3P4

**AT KEYBOARDS** Made by Apricot these quality keyboards need just a small modification to run on any AT, they work perfectly but you will have to put up with 1 or 2 foreign keycaps! Price £6 REF: MAG6P3

**XT KEYBOARDS** Mixed types, some returns, some good, some foreign etc but all good for spares! Price is £2 each REF: MAG2P6 or 4 for £6 REF: MAG6P4

**PC CASES** Again mixed types so you take a chance next one off the pile! £12 REF: MAG12 or two identical ones for £20 REF: MAG20P4 component pack bargain 1,000 resistors +1,000 capacitors (all same value) £2.50 a pack. REF: MAG2P7

**1994 CATALOGUE  
OUT SOON**

## BULL'S BULLETIN BOARD

**MASSIVE  
WAREHOUSE CLEARANCE  
FANTASTIC £20.00 REDUCTION**

**REFURBISHED PC BASE UNITS  
COMPLETE WITH KEYBOARD  
FROM ONLY £29.00  
AMSTRAD 1512 BASE UNITS  
GUARANTEED  
PERFECT WORKING ORDER.**

A LOW COST INTRODUCTION TO THE HOME COMPUTER MARKET.

**AMSTRAD 1512SD  
1512 BASE UNIT, 5.25" FLOPPY DRIVE AND  
KEYBOARD. ALL YOU NEED IS A MONITOR AND  
POWER SUPPLY. WAS £49.00**

**NOW ONLY £29.00  
REF: MAG29**

**AMSTRAD 1512DD  
1512 BASE UNIT AND KEYBOARD AND TWO  
5.25" 360K DRIVES. ALL YOU NEED IS A MONITOR  
AND POWER SUPPLY. WAS £59.00**

**NOW ONLY £39.00  
REF: MAG39**

## SOLAR POWER PANELS

**3FT X 1FT 10WATT GLASS PANELS  
14.5v/700mA  
NOW AVAILABLE BY MAIL ORDER  
£33.95**

(PLUS £2.00 SPECIAL PACKAGING CHARGE)

TOP QUALITY AMORPHOUS SILICON CELLS HAVE ALMOST A TIMELESS LIFESPAN WITH AN INFINITE NUMBER OF POSSIBLE APPLICATIONS, SOME OF WHICH MAY BE CAR BATTERY CHARGING, FOR USE ON BOATS OR CARAVANS, OR ANYWHERE A PORTABLE 12V SUPPLY IS REQUIRED. REF: MAG34

ALSO 1FT X 1FT GLASS SOLAR PANELS 12v 200mA ONLY £15.00. REF: MAG15P3

## FREE SOFTWARE!

Brand new, UNUSED top quality Famous brand licensed software discs. Available in 5.25" DSD or 5.25" HD only. You buy the disk and it comes with free BRAND NEW UNUSED SOFTWARE. We are actually selling you the floppy disc for your own "MEGA CHEAP" storage facilities, if you happen to get software that you want/need/like as well..... you get a "MEGA BARGAIN" too!

OSDD PKT10 £2.99 REF: MAG3P7 PKT100 £16.00 REF: MAG16 HD PKT10 £3.99 REF: MAG4P3 PKT100 £26.00 REF: MAG26P1

LARGER QUANTITY PRICES AVAILABLE ON APPLICATION

\*\*\*\*\*WE BUY SURPLUS STOCK\*\*\*\*\*

TURN YOUR SURPLUS STOCK INTO CASH.  
IMMEDIATE SETTLEMENT. WE WILL ALSO QUOTE FOR  
COMPLETE FACTORY CLEARANCE.  
COMING SOON

## 1994 CATALOGUE.

PLEASE SEND 42P, A4 SIZED SAE FOR YOUR FREE COPY.  
MINIMUM GOODS ORDER AS OR TRADE ORDERS FROM GOVERNMENT, SCHOOLS,  
UNIVERSITIES, A LOCAL AUTHORITIES WELCOME. ALL GOODS SUPPLIED SUBJECT TO  
OUR CONDITIONS OF SALE AND UNLESS OTHERWISE STATED GUARANTEED FOR 30  
DAYS. RIGHTS RESERVED TO CHANGE PRICES & SPECIFICATIONS WITHOUT PRIOR  
NOTICE. ORDERS SUBJECT TO STOCK. QUOTATIONS WILL ONLY BE GIVEN FOR QUANTITIES  
HIGHER THAN THOSE STATED.

\*SOME OF OUR PRODUCTS MAY BE UNLICENSEABLE IN THE UK

**BULL ELECTRICAL**  
250 PORTLAND ROAD HOVE SUSSEX  
BN3 5QT  
MAIL ORDER TERMS: CASH PO OR CHEQUE  
WITH ORDER PLUS £3.00 POST PLUS VAT.  
PLEASE ALLOW 7 - 10 DAYS FOR DELIVERY  
TELEPHONE ORDERS WELCOME  
TEL: 0275 203500  
FAX: 0275 223077



**COMMODORE MICRODRIVE SYSTEM** mini storage device for C64's 4 times faster than disc drives, 10 times faster than tapes. Complete unit just £12 REF: MAG12P1

**SCHOOL STRIPPERS** We have quite a few of the above units which are 'returns' as they are quite comprehensive units they could be used for other projects etc. Let us know how many you need at just 50p a unit (minimum 10).

**HEADPHONES 16P** These are ex Virgin Atlantic. You can have 8 pairs for £2 REF: MAG2P8

**PROXIMITY SENSORS** These are small PCB's with what look like a source and sensor LED on one end and lots of components on the rest of the PCB. Complete with flyleads. Pack of 5 £3 REF: MAG: 3P5 or 20 for £8 REF: MAG8P4

**FIBRE OPTIC CABLE** Made for Hewlett Packard so pretty good stuff! you can have any length you want (min 5m) first 5m £7 REF: MAG7 thereafter £1 a metre (ie 20m is £22). REF: MAG1 Max length 250m.

**SNOOPERS EAR?** Original made to clip over the earpiece of telephone to amplify the sound - it also works quite well on the cable running along the wall! Price is £5 REF: MAG5P7

**DOS PACKS** Microsoft version 3.3 or higher complete with all manuals or price just £5 REF: MAG5P8 Worth it just for the very comprehensive manual 5.25" only.

**DOS PACK** Microsoft version 5 Original software but no manuals hence only £3 REF: MAG3P8 5.25" only.

**FOREIGN DOS** 3.3-German, French, Italian etc £2 a pack with manual. 5.25" only. REF: MAG2P9

**MONO VGA MONITOR** Made by Amstrad, refurbished £49 REF: MAG49

**CTM644 COLOUR MONITOR** Made to work with the CPC464 home computer. Standard RGB input so will work with other machines. Refurbished £59.00 REF: MAG59

**JUST A SMALL SELECTION** of what we have to see more get our 1994 catalogue (42p stamp) or call in Mon-Sat 9-5.30

**HAND HELD TONE DIALLERS** Ideal for the control of the Response 200 and 400 machines. £5 REF: MAG5P9

**PIR DETECTOR** Made by famous UK alarm manufacturer these are hi spec, long range internal units. 12v operation. Slight marks on case and unboxed (although brand new) £8 REF: MAG8P5

**WINDUP SOLAR POWERED RADIO** AM/FM radio complete with hand charger and solar panel £14 REF: MAG14P1

**COMMODORE 64** Customer returns but ok for spares etc £12 REF: MAG12P2 Tested and working units are £69.00 REF: MAG69

**COMMODORE 64 TAPE DRIVES** Customer returns at £4 REF: MAG4P9 Fully tested and working units are £12 REF: MAG12P5

**COMPUTER TERMINALS** complete with screen, keyboard and RS232 input/output. Ex equipment. Price is £27 REF: MAG27

**MAINS CABLES** These are 2 core standard black 2 metre mains cables fitted with a 13A plug on one end, cable the other. Ideal for projects, low cost manufacturing etc. Pack of 10 for £3 REF: MAG3P8 Pack of 100 £20 REF: MAG20P5

**SURFACE MOUNT STRIPPER** Originally made as some form of high frequency amplifier (main chip is a TSA5511T 1.3GHz synthesiser) but good stripper value, an excellent way to play with surface mount components! £1.00 REF: MAG1P1

**MICROWAVE TIMER** Electronic timer with relay output suitable to make enlarger timer etc £4 REF: MAG4P4

**PLUG 420?** showing your age? pack of 10 with leads for £2 REF: MAG2P11

**MOBILE CAR PHONE** £5.99 Well almost! complete in car phone excluding the box of electronics normally hidden under seat. Can be made to illuminate with 12v also has built in light sensor so display only illuminates when dark. Totally convincing! REF: MAG6P6

**ALARM BEACONS** Zenon strobe made to mount on an external bell box but could be used for caravans etc. 12v operation. Just connect up and it flashes regularly! £5 REF: MAG5P11

**FIRE ALARM CONTROL PANEL** High quality metal cased alarm panel 350x165x80mm. Comes with electronics but no Information. £15 REF: MAG15P4

**SUPER SIZE HEATSINK** Superb quality aluminium heatsink 365 x 183 x 61mm, 15 fins enable high heat dissipation. No holes! £9.99 REF: MAG10P1P

**REMOTE CONTROL PCB** These are receiver boards for garage door opening systems. You may have another use? £4 ea REF: MAG4P5

**LOPTX** Line output transformers believed to be for hi res colour monitors but useful for getting high voltages from low ones! £2 each REF: MAG2P12 bumper pack of 10 for £12 REF: MAG12P3

## PORTABLE RADIATION DETECTOR

**£49.99**

A Hand held personal Gamma and X Ray detector. This unit contains two Geiger Tubes, has a 4 digit LCD display with a Piezo speaker, giving an audio visual indication. The unit detects high energy electromagnetic quanta with an energy from 30K eV to over 1.2M eV and a measuring range of 5-9999 UR/h or 10-99990 Nr/h. Supplied complete with handbook.

REF: MAG50

# EVERYDAY WITH PRACTICAL ELECTRONICS

INCORPORATING ELECTRONICS MONTHLY

VOL. 23 No. 1 JANUARY 1994

The No. 1 Independent Magazine for Electronics, Technology and Computer Projects

ISSN 0262 3617

PROJECTS ... THEORY ... NEWS ... COMMENT ... POPULAR FEATURES ...

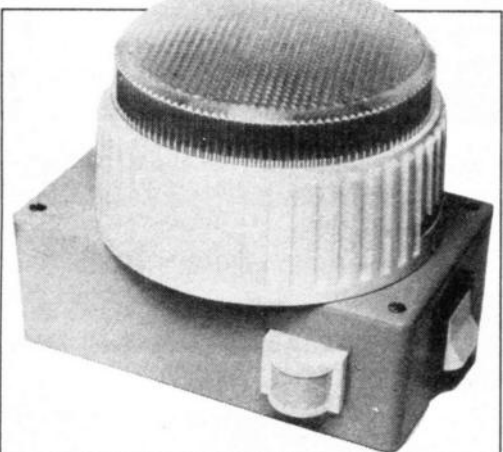
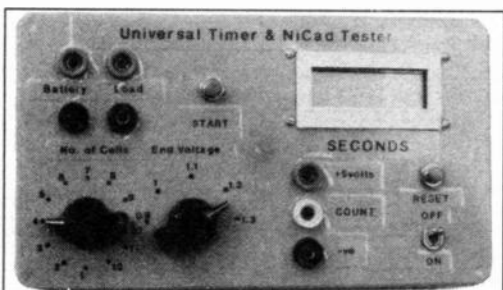

## Projects

- AUTOLIGHT** by T. R. de Vaux-Balbirnie 16  
No more stumbling in the dark. Automatic nightlight for the children's, or elderly person's room
- TIMER and NiCAD CAPACITY CHECKER** by Andy Flind 35  
Keep your NiCads in top condition
- 250W/600W INVERTER & UNINTERRUPTABLE POWER SUPPLY - 2** by Mark Daniels 42  
Beat any power cuts with this powerful emergency back-up supply - will run the central heating or protect computer data
- MULTI-PURPOSE AUDIO SYSTEM - 4** by Max Horsey 56  
10W plus 10W Stereo Power Amplifier
- POND HEATER THERMOSTAT** by Alan Winstanley 70  
Help your prize fish survive the winter

## Series

- CIRCUIT SURGERY** by Alan Winstanley 26  
Your problems solved and circuit ideas
- SAFETY FIRST - 2** by T. R. de Vaux Balbirnie 28  
Electrical safety in the home
- CALCULATION CORNER - 1** by Steve Knight 50  
Removing the fear from circuit design calculations
- INTERFACE** by Robert Penfold 54  
The page for computer enthusiasts
- TECHNIQUES - ACTUALLY DOING IT** by Robert Penfold 76  
Getting started
- AMATEUR RADIO** by Tony Smith G4FAI 84  
Survey Favours Morse; Chasing Islands; IOTA Directory; Young Amateur Award

## Features

- EDITORIAL** 15
- INNOVATIONS** 22  
Everyday news from the world of electronics
- NEW TECHNOLOGY UPDATE** by Ian Poole 24  
Battery management i.c.s.
- ELECTRONIC PRINCIPLES** 34  
A new software service for those interested in teaching or learning electronics
- ELECTRONIC TESTING AND FAULT DIAGNOSIS** 64  
by Mike Tooley  
The NTC Open Learning Course Reviewed
- FOX REPORT** by Barry Fox 68  
Wharfedale Revisited; Moving Ahead; Curtain Up
- SHOPTALK** with David Barrington 69  
Component buying for EPE projects
- PLEASE TAKE NOTE** 69  
Three-way Christmas Tree Lights Flasher; Waterproof Delay Switch; Battery to Mains Inverter
- ELECTRONICS VIDEOS** 78  
Our range of educational videos to complement your studies
- DIRECT BOOK SERVICE** 79  
A wide range of technical books available by mail order
- PRINTED CIRCUIT BOARD SERVICE** 82  
PCBs for EPE projects - some at sale prices!
- ADVERTISER'S INDEX** 88
- FREE DISPLAY ELECTRONICS CATALOGUE** 88  
between pages 44 and 45

© Wimborne Publishing Ltd 1993. Copyright in all drawings, photographs and articles published in EVERYDAY with PRACTICAL ELECTRONICS is fully protected, and reproduction or imitations in whole or in part are expressly forbidden.

Our February '94 Issue will be published on Friday, 7 January 1994. See page 3 for details.

Readers Service • Editorial and Advertisement Departments 15



# SURVEILLANCE

## PROFESSIONAL QUALITY KITS

# No. 1 for Kits

Whether your requirement for surveillance equipment is amateur, professional or you are just fascinated by this unique area of electronics SUMA DESIGNS has a kit to fit the bill. We have been designing electronic surveillance equipment for over 12 years and you can be sure that all our kits are very well tried, tested and proven and come complete with full instructions, circuit diagrams, assembly details and all high quality components including fibreglass PCB. Unless otherwise stated all transmitters are tuneable and can be received on an ordinary VHF FM radio.

**Genuine SUMA kits available only direct from Suma Designs. Beware inferior imitations!**

#### UTX Ultra-miniature Room Transmitter

Smallest room transmitter kit in the world! Incredible 10mm x 20mm including mic. 3-12V operation. 500m range.....£16.45

#### MTX Micro-miniature Room Transmitter

Best-selling micro-miniature Room Transmitter  
Just 17mm x 17mm including mic. 3-12V operation. 1000m range.....£13.45

#### STX High-performance Room Transmitter

Hi performance transmitter with a buffered output stage for greater stability and range. Measures 22mm x 22mm including mic. 6-12V operation, 1500m range.....£15.45

#### VT500 High-power Room Transmitter

Powerful 250mW output providing excellent range and performance. Size 20mm x 40mm. 9-12V operation. 3000m range.....£16.45

#### VXT Voice Activated Transmitter

Triggers only when sounds are detected. Very low standby current. Variable sensitivity and delay with LED indicator. Size 20mm x 67mm. 9V operation. 1000m range...£19.45

#### HYX400 Mains Powered Room Transmitter

Connects directly to 240V AC supply for long-term monitoring. Size 30mm x 35mm. 500m range.....£19.45

#### SCRX Subcarrier Scrambled Room Transmitter

Scrambled output from this transmitter cannot be monitored without the SCDM decoder connected to the receiver. Size 20mm x 67mm. 9V operation. 1000m range.....£22.95

#### SC LX Subcarrier Telephone Transmitter

Connects to telephone line anywhere, requires no batteries. Output scrambled so requires SCDM connected to receiver. Size 32mm x 37mm. 1000m range.....£23.95

#### SCDM Subcarrier Decoder Unit for SCR X

Connects to receiver earphone socket and provides decoded audio output to headphones. Size 32mm x 70mm. 9-12V operation.....£22.95

#### ATR2 Micro Size Telephone Recording Interface

Connects between telephone line (anywhere) and cassette recorder. Switches tape automatically as phone is used. All conversations recorded. Size 16mm x 32mm. Powered from line.....£13.45

#### UTLX Ultra-miniature Telephone Transmitter

Smallest telephone transmitter kit available. Incredible size of 10mm x 20mm! Connects to line (anywhere) and switches on and off with phone use. All conversation transmitted. Powered from line. 500m range.....£15.95

#### TLX700 Micro-miniature Telephone Transmitter

Best-selling telephone transmitter. Being 20mm x 20mm it is easier to assemble than UTLX. Connects to line (anywhere) and switches on and off with phone use. All conversations transmitted. Powered from line. 1000m range.....£13.45

#### STLX High-performance Telephone Transmitter

High performance transmitter with buffered output stage providing excellent stability and performance. Connects to line (anywhere) and switches on and off with phone use. All conversations transmitted. Powered from line. Size 22mm x 22mm. 1500m range.....£16.45

#### TKX900 Signalling/Tracking Transmitter

Transmits a continuous stream of audio pulses with variable tone and rate. Ideal for signalling or tracking purposes. High power output giving range up to 3000m. Size 25mm x 63mm. 9V operation.....£22.95

#### CD400 Pocket Bug Detector/Locator

LED and piezo beeper pulse slowly, rate of pulse and pitch of tone increase as you approach signal. Gain control allows pinpointing of source. Size 45mm x 54mm. 9V operation.....£30.95

#### CD600 Professional Bug Detector/Locator

Multicolour readout of signal strength with variable rate beeper and variable sensitivity used to detect and locate hidden transmitters. Switch to AUDIO CONFORM mode to distinguish between localised bug transmission and normal legitimate signals such as pagers, cellular, taxis etc. Size 70mm x 100mm. 9V operation.....£50.95

#### QTX180 Crystal Controlled Room Transmitter

Narrow band FM transmitter for the ultimate in privacy. Operates on 180 MHz and requires the use of a scanner receiver or our QRX180 kit (see catalogue). Size 20mm x 67mm. 9V operation. 1000m range.....£40.95

#### QLX180 Crystal Controlled Telephone Transmitter

As per QTX180 but connects to telephone line to monitor both sides of conversations. 20mm x 67mm. 9V operation. 1000m range.....£40.95

#### QSX180 Line Powered Crystal Controlled Phone Transmitter

As per QLX180 but draws power requirements from line. No batteries required. Size 32mm x 37mm. Range 500m.....£35.95

#### QRX180 Crystal Controlled FM Receiver

For monitoring any of the 'Q' range transmitters. High sensitivity unit. All RF section supplied as a pre-built and aligned module ready to connect on board so no difficulty setting up. Output to headphones. 60mm x 75mm. 9V operation.....£60.95

**A build-up service is available on all our kits if required.**

UK customers please send cheques, POs or registered cash. Please add £1.50 per order for P&P. Goods despatched ASAP allowing for cheque clearance. Overseas customers send sterling bank draft and add £5.00 per order for shipment. Credit card orders welcomed on 0827 714476.

**OUR LATEST CATALOGUE CONTAINING MANY MORE NEW SURVEILLANCE KITS NOW AVAILABLE. SEND TWO FIRST CLASS STAMPS OR OVERSEAS SEND TWO IRCS.**

## ★★★ Specials ★★★

#### DLTX/DLRX Radio Control Switch

Remote control anything around your home or garden, outside lights, alarms, paging system etc. System consists of a small VHF transmitter with digital encoder and receiver unit with decoder and relay output, momentary or alternate, 8-way dit switches on both boards set your own unique security code. TX size 45mm x 45mm. RX size 35mm x 90mm. Both 9V operation. Range up to 200m.

Complete System (2 kits).....£50.95  
Individual Transmitter DLTX.....£19.95  
Individual Receiver DLRX.....£37.95

#### MBX-1 Hi-Fi Micro Broadcaster

Not technically a surveillance device but a great idea! Connects to the headphone output of your Hi-Fi, tape or CD and transmits Hi-Fi quality to a nearby radio. Listen to your favourite music anywhere around the house, garden, in the bath or in the garage and you don't have to put up with the DJ's choice and boring waffle. Size 27mm x 60mm. 9V operation. 250m range.....£20.95

**SUMA  
DESIGNS**

DEPT. EE

THE WORKSHOPS, 95 MAIN ROAD,  
BAXTERLEY, NEAR ATHERSTONE,  
WARWICKSHIRE CV9 2LE

VISITORS STRICTLY BY APPOINTMENT ONLY



Tel/Fax:  
**0827 714476**





**UK Distributor for the complete ILP Audio Range**

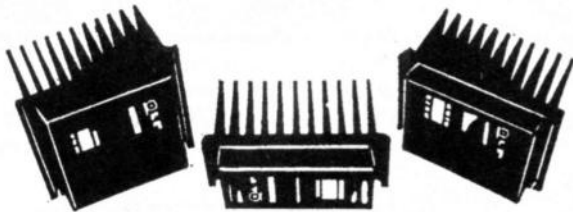

**BIPOLAR AMPLIFIER MODULES**

Encapsulated amplifiers with integral heatsink.

HY30P	15W Bipolar amp	£9.95
HY60	30W Bipolar amp	£12.62
HY6060	30W Stereo Bipolar amp	£26.46
HY124	60W Bipolar amp (4 ohm)	£20.69
HY128	60W Bipolar amp (8 ohm)	£20.69
HY244	120W Bipolar amp (4 ohm)	£27.38
HY248	120W Bipolar amp (8 ohm)	£27.38
HY364	180W Bipolar amp (4 ohm)	£42.86
HY368	180W Bipolar amp (8 ohm)	£42.86

**MOSFET AMPLIFIER MODULES**

Encapsulated amplifiers with integral heatsink.

SMOS60	30W Mosfet amp	£23.15
SMOS6060	30W Stereo Mosfet amp	£39.95
SMOS128	60W Mosfet amp	£30.95
SMOS248	120W Mosfet amp	£42.50

**CLASS A AMPLIFIER MODULE**

Encapsulated Class A amplifier with integral heatsink

HCA40	20W Class A amp	£36.60
-------	-----------------	--------

**POWER SUPPLIES**

Full range of transformers and DC boards available for the above amplifiers.

**100 VOLT LINE TRANSFORMERS**

Full range of speech and music types for amplifiers from 30 watt to 180 watt

**PREAMPLIFIER MODULE**

General purpose preamplifier for a wide range of applications.

Prices include VAT and carriage



Quantity prices available on request

Write, phone or fax for free Data Pack

**Jaytee Electronic Services**

143 Reculver Road, Herne Bay, Kent CT6 6PL  
Telephone: (0227) 375254 Fax: 0227 365104

**REVIVING THE VALVE SOUND**

With a wiff of nostalgia and cooking valves, Jake Rothman rebuilds a pair of Quad II power-amps.

Quad II valve power-amplifiers made by the famous Acoustical Mfg. Co. of Huntingdon have had a loyal following for many years. They represent 1950s British technology typified by English Electric Locomotives and the Vulcan bomber.

With the current valve revival, it is worth rebuilding old Quads to enjoy their inherent beauty and sound quality, as well as for profit - as some hi-fi companies are now doing. There have been some articles about Quads in the hi-fi press but these did not deal much with the electronic side. Jake provides the missing technical data in this article.

**WHISTLE CONTROLLED LIGHT SWITCH**

Remote control of various appliances has enjoyed a great deal of popularity in the past few years, especially as the cost of adding such a facility to a product has decreased with the falling cost of integrated circuits. This can be seen in the proliferation of gadgets around for controlling the television, video, hi-fi and, if you are a keen electronics enthusiast, the curtains, the heating and any other gadgets which you can think of.



The TV is perhaps not a good example of where a remote control is of paramount importance as "getting up" may be the only exercise many viewers get in an evening! The light switch on the other hand would perhaps be more useful as one often enters a room carrying the shopping or a tray which makes it difficult to reach the switch to turn the lights on. In this case unfortunately, it would be no easier to operate your remote control handset even if this were to hand - this is where our Whistle Controlled Light Switch comes into its own!

**BALANCED MIC. PRE-AMPLIFIER**

A balanced microphone pre-amp is essential for high quality work since most higher priced microphones are of the balanced variety. This stereo pre-amp is designed to electronically unbalance the signal and raise it to "line level"; in other words make it suitable for any mixer or power amplifier input which is designed for tape recorders, CD players, tuners etc. It may be connected to the Mixer described in part 1 of our Multi Purpose Audio System series and includes a 15V d.c. output which may be used to power the Mixer.

The preamplifier is based on a new i.c. type SSM2017. This device boasts very low noise, wide bandwidth and low cost. It is particularly suitable for use as a balanced microphone amplifier, although it can be used with unbalanced microphones as well.

**TIMEOUT**

A quiet revolution is taking place in electronics today. It is almost as important as the replacement of valves by transistors and i.c.s in the 60's and 70's. This is the rise of the microcontroller. The increasing power and versatility of the microcontroller at steadily decreasing prices is such that many of the simplest logic i.c. circuits may now be better designed using them.

Microcontrollers are a computer on a single chip - a central processing unit plus memory, clock, input/output and some sort of peripheral device.

Timeout is down-counter designed to introduce you to the world of microcontroller design and programming. It is preset to start from 60 or 90 seconds. Press any button to wake it up; there is no off/on switch. Press to start the countdown; during count down pressing again will pause the count. Timeout is a simple and inexpensive yet versatile (because it can be programmed) project. Get into this fascinating area of electronics.

**EVERYDAY WITH PRACTICAL ELECTRONICS**

FEBRUARY '94 ISSUE ON SALE FRIDAY, JANUARY 7th

NEW VERSION 2  
NOW SHIPPING

# SCHEMATIC DRAWING FOR WINDOWS

NEW  
LOW PRICES

ISIS ILLUSTRATOR combines the high functionality of our DOS based ISIS products with the graphics capabilities of Windows 3. The result is the ability to create presentation quality schematics like you see in the magazines. ILLUSTRATOR gives you full control of line widths, fill styles, fonts, colours and much more. When the drawing is complete, transferring it your WP or DTP program is simply a matter of cutting and pasting through the Windows Clipboard.

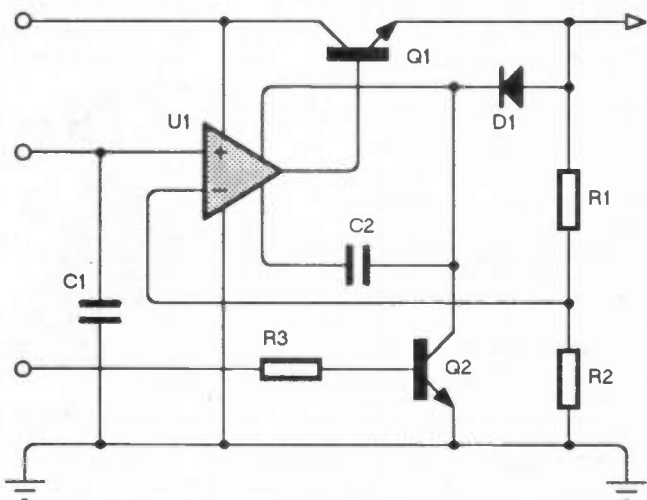

## Features

- Full control of drawing appearance including line widths, fill styles, fonts, colours and more.
- Curved or angular wire corners.
- Automatic wire routing and dot placement.
- Fully automatic annotator
- Comes complete with component libraries.
- Full set of 2D drawing primitives + symbol library for logos etc.
- Output to Windows printer devices including POSTSCRIPT and colour printers.
- ILLUSTRATOR+ adds netlist generation, bill of materials etc. and is compatible with most popular CAD software for DOS & Windows.

From  
£99

## CADPAK - Two Programs for the Price of One.

### ISIS SUPERSKETCH

A superb schematic drawing program for DOS offering Wire Autorouting, Auto Dot Placement, full component libraries, export to DTP and much more.

Only  
£79

Exceptionally easy and quick to use. For example, you can place a wire with just two mouse clicks - the wire autorouter does the rest.

### PCB II

High performance manual PCB layout package for DOS. Many advanced features including curved tracks, auto track necking, DXF export, Gerber and NC file generation, Gerber viewing and more.

Graphical User Interface with intuitive "point and do" operation gives unparalleled ease of use.

## ISIS and ARES for DOS - The Professional's Choice

### ISIS

from £275

ISIS DESIGNER+ forms the ideal front end of your CAD system, providing schematic capture, netlisting, bill of materials and electrical rules checks. Advanced features include automatic annotation, hierarchical design and an ASCII data import facility. Put simply, DESIGNER+ is one of the easiest to learn and most powerful schematics packages available for the PC.

### ARES

from £275

The ARES range of advanced PCB design products links with ISIS (DOS or Windows) and other schematics programs. Working from a netlist, ARES helps you get it right first time with each connection automatically verified against the schematic.

ARES AUTOROUTE adds multi-strategy autorouting, whilst for the ultimate in performance, ARES 386 goes up to 400% faster with unlimited design capacity.

Labcenter  
Electronics



Call us today on 0274 542868 or  
fax 0274 481078 for a demo pack.  
Combination, multi-copy and  
educational discounts available.

14 Marriner's Drive, Bradford, BD9 4JT.



# SOME GREAT AUDIO/VIDEO EQUIPMENT AT *hama* ZINGLY LOW PRICES

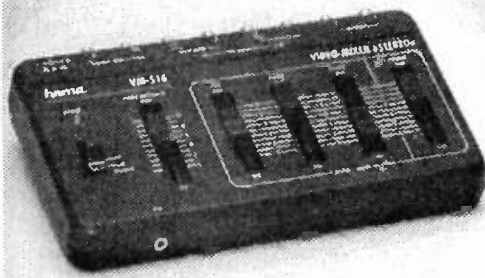

**VM516 Stereo Video Mixer**  
Desk type video sound mixer with enhancer. Allows separate smooth adjustment and mixing of original video sound with 3 external sources (mic, cassette etc). Master output control. Also continuously adjustable slider corrects video signal when copying. Supplied with 12V mains adaptor  
**Our Special Low Price: £39.95**



**SM502 Stereo Mixer**  
4 Channel audio mixer with inputs for mic, mag/er phono and tape/tuner. Outputs for headphones and to amplifier. Freq Res 20-20000Hz, S/N ratio >55dB. Supplied with 9V mains adaptor  
**Our Special Low Price: £44.95**



**SM507 Stereo Mixer**  
Big brother of SM502 - this one has all the facilities of the above mixer + twin VU meters and an additional record/replay DIN socket. As can be seen from the inset pic, the socketry on the rear is excellent.  
**Our Special Low Price: £69.95**

*hama* - one of the largest manufacturers of video and camcorder accessories, providing the amateur and semi-professional with high quality state-of-the-art technology. Full details (4 pages) of new products in our 1994 Catalogue - items listed here are only available until stocks are exhausted. Order soon!

**REMEMBER... 12th DEC**  
...that's when we're having a **CLEARANCE SALE**  
of surplus & redundant stock **ALL AT KNOCKOUT PRICES!**

**1994 CATALOGUE**  
172 Pages of Regular Lines + 24 Bargain List Pages  
**OUT NOW!!**

Many New Lines including Casio Audio Products; Hama Video mixers, lenses and accessories; Scanners & accessories; Books from Butterworths, McGraw-Hill, MacMillan and Haynes; CD's; Big selection of CD ROM's; Single Board Computer; + our usual enormous range of electronic components and equipment.

**All for just £2.00!!**

Why not become a Subscriber? For just £6 a year, we'll send you a monthly newsletter with details of all our latest Special Offers, exclusive deals, competitions, gifts and extra discounts



List Price £179.99

**AV140 Audio/Video Processor**  
Corrects video colour signals during copying. Variable colour intensity and contrast. 2 Scart in/outputs; 3rd Scart mon/VCR skt; Aux audio in and mic input, too. Makes & corrects two copies simultaneously!

**Our Special Low Price: £79.95**



List Price £459.99

**AV144 Audio/Video Processor**  
The ultimate processor - excellent spec, will handle S-VHS & Hi-8. Fitted with a variety of sockets. 5 video, 3 audio inputs; 5 mixed outputs + headphone monitoring. Contrast, Colour sat, Contour controls, 7.7Mhz video bandwidth, resolution >430 lines; 30-25,000Hz audio freq res. Auto noise suppression. 12V PSU supplied.

**Our Special Low Price: £199.95**

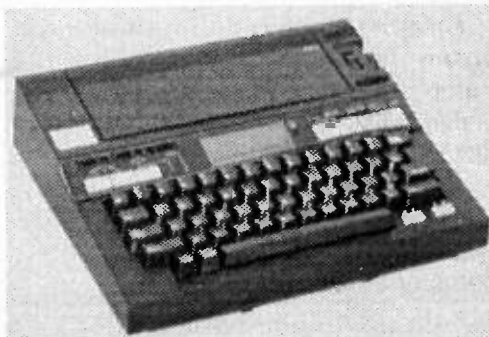

**HAN101 Graphic Writer**  
Produces tables, bar & linear graphs, pie charts - 18 fonts in 9 type sizes (8-75 char. per line). Prints on paper or clear film. Ideal for producing OHP transparencies in up to 4 colours! Compact - 320x260x60mm. Uses 4xD cells, or mains adaptor (supplied) FREE OHP set - 10 sheets + 2 x 4 colour pen sets  
List Price £299

**Our Special Low Price: £99**



All prices in this ad include VAT, P&P £3.00 per order (£9.50 next day) Min Credit Card £12. Official orders from Education welcome; min invoice charge £15. Payment is accepted by cheque, PO, cash (inc foreign currency banknotes), book tokens, Access, Visa, Connect. Our stores have enormous stocks - we are open from 9-5.30 Mon-Sat. Come and see us!



Due to a massive increase in business, we've now installed some extra facilities on new numbers:  
**SALES & GENERAL ENQUIRIES: 0703 236363**  
**TECHNICAL QUERIES: 0703 325999; ACCOUNTS: 0703 231003; FAX (ALL DEPTS) 0703 236307**  
FaxOnDemand - A new service from Greenweld to replace our BBS. Masses of information, details of latest offers, all faxed to you automatically. By using the touch tone keys on your fax machine, you will be guided through a menu and be able to select the information you want - or you can leave a voice message.  
The number for this service is **0703 236315**

**27D PARK ROAD, SOUTHAMPTON, SO1 3TB**

# MARCO

VISA

(Incorporating East Cornwall Components) Dept. 1

THE MALTINGS, HIGH STREET, WEM,  
SHREWSBURY SY4 5EN

Tel: (0939) 232763 (3 lines) or  
(0939) 232689 (2 lines). Fax: (0939) 233800

MAIL ORDER - WHOLESALE - RETAIL

P&P NOW £3.00. All prices include V.A.T.

VISIT OUR BRANCHES

WALTONS SUPERTRONICS  
55A WORCESTER STREET 55A WORCESTER STREET  
WOLVERHAMPTON WV2 4LL WEST MIDLANDS WV2 4LL  
Tel: 0902 22039

HAVE YOU GOT OUR LATEST  
'94 CATALOGUE

158 PAGES - LOADS OF SPECIAL OFFERS  
ONLY **£2.00** (Inc. pre-paid envelope)

## Universal Remote Control SPECIAL INTRODUCTORY PRICE **£28.99**

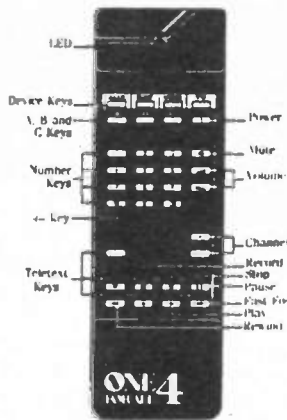

**THIS ONE OPERATES UP TO FOUR  
RECEIVERS**

(ie 1 x VCR, 2 x TV, 1 x Satellite/Cable or any combination  
to suit including Teletext etc.)

The remote comes complete with Free Telephone 0800 Help-line and the manufacturer guarantees that if the remote will not operate any of your VCR's TV or Satellite receivers they will refund you double what you paid for the remote! Full comprehensive Instruction Book - we have tried these units, they are incredibly easy to set up.

## PORTASOL SOLDERING KIT

Serves as Gas Soldering  
Iron. Blow Torch Hot  
Blow and Hot Knife.  
Normally **£38.00**



Order Code: SOLD/PORTA  
NOW ONLY **£35.00**

## TUNGSTEN HALOGEN LAMPS



Standard halogen lamps offering a choice to suit every pocket!

Wattage	Order Code	1+	10+
200Watt	OPO70	£3.75	£2.50
300Watt	OPO71	£3.50	£2.25
500Watt	OPO72	£3.72	£2.50



**MAINS POWERED SOLDERING IRON WITH STAND - Y061D**  
Newly designed high quality mains powered soldering iron with long life ceramic element. Fitted with extra flexible cable for ease of use. Supplied packed on a blister card with one spare bit. 1.7m lead.

Order Code: TOOL/SOLD/B Price: **£4.99**

## NI-CAD BATTERIES

A range of Nickel Cadmium batteries that will replace dry cell batteries. Capable of being recharged some 1000 times they are very economical in all applications.

\*When possible Hitachi brand will be supplied.

(We offer a suitable charger for these Ni-Cads at the end of this section).



Type	Volt	Ah	Order Code	Price	10+	100+
AAA	1.2V	180mAh	BAT/AAA	£1.60	£1.40	£1.15
AA	1.2V	500mAh	BAT/AA	£1.00	90p	70p
AA	1.2V	650mAh	BAT/A650	£1.60	£1.40	£1.15
C	1.2V	1.2Ah	BAT/C	£1.99	£1.79	£1.40
C	1.2V	2.0Ah	BAT/C1	£2.65	£2.40	£1.99
D	1.2V	1.2Ah	BAT/D	£2.15	£1.90	£1.50
D	1.2V	4.0Ah	BAT/D1	£5.95	£5.30	£4.25
PP3	9V	110mAh	BATPP3	£4.75	£4.25	£3.89

## RECHARGEABLE TORCH



Limited quantity. High quality fully waterproof, rechargeable torch. Complete with in-built charger - simply plug into the mains socket for overnight charge. When charged lasts about one hour constant use. In-built charger is 2-pin, fitting shaver socket or most 13A type sockets. Snap fit cover conceals pins when in normal use. Complete with carrying strap. Ideal for cars, caravans, boats, handbags, fuse boxes etc.

Overall dimensions: 160mm length x 40mm dia.  
Colour: White

ONLY **£6.50** Two for **£12.00**

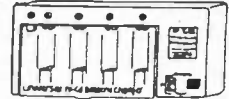

## NI-CAD BATTERY CHARGER

Capable of charging 4 x AAA, AA, C or D sizes, 2 x PP3. White in colour, free-standing unit with LED 'Charging' indicators. A built-in tester is provided for 1.5V batteries.

Power 240V AC. Dimensions: 180 x 85 x 50mm.

Order Code: BAT/CHARGE/UNI/B  
Price 1+ **£4.99** 10+ **£4.75**

## SOLDER 18 & 22SWG 500gm REEL

	1+	10+
18SWG 500G	£4.95	£4.70
22SWG 500G	£4.99	£4.75

Remember: Our prices INCLUDE VAT!

## PIR ALARM - PORTABLE

Wall mounting or free standing PIR detector with a loud (90dB at high volume) sounder. Self contained operation from 4 x AA batteries (not included).

Coverage 90°, 10m, 24 beams in 3 layers. Power: 4 x AA batteries or external adaptor, Dimensions: 145 x 95 x 68mm.

Order Code: SEC/F601C

PRICE: 1 + **£9.75** 4 + **£8.50**



## SATELLITE FINDER

Satellite finder kit designed to aid the speedy installation and lining up of satellite dishes. The kit consists of a signal strength meter, a compass, a connecting lead and a battery pack within a vinyl case. Requires 10 x AA batteries (not supplied).

Order Code: T135  
ONLY **£36.99**

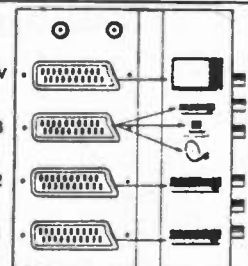
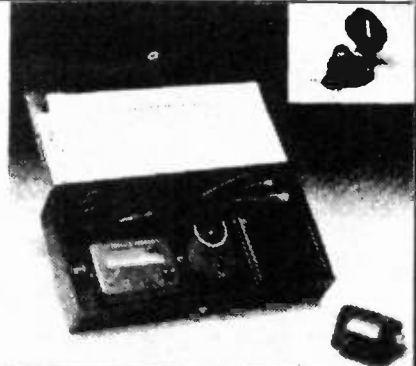

## THREE-WAY SCART VIDEO CONTROL

Connects up to 3 video recorders (VCRs), 1 satellite + 2 VCRs, 1 computer + 2 VCRs. Push button switch to select viewing. Record from satellite or another VCR whilst watching TV. Phono output sockets for TV sound through your Hi-Fi system.

Order Code: AER/BT21 Price **£27.99**



**At last, a fully functional upgradeable PCB CAD system to suit any budget. Substantial trade-in discounts are available against other "professional" PCB design packages ...**

**... call now for details.**

## Board Capture

*Schematic Capture Design Tool*

**£395**

- Direct netlist link to BoardMaker2
- Forward annotation with part values
- Full undo/redo facility (50 operations)
- Single-sheet, multi-paged and hierarchical designs
- Smooth scrolling
- Intelligent wires (automatic junctions)
- Dynamic connectivity information
- Automatic on-line annotation
- Integrated on-the-fly library editor
- Context sensitive editing
- Extensive component-based power control
- Back annotation from BoardMaker2

## BoardMaker

*BoardMaker1 - Entry level*

**£95**

- PCB and schematic drafting
- Easy, and intuitive to use
- Surface mount and metric support
- 90, 45 and curved track corners
- Ground plane fill
- Copper highlight and clearance checking

*BoardMaker2 - Advanced level*

**£295**

- All the features of BoardMaker1 +
- Full netlist support - BoardCapture, OrCad, Schema, Tango, CadStar and others
- Full Design Rule Checking both mechanical and electrical
- Top down modification from the schematic
- Component renumber with back annotation
- Report generator - Database ASCII, BOM
- Thermal power plane support with full DRC

NEW

## Board Router

*Gridless re-entrant autorouter*

**£200**

- Simultaneous multi-layer routing
- SMD and analogue support
- Full interrupt, resume, pan and zoom while routing

*Output drivers - Included as standard*

- Printers - 9 & 24 pin Dot matrix, HPLaserjet and PostScript
- Penplotters - HP, Graphic & Houston
- Photoplotters - All Gerber 3X00 and 4X00
- Excellon NC Drill and Annotated drill drawings (BM2)

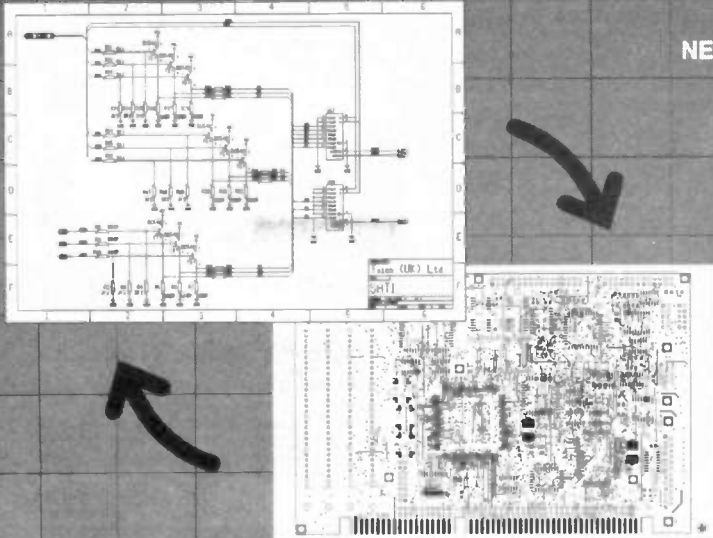

Call, write or fax for more information or a full evaluation kit

Tsien (UK) Limited  
Aylesby House  
Wenny Road, Chatteris  
Cambridge  
PE16 6UT

Tel (0354) 695959  
Fax (0354) 695957

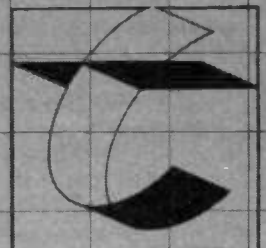

**tsien**

# SOME POPULAR BARGAINS

## MOTORS - BATTERY 1-12V

3 DIFFERENT MODEL MOTORS, £1, Order Ref. 35.  
 SPIN TO START 3V DC MOTORS for model aircraft etc. for £1, Order Ref. 134.  
**CASSETTE MOTOR** 1.5-12V, powerful, speed increases with voltage, £1, Order Ref. 224.  
**MINI CASSETTE MOTOR**, 6-9V working, £1, Order Ref. 944.  
**HIGH EFFICIENCY MOTOR** for solar cell working, £1, Order Ref. 643.  
**12V MOTOR**, ex BSR record player, £1, Order Ref. 687.  
**9V CASSETTE MOTOR**, brushless, £1.50, Order Ref. 1.5P14.  
**1/10HP 12V DC MOTOR**, Smiths, £4, Order Ref. 4P22.  
**1/8HP 12V MOTOR**, Smiths, £8, Order Ref. 6P1.  
**1/8HP 12V MOTOR**, Smiths, £8, Order Ref. 8P14.  
**1/3HP MOTOR**, (Sinclair C5), £15, Order Ref. 15P8.

## MAINS MOTORS WITH GEARBOXES

**5RPM 60W**, £5, Order Ref. 5P54.  
**40RPM 100W**, £8, Order Ref. 6P21.  
**50RPM 60W**, £5, Order Ref. 5P168.  
**60RPM 60W**, £5, Order Ref. 5P171.  
**110RPM 60W**, £5, Order Ref. 5P172.  
**150RPM 60W**, Order Ref. 5P169.  
**200RPM 60W**, £5, Order Ref. 5P216.  
**500W MOTOR** with gearbox & variable speed selector, 100rpm upwards, £5, Order Ref. 5P220.  
**1 REV PER 24 HRS 2W MOTOR**, £1, Order Ref. 89.  
**1 REV PER 12 HRS 2W MOTOR**, £1, Order Ref. 90.  
**1 REV PER 4 HRS 2W MOTOR**, £2, Order Ref. 2P239.  
**1 REV PER HOUR 2W EXTRA SMALL MOTOR**, 2 for £1, Order Ref. 500.  
**1/4RPM MINI MOTOR**, £3, Order Ref. 3P64.  
**1RPM MINI MOTOR**, £2, Order Ref. 2P328.  
**4RPM 2W MOTOR**, £1, Order Ref. 446.  
**15RPM 2W MOTOR**, £2, Order Ref. 2P321.  
**25RPM 2W MOTOR**, £2, Order Ref. 2P322.  
**200RPM 2W MOTOR**, £1, Order Ref. 175.  
**250RPM 2W MOTOR**, £1, Order Ref. 750.

## MAINS MOTORS

**1/4 STACK MOTOR** with 1/4" spindle, £1, Order Ref. 85.  
**MOTOR 1 1/2" STACK** with good length spindle from each side, £2, Order Ref. 2P55.  
**MOTOR 1 1/2" STACK** with 4" long spindle, £2, Order Ref. 2P203.  
**MOTOR BY CROMPTON** .06HP but little soiled, £3, Order Ref. 3P4.  
**JAP MADE PRECISION MOTOR** balanced rotor reversible, 1500rpm, £2, Order Ref. 2P12.  
**TAPE MOTOR BY EMI**, 2 speed & reversible, £2, Order Ref. 2P70.  
**1/4HP 1000RPM**, £8, Order Ref. 8P7.  
**VERY POWERFUL MAINS MOTOR**, with extra long (2 1/2") shafts extending out each side. Makes it ideal for a reversing arrangement for, as you know, shaded pole motors are not reversible, £3, Order Ref. 3P157.

## MOTORS - STEPPER

**MINI MOTOR BY PHILIPS**, 12V-7.5 degree step, quite standard, data supplied, only £1, Order Ref. 910.  
**MEDIUM POWERED Jap** made 1.5 degree step, £3, Order Ref. 3P162.  
**VERY POWERFUL MOTOR** by American Philips 10-14V 7.5 degree step, £5, Order Ref. 5P81.

## LOUDSPEAKERS

**2" ROUND 50 OHM COIL** 1/4W, 2 for £1, Order Ref. 908.  
**2 1/2" 8 OHM**, 2 for £1, Order Ref. 454.  
**2 1/2" 35 OHM**, 2 for £1, Order Ref. 514.  
**3 1/2" 8 OHM**, 2 for £1, Order Ref. 682.  
**6 1/2" 4 OHM WITH TWEETER**, £1, Order Ref. 895.  
**6 1/2" 8 OHM**, £1, Order Ref. 896.  
**6 1/2" 6 OHM WITH TWEETER**, £1, Order Ref. 897.  
**6" x 4" 4 OHM**, £1, Order Ref. 242.  
**5" x 5" 15 OHM**, £1, Order Ref. 906.  
**5" x 3" 16 OHM**, £1, Order Ref. 725.  
**6" x 4" 16 OHM**, 2 for £1, Order Ref. 884.  
**8" 15 OHM AUDAX**, £1, Order Ref. 504.  
**9" x 3" 8 OHM 5"**, £1, Order Ref. 138.  
**3" 4 OHM TWEETER**, £1, Order Ref. 433.  
**GOODMANS 8 1/2" 10W 4 OHM**, £2, Order Ref. 2P27.  
**HORN SPEAKER**, 4 1/2" 8 OHM, £3, Order Ref. 3P82.  
**20W 5" BY GOODMAN**, £3, Order Ref. 3P145.  
**20W 4" OHM TWEETER**, £1.50, Order Ref. 1.5P9.  
**AMSTRAD 8" 15W 8 OHM** with matching tweeter, £4, Order Ref. 4P57.  
**CASED PAIR OF STEREO SPEAKERS BY BUSH**, 4 ohm, £5 per pair, Order Ref. 5P141.  
**DOUBLE WOUND VOICE COIL**, 25W ITT, with tweeter and crossover, £7, Order Ref. 7P12.  
**BULKHEAD SPEAKER** metal cased, £10, Order Ref. 1043.  
**25W 2 WAY CROSSOVER**, 2 for £1, Order Ref. 22.  
**40W 3 WAY CROSSOVER**, £1, Order Ref. 23.

## MONITORS AND BITS

**PHILIPS 9" HIGH RESOLUTION MONITOR**, £15, Order Ref. 15P1.  
**METAL CASE** for the above Philips monitor, £12, Order Ref. 12P3.  
**PHILIPS 9" HIGH RESOLUTION TUBE**, ref. M24 306W, £12, Order Ref. 12P7.  
**6" ELECTROSTATIC MONITOR TUBE**, ref. SE5J31, £10, Order Ref. 10P104.  
**MINI SCOPE TUBE** face size, 2" x 2 1/4", electrostatic 3V heater, 1KV, in mu metal shield, £10, Order Ref. 10P73.

**LCD 3 1/2 DIGIT PANEL METER**, this is a multi range voltmeter/ammeter using the A-D converter chip 7106 to provide 5 ranges each of volts and amps. Supplied with full data sheet. Special snip price of £12. Order Ref. 12P19.

**12V-0-12V 6VA PCB MOUNTING MAINS TRANSFORMER**, normal 230V primary and conventional open winding construction, £1, Order Ref. 938.

**AMSTRAD 3" DISK DRIVE** brand new. Standard replacement or why not have an extra one? £20, Order Ref. 20P28.

**THIS COULD SAVE YOU EXPENSIVE BATTERIES**, an in car unit for operating 6V radio, cassette player, etc. from car lighter socket, £2, Order Ref. 2P318.

**MEDICINE CUPBOARD ALARM**, or it could be used to warn when any cupboard door is opened, built and neatly cased, requires only a battery, £3, Order Ref. 3P155.

**FULLY ENCLOSED MAINS TRANSFORMER**, on a 2M 3-core lead terminating with a 13A plug. Secondary rated at 6V 4A. Brought out on a well insulated 2-core lead terminating with insulated push on tags, £3, Order Ref. 3P152. Ditto but 8A, £4, Order Ref. 4P69.

**DON'T LET IT OVERFLOW**, be it bath, sink, cellar, sump or any other thing that could flood. This device will tell you when the water has risen to the pre-set level. Adjustable over quite a useful range. Neatly cased for wall mounting, ready to work when battery fitted, £3, Order Ref. 3P156.

**DIGITAL MULTI TESTER MG3800**, single switching covers 30 ranges including 20A AC and DC, 10 MEG input impedance, 3 1/2 LCD display. Complete with lead. Currently advertised by many dealers at nearly £40, our price only £25, Order Ref. 25P14.

**ANALOGUE TESTER**, input impedance 2K ohms per volt. It has 14 ranges, AC volts 0-500 DC volts 0-500, DC current 500 micro amps at 250 milliamper, resistance 0-1meg-ohm, decibels 20 56dB. Fitted diode protection, overall size 90 x 60 x 30mm. Complete with test prods, £7.50, Order Ref. 7.5P8.

**LCD CLOCK MODULE**, 1.5V battery operated, fits nicely into our 50p project box, Order Ref. 876. Only £2, Order Ref. 2P307.

**SENTINEL COMPONENT BOARD**, amongst hundreds of other parts this has 15 ICs all plugs in so don't need desoldering. Cost well over £100, yours for £4, Order Ref. 4P67.

**AMSTRAD KEYBOARD MODEL KB5**, this is a most comprehensive keyboard, having over 100 keys including of course full numerical and qwerty. Brand new still in maker's packing, £5, Order Ref. 5P202.

**SOLAR PANEL BARGAIN** gives 3V at 200mA, £2, Order Ref. 2P324.

**ULTRA SONIC TRANSDUCERS**, 2 metal cased units, one transmits one receives. Built to operate around 40kHz, £1.50 the pair, Order Ref. 1.5P4.

**INSULATION TESTER WITH MULTIMETER**, internally generates voltages which enable you to read insulation directly in megohms. The multimeter has four ranges, AC/DC volts, 3 ranges DC milliamps, 3 ranges resistance and 5 amps. These instruments are ex-British Telecom but in very good condition, tested and guaranteed OK, yours for only £7.50 with leads, carrying case £2 extra. Order Ref. 7.5P4.

**MAINS ISOLATION TRANSFORMER** stops you getting "to earth" shocks, 230V in and 230V out. 150 watt upright mounting, £7.50, Order Ref. 7.5P5 and a 250W toroidal isolation, £10, Order Ref. 10P97.

**MINI MONO AMP**, on pcb. Size 4" x 2" with front panel holding volume control and with spare hole for switch or tone control. Output is 4W into 4 ohm speaker using 12V or 1W into 8 ohm using 9V. Brand new and perfect, only £1 each, Order Ref. 495.

**EXPERIMENTING WITH VALVES** don't spend a fortune on a mains transformer, we can supply one with standard mains input and secs. of 250V-0V-250V at 75mA and 6-3V at 3A, £5, Order Ref. 5P167.

**0-1MA FULL VISION PANEL METER 2 1/2"** square, scaled 0-100 but scale easily removed for re-writing, £1 each, Order Ref. 7.5P8.

**PCB DRILLS**, 12 assorted sizes between .75 and 1.5mm, £1 the lot, Order Ref. 128.

**12V AXIAL FAN**, for only £1, ideal for equipment cooling, brand new made by West German company. Brushless so virtually everlasting. Supplied complete with a circuit diagram of transistor driver, £1, Order Ref. 918.

**PC OPERATING SYSTEMS**, fully user documented and including software, MS-DOS 3.20, with 5" disk, £5, Order Ref. 5P2076; MS-DOS 3.3 with 3 1/2" disk, £5, Order Ref. 5P208, or with 5" disk, £5, Order Ref. 5P208/5; MS-DOS 4.01 with 3 1/2" disk, £10, Order Ref. 10P99.

**45A DOUBLE POLE MAINS SWITCH**. Mounted on a 6 x 3 1/2 aluminium plate, beautifully finished in gold, with pilot light. Top quality, made by MEM, £2, Order Ref. 2P316.

**HIGH QUALITY KEY SWITCH**. This is a single pole, 2 position switch, changeover or on/off. Ideal for mounting through a front panel when it would be secured by a hexagonal nut. It's a Yale type switch and comes complete with 2 keys. Good British make, normally retails at £3, our price £1.50, Order Ref. 1.5P12.

**SOLAR ENERGY EDUCATIONAL KIT**. It shows how to make solar circuits and electrical circuits, how to increase voltage or current, to work a radio, calculator, cassette player and to charge NiCad batteries. The kit comprises 8 solar cells, one solar motor, fan blades to fit motor and metal frame to hold it to complete a free-standing electric fan. A really well written instruction manual, £8, Order Ref. 8P42B.

## POWER SUPPLIES - SWITCH MODE

(all 230V mains operated)  
**ASTEC REF. B51052** with outputs +12 -5A, -12V -1A, +5V 3A, +10V 0.5A, +5V 0.2A unboxed on pcb size 180 x 130mm, £5, Order Ref. 5P188.  
**ASTEC REF. BM4 1004** with outputs +5V 3 1/2A, +12V 1-3A, -12V 2A, £5, Order Ref. 5P199.  
**ASTEC No. 12530** +12V 1A, -12V 1A, +5V 3A, uncased on pcb size 180 x 100mm, £3, Order Ref. 3P14.

**ASTEC No. BM41001** 110W 38V 2.5A, 25.1V 3A part metal cased with instrument type main input socket & on/off dp rocker switch size 354 x 118 x 84mm, £8.50, Order Ref. 8.5P2.

**ASTEC MODEL No. BM135-3302** +12V 4A, +5A 16A, -12V 0.5A totally encased in plated steel with mains input plug, mains output socket & double pole on/off switch size 400 x 130 x 65mm, £9.50, Order Ref. 9.5P4.

## POWER SUPPLIES - LINEAR

(all cased unless stated)  
**4-5V DC 150mA**, £1, Order Ref. 104.  
**5V DC 2 1/2A** psu with filtering & volt regulation, uncased, £4, Order Ref. 4P63.  
**6V DC 700mA**, £1, Order Ref. 103.  
**6V DC 200mA** output in 13A case, £2, Order Ref. 2P112.

**6-12V DC** for models with switch to vary voltage and reverse polarity, £2, Order Ref. 2P3.

**9V DC 150mA**, £1, Order Ref. 762.

**9V DC 2-1A** by Sinclair £3, Order Ref. 3P151.

**9V DC 100mA**, £1, Order Ref. 733.

**12V DC 200mA** output in 13A case, £2, Order Ref. 2P114.

**12V DC 500mA** on 13A base, £2.50, Order Ref. 2.5P4.

**12V 1A** filtered & regulated on pcb with relays & Piezo sounder, uncased, £3, Order Ref. 3P80.

**AMSTRAD 13-5V DC** at 1-8A or 2V DC at 2A, £8, Order Ref. 6P23.

**24V DC** at 200mA twice for stereo amplifiers, £2, Order Ref. 2P4.

**9-5V AC 600mA** made for BT, £1.50, Order Ref. 1.5P7.

**15V 500mA AC** on 13A base, £2, ref. 2P281.

**AC OUT 9-8V** at 60mA & 15-3V at 150mA, £1, Order Ref. 751.

**BT POWER SUPPLY UNIT 208AS**, charges 12V battery and cuts off output should voltage fall below pre-set, £16, Order Ref. 16P6.

**SINCLAIR MICROVISION PSU**, £5, Ref. 5P148.

## LASERS & LASER BITS

**2MW LASER**, Helium neon by Philips, full spec. £30, Order Ref. 30P1.

**POWER SUPPLY** for this in kit form with case is £15, Order Ref. 15P16, or in larger case to house tube as well, £16, Order Ref. 18P2.

**THE LARGER UNIT**, made up, tested and ready to use, complete with laser tube, £69, Order Ref. 69P1.

## HEATING UNITS

**LINEAR QUARTZ GLASS TUBES 360W**, 2 in series for mains, £1, Order Ref. 907.

**1000W SPIRAL ELEMENTS** for repairing fires etc. 3 for £1, Order Ref. 223.

**1000W PENCIL ELEMENTS**, 2 for £1, Ref. 376.

**1-2KW MINI TANGENTIAL HEATER**, ideal for under desk etc. £5, Order Ref. 5P23.

**2KW TANGENTIAL HEATER**, £6, Order Ref. 6P30.

**3KW TANGENTIAL HEATER**, £8, Order Ref. 8P24.

**12" TUBULAR HEATER**, slightly storage soiled, £6, Order Ref. 6P31.

**WATER-PROOF HEATING WIRE**, 80 ohms per metre, 15M is right length for connecting to mains, £5, Order Ref. 5P109.

The above prices include VAT but please add £3 towards our packing and carriage if your order is under £50. Send cheque or postal orders or quote credit card number.

**M & B ELECTRICAL**  
**SUPPLIES LTD**  
 Pilgrim Works (Dept. E.E.)  
 Stairbridge Lane,  
 Bolney,  
 Sussex RH17 5PA  
 Telephone: 0444 881965  
 (Also fax but phone first)  
 Callers to 12 Boundary Road,  
 Hove, Sussex.



# Low cost data acquisition for IBM PCs & compatibles...

A unique range of low cost data acquisition products for IBM PCs and compatibles. Installed in seconds they simply plug directly into either the serial or parallel port. They are completely self contained, require no external power supply and take up no expansion slots.

Each device comes with an easy to use software package (PicoScope, PicoLog or both). C, Pascal, and Basic drivers are supplied for those who want to develop their own software, as is a manual giving full details of the hardware and software. All software supplied on 3.5" disk.

**ADC-10** Up to 24kHz sampling rate from a 386/33MHz machine

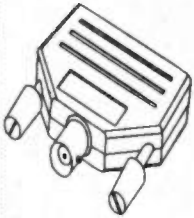

0-5V Input range  
BNC input connector allows use of standard scope probes  
30V overload protection  
Parallel port connection  
Includes PicoScope software

Single Channel 8 bit ADC

£49

**ADC-16**

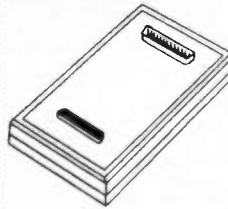

Software selectable single ended or differential inputs  
Resolution programmable between 8 and 16 bits + sign  
 $\pm 2.5V$  input range  
5V reference output  
Connects to serial port  
Includes PicoLog software

8 Channel 16 bit + sign ADC

£99

**ADC-11** 15K samples per second

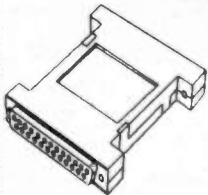

0-2.5V Input range  
Digital output  
D25 input connector  
30V overload protection  
Parallel port connection  
Includes both PicoScope and PicoLog software

11 Channel 10 bit ADC

£75

**PicoScope**

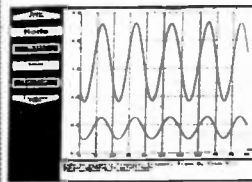

Scope, voltmeter, spectrum analyser

'Virtual instrument' software package for the ADC-10, ADC-11 and ADC-12.

Storage oscilloscope with trigger and timebase. Traces can be printed and saved. Multiple meters on screen. Real time spectrum analysis.

**ADC-12** Up to 18kHz sampling rate

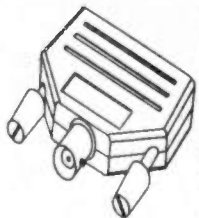

0-5V Input range  
BNC input connector allows use of standard scope probes  
30V overload protection  
Parallel port connection  
Includes both PicoScope and PicoLog software

Single Channel 12 bit ADC

£85

**PicoLog**

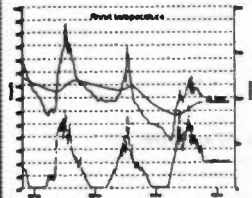

Advanced data logging software

Collect samples from 1 permsto one per day. Scale samples linearly, by equation or by table look-up. Graphical (against time or XY) and text reports can be displayed, printed or exported.

Picolog is also available for the ADC-10: call for details.

Typical application	ADC-10	ADC-11	ADC-12	ADC-16
Oscilloscope	●	●	●	
Voltmeter	●	●	●	●
Spectrum analyser	●	●	●	
Audio sampling	●		●	
Chart recorder emulation		●		●
Temperature measurement	●	●	●	●
Pressure measurement	●	●	●	●
Chromatography				●
Automotive monitoring		●		●
Medical research		●	●	●
Education	●	●	●	●

## PICO BENEFITS

- 30 day no quibble money back policy
- Full 1 year guarantee
- 1 year's free software upgrades
- Free technical support
- Free user newsletter
- Same day dispatch



Pico Technology Ltd. Broadway House, 149-151 St Neots Road, Hardwick, Cambridge. CB3 7QJ.

**TEL: 0954-211716 FAX: 0954-211880**



Phone or FAX for sales, ordering information, data sheets, technical support. All prices exclusive of VAT.

# KARE ELECTRONICS

P.C. E(E)prom Programmer

**HAPPY CHRISTMAS**  
SPECIAL OFFER 17½% OFF  
TREAT YOURSELF!

£128 INC  
BEST EVER  
VALUE

## Device Programmer PLD, GAL, PALCE

As well as E(E)proms, Flash,  
Micro-controllers inc PIC's & Serial E(E)prom.  
Fast programming 27C040 4 meg 90 sec's.  
Small enough for briefcase.  
Made in U.S.A.  
Call for leaflet and  
further details.

£325 INC

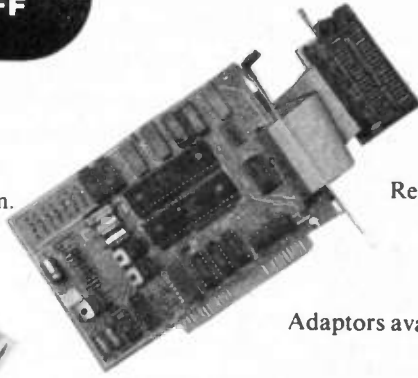

For PC, XT, AT, 386, 486.

Internal card for greater security.  
Reads, verifies & Program's devices to 4 Meg.  
Binary, Intel Hex, Motorola S. Format  
Fast Program's 64A in 10 sec.  
Fully Comprehensive & simple to operate  
colour software and 60 page manual.  
Adaptors available for Micro's, 16 bit, Epson cards etc.  
Call today for demo disk and leaflet.

## Universal Assembler

Inc H8/3xx H8/5xx PIC16Cxx PIC17Cxx etc.

Cross 32 Assembler, Table Based Cross-assembler.

Probably the only assembler you need to buy.

Generates object code in Binary, Hex, Motorola S format.

Full details provided to compile tables for future Processors.

To many features to list. Call for leaflet and further information.

£175 INC

## MICRO-CONTROLLERS

80C31 d.i.l. Plastic £3.50 P80C32 d.i.l. Plastic £5.75  
D87C51 Eprom Ceramic £24.00 D8748H Eprom Ceramic £7.00

Save Hours hardwiring that controller project.  
Printed circuit board for 8040 + latch + 2k memory PCB only £4.75  
Printed circuit board for 8031/2 + latch + 2k memory PCB only £5.75

All prices include V.A.T. please add £1.50 p&p  
for Micro's and P.C.B's and £4.50 p&p for  
Programmings and Assemblers. Please send  
cheque with order and allow up to 10 days for  
delivery.

32, Pear Tree Ave., Ditton, Aylesford, Kent ME20 6EB. Tel/Fax 0732 844633

## electronize electronic kits

### TOTAL ENERGY DISCHARGE ELECTRONIC IGNITION

A unique extended CDI system gives a super high power spark under conditions where the standard system just cannot cope. The contact breaker is retained for ease of fitting but operates only at low power.

EXTENDED CDI IGNITION parts kit £24.75 assembled £32.75

### MICRO-PRESSURE CAR ALARM

A unique air pressure sensing system operates automatically without door switches etc. and is disarmed with the ignition key. Provides exit and entry delays with audible warning when triggered. Easily fitted with only three leads. A Power MOSFET output drives a siren or the car horn.

MICRO-PRESSURE CAR ALARM parts kit £15.95 assembled £22.35

### VOLT DROP OPERATED CAR ALARM

A similar unit to the above but relying on the courtesy light operation and the well known volt drop detection system.

VOLT DROP CAR ALARM parts kit £14.90 assembled £20.95

### MICRO PRESSURE TRIGGER

A small module to up-grade any volt drop alarm to "Micro-Pressure" sensing or combine the benefits of both systems.

MICRO PRESSURE TRIGGER parts kit £10.95 assembled £14.95

### 120dB PIEZO SIREN

A high intensity vehicle alarm siren for use with the above alarms.

120dB PIEZO SIREN assembled only £11.95

### CODED INFRARED RECEIVER

A dash top mounted unit gives coded remote control of the above alarms. Includes a security chip with anti-scanning and 59,046 customer selectable combinations. Also has "Mega Bright" flashing LED to warn off intruders.

CODED IR RECEIVER parts kit £21.35 assembled £26.55

### CODED INFRARED TRANSMITTER

A key ring code transmitter for the above with a range up to 5 metres.

CODED IR TRANSMITTER parts kit £13.95 assembled £17.95

All the above include cable, connectors and clear easy to follow instructions.  
All kits include case, PCB, everything down to the last washer, even solder.  
Prices are mail order discount, fully inclusive and apply for U.K. and export.  
Telephone orders accepted with VISA or ACCESS payment.

Ask for detailed brochures or order direct (please quote EE11) from:-

**ELECTRONIZE DESIGN** Tel. 021 308 5877  
2 Hillside Road, Four Oaks, Sutton Coldfield, B74 4DQ

## OMNI ELECTRONICS

174 Dalkeith Road, Edinburgh EH16 5DX ★ 031 667 2611

The supplier to use if you're looking for:-

A WIDE RANGE OF  
★ COMPONENTS AIMED AT THE ★  
HOBBYIST

★ COMPETITIVE VAT INCLUSIVE ★  
PRICES

★ MAIL ORDER - generally by ★  
RETURN OF POST

★ FRIENDLY SERVICE ★

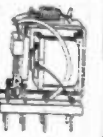
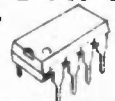
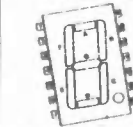

OPEN:

Monday-Thursday 9.15 - 6.00

Friday 9.15-5.00

Saturday 9.30-5.00





# EASY-PC, SCHEMATIC and PCB CAD

Over 17,000 Installations  
in 70 Countries World-wide!

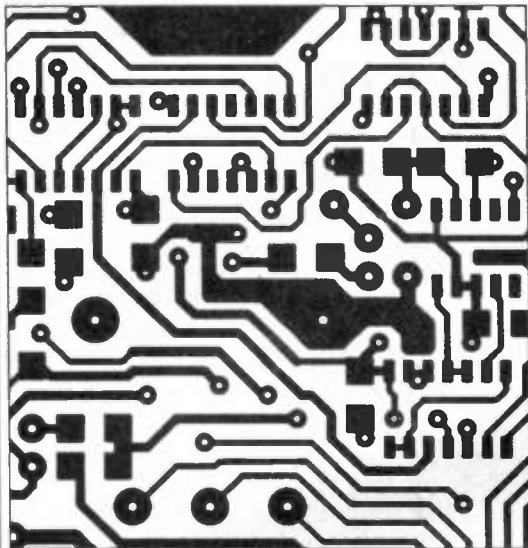

- Runs on:- PC/XT/AT/ 286/ 386/ 486 with Hercules, CGA, EGA or VGA display and many DOS emulations.
- Design:- Single sided, Double sided and Multi-layer (8) boards.
- Provides full Surface Mount support.
- Standard output includes Dot Matrix / Laser / Ink-jet Printer, Pen Plotter, Photo-plotter and N.C. Drill.
- Tech Support - free.
- Superbly easy to use.

**Still  
Only  
£98.00!**

Plus P&P+VAT

**BRITISH  
DESIGN  
AWARD  
1989**

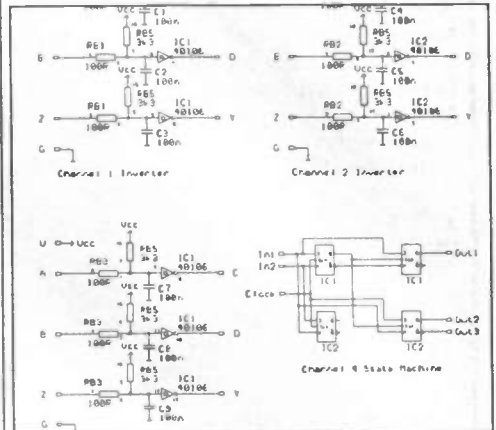

Options:-500 piece Surface Mount Symbol Library £48,  
1000 piece Symbol Library £38, Gerber Import facility £98.

## Electronic Designs Right First Time?

Ask for our fully functional Integrated Demo

### Integrated Electronics CAD

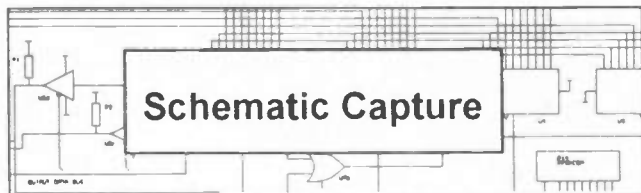

Analogue  
& Digital  
Simulation

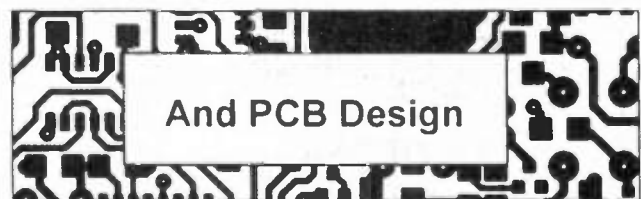

And PCB Design

For Less than £400/\$775!

### Affordable Electronics CAD

EASY-PC: Low cost, entry level PCB and Schematic CAD.	\$195.00	£98.00
EASY-PC Professional: Schematic Capture and PCB CAD. Links directly to ANALYSER III and PULSAR.	\$375.00	£195.00
PULSAR: Low cost Digital Circuit Simulator ~ 1500 gate capacity.	\$195.00	£98.00
PULSAR Professional: Digital Circuit Simulator ~ 50,000 gate capacity.	\$375.00	£195.00
ANALYSER III: Low cost Linear Analogue Circuit Simulator ~ 130 node capability	\$195.00	£98.00
ANALYSER III Professional: Linear Analogue Circuit Simulator ~ 750 node capability.	\$375.00	£195.00
Z-MATCH for Windows: NEW Windows Smith-Chart program for RF Engineers.	\$475.00	£245.00
<small>We operate a no penalty upgrade policy. You can upgrade at any time to the professional version of a program just for the difference in price.</small>	<small>US\$ prices include Post and Packing</small>	<small> Sterling £ prices exclude P&amp;P and VAT</small>

For full information, Write, Phone or Fax:-

### Number One Systems Ltd.

REF: EVD, HARDING WAY, ST. IVES, HUNTINGDON, CAMBS, ENGLAND, PE17 4WR.

Telephone: 0480 461778 (7 lines) Fax: 0480 494042

International: +44 -480-461778, Fax:+44-480-494042



- TECHNICAL SUPPORT FREE FOR LIFE!
- PROGRAMS NOT COPY PROTECTED.
- SPECIAL PRICES FOR EDUCATION.

ACCESS, AMEX, MASTERCARD, VISA Welcome.



**SHOP OPEN 9-5 MON-FRI. CLOSED SAT --- OFFICIAL ORDERS WELCOME**

## E.E. TREASURE HUNTER P.I. METAL DETECTOR

Magenta's highly developed & acclaimed design. Quartz crystal controlled circuit MOSFET coil drive. D.C. coupled amplification. Detects 10p coin at 20 cm. Full kit includes PCB, handle, case & search coil.



- KIT INC. HEADPHONES
- EFFICIENT CMOS DESIGN
- POWERFUL COIL DRIVE

- DETECTS FERROUS AND NON-FERROUS METAL - GOLD, SILVER, COPPER ETC.
- 190mm SEARCH COIL
- NO 'GROUND EFFECT'

KIT 815.....£45.95

## DIGITAL LCD THERMOSTAT

A versatile thermostat using a thermistor probe and having an l.c.d. display. MIN/MAX memories, -10 to 110 degrees celsius, or can be set to read in Fahrenheit. Individually settable upper and lower switching temperatures allow close control, or alternatively allow a wide 'dead band' to be set which can result in substantial energy savings when used with domestic hot water systems. Ideal for greenhouse ventilation or heating control, aquaria, home brewing, etc. Mains powered, 10A SPCO relay output. Punched and printed case.

KIT 841.....£29.95

## 4 CHANNEL LIGHT CHASER

A 1000W per channel chaser with Zero Volt Switching, Hard Drive, and full inductive load capability. Built-in mic. and sophisticated 'Beat Seeker' circuit - chase steps to music, or auto when silent. Variable speed and mic. sensitivity control, i.e.d. mimic on front panel. Switchable for 3 or 4 channels. P552 output socket. Suits Rope Lights, Pin Spots, Disco, and Display lighting.

KIT 833.....£32.13

## SUPERHET LW MW RADIO

At least an easy to build SUPERHET AM radio kit. Covers Long and Medium waves. Built in loudspeaker with 1 Watt output. Excellent sensitivity and selectivity provided by ceramic IF filter. Simple alignment and tuning without special equipment. Supplied with pre-drilled transparent front panel and dial, for interesting see-through appearance.

KIT 835.....£17.16

## ACOUSTIC PROBE

A very popular project which picks up vibrations by means of a contact probe and passes them on to a pair of headphones or an amplifier. Sounds from engines, watches, and speech travelling through walls can be amplified and heard clearly. Useful for mechanics, instrument engineers, and nosey parkers!

KIT 740.....£19.98

## KIT HIGHLIGHT

### DIGITAL CAPACITANCE METER KIT 493

This has been one of Megenta's best ever kits. It provides clear readings of capacitance values from a few pF up to thousands of µF. It is ideal for beginners as there is no confusion over the placing of the decimal point, and it allows obscurely marked components to be identified quickly and easily. Quartz controlled accuracy of 1%, large clear 5 digit display and high speed operation make it a very useful instrument for production and testing departments. The kit is now supplied with a punched and printed front panel as well as the case, all components and top quality printed circuit board. When assembled it looks a really professional job. For a limited time this kit is offered at a new low price.



PRICE  
£39.95

### MOSFET VARIABLE BENCH POWER SUPPLY 25V 2.5A

Our own high performance design. Variable output Voltage from 0 to 25V and Current limit from 0 to 2.5A. Capable of powering almost anything. Two panel meters indicate Voltage and Current. Fully protected against short-circuits. The variable Current limit control makes this supply ideal for constant current charging of NICAD cells and batteries. A Power MOSFET handles the output for exceptional ruggedness and reliability. Uses a toroidal mains transformer.

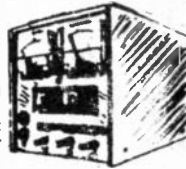

KIT 769.....£56.82

### ULTRASONIC PeST SCARER

Keep pets/pests away from newly sown areas, fruit, vegetable and flower beds, children's play areas, patios etc. This project produces intense pulses of ultrasound which deter visiting animals.



- KIT INCLUDES ALL COMPONENTS, PCB & CASE
- EFFICIENT 100V TRANSDUCER OUTPUT
- LOW CURRENT DRAIN

- COMPLETELY INAUDIBLE TO HUMANS
- UP TO 4 METRES RANGE

KIT Ref. 812.....£14.81

### IONISER

A highly efficient mains powered Negative Ion Generator that clears the air by neutralising excess positive ions. Many claimed health benefits due to the ioniser removing dust and pollen from the air and clearing smoke particles. Costs virtually nothing to run and is completely safe in operation. Uses five point emitters.

KIT 707.....£17.75

### BAT DETECTOR

An excellent circuit which reduces ultrasound frequencies between 20 and 100 kHz to the normal (human) audible range. Operating rather like a radio receiver the circuit allows the listener to tune-in to the ultrasonic frequencies of interest. Listening to Bats is fascinating, and it is possible to identify various different types using this project. Other uses have been found in industry for vibration monitoring etc.

KIT 814.....£21.44

### 12V EPROM ERASER

A safe low cost eraser for up to 4 EPROMs at a time in less than 20 minutes. Operates from a 12V supply (400mA). Used extensively for mobile work - updating equipment in the field etc. Also in educational situations where mains supplies are not allowed. Safety interlock prevents contact with UV.

KIT 790.....£28.51

### EE TREASURE HUNTER

Our own widely acclaimed design. This sensitive Pulse Induction metal detector picks up coins and rings etc up to 20cm deep. Negligible 'ground effect' means that the detector can even be used with the head immersed in sea water. Easy to use, circuit requires only a minimum of setting up as a Quartz crystal provides all of the critical timing. Kit includes search-head, handle, case, PCB and all components.

KIT 815.....£45.95

### INSULATION TESTER

A reliable and neat electronic tester which checks insulation resistance of wiring and appliances etc., at 500 Volts. The unit is battery powered, simple and safe to operate. Leakage resistance of up to 100 Megohms can be read easily. A very popular college project.

KIT 444.....£22.37

### 3 BAND SHORT WAVE RADIO

Covers 1.6 to 30MHz in three bands using modern miniature plug-in coils. Audio output is via a built-in loudspeaker. Advanced stable design gives excellent stability, sensitivity and selectivity. Simple to build battery powered circuit. Receives a vast number of stations at all times of the day.

KIT 718.....£30.30

### DIGITAL COMBINATION LOCK

Digital lock with 12 key keypad. Entering a four digit code operates a 250V 16A relay. A special anti-tamper circuit permits the relay board to be mounted remotely. Ideal car immobiliser, operates from 12V. Drilled case, brushed aluminium keypad.

KIT 840.....£19.86

### PORTABLE ULTRASONIC PeST SCARER

A powerful 23kHz ultrasound generator in a compact hand-held case. MOSFET output drives a special sealed transducer with intense pulses via a special tuned transformer. Sweeping frequency output is designed to give maximum output without any special setting up.

KIT 842.....£22.56

### LIGHT RIDER DISCO LIGHTS

A six channel light driver that scans from left to right and back continuously. Variable speed control. Up to 500 watts per channel. Housed in a plastic box for complete safety. Built on a single printed circuit board.

KIT 560.....£22.41

### LIGHT RIDER 9-12V CHASER LIGHTS

A low voltage DC powered end-to-end type chaser that can be set for any number of lights between 3 and 16. The kit is supplied with 16 l.e.d.s but by adding power transistors it is possible to drive filament bulbs for a larger brighter display. Very popular with car customisers and modellers. L.e.d.s can be randomly positioned and paired to give twinkling effects.

KIT 559.....£15.58

## HAMEG HM203-7 20 MHz DUAL TRACE OSCILLOSCOPE & COMPONENT TESTER

Western Europe's best selling oscilloscope - It is RELIABLE, HIGH PERFORMANCE, & EASY TO USE.

Sharp bright display on 8 x 10cm screen with internal graticule. A special extra feature is the built-in component tester which allows capacitors, resistors, transistors, diodes and many other components to be checked. The quality of this instrument is outstanding, and is supported by a two year parts and labour warranty.

If you are buying an oscilloscope - this is the one. - It costs a fraction more than some other 20 MHz 'scopes but it is far far superior. Supplied with test probes, mains lead, and manual.

£362.00 + £63.35 VAT Includes FREE Next-day delivery (Cheques must be cleared)

## EDUCATIONAL BOOKS & PACKS

### ADVENTURES WITH ELECTRONICS

The classic book by Tom Duncan used throughout schools. Very well illustrated, ideal first book for age 10 on. No soldering. Uses an S.DEC breadboard.

Book & Components £28.95, Book only £6.99

### FUN WITH ELECTRONICS

An Usborne book, wonderfully illustrated in colour. Component pack allows 6 projects to be built and kept. Soldering is necessary. Age 12 on, or younger with adult help. Book & Components £20.88, Book only £2.95

### 30 SOLDERLESS BREADBOARD PROJECTS

A more advanced book to follow the others. No soldering. Circuits cover a wide range of interests.

Book & Components £30.69, Book only £2.95

## DC MOTOR/GEARBOXES

Ideal for robots, buggies, and many other mechanical projects. Min. plastic gearbox with 1.5-4.5V DC motor. 6 ratios can be set up. Small type MGS.....£4.77 Large type MGL.....£5.58

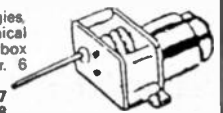

## STEPPING MOTORS

For computer control via MD35 1/4 - standard 48 standard 4 pole unipolar steps per rev.....£12.99 drivers.

MD38 - miniature 48 MD200 - miniature 200 steps per rev.....£9.15 steps per rev.....£17.10



# MAGENTA

ELECTRONICS LTD

## Teach-In '93

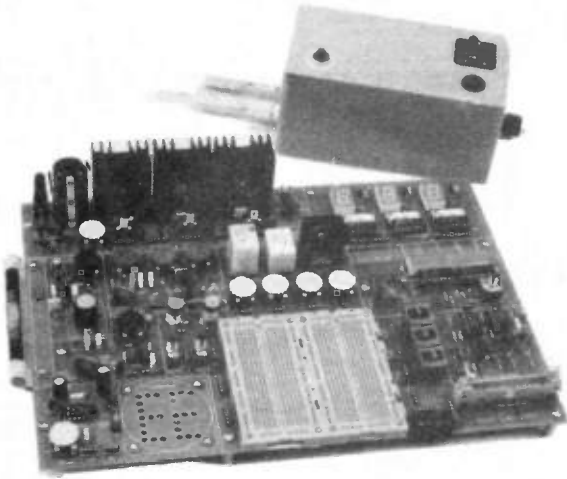

### MINI LAB KITS

ALL COMPONENTS TO ASSEMBLE  
THE EPE MINI LAB.

Follow this exciting educational series as  
featured in EPE through 1993.

Full set of reprints .....£4.00

Components are supplied in packs to keep  
ordering simple.

A full MINI LAB consists of ML1, ML3, ML5,  
ML6. These are available at a special  
combined price of.....£114.99

or less the p.c.b.

ML2, ML3, ML5, ML6 at.....£104.99

The transformer unit ML4 is also needed....£21.45

- |         |   |        |
|---------|---|--------|
| KIT ML1 | MINI-LAB P.C.B. + all components<br>inclusive of breadboard for<br>Part 1 (Nov. '92)..... | £49.95 |
| KIT ML2 | All Components for Part 1 less<br>p.c.b.....  | £39.95 |
| KIT ML3 | Power Supply components.....  | £19.95 |
| KIT ML4 | Transformer unit.....   | £21.45 |
| KIT ML5 | L.E.D. Voltmeter, signal<br>generator, audio amplifier and<br>555 timer.....              | £33.95 |
| KIT ML6 | Logic probe, display, radio<br>tuner.....   | £17.95 |

(Note: batteries not included)

All prices include V.A.T. Add £2.00 p&p.

Tel: 0283 65435 Fax: 0283 46932

# MAGENTA

ELECTRONICS LTD

## Teach-In '93



### MICRO LAB KITS

ALL COMPONENTS TO ASSEMBLE  
THE EPE MICRO LAB.

A 6502 Microprocessor trainer with many  
features. Accompanied by an excellent set  
of tutorial articles and a manual.

Repair/fault-finding help assured when you  
buy your kit from us.

Full MICRO LAB kit including PC Board,  
EPROM, PAL, & Manual.

MIC 1 .....£149.95

(Also available less PCB etc. if required).

Full set of reprints.....£4.60

### BUILT & TESTED

Full MICRO LAB AS MIC1 (above)  
MIC1B.....£179.95

Professionally assembled, inspected,  
cleaned and tested. Full back-up service,  
spares, etc available.

All prices include V.A.T. Add £2.00 p&p.

Tel: 0283 65435 Fax: 0283 46932

# ESR ELECTRONIC COMPONENTS

Station Road, Cullercoats,

Tyne & Wear NE30 4PQ

Tel. 091 251 4363

Fax. 091 252 2296

74LS Series		4000 Series		TRANSISTORS				LINEAR ICs				SOLDERING IRONS		RF CONNECTORS	
74LS00	£0.14	4000	£0.17	2N1613	£0.31	BC186	£0.33	BD534	£0.47	CA311E	£0.28	Antex Soldering Irons		BNC Solder Plug 50R	£0.93
74LS01	£0.14	4001	£0.17	2N1711	£0.29	BC204C	£0.28	BD535	£0.48	CA324	£0.23	M 12 Watt	£8.18	BNC Solder Plug 75R	£0.96
74LS02	£0.14	4002	£0.17	2N1891	£0.28	BC206B	£0.72	BD536	£0.65	CA585	£0.22	C 15Watt	£7.87	BNC Crimp Plug 50R	£0.68
74LS03	£0.14	4006	£0.32	2N218A	£0.28	BC207C	£0.72	BD646	£0.62	CA741CE	£0.18	G 18Watt	£8.31	BNC Crimp Plug 75R	£0.68
74LS04	£0.14	4007	£0.31	2N2219A	£0.25	BC208	£0.72	BD648	£0.52	CA747CE	£0.39	CS 17Watt	£8.41	BNC Solder Skt	£1.08
74LS05	£0.14	4008	£0.31	2N2222A	£0.18	BC209A	£0.72	BD650	£0.53	CA3046	£0.37	PS 25Watt	£2.97	BNC Chassis Skt	£1.60
74LS08	£0.14	4009	£0.19	2N2646	£0.80	BC212	£0.08	BD707	£0.42	CA3080	£0.72	ST4 Stand	£2.97	PL259 5 2mm	£0.80
74LS09	£0.14	4011	£0.16	2N2905A	£0.23	BC212BLB	£0.08	BD807	£0.80	CA3130	£0.98	35Watt Gas Iron	£11.58	PL259 11mm	£0.82
74LS10	£0.14	4010	£0.23	2N2906	£0.20	BC213	£0.08	BD832	£1.78	CA3130E	£0.98	'Gascat' Gas Iron	£16.26	RND UHF socket	£0.68
74LS107	£0.23	4013	£0.17	2N2926	£0.16	BC213CL	£0.08	BDX33C	£0.49	CA3140	£0.56	Low Cost 15 Watt Iron	£3.93	SQR UHF socket	£0.45
74LS109	£0.21	4013	£0.17	2N2926	£0.16	BC213CL	£0.08	BDX34C	£0.50	CA3240	£1.22	Desolder Pump	£3.00	RND UHF socket	£0.68
74LS111	£0.17	4014	£0.30	2N3053	£0.27	BC214	£0.08	BDX53C	£0.47	ICI7621	£1.70	Antistatic Pump	£4.30	SQR UHF socket	£0.45
74LS112	£0.21	4015	£0.30	2N3054	£0.27	BC214L	£0.08	BDX53C	£0.47	ICI7621	£1.70	Antistatic Pump	£4.30	SQR UHF socket	£0.45
74LS113	£0.21	4016	£0.18	2N3055	£0.62	BC237B	£0.09	BF180	£0.31	ICM7556	£0.96	22SWG 0.5kg Solder	£7.40	F Plug RG6	£0.27
74LS114	£0.21	4017	£0.27	2N3440	£0.50	BC238C	£0.09	BF182	£0.31	LM301A	£0.25	18SWG 0.5kg Solder	£6.80	N Socket RG6	£1.60
74LS115	£0.21	4018	£0.27	2N3702	£0.09	BC239C	£0.10	BF185	£0.31	LM3048N	£0.31	1mm 3 yds Solder	£0.62	BNC Crimp Pliers	£15.50
74LS116	£0.21	4019	£0.30	2N3703	£0.10	BC251	£0.13	BF194	£0.19	LF381N	£0.36	Desolder Pump	£3.93	BNC Crimp Pliers	£15.50
74LS122	£0.31	4020	£0.31	2N3704	£0.10	BC252	£0.13	BF195	£0.19	LF381N	£0.36	UV EXPOSURE UNIT	£67.38		
74LS123	£0.31	4020	£0.31	2N3704	£0.10	BC252	£0.13	BF195	£0.19	LF381N	£0.36	PLASTIC DEVELOPING TRAY	£1.35		
74LS125	£0.21	4021	£0.32	2N3705	£0.10	BC261B	£0.24	BF244	£0.36	LM358N	£0.27	PHOTO RESIST AEROSOL SPRAY (100ml)	£3.90		
74LS126	£0.21	4022	£0.32	2N3706	£0.10	BC262B	£0.24	BF257	£0.33	LM377	£2.57	FERRIC CHLORIDE CRYSTALS (0.5kg)	£2.45		
74LS133	£0.14	4023	£0.16	2N3771	£1.44	BC267B	£0.30	BF259	£0.33	LM380N	£1.12	ETCH RESIST PEN	£0.72		
74LS134	£0.14	4024	£0.21	2N3772	£1.51	BC307	£0.10	BF337	£0.36	LM381	£2.70	PCB POLISHING BLOCK	£1.84		
74LS132	£0.21	4025	£0.15	2N3773	£1.79	BC308	£0.10	BF356	£0.38	LM388	£0.48				
74LS133	£0.18	4026	£0.59	2N3819	£0.40	BC327	£0.10	BF357	£0.38	LM388	£0.48				
74LS136	£0.16	4027	£0.18	2N3820	£0.35	BC359B	£0.10	BF451	£0.19	LM392N	£0.79				
74LS138	£0.25	4028	£0.22	2N3905	£0.10	BC338	£0.10	BF459	£0.29	LM393N	£0.28				
74LS14	£0.25	4030	£0.17	2N3906	£0.10	BC341C	£0.13	BF469	£0.29	LM748CN	£0.31				
74LS145	£0.56	4031	£0.70	2N4036	£0.57	BC441	£0.40	BFX84	£0.31	LM748CN	£0.31				
74LS147	£1.26	4033	£0.56	2N4036	£0.57	BC461	£0.40	BFX84	£0.31	LM748CN	£0.31				
74LS148	£0.70	4034	£0.31	2N4036	£0.57	BC461	£0.40	BFX84	£0.31	LM748CN	£0.31				
74LS151	£0.25	4040	£0.29	2N4036	£0.57	BC461	£0.40	BFX84	£0.31	LM748CN	£0.31				
74LS153	£0.25	4040	£0.29	2N4036	£0.57	BC461	£0.40	BFX84	£0.31	LM748CN	£0.31				
74LS154	£0.70	4042	£0.22	2N4036	£0.57	BC461	£0.40	BFX84	£0.31	LM748CN	£0.31				
74LS155	£0.25	4043	£0.28	2N4036	£0.57	BC461	£0.40	BFX84	£0.31	LM748CN	£0.31				
74LS156	£0.25	4044	£0.35	2N4036	£0.57	BC461	£0.40	BFX84	£0.31	LM748CN	£0.31				
74LS157	£0.25	4046	£0.31	2N4036	£0.57	BC461	£0.40	BFX84	£0.31	LM748CN	£0.31				
74LS158	£0.25	4047	£0.25	2N4036	£0.57	BC461	£0.40	BFX84	£0.31	LM748CN	£0.31				
74LS160	£0.32	4048	£0.31	2N4036	£0.57	BC461	£0.40	BFX84	£0.31	LM748CN	£0.31				
74LS161	£0.32	4049	£0.20	2N4036	£0.57	BC461	£0.40	BFX84	£0.31	LM748CN	£0.31				
74LS162	£0.32	4050	£0.20	2N4036	£0.57	BC461	£0.40	BFX84	£0.31	LM748CN	£0.31				
74LS163	£0.32	4051	£0.25	2N4036	£0.57	BC461	£0.40	BFX84	£0.31	LM748CN	£0.31				
74LS164	£0.28	4052	£0.25	2N4036	£0.57	BC461	£0.40	BFX84	£0.31	LM748CN	£0.31				
74LS165	£0.48	4053	£0.25	2N4036	£0.57	BC461	£0.40	BFX84	£0.31	LM748CN	£0.31				
74LS170	£0.24	4054	£0.34	2N4036	£0.57	BC461	£0.40	BFX84	£0.31	LM748CN	£0.31				
74LS173	£0.24	4055	£0.34	2N4036	£0.57	BC461	£0.40	BFX84	£0.31	LM748CN	£0.31				
74LS174	£0.24	4056	£0.31	2N4036	£0.57	BC461	£0.40	BFX84	£0.31	LM748CN	£0.31				
74LS175	£0.24	4063	£0.29	2N4036	£0.57	BC461	£0.40	BFX84	£0.31	LM748CN	£0.31				
74LS190	£0.25	4066	£0.18	2N4036	£0.57	BC461	£0.40	BFX84	£0.31	LM748CN	£0.31				
74LS191	£0.24	4067	£1.91	2N4036	£0.57	BC461	£0.40	BFX84	£0.31	LM748CN	£0.31				
74LS192	£0.24	4068	£0.16	2N4036	£0.57	BC461	£0.40	BFX84	£0.31	LM748CN	£0.31				
74LS193	£0.24	4069	£0.20	2N4036	£0.57	BC461	£0.40	BFX84	£0.31	LM748CN	£0.31				
74LS196	£0.24	4070	£0.17	2N4036	£0.57	BC461	£0.40	BFX84	£0.31	LM748CN	£0.31				
74LS197	£0.24	4071	£0.20	2N4036	£0.57	BC461	£0.40	BFX84	£0.31	LM748CN	£0.31				
74LS198	£0.24	4072	£0.17	2N4036	£0.57	BC461	£0.40	BFX84	£0.31	LM748CN	£0.31				
74LS20	£0.16	4073	£0.17	2N4036	£0.57	BC461	£0.40	BFX84	£0.31	LM748CN	£0.31				
74LS21	£0.14	4075	£0.17	2N4036	£0.57	BC461	£0.40	BFX84	£0.31	LM748CN	£0.31				
74LS22	£0.14	4077	£0.17	2N4036	£0.57	BC461	£0.40	BFX84	£0.31	LM748CN	£0.31				
74LS221	£0.40	4078	£0.14	2N4036	£0.57	BC461	£0.40	BFX84	£0.31	LM748CN	£0.31				
74LS240	£0.32	4081	£0.14	2N4036	£0.57	BC461	£0.40	BFX84	£0.31	LM748CN	£0.31				
74LS241	£0.32	4082	£0.17	2N4036	£0.57	BC461	£0.40	BFX84	£0.31	LM748CN	£0.31				
74LS242	£0.32	4085	£0.28	2N4036	£0.57	BC461	£0.40	BFX84	£0.31	LM748CN	£0.31				
74LS243	£0.32	4086	£0.26	2N4036	£0.57	BC461	£0.40	BFX84	£0.31	LM748CN	£0.31				
74LS244	£0.32	4093	£0.19	2N4036	£0.57	BC461	£0.40	BFX84	£0.31	LM748CN	£0.31				
74LS245	£0.33	4094	£0.31	2N4036	£0.57	BC461	£0.40	BFX84	£0.31	LM748CN	£0.31				
74LS247	£0.32	4095	£0.56	2N4036	£0.57	BC461	£0.40	BFX84	£0.31	LM748CN	£0.31				
74LS251	£0.34	4098	£0.17	2N4036	£0.57	BC461	£0.40	BFX84	£0.31	LM748CN	£0.31				
74LS257	£0.24	4097	£1.20	2N4036	£0.57	BC461	£0.40	BFX84	£0.31	LM748CN	£0.31				
74LS258	£0.24	4098	£0.31	2N4036	£0.57	BC461	£0.40	BFX84	£0.31	LM748CN	£0.31				
74LS259	£0.24	4099	£0.38	2N4036	£0.57	BC461	£0.40	BFX84	£0.31	LM748CN	£0.31				
74LS26	£0.14	4099	£0.38	2N4036	£0.57	BC461	£0.40	BFX84	£0.31	LM748CN	£0.31				
74LS266	£0.14	4503	£0.31	2N4036	£0.57	BC461	£0.40	BFX84	£0.31	LM748CN	£0.31				
74LS27	£0.14	4508	£0.90	2N4036	£0.57	BC461	£0.40	BFX84	£0.31						



# EVERYDAY WITH PRACTICAL ELECTRONICS

INCORPORATING ELECTRONICS MONTHLY

VOL. 23 No. 1

JANUARY '94

## READER POWER

I have often made the point in this column that this is *your* magazine and that *you* can influence what we publish, either by simply asking for a certain project or feature, or by expressing views on what we presently publish. The start of *Calculation Corner* represents "reader power".

Back in the September '93 issue we asked if you wanted to see more on the maths used in electronics. We also published a small feature called *Working It Out* in that issue to give a feel for the idea. Your response to the request to let us know what you want on this subject was very positive; *Calculation Corner* is a direct result of that response. So to all those readers that wrote in, our thanks, we hope you find the series helpful and interesting.

## THANKS AGAIN

While on the subject of "reader power" it seems an appropriate time to thank you all for making EPE the best selling independent hobby electronics title in the UK for another year. Our research indicates that no other independent title comes anywhere near our UK sales figures, which of course pleases us no end.

This also results in bigger and better issues for you. Our advertisers find that EPE generally gives them a good response from readers which leads to more advertisement pages and, in turn, more editorial pages – this issue is 88 pages plus the covers and the free catalogue, I doubt if you will find that sort of value for money in any rival title.

Thank you for your support and may I wish you on behalf of all the EPE staff all the best for 1994

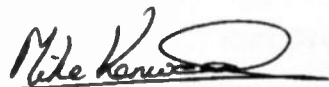

## SUBSCRIPTIONS

Annual subscriptions for delivery direct to any address in the UK: £22. Overseas: £28 (£45.50 airmail). Cheques or bank drafts (in £ sterling only) payable to Everyday with Practical Electronics and sent to EPE Subscriptions Dept., 6 Church Street, Wimborne, Dorset BH21 1JH. Tel: 0202 881749. Subscriptions start with the next available issue. We accept Access (MasterCard) or Visa payments, minimum credit card order £5.

## BACK ISSUES

Certain back issues of EVERYDAY ELECTRONICS, PRACTICAL ELECTRONICS and EVERYDAY WITH PRACTICAL ELECTRONICS (from Nov '92 onwards) are available price £2.20 (£3 overseas surface mail) inclusive of postage and packing per copy – £ sterling only please, Visa and Access (MasterCard) accepted, minimum credit card order £5. Enquiries with remittance, made payable to Everyday with Practical Electronics, should be sent to Post Sales Department, Everyday with Practical Electronics, 6 Church Street, Wimborne, Dorset BH21 1JH Tel: 0202 881749. In the event of non-availability one article can be photostatted for the same price. Normally sent within seven days but please allow 28 days for delivery. We have sold out of Jan, Feb, Mar, Apr, May, June, Oct. & Dec 88, Mar, May & Nov 89, Mar 90, April, Aug & Sept 91 Everyday Electronics, and can only supply back issues from Jan 92 to Aug 92 (excluding Mar 92) of Practical Electronics. Dec 92, Jan, Feb and March 93 Everyday with Practical Electronics are also unavailable.

## BINDERS

New style binders to hold one volume (12 issues) are now available from the above address for £4.95 plus £3.50 post and packing (for overseas readers the postage is £6.00 to everywhere except Australia and Papua New Guinea which cost £10.50). Normally sent within seven days but please allow 28 days for delivery.

Payment in £ sterling only please. Visa and Access (MasterCard) accepted, minimum credit card order £5. Send card number and card expiry date with your name and address etc.

## Editorial Offices:

EVERYDAY with PRACTICAL ELECTRONICS EDITORIAL,  
6 CHURCH STREET, WIMBORNE,  
DORSET BH21 1JH

Phone: Wimborne (0202) 881749

Fax: (0202) 841692. DX: Wimborne 45314.

See notes on Readers' Enquiries below – we regret that lengthy technical enquiries cannot be answered over the telephone. Due to the high cost we cannot reply to overseas readers queries by Fax.

## Advertisement Offices:

EVERYDAY with PRACTICAL ELECTRONICS  
ADVERTISEMENTS,

HOLLAND WOOD HOUSE, CHURCH LANE,  
GREAT HOLLAND, ESSEX CO13 0JS.

Phone/Fax: (0255) 850596

Editor: MIKE KENWARD

Secretary: PAM BROWN

Deputy Editor: DAVID BARRINGTON

Business Manager: DAVID J. LEAVER

Subscriptions: MARILYN GOLDBERG

Editorial: Wimborne (0202) 881749

Advertisement Manager:

PETER J. MEW, Frinton (0255) 850596

Advertisement Copy Controller:

DEREK NEW, Wimborne (0202) 882299

## READERS' ENQUIRIES

We are unable to offer any advice on the use, purchase, repair or modification of commercial equipment or the incorporation or modification of designs published in the magazine. We regret that we cannot provide data or answer queries on articles or projects that are more than five years old. Letters requiring a personal reply must be accompanied by a stamped self-addressed envelope or a self addressed envelope and international reply coupons. Due to the high cost we cannot reply to overseas readers queries by Fax.

All reasonable precautions are taken to ensure that the advice and data given to readers is reliable. We cannot however guarantee it and we cannot accept legal responsibility for it.

## COMPONENT SUPPLIES

We do not supply electronic components or kits for building the projects featured, these can be supplied by advertisers.

We advise readers to check that all parts are still available before commencing any project in a back-dated issue.

We regret that we cannot provide data or answer queries on projects that are more than five years old.

## ADVERTISEMENTS

Although the proprietors and staff of EVERYDAY with PRACTICAL ELECTRONICS take reasonable precautions to protect the interests of readers by ensuring as far as practicable that advertisements are *bona fide*, the magazine and its Publishers cannot give any undertakings in respect of statements or claims made by advertisers, whether these advertisements are printed as part of the magazine, or are in the form of inserts.

The Publishers regret that under no circumstances will the magazine accept liability for non-receipt of goods ordered, or for late delivery, or for faults in manufacture. Legal remedies are available in respect of some of these circumstances, and readers who have complaints should first address them to the advertiser.

## TRANSMITTERS/BUGS/TELEPHONE EQUIPMENT

We would like to advise readers that certain items of radio transmitting and telephone equipment which may be advertised in our pages cannot be legally used in the UK. Readers should check the law before using any transmitting or telephone equipment as a fine, confiscation of equipment and/or imprisonment can result from illegal use. The laws vary from country to country; overseas readers should check local laws.



# PORTABLE AUTOLIGHT

T. R. de VAUX-BALBIRNIE

An automatic night-light  
- useful for children and the elderly.



**L**IGHT switches can be difficult to locate in the dark, especially by the young and by those who are not as agile as they used to be. This system avoids switches and operates a light without conscious effort on the part of the user.

By making sure that a light comes on when a person gets out of bed, accidents are avoided. Autolight switches on for a preset time - in the prototype this is for one minute approximately but it could be easily increased or reduced as required.

Although this circuit was designed as an automatic night-light, there is no doubt that readers will have ideas of their own and find alternative uses for the basic design. This could be the basis for numerous automatic control systems in and around the home.

Constructors are warned, however, that by the nature of this circuit, some false operation is inevitable. This is not of much consequence for the intended purpose but the device as it stands would not make a reliable basis for a burglar alarm.

## TOTALLY SAFE

The Autolight is entirely self-contained so may be carried anywhere and used wherever the need arises. Being battery-powered, it is entirely safe in operation and could even be used in a damp environment.

The lamp used in the prototype unit was a ready-made "cupboard light" with integral batteries. This needs a simple modification to make it suitable for use

with the Autolight circuit. A ready-made lamp gives a better appearance to the finished project than a home-made one (see photograph) and although not particularly bright, the light will be found adequate for the purpose.

A light sensor prevents the circuit from operating when there is sufficient light in the room already - either mains lighting or daylight. This is important to save the batteries from unnecessary drain. The sensitivity of the light-sensing section is adjustable and will be set at the end of construction.

The supply may be switched off completely so that no power is used - when the user is away from home, for example. However, it will normally be left on in standby mode - the current requirement being 200µA approximately which may be regarded as negligible.

The specified batteries operating the main unit should provide at least one year of service and the life of those in the lamp (two D-size cells), should be several months depending on how often the light is used and how long the operating time is set for.

## PIR DETECTOR

The circuit operates when a detector senses a moving source of *infra-red radiation*. Such radiation is emitted by a warm object such as a person - the same principle as used in many modern burglar alarms of the so-called *Passive Infra-Red* (PIR) type.

Infra-red is a type of *electromagnetic radiation* akin to visible light but of a longer wavelength. Whereas light has a wavelength of less than 1µm, infra-red covers the range from 1µm until it blends into the *radio waves* at around 1mm.

For readers who are unfamiliar with these units, one micron (1µm) is defined as one millionth of a metre - that is, one thousandth of a millimetre. The detector used in this project detects infra-red in the band 4µm to 20µm.

The detector itself uses a special pyroelectric detector element situated behind a plastic lens. The lens focuses the infra-red radiation on to the sensitive surface. This is built into a ready-made hermetically-sealed module which also contains some of the essential circuitry.

While nothing is being detected, the output from the detector remains substantially high with a few very short random low pulses. When an infra-red emitting object is detected, the output provides a regular chain of square-wave pulses each going low for some random time but typically around 10ms. It is this change which triggers the rest of the circuit.

## MOVING TARGET

The principle on which the detector is based is that of *multiple-zone detection*. Thus, triggering occurs only when the infra-red radiation passes from one detection zone to another fairly quickly. Steady sources such as light bulbs or the sun will therefore have no effect.

The detector used in this circuit has 20 detection zones each having an angular spacing of eight degrees (see Fig. 1). It thus covers an angle of some 160 degrees. Since it needs a movement of at least half a zone to activate the circuit, an angular movement of four degrees is required for triggering to occur.

At a distance of 3m (10ft. approx.) - a likely working distance - the target will need to move 20cm approximately to operate the unit. Note that the performance is most efficient when the detector directly faces the target and when the object moves *across* the detection field rather than backwards and forwards in line with the sensor.

The characteristics of the sensor are optimized for an object approximately the size of a person. A pet cat, for example, is less likely to operate it. The useful range is about 10m (33ft approx.). Although this is unlikely to be of value for the intended purpose, it may be appropriate for certain alternative applications.

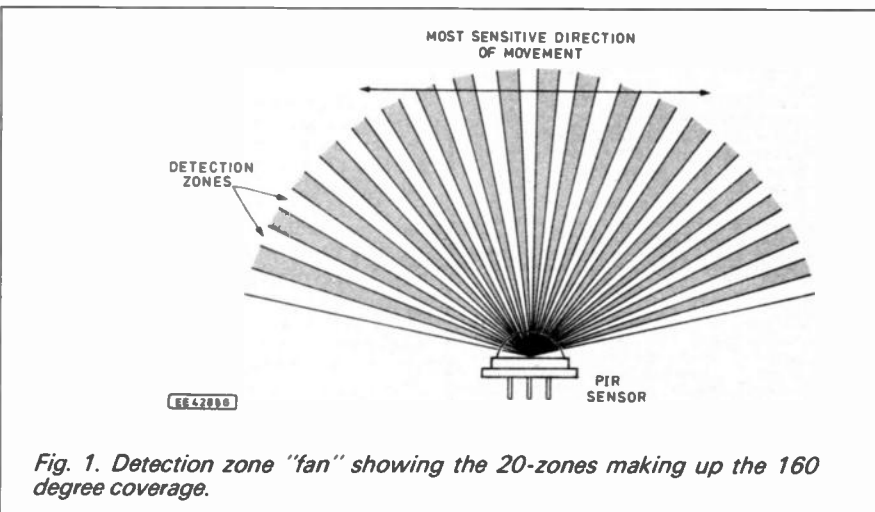

Fig. 1. Detection zone "fan" showing the 20-zones making up the 160 degree coverage.



Extra care will be needed when positioning the unit if a large pet is likely to enter the detection zone or where other warm objects pass nearby. Despite the operating characteristics mentioned above, small objects may still cause triggering depending on exactly how they move. Although of little significance, the incidence of false triggering may be greatly reduced by taking care over the final position of the unit.

## CIRCUIT DESCRIPTION

The complete circuit diagram for Autolight is shown in Fig. 2. The PIR sensor, PIR1, needs a stable supply and the only successful way of providing this is to use a separate dedicated battery pack. Attempts to use the same supply as the rest of the circuit tend to cause false triggering when the relay operates with a consequent voltage drop at the supply.

sufficiently high to be interpreted as *Logic 1* ("high") by IC2 trigger input, pin 2, to which it is connected and has no further effect.

## ON THE MOVE

When an object is detected, the regular chain of *low* pulses produced by PIR1 pin 3 allows capacitor C1 to discharge more deeply. The relatively low value of resistor R1 in comparison with R2 allows a fairly rapid discharge of C1. The voltage developed across it then falls to only a fraction of a volt. This is sufficiently low to be interpreted as *Logic 0* ("low") by IC2 pin 2 and so supplies a trigger pulse. It is a characteristic of this particular type of i.c. that triggering takes place on the arrival of a *low* pulse rather than a *high* one as may be expected.

A CMOS 555 timer, IC2, is used in this application and is configured as a *mono-*

*stable multivibrator*. Thus, providing it is enabled by making the reset input, pin 4, high (assume this is the case for the moment), on the arrival of the trigger pulse, the output, pin 3, will switch on (become *high*) for a certain time then revert to *low*.

The time during which the output remains high is related to the value of resistors R10 (ignore the wire link), R11 and capacitor, C4. With the appropriate choice of resistor, R10, this may take anything from only a few seconds to several minutes.

With IC2 output high, current enters transistor TR1 base through current-limiting resistor R12. Collector current then flows from the supply through relay RLA coil. The normally-open contacts (RLA1) of the relay then "make" and operate lamp LP1, from the independent 3V battery supply B1, housed within its case.

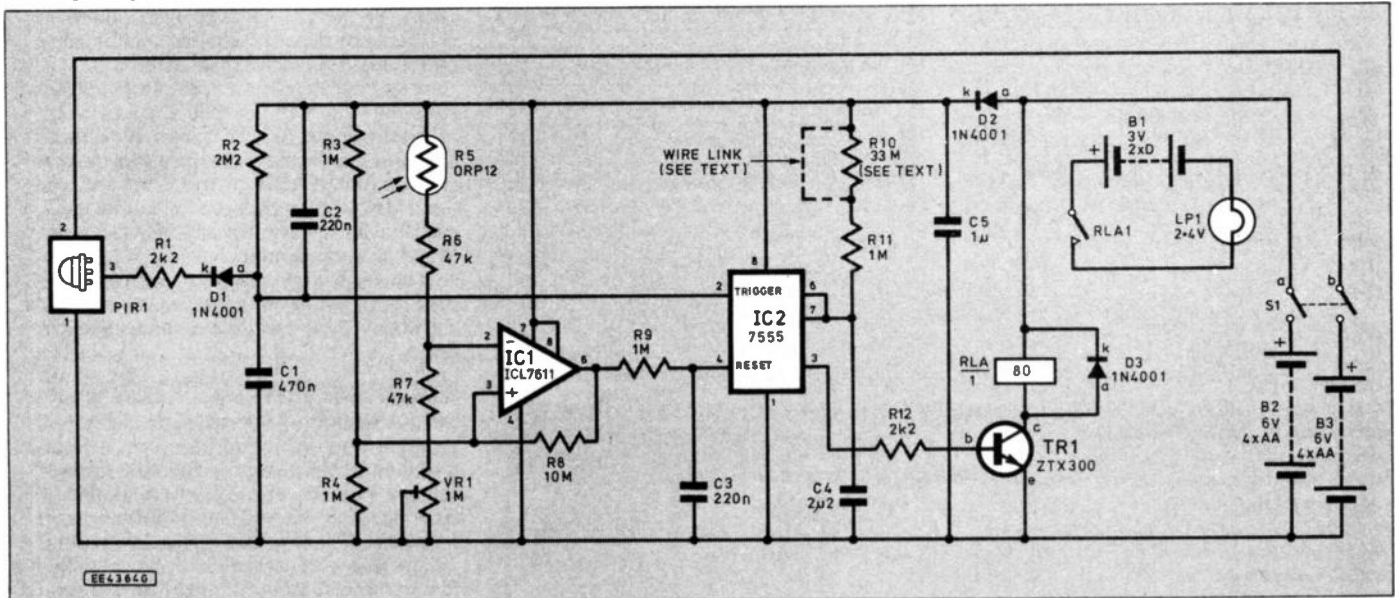

Fig. 2. Full circuit diagram for the Portable Autolight.

Two similar 6V battery packs, B2 and B3, are used. B2 is responsible for the control circuit while B3 is responsible for the PIR unit itself. Each battery pack consists of four AA-size cells in a suitable holder.

The current drawn from them is roughly balanced with each one providing around 100µA under quiescent conditions. Switch S1 is a double-pole on-off type, with pole S1a being responsible for B2 and pole S1b for B3.

Ignore the section of the circuit centred on IC1 for the moment – this is the light-sensing part and will be discussed presently. With switch S1 *on*, current flows from B2 through S1a and diode D2. This charges capacitor C1 through fixed resistor, R2, taking a few seconds to do so.

In the absence of sensor PIR1, the voltage across capacitor C1 would rise to that of the supply – nominally 6V. The connection of PIR1 to the system, however, modifies its behaviour. With the occasional *low* transition of the output, pin 3, C1 is allowed to discharge to some extent through diode D1 and fixed resistor R1 by allowing the PIR to *sink* current (that is, to allow current to *enter* it rather than flow from it).

Capacitor C1 has a large enough value to smooth out the individual variations and this results in a steady voltage of near 6V being developed across it under quiescent conditions – that is, while no infra-red is being detected. This voltage is

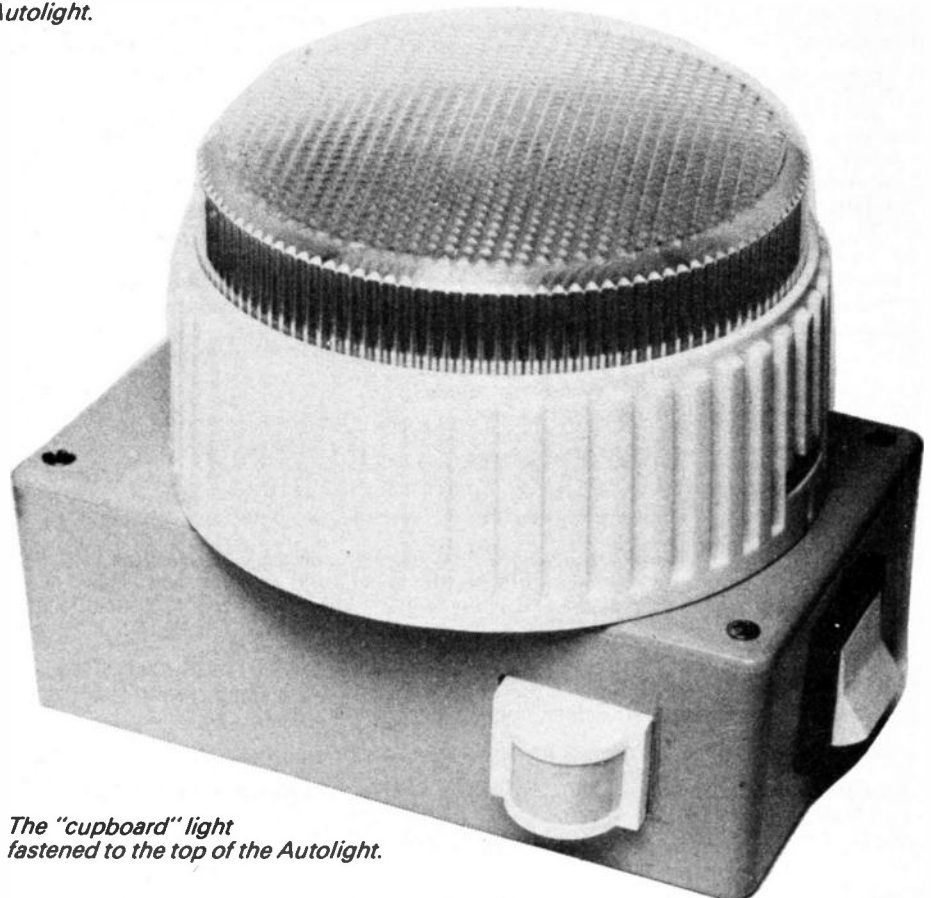

The "cupboard" light fastened to the top of the Autolight.

Diode D3 by-passes the reverse high-voltage "spike" which occurs when the magnetic field in the relay core collapses on switching off. Without this precaution, semiconductor components in the circuit could be destroyed.

Note that the relay coil is connected to supply positive *direct* – that is *before* diode D2. This avoids the forward voltage drop of D2 (0.7V approx.) in the coil feed and so maximizes the operating voltage. The nominal 6V relay will operate down to 4.8V so the battery pack will be adequate even allowing for the voltage appearing between TR1 collector and emitter (up to 1V approximately).

## INHIBITIONS

It is necessary to prevent the lamp from operating if the room is light already. This is the purpose of IC1 and associated components. IC1 is a micropower operational amplifier which is connected here as a *voltage comparator*.

If the non-inverting input voltage (pin 3) exceeds the inverting one (pin 2) the device will be *on* with the output (pin 6) *high* (positive supply voltage). In other situations, it remains *low*. While high, the output makes IC2 reset input (pin 4) high so enabling it.

Light-dependent resistor (l.d.r.) R5 is the light detector – its resistance falls with increasing light intensity reaching its sensitive surface. This component, in conjunction with fixed resistor R6 forms the upper limb of a potential divider.

The corresponding lower limb comprises

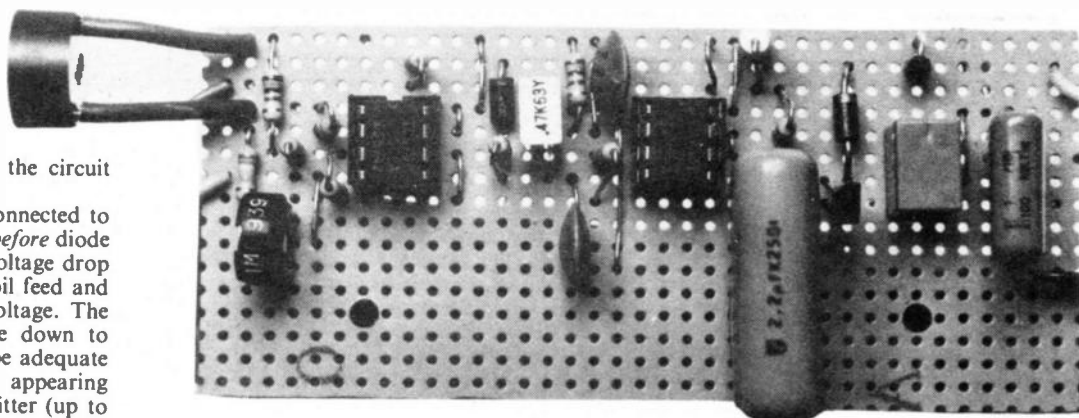

Layout of components on completed board.

fixed resistor R7 and preset potentiometer VR1, connected as a variable resistor. Thus, as the light falling on R5 becomes *brighter*, the voltage appearing across it *falls* and the voltage at IC1 pin 2 *rises*. Meanwhile, ignoring feedback resistor R8 for the moment, a fixed voltage of approximately one-half that of the supply exists at the non-inverting input, pin 3, due to the potential divider action of equal-value resistors R3 and R4.

While R5 is dark enough, the voltage at IC1 inverting input will be near-zero. The non-inverting input voltage will exceed this so IC1 will be *on* with its output *high* – the monostable section based on IC2 will therefore be enabled.

At a certain brightness level, the voltage at IC1 inverting input will rise above that at the non-inverting one. The output will

then switch off and so disable IC2. Detection of any infra-red by PIR1 will then have no effect in triggering the circuit. By appropriate adjustment to preset VR1, the switching voltage level corresponding to the amount of light required can be controlled and the operating point set.

Resistor R8 applies a little positive feedback between IC1 output and the non-inverting input – this gives a Schmitt trigger action and ensures that the output switches *sharply*. This is necessary because light levels often change slowly and may even reverse temporarily as when a shadow is cast over the sensor. Resistor R8 builds some backlash into the system so that, once off, the light level would need to fall significantly for the op.amp to switch on again.

## CONSTRUCTION

Construction of the Autolight project is based on a main circuit panel made from a piece of 0.1in. matrix stripboard size, 16 strips x 37 holes. Fig. 3 shows full topside component layout and details of the breaks required in the underside copper strips.

Commence construction by cutting the material to size and drilling the two mounting holes in the positions indicated. Make all track breaks and inter-strip links then add the soldered on-board components including the i.c. sockets and relay RLA.

Use the whole length of R5 end leads and sleeve them before soldering into position. Take care over the polarity of the three diodes.

## TIMING RESISTOR

The value of resistor R10 will be determined by the required operating time – 10 megohms for each 20 seconds approximately. Since "10 megs" is the highest easily obtainable value it may be necessary to connect several similar resistors in series to achieve the required result.

An alternative method is to use a so-called "high voltage" resistor obtainable from certain suppliers. These are made in very high values – 33 megohms was used in the prototype unit. This provides about one minute of operation.

The wire link made between matrix positions A22 and C22 provides a short-circuit for resistor R10 and so allows a timing of only a few seconds due to the effect of resistor R11 alone. This is useful for setting-up purposes. Afterwards the link wire is cut through to allow the full timing period.

## INTERWIRING

When the circuit panel is complete, adjust preset VR1 to approximately mid-track position and solder 20cm pieces of light-duty stranded connecting wire to

## COMPONENTS

### Resistors

R1, R12	2k2 (2 off)
R2	2M2
R3, R4, R9, R11	1M (4 off)
R5	ORP12 light-dependent resistor (photoconductive cell). Dark resistance 1M approximately.
R6, R7	47k (2 off)
R8	10M
R10	33M timing resistor – see text

All 0.25W 5% carbon, except R5 and possibly R10 (see text)

### Potentiometer

VR1	1M miniature vertical skeleton preset, lin.
-----	---

### Capacitors

C1	470n ceramic
C2, C3	220n ceramic (2 off)
C4	2μ2 polyester
C5	1μ ceramic

### Semiconductors

PIR1	Sub-miniature passive infra-red sensor, type FIRM-287 size 33mm x 24mm x 29mm
D1 to D3	1N4001 1A 50V rect. diode (3 off)
TR1	ZTX300 npn transistor
IC1	ICL7611 micropower op.amp
IC2	ICM7555 CMOS timer

### Miscellaneous

RLA1	Miniature relay with 6V 80 ohm coil and s.p.s.t. contacts rated at 1A minimum.
B1	Two D-size alkaline cells or as appropriate for cupboard light.
B2, B3	AA cell holder and 4 AA cells to fit (2 off). Connectors as required (2 off)
LP1	Cupboard light – see text
S1	Miniature d.p.s.t. rocker switch

Plastic box, size 150mm x 90mm x 53mm external; stripboard, size 16 strips x 37 holes; 8-pin d.i.l. socket (2 off); 3-pin s.i.l. socket (or 8-pin d.i.l. cut to size, see text); stranded connecting wire; circuit board fixings; nuts and bolts; solder etc.

See  
**SHOP  
TALK**  
Page

Approx cost  
guidance only

**£20**

excluding batteries and lamp

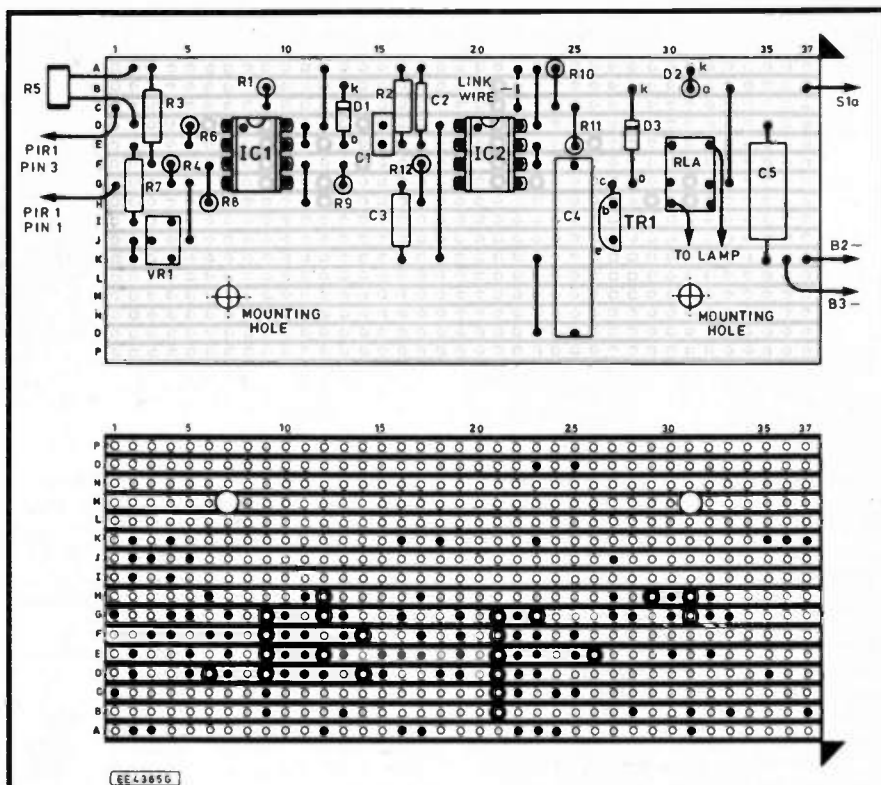

Fig. 3. Stripboard component layout and details of breaks required in the underside copper tracks. Note the leads to the relay contacts are soldered directly to the relay tags.

strips C and G on the left-hand side and to strip B on the right. Solder the negative wires for both battery connectors to strip K as shown. Solder similar pieces of wire direct to the relay normally-open (n.o.) contacts on the underside of the panel. Make sure these cannot touch any other connections.

Insert both i.c.s into their sockets taking care over the orientation. These are CMOS components and, in theory at least, vulnerable to damage by static charge which may exist on the body. It is a wise precaution to either avoid touching the pins when inserting them or to touch something which is earthed (such as a water tap) first. Bend the l.d.r. leads at right angles to the panel to the position indicated.

### BASIC TEST

It is convenient at this stage to perform a basic test on the circuit panel before proceeding further since any minor problems will be easier to solve. This test is made without the PIR sensor or its supply being connected.

Tape over the l.d.r. window with some opaque material to simulate operation under dark conditions and so enable the timing section. Insert the batteries, B2, into their holder. Connect the positive wire of the battery connector to the wire leading to strip B on the circuit panel.

Often the unit self-triggers when powered-up – listen for a click from the relay and a further click “off” a few seconds later. Touch the wire leading to strip C momentarily on to the wire leading to strip G (this simulates the action of the PIR unit) – the relay should click and after a short delay, click off again. If there is any problem with hearing the relay, make a simple battery and bulb circuit with the wires leading to the relay normally-open contacts.

### BOXING UP

If all is well, the box may be prepared to receive the circuit panel and other components and the light unit modified and fitted to the lid. Start with the box itself.

The hole for the PIR sensor is best made by carefully measuring its size and drawing the outline on the side of the case. Drill several holes on the inside of this line then join them together using a small hacksaw blade. Finish by smoothing off the work with a file. The hole should be made a tight push fit for the PIR unit. Make the hole for switch S1.

Hold the circuit panel in place and mark the position of the mounting holes. Mark also the position directly opposite the l.d.r. R5. Remove the circuit panel again and drill holes in the case to correspond with the markings. The hole through which light reaches the l.d.r. should not exceed 5mm diameter.

Referring to Fig. 4 complete the internal wiring shortening any wires as necessary. Mount the circuit panel using two small fixings and short plastic spacers. Bend the l.d.r. leads as necessary so that this component stands approximately 5mm behind the hole drilled for the light to pass to it.

Fig. 4. (bottom). Interwiring to off-board components.

(below) Circuit board mounted inside the case.

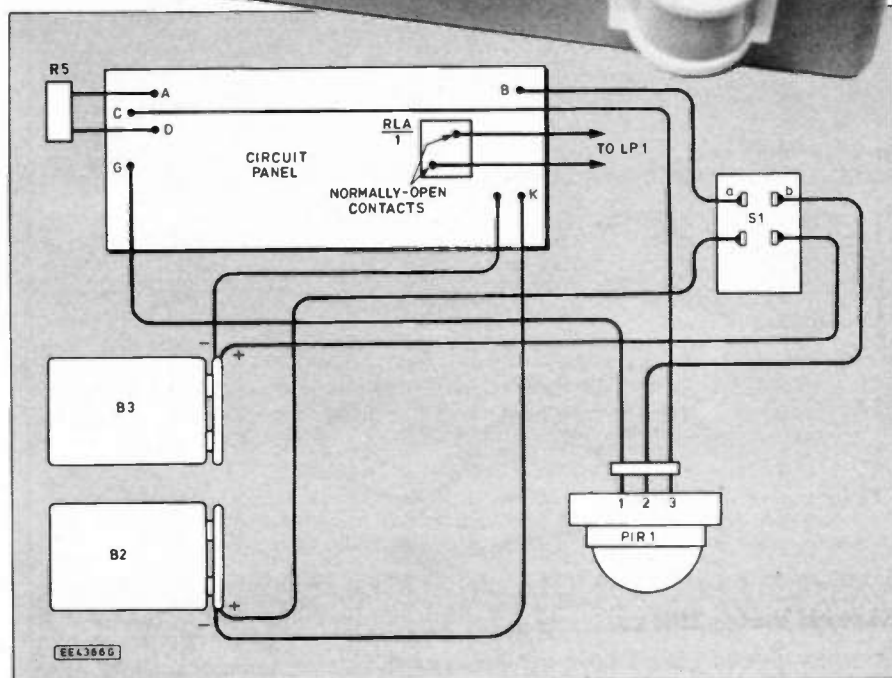
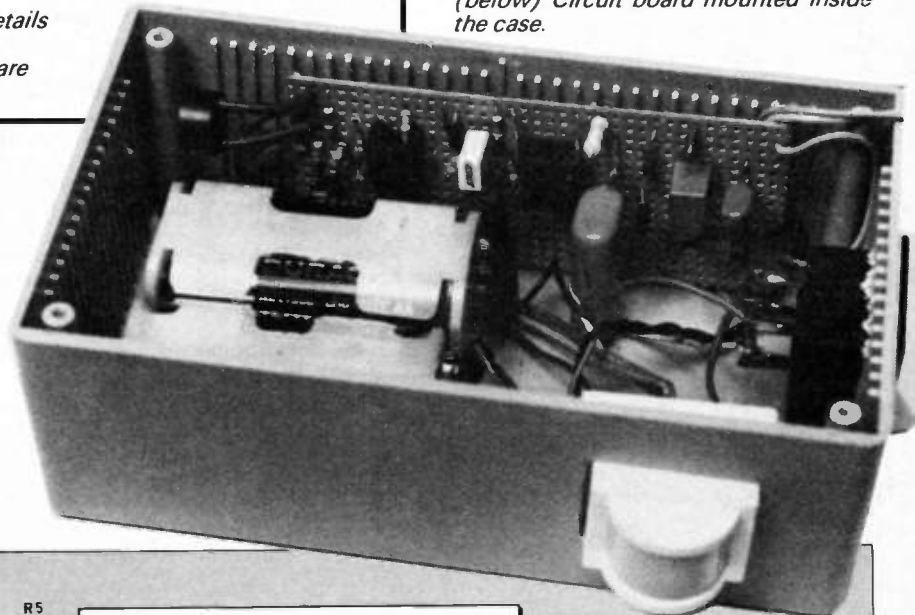



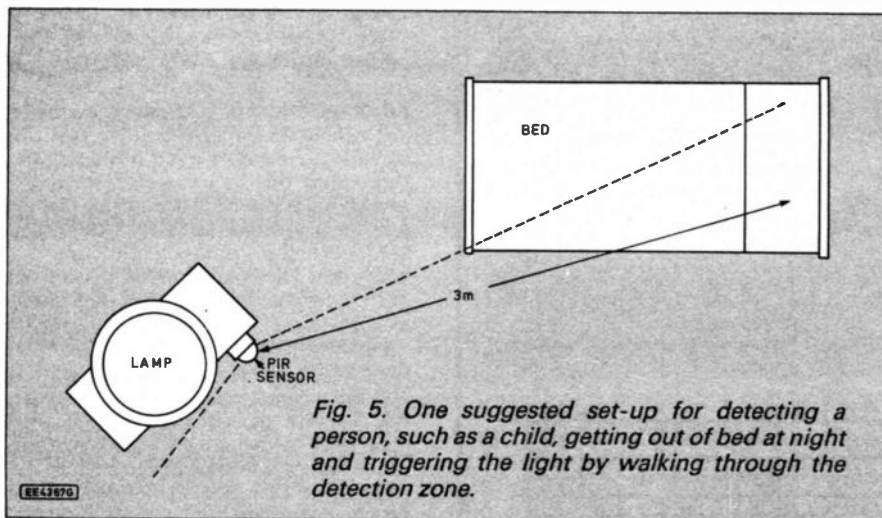

Fig. 5. One suggested set-up for detecting a person, such as a child, getting out of bed at night and triggering the light by walking through the detection zone.

## PIR CONNECTIONS

Do not be tempted to solder the connections on to the PIR tags direct. Excessive heat from the soldering iron could ruin internal components. Instead, use a 3-pin single in-line (s.i.l.) socket. If this is not available make one by cutting down an 8-pin d.i.l. socket.

Solder the connecting wires leading to strip G, S1b and strip C to tags 1, 2 and 3 respectively on the socket. Make certain that the numbering of the pins (as marked on the sensor plastic body) is correctly followed. There is no room for error here – incorrect polarity is likely to cause permanent damage. Push the socket gently into position on the sensor pins and press the unit into place.

## CUPBOARD LIGHT

Attention may now be given to modifying the cupboard light unit. Exactly how this is done will depend on the particular lamp being used.

The important point is that the existing

circuit wiring, between batteries and bulb should be broken at some point and the new ends "bridged" with the wires leading to the normally-open contacts of the relay. A convenient method is to remove the internal switch and solder the wires to each side of the gap so formed.

Drill a small hole in the lamp base and in the lid of the components case for the wires to pass through. Drill two further holes to mount the lamp on the lid.

The bulb fitted in the light unit will probably be a 2.5V 300mA type. It may be possible to upgrade it using a cycle light type 2.4V 500mA lamp. This was checked in the prototype unit but the additional light output was found to be hardly worthwhile especially since it puts an additional load on the batteries.

Note that it is correct for a 2.4V or 2.5V lamp to be used with the 3V nominal battery supply. This allows for the voltage drop which occurs when the cells deliver the rather high current required especially as they age somewhat.

Mount the lamp on the lid of the box. Note that, in service, no significant light

from the unit must enter the l.d.r. hole in the side. This is important – if it does, there will be triggering problems later. Also, direct light from the lamp should not reach the PIR sensor. Secure both battery holders to the base of the box – Velcro fixing pads would be a good method.

## FINAL TESTING

With construction complete, a final test should be made and the timing set. Leave the opaque tape over the l.d.r. for the moment.

Stand the unit on a horizontal surface, point the PIR unit away from any moving infra-red emitting source and switch on. The light may self-trigger and go off a few seconds later.

There may follow a period of instability and re-triggering for no apparent reason. This is due to the PIR unit stabilizing. Once it has done so, the light should remain off. When the sensor is subject to large environmental changes, it can take up to 30 minutes to stabilize. However, under normal household conditions it will be only a minute or so.

If a person now walks into the detection zone, the unit should trigger. Some thought should be given as to the best position for the unit and some tests made. Fig. 5 shows a successful arrangement tried with the prototype unit. When satisfied, remove the tape from the l.d.r. window.

With preset VRI adjusted as it is (mid-track position) and with a reasonable amount of light in the room, it should be found that the unit will not operate. The operating point may then be adjusted – clockwise rotation of VRI sliding contact (as viewed from the left-hand edge of the circuit panel) decreases the light level at which the circuit is inhibited. A form of course adjustment may also be made by moving the l.d.r. nearer or further from the light entry hole.

## CORRECT OPERATION

Correct operation is obtained when very little light reaches the l.d.r. For this reason, if the hole faces direct light such as a window, it may need to be covered over to some extent.

Operation cannot be checked with the lid of the case removed since the extra light reaching the l.d.r. would completely alter the triggering point. After any adjustment to VRI, the lid must therefore be replaced. Note that the presence of a warm hand making adjustments even from behind the PIR unit may cause a period of instability when the unit is tested.

If the light switches on and off rapidly, this is a sign that a small amount of light from the lamp is falling on the l.d.r. – possibly by reflection from a wall. This may usually be cured by re-positioning the unit or by making a cardboard shield. Do not point the sensor at a flickering flame such as an open fire or false triggering may result.

The best orientation for the PIR sensor will provide reliable triggering without excessive false operation. It is probably as well to leave the timing as it is until the unit has undergone a period of trial. After that, the link wire on the circuit board should be cut through and the ends bent apart. This will provide the correct timing as set previously. Autolight may then be put into permanent service. □

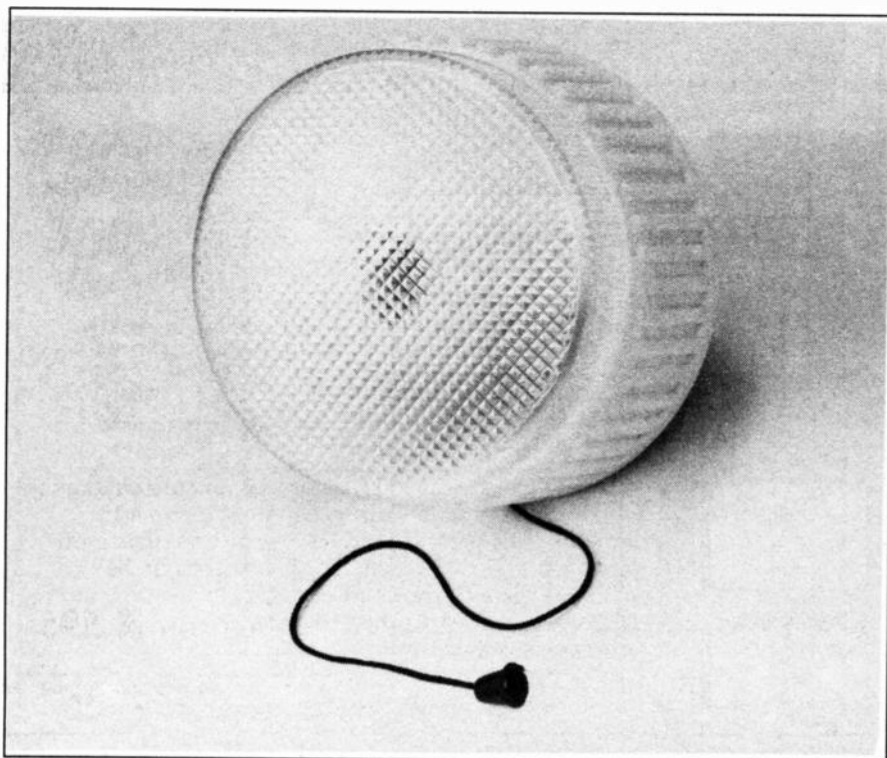

The recommended battery-operated wall light for use in cupboards, under stairs, cellars and lofts prior to modification for the Autolight.

# TESTING WITH YOUR COMPUTER

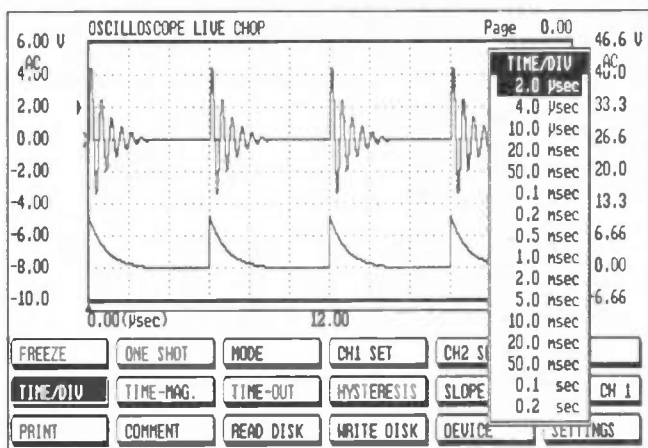

**TiePie engineering** manufactures a complete range of computer-controlled measuring instruments. Connecting these units to a PC (MS DOS 3.0 or higher) results in a number of comprehensive test instruments:

- oscilloscope;
- voltmeter;
- spectrum analyzer;
- frequency meter;
- transient recorder.

All measured data can be stored on disk or run off for documentation. Because of the many trigger possibilities, a variety of signals can be measured, while the powerful software enables a multitude of measurements to be carried out in a straightforward manner. Application areas include: service; medical research; automatic test systems; research and development; and education.

## LOW COST: HANDYPROBE

Connect the HANDYPROBE to the parallel printer port of the PC and start the software. Measuring can be carried out at once. The HANDYPROBE does not need an external power supply. Some technical parameters:

0.5-400 V software select input range; one input channel; 8 bits resolution (overall accuracy 2%); A complete software program consisting of a digital storage oscilloscope, spectrum analyzer, voltmeter and a transient recorder is provided. The HANDYPROBE is eminently suitable for servicing and educational purposes.



£ 99

## BEST PERFORMANCE: HANDYSCOPE

The HANDYSCOPE is connected to the parallel printer port. This makes it possible to carry out measurements with a laptop or notebook PC. Because of its high resolution (12 bits), the HANDYSCOPE is a very accurate instrument. The measuring rate is 100,000 samples/sec. Either of the two channels can be set independently over a range of 0.5-20 V (with a 1:10 probe up to 200 V). The advanced software enables many measurements to be carried out. Two probes (switchable 1:1-1:10) are provided. The HANDYSCOPE is constructed as a small table model with two BNC connectors.

The length of the cable linking the PC and the HANDYSCOPE is 1.8 m, which can be extended to 3.8 m.

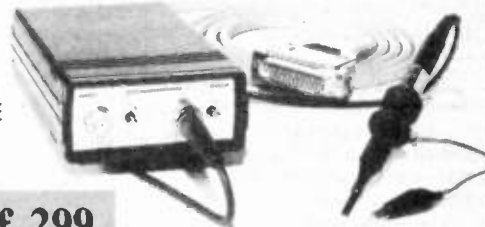

£ 299

## MULTIFUNCTIONAL: TP5008

The TP5008 is an interface card that provides an analogue output in addition to two input channels. This output in combination with the two inputs may be used for the setting up of a complete control loop. The output may also be used as a function generator. The TP5008 has a resolution of 8 bits and a sampling rate of 200,000 samples/sec (200 kHz). The input range may be set to 0.5-20 V full-scale deflection. The output range covers 1.25-2.5 V. The TP5008 is fitted with BNC connectors and is delivered complete with a user manual and software. Separately available are 1:1-1:10 probes and 1:100 oscilloscope probes.

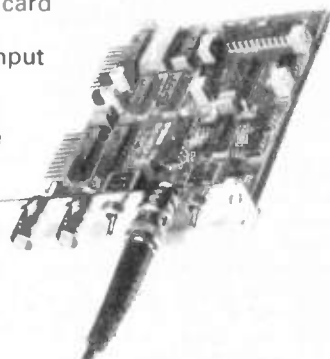

£ 197

## VERY HIGH SPEED: TP208

The TP208 is an interface card with a measuring speed of 2x20 Megasamples/sec (8 bits). Phenomena shorter than one millionth of a second can still be measured well. The completely digitized triggering ensures very stable triggering with many trigger possibilities. The TP208 has an input range of 5 mV/div to 20 V/div in 12 steps and an auto calibration function. Since both channels may be sampled simultaneously, phase differences can be measured very accurately. Even single phenomena can be measured since each channel has a 32 KByte memory. Comprehensive software is provided.

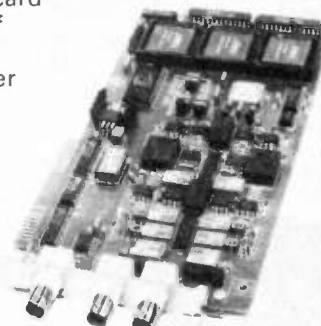

£ 595

(All prices are exclusive of VAT and P&P)

Interested? Then write or fax for a FREE demo diskette to

**INSTRUTEK (UK)**

28 Stephenson Road  
Industrial Estate  
St Ives, Cambs PE17 4WJ  
England

Telephone (0480) 460 028  
Fax (0480) 460 340

## NEW CONCEPT OF 'VIRTUAL REALITY'

British Industry Gives a Lead to Europe – by Hazel Cavendish

ONE can be forgiven for posing the question: Just what IS Virtual Reality and Telepresence?

Although certain parts of British industry are becoming increasingly aware of the value of this new scientific approach as a means of visualising data and applications, the general public is still in a mist of confusion. The man in the street is likely to link the technology with arcade and TV games – particularly if he has teenage children – and wonders how this can be usefully employed in the hard world of commerce. In fact this new scientific development has come a long way from amusement arcades in five years, and offers great earning potential to British industry. Meanwhile Western Europe is more than a little interested.

The Virtual Reality and Telepresence was set up in the U.K. in 1988 by the Advanced Robotics Research Centre in Salford near Manchester. Since then their experimental testbed – the most advanced of its kind in Europe – has been used to evaluate the interaction between operators and semi-autonomous robots. Equipped with head-mounted or area projection stereoscopic displays and intuitive input devices such as gloves, 3D "mice", speech recognition and synthesis, operators are tested controlling either a robot vehicle or an enhanced Puma Robot Arm. "Virtual" models of architectural and hazardous environments are constructed using a range of VR toolkits, although ARRC was the first to demonstrate

### BUZZ WORDS

**Teleoperation** is the extension of a person's sensing and manipulation capability to a remote location; a teleoperator uses all the aids to communicate through channels to the human operator.

**Telepresence** is the ideal of sensing sufficient information about the teleoperator and task environment to communicate this to the human operator in a sufficiently natural way so that the latter feels physically present at a remote site.

**Robotics** is the science and art of performing functions normally ascribed to human beings through an automatic apparatus or device, which assumes almost human intelligence.

**Telerobotics** is a form of teleoperation in which a human operator acts as a supervisor, intermittently communicating to a computer information about goals, constraints, plans, contingencies, assumptions, suggestions and orders relative to a limited task, receiving in return information about accomplishments, difficulties and sensory data, while the subordinate telerobot executes the task based on information received from the human operator plus its own artificial sensing and intelligence. [One may be permitted to wonder: with such powers, will the robot learn to argue with its boss?]

**Nanopresence.** The concept of telepresence can be readily extended to providing the human with an experience of presence in 3D worlds which are invisible to the naked eye. The implications of using *Nanopresence* for non-destructive testing and inspection of materials in the offshore, aerospace and medical industry are enormous, as is its use in assisting people in the assembly of future micro-devices, such as motors, pumps and actuators. 1994 is likely to see interesting developments in this sphere.

the feasibility of converting objects and surfaces into 3D images by using a scanning laser range-finder system, so that they could be viewed on a stereo headset.

In order to understand this fascinating new development it is necessary to know some of the buzz-words connected with it, otherwise one flounders in a sea of jargon (see the list above).

In the mid-80s only a few European researchers were aware of the significant developments in telepresence for robotic space application that were occurring in human factors laboratories of

NASA's Ames Research Centre at Moffat Field, California. Advanced Robotics Research Ltd based on the campus of Salford University near Manchester was the first European establishment to exploit the new technology as a means of achieving telepresence, under the British Government's "Advanced Robotics Initiative", backed by investment from a group of industrial companies including British Nuclear Fuels, Hunting Engineering and the National Nuclear Corporation.

### VIRTUAL WORLDS

Led since 1989 by Bob Stone, Technical Manager and visiting Professor of Virtual Reality at the University of Salford, the company is definitely going places. The building of virtual worlds using sensory data is a key element in their research. A prime requirement for the sensory system is that it can produce enough 3D information to build a useful representation of the environment in which it operates. Work at ARRL has focussed on an approach which uses an infra-red scanning laser rangefinder. Such a system is capable of producing extremely dense range information.

It was soon realised that if virtual technologies were to become accepted throughout industry as a standard for future human-system interfaces, they must support, in a

cost-effective manner, the involvement of a team of users – not just a single operator equipped with a headset and gloves. A prime example of the need to involve a team of users was found in the nuclear and offshore industries, where many specialists need to rehearse the decommissioning of radioactive facilities or platform structures. To achieve this ARRL established a remote Studio where stereoscopic images from the Company's VR computer were relayed for 3D display on a special silvered screen, using a pair of liquid crystal video projectors with polarising filters. Team observers experienced a full image by wearing polarised filter spectacles, complimentary to those used on the projectors.

### MICROSCOPIC WORLDS

The concept of telepresence was not to be restricted to hazardous environments originally designed for intervention by humans but had to be extended to providing the human with an experience of presence in 3D worlds invisible to the human eye. Successful developments in the new and exciting field of nano and micro-technology could well depend on providing researchers with the means of visualising materials at, for example, an atomic level.

In pursuit of this aim Salford University and the Company demonstrated that VR could be used to visualise new surface features previously undetectable when using conventional display techniques. VR was used to allow virtual "flight" over materials at the right level. To do this, a device known as a scanning tunnelling microscope – one of the University's key development facilities – was used.

Selling the vision and technical potential of VR to a sceptical and money-conscious market proved a highly challenging and sometimes frustrating exercise, says Professor Stone. There had been so much "hype" about it that many potential industrial users declared they would never contemplate procuring a "child's game" for serious commercial application.

The first important breakthrough came when Rolls-Royce approached the Company to investigate using VR as a means of

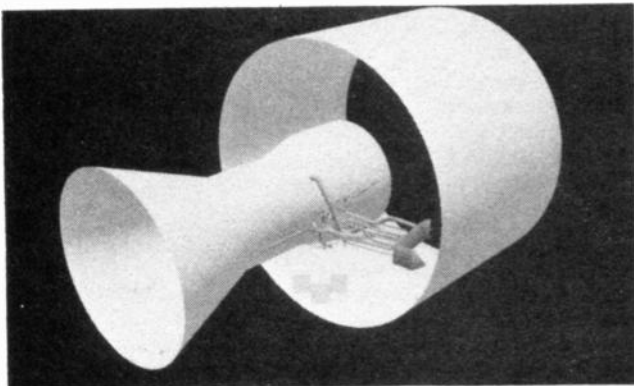

Rolls Royce Trent aero engine model as displayed on a high-resolution screen, hosted on a Silicon Graphic Onyx Graphics 'Supercomputer'. The model shows the fan casing and part of the lower bifurcation assembly.



radically changing its design and maintenance procedures. After a feasibility study VR was used to simulate the Trent 800 aero-engine, currently being developed for the new breed of twin-engine airliner such as the Boeing 777. (The engine had its running tests last month). A fitter wearing a VR headset and gloves was able to interact with the virtual representation in much the same way as he would have done with a physical model. The pipework assembly was found to generate excellent stereoscopic images, and additional routines were written in to colour-code individual pipe routes selectively and to segment pipes into groups of objects, allowing detail switching and their removal and manipulation by engineers.

The feasibility study culminated in a demonstration of the virtual Trent engine to senior Rolls-Royce personnel, using both immersion and stereoscopic projection displays. Later the Rolls company was to become one of the founder members of ARRL's Virtual Reality and Simulation Initiative in May this year, entirely funded by the industrial sector, to inform and assist industry in introducing VR technology into their businesses. Thirteen British companies have now joined the initiative, which is steadily gaining members.

### VR ACTIVITY

As early as 1991 there were four main centres of VR activity in Britain: W Industries of Leicester,

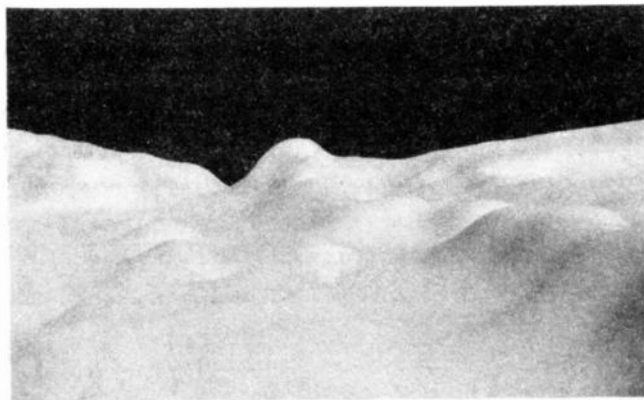

Virtual Environment fly-through of a sample of platinum measuring 14,500 Ångströms square. This model was reconstructed using real data obtained using Salford University's Scanning Tunnelling Microscope and revealed such features as stylus impact damage, diamond polishing irregularities and surface characteristics when bombarded with helium ions.

British Aerospace in North Humber-side, Dimension International of Aldermaston and Division Limited of Bristol.

W Industries developed a range of "Virtuality" products primarily for the leisure and entertainment market, expending considerable sums in packaging and marketing the technology to secure a lucrative early market in excess of £11 million. Since then it has sought to open out its product range to more serious applications such as engineering design. In Humber-side British Aerospace's Brough Division spearheaded UK efforts in advanced fighter aircraft cockpit design, using VR technology. This advance was

led by Professor Roy Kalawsky, Britain's first Professor of VR, who holds a visiting chair at Hull University.

Dimension International pioneered the concept of "Desktop" VR in the South of England, and worked with the TV Company Broadsword on *Cyberzone* - claimed to be the world's first VR TV Game Show. In Bristol, Division Limited pioneered the use of transputer technology in their development of the Vision, ProVision and Supervision Systems - modular and high speed graphics engines which avoid the processing bottlenecks associated with previous approaches to generating.

More recently Nottingham University's VR Application Research Team has been working closely with the nearby Shepherd School to introduce Desktop VR technology into the educational lives of children with learning difficulties and severe physical handicaps.

A very important contract, still shrouded in secrecy, was the first one to be industrially-funded in Britain and related to the development of a virtual model of the Deep waste Repository currently being considered for the safe and cost-effective disposal underground of low and intermediate level radioactive wastes at Sellafield.

### UNSUNG HEROS

Professor Stone pays tribute to many "unsung" heroes and inventors engaged in developing systems which are likely to find their way into VR in the not-so-distant future. Willie Johnson's "Goggle Vox" (described in *Everyday with Practical Electronics* last January) is cited as a breakthrough in head-mounted displays brought about by the diffusion film *Microsharp* developed by Johnson and his team at Loughborough University, and currently the subject of a patent application.

Stone regrets the necessity for Johnson and many others to seek development funding in countries other than Britain. "One can only guess at how often this state of affairs actually results in the UK and other European countries losing valuable inventions and personalities" he says.

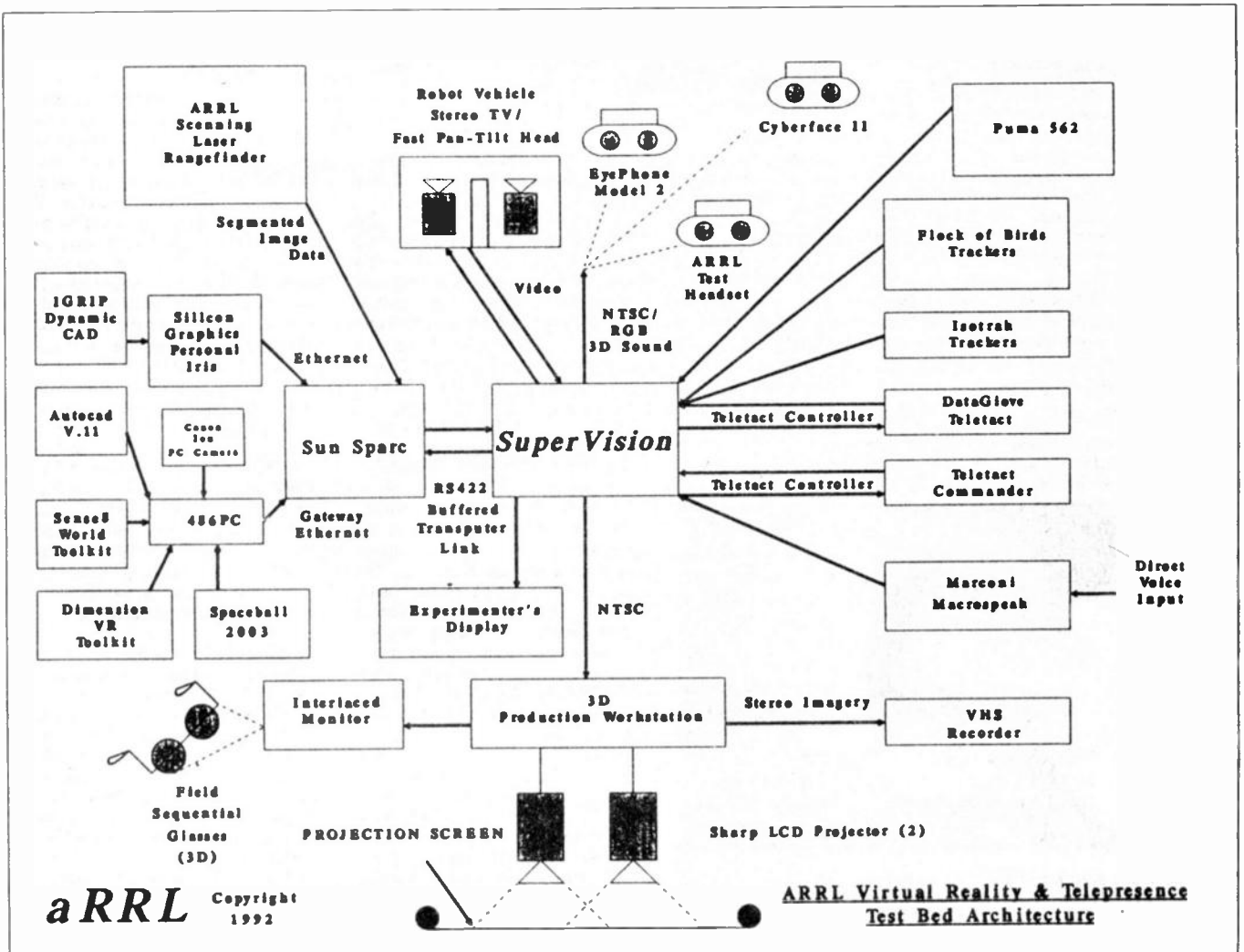

# New Technology Update

Ian Poole investigates battery management i.c.s.

**B**ATTERY management is becoming increasingly important. In the August 1993 issue of *Everyday with Practical Electronics* a look was taken at the new Nickel Metal Hydride (NMH) cells which are beginning to appear on the market in various pieces of equipment. However the major drawback with these cells is that they must not be overcharged otherwise their performance will be greatly impaired. This is true not only of NMH cells but also of the more familiar NiCads which are in widespread use. These cells rarely live up to their expected life chiefly because they are rarely charged properly.

In addition to this fast charge facilities are being increasingly required. In many professional applications it is not possible to wait 12 hours or more for the battery to be recharged. However fast charging needs to be very carefully monitored. Even a few minutes of overcharge can have a disastrous effect, even if the cells are designed for fast charging.

## Battery Monitoring I.C.s

To overcome these problems a number of battery management i.c.s are appearing on the market. Using these i.c.s it is possible to manage fast charging of NiCad and NMH cells in as little as 15 minutes. This can be done whilst still being able to monitor the state of charge, ensuring that the correct charging conditions are met so that battery life is not impaired.

The major problem encountered in battery management is that both NiCad and NMH cells give little information to the outside world about their state of charge. Matters are further complicated by the fact that any indicators are often several stages removed from the original property which needs to be monitored. Furthermore the these indicators are often the result of the interaction of several properties within the battery.

Despite all of these problems battery management i.c. designers have homed in on three main properties which are able to give the vital information about the battery state. The voltage is probably the most obvious one. It can be seen that when a cell is fully charged its voltage peaks as shown in Fig. 1. Also when the cell is nearly discharged the voltage falls away rapidly. This information combined with the charge/discharge current and the cell temperature are all that is needed directly from the cell.

A forth and final item is the time for which the various activities have been taking place. By using a knowledge of the time it is possible for the management i.c. to build up an almost exact picture of the

state of the cell. From this it is then possible to control the charge and discharge of the battery.

## NiCad and NMH

Although NiCad and NMH cells exhibit slightly different characteristics they are sufficiently similar that the same techniques can be used. In fact many i.c.s can be used for both types.

Obviously there are some differences which need to be taken into account. In the first case NMH cells have a less pronounced rise in output voltage when the cell is fully charged. As NMH cells are less tolerant to overcharge than their NiCad counterparts this is very important.

Fast charging is also different. This is mainly because of the low tolerance of the NMH cell to overcharge. Normally the maximum rate for NMH cells is limited to only 1.3C whereas NiCads can often be charged at a rate of as much as 4C and sometimes more. (To charge a cell or battery at 1C, a 700mA hour cell would be charged at 700mA).

## Types of I.C.

There are two main types of battery management i.c. The first is the monitor and the second is the charge controller. Often the two types are available as separate items. However, as they are generally used together they are also available in combined packages.

The controllers contain an internal register. This contains the chip's representation of the state of charge of the battery. To update the i.c. all the relevant information is fed into it. By combining this information with a timer on the chip it is then possible to calculate the amount of charge in the battery. However to be able to achieve this the controller must remain connected to the battery all the time and as a result, these chips are usually an integral part of the battery pack.

When it comes to charging, great care has to be taken to ensure that the batteries cannot become overcharged. To avoid this most charger i.c.s use more than just one indication to signal the right time to stop charging. This has to be done because the i.c.s will have to be used for batteries of all makes. Although they will all perform in basically the same way there will naturally be some variations between manufacturers and even between different batteries made by the same company.

## Full Charge

One of the major triggers used to signify full charge is the fall in output voltage. For fast charge rates the controller i.c. will sample the voltage every few seconds to monitor whether voltage is falling. For lower rates it will be every few minutes. When a distinct fall in voltage is measured over successive samples the charging will cease.

The other indicator of full charge is the battery temperature. In many ways this is better because it is more closely linked to the state of charge than the voltage. Once the battery is charged its temperature will start to rise steadily. It is then fairly easy to detect this change. However changing room temperature can cause this method to fail, and therefore it is best used in conjunction with the voltage detection method as a fail safe.

One additional feature which these controllers include is an automatic switch to a trickle charge once the main charging is complete. For NiCad cells a rate of C/10 is quite acceptable. However NMH cells are far less tolerant of trickle charging and a lower rate must be employed. This trickle charge will equate to the self discharge rate of the battery.

## The Future

As battery management technology becomes more established costs will fall and it is likely that most new battery packs will include management chips. Unfortunately this will mean that the battery management circuitry is most likely to have to be discarded with the rest of the battery when it reaches the end of its life. However when its cost is balanced against the initial cost of the battery and the increased life there will still be a significant saving. There will also be the added advantage that batteries can be made even more reliable than they are today.

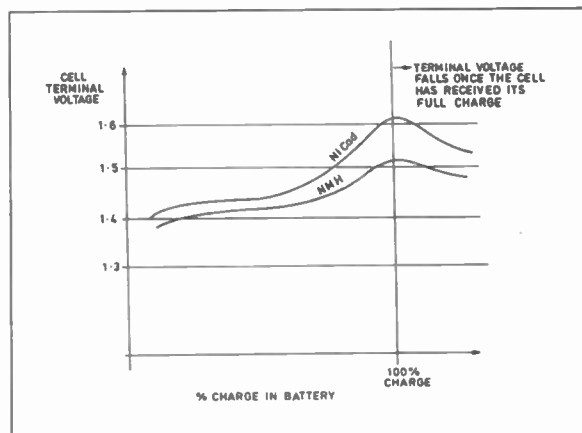
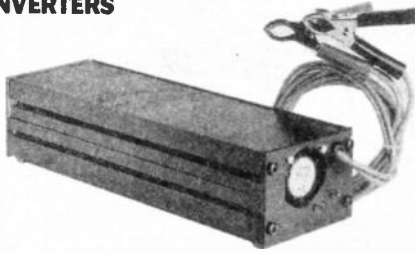

Fig. 1. Charge characteristics of NiCad and NMH cells.

# VELLEMAN KITS

## 250W 12V DC and 24V DC TO 230Vac INVERTERS



- LIGHTWEIGHT, PORTABLE DESIGN
- AUTOMATIC SHUTDOWN
- SHORT CIRCUIT AND OVERLOAD PROTECTION

Two very useful compact 12V and 24V car battery to mains inverters. The inverters are lightweight (1.4kg), making it easier to travel with, have a continuous power of 250W (500W peak output), and crystal controlled 50Hz modified sine wave output frequency. Additional features include automatic shut-off, if battery is too weak, short circuit and overload protection, and protection against inversion of battery polarity. 100Vac 60Hz output at 150W is also achievable with modification. Supplied with a pair of heavy-duty croc-clips, cable 30A fuse, and black anodised aluminium housing.

**£109.50**  
K3507(12V)

**£109.50**  
K3509(24V)

## 3 CHANNEL SOUND TO LIGHT

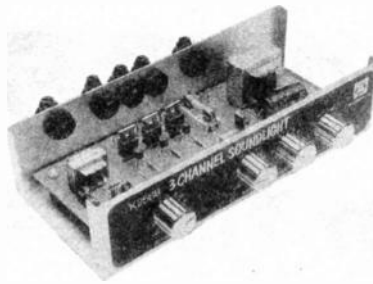

A complete three channel sound to light unit to enable entertaining colours to be added to your music. Three outputs, high, middle and low tones have separate sensitivity adjustment making the unit compatible with either amplifiers or tape/cassette decks etc. Complete with housing, components, PCBs, knobs and transformers. NB not suitable for halogen lights.

**£34.98**  
K2588

## STROBOSCOPE

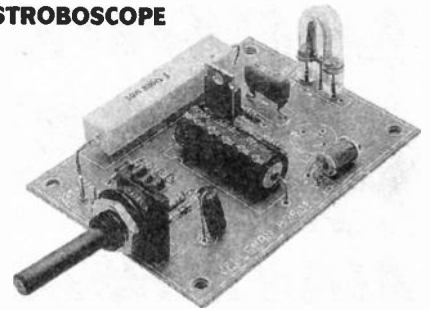

- SUITABLE FOR DISCO LIGHTING, FILM EFFECTS AND EXPERIMENTS

Stroboscope flashing light effect. Suitable for many applications, for example disco lighting, photography, lightning effects for films, making moving objects appear to be stationary. Supplied with a high quality PCB, all components and full instructions.

**£13.25**  
K2601

## 400W MONO/STEREO AMPLIFIER

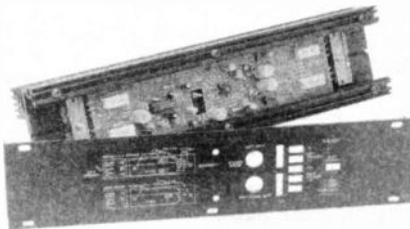

- UNIVERSAL, SOLID AND COMPACT
- OVERLOAD AND SHORT CIRCUIT PROTECTED
- IDEAL FOR USE IN THE CAR WITH THE IN-CAR AMPLIFIER POWER SUPPLY (K3508)

A universal, solid and compact 400w Mono/Stereo amplifier offering stereo amplification of 2 x 100W into 4 ohms, 2 x 75W into 8 ohms and 200W into 8 ohms Bridged-Mono. The amplifier is overload and short-circuit protected with thermal and speaker pop switch On/Off suppression. It may be used as a built-in module or free-standing in an enclosure. Complete with heatsink housing, self-adhesive printed panel, components, PCB and full instructions.

**£59.80**  
K4005

## IN CAR AMPLIFIER POWER SUPPLY

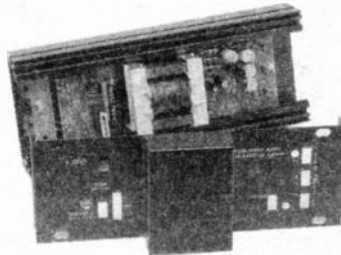

A power supply that allows conventional amplifiers or amplification modules to be used in the car, such as the K4005 400W mono/stereo amplifier. The advantage of a separate supply module is that the high current connecting wires to the battery can be kept short, thus reducing power loss and the amplifier can be placed close to the loudspeakers to maintain optimum damping for excellent bass-frequencies. To avoid interference the 0V output has been separated from the cars chassis. The PSU is supplied with casing.

**£65.90**  
K3508

## MORSE DECODER WITH LC-DISPLAY

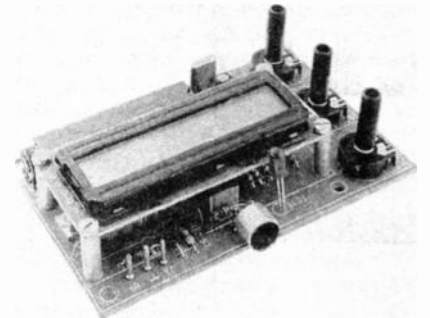

Everybody who owns a shortwave receiver may already have tried to decode those mysterious morse messages. Unfortunately, intensive training is required to follow experienced signallers or automatic stations. This decoder easily keeps up with the quickest of signallers, and neatly notes everything on the LCD.

**£58.75**  
K2659

## VELLEMAN CATALOGUE



**FREE!**

Just send an A5 stamped addressed envelope.

Prices included VAT (at 17.5%).  
Postage and packing £1.40 per order.

The 224 page Cirkuit Electronic Constructors Catalogue has complete details of all the above kits plus many more, together with components, books and test equipment. Send for your copy today!  
£1.90 (+30p p&p)

**Cirkit**

Cirkit Distribution Ltd

Park Lane • Broxbourne • Herts • EN10 7NQ

Telephone: Sales (0992) 444111 • Enquiries (0992) 441306 • Fax (0992) 464457





# CIRCUIT SURGERY

ALAN WINSTANLEY

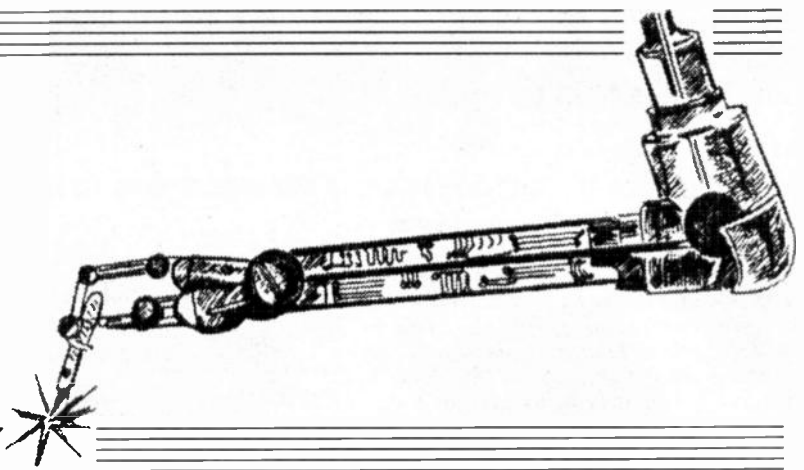

Welcome to our monthly forum to discuss readers' requests and to help out with puzzling projects. Circuit Surgery is here to try and lend a hand with general electronic topics, so if you think you have a query which might be of interest to others, then write in! We're also keen to pass on any useful hints or tips, so drop me a line if you have any suggestions to share with your fellow readers.

This month, I start with a topic which follows on from our very successful educational series *Teach-In '93* (published Nov '92 to Oct '93) which was specially designed to support students of GCSE and GCE "A" Level Electronics. Then we investigate a voltage detection chip – the ICL8211 – which is useful as an over or under-voltage alarm or monitor. First, a question from a *Teach-In '93* follower, A.J. Granger of Brighton:

## Teach-In: Zener Diodes

"I haven't worked with Zener diodes before and wondered if you could clarify how you calculate the value of a series resistor and also the current and power ratings of the components. Please can you explain?"

I'll try! Mr. Granger was referring to our explanation of Zener diodes given in *Teach-In '93* (Part 3). One or two other letters also asked for further clarification, so here goes. The Zener diode is a component which is capable of providing a reasonably stable voltage even if the voltage supplied to it, varies. Basically, if you supply it with a higher (steady or varying) voltage, a stable lower voltage appears across it! You can use this steady voltage for several purposes: as part of a power supply (called a "stabilised" or "regulated" supply) or as a "reference" voltage for other circuitry perhaps.

A series limiting resistor is needed with the Zener diode. Take a look at Fig. 1

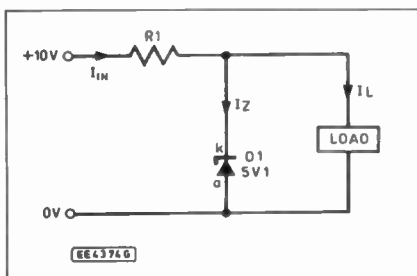

Fig. 1. Simple Zener diode application.

which depicts a 10V d.c. voltage connected to a resistor R1 and a Zener diode D1. Note how the Zener diode is "reverse biased" to produce a steady voltage, the value of which depends on which Zener diode you pick. They have a tolerance on their values, too, typically  $\pm 5\%$ .

The Zener diode we chose was a 5.1V type (e.g. a BZY88C5V1 which is rated at 500mW maximum power dissipation) – which means that it will produce a 5.1V reference voltage under suitable conditions. A load is shown which could perhaps be a 5V logic circuit.

The resistor R1 limits the total current flowing, in order to prevent destruction of the Zener. The current  $I_N$  which flows through the resistor, then splits into two paths.  $I_Z$  is the current flowing through the Zener diode, and  $I_L$  is the current flowing into the load. It follows that  $I_N = I_Z + I_L$ . Let's assume that the load draws a constant 25mA i.e.  $I_L = 0.025A$ .

Before calculating the required series resistor, we need to bear in mind that a nominal current needs to flow through the Zener too. We can decide this figure ourselves and we have to pick a reasonably small value for  $I_Z$  to ensure that the Zener's power rating is not exceeded. Let's say that  $I_Z = 5mA$ . So with 5.1V appearing across the Zener and 5mA flowing through it, the power dissipated by the Zener diode is ( $P = I \times V$ ) 0.0255 Watts or 25mW, well within its 500mW rating.

By Ohm's Law, the resistor value is then equivalent to the required voltage drop across it (which is  $10V - 5.1V = 4.9V$ ) divided by the total current  $I_N$  flowing through it – which is  $5mA + 25mA = 30mA$ . So in this simple circuit you could use a series resistor of 163 ohms ( $4.9/0.03$ ), if one existed. You would use the nearest preferred value down instead, say 150 ohms.

Now double check. Using a 150 ohm resistor means that more current than we originally intended will flow through the

resistor, although the voltage across the resistor won't change because the Zener maintains a steady 5.1V. How much current flows through R1?

Again, from Ohm's Law, the current will be  $I = V/R$  so  $I_N = 4.9V/150$  which gives us a current of 32mA. Because the load still faithfully draws 25mA, the rest of the current flowing will be consumed by the Zener, which draws 7mA (instead of the 5mA we intended) and therefore will dissipate about 36mW ( $5.1V \times 7mA$ ). Still very safe.

The power dissipated by the resistor could be worked out using either of two formulae:  $P = I \times V$  or  $P = I^2 R$ . It's roughly 160mW so a 250mW ( $\frac{1}{4}W$ ) type is fine. By reducing the resistance even more, the Zener current will increase accordingly. The maximum current which we may allow the Zener to draw is determined by its power rating. A 5.1V 500mW Zener diode may pass no more than 98mA maximum ( $I = P/V$ ).

## Surprise Supplies

Suppose the supply rises to 25V. The current flowing through the resistor will now be  $(19.9V/150 \text{ ohms}) = 133mA$ . R1 will dissipate 2.6 Watts and will soon bite the dust. The Zener will dissipate 550mW so is now over-rated too. Yikes!

The picture's more complicated when the supply voltage and/or the load current varies. Designers have to take into account "worst case conditions" when specifying the components. The resistor's power rating is peak when the supply voltage is at its maximum – but choose a resistor value low enough for the required peak load current to flow when the supply's at its minimum voltage.

The Zener's power figure is peak when the supply rail is maximum voltage and the load is at minimum current. For instance, take a 5V Zener, and if the supply varies between 10 to 15V, the load varies between 20mA and 100mA. Assuming a nominal Zener current of 5mA, I reckoned that the resistor would need to be 47 ohms 2.2 Watts and the Zener

would need to be rated at 0.96 Watts minimum to cope with the varying load and supply. See if you agree!

## Low Voltage Monitor

Talking of voltage references, *Clifford Beck* of Co. Offaly, Ireland, wrote:

"I have an experimental rechargeable lighting circuit which is charged by a wind charger, and I run a few lights from it. Could you design a circuit to switch the lights off when the battery drops below 11.5V, so when the battery is fully charged the lights can come on again? I was thinking of using the 8211 integrated circuit."

Thanks for the suggestion, Mr. Beck. Presumably the idea is to prevent the lighting from flattening the battery until it has recharged again. It occurred to me that this might also appeal to caravaners, boating enthusiasts or campers, and the device concerned – the 8211 programmable voltage detector – is a really easy i.c. to use and is a neat way of monitoring the supply voltage level, or any other d.c. level for that matter.

There are actually two 8-pin d.i.l. devices available – the ICL8211 and the ICL8212. I'll describe both. They are almost identical except that the 8212 functions in the opposite manner to the 8211. Firstly Fig. 2 shows a basic under-voltage alarm using the ICL8211. The chip monitors the supply by comparing

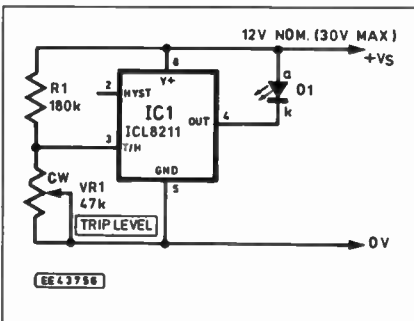

Fig. 2. Low voltage alarm.

it against an accurate internal 1.15V reference or "threshold". With the 8211, when the voltage at pin 3 is less than the 1.15V reference, the output (pin 4) goes low and sinks typically 7mA in this state – it's current limited by the i.c. so I added an l.e.d. D1 as shown, with no series resistor being necessary.

Hence, when pin 3 is less than 1.15V, the l.e.d. lights. A potential divider is needed (R1 and VR1) and is calculated so that the voltage at pin 3 will fall below 1.15V when the supply voltage itself drops to the required level. In our case, the rail is assumed to be 12V d.c. or more but an alarm/cut out is required when it falls to 11.5V or so, the exact alarm point being set by VR1.

The i.c. only consumes 20µA typically and the potential divider resistance can be set for 50µA current flowing through it, or even less, hence the circuit itself has negligible loading on the supply rail. The supply voltage can be up to 30V absolute maximum.

## Sister Chips

The complementary ICL8212 device has two major differences: its output is not current limited (35mA sink, maxi-

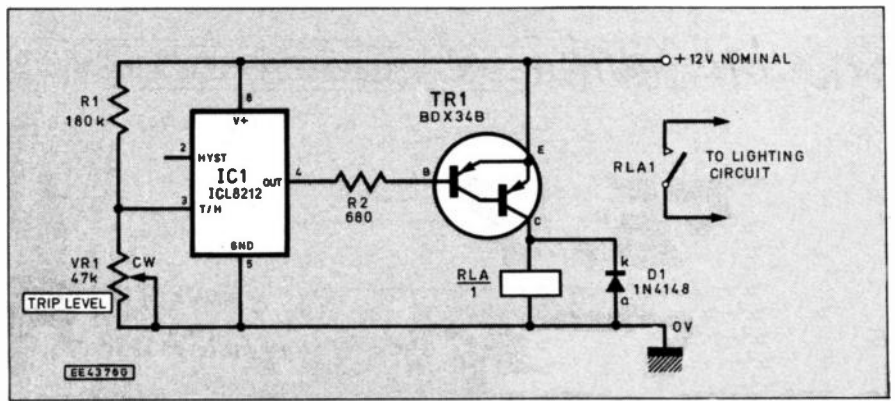

Fig. 3. Low voltage trip circuit using ICL8212. RLA only operates when supply rail exceeds trip level. TR1 can provide up to 10A drive.

mum), and the output goes low when pin 3 is higher than 1.15V. This is probably more suitable for our application because we could just add a pnp transistor driver to the output, see Fig. 3.

Transistor TR1 is a pnp Darlington power transistor which turns on when pin 4 is low (pin 3 > 1.15V). The load shown here is just a relay which in turn switches the lighting, but TR1 is rated at up to 10A and could easily drive a load directly. By adjusting VR1, when the supply rail is higher than the desired switching level (11.5V, Mr. Beck specified), then pin 4 is low – this is equivalent to the "alarm state" of the 8212 – therefore the transistor is on. When the supply rail falls, eventually dropping below 11.5V, the potential at pin 3 drops below 1.15V and thus the output goes high. TR1 turns off, switching off the lights!

The circuit consumes little current under these circumstances, preserving the battery. It's probably easier to use the 8212 this way since all it then needs is a single transistor to directly drive the load. Hence we're actually using the 8212 to detect not a fall but a rise in voltage – when the supply rail exceeds 11.5V this is deemed the "alarm" and is used to turn the lighting on.

It's possibly worth introducing some hysteresis – a difference in the switch-on and switch-off levels which prevents the load from constantly jittering. Pin 2 (hysteresis) can be used to introduce positive feedback by connecting it via a resistor to the potential divider. (The hysteresis pin is actually a complement of the output pin but it only sources some 20µA.) This means that the load won't forever be switching on and off when the circuit is just on the threshold level. Try it by adding a resistor – say 1M or 2M2 – between pins 2 and 3.

Finally, whilst the ICL8211/8212 are

bipolar devices made by Harris, improved CMOS versions of both chips are produced by Maxim – the MAX8211 and MAX8212. They're only suitable for supply rails up to 16.5V though, the CMOS chips have much lower quiescent currents and the resistance of the potential divider network can be greatly increased to reduce the supply drain. Also the hysteresis pins source a useful 10mA. All four devices are available from Farnell (0532 636311) – Part Numbers are ICL8211?CPA or MAX8211?CPA2.

Suggestions for experimenters: design using an opto-isolator driven straight from the ICL8211 output, or maybe use the hysteresis pin of the MAX8212 (goes high when the threshold exceeds 1.15V) to drive an npn transistor or MOSFET to power the lights.

## Soft Where?

*D. Evans* of Gwynedd asks if there is any suitable educational software to run on a PC. *Electronics Principles* from EPT Educational Software is now available from the EPE Direct Book Service and a demo disk costs £2 – see advert elsewhere in this issue. It's definitely worth checking out if you're looking for an imaginative and concise way of learning the basics of electronics using a computer as a learning aid.

*C.L. Quay* from Malaysia wrote to say he's delighted with the hi-fi speaker de-thump which worked a treat (see last month).

I read every letter but unfortunately I cannot guarantee an individual reply or advise on the repair or modification of commercial equipment. If you have a suggestion or idea which might interest other readers, then write to me at *Circuit Surgery*, Everyday with Practical Electronics, 6 Church Street, Wimborne, Dorset BH21 1JH. See you next month!

## CIRCUIT SURGERY

*Circuit Surgery* is for your queries, hints and tips. If you think we can help with an interesting problem or if you have a tip worth passing on then write to Alan at *Circuit Surgery*, Everyday with Practical Electronics, 6 Church Street, Wimborne, Dorset BH21 1JH.

# SAFETY FIRST!

T.R. de VAUX-BALBIRNIE

Part two

## Staying alive with electrical equipment

**L**AST month we discussed electric shock, some first-aid procedures and a little of the theory. This time we shall pursue the same topic.

By understanding this, it is more likely that we shall avoid electric shock or reduce its severity in an accident. Note that those working in industry and education must seek more specific guidance. Also, overseas readers should check their own national regulations since there may be differences in detail.

### MAINS SUPPLY

Before proceeding, it is necessary to have at least a simplified knowledge of how mains electricity is supplied to the consumer. The energy is transmitted from the power stations along the National Grid network at very high voltage (up to 400,000 volts – 400kV). It arrives at a local transformer (see Fig. 1a) which may be situated at ground level or may be a *pole transformer* of the type shown in the photograph opposite.

The transformer reduces the voltage to the household working level of 240V and the supply arrives in the house through two wires – *Live* (L) and *Neutral* (N). These, together with a third one connected directly to Earth (E), appear at each power socket in the house (see Fig. 1b). For technical reasons, the neutral wire is also connected to earth – this is an important point as we shall see presently.

To operate an appliance, a circuit is made by connecting it between the live (L) and neutral (N) wires. For simplicity, we refer to the current *entering* by the live wire and *returning* by the neutral one. However, in reality it pulses backwards and forwards through the circuit because the mains supplies *alternating current* (a.c.).

Imagine we have an electric shock situation where a person is holding both live and neutral wires at the same time – one in each hand (see Fig. 2). Current flows through the body completing a circuit.

However, holding both conductors in this way seems rather unlikely and it is difficult to see how it could easily happen by accident. It is more likely that a single bare wire – the live one – will be touched while the feet make contact with the ground. This may also produce an electric shock called an *earth-loop shock*.

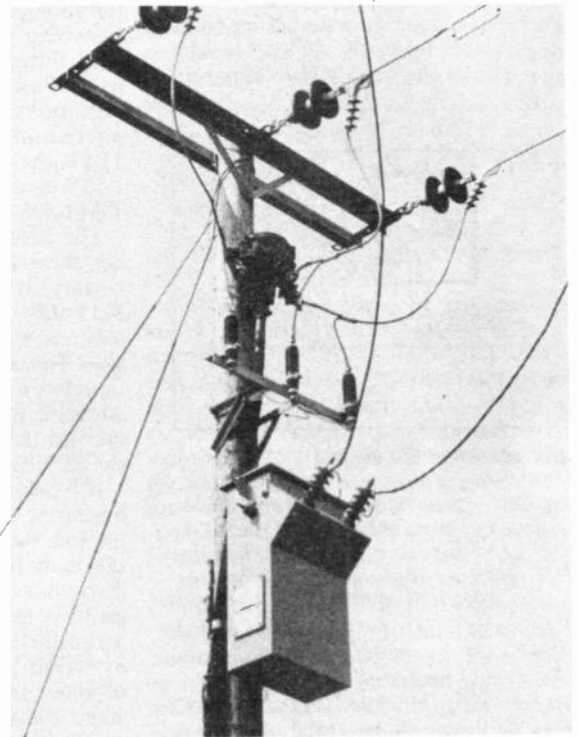

Pole mounted local transformer.

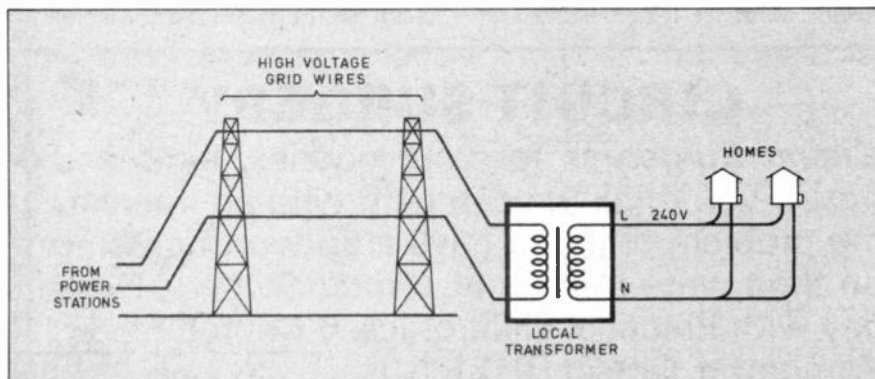

Fig 1a. Simplified Electricity distribution system.

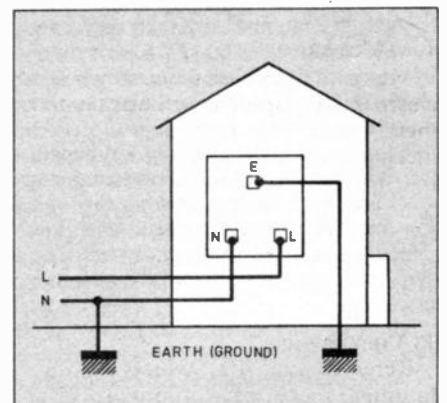

Fig 1b. Connections in the house.



Fig. 2. Current flow through the body.

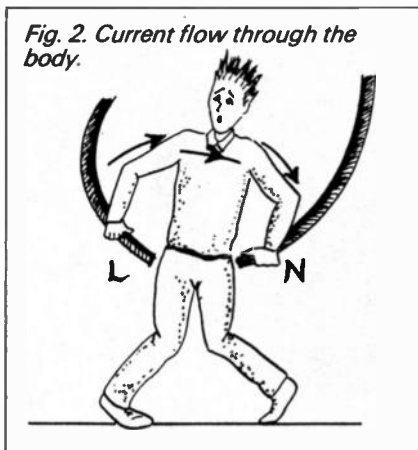
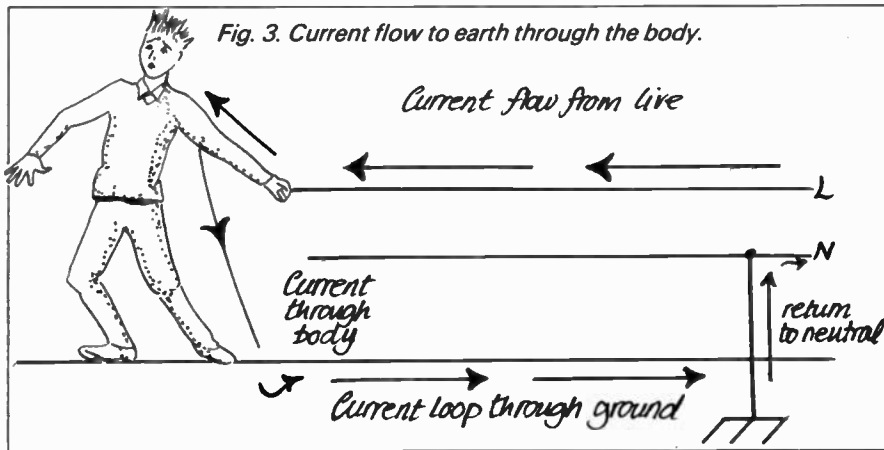

Fig. 3. Current flow to earth through the body.



## DOWN TO EARTH

To understand this "loop", refer to Fig. 3. Suppose, due to some fault, the live wire is exposed and a person touches it. Sufficient electrical contact is made with the ground ("earth") through most shoes and, for example, a wooden floor. The earth conducts electricity due to the presence of moisture and various conducting substances. There is therefore a circuit formed through the body from live to neutral via the earth as shown by the arrows. Accidental touching of a live conductor can happen very easily if wires are pulled free, cut through or sufficiently worn so as to expose the copper beneath the insulation.

The severity of the shock depends on the strength of the current which, as well as the *skin contact resistance* with the live wire, is also related to the resistance between the person's feet and ground. This, in turn, is influenced by the type of footwear, if any, the material used for the floor and the amount of any moisture present. Note that an accidental brush with the *neutral* wire will not cause a shock because no circuit is formed from the live one.

Since touching the *live* wire is so dangerous, it is essential to distinguish it from the neutral one. This is done by using a colour code for the insulation. The live lead is usually *red* in fixed cable (that is, *permanent* wires) and *brown* in flexible ones.

The corresponding colours for the neutral are *black* and *blue* respectively. In fixed cables, the Earth wire is bare copper and in flexible ones the insulation on the earth wire has *green and yellow* stripes. It is obviously essential for everyone to follow this code.

## AN INTERESTING CASE

Many pieces of electrical and electronic equipment are housed in a metal case. This may be to provide mechanical strength, electrical screening, to withstand high temperatures or for any other reason where plastic would be unsuitable. It is usual to connect *all* exposed metalwork to ground via the earth wire mentioned previously using the top pin of the 13A mains plug.

Refer to Fig. 4(a) which shows a familiar piece of equipment – an electric iron – operating from the mains with the element correctly

connected between live and neutral and with the case earthed. Suppose the live (L) wire became detached and touched the metal case – see Fig. 4(b). There would now be a circuit formed from the live wire to the metal work, to earth and hence to the neutral of the supply as shown by the arrows.

Since the resistance of this circuit is low, the current would be correspondingly high and blow the fuse in the live wire at the plug or elsewhere. This would isolate the appliance from the mains live feed so if someone touched the case it would be safe.

If the earth (E) wire broke loose – perhaps inside the plug (see photograph) – the earth loop would be broken. In the event of the above fault developing, the fuse would fail to blow and the next person touching the case would receive an earth-loop shock. For this reason, the proper earthing of metal cases should be checked frequently.

This may be done using a multitester set to a low

Fig. 4a. Normal current flow.

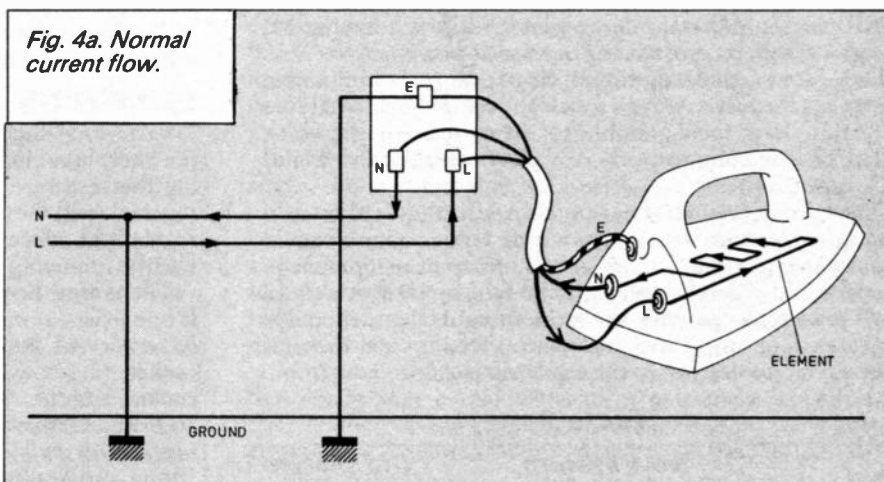
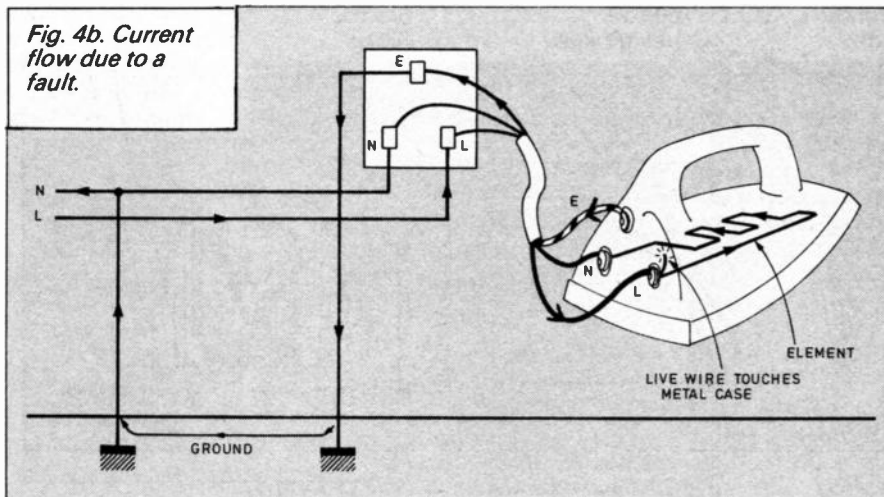
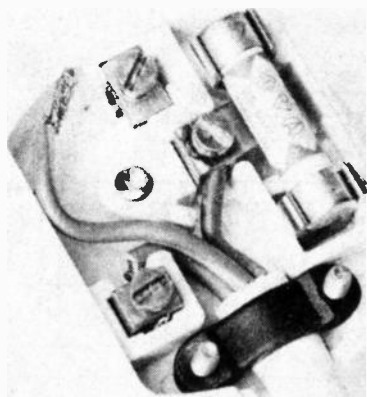
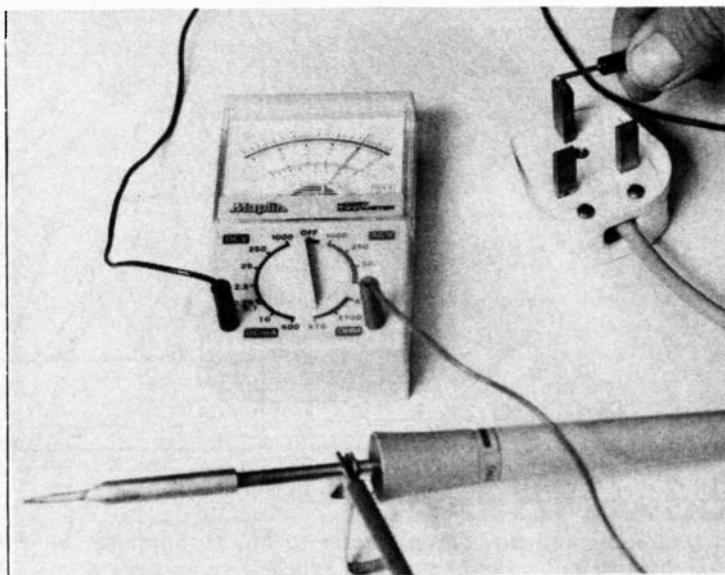

Fig. 4b. Current flow due to a fault.





*Dangerous situation with earth wire disconnected.*



*Simple test to check appliance earth continuity.*

resistance range. **With the appliance unplugged from the mains;** touch one probe on the earth pin of the plug and the other on a metal part of the appliance (see photograph of this test being carried out on a soldering iron). Practically zero resistance (a fraction of an ohm) should be indicated. This is a very basic test but is better than no testing at all. Note that this does *not* apply to *double-insulated* appliances (see below).

## DOUBLE-INSULATION

Certain appliances do not need earthing. Totally plastic-cased equipment, for example, where there are no exposed metal parts and certain items which, although having exposed metal parts, are said to be *double-insulated*.

Here, because of additional insulation, it is impossible for a detached live wire to touch the metalwork whatever the fault. It is then possible to dispense with the earth wire. This is common practice with certain garden and DIY-type tools.

The correct wiring of a 3-pin 13A UK plug is shown in Fig. 5. Table 1 shows the old wiring colour code mapped against the new one – there is still plenty of equipment in use with old coloured wiring although, by now, it should have been replaced with the modern equivalent. If equipment needing only a live and neutral feed is used then, of course, the connection to the earth pin is ignored.

**Table 1:**

	<i>New system</i>	<i>Old system</i>
Live	Brown	Red
Neutral	Blue	Black
Earth	Green/Yellow	Green

When wiring a plug, the following points should be especially noted:

- The wires *must* be connected to the correct terminals.
- Only a *small* amount of insulation should be removed from the wires.
- When removing insulation, no strands of copper wire should be lost.
- Wire should be securely gripped *on the outer sheath*. It must not be possible to dislodge it with an accidental pull.
- The correct value of fuse must be fitted.

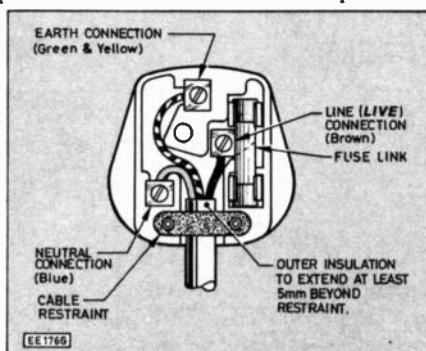

*Fig. 5. 13A plug wiring.*

Choosing the correct fuse value will be one of next month's topics.

In an appliance, any on-off switch is placed in the *live wire*. When switched off, the live feed is therefore disconnected. This is why it is essential when a mains plug is fitted, that the live and neutral wires are connected to the correct terminals.

If the neutral wire is inadvertently connected to the *live* terminal instead, the switch would appear in the *neutral* wire. The appliance would still work but, when switched off, the live wire would still be connected – a dangerous situation. Double-pole switches are inherently safer because they disconnect both *live and neutral* wires but they are more expensive.

## SAFETY CHECK

Earth-loop shocks are more serious in a bathroom due to the likely combination of bare feet and condensation lowering the resistance, also the taps and pipes which may be touched will be earthed. This is why there are special regulations concerning the use of electrical equipment here. Use the following information to do a safety check yourself.

There must be no standard power socket in a bathroom. If one exists, *it has been installed by an amateur and must be removed and the circuit isolated*. A special shaver socket is allowed – perhaps combined with a small enclosed lamp. The light switch must be cord-operated and situated out of reach – probably on the ceiling. *There must be no wall-mounted switches*.

Any radiant heater must be situated high enough to prevent accidental touching and, again, the switch must be operated through a cord. Any such heater must be fixed securely to the wall and wired-in permanently – that is, not through a plug and socket.

An electric shower should be provided with a *double-pole* switch and, in common with other switches, must be ceiling-mounted and cord-operated. No appliance may be situated above the bath nor near enough to be touched by a person in the bath.

Obviously, leading a temporary supply into the bathroom by, for example, passing an extension lead under the door is extremely dangerous. The worst scenario is that of a person receiving a shock while submerged in bath water. The earth-loop resistance here is extremely low and the current through the body will be lethal.

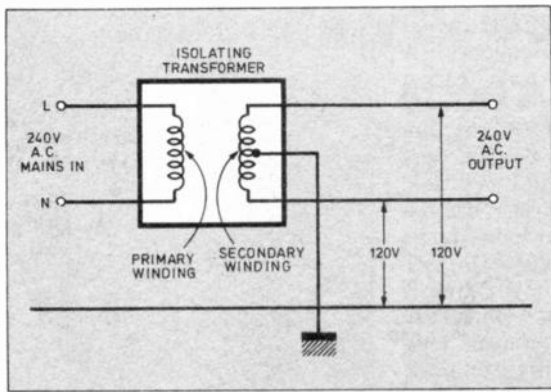

Fig. 6. Power isolated transformer wiring.

It is not unknown for mains electrical equipment to be placed on a shelf above the bath. It is difficult to see how a person doing this could be so stupid.

## IN ISOLATION

We can eliminate the possibility of receiving an earth-loop shock by removing the connection between the neutral wire and ground. If a person then touched the live wire – even while making good contact with earth – there would be no circuit and therefore no shock (see Fig. 3).

This can be achieved by using an *isolating transformer*. An example of a small isolating transformer is the one used in a shaver socket. This has the same number of turns on both primary and secondary windings so the voltages at both input and output are the same – that is, the output voltage will be 240V.

A shaver plugged into the outlet operates just as it would if connected *direct* to the mains. However, there is no longer a link between either output wire and earth (the terms *live* and *neutral* do not now apply).

Since a shaver socket provides an output at mains voltage, it is still possible to receive a lethal shock if both output terminals are touched at the same time but this is unlikely. However, check the condition of the razor plug and connecting wire regularly just in case it could happen.

More substantial isolating transformers are used to provide large-scale power. Often the secondary winding is centre-tapped to ground (see Fig. 6). Since this winding has two equal sections, only one-half mains voltage exists between either output wire and Earth i.e. 120V. Although it is now possible to receive an earth-loop shock by touching *either* output wire, the chance of a lethal shock is greatly reduced.

Last month we mentioned that portable tools on a building site are often powered from a 110V supply. This is done by using an isolation transformer having fewer than half the number of turns on the secondary winding compared with the primary. The secondary is wound in

**Dangerous connections with too much insulation stripped off. Connecting blocks should only be used inside a suitable fixed housing.**

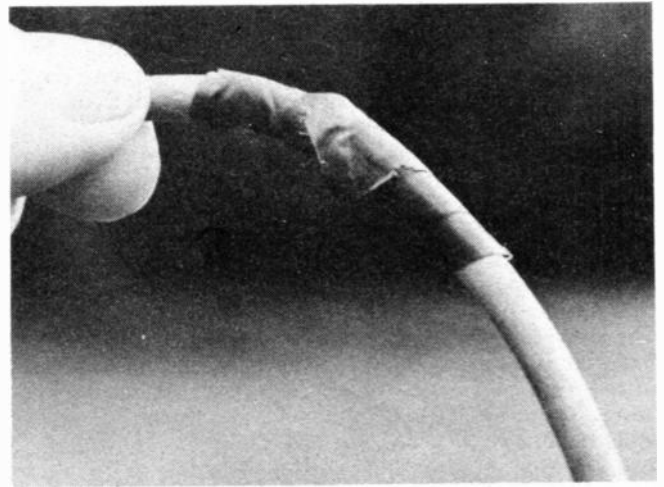
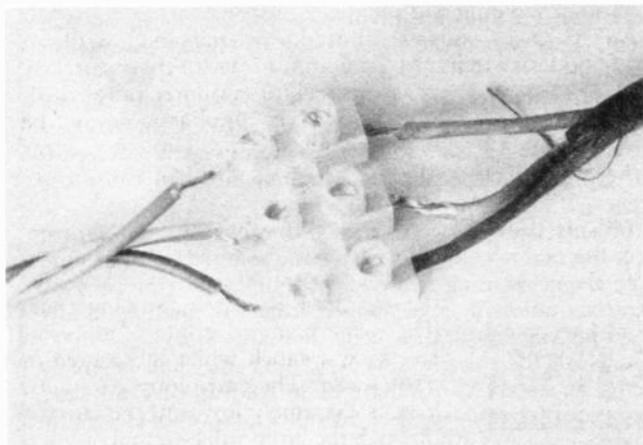

Never repair a damaged lead in this way.

two equal sections centre-tapped to earth. This means that the maximum voltage between either output wire and ground is 55 volts and it is thought that, in the event of an earth-loop shock, the current would be too low to present much of a hazard.

## HAVING AN EXTENSION

In an ideal world there would be no extension leads but they are sometimes necessary. A short discussion about their safety is therefore worthwhile.

If an extension lead is needed for a double-insulated appliance, this may be of the two-core (live and neutral) only variety and so save costs. The danger is in using it for an appliance which needs an earth connection. On the whole, it is safer to use only *three-core* extension leads.

For the same reason, it is extremely foolish to mix pieces of two-core and three-core wire to make a long extension lead. If someone removed a plug cover to check that an earth wire existed, on seeing one, they would assume that it was continuous through to the other end. If the live wire in an appliance were to touch the case, the metal work would become live and deliver a shock to the next person handling it.

Ideally, extension leads *should not* be lengthened but, again, this is sometimes necessary. If it must be done, use proper flex connectors with cable grips and *never taped joints*. Do not repair sections of insulation removed by abrasion or accidental cutting by using p.v.c. tape or a screw terminal block. The whole length of wire must be replaced or, at least, the offending section removed and a proper connector used.

Sometimes the two parts of a flex connector are used the wrong way round and this is extremely dangerous. Each connector has a *plug* and a *socket* section (see photograph). It is essential for the *socket* to be used in the piece

**The plug and socket of a two-core extension must be fitted in the correct part of the lead.**





of wire which is connected to the mains and the *plug* part to the wire leading to the appliance. If this precaution is not observed, then with the connector parted and with the lead plugged in to the mains, exposed live pins will exist.

Extension leads should be inspected regularly along their entire length since they are subject to more pulling and abrasion than other forms of wiring. Strain relief clamps in the mains plug and in any connectors *must* be regularly inspected for tightness. It often happens that wires are accidentally pulled free to expose live conductors. In a damp garden environment this is very dangerous.

The Earth wire in an extension lead should be checked for continuity every so often. *To do this, the lead MUST be disconnected from the mains.* A multimeter set to its lowest resistance range should then be used to measure the resistance of the earth wire from one end to the other. Depending on the type of extension lead, an earth pin removed from a discarded plug may be used to make the connection at the socket end. Practically zero-resistance (a fraction of an ohm) should be indicated.

Note that in this discussion, we are not concerned with the *current rating* of the wire. This is equally important and will be looked at in detail next month.

## RESIDUAL CURRENT DEVICE (RCD)

The Residual Current Device (RCD) is instrumental in preventing electric shock but – presumably because of its cost and some apathy on the part of householders – is not used as much as it should be. An RCD is often called a *Powerbreaker* or *trip switch*.

Contrary to popular belief, an RCD is not an overload cut-out so the correct fuse must still be fitted in the circuit. An RCD should always be used with extension leads and particularly with appliances being used in damp conditions or in the garden where there is a chance of the wire being cut accidentally.

An RCD is connected between supply and appliance so that the current in both live and neutral wires flows through it. Inside is a circuit which compares these currents. Normally they are the same (that is, current in equals current out) and there is no further effect. If someone touches a bare live wire, current will flow through the body to ground. The effect of this is to reduce the current returning through the neutral wire since some is now diverted to earth. This imbalance is detected and relay contacts break the circuit instantly.

Regulations state that the trip current of an RCD shall not exceed 30mA and it should operate in 40ms maximum. Although 30mA is regarded as a lethal current, the disconnection time is too short to cause harm. Before the circuit can be re-used, the fault must be corrected and the RCD reset by pressing a button.

RCD's come in various forms. The smallest type replaces a standard mains plug but there are also high-current ones which can protect a whole building. RCD's occasionally trip for no apparent reason so it is best not to use one where failure of the supply could be disastrous – with a freezer, for example. The test button provided on an RCD should be used regularly to test its action.

Touring caravan mains hook-up supplies must be protected with an RCD. Installing these, or adding to an existing system, must be carried out only by those with a proper knowledge of the regulations. A section of next month's work will be devoted to such caravan electrics.

## FAINTING IN COILS

Suppose you are checking a relay by connecting its coil to a battery. This is a standard test and the armature will move and click confirming that it is working. If you hold the coil terminals between your fingers while you do this, as the battery is removed it is possible to receive a short, sharp shock.

This often confuses people since only a low-voltage (perhaps 9V) battery has been used as a supply. The shock

is unlikely to be of any consequence – it occurs only for a very short time and is confined to the fingers but an explanation is in order.

When the battery is connected, a magnetic field is set up in the iron core on which the coil is wound. This causes the armature to be attracted and the contacts operate. When the battery is disconnected, the magnetic field collapses very quickly. This sets up a high reverse voltage (that is, in reverse compared with the battery supply) and this may be sufficient to cause a shock. To avoid it, never hold *both* coil connections when you test a relay.

Any coils of wire, especially when wound on an iron core to enhance the magnetic effect, can cause similar shocks. For this reason, it is unwise to experiment with transformers by connecting a battery while holding any terminals between the fingers. Some very nasty shocks can be delivered this way and there may be a stepping-up effect too.

## CAPACITORS

Electronics enthusiasts should beware of another source of electric shock which may occur even when equipment has been switched off. This is the energy stored in a *capacitor*.

When a capacitor is connected to a d.c. supply, it will charge up until the voltage across its terminals matches that of the supply. It follows that a charged capacitor can deliver a shock similar to that which would have occurred had the victim touched the supply terminals *direct*. Real danger exists when a capacitor charges up to more than 25V or so.

In commercial equipment, a high-value resistor is usually connected between the terminals of a capacitor so that when the appliance is switched off, it gradually discharges. However, this cannot be relied on. It is best to check the voltage across the terminals of any suspect capacitor cautiously using a multimeter set to an appropriate (or higher) voltage range. If it is charged to a dangerously high voltage it is best left to self-discharge – check again later.

Some people discharge capacitors by bridging the terminals with an insulated-handled screwdriver (this is not recommended as it is dangerous and it can damage the capacitor). With large-value capacitors – and especially where high voltages are involved – the effect can be very violent. This is because the amount of energy involved is quite high.

The resistance of the circuit is very low, so the current will be enormous – thousands of amps for a short while. This can cause a flash and melt off pieces of screwdriver. It has been known for pieces of molten metal to cause eye injury.

Problems usually occur with old valve-type equipment where the mains voltage is frequently stepped up to around 350V. Experimenting with such equipment can be very dangerous unless it is *unplugged* from the mains and any smoothing capacitors allowed to discharge first.

That's all for this month. Next time we shall begin by looking at electrical installations in touring caravans and continue with a discussion of the other dangers of electricity – Overheating and Fire.



*A high voltage capacitor can store a dangerous charge.*

# Laboratory Power Supplies from CROTECH

Available at very **LOW** prices until stocks last

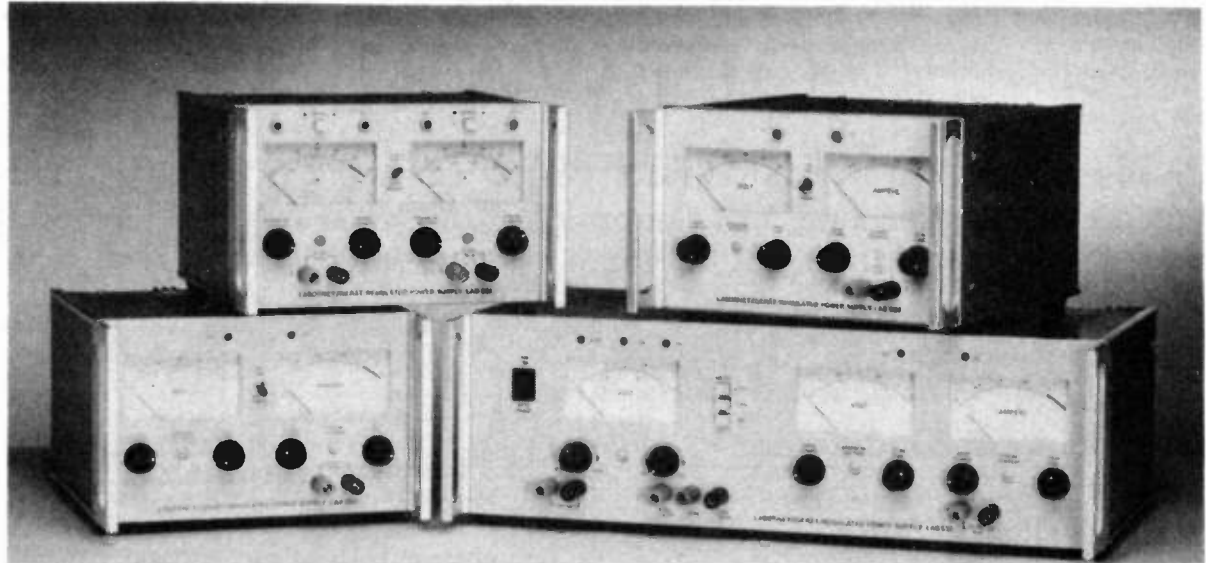

Each Power Supply Unit offers an excellent Value For Money.

And whether you test simple or complex circuits, whether you are a professional Engineer or a hobbyist, one of these Power Supply Units is certain to suit your application (and your budget).

But stocks are limited. So, hurry to avoid disappointment...

<b>Model LAB 501</b> Single Output 0-30V/0-1A <b>Price: £ 87</b> RRP: £116	<b>Model LAB 502</b> Single Output 0-30V/0-2A <b>Price: £ 110</b> RRP: £ 147	<b>Model LAB 521</b> Dual Output 0-30V/0-1A <b>Price: £ 139</b> RRP: £ 185
---	---	---

### Multiple Output Model LAB 532

Output 1 : 0-30V/0-2A

Output 2 : +12V to +15V/0 to 0.5A

Output 3 : -12V to -15V/0 to 0.5A

Output 4 : 4.5V to 5.5V/0 to 5A

**Price: £ 240**

RRP: £ 320

### Features :

- Built-in Overload Protection
- Analogue meters for output voltage and current
- Line Regulation :  $\pm 0.05\%$
- Load Regulation :  $\pm 0.05\%$
- Ripple & Noise : 1 mV rms max.

Prices exclude VAT

**CROTECH INSTRUMENTS LTD.**  
**UNIT A1, FARADAY ROAD, NEWBURY, BERKS. RG13 2AD**  
**Tel.: 0635 550789 Fax.: 0635 49305**

# ELECTRONICS PRINCIPLES SOFTWARE

from E.P.T. Educational Software

If you are looking for a means of improving your knowledge of the basics of electronics then this software is for you.

*Electronics Principles* covers:

- ★ Insulators, Conductors, Resistance
- ★ D.C. Circuits
- ★ Capacitance and Inductance
- ★ A.C. Series Circuits
- ★ A.C. Parallel Circuits
- ★ Reactance and Impedance
- ★ A.C. and D.C. Power
- ★ Frequency and Tuned Circuits
- ★ Using Numbers
- ★ Complex Numbers, Phase Angles
- ★ P.N. Junction Diode
- ★ Transistors
- ★ Operational Amplifiers
- ★ Logic Gates
- ★ Digital Number Systems
- ★ Combinational Logic
- ★ Flip Flops
- ★ Counters and Shift Registers
- ★ Memory

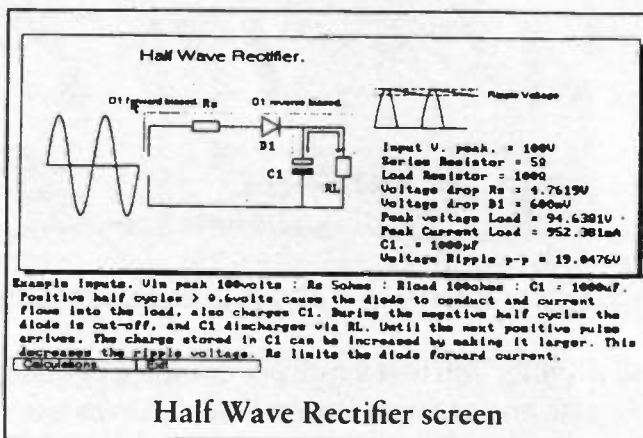

Half Wave Rectifier screen

Having reviewed a dozen, or more, educational software packages designed to "teach" electronics, I was more than a little sceptical when I first heard about *Electronics Principles*: there seemed to be little that could be done that has not been done elsewhere. When I started to use the package my views changed. Indeed, I was so impressed with it that I quickly came to the conclusion that *Everyday with Practical Electronics* readers should have an opportunity to try the package out for themselves!

MIKE TOOLEY B.A.  
Dean of Faculty of Technology,  
Brooklands Technical College

Over 200 menu driven screens with interactive graphics enabling a learning by doing approach to encourage experimentation.

*Electronics Principles* requires a PC (or fully compatible system) running DOS with an 80286 or better processor and VGA (ideally colour) graphics. In addition you must have 4Mb of hard disk space, a high density (1.44Mb) floppy drive and at least 640K of RAM. We also recommend the use of a mouse with this program. The program is supplied on three 3.5 inch disks.

Complete package

**Only £49.95** inc. VAT, plus £1 post and packing.

Demonstration disk available  
send £2 (Overseas orders  
send £3) – includes P&P

Distributed by Direct Book Service, 33 Gravel Hill, Merley, Wimborne, Dorset, BH21 1RW. (Mail Order Only).  
Direct Book Service is a division of Wimborne Publishing Ltd. publishers of *Everyday with Practical Electronics*.  
Tel: 0202 881749. Fax: 0202 841692.

Visa and Mastercard orders accepted for the complete package – please give card number, card expiry date and cardholders address if different to the delivery address. Credit card orders NOT ACCEPTED for demonstration disks.

OVERSEAS ORDERS: Add £2 postage for countries in the E.E.C. Overseas readers, outside the E.E.C. countries send £42.51 (price less VAT) plus £3 airmail postage (Total £45.51).



# TIMER AND NiCAD CAPACITY CHECKER

ANDY FLIND

Check the condition of your NiCads - Don't let them fade away!

LIKE all batteries, NiCad cells do not last for ever. Occasionally they develop internal short circuits due to metal whisker growth, but more often their capacity simply fades away due to the well-known "memory" effect, or plain old age.

Camcorder batteries in particular often fail prematurely due to the use of relatively high charge and discharge rates. With the ever-increasing popularity of NiCads, a means of checking remaining storage capacity is highly desirable.

This project first saw daylight some three years ago, in answer to a need to test some single "AA" cells from a "Walkman" before a holiday. The principle was simple; the cells were fully charged, then discharged at their ten-hour rate whilst a timer recorded the period taken to reach the "discharged" state.

The circuit simply ran the cell right down, with a crystal oscillator and divider for timing. The display consisted of l.e.d.'s driven by the divider and was therefore a "binary" readout. It was crude and required a mains power supply, but it worked.

Holidays over, the possibility of checking transceiver NiCad packs for the author's employer was assessed, as these

were causing problems. "Load disconnection" was required when these reached the "discharged" voltage, as with a battery some cells will always have less capacity than others and further discharge may cause permanent damage by "reverse-charging" these.

By now, the use of mains power for an instrument requiring an uninterrupted supply was causing concern. A battery-operated "micropower" circuit design would be preferable. However, whilst the l.e.d.'s could be turned off between readings, the added need for load disconnection required a relay, which would draw current incompatible with micropower design.

Gradually the project lost appeal, and was not revived until recently when it's suitability for testing camcorder batteries had become available. A quick check of one catalogue revealed latching relays, which can be energised or de-energised with a single brief pulse instead of a continuous current.

Another catalogue offered a cheap five digit l.c.d. counter, ideal for the display. As this also provided a 512Hz output, a simple divider could turn it into a "seconds" elapsed time indicator able to



record over 24 hours, with electronic stop-start.

It seemed wasteful to build such a sophisticated instrument just for checking the odd suspect battery, so it was decided to adapt it for more general timing tasks. Stop-start terminals are provided on the front panel, with a regulated supply which can be used for low-power interface circuitry.

No doubt readers will find many applications for the timer, the most obvious being to check the daily operating time of mains appliances. Notes for doing this will be given later.

## HOW IT WORKS

A block diagram of the unit is shown in Fig.1. It can be seen that the counter's 512Hz output passes through a run/stop control circuit and a divider, then back to the "count" input to register seconds. The control circuit operates either from an external input or from the battery testing circuit, as does the display "Reset".

The comparator monitors the voltage of the cell or battery under test, disconnecting it and stopping the timer when the final value is reached. A switch allows adjustment for up to twelve cells.

## CIRCUIT DESCRIPTION

The circuit has been split into two sections, Timer and Battery Tester. Constructors wanting only the timer can build this on it's own, leaving out the parts needed for battery testing.

Starting with the timer circuit diagram, Fig.2, this operates as follows. The supply, nominally 9V from a PP3, is switched by S1 and regulated to 5V by IC1, with decoupling capacitors C1, C2, C3 and C4. IC1 is an LP2950CZ, which offers significant advantages over standard "78" type regulators, especially for battery operation.

The micropower regulator uses less current, and will operate with a much lower input-output voltage differential. It's output is more accurate, useful where, as here, it is used as a reference. Also, this project will operate from just above 5V and consumes about a quarter of a milliamp, it can be run with "flat" batteries from other appliances!

The counter module X1 requires a 1.5V supply (it is intended to work with a single

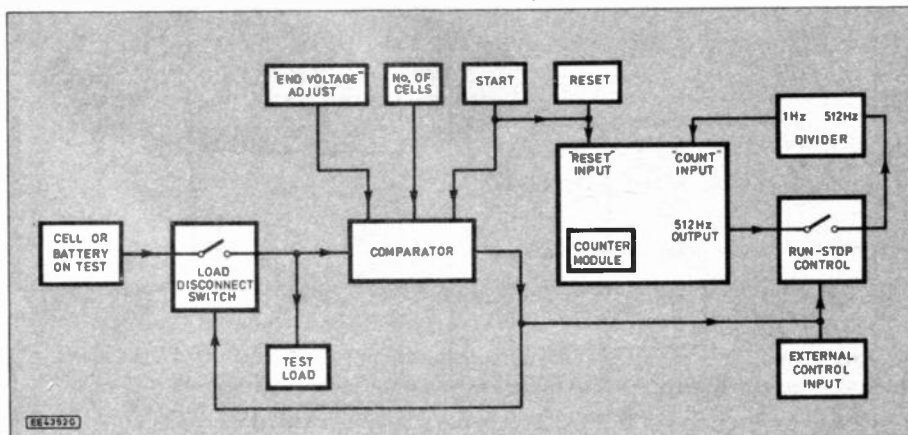
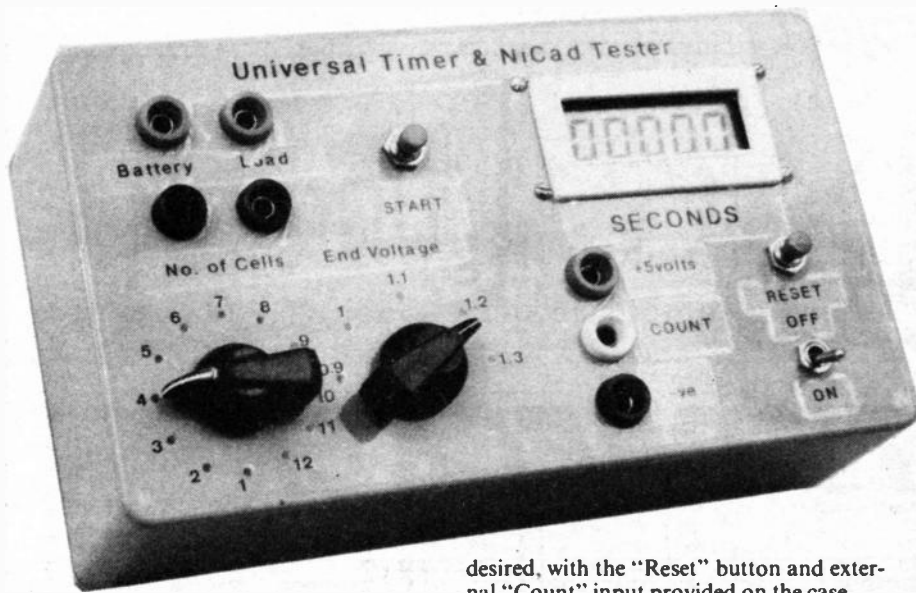

Fig. 1. Block diagram of the Timer and NiCad Capacity Checker.



cell), which is provided by transistor TR2 and resistors R1, R2 and R3. Its output drives an input of IC2, to ensure this will work with the available 1.5V swing IC2 and IC3 are supplied with 3V from TR1.

Although the counter's 512Hz output is a squarewave, it swings not from zero to +1.5V as might be expected, but between zero and -1.5V! The counter apparently includes a negative rail generator as well as a clock.

This output is coupled by capacitor C7 into IC2d, one section of a CMOS 4016B quad switch. For the signal to pass through IC2d, IC2c must be "on", and for this either point "B" or the "Count" input must be positive, so providing the "run-stop" function.

The 3V peak-to-peak squarewave from IC2d drives the "clock" input of divider IC3, the divide-by-512 output of this goes to switch IC2b, which controls the "count" input of the counter X1, causing it to advance at the rate of 1Hz. IC2a operates the counter "reset" input, which resets the display to zero.

In this circuit IC2a is normally off, but a positive pulse from point "A" or a press of Reset switch S2 will operate it. This section of the circuit can be used on its own if

desired, with the "Reset" button and external "Count" input provided on the case.

### BATTERY TESTER

The battery tester circuit, Fig.3, uses op.amp IC4 as a comparator. This is a 7611, a "micropower" device, with pin 8 connected to the positive supply it draws only a few microamps. It has a CMOS output stage which can swing virtually from rail to rail.

Resistors R22, R23 and R24 with potentiometer VR1 set the comparator switching point to the final or "end" voltage of a discharging NiCad cell. This is generally taken to be about 1.1V, but VR1 allows some adjustment. Positive feedback from R27 ensures rapid comparator switching, whilst pressing Start switch S4 forces it to reset.

Although this stage covers the voltage for a single cell, batteries of up to twelve cells are catered for by rotary switch S3 with resistors R11 to R21. Relay RLA is a latching type, with separate coils for "on" and "off".

When the output of IC4 goes high, IC5a output goes low, IC5c output thus remains low, but IC5b output goes high, causing a positive pulse of about 100mS at IC5d input. IC5d output pulses negative, operating the "on" coil of the relay through

transistor TR4 to connect the battery on test to the comparator and load. At the same time, a pulse to point "A" from capacitor C10 and resistor R32 resets the timer, whilst a positive voltage from diode D1 and resistor R33 to point "B" sets it running.

When the battery voltage reaches the lower limit, the comparator output goes low and IC5a output goes high. This causes a negative pulse at IC5c output, which through transistor TR3 operates the "off" coil of the relay, disconnecting the battery. The positive supply is removed from point "B" and counting stops.

As this unit can test a wide variety of batteries with various capacities and voltages, it was decided not to include the "load" in the circuit. Instead, terminals are provided on the front panel to which users may connect the load of their choice. Since NiCads have a very flat discharge voltage characteristics, this will normally be just a resistor of suitable value and wattage rating.

### CONSTRUCTION

The NiCad checker is built on a single-sided printed circuit board (p.c.b.) which is housed in a plastic case measuring 190mm x 110mm x 60mm. The p.c.b. topside component layout and underside full size copper master pattern is shown in Fig. 4. This board is available from the *EPE PCB Service*, code 857.

Construction is relatively uncomplicated, although the i.c.'s and the counter module are CMOS devices so the usual precautions against static damage should be observed. Sockets are advised for the relay and all i.c.'s except IC1, as this simplifies testing.

Circuit board assembly should start with the fitting of all components save IC2 to IC5 (only sockets mounted) and (the relay). The diode polarities and transistor types should be checked before insertion, as it's easy to make a mistake with these. It will be seen that transistor TR1 faces the opposite way to all the others.

If a 9V supply is connected to the completed board, the regulated five volts should appear across capacitor C4, with about 3V across capacitor C5 and 1.5V across C6. (These last two may be 0.1V to 0.2V higher). The current consumption should be very low, always less than

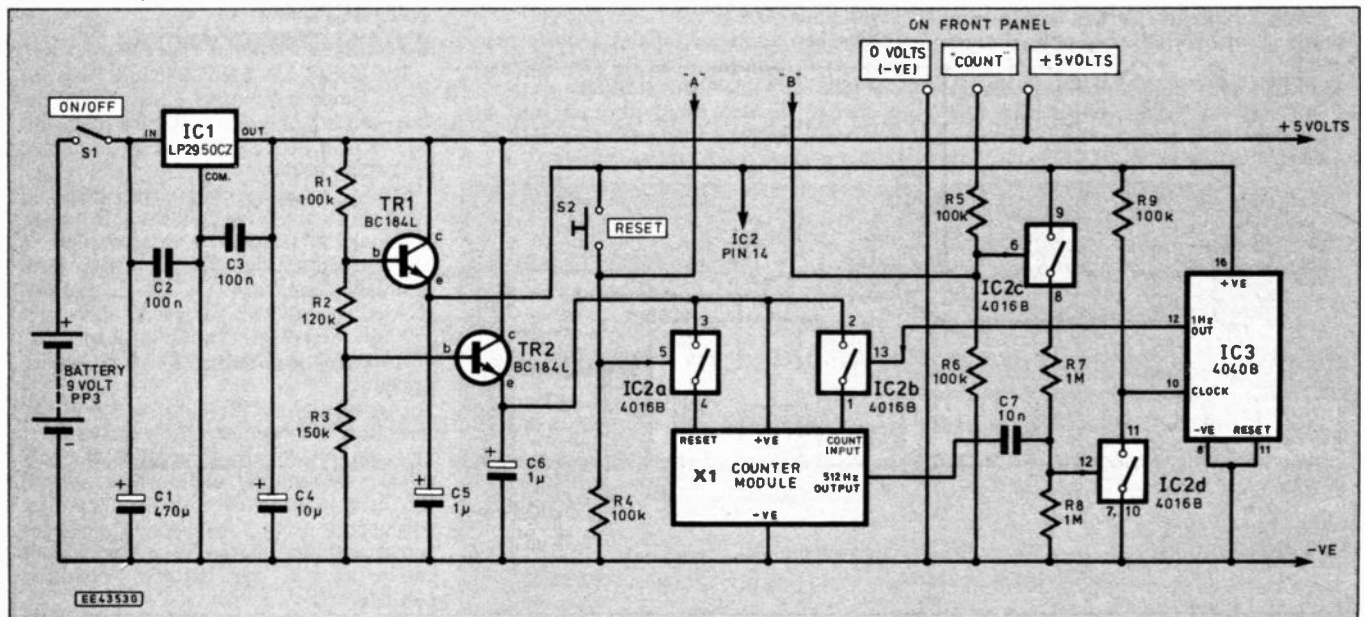
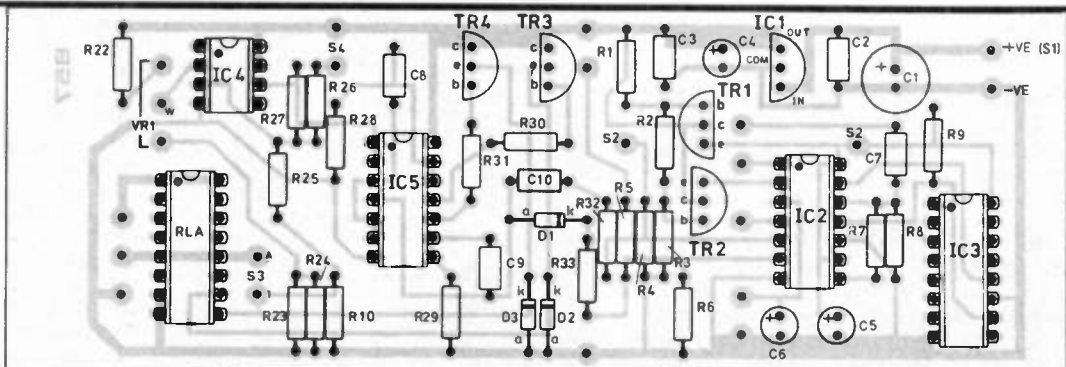

Fig. 2. Circuit diagram for the Timer section, using a ready-made Counter Module.

Fig. 4. Printed circuit board component-layout and full size underside copper foil master pattern.



## COMPONENTS

### Resistors

R1, R4, R5,	100k
R6, R9	(5 off)
R2	120k
R3	150k
R7, R8,	
R28, R29	1M (4 off)
R10 to R21	1k (12 off)
R22, R32,	
R33	68k (3 off)
R23	27k
R24	270k
R25, R26	33k (2 off)
R27	330k
R30, R31	4k7

All 0-25W 5% carbon film

### Potentiometer

VR1	10k rotary carbon, linear
-----	---------------------------

### Capacitors

C1	470µ radial elect. 16V
C2, C3, C8,	
C9, C10	100n polyester layer (5 off)
C4	10µ radial elect. 50V
C5, C6	1µ radial elect. 100V (2 off)
C7	10n polyester layer

### Semiconductors

D1, D2, D3	1N4148 signal diode (3 off)
TR1, TR2	BC184L npn transistor (2 off)
TR3, TR4	BC214L pnp transistor (2 off)

IC1	LP2950CZ 5V micropower regulator
IC2	4016B CMOS quad switch
IC3	4040B CMOS 12-stage binary divider
IC4	ICL7611 micropower op.amp
IC5	4011B CMOS quad NAND gate
X1	Counter Module, with 512Hz clock output

### Miscellaneous

S1	S.P.S.T toggle switch
S2, S4	Min. press-to-make release-to-break switch (2 off)
S3	1-pole 12-way rotary switch

RLA	5V 167 ohm, twin-coil p.c.b. mounting d.i.l. latching relay, with 1A d.p.c.o. contacts
-----	--

B1 9V PP3 battery with connector leads  
 Plastic ABS case, size 190mm x 110mm x 60mm; 8-pin d.i.l. socket; 14-pin d.i.l. socket; (2 off); 16-pin d.i.l. socket (2 off); 4mm sockets, red (4 off); 4mm sockets, black (3 off); small pointer type knobs (2 off); multistrand connecting wire; mounting bezel for counter module; solder etc.  
 Printed circuit board available from EPE PCB Service, code 857.

Approx cost guidance only

**£36**

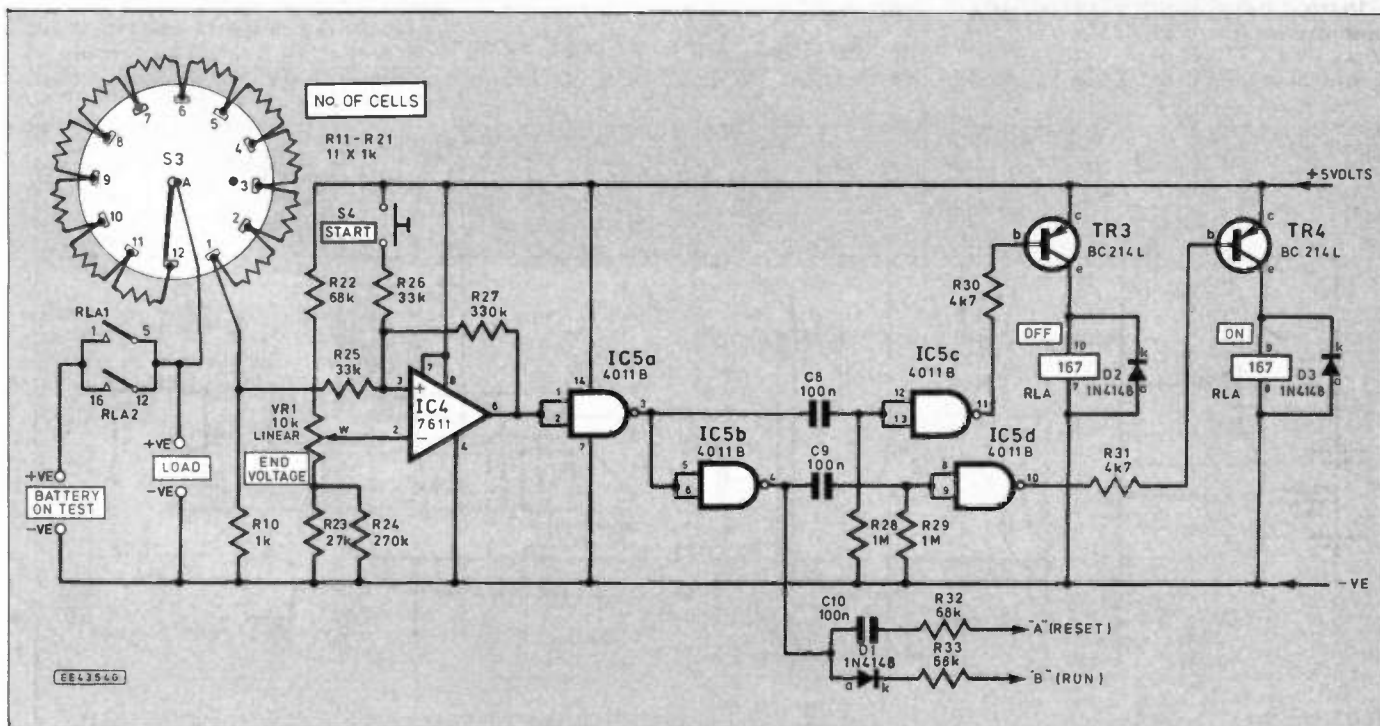
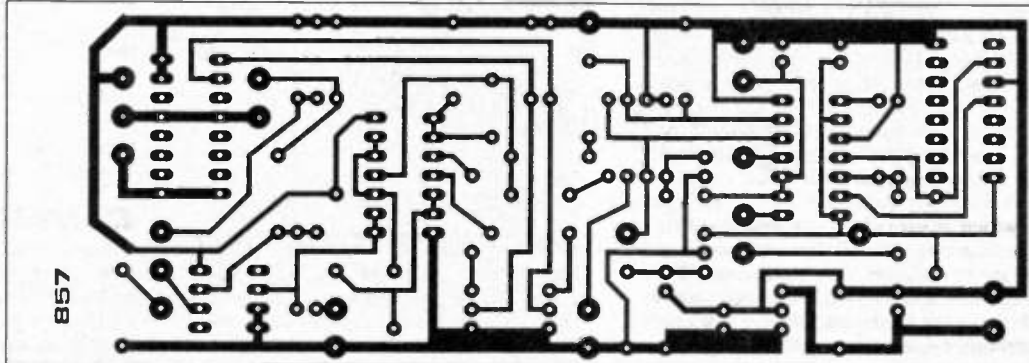

Fig. 3. Circuit diagram for the Battery Tester section. Up to 12 cells can be selected by rotary switch S3.



a milliamp except for a surge as the capacitors charge at switch-on, or when the relay operates.

## FINAL ASSEMBLY

Further testing requires connection to the controls, which may be fitted to the case first for convenience. The layout is not critical in any way, that used with the prototype can be seen from the photos.

Resistors R11 to R21, all one kilohm, are soldered directly to switch S3 as shown in Fig.5; it is easier to do this before fitting S3 into the case. It's advisable to test the completed switch and resistor assembly before installation.

The counter is supplied with a holder for a single AA cell, attached by four self-tappers. A suitable bezel was purchased with it for the prototype. The four screws and battery holder were removed, giving access to the external connections on the rear of the counter. The battery holder should be retained as it is useful for testing AA cells.

The diagram supplied with the counter module shows it from the front, so Fig. 5 shows connections to the rear for this project, together with all other connections to the p.c.b. A length of ribbon cable was carefully soldered to the counter before assembly into the bezel, and then the whole secured to the case with four 8BA screws.

## FINAL TESTING

Once the board is connected to the controls, counter testing can proceed. When powered up, the counter display should appear, although it will not yet count. It will be found that when power is removed it will take some time for the display to disappear, due to power stored in the electrolytic capacitors.

If the battery tester has been built, IC2, IC5 and the relay should be fitted next, taking care to fit the relay the correct way round. With these in place, whenever "Start" (S4) is pressed there should be an audible click from the relay, although it will open again when the switch is released.

A simple check of the input circuit may now be carried out. The End Voltage control VR1 should be set to minimum (anti-clockwise), Rotary switch S3 to position 4

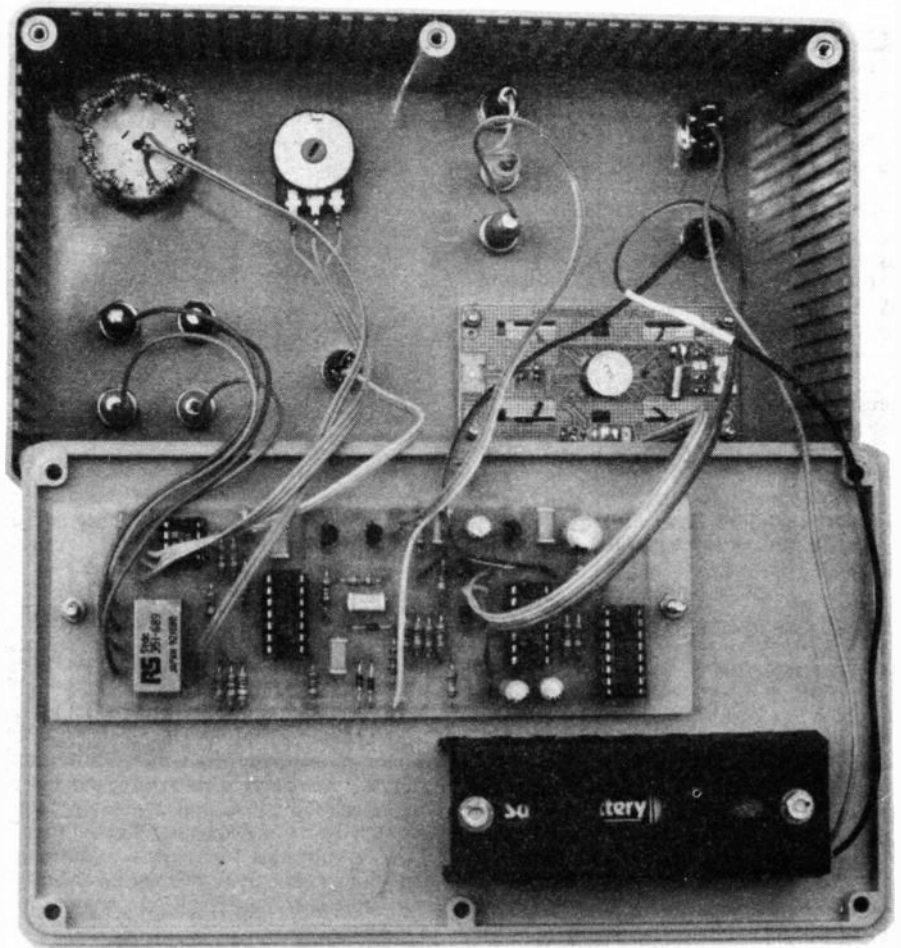

Layout of components inside the case and on the lid.

(four cells) and the "+5 volts" socket on the front panel connected to the "Battery on Test" positive socket.

If S4 Start is now pressed, the relay should close and stay closed. If VR1 is now rotated slowly clockwise, at around 3/4 travel (equivalent to 1.25V) the relay should open. If this seems OK IC2 and IC3 can be fitted.

Connecting +5 volts to the "count" input should cause the counter to run. The

previous test using the battery input with "+5V" can be repeated, when Start is pressed the counter should reset and start counting, and it should stop if the input voltage is removed, or VR1 rotated as before.

With testing complete, the p.c.b. is secured in the case with a couple of small screws, and the battery positioned beside it. The prototype used a small piece of cable-trunking as a battery holder.

Fig. 5. Interwiring from p.c.b. to all off-board components.

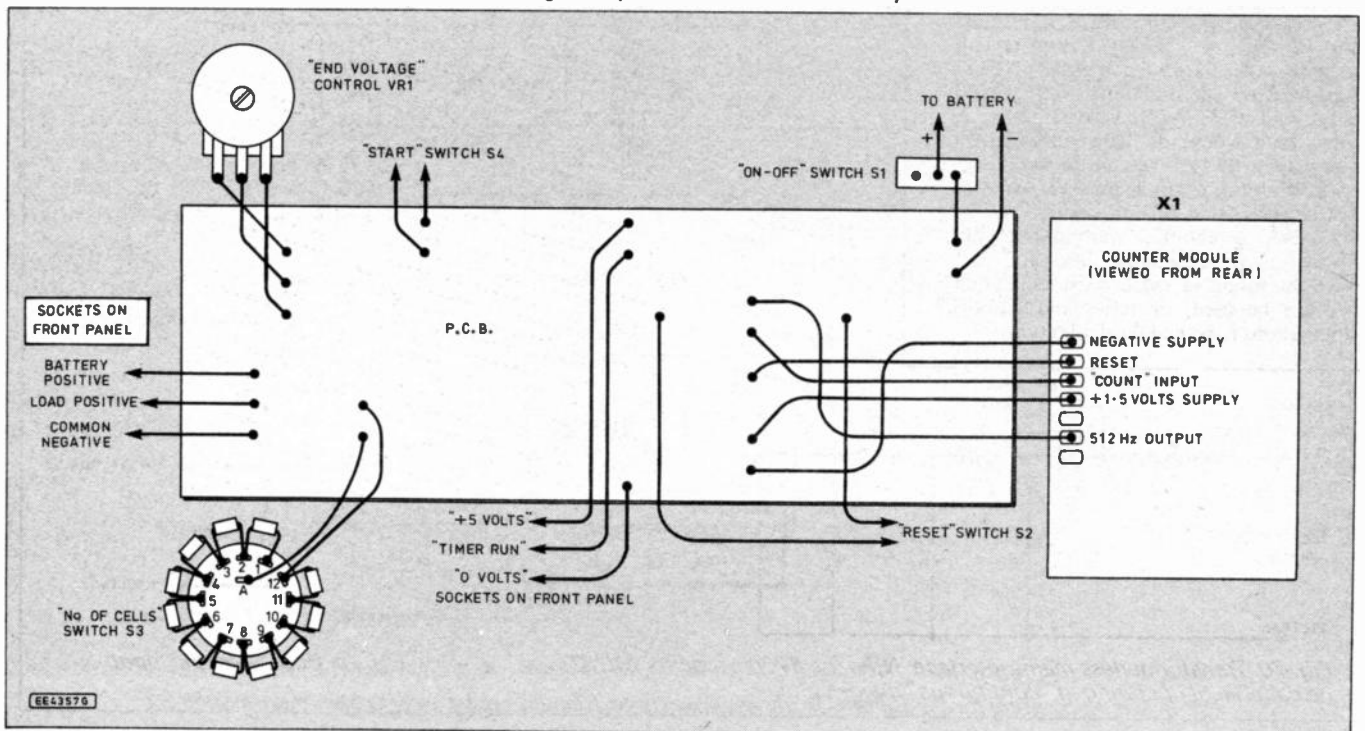

## CALIBRATION

Finally, to finish the project the End Voltage control VR1 can be calibrated. The easiest way to do this is with a variable voltage power supply and a resistor arranged as shown in Fig.6a. If such a supply is not available the job can be done with a one kilohm linear potentiometer and a couple of resistors, using the +5V supply as shown in Fig.6b.

Either way, the procedure is as follows: With the Number of Cells switch S3 set to "1", VR1 at it's lowest setting (fully anti-clockwise), and the input voltage set to maximum, the Start button should be pressed and released. This will cause the relay to close.

The input should now be adjusted for an indication of 1.1V on the meter, and VR1 advanced slowly until the relay is heard to open. This should occur around the midpoint of VR1 and the point should be marked.

This process is repeated to find the other main points for VR1: 0.9V, 1.0V, 1.2V and 1.3V. The reason for this apparently complicated procedure is that, with a voltage source having series resistance, the voltage at the input will change when the comparator operates, and will even vary a little when the Start switch is pressed. It must therefore be set with the relay closed and S4 released.

## IN USE

This completes construction of the unit. For checking NiCad capacity, first give the cell or battery a full charge. Then connect it to the "Battery" terminals, with a suitable load resistance across the "load" terminals.

Set the "Number of Cells" to the appropriate value, and the End Voltage to the voltage-per-cell at which they are considered to be fully discharged, 1.1V being a suitable value. Then just press Start, and leave the unit to time the battery's discharge period. That's it, the process could hardly be simpler.

Cell capacities are usually quoted for a 10-hour rate, or their capacity when discharged over a period of ten hours. For an AA cell rated at 500mA-hour, a load is needed that will draw 50mA. Given that the nominal voltage of a cell during discharge is about 1.2V, a resistor of 1.2/0.05 ohms, or 24 ohms, would be the load to use. In practice a 27ohm component is fine.

Likewise, six 2amp-hour "C" cells would need a load of 7.2/0.2ohms, or 36ohms. A 33ohm load would do here, although 39 in parallel with 470 would be more accurate. With this example however, wattage must be considered. The dissipation will be  $7.2 \times 0.2W$ , or about a watt and a half, sufficient to produce some heat and also above the rating of small resistors. Larger ones can be used, or series and parallel combinations to spread the dissipation.

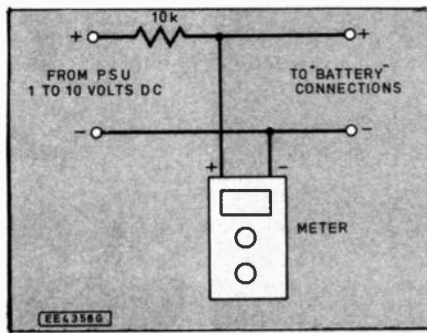

Fig. 6. Calibrating VR1. (a) Using a 1 to 10V variable power supply (above) and (b) using internal 5V supply (right).

However, if a camcorder battery is to be tested at it's working current, the dissipation may well be five to ten watts or more, so resistor ratings and heat dissipation will assume greater importance.

## TIMER

Finally, the unit can be used as a timer. The obvious application is checking how much of the day an appliance, such as a fridge or a thermostatically controlled heater, actually runs.

This means interfacing the unit to the mains. There are various methods of doing this. Best of all is an isolated contact, if this is available. It probably won't be, in which case other means will have to be found. The simplest is a small transformer, supplying an external voltage to "count" as shown in Fig. 7a.

Application of an input voltage a little above the internal supply rail of the instrument will not cause any harm, as resistor R5 and the internal protection diodes of IC2 will handle it. The 100µF capacitor ensures a steady d.c. potential, whilst the 4k7 resistor discharges it within a second or two when the mains turns "off".

Another method, using a capacitive mains dropper and an opto-isolator, is shown in Fig. 7b. This is simpler and cheaper but potentially more hazardous,

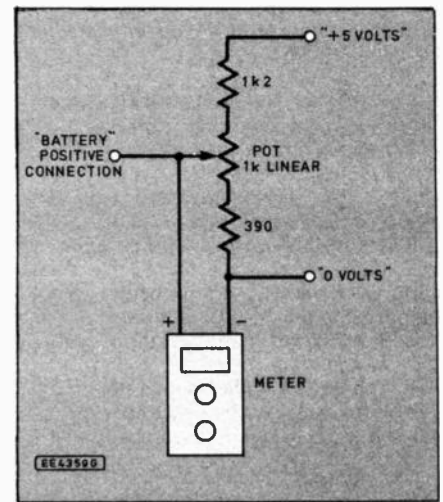

and should only be used by experienced constructors. In particular the 470nF capacitor **MUST** be rated for continuous application of mains supply voltage.

The simplest interface is photoelectric. Provided "dark" is dim enough, a phototransistor can be placed directly across the "+5V" and "count" connections, and will cause the timer to operate only when exposed to light. The one tried with the prototype had a flat to identify it's "collector", this went to the +5V side. This is all you need to find out how long the kids leave the lights on!

A CDS photocell also worked, but proved more sensitive. The simple circuit of Fig. 7c improves the performance for both CDS cell and phototransistor, and allows a reasonable degree of sensitivity adjustment.

Finally, note that as both negative and +5 volts are brought out to the front panel, it is possible to connect these together with potentially disastrous results for regulator IC1. If you think you're likely to do this, it might be wise to insert a 100 ohm or greater resistor between the board and this terminal to limit the maximum current that can be supplied from it. □

Fig. 7. Assorted interface circuits for the Timer.

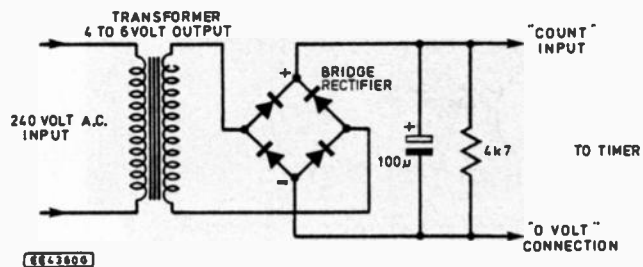

Fig. 7a. Mains interface using a transformer.

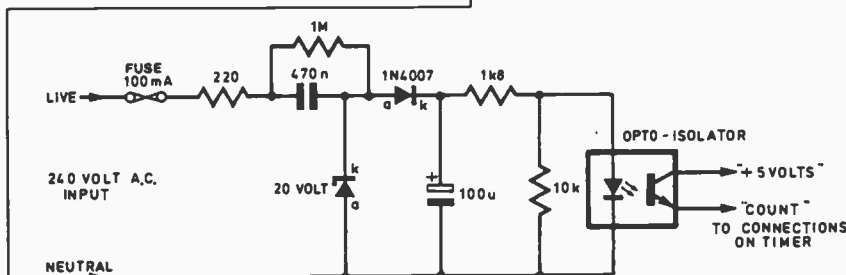

Fig. 7b. Transformerless mains interface. Note the 470nF capacitor **MUST** be capable of operating at "continuous" mains voltage.

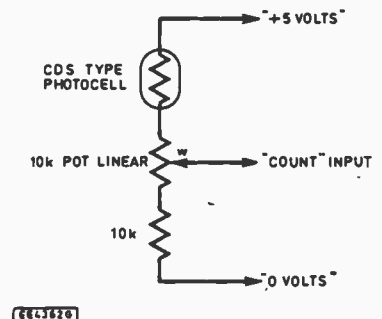

Fig. 7c. Photo-electric input.

# Roline Systems Ltd



**AD/DA Conversion Card**  
12 Bits Res. 16 Channels I/P

From £45

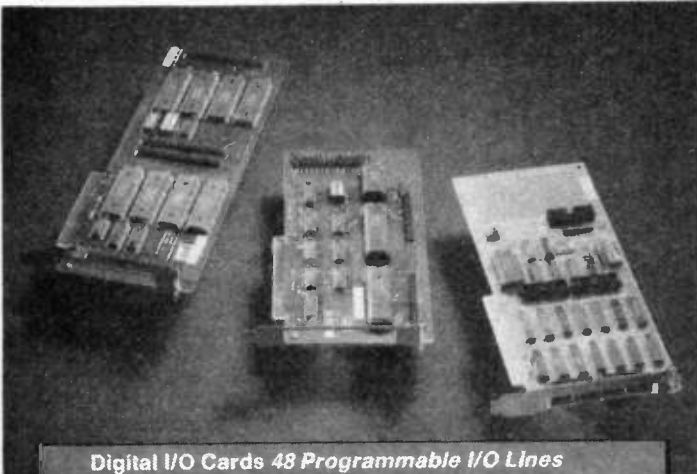

**Digital I/O Cards** 48 Programmable I/O Lines  
(3 Independent 16 Bit Counters)

From £23



**Voice Communications Card**  
Intelligent Telephone Card

From £175



**8 Port RS-232 Card with Software**

From £99

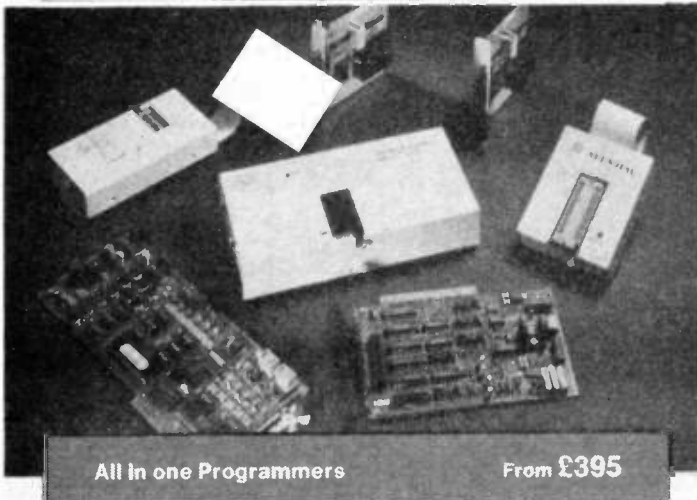

**All in one Programmings**

From £395

## PC Based Industrial and Lab, Data Acquisition, Control and Measurement, Instrument Cards

### AD/DA Cards

Plus Accessories & Software

### C.P.U. Boards

Device Programmers

Digital I/O Cards

I EEE 488 Cards

Industrial Chassis

Industrial Control Cards

Interface Convertors

Relay Output Cards

RS 232 Cards

Single, 2, 4, 8, 16, Port

RS 422 Cards

Single, 2, 4, 8, Port

PC ROM Disk Cards

Slot Extender Cards

For further information,

Product/Price List

Call Us On :

**Tel: 0902 20267**



Roline Systems Ltd  
Imex House  
Imex Business Park  
Upper Villiers Street  
Wolverhampton  
West Midlands  
WV2 4NU

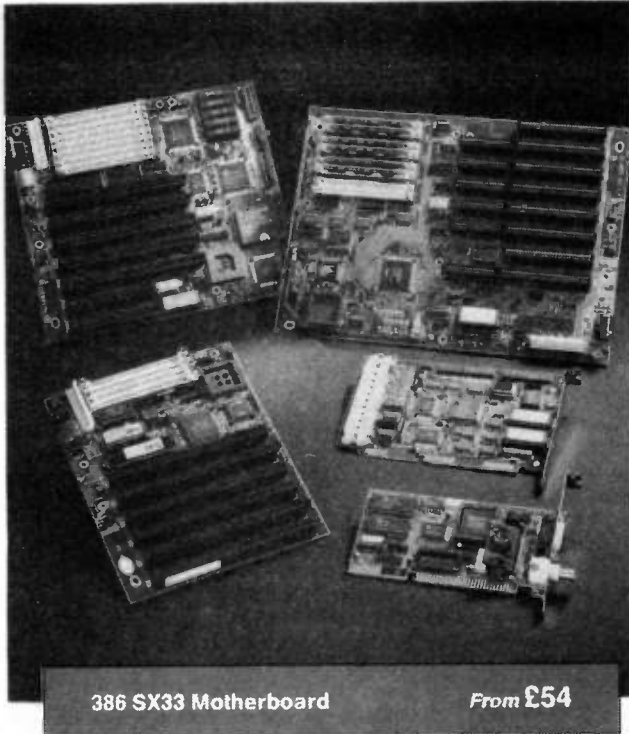

386 SX33 Motherboard

From £54

## Specialist PC & Multimedia Add-on Cards

PC - Telephone Voice  
Communication Cards  
Fax Modem Cards  
Voice Recognition Cards  
Voice Digitiser Cards  
TV/Video - PC Adaptor  
Video Grabber Cards  
Video/TV - PC - Video/TV Cards  
Sound Cards

## Components

Cases  
Floppy Disk Drives  
Hard Disk Drives  
From 40MB to 2.1GB  
Keyboards  
Monitors  
Mother Boards  
Cache Controller Cards  
Network Cards  
Tape Back Up Units

**Fax: 0902 28439**

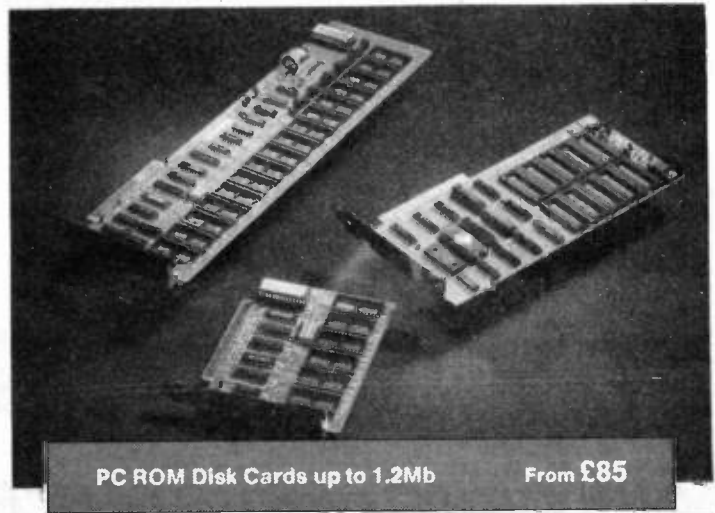

PC ROM Disk Cards up to 1.2Mb

From £85

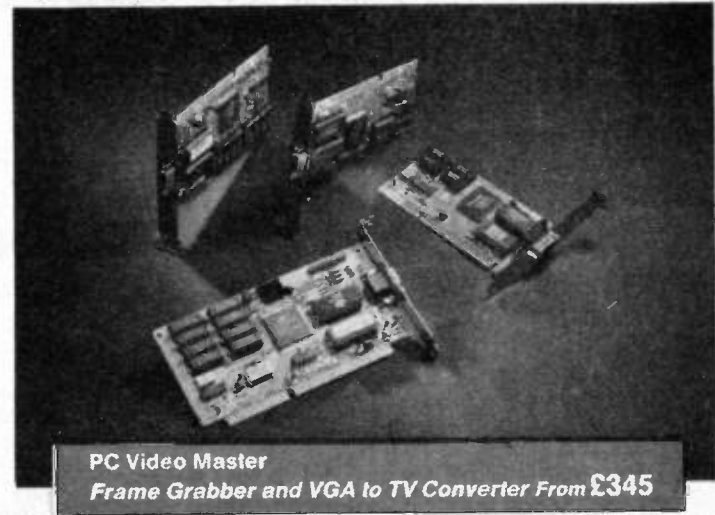

PC Video Master

Frame Grabber and VGA to TV Converter From £345



1.0 GB 3 1/2 HDD

From £685



# BATTERY TO MAINS INVERTER



## AND UNINTERRUPTABLE POWER SUPPLY

MARK DANIELS

Part Two

A 250W to 600W design with pulse width modulation for voltage control and an uninterruptable supply add-on. It can also be built for 50Hz or 60Hz operation.

CONSTRUCTION of the Inverter p.c.b. was completed last month. Before continuing check that all components are fitted correctly to the p.c.b. and, if you have not already done so, solder the components to the top foil where appropriate. When the Inverter has been tested the p.c.b. should be given a coat of protective lacquer to prevent corrosion of the copper tracks.

### CASE PREPARATION

This section describes all the case preparation details for the complete U.P.S. since all the metalworking will have to be completed before any components are fitted to the case. If only the Inverter section is being built then some of the holes will be redundant and may be omitted. Also, two extra holes are required for the battery leads and should be included.

A 3U high 19 inch rack mounting case is specified for the Inverter with U.P.S. since it will give sufficient room for internal mounting of the stand-by batteries and charger circuit. A smaller case may be used as an alternative for the stand alone

Inverter, and many suitable metal ones are readily and cheaply available.

All necessary back panel cutouts for the complete U.P.S. are shown on the dimensioned drawing of Fig. 11. Before putting drill to metal ensure that all parts can be obtained and the mounting apertures required are identical to those on the diagram. If not, alternative cutouts will have to be made to suit. For the U.P.S., a 90mm slimline 240 volt fan, an I.E.C. mains inlet connector and a d.p.d.t. mains rocker switch rated at 5 amps (which are not included in the components list for the inverter) are also to be mounted on this panel, so it may be advisable to obtain them before starting the metal working.

The ten 4mm holes may easily be drilled and will cause few problems. The rest of the holes require a little more care and a somewhat different approach.

To drill six 13mm holes close together in thin sheet steel is asking for problems: the metal will almost certainly buckle, unless securely clamped with the drill mounted in a drill press. It may be wiser to drill small pilot holes and use a "Q-Max" chassis cutter or similar. A 14mm cutter, the smallest size generally available, should prove

suitable. Alternatively drill the holes under size and finish with a file.

The 90mm hole for the fan may also be cut using a suitable punch, but being close to the edges of the metal it will generally cause considerable distortion. A better method, in this case, would be to use an electric jigsaw (preferably variable speed).

Mask the panel with tape before starting to protect the vinyl finish, mark out the cut to be made and drill a 10mm hole near the cut line. Clamp the metal securely and, with a fine steel cutting blade fitted to the saw, make the cut very slowly. Do NOT use cutting oil as it may damage the vinyl finish. CAUTION: Always wear eye protection when using a power saw to cut steel.

Punches are available for the remaining cutouts, but tend to be extremely expensive, particularly for the cruciform sockets. Circular 13 amp sockets of 50mm diameter are also suitable and the punches are cheaper so may prove a viable substitute.

An alternative method of making the necessary cut-outs is to mark out the holes and chain drill inside the lines before knocking out the waste. File to the finished size, using the components as a guide. There are only two components to be fitted to the front panel, but considerable care must be taken to avoid marking the brushed finish when drilling and filing, other than this the same techniques as applied to the back panel may be employed. A suitable front panel layout is given in Fig. 12.

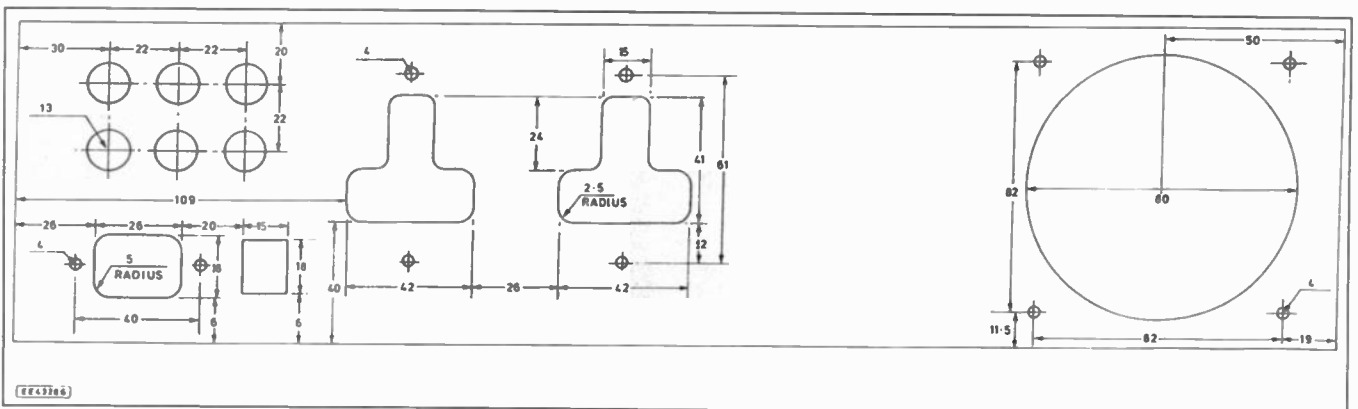

Fig. 11. Back panel cut-out for the U.P.S./Inverter.

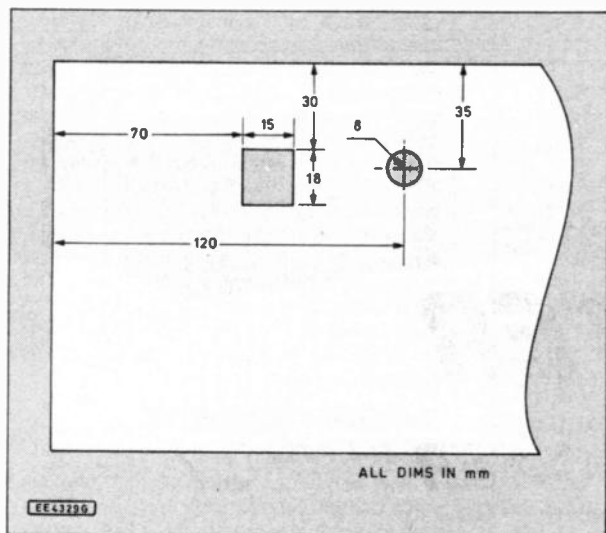

Fig. 12. Front panel cutout details.

Clean any burrs off with a fine file before lettering the panels then apply two coats of semi-matt lacquer to protect the letters.

Assemble the components to both panels before finally putting the case together in accordance with the manufacturers instructions.

### HEATSINK ASSEMBLY

Fit a silicone rubber insulating gasket to each BUV20 power transistor (TR7, TR8) before fitting uninsulated crimp type butt connectors (blue insulated crimps may be used if the insulation is removed first) to their emitter pins (see Fig. 13 for pin-out). Crimp the connectors before soldering to ensure a good joint and insulate with heat resistant sleeving where they pass through the heatsink.

Fit a silicone rubber gasket to each 2N3055 (TR5, TR6) and fasten a BUV20 and a 2N3055 to each heatsink with long "top hat" insulating bushes in the heatsink for the mounting bolts to pass through. No heatsink compound is necessary if silicone rubber gaskets are used. Use M3 x 16mm screws inserted from the top side of the transistors with a plain and a spring washer under each nut.

A short length of 20 s.w.g. tinned copper wire fitted with M3 eyelets at each end should be used to make the connection between the collectors of each pair of transistors. Fit the eyelet between two plain washers and fit a spring washer under the nut. The spring washers must NOT be omitted as the nuts will eventually work loose leading to a non-existent electrical connection and ultimate failure of the expensive output transistors.

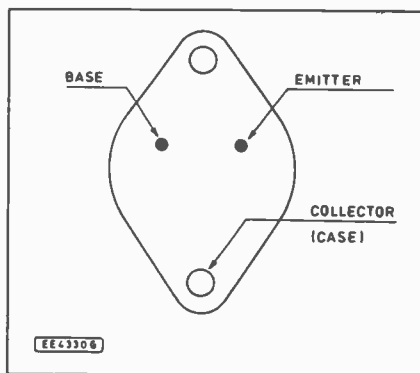
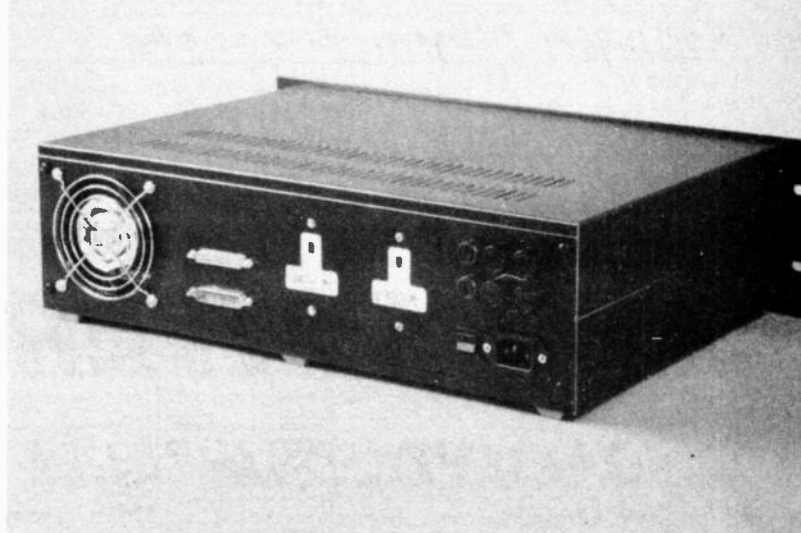

Fig. 13. Power transistor connections.



Layout of the back panel for the U.P.S.

### CHOKES CONSTRUCTION

The output filter choke L3 is wound on a large ferrite core with thick enamelled copper wire. A single 110 turn winding is wound in four close spaced layers on the bobbin and is terminated at any convenient pair of tags on the bobbin.

The winding direction and precise number of turns is unimportant, four complete winding layers of 1.2mm (or thicker) enamelled wire will be adequate. The inductance of the completed choke should be approximately 5.6mH and its d.c. resistance less than 0Ω1.

P.T.F.E. pipe thread tape may be used for covering the winding, applied tightly this will reduce vibration and aid noise reduction although the prototype was left uncovered and produced little noise.

Before assembling the core to the wound bobbin clean the mating faces to ensure a zero gap when finally clamped. This will reduce the possibility of cracking the fragile ferrite core material and reduce buzzing when in operation.

### MAIN ASSEMBLY

The case layout for the Inverter components is shown in Fig. 14 and should be adhered to if the U.P.S. add-on is to fit in the remaining space.

The printed circuit board is mounted vertically by means of an aluminium angle bracket, 165mm by 115mm with a 30mm lip along one long side. Four 10mm long insulated pillars are used between the bracket and the p.c.b. with a sheet of insulating material, such as acetate (available from photocopier suppliers or stationers), secured between the p.c.b. and

the pillars to prevent possible short circuits between the board and the metal.

The pre-assembled heatsinks can be fitted, with the connections facing outwards as shown, using the pre-punched holes in the bottom of the case and self-tapping screws in the keyhole slots provided in each extrusion.

An optional 80mm fan may be fitted on top of the heatsinks using self-tapping screws in the same keyhole slots as above. If heatsinks other than those recommended are used an adaptor plate similar to that shown in Fig. 15 will have to be fabricated.

The large electrolytic supply decoupling capacitor C1, if fitted, is fastened to the case with a capacitor mounting clip as shown. C1 is only essential if long input cables are fitted but may be retained with some benefit in other cases. Values between 10,000μF and 47,000μF are recommended, with the larger sizes giving maximum benefit, albeit at a price.

Fit the toroidal transformer T1 between the two supplied neoprene gaskets, with the dished steel washer on the top, and clamp it down with the bolt. One of the pre-punched holes in the bottom of the case may be used for the mounting bolt after opening it up to 6mm.

**IMPORTANT:** Do NOT overtighten the nut as this can damage the insulation on the windings, causing an internal short circuit and ultimate failure of the transformer. Also ensure that the top end of the mounting bolt cannot come into contact with anything electrically connected to the chassis (including the case lid) as this would constitute a shorted turn and cause the transformer to overheat. Do not attempt to make an earth connection via this mounting bolt either as this will have the same effect.

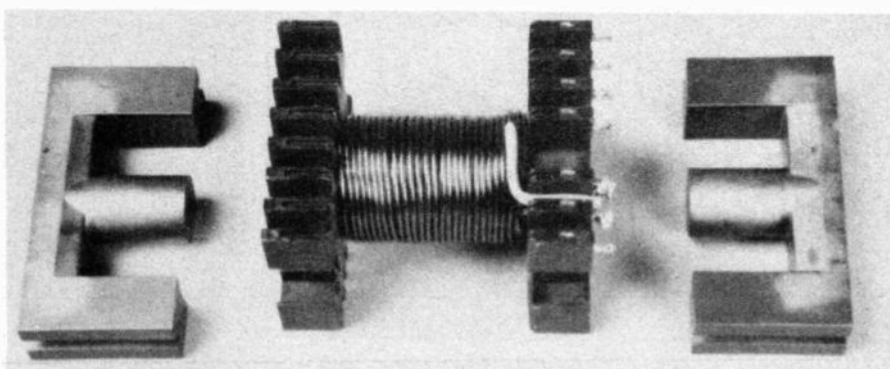

Exploded view of inductor L3



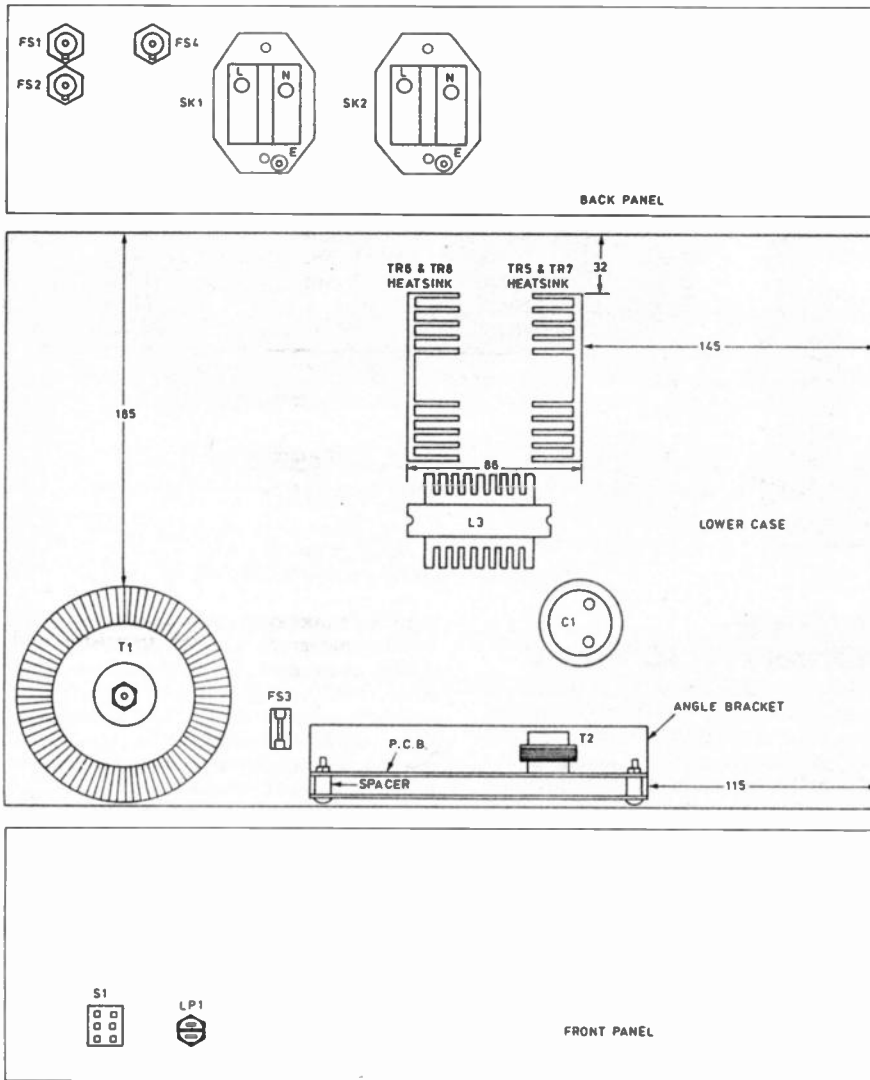

Fig. 14. Case layout for the main components.

## LOW POWER WIRING

The main wiring diagram of Fig.16 shows all the low current connections to be made between the p.c.b. and off-board components using 7/0.2mm stranded wire. Sensible use of colour coding is recommended as this will ease the task considerably and make fault finding at a later stage much more straightforward.

If p.c.b. plug and socket connectors are used the terminals will need to be crimped or soldered onto the ends of each lead before fitting them into their respective

positions in the shell. Ensure that all wires are of adequate length to reach their destinations when correctly routed, they can always be shortened at a later stage.

All six leads from PL2 go directly to the power transistors TR5 to TR8. Extreme care must be exercised when making the connections to these devices since an error here will almost certainly result in one or both of the BUV20's self-destructing at switch on. Sleeve the connections to the transistor pins, preferably with heat shrink sleeving, as a precaution against possible short circuits.

Three of the leads from PL1 go to the

main switch S1. Care should be taken to ensure that the correct lead is connected to the common terminal of the switch. Only one pole of this d.p.d.t. switch is presently used, the other being reserved for the U.P.S. circuit to be described next month.

Two of the remaining connections on PL1 are for the 12 volt d.c. supply, which is fused at 250mA in the positive line by FS3. The other connects directly to the negative supply rail and provides the common return for the logic and p.w.m. circuits. The final connection to this plug provides a 7.5 volt supply to the U.P.S. add-on board to be described next month and should be ignored at present.

## HIGH POWER WIRING

The remaining wiring is high voltage and/or high current and must be carried out in accordance with the I.E.E. wiring regulations for the completed inverter to be electrically safe.

All cables on the high voltage side must be rated for continuous operation at mains voltage and must be suitable for the anticipated maximum current (approximately 1.7 amps).

The high current cables in certain sections of the low voltage side may be called upon to carry currents of up to 40 amperes. A minimum cross-section of 6mm<sup>2</sup> is necessary for all internal wiring operating at this current. The battery leads may need to be considerably thicker and should be chosen according to their length and the recommendations in Table 2.

Flexible cable above 6mm<sup>2</sup> cross-section may prove difficult to obtain from your regular electronic component supplier, although Maplin list some up to 10mm<sup>2</sup> for use with their high power car audio equipment.

Welding cable, which is ideal, is much more readily available, along with suitable solder lugs, from large motor factors or welding equipment suppliers. This is normally extremely flexible and easy to work with, soldering being accomplished with a gas torch! Large crocodile clips of the type fitted to car booster cables should also be stocked by the same sources and will be ideal for the final battery connection.

All the heavy current wiring is shown in Fig. 17, with appropriate cable sizes indicated. Heavier gauge wire may be substituted, but the indicated sizes should be regarded as an *absolute minimum*. Keep all low voltage, high current connections as short as possible to minimise cable volt drops.

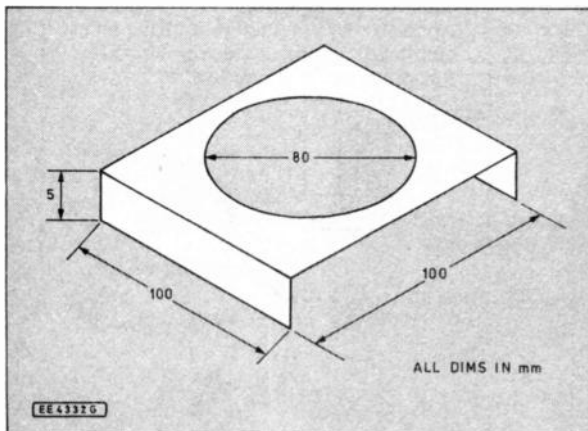

Fig. 15. Adaptor plate for optional fan mounted on the heatsinks - not shown in photographs.

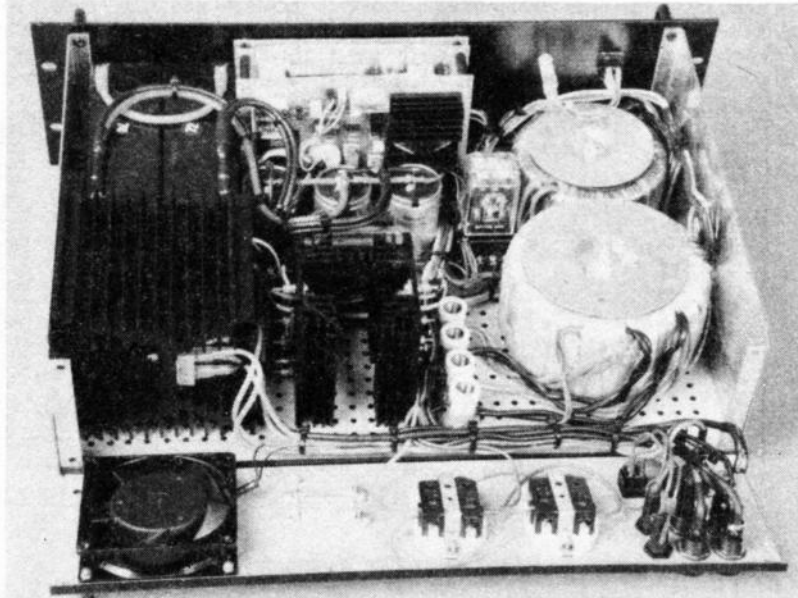

Table 2. Cable Size Recommendations.

Cable Size	Resistance ( $\mu\Omega\text{m}^{-1}$ )	Max Current (Free Air)	Max length for 0.2V Drop @ 25A	Max length for 0.2V Drop @ 60A
6mm <sup>2</sup>	2650	48A	3.0m	+
10mm <sup>2</sup>	1590	68A	5.0m	+
16mm <sup>2</sup>	994	95A	8.0m	3.0m
25mm <sup>2</sup>	636	130A	12.5m	5.0m
35mm <sup>2</sup>	454	175A*	17.5m	7.0m
50mm <sup>2</sup>	318	230A*	25.0m	10.5m
75mm <sup>2</sup>	212	310A*	+	16.0m
100mm <sup>2</sup>	159	380A*	+	21.0m

\*Approximate values. + Not recommended. Specified lengths are total cable lengths, i.e. feed and return.

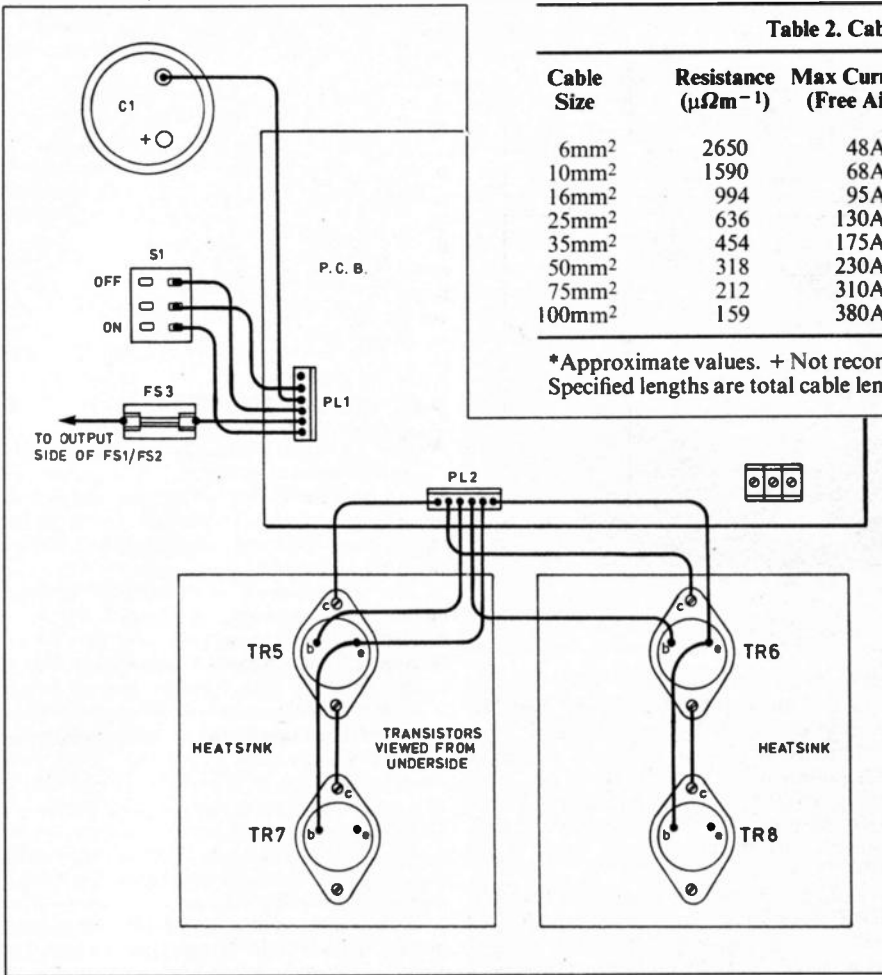

Fig. 16. (above) Main wiring diagram.

## TRANSISTOR CONNECTIONS

The emitter terminations for TR7 and TR8 are made by crimping and soldering an M5 tag onto the end of a length of 2.5mm wire. The tag may then be slipped onto the bullet connector already attached to the emitter pin of the transistor and soldered in place. A lot of heat is required for this and a soldering iron rated at a minimum of 50 watts will be required. Keep the iron on the joint until the solder flows around the entire connection, which may take 20 or 30 seconds and although the transistor may get very hot during this operation it will survive, provided it is well heatsinked.

Solder tags (M3) fitted to the blue and yellow leads of T1 will facilitate connection to TR7 and TR8 collectors via the transistor mounting bolts.

Fig. 17. (below) High voltage and high current wiring.

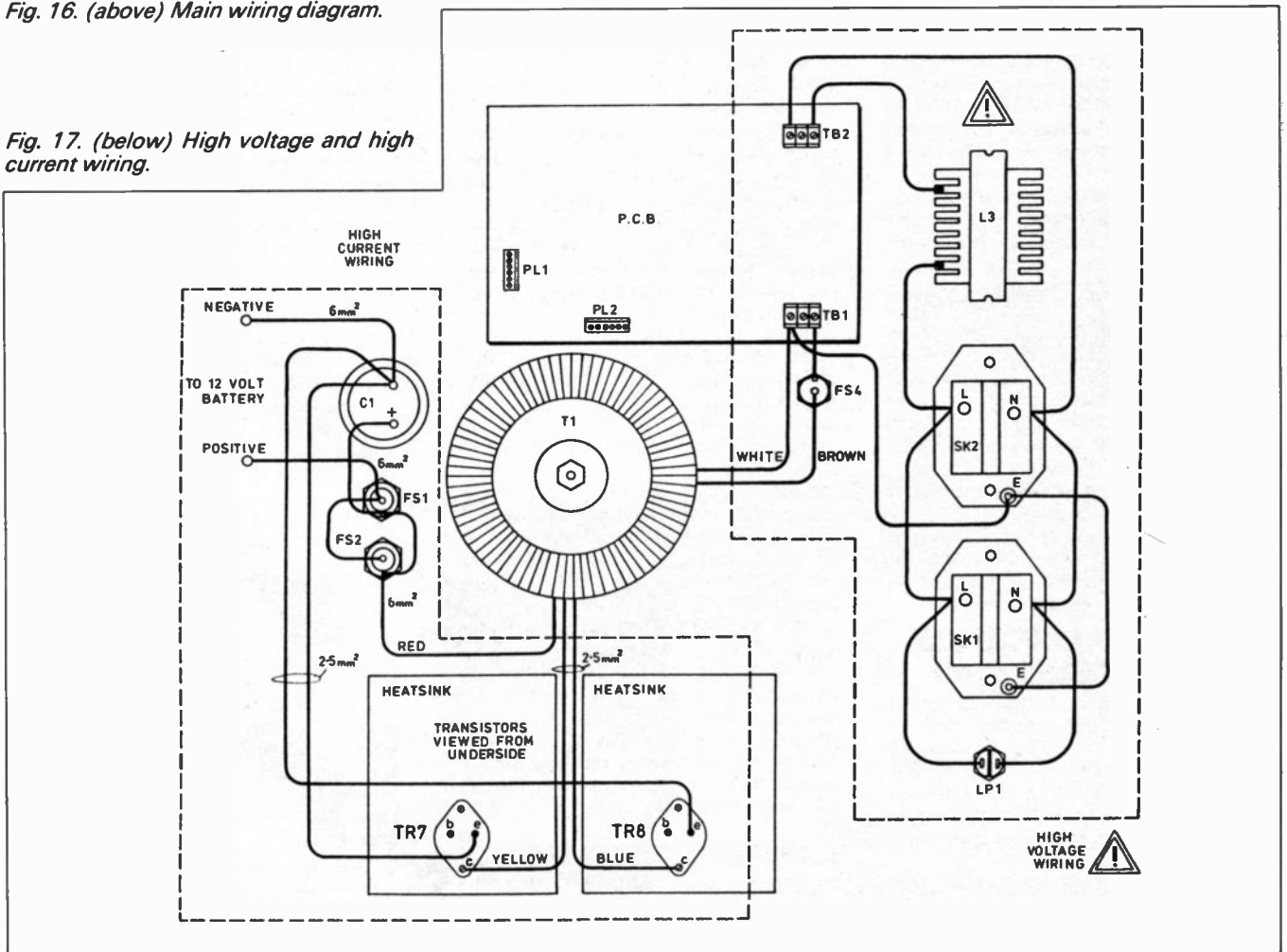

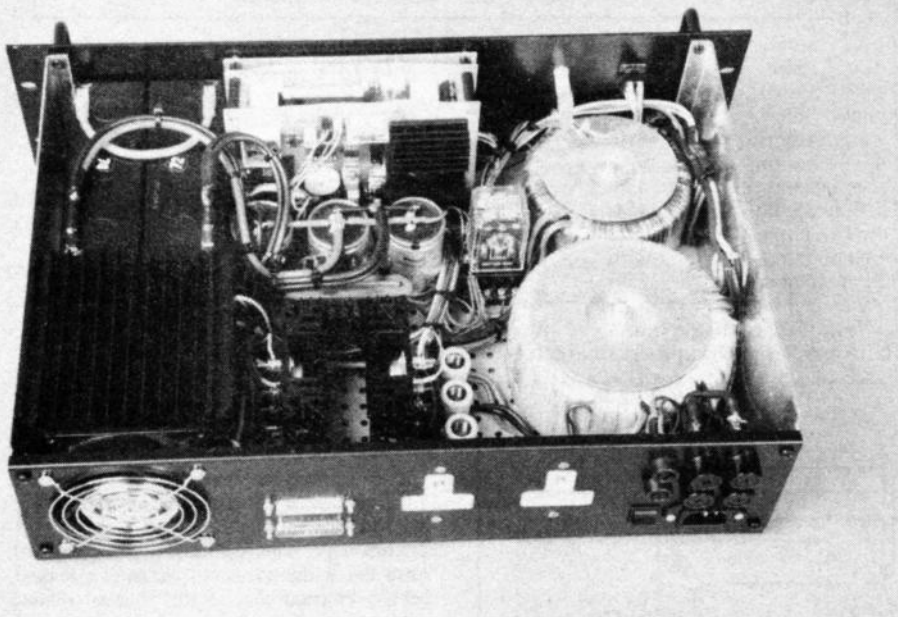

Use a plain washer either side of the tag and a spring washer under the nut.

If loading is expected to be intermittent or light a 30 amp terminal block, may be used for the connection to the battery leads, otherwise a 50 or 100 amp rating is required. The larger sizes of welding cable (above 10mm<sup>2</sup>) will need the 100 amp type to accommodate the conductor size. Most small electrical factors will sell these in one and two-way strips cut from a standard 12-way block.

Large compression type cable glands should be fitted through the back panel to provide strain relief for the battery leads. The terminal lugs for large welding cables are normally fitted with a special crimping or swaging tool which compresses the soft copper lug around the cable providing a very secure joint. Some of the smaller suppliers will terminate the cables for a small charge.

An alternative method is soft soldering which may be readily carried out at home using a standard full size gas torch. Strip the insulation back approximately 10mm to 15mm from the cable end and fit the terminal, compressing it sufficiently with a pair of pliers to grip the cable lightly. Support the cable with the terminal uppermost and apply heat to the terminal, taking care not to burn the cable insulation. With the joint up to temperature remove the flame and feed flux cored solder into the joint until it is saturated, re-heating as necessary. Two metres, or more, of 22 s.w.g. solder may be needed for each joint.

Once cooled the joint should be taped with p.v.c. insulating tape and bolted to the appropriate crocodile clip, slipping the insulated handle grip onto the cable first.

## SETTING UP AND INITIAL TESTING

Before rushing out and removing the car battery to test the newly completed inverter spend a few minutes re-checking all wiring and p.c.b. assembly (also make sure removal of the car battery will not affect a coded stereo or the car electronics, which in some case may need expensive resetting if the battery is disconnected).

The time spent at this stage could save hours of valuable time and money later – remind yourself how much the pair of BUV20 transistors cost, as these are the

most likely components to suffer terminal failure if an error has been made! **Read this section thoroughly before proceeding.**

Initially fit FS1 in its holder and leave FS2 out. Ensure that the other two fuses are fitted and of the correct rating. Check that the preset VR1 is adjusted to the mid-point of its travel and that S1 is in the "Off" position.

Connect the battery leads to a 12 volt car battery, which is known to be fully charged and in good condition, observing polarity as **no reverse polarity protection is provided.** See the Modifications section at the end of this article if this is desired.

Connect a meter set to read 500 volts a.c. to the output of the inverter and, if available, a 30 amp f.s.d. ammeter in series with the battery positive connection. Switch the inverter on and watch the ammeter needle, which should flick momentarily across a large part of the scale before quickly settling down close to the zero. Any reading much greater than two amps indicates a potential fault and the Inverter must be switched off immediately and all wiring double checked. In practice the off-load input current will probably be 500mA or less.

Check the voltage indicated by the voltmeter, anything in the region 200 to 350 volts is indicative of normal operation. Adjust the preset VR1 to obtain approximately 240 volts. With the step regulation employed exact voltages are often unattainable and will vary by a few volts in normal circuit operation, but this is unimportant in this type of application.

Switch off and check the temperature of all the power transistors, including TR3 and TR4 and the small voltage monitoring transformer T2. Also check resistors R24 to R29 and R33, some of which may be quite hot, but not unacceptably so.

If all is well so far, run the Inverter off-load for a minimum period of 30 minutes whilst checking all of the above components for any sign of overheating. **Always switch off before touching anything since mains voltages are present on the p.c.b. and some of the wiring.**

## LOAD TESTING

Connect a small load of around 25 watts (e.g. a soldering iron) to the Inverter and check the voltage, which may change slightly. Monitor the temperature for a

further five minutes before connecting a larger load of around 100 watts (a table lamp is ideal).

The power transistors should start to warm up a little now and it would be wise to keep an eye on all high current connections, particularly soldered ones, for any sign of potential failure. Fifteen to twenty minutes should reveal any problems likely to occur at this stage.

Full load for this Inverter is 300 watts continuous and will require FS2 to be fitted for a prospective input current of around 30 amps.

Two table lamps fitted with 150 watt bulbs (the shades will need removing!) will provide a suitable full load test and will require the battery to be in good condition and to have been fully charged for the initial stages of testing.

**CAUTION: The battery may gas heavily during this test, producing hydrogen and oxygen which will form an EXPLOSIVE mixture. Do NOT smoke near the battery or produce sparks or naked flames of any kind.** Extinguish any gas soldering irons, even the catalytic types which do not produce an actual flame. **Simply disconnecting one of the crocodile clips from the battery before switching the Inverter off will cause a spark of sufficient magnitude to initiate an explosion!** See also the section on Safety (last month).

A 30 minute continuous full load test should be accepted as the minimum before the Inverter is put into service. The main points to watch are the soldered connections to the BUV20 output devices, FS1, FS2 and the centre-tap of T1. The transistors will get quite hot during this test, but should remain below 85°C at all times. If not, consider upgrading the heatsinks or fitting the optional fan.

The Inverter should be able to maintain at least 220 volts into the load for the full 30 minutes of the test. If it does not, suspect the battery first, then try adjusting VR1 slightly to ensure that the maximum pulse width is being obtained. An oscilloscope may be helpful here (see the section on Fault Finding). Note: it may be necessary to adjust VR1 to obtain the best regulation across the entire load range.

At this stage it may be prudent to disconnect the Inverter and run the car engine for a while to replenish the charge in the battery. The final test is to use the Inverter with an electric drill under load which will require an input current to the Inverter of around 45 to 50 amps. The prototype was tested using a heavy duty portable drill with a 620 watt motor to bore a 16mm diameter hole through mild steel!

The performance was not quite up to mains standard but the task was still completed quite rapidly.

## FAULT FINDING

The complete circuit is quite complex and fault finding may be quite a daunting prospect. If the circuit is considered in sections as shown in the block diagram of Fig. 6 each may be individually analysed in a simple and straight forward manner by referring to the appropriate sections of the text and main schematic of Fig. 7. A multimeter and an oscilloscope are the most useful pieces of test equipment for fault finding on this circuit, without them there is very little you can check.

Before delving into the depths of the electronics check for simple things such as ruptured or missing fuse links, poor battery connections, etc.



If the Inverter refuses to work at initial power up re-check all connections between the p.c.b. and off-board components, then check the p.c.b. for bad joints and incorrectly placed or orientated components. At this stage do not assume that any of the components are faulty, as this is most unlikely unless they failed when the circuit was switched on, in which case there is still an error to locate.

Home produced p.c.b.s are another likely source of errors, particularly when as complex as the double-sided board in this Inverter. Check the p.c.b. against the foil patterns of Fig. 10 and the circuit diagram of Fig. 7 (last month).

If FS3 ruptures repeatedly at switch-on it is likely that D1 is connected with the incorrect polarity and should be replaced with a correctly fitted new one. Measure the voltage across the Zener diode D2 which should be 7.5 volts  $\pm$  5 per cent and compare this with the voltage across the power supply pins of each i.c. in turn. Zero volts at any i.c. indicates a broken or missing track.

Once it is ascertained that power is present at all i.c.s the inputs and outputs may be checked using an oscilloscope. The output of one should match the input to the next (refer to Fig. 7 to obtain connection details).

## LOGIC CIRCUITS

For the logic circuits it is worth noting the following. An AND gate requires a logic 1 (about 7.5 volts) on both inputs to give a logic 1 at its output, anything else will give a logic 0 (zero volts). The Schmitt Inverters in IC10 change a logic 1 at the input to a logic 0 at the output and vice-versa. The NOR gate in IC6 will only give a logic 1 at its output when all inputs are logic 0, otherwise it gives logic 0.

If the Inverter runs but will not regulate the fault is most likely to be around the op. amps IC8 and IC9 or the NOR gate IC6. Check that transformer T2 is giving an output of around 12 volts a.c. Capacitor C15 should have approximately 12 volts d.c. across it which is regulated to 5.1 volts  $\pm$  5 per cent by D6. A voltage of approximately 0.6 volts across a Zener would normally indicate that the diode is incorrectly polarised. Check also that the voltages across the resistors in the potential divider are in proportion to their value.

The power output stage is relatively simple and should not pose any problems. Simple checking of the connections and security of the joints will usually suffice. It is possible, though unlikely, that a transistor may have failed at initial power up, in which case the following section may provide some fault-finding clues.

## COMMON FAILURE MODES

Practical experience with Inverter design over a period of several years has generated a list of stock faults and common failure modes. A number of these are presented here, but the list is by no means exhaustive and should not be treated as such.

Failure mode 2 is the most common, occurring in probably 90 per cent of cases, fortunately it is also the easiest to diagnose.

1. CMOS devices, when they fail, often "crowbar" the power supply rails. To detect which device has failed, once a short-circuited supply has been spotted, simply involves measuring the voltage across the supply pins of each chip in turn with a digital multimeter. The failed device will

be the one with the lowest supply voltage measured and may be removed, the supply re-checked and a new device inserted.

2. Switching transistor base-emitter junction breakdown is characterized by the other transistor overheating as it drives pulsed d.c. into a low resistance primary winding. If this is not spotted immediately the remaining functional transistor will also breakdown.

When the first transistor fails the tone of the Inverter will change dramatically, from a smooth buzzing to a raspy tone. Switch off immediately to preserve the surviving device.

With the case lid removed it is normally fairly easy to detect which device has failed, since its base voltage will rise taking the voltage across its base-emitter shunt resistor several times higher than normal. The resistor is called upon to dissipate several times its rated power and overheats turning it black or brown. A darkened R28 indicates TR7 failure, likewise with R29 and TR8. Replace both transistor and resistor in each case.

3. Collector-base junction failure is much rarer and is accompanied by a similar change in Inverter tone, but no base-emitter resistor darkening.

To determine which device has failed in this case the transformer must be disconnected from the power transistors and the circuit powered up transformerless. Connect a 1k resistor between each collector and the 12 volt rail and use an oscilloscope to look at the waveform across each resistor. The good transistor will produce a reasonable quality square wave on the 'scope, whereas the failed device will produce a straight line at 12 volts.

Fit a replacement BUV20 and re-check with the 'scope before re-connecting the transformer.

4. A timebase failure will often leave one transistor switched off whilst the other drives d.c. into the low resistance primary winding of the transformer.

The Inverter stops functioning immediately in this instance, accompanied by complete silence, i.e. no change in tone first. The failed transistor is located as in 2 or 3 above, but the timebase must be repaired before re-starting the Inverter.

## EARTHING

There are a number of ways of wiring the output of the Inverter, including one which requires no earth connection. For maximum safety earthing is necessary in the majority of applications.

The simplest method is to connect one

side of the high voltage secondary to mains earth and to the socket outlet earth terminal, as shown in the wiring diagram of Fig. 17. This method may also be used with a properly installed grounding rod where no mains supply is installed. Consult the I.E.E. Wiring Regulations for further information on the installation of grounding rods.

Moving motor vehicles require a different earthing method to that described above, since they are not fixed in relation to the ground. In this case the 0 volt (white) side of the secondary should be connected to the negative\* battery connection and also to the earth terminal of the socket outlets. A grounding strap, of the type sold as a travel sickness remedy, should also be fitted to the vehicle in accordance with the manufacturers installation instructions to dissipate any static electricity build-up on the vehicle.

It may be necessary to use the Inverter without an earth connection in some circumstances, which will not be described here since they are well known to those who will need this facility. Since a non-earthed winding leaves the supply voltage floating it is possible for either side of the supply to be at a high potential above earth (although normally it will also be at a high impedance) it is therefore necessary for BOTH output leads to be fused identically.

The connection between the secondary 0 volt lead and the socket earth terminals should be omitted. If you do not specifically need an earth free supply, or are at all unsure about its application, then you MUST earth the output in one of the ways described above.

A residual current device (R.C.D.) which detects earth leakages and automatically disconnects the supply in the event of a fault would be a sensible addition to the Inverter, particularly in the earth free configuration. All commercial units are supplied with full installation instructions which must be adhered to, further information on installation and use may be found in the I.E.E. Wiring Regulations.

\*This applies to negative ground vehicles only. For positive ground systems this connection must be made to the positive battery terminal.

## MODIFICATIONS

The output frequency may readily be changed to 60Hz for use with American equipment by substituting a 4.9152MHz crystal for X1 as suggested in the text. To obtain 117 volts connect a 240 to 110 volt step-down transformer to the output of the

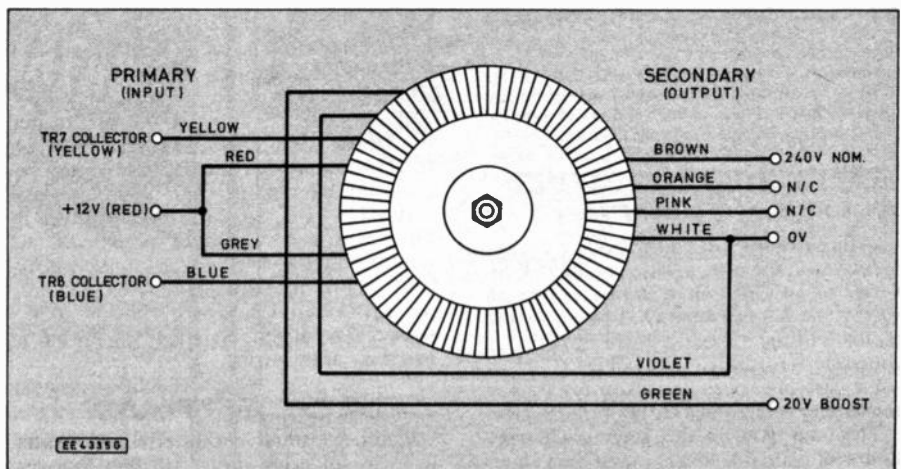

Fig. 18. Connection details of the transformer used for the 600W version.

**Table 3. Power Transistor Specifications.**

Type	I <sub>C</sub> (max)	PO (max)	V <sub>CE</sub> (max)	H <sub>FE</sub> (min)	at I <sub>C</sub>	Case*
2N3055	15A	115W	60V	20	4A	TO3
2N3771	30A	150W	40V	15	15A	TO3
BUV20	50A	250W	125V	20	25A	TO204
BUP49	90A	300W	80V	15	80A	TO204
BUP48	100A	300W	60V	10	100A	TO204

\*TO204 is identical to TO3, with the exception that it has 1.6mm diameter pins for heavier current handling.

Inverter and adjust VR1 to give approximately 117 volts across the 110 volt winding.

For a greater power output a larger transformer will be required, a 9E284 will be suitable for up to 600 Watts. The connection details for this multiple winding transformer are provided in Fig. 18.

The BUV20 output transistors will also need upgrading to BUP49 or BUP48 (see Table 3 for specifications) devices in order to take full advantage of the greater output capabilities. Resistors R24 and R25 will need reducing to 10 or 12 ohms, with a 2 Watt rating. Heatsinks, cables and fuses, etc. will also require appropriate increases in their respective ratings.

The chokes, L1 and L2, in the secondary circuit may be retained as they have a maximum rating of 3 amps. It is advisable to reinforce the p.c.b. tracks carrying this current with 20 s.w.g. tinned copper wire to prevent them from melting at full load.

By duplicating R24 to R29, C7 to C12, TR5 to TR8, L1, L2, VDR1, VDR2, FS4 and T1 the control electronics may be employed to drive more than one Inverter. T2 connects to only one of the power transformers, which then becomes

the master and has better regulation than the rest. Separate input fuses should also be used for each additional transformer. Up to three slave Inverters may be run in conjunction with one master. If the slave units are to be switched to allow individual control double pole switching of the power Darlington base drives MUST be employed.

All the above components will have to be mounted off the main p.c.b. and TR3 and TR4 will need additional heatsinking. The p.c.b. tracks connecting the power transistors will need uprating with tinned copper wire to provide the extra current handling capabilities required to drive the multiple Darlington power stages. This also applies to the 600 watt single transformer Inverter.

### POLARITY PROTECTION

To provide protection against accidental reversed battery connections a 15A stud rectifier should be connected across the centre-tap (red) of T1 and the battery negative lead. The cathode must be positive.

In the event of the battery connections being reversed a large current will flow through the rectifier and cause the fuses FS1, FS2 to fail and the rectifier to fail to a short circuit. All three components should then be replaced before correctly reconnecting the battery.

### REFERENCES AND FURTHER READING

*An Introduction to Power Electronics*, Bird & King

*The Art of Electronics*, Paul Horowitz and Winfield Hill

*Electronic Power Control for Technicians*, J R Penketh

*Unitrode IC Data Handbook*, Unitrode Semiconductor Products

*Battery to Mains Inverter*, EE, March 1990, Self

*Battery to Mains Inverter Daughter-board*, EPE, Nov 1992, Self

*Mains Inverter*, ETI, Dec 1992, Self

*I.E.E. Wiring Regulations*, 16th Edition

### ACKNOWLEDGEMENTS

The author would like to thank the following companies and individuals for their assistance during the preparation of this article: Peter Godfrey and Andy Sharp (formerly of I.L.P.) of Jaytee Electronic Services, Tom Peach of I.L.P. Electronics Ltd, Maplin Electronics P.L.C. and Electromail.

**Next Month:** Uninterruptable Power Supply add-on.

**PD/SHAREWARE FOR THE PC**

★★★★ **ELECTRONICS** ★★★★★

E01 ELECTRON electrical & electronic calculators res codes calcs & more  
 E02 NETWORK electronic analysis for ladder networks hi-res printouts  
 E03 HAM ELECTRONIC calculations 70+ items some in basic  
 E04 PCB-CAD printed circuit board CAD package with c source code  
 E05 HCMOS phase locked loop design program  
 E06 LSYSTEM universal digital logic simulator  
 E07 PC-TECH electronics tutor + electro8 calculator  
 E08 POWER utility to aid IC designers  
 E09 RESISTOR GUIDE easy program color code to value - value to code + Tutorial  
 E10 AUTOSKEM schematics drawing program + 40 electric symbols many features  
**OUR LOW PRICE £1.95 per DISK**

E00 PACK CONTAINING ALL ABOVE £12.50 INCLUSIVE

★★★★ **HAM RADIO** ★★★★★

H01 Enjoy Packet Radio without a TNC - Dutch Program - Not for the beginner  
 H02 Demonstration of expert systems for HAM radio  
 H03 Decode Morse code with a Sound Blaster and a microphone  
 H04 MicroHam: Radio workstation for logging, contests, awards, technical reference  
 H05 Pk Gold v6.24 packet program for Ham Radio  
 H06 Ham Radio Packet Doorway Program  
 H07 Novice/Tech/General/Adv./Extra ham Radio exams  
 H08 Select best beam antenna design  
 H09 Hams: Send and receive CW via RS-232 port  
 H10 Amateur radio logbook program (w/BAS)  
 H11 Hams: Programs ACC RC85 parms/speech by modem  
 H12 Hams: Send and Receive SSTV and FAX pictures  
 H13 Database for SW logs & requests QSLs ver. 1.14  
 H14 HAM RADIO COLLECTION antenna analysis, morse, propagation  
 H15 HAM radio, Yagi design, PCB design, Packet radio info.  
 H16 PC-HAM COLLECTION a good mix radio ham programs  
 H17 WORL! Mailbox Packet Mailbox Program  
 H18 PTM Packet Terminal Program and Mailbox  
 H19 HAMRADIO DXCC program, ICs reference prog misc utils  
 H20 RF PROPAGATION loss, moon bounce, MUF, HF/VHF/UHF paths  
 H21 EME calculator, Miniprop, HF groundwave, Time zone clock  
 H22 Noise calculations, Dish data etc (3 disks) G8PTH/4DQY (part 2)  
 H23 TRIO/KENWOOD Control Programs for TS440/940 Transceivers  
**OUR LOW PRICE £1.95 per DISK**

H00 PACK CONTAINING ALL ABOVE £21.00

Please state disk size, free catalogue on disk. CHECKS, POSTAL ORDERS, OR CREDIT CARD ORDERS TO:-

P.C.L. (Software) Ltd, 1 Silvey Grove,  
 Spondon, Derby DE21 7GH.  
 Tel: 0332 678713

100's MORE TO CHOOSE FROM SEND FOR LIST NOW!

**OUT NOW!!**

**HENRY'S**  
**NEW**  
**1994**  
**COLOUR**  
**CATALOGUE**

TRADE • EDUCATION  
 RETAIL • MAIL ORDER  
 EXPORT

1994-1995 EDITION  
**HENRY'S**  
 AUDIO ELECTRONICS  
 CATALOGUE

ELECTRONICS FOR EVERY PURPOSE!

OPEN 6 DAYS A WEEK - CALLERS WELCOME

EXPORT • RETAIL • MAIL ORDER  
 EDUCATION • TRAINING £2.00

Open 6 days a week - CALLERS WELCOME

**HENRY'S**  
 404 Edgware Road,  
 London W2 1ED

**Components**  
 Telephone: 071-723 1008

**Security - Communications**  
 Telephone: 071-724 0323

**Audio and Test Instruments**  
 Telephone: 071-724 3564

**Trade/Quantity**  
 Telephone: 071-258 1831  
 Fax: 071 724 0322

**RETAIL - MAIL ORDER VERSION**  
 With price lists, special offers and purchase vouchers. Send PO/Cheque £4.00 (UK) £6.00 (EC) £10.00 (Non EC) Callers £2.00.

**Education, trade, quantity purchasers**  
 Post or fax letterhead for **FREE** copy with trade/quantity price list (UK).  
 Overseas prices as above.

# ★ THE IDEAL X'MAS PRESENT ★

FOR THE PROFESSIONAL & ENTHUSIASTIC ALIKE

## ★ 418 MHz RADIO DATA LINK EVALUATION KITS ★

### Applications:

- ★ Demonstrates the use of low power radio.
- ★ Range test using signal strength meter.
- ★ Design platform for projects.
- ★ Test kit for digital communications.

**ONLY  
£84.95  
+ VAT  
FREE POSTAGE**

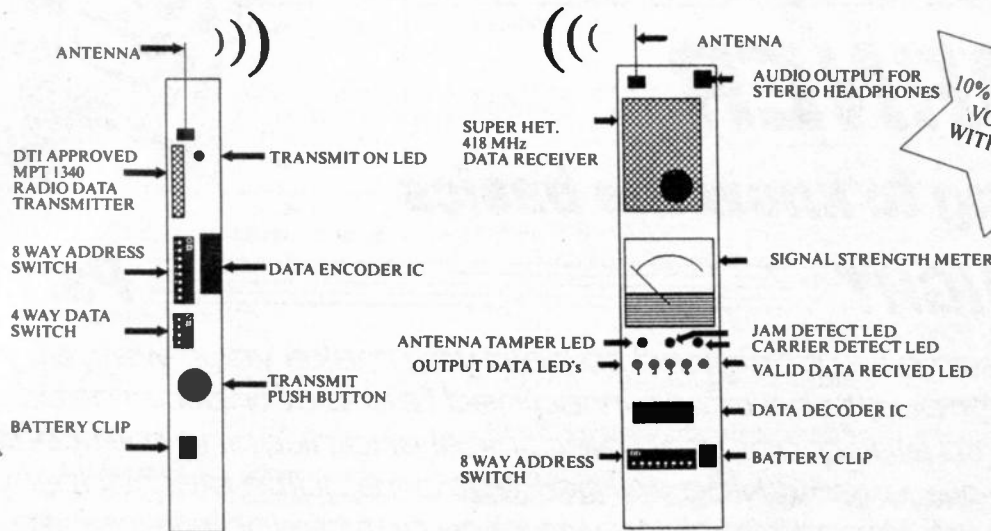

FOR EVERYONE WHO WANTS TO COMMUNICATE IN THE FUTURE!

M&B ELECTRONICS LTD, THE PROFESSIONAL SUPPLIERS OF DTI APPROVED RADIO DATA MODULES



**WE UNDERTAKE TO BEAT ANY PUBLISHED PRICES**

THE GROUND FLOOR, MIDDLESEX UNIVERSITY BUILDING,  
BOUNDS GREEN ROAD, LONDON N11 2NQ. TELEPHONE/FAX: 081-368 8277 2-LINES



# BUILD YOUR OWN PC

Using our low cost component parts or we can assemble for you for only £25

### MOTHERBOARDS With VESA Local Bus-2 Slots & Pentium P24T Socket.

386SX-33MHz	.....	£65
386DX-40MHz	..... 128k Cache	£99
486SX-25MHz	..... 256k Cache	£149
486DX-33MHz	..... 256k Cache	£279
486DX-40MHz	..... 256k Cache	£299
486DX2-50MHz	..... 256k Cache	£333
486DX-50MHz	..... 256k Cache	£369
486DX2-66MHz	..... 256k Cache	£389
486DX-33MHzEISA	..... 256k Cache	£380
486DX-40MHz EISA	..... 256k Cache	£390
486DX2-50MHz EISA	..... 256k Cache	£410
486DX-50MHz EISA	..... 256k Cache	£460
486DX2-66MHz EISA	..... 256k Cache	£489

### HARD DISK DRIVES

42MB	..... IDE 28ms	£77
89MB	..... IDE 16ms	£118
130MB	..... IDE 16ms	£133
170MB	..... IDE 15ms	£155
213MB	..... IDE 15ms	£169
245MB	..... IDE 12ms	£179
330MB	..... IDE 12ms	£225
420MB	..... IDE 12ms	£360
520MB	..... IDE 12ms	£430
1GB	..... SCSI-2 9ms	£699
2GB	..... SCSI-2 10ms	£980
Hard Disk Mounting Brackets	.....	£5

### FLOPPY DISK DRIVES

3½" 1.44Mb Floppy Disk Drive	.....	£33
3½" 1.44Mb Floppy with 5¼" Frame	.....	£36
5¼" 1.2Mb Floppy Disk Drive	.....	£35

### MONITOR

14" Mono VGA	.....	£89
14" SVGA Colour (Interlaced) (0.28mm)	.....	£175
14" SVGA Colour (Non Interlaced)(0.28mm)	..	£199
17" High Resolution (0.28mm)	.....	£640

### MEMORY

256k x 9 Simm 70ns	.....	£13
1m x 9 Simm 70ns	.....	£39
4m x 9 Simm 70ns	.....	£135

### DISPLAY CARDS

Mono card with Parallel Printer Port	.....	£13
Oak 16-Bit SVGA Card 256k	.....	£22
Oak 16-Bit SVGA Card 512k	.....	£28
Oak 16-Bit SVGA Card 1MB	.....	£38
Trident 8900CL 16Bit SVGA Card1MB	.....	£39
S3 Windows Accelerator Card 1MB	.....	£99
S3 Windows Accelerator Card 2MB	.....	£150
VESA Local Bus Oak Windows Accel 1MB	.....	£55
VESA Local Bus Oak Windows Accel 2MB	.....	£99
VESA Local Bus S3 Windows Accel 1MB	.....	£110
VESA Local Bus S3 Windows Accel 2MB	.....	£160



### KEYBOARDS

102 Key Standard	.....	£22
102 Key Deluxe	.....	£27

### ADD-ON CARDS

I/O Card 2S/1P/1G	.....	£12
IDE Card 2HD/2FD with Cables	.....	£12
IDE I/O Card 2HD/2FD/2S/1P/1G with cables	..	£18
IDE Caching Controller (16MB Max) 4HD/2FD	.....	£135

### OTHER ITEMS

Microsoft Compatible Mouse	.....	£12
Deluxe Desktop Case (200W PSU)	.....	£55
Mini Tower Case (200W PSU)	.....	£59
Tower Case (250W PSU)	.....	£89
MS-DOS 6.0	.....	£39
Novell Netware Lite	.....	£30
Windows 3.1	.....	£35
Windows NT	.....	£279

### CD ROM DRIVES

Mitsumi CD-ROM Drive Interface card	.....	£129
Panasonic CR-582B Double speed CD-ROM	.....	£159
Toshiba XM3301 Single speed SCSI CD-ROM	.....	£199
Toshiba SM3401 Double Speed SCSI CD-ROM	.....	£289
Pioneer DRM-604 Quad Speed 6 Disc CD-ROM	.....	£950

**Eurocom International Ltd**

**Telephone (035 388) 325**

**The Old School, Prickwillow, Ely, Cambridgeshire, CB7 4UN.**

Send cheque with order. Carriage £15.00 per order. All prices exclude VAT please add at current rate to total order.



# CALCULATION CORNER

Getting to know the basics

S. KNIGHT

Part One

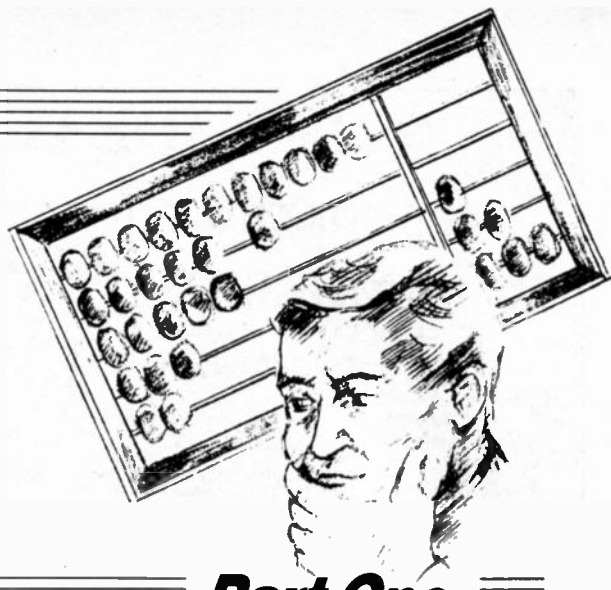

This series is designed to help you make your way, at your own pace, through the often imagined fears of mathematics, as this is applied to electronic and electrical engineering matters. As far as possible, everything will be kept on a quite elementary level so that even those readers who are not taking examinations in this subject will, we hope, find something of interest to them and, hopefully too, overcome their fears by giving them an opportunity to see how illusionary many of these fears actually are.

THE only piece of equipment you will need for this series, beside some sheets of paper and a pencil, is a calculator. For the earlier parts of the course this need be nothing more than a basic model having the four functions of add, subtract, divide and multiply along with a square root and a reciprocal key. Later on we will need keys for the trigonometric and logarithmic functions but don't be deterred by the appearance of these words. By the time they turn up, you should be meeting them (if you haven't already) with sufficient confidence to see these imposters for what they really are.

In general terms then, there will be brief notes on the relevant theory, worked examples to illustrate methods, with explanations where these are needed, and each part will conclude with some self-assessment problems showing, where possible, the practical applications of the calculations. The solutions to these will be provided in the following part.

We begin in this introductory part of the series by sorting out the basic units we will be working in. Others will turn up as we go along but we need right from the word go those units (and their sub-units) associated with the simple electrical circuits, shown in Fig. 1.1 to get us on our way.

## THE ELECTRIC CIRCUIT

All sources of current electricity provide a concentration of negatively charged particles, the electrons, at one terminal of the source, the negative pole, and an equivalent deficiency of electrons at the positive pole. When the poles are connected together by way of a conducting path, the electrons, with their negative charges, move from the negative to the positive pole, so constituting an electric current. This is how we accept things today.

However, before the electron was discovered and the true nature of electricity was properly understood, it was quite naturally taken for granted that current flowed around a circuit from the positive pole (what we might call the *high potential* point) to the negative pole (the *low potential* point), and all the rules and conventions about how the electric circuit worked and how electricity was generated were established on this premise.

To avoid turning everything on its head as it were once the true nature of things became known and to leave the conventions undisturbed, it became necessary to distinguish between the true current flow and, up to that time, the assumed current flow. The problem was resolved by calling the true current flow (from the negative to the positive pole) the *electron flow*, and the supposed current flow (from the positive to the negative pole) the

*conventional flow*. In all our work on passive circuit systems, the conventional flow will be used. When we get on to active systems – those with transistors, for example, we will find that the true electron flow is often a lot more useful.

## CURRENT AND QUANTITY

An electric current is the movement of free electrons along a conducting path. The unit of current is the **ampere** (I) and is the rate of flow of about  $6.3 \times 10^{18}$  electrons per second (the power of ten method of expressing a number is discussed in detail later in this article). This enormous number, which is greater than six million million times the charge on an individual electron (which is much too small to be of practical use) is the basic quantity of charge known as the **coulomb** and symbolised Q. Hence one ampere is a rate of flow of one coulomb per second, or

$$Q \text{ (coulombs)} = I \text{ (amperes)} \times \text{time (seconds)}$$

A current of one ampere may not be large to the power engineer but it is to the electronics man. It is therefore divided into a thousand parts called **milliamperes** (mA) and each of these in turn is divided into a further thousand parts called **micro-amperes** ( $\mu$ A).

So:

$$1 \text{ mA} = \frac{1}{1,000} \text{ A} = 0.001 \text{ A} = 10^{-3} \text{ A}$$

$$1 \mu\text{A} = \frac{1}{1,000,000} \text{ A} = 0.000001 \text{ A} = 10^{-6} \text{ A}$$

We will come back to these different ways of expressing the same quantity in a little while.

## ELECTROMOTIVE FORCE

A battery or any other source of electricity has the ability to move a quantity of electrons along a conductor; this ability is known as the **electromotive force** (e.m.f.) and represents an electrical *pressure*. The unit of this force is the **volt**, symbolized E. There is also a pressure developed between any two separated points in a circuit, say, between the ends of a resistor, established by the flow of current through the resistor. This is known as a **potential difference** (p.d.) and is also measured in volts, symbolized V. It is important to distinguish between the precise meanings of e.m.f. and p.d. and Fig. 1.1 should make this clear for you.

Like current, the volt is divided into a thousand sub-units called **millivolts** (mV) and each millivolt is further divided into a thousand parts called **microvolts** ( $\mu$ V).

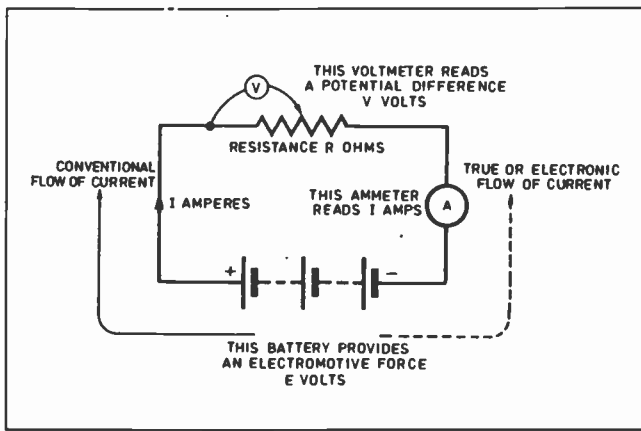

Fig. 1.1. The essential details of the simple electric circuit.

So:

$$1\text{mV} = \frac{1}{1,000} \text{V} = 0.001\text{V} = 10^{-3}\text{V}$$

$$1\mu\text{V} = \frac{1}{1,000,000} \text{V} = 0.000001\text{V} = 10^{-6}\text{V}$$

## RESISTANCE

We can define resistance as that property of a substance which opposes the passage of electrons through it. Those substances which offer only a small opposition to the flow are known as conductors; those which offer an extremely large opposition are known as insulators. Resistance is denoted by the symbol  $R$  and the unit of resistance is the **ohm**, symbol  $\Omega$  (omega). A resistance of  $1\Omega$  is small in relation to the resistances normally used in electronics and larger units, the **kilohm** ( $1\text{k}\Omega = 1,000\Omega$  or  $10^3\Omega$ ), and the **megohm** ( $1\text{M}\Omega = 10^6\Omega$ ) are used.

An alternative way of looking at resistance, and very useful in certain calculations, is to consider a conductor not in terms of its *opposition* to electron flow but in terms of its *ability* to conduct. Hence a circuit of *high* resistance could equally be described as having a *low* conductance, and conversely. **Conductance**, therefore, is the inverse of resistance and is expressed as the reciprocal of resistance:

$$\text{Conductance (G)} = \frac{1}{\text{Resistance (R)}}$$

and is measured in **Siemens (S)**.

## OHM'S LAW

In an electrical circuit, the current  $I$  is directly proportional to the applied e.m.f. or to the p.d. across the conductor. It is also inversely proportional to the resistance of the conductor. Hence  $I$  varies as  $V$  or as  $1/R$ . We will use the symbol  $V$  for voltage throughout this section, irrespective of whether it is an applied e.m.f. or a potential difference.

By choosing the appropriate units therefore we get the relationship  $I = V/R$ . We can say that an ampere is therefore the current flowing in a resistance of one ohm when the voltage across the resistance is one volt. Clearly, if any two of the quantities are known, the third can always be calculated. This simple relationship (which nonetheless is very difficult to *prove*) between  $I$ ,  $V$  and  $R$  is known as **Ohm's Law**.

## TRANSPOSING A FORMULA

In Ohm's law as given above, the current  $I$  is known as the *subject* of the formula since its value is given in terms of  $V$  and  $R$ . For example, if  $V = 5$  volts and  $R = 2\Omega$ , then  $I = 5/2$  or  $2.5\text{A}$ . As arranged, therefore, the formula will enable us to find  $I$  for any values of  $V$  and  $R$ . However, in other circumstances the current and the resistance may be known and we need to find the voltage.

The formula we now want must have voltage  $V$  as the subject and this has to lie on the left-hand side with the other variables  $I$  and  $R$  appropriately arranged on the other side. This rearrangement is known as **transposition** and the result of the transposition must be such that the intrinsic truth of the original statement, that is,  $I = V/R$ , is not altered.

Any formula (and we will meet with quite a few as we go along) gives us the relationship between one variable quantity and others; it may be compared to a pair of scales in which an originally balanced condition can only be restored if anything added to or removed from one of the pans is added to or removed from the other pan. With a formula, the original equality (indicated by the equals sign =) is no longer valid if anything changed on one side of

the equation is not identically changed on the other. We will illustrate this procedure on the formula  $I = V/R$ .

To make  $V$  the subject, we *multiply* both sides by  $R$  so that we get

$$IR = \frac{VR}{R}$$

and then

$$IR = V \text{ or } V = IR$$

since the  $R$ 's cancel out on the right-hand side.

To make  $R$  the subject, we *divide* each side of this last formula by  $I$  so that

$$\frac{V}{I} = \frac{IR}{I}$$

and then

$$\frac{V}{I} = R \text{ or } R = \frac{V}{I}$$

since the  $I$ 's now cancel out on the right-hand side.

We now have all three possible arrangements of  $I$ ,  $V$  and  $R$ . Summarising, we have

$$\text{Current } I = \frac{V}{R} = \frac{\text{voltage}}{\text{resistance}}$$

$$\text{Voltage } V = IR = \text{current} \times \text{resistance}$$

$$\text{Resistance } R = \frac{V}{I} = \frac{\text{voltage}}{\text{current}}$$

Ohm's law can be applied to a complete circuit or to any part of a circuit and should be memorised in all three forms.

## SOME WORKED EXAMPLES

Here are a few worked examples on what we have talked about so far. At this very basic level it is easy to make up such examples for yourself and you should do this until you are completely familiar with all the units we have so far mentioned

1. A current of  $0.5\text{A}$  flows for a period of 1 minute; what quantity of electricity has moved around the circuit? How many electrons does this quantity represent?

$$\text{Quantity } Q = I \times t \text{ coulombs (C)}$$

Keep the proper units in mind here:  $I = 0.5\text{A}$ ,  $T = 60$  secs; then

$$Q = 0.5 \times 60 = 30\text{C}$$

Now 1 coulomb is equivalent to the charges of  $6.3 \times 10^{18}$  electrons. Hence 30 coulombs is equal to

$$6.3 \times 10^{18} \times 30 = 189 \times 10^{18} \text{ or } 1.89 \times 10^{20} \text{ electrons}$$

Most calculators have a key to facilitate the entering of large numbers like  $10^{18}$ . This key is usually marked EXP, so the above calculation would be done by entering  $6.3$  times 30 times EXP 18 and the answer will appear as 1.89 20, the index being spaced out from the other part of the number. Try to develop the use of this key as it will be very useful in many electronic calculations.

2. What voltage is required to produce a current of  $0.35\text{A}$  in a resistance of  $7.5\Omega$ ?

Here we have  $I = 0.35\text{A}$ ,  $R = 7.5\Omega$  and we need to find  $V$   
Using  $V = IR$  we get  $V = 0.35 \times 7.5 = 2.625\text{V}$

3. A circuit carries a current of  $150\text{mA}$  when the applied voltage is  $13.8\text{V}$ . What is the circuit resistance?

Here we have  $I = 150\text{mA}$ ,  $V = 13.8\text{V}$  and we need to find  $R$ .

So we can use the relationship  $R = V/I$ . But we must *not* write the equation as  $R = 13.8/150$ ; the current has to be expressed in amperes, not milliamperes.  $150\text{mA} = 0.15\text{A}$ , hence

$$R = \frac{13.8}{0.15} = 92\Omega$$

4. A circuit of resistance  $28\Omega$  is connected to a battery of e.m.f.  $5\text{V}$ . What current flows in the circuit?

The actual calculation should present us with no problem but the form of the answer might. Here we have  $R = 28\Omega$ ,  $E = 5\text{V}$ , and we have to find  $I$ .

$$\text{Using } I = \frac{E}{R} \text{ we get } I = \frac{5}{28} = 0.178571428 \dots \text{A}$$

on our magic machine, but *never* write down a string of figures such as this as an answer to a question, particularly if it is an examination question. *An answer cannot be more accurate than the accuracy of the information supplied.* It would be quite sufficient in this case to leave the answer as  $0.18\text{A}$  (or as  $180\text{mA}$ ) or, of course, as a fraction  $5/28\text{A}$ . We will return to this question of accuracy in a later section.

## POWERS OF TEN

You will have noticed from what we have already mentioned about sub-units and multiples of the basic units, mA,  $\mu$ A, k $\Omega$  and so on, that powers of 10 appear in all cases. This simplifies calculations since it is a lot easier to use, say,  $4.7 \times 10^6 \Omega$  than to write out 4,700,000 $\Omega$ ; both forms represent 4.7M $\Omega$  (often written 4M7).

Try to use the powers of 10 in this way whenever you can, remembering that a *negative* power of 10 represents a *fraction*:  $10^{-1}$  for example represents 1/10 or 0.1, and  $10^{-3}$  represents 1/1,000 or 0.001. For example, a current of 0.017A is expressed as 17mA since  $0.017 = 17 \times 10^{-3}$ , and a voltage of 6,275V is expressed as 6.275kV since  $6,275 = 6.275 \times 10^3$ .

In many cases, of course, there is no objection to your using decimal fractions, such as 1mA = 0.001A or 30mV = 0.03V. Use whichever method you feel most comfortable with, but *avoiding* long decimals like expressing 1 $\mu$ A as 0.000001A or 10pF as 0.0000000001 farads!

The most commonly encountered prefixes in electronic calculations are given in the following table.

MULTIPLIER	PREFIX	ABBREVIATION
$10^6$	mega	M
$10^3$	kilo	k
$10^{-3}$	milli	m
$10^{-6}$	micro	$\mu$
$10^{-9}$	nano	n
$10^{-12}$	pico	p

You will probably recall that when we *multiply* powers of 10 we simply *add* the indices and when we *divide* we *subtract* the indices. So, for example

$$10^5 \times 10^3 = 10^{5+3} = 10^8; \quad \text{and} \quad 10^5 \div 10^3 = 10^{5-3} = 10^2.$$

Take particular care when negative indices turn up, such as

$$10^{-7} \times 10^3 \text{ which becomes}$$

$$10^{-7+3} = 10^{-4} \quad \text{or} \quad 10^4 \div 10^3 = 10^{4-3} = 10^{4+3} = 10^7.$$

The next examples will make the method clear.

5. A current of 275 $\mu$ A flows in a resistance of 3.3M $\Omega$ . What voltage is developed across the resistance?

Here  $I = 275 \mu\text{A} = 275 \times 10^{-6}\text{A}$ ,  $R = 3.3\text{M}\Omega = 3.3 \times 10^6\Omega$ . This then expresses both I and R in the basic units of amperes and ohms.

Then since  $V = IR$  we get  $V = 275 \times 10^{-6} \times 3.3 \times 10^6$  volts. The powers of 10 cancel out and we have  $V = 275 \times 3.3 = 907.5\text{V}$

6. What value of resistance is required to limit a current to 1.5mA when a voltage of 270V is applied?

We already have the voltage in its basic units but it is still convenient to express it in powers of 10. So we have  $I = 1.5 \times 10^{-3}\text{A}$ ,  $V = 2.7 \times 10^2\text{V}$ . Then

$$R = \frac{V}{I} = \frac{2.7 \times 10^2}{1.5 \times 10^{-3}} = \frac{2.7}{1.5} \times 10^{2-(-3)}$$

$$= 1.8 \times 10^5 \Omega$$

Be sure you understand how we arrived at this: we divided  $10^2$  by  $10^{-3}$  so the indices were subtracted as 2 minus (-3) which is  $2 + 3 = 5$ . The answer can of course be expressed as 180k $\Omega$  or as 0.18M $\Omega$ .

## SELF ASSESSMENT

This is as far as we will go this month and a number of self-assessment problems follow. Some of these are not just repetitions of the worked examples in the above text. They can all be solved by the general methods and information given but for some of them you will have to think things through for yourself. The solutions will be given next month.

1. What basic unit is also known as the ampere-second?
2. If 1 coulomb is equal to  $6.3 \times 10^{18}$  electron charges, what is the charge of a single electron?
3.  $Q = It$  coulombs. Express  $t$  in terms of  $Q$  and  $I$ , hence find how long a current of 700mA must flow for 126 coulombs of charge to be moved around a circuit.
4. What is the conductance of a 47 $\Omega$  resistor?
5. A coil has a conductance of 0.125S. What is its resistance?
6. A current of 25mA flows through a 470 $\Omega$  resistor. What voltage would be measured across the resistor? Is this voltage an e.m.f. or a p.d.?
7. Express, preferably in powers of 10, the following quantities: (a) 15mA in A, (b) 256 $\mu$ V in V, (c) 8.2M $\Omega$  in  $\Omega$ , (d) 3185mS in S, (e) 650 $\mu$ C in C.
8. Write down the three forms of Ohm's law in terms of conductance (G) instead of resistance (R).

Next month: Ohm's Law and its applications.

## THIS IS THE COUPON

## that brings the 1993-94 CATALOGUE

140 pages, A4, copiously illustrated, bang up to date and with bonus vouchers. Send cheque/PO for £1.50.



## that brings the SERVICE

with choice of very wide ranges of famous-name quality electronic components and associated gear sent promptly on receipt of your order. A service

## that ElectroValue

have been providing constructors with continuously since 1965. With *this* Catalogue, you will find our service the best ever. Send for your copy **NOW!**

ELECTROVALUE LTD., UNIT 3, CENTRAL TRADING ESTATE, STAINES, MIDDX TW18 4UX  
Tel: 0784 442253 Fax: 0784 480320

I enclose Cheque/PO/Credit Card No. ....  
Value £1.50 for your 1993-94 Catalogue

Name .....

Address .....

Post Code ..... Ep.1

## AITKEN BROS & Co

### HM102 ANALOGUE MULTIMETER

19 ranges Inc leads & batts  
AC volts.....0-10-50-250-1KV  
DC volts.....0-2.5-10-50-250-1KV  
DC current...0-5m050m-500m-10A  
Resistance...0-10K-100K-10M  
Dims.....135x89x40mm



SPECIAL PRICE £13.50  
NP £15.99

### ALT26 DIGITAL MULTIMETER

7 ranges inc 10A DC Inc leads & batts  
3.5 digit 12mm LCD display  
AC volts.....0-500v  
DC volts.....0-20-200v  
DC current...0-10A  
Resistance...0-2K-2M  
Dims.....148x73x32mm



SPECIAL PRICE £14.99  
NP £20.99

### CONSTRUCTOR'S PACK

Containing:  
2 x stripboard 64x95mm  
5 linear IC's - 555, TL081, 7805, 7812, LM386  
8 74LS IC's - LS00(x2) 04, 10, 14(x2) 20, 74

10 CMOS IC's  
4000(x2) 4001, 4011(x2)  
4017(x2) 4040, 4081, 4093

100 asst. 25watt resistors  
14 Electrolytic Capacitors  
Normal price over £14.50

**Special price**  
**£9.99**

### SOLDERING EQUIPMENT



ANTEX  
18W SOLDERING IRON  
SPECIAL PRICE £8.50  
NP £9.99

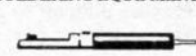

DE-SOLDER  
PUMP  
SPECIAL PRICE £2.99  
NP £3.99



PORTASOL  
GAS IRON  
SPECIAL PRICE £11.99  
NP 14.99

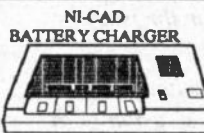

NI-CAD  
BATTERY CHARGER  
SPECIAL PRICE £5.99  
NP £6.99



4x NIKAD  
AA BATTERIES  
SPECIAL PRICE £3.80  
NP £4.00 per 4

Order the  
BATTERY CHARGER  
+  
4x AA NI-CAD'S  
TOGETHER

SPECIAL PRICE £8.99  
NP £10.99

PLEASE ADD £1.00 POSTAGE TO ORDER



CATALOGUE AVAILABLE £1.50

(refundable with order)

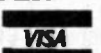

35 HIGH BRIDGE, NEWCASTLE UPON TYNE

NE1 1EW Tel. 091 2329877 Fax 091 2619664

SCHOOL & COLLEGE ORDERS WELCOME (automatic account facility)



## SYSTEM 200 DEVICE PROGRAMMER

**SYSTEM:** Programs 24, 28, 32 pin EPROMS, EE-PROMS, FLASH and Emulators as standard, quickly, reliably and at low cost.

Expandable to cover virtually any programmable part including serial E<sup>2</sup>, PALS, GALS, EPLD's and microcontrollers from all manufacturers.

**DESIGN:** Not a plug in card but connects to the PC serial or parallel port; it comes complete with powerful yet easy to control software, cable and manual.

**SUPPORT:** UK design, manufacture and support. Same day dispatch, 12 month warranty. 10 day money back guarantee.



ASK FOR FREE INFORMATION PACK



MQP ELECTRONICS Ltd.  
Unit 2, Park Road Centre,  
Malmesbury, Wiltshire, SN16 0BX UK  
TEL. 0666 825146 FAX. 0666 825141

GERMANY 089/4602071  
NORWAY 0702-17890  
ITALY 02 92 10 3554  
FRANCE (1)69.41.28.01  
Also from VEROSPEED UK



## TRANSMITTERS

**AT LAST.** A fully comprehensive, easy to follow guide to building short range micro transmitters. Packed with useful information and circuits.

- ★ How to build micro surveillance devices.
- ★ Radio mics.
- ★ Tracking and signaling transmitters.
- ★ Only **£3.95** inc p&p.



(Some of the circuits included can not be used legally in the UK)

**MICRO FM TRANSMITTER.** Easy to build, 1 mile range, very small including mic. Pick up on any FM radio. **£6.95**

**TRACKING FM.** Transmits a constant pulse tone that can be used for direction finding, tracking cars or animals etc. **£8.50**

**CRYSTAL RADIO.** Simple introduction to radio and electronics. Includes easy instructions, ferrite rod, tuner etc. **£5.75**

**AM RADIO.** Tuner and power amp that make a tiny AM radio. Will drive a small pair of headphones. Simple to make and fun to use. **£8.50**

**INFRA RED REMOTE CONTROL.** Simple but effective remote control of relay switch up to 10 metres. Ideal for car alarms, light switches etc. Includes 240V relay. **£10.50**

### MUSIC KITS      PREAMPS      POWER AMPS

Full range of on board units for guitars etc. – active tone controls/boosters, wah wah and other effects kits – send for list. Prices include P&P. Mail order only. Make cheques and postal orders payable to:

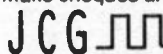

3 Bainbrigge Road, Headingley, Leeds LS6 3AD.

## PCB Designer

For Windows 3.0 & 3.1  
Runs on any PC running Windows in standard or enhanced mode with 2MB RAM

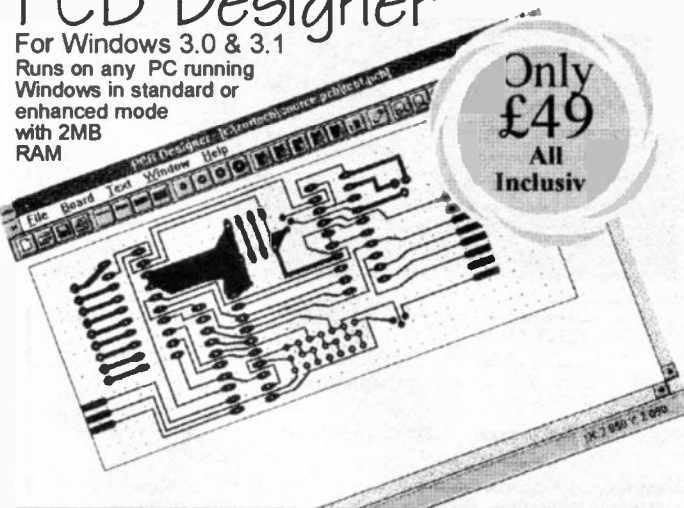

Only **£49**  
All Inclusive

'...at that price many users will find it (PCB Designer) preferable to the freeware competition, or the more expensive commercial alternatives...'

'...I must have tried over a dozen PCB design programs in the last few years and PCB Designer is certainly the easiest to learn and use...'

R A Penfold  
Everyday with Practical Electronics

## DATA ACQUISITION SYSTEMS FOR THE PC

### FROM ALFRED ENTERPRISES LTD.

- **LIO-24** (£27)
  - 24 Digital I/O Lines
  - Uses industry standard 8255 IC
  - +/- 12V, +/- 5V supplies from PC
- **ADC-12-1** (£49)
  - 12 Bit high accuracy integrating ADC
  - 2 DC ranges 0 to +/- 5V, 0 to +/- 15V
  - Ideal for use with most transducers
- **ADC-8-1** (£37)
  - 8 Bit general purpose ADC
  - 0 to 5V range
- **AD-DA-8** (£45)
  - Dual function plug-in card
  - 8 Bit DAC and 8 Bit ADC
  - 0 to + 5V ranges
- **DAC-8-2** (£34)
  - 8 Bit DAC, Dual outputs
  - 0 to +/- 5V tracking outputs
  - Ideal for use with tracking power supplies
- **DAC-12-2** (£49)
  - 12 Bit DAC, Dual Outputs
  - 0 to +/- 5V Tracking Outputs
  - Uses Analog Devices 7545
- **RLY-1C-8** (£33)
  - 8 Relays, 2A, 24V, SPDT
  - Ideal for controlling motors, etc.
  - Can be used for process control
- **DVR-16** (£28)
  - 16 Buffered outputs
  - Can drive LED's, relays, etc
  - 24V, 500mA sink capability
- **PACK-1** (£8)
  - 5 1/4" disk containing a range of demo programmes
  - If preferred please specify 3 1/2" disk
  - 37 way solder socket connector

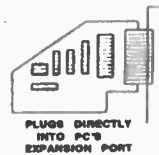

Prices Exclude VAT  
Prices in Sterling  
Add £1.50 P & P

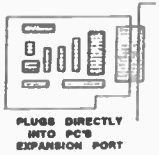

All cards are suitable for use in IBM PC/XT/AT and compatibles. All cards are supplied with relevant instruction manuals and a 37 way D-type plug connector mounted on a metal bracket to provide support and protection for both the PC and card.

**A & G ELECTRONICS LTD.** (UK)  
513A Channeleea Business Centre, Tel: 081-519-0373  
Canning Road, Abbey Lane, Tel: 081-552-2386  
London E15 3ND. Fax: 081-471-7968

**ALFRED ENTERPRISES LTD.** (EIRE)  
Cummeen, Adare, Tel: +353-61-396-696  
Co. Limerick, Ireland. Fax: +353-61-396-750



## Niche Software

22 Tavistock drive, Belmont, Hereford, HR2 7XN  
Phone (0432) 264 800, FAX (0432) 264 800

Please Note: Since PCB designer is so easy to use, and to keep costs down, PCB Designer has an On-Line manual, in Windows Help format. A tutorial is also supplied online.

# INTERFACE

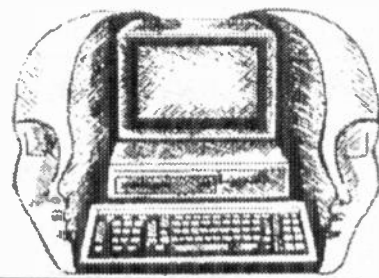

## Robert Penfold

**A** START was made on the subject of EPROMs and EPROM programming in an *Interface* article a few months ago. Progress has been limited due to the arrival of various printed circuit design programs for review, but this month we resume our look at EPROM programming with a review of the MQP Electronics Model 200P EPROM programmer. This is designed for use with PCs, and it does not require a particularly advanced host PC. However, one having a hard disk drive is a definite advantage, since the supplied software seems to make quite frequent disk accesses.

### Hardware

The programmer itself is housed in a tough metal case which is largely devoid of controls. In fact the only control is the on/off switch on the rear panel. The unit has an internal mains power supply incidentally,

A 32-pin ZIF (zero insertion force) socket is mounted at the front edge of the top panel, and this has the usual lever to trap and release the EPROMs. Markings on the top panel make the correct positions for 24 and 28 pin devices perfectly clear.

To the left of the ZIF socket there are indicator lights which show whether the power is switched on, and whether the ZIF socket is active. This second indicator is important, since damage can occur to an EPROM if it is connected or disconnected while the ZIF socket is active.

Connection to the host PC is via the parallel port, and a suitable cable is supplied with the unit. Using the parallel port could be a bit inconvenient as many PCs will already have a printer connected here. A serial version of the programmer is also available, and this would probably be a more convenient option for most users. However, the parallel port version

presumably gives shorter programming times.

A very wide range of devices can be programmed, including all normal 24, 28, and 32 pin EPROMS. It is also possible to program EEPROMs and emulators. Various other components can be programmed via adaptors which are available as optional extras. These include 40 pin EPROMs, the 8748 and 8751 families, and the Z8 single chip micro-controller. The MQP 200P should be able to handle any normal programming requirements.

### Software

The reason that the programmer is virtually control-free is that, like most units of this type, it is largely software controlled. It is supplied complete with programs that provide the usual range of facilities, and can handle a wide range of devices. The software is on a single 3.5 inch double den-

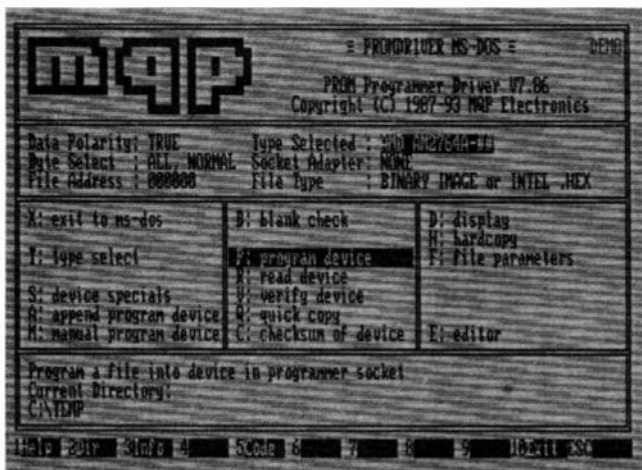

The main control screen.

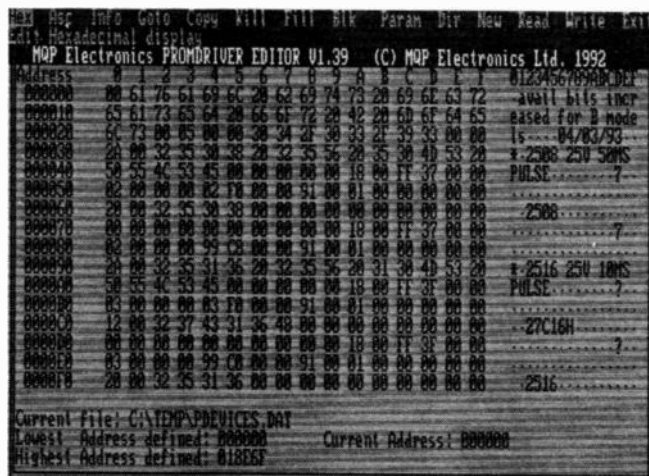

The editor screen.

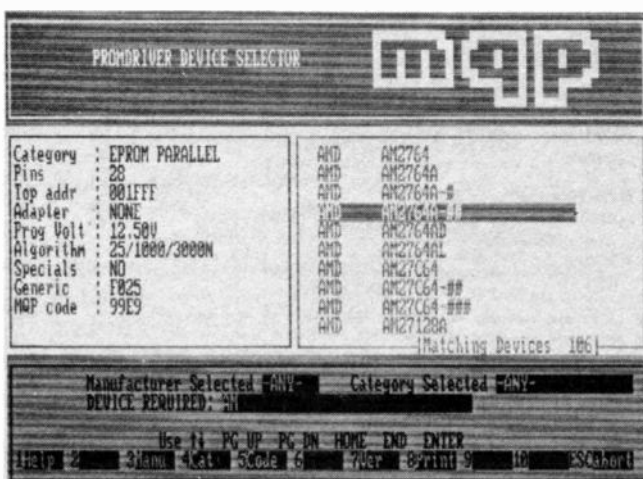

The device selection screen.

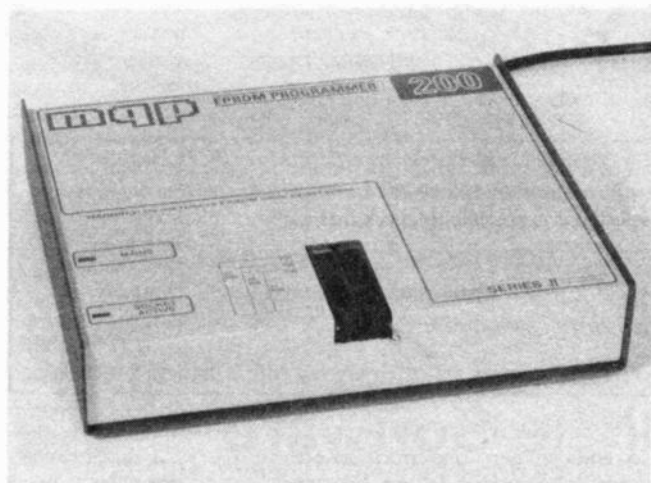

The MQP 200P EPROM programmer.

sity disk, and it is easily installed. It is possible to run a demonstration version of the software so that you can familiarise yourself with its operation before any real programming is attempted.

When the main program is first run it is necessary to complete a simple installation process to make sure that the software is set to communicate with the programmer properly. If all is well, you are then taken into the main control screen. There is no mouse control with pop-down menus. Instead, the top section of the screen shows the options currently selected, while the lower section is a large menu area. The desired option is selected by pressing the appropriate key, or using the cursor to highlight the option and then pressing ENTER.

This method of control is a bit old fashioned, but it works well in an application such as this. Moving around the program is certainly very quick and easy, even when using it for the first time. Provided you have some previous knowledge of EPROMs there should be no difficulty in finding your way around this program and using it effectively.

## Database

The first task is to set the program to suit the particular type of EPROM you will be using. This does not work on the basis of selecting a particular pinout configuration and programming voltage. The software has a substantial database of EPROMs and their characteristics.

If you wish to program (say) a TI 2564, then you simply specify TI as the manufacturer and 2564 as the device you wish to program. Provided the program has an entry for the device in question, general details (number of pins, programming voltage, etc.) will be shown on the screen, and the EPROM programmer will be set to suit this particular device.

A wide range of devices are catered for, and I found matches for all my 25\*\*\* and 27\*\*\* series EPROMs. If an exact match cannot be found, then it would presumably be possible to find an entry for a device having identical characteristics.

The database is quite sophisticated. For example, you could just give "27" as the first two digits of a type number, and the program will then provide a list of devices which have type numbers starting with these two digits. It is then possible to scroll slowly through the list, looking at the characteristics of each device as you do so.

## Programming

Once the correct EPROM type has been selected it is possible to check that a device is blank, or to read in the contents of an EPROM and examine it. The contents are displayed in the both hexadecimal and ASCII form, using the conventional screen arrangement. A useful hex/ASCII editor is provided, and this can be called up from within the main program. This makes it easy to make changes to an existing program, or to enter a new one from scratch. The contents of an EPROM can be saved to a file, and it is possible to read in a file of 8-bit binary values.

It is also possible to enter a program on an address by address basis. This is probably not a very practical means of programming 100K into a EPROM, but it is a quick and easy method for applications where only a few dozen bytes need to be programmed. There is a useful "quick copy" facility. This enables an EPROM to be read, and then copied onto a blank EPROM. Several copies can be made one after the other if desired.

The editing facilities are comprehensive, and make it very straightforward to get the right data into memory and ready for programming into an EPROM. The programming process itself is very rapid. I did not make any accurate timings, but fully programming some 2764 EPROMs only seemed to take about 20 seconds or so.

EPROM manufacturers recommend fast program techniques for many devices. The slow way is to apply the programming voltage for the same length of time for each address. The duration used is a relatively long one that is guaranteed to "blow" the EPROM properly.

The quick way is to use a very short pulse, and then check to see if the current byte of data has been programmed correctly. This process is continued until the current byte has been "blown" into the EPROM successfully. Using this method the time taken to fully program an EPROM will vary somewhat from one component to another, but it always seems to be just a fraction of the time needed using the slow method. Where appropriate, the MQP 200P will use the fast programming method.

## Conclusion

The MQP Model 200P EPROM programmer is a very solidly made piece of equipment. Unusually for a computer peripheral, there was no difficulty in getting everything connected together properly, and it worked first time! The software does not have a particularly modern user interface, but it is still very easy to use. A small ring-bound manual is supplied with the unit, but I did not find it necessary to refer to this very often. The facilities offered by the software are fairly comprehensive, and cover all normal requirements.

I did not test the unit using a vast range of EPROMs, but it worked flawlessly using some 25\*\*\* and 27\*\*\* series components. The MQP Model 200P is equipped to handle virtually any normal EPROM, and via optional adaptors it can handle the more awkward programmable components such as serial EPROMs. It is undoubtedly a very desirable piece of equipment which seems to be free from any serious defects.

At a price of £295.00 for the basic unit it is not particularly cheap in absolute terms. Bear in mind that when experimenting with EPROMs an eraser is every bit as important as a programmer. An eraser is likely to cost about £50.00 or so. Even assuming you already have a suitable host PC, getting into EPROM programming using the MQP model 200P is a fairly costly business.

In fairness though, it has to be pointed out that compared to other EPROM programmers this unit offers very good value for money. Cheaper programmers are available, but they are very basic compared to

the MQP Model 200P. Some can only handle one particular type of EPROM. If you are looking for a comprehensive PC EPROM programmer, then this one should certainly be given serious consideration. It is available from MQP Electronics Ltd, Dept EPE, Unit 2, Park Road Centre, Malmesbury, Wiltshire SN16 0BX. Tel 0666 825 146.

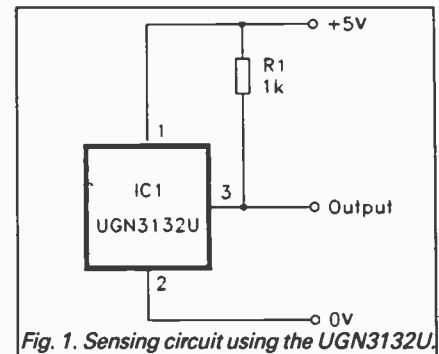

Fig. 1. Sensing circuit using the UGN3132U

## Hall Effect

Some time ago I mentioned the demise of the TI TL170C and TL172C Hall effect switches. These are semiconductor switches that are activated by magnetic fields. They are popular for use as sensors in model railways and robotics, offering a modern alternative to reed switches. One or two readers wrote in to point out that other Hall effect devices were still available. Unfortunately, a little investigation showed that although some likely looking alternatives were still listed in catalogues, they had in fact been discontinued. Other devices were still available, but they proved to be too expensive or were simply not suitable.

The latest Maplin catalogue includes some new Hall effect devices. I tried out the UGN3132U in the circuit shown in Fig.1, and it works very well. The output stage is an open collector type, and the only discrete component needed is pull-up resistor R1. Although this is just a three terminal device, it apparently has quite a complex internal circuit. The sensitivity is certainly good, and trying various small bar magnets gave a range of at least 10 millimetres. This is more than adequate for applications such as train position sensing. In fact the less sensitive (and cheaper) UGN3133U should be adequate for most applications.

An important point to note about these two sensors is that they are operated by an alternating field. In other words, if the north pole of a magnet is used to switch the device on, only a south pole will switch it off again. This can be used to good effect in some applications where it permits direction sensing using multiple magnets.

If simple position sensing is all that is required, use two bar magnets mounted about 20 millimetres or more apart. They should be set so that one applies a south pole to the sensor and the other applies a north pole. This will always give a transition at the output of the sensor when the train (or whatever) passes. In a model railway context I found that simply mounting a small bar magnet lengthwise along a piece of rolling stock gave the same effect. This applies one pole to the track sensor and then the other, and the fact that the magnet is not end-on to the sensor does not seem to affect the maximum operating range.



# MULTI-PURPOSE AUDIO SYSTEM

## Part 4 - 10W plus 10W STEREO POWER AMPLIFIER and SYSTEM POWER SUPPLY

**MAX HORSEY** P.C.B. Design **JAMES GREEN**

*If you want to set up a home recording system, mix sound videos, run a disco or a small band then these modules are for you! All modules will operate alone, but are compatible with each other.*

**S**O FAR in this short series of audio modules we have dealt with a 12-channel mixer, individual microphone and RIAA pre-amps, and a tone control module with or without a stereo 1W amplifier. We continue the series this month with a 10W plus 10W Stereo Power Amplifier, including the system power supply.

The 10+10 watt amplifier and power supply unit forms the last link in the audio chain. The amplifier is based on the TDA 2030 i.c. The specification for this i.c. seems to vary depending upon the supplier, but it is capable of up to 20 watts when driven at full voltage (30V) with a loudspeaker impedance of 4 ohms. The power supply described in this article provides about 26V, and since many loudspeakers have an impedance of 8 ohms a power rating of 10W per channel is a more realistic, if conservative claim.

The TDA2030 is a small inexpensive device, yet is capable of very good results. The output current is limited to a safe operating level and the i.c. features built in short circuit protection and thermal shut-down. In other words, if it becomes too hot it switches off automatically until it has cooled down.

### POWER SUPPLY REQUIREMENTS

The TDA2030 may be operated on a dual rail supply, but in this project the single rail option is used since the design of the power supply is simplified (and therefore less expensive). The circuit may also be driven at reduced power from a single 12V supply.

The current required depends upon the supply voltage and the sound level. For example the quiescent current (i.e. the current when there is no audio signal) is between 30mA and 40mA. On a 12V supply the average current used is less than

500mA when played at "full" volume. (The meaning of "full" is described in the next paragraph). When used at a higher voltage the power supply must be capable of supplying an average current of 1A.

The gain of the circuit is set by external resistors. The gain does *not* depend upon the operating voltage. In other words the sound level is roughly the same regardless of whether the i.c. is supplied with 12V or the 26V in this project.

However, as the volume level is advanced, clipping will occur more quickly on a 12V supply than if the circuit had been driven from 26V. Clipping causes sound distortion. It is easy to make the circuit produce a louder sound - simply changing the value of one resistor will achieve this; but the term "full" volume means the maximum level of sound *before* distortion occurs.

### PRINCIPLE OF OPERATION

The TDA2030 power amp i.c. behaves like an ordinary operational amplifier and in this circuit is connected in a non-inverting mode. However the pin layout and pin numbers are different to a "normal" op. amp, such as the 741.

Unlike a 741 the output current is quite large and hence the current flowing through the supply rails is equally large. This can cause interference to adjacent conductors and great care is needed in the design of the layout. **Testing the circuit on prototype board, or building on stripboard is not recommended.**

### CIRCUIT DESCRIPTION

A glance at the 10W plus 10W Stereo Power Amplifier circuit diagram shown in Fig. 1 should reveal the similarity between this circuit and a standard single rail non-

inverting amplifier as represented by the Microphone Amplifier in a previous article. The two stereo halves are identical, and as usual, only one (the left hand channel) will be described.

The power supply connections to the TDA2030 are via pin 5 (positive) and pin 3 (negative, or 0V in this case). The non-inverting input is at pin 1, the inverting input at pin 2 and the output from pin 4.

When used on a single rail supply, the average voltage at the inputs and output must be held at half the supply voltage. This is achieved by the potential divider comprising resistors R1 and R2. This voltage is coupled to pin 1 via R3.

The audio signal input is applied via capacitor C1. No volume control is provided since the Tone Control Module (last month) controls the volume. However, Fig. 2 shows how a volume control could be added if required.

### FEEDBACK

The output from pin 4 is connected to the inverting input (pin 2) via resistor R5. Resistor R4 has no effect on the d.c. feedback level since any d.c. is blocked by capacitor C3. Since any change of d.c. level at the output is fed back to the *inverting* input pin 2, the change self cancels, producing a gain of unity i.e. the d.c. output from pin 4 equals the d.c. input at pin 1. Hence the d.c. levels at pins 2 and 4 settle at the same voltage as pin 1 - half the supply voltage.

However, the a.c. audio signal can pass via capacitor C3. Therefore a.c. changes at pin 4 are not self cancelling and there is a gain of approximately the ratio of resistor R5 to R4.

Either one or both these resistors can be changed in value if a different gain is required. Note the point made earlier however, that the maximum sound output is determined by the power available from



the supply and the power handling capacity of the i.c. Simply increasing the gain in order to produce a louder sound will result in distortion.

## OUTPUT

The output from the i.c. is fed to the loudspeaker via capacitor C5. C5 is necessary since the d.c. output from pin 4 is at half the supply voltage. Connecting a loudspeaker directly to this supply would be very unwise.

The capacitor blocks the d.c. but allows the a.c. audio signal to pass. The loudspeaker should have an impedance of 4 ohm for maximum power; however an 8 ohm speaker is very satisfactory.

## STABILITY

The high currents flowing through the supply rails and the output tend to cause instability problems. This may be in the form of high frequencies – beyond the audio spectrum – which result in distortion, high power consumption and over-heating of the i.c.

Stability may be restored by careful design of the p.c.b. layout, and by adding components such as resistor R6 in series with capacitor C4. This is known as a Zobel network and eliminates very high frequencies caused by the loudspeaker. The

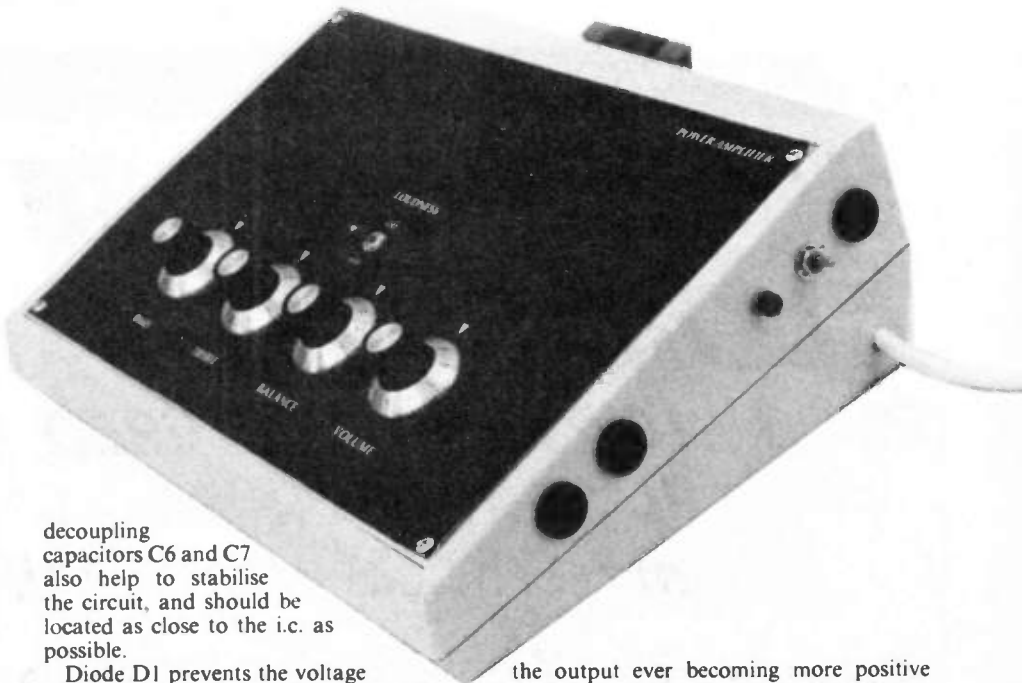

decoupling capacitors C6 and C7 also help to stabilise the circuit, and should be located as close to the i.c. as possible.

Diode D1 prevents the voltage at the 0V rail ever becoming more positive than the output and similarly, D2 prevents

the output ever becoming more positive than the positive rail. This protects the i.c. against all known causes of disaster!

## STEREO PAIR

The two circuits of the stereo pair are identical. They may share the same power supply if preferred, but in this project the current requirements were more easily satisfied by using the supplies from two separate secondary windings on the mains transformer.

However, the 0V connections are joined at one point. Some care must be observed if the 0V or ground lines are connected at other points since an "earth loop" could be introduced, resulting in mains hum.

## COMPONENTS

### POWER AMPLIFIER

#### Resistors

R1, R2,	
R3	100k (3 off)
R4	4k7
R5	150k
R6	1Ω
R7, R8,	
R9	100k (3 of)
R10	4k7
R11	150k
R12	1Ω

All 0.25W carbon film

#### Capacitors

C1, C8	1μ polyester layer (2 off)
C2, C9	22μ axial elect. 35V (2 off)
C3, C10	4μ7 radial elect. 63V (2 off)
C4, C11	0μ22 disc ceramic (2 off)
C5, C12	2200μ axial elect. 35V (2 off)
C6, C13	0μ1 disc ceramic (2 off)
C7, C14	100μ radial elect. 35V (2 off)

#### Semiconductors

D1, D2	1N4001 1A 50V rect. diode
D3, D4	(4 off)
IC1, IC2	TDA2030 20W power amp. (2 off)

#### Miscellaneous

SK1, SK2	Phono chassis socket (2 off)
SK3	4-way spring-loaded, lever action, speaker connector

Console case (with metal sloping front panel), size 262mm x 160mm x 78mm; printed circuit board available from EPE PCB Service, code 852a (power amp); high power, twisted vane, heatsink (9.9°C/W), size 38mm x 28mm x 22mm (2 off); loudspeakers to choice; screened audio cable; multistrand connecting wire; p.c.b. supports; solder triminal pins; solder etc.

See  
**SHOP  
TALK**  
Page

Approx cost  
guidance only

**£27**  
excl. speakers

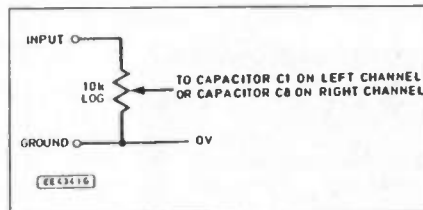

Fig. 2. Adding a Volume control to the Power Amplifier. A second potentiometer is required for the other channel, or use a dual (stereo) control.

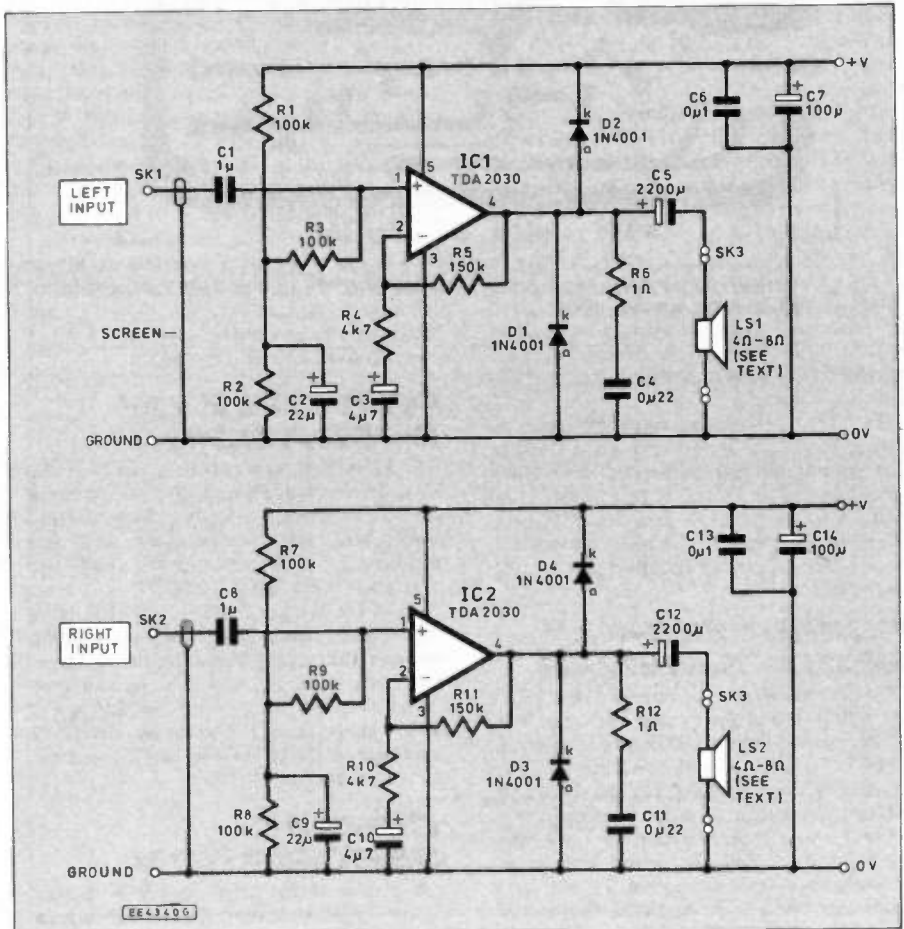

Fig. 1. Circuit diagram for the 10 plus 10 Stereo Power Amplifier

# 10W plus 10W STEREO POWER AMPLIFIER – CONSTRUCTION

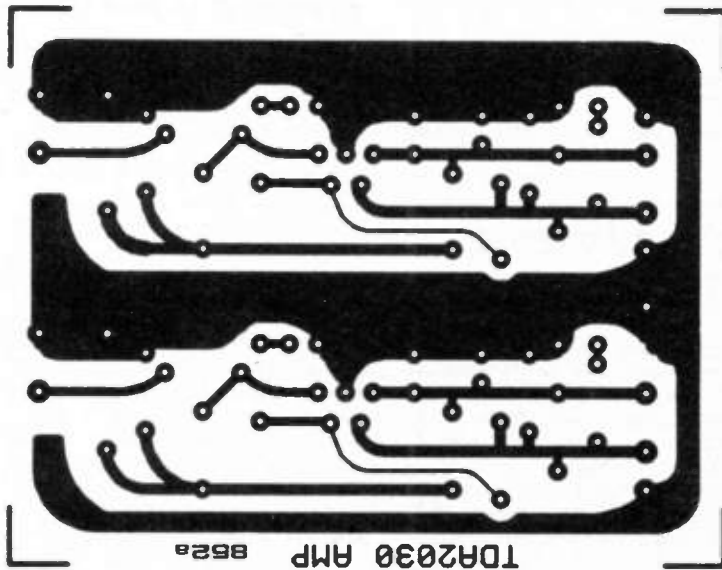
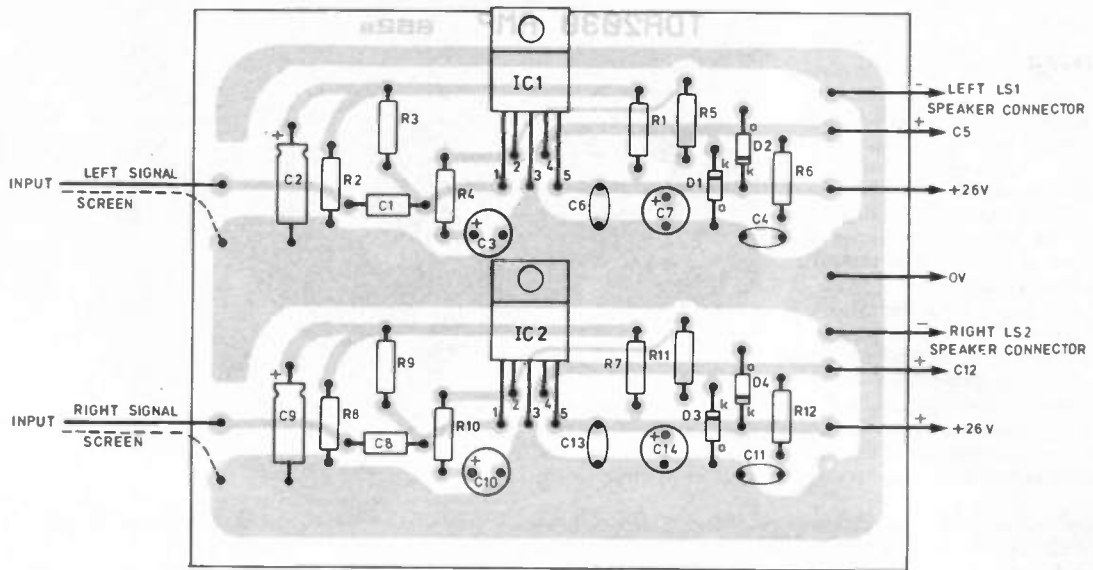

Fig. 3. Printed circuit board component layout and full size copper foil master pattern for the Power Amplifier.

## CONSTRUCTION

The layout of this circuit is quite critical and use of the printed circuit board (p.c.b.) layout provided is recommended. Strip-board is unlikely to offer good results (see "Stability" above), and prototype board (breadboard) may fair even worse.

The p.c.b. topside component layout and the full size underside copper foil master pattern for the Power Amp. is shown in Fig. 3. This board is available from the *EPE PCB Service*, code 852a.

Begin construction by checking the TDA2030 i.c.s. Some are designed to stand upright, and others lie flat. If you have the lie flat types it may be wise to bolt on the heatsinks before inserting the i.c.s into the p.c.b. Check that the i.c.s will fit into the holes in the board, but do not solder them in at this stage.

The smallest components, such as resistors and diodes should be inserted and soldered in place first. Check that the diodes are the correct way round. Next insert and solder the smallest capacitors, noting that C1 (and C8) are non-electrolytic even though they are quite high in value.

The larger electrolytic types should now be inserted, checking that they are fitted the correct way round. The negative (–) side is generally marked on the capacitor body, and the positive side is indicated by a longer lead. Note capacitors C5 and C12 are mounted off the board at a later stage.

All the inter-board leads should be connected using p.c.b. terminal pins. These make life much easier, especially when installing the boards into the case. Ensure that the leads are colour coded and not too thin. Stranded wires (such as "extra flex") are ideal. If the amplifier board is to be used separately, the interwiring to the p.c.b. is shown in Fig. 4.

Remember that long thin leads may result in instability. The audio input leads should be screened cable, with the outer copper "braid" connected to the power amp copper "ground" (0V) as shown; the other end of the screen is left unconnected.

Now solder in the i.c., first bolting on the heatsink if it is to lie flat against the p.c.b.

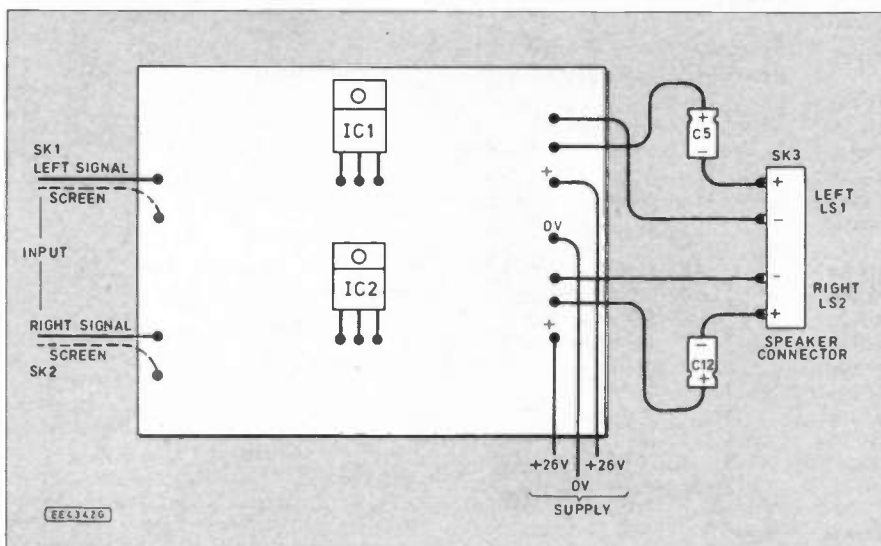

Fig. 4. Interwiring to the amplifier printed circuit board if it is to be used as an individual module.

If you intend using the suggested case and layout, then the i.c. will eventually need to be gently prised into a 45 degree angle. Do this at the last moment, i.e. when installing the board into its case, since the i.c. will not tolerate a change of mind!

## TESTING

**Warning:** If abnormal results are obtained during testing, switch off and check the polarity of the diodes and electrolytic capacitors. It is very easy to make a mistake, with disastrous consequences!

Each stereo half of the amplifier should be tested separately at this stage, using a 12V supply if one is available. A 100mA supply will test whether a fault exists, without damaging the circuit. However, a supply capable of delivering up to 1A will be required to test the *sound* quality.

Connect capacitor C5 temporarily to the output, with the positive (+) side of C5 connected to the board solder pin which leads from the output of the IC1. One side of a speaker should be connected to the negative side of C5 and the other side of the speaker to the 0V line. (The same procedure should be adopted when checking the right channel i.e. IC2/C12).

Do not connect an audio input at this stage. Switch on. There should be no noise or hum from the speaker, the i.c. should not get hot, and the current used should be less than 50mA per stereo half.

If these conditions are not met, switch off without delay and check for faults. Bridges, and components the wrong way round are obvious problems; less obvious is overheating (and high current consumption) of the i.c., caused by instability. (The causes of instability were discussed earlier).

## APPLYING AN AUDIO SIGNAL

A volume control is essential at this stage when applying an audio test signal. The amplifier should be connected to the output from the Audio Mixer or Tone/Volume Control Module (previous articles) or some other device where the volume can be controlled. Otherwise a volume control should have been included as shown in Fig. 2.

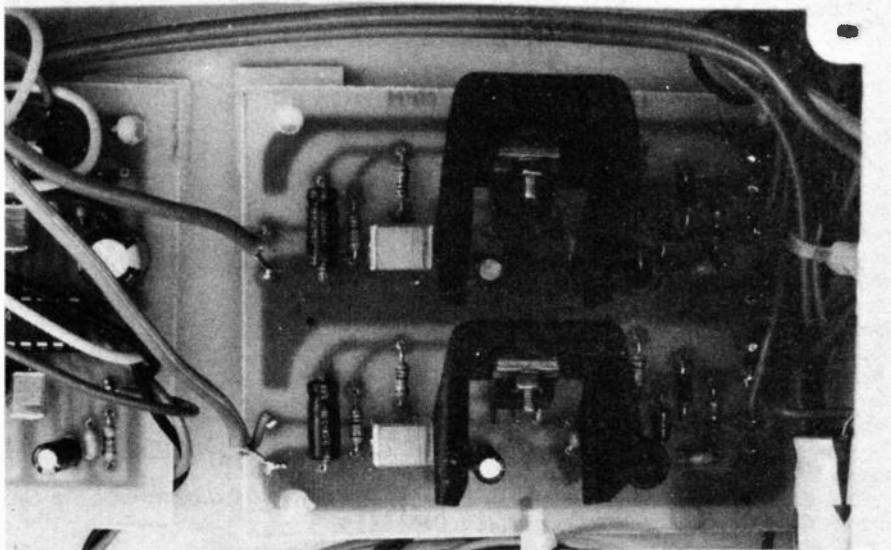

*The completed power amplifier board showing the heatsinks bolted to the i.c.s.*

Set the Volume control to a low level, apply an audio signal, and carefully advance the volume. Hopefully the signal will be played through the speaker.

As the volume level is advanced distortion will arise, the degree depending upon the voltage and current available from the supply. A 12V 1A supply should allow an appreciable level of sound, but the 26V supply suggested will result in an appreciable jump in quantity and quality.

## FAULT FINDING

Try to use a regulated 12V supply if possible when fault finding, since it is easy to short circuit connections when taking voltage measurements. Begin by taking some d.c. voltage measurements using a voltmeter, without an audio signal. Connect the negative lead of the voltmeter to 0V in the circuit, and use the positive voltmeter lead as a probe.

Check the power supply pins on the i.c. pin 5 should be at the supply voltage, and pin 3 should be at 0V. Note that the pin

numbers count from left to right when the i.c. is viewed from the front. The d.c. voltage at pins 1, 2 and 4 should be half the supply voltage.

Any errors in these readings indicates a short circuit, open circuit (e.g. a dry joint) a wrong resistor value, or an electrolytic capacitor or diode the wrong way round. If the voltage at pin 1 is wrong, check the voltage at the junction between resistors R1 and R2. An error here indicates that R1 or R2 or possibly R3 are not the correct values, or are not connected properly.

Further tests require an oscilloscope to monitor the a.c. audio signal through the circuit. When an audio signal is applied to the input there should be a small signal (e.g. about 1V or less, peak voltage) at pin 1 and a larger signal at pin 4. Note that there will be a constant d.c. voltage present. The oscilloscope input should be switched to "AC" to remove the d.c. from the display. If the signal at pin 4 is not magnified check the values of resistors R4 and R5.

## SYSTEM POWER SUPPLY

**T**HE System Power Supply produces *two* unregulated outputs of 26V, plus a 12V *regulated* output.

The two 26V supplies are designed for the power amplifier (one supply for each channel) and the 12V supply drives the tone control module and if required, the 6-Channel (12 mono) Stereo Mixer.

A regulated supply is not required for the single rail power amplifier since a slight change in voltage only affects the maximum sound level achieved, not the level at that particular moment. The amplifier could have been designed for a plus/minus 15V dual supply, but an even larger transformer would have been needed particularly to allow for the wasted power in the regulators.

The power supply for an amplifier always accounts for a significant part of the weight, size and cost, and this one is no exception. The average current required by each amplifier is less than 1A. However, it is essential to allow for the larger current required for the audio peaks, hence the choice of an 80VA toroidal transformer.

A 50VA transformer would also be satisfactory, and a standard (non toroidal) type could be used at about half the cost. However, a standard transformer might produce more magnetic interference, and will not fit inside the case specified.

The current required by the Tone Control Module is not particularly significant, and even with the Mixer connected to the same supply, the 12V regulator may be powered by one of the 26V supplies with no ill effect.

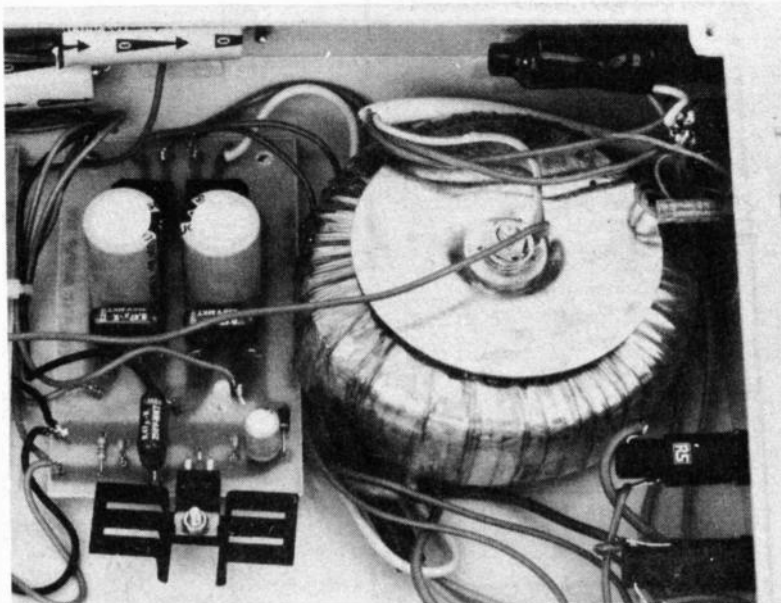

*The finished power supply, with "gull-winged" heatsink, sits next to the toroidal mains transformer.*

## CIRCUIT DESCRIPTION

The complete Circuit diagram for the System Power Supply is shown in Fig. 5. The a.c. mains is delivered via switch S1 and a mains neon, with integral resistor, indicates the presence of the supply. An anti-surge fuse is suggested for FS1 since the type of transformer used causes a high initial surge of current to flow at switch on.

The transformer is a toroidal type rated at 80VA with 2 × 18V secondaries (Maplin code YK17T). Toroidal transformers are more expensive than standard transformers, but produce a lower magnetic field and a well regulated supply. The type chosen also fitted easily into the case which was chosen to match the Audio Mixer.

However, if a different case is used, and the supply is not required to power the mixer, a 50VA chassis mounting transformer with a 2 × 20V output will probably work just as well, and costs half as much, although care must be taken with the layout since magnetic interference from the transformer could cause "mains hum".

Since the two 26V supplies are identical, only one will be described. The 18V a.c. output is changed to d.c. by the bridge rectifier REC1, and smoothed by capacitor C1. The voltage across the capacitor rises to nearly 26V d.c. which represents the approximate peak level of the 18V a.c. supply.

However the current available drops from the 2.22A output from the trans-

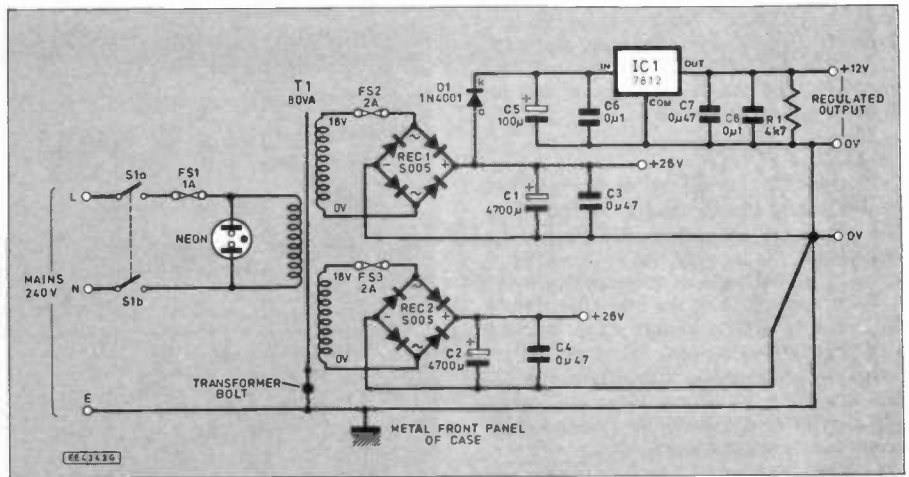

Fig. 5. Full circuit diagram for the System Power Supply. Note the common 0V point.

former to 1.6A. This is more than sufficient to drive the power amplifier and 12V regulator which in turn powers the tone control module and mixer. Capacitor C3 removes any spikes present on the supply.

Diode D1 allows current to flow and charge capacitor C5, which provides a smooth supply for the regulator IC1. This converts the supply to a very stable 12V, with current limited to 1A. This is much more than required, since the Tone Control

Module and Mixer together require less than 100mA. Capacitors C6, C7 and C8 remove any spikes present on the supply rails.

## CIRCUIT LAYOUT

Some care is required to ensure that the amplifiers in the p.c.b. design etc. receive a stable, spike free supply. Substantial copper tracks have been used in the p.c.b. design and the 0V supplies have been

## COMPONENTS

### POWER SUPPLY

#### Resistors

R1 4k7 0.25W carbon film

#### Capacitors

C1, C2 4700µ radial elect. 35V (2 off)  
C3, C4, C7 0µ47 polyester metallised (PEPT) film, 100V (3 off)  
C5 100µ radial elect. 35V  
C6, C8 0µ1 disc ceramic

#### Semiconductors

D1 1N4001 1A 50V rect. diode  
REC1, REC2 S005 2A bridge rectifier (2 off)  
IC1 7812 +12V 1A voltage regulator

#### Miscellaneous

T1 80VA toroidal mains transformer, with 2 x 18V secondaries  
FS1 20mm panel fuseholder, with 1A anti-surge fuse  
FS2, FS3 20mm panel fuseholder, with 2A quick-blow fuse (2 off)  
S1 D.P.D.T. mains on/off toggle switch

Printed circuit board available from the EPE PCB Service, code 852b (power supply); neon mains indicator; TO220 top mounting heatsink; p.v.c. fuseholder insulating boot; p.c.b. supports; earthing solder tag; multistrand connecting wire; power output plug and socket (see text); solder etc.

Approx cost guidance only

**£28**

## SYSTEM POWER AMPLIFIER - CONSTRUCTION

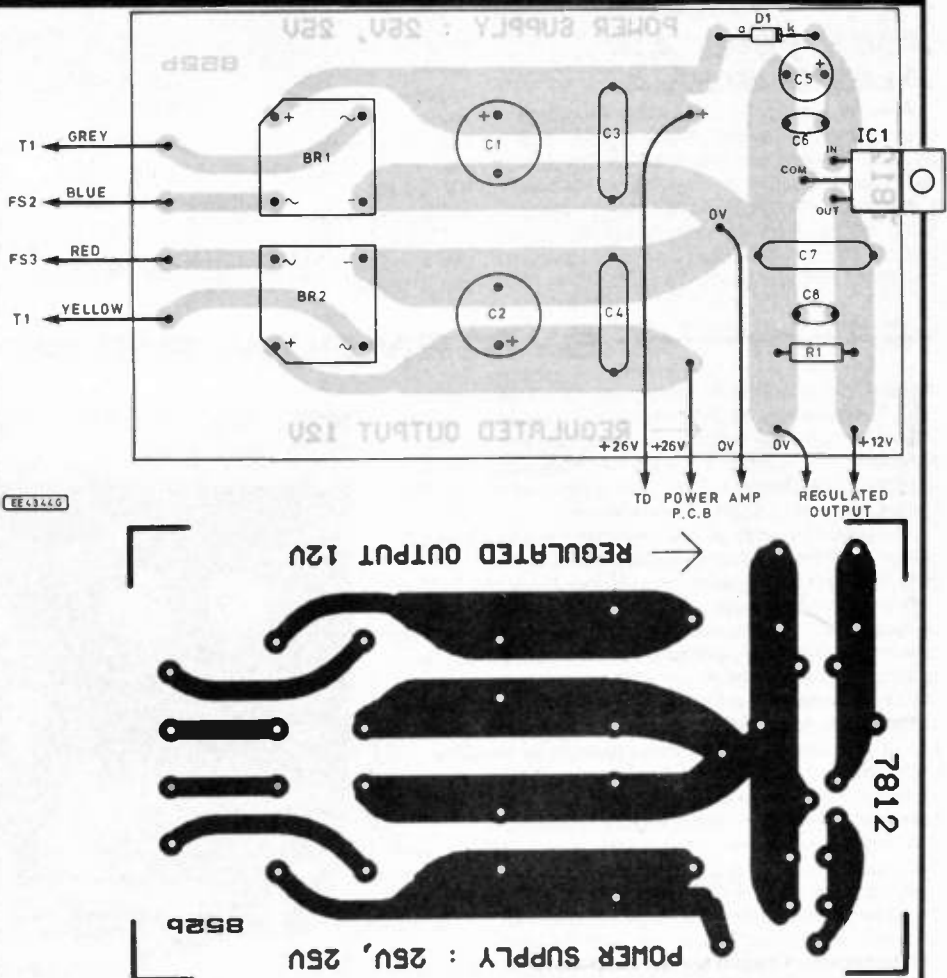

Fig. 6. System Power Supply printed circuit board component layout and full size underside copper foil master pattern.



joined at a single point to help avoid "earth loops".

The 0V point is also connected to the mains "Earth". However this could be removed if the screen or ground connection elsewhere in the audio system is connected to the mains "earth" at any other point.

## CONSTRUCTION- POWER SUPPLY

The Power Supply printed circuit board topside component layout and full size underside copper foil master pattern is shown in Fig. 6. This board is available from the *EPE PCB Service*, code 852b.

Begin construction by soldering in the smallest components, such as small capacitors, diode D1 (the correct way round) and the resistor. Be careful to fit the bridge rectifiers REC1 and REC2 the correct way round (*in mirror image fashion*) as shown in Fig. 6 and Fig. 7..

The leads of the 12V regulator i.c. (type 7812) should be bent slightly since the p.c.b. pads are not in line. Placing the pads out of line allows large solder joints to be made without the risk of bridging. Next solder in the terminal pins ready for the wire connections to be made later.

Finally, insert the large electrolytic capacitors, taking great care to fit them the correct way round. The negative side is marked on the body of the capacitor, and the positive side is indicated by a longer lead. Remember that these capacitors are likely to rupture if used with the wrong polarity (i.e. the wrong way round). A small heatsink should be fitted to the regulator i.c.

## TESTING

It is always wise to test a power supply with a voltmeter before connecting it to another circuit! If an a.c. supply of between 6V and 20V is available it could be connected to the input of the p.c.b., with a d.c. voltmeter monitoring the output. Otherwise testing will have to wait until the transformer is *safely* installed into the case, and connected to the mains supply.

*Avoid the temptation to connect the mains transformer before dealing with the case; this is both difficult and highly dangerous.*

## CASE DETAILS

The case must be large enough to house the two power amplifier circuits (which will normally be housed on a single p.c.b.), the power supply p.c.b., and tone control module, together with the mains transformer fuse etc. Space is also required for the heatsinks and the volume/bass/treble/balance controls which are fitted to the sloping metal front panel. A case was chosen to match the Audio Mixer but some care is required both to ensure that all the items fit, and that there is no interference between the a.c. supply and the sensitive audio circuits.

The suggested internal layout showing the positioning of the p.c.b.s is shown in Fig. 8. The amplifier heatsinks will fit, providing the i.c.s are carefully bent into a 45 degree angle. Note that the heatsinks will be at 0V - *Do not let them touch any other metal surface.*

## FRONT PANEL

The layout of the front panel is determined to some extent by the components underneath. You can use the template from last month (Fig. 10), if you are including the Tone Control, the hole spacings are the same but the overall size is larger. Make two

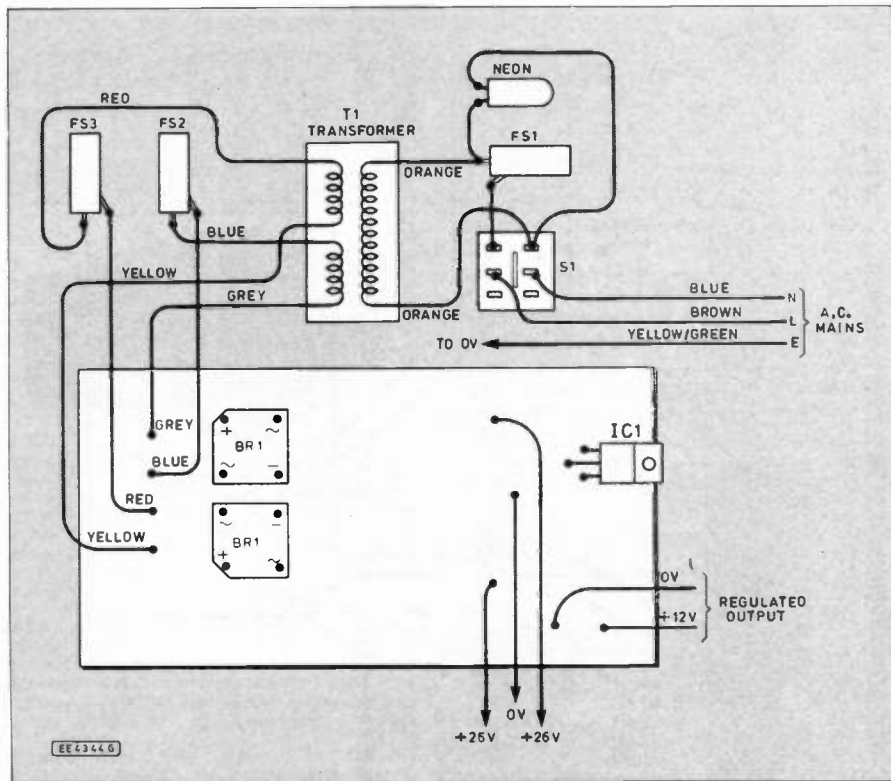

Fig. 7. Interwiring from the circuit board to the toroidal mains transformer and other off-board components.

copies, so that one may be taped in position on the front panel for drilling and the other, covered with material, for the finished panel.

Changing the positions of the potentiometers (pots) or switches should be done with caution, checking that there is sufficient clearance below the metal panel. Fortunately the audio signal does not pass through the wires linking the pots, with the tone control circuit, so screened leads are not required.

Begin case preparation by carefully marking out all the holes required in the case. Some extra ventilation holes in the base and at the back are desirable, since the heatsinks become quite hot when the amplifier is driven at high levels.

The loudspeaker output connectors provide a convenient method of connecting bare loudspeaker wires to the

amplifier, and require six holes, two for mounting with M3 nuts and bolts, and one for each terminal. Two other holes are required at the back for the phono input connectors.

A power output socket was provided in the side of the prototype to enable the Audio Mixer to be powered. It may be wise to fit a different type of connector, since plugging in an external power unit to this output socket would damage the regulator i.c.

Five holes are required in the right hand side panel, three for the fuseholders, and one each for the mains cable, mains switch and neon. The mains devices are best positioned in the least accessible place, behind the transformer. However, check that there is sufficient clearance, bearing in mind that the transformer must be fitted at the right hand side of the case to allow space for the p.c.b.s.

Layout of components inside the console type case.

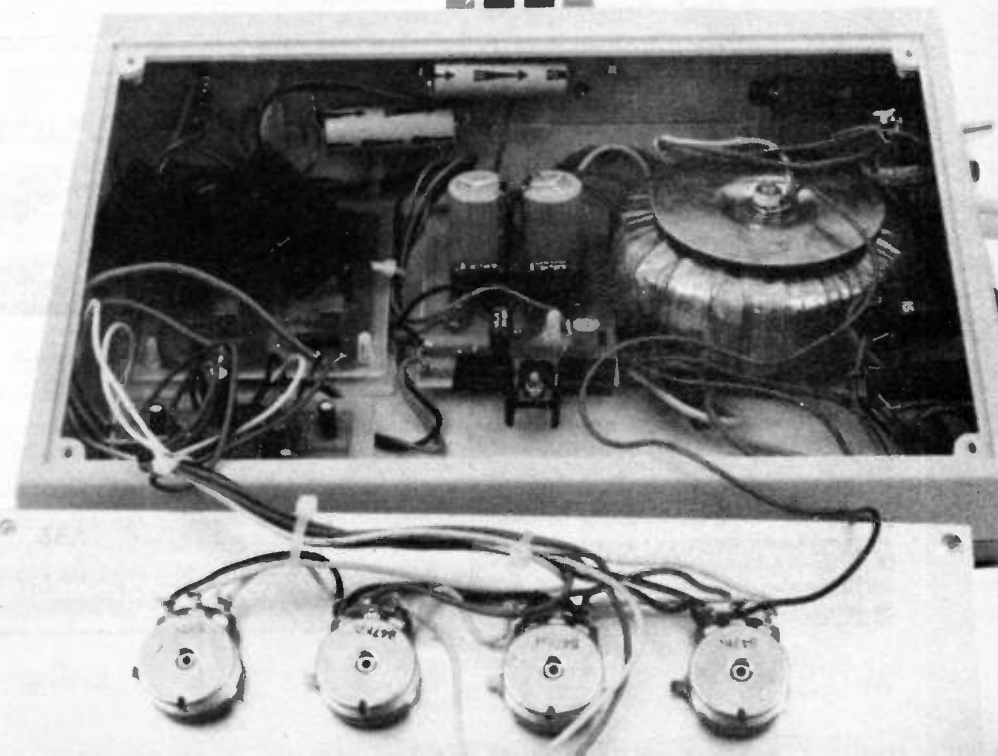

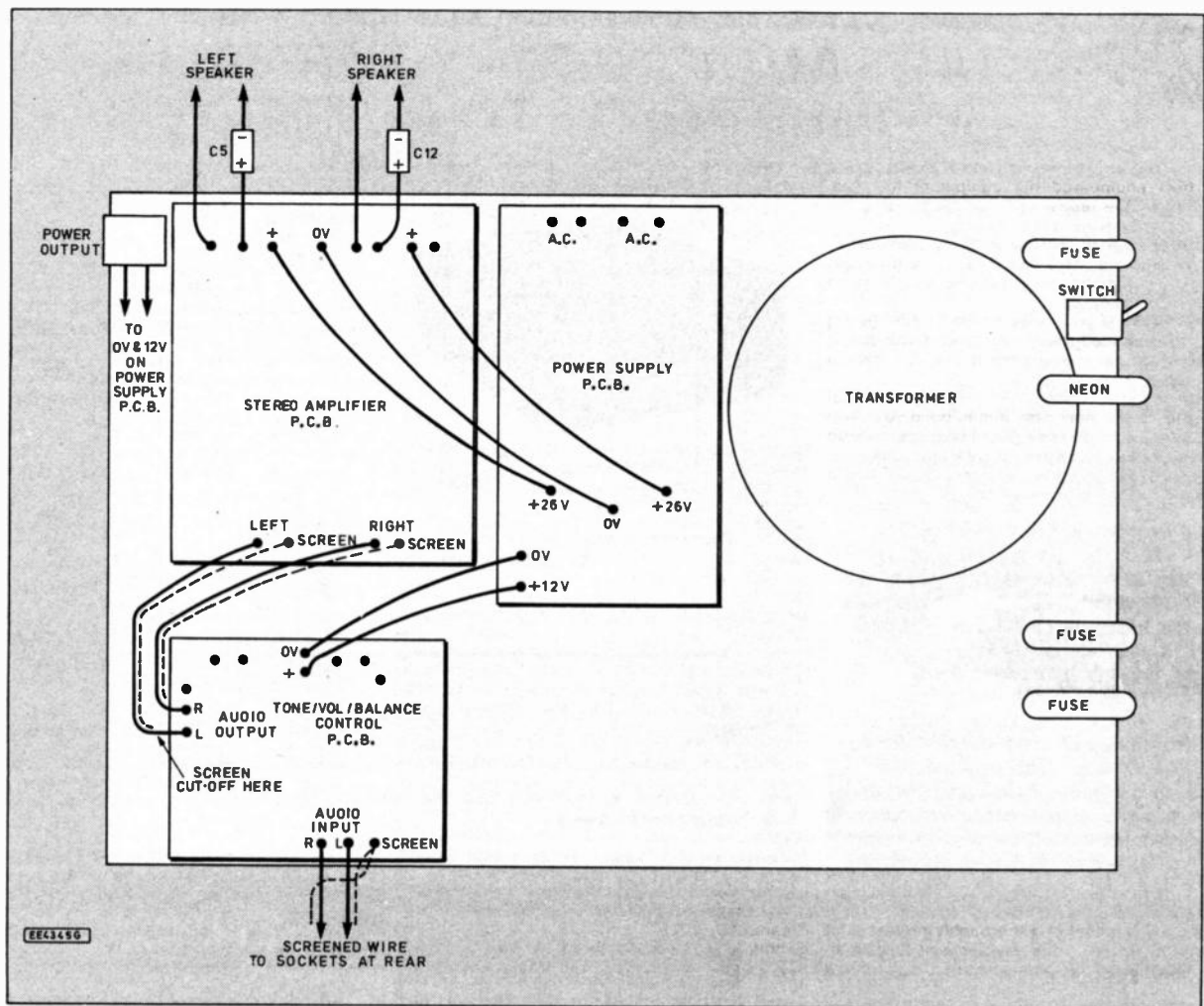

Fig. 8. Positioning and interwiring between the Stereo Power Amplifier, Tone Control and System Power Supply printed circuit boards. All mains connecting terminal points at the fuse, transformer, switch and neon must be covered with insulating sleeving.

The transformer is mounted on the base of the case using the single bolt provided. A word of caution here! Two large flexible washers are provided to sandwich the toroidal transformer, together with a dished washer which is placed on top. When the bolt is placed through the case, and tightened, the case will distort and possibly break. An old piece of p.c.b. or stripboard, about 9cm. square placed between the flexible washer and the case will help prevent damage. However, do not overtighten the bolt.

If the amplifier is housed in a metal case, ensure that the transformer mounting bolt does not touch the top of the case as well as the bottom. This is because the bolt will act like a shorted transformer winding, and generate a large quantity of heat.

## TRANSFORMER CONNECTIONS

The only exposed mains connections are the tags of switch S1 and the mains fuse holder. If these are insulated with suitable sleeving there is little risk of shock even if the unit is tested with the front panel removed.

The instructions supplied with the transformer should be checked, but it is likely that the orange coloured leads are connected to the 240V primary coil. Connect the mains circuit as shown in Fig. 7, noting that the mains Earth (E) is joined to the metal front panel.

The two secondary windings are likely to be coloured Red/Yellow, and Blue/Grey.

Connect these leads exactly as shown in the diagram, including the protective fuses in the circuit.

## INTERWIRING

How the p.c.b.s are arranged in the case and interwired is shown in Fig. 8. They may be mounted using self-adhesive p.c.b. supports and/or the self-tapping screw mounting holes provided in the case.

Complete the wiring between p.c.b.s *after* mounting them in position (assuming terminal pins have been used) in order to route the leads neatly around the boards. D.C. power leads should be colour coded red and black and should not be too thin. Stranded wires will give the best results; keep them as short as possible, but route them neatly around the edges of the p.c.b.s.

All audio connections must be made with *screened* cables. The screen braiding of the lead which connects the Tone Control Module to the Amplifier should be neatly cut away at the Tone Control p.c.b. end of the cable, since the 0V connection is made via the power supply and a possible "earth loop" will be avoided.

The tone control pots. and switch are best connected at this stage since the wires can be cut to an exact length. However, it is likely that they will have already been connected in order to test the tone control module, in which case they can either be removed, or bound up neatly. Since they only carry d.c. supplies (not the audio signals) no precautions need be taken regarding screening.

## FINAL TOUCHES

The photocopy of the front panel, which has been covered with self-adhesive book covering material, should be attached to the metal panel, behind the controls fixing bolts and washers, using thin glue or Pritt stick. It may be possible to reverse the image and produce a white on black copy.

Finally screw the front panel into place, trim the shafts of the pots. to a suitable length and fit the control knobs. Calibrated control knobs are suggested to provide a neat finish.

## THE MOMENT OF TRUTH

If the mains transformer has been connected for the first time, it is worth checking that the supply to the power amps is about 26V while there is time to switch the unit off!

All being well, and assuming that each module has been individually tested during its construction, the chances are that the whole project will work with little trouble. When fitting the front panel in place, ensure that the flexible cables do not touch any of the heatsinks. If necessary, support the wires with cable ties. The final step is to connect the mixer unit, sit back, and marvel at your craftsmanship.

**Next Month:** We add the option of a **Balanced Stereo Microphone Pre-Amplifier module.** This type of pre-amp is essential for high quality work.

# HART

## HART AUDIO KITS – YOUR VALUE FOR MONEY ROUTE TO ULTIMATE HI-FI

HART KITS give you the opportunity to build the very best engineered hifi equipment there is, designed by the leaders in their field, using the best components that are available.

Every HART KIT is not just a new equipment acquisition but a valuable investment in knowledge, giving you guided hands-on experience of modern electronic techniques.

In short HART is your 'friend in the trade' giving you, as a knowledgeable constructor, access to better equipment at lower prices than the man in the street.

You can buy the reprints and construction manual for any kit to see how easy it is to build your own equipment the HART way. The FULL cost can be credited against your subsequent kit purchase.

Our list will give you fuller details of all our Audio Kits, components and special offers.

### AUDIO DESIGN 80 WATT POWER AMPLIFIER.



This fantastic John Linsley Hood designed amplifier is the flagship of our range, and the ideal powerhouse for your ultimate hifi system. This kit is your way to get £K performance for a few tenths of the cost! Featured on the front cover of 'Electronics Today International' this complete stereo power amplifier offers World Class performance allied to the famous HART quality and ease of construction. John Linsley Hood's comments on seeing a complete unit were enthusiastic: "The external view is that of a thoroughly professional piece of audio gear, neat elegant and functional. This impression is greatly reinforced by the internal appearance, which is redolent of quality, both in components and in layout." Options include a stereo LED power meter and a versatile passive front end giving switched inputs using ALPS precision, low-noise volume and balance controls. A new relay switched front end option also gives a tape input and output facility so that for use with tuners, tape and CD players, or indeed any other 'flat' inputs the power amplifier may be used on its own, without the need for any external signal handling stages. 'Slave' and 'monobloc' versions without the passive input stage and power meter are also available. All versions fit within our standard 420 x 260 x 75mm case to match our 400 Series Tuner range. ALL six power supply rails are fully stabilised, and the complete power supply, using a toroidal transformer, is contained within a heavy gauge aluminium chassis/heat-sink fitted with IEC mains input and output sockets. All the circuitry is on professional grade printed circuit boards with roller tinned finish and green solder resist on the component ident side, the power amplifiers feature an advanced double sided layout for maximum performance. All wiring in this kit is pre-terminated, ready for instant use!

RLH11 Reprints of latest articles.....£1.80  
K1100CM HART Construction Manual.....£5.50

### LINSLEY HOOD 1400 SERIES ULTRA HIGH-QUALITY PREAMP

Joining our magnificent 80 Watt power amplifier now is the most advanced preamplifier ever offered on the kit, or indeed made-up marketplace. Facilities include separate tape signal selection to enable you to listen to one programme while recording another, up to 7 inputs, cross recording facilities, class A headphone amplifier, cancellable 3-level tone controls and many other useful functions, all selected by high quality relays. For full details see our list.

Send or 'phone for your copy of our List (50p) of these and many other Kits & Components. Enquiries from Overseas customers are equally welcome, but PLEASE send 2 IRCs if you want a list sent surface post, or 5 for Airmail.

Ordering is easy. Just write or telephone your requirements to simplify the friendly and efficient HART service. Payment by cheque, cash or credit card. A telephoned order with your credit card number will get your order on its way to you THAT DAY.

Please add part cost of carriage and insurance as follows:—INLAND Orders up to £20 - £1.50,  
Orders over £20 - £3.50. Express Courier, next working day £10.

OVERSEAS - Please see the ordering information with our lists.

### LINSLEY HOOD 'SHUNT FEEDBACK' R.I.A.A. MOVING COIL & MOVING MAGNET PICKUP PREAMPLIFIERS



Modern, ultimate sound systems are evolving towards built-in preamplifiers within or near the turntable unit. This keeps noise pickup and treble loss to a minimum. We now offer two units, both having the sonically preferred shunt feedback configuration to give an accurate and musical sound, and both having the ability to use both moving magnet and moving coil cartridges.

Kit K1500 uses modern integrated circuits to achieve outstanding sound quality at minimal cost. The very low power requirements enable this unit to be operated from dry batteries and the kit comes with very detailed instructions making it ideal for the beginner. K1500 Complete kit with all components, printed circuit board, full instructions and fully finished case.....£67.99

Instructions only.....£2.80  
Kit K1450 is a fully discrete component implementation of the shunt feedback concept and used with the right cartridge offers the discerning user the ultimate in sound quality from vinyl disks. Can be fitted inside our 1400 Preamp, used externally or as a standalone unit. It has a higher power requirement and needs to be powered from our 1400 Series preamplifier or its own dedicated power supply. K1450 Complete Discrete Component RIAA Phono Preamp.....£109.58

Factory Assembled and Tested.....£159.58  
K1565 Matching Audio Grade Power Supply with potted toroidal transformer and limited shift earthing system.....£79.42  
Factory Assembled and Tested.....£118.42  
U1115 Power Interconnect Cable.....£7.29

### ALPS PRECISION LOW-NOISE STEREO POTS



Super Savings with our "3 for the price of 2" Offer.

Now back in stock our range of the fabulous ALPS range of High Grade Audio Pots fulfill the need for no compromise quality controls as used in HART Kits and other World Class Amplifiers. This exciting range covers the values needed for most quality amplifier applications.

Now you can throw out those noisy ill-matched carbon pots and replace with the real hi-fi components. The improvement in track accuracy and matching really is incredible giving better tonal balance between channels and rock solid image stability.

All pots are 2-gang stereo format, with 20mm long 6mm diam. steel shafts. Overall size of the manual pot is 27mm wide x 24mm high x 27mm deep, motorised versions are 72.4mm deep from the mounting face. Mounting bush for both types is 8mm diameter. Motorised versions have 5V d.c. drive motor.

### MANUAL POTENTIOMETERS

2-Gang 100K Lin.....£15.67  
2-Gang 10K, 50K or 100K Log.....£16.40  
2-Gang 10K Special Balance, zero crosstalk and zero centre loss.....£17.48

### MOTORISED POTENTIOMETERS

2-Gang 20K Log Volume Control.....£26.20

2-Gang 10K RD Special Balance, zero crosstalk and less than 10% loss in centre position.....£26.98  
OUR SPECIAL OFFER ON ALPS POTS. Buy any two and get the third FREE. (The third must be the same or a cheaper type).

### STUART REEL-TO-REEL TAPE RECORDER CIRCUITS

Complete stereo record, replay and bias circuit system for reel-to-reel recorders. These circuits will give studio quality with a good tape deck. Separate sections for record and replay give optimum performance and allows a third head monitoring system to be used where the deck has this fitted. Standard 250mV input and output levels. Ideal for bringing that old valve tape recorder back to life. Suitable stereo heads are in our head list. This basic kit is suitable for advanced constructors only. K900W Stereo Kit with Wound Coils and Twin Meter Drive.....£123.93  
RJS1 Reprints of Original Descriptive Articles.....£3.60

### HIGH QUALITY REPLACEMENT CASSETTE HEADS

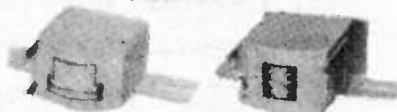

Do your tapes lack treble? A worn head could be the problem. For top performance cassette recorder heads should be replaced every 1,500 hours. Fitting one of our high quality replacement heads could restore performance to better than new! Standard inductances and mountings make fitting easy on nearly all machines (Sony are special dimensions, we do not stock) and our TC1 Test Cassette helps you set the azimuth spot on. As we are the actual importers you get prime parts at lower prices, compare our prices with other suppliers and see! All our heads are suitable for use with any Dolby system and are normally available ex stock. We also stock a wide range of special heads for home construction and industrial users.

HC80 NEW RANGE High Beta Permalloy Stereo head. Modern space saver design for easy fitting and lower cost. Suitable for chrome metal and ferric tapes, truly a universal replacement head for everything from hi-fi decks to car players and at an incredible price too!.....£8.30

HRP373 Downstream Monitor Stereo Combination Head.....£53.90  
HQ551A 4-Track Record/Play Head.....£8.75  
HM120 Standard Mono R/P Head.....£3.44  
H524 Standard Erase Head.....£1.90  
H561 Hi Field Erase Head for METAL Tapes.....£3.49  
SM150 2/2 (Double Mono) DC Erase Head.....£5.20  
HQ751E 4/4 True 4-Track Erase Head.....£57.06

### REEL TO REEL HEADS

999R 2/4 Record/Play 110mH. Suits Stuart Tape Circuits.....£13.34  
998E 2/4 Erase Head 1mH. Universal Mount. Suits Stuart.....£11.96

**"Full spec., treble D Quality Classical and Opera Compact Disks at incredible prices. Send for full list of titles."**

### HART TC1D Triple Purpose TEST CASSETTE

Now available again and even better than before! Our famous triple purpose test cassette will help you set up your recorder for peak performance after fitting a new record/play head. This quality precision Test Cassette is digitally mastered in real time to give you an accurate standard to set the head azimuth, Dolby/VU level and tape speed, all easily done without test equipment.  
TC1D Triple Purpose Test Cassette.....£14.99

### TAPE RECORDER CARE PRODUCTS

DEM1 Mains Powered Tape Head Demagnetizer, prevents noise on playback due to residual head magnetisation.....£4.08  
DEM115 Electronic, Cassette Type, demagnetizer.....£8.61

QUALITY  
AUDIO KITS

24 hr. SALES LINE  
(0691) 652894

ALL PRICES  
INCLUDE  
UK/EC VAT



**HART**  
HART ELECTRONIC KITS LTD  
6 PEWLAN MILL  
OSWESTRY, SHROPSHIRE  
SY10 9AF



# ELECTRONIC TESTING AND FAULT DIAGNOSIS

MIKE TOOLEY BA

*Mike Tooley examines one of the latest distance learning offerings from the National College of Technology.*

THE National College of Technology (NCT Ltd.) was founded approximately seven years ago. Since then it has provided training for several thousand students and currently has over 900 students taking courses. It is interesting to note that 85 per cent of NCT's students are industrial practitioners (mostly engineers and technicians) whilst the remaining 15 per cent are hobbyists and enthusiasts.

NCT is no stranger to the development of electronics distance learning courses. The college has now produced more than a dozen distance learning packages, including several popular courses dealing with analogue electronic circuits, digital circuits, and programmable logic controllers.

NCT's clients include colleges and firms as well as independent learners. Many colleges have used NCT packages as an integral part of "bridging" courses where students use distance learning material to "top up" their existing knowledge to a point which can allow them to join a conventional full-time or part-time BTEC programme.

Employers, on the other hand, tend to use NCT courses as a means of develop-

ing particular skills that are in short supply. Distance learning is a particularly cost-effective way of doing this without having to recruit specialist staff.

## ELECTRONIC TESTING

NCT's latest course is delivered in two Volumes entitled *Electronic Testing and Fault Diagnosis*. Volume 1 has been designed to lead on to Volume 2 however, students with some previous experience may find that they can move straight to Volume 2. The contents for Volumes 1 and 2 are summarised in Tables 1 and 2, respectively.

Each of the two course Volumes involves more than 65 hours of study. NCT provides a suggested timetable which should suit the vast majority of students. This timetable gives suggested times for each of the course assignments but these are for guidance only (individual students may find that they need more or less time depending upon their own individual circumstances and, in particular, the level of previous experience that they may, or may not have.

As with other NCT courses, the learning process has been designed around a series of practical assignments which enable students to learn from hands on experience. The study time for these assignments varies from about 1 to 4 hours. Volume 1 contains 80 student centred assignments and over 120 self test questions.

More than 100 student centred assignments and 114 self test questions are provided in Volume 2. In addition, those who have registered for NCT tutoring support will have three test papers to complete. For this reason, NCT's students will not be able to complain that they don't have enough work to do!

## DISTANCE LEARNING

Distance learning provides an alternative to conventional day release, evening and short courses held at technical and further education colleges and other training centres. Distance learning is inherently more flexible than conventional learning methods; you can study at a time and pace to suit you. This means that you can structure your learning experience to occupy the time that you actually have available - you don't need to attend your local college on a regular day or evening each week.

The better distance learning providers, NCT included, make available tutor support. This is an important aspect of a distance learning course since, however good the materials you are provided with, there will always be questions and problems that are best resolved by discussion with a tutor. Furthermore, the fact that there is a named person available at the end of a telephone can be a great reassurance.

You probably won't need to talk to your tutor on a regular basis but the simple fact that he or she is there and ready to share your problems can be instrumental in giving you extra confidence to tackle concepts that you might otherwise be completely unfamiliar with.

Distance learning also requires that you have all of the support materials and hardware available that would be provided as a matter of routine in a conventional learning centre. In the case of an electronics course, this means not only providing the electronic components that you may need to carry out practical circuit construction but also the provision of a means of connecting the components together (i.e., "breadboarding") and testing the circuits when they are completed.

*Contents of Volume 1 (left).*





**Table 1**  
**Contents of Volume 1**

**PART 1**  
Introduction to your course  
Assignment 1. Know your circuit board  
Assignment 2. Testing your printed circuit board  
Assignment 3. Introducing Integrated Circuits  
Assignment 4. Resistors  
Assignment 5. Voltage measurements  
Assignment 6. Use of the Ohmmeter  
Assignment 7. Testing series circuits 'A'  
Appendix 1. Resistor E - ranges

**PART 2**  
Assignment 8. Cells and Switches  
Assignment 9. Current measurements  
Assignment 10. Ohm's law  
Assignment 11. Testing series circuits 'B'  
Assignment 12. Testing parallel circuits

**PART 3**  
Assignment 13. Testing series/parallel circuits  
Assignment 14. Digital numbers and logic  
Assignment 15. Testing the INVERTER gate  
Assignment 16. Counting in binary  
Assignment 17. Testing the AND gate  
Assignment 18. Testing & Diagnosis Workshop 'A'  
Assignment 19. Testing & Diagnosis Workshop 'B'  
Course Topic Reference

All this means that a great deal of care and thought has to be put into planning the contents of the practical assignments and the contents of the kits that accompany a distance learning package.

## **SUCCESS FACTORS**

At the outset it is important to realise that successful completion of a distance learning course depends almost entirely on two factors; the level of personal commitment on the part of the individual student and the quality of the material and learning support provided. NCT are well aware of this and have, as a result, made a great deal of effort to ensure that the learning materials are of a very high standard.

Successful electronic fault diagnosis, on the other hand, depends upon the depth of understanding of the behaviour of electronic components, circuits and systems. Diagnostic technicians rely very heavily upon their knowledge of how a device *should* work when it is functionally sound. Only when this knowledge is adequate can a technician fully appreciate that a circuit *has* developed a fault condition. Furthermore, a thorough understanding of circuit behaviour is essential if a technician is to be able to diagnose the cause of a problem *and* how it should be corrected. The NCT course aims to impart just this sort of information.

## **CERTIFICATION**

One of the major attractions of the NCT courses is that they can lead to the award of a nationally recognised certificate. This provides students with some tangible evidence of their achievement which can be used to enhance employment prospects and also as a means of progression to other awards at equivalent or higher levels. These Certificates are awarded by a well respected body, the Business and Technology Education Council (BTEC).

Recognising that perhaps not every student will want to obtain a certificate (actually, the vast majority do!), NCT have made the BTEC assessment component op-

*Contents of Volume 2 (right)*

**Table 2**  
**Contents of Volume 2**

**PART 1**  
Introduction to your course  
Assignment 1. Essential revision and workout  
Assignment 2. Soldering techniques 'A'  
Assignment 3. Capacitor testing  
Assignment 4. Testing RC circuits  
Assignment 5. Using the analogue multimeter  
Assignment 6. Shunts and multipliers  
Appendix 1. Capacitor codes  
Appendix 2. Recharging your gas soldering iron  
Appendix 3. Integrated circuit pin-out references

**PART 2**  
Assignment 7. Soldering techniques 'B'  
Assignment 8. The fundamentals of semiconductor devices  
Assignment 9. Diode tests, characteristics and fault diagnosis  
Assignment 10. Circuit construction and testing 'A'  
Assignment 11. The transistor - serviceability testing  
Assignment 12. Transistor circuits and characteristics

**PART 3**  
Assignment 13. Transistor biasing and testing  
Assignment 14. Understanding and testing the NAND gate  
Assignment 15. Logical specifications and operation  
Assignment 16. The 555 timer  
Assignment 17. Circuit construction and testing 'B'  
Assignment 18. Workshop 'A', Circuit construction  
Assignment 19. Workshop 'B', Assembly and test

tional with a modest additional fee to cover registration and certification.

## **PHASE TESTS**

Students who wish to qualify for a certificate must achieve a certain level of attainment on each of the three phase tests supplied with each Volume of the course. The phase tests are designed to check the student's understanding of each part of the course but they can also be taken at the end of the course if a student decides to register for certification at a later stage.

Where students may be unsure of the required level of performance, NCT's tutors will provide advice and guidance. Most students will not find this aspect of the course particularly arduous and the vast majority of NCT's students do register for tutor support and do obtain the BTEC Certificate of Achievement when they complete the course.

## **HARDWARE**

NCT believe in supporting their distance learning packages with sufficient hardware to carry out a large number of practical assignments. In the case of *Electronic Testing and Fault Diagnosis*, this naturally

extends to soldering and measurement techniques using digital and analogue multi-range meters and a logic probe. The digital multimeter (a 3½-digit l.c.d. instrument) is supplied with Volume 1 whilst the analogue test-meter (which offers 2kΩ/V loading on both a.c. and d.c. ranges) comes with Volume 2.

A neat portable gas-powered soldering tool provides students with a means of practising basic soldering technique. It is also the means by which two of the circuits used in the later assignments for Volume 2 are assembled onto stripboard. Nor has NCT forgotten the need for a soldering iron stand - a large paper clip is supplied together with instructions for bending it to form a simple but nevertheless effective holder!

NCT's experimental motherboard is neat and well thought out. It contains a prototyping breadboard area with space for up to six standard 14 or 16-pin d.i.l. packaged integrated circuits, an on-board +5V regulator, and a number of l.e.d.s, drivers and switches. The motherboard also has space for two smaller daughterboards which can be used to further extend the range of functions.



The motherboard is screen printed with component legends and well made. Its layout is logical and this makes it easy to understand and use. If you have never made use of a breadboard before, NCT's hardware and detailed instructions should make this a very simple and totally painless experience! Finally, it is worth noting that NCT's motherboard is used on other courses and students will be able to make further use of it at some later date.

## AUDIO CASSETTE TAPE

The audio cassette tape supplied by NCT is used, together with the course books at regular intervals throughout the course. As with other NCT courses, a cheery female voice welcomes you to the National College of Technology and reminds you that tutor support is available to all registered students. She explains that if you are attending a conventional college, the role of tutor will be performed by your college lecturer.

The introductory part of the audio tape explains the basic concepts of the course and briefly describes the constituent parts of the NCT package. All of this information is available in writing but NCT's friendly voice reinforces this and helps to remind you what the course is all about.

Undoubtedly the two most important parts of this introductory audio material is the advice given on setting aside study time on a regular basis. The discipline of a regular learning routine should not be underestimated. Such a routine can take the form of a number of short study periods at regular times dispersed throughout the week or perhaps just two or three longer periods each week.

## THE TEXT

In each of the Volumes, NCT supplies three course books together with a book containing fully worked solutions to the assignments. This is where the NCT course really excels. The text is very thorough and it leaves very little to chance as the reader is guided gently but firmly through each of the Assignments and Workshops. At all times, the approach is both friendly and logical.

NCT believe that all study should be enjoyable and the course books have been written in a style which not only

emphasises the essential points but also gives the learner a great sense of achievement. At times, the writing style is perhaps too chatty. Comments like; "*Phew that was a marathon but you are truly introduced to the soldering technique. You had better take a break.*" and "*Now for some sneaky test questions, moan!*" are a little unnecessary. You either like this style or you hate it...

## ASSIGNMENTS AND WORKSHOPS

Each of the course assignments is fully described within the books that accompany each part. Each assignment is presented with a list of learning outcomes. As an example, the third Assignment from Volume 1 is entitled "Introducing Integrated Circuits" and it should be completed within about 2 to 3 hours. When the assignment has been completed, students should be able to:

- Understand why the word "integrated" is used.
- Understand the terms "chip" and "d.i.l." pack.
- Explain how d.i.l. packs are assembled.
- Identify d.i.l. packs and their pin numbers.
- Test i.c.'s as the course proceeds.

Later in Volume 1, students are involved in a "Testing and Diagnosis Workshop". This constitutes the eighteenth assignment and it has been designed to take about four hours to complete. The learning outcomes for this assignment are that students should be able to:

- Test and understand the behaviour of series circuits.
- Test and understand the behaviour of parallel circuits.
- Test and understand the behaviour of combinational circuits.
- Deduce causes of faults in all of the above.
- Conduct remedial action to overcome the faults within circuits.

The first assignment in Volume 2 provides essential revision (including resistor colour codes, using a digital multimeter to measure voltage, current and resistance, calculations involving voltage, current and resistance, binary to decimal number conversion, and truth tables.

The structure of the Volume 2 course is to have an on-going project within the text. As the student increases his/her skills level so the project is expanded until all the various parts of the project are connected together to form a composite working system.

The last assignment in Volume 2 (entitled "Workshop B: Assembly and Test") is designed to take about 4 hours to complete and it allows students to:

- Examine the correct behaviour of a 555 timer in an astable mode.
- Test the operation of a transistor circuit.
- Drive the transistor circuit from the 555 circuit.
- Test the combined circuit operation.
- Verify the correct operation of a diode circuit.
- Drive the diode circuit from the transistor circuit.
- Test the completed circuit assembly.

The workshop sessions are extended assignments which aim to establish the fault conditions which students may well encounter in practice. Unlike the assignments which lead up to them (most of which deal with a specific topic) the workshop sessions provide a specific range of techniques for circuit testing and encourage students to develop a structured and systematic approach to fault finding. NCT's workshops succeed admirably in putting the underpinning knowledge developed as the course progresses into practice.

Where students have opted for tutor support, NCT reserve the right to call in students' completed workbooks so that they can be examined by an external (BTEC appointed) assessor. This is only likely to happen within 90 days of the completion of the course and all submitted material is returned to students. As is normal practice with BTEC approved programmes, certification is only likely to be withheld if the prescribed minimum standard has not been reached or if the course books have not been satisfactorily completed.

## IN CONCLUSION

NCT's new offering can be very highly recommended. Students who successfully complete the course will have acquired a range of useful skills and should be capable of dealing with routine fault-finding on a wide variety of basic electronic circuits. Course volumes three and four are already in the pipeline and these will enable students to study more complex systems using the basic skills from the earlier courses. So, if you are a looking for a means of developing your own fault-finding competence and one that will lead to a recognised BTEC certificate, you need look no further!

The National College of Technology can be contacted at PO Box 11, High Street, Wendover, Bucks., HP22 6XA. Tel: (0296) 624270. Volume 1 of the Electronic Testing and Fault Diagnosis course costs £199, Volume 2 costs £210 (plus VAT and carriage). Students with previous experience who opt to start at Volume 2 must also to invest in a "start-up" kit priced at £69 (VAT and carriage extra). NCT tutor support for each Volume costs a further £29.50 (plus VAT). Alternatively, the combined fee for tutorial support and BTEC registration is £51 (plus VAT).

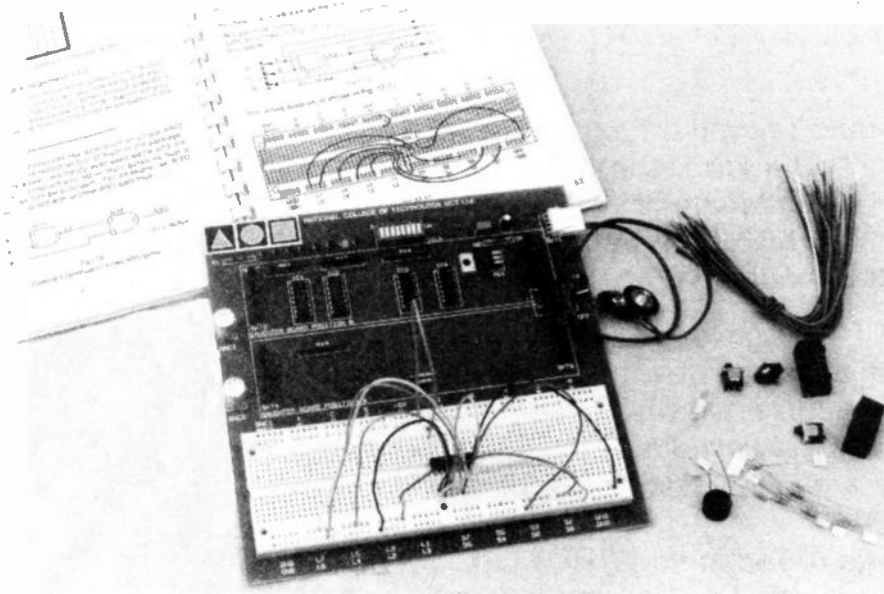

A Volume 1, Part 3 assignment on the experimental motherboard.

# PCB DESIGN SOFTWARE

## RANGER 1

XT/AT PC  
Circuit — PCB

From Circuit Design  
Through to Artwork  
In One Package!

**£100**

Fully Integrated  
AutoRouter

**£50**

Exchange your easy PC  
For a free AutoRouter

## RANGER 2

XT/AT + 386 PC

It has all the features you will ever need  
at an outstanding price. But now with a new 2  
layer 386 Ripup & Retry AutoRouter

**£599**

Option Pack 100% Router  
Simultaneous 6 layer Ripup & Retry  
AutoRouter with via Minimisation.  
Autocad DXF in & out. GERBER in.

**£350**



Call us for details & demo disk on 0705 591037

**SEETRAX**  
CAE



Seetrax CAE, Hinton Daubnay House, Broadway Lane, Lovedean, Hants. PO8 0SG

Tel: 0705 591037 Fax 0705 599036

**BTEC**  
Certificated



**TUTOR**  
Supported

N A T I O N A L  
C O L L E G E O F  
T E C H N O L O G Y

## DISTANCE LEARNING COURSES

Update and reskill at home or in your workplace training centre with these highly practical industrially approved short courses. There is no travelling so commence at any time on . . . .

**Electronic Testing & Fault Diagnosis**  
**Analogue Electronics**  
**Digital Electronics**  
**Fibre/Optoelectronics**  
**Programmable Logic Controllers**

Courses are supplied with NCT training workbooks, audio cassette lecturettes, PCB's, instruments, tools, components and leads as necessary for each course. Continuous tutor support and **BTEC** certification is available as an option from NCT. Individual course certificates can be credited towards a **BTEC** Continuing Education Certificate which is at **NVQ level 4**. For the latest information on courses and your options write or telephone:

**National College of Technology, NCT Ltd., PO Box 11**  
**Wendover, Bucks. Tel: (0296) 624270**

# FOX

## REPORT

by Barry Fox



### Wharfedale Revisited

The first time I visited the Wharfedale factory, some twenty years ago, it was at Idle, near Bradford. Founder Gilbert Briggs had by then sold out to Rank and the company had grown a large research and development division.

Wharfedale hosted open days for the press every year and we saw what the researchers were developing, and heard their theories on sound. We also visited the loudspeaker factory and saw the production lines.

I was always very impressed with the research and development. The division employed some of the best engineering brains in the country who worked with a large anechoic chamber, and developed some of the first laser holography and computer equipment for analysing cone performance.

But year after year I reckoned that the factory production lines were only busy because Japanese factories could not compete on price when shipping speakers, which are largely empty boxes of heavy wood, across the world. Although the work staff was loyal, Wharfedale's production lines were very old and inefficient, and the unions were resisting change.

Over the years Wharfedale tried to improve its lines, but there was no real incentive because the Japanese still could not compete on price and were often buying Wharfedale speakers for sale with Japanese rack systems. In 1979 Wharfedale made a million speakers. But things slid downhill and in 1982 Rank sold out to a private owner, Peter Newman. By 1985 the company had moved out of the large Idle factory and into smaller premises in Crossgates, Leeds.

### Curtain Up

On a radio phone-in recently I had a call, which I do not doubt was genuine, about a listener's electronic problem. All round his house he has remote control equipment. Everything, from the flame effect fire to the window curtains, is under infra-red remote control. And by rotten luck, the code for opening and closing the curtains matches some of the recording control codes for his VCR.

He never knew this until his neighbours tactfully asked him why his curtains kept opening and closing on evenings when he was out. What was happening was quite simple. He also had a VideoPlus remote which beams out a

signal to switch on the VCR, select a channel and start recording, and then switches it off again at the end of a taped programme. When the VideoPlus triggers the VCR, the curtains obediently open, close, open and close again.

### Mission Control

Things then slid even further downhill in all there were ten different managing directors in twelve years. The once famous name Wharfedale ended up as a "W" logo on a lot of very "samey" black box loudspeakers. For a while it looked as if Wharfedale would disappear altogether, going the same way to oblivion as other famous British hi fi names like Leak, Garrard and Armstrong. But in October 1992 Mission merged with Wharfedale under Verity Group PLC.

Mission's founder Farad Azima admits that Verity found that what it had bought was "grim - much worse than we were led to believe". Wharfedale was very heavily in debt. In August 1993 Verity completely re-structured Wharfedale, with Hong Kong OEM supplier Tomei buying 7.7 per cent.

"This gives Wharfedale the chance to move into affordable electronics, by using Tomei's Far Eastern manufacturing base" says Azima. "Press reports of a tie-up with Sansui are not true. Tomei owns distributor Cascade in the UK and Cascade distributes Sansui in the UK. That is the only connection."

Technical Director Stan Curtis tells what Verity found when they looked at Wharfedale's factory and warehouse in Leeds.

"Stock supposedly worth several million pounds, was covered with a half inch layer of dust, with ten year old company labels. We just got rid of it. You have never seen so many skips lined up."

"The company was adopting the scatter gun approach. It had lost its way. The last new driver was made in 1984.

The solution? Easy. The same as for anyone who finds that one piece of audio or video equipment is triggered by the remote control for another. Just put a high tech piece of cardboard over the remote control sensor "eye" of the equipment you have less interest in controlling.

In this case, this would presumably be the remote control for the curtains, not the VCR.

The company had gone off into making esoteric products, like the ceramic dome tweeter which must have been the most expensive audio product ever designed in the UK. It cost £37 to make, and was on the parts list at £3.

"The Option One dipole loudspeakers cost £10,000 a pair. The company only sold seven and one pair was given away. There were a thousand different drive units and several hundred different loudspeaker models. Wharfedale would make anything for anyone who asked for it, even for short runs where tooling up would cost more than the profit.

"But Wharfedale had a very loyal workforce, and is very good at manufacturing drivers. Wharfedale very nearly died. Anyone with business sense and no commitment to the audio industry would have just walked away.

### Moving Ahead

"We are now moving Wharfedale away from the hi fi niche. We want to capitalize on the name. Everyone knows someone who has at some time bought a Wharfedale speaker so they know the name. We have got a new logo. The old one looked old-fashioned and a 'W' means nothing. Wharfedale were making loudspeakers that sounded good, but they now look very dated."

The new Modus Vivendi range (Latin for "way of life") is based on modular design; black rounded cubes with a mid/l.f. driver inside and a tweeter on top that can be turned by hand. The whole range uses just five drivers, two tweeters and three mid/l.f. units. The plastic moulded cubes can be clipped together with wooden planks to make a wide range of different sized cabinets. Curtis calls it his Leggo kit.

The first prototypes are just coming off the moulds. Production quantities left the factories just before Christmas, for sales in January. There will be a big push for the US market in Las Vegas in January with sales and distribution handled by Verity, North America. There will be a remote control Dolby Pro Logic amplifier in January, too.

"Wharfedale will not be Mission's B brand" says Azima "like Aiwa to Sony. Both companies will have their own production facilities. Leeds is not in the same league as Mission, which has probably the most modern factory in Europe. But in a few weeks the bulldozers move into Wharfedale at Leeds to start re-building the lines. It's the re-birth of a company that is going to be great again."



# SHOP-TALK

with David Barrington

## Autolight

The ready-made cupboard light used in the prototype *Autolight* project was purchased from **Maplin**, code KR34M. This lamp is operated by a pull-cord switch and is powered by two D-size batteries, not included. The lamp will, of course, have to be adapted as outlined in the article. Obviously, other lamps can be used here provided they can also be adapted.

The specified multizone infra-red pyroelectric (PIR) sensor used in the model was obtained from **Mailtech** (☎ 058 474475) and its sub-miniature FIRM-287 type, listed at £5.95 plus 75p p&p. These miniature infra-red sensors are beginning to appear in other advertisers listings.

If any readers have difficulty in locating a source for the microphone op. amp type ICL7611 it is currently being listed by **Cricklewood Electronics** (☎ 081 452 0161) and **Greenweld** (☎ 0703 236363). The light-dependent resistor may not be listed by its type number ORP12, but most of our component advertisers know this device and carry a suitable substitute.

We feel sure that the 6V 80 ohm miniature relay is, in fact, the **Maplin** micro-miniature version, code FM89W. Other relays can be used provided they have similar electrical characteristics. They may not fit on the board and watch out for differing pin-out arrangements.

## Pound Heater Thermostat

One or two items called for in the *Pound Heater Thermostat* have been selected to fit on the "custom" printed circuit board and if any alternative components are offered they should be checked to see that they will fit on the board before purchasing. The printed circuit board has been specially designed to fit the specified weatherproof box and also carries mains voltages, so *never handle the unit with the lid removed unless it is unplugged from the mains*. It is recommended that the unit is powered from the mains via a mains "Powerbreaker" for personal safety.

The weatherproof and frostproof plastic box is an RS component and is rated down to -20°C. The box is available from **Electromail** (code 507-933), RS's mail order outlet. The cable sealing glands are coded 544-011. Waterproof plastic cases are also offered by many of our advertisers, together with waterproof sealing glands, and again a check should be made to see that the p.c.b. will fit inside before purchase.

The "flatpack" 8A 12V relay only appears listed in the **Electromail** catalogue, code 344-467. Other relays could be used but they must have sufficient electrical ratings and fit on the p.c.b. or be able to fit safely inside the case.

The p.c.b. mounting 3VA mains transformer used in the model is available from several sources, such as **Verospeed** (part no. 289-51565G) and **Electromail**. The latter's code has been changed from 207-829 to be superseded by 210-774.

The printed circuit board is available from the *EPE PCB Service*, code 856. The 8-pin accurate temperature sensing i.c. type LM311N should be stocked by most major component suppliers. If any readers have difficulty in finding a 25-turn cermet potentiometer, the one in the prototype came from an RS supplier and is coded 186-542.

## 250W/600W Battery to Mains Inverter

It should be pointed out that anyone undertaking the task of building the *Battery to Mains Inverter* should be skilled in electronics construction work. Also, it is *vitaly important* that they should read the "Safety Panel", published last month.

The toroidal inverter transformer has been specially made up for this project by **Jaytee** (☎ 0227 375254) and readers should quote code 7E283 for the 300VA version and code 9E284 for details of the 600VA 600W version. The 3VA mains transformer is an RS component stocked by **Electromail**, code 207-780.

We have been unable to locate any source for the 4-096MHz (50Hz) or the 4-9152MHz (60Hz) crystals other than **Farnell** (☎ 0532 636311). If they are unwilling to supply, then someone like **Greenweld** (☎ 0703 236363) might be persuaded to order for you.

The 5.6mH choke was made up on a EC70 ferrite coil kit from **Electrovaule** (☎ 0784 442253), order codes B66343-GX127 (core 2 off), B66278-B1011T1 (bobbin) and B66278-B2002 (mount). The 47µH 2A axial choke is listed by **Maplin** (UM12N). The BUV20 transistor varies in price quite considerably from just over £4 up to about £8. The ones used in the model were purchased from **JPG Electronics** (☎ 0246 211202) and cost £4.50 plus p&p each.

The double-sided printed circuit board can be obtained from the *EPE PCB Service*, code 855. The 7W wirewound resistor and mains rated X-class capacitor should be generally available.

Finally, some errors crept into part one and remained undetected during the checking process. The corrections are listed under the "Please Take Note" section.

## Timer/NiCad Capacity Checker

Looking through the components list for the *Timer/NiCad Capacity Checker* project several items appear to be "special" and only available from a single source.

At the heart of the circuit is the special Counter Module X1, with a 512Hz output. This ready-built module comes on its own small p.c.b., including a 5-digit liquid crystal display, and was purchased from **Maplin** (☎ 0702 554161) code FS13P.

The twin-coil 5V latching relay is another device that could be classed in the special category and only appears to be available from **Electromail** or through any *bona-fide* RS component stockist. This d.i.l. package relay can be ordered by quoting stock number 351-689.

The 5V micropower regulator LP2950CZ is also available through the above mentioned sources, code 648-567. The ICL 7611

micropower op. amp is currently being listed by **Cricklewood** (☎ 081 452 0161) and **Greenweld** (☎ 0703 236363).

The printed circuit board has been designed to take the d.i.l. type relay and is obtainable from the *EPE PCB Service*, code 857 (see page 83).

## 10W plus 10W Stereo Power Amplifier

Before we move on to buying components for this month's audio module in the *Multi-Purpose Audio System* series, we gave some incorrect information on the centre-off switches required for the Mixer module in part one. These switches should be p.c.b. mounting types for use on 0.1in matrix spacing. The ones used in the prototype came from **Rapid Electronics** (☎ 0206 751166), code 75-0195 (s.p.d.t. centre-off) and 75-0205 (d.p.d.t. centre-off).

Now for this month's *10W + 10W Stereo Power Amplifier*. We do not expect too many problems to arise when purchasing components. Certainly, the TDA 2030 20W power amplifier i.c. is stocked by most of our component advertisers.

If you build the power supply, the 80VA toroidal transformer came from **Maplin**, code YK17T. The amplifier heatsink, code FG55K, came from the same source.

We suggest you shop around for the console type case as prices vary quite considerably. The two printed circuit boards are available from the *EPE PCB Service*, codes 852a (amp) and 852b (power supply).

## Circuit Surgery

A couple of points have been passed on by Alan regarding this month's *Circuit Surgery* column.

The bipolar version of the ICL8211CPA and ICL8212CPA programmable voltage detector are stocked by **Electromail**, codes 283-249 and 636-615. If you want the CMOS versions, these are stocked by **Farnell**, see *Surgery* column.

The Darlington transistor and relay can be chosen to suit required application.

## PLEASE TAKE NOTE

### Three-way Christmas Tree Lights Flasher (December '93)

Page 888, Fig. 1. The type number for the "bridge" diodes D1 to D4 should read 1N4004. The components list is correct.

### Waterproof Delay Switch (December '93)

Page 937, Fig. 3. The terminal block TB2, pin 2 should read L (live) IN (input).

### 250W/600W Battery to Mains Inverter (December '93)

Page 912/913, Fig. 7. The connections between IC10 and IC4/IC5 have had their order reversed. The connections should be as follows: IC10a pin 10 to IC4a pin 13; IC10b pin 12 to IC4b pin 8; IC10c pin 6 to IC4c pin 6; IC10d pin 8 to IC4d pin 6; IC10e pin 2 to IC5a pin 8; IC10f pin 4 to IC5b pin 12.

Page 916, Fig. 10. Transistors TR3 and TR4 are shown incorrectly orientated. Their pins, however, are correctly annotated and the photograph on the same page shows the correct orientation. This error crept in when the original BD437 devices used in early prototyping were replaced with the current TIP31 type and the diagram was not updated.

## CONTROL PORT for PCs

This I/O Port follows the general approach of the 'INTERFACING to PCs' series in this mag, with the Port safely inside the PC/XT/AT, BUT allows user's prototype control circuitry to be set up and run OUTSIDE the PC. The double sided pcb fits into an I/O slot, and a ribbon cable terminating in a D-25 plug allows the control of projects with little risk to the PC. On board facilities include: 8-bit A-D, 8-bit D-A, 8 inputs, 8 latched outputs, 3 strobes and 1 IRQ.

(a) Etched double sided board only, with full instructions for drilling/assembly/testing using BASIC.....£12.50

(b) Complete I/O card with ribbon cable and BASIC test programs. (Built and tested).....£29.00

Also available: Test pod with D-25 socket providing analogue and digital test signals/outputs for the I/O card, with BASIC test plus oscilloscope and data logger programs on disc.....£17.00

Please add £1 P&P in UK, Europe £1.50, others £2.00.

(Please send A4 S.A.E. or 2 IRCs for more details of the Port and the range of circuits enabling a full Measurement and Control System, very suitable for teaching National Curriculum TECHNOLOGY)

Mail Order only from:- **R. BARTLETT**  
17 LIME TREE AVENUE, TILE HILL, COVENTRY CV4 9EY  
(0203) 473 851

## ANNEX SHAREWARE LIBRARY

### PCB DESIGN & CAD

- E001 DROEGE General purpose CAD for layout of PCBs, up to 12 layers, 20 IC chips.
- E002 LAYO1 Fully featured vector based PCB design, up to 15 layers.
- E003 LASI CAD drawing for IC and device layout PCBs, Schematics & precision drawing.
- E004 PADS-PCB Sophisticated PCB design, will create schematics, autoroute etc.
- E005 PCB-CAD PCB CAD package with autoroute, board viewer and board printer.
- E006 PC TRACE Circuit board design, S/S & D/S boards autoroute, laser & deskjet (2 Deltas)
- E007 QUICKROUTE Powerful PCB or circuit design featuring 'rats nest' autorouting.

### CIRCUIT DESIGN & ANALYSIS

- E011 ACIRAN Linear AC circuit analysis, Res, Cap, Inductor
- E012 ACNET Steady state analysis of R, C, L & Transistors
- E013 AC SOLVE Solves RL, RC, LC, RLC networks, AC & DC
- E014 PC ECAP Analysis, mag, phase, imp, VSWR etc.
- E015 SCAT Scattering parameters for HP RF Amps.
- E016 POWER Circuit designer utility for IC chips.
- E017 SWITCHERS MADE SIMPLE Design of switcher based regulators & invert regulators.

### SPECIAL OFFER

- 8 DISK SET PCB DESIGN & CAD \$11.95
  - 7 DISK SET CIRCUIT DESIGN & ANALYSIS \$10.50
  - ALL 15 DISKS \$19.95
- Just For Light Relief in the Festive Season
- ARCADÉ ACTION SELECTION
- 10 DISK PACK ONLY \$15.95
- CARD + BOARD GAMES + DUNGEONS & DRAGONS
- 7 DISK PACK ONLY \$11.95

DISK BASED CATALOGUE WITH OVER 1000 TITLES INCLUDING FREE UTILITY SOFTWARE £1.25

★ DISK PRICE \$1.95 EACH ★

Post & Packing (extra)

OVERSEAS CUSTOMERS ADD £3.50 TO ORDER

Please state disk also when placing orders

BLANK FLOPPY DISKS SUPPLIED FROM \$9p EACH + P & P

ANNEX SOFTWARE, PORT PENENNIS  
FALMOUTH TR11 3XU  
TELEPHONE (0326) 212187

ACCESS. VISA. MASTERCARD  
ACCEPTED  
Telephone orders 9am to 6.30pm Mon - Sat

# POND HEATER THERMOSTAT

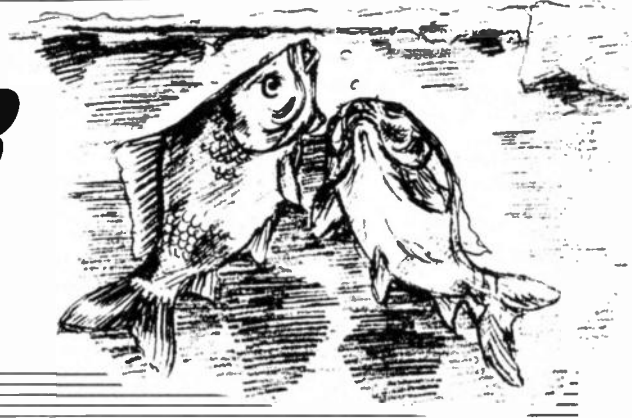

A. R. WINSTANLEY

An essential winter accessory for pond fish enthusiasts. Ensures that fish will not suffer if the pond ices over.

THOSE readers who keep coldwater pond fish will know of the dangers which exist during wintertime, when low temperatures can give rise to ice formation on the fishpond. During summer, the oxygenating plants in the water provide a plentiful supply (hopefully) of oxygen which enables the fish to breathe.

In severe winters, no such oxygen is produced and so the pond's inhabitants rely on air entering the water from the surface. If the pond then freezes over, firstly the air supply to the fish is reduced if not cut off altogether, and secondly, toxic gases from decomposing material in the water can build up in the pond and poison fish.

Several tricks are employed by fish-keepers during icy weather to help the fish to breathe and gases to escape. A floating electric heating element is popularly used, the idea being that the warmth generated by the heater provides some local heating and keeps a small surrounding area - say 12 to 18 inches diameter - of water free from ice. The object is not to heat up the water to any extent but merely provide an air-hole in the ice.

## FIT AND FORGET

Forgetting to switch the unit on during icy weather could result in thick ice formation with possible distress being caused to fish, and the build up of toxins and the lack of air can eventually be fatal to the pond's inhabitants. Conversely, leaving the heater

continually switched on is wasteful and can only shorten the life of the heater.

Fish enthusiasts who own any expensive breeds such as Koi Carp will not wish to take any risks and even if you simply keep cheap and cheerful goldfish, you will certainly want to take precautions to protect them during harsh weather conditions. The Pond Heater Thermostat was designed as a "fit and forget" outdoor controller which monitors the ambient air temperatures and switches on the floating pond heater if the air temperature drops to near zero degrees Celsius.

The prototype unit has been of great success when used at the author's fish pond, and it reliably powers a nearby floating electric heater when the air temperature is just above freezing or colder. By using the Pond Heater Thermostat, it is no longer necessary to remember to watch weather forecasts and turn on the heater if frost or ice is looming.

In fact, the prototype has been operating very efficiently under very harsh weather conditions when temperatures have been measured as low as -8 degrees Celsius.

## FISH AND CHIPS

Aquarists will know that the most common method of maintaining temperatures in a tropical fish tank is to use a bi-metallic strip thermostat immersed in the water. These are notoriously temperamental to set up at the desired switching point and their crude method of operation can be unreli-

able. Additionally they are generally un-calibrated.

The problem of detecting near-zero temperatures as required in our outdoor pond application is solved by employing a solid-state temperature sensing integrated circuit. In fact several types of device are available in this category, and one of the cheapest types, the well-established LM3911N is used in this design. A simplified block diagram of this device appears in Fig. 1.

## HOW IT WORKS

The LM3911N is a highly accurate temperature measuring chip which is usable between -25° to +85° Celsius. The device comes in an 8-pin d.i.l. package which contains a temperature sensor, supply voltage reference and a comparator.

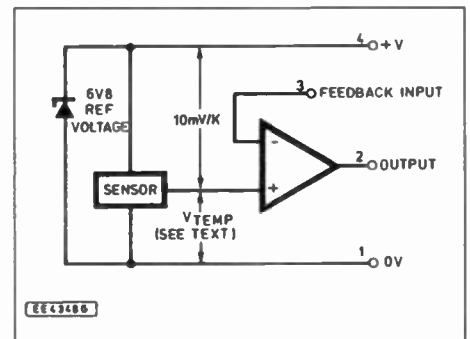

Fig. 1. Simplified structure of the LM3911 temperature sensor chip.

Its circuit utilises a pair of transistors operating at differing currents as the temperature sensor, and since the base-emitter voltages of the transistors vary by a tiny amount with temperature, the difference in the base-emitter voltages can be utilised to generate a temperature-dependent potential difference. The result is that the sensor is very stable and highly accurate.

From the block diagram, it can be seen that the temperature sensor output is equal to 10mV/ degree Kelvin - directly equivalent to 10mV/ degree Celsius. (A brief explanation of the Kelvin scale of temperature measurement is given Table 1.) It can be seen that the temperature sensor is directly connected to the non-inverting (+) input of an operational amplifier.

## REFERENCE VOLTAGE

Also on board the chip is a stable voltage reference working in a manner similar to a

Table 1: Kelvin Temperature Scale

The Celsius Scale of temperature measurement has an identical temperature interval to that of the Kelvin Scale. In order to convert from Kelvin to Celsius, it is necessary to "re-align" the two scales by a factor of 273 thus:

Freezing Point = 0 Degrees Celsius = 273 Degrees Kelvin

Steam (Boiling) point = 100 Degrees Celsius = 373 Degrees Kelvin

Therefore, Degrees K = Degrees C + 273

and, Degrees C = Degrees K - 273

### Examples

+ 20 degrees Celsius = 293 degrees Kelvin

+ 5 degrees C = 278 degrees K

- 2 degrees C = 271 degrees K

Zener diode. This reference voltage is used by the temperature sensor, and requires an external voltage-dropping resistor to be connected to pin 4 of the i.c., with the Zener forward current preferably kept to a minimum (1mA or less is recommended), in order that the self-heating effects of the i.c. are minimised – this helps to improve accuracy.

The reference voltage is typically 6.85V, and given that the potential at the sensor output varies by 10mV/degree Celsius as shown in the diagram, it means that the voltage at the non-inverting input (call it

The temperature control is set by the user so that the voltage at the inverting input of the comparator (pin 3) equals the voltage from the temperature sensor which will exist at the non-inverting input when the i.c. is at the desired switching temperature.

For example earlier we saw how, at a temperature of 25°C, the voltage ( $V_{temp}$ ) at the non-inverting input was 3.87V. By setting the preset control VR1 to this voltage also, the comparator will then be at the thermostat switching point of +25°C.

As the ambient temperature rises above this set point, the voltage at the non-

The only point to note is that it is necessary to set the external control quite accurately because an error of only 0.1V at pin 3 is equivalent to a temperature spread of 10°C.

## CIRCUIT DESCRIPTION

The full circuit diagram for the Pond Heater Thermostat is given in Fig. 2 and, as can be seen, is very simple.

The LM3911N, IC1, behaves as an on-off thermostatic controller. The circuit

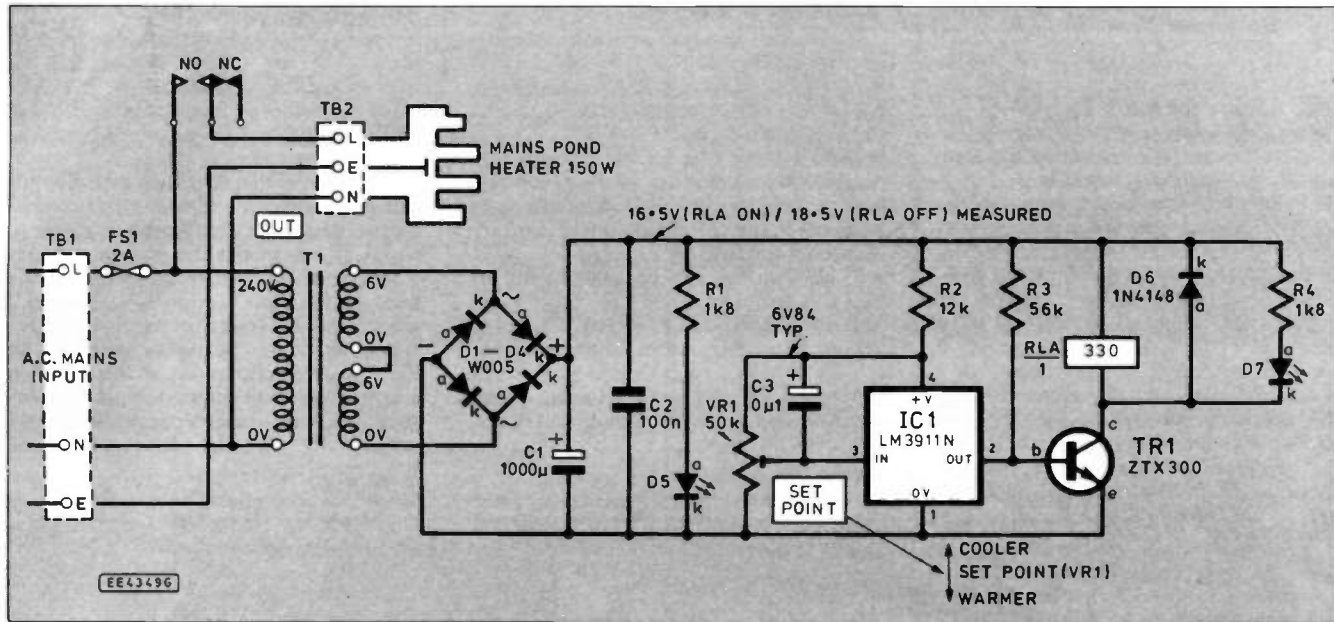

Fig. 2. Complete circuit diagram for the Pond Heater Thermostat.

$V_{temp}$ ) of the op.amp with respect to 0V is equivalent to:

$$V_{temp} = (6.85 - 10mV/\text{degree Kelvin}) \text{ Volts.}$$

For example, at an ambient temperature of +25°C., this equates to a temperature of 298 degrees Kelvin. The sensor output voltage at 10mV/degree K is thus 2.98V as measured between the sensor output and the +6.85V reference rail. This is indeed confirmed in the manufacturer's data.

Using the above formula,  $V_{temp}$  therefore typically equals 3.87V (6.85 - 2.98V) at a temperature of +25 degrees Celsius.

At a temperature of, say, +85 degrees,  $V_{temp}$  typically equals 3.27V.

It can be seen therefore that, with respect to the 0V rail, the voltage at the op.amp non-inverting (+) input decreases as the i.c. temperature increases.

## FEEDBACK

No mention has yet been made of the "feedback" input (pin 3) to the op.amp, which is actually the inverting input (-). By normal comparator action, when the non-inverting input has a higher voltage than the inverting input, then the output of the op-amp (pin 2) is high, and vice versa.

Looking at how this device can be used as a thermostat, in our application we want a simple on-off controller which can operate at a switching point of just above freezing – say +1°C.

Given that the non-inverting input is directly connected to the temperature sensor (and is not accessible), in order to act as a simple thermostat, an external reference voltage is set at the feedback input terminal by using a potential divider strapped across the 6.85V reference, (VR1 in Fig. 2).

inverting input of the comparator will decrease at a rate of 10mV/degree Celsius. Pin 2 will therefore be low because the non-inverting input voltage is less than the inverting voltage.

Conversely when the ambient temperature falls, the non-inverting input voltage will rise until it exceeds the set point, as determined by VR1. Then the comparator output pin 2 will go high. Thus a simple on-off temperature controller can very easily be formed, using a simple potential divider to act as the temperature control point.

is mains powered, and uses a 12V step-down transformer T1 coupled with a standard full-wave bridge rectifier circuit (D1 to D4 and smoothing capacitor C1) to produce a d.c. supply rail of approximately 16V to 18V. The l.e.d. D5 is a power-on indicator.

The 18V rail is too high of course for direct operation of IC1 and so R2 is a series dropping resistor which limits the current to just 1mA for the internal reference voltage. The voltage at pin 4 is therefore about 6.8V (and this can be measured with a voltmeter).



Preset control VR1 is a 50kilohm 25-turn cermet trimmer, the wiper of which is connected directly to pin 3 (comparator feedback input) and is used to adjust the thermostat switching point. Capacitor C3 removes any noise and improves stability.

The output of the i.c. drives a simple transistor switch TR1 which is used to control a mains-rated relay RLA. Diode D6 removes back e.m.f. when the relay de-energises, in order to protect the transistor and chip.

Preset VR1 is adjusted to the desired set point, which in this application should be no more than +1°C – equivalent to setting a voltage at pin 3 of about 4.11V or so (but this setting depends on the actual Zener reference voltage of readers' individual units – see later).

When the i.c. temperature exceeds +1°C, therefore, the voltage present at the comparator non-inverting input is less than 4.11V and so the comparator output is low, near 0V. The transistor switch is off.

When the ambient temperature drops, the non-inverting (+) input of the comparator is sent more positive, towards the internal 6.85V reference, until the set point voltage of 4.11V is exceeded, when pin 2 goes high, switching on the transistor.

This then completes the circuit to relay RLA which operates and closes the normally-open mains-rated contacts RLA1.

These directly switch on the mains (L) supply to the floating heating element which is connected via terminal block TB2. The l.e.d. D7 also illuminates to indicate that the heater has switched on.

Resistor R3 is required in order to shunt an internal resistor which is present at the comparator output, and enables more base drive current to flow into the transistor TR1.

The thermostat will cycle quite happily like this, turning the heater on and off according to the ambient temperatures detected by the integrated circuit.

### SOAK TIME

One further practical aspect to take into account is the fact that the "die" or chip within the i.c. is, of course, embedded in the plastic resin of the dual-in-line package. This can slow down the reaction of the i.c. slightly because it takes time for the ambient temperature to soak through to the silicon chip itself – especially when the device is mounted flush on a printed circuit board and the changes in temperature are slight.

In practice this can be adjusted out by trial and error, trimming VR1 accordingly to advance the point at which IC1 would trigger: This compensates for any temperature lag. It is also necessary to use a multi-turn preset for VR1 because the i.c. is very sensitive, and a 25-turn preset makes setting up much easier.

The prototype was quickly set up and was adjusted once only, and has been in successful operation for many months. It starts to power the heater on and off when the temperature is just above freezing, and the heater is hard on at sub-zero levels.

### CONSTRUCTION

**Important Safety Notice:** Constructing this unit involves making MAINS connections. Any reader who is not certain of being able to build it safely is strongly advised to seek professional advice. If necessary, a qualified electrician should carry out the fixed installation work.

The Pond Heater Thermostat is designed for outdoor use in harsh weather and the circuit itself is constructed on a single-sided glass-fibre printed circuit board size 130mm x 70mm. This is available from the EPE PCB Service code 856.

The printed circuit board (p.c.b.) top-side component layout and full size underside copper foil master pattern is shown in Fig. 3. If you are tempted to produce your own p.c.b., make sure you keep to the published design i.e. large "ambient sink" plane and large tracks for mains voltages. All connections to IC1 (pins 1 to 4) are on one side of the d.i.l. package, but pins 5 to 8 are electrically isolated from the integrated circuit. In order that the i.c. can monitor the ambient temperature more

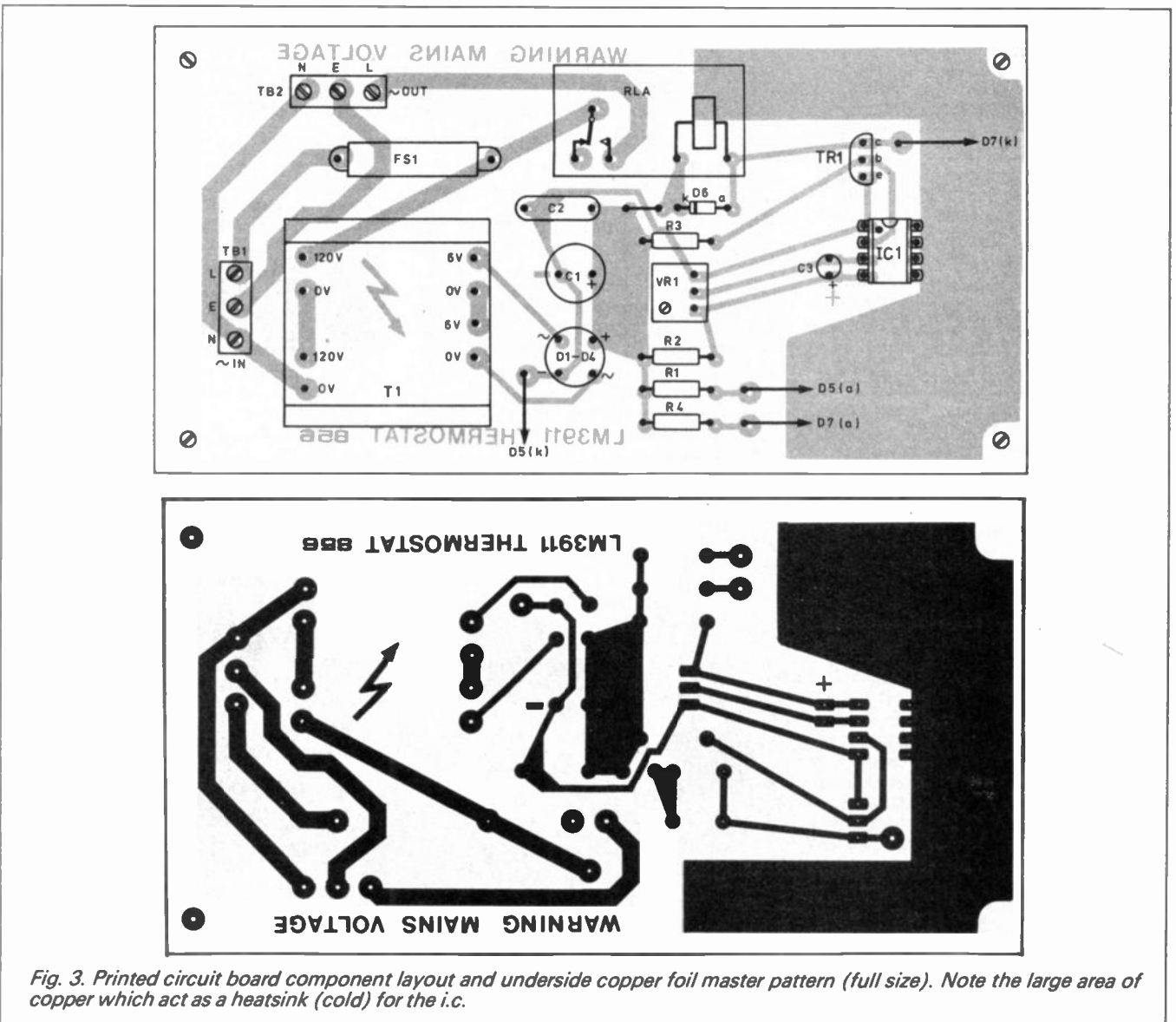

Fig. 3. Printed circuit board component layout and underside copper foil master pattern (full size). Note the large area of copper which act as a heatsink (cold) for the i.c.



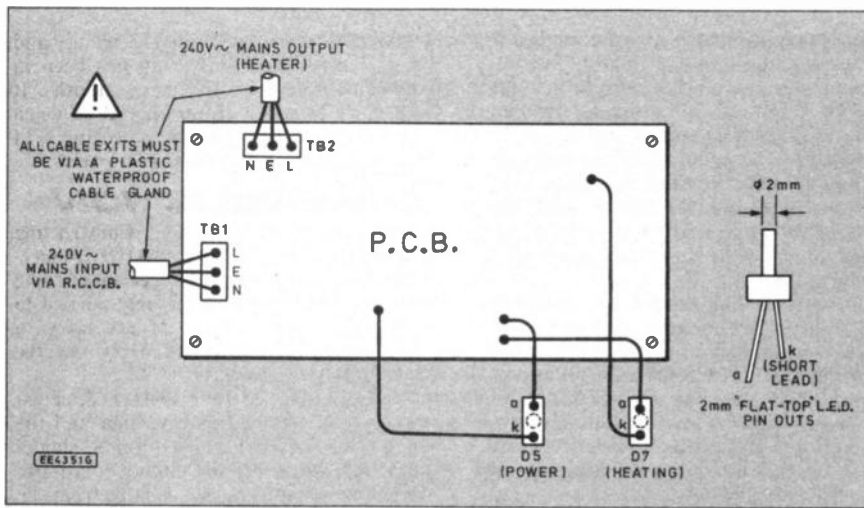

Fig. 4. Wiring from the circuit board to the power-on and heating l.e.d.s.

effectively, a large area of copper foil acts as a simple heatsink, monitoring the surrounding heat level, and this is soldered directly to pins 5 to 8 of the chip. This helps the surrounding heat (or cold) to soak through to the i.c. die.

In fact National Semiconductor suggest that a d.i.l. heatsink is bonded to the package to improve thermal transfer even more, but the author could not successfully locate a suitable type.

This printed circuit board has been specially designed to fit a weatherproof and frostproof plastic box, RS type 507-933, which measures 160mm x 80mm x 55mm. It is rated down to  $-20^{\circ}\text{C}$  and so should be quite shatterproof at sub-zero temperatures. The box incorporates p.c.b. mounting bushes which are utilised to carry the p.c.b. shown, using M3 screws.

All parts including the mains-voltage section are p.c.b. mounted for maximum reliability. Other parts may not fit the p.c.b. so check before purchasing.

Construction starts by fitting the smaller, lighter components to the board in accordance with Fig. 3. Observe carefully the polarity of the bridge rectifier, electrolytic capacitors and transistor. Note that you

should solder the i.c. directly to the board as shown without using a socket.

Follow on with the relay, mains terminal blocks and finally the mains transformer. An insulated cover fuseholder is recommended for FS1.

The lid of the plastic box needs to be drilled to take the two light-emitting diodes, and here 2mm diameter "flat-top" types were used on the prototype. Two 2mm diameter holes were drilled in the lid and the l.e.d.s are a tight, waterproof push fit giving a very neat effect.

They are connected to the board with flying leads, and it must be ensured that the lead-outs will not touch or interfere with the p.c.b. once the lid is screwed down. Other types of l.e.d. can be used but it may be necessary to seal them with silicone sealant to prevent water seeping in.

It is also necessary to drill the box to accept a mains cable input, 6A three-core cable is suitable and this *MUST* be fitted through the box using a plastic cable gland with sealing washer to make the cable entry waterproof. Similarly a cable entry is needed for the heating element, which will probably also use 6A three-core cable. Again

## COMPONENTS

### Resistors

R1	1k8
R2	12k
R3	56k
R4	1k8

All 0.25W 5% carbon film

See  
SHOP  
TALK  
Page

### Potentiometer

VR1	50k 25-turn cermet preset
-----	---------------------------

### Capacitors

C1	1000 $\mu$ radial elect. 25V
C2	100n polyester
C3	0 $\mu$ 1 tantalum bead, 35V

### Semiconductors

D1 to D4	W005 50V 1A bridge rect.
D5, D7	2mm flat top l.e.d. (2 off - see text)
D6	1N4148 signal diode
TR1	ZTX300 <i>n</i> pn transistor
IC1	LM3911 N temperature sensor i.c.

### Miscellaneous

RLA	12V 330ohm coil flatpack relay, with s.p.c.o. contact rated at 8A 250V a.c.
T1	3VA p.c.b. mounting mains transformer, with 0V-6V, 0V-6V secondaries
FS1	20mm p.c.b. insulated fuseholder, with 2A quick-blow fuse
TB1, TB2	3-way p.c.b. mounting screw terminal block, mains rated (2 off)

Weatherproof ABS box, size 160mm x 80mm x 55mm; cable-sealing glands (2 off); 6A 3-core mains cable, length as required; connecting wire; M3 x 10mm pan-head screws for p.c.b. mounting (4 off); solder etc.

Printed circuit board available from the EPE PCB Service, code 856.

Approx cost  
guidance only

**£30**  
excl. Heater

Interior of the completed thermostat showing layout of components inside the waterproof case.

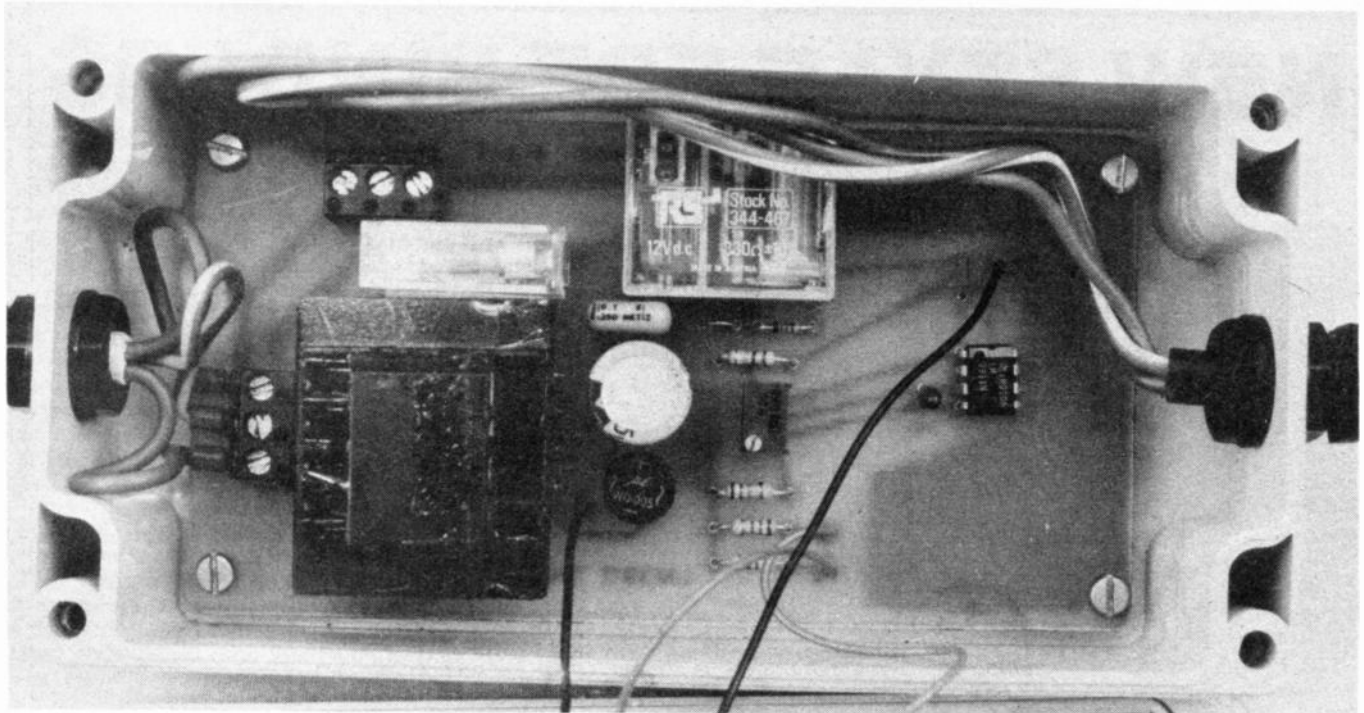

a weatherproof cable gland **MUST** be employed.

The mains flying leads are connected to the appropriate screw terminal blocks – taking great care to ensure that stray strands of wire do not short adjacent terminals. It is *essential* that the earth continuity is maintained, so that the metal case of the heating element is properly connected to the mains Earth (E) input.

## TESTING AND CALIBRATION

After construction is complete, the best way to test the unit is to power it up using a d.c. bench power supply rather than connecting it to the mains. Clip an 18V d.c. supply across the positive and negative leads of the bridge rectifier.

By rotating VR1 with a trimming tool it should be possible to make the relay (and i.e.d. D5) turn on and off. This confirms that the comparator and temperature sensor are working. Then trim VR1 so that the thermostat will switch at +1°C. It is possible to calibrate this point to a certain extent by taking a few test readings, preferably with a DMM (digital multimeter).

It is best to adjust your setting to take account of the tolerance of the Zener reference voltage because yours may not be precisely 6.85V, so you can get a good idea of the setting required at VR1 wiper for your unit by using this simple formula, which is based on the voltage divider effect present at the comparator non-inverting input:

$$V_{temp} = V_z - 2.74V$$

where  $V_{temp}$  is the voltage at pin 3 (the switching voltage for +1°C operation) – you will trim this with VR1, and

$V_z$  is the reference voltage of your unit (measured at pin 4 (+) and pin 1 (0V) – this should be between 6.55V and 7.25V).

N.B. 2.74V represents the temperature sensor output voltage at a temperature of +1°C (i.e. 10mV per degree Kelvin).

Measure the reference voltage of your i.c. then calculate the setting you need for your

own unit and trim this with VR1, monitoring the potential at pin 3 of IC1. For example, if you measure a reference voltage of 6.25V at pin 4, you will need to trim VR1 so that pin 3 measures roughly 3.51V. A reference voltage of 6.85V for instance would require VR1 to be trimmed to 4.11V.

Using this simple method you will be able to easily set up your unit on the bench so that it will start to switch just above freezing point.

Even using a high impedance DMM it was found that the meter loaded the circuit slightly, and in view of the high sensitivity of the LM3911, the simple calibration procedure will enable you to position VR1 at approximately the correct setting. However, you will still probably need to make one or two trial and error fine adjustments *in situ* to finalise the setting up.

If no test equipment is available, then you will have to adjust VR1 by trial and error. If you use the "trial and error" method, take great care to keep clear of mains components, and to keep water out of the box when the lid is removed.

You could for instance, test your unit by using a cool box filled with ice packs to simulate near-freezing conditions. A mercury thermometer will be of help also.

## INSTALLATION

If you are satisfied that the device operates correctly, the Pond Heater Thermostat can be installed outdoors perhaps by securing the box to a wall or a nearby fixture. It will be seen that the wall-mounting holes in the weatherproof box are outside the sealed compartment, and it is therefore not necessary to seal the box mounting screws. However, ensure that the lid is secured evenly but *do not overtighten* the screws as the bushes may be damaged.

It is recommended to connect the mains power to your Pond Heater Thermostat through an Earth Leakage Circuit Breaker/Residual Current Device (ELCB/RCD) for maximum protection.

**It is important to remember that floating heater elements must not be powered unless they are in water – do not operate them unless they are submerged or they could be**

**seriously damaged.** Floating them in a nine litre (two-gallon) bucket of water will be quite adequate if you power up the unit indoors.

The siting of the Thermostat is quite important, and you need to bear in mind any likely windchill or sunlight which might affect the operation slightly. It is best to locate the unit in a sheltered spot as near to the pond as possible. It will be simple to compensate for any local conditions by adjusting the Set Point preset VR1 as necessary.

In normal operation you will hear the relay switch on and off (with i.e.d. D7 turning on and off) as the thermostat responds to changing temperatures. A slight relay "chatter" may be evident at times but this is normal and there is no need to be concerned.

Larger pools may use several heaters and it should be possible to connect up to two extra heaters from the same circuit as the unit could comfortably handle up to 500 Watts. Each cable exit from the box **MUST** employ a sealing gland.

## LOW VOLTAGE HEATERS

Presumably on the grounds of improved safety, it is now possible to use a low voltage heating element which is powered from the mains via a heavy duty (typically 50VA) step-down transformer, which itself is situated under cover. It should be perfectly feasible to use these low voltage systems also with the Pond Heater Thermostat, by connecting the mains (primary) of the transformer in place of the mains heating element, at TB2.

A low voltage heater has not been tested with the prototype shown, and the only potential problem may be noise or spikes generated by the step-down transformer when RLA1 switches it off. It might be a good idea to carefully wire a 240V varistor (mains transient suppressor) across the Live and Neutral connections at TB2, i.e. in parallel with the transformer unit. It is still important to protect yourself from the mains-voltage side of the circuit by using an ELCB/RCD trip. □

# NEW STYLE EPE BINDERS



A totally new type of binder is now available to hold and protect 12 issues of *Everyday with Practical Electronics*. This new ring binder uses a special system to allow the issues to be easily removed and reinserted without any damage. A nylon strip slips over each issue and this passes over the four rings, thus holding the magazine in place (see photo).

The new binders are finished in hard wearing royal blue p.v.c. with the magazine logo in gold on the spine. We were hoping to keep the price the same as the previous binders but unfortunately the postage cost has defeated us as they are much heavier than the previous ones. The price is £4.95 plus £3.50 post and packing (for overseas readers the postage is £6.00 to everywhere except Australia and Papua New Guinea which costs £10.50).

Send your payment in £'s sterling to Everyday with Practical Electronics, 6 Church Street, Wimborne, Dorset BH21 1JH. Tel: 0202 881749. Fax: 0202 841692.

We also accept credit card payments. Mastercard (Access) or Visa (minimum credit card order £5). Send your card number and card expiry date plus cardholders address (if different to the delivery address).

# MAILTECH

## ELECTRONIC COMPONENTS

**PROJECT BOXES** A range of high quality boxes moulded in black high impact ABS, easily drilled or punched to produce a professional looking end product

TYPE	W	L	H	PRICE
T2	75	56	25	£0.77
T4	111	57	22	£0.92
MB1	79	61	40	£1.35
MB2	100	76	41	£1.47
MB3	118	98	45	£1.71
MB4	216	130	85	£5.19
MB5	150	100	60	£2.35
MB6	220	150	64	£3.95
MB7	177	120	83	£3.42
MB8	150	80	50	£2.22

All sizes are in millimetres

**MICRO SWITCH** roller arm operation spdt 40p each  
**MINIATURE TOGGLE SWITCHES**

spdt	60p each	spdt 3 position c/off	70p each
dpdt	70p each	dpdt 3 position c/off	80p each
spdt biased	60p each	spdt 3 position c/off biased both ways	70p each
		dpdt 3 position c/off biased one way	80p each

**MINIATURE PUSH TO MAKE SWITCH**

<b>DIL RELAYS</b> 5 volt dp/changeover	60p each	12 volt dp/changeover	80p each
<b>RELAY</b> 10 amp contacts sp/changeover 12 volt coil	50p each	10 for £5.00	80p each
<b>CAR HORN RELAY</b> in metal can with fixing lug, s/pole on 10 amp contacts	£1.00 each	6 for £5.00	£1.20 each
<b>20 AMP RELAY</b> dp on 12 volt coil	£1.50 each	4 for £5.00	
<b>REED RELAY</b> 12 volt	50p each	10 for £4.00	
<b>240 VOLT AC RELAY</b> , 3-pole c/o 10 amp contacts	£1.50 each	4 for £5.00	

'D' CONNECTORS			
	plug	socket	cover
9 pin	30p	30p	35p
15 pin	40p	40p	35p
25 pin	50p	50p	40p

**SEMICONDUCTORS - TRANSISTORS - ICs - DIODES - REGULATORS - ETC**

**VOLTAGE REGULATORS**  
1 amp 7805/7812/7815 all 33p each. 7905/7912/7915 all 39p each  
2 amp 7805/7812 54p each  
100mA 78L05/78L12/78L15 all 26p each. 79L05/79L12/79L15 all 29p each  
Adjustable LM317T 47p each. LM723 29p each. L200 £1.28 each  
Transistors TIP2955 70p each, TIP 3055 70p each  
2N3053 29p each, 2N3055 70p each, 2N4403 28p each, 2N3819 40p each  
**MICRO IC'S** - Z80A CPU £1.20; Z80A PIO £1.50; Z80B SIO-1 £4.00

**SPECIAL OFFER PROJECT BOX**  
In white high impact ABS  
50 x 70 x 25mm  
60p each 10 for £5.00

**OPTO DEVICES - LEDS - ETC**  
5mm rnd red/yellow/green/amber 10p each 12 for £1.00 any mix  
5mm rnd high brightness red/green 20p each 6 for £1.00 any mix  
5mm rnd flashing red 60p each, yellow/green 70p each  
5mm rnd bi-colour 35p each, tri-colour 45p each  
LED mounted in chrome bezel red, yellow or green 30p each, 4 for £1  
LED mounted in a black bezel red only 25p each, 5 for £1.00  
PLASTIC BEZEL for 5mm rnd leds 10 for 40p  
High brightness bi-colour i.e.d., rectangular, red/green, two leads 40p each

**TEMPERATURE PROBE**  
High quality probe made for the medical profession. Consists of a resistive sensor mounted in a plastic covered probe with a 1 meter curled lead. Temp. range -40 to 150°C. Resistance at: 150°C 188.3 ohms; -40°C 336.5 kohm; 25°C 10.0 kohm ± 70 ohms. The original price of these probes was over £24.00. Full data supplied.  
**OUR PRICE £3.76**

**RESET TIMER PCB**  
Gives a timed relay closure following a momentary input. Requires 12V d.c. supply SP c/o relay output LED indication. 19 different time intervals from 25sec to 35min 20sec. £5.98 each.

**UNIVERSAL BELL TIMER**  
10 or 20 minute bell cut off +ve or -ve trigger. Timed relay contacts. £4.96

**ALARM CONTROL UNIT**  
Single zone alarm control unit built into a domestic light switch box. Ideal for home, caravan, boat, garage, shed etc.  
Facilities: - Normally closed loop for pir sensors, door/window contacts etc. Normally open loop for pressure mats. 24-hour loop for personal attack button Visual indication that the system is operational.  
Automatic entry/exit delay.  
Automatic system reset.  
Alarm output cmos logic level.

**SIREN**  
12 volt dc for external use 115db £8.95

**PRICE COMPLETE WITH FULL INSTRUCTIONS** £8.95  
**EX INSTALLATION SENSORS** tested working.  
Type 1. Measures 180 x 112 x 70mm with walk test led, relay output and tamper protection. 12 volt dc supply required £8.50 each  
Type 2. As above but a smaller unit 123 x 62 x 50mm £11.75 each  
Type 3. Ceiling mounting passive. Infra red sensor 360° detection, 12V d.c. supply relay output, tamper circuit and pulse count option. Data supplied. £15.70 each

**DOOR/WINDOW CONTACTS**  
Surface or flush mounting, white £1.10 each  
**JUNCTION BOX**  
white 6 way 60p

Please note: There may be variations in the size of the above passive infra red sensors depending on stock at the time of ordering. But the unit will certainly be within the stated sizes.

**DUAL TECH SENSOR** Microwave and passive infra-red combined. Separate led indication for each function. Measures 120 x 75 x 50mm. 12 volt d.c. supply. Relay output. Tamper protection. £29.95 each

**ALARM CONTROL PANEL ST3000**  
"Wire free alarm control panel, detectors communicate with the panel by means of radio transmitters". Speech synthesis for programming and general operating guidance". Built in user programmable telephone dialler". Up to 32 transmitters can be used". Programmable exit/entry and bell timers". Programmable user codes". Full installation data supplied, the only thing that has to be hardwired is the output to the siren/bell unit (not supplied)". These control panels cost over £300.00. Yours for only £59.95.  
Suitable **PASSIVE INFRA SENSOR/TX** £25.85  
Battery operated, available in 8m range, 10m range or 25m range.



**UNIVERSAL TX**  
For connection of normally open or closed contacts e.g. door/window switches, pressure mats etc. £17.63

**BREADBOARDS - CAPACITORS - SOLAR CELLS - HEATSHRINK - ETC**

**SOLAR CELL** 2 volt 150mA max. size 60 x 100mm £1.35 each 5 for £6  
**BNC SOCKETS** 50 ohm single hole fixing 50p each 10 for £4.00

**MERCURY TILT SWITCH**  
Standard on/off £1.00 each  
4 Contact (Directional) £1.50 each  
**PIEZOE VIBRATION SENSOR**  
with data sheet £1.00 each

**BREADBOARD**  
173 X 65mm 840TP £5.25 each  
**TEXT TOOL ZIF SOCKET**  
28 pin zero insertion socket £5.95 each

**6 VOLT NI-CAD PACK** 5AA NI-CADS, fast charge type £3.95  
**CAPACITOR** 10,000 mfd 25 volt with fixing clip 60p each  
**EPROMS** 27C256 - 30 27C512 - 25. Once programmed but never used eeprom. Mounted on a plastic carrier, can easily be removed from the carrier or used with a low insertion force socket.  
**27C256** £1.00 each 6 for £5.00 **27C512** £1.20 each 5 for £5.00  
Suitable low insertion force socket 28 pin 40p each 3 for £1.00  
**MULTITURN PRESETS** 20mm RECT, 500R, 1K, 5K, 10K, 20K, 50K, 100K 1MO. 40p each, 3 for £1.00

**CAR CIGAR LIGHTER ADAPTER (DUAL SIZE)**  
mounted on two metres of cable £2.00 each  
**100db PIEZO SOUNDER**

2KHz note, 3-12V d.c. 40Ma, 45mm dia. x 26mm £1.76 each  
**VIBRATION SENSITIVE ALARM BOARD WITH PIEZO SOUNDER**  
Originally a bike alarm. There is a short delay after activation then the piezo sounder operates for a preset period. £3.76 each  
or the above alarm board with custom designed case, fixing clip and keyswitch £9.95

**INFRA-RED BREAK BEAM** Transmitter and receiver p.c.b. with 2 lens assemblies. 12V d.c. supply. These are ex-installation units and are not guaranteed to be working. £4.96 pair  
**RECHARGEABLE BATTERIES**

AA (HP7) 600 mA £1.02 each C (HP11) 1200 mA £2.29 each  
D (HP2) 1200 mA £2.40 each PP3 8.4V 100 mA £4.77 each  
**FLOURESCENT LIGHT INVERTOR.** Drives an 8 watt tube directly from 6V d.c. Data supplied £4.50 each

## £1.00 BARGAIN PACKS

**SUB-MINIATURE TOGGLE SWITCHES**  
P.C.B. Mounting

- BO1 S.P. on 4 for £1.00
- BO2 D.P. on 3 for £1.00
- BO3 3 x D.P. 3 pos, centre off
- BO04 **DIL SWITCHES** 4-way S.P. on 3 for £1.00
- BO05 **DIL SWITCHES** 8-way S.P. on 2 for £1.00
- BO06 **DIL SWITCHES** 12-way 90° sp on 2 for £1.00
- BO07 **12 x PP3 BATTERY SNAPS**
- BO08 **1 x CAPACITOR** 1 FARAD 5.5 VOLT 20mm dia. x 7mm high
- BO09 **INSTRUMENT KNOBS (0.25" SHAFT)** High quality grey plastic knob, collet fixing 15mm dia, 5 for £1.00
- BO10 as above but 29mm dia, 3 for £1.00
- BO11 **4 x MAGNETIC EARPICCE** 8 ohm with 3.5mm plug
- BO12 **4 x 28-WAY TURNED PIN DIL SOCKET**
- BO13 **15 x 12 VOLT WIRE-ENDED LAMPS**
- BO14 **8 x 2 PIN DIN PLUGS** screw terminal connection
- BO15 **2 x LIGHT DEPENDENT RESISTOR** Less than 200 ohms in daylight, greater than 10 megohms in darkness
- BO16 **1 x KEYPAD** 20-key in 5 x 4 matrix bubble type switch contacts
- BO17 **2 x PIEZO BUZZERS** approx 3 to 20 volt d.c.
- BO18 **5 x 78M12 VOLTAGE REGULATORS** positive 12V 500mA
- BO19 **4 x TL082CP** bi-fet op-amps
- BO20 **20 x ASSORTED LEDS** full spec. various shapes and sizes
- BO21 **3 x INFRA-RED DIODE TX/RX PAIRS** made by Honeywell (no info)
- BO22 **4 x CONSTANT CURRENT LED** 5mm round, red 2-18V d.c. or a.c. nominal 14mA
- BO23 **50 x IN4148 diode**
- BO24 **2 x INFRA-RED TRANSISTOR** FPTS133
- BO25 **5 x DIACS**
- BO26 **3 BDX33C** 10 amp 100V npn transistor
- BO27 **12 x 2N3702** Transistor
- BO28 **12 x 2N3904** Transistor
- BO29 **12 x BC337** Transistor
- BO30 **4 x LM317T** Variable regulator mounted on a small heatsink
- BO31 **2 x MAN6610** 2 digit 0.6" 7 segment display Com anode, amber
- BO32 **3 x PHONO TO PHONO LEAD** 63cm long
- BO33 **15 x RECTANGULAR RED LEDs** 6 x 6 x 2mm stackable
- BO34 **1 x PHOTO SENSITIVE SCR** mounted on a PCB, data sheet supplied
- BO35 **4 x IEC Panel Mounting Mains Plug Snap fix**
- BO36 **5 x ASSORTED PIEZO TRANSDUCERS**
- BO37 **5 LENGTHS OF HEATSHRINK SLEEVING** 8mm dia. 400mm long
- BO38 **25 x CERAMIC DISC CAPACITORS** 0.1 mfd 63V
- BO39 **15 x MONOLITHIC CERAMIC CAPACITORS** 0.1 mfd 63V, in a dil package
- BO40 **25 x ASSORTED ELECTROLYTIC CAPACITORS** PCB mounting useful values
- BO41 **25 ASSORTED PRE-SET RESISTORS**
- BO42 **6 x 3.5mm JACK SOCKETS (mono)**
- BO43 **6 x 3.5mm JACK PLUG (mono)**
- BO44 **8 x 3.5mm CHASSIS SOCKET (mono)**
- BO45 **2 x TRIACS** 800 volt 8 amp
- BO46 **12 x BC213L** Transistor
- BO47 **12 x MIN SLIDE SWITCH** dpdt
- BO48 **15 x MIN CERMET TRIMMER POTS** (good range of values)
- BO49 **1 x PCB WITH TWO LARGE LEDS** 15mm square, one red and one green
- BO50 **1 x 12V DC RELAY** 4-pole c/o with plug in base
- BO51 **4 x LM324** quad op-amps
- BO52 **4 x 555** Timer
- BO53 **5 x 741** op-amp
- BO54 **25 x IN4001** diode
- BO55 **20 x IN4007** diode
- BO56 **1 x SLOTTED OPTO**
- BO57 **1 x DAC08** Digital to analogue converter with data
- BO58 **4 x OPTO ISOLATOR**
- BO60 **3 x C106D** Thyristor
- BO61 **5 x 78M05 VOLTAGE REGULATORS** positive 5 volt 500mA

Please use order code when ordering the bargain packs.

Please make cheques and postal orders payable to Mailtech.  
All prices include VAT.  
Please add 75p postage to all orders.

At the moment it is not possible to have a full telephone answering service. But we will have the phone definitely manned on Tuesdays, Wednesdays and Thursdays between 10am and 4pm.

**Dept EE, Mailtech**  
**PO Box 16 Ludlow**  
**Shropshire SY8 4NA**  
**Tel: 058 474475**

# Techniques

## ACTUALLY DOING IT!

by Robert Penfold

**T**RADITIONALLY, electronics is a hobby that is pursued most earnestly in the colder months of the year. We are now well into a new season, and no doubt many potential newcomers to the hobby are wondering whether or not they should try their hand at project building.

A factor that deters many would-be project builders from actually making anything is "will it work" syndrome. Worries about spending good money on a project that will never work are understandable, but are probably less justified than in the past. These days the average project is rather more complex than its counterpart of twenty or thirty years ago, but for a number of reasons it represents a far lower risk.

### GENUINE DUDS

Some constructors complain about the high cost of modern components, but as I have pointed out before, most components are now relatively cheap. Allowing for inflation, many semiconductors are only about one to ten per cent of their cost 20 to 25 years ago. Switches, cases, and most passive components are also only a fraction of their previous cost. Although the average project seems to get more complex year-by-year, the "real terms" cost probably gets lower.

Although one might expect the reduction in cost to be accompanied by a reduction in the quality of components, this is not the case. Manufacturing and testing methods have steadily improved over the years, and "dud" components are now very few and far between. If you were to buy several thousand components a year for the next 20 years, the chances are that you would not get a single "dud" (excluding any components that had sustained obvious physical damage at some stage). Some mechanical components (particularly switches) are no longer built to "belt and braces" standards, but they will still stand up to many years of use.

At one time there was a serious problem with so-called "genuine duds". These were sub-standard semiconductors that

were bought by unscrupulous retailers and remarked to look like the "real thing". Fortunately, this practice seemed to die out many years ago. Presumably there is no point in faking components which cost a few pence each when bought in bulk. Any semiconductors you buy these days will be good quality devices which meet the full manufacturers specification.

### KEEP IT SIMPLE

Although the general complexity of projects has increased over the years, there are still plenty of simple projects published. Although it is tempting to dive straight in and build an impressive up-market project, this is definitely not a good idea. Starting with a complex project does not guarantee failure, but it certainly reduces your chances of success.

The larger the number of components you have to deal with, the greater the risk of components being swapped over, fitted the wrong way round, or whatever. With a simple project you are risking relatively little money, and have a very good chance of producing a project that will work first time.

It is probably best to start with something mundane, such as a simple radio, or a car or household gadget. From time to time I still receive letters from readers who are having problems with a project, but where it is clear from their comments that they have misunderstood its precise use. In some cases it is obvious that the project is actually functioning, and that it is the constructor's expectations that are at fault!

### P.C.B.

When selecting your first project I would suggest that you look for one that can be built on a ready-made printed circuit board (p.c.b.). This is not a ploy on my part to boost sales of ready-made printed circuit boards. Using a printed circuit board it is relatively difficult to make mistakes. It is possible to make an error such as fitting a component between the wrong pair of holes, but any mistakes that are made usually become obvious before the board is completed.

The main alternative to a ready-made printed circuit board is stripboard. This is a form of proprietary printed circuit board which is drilled with a matrix of small holes, and has rows of copper strips on one side. It is an excellent product, but when using stripboard it is easy to make a careless error such as fitting a component leadout into the wrong hole. Spotting an error such as this can be quite difficult. Problems with short circuits between the copper tracks also tend to be more common than when using a custom printed circuit board.

It is probably best to avoid projects which have large amounts of "spaghetti" wiring from the board to controls, sockets, etc. This wiring is not actually too difficult to fit, but there is more scope for confusion and errors in this type of wiring than when fitting components to the circuit board.

**You should definitely not start with mains powered projects.** These are potentially lethal and should only be undertaken by those who know what they are doing. There are plenty of safe, battery powered projects to choose from.

### PREVENTION

It is clearly a good idea to get things right first time, rather than to make mistakes and then do some fault finding. Check carefully that each component is fitted in the right place. Double check resistor colour codes, and look carefully at each resistor to determine the colour of each band.

The body colours of some modern resistors make it hard to see the colour codes clearly. Particularly under artificial light, red, brown, and orange bands can be difficult to distinguish from one another. A fairly powerful magnifier makes the task much easier, and should also be helpful when reading the tiny lettering used on many semiconductors.

Some components are polarised, and must be fitted to the board the right way round. Electrolytic capacitors are the most common type of polarised component. These are usually marked clearly with "+" and "-" signs to indicate their polarity, and component overlay diagrams are marked in the same way. This makes it very easy to get their orientation correct. Note that getting an electrolytic capacitor the wrong way round can result in it bursting and being rendered completely useless.

### SEMICONDUCTOR ORIENTATION

Virtually all semiconductors must be fitted the right way round if they are to function properly. Integrated circuits often draw very high supply currents if they are fitted the wrong way round, which usually results in their rapid destruction. It pays to be especially careful with integrated circuits, particularly the more expensive types.

Component overlays do not usually leave room for any doubt about the correct orientation for semiconductors, but before fitting a transistor make sure that two of the leadout wires have not become crossed over. This can easily happen, and is very difficult to spot once the device has been soldered in place.

There is a temptation to rush through construction and get the completed project switched on as soon as possible. When building anything, rushing the job is almost invariably an approach which leads to careless errors. Take your time, and keep checking everything that you do. Look

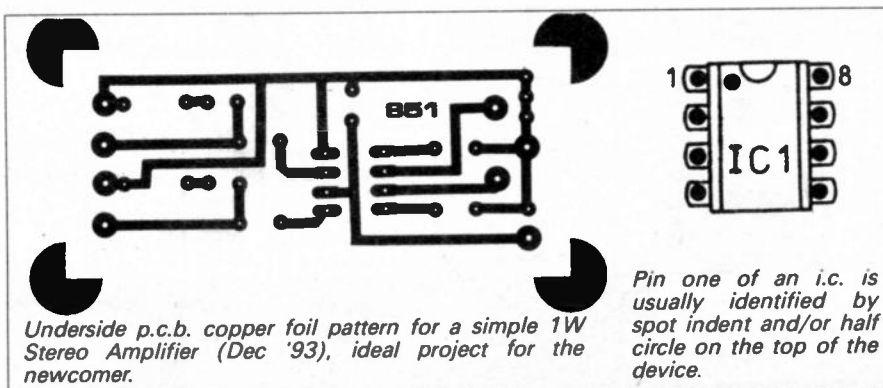



carefully at what you are doing, and do not jump to conclusions. Thoroughly check the finished unit against the construction diagrams. I think it is fair to say that most of the errors in non-functioning projects are glaringly obvious.

### PICKING FAULT

If the unthinkable should happen and the finished unit does not work, the problem is almost certainly due to a simple error somewhere. Check everything again, component by component, and wire by wire. Many constructors find it is best to put the project to one side for a day or two, and then take a fresh look at it. This will often result in the mistake being spotted almost at once.

With modern components and solder, "dry" joints are less of a problem than they once were. They can still occur from time to time though, unless your soldering technique is sound. There is insufficient space available here for a proper discussion of soldering procedures, but there are some common mistakes which beginners should try to avoid.

Only use a soldering iron and solder which is intended for electronic construction work. This means an iron fitted with a miniature bit of around two millimetres in diameter, and having a rating of about 15 to 25 watts. The solder should be a 60/40 tin/lead type (not a 60/40 lead/tin solder) having built-in flux.

Both surfaces to be joined must be reasonably clean. Tin the bit with solder and apply it to the joint first, and then feed in plenty of solder. Do not feed a lot of solder onto the bit of the iron and then try to "pour" this onto the joint. That is the most efficient way of producing a "dry" joint! Keep the tip of the bit well "tinned" with fresh solder.

Accidental short circuits between tracks due to solder splashes and blobs of excess solder are a likely cause of problems. These are not usually too difficult to spot on a custom printed circuit board. Some form of magnifier is very useful when looking for excess solder, and something like an 8x loupe (also known as a "lupe") is ideal. Solder splashes are sometimes hidden underneath excess flux.

Special solvents for cleaning printed circuit boards are available, but any fairly stiff-haired brush (an old toothbrush) seems to be equally effective at removing flux. Pay particular attention to areas of the board where the joints are crowded together. This mainly means areas of the board occupied by d.i.l. integrated circuits or other in-line components.

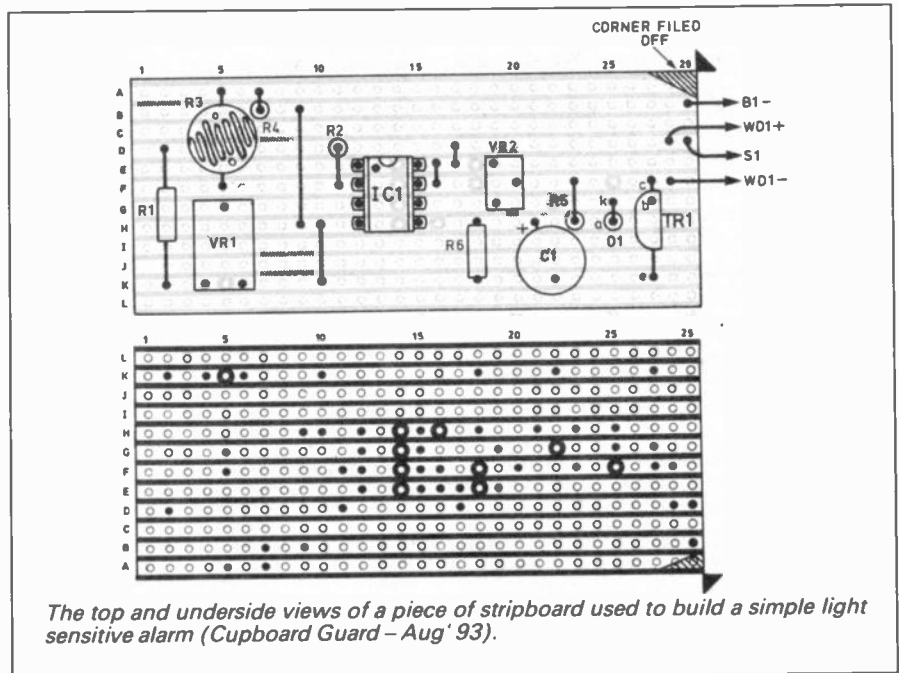

The top and underside views of a piece of stripboard used to build a simple light sensitive alarm (Cupboard Guard - Aug '93).

### INTERWIRING

As already pointed out, the wiring to the controls etc. often gives problems. This can be due to a simple wiring error which is easily located and corrected. It can also be due to confusion caused by components of the same general type having quite different physical appearances. For example, in my spares box I have standard jack sockets in three totally different styles. A wiring diagram for one style of socket is of little help if you have a different type.

Experienced constructors can simply make a few tests on controls and sockets to determine the correct method of connection, but for absolute beginners there is no alternative to copying the pictures. This will obviously be much easier if you obtain components that closely match those used in the prototype. This is in turn much easier if you have a good range of component catalogues. Many newcomers to the hobby overlook the importance of component catalogues, and soon run into trouble as a result of this.

### CATALOGUES

Component catalogues are particularly useful for beginners, as they contain helpful illustrations of components, plus a lot of data and other useful information. This helps to familiarise you with components, and should generally clarify things. Component catalogues are given away with

Everyday with Practical Electronics from time to time, or can be bought at quite low prices. Some of the larger ones cost a few pounds each, but they are often supplied with discount vouchers which enable the cost of the catalogue to be recouped if you spend a moderate amount on components.

It is understandable if constructors would prefer to spend money on components instead of using it to buy catalogues. However, this is definitely a false economy. In terms of their usefulness, component catalogues more than justify their cost. Obtain as many catalogues as you can, and buy at least one really large component catalogue.

### POSITIVE THOUGHT

If you run into problems with a project, the most important thing is to think positively. If you get everything connected together in the correct manner, the project will work. It is just a matter of going through the component layout and wiring until everything is correct.

The most important thing is to actually have a go at building a project, which is a lot more fun than sitting around thinking about it. Do not worry if there are some points about the components or construction of the project that you do not fully understand. Once you have the components everything will probably become apparent.

**Call us now! We have the widest range of components available - At competitive prices!**

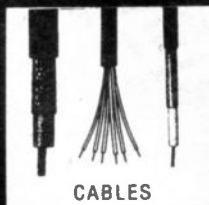

CABLES

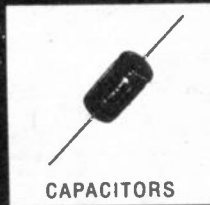

CAPACITORS



VIDEO HEADS

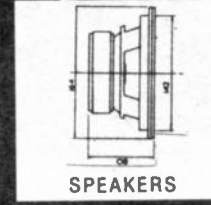

SPEAKERS

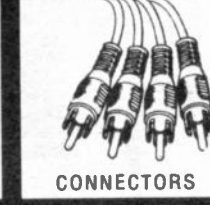

CONNECTORS

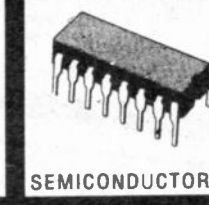

SEMICONDUCTORS

**CRICKLEWOOD**  
ELECTRONICS

Cricklewood Electronics Ltd. 40 Cricklewood Broadway, London NW2 3ET.  
Telephone: 081 452 0161 Faxsimile: 081 208 1441

All Major Credit Cards Accepted



# VIDEOS ON ELECTRONICS

A range of videos designed to provide instruction on electronics theory. Each video gives a sound introduction and grounding in a specialised area of the subject. The tapes make learning both easier and more enjoyable than pure textbook or magazine study. They should prove particularly useful in schools, colleges, training departments and electronics clubs as well as to general hobbyists and those following distance learning courses etc.

**VT201 to VT206 is a basic electronics course and is designed to be used as a complete series, if required.**

**VT201** 54 minutes. Part one; D.C. Circuits. This video is an absolute must for the beginner. Series circuits, parallel circuits, Ohms law, how to use the digital multimeter and much more. **Order Code VT201**

**VT202** 62 minutes. Part two; A.C. Circuits. This is your next step in understanding the basics of electronics. You will learn about how coils, transformers, capacitors, etc are used in common circuits. **Order Code VT202**

**VT203** 57 minutes. Part three; Semiconductors. Gives you an exciting look into the world of semiconductors. With basic semiconductor theory. Plus 15 different semiconductor devices explained. **Order Code VT203**

**VT204** 56 minutes. Part four; Power Supplies. Guides you step by step through different sections of a power supply. **Order Code VT204**

**VT205** 57 minutes. Part five; Amplifiers. Shows you how amplifiers work as you have never seen them before. Class A, class B, class C, op.amps. etc. **Order Code VT205**

**VT206** 56 minutes. Part six; Oscillators. Oscillators are found in both linear and digital circuits. Gives a good basic background in oscillator circuits. **Order Code VT206**

By the time you have completed VT206 you have completed the basic electronics course and should have a good understanding of the operation of basic circuit elements.

**Now for the digital series of six videos. This series is designed to provide a good grounding in computer technology.**

**VT301** 56 minutes. Digital One begins with the basics as you learn about seven of the most common gates which are used in almost every digital circuit, plus Binary notation. **Order Code VT301**

**VT302** 55 minutes. Digital Two will further enhance your knowledge of digital basics. You will learn about Octal and Hexadecimal notation groups, flip-flops, counters, etc. **Order Code VT302**

**VT303** 56 minutes. Digital Three is your next step in obtaining a solid understanding of the basic circuits found in today's digital design. Gets into multiplexers, registers, display devices, etc. **Order Code VT303**

**VT304** 57 minutes. Digital Four shows you how the computer is able to communicate with the real world. You will learn about digital to analogue and analogue to digital converter circuits. **Order Code VT304**

**VT305** 56 minutes. Digital Five introduces you to the technology used in many of today's memory devices. You will learn all about ROM devices and then proceed into PROM, EPROM, EEPROM, SRAM, DRAM, and MBM devices. **Order Code VT305**

**VT306** 56 minutes. Digital Six gives you a thorough understanding in the basics of the central processing unit and the input/output circuits used to make the system work. **Order Code VT306**

By now you should have a good understanding of computer technology and what makes computers work. This series is also invaluable to the computer technician to understand the basics and thus aid troubleshooting.

## VCR MAINTENANCE

**VT102** 84 minutes: Introduction to VCR Repair. Warning, not for the beginner. Through the use of block diagrams this video will take you through the various circuits found in the VHS system. You will follow the signal from the input to the audio/video heads then from the heads back to the output. **Order Code VT102**

**VT103** 35 minutes: A step-by-step easy to follow procedure for professionally cleaning the tape path and replacing many of the belts in most VHS VCR's. The viewer will also become familiar with the various parts found in the tape path. **Order Code VT103**

Each video uses a mixture of animated current flow in circuits plus text, plus cartoon instruction etc., and a very full commentary to get the points across. The tapes are imported by us and originate from VCR Educational Products Co, an American supplier.

(All videos are to the UK PAL standard on VHS tapes)

**ORDERING:** Add £1 p&p per order for UK orders. **OVERSEAS ORDERS:** Add £2 postage for countries in the EEC. Overseas orders outside the EEC countries send £24.44 per tape (price less VAT) plus £3 per tape airmail postage (or £3 per order surface mail postage). All payments in £ sterling only (send cheque or money order drawn on a UK bank. Visa and Mastercard orders accepted - please give card number, card expiry date and cardholders address if different to the delivery address. Send your order to: Direct Book Service, 33 Gravel Hill, Merley, Wimborne, Dorset BH21 1RW (Mail Order Only)

Direct Book Service is a division of Wimborne Publishing Ltd., publishers of *Everyday with Practical Electronics*. Tel: 0202 881749. Fax: 0202 841692

**£29.95**  
each inc. VAT





**ELECTRONICS TEACH-IN 88/89- INTRODUCING MICROPROCESSORS**  
Mike Tooley BA (published by *Everyday Electronics*)

A complete course that can lead successful readers to the award of a City and Guilds Certificate in Introductory Microprocessors (726/303). The book contains everything you need to know including full details on registering for assessment, etc.

Sections cover Microcomputer Systems, Micro-processors, Memories, Input/Output, Interfacing and Programming. There are various practical assignments and eight Data Pages covering the most popular microprocessors.

An excellent introduction to the subject even for those who do not wish to take the City and Guilds assessment.  
80 pages (A4 size) **Order code T1-88-89** £2.45

**ELECTRONIC PROJECTS BOOK 1**  
Published by *Everyday Electronics* in association with *Magenta Electronics*.

Contains twenty of the best projects from previous issues of EE each backed with a kit of components. The projects are: Seashell Sea Synthesiser, EE Treasure Hunter, Mini Strobe, Digital Capacitance Meter, Three Channel Sound to Light, BBC 16K sideways Ram, Simple Short Wave Radio, Insulation Tester, Stepper Motor interface, Eprom Eraser, 200MHz Digital Frequency Meter, Infra Red Alarm EE Equaliser Isolator, Bat Detector, Acoustic Probe, Mainstester and Fuse Finder, Light Rider - (Lapel Badge, Disco Lights, Chaser Light), Musical Doorbell, Function Generator, Tilt Alarm, 10W Audio Amplifier, EE Buccaneer Induction Balance Metal Detector, BBC Midi Interface, Variable Bench Power Supply, Pet Scanner, Audio Signal Generator.  
128 pages (A4 size) **Order code EPT1** £2.45

**ELECTRONICS TEACH-IN No. 3 - EXPLORING ELECTRONICS** (published by *Everyday Electronics*)  
Owen Bishop

Another EE value for money publication aimed at students of electronics. The course is designed to explain the workings of electronic components and circuits by involving the reader in experimenting with them. The book does not contain masses of theory or formulae but straightforward explanations and circuits to build and experiment with.

Exploring Electronics contains more than 25 useful projects, assumes no previous knowledge of electronics and is split into 28 easily digestible sections.  
88 pages (A4 size) **Order code T1-3** £2.45

**ELECTRONICS TEACH-IN No. 4 INTRODUCING DIGITAL ELECTRONICS** (published by *Everyday Electronics*)  
Michael J. Cockcroft

Although this book is primarily a City & Guilds Introductory level course (726/301), approximately 80% of the information forms a very basic introduction to electronics in general, it therefore provides an excellent introductory text for beginners and a course and reference book for GCSE students.

Full details on registering for C&G assessment, details of assessment centres, components required and information on the course in general are given.

"The City & Guilds introduction to module 726/301 reads: "A candidate who satisfactorily completes this module will have a competence to identify basic components and digital integrated circuits and connect them together to form simple working circuits and logic units." This provides an excellent introduction to the book.  
112 pages (A4 size) **Order code T1-4** £2.95

**ELECTRONICS TEACH-IN No.5 GUIDE TO BUILDING ELECTRONIC PROJECTS**  
Published by *Everyday Electronics*

Due to the demand from students, teachers and hobbyists we have put together a range of articles from past issues of *Everyday Electronics* that will assist those involved with the construction of electronic projects.

The book contains the complete *Project Development* for GCSE series.

**Contents:** Features - First Steps in Project Building; Building with Vero; Project Development for GCSE; Getting your Projects Working; Guide to Printed Circuit Boards; Choosing and Using Test Equipment - The Multimeter, The Oscilloscope, P.S.U.s, Logic Probes, Digital Frequency Meters, Signal Generators, etc; Data - Circuit Symbols; Component Codes; Resistors; Identifying Components; Component Codes; Actually Doing It - Understanding the Circuit Diagram; Component Codes, Mounting circuit boards and controls; Understanding Capacitors; Projects - Lie Detector; Personal Stereo Amplifier; Digital Experimenters' Unit; Quizmaster; Siren Effects Unit; UV Exposure Unit; Low-cost Capacitance Meter; Personal Radio.  
88 pages (A4 size) **Order code T1-5** £2.95

**ELECTRONICS TEACH-IN No. 6 DESIGN YOUR OWN CIRCUITS**  
(Published by *Everyday with Practical Electronics*)

Mike Tooley B.A.  
This book is designed for the beginner and experienced reader alike, and aims to dispel some of the mystique associated with the design of electronic circuits. It shows how even the relative newcomer to electronics can, with the right approach, design and realise quite complex circuits.

Fourteen individual p.c.b. modules are described which, with various detailed modifications, should allow anyone to design and construct a very wide range of different projects. Nine "hands-on" complete DIY projects have also been included so readers can follow the thinking behind design, assembly, construction, testing and evaluation, together with suggested "mods" to meet individual needs. The practical projects have each been designed to stand on their own as complete items of equipment. P.C.B.s for all the modules and projects are available by mail order.

The subjects covered in each chapter of the book are: Introduction and Power Supplies; Small Signal Amplifiers; Power Amplifiers; Oscillators; Logic Circuits; Timers; Radio; Power Control; Optoelectronics.

The nine complete constructional projects are: Versatile Bench Power Supply; Simple Intercom; Bench Amplifier/Signal Tracer; Waveform Generator; Electronic Die; Pulse Generator; Radio Receiver; Disco Lights Controller; Optical Communications Link.  
136 pages **Order code T1-6** £3.45

# DIRECT BOOK SERVICE

The books listed have been selected by *Everyday with Practical Electronics* editorial staff as being of special interest to everyone involved in electronics and computing. They are supplied by mail order direct to your door. Full ordering details are given on the last book page. For another selection of books see next month's issue

**PRACTICAL ELECTRONICS HANDBOOK - Third Edition**  
Ian Sinclair

A completely updated and revised third edition of this popular title. It still contains a carefully selected collection of standard circuits, rules-of-thumb, and design data for professional engineers, students and enthusiasts involved in radio and electronics, but is now over one hundred pages bigger...

The book covers many areas not available elsewhere in such a handy volume, and this new edition now includes chapters on: Microprocessors and microprocessor systems; The instruction register, Clocking, Memory, Read-write memory, The buses, Reading and writing actions, Three-state control, The control bus, Timing and bus control, The PC register and addressing, Addressing methods, Interrupts, Inputs and outputs, Port, Keyboard interfacing, Video interfacing, Digital-analogue conversions: Analogue-to-digital conversion, Sampling and conversion, Digital-to-analogue conversion, Current addition methods, Conversion problems, Bitstream methods, Computer plug-in boards, Computer aids in electronics: The computer, Linear circuit analysis by computer, The menus, Circuits and nodes, PCB layouts, Circuit diagrams, The Public Domain Software Library. Hardware components and practical work: Hardware, Video connectors, Control knobs and switches, Switches, Cabinets and cases, Packages for semiconductors, Integrated circuit packages, Constructing circuits, Surface mounting, testing and trouble-shooting, Practical work on microprocessing equipment, Instruments for digital servicing work, Logic analysers.

Other chapters cover Passive Components, Active Discrete Components, Discrete Component Circuits, Linear ICs, Digital ICs, Transferring Digital Data and Computer Aids in Electronics  
338 pages **Order code NE19** £14.95

**ELECTRONIC TEST EQUIPMENT HANDBOOK**  
Steve Money

The principles of operation of the various types of test instrument are explained in simple terms with a minimum of mathematical analysis. The book covers analogue and digital meters, bridges, oscilloscopes, signal generators, counters, timers and frequency measurement. The practical uses of the instruments are also examined.

Everything from Audio oscillators, through R, C & L measurements (and a whole lot more) to Waveform Generators and testing Zeners.  
206 pages **Order code PC109** £8.95

**A REFERENCE GUIDE TO BASIC ELECTRONICS TERMS**  
F.A. Wilson

The wonders of electronics multiply uncasingly and electronic devices are creeping relentlessly into all walks of

## TESTING, THEORY AND REFERENCE

modern life. As with most professions, ours too has a language of its own, ever expanding and now encompassing several thousands of terms. This book picks out and explains some of the more important fundamental terms (over 700), making the explanations as easy to understand as can be expected of a complicated subject and avoiding high-level mathematics.

Through its system of references, each term is backed up by a list of other relevant or more fundamental terms so that a chosen subject can be studied to any depth required.

472 pages **Order code BP286** £5.95

**GETTING THE MOST FROM YOUR MULTIMETER**  
R.A. Penfold

This book is primarily aimed at beginners and those of limited experience of electronics. Chapter 1 covers the basics of analogue and digital multimeters, discussing the relative merits and the limitations of the two types. In Chapter 2 various methods of component checking are described, including tests for transistors, thyristors, resistors, capacitors and diodes. Circuit testing is covered in Chapter 3, with subjects such as voltage, current and continuity checks being discussed.

In the main little or no previous knowledge or experience is assumed. Using these simple component and circuit testing techniques the reader should be able to confidently tackle servicing of most electronic projects.  
96 pages **Order code BP239** £2.95

**MORE ADVANCED USES OF THE MULTIMETER**  
R.A. Penfold

This book is primarily intended as a follow-up to BP239, (see above), and should also be of value to anyone who already understands the basics of voltage testing and simple component testing. By using the techniques described in chapter 1 you can test and analyse the performance of a range of components with just a multimeter (plus a very few inexpensive components in some cases). Some useful quick check methods are also covered.

While a multimeter is supremely versatile, it does have its limitations. The simple add-ons described in chapter 2 extended the capabilities of a multimeter to make it even more useful.  
84 pages **Order code BP265** £2.95

**THE ILLUSTRATED DICTIONARY OF ELECTRONICS - 5th EDITION**  
Rufus P. Turner and Stan Gibilisco

With more than 27,000 terms used in electronics today, this collection is THE most comprehensive dictionary available. Including all practical electronics and computer

terms, it is as up-to-date as the latest advances in the field itself! Tables and data on subjects most often consulted for projects and experiments are included. Other conversion tables include English/metric and metric/English conversions for units of energy, power and volume, and Fahrenheit/Celsius temperature conversion charts.

Setting this edition apart from other electronic dictionaries is its emphasis on illustration. Featuring more than complete definitions, this fourth edition includes over 450 drawings and diagrams. (An American book).  
720 pages **Order code T1900** £23.95

**ELECTRONICS-BUILD AND LEARN**  
R.A. Penfold

The first chapter gives full constructional details of a circuit demonstrator unit that is used in subsequent chapters to introduce common electronic components - resistors, capacitors, transformers, diodes, transistors, thyristors, fets and op amps. Later chapters go on to describe how these components are built up into useful circuits, oscillators, multivibrators, bistables and logic circuits.

At every stage in the book there are practical tests and experiments that you can carry out on the demonstrator unit to investigate the points described and to help you understand the principles involved. You will soon be able to go on to more complex circuits and tackle fault finding logically in other circuits you build.  
120 pages **Order code PC103** £6.95

**ELECTRONICS - A "MADE SIMPLE" BOOK**  
G. H. Olsen

This book provides excellent background reading for our *Introducing Digital Electronics* series (Teach-In No.4 above) and will be of interest to everyone studying electronics. The subject is simply explained and well illustrated and the book assumes only a very basic knowledge of electricity.  
330 pages **Order code NE10** £5.95

**PRACTICAL ELECTRONICS CALCULATIONS AND FORMULAE**  
F.A. Wilson, C.G.I.A., C.Eng., F.I.E.E., F.I.E.R.E., F.B.I.M.

Bridges the gap between complicated technical theory, and "cut-and-try" methods which may bring success in design but leave the experimenter unfulfilled. A strong practical bias - tedious and higher mathematics have been avoided where possible and many tables have been included.

The book is divided into six basic sections: Units and Constants, Direct-current Circuits, Passive Components, Alternating-current Circuits, Networks and Theorems, Measurements.  
256 pages **Order code BP53** £3.95



# COMPUTING

## INTERFACING PCs AND COMPATIBLES

R. A. Penfold

Once you know how, PC interfacing is less involved than interfacing many eight-bit machines, which have tended to use some unusual interfacing methods.

This book gives you: A detailed description of the lines present on the PC expansion bus. A detailed discussion of the physical characteristics of PC expansion cards. The I/O map and details of the areas where your add-ons can be fitted. A discussion of address decoding techniques. Practical address decoder circuits. Simple TTL 8-bit input and output ports. Details of using the 8255 parallel interface adaptor. Digital to analogue converter circuits. Analogue to digital converter circuits. In fact everything you need to know in order to produce successful PC add-ons.

80 pages

Order code BP272

£3.95

## HOW TO CHOOSE A SMALL BUSINESS COMPUTER SYSTEM

D. Weale

This book is for anyone intending to buy an IBM compatible computer system, whether it is their first system or a replacement. There are sections on hardware, application and systems programs, and how to actually make your choice as well as sections on the law, ergonomics and a glossary or common terms. The text contains many useful tips and some warnings (which could save much effort and expense). After having read this book you should have a better idea of what is suitable for your needs, how to obtain it and how to ensure that the system is operated with the minimum of difficulty.

144 pages

Order code BP323

£4.95

## HOW TO EXPAND, MODERNISE AND REPAIR PCs AND COMPATIBLES

R. A. Penfold

Not only are PC and compatible computers very expandable, but before long most users actually wish to take advantage of that expandability and start upgrading their PC systems. Some aspects of PC upgrading can be a bit confusing, but this book provides advice and guidance on the popular forms of internal PC expansion, and should help to make things reasonably straightforward and painless. Little knowledge of computing is assumed. The only assumption is that you can operate a standard PC of some kind (PC, PC XT, PC AT, or a 80386 based PC).

The subjects covered include: PC overview; Memory upgrades; Adding a hard disk drive; Adding a floppy disk drive; Display adaptors and monitors; Fitting a maths co-processor; Keyboards; Ports; Mice and digitisers;

Maintenance (including preventative maintenance) and Repairs, and the increasingly popular subject of d.i.y. PCs. 156 pages **Temporarily out of print**

## THE PRE-BASIC BOOK

F. A. Wilson, C.G.I.A., C.ENG., F.I.E.E., F.I.E.R.E., F.B.I.M.

Another book on BASIC but with a difference. This one does not skip through the whole of the subject and thereby leave many would-be programmers floundering but instead concentrates on introducing the technique by looking in depth at the most frequently used and more easily understood computer instructions. For all new and potential micro users.

192 pages

Order code BP146

£2.95

## AN INTRODUCTION TO 6502 MACHINE CODE

R. A. & J. W. Penfold

No previous knowledge of microprocessors or machine code is assumed. Topics covered are: assembly language and assemblers, the register set and memory, binary and hexadecimal numbering systems, addressing modes and the instruction set, and also mixing machine code with BASIC. Some simple programming examples are given for 6502-based home computers like the VIC-20, ORIC-1/Atmos, Electron, BBC and also the Commodore 64.

112 pages

Order code BP147

£2.95

## A CONCISE USER'S GUIDE TO WINDOWS 3.1

N. Kantonis

If you are a PC user and want to get to grips with Microsoft's Windows 3.1, then this book will teach you how to do just that in the shortest and most effective way.

The book is written with the non-expert, busy person in mind, and as such, it has an underlying structure based on "what you need to know first, appears first". However, the more experienced user can start from any section, as the sections are self contained.

The book explains: what hardware requirements you need in order to run Windows 3.1 successfully, and how to install, customise and fine-tune the program, and how to optimise your system resources. How to manipulate Windows screens and how to run Windows and DOS applications under the Windows Graphical User Interface (GUI) environment. How to use the Windows triple Management system: Program Manager, File Manager and Print Manager to

advantage. How to use the word processor accessory Write to type, edit, format, print and save documents.

How to use Paintbrush and its tools to draw and edit drawings, and how to set up, sort and search a Cardfile database and exploit its autodial feature. How to use the Windows Calendar to enter appointments, add special times and alarms. How to use the Terminal accessory to connect to remote systems, specify terminal emulation preferences, communications setting, telephone number and prepare files for transfer. How to use the Notepad, Macro Recorder, PIF Editor and Calculator.

138 pages

Order code BP325

£4.95

## SERVICING PERSONAL COMPUTERS - 3rd EDITION

Mike Tooley BA

The revised and enlarged third edition contains a new chapter on servicing 68,000 based microcomputers. It has been updated throughout and includes many new photos and diagrams. It is essential for anyone concerned with the maintenance of personal computer equipment or peripherals, whether professional service technician, student or enthusiast.

240 pages

Order code NE15

£25

## A CONCISE USER'S GUIDE TO MS-DOS 5

N. Kantonis

If you are a PC user and want to get the most out of your computer in terms of efficiency and productivity, then you must learn the intricacies of its MS-DOS operating system. With this book you will learn to do just that in the shortest and most effective way.

The book explains: The enhancements to be found in MS-DOS version 5, over previous versions of the operating system. How the DOS operating system is structured so that you can understand what happens when you first switch on your computer. How directories and subdirectories can be employed to structure your hard disc for maximum efficiency. How to use the DOS Shell program (a menu-driven graphical interface) to perform various house-keeping operations on your disc. How to manage disc files, and how to use the MS-DOS Editor to fully configure your system by writing your own CONFIG.SYS and AUTOEXEC.BAT files. How to optimise your system by either increasing its conventional memory or increasing its speed. How to write batch files to automate the operation of your system.

A summary of all DOS commands, illustrated with examples, is given in the penultimate chapter, which turns it into a useful reference guide.

124 pages

Order code BP318

£4.95

# CIRCUITS AND DESIGN

## REMOTE CONTROL HANDBOOK

Owen Bishop

Remote control systems lend themselves to a modular approach. This makes it possible for a wide range of systems, from the simplest to the most complex, to be built up from a number of relatively simple modules. The author has tried to ensure that, as far as possible, the circuit modules in this book are compatible with one another. They can be linked together in many different configurations to produce remote control systems tailored to switch a table lamp on and off, or to operate an industrial robot, this book should provide the circuit you require.

226 pages

Order code BP240

£3.95

## COIL DESIGN AND CONSTRUCTION MANUAL

B. B. Babani

A complete book for the home constructor on "how to make" RF, IF, audio and power coils, chokes and transformers. Practically every possible type is discussed and calculations necessary are given and explained in detail. Although this book is now rather old, with the exception of toroids and pulse transformers little has changed in coil design since it was written.

96 pages

Order code 160

£2.50

## 30 SOLDERLESS BREADBOARD PROJECTS - BOOK 1

R. A. Penfold

Each project, which is designed to be built on a "Verobloc" breadboard, is presented in a similar fashion with a brief circuit description, circuit diagram, component layout diagram, components list and notes on construction and use where necessary. Whenever possible, the components used are common to several projects, hence with only a modest number of reasonably inexpensive components, it is possible to build in turn, every project shown. Recommended by BICC-Verobloc.

160 pages

Order code BP107

£2.95

## AUDIO IC CIRCUITS MANUAL

R. M. Marston

A vast range of audio and audio-associated i.c.s. are readily available for use by amateur and professional design engineers and technicians. This manual is a guide to the most popular and useful of these devices, with over 240 diagrams. It deals with i.c.s. such as low frequency linear amplifiers, dual pre-amplifiers, audio power amplifiers, charge coupled device delay lines, bar-graph display drivers, and power supply regulators, and shows how to use these devices in circuits ranging from simple signal conditioners and filters to complex graphic equalizers, stereo amplifier systems, and echo/reverb delay line systems etc.

168 pages

Order code NE13

£13.95

## 50 CIRCUITS USING GERMANIUM SILICON AND ZENER DIODES

R. N. Soar

Contains 50 interesting and useful circuits and applications, covering many different branches of electronics, using one of the most simple and inexpensive of components - the diode. Includes the use of germanium and silicon signal diodes, silicon rectifier diodes and Zener diodes, etc.

64 pages

Order code BP36

£1.95

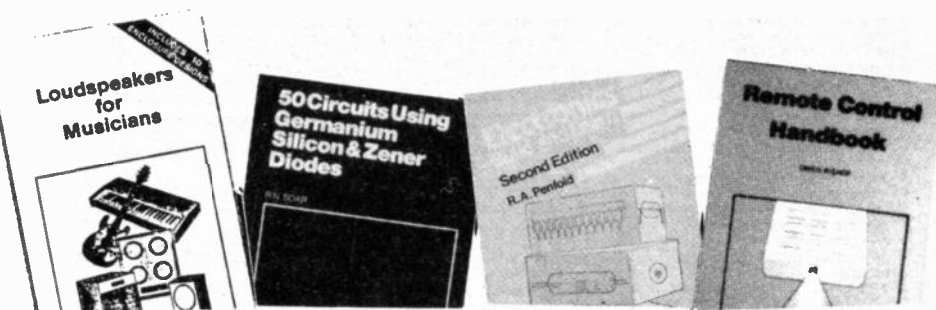

## A BEGINNERS GUIDE TO CMOS DIGITAL ICs

R. A. Penfold

Getting started with logic circuits can be difficult, since many of the fundamental concepts of digital design tend to seem rather abstract, and remote from obviously useful applications. This book covers the basic theory of digital electronics and the use of CMOS integrated circuits, but does not lose sight of the fact that digital electronics has numerous "real world" applications.

The topics covered in this book include: the basic concepts of logic circuits; the functions of gates, inverters and other logic "building blocks"; CMOS logic i.c. characteristics, and their advantages in practical circuit design; oscillators and monostables (timers); flip/flops, binary dividers and binary counters; decade counters and display drivers.

The emphasis is on a practical treatment of the subject, and all the circuits are based on "real" CMOS devices. A number of the circuits demonstrate the use of CMOS logic i.c.s in practical applications.

119 pages

Order code BP333

£4.95

## TIMER/GENERATOR CIRCUITS MANUAL

R. M. Marston

This manual is concerned mainly with waveform generator techniques and circuits. Waveform generators are used somewhere or other in most types of electronic equipment, and thus form one of the most widely used classes of circuit. They may be designed to produce outputs with sine, square, triangle, ramp, pulse, staircase, or a variety of other forms. The generators may produce modulated or unmodulated outputs, and the outputs may be of single or multiple form.

Waveform generator circuits may be built using transistors, op-amps, standard digital ICs, or dedicated waveform or "function" generator ICs.

The manual is divided into eleven chapters, and presents over 300 practical circuits, diagrams and tables. The subjects covered include: Basic principles; Sine wave generators; Square wave generators; Pulse generator circuits; "Timer IC" generator circuits; Triangle and sawtooth generators; Multi-waveform generation;

Waveform synthesizer ICs; Special waveform generators; Phase-locked loop circuits; Miscellaneous "555" circuits.

267 pages

Order code NE18

£13.95

## OPTOELECTRONICS CIRCUITS MANUAL

R. M. Marston

A useful single-volume guide to the optoelectronics device user, specifically aimed at the practical design engineer, technician, and the experimenter, as well as the electronics student and amateur. It deals with the subject in an easy-to-read, down-to-earth, and non-mathematical yet comprehensive manner, explaining the basic principles and characteristics of the best known devices, and presenting the reader with many practical applications and over 200 circuits. Most of the i.c.s. and other devices used are inexpensive and readily available types, with universally recognised type numbers.

182 pages

Order code NE14

£13.95

## POPULAR ELECTRONIC CIRCUITS - BOOK 1

## POPULAR ELECTRONIC CIRCUITS - BOOK 2

R. A. Penfold

Each book provides a wide range of designs for electronic enthusiasts who are capable of producing working projects from just a circuit diagram without the aid of detailed construction information. Any special setting-up procedures are described.

BOOK 1 160 pages

Order code BP80

£2.95

BOOK 2 160 pages

Order code BP98

£2.95

## CMOS CIRCUITS MANUAL

R. M. Marston

Written for the professional engineer, student or enthusiast. It describes the basic principles and characteristics of these devices and includes over 200 circuits.

All the circuits have been designed, built and fully evaluated by the author; all use inexpensive and internationally available devices.

187 pages

Order code NE12

£13.95



# PROJECT CONSTRUCTION

## POPULAR ELECTRONIC PROJECTS

R. A. Penfold

Included in this book are a collection of the most popular types of projects which, we feel sure, will provide many designs to interest all electronics enthusiasts. All the circuits utilise modern, inexpensive and freely available components. The 27 projects selected cover a very wide range and are divided into four basic areas: Radio Projects, Audio Projects, Household Projects and Test Instruments. An interesting addition to the library of both the beginner and more advanced constructor.

135 pages

Order code BP49

£2.50

## TEST EQUIPMENT CONSTRUCTION

R. A. Penfold

This book describes in detail how to construct some simple and inexpensive but extremely useful, pieces of test equipment. Stripboard layouts are provided for all designs, together with wiring diagrams where appropriate, plus notes on construction and use.

The following designs are included:-

AF Generator, Capacitance Meter, Test Bench Amplifier, AF Frequency Meter, Audio Millivoltmeter, Analogue Probe, High Resistance Voltmeter, CMOS Probe, Transistor Tester, TTL Probe.

The designs are suitable for both newcomers and more experienced hobbyists.

104 pages

Order code BP248

£2.95

## HOW TO DESIGN AND MAKE YOUR OWN P.C.B.s

R. A. Penfold

Deals with the simple methods of copying printed circuit board designs from magazines and books and covers all aspects of simple p.c.b. construction including photographic methods and designing your own p.c.b.s.

80 pages

Order code BP121

£2.50

## HOW TO GET YOUR ELECTRONIC PROJECTS WORKING

R. A. Penfold

We have all built projects only to find that they did not work correctly, or at all, when first switched on. The aim of this

book is to help the reader overcome just these problems by indicating how and where to start looking for many of the common faults that can occur when building up projects.

96 pages

Order code BP110

£2.95

## AUDIO AMPLIFIER CONSTRUCTION

R. A. Penfold

The purpose of this book is to provide the reader with a wide range of preamplifier and power amplifier designs that will, it is hoped, cover most normal requirements.

The preamplifier circuits include low noise microphone and RIAA types, a tape head preamplifier, a guitar preamplifier and various tone controls. The power amplifier designs range from low power battery operation to 100W MOSFET types and also include a 12 volt bridge amplifier capable of giving up to 18W output.

All the circuits are relatively easy to construct using the p.c.b. or stripboard designs given. Where necessary any setting-up procedures are described, but in most cases no setting-up or test gear is required in order to successfully complete the project.

100 pages

Order code BP122

£2.95

## BEGINNER'S GUIDE TO BUILDING ELECTRONICS PROJECTS

R. A. Penfold

Shows the complete beginner how to tackle the practical side of electronics, so that he or she can confidently build the electronic projects that are regularly featured in magazines and books. Also includes examples in the form of simple projects.

112 pages

Order code 227

£1.95

# AUDIO AND MUSIC

## LOUDSPEAKERS FOR MUSICIANS

Vivian Capel

This book contains all that a working musician needs to know about loudspeakers; the different types, how they work, the most suitable for different instruments, for cabaret work, and for vocals. It gives tips on constructing cabinets, wiring up, when and where to use wadding, and when not to, what fittings are available, finishing, how to ensure they travel well, how to connect multi-speaker arrays and much more.

Ten practical enclosure designs with plans and comments are given in the last chapter, but by the time you've read that far you should be able to design your own!

164 pages

Order code BP297

£3.95

## MAKE MONEY FROM HOME RECORDING

Clive Brooks

Now that you've spent a fortune on all that recording gear, MIDI and all, wouldn't it be nice to get some of it back? Well here's the book to show you how.

It's packed with money making ideas, any one of which will recoup the price of the book many times over. Whether you have a fully fledged recording studio at home, or just a couple of stereo cassette recorders and a microphone, you'll be able to put the ideas in this book into practice and make money.

105 pages

Order code PC104

£5.95

Yamaha's frequency modulation, and sampling - and then describes how the instruments are adjusted to produce various types of sound - strings, brass, percussion, etc. The theoretical side of synthesis is treated in an easy to understand way - the technical information being restricted to what you need to know to use your instrument effectively.

168 pages

Order code PC105

£6.95

## AUDIO

F. A. Wilson, C. G. I. A., C. Eng., F.I.E.E., F.I.E.R.E., F.B.I.M.

Analysis of the sound wave and an explanation of acoustical quantities prepare the way. These are followed by a study of the mechanism of hearing and examination of the various sounds we hear. A look at room acoustics with a subsequent chapter on microphones and loudspeakers then sets the scene for the main chapter on audio systems - amplifiers, oscillators, disc and magnetic recording and electronic music.

320 pages

Order code BP111

£3.95

# DATA

## PRACTICAL ELECTRONIC DESIGN DATA

Owen Bishop

This book is a comprehensive ready-reference manual for electronics enthusiasts of all levels, be they hobbyists, students or professionals. A helpful major section covers the main kinds of component, including surface-mounted devices. For each sort, it lists the most useful and readily available types, complete with details of their electronic characteristics, pin-outs and other essential information. A special feature of this section are the easily followed charts and tables which advise the reader on how to select the best type of component for any particular purpose.

Basic electronic units are defined, backed up by a compendium of the most often required formulae, fully explained. There are five more extensive sections devoted to circuit design, covering analogue, digital, radio, display, and power supply circuits. Over 150 practical circuit diagrams cover a broad range of functions. The reader is shown how to adapt these basic designs to a variety of applications. Many of the circuit descriptions include step-by-step instructions for using most of the standard types of integrated circuit such as operational amplifiers, comparators, filters, voltage converters and switched-mode power supply devices, as well as the principal logic circuits.

328 pages

Order code BP316

£4.95

## INTERNATIONAL TRANSISTOR EQUIVALENTS GUIDE

A. Michaels

Helps the reader to find possible substitutes for a popular selection of European, American and Japanese transistors. Also shows material type, polarity, manufacturer and use.

320 pages

Order code BP85

£3.95

# RADIO/TV

## SETTING UP AN AMATEUR RADIO STATION

I. D. Poole

The aim of this book is to give guidance on the decisions which have to be made when setting up an amateur radio or short wave listening station. Often the experience which is needed is learned by one's mistakes, however, this can be expensive. To help overcome this, guidance is given on many aspects of setting up and running an efficient station. It then proceeds to the steps that need to be taken in gaining a full transmitting licence.

Topics covered include: The equipment that is needed; Setting up the shack; Which aerials to use; Methods of construction; Preparing for the licence.

An essential addition to the library of all those taking their first steps in amateur radio

86 pages

Order code BP300

£3.95

## EXPERIMENTAL ANTENNA TOPICS

H. C. Wright

Although nearly a century has passed since Marconi's first demonstration of radio communication, there is still research and experiment to be carried out in the field of antenna design and behaviour.

The aim of the experimenter will be to make a measurement or confirm a principle, and this can be done with relatively fragile, short-life apparatus. Because of this, devices described in this book make liberal use of cardboard, cooking foil, plastic bottles, cat food tins, etc. These materials are, in general, cheap to obtain and easily worked with simple tools, encouraging the trial-and-error philosophy which leads to innovation and discovery.

Although primarily a practical book with text closely supported by diagrams, some formulae which can be used by straightforward substitution and some simple graphs have also been included.

72 pages

Order code BP278

£3.50

## NEWNES SHORTWAVE LISTENING HANDBOOK

Joe Pritchard G1UWQ

Part One covers the "science" side of the subject, going from a few simple electrical "first principles", through a brief treatment of radio transmission methods to simple receivers. The emphasis is on practical receiver designs and how to build and modify them, with several circuits in the book.

Part Two covers the use of sets, what can be heard, the various bands, propagation, identification of stations, sources of information, QSLing of stations and listening to amateurs. Some computer techniques, such as computer Morse decoding and radio teletype decoding are also covered.

224 pages

Order code NE16

£15.95

## INTRODUCTION TO DIGITAL AUDIO

(Second Edition)

Ian Sinclair

Digital recording methods have existed for many years and have become familiar to the professional recording engineer, but the compact disc (CD) was the first device to bring digital audio methods into the home. The next step is the appearance of digital audio tape (DAT) equipment.

All this development has involved methods and circuits that are totally alien to the technician or keen amateur who has previously worked with audio circuits. The principles and practices of digital audio owe little or nothing to the traditional linear circuits of the past, and are much more comprehensible to today's computer engineer than the older generation of audio engineers.

This book is intended to bridge the gap of understanding for the technician and enthusiast. The principles and methods are explained, but the mathematical background and theory is avoided, other than to state the end product.

128 pages

Order code PC102

£6.95

## SYNTHESIZERS FOR MUSICIANS

R. A. Penfold

Modern synthesizers are extremely complex, but they mostly work on principles that are not too difficult to understand. If you want to go beyond using the factory presets or the random poking of buttons, this is the book for you.

It covers the principles of modern synthesis - linear arithmetic as used by Roland, phase distortion (Casio),

# DIRECT BOOK SERVICE ORDERING DETAILS

Please state the title and order code clearly, print your name and address and add the required postage to the total order.

Add £1 to your total order for postage and packing (overseas readers add £2 for countries in Europe, or add £5 for all countries outside Europe, surface mail postage) and send a PO, cheque, international money order (£ sterling only) made payable to Direct Book Service or credit card details (including card expiry date), Visa or Mastercard (Access) - minimum credit card order is

£5 - quoting your name and address, the order code and quantities required to DIRECT BOOK SERVICE, 33 GRAVEL HILL, WIMBORNE, DORSET BH21 1RW (mail order only).

Although books are normally sent within seven days of receipt of your order, please allow a maximum of 28 days for delivery. Overseas readers allow extra time for surface mail post.

Please check price and availability (see latest issue of *Everyday with Practical Electronics*) before ordering from old lists.

For a further selection of books see next month's issue

DIRECT BOOK SERVICE IS A DIVISION OF WIMBORNE PUBLISHING LTD.

"... there is no doubt that running under *Windows* puts it ahead of the field and makes it a visually attractive package." **Electronics World + Wireless World July 1993**

*High Quality PCB and Schematic Design for Windows 3/3.1 and DOS*

- Supports over 150 printers/plotters including 9 or 24 pin dot-matrix, DeskJet, LaserJet, Postscript, and HPGL. Professional Edition imports GERBER files, and exports GERBER and NC-DRILL files.
- Up to 200,000 pads/track nodes depending on memory. Simple auto-router and schematic capture tools with SPICE compatible net-list output.
- Low cost DOS version (reduced features) also available. Ring for full details!

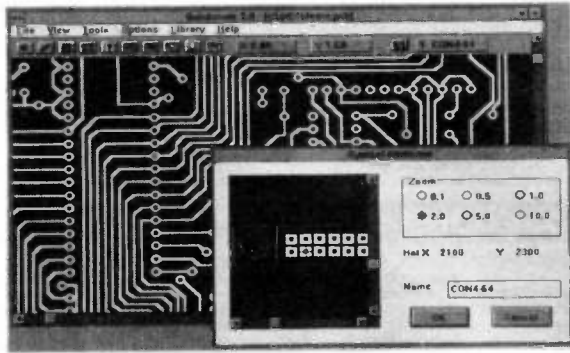

"Quickroute provides a comprehensive and effective introduction to PCB design which is a pleasure to use" **Radio Communication May 1993.**

**Quickroute**



POWERware, Dept EE, 14 Ley Lane, Marple Bridge, Stockport, SK6 5DD, UK.  
Ring us on 061 449 7101 or write, for a full information pack.

Quickroute is available for Windows 3/3.1 in Professional (£99.00) and Standard (£59.00) editions, and for DOS with reduced features (£39.00). All prices inclusive. Add £5 P+P outside UK.

from  
**£39**

# PCB SERVICE

Printed circuit boards for certain EPE constructional projects are available from the PCB Service, see list. These are fabricated in glass fibre, and are fully drilled and roller tinned. All prices include VAT and postage and packing. Add £1 per board for airmail outside of Europe. Remittances should be sent to **The PCB Service, Everyday with Practical Electronics, 6 Church Street, Wimborne, Dorset BH21 1JH.** Cheques should be crossed and made payable to *Everyday with Practical Electronics* (Payment in £ sterling only).

NOTE: While 95% of our boards are now held in stock and are dispatched within seven days of receipt of order, please allow a maximum of 28 days for delivery – overseas readers allow extra if ordered by surface mail.

Back numbers or potostats of articles are available if required – see the Editorial page for details.

*Please check price and availability in the latest issue.*

Boards can only be supplied on a payment with order basis.

**SALE!** All p.c.b.s on THIS page reduced to **1/2 PRICE**

*(Just send half the price shown, while stocks last.)*  
**PCBS ON OPPOSITE PAGE PRICES AS SHOWN**

PROJECT TITLE	Order Code	Cost
Video Guard Alarm <b>FEB '87</b>	556	£3.80
Multi-Chan Remote Light Dim Relay/Decoder	601	£4.86
Power Supply	603	£3.00
Tea Tune Thermostat <b>AUG '88</b>	609	£3.00
Suntan Timer	610	£3.07
Car Alarm	615	£3.12
Eprom Eraser <b>OCT '88</b>	620	£4.07
Doorbell Delay <b>NOV '88</b>	616	£3.56
Sound-to-Light Interface <b>MAR '89</b>	637	£6.24
Midi Pedal	639	£7.00
Midi Merge	640	£3.00
Audio Lead Tester	641	£5.77

PROJECT TITLE	Order Code	Cost
Light Sentinel: Main Board <b>APR '89</b>	632	£9.20
4-Channel Auto-Fader Interface	642	£6.80
Electronic Spirit Level <b>AUG '89</b>	649	£3.85
Distance Recorder	651	£5.23
Power Supplies: Fixed Voltage <b>SEP '89</b>	654	£4.08
Music on Hold <b>OCT '89</b>	646	£3.85
Power Supplies – 25V 700mA	656	£4.35
EE Seismograph – Control board only	658	£4.08
Wash Pro <b>NOV '89</b>	643	£3.83
Logo/lego & Sepctrum Interface	664	£5.60
Biofeedback Signal Generator <b>JAN '90</b>	666	£4.08
Quick Cap Tester <b>FEB '90</b>	668	£3.92
Superhet Receiver/Tuner/Amp <b>MAR '90</b>	679/680	£4.22
Stereo Noise Generator <b>APR '90</b>	681	£4.24
Amstrad Speech Synthesiser <b>MAY '90</b>	689	£4.68
The Tester <b>JUL '90</b>	696	£4.15
Mains Appliance Remote Control Mains ON/OFF Decoder <b>AUG '90</b>	697	£4.55
Hand Tally: Main Bd and Display Bd <b>SEP '90</b>	699, 700	£10.95
Ghost Waker <b>OCT '90</b>	703	£4.32
Frequency Meter	704	£5.25
Freq. Meter/Tachometer <b>NOV '90</b>	705	£3.98
EE Musketeer (TV/Video/Audio Remote Control)	706	£5.78
Microcontroller Light Sequencer <b>DEC '90</b>	708/709	£10.90
Spatial Power Display <b>JAN '91</b>	714	£5.33
Amstrad PCW Sound Generator	715	£5.03
Pocket Tone Dialler <b>MAR '91</b>	729	£4.36
Simple Basic Alarm	731	£4.50
Humidity Tester <b>APR '91</b>	716	£4.97
Model Train Controller (double-sided)	736	£9.75
Digital LCD Thermostat <b>MAY '91</b>		
– Control Board	740	£4.05
– Power Relay Board	741	£3.76
Control and Power Relay Boards together		£5.00



# REPORTING AMATEUR RADIO

**Tony Smith G4FAI**

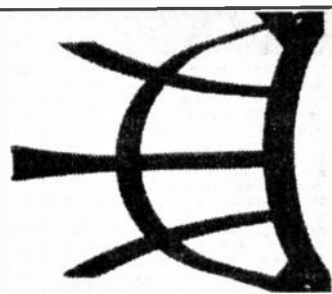

## SURVEY FAVOURS MORSE

At the time of writing (October), the Radio Society of Great Britain had not yet announced the result of its survey among UK radio amateurs on whether they are for or against the idea of a Morse-free HF licence. However, RSGB representatives at the IARU Region 1 Conference in Belgium, in September, reported that the survey has revealed an overwhelming majority in favour of maintaining a Morse code requirement.

This interesting news was disclosed during discussion on a motion from the Austrian national radio society, OVSV, that "This conference maintains its present position concerning the necessity of a Morse code test without technical aids as part of the licence requirements for radio operators under 30MHz."

The motion was carried by 38 votes in favour, with none against, and five abstentions. Surprisingly, the RSGB was among the abstentions and their representatives explained that they were not voting because the survey results had not yet been discussed by their national Council.

The first report on this paradoxical voting pattern appeared in the October issue of *Morsum Magnificat*, the Morse magazine. As the survey result was apparently known before the conference, RSGB members who supported the retention of the Morse test are now questioning why their conference representatives were not given a clear mandate to vote in accordance with the results of the survey.

## CHASING ISLANDS

"Islands on the Air" is among the four top international HF award programmes in amateur radio. It was created nearly 30 years ago by Geoff Watts, a leading UK shortwave listener. The Radio Society of Great Britain took it over in 1958 and it is now managed by an RSGB IOTA Committee.

It is an award programme for radio amateurs and SWLs interested in making, or hearing, contacts with islands and island groups worldwide. Eighteen different awards are available, graded in difficulty, and there is a Plaque of Excellence for supreme achievement.

While being attractive to island "chasers", the programme also offers a challenge to island "activators", those who like to combine radio with travelling, sailing, camping, or mountaineering. Groups, or individuals of this ilk undertake IOTA expeditions to put "rare", sometimes uninhabited, islands on the air, and advance news of their activities is contained in the RSGB's weekly DX News Sheet (DXNS) and other DX bulletins.

Island news can also be heard on the IOTA net at 1300 GMT on 14.260MHz on Saturdays and on 21.260MHz on

Sundays. In fact, these frequencies, together with 28.460 and 28.560MHz are used as the meeting place for island stations at any time.

## IOTA DIRECTORY

The IOTA Directory contains all the rules, and claims to list at least 99.9 per cent of the world's ocean islands appearing on a scale map of 1,000,000: 1. Grouping limits the size of the list, but the 30 or so largest islands in the world all count separately as do all islands recognised as countries for the American DXCC award, and many other single islands which do not fall naturally into wider groupings.

Each qualifying island/group activated since 15th November 1945, for which evidence of contact has been provided, has been allocated an IOTA reference number, and these numbers are often quoted on QSL cards (for example, EU-001, Dodecanese Is). Some 750 islands/groups have reference numbers, and groups which have yet to be activated have been included in the directory without a number as a guide to enterprising activators.

An IOTA convention is held at least once a year where participants can meet each other, discuss their common interests and hear about the adventures and experiences of some of the island expeditions mounted on their behalf. Additionally, an IOTA contest was held in 1993 for the first time, providing an opportunity to work/hear many more islands/groups in one weekend than is normally possible.

## IMPRESSIVE VOLUNTARY EFFORT

The starting off point for newcomers is to get a copy of the IOTA directory, and then work for the IOTA 100 Islands award. This requires proof of contact with, or hearing, at least 100 islands/groups with different reference numbers, including at least one contact with each of the seven continents. Many amateurs and SWLs will find that QSL cards they already have will take them some way towards gaining the first award, thus whetting their appetite to go on to the higher levels.

Much painstaking effort has been involved in producing the rules, the list of islands and the comprehensive criteria needed for island eligibility, also in administering the programme on a continuing basis. This work by members of the IOTA committee, and Country Assistants acting as local IOTA administrators in their own countries, impressively demonstrates the degree of voluntary effort that many radio amateurs are willing to "put back" into their hobby.

The programme is non profit-making, but has to be self-funding to meet administration costs, etc. Charges are therefore made for certificates and di-

rectories. Additionally, UK radio amateurs and SWLs taking part in the programme must be members of the RSGB, but this requirement does not apply to participants from other countries.

The IOTA directory, printed or on computer disk (disk provided), costs £6.00, US\$10 or 15 IRCs (£7.00, US\$12 or 18 IRCs outside Europe). It can be obtained from the RSGB IOTA Director, Roger Balister G3KMA, La Quinta, Mimbridge, Chobham, Woking, Surrey GU24 8AR. Send a self-addressed adhesive label and make cheques (sterling only) payable to R. Balister. The Directory is also available in foreign language versions in French, German, German Braille, Italian, Polish, Portuguese and Spanish, with one or two more translations pending.

If you become addicted to IOTA (which does happen!), you will then want to have the DX News Sheet which is a "must" for all serious DX operators, involved in IOTA or not. Write for details to the RSGB, Lambda House, Cranborne Road, Potters Bar, Herts EN6 3JE.

## YOUNG AMATEUR AWARD

The Young Amateur of the Year Award 1993 has gone to 15-year old Tim Munn G7OTO/2E1AMX, from Ventnor, Isle of Wight. Organised by the Radiocommunications Agency, in conjunction with the Radio Society of Great Britain, this award aims to increase interest in, and introduce more young people to, amateur radio. This, says the RA, reflects the recognition of both the Agency and the Government that amateur radio is an excellent training ground for the future supply of electronics and communications engineers.

Tim became interested in the hobby when he was 10, and now runs a radio club at Sandown High School. He is one of the youngest Novice Instructors in the UK and recently his first three pupils all passed the Novice Radio Amateur Examination (NRAE).

He has constructed many items of home-made equipment, including an 80m receiver and a 50MHz transmitter/receiver, and is converting a Storno radio telephone to 2m operation. He received £250, a certificate signed by the President of the Board of Trade, a visit to the RA's Radio Monitoring Centre at Baldock, and other prizes.

Close runner-up was Simon Kahn, aged 14, GOSTU/2E1AAB, of Salford, Lancs, who passed his Radio Amateur's Examination at the age of 11, subsequently passed the NRAE, and on his 14th birthday obtained his full licence. He is heavily involved with the Bury Radio Society, edits the society's magazine *Feedback* and, like Tim, is also an Instructor for other youngsters in the Novice Licence scheme. He too received a number of prizes and an invitation to visit Baldock.



## N. R. BARDWELL LTD (EPE)

200	Signal diodes 1N4148.....	£1.00	200	Printed circuit board 20mm fuse clips.....	£1.00
75	Rectifier Diodes 1N4001.....	£1.00	200	Ass'd. disc ceramic capacitors.....	£1.00
50	Rectifier Diodes 1N4007.....	£1.00	80	Ass'd. capacitors 1nf to 1uf.....	£1.00
56	Rectifier Diodes 1N5401.....	£1.00	80	Ass'd. electrolytic capacitors.....	£1.00
100	Ass'd. Zeners.....	£1.00	80	1UF 16V Radial electrolytics.....	£1.00
10	NE555 Timer ICs.....	£1.00	80	4.7UF 16V Radial electrolytics.....	£1.00
30	BC478 Transistors.....	£1.00	75	4.7UF 63V Radial electrolytics.....	£1.00
8	8F51 Transistors.....	£1.00	80	10UF 16V Radial electrolytics.....	£1.00
20	2N3904 Transistors.....	£1.00	50	10UF 50V Radial electrolytics.....	£1.00
30	MPSA42 Transistors.....	£1.00	40	22UF 25V Radial electrolytics.....	£1.00
30	5mm red l.e.d.s.....	£1.00	60	33UF 16V Radial electrolytics.....	£1.00
25	Ass'd. high brightness l.e.d.s.....	£1.00	80	100UF 10V Radial electrolytics.....	£1.00
24	Miniature red l.e.d.s 3mm dia.....	£1.00	50	220UF 16V Radial electrolytics.....	£1.00
50	Axial l.e.d.s (Diode package) wide angle l.e.d.s.....	£1.00	60	470UF 10V Radial electrolytics.....	£1.00
12	Ass'd. seven segment displays.....	£1.00	40	1000UF 10V Axial electrolytics.....	£1.00
30	Ass'd. IF transformers.....	£1.00	1	12 1000UF 25V Axial electrolytics.....	£1.00
48	Ass'd. coil formers.....	£1.00	1	1 Farad 5.5V memory back up capacitor.....	£1.00
100	Ass'd. RF chokes (inductors).....	£1.00	100	4N7 Mini Axial capacitors.....	60p
30	Ass'd. connectors edge-dill-sil etc.....	£1.00	1	10 watt Stereo amplifier, 4 controls plus data.....	£2.95
10	4P 3W MBB min. rotary switches.....	£1.00			
20	1 Inch Glass red switches.....	£1.00			
20	Magnetic ear pips plus lead & plug.....	£1.00			
20	Min SP/CO slide switches.....	£1.00			
30	Ass'd. d.i.l. sockets up to 40 pin.....	£1.00			
20	24-way turned pin IC sockets.....	£1.00			
16	40 pin d.i.l. wire wrap IC sockets.....	£1.00			
2	ORP12 light dependant resistors.....	£1.00			

Prices include VAT, postage £1.25, Stamp for Lists  
288 Abbeydale Road, Sheffield S7 1FL  
Phone (0742) 552886 Fax (0742) 500689

## ELECTRONIC DESIGNER TOOLKITS SHAREWARE FROM \*£2.49 A DISC

Filter20, CCI Analysis, DCCAD PCB Design, and Utils  
Previously sold at over £100.00. Try these professional aids for only £19.95  
These fully featured packages offer easy to use facilities for beginner and expert alike. Design Butterworth, Chebyshev, Elliptical, Bessel filters at the touch of a key. CCICAP analyses circuits with R,C,I, and FETs, BJTs, op-amps. DCCAD designs schematics and PCB layouts for double sided boards. Utils minimise logic circuits and provide electronic calculators. E1: 8 360K discs all the above for £19.95 E2: Filters and Circuit analysis 4 360K discs £9.95. E3 Electronic calculators and Utils only £4.95. Please state disc size when ordering. Charges relate solely to admin. See our FREE CATALOGUE for registration details, regular use.

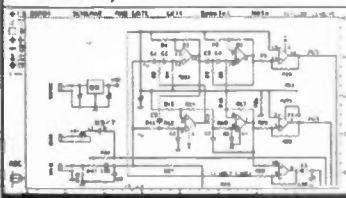

The Shareware Concept  
Shareware is often known as 'Try before you buy software'. You can try out many packages and register only the ones you want to use. The registration fee brings various benefits which are listed in the registration documentation in the package. These may include manuals, the latest version and support. Buy with confidence as we are an ASP Approved outlet.



Approved Vendor

S&N Enterprises Tel: 0252 510486  
Mail Order: 5 Polden Close, Farnborough, Hants GU14 9HN

## CAMBRIDGE COMPUTER SCIENCE LIMITED

Borland C++ 2.0 for DOS & Windows complete with mouse.....	£45.00
LCD modules..... 16 char by 1: £4.00, 20 char by 2: £6.00, 40 char by 1: £8.00	
3.5" 720K Diskette Drives.....	£25.00 each
Used hard disk drives, 112MByte £110, 70MByte £75, 40MByte £45	
20MByte £29, 10MByte £14, Limited quantities, phone before ordering	
Used PC memory/IO card AST six pack with 384K RAM.....	£15.00 each
Used IBM PC hard disk controller, 8 bit MFM.....	£5.00 each
Used Tseng labs, multi I/O + mono video card for PCs.....	£10.00 each
Used Compaq Enhanced Colour Graphics Card.....	£5.00 each
'Lucky Dip' PC cards, untested, no warranty, various types.....	£1.00 each
5.25" Disk Drives, 1.2MByte Slimline PC.....	£19.00 each
5.25" Disk Drives, 80 Tk, DSDD.....	£19.00 each
5.25" Disk Drives, 80 Tk, DSDD Used, No Wty.....	£7.00 each
(The £7.00 drives are sold on a strictly "as is" basis)	
5.25" Disks, DSDD, 48tpi, boxes of 10.....	£2.00/box
Digital multimeter, 14 ranges, inc. leads & manual.....	£9.00 each
Apricot Disk drive PSU 5V @ 2.5A, 12V @ 2A.....	£10.00 each
5V @ 6A PSU.....	£4.00 each
5V @ 10A PSU.....	£5.00 each
Disk Drive Data lead BBC Micro to Disk Drives.....	Single 2.00 Dual £4.00 each
Disk Drive Power lead BBC Micro to Disk Drives.....	Single 2.00 Dual £4.00 each
68000 CPUs 8MHz.....	£2.50 each
8086 CPU chips.....	£2.00 each
Z80A CPU, CTC, PIO.....	£1.20 each; DMA £2.00; £4.50 all 4
74LS TTL, pick and mix, buy 10 or more for.....	£0.12 each
Types available: '00' '02' '04' '08' '10' '11' '12' '13' '14' '15' '20' '21' '26' '27' '30' '32' '33' '37' '38' '42' '74' '83' '85' '86' '96' '107' '109' '122' '125' '132' '136' '138' '139' '145' '151' '153' '157' '158' '160' '162' '163' '164' '165' '174' '191' '193' '240' '253' '257' '260' '298' '353' '365' '366' '373' '385' '390' '399' '670' '682'	
27128 EPROMS (Ex equipment).....	£1.20 each or £5.00/5
27128 EPROMS.....	£2.50 each
27256 EPROMS (Ex Equipment).....	£1.50 each
27256 EPROMS.....	£2.60 each
27256-25 EPROMS.....	£3.50 each
27C512 EPROMS (Ex Equipment).....	£1.40 each
256K DRAM (Ex Equipment).....	£0.40 each
1MBit '10' DRAM (Ex Equipment).....	£1.40 each
6116 2K Byte SRAM.....	£1.10 each
6264-12 8K Byte SRAM.....	£3.80 each
62256-10 32K Byte SRAM.....	£5.00 each
65256 32K Byte RAMs.....	£4.00 each
8K Byte NV ram chips.....	£3.00 each or £10.00 four
16, 18 & 20 pin dill low profile IC sockets 0.3" wide.....	£0.40/10; £3.00/100
22 & 24 pin dill low profile IC sockets 0.4" wide.....	£0.40/10; £3.00/100
24, 28, 32, 40 & 48 pin dill low profile IC sockets 0.6" wide.....	£0.40/10; £3.00/100
Circuit tester, finds faults in TTL & CMOS logic circuits, inc leads.....	£6.00 each
Metal project boxes drilled & painted but unused 28 x 32.5 x 5cm.....	£4.00 each
Eurocard Racks.....	£10.00 each
Smoke detectors.....	£4.00 each
Used computer cards many useful components (large ones socketed)	
Wini controller (WD HDC chip).....	£1.00 each
CPU card (8088, Z80 & EPROMS).....	£3.00 each
Keyboards, full Qwerty, number pad and LCD.....	£8.00 each
Desktop computer case with 200W mains PSU (used).....	£19.00 each
Used IBM PC Cases with PSU.....	£30.00 each

Prices include postage. Add £1 (plus VAT) to orders below £5.00. All items new unless stated.  
Include 17.5% VAT to all prices. Send an SAE for our latest list or for more info.  
Dept EE, 374 Milton Road, Cambridge CB4 1SU  
Tel: 0223 424602, 0831 430496 or 0831 430552 (Mail order only)



# DELICIA

## THE TRANSMITTER PEOPLE

**4 WATT PPO FM BROADCAST (Built) TRANSMITTER:** with Low Pass Filter Modulation ..... 75KHz Wide Band Range ..... up to 4.2 miles Supply ..... 10-16 Volts AC/DC Current ..... 250mA Audio Input ..... 100mV (ADJ) Frequency range ..... 88-108MHz FM Stability ..... ± 20KHz Size ..... W. 70mm, D. 90mm, H. 50mm. **MANY USER CONTROLS ..... Price: £23.50**

**7 WATT PPO FM BROADCAST (Built) TRANSMITTER:** Higher Watt Version of above Transmitter..... **Price: £52.50**

**KIT: 3 WATT TRANSMITTER 80-108MHZ**  
Coil Tank Controlled up to 3 miles range.  
Supply 12V dc at 0.5 amps.

**ALL PRICES INCLUDE VAT PLEASE ADD £1 P&P PAYMENT WITH ORDERS TO:**  
**DELICIA ELECTRONICS,**  
14 ST. MERYL PARK, GLEN ROAD,  
BELFAST, BT11 8FY. **24 Hour Turn Around**

Inverter toroidal transformers 225VA 10-5-0-10-5V primary 0.250-285V secondary.....	£29.95	DC-DC converter, Reliability model, V12PS, 12V in 5V 200mA out, 300V input to output isolation, with data.....	£4.95 each or pack of 10 - £39.50
LEOs 3mm or 5mm red or green 6p each, yellow 11p each. High intensity red, green or yellow, 5mm 30p each.....		Hour counter used 7 digit 240V a.c. 50Hz.....	£1.45
Cable Ties 1p each. £5.95 per 1000. £49.50 per 10,000.....		QWERTY keyboard, 68 key good quality switches.....	£5.00
Small stepping motor 4-phase 12V 7.5' step 50 ohms.....	£8.95	Alipax AB2903-C large stepping motor 14V 7.5' step 27 ohm, 68mm dia. body, 6.3mm shaft.....	£8.95 or £200.00 for a box of 30
SAA1027 stepping motor driver chip.....	£4.95	Polyester capacitors, box type, 22.5mm lead pitch 0.9uF 250V d.c. 20p each, 14p 100+, 9p 1000+ 1uF 250V d.c. 18p each, 15p 100+, 10p 1000+ 2.2uF 250V d.c. 30p each, 20p 100+, 15p 1000+ 3.3uF 100V d.c. 30p each, 20p 100+, 15p 1000+ 1uF 50V bipolar electrolytic axial leads, 15p each, 7.5p 1000+	
High quality photo resist copper clad epoxy glass boards		0-22uF 250V polyester axial leads, 15p each, 100+ & 7.5p each	
Dimensions single-sided double-sided		Philips 123 series solid aluminium axial leads, 33uF 10V & 2.2uF 40V 40p each, 25p 100+ & Philips 108 series 22uF 63V axial	
3x4 inches £0.95	£1.07	30p each, 15p 1000+	
4x8 inches £2.40	£2.68	Multilayer AVX ceramic capacitors, all 5mm pitch, 100V 100pF, 150pF, 220pF, 0.0000F (10m) 10p each, 5p 100+, 3.5p 1000+	
6x12 inches £5.37	-	500pF compression trimmer.....	60p
12x12 inches £10.66	-	40uF 370V a.c. motor start capacitor (dielectric type containing no p.c.b.a.).....	£5.95 or £49.50 for 10
<b>RECHARGEABLE BATTERIES</b>		Welwyn W23 9W 120 ohm 35p each, 20p 100+ & 680 ohm 2W metal film resistor.....	4p 1000+, 2p 1000+ & 100+ & 7.5p each
AA (HP7) 500mAh.....	£0.99	Solid carbon resistors, very low inductance, ideal for r.f. circuits, 27ohm 2W, 68ohm 2W 25p each, 15p each 100+	
AA 700mAh.....	£0.95	we have a range of 0.25W, 0.5W, 1W and 2W solid carbon resistors - please send SAE for list	
C 2AH with solder tags.....	£3.60	Intelligent 4-digit alphanumeric (5x7 dot 0-145") red LED display, 12 pin 0.6 inch wide package, Siemens type DLR1 414 £2.50 each, £2.00 30+, data sheets £1.00	
D 4AH with solder tags.....	£4.95	AND 27256-3 EPROMS £2.00 each, £1.25 100+ D11 switch 3PCO 12 pin (EGC SDC-3-023) 60p each, 40p 100+	
1/2AA with solder tags.....	£1.55	Disk Drive Boxes for a 5.25 disk drive, with room for a power supply, light-grey plastic 67mm x 268mm x 247mm.....	£7.95 or £49.50 for 10
AAA (HP16) 180mAh.....	£1.75	Handheld Ultrasonic remote control.....	£3.95
AA 500mAh with solder tags.....	£1.55	CV2486 gate 30y 30mm x 10mm dia. with 3 wire terminals, will also work as a neon light.....	20p each, £7.50 per 100
C (HP11) 1.8Ah.....	£2.20	A23 1.2V battery for car alarms or lighters.....	75p each, £50 100+
D (HP2) 1.2Ah.....	£2.60		
PP3 8.4V 110mAh.....	£4.95		
Sub C with solder tags.....	£2.50		
1/3 AA with tags (Philips CTV).....	£1.95		
Standard charger, charges 4 AA cells in 5 hours or 4Cs or 4Ds in 12 to 14 hours + 1x PP3 (1.2, 3 or 4 cells may be charged at a time).....	£5.95		
High power charger, as above but charges the Cs and Ds in 5 hours; AAs, Cs and Ds must be charged in twos or fours.....	£10.95		
<b>SPECIAL OFFERS - PLEASE CHECK FOR AVAILABILITY</b>			
F cells 32dis. x 87mm.....	£3.95		
F cell with solder tags 1-2V.....	£4.30		
42mm x 16mm dia. 1.2V.....	£1.45		
Stick of 4 171mm x 16mm dia., with red and black leads 4.8V.....	£5.95		
4 cell battery 94mm x 25mm dia. (1/2C cells).....	£3.50		
Computer grade capacitors with screw terminals.....			
3800uF 20V £2.50; 8700uF 10V £1.95;			
6800uF 15V £2.95; 1000uF 16V £1.50;			
5800uF 90V £4.95			
7-segment common anode l.e.d. display, 12mm.....	£0.45		
LM2931AT 5.0 low drop out 5V regulator TO220 package.....	£0.85		
7812 and 7812 12V 1A regulators.....	£20.00 per 100		
LM337K TO3 case variable regulator.....	£1.80 100+ £1.10 each		
GeAs F.E.T. low leakage current 88873 £12.95 each, £9.95 10+; £7.95 100+			
BS250 p-channel MOSFET.....	45p		
BC558 transistor.....	£3.95 per 100		
74LS05 Hex Inverter.....	£10.00 per 100		
Used 8748 Microcontroller.....	£3.50		
LSB52 UHF Limiting amplifier, LC 16 surface mounting package with data sheet.....	£1.95		
AM27502.....	£1.25 each; 90p 100+		
CD4007UB.....	10p 100+, 6p 1000+		
Sinclair light gun terminated with a jack plug and PP3 clip gives a signal when pointed at 50Hz flickering light, with output waveform chart.....	£3.95		

**JPG ELECTRONICS**  
276-278 Chatsworth Road  
Chesterfield S40 2BH  
Access Visa Orders:  
(0246) 211202  
Cullers welcome

# EVERYDAY WITH PRACTICAL ELECTRONICS

CLASSIFIED

Everyday with Practical Electronics reaches twice as many UK readers as any other independent monthly hobby electronics magazine, our audited sales figures prove it. We have been the leading independent monthly magazine in this market for the last nine years

If you want your advertisements to be seen by the largest readership at the most economical price our classified and semi-display pages offer the best value. The prepaid rate for semi-display space is £8 (+VAT) per single column centimetre (minimum 2.5cm). The prepaid rate for classified adverts is 30p (+VAT) per word (minimum 12 words).

All cheques, postal orders, etc., to be made payable to Everyday with Practical Electronics. VAT must be added. Advertisements, together with remittance, should be sent to Advertisements, Everyday with Practical Electronics, Holland Wood House, Church Lane, Great Holland, Essex CO13 0JS. Phone/Fax (0255) 850596.

For rates and information on display and classified advertising please contact our Advertisement Manager, Peter Mew as above.

**PC TECHNICAL SHAREWARE**  
 Would you like to see the best range of low cost technical and scientific public domain & shareware for IBM PC in the UK?  
**HUGE RANGE** includes: - PACKET, FAX, RT, TX control, PCB design, Circuit and ANTENNA analysis, QSO logging, CAD ELECTRONIC & MECH engineering, SCIENTIFIC, MATHS & STATS, MEDICAL, PROGRAMMING, SOURCE CODE, DATA, EDUCATIONAL, WINDOWS, BUSINESS and lots more  
 Write, phone or fax today for your free 124 page printed catalogue

*The Public Domain Software Library*  
 Winscombe House, Beacon Road  
 Crowborough, Sussex TN6 1UL  
 Tel 0892 663296, Fax 0892 667473

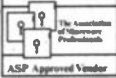

**RCS VARIABLE VOLTAGE D.C. BENCH POWER SUPPLY**  
 1 to 24 volts up to 1/2 amp, 1 to 20 volts up to 1 amp, 1 to 16 volts up to 1 1/2 amps d.c. Fully stabilised. Twin panel meters for instant voltage and current readings. Overload protection  
 Fully variable. Operates from 240V a.c. Compact unit. Size 9 x 5 1/2 x 3 in.  
**NEW MODEL.** Up to 38volts d.c. at 6 amps 10 amps peak. Fully variable Twin panel meters. Size 14 1/2 x 11 x 4 1/2 in. £96 inc VAT. Carr £6.



**£45 inc. VAT**  
 + Post and insurance £4

**RADIO COMPONENT SPECIALISTS**  
 337 WHITEHORSE ROAD, CROYDON  
 SURREY, U.K. Tel: 081-6841665

List, Large SAE. Delivery 7 days. Callers welcome. Closed Wednesday

**BREADBOARDS**  
 Camboard Breadboard enables circuits to be constructed in a theory layout, no soldering is required and components are re-usable.



**£7.95 inc. vat. + £2.50 p&p.**

Camboard P.O. Box 416 Cambridge CB3 7YS.  
 Tel. Cambridge (0223) 264512.

**BTEC ELECTRONICS TECHNICIAN FULL-TIME TRAINING**

THOSE ELIGIBLE CAN APPLY FOR E.T. GRANT SUPPORT AN EQUAL OPPORTUNITIES PROGRAMME

O.N.C., O.N.D. and H.N.C.

Next course commences  
**Monday 10th January 1994**  
 FULL PROSPECTUS FROM

**LONDON ELECTRONICS COLLEGE**  
 (Dept EPE) 20 PENYWERN ROAD  
 EARLS COURT, LONDON SW5 9SU  
 TEL: 071-373 8721

**NEWMARKET TRANSFORMERS LTD**  
 Mail Order Transformer Specialists.  
 Toroidal and Laminated Transformers, 3VA to 1kVA.  
 Fast delivery. Competitive prices. Quality guaranteed.  
 Phone: Michael Doman  
 on 0638 662989 for Immediate Quote

**MAIL ORDER**  
 Extensive range of over 40,000 items including:- Electronic components, tools, computer hard/software and office equipment, all at very competitive prices. Please send two first class stamps with specific requirements for relevant price lists to:-  
**LB International, 76 Knighton Road, Leicester LE2 3HJ.**

**DETRONICS ORDINARY BATTERY CHARGERS**  
 Dead, dead batteries. NiCads too expensive? Huge business opportunity. Buy or sell our revolutionary ordinary battery chargers. Think green. Recharge ordinary batteries for models, radios, gameboys, eleven types available. Price £15.  
**To Order Telephone 0206 369226**

**SURVEILLANCE KITS**  
 MICRO TRANSMITTER, tuneable 70-115MHz, 500M range, 40mm x 20mm including microphone, 3-12V. Kit £5.95, Assembled £9.95. Order Code KT1.  
 TELEPHONE TRANSMITTER, 30mm x 10mm, powered from line, transmits both sides of conversation, 500M range, 88-130MHz. Kit £7.95, Assembled £12.95. Order Code KT3.  
 3 WATT TRANSMITTER, 80-110MHz, 12-15V, adjustable input sensitivity, varicap controlled, several miles range, Kit £15.95, Assembled £25.95. Order Code KT4.  
 All prices include p&p  
 Credit card orders telephone 021 486 3092.  
 Send 2x1st class stamps for Catalogue. Cheques/P.O.s payable to:  
**C.E.C.**  
 (Dept. EPE), 515A Bristol Road, Birmingham B29 6AU

**Barker GS10**  
 Revolutionary microprocessor controlled intruder deterrent

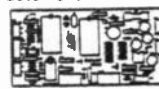

Adaptive multi-sample algorithm with barka and growls gives one of the most realistic effects currently on the market. Includes on board amp. Easy to fit a speaker cabinet. Runs from a plug top mains adaptor.  
 Just send your address along with 4 first class stamps for a demo tape.  
 Available assembled or in kit form from £28.95 + P&P £1.80 - Cheques to:  
 D. Hirst, 176 Lister Avenue, Bradford, W. Yorks BD4 7QU

**THE BRITISH AMATEUR ELECTRONICS CLUB**  
 exists to help electronics enthusiasts by personal contact and through a quarterly Newsletter.  
 For membership details, write to the Secretary  
**Mr. J. F. Davies, 70 Ash Road, Cuddington, Northwich, Cheshire CW8 2PB.**  
 Space donated by Everyday with Practical Electronics

**Miscellaneous**

**PROTOTYPE PRINTED CIRCUIT BOARDS**  
 one offs and quantities, for details send s.a.e. to B. M. Ansbro, 38 Poynings Drive, Sussex BN3 8GR, or phone Brighton 883871.  
 PLDs and EPROMS copied or programmed. We supply logic devices/convert discrete logic to PLDs. Also PCBs designed. Send for details to PO Box 1561 Bath, or phone 0225-444467.  
**G.C.S.E. ELECTRONICS KITS**, at pocket money prices. S.A.E. for FREE catalogue. SIR-KIT Electronics, 70 Oxford Road, Clacton, CO15 3TE.  
**TO CLEAR.** Hundreds of resistors, capacitors, semiconductors, i.c. sockets, plastics boxes etc. Retail value over £100. Only £19.95. Joe Karajos, 42 West Parade, Peterborough, PE3 6BD.  
**MINI FM TRANSMITTER**, ready built on p.c.b. with sensitive microphone, approx. 100 yards range, runs for weeks on 2 AA batteries. £4.50 including postage. Livewireless, 25 Halsall Road, Birkdale, Southport, Lancs. Mail order only please.  
**DIY PLANS**, catalogue of over 20 plans plus books and manuals including portable generators, wind generators, inverters, electric bike, welding generators, solar and water projects. Send 2 x 1st class stamps. Jemmett Engineering, 8 Hallam Gardens, Pinner, Middlesex HA5 4PR.  
**MINIATURE TRANSMITTER.** One of the most powerful devices available for its compact size and low price. Just 20x25mm, it discreetly transmits voices/sounds to standard VHF/FM radio. Full instructions provided. SPECIAL JANUARY OFFER: Only £7.95 assembled; kit £4.50. Cheques/PO's to Excel Products, (E.P.E.), Unit 14, Sunningdale, Bishop's Stortford, Herts CM23 2PA.  
**INTERESTED IN** using a Microcontroller in your next project? Computer Kit and software available from £32. Phone 0642 480620 for details and free advice.  
**PC SCOPE.** 4 channels, ± trigger, variable timebase, frequency and milliseconds readout. Easy connection to Printer Port (N.B. will not display A.C. waveforms), software and instructions, £10.00. I Judd, 5 Springhill House, Nailsworth, Gloucestershire GL6 0LT or Tel. 0453 835692 for info.  
**COMPONENT CLEAROUT!** Send £1.25 (coins/stamps) to, Carl Redfern, 30 Dingle Close, Dudley, West Midlands DY2 8AG.

**EVERYDAY WITH PRACTICAL ELECTRONICS**

**SUBSCRIPTION ORDER FORM**

Annual subscription rates (1994):  
**UK £22.00. Overseas £28 (surface mail). £45.50 (airmail)**

To:  
**Everyday with Practical Electronics, 6 Church Street, Wimborne, Dorset BH21 1JH**

Name .....

Address .....

I enclose payment of £.....  
 (cheque/PO in £ sterling only, payable to Everyday with Practical Electronics). Alternatively send Access or Visa number and card expiry date.

Signature .....

Please supply name and address of card-holder if different from the subscription address shown above. Subscriptions can only start with the next available issue. For back numbers see the Editorial page.

M1/94

# SECURITY EQUIPMENT

**COMPLETE SYSTEMS FROM ONLY £63.95**

Complete range of security parts to protect your house and property. Passive infra-red sensors ultra-sonic movement detectors, control panels, cable, etc etc supplied with instructions.

## QUALITY AUDIO MODULES

Power amplifiers from 10-125W, mixer units, pre-amplifiers etc. Build your own disco units, guitar amps, public address systems etc., etc.

CALL FOR **FREE LITERATURE** TODAY

**AUTONA LTD** TEL 0844 346386  
51 POPPY ROAD, PRINCES RISBOROUGH, BUCKS. HP27 9DB

VISA



# Cooke International

SUPPLIER OF QUALITY USED TEST INSTRUMENTS

ANALYSERS, BRIDGES, CALIBRATORS, VOLTMETERS, GENERATORS, OSCILLOSCOPES, POWER METERS, ETC. ALWAYS AVAILABLE

ORIGINAL SERVICE MANUALS FOR SALE  
COPY SERVICE ALSO AVAILABLE

EXPORT, TRADE AND U.K. ENQUIRIES WELCOME  
SEND S.A.E. FOR LISTS OF EQUIPMENT AND MANUALS  
ALL PRICES EXCLUDE VAT AND CARRIAGE  
DISCOUNT FOR BULK ORDERS SHIPPING ARRANGED

REPAIRS & CALIBRATION UNDERTAKEN

OPEN MONDAY TO FRIDAY 9AM-5PM

Unit Four, Fordingbridge Site, Main Road, Barnham, Bognor Regis,  
West Sussex, PO22 0EB

Tel (+ 44) 0243 545111/2 Fax (+ 44) 0243 542457  
HIGH END EQUIPMENT PURCHASED

# SERVICE MANUALS

We have what is probably the largest range of Service Information available anywhere.

From the Earliest Valve Wireless to the Latest Video Recorders. Colour Televisions, Test Gear, Audio, Computers, Amateur Radio in fact practically anything.

Originals or Photostats as available.

Also available. Our FREE catalogue detailing Hundreds of Technical Books and Repair Guides available.

Send 2 x 1st class stamps for your copy TODAY.

**Mauritron Technical Services (EPE),**  
47A High Street,  
Chinnor,  
Oxfordshire,  
OX9 4DJ.

Tel: 0844 351694. Fax: 0844 352554.



## COMPONENTS

For TV ★ Video  
Audio ★ Computer

### VIDEO SPARES

We can supply Pinch Rollers, Idlers, Belt Kits, Heads & many other Service & Specific parts for over 100 makes.

### TV - SATELLITE AUDIO SPARES

Switches, Transformers, Semiconductor, etc., etc. Large range available.

### EQUIPMENT MANUALS

Large selection of Manufacturers Service & User information available. Original manuals supplied if possible.

### SEMICONDUCTORS

We can supply thousands of different Custom & Industry Standard devices.

BU608A	£1.50	TDA4607	£3.25
BUV48A	£4.90	UC3884	£8.95
LM733CN	£2.43	UM6822	£8.95
MA8004RH	£5.17	UPC137BH	£2.82
P8255A	£2.85	UPC1397C	£4.34
STK4141H	£8.75	2SK301R	£1.85
TA7280P	£8.85	27C256-200	£2.95

Order by Post or Phone. VISA, ACCESS, DELTA & SWITCH accepted with pleasure. Minimum P&P charge is £1.25 - Please then add extra 50p if ordering a Manual or LOPTx. All items subject to availability. Prices can change without notice.



MARAPET (EEA)  
1 HORNBEAM MEWS  
GLOUCESTER GL2 0UE

WE CAN SUPPLY A VAST RANGE OF SPARES for many makes of TV, Video, Computer & Audio Equipment. WRITE (Encl. s.a.e. please) or PHONE FOR A PRICE & AVAILABILITY on your requirements.

0452 526883

### COMPUTER SPARES

#### PHILIPS MONITORS

BM7513 Serv. Manual	£3.49
CM8533 Serv. Manual	£7.84
CM8533 Line O/P Tx	£2.94
CM8073 O/O Switch	£8.63
CM11342 Line O/P Tx	£26.51

#### AMSTRAD

CPC464 User Manual	£10.95
PC1640 Serv. Manual	£19.32
PCW 8512 Serv. Manual	£14.99
AY38012	£7.95
SED0420CAC	£14.95

#### FLYBACK TRANSFORMERS

DIGITAL VT320	£29.05
IBM 8512 (State type)	£49.93

We can supply over 300 types of L.O.P.T.s. Please enquire with info. taken from part.

We only show a small sample of our range. Batteries, Leads, ribbons also stocked.

#### SPECIAL OFFER

Sinclair Atari  
 Commodore CHIPS

40054 ROM (+2)	£11.66
TMS4632NL4 DRAM	£9.99
ZX8302 LULA (GL)	£8.49
ZX8401 LULA (Spec.)	£5.44
CO25913 DMA (ST)	£32.99
Keyboard CPU (ST)	£23.50
PC713V (STE-P8U)	£2.80
PC900V/H11L3 (ST)	£2.78
6559 VIC (C64)	£19.95
6555 VIC (C64C)	£18.85
MB81416-12 DRAM (C16)	£4.40

#### COMMODORE

C64/64C Serv. Manual	£14.99
C64C User Manual	£4.40
908114-01 PLA (C64)	£3.90
8372B (A3000)	£44.19

# XMAS SMARTS

Why don't you drop us a post card to receive your free copy of the Christmas issue of our Getting Started in Home Automation leaflet plus our current catalogue of exciting home automation components.

October draw winner R C Mort of Leeds

Discover a remarkable range of home automation components

**Smart House Systems Ltd**

3 Buchanan Street, Largs, Ayrshire KA30 8PP

Tel: 0475 672589

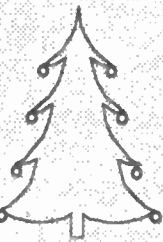

- Metal detector boards with Data has tuner, mode, discriminate, headphone jack, on/off volume & push button facilities..... £7.95 ea\*
- 35mm Camera returns with auto flash, wind on etc..... £6 ea or 2 for £10
- Dictaphone cassette, mech/record erase playback heads, 6V solenoid, motor, half effect switch..... £2.00 ea\*
- Dot matrix LCD 10x2 lines..... £3.75 ea\*
- 40 characters x 1 line dot matrix LCD with data..... £6.95\*
- 2 digit 16 segment VF display with data..... £2.95 ea\*
- 17 segment V.F. display with driver board and data..... £2.99 ea\*
- 8 digit liquid crystal display..... £1.75 ea\*
- 4 digit LCD with 7211 driver chip..... £3.50 ea\*
- Digital clock display..... £2.50
- 19" 3U sub rack enclosures..... £8.95
- 12V stepper motor, 48 steps per rev, 7.3° step angle..... £3.95 ea\*
- Stepper motor board with 2 slotted opto + 2 mercury tilt switches..... £3.95 ea\*
- 1000 mixed 1/4 watt 1% resistors..... £4.95 ea\*
- 250 electrolytic axial + radial caps..... £4.95 ea\*
- 200 off mixed polyester caps..... £7.95\*
- 100 Mixed trimmer caps popular values..... £4.95\*
- 100 off Phono plugs (red/black/gray)..... £3.50\*
- 50 Mixed terminal blocks..... £2.95
- 25 off asst. buzzers & sounders..... £4.95
- Cable box UHF modulator/video preamp/transformer/R's + C's/leads..... £6.95
- 1000 off mixed Multilayer Ceramic Caps..... £7.95
- SM P.S.U. 115-240V input + 5V 5-5A + 12V 1-5A - 12V 0-3A - 5V 0-3A with IEC inlet and outlet, fully cased..... £6.95 ea\*
- UM1233 Video Modulators..... £3.50 ea\*
- Universal bell timer, both 10 min. delay and 20 min. cut off functions..... £4.95
- Spectrum 128k + 2 PSU's..... £6.95
- STC P.S.U. 240V input 5V 6A output (converts to 12V 3A details available)..... £5.95 ea\*
- 3 to 16V Piezoelectric sounders..... 50p\*
- DIL switches PCB MT 3/4/6 way..... 35p\*
- 5V SPCO SIL reed relay..... 40p\*
- 5V 2PCO DIL miniature relay..... 60p\*

- 12V 2PCO or 4PCO continental relay..... 60p\*
- 12V 10A PCB MT (to make contact) relay..... 85p\*
- 3 to 12V electro magnetic acoustic transducer with data..... 75p\*
- 2.4576/8.8329/21.10 MHz crystals..... 50p ea\*
- 31b Mixed components pack..... £4.95
- 25 off mixed relays..... £5.95
- 40 off mixed toggle switches..... £9.95
- 50 off mixed switches, toggle, rocker, slide, micro..... £9.95
- 250 off 16/22/24/40 way IC Sks..... £4.95
- Crystal Oscillators 10/24/48 MHz..... £1 ea\*

### TOOLS

- 40 pce socket set..... £7.95
- 16 pce socket set..... £3.50
- Hand Rivet Gun..... £6.95
- Crimping tool..... £2.95\*
- Safety goggles..... £1.50\*
- Baby bench vice..... £4.95
- 3m retractable tape..... £2.50
- 5 pce wood carving set..... £2.50
- 6 utility knife..... £1.95
- 25 pce allen key set..... £3.95\*
- 7 pce powerbit set..... £2.50\*
- Conerclamps..... £2.50
- 4 adj wrench..... £1.50
- 6 adj wrench..... £1.50
- 8 adj wrench..... £2.50
- 21 pce mini precision wrench crosspoint hex screwdriver set..... £5.95\*
- Universal test lead kit..... £3.95\*
- 10 crocodile clip leads..... £3.50
- 10 AA rechargeable ni-cads..... £7.50
- Glue gun glue sticks 36..... £4.50\*

### QUANTITY DISCOUNTS AVAILABLE PLEASE RING

We also buy all forms of electronic components, p.s.u.'s, disk drives etc. Lists to below address.

ALL PRICES INCLUDE V.A.T. PLEASE ADD £2.00 p&p EXCEPT ITEMS MARKED \* WHICH ARE 50P. SAE FOR BULK BUYING LIST PAYMENT WITH ORDER TO:

**Dept EE, COMPELEC,**  
14 Constable Road,  
St. Ives, Huntingdon,  
Cambs PE17 6EQ.  
Tel/Fax: 0480 300819



## MAKE YOUR INTERESTS PAY!

Over the past 100 years more than 10 million students throughout the world have found it worth their while! An ICS home-study course can help you get a better job, make more money and have more fun out of life! ICS has over 100 years experience in home-study courses and is the largest correspondence school in the world. You learn at your own pace, when and where you want under the guidance of expert 'personal' tutors. Find out how we can help YOU. Post or phone today for FREE INFORMATION on the course of your choice. (Tick one box only!)

Electronics	<input type="checkbox"/>	TV, Video & Hi-Fi Servicing	<input type="checkbox"/>
Basic Electronic Engineering (City & Guilds)	<input type="checkbox"/>	Refrigeration & Air Conditioning	<input type="checkbox"/>
Electrical Engineering	<input type="checkbox"/>	Car Mechanics	<input type="checkbox"/>
Electrical Contracting/Installation	<input type="checkbox"/>	Computer Programming	<input type="checkbox"/>

CCSE / CCE / SCE over 40 examination subjects to choose from

Name \_\_\_\_\_

Address \_\_\_\_\_

**ICS**

International Correspondence Schools Dept ECS 14  
312/314 High Street, Sutton, Surrey SM1 1PR or 041-221 7373 (24 hours).

## SHERWOOD ELECTRONICS

9 Lower Birchwood, Somercotes, Derbyshire DE55 4NG

£1 Special Packs - choose 1 pack FREE for every 10 purchased

SP1 15 x 5mm Red Leds	SP36 25 x 10uF/25V radial elect caps
SP2 15 x 5mm Green Leds	SP37 20 x 100uF/40V radial elect caps
SP3 12 x 5mm Yellow Leds	SP39 12 x 470uF/16V radial elect caps
SP6 15 x 3mm Red Leds	SP42 200 x Mixed 0.25W C.Film resistors
SP7 12 x 3mm Green Leds	SP47 5 x Min. push button switches
SP8 10 x 3mm Yellow Leds	SP102 20 x 8 pin DIL sockets
SP10 100 x 1N4148 diodes	SP103 15 x 14 pin DIL sockets
SP11 30 x 1N4001 diodes	SP104 15 x 16 pin DIL sockets
SP12 30 x 1N4002 diodes	SP112 8 x Cmos 4002
SP16 20 x 8C182 transistors	SP125 10 x 100uF/16V rad. elect caps
SP20 20 x 8C184 transistors	SP130 100 x Mixed 0.5W C.Film resistors
SP23 20 x 8C540 transistors	SP133 20 x 1N4004 diodes
SP25 5 x 555 timers	SP134 15 x 1N4007 diodes
SP26 5 x 741 Op-amps	SP135 6 x Min. slide switches
SP28 6 x Cmos 4011	SP137 4 x W005 bridge rectifiers
SP29 4 x Cmos 4013	SP138 20 x 2.2uF/50V radial elect caps

RESISTOR PACKS - 0.25W C.Film

RP3 5 each value - total 365	£2.75
RP7 10 each value - total 730	£4.15
RP10 1000 popular values	£5.60

Catalogue available £1 or FREE with first order over £5

Cheques or P.O. to **SHERWOOD ELECTRONICS** NO VAT Please add £1 P&P to all orders

Carbon Film resistors 1/4W 5% E24 series 0.51 R to 10MΩ	1p
100 off per value - 75p. even hundreds per value totalling 1000	£6.00p
Metal Film resistors 1/4W 10R to 1 MΩ 5% E12 series - 2p. 1% E24 series	3p
Mixed metal/carbon film resistors 1/4W E24 series 1R to 10MΩ	1 1/2p
1 watt mixed metal/Carbon Film 5% E12 series 4R7 to 10 Megohms	5p
Linear Carbon pre-sets 100mW and 1/4W 100R to 4M7 E6 series	7p
<b>Miniature polymer capacitors 250V working for vertical mounting</b>	
.015, .022, .033, .047, .068-4p, 0.1 - 5p, 0.12, 0.15, 0.22 - 6p, 0.47 - 8p, 1.0 - 12p	
Mylar (polyester) capacitors 100V working E12 series vertical mounting	
1000p to 8200p - 3p. .01 to .068 - 4p, 0.1 - 5p, 0.12, 0.15, 0.22 - 6p, 0.47/50V - 8p	
Submin ceramic plate capacitors 100V wkg vertical mountings. E12 series	
2% 1.8pf to 47pf - 3p. 2% 56pf to 330pf - 4p. 10% 390p-4700p	4p
Disc/plate ceramics 50V E12 series 1P0 to 1000P, E6 Series 1500P to 47000P	2p
<b>Polystyrene capacitors 63V working E12 series long axial wires</b>	
10pf to 820pf - 5p. 1000pf to 10,000pf - 6p. 12,000pf	7p
741 Op Amp - 20p. 555 Timer - 20p. LM3900	80p
cmos 4001 - 20p. 4011 - 22p. 4017 - 40p. 4069UB unbuffered	20p
<b>ALUMINIUM ELECTROLYTICS (Mfds/Volts)</b>	
1/50, 2.2/50, 4.7/50, 10/25, 10/50	5p
22/16, 22/25, 22/50, 33/16, 47/16, 47/25, 47/50	6p
100/16, 100/25 7p; 100/50	12p
220/16 8p; 220/25, 220/50 10p; 470/16, 470/25	11p
1000/25 25p; 1000/35, 2200/25 35p; 4700/25	70p
<b>Submin. tantalum bead electrolytics (Mfds/Volts)</b>	
0.1/35, 0.22/35, 0.47/35, 1.0/35, 3.3/16, 4.7/16	14p
2.2/35, 4.7/25, 4.7/35, 6.8/16 15p; 10/16, 22/6	20p
33/10, 47/6, 22/16 30p; 47/10 35p; 47/16 60p; 47/35	80p
<b>VOLTAGE REGULATORS</b>	
1A + or - 5V, 8V, 12V, 15V, 18V & 24V - 55p. 100mA 5.8, 12, 15, V +	30p
<b>OIOES (piv/amps)</b>	
75/25mA 1N4148 2p. 800/1A 1N4006 4 1/2p. 400/3A 1N5404 14p. 115/15mA OA91	8p
100/1A 1N4002 3 1/2p. 1000/1A 1N4007 5p. 80/1.5A S1M1 5p. 100/1A bridge	25p
400/1A 1N4004 4p. 1250/1A BY 127 10p. 30/150mA OA47 gold bonded	18p
Zener diodes E24 series 3V3 to 33V 400mW - 8p. 1 watt	12p
Battery snaps for PP3 - 8p for PP9	12p
L.E.D.'s 3mm. & 5mm. Red, Green, Yellow - 10p. Grommets 3mm - 2p. 5mm	2p
Red flashing L.E.D.'s require 9-12V supply only	50p
Main indicator neons with 220k resistor	6p
20mm fuses 100mA to 5A. O. blow 8p. A/surge 10p. Holders, chassis, mounting	8p
High speed pc drill 0.8, 1.0, 1.3, 1.5, 2.0mm - 40p. Machines 12V dc	£15.00
HELPPING HANDS 6 ball joints and 2 croc clips to hold awkward jobs	£3.60
AA/HP7 Nicad rechargeable cells 90p each. Universal charger unit	£6.60
AA/HP7 zinc/carbon batteries in packs of 4	£1.10 per pack
Glass reed switches with single pole make contacts - 8p. Magnets	15p
0.1" Stripboard 2 1/2" x 1" 9 rows 25 holes - 25p. 3 1/2" x 2 1/4" 24 rows 37 holes	70p
Jack plugs 2.5 & 3.5mm - 14p; Sockets Panel Mtg. 2.5 & 3.5mm	10p
Ear pieces 2.5 & 3.5mm, dynamic - 20p; 3.5mm crystal	£1.50
Multi cored solder, 22G - 8p yard, 18G - 14p yard.	

**TRANSISTORS**  
BC107/8/9 - 12p. BC547/8/9 - 8p. BC557/8/9 - 8p. BC182, 182L, BC183, 183L, BC184, 184L, BC212, 212L - 10p.  
BC327, 337, 337L - 12p. BC727, 737 - 12p. BD135/6/7/8/9 - 25p. BCY70 - 18p.  
BFY50/51/52 - 20p.  
8FX88 - 15p. 2N3055 - 55p. TIP31, 32 - 30p. TIP41, 42 - 40p. 8U208A - £1.50, 8F195, 197 - 12p.  
Ionisers with seven year guarantee, list price £16.95

All prices are inclusive of VAT. Postage 30p (free over £5). Stamp for list.

## THE CR SUPPLY CO

127 Chesterfield Rd., Sheffield S8 0RN  
Tel: 0742 557771 Return posting

## Millions of quality components at lowest ever prices!

Plus Tools, Watches, Fancy Goods, Toys.  
Mail order UK only.

All inclusive prices -  
NO VAT to add on.

Send 43p stamped self addressed label or envelope for catalogue/clearance list.

At least 2,100 offers to amaze you.

**Brian J Reed**

**6 Queensmead Avenue, East Ewell  
Epsom, Surrey KT17 3EQ  
Tel: 081-393 9055**

## ADVERTISERS INDEX

AITKEN BROS. & CO.....	52
ALFRED ENTERPRISES.....	53
ANNEX SOFTWARE.....	69
AUTONA.....	87
N. R. BARDWELL.....	85
R. BARTLETT.....	69
B.K. ELECTRONICS.....	Cover (iii)
BRIAN J. REED.....	88
BULL ELECTRICAL.....	Cover (ii)
CAMBRIDGE COMP. SCIENCE.....	85
CHATWIN GUITARS (JCG).....	53
CIRKIT DISTRIBUTION.....	25
COMPELEC.....	87
COOKE INTERNATIONAL.....	87
CRICKLEWOOD ELECTRONICS.....	77
CROTECH INSTRUMENTS.....	33
CR SUPPLY COMPANY.....	88
DELICIA ELECTRONICS.....	85
ELECTRONIZE DESIGN.....	10
ELECTROVALUE.....	52
ESR ELECTRONIC COMPONENTS.....	14
EUROCOM INTERNATIONAL.....	49
GREENWELD ELECTRONICS.....	5
HART ELECTRONIC KITS.....	63
HENRY'S AUDIO ELECTRONICS.....	48
ICS.....	88
INSTRUTEK (UK).....	21
JAYTEE ELECTRONIC SERVICES.....	3
JPG ELECTRONICS.....	85
KARE ELECTRONICS.....	10
LABCENTER.....	4
MAGENTA ELECTRONICS.....	12/13
MAILTECH.....	75
MAPLIN ELECTRONICS.....	Cover (iv)
MARAPET.....	87
MARCO TRADING.....	6
MAURITRON.....	87
M&B ELECTRICAL SUPPLIES.....	8
M&B ELECTRONICS.....	49
MQP ELECTRONICS.....	53
NATIONAL COLLEGE OF TECHNOLOGY.....	67
NICHE SOFTWARE.....	53
NUMBER ONE SYSTEMS.....	11
OMNI ELECTRONICS.....	10
PCL SOFTWARE.....	48
PICO TECHNOLOGY.....	9
POWERWARE.....	82
ROLINE SYSTEMS.....	40/41
SEETRAX CAE.....	67
SHERWOOD ELECTRONICS.....	88
SMART HOUSE SYSTEMS.....	87
S&N ENTERPRISES.....	85
SUMA DESIGNS.....	2
TSIEN (UK).....	7

### ADVERTISEMENT MANAGER:

PETER J. MEW

### ADVERTISEMENT OFFICES:

EVERYDAY with PRACTICAL ELECTRONICS,  
ADVERTISEMENTS,  
HOLLAND WOOD HOUSE, CHRUCH LANE,  
GREAT HOLLAND, ESSEX CO13 0JS.  
Phone/Fax: (0255) 850596

For Editorial address and phone numbers see page 15.



**OMP MOS-FET POWER AMPLIFIERS**  
HIGH POWER, TWO CHANNEL 19 INCH RACK

**THOUSANDS PURCHASED BY PROFESSIONAL USERS**



**THE RENOWNED MXF SERIES OF POWER AMPLIFIERS**  
FOUR MODELS:- MXF200 (100W + 100W) MXF400 (200W + 200W)

MXF600 (300W + 300W) MXF900 (450W + 450W)

ALL POWER RATINGS R.M.S. INTO 4 OHMS, BOTH CHANNELS DRIVEN

**FEATURES:** ★ Independent power supplies with two toroidal transformers ★ Twin L.E.D. Vu meters ★ Level controls ★ Illuminated on/off switch ★ XLR connectors ★ Standard 775mV inputs ★ Open and short circuit proof ★ Latest Mos-Fets for stress free power delivery into virtually any load ★ High slew rate ★ Very low distortion ★ Aluminum cases ★ MXF600 & MXF900 fan cooled with D.C. loudspeaker and thermal protection.

USED THE WORLD OVER IN CLUBS, PUBS, CINEMAS, DISCOS ETC.

**SIZES:-** MXF200 W19" xH3 3/4" (2U)xD11"  
MXF400 W19" xH5 1/4" (3U)xD12"  
MXF600 W19" xH5 1/4" (3U)xD13"  
MXF900 W19" xH5 1/4" (3U)xD14 1/2"

**PRICES:-** MXF200 £175.00 MXF400 £233.85

MXF600 £329.00 MXF900 £449.15

SPECIALIST CARRIER DEL. £12.50 EACH



**OMP XO3 STEREO 3-WAY ACTIVE CROSS-OVER**



Advanced 3-Way Stereo Active Cross-Over, housed in a 19" x 1U case. Each channel has three level controls: bass, mid & top. The removable front fascia allows access to the programmable DIL switches to adjust the cross-over frequency: Bass-Mid 250/500/800Hz, Mid-Top 1.8/3/5KHz, all at 24dB per octave. Bass invert switches on each bass channel. Nominal 775mV input/output. Fully compatible with OMP rack amplifier and modules.

Price £117.44 + £5.00 P&P

**STEREO DISCO MIXER SDJ3400S**

★ ECHO & SOUND EFFECTS ★

**STEREO DISCO MIXER** with 2 x 7 band L & R graphic equalisers with bar graph LED Vu meters. **MANY OUTSTANDING FEATURES:-** including Echo with repeat & speed control, DJ Mic with talk-over switch, 6 Channels with individual faders plus cross fade, Cue Headphone Monitor, 8 Sound Effects. Useful combination of the following inputs:- 3 turntables (mag), 3 mics, 5 Line for CD, Tape, Video etc.



Price £144.99 + £5.00 P&P

SIZE: 482 x 240 x 120mm

**PIEZO ELECTRIC TWEETERS - MOTOROLA**

Join the Piezo revolution! The low dynamic mass (no voice coil) of a Piezo tweeter produces an improved transient response with a lower distortion level than ordinary dynamic tweeters. As a crossover is not required these units can be added to existing speaker systems of up to 100 watts (more if two are put in series). **FREE EXPLANATORY LEAFLETS ARE SUPPLIED WITH EACH TWEETER.**

**TYPE 'A'** (KSN1036A) 3" round with protective wire mesh. Ideal for bookshelf and medium sized Hi-Fi speakers. Price £4.90 + 50p P&P.  
**TYPE 'B'** (KSN1005A) 3 1/2" super horn for general purpose speakers, disco and P.A. systems etc. Price £5.99 + 50p P&P.  
**TYPE 'C'** (KSN1016A) 2" x 5" wide dispersion horn for quality Hi-Fi systems and quality discos etc. Price £6.99 + 50p P&P.  
**TYPE 'D'** (KSN1025A) 2" x 6" wide dispersion horn. Upper frequency response retained extending down to mid-range (2KHz). Suitable for high quality Hi-Fi systems and quality discos. Price £9.99 + 50p P&P.  
**TYPE 'E'** (KSN1038A) 3 1/4" horn tweeter with attractive silver finish trim. Suitable for Hi-Fi monitor systems etc. Price £5.99 + 50p P&P.  
**LEVEL CONTROL** Combines, on a recessed mounting plate, level control and cabinet input jack socket. 85x85mm. Price £4.10 + 50p P&P.

TYPE A

TYPE B

TYPE C

TYPE D

TYPE E

TYPE F

TYPE G

TYPE H

TYPE I

TYPE J

TYPE K

TYPE L

TYPE M

TYPE N

TYPE O

TYPE P

TYPE Q

TYPE R

TYPE S

TYPE T

TYPE U

TYPE V

TYPE W

TYPE X

TYPE Y

TYPE Z

TYPE AA

TYPE AB

TYPE AC

TYPE AD

TYPE AE

TYPE AF

TYPE AG

TYPE AH

TYPE AI

TYPE AJ

TYPE AK

TYPE AL

TYPE AM

TYPE AN

TYPE AO

TYPE AP

TYPE AQ

TYPE AR

TYPE AS

TYPE AT

TYPE AU

TYPE AV

TYPE AW

TYPE AX

TYPE AY

TYPE AZ

TYPE BA

TYPE BB

TYPE BC

TYPE BD

TYPE BE

TYPE BF

TYPE BG

TYPE BH

TYPE BI

TYPE BJ

TYPE BK

TYPE BL

TYPE BM

TYPE BN

TYPE BO

TYPE BP

TYPE BQ

TYPE BR

TYPE BS

TYPE BT

TYPE BU

TYPE BV

TYPE BW

TYPE BX

TYPE BY

TYPE BZ

TYPE CA

TYPE CB

TYPE CC

TYPE CD

TYPE CE

TYPE CF

TYPE CG

TYPE CH

TYPE CI

TYPE CJ

TYPE CK

TYPE CL

TYPE CM

TYPE CN

TYPE CO

TYPE CP

TYPE CQ

TYPE CR

TYPE CS

TYPE CT

TYPE CU

TYPE CV

TYPE CW

TYPE CX

TYPE CY

TYPE CZ

TYPE DA

TYPE DB

TYPE DC

TYPE DD

TYPE DE

TYPE DF

TYPE DG

TYPE DH

TYPE DI

TYPE DJ

TYPE DK

TYPE DL

TYPE DM

TYPE DN

TYPE DO

TYPE DP

TYPE DQ

TYPE DR

TYPE DS

TYPE DT

TYPE DU

TYPE DV

TYPE DW

TYPE DX

TYPE DY

TYPE DZ

TYPE EA

TYPE EB

TYPE EC

TYPE ED

TYPE EE

TYPE EF

TYPE EG

TYPE EH

TYPE EI

TYPE EJ

TYPE EK

TYPE EL

TYPE EM

TYPE EN

TYPE EO

TYPE EP

TYPE EQ

TYPE ER

TYPE ES

TYPE ET

TYPE EU

TYPE EV

TYPE EW

TYPE EX

TYPE EY

TYPE EZ

TYPE FA

TYPE FB

TYPE FC

TYPE FD

TYPE FE

TYPE FF

TYPE FG

TYPE FH

TYPE FI

TYPE FJ

TYPE FK

TYPE FL

TYPE FM

TYPE FN

TYPE FO

TYPE FP

TYPE FQ

TYPE FR

TYPE FS

TYPE FT

TYPE FU

TYPE FV

TYPE FW

TYPE FX

TYPE FY

TYPE FZ

TYPE GA

TYPE GB

TYPE GC

TYPE GD

TYPE GE

TYPE GF

TYPE GG

TYPE GH

TYPE GI

TYPE GJ

TYPE GK

TYPE GL

TYPE GM

TYPE GN

TYPE GO

TYPE GP

TYPE GQ

TYPE GR

TYPE GS

TYPE GT

TYPE GU

TYPE GV

TYPE GW

TYPE GX

TYPE GY

TYPE GZ

TYPE HA

TYPE HB

TYPE HC

TYPE HD

TYPE HE

TYPE HF

TYPE HG

TYPE HH

TYPE HI

TYPE HJ

TYPE HK

TYPE HL

TYPE HM

TYPE HN

TYPE HO

TYPE HP

TYPE HQ

TYPE HR

TYPE HS

TYPE HT

TYPE HU

TYPE HV

TYPE HW

TYPE HX

TYPE HY

TYPE HZ

TYPE IA

TYPE IB

TYPE IC

TYPE ID

TYPE IE

TYPE IF

TYPE IG

TYPE IH

TYPE II

TYPE IJ

TYPE IK

TYPE IL

TYPE IM

TYPE IN

TYPE IO

TYPE IP

TYPE IQ

TYPE IR

TYPE IS

TYPE IT

TYPE IU

TYPE IV



**NEW**

**FULL COLOUR GUIDE TO ELECTRONIC PRODUCTS**

# Maplin



BS 5750  
Part 2 1987  
Level B:  
Quality Assurance  
RS12750

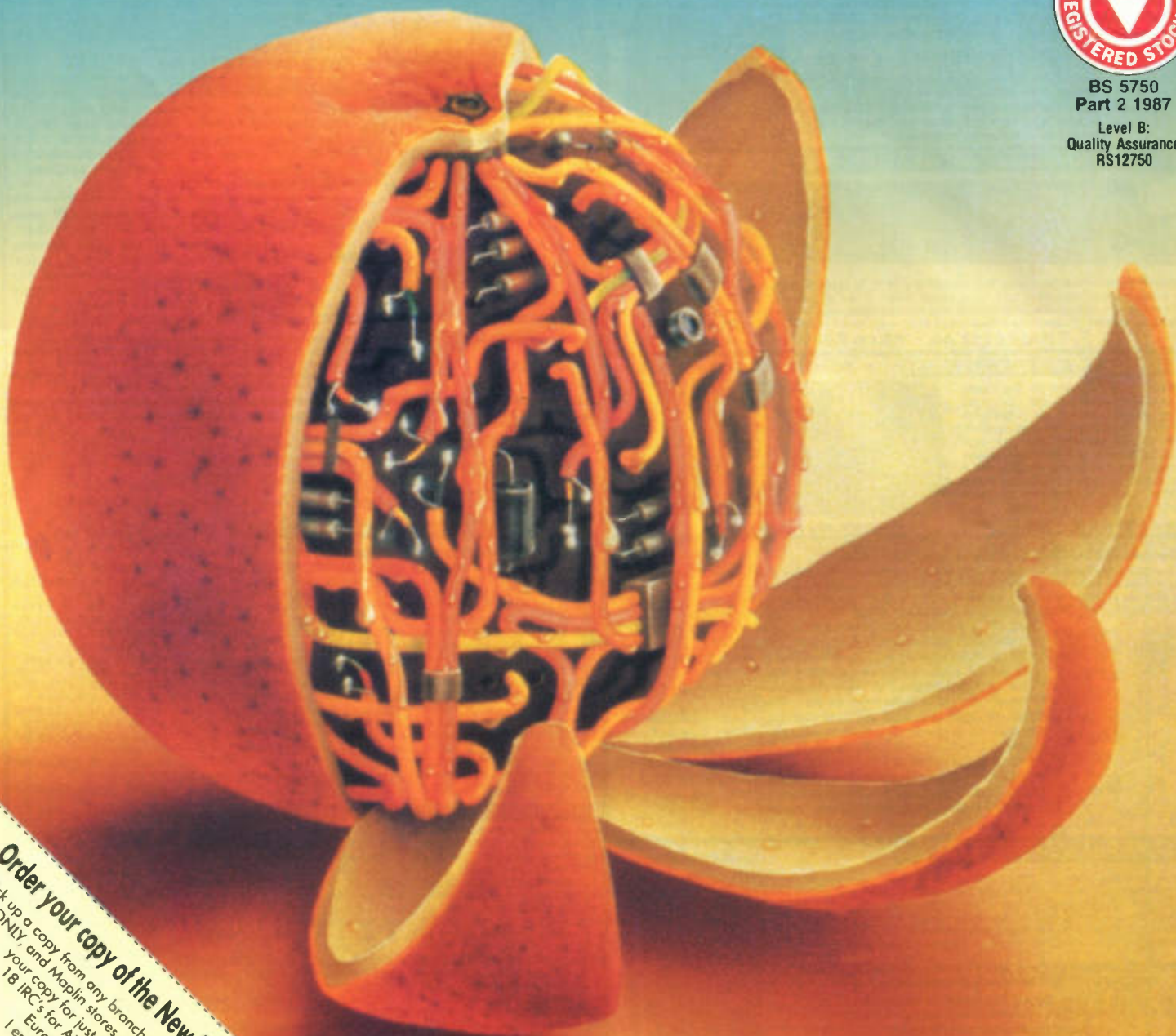

**Order your copy of the New MAPLIN Catalogue on sale NOW!**  
Pick up a copy from any branch of WHSMITH, selected branches of RSM<sup>COLL</sup> in Scotland ONLY and Maplin stores nationwide for just £2.95 inc. p&p. If you live outside the U.K. send £6.80 or your copy for just £3.45 inc. p&p. If you live outside Europe, send £6.80 or 18 IRC's for Airmail in Europe/£5.20 or 13 IRC's for Airmail outside Europe. I enclose £3.45/£6.80/£5.20/£1.50 (delete as applicable).

Name.....  
Address.....  
Post Code.....  
Send to Maplin Electronics,  
P.O. Box 3, Rayleigh,  
Essex, England  
SS6 8LR.  
EE94

Over 700 colour packed pages with hundreds of brand New Products at Super Low Prices, on sale now, **only £2.95.**

Available from all branches of WHSMITH, selected branches of RSM<sup>COLL</sup> in Scotland ONLY, and Maplin stores nationwide. The Maplin Electronics 1994 Catalogue – **UNIQUELY DIFFERENT!** Southern Africa customers please contact Maplin (South Africa). Telephone (024) 51-5124

