

**EVERYDAY** AUGUST 1993  
**WITH PRACTICAL**  
**ELECTRONICS**

INCORPORATING ELECTRONICS MONTHLY

FULLY S.O.R. £1.80

**FREE INSIDE!** 48 page  
**GREENWELD**  
Summer Sale Catalogue

**EXPERIMENTAL  
ELECTRONIC  
PIPE DESCALER**

**Hard Water? Build this  
experimental descaler  
for under £20.**



**TRI-STATE THERMOMETER**

**Keep an eye on your engine temperature**

**AUDIO AMPLIFIED DESIGN**

**ENGINEERING OR ALCHEMY? PART 1**

**John Linsley Hood investigates**

**BIKE ODOMETER**

**How far have you pedaled?**



## AMP KITS

### 30 WATT SINGLE CHANNEL

30 watt rms into 8ohm, 20HZ-20KHZ harmonic distortion 0.1%, sensitive to 150MV, mic sensitivity 50MV, 36V x 2 psu's required complete with base, treble and volume controls and heat sink.

**Our Price : £8.00 each**

**Our Ref : EE/W8P7**

### 120+120 WATT STEREO AMP

240 watts rms into 4 ohm, 10KZ-20KHZ, harmonic distortion less than 0.01%, sensitivity 3MV (phono), 130MV (aux), 2 x 30V psu's required.

**Our Price : £30.00 each**

**Our Ref : EE/W30P3**

### 30 WATT STEREO AMP

30 watts rms into 8ohm, harmonic distortion .1%, sensitivity 3MV (phono), 130MV (tuner), signal to noise 80db, 36V x 2 psu's required.

**Our Price : £16.00 each**

**Our Ref : EE/W16P1**

### 300 WATT MONO AMP

300 watt rms output, harmonic distortion less than 0.05% 10KHZ. 2 x 60V psu's required.

**Our Price : £40.00 each**

**Our Ref : EE/W40P3**

**WE HAVE HUNDREDS AND HUNDREDS MORE STOCK LINES - TOO MANY TO LIST IN ONE ADVERT ! HERE ARE JUST A FEW OF THE PRODUCTS LINES WE STOCK.....**

**MICROWAVE CONTROL PANEL.** Mains operated, with touch switches. Complete with 4 digit display, digital clock, and 2 relay outputs one for power and one for pulsed power (programmable). Ideal for all sorts of precision timer applications etc. Now only £4.00 ref 4P151. Good experimenters board.

**FIBRE OPTIC CABLE.** Stranded optical fibres sheathed in black PVC. Five metre length £7.00 ref 7P29R or £2 a metre.

**12V SOLAR CELL.** 200mA output ideal for trickle charging etc. 300 mm square. Our price £15.00 ref 15P42R. Gives up to 15v.

**PASSIVE INFRA-RED MOTION SENSOR.** Complete with daylight sensor, adjustable lights on timer (8 secs - 15 mins), 50' range with a 90 deg coverage. Manual override facility. Complete with wall brackets, bulb holders etc. Brand new and guaranteed. Now only £19.00 ref 19P29

**PACK OF TWO PAR38 BULBS** for above unit £12.00 ref 12P43R

**VIDEO SENDER UNIT.** Transmits both audio and video signals from either a video camera, video recorder or computer to any standard TV set within a 100' range (tune TV to a spare channel).

**12V DC OP.** £15.00 ref 15P39R Suitable mains adaptor £5.00 ref 5P191R. Turn your camcorder into a cordless camera!

**FM TRANSMITTER** Housed in a standard working 13A adapter (bug in mains driven). £26.00 ref 26P2R. Good range.

**MINIATURE RADIO TRANSCIEVERS.** A pair of walkie talkies with a range of up to 2 kilometres. Units measure 22x52x155mm. Complete with cases and earpieces. £30.00 ref 30P12R

**FM CORDLESS MICROPHONE.** Small hand held unit with a 500' range! 2 transmit power levels. Reqs PP3 battery. Tuneable to any FM receiver. Our price £15 ref 15P42AR.

**12 BAND COMMUNICATIONS RECEIVER.** 9 short bands, FM, AM and LW DX/accal switch, tuning 'eye' mains or battery. Complete with shoulder strap and mains lead. £19 ref 19P14R. Ideal for listening all over the world.

**CAR STEREO AND FM RADIO.** Low cost stereo system giving 5 watts per channel. Signal to noise ratio better than 45db, wow and flutter less than .35%. Neg earth. £19.00 ref 19P30

**LOW COST WALKIE TALKIES.** Pair of battery operated units with a range of about 200'. Our price £8.00 a pair ref 8P50R. Ideal for garden use or as an educational toy.

**7 CHANNEL GRAPHIC EQUALIZER** plus a 60 watt power amp! 20-21KHZ 4-8R 12-14V DC negative earth. Cased. £25 ref 25P14R.

**NICAD BATTERIES.** Brand new top quality. 4 x AA's £4.00 ref 4P44R. 2 x C's £4.00 ref 4P73R. 4 x D's £9.00 ref 9P12R. 1 x PP3 £6.00 ref 6P35R Pack of 10 AA's £4.00 ref 4P92R.

**MINIMUM GOODS ORDER £5.00. TRADE ORDERS FROM GOVERNMENT, SCHOOLS, UNIVERSITIES, & LOCAL AUTHORITIES WELCOME. ALL GOODS SUPPLIED SUBJECT TO OUR CONDITIONS OF SALE AND UNLESS OTHERWISE STATED GUARANTEED FOR 30 DAYS.**

**RIGHTS RESERVED TO CHANGE PRICES & SPECIFICATIONS WITHOUT PRIOR NOTICE. ORDERS SUBJECT TO STOCK. QUOTATIONS WILLINGLY GIVEN FOR QUANTITIES HIGHER THAN THOSE STATED.**

## THIS MONTHS SPECIAL OFFERS

### COMMODORE 64 & PSU

Once again available due to a bulk purchase. Commodore 64 together with Power Supply, supplied and tested in working order.

**Our Price: £50.00 Ref: EE/W50P1**

### PIR MOVEMENT DETECTOR

Once again we have acquired stocks of this popular line and are able to offer you a very high quality and professional detector at only \*\*\*£15.00\*\*\*. Range: 20 Mtrs with a 90° arc. Day and Night Mode Dimensions: 15cm x 9cm x 11cm. New and boxed complete with installation guide.

**Our Price: £15.00**

**Our Ref : EE/W15P2**

### ELECTRIC MOTOR - 3 PHASE

GEC Alpax Induction Motor. This is an extremely well made industrial 3 phase motor. BRAND NEW & UNUSED. Supplied with full installation and maintenance literature.

**Our Price: £60.00**

**Our Ref : EE/W60P1**

### PORTABLE ALARM SYSTEM

'PAL' Portable Multi Beam Scanning System. Lockable Stand-alone PIR unit with removable keys (3 supplied). This unit uses a PP3 battery and when activated emits a piercing SHRILL! The units scans the room and memorises the layout. Should this change, the alarm is triggered. There is a 60 second exit delay.

**Our Price: £17.00**

**REF : EE/W17P1**

### CAR PHONE HANDSETS YUPIES LOOKOUT!!

Brand New High quality handsets originally intended for use with Phillips Mobile Phone System. We have acquired a number of these handsets, supplied in two parts, speaker and combined phone rest unit plus handset with LCD display, LED indicators and push button dialling. 6 additional keys as well as the conventional 12 numeric keypad. No transmitter /receiver. 5 Mtr 12 core black cable attached. Excellent Dummy Mobile Phone!!!

**Price: £6.00 each**

**Ref : EE/W6P3**

### MINI MULTI TESTER

Mini multi-tester with 9 ranges. AC Volts up to 1000. DC Volts up to 500.

Ohms/mA ranges.

1K ohm/V. Ideal for pocket or toolbox use and at only £5.00 each - replaceable!!

**Our Price: £5.00**

**Our Ref : EE/W5P2**

### HEAT DETECTOR

This is a Japanese made combination type heat detector which could be linked to a suitable fire alarm panel. 105mm dia. 30V operational.

**Our Price: £4.00 Our Ref: EE/W4P1**

SOME OF OUR PRODUCTS MAY BE UNLICENSABLE IN THE UK

## BULL ELECTRICAL

250 PORTLAND ROAD HOVE SUSSEX BN3 5QT

MAIL ORDER TERMS: CASH PO OR CHEQUE WITH ORDER PLUS £3.00 POST PLUS VAT.

PLEASE ALLOW 7 - 10 DAYS FOR DELIVERY

TELEPHONE ORDERS WELCOME

TEL: 0273 203500

FAX: 0273 323077



## USEFUL POWER SUPPLY - £5.00

14.5V DC @ 400Ma battery charger  
Plug in type with sleeved pins. Lead terminates in 3 pin din plug, easily removable. Originally intended for mobile phone charging. (Large quantities available)

**Our Price : £5.00 each**

**Our Ref : EE/W5P8**



## AMSTRAD PRINTER MECHS

We have both Amstrad LQ3500 and Amstrad DMP4000 printer mechanisms. No case or electronics but complete with print head. Ideal for replacement. The mechanism comes with two high quality stepper motors which together with the print head are worth much more than we are selling the whole unit for!!!! This unit could also be utilised for a number of other projects including coil winding, laser scanning(\*) etc.

(Quantity Prices available on application)

### AMSTRAD LQ3500 units

**Our Price : £10.00 each**

**Our Ref : EE/W10P5**

### AMSTRAD DMP4000 units

**Our Price : £20.00 each**

**Our Ref : EE/W20P3**

## MANY MORE SPECIAL OFFERS IN OUR REGULAR NEWSLETTERS

## PC CORNER

**PC CASES** desk top case +psu £51.60 ref BPC/C1. Deluxe slimline case +psu £60.00 ref BPC/C2. Minitower case +psu £51.60 ref BPC/C3. Deluxe midi case +psu £90.00 ref BPC/C4. **MONITORS** Mitac 14" SVGA. 39DP £174.00 ref BPC/MO2. Mitac 14" SVGA. 28DP £202.00 ref BPC/MO1. **MEMORY** 256K Simm 70ns £8.40 ref BPC/M11. 1MB Simm 70ns £26.40 ref BPC/M12. 4MB Simm 70ns £96.00 ref BPC/M13. **MICE** 2 button serial mouse with 3.5" s/ware £8.40 ref BPC/M16. 3 button serial mouse with 3.5" s/ware £9.60 ref BPC/M17. **KEYBOARDS** 102 AT UK standard keyboard £18.60 ref BPC/M14. Deluxe keyboard 102 AT UK £26.40 ref BPC/M15. **SOFTWARES** DOS 5 OEM version £39.60 ref BPC/M18. MS WINDOWS 3.1 OEM version £42.00 ref BPC/M19. 6 286-16 Headland chipset £46.80 ref BPC/MB1. 386SX-33 Acer chipset £82.80 ref BPC/MB2. 386SX-40 UMC with 64K cache £110.00 ref BPC/MB3. 486SX-25 UMC with 64K cache £191.00 ref BPC/MB4. 486DX-33 UMC with 256K cache £378.00 ref BPC/MB5. 486DX-66 UMC with 256K cache £515.00 ref BPC/MB6. **FLOPPY DRIVES** 1.44mb 3.5" drive £32.34 ref BPC/DD05. 1.2mb 5.25" drive £38.40 ref BPC/DD02. 3.5"-5.25" mounting kit £5.00 ref BPC/DD07. **HARD DRIVES** 42MB IDE 17ms £99.00 ref BPC/DD01. 89MB IDE 16ms £166.00 ref BPC/DD02. 130MB IDE 15ms £215.00 ref BPC/DD03. 213MB IDE 14ms £298.00 ref BPC/DD04. **VIDEO CARDS** 256K C&T 8 bit SVGA card £22.20 ref BPC/VC01. 512K Trident 9000 16 bit SVGA card £31.20 ref BPC/VC02. 1MB Trident 8900 16 bit SVGA card £45.00 ref BPC/VC03. 1MB Cirrus AVGA3 16.7M colours £48.00 ref BPC/VC04. 1MB Tseng multimedia £82.80 ref BPC/VC05. **ADD ON CARDS** Multi I/O card 2s, 1p, 1g, 2fd, 2hd £11.00 ref BPC/AOC01. ADLIB sound card with speakers £37.00 ref BPC/AOC02. Orchid sound card with speakers £63.00 ref BPC/AOC03.

### EXAMPLES OF COMPLETE SYSTEMS

#### 386SX-33 SYSTEM

386SX-33 board at £82.80, case £51.60, 2MB ram £52.80, 42MB drive £99.00, SVGA colour monitor £174.00, 102 keyboard, £25 build fee if required. Total £579.34

#### 486DX-33 SYSTEM

486DX-33 board £378.00, case £51.60, 2MB ram £52.80, 89MB drive £166.00, 512 SVGA card £31.20, 3.5" FDD £32.34, multi I/O card £11.00, SVGA monitor £174.00, 102 keyboard £18.60, £25 build fee if required. Total £939.84

ALL PC PARTS AND SYSTEMS ARE GUARANTEED FOR 1 YEAR PARTS AND LABOUR.

## IN SUSSEX?

CALL IN AND SEE US!!

TURN YOUR SURPLUS STOCK INTO CASH. IMMEDIATE SETTLEMENT. WE WILL ALSO QUOTE FOR COMPLETE FACTORY CLEARANCE.

MUCH MUCH MORE IN OUR 1993 CATALOGUE. PLEASE SEND 41P, A4 SIZED SAE FOR YOUR FREE COPY.

# EVERYDAY WITH PRACTICAL ELECTRONICS

INCORPORATING ELECTRONICS MONTHLY

VOL. 22 No. 8 AUGUST 1993

The No. 1 Independent Magazine for Electronics,  
Technology and Computer Projects

ISSN 0262 3617

PROJECTS... THEORY... NEWS...  
COMMENT... POPULAR FEATURES...

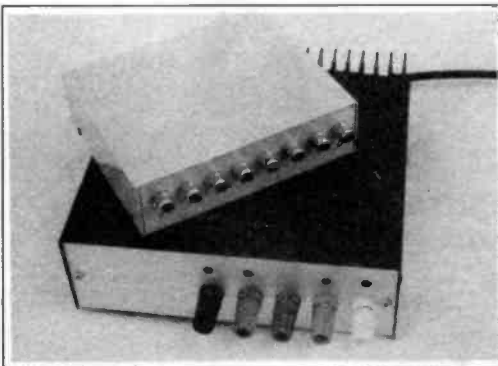
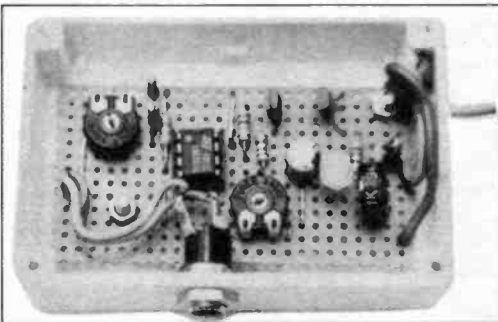
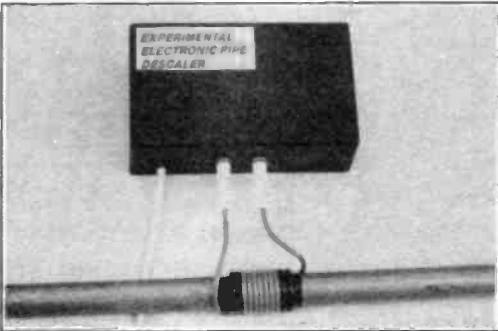

© Wimborne Publishing Ltd 1993. Copyright in all drawings, photographs and articles published in EVERYDAY with PRACTICAL ELECTRONICS is fully protected, and reproduction or imitations in whole or in part are expressly forbidden.

## Projects

- BICYCLE ODOMETER** by Steve Knight **566**  
Watch the miles fly by as you pedal along!
- TRI-STATE THERMOMETER** by T. R. de Vaux Balbirnie **578**  
An illuminated and illuminating warning device
- EXPERIMENTAL ELECTRONIC PIPE DESCALER** **592**  
by Andy Flind  
Should prevent your pipes getting furred up
- AMSTRAD PCW 8-CHANNEL ADC** by Jason Sharpe **598**  
Use your computer to monitor events in the real world
- CUPBOARD GUARD** by T. R. de Vaux Balbirnie **618**  
Sounds an audible warning if a cupboard is opened

## Series

- TEACH-IN '93 - 10** **583**  
by Alan Winstanley, Keith Dye and Geoff MacDonald  
Micro Lab demonstrations and software development
- AUDIO AMPLIFIER DESIGN - ENGINEERING OR ALCHEMY** by John Linsley Hood **596**  
John looks at opposing views on amplifier performance measurements
- INTERFACE** by Robert Penfold **604**  
The page for computer enthusiasts
- DOWN TO EARTH** by George Hylton **610**  
Conductance investigated
- TECHNIQUES - ACTUALLY DOING IT** by Robert Penfold **612**  
Disappearing devices
- CIRCUIT SURGERY** by Mike Tooley **616**  
Mike solves your problems and provides circuit ideas
- AMATEUR RADIO** by Tony Smith G4FAI **622**  
More Space Experiments; Remember The 1-V-1; Radio Bygones; Repeater Licence Changes; Summer Broadcasting Guide

## Features

- EDITORIAL** **565**
- INNOVATIONS** **574**  
Everyday news from the world of electronics
- NEW TECHNOLOGY UPDATE** by Ian Poole **576**  
Developments in battery technology
- FOX REPORT** by Barry Fox **582**  
Interfering Interference; MS-DOS Patent Battle; Stacker Stall? Wilful
- THOSE AMAZING BARCODE** by Alan Winstanley **606**  
The how what and why of barcodes
- READOUT** **613**  
Your news and views
- HOME BASE** by Terry Pinnell **614**  
Jottings of an electronics hobbyist
- SHOPTALK** with David Barrington **617**  
Component buying for EPE projects
- DIRECT BOOK SERVICE** **623**  
A wide range of technical books available by mail order
- PRINTED CIRCUIT BOARD SERVICE** **626**  
PCBs for EPE projects - some at sale prices
- ELECTRONICS VIDEOS** **628**  
Our range of educational videos to compliment your studies
- FREE WITH THIS ISSUE - GREENWELD SUMMER SALE CATALOGUE** **between pages 592 and 593**
- ADVERTISER'S INDEX** **632**

Our September '93 Issue will be published on Friday, 6 August 1993. See page 555 for details.

Readers Services • Editorial and Advertisement Departments 565

# Electronic Designs Right First Time?

## From Schematic Capture -

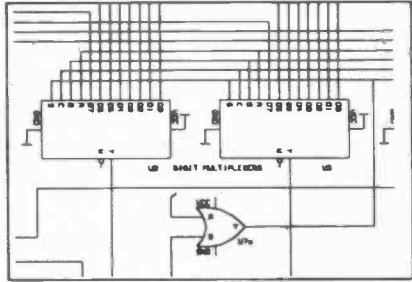

EASY-PC Professional

Create your schematics quickly and efficiently on your PC using **EASY-PC Professional**. Areas of the circuit can be highlighted on screen and simulated automatically using our **PULSAR**, **ANALYSER III** and **Z-MATCH II** simulation programs.

## through Analogue and Digital Simulation -

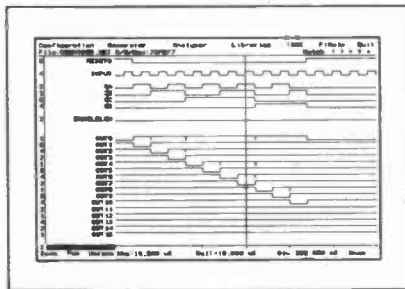

PULSAR

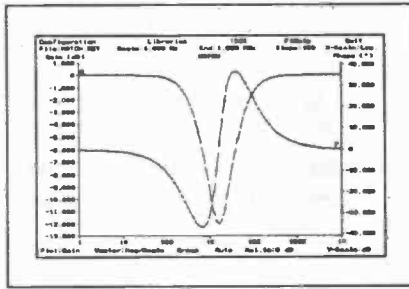

ANALYSER III

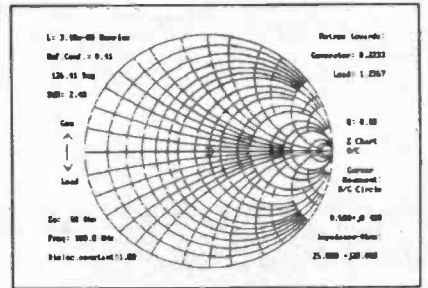

Z-MATCH II

If the results of the simulations are not as expected, the configuration and component values of the circuit can be modified until the required performance is achieved.

## to Printed Circuit Board Design!

The design, complete with connectivity, can then be translated into the PCB. The connectivity and design rules can be checked automatically to ensure that the PCB matches the schematic.

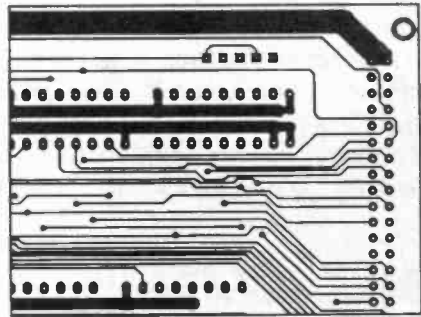

EASY-PC Professional

## Affordable Electronics CAD

<b>EASY-PC:</b> Low cost, entry level PCB and Schematic CAD.	<b>\$195.00</b>	<b>£98.00</b>
<b>EASY-PC Professional:</b> Schematic Capture and PCB CAD. Links directly to ANALYSER III and PULSAR.	<b>\$375.00</b>	<b>£195.00</b>
<b>PULSAR:</b> Low cost Digital Circuit Simulator ~ 1500 gate capacity.	<b>\$195.00</b>	<b>£98.00</b>
<b>PULSAR Professional:</b> Digital Circuit Simulator ~ 50,000 gate capacity.	<b>\$375.00</b>	<b>£195.00</b>
<b>ANALYSER III:</b> Low cost Linear Analogue Circuit Simulator ~ 130 nodes.	<b>\$195.00</b>	<b>£98.00</b>
<b>ANALYSER III Professional:</b> Linear Analogue Circuit Simulator ~ 750 nodes.	<b>\$375.00</b>	<b>£195.00</b>
<b>Z-MATCH II:</b> Smith Chart program for RF Engineers - direct import from ANALYSER III.	<b>\$375.00</b>	<b>£195.00</b>
<i>We operate a no penalty upgrade policy. You can upgrade at any time to the professional version of a program for the difference in price.</i>	US\$ prices include Post and Packing	Sterling Prices exclude P&P and VAT.

Ask for our fully functional Integrated CAD DEMO!

## Number One Systems Ltd.

Ref: EVD, Harding Way, St. Ives, Huntingdon, Cambs. PE17 4WR, UK.

For Full Information Please Write, Phone or Fax.

**Tel: 0480 461778**

**Fax: 0480 494042**

USA tel 011- 44 - 480 461778 fax 011- 44 - 480 494042

VISA, MasterCard, AMERICAN EXPRESS



## **SOUND ACTIVATED CAMERA TRIGGER**

*Most cameras have a self-timer facility which enables photographs to be taken about five to ten seconds after the release button has been activated. This facility is included primarily to enable the photographer to take self portraits. In many instances a simple self-timer facility is quite adequate, but the delay sometimes proves to be too short. In particular, it is often inadequate when the photographer has to position him or herself in a group of people. The delay can also be too short if the photographer wishes to pose with a prop, such as "the one that did not get away", or some sort of cup or trophy.*

*With this unit the general idea is to get into position and then shout to activate the trigger. After a brief delay to allow the operator to compose him or herself, the camera is then automatically triggered.*

## **CHARGE-15**

### **Quarter-hour charging for AA batteries**

*Charge-15 is a mains-operated unit designed to charge a set of the popular "AA" type (HP7 size) nickel-cadmium cells in about 15 minutes – hence the name. This time compares with 15 hours for commercial standard charging units and between two and five hours for the fast charge variety. It will thus be found useful whenever batteries are likely to let you down suddenly or where it is essential to have ready access to a fully-charged set.*

*Ultra-fast charging is not thought to be particularly good for batteries and it is possible that they may suffer from some shortening of life. However, in tests on the prototype unit, cells were repeatedly charged and discharged over 50 cycles and were found to be still in perfectly good condition at the end with no significant loss of capacity. Since a nickel-cadmium cell costs little more than the throw-away alkaline variety these days (about £1 compared with 70p) any shortening of life is thought to be of little consequence even taking into account the much lower energy content (one fifth approximately) of rechargeable cells compared with alkaline ones.*

## **LIGHT WORK**

### **A handy aid for checking trailer or caravan lights**

*Light Work provides a convenient way of testing the operation of rear lights on a caravan or trailer. It will thus be found useful for any reader who owns a caravan, boat or motorcycle trailer, horse box, etc. With this unit you can check the rear lights from the drivers seat without assistance, trailing wires or mirrors etc. It's all done with electronics!*

**EVERYDAY**

WITH **PRACTICAL**

**ELECTRONICS**

SEPTEMBER ISSUE ON SALE FRIDAY, AUGUST 6th

# SURVEILLANCE PROFESSIONAL QUALITY KITS

## No. 1 for Kits

Whether your requirement for surveillance equipment is amateur, professional or you are just fascinated by this unique area of electronics SUMA DESIGNS has a kit to fit the bill. We have been designing electronic surveillance equipment for over 12 years and you can be sure that all of our kits are very well tried, tested and proven and come complete with full instructions, circuit diagrams, assembly details and all high quality components including fibreglass PCB. Unless otherwise stated all transmitters are tuneable and can be received on an ordinary VHF FM radio.

- UTX Ultra-miniature Room Transmitter**  
Smallest room transmitter kit in the world! Incredible 10mm x 20mm including mic. 3-12V operation. 500m range.....£16.45
- MTX Micro-miniature Room Transmitter**  
Best-selling micro-miniature Room Transmitter  
Just 17mm x 17mm including mic. 3-12V operation. 1000m range.....£13.45
- STX High-performance Room Transmitter**  
Hi performance transmitter with a buffered output stage for greater stability and range. Measures 22mm x 22mm including mic. 6-12V operation, 1500m range.....£15.45
- VT500 High-power Room Transmitter**  
Powerful 250mW output providing excellent range and performance. Size 20mm x 40mm. 9-12V operation. 3000m range.....£16.45
- VXT Voice Activated Transmitter**  
Triggers only when sounds are detected. Very low standby current. Variable sensitivity and delay with LED indicator. Size 20mm x 67mm. 9V operation. 1000m range...£19.45
- HVX400 Mains Powered Room Transmitter**  
Connects directly to 240V AC supply for long-term monitoring. Size 30mm x 35mm. 500m range.....£19.45
- SCRX Subcarrier Scrambled Room Transmitter**  
Scrambled output from this transmitter cannot be monitored without the SCDM decoder connected to the receiver. Size 20mm x 67mm. 9V operation. 1000m range.....£22.95
- SC LX Subcarrier Telephone Transmitter**  
Connects to telephone line anywhere, requires no batteries. Output scrambled so requires SCDM connected to receiver. Size 32mm x 37mm. 1000m range.....£23.95
- SCDM Subcarrier Decoder Unit for SCR X**  
Connects to receiver earphone socket and provides decoded audio output to headphones. Size 32mm x 70mm. 9-12V operation.....£22.95
- ATR2 Micro Size Telephone Recording Interface**  
Connects between telephone line (anywhere) and cassette recorder. Switches tape automatically as phone is used. All conversations recorded. Size 16mm x 32mm. Powered from line.....£13.45

- UTLX Ultra-miniature Telephone Transmitter**  
Smallest telephone transmitter kit available. Incredible size of 10mm x 20mm!  
Connects to line (anywhere) and switches on and off with phone use.  
All conversation transmitted. Powered from line. 500m range.....£15.95
- TLX700 Micro-miniature Telephone Transmitter**  
Best-selling telephone transmitter. Being 20mm x 20mm it is easier to assemble than UTLX. Connects to line (anywhere) and switches on and off with phone use. All conversations transmitted. Powered from line. 1000m range.....£13.45
- STLX High-performance Telephone Transmitter**  
High performance transmitter with buffered output stage providing excellent stability and performance. Connects to line (anywhere) and switches on and off with phone use. All conversations transmitted. Powered from line. Size 22mm x 22mm. 1500m range.....£16.45
- TKX900 Signalling/Tracking Transmitter**  
Transmits a continuous stream of audio pulses with variable tone and rate. Ideal for signalling or tracking purposes. High power output giving range up to 3000m. Size 25mm x 63mm. 9V operation.....£22.95
- CD400 Pocket Bug Detector/Locator**  
LED and piezo bleeper pulse slowly, rate of pulse and pitch of tone increase as you approach signal. Gain control allows pinpointing of source. Size 45mm x 54mm. 9V operation.....£30.95
- CD600 Professional Bug Detector/Locator**  
Multicolour readout of signal strength with variable rate bleeper and variable sensitivity used to detect and locate hidden transmitters. Switch to AUDIO CONFORM mode to distinguish between localised bug transmission and normal legitimate signals such as pagers, cellular, taxis etc. Size 70mm x 100mm. 9V operation.....£50.95
- QTX180 Crystal Controlled Room Transmitter**  
Narrow band FM transmitter for the ultimate in privacy. Operates on 180 MHz and requires the use of a scanner receiver or our QRX180 kit (see catalogue). Size 20mm x 67mm. 9V operation. 1000m range.....£40.95
- QLX180 Crystal Controlled Telephone Transmitter**  
As per QTX180 but connects to telephone line to monitor both sides of conversations. 20mm x 67mm. 9V operation. 1000m range.....£40.95
- QSX180 Line Powered Crystal Controlled Phone Transmitter**  
As per QLX180 but draws power requirements from line. No batteries required. Size 32mm x 37mm. Range 500m.....£35.95
- QRX180 Crystal Controlled FM Receiver**  
For monitoring any of the 'Q' range transmitters...High sensitivity unit. All RF section supplied as a pre-built and aligned module ready to connect on board so no difficulty setting up. Outpt to headphones. 60mm x 75mm. 9V operation.....£60.95

### ★★★ Specials ★★★

- DLTX/DLRX Radio Control Switch**  
Remote control anything around your home or garden, outside lights, alarms, paging system etc. System consists of a small VHF transmitter with digital encoder and receiver unit with decoder and relay output, momentary or alternate, 8-way di1 switches on both boards set your own unique security code. TX size 45mm x 45mm. RX size 35mm x 90mm. Both 9V operation. Range up to 200m.  
Complete System (2 kits).....£50.95  
Individual Transmitter DLTX.....£19.95  
Individual Receiver DLRX.....£37.95
- MBX-1 Hi-Fi Micro Broadcaster**  
Not technically a surveillance device but a great idea! Connects to the headphone output of your Hi-Fi, tape or CD and transmits Hi-Fi quality to a nearby radio. Listen to your favourite music anywhere around the house, garden, in the bath or in the garage and you don't have to put up with the DJ's choice and boring waffle. Size 27mm x 60mm. 9V operation. 250m range.....£20.95

#### A build-up service is available on all our kits if required.

UK customers please send cheques, POs or registered cash. Please add £1.50 per order for P&P. Goods despatched ASAP allowing for cheque clearance. Overseas customers send sterling bank draft and add £5.00 per order for shipment. Credit card orders welcomed on 0827 714476.

**OUR LATEST CATALOGUE CONTAINING MANY MORE NEW SURVEILLANCE KITS NOW AVAILABLE. SEND TWO FIRST CLASS STAMPS OR OVERSEAS SEND TWO IRCS.**

**SUMA  
DESIGNS**

**DEPT. EE**  
**THE WORKSHOPS, 95 MAIN ROAD,**  
**BAXTERLEY. NEAR ATHERSTONE,**  
**WARWICKSHIRE CV9 2LE**  
VISITORS STRICTLY BY APPOINTMENT ONLY



**Tel/Fax:**  
**0827 714476**

# MAILTECH

## ELECTRONIC COMPONENTS

**PROJECT BOXES** A range of high quality boxes moulded in black high impact ABS, easily drilled or punched to produce a professional looking end product

TYPE	W	L	H	PRICE
T2	75	56	25	£0.77
T4	111	57	22	£0.92
MB1	79	61	40	£1.35
MB2	100	76	41	£1.47
MB3	118	98	45	£1.71
MB4	216	130	85	£5.19
MB5	150	100	60	£2.35
MB6	220	150	64	£3.95
MB7	177	120	83	£3.42
MB8	150	80	50	£2.22

All sizes are in millimetres

**MICRO SWITCH** roller arm operation spdt 40p each

**MINIATURE TOGGLE SWITCHES**

spdt	60p each	spdt 3 position c/off	70p each
dpdt	70p each	dpdt 3 position c/off	80p each
spdt biased	60p each	spdt 3 position c/off biased both ways	70p each
		dpdt 3 position c/off biased one way	80p each

**MINIATURE TOGGLE SWITCH** pcb mounting 3pdt 50p each 10 for £4.00

**MINIATURE PUSH TO MAKE SWITCH** 50p each

**DIL RELAYS** 5 volt dp/changeover 60p 10 for £5.00

12 volt dp/changeover 80p 10 for £6.00

**RELAY** 10 amp contacts sp/changeover 12 volt coil £1.20 each

**CAR HORN RELAY** In metal can with fixing lug, s/pole on 10 amp contacts £1.00 each 6 for £5.00

**20 AMP RELAY** dp on 12 volt coil £1.50 each 4 for £5.00

**REED RELAY** 12 volt 50p each 10 for £4.00

**240 VOLT AC RELAY** 3-pole c/o 10 amp contacts £1.50 each 4 for £5.00

DIL SKTS		'D' CONNECTORS		
8 pin	10 for £0.60	plug	socket	cover
14 pin	10 for £0.90	9 pin	30p	35p
16 pin	10 for £1.00	15 pin	40p	35p
18 pin	10 for £1.00	25 pin	50p	40p
20 pin	8 for £1.00			
24 pin	8 for £1.00			
28 pin	6 for £1.00			
40 pin	5 for £1.00			

### ALL COMPONENTS FULL SPECIFICATION DEVICES

### SEMICONDUCTORS - TRANSISTORS - ICS - DIODES - REGULATORS - ETC

<b>VOLTAGE REGS</b>		
7812/7805/7912/7905		all 35p each, any 4 for £1.20
AD592An Temperature Sensor i.c. mounted on 1.5m screened lead		
complete with data and application notes		£1.50 each
LM3914/LM3915 Bargraph ic's		£2.95 each
78512 12V +VE 2amp regulator		50p each
78505 5V +VE 2amp regulator		50p each
<b>MICRO IC'S</b> -Z80A CPU £1.20; Z80A PIO £1.50; Z80B SIO-1 £4.00		

### OPTO DEVICES - LEDS - ETC

5mm rnd red/yellow/green/amber	10p each 12 for £1.00 any mix
5mm rnd high brightness red/green	20p each 6 for £1.00 any mix
5mm rnd flashing	red 60p each, yellow/green 70p each
5mm rnd bi-colour	35p each, tri-colour 45p each
LED mounted in chrome bezel red, yellow or green	30p each, 4 for £1
LED mounted in a black bezel red only	25p each, 5 for £1.00
PLASTIC BEZEL for 5mm rnd leds	10 for 40p
High brightness bi-colour i.e.d., rectangular, red/green, two leads	40p each

### RESET TIMER PCB

Gives a timed relay closure following a momentary input. Requires 12V d.c. supply SP c/o relay output LED indication. 19 different time intervals from 25sec to 35min 20sec. £5.98 each.

### ALARM CONTROL UNIT

Single zone alarm control unit built into a domestic light switch box. Ideal for home, caravan, boat, garage, shed etc.

Facilities: - Normally closed loop for pir sensors, door/window contacts etc.

Normally open loop for pressure mats.

24-hour loop for personal attack button

Visual indication that the system is operational.

Automatic entry/exit delay.

Automatic system reset.

Alarm output cmos logic level.

PRICE COMPLETE WITH FULL INSTRUCTIONS £8.95

BELL/SIREN INTERFACE BOARD COMPLETE £3.95

### PASSIVE INFRA-RED ALARM SENSORS

**SUB-MINIATURE PASSIVE INFRA-RED SENSOR ONLY £5.95**

Brand new passive infra-red sensor, measures only 33mmW x 24mmH x 29mmD.

Logic level output. Full data and application notes supplied.

**EX INSTALLATION SENSORS** tested working.

Type 1. Measures 180 x 112 x 70mm with walk test led, relay output and tamper protection. 12 volt dc supply required £8.50 each

Type 2. As above but a smaller unit 123 x 62 x 50mm £11.75 each

Type 3. Ceiling mounting passive, infra red sensor 360° detection, 12V d.c. supply relay output, tamper circuit and pulse count option. Data supplied. £15.70 each

**DOOR/WINDOW CONTACTS** Surface or flush mounting, white £1.10 each

**JUNCTION BOX** white 6 way 60p

**DUAL TECH SENSOR** Microwave and passive Infra-red combined. Separate led indication for each function. Measures 120 x 75 x 50mm. 12 volt d.c. supply, Relay output. Tamper protection. £29.95 each



Please note: There may be variations in the size of the above passive infra red sensors depending on stock at the time of ordering. But the unit will certainly be within the stated sizes.

### BREADBOARDS - CAPACITORS - SOLAR CELLS - HEATSHRINK - ETC

**SOLAR CELL** 2 volt 150mA max, size 60 x 100mm £1.35 each 5 for £6

**BNC SOCKETS** 50 ohm single hole fixing 50p each 10 for £4.00

**MERCURY TILT SWITCH**  
Standard on/off £1.00 each  
4 Contact (Directional) £1.50 each  
**PIEZD VIBRATION SENSOR**  
with data sheet £1.00 each

**BREADBOARD**  
173 X 65mm 840TP £5.25 each  
**TEXTOL ZIF SOCKET**  
28 pin zero insertion socket £5.95 each

**6 VOLT NI-CAD PACK** 5AA NI-CADS, fast charge type £3.95

**CAPACITOR** 10,000 mfd 25 volt with fixing clip 60p each

**EPROMS 27C256 - 30 27C512 - 25.** Once programmed but never used eprom.

Mounted on a plastic carrier, can easily be removed from the carrier or used with a low insertion force socket.

**27C256** £1.00 each 6 for £5.00 **27C512** £1.20 each 5 for £5.00

Suitable low insertion force socket 28 pin 40p each 3 for £1.00

**MULTITURN PRESETS** 20mm RECT, 500R, 1K, 5K, 10K, 20K, 50K, 100K, 1M0. 40p each, 3 for £1.00

**CAR CIGAR LIGHTER ADAPTER (DUAL SIZE)** mounted on two metres of cable £2.00 each

**100db PIEZO SOUNDER** 2KHz note, 3-12V d.c. 40Ma, 45mm dia. x 26mm £1.76 each

**VIBRATION SENSITIVE ALARM BOARD WITH PIEZO SOUNDER** Originally a bike alarm. There is a short delay after activation then the piezo sounder operates for a preset period. £3.76 each

or the above alarm board with custom designed case, fixing clip and keyswitch £9.95

**INFRA-RED BREAK BEAM** Transmitter and receiver p.c.b. with 2 lens assemblies. 12V d.c. supply. These are ex-installation units and are not guaranteed to be working. £4.96 pair

**RECHARGEABLE BATTERIES** AA (HP7) 600 mA H £1.02 each C (HP11) 1200 mA H £2.29 each

D (HP2) 1200 mA H £2.40 each PP3 8.4V 100 mA H £4.77 each

**FLOURESCENT LIGHT INVERTOR.** Drives an 8 watt tube directly from 6V d.c. Data supplied £4.50 each

## £1.00 BARGAIN PACKS

### SUB-MINIATURE TOGGLE SWITCHES

P.C.B. Mounting

- BO1 S.P. on 4 for £1.00
- BO2 D.P. on 3 for £1.00
- BO3 3 x D.P. 3 pos. centre off
- BO04 DIL SWITCHES 4-way S.P. on 3 for £1.00
- BO05 DIL SWITCHES 8-way S.P. on 2 for £1.00
- BO06 DIL SWITCHES 12-way 90° sp on 2 for £1.00
- BO07 12 x PP3 BATTERY SNAPS
- BO08 1 x CAPACITOR 1 FARAD 5.5 VOLT 20mm dia. x 7mm high
- BO09 INSTRUMENT KNOBS (0.25" SHAFT) High quality grey plastic knob, collet fixing 15mm dia, 5 for £1.00
- BO10 as above but 29mm dia, 3 for £1.00
- BO11 4 x MAGNETIC EARPICCE 8 ohm with 3.5mm plug
- BO12 4 x 28-WAY TURNED PIN DIL SOCKET
- BO13 15 x 12 VOLT WIRE-ENDED LAMPS
- BO14 8 x 2 PIN DIN PLUGS screw terminal connection
- BO15 2 x LIGHT DEPENDENT RESISTOR Less than 200 ohms in daylight, greater than 10 megohms in darkness
- BO16 1 x KEYPAD 20-key in 5 x 4 matrix bubble type switch contacts
- BO17 2 x PIEZO BUZZERS approx 3 to 20 volt d.c.
- BO18 5 x 78M12 VOLTAGE REGULATORS positive 12V 500mA
- BO19 4 x TL082CP bi-fet op-amps
- BO20 20 x ASSORTED LEDS full spec. various shapes and sizes
- BO21 3 x INFRA-RED DIODE TX/RX PAIRS made by Honeywell (no info)
- BO22 4 x CONSTANT CURRENT LED 5mm round, red 2-18V d.c. or a.c. nominal 14mA
- BO23 50 x IN4148 diode
- BO24 2 x INFRA-RED TRANSISTOR FPT5133
- BO25 5 x DIACS
- BO26 3 BDY33C 10 amp 100V npn transistor
- BO27 12 x 2N3702 Transistor
- BO28 12 x 2N3904 Transistor
- BO29 12 x BC337 Transistor
- BO30 4 x LM317T Variable regulator mounted on a small heatsink
- BO31 2 x MAN6610 2 digit 0.6" 7 segment display Com anode, amber
- BO32 3 x PHONO TO PHONO LEAD 63cm long
- BO33 15 x RECTANGULAR RED LEDs 6 x 6 x 2mm stackable
- BO34 1 x PHOTO SENSITIVE SCR mounted on a PCB, data sheet supplied
- BO35 4 x IEC Panel Mounting Mains Plug Snap fix
- BO36 5 x ASSORTED PIEZO TRANSDUCERS
- BO37 5 LENGTHS OF HEATSHRINK SLEEVING 8mm dia. 400mm long
- BO38 25 x CERAMIC DISC CAPACITORS 0.1 mfd 63V
- BO39 15 x MONOLITHIC CERAMIC CAPACITORS 0.1 mfd 63V, in a dil package
- BO40 25 x ASSORTED ELECTROLYTIC CAPACITORS PCB mounting useful values
- BO41 25 ASSORTED PRE-SET RESISTORS
- BO42 6 x 3-5mm LINE JACK SOCKETS (mono)
- BO43 6 x 3-5mm JACK PLUG (mono)
- BO44 8 x 3-5mm CHASSIS SOCKET (mono).
- BO45 2 x TRIACS 800 volt 8 amp
- BO46 12 x BC213L Transistor
- BO47 12 x MIN SLIDE SWITCH dpdt
- BO48 15 x MIN CERMET TRIMMER POTS (good range of values)
- BO49 1 x PCB WITH TWO LARGE LEDS 15mm square, one red and one green
- BO50 1 x 12V DC RELAY 4-pole c/o with plug in base
- BO51 4 x LM324 quad op-amps
- BO52 4 x 555 Timer
- BO53 5 x 741 op-amp
- BO54 25 x IN4001 diode
- BO55 20 x IN4007 diode
- BO56 1 x SLOTTED OPTO
- BO57 1 x DAC08 Digital to analogue converter with data
- BO58 4 x OPTO ISOLATOR

Please use order code when ordering the bargain packs.

Please make cheques and postal orders payable to Mailtech.

All prices include VAT.

Please add 75p postage to all orders.

At the moment it is not possible to have a full telephone answering service. But we will have the phone definitely manned on Tuesdays, Wednesdays and Thursdays between 10am and 5pm.

**Dept EE, Mailtech**  
**PO Box 16 Ludlow**  
**Shropshire SY8 4NA**  
**Tel: 058 474475**

**WE HAVE THE WIDEST CHOICE OF USED OSCILLOSCOPES IN THE COUNTRY**

**TEKTRONIX 7000 SERIES OSCILLOSCOPES**  
Dual Trace Plug-in with TB from **£200**  
Many Plug-in options available. 4 Traces, Differential etc. PLUG-INS SOLD SEPARATELY.

PHILIPS 3070 Dual Trace 100MHz Delay Sweep Trig View  
CleverCursors Liquid Crystal Display **£900**  
KIKUSUI CS056100M 3 Channel + Ch4/Ch5 Trig View 100MHz Delay Sweep **£900**  
HITACHI V1050F Dual Trace 100MHz Dual TB with 4 Chn. Mode **£450**  
TEKTRONIX 475 Dual Trace 20MHz Delay Sweep **£550**  
HP 1715A Dual Trace 20MHz Delay Sweep **£550**  
TEKTRONIX 465 Dual Trace 100MHz Delay Sweep **£600**  
HP 1740A Dual Trace 100MHz Delay Sweep **£600**  
TEKTRONIX 2225 Dual Trace 50MHz Alternate TB Magnification **£650**  
PHILIPS PM3217 Dual Trace 50MHz Delay Sweep **£600**  
HITACHI V650F Dual Trace 60MHz Delay Sweep **£600**  
TB EQUIPMENT DB3 Dual Trace 50MHz Delay Sweep **£200**  
GOULD OS3000A Dual Trace 40MHz Delay Sweep **£200**  
KIKUSUI 5530 Dual Trace 30MHz **£180**  
GOULD OS1100 Dual Trace 30MHz **£160**  
GOULD OS500 Dual Trace 20MHz **£200**  
GOULD OS250B Dual Trace 15MHz **£125**

THIS IS JUST A SAMPLE - MANY OTHERS AVAILABLE

PHILIPS PMS193 Programmable synthesizer/Function generator 0.1MHz-50MHz IEEE-488. As new **£1500**

MARCONI 2019 Synthesised AM/FM Sig Gen 80kHz-1040MHz **£2000**  
MARCONI 2018 Synthesised AM/FM Sig Gen 80kHz-520MHz **£950**  
EP 545 Microwave Frequency Counter 10Hz-18GHz **£1400**  
EP/DANA 351D Microwave Frequency Counter 20Hz-18GHz **£1400**  
RACAL 9921 Frequency Counter 3GHz **£300**  
HP 339A Distortion Measuring Set 10Hz-110kHz **£1500**  
RACAL/DANA 1991 Nanosecond Universal Counter **£800**  
RACAL 9302 RF Millivoltmeter True RMS 10kHz-1.5GHz **£450**  
RACAL 9301A RF Millivoltmeter True RMS 10kHz-1.5GHz **£300**  
RACAL 3009 Automatic Mod Meter 10kHz-1.5GHz Wide **£180**  
Distortion **£250**  
HP Pulse Generator Type 214B **£750**  
LYONS PG73N Pulse Gen PPF 1Hz-20MHz **£150**  
MARCONI 2610 True RMS Voltmeter **£800**  
GOULD Biomation K5000 Logic Analyser **£500**  
FARNELL P9520H Synthesised Sig Gen AM/FM 100kHz-520MHz **£600**  
LEADER LSC216 AM/FM Sig Gen 0.1-30MHz & 75-115MHz **£400**  
KEITHLEY 1975 1/2 digit Autorange Microvolt DMM with IEEE **£250**

**SPECTRUM ANALYSERS**

HP 141T 855A & IF Plug-in 10MHz-18GHz **£1800**  
HP 141T with 855A & 8552B 500kHz-1250MHz **£1300**  
HP 140T with 855A & 8552A 500kHz-1250MHz **£1000**  
HP 141T with 855A & 8552B 20Hz-300MHz **£1000**  
HP 140T with 855A & 8552A 10Hz-110MHz **£800**  
MARCONI TF2370 30Hz-100MHz **£1500**  
HP 182C with 8558 100kHz-1500MHz **£1500**

DATRON 1061A Multimeter 6 1/2 digit with True RMS AC/Current **£1250**  
DATRON 1065 Multimeter 5 1/2 digit AC/DC/Ohms IEEE **£800**  
HEWLETT PACKARD 3490A Bench Multimeter, 5 1/2 digit **£200**  
AC/DC/Ohms **£450**  
PHILIPS MA2534 Multi-Function DMM 6 1/2 digit GPIB/IEEE **£175**  
MARCONI Digital Frequency Meter 2450A 10Hz-800MHz **£150**  
MARCONI Digital Frequency Meter 2451A 10Hz-200MHz **£150**  
MARCONI Universal Counter Timer 2437 DC-100MHz **£175**  
MARCONI Universal Counter Timer 2438 DC-520MHz **£225**  
HP 3311A Function Generator 0.1Hz-1MHz Sine/Sq/Tri **£125**  
BLACK STAR Jupiter 500 Sine/Tri 1Hz-500kHz **£70**  
FEEDBACK FG600 Sine/Sq/Tri 0.1Hz-100MHz **£80**  
MULTIMETER handheld M2355-32 ranges AC/DC 10 Amps Dode/Transistor Tester Freq counter **£32.50**

**FARNELL ELECTRONIC LOAD RB1030-35**

1KW 30Amp 35 Volt **£600**  
HP B690B Sweep Osc with B6974 Plug-in 26.5-400Hz **£300**  
RACAL/DANA RF Power Meter 9104 **£800**  
RACAL/DANA 9341 Databridge Automatic LCR & Q **£350**  
WAYNE KERR B905 Automatic Precision Bridge 0.05% **£900**  
WAYNE KERR B605 Automatic Component Bridge 0.1 **£350**  
AVO AC/DC Breakdown Leakage & Ionization Tester RM215L/2 **£600**  
FARNELL PSU TV570MK2 70V 5A/30V 10A **£900**  
FARNELL PSU H60/25 0-60V 0-25A Metered **£800**  
FARNELL PSU L30E 0-30V 0-5A Metered **£80**  
FARNELL B30 20-0-30V 20A **£250**  
HP B255A 0-40V 0-1.5A Twice Metered **£150**  
HP B2095 0-320V 0.01A Metered **£125**  
TELEQUIPMENT CT71 Curve Tracer **£150**  
MARCONI TF2700 Universal LCR Bridge Battery **£150**  
AVO Wave Characteristic Meter VM163 **£300**  
LEADER LFM 39A Wow & Flutter Meter **£250**  
PHILIPS PMS509 Colourbar Generator **£275**  
FARNELL LAS20 RF Power Amp 1.5-520MHz 100W **£175**  
RACAL 9100 Absorption Wattmeter 1MHz-1GHz 3W **£100**

FARNELL Isolating Transformers GU500 240V 500VA Un-used **£50**

**NEW EQUIPMENT**

HAMEG OSCILLOSCOPE HM1005 Triple Trace 100MHz Delay Timebase **£847**  
HAMEG OSCILLOSCOPE HM604 Dual Trace 60MHz Delay Sweep **£653**  
HAMEG OSCILLOSCOPE HM203-7 Dual Trace 20MHz Component Tester **£362**  
HAMEG OSCILLOSCOPE HM205-3 Dual Trace 20MHz Digital Storage **£665**  
All other models available - all oscilloscopes supplied with 2 probes

**BLACK STAR EQUIPMENT (P&P all units £5)**  
APOLLO 10-100MHz Counter Timer Ratio/Period/Time interval **£222**  
APOLLO 100-100MHz (as above with more functions) **£325**  
METEOR 100 FREQUENCY COUNTER 100MHz **£109**  
METEOR 600 FREQUENCY COUNTER 600MHz **£135**  
METEOR 1000 FREQUENCY COUNTER 1GHz **£178**  
JUPITOR 500 FUNCTION GEN 0.1Hz-500kHz Sine/Sq/Tri **£110**  
ORION COLOUR BAR GENERATOR Pal/TV/Video **£229**  
All other Black Star equipment available

OSCILLOSCOPE PROBES Switched X1 X10 (P&P £3) **£11**

# SUMMER 1993 CATALOGUE



## The new enlarged Cirkit Catalogue is out now!

- 32 more pages
- New range of Kenwood 'scopes
- The latest scanning receivers and accessories
- New section of low cost security products
- Extended range of Velleman kits including: 250W 12Vdc to 220Vac inverter, in-car amplifier power supply, 200 and 400W amplifiers, suppressed lamp dimmer, halogen lamp dimmer, day/night thermostat and telephone remote control unit
- New test equipment, includes: 2.3GHz bench frequency counter, EPROM emulator/programmer, portable 'scopes and bench function generators
- Host of new components, including: compression trimmers, variable capacitors, connectors, fuses, and fuseholders, potentiometers, IC's, soldering irons and lead free solder
- Published 27th May 1993
- Available from most large newsagents or directly from Cirkit
- **Send for your copy today!**

**£1.90**  
+ 30p p&p

**Cirkit**



**CIRKIT DISTRIBUTION LTD**

Park Lane · Broxbourne · Hertfordshire · EN10 7NQ  
Telephone (0992) 444111 · Fax (0992) 464457

**TRANSFORMERS FROM JAYTEE**

The UK Distributor for  
**Standard Toroidal Transformers**

\* 106 types available from stock  
\* Sizes from 15VA to 625VA

Write or phone for free Data Pack

**Jaytee Electronic Services**  
143 Reculver Road, Beltinge, Herne Bay, Kent CT6 6PL  
Telephone: (0227) 375254



# EASY FAST & POWERFUL CAD SOFTWARE THAT GIVES YOU THE EDGE

## ISIS - SCHEMATIC CAPTURE

Easy to use yet extremely powerful schematic entry system with all the features you need to create input for ARES or other CAD software. Now available in a super-fast 32 bit version capable of handling huge designs even on A0-sized sheets.

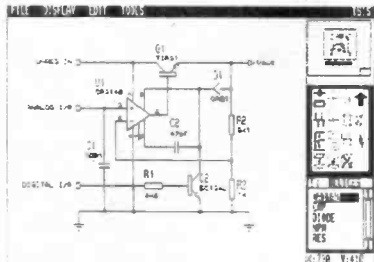

- Graphical User Interface gives exceptional ease of use - two mouse clicks will place & route a wire.
- Automatic wire routing, dot placement, label generation.
- 2D drawing capability with symbol library.
- Comprehensive device libraries.
- Heterogeneous devices (e.g. relay and coil) allowed in different places on the schematic.
- Special support for connector pins put each pin just where you want it.
- Output to printers, plotters, Postscript.
- Export designs to DTP and WP packages.
- Netlist formats for most popular PCB & simulation software.
- Bill of Materials and Electrical Rules Check reports.
- Multi-sheet and hierarchical design support.
- Automatic annotation/packaging.
- ASCII data import database facility.

from

**£275**

## ARES - PCB DESIGN

Advanced netlist based PCB layout software newly updated to version 2.5. Major new features include SMT library, real time snap (for those tricky SMT spacings), thermal relief power planes and enhanced autorouting.

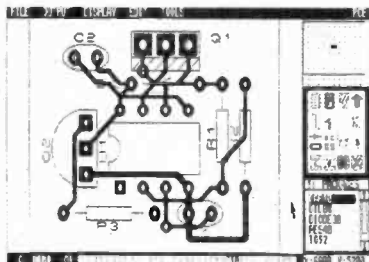

- Graphical User Interface.
- Real time snap.
- Auto track necking.
- Curved, 45/90 or any angle tracks.
- Extensive through hole and SMT package libraries as standard.
- 2D drawing capability with symbol library.
- Connectivity highlight.
- Output to printers, plotters, Postscript, Gerber and NC drill.
- Gerber View facility.
- Graphics export for DTP etc.
- Advanced netlist management with forward design modification.
- Component renumber and back-annotate to ISIS.
- Full physical and electrical design rule checks.
- Autorouter handles single, double or multi-layer boards.
- Power plane generator with reliefs.
- Strategy & DRC information loadable from ISIS.
- Gerber import utility available.

from

**£275**

## ISIS ILLUSTRATOR

Schematic capture for MS Windows 3.1 - produces high quality schematics like you see in the magazines with your choice of line thicknesses, fill styles, fonts, colours etc. Once entered, drawings can be copied to most Windows software through the clipboard.

*New version 2 includes netlisting, bill of materials, hierarchy, and much more. An ideal front end for Windows Simulation and PCB design.*

new low prices from

**£99**

## CADPAK - BUDGET PRICE CAD

Two programs ISIS SUPERSKETCH and PCB II for the price of one.

CADPAK has everything you need to produce circuit diagrams and PCBs on your PC and is exceptionally easy to use.

superb value at only

**£79**

**labcenter**  
Electronics



Call us today on 0274 542868 or fax 0274 481078 for a demo pack. Combination, multi-copy and educational discounts available. Prices exc P&P and VAT.

14 Marriner's Drive, Bradford, BD9 4JT.

## electronize electronic kits

### TOTAL ENERGY DISCHARGE ELECTRONIC IGNITION

A unique extended CDI system gives a super high power spark under conditions where the standard system just cannot cope. The contact breaker is retained for ease of fitting but operates only at low power.

EXTENDED CDI IGNITION parts kit £24.75 assembled £32.75

### MICRO-PRESSURE CAR ALARM

A unique air pressure sensing system operates automatically without door switches etc. and is disarmed with the ignition key. Provides exit and entry delays with audible warning when triggered. Easily fitted with only three leads. A Power MOSFET output drives a siren or the car horn.

MICRO-PRESSURE CAR ALARM parts kit £15.95 assembled £22.35

### VOLT DROP OPERATED CAR ALARM

A similar unit to the above but relying on the courtesy light operation and the well known volt drop detection system.

VOLT DROP CAR ALARM parts kit £14.90 assembled £20.95

### MICRO PRESSURE TRIGGER

A small module to up-grade any volt drop alarm to "Micro-Pressure" sensing or combine the benefits of both systems.

MICRO PRESSURE TRIGGER parts kit £10.95 assembled £14.95

### 120dB PIEZO SIREN

A high intensity vehicle alarm siren for use with the above alarms.

120dB PIEZO SIREN assembled only £11.95

### CODED INFRARED RECEIVER

A dash top mounted unit gives coded remote control of the above alarms. Includes a security chip with anti-scanning and 59,046 customer selectable combinations. Also has "Mega Bright" flashing LED to warn off intruders.

CODED IR RECEIVER parts kit £21.35 assembled £26.55

### CODED INFRARED TRANSMITTER

A key ring code transmitter for the above with a range up to 5 metres.

CODED IR TRANSMITTER parts kit £13.95 assembled £17.95

All the above include cable, connectors and clear easy to follow instructions. All kits include case, PCB, everything down to the last washer, even solder. Prices are mail order discount, fully inclusive and apply for U.K. and export. Telephone orders accepted with VISA or ACCESS payment. Ask for detailed brochures or order direct (please quote EE8) from :-

**ELECTRONIZE DESIGN** Tel. 021 308 5877  
2 Hillside Road, Four Oaks, Sutton Coldfield, B74 4DQ

## NEW FROM AUSTRALIA

### SINGLE BOARD COMPUTER FOR 1990s

The Southern Cross SBC is designed to teach beginners modern code development techniques as well as assembly language. Start with machine language using the on-board 21 hex digit keypad, then progress to using a PC. Assembler provided with many program examples. Serial download assembled program from PC to Southern Cross. Serial interface provided.

Simple but powerful monitor program fully annotated. Learn to use parts of it in your own programs by 'system calls' & using a 'header file'.

Learn how to single step through your program to find errors. Both hardware & software single stepping provided & explained.

We do not fill the User Manual with pages of theory. Go straight to program examples. Starts from a very basic level anyone can follow.

The Southern Cross system includes ● all CMOS ICs ● hardware speed control ● 8K EPROM ● 64K RAM ● 4.00 MHz Z80 ● 10 year RAM backup with optional DS1213B ● calendar/time access & RAM backup with optional DS1216B ● 9-15V AC/DC. Single-sided PCB 9.75" x 5.15".

Two add-on boards available. Relay Board to connect to real world of lights & motors and 8x8 LED module Board to write moving displays.

**Southern Cross Kit £79.50 Assembled £94.50**  
8x8 Board £29.90 DS1213B SmartSocket £24.50  
Relay Board £15.50 DS1216B SmartWatch £34.50

### 'INTELLIGENT' EPROM EMULATOR

Full explanation of how to construct & use it. Uses 5 ICs & 8748 uC. Emulates 8K, 16K & 32K EPROM. Recognises binary & Intel hex files in software. Connects to printer port 1 or 2 on a PC. Reset sent in software before file transfer. /F switch fills unused emulated ROM with any hex byte. Powered from target system. Cables included. Small 4.5" x 2.3" double-sided, PCB with overlay. Many examples provided on floppy disk.

Kit £52.90 Assembled £59.50

Designed in Australia, manufactured in Hong Kong. Airmail postage included. Ask me for more information. Full technical support.

Peter Crowcroft Ph.D. Fax: (852) 7250610  
DIY Electronics  
GPO Box 904 HONG KONG



### UK DISTRIBUTOR AND STOCKIST FOR THE COMPLETE ILP RANGE

- ★ AMPLIFIER MODULES
- ★ PRE-AMPLIFIERS
- ★ 100V LINE TRANSFORMERS
- ★ TOROIDAL TRANSFORMERS
- ★ LIGHTING TRANSFORMERS

*Write, phone or fax  
for data and prices*

### Jaytee Electronic Services

143 Reculver Road, Beltinge, Herne Bay, Kent CT6 6PL  
Telephone: (0227) 375254. Fax: (0227) 365104

SERVICE  
MANUALS

### TEST EQUIPMENT MAINTENANCE

SPARE  
PARTS

Did you know that we provide repair and calibration services, supply technical manuals, and spare parts for test equipment-manufactured by over 100 different companies?

POWER SUPPLIES, SIGNAL GENERATORS,  
SPECTRUM ANALYSERS, AMPLIFIERS,  
FREQUENCY COUNTERS, MULTIMETERS  
(ANALOGUE & DIGITAL), OSCILLOSCOPES,  
POWER METERS ETC. ETC.

FULL TECHNICAL SUPPORT INCLUDING  
PROFESSIONAL DESIGN,  
DEVELOPMENT, COMMISSIONING,  
CONTRACT MAINTENANCE AND  
SYSTEM INTEGRATION.

### Hesing Technology <sup>HT</sup>

Cromwell Chambers,  
8 St. Johns Street,  
Huntingdon,  
Cambs. PE18 6DD  
Tel: (0480) 433156  
Fax: (0480) 413357

NEW &  
SECONDHAND  
TEST EQUIPMENT

REPAIR  
AND CALIBRATION  
(TRACEABLE IF  
REQUIRED)

# MARCO

VISA

(Incorporating East Cornwall Components) Dept. 8

THE MALTINGS, HIGH STREET, WEM,  
SHREWSBURY SY4 5EN

Tel: (0939) 232763 (3 lines) or  
(0939) 232689 (2 lines). Fax: (0939) 233800

MAIL ORDER - WHOLESALE - RETAIL

P&P NOW £3.00. All prices include V.A.T.  
Delivery Guaranteed within three days

VISIT OUR BRANCHES

WALTONS SUPERTRONICS  
55A WORCESTER STREET 65 HURST STREET  
WOLVERHAMPTON WV2 4LL BIRMINGHAM B5 4TE  
Tel: 0902 22039 Tel: 021 666504

HAVE YOU GOT OUR LATEST  
'93 CATALOGUE

172 PAGES - LOADS OF SPECIAL OFFERS  
ONLY £2.00 (Inc. pre-paid envelope)

## ★ AUGUST SPECIAL OFFER ★

### JUST IN "SUPER LOOP"

#### MICROCHIP TV AERIAL

An integral signal amplifier  
a unique multi-function  
i.e.d. indicator - needs  
no power supply - instead  
powered by TWO batts.  
Super loop sensor circuits  
detect whether the  
TV set is on or off.  
An override facility  
is provided for  
unattended video  
recording.

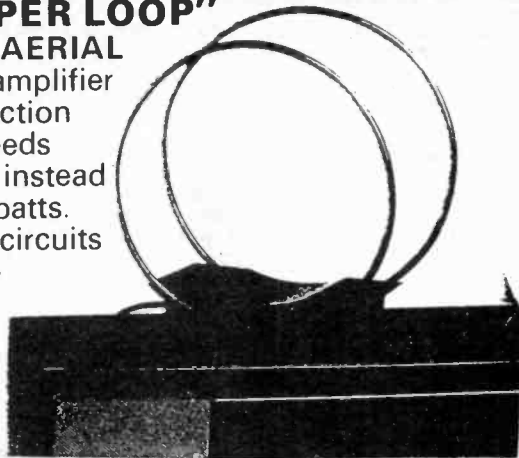

Designed to BS5373.

**ONLY £19.99** (NORMALLY £25.99)

### COAX CABLE SPECIAL

- ★ WHILE STOCKS LAST ★
  - 100 metre reel **White** ★
  - ★ 75 ohm low loss UHF TV ★
  - ★ down lead ★
- (Cat. Price £15.95) **£12.99**  
A REEL

### HOME ALARM PACKAGE

Includes:  
★ Optima Alarm Control Panel  
★ External Red Bell Box  
★ 2 x 1 Internal Passive I.R.  
★ 2 x Door Contacts  
★ Siren for bell box  
★ 100 mtrs. cable and clips  
★ Full fitting instructions

**BELL BOXES**  
3 colours  
White/Red/  
Yellow  
**£6.99**

ONLY £130

### TWIN FLUORESCENT LAMP - 12V PORTABLE FLUORESCENT LAMP - 12V



A very attractive twin tube lamp-holder with two 12V BW fluorescent tubes. White plastic case with clear plastic ribbed diffuser and ON/OFF switch. Supplied with 90cms of twin flex for connection to 12V battery (Red stripe to positive). Ideal for caravans, boats, vans, etc.  
Overall dimensions: 370 x 65 x 41mm  
ORDER CODE Opto TFL12

Free-standing or hanging with 15ft cable terminating in cigar lighter plug. For use in car, boat, van or home emergency. 12V d.c. EVEN FLOATS IN WATER!  
Overall dimensions: 430 x 30mm  
ORDER CODE OPTO/T12

1+ 10+  
PRICE **£6.50** **£6.00**

**SPARE TUBES**  
Replacement tube for above Twin and Single fluorescent lamps. Fits most 12V fluorescent lamps. Philips, etc. Tube length: approx 300mm (inc. pins).  
ORDER CODE Opto Tube **£1.50 ea, 10 for £12**

**SINGLE FLUORESCENT LAMP - 12V**  
Identical to above unit but single tube. 12V d.c. 8 Watts. Dims 360 x 62 x 37mm.  
ORDER CODE Opto SL **£5.50**

### STRIPBOARD CUTTER

Simply insert tool at the break required and twist clockwise.  
Order Code: PCB/0600  
Price: 1 + £2.45 10 + £2.05

★ ★ ★ ★  
**ULTRA VIOLET EXPOSURE UNIT WITH TIMER**  
Code PCB UV  
**£79.50**

### CLOSED CIRCUIT TELEVISION SYSTEM

1x CAMERA **£125** 1x CAMERA BRACKET **£8.50**  
USED NEW  
Complete price **£199** Plus £12 carr  
Wide Angle Lens (NEW) **£55**  
USED  
£95 1x MONITOR

### PORTASOL SOLDERING KIT

Made in Ireland.



Serves as Gas Soldering Iron, Torch, Hot Blow and Hot Knife.

Normally **£38.00**  
Order Code: OLD/PORTA  
Special Price: **£29.99**  
(ALSO PORTABLE GAS IRON ONLY £15.50 SPARE TIPS £5.75)

### QUARTZ-HALOGEN SPOTLIGHT

THIS UNIT SUBJECT TO DESIGN CHANGE  
Hand held or hanging. Heat resistant polycarbonate housing, highly polished reflector. Protective lens cover doubles as base stand. With On/Off switch and 12ft curly cable terminating in cigar lighter plug. Produces 250,000 candle power - 5 times the intensity of average car headlamps.  
Price **£5.75**



Power ..... 12V d.c. 4.5A 55W  
Dims ..... 160 x 88 x 110mm

### ANTEX IRONS

C-15W IRON...£9.30 XS-KIT 25W...£13.45  
CS-17W IRON...£9.35 CS-KIT 17W...£13.30  
XS-25W IRON...£9.50 C-KIT 15W...£13.15  
All bits for irons £1.95, Elements £5.30 Stands £3.75

### DESOLDER MP

High quality ..... **£3.50**  
Spare Tips ..... **75p each**

### NI-AD CHARGER

Charges AA, AAA, C, D & PP3  
Ni-Cads 240V AC

**£4.99**



**24 HOUR ANSWER PHONE OR FAX  
YOUR ORDER NOW 0939 233800**

### NI-CAD RECHARGEABLE BATTERIES

	PRICE EACH	10+
AAA	£1.50	£1.30
AA	95p	85p
C	£1.95	£1.80
D	£2.00	£1.85
PP3	£3.90	£3.75

### SOLDER 18 & 22SWG 500gm REEL

	1+	10+
18SWG 500G	£4.95	£4.70
22SWG 500G	£4.99	£4.75

Remember: Our prices INCLUDE VAT!

### PCB ETCH-RESIST MARKER PEN - DALO

An etch-resist marker pen similar to the one above, but having better adhesion to the board if it is not perfectly clean of grease and oxides.

Order Code: PCB/PEN 2  
Price 1 + £2.40 10 + £2.20



**SHOP OPEN 9-5 MON-FRI. CLOSED SAT --- OFFICIAL ORDERS WELCOME**

## E.E. TREASURE HUNTER P.I. METAL DETECTOR

Magenta's highly developed & acclaimed design. Quartz crystal controlled circuit MOSFET coil drive. D.C. coupled amplification. Detects 10p coin at 20 cm. Full kit includes PCB, handle, case & search coil.



- KIT INC. HEADPHONES
- EFFICIENT CMOS DESIGN
- POWERFUL COIL DRIVE

- DETECTS FERROUS AND NON-FERROUS METAL - GOLD, SILVER, COPPER ETC.
- 190mm SEARCH COIL
- NO 'GROUND EFFECT'

KIT 815.....£45.95

## DIGITAL LCD THERMOSTAT

A versatile thermostat using a thermistor probe and having an I.c.d. display. MIN/MAX memories, -10 to 110 degrees celsius, or can be set to read in Fahrenheit. Individually settable upper and lower switching temperatures allow close control, or alternatively allow a wide 'dead band' to be set which can result in substantial energy savings when used with domestic hot water systems. Ideal for greenhouse ventilation or heating control, aquaria, home brewing, etc. Mains powered, 10A SPCO relay output. Punched and printed case.

KIT 841.....£29.95

## 4 CHANNEL LIGHT CHASER

A 1000W per channel chaser with Zero Volt Switching, Hard Drive, and full inductive load capability. Built-in mic. and sophisticated 'Beat Seeker' circuit - chase steps to music, or auto when silent. Variable speed and mic. sensitivity control, I.e.d. mimic on front panel. Switchable for 3 or 4 channels. P552 output socket. Suits Rope Lights, Pin Spots, Disco, and Display lighting.

KIT 833.....£32.13

## SUPERHET LW MW RADIO

At last an easy to build SUPERHET AM radio kit. Covers Long and Medium waves. Built in loudspeaker with 1 Watt output. Excellent sensitivity and selectivity provided by ceramic IF filter. Simple alignment and tuning without special equipment. Supplied with pre-drilled transparent front panel and dial, for interesting see-through appearance.

KIT 835.....£17.16

## ACOUSTIC PROBE

A very popular project which picks up vibrations by means of a contact probe and passes them on to a pair of headphones or an amplifier. Sounds from engines, watches, and speech travelling through walls can be amplified and heard clearly. Useful for mechanics, instrument engineers, and nosey parkers!

KIT 740.....£19.98

## KIT HIGHLIGHT

### DIGITAL CAPACITANCE METER KIT 493

This has been one of Megenta's best ever kits. It provides clear readings of capacitance values from a few pF up to thousands of µF. It is ideal for beginners as there is no confusion over the placing of the decimal point, and it allows obscurely marked components to be identified quickly and easily. Quartz controlled accuracy of 1%, large clear 5 digit display and high speed operation make it a very useful instrument for production and testing departments. The kit is now supplied with a punched and printed front panel as well as the case, all components and top quality printed circuit board. When assembled it looks a really professional job. For a limited time this kit is offered at a new low price.

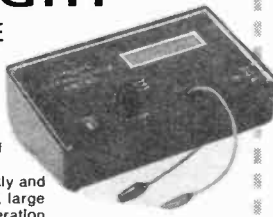

PRICE  
£39.95

### MOSFET VARIABLE BENCH POWER SUPPLY 25V 2.5A

Our own high performance design. Variable output Voltage from 0 to 25V and Current limit from 0 to 2.5A. Capable of powering almost anything. Two panel meters indicate Voltage and Current. Fully protected against short-circuits. The variable Current limit control makes this supply ideal for constant current charging of NICAD cells and batteries. A Power MOSFET handles the output for exceptional ruggedness and reliability. Uses a toroidal mains transformer.

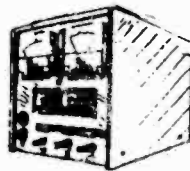

KIT 769.....£56.82

### ULTRASONIC PeST SCARER

Keep pets/pests away from newly sown areas, fruit, vegetable and flower beds, children's play areas, patios etc. This project produces intense pulses of ultrasound which deter visiting animals.



- KIT INCLUDES ALL COMPONENTS, PCB & CASE
- EFFICIENT 100V TRANSDUCER OUTPUT
- LOW CURRENT DRAIN

- COMPLETELY INAUDIBLE TO HUMANS
- UP TO 4 METRES RANGE

KIT Ref. 812.....£14.81

MAINS ADAPTOR.....£2.50

### IONISER

A highly efficient mains powered Negative Ion Generator that clears the air by neutralising excess positive ions. Many claimed health benefits due to the ioniser removing dust and pollen from the air and clearing smoke particles. Costs virtually nothing to run and is completely safe in operation. Uses five point emitters.

KIT 707.....£17.75

### BAT DETECTOR

An excellent circuit which reduces ultrasound frequencies between 20 and 100 kHz to the normal (human) audible range. Operating rather like a radio receiver the circuit allows the listener to tune-in to the ultrasonic frequencies of interest. Listening to Bats is fascinating, and it is possible to identify various different types using this project. Other uses have been found in industry for vibration monitoring etc.

KIT 814.....£21.44

### 12V EPROM ERASER

A safe low cost eraser for up to 4 EPROMs at a time in less than 20 minutes. Operates from a 12V supply (400mA). Used extensively for mobile work - updating equipment in the field etc. Also in educational situations where mains supplies are not allowed. Safety interlock prevents contact with UV.

KIT 790.....£28.51

### EE TREASURE HUNTER

Our own widely acclaimed design. This sensitive Pulse Induction metal detector picks up coins and rings etc up to 20cm deep. Negligible 'ground effect' means that the detector can even be used with the head immersed in sea water. Easy to use, circuit requires only a minimum of setting up as a Quartz crystal provides all of the critical timing. Kit includes search-head, handle, case, PCB and all components.

KIT 815.....£45.95

### INSULATION TESTER

A reliable and neat electronic tester which checks insulation resistance of wiring and appliances etc., at 500 Volts. The unit is battery powered, simple and safe to operate. Leakage resistance of up to 100 Megohms can be read easily. A very popular college project.

KIT 444.....£22.37

### 3 BAND SHORT WAVE RADIO

Covers 1.6 to 30MHz in three bands using modern miniature plug-in coils. Audio output is via a built-in loudspeaker. Advanced stable design gives excellent stability, sensitivity and selectivity. Simple to build battery powered circuit. Receives a vast number of stations at all times of the day.

KIT 718.....£30.30

### DIGITAL COMBINATION LOCK

Digital lock with 12 key keypad. Entering a four digit code operates a 250V 16A relay. A special anti-tamper circuit permits the relay board to be mounted remotely. Ideal car immobiliser, operates from 12V. Drilled case, brushed aluminium keypad.

KIT 840.....£19.86

### PORTABLE ULTRASONIC PeST SCARER

A powerful 23kHz ultrasound generator in a compact hand-held case. MOSFET output drives a special sealed transducer with intense pulses via a special tuned transformer. Sweeping frequency output is designed to give maximum output without any special setting up.

KIT 842.....£22.56

### LIGHT RIDER DISCO LIGHTS

A six channel light driver that scans from left to right and back continuously. Variable speed control. Up to 500 watts per channel. Housed in a plastic box for complete safety. Built on a single printed circuit board.

KIT 560.....£22.41

### LIGHT RIDER 9-12V CHASER LIGHTS

A low voltage DC powered end-to-end type chaser that can be set for any number of lights between 3 and 16. The kit is supplied with 16 I.e.d.s but by adding power transistors it is possible to drive filament bulbs for a larger brighter display. Very popular with car customisers and modellers. I.e.d.s can be randomly positioned and paired to give twinkling effects.

KIT 559.....£15.58

**SEE OUR FULL RANGE OF KITS, BOOKS, TOOLS, AND COMPONENTS IN OUR CATALOGUE**

### HAMEG HM203-7 20 MHz DUAL TRACE OSCILLOSCOPE & COMPONENT TESTER

Western Europe's best selling oscilloscope - It is RELIABLE, HIGH PERFORMANCE, & EASY TO USE. Sharp bright display on 8 x 10cm screen with internal graticule. A special extra feature is the built-in component tester which allows capacitors, resistors, transistors, diodes and many other components to be checked. The quality of this instrument is our warranty. If you are buying an oscilloscope - this is the one. - It costs a fraction more than some other 20 MHz scopes but it is far far superior. Supplied with test probes, mains lead, and manual.

£338.00 + £59.15 VAT Includes FREE Next-day delivery (Cheques must be cleared)

### EDUCATIONAL BOOKS & PACKS

#### ADVENTURES WITH ELECTRONICS

The classic book by Tom Duncan used throughout schools. Very well illustrated, ideal first book for age 10 on. No soldering. Uses an S.DEC breadboard.

Book & Components £28.95, Book only £6.25

#### FUN WITH ELECTRONICS

An Usborne book, wonderfully illustrated in colour. Component pack allows 6 projects to be built and kept. Soldering is necessary. Age 12 on, or younger with adult help. Book & Components £20.88, Book only £2.95

#### 30 SOLDERLESS BREADBOARD PROJECTS

A more advanced book to follow the others. No soldering. Circuits cover a wide range of interests.

Book & Components £30.69, Book only £2.95

### DC MOTOR/GEARBOXES

Ideal for robots, buggies, and many other mechanical projects. Min. plastic gearbox with 1.5-4.5V DC motor. 6 ratios can be set up.

Small type MGS...£4.77  
Large type MGL...£5.58

### STEPPING MOTORS

For computer control via standard 4 pole unipolar drivers.

MD35 1/4 - standard 48 steps per rev.....£12.99  
MD38 - miniature 48 MD200 - miniature 200 steps per rev.....£9.15

# Teach-In '93

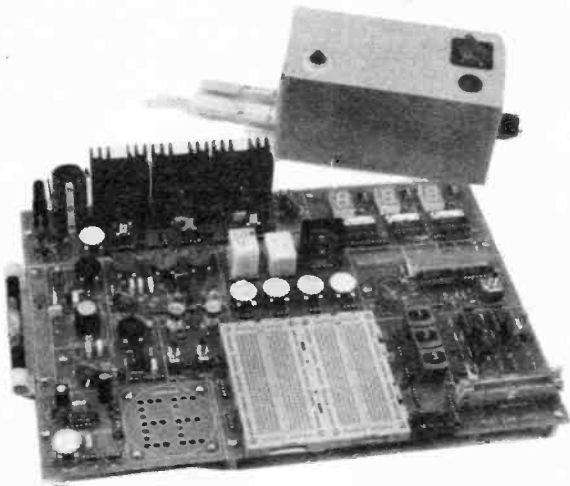

## MINI LAB KITS

ALL COMPONENTS TO ASSEMBLE THE EPE MINI LAB ARE AVAILABLE FROM MAGENTA.

The easy way to buy the correct parts to follow this exciting new educational series.

Components are supplied in packs to keep ordering simple.

A full MINI LAB consists of ML1, ML3, ML5, ML6. These are available at a special combined price of.....**£114.99**  
or less the p.c.b.

ML2, ML3, ML5, ML6 at.....**£104.99**

The transformer unit ML4 is also needed....**£21.45**

- |         |   |               |
|---------|---|---------------|
| KIT ML1 | MINI-LAB P.C.B. + all components inclusive of breadboard for Part 1 (Nov. '92)..... | <b>£49.95</b> |
| KIT ML2 | All Components for Part 1 less p.c.b.....   | <b>£39.95</b> |
| KIT ML3 | Power Supply components.....  | <b>£19.95</b> |
| KIT ML4 | Transformer unit.....   | <b>£21.45</b> |
| KIT ML5 | L.E.D. Voltmeter, signal generator, audio amplifier and 555 timer.....              | <b>£33.95</b> |
| KIT ML6 | Logic probe, display, radio tuner.....  | <b>£17.95</b> |

(Note: batteries not included)

All prices include V.A.T. Add **£2.00** p&p.

Tel: 0283 65435 Fax: 0283 46932

# Teach-In '93

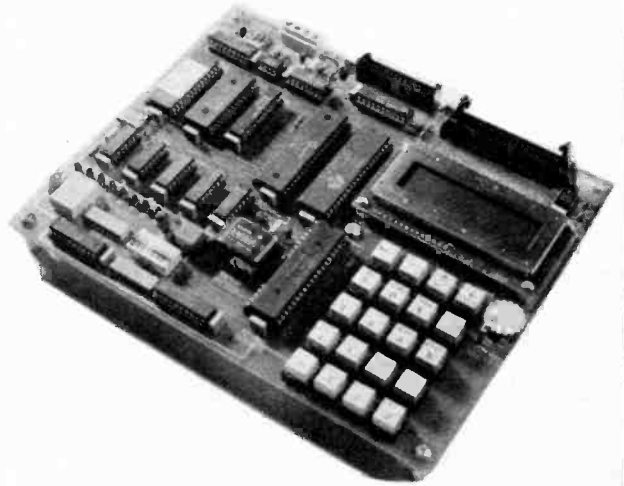

## MICRO LAB KITS

ALL COMPONENTS TO ASSEMBLE THE EPE MICRO LAB ARE AVAILABLE FROM MAGENTA.

Be sure that you have all the correct parts for the MICRO LAB.

Repair/fault-finding help assured when you buy your kit from us.

Full MICRO LAB kit including PC Board, EPROM, PAL, & Booklet

MIC 1 .....**£149.95**

(Also available less PCB etc. if required).

## BUILT & TESTED

Full MICRO LAB AS MIC1 (above)

MIC1B.....**£179.95**

Professionally assembled, inspected, cleaned and tested. Full back-up service, spares, etc available.

All prices include V.A.T. Add **£2.00** p&p.

Tel: 0283 65435 Fax: 0283 46932



# ESR ELECTRONIC COMPONENTS

Station Road, Cullercoats,  
Tyne & Wear NE30 4PQ  
Tel. 091 251 4363 Fax. 091 252 2296

74LS-Series		4000 Series		TRANSISTORS		LINEAR ICs		SOLDERING IRONS		RF CONNECTORS	
74LS00	£0.14	4000	£0.17	2N1613	£0.33	BC186	£0.47	CA311E	£0.28	Antex Soldering irons	
74LS01	£0.14	4001	£0.17	2N1711	£0.26	BC204C	£0.48	CA32A	£0.23	M 12 Watt	£7.75
74LS02	£0.14	4002	£0.17	2N1893	£0.29	BC206E	£0.72	CA355	£0.22	C 15 Watt	£7.78
74LS03	£0.14	4006	£0.22	2N2194	£0.32	BC207C	£0.72	CA371E	£0.18	G 18 Watt	£7.96
74LS04	£0.14	4007	£0.17	2N2188A	£0.28	BC208A	£0.72	CA374CE	£0.39	CS 17 Watt	£7.88
74LS05	£0.14	4008	£0.31	2N2222A	£0.18	BC209A	£0.65	CA380E	£0.37	XS 25 Watt	£7.96
74LS08	£0.14	4009	£0.19	2N2646	£0.80	BC212	£0.08	CA3080	£0.72	ST4 STAND	£2.85
74LS09	£0.14	4010	£0.23	2N2904A	£0.25	BC212L	£0.08	CA3130	£0.98	35 Watt Gas Iron	£11.58
74LS10	£0.14	4011	£0.16	2N2905A	£0.23	BC212L	£0.08	CA3130E	£0.98	Dissolder Pump	£3.00
74LS107	£0.23	4012	£0.16	2N2907	£0.20	BC213	£0.08	CA3140	£0.56	Antistatic Pump	£1.60
74LS109	£0.21	4013	£0.17	2N2926	£0.16	BC213L	£0.08	CA3240	£1.22	22SWG 0.5Kg Solder	£7.40
74LS11	£0.17	4014	£0.30	2N3053	£0.27	BC214	£0.08	ICL7621	£1.70	18SWG 0.5Kg Solder	£6.60
74LS112	£0.21	4015	£0.31	2N3054	£0.90	BC214L	£0.08	LM7555	£0.43	1mm 3 yds Solder	£0.62
74LS113	£0.21	4016	£0.18	2N3055	£0.62	BC237B	£0.09	LM7555	£0.96	Dissolder Braid	£0.87
74LS114	£0.21	4017	£0.27	2N3440	£0.50	BC238C	£0.09	LM301A	£0.25		
74LS112	£0.14	4018	£0.27	2N3702	£0.09	BC239C	£0.10	LM348N	£0.31		
74LS122	£0.31	4020	£0.19	2N3703	£0.10	BC251	£0.13	LM351N	£0.36		
74LS123	£0.31	4021	£0.31	2N3704	£0.10	BC252	£0.13	LM358N	£0.27		
74LS125	£0.31	4022	£0.32	2N3705	£0.10	BC261B	£0.24	LM3875	£1.60		
74LS126	£0.31	4023	£0.32	2N3706	£0.10	BC262B	£0.24	LM3877	£2.57		
74LS13	£0.14	4023	£0.16	2N3771	£1.44	BC267B	£0.30	LM380N	£1.12		
74LS132	£0.21	4024	£0.21	2N3772	£1.51	BC307	£0.10	LM381	£2.70		
74LS133	£0.18	4025	£0.15	2N3773	£1.79	BC308	£0.10	LM386	£0.48		
74LS136	£0.16	4026	£0.59	2N3819	£0.25	BC327	£0.10	LM3875	£1.60		
74LS138	£0.24	4028	£0.22	2N3904	£0.10	BC337	£0.10	LM3915	£0.70		
74LS139	£0.25	4029	£0.27	2N3905	£0.10	BC338	£0.10	LM393N	£0.28		
74LS14	£0.18	4030	£0.17	2N3906	£0.10	BC341C	£0.13	LM458	£0.26		
74LS147	£1.26	4031	£0.70	2N4306	£0.31	BC441	£0.40	LM3900	£0.72		
74LS148	£0.70	4034	£0.56	2N5295	£0.37	BC461	£0.40	LM3914	£2.70		
74LS15	£0.14	4035	£0.31	2N5321	£0.57	BC463	£0.29	LM3915	£1.60		
74LS151	£0.25	4040	£0.29	2N6107	£0.60	BC478	£0.32	MC3340	£1.60		
74LS153	£0.25	4041	£0.31	AC126	£0.30	BC479	£0.32	MC4558	£0.36		
74LS154	£0.25	4042	£0.22	AC127	£0.30	BC490	£0.24	NE531	£1.56		
74LS155	£0.25	4043	£0.22	AC128	£0.28	BC516	£0.22	NE566N	£0.36		
74LS156	£0.25	4044	£0.28	AC188	£0.37	BC517	£0.20	NE567N	£0.80		
74LS157	£0.25	4045	£0.35	AC189	£0.37	BC528	£0.20	NE568N	£0.80		
74LS158	£0.25	4047	£0.47	AC190	£0.37	BC529	£0.20	NE569N	£0.80		
74LS160	£0.32	4048	£0.31	AD161	£0.92	BC546C	£0.08	BU226A	£0.68		
74LS161	£0.32	4049	£0.20	AD162	£0.92	BC547C	£0.09	BU200A	£0.39		
74LS162	£0.32	4050	£0.20	AD163	£0.92	BC548C	£0.08	BU200B	£0.39		
74LS163	£0.32	4051	£0.25	BC107B	£0.15	BC549C	£0.08	BU200C	£0.39		
74LS164	£0.32	4052	£0.25	BC108	£0.15	BC550C	£0.08	BU200E	£0.66		
74LS165	£0.48	4053	£0.25	BC108A	£0.14	BC555C	£0.08	BU200F	£0.66		
74LS170	£0.30	4054	£0.58	BC108C	£0.14	BC557C	£0.08	BU200G	£0.66		
74LS173	£0.24	4055	£0.34	BC109	£0.14	BC558C	£0.08	BU200H	£0.66		
74LS174	£0.24	4060	£0.31	BC110	£0.14	BC559C	£0.08	MJ11015	£2.11		
74LS175	£0.24	4063	£0.29	BC115	£0.41	BC560B	£0.08	MJ2016	£1.60		
74LS190	£0.25	4066	£0.18	BC116	£0.41	BC637	£0.21	MJ3001	£1.52		
74LS191	£0.24	4067	£1.91	BC117	£0.41	BC638	£0.21	MJ3002	£1.52		
74LS192	£0.24	4068	£0.16	BC118	£0.41	BC639	£0.21	MJ3003	£1.52		
74LS193	£0.24	4069	£0.20	BC119	£0.41	BC640	£0.21	MJ3004	£1.52		
74LS195	£0.24	4070	£0.20	BC120	£0.41	BC641	£0.21	MJ3005	£1.52		
74LS196	£0.24	4071	£0.20	BC121	£0.41	BC642	£0.21	MJ3006	£1.52		
74LS197	£0.24	4072	£0.17	BC122	£0.41	BC643	£0.21	MJ3007	£1.52		
74LS20	£0.16	4073	£0.17	BC123	£0.41	BC644	£0.21	MJ3008	£1.52		
74LS21	£0.14	4075	£0.17	BC124	£0.41	BC645	£0.21	MJ3009	£1.52		
74LS22	£0.16	4076	£0.30	BC125	£0.41	BC646	£0.21	MJ3010	£1.52		
74LS221	£0.36	4077	£0.17	BC126	£0.41	BC647	£0.21	MJ3011	£1.52		
74LS240	£0.32	4081	£0.14	BC127	£0.41	BC648	£0.21	MJ3012	£1.52		
74LS241	£0.32	4082	£0.17	BC128	£0.41	BC649	£0.21	MJ3013	£1.52		
74LS242	£0.32	4085	£0.28	BC129	£0.41	BC650	£0.21	MJ3014	£1.52		
74LS243	£0.32	4086	£0.26	BC130	£0.41	BC651	£0.21	MJ3015	£1.52		
74LS244	£0.32	4089	£0.55	BC131	£0.41	BC652	£0.21	MJ3016	£1.52		
74LS245	£0.32	4093	£0.18	BC132	£0.41	BC653	£0.21	MJ3017	£1.52		
74LS247	£0.32	4094	£0.31	BC133	£0.41	BC654	£0.21	MJ3018	£1.52		
74LS251	£0.24	4095	£0.56	BC134	£0.41	BC655	£0.21	MJ3019	£1.52		
74LS257	£0.24	4097	£1.20	BC135	£0.41	BC656	£0.21	MJ3020	£1.52		
74LS258	£0.24	4098	£0.31	BC136	£0.41	BC657	£0.21	MJ3021	£1.52		
74LS26	£0.14	4099	£0.38	BC137	£0.41	BC658	£0.21	MJ3022	£1.52		
74LS266	£0.14	4502	£0.38	BC138	£0.41	BC659	£0.21	MJ3023	£1.52		
74LS273	£0.24	4508	£0.30	BC139	£0.41	BC660	£0.21	MJ3024	£1.52		
74LS279	£0.25	4510	£0.26	BC140	£0.41	BC661	£0.21	MJ3025	£1.52		
74LS30	£0.14	4511	£0.32	BC141	£0.41	BC662	£0.21	MJ3026	£1.52		
74LS32	£0.14	4512	£0.32	BC142	£0.41	BC663	£0.21	MJ3027	£1.52		
74LS365	£0.21	4515	£0.73	BC143	£0.41	BC664	£0.21	MJ3028	£1.52		
74LS367	£0.21	4516	£0.31	BC144	£0.41	BC665	£0.21	MJ3029	£1.52		
74LS368	£0.21	4518	£0.27	BC145	£0.41	BC666	£0.21	MJ3030	£1.52		
74LS37	£0.14	4520	£0.26	BC146	£0.41	BC667	£0.21	MJ3031	£1.52		
74LS373	£0.32	4520	£0.26	BC147	£0.41	BC668	£0.21	MJ3032	£1.52		
74LS374	£0.32	4521	£0.62	BC148	£0.41	BC669	£0.21	MJ3033	£1.52		
74LS375	£0.32	4526	£0.40	BC149	£0.41	BC670	£0.21	MJ3034	£1.52		
74LS376	£0.32	4527	£0.39	BC150	£0.41	BC671	£0.21	MJ3035	£1.52		
74LS377	£0.32	4528	£0.40	BC151	£0.41	BC672	£0.21	MJ3036	£1.52		
74LS378	£0.62	4529	£0.44	BC152	£0.41	BC673	£0.21	MJ3037	£1.52		
74LS38	£0.14	4532	£0.32	BC153	£0.41	BC674	£0.21	MJ3038	£1.52		
74LS380	£0.25	4534	£2.24	BC154	£0.41	BC675	£0.21	MJ3039	£1.52		
74LS393	£0.24	4536	£1.00	BC155	£0.41	BC676	£0.21	MJ3040	£1.52		
74LS395	£0.26	4538	£0.37	BC156	£0.41	BC677	£0.21	MJ3041	£1.52		
74LS399	£0.62	4541	£0.32	BC157	£0.41	BC678	£0.21	MJ3042	£1.52		
74LS40	£0.14	4543	£0.46	BC158	£0.41	BC679	£0.21	MJ3043	£1.52		
74LS42	£0.25	4555	£0.34	BC159	£0.41	BC680	£0.21	MJ3044	£1.52		
74LS47	£0.42	4566	£0.34	BC160	£0.41	BC681	£0.21	MJ3045	£1.52		
74LS51	£0.14	4560	£1.18	BC161	£0.41	BC682	£0.21	MJ3046	£1.52		
74LS570	£0.69	4572	£0.25	BC162	£0.41	BC683	£0.21	MJ3047	£1.52		
74LS73	£0.14	4576	£1.96	BC163	£0.41	BC684	£0.21	MJ3048	£1.52		
74LS74	£0.19	4584	£0.21	BC164	£0.41	BC685	£0.21	MJ3049	£1.52		
74LS75	£0.19	4585	£0.32	BC165	£0.41	BC686	£0.21	MJ3050	£1.52		
74LS76	£0.25	4724	£0.70	BC166	£0.41	BC687	£0.21	MJ3051	£1.52		
74LS83	£0.31	40106	£0.31	BC167	£0.41	BC688	£0.21	MJ3052	£1.52		
74LS85	£0.36	40109	£0.50	BC168	£0.						

# EVERYDAY WITH PRACTICAL ELECTRONICS

INCORPORATING ELECTRONICS MONTHLY

VOL. 22 No. 8

AUGUST '93

## GOLDEN EARED

When you get to the end of John Linsley Hood's *Audio Amplifier Design – Engineering or Alchemy* series, you will find the following paragraph. "Much of what is claimed by the 'golden eared' fraternity, does exist – but is much, much smaller than they think – and when it exists, and it sometimes doesn't, there are good reasons why."

I feel it is one of those statements that will be well quoted over the coming years. The series leads up to this conclusion and explains it "stage by stage", looking first at tests, both listening and engineering, and going on to see how components, even wire, can affect the results. Few designers are as open minded or enlightened as John and his examples and conclusions are interesting and stimulating. The series will make you think and hopefully understand the various views proffered within the hi-fi fraternity.

We are sure that not everyone will agree with everything he says and your letters on the subject are welcome, we must however ask that you keep them as short as possible. We hope to provide a couple of John's amplifier designs to round off the series.

## DESCALER

Everytime you look around at the moment the subject of the effects of magnetism on fluids and gases is causing controversy. We have seen various articles and tests on magnets used for car fuel enhancement and even on beer to reduce the requirements of cleaning pipes in Public Houses. We are sure there is more to come on this subject.

We will certainly be interested to hear of readers' experiences with our *Experimental Electronic Pipe Descaler* and hopefully such information will lead to a better general understanding of the subject by Joe Public. Once again your letters are welcome.

While the action of magnetism on water seems to be well accepted, claims for other magnetic devices aimed at fuel saving are certainly not yet proven, or at least not yet generally accepted as being proven. Anyone want to try a Descaler on their car fuel line or boiler gas pipe?

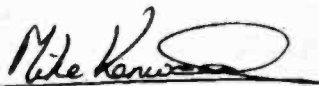

## SUBSCRIPTIONS

Annual subscriptions for delivery direct to any address in the UK: £20. Overseas: £26 (£43.50 airmail). Cheques or bank drafts (in £ sterling only) payable to Everyday with Practical Electronics and sent to EPE Subscriptions Dept., 6 Church Street, Wimborne, Dorset BH21 1JH. Tel: 0202 881749. Subscriptions start with the next available issue. We accept Access (MasterCard) or Visa payments, minimum credit card order £5.

## BACK ISSUES

Certain back issues of EVERYDAY ELECTRONICS, PRACTICAL ELECTRONICS and EVERYDAY WITH PRACTICAL ELECTRONICS (from Nov '92 onwards) are available price £2.00 (£2.50 overseas surface mail) inclusive of postage and packing per copy – £ sterling only please, Visa and Access (MasterCard) accepted, minimum credit card order £5. Enquiries with remittance, made payable to Everyday with Practical Electronics, should be sent to Post Sales Department, Everyday with Practical Electronics, 6 Church Street, Wimborne, Dorset BH21 1JH Tel: 0202 881749. In the event of non-availability one article can be photostatted for the same price. Normally sent within seven days but please allow 28 days for delivery. We have sold out of Jan, Feb, Mar, Apr, May, June, Oct, & Dec 88, Mar, May & Nov 89, Mar 90, April, Aug & Sept 91 Everyday Electronics, and can only supply back issues from Jan 92 to Oct 92 (excluding Mar 92) of Practical Electronics. Dec 92, Jan 93 and Feb 93 Everyday with Practical Electronics are also unavailable.

## BINDERS

New style binders to hold one volume (12 issues) are now available from the above address for £4.95 plus £3.50 post and packing (for overseas readers the postage is £6.00 to everywhere except Australia and Papua New Guinea which cost £10.50). Normally sent within seven days but please allow 28 days for delivery.

Payment in £ sterling only please. Visa and Access (MasterCard) accepted, minimum credit card order £5. Send card number and card expiry date with your name and address etc.

**Editorial Offices:**  
EVERYDAY with PRACTICAL ELECTRONICS EDITORIAL,  
6 CHURCH STREET, WIMBORNE,  
DORSET BH21 1JH  
Phone: Wimborne (0202) 881749  
Fax: (0202) 841692. DX: Wimborne 45314.  
See notes on Readers' Enquiries below – we regret that lengthy technical enquiries cannot be answered over the telephone.

**Advertisement Offices:**  
EVERYDAY with PRACTICAL ELECTRONICS  
ADVERTISEMENTS,  
HOLLAND WOOD HOUSE, CHURCH LANE,  
GREAT HOLLAND, ESSEX CO13 0JS.  
Phone/Fax: (0255) 850596

Editor: MIKE KENWARD

Secretary: PAM BROWN

Deputy Editor: DAVID BARRINGTON

Business Manager: DAVID J. LEAVER

Subscriptions: MARILYN GOLDBERG

Editorial: Wimborne (0202) 881749

Advertisement Manager:

PETER J. MEW, Frinton (0255) 850596

Advertisement Copy Controller:  
DEREK NEW, Wimborne (0202) 882299

## READERS' ENQUIRIES

We are unable to offer any advice on the use, purchase, repair or modification of commercial equipment or the incorporation or modification of designs published in the magazine. We regret that we cannot provide data or answer queries on articles or projects that are more than five years old. Letters requiring a personal reply must be accompanied by a stamped self-addressed envelope or a self addressed envelope and international reply coupons.

All reasonable precautions are taken to ensure that the advice and data given to readers is reliable. We cannot however guarantee it and we cannot accept legal responsibility for it.

## COMPONENT SUPPLIES

We do not supply electronic components or kits for building the projects featured, these can be supplied by advertisers.

We advise readers to check that all parts are still available before commencing any project in a back-dated issue.

We regret that we cannot provide data or answer queries on projects that are more than five years old.

## ADVERTISEMENTS

Although the proprietors and staff of EVERYDAY with PRACTICAL ELECTRONICS take reasonable precautions to protect the interests of readers by ensuring as far as practicable that advertisements are *bona fide*, the magazine and its Publishers cannot give any undertakings in respect of statements or claims made by advertisers, whether these advertisements are printed as part of the magazine, or are in the form of inserts.

The Publishers regret that under no circumstances will the magazine accept liability for non-receipt of goods ordered, or for late delivery, or for faults in manufacture. Legal remedies are available in respect of some of these circumstances, and readers who have complaints should first address them to the advertiser.

## TRANSMITTERS/BUGS/TELEPHONE EQUIPMENT

We would like to advise readers that certain items of radio transmitting and telephone equipment which may be advertised in our pages cannot be legally used in the UK. Readers should check the law before using any transmitting or telephone equipment as a fine, confiscation of equipment and/or imprisonment can result from illegal use. The laws vary from country to country; overseas readers should check local laws.



# BIKE ODOMETER

STEVE KNIGHT

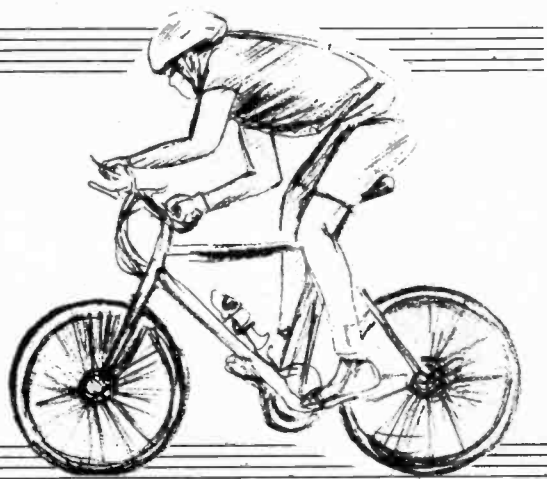

*Pedal power takes on a new meaning with this digital readout distance recorder.*

CYCLING is good for us all, so they say, and so a year or so ago the author abandoned his car and bought himself a two-wheeled machine with which he took to the leafy lanes whenever the sun was in the sky and strong winds were in another part of the country. All very nice and refreshing, too, but liking to know how far I had gone on each excursion so that my progress (or lack of it) could be quantified, I felt the need for some kind of distance measurer, or "odometer" as they call it in the trade.

Simple mechanical counters affixed to the front fork of the bike and tapped around by a projection attached to one of the spokes were common some years ago and perhaps still are. However, the making of an electronic system was enough of a challenge to get me started in that direction.

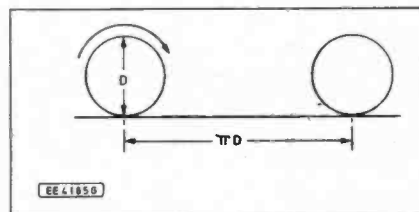

Fig. 1. For each revolution of the wheel the distance travelled is  $\pi$  times the diameter.

There is available a fully computerised odometer from "bike" shops which gives us not only distance but average speed, elapsed time, maximum speed and clock time; no doubt this will be used by entrants for the Olympics and the Milk Race, but something a little more basic (with component availability) will suit the rest of us.

## BASIC PRINCIPLES

Basically any distance measuring system must depend upon counting the number of revolutions a wheel; of known circumference, makes during a particular journey, and interpreting this number in terms of the total distance travelled. For a wheel of diameter  $D$  as shown in Fig. 1, the distance travelled per revolution is  $\pi D$ , hence the number of revolutions per mile (or km) is easily found by dividing the mile (or the km) by the distance  $\pi D$ , both in the appropriate units.

Knowing by some means how many revolutions have been made over the journey, the total distance can then be determined. To keep things uncomplicated we will work in miles, but anyone who wishes to work in metric may do so by following the same approach to the problem and making the necessary adjustments to the dividing circuitry in the general design.

There are three basic questions to ask before beginning an odometer design; what kind of display should be used; what kind of accuracy is required to make the building of the unit worth the while, and what maximum mileage needs to be recorded?

Well, answering the last question first. Not being an entrant for the Milk Race and being completely satisfied with a leisurely ride of perhaps twenty to thirty miles with a country pub somewhere about the half-way mark, I plumped for a maximum readout of 100 miles (161km), in steps of 0.1 mile.

So returning to the first question, what kind of display do we want, this can now be a three-digit l.e.d. system reading up to 99.9 miles. And the accuracy? Well, as we shall see later on, the basic accuracy at the 0.1 mile points can be less than one per cent; however, the readable accuracy must lie within the 0.1 mile minimum step.

For instance, at the end of a ride, if the display indicates, say, 23.4 miles, the actual distance may be anything from 23.4 miles to 23.49 miles; you may have only just passed the 23.4 mark or you may be just short of the 23.5 mark. But an "error" of

176 yards (0.1 mile) is not a lot to worry about on a journey of several miles and the added complication of another decimal place to read to an accuracy of 0.01 mile is hardly justified. So down to a practical design.

## BASIC CALCULATIONS

The cycle to be fitted with the odometer had 24in. diameter wheels, which are common enough, and the overall diameter with the tyres, measured from hub to ground with the machine upright was 26.2in. Working from this figure, the wheel circumference is  $26.2\pi$  or 82.3in. In travelling 0.1 mile, or 6336in., therefore, the wheel will rotate  $6336/82.3 = 77$  times. What we want, then, is a circuit system based on the block diagram of Fig. 2.

Some sort of wheel operated switch sends a pulse for each rotation of the wheel, via an anti-bounce circuit, to a system that will divide the input by 77, so that an output pulse is obtained for every 77 input pulses. Hence an output pulse is received for each 0.1 mile travelled. By counting these pulses and showing the result on a conventional display, the mileage covered will be indicated in steps of 0.1 mile up to the maximum of 99.9 miles.

Slight variations in tyre size will, of course, affect things somewhat, but even for changes in the overall wheel diameter of up to 0.5in., the error will be quite small and of little significance on the accuracy of the readout.

## CIRCUIT DESCRIPTION

Division by 77 is not quite so straightforward as division by, say, five or 10. There

Fig. 2. The block diagram for the Cycle Odometer designed for nominal 26in. wheels.

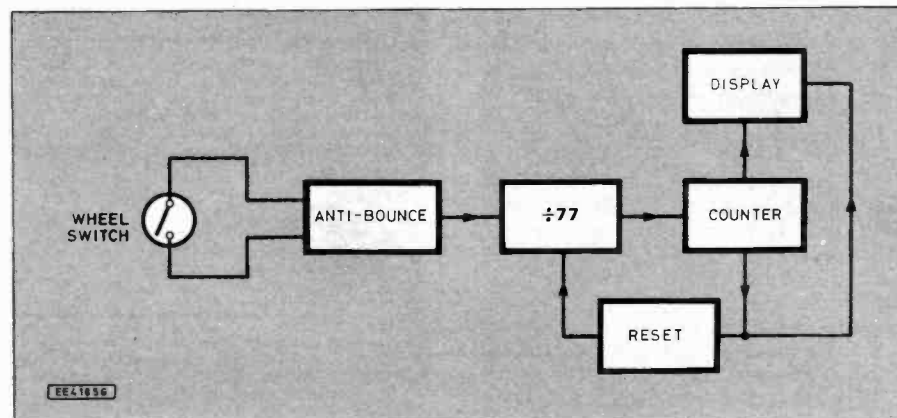



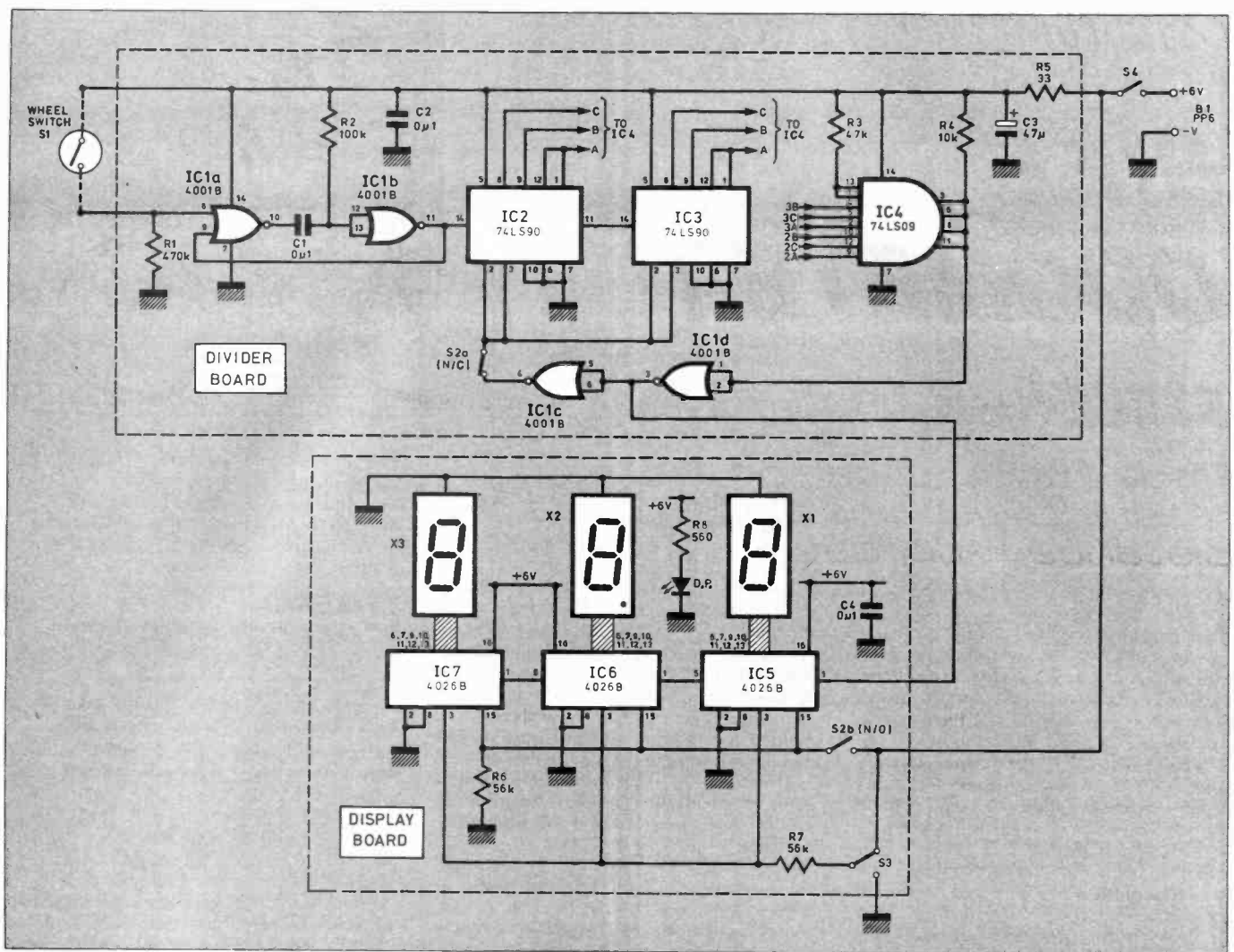

are a number of ways of achieving the division but the one used employs a couple of 74LS90 decade counter i.c.s followed by a 74LS09 quad 2-input AND gate i.c., with open-collector outputs.

It is possible to use the reset-to-nine facilities on the 74LS90 to divide by 7, but it is easier in this circuit to use the AND gate method. A 4001B quad-input NOR chip additionally serves as a debouncing circuit for the wheel generated pulses and as a resetting and isolating buffer for the dividing circuits.

The complete circuit diagram for the Bike Odometer is shown in Fig. 3. This includes both the divider and the l.e.d. display systems. The assembly is on two small p.c.b.s (printed circuit boards), measuring 82mm by 55mm and 82mm by 45mm respectively. These are indicated by the broken outlines on the diagram; the upper being the divider system, debouncer and reset facilities, and the lower the display and the display counter and driver i.c.s.

### DIVIDER CIRCUIT

The wheel operated switch S1 (of which more later) closes once per wheel revolution; the resulting pulse passes through the conventional debouncer, IC1a, IC1b, to the input pin (14) of the first of the dividers, IC2. The first counter IC2 divides by 10 in the usual manner and on the tenth pulse input passes an output, from pin 11, to the input pin of IC3. This in turn is connected as a divide-by-10, so although in a normal situation this would enable a count up to 99 to be achieved, the output this time cannot exceed 77 before resetting to zero.

Fig. 3. Full circuit diagram for the Bike Odometer. The circuit is built in two stages - Divider board and Display board.

This is easily explained by looking at the circuit again. We have only a two-digit number to deal with and it is convenient to express this as two groups of binary, that is, as 0111 0111.

When the count of 77 is reached, therefore, the A, B, and C binary coded outputs of both dividers are all high. When these highs are applied to the inputs of the AND gate IC4, the output of this gate will also



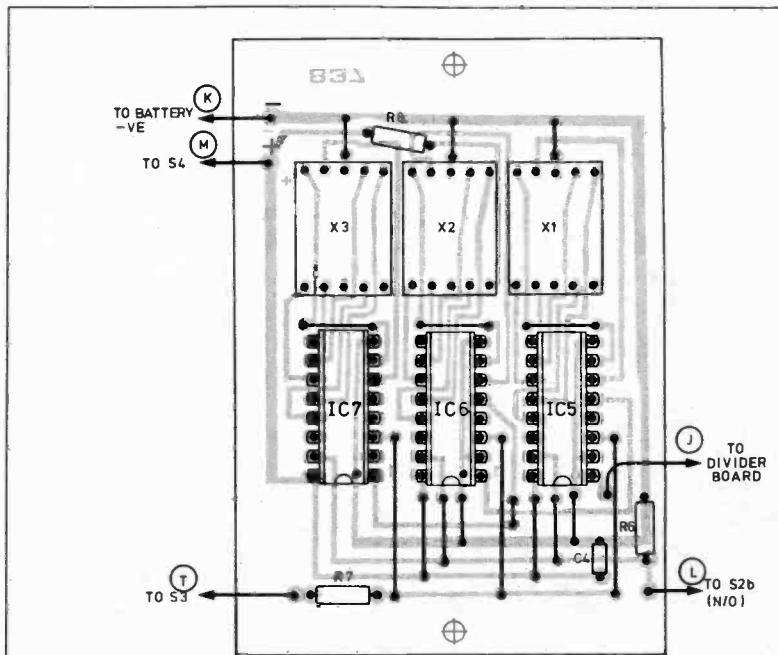

Fig. 5. Display printed circuit board component layout and full size copper foil (opposite) master pattern.

go high, hence a single pulse output is obtained for each group of 77 input pulses (or wheel revolutions) from the wheel switch.

The AND gate used is a 74LS09 (IC4) which as mentioned above comprises four 2-input AND gates with open-collector outputs. This last requirement is necessary as the four outputs can then be connected together with a single load resistor, R4, giving us an 8-input, single-output gate.

We need only six of these inputs for our present purpose, the remaining pair simply being held permanently high by returning them to the positive line by way of resistor R3. An output is then obtained only when all eight inputs are simultaneously high.

The output pulse is then passed to the counter display board by way of a buffering inverter IC1d and also to the reset pins of IC2 and IC3 via a further inverter, IC1c, and the manual reset switch S2a which is normally closed (N/C). Opening this switch momentarily will reset the dividers to zero and is normally used only at the start of a journey.

## DISPLAY BOARD

The display board houses the three 7-segment i.e.d. displays together with the associated counter-divider chips, IC5 to IC7. The CD4026B counters not only do the necessary counting of the input pulses from the AND gate but also include an output decoder which converts the binary information about the count into the form necessary to drive the i.e.d. displays directly.

The pin-out information is shown in Fig. 4. The circuit is therefore very economical in components and runs satisfactorily from a 6V supply.

The display must be zeroed at the start of a journey and this is accomplished by a momentary closing of the reset switch S2b which is ganged to S2a, the reset for the 7490 dividers. For economy of the battery supply, the display itself can be turned off if necessary by the Display Enable switch S3 during the journey or part of a journey.

All the time the readout is switched off, the count continues and the distance travelled will be fully logged and restored when reactivating the display i.e.d. segments. The decimal point on the centre digit is permanently activated via resistor R8 and can be used, when the display itself is off, as an indicator that the circuit is switched on.

Total current consumption averages 140mA with the display enabled and 40mA with the display off.

## CONSTRUCTION

A home built electronic system cannot compete for size with the small mechanical or computerized devices mentioned earlier, but the ABS plastic box used for this project does fit neatly on the crossbar of the bike and is sufficiently waterproof to resist anything but a tropical downpour. Those who wish may, of course, use a die-cast box of similar dimensions.

A smaller box can be used if the battery is separated from it and carried, say, in a

rear pannier. In fact, the whole box can be carried in a pannier but access to it can then only be made at the end of a trip or a stop-off at a pub!

So these constructional notes will cover only the existing boxed assembly as used on my own machine; any enthusiastic constructor can of course feel free to do his own thing with the basic circuit and make the disposition of things and the attachment to the bike to suit his or her particular liking. This kind of project can be quite open-ended.

The Divider and Display printed circuit boards topside component layouts and underside full size copper foil master patterns are shown in Fig. 5. and Fig. 6. These boards are available from the *EPE PCB Service*, codes EPE 836 (Divider) and EPE 837 (Display). If you make your own, some care is needed particularly with the display board to avoid shorting between the copper foil paths.

The Display board layout suits the specified 7-segment displays which have 0.56in. high digits with overall dimensions 0.7in. by 0.5in. Alternative displays will need adjustment to the board pin spacings, but see Shop Talk.

Assemble the boards carefully; there are quite a number of links, particularly on the display board. Notice particularly that there is a link which goes *under* IC2, insert this link *before* mounting the i.c. or its holder.

Next mount the resistors and capacitors. If you decide to use holders for the i.c.s., make these low profile types and when fitting the displays, space these about 2mm from the board surface so that their upper faces are slightly higher than the tops of the i.c.s.

There is only one board interconnection to be made later, that from the "commoned" 3, 5 and 6 pins of IC1c and IC1d to the input (pin 1) of IC5. All other leads go to the various switches mounted on the lid of the box. Use solder pins for the battery connection points and flying leads for the other outgoing wires, leaving these about 6 inches (150mm) for the time being.

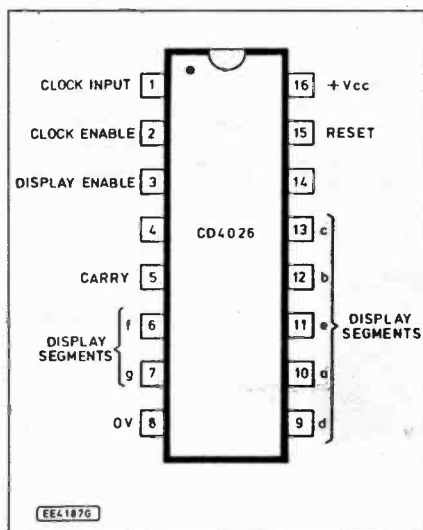

Fig. 4. Pin-out details for the CD4026 counter/divider i.c.

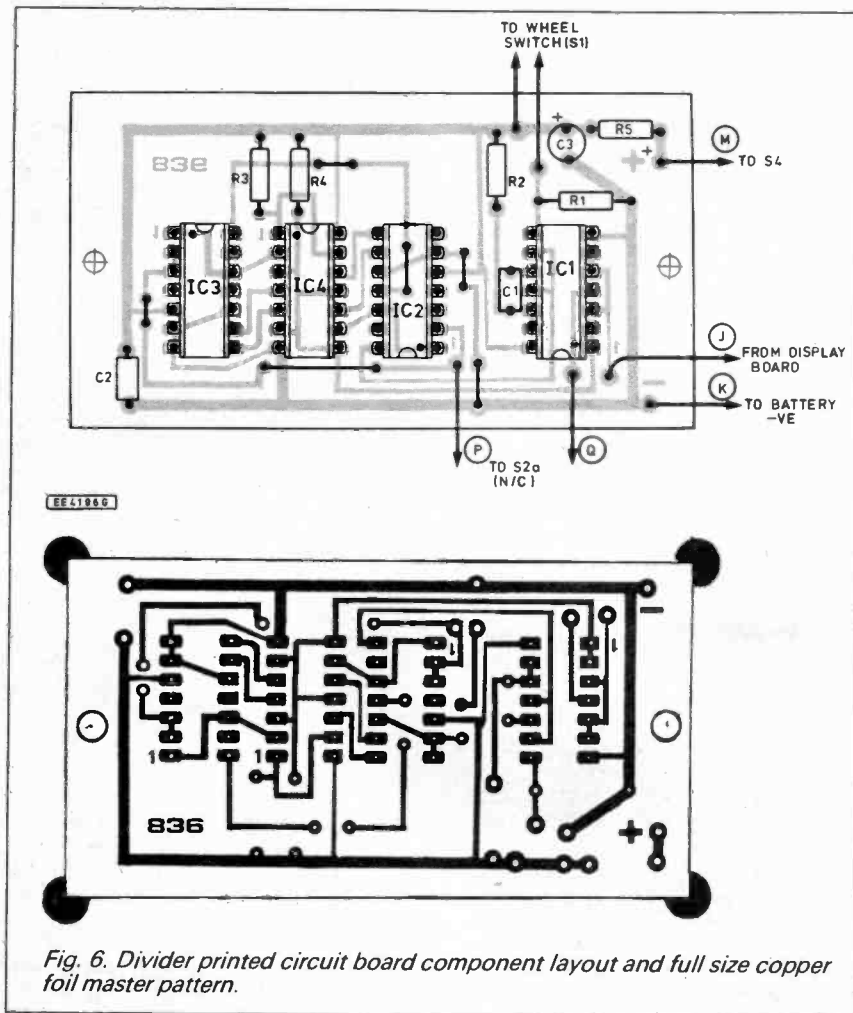
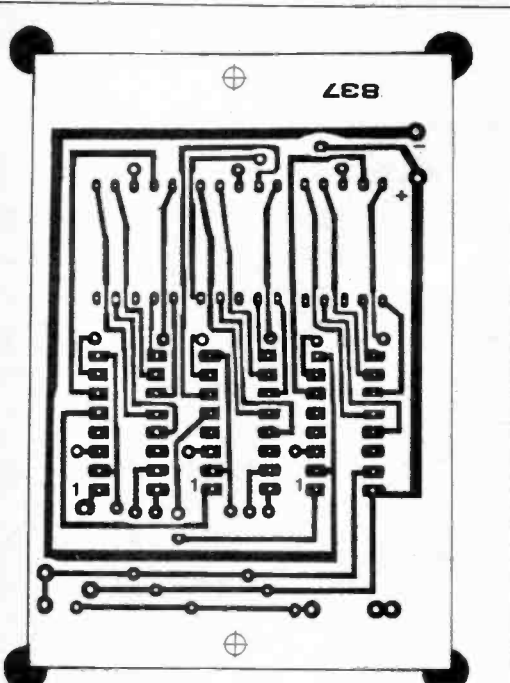

Fig. 6. Divider printed circuit board component layout and full size copper foil master pattern.

## COMPONENTS

### Resistors

R1	470k
R2	100k
R3	47k
R4	10k
R5	33
R6, R7	56k (2 off)
R8	560

All 0.25W 5% carbon film

### Capacitors

C1, C2	
C4	0μ1 min. polyester (3 off)
C3	4μ7 tantalum bead, 25V

### Semiconductors

IC1	4001B quad 2-input NOR gate
IC2, IC3	74LS90 decade counter (2 off)
IC4	74LS09 quad 2-input AND gate
IC5, IC6, IC7	4026BE 7-segment display counter/driver (3 off)
X1 to X3	7-segment 0.56in., common-cathode, display type HDSP-5303 (3 off).

### Miscellaneous

S1	Min. microswitch, with roller-lever actuator.
S2	Pushbutton switch with N/C and N/O contacts
S3, S4	Miniature, s.p.c.o. toggle (2 off)

Printed circuit boards available from the *EPE PCB Service*, codes EPE 836 (Divider) and EPE 837 (Display); ABS case, 150mm x 80mm x 50mm (or see text); 16-pin d.i.l. holders, low profile (3 off); 14-pin d.i.l. holders (4 off); 15mm 6BA clear spacers (4 off); small piece of 18s.w.g. aluminium sheet; 1mm sockets and plugs (2 off); PP6 battery, or similar; Terry clips (2 off); 45mm to 50mm long 6BA screws or studding (2 off); flexible wire; piece of thin red perspex or display filter material approx 30 by 60mm.

Approx cost guidance only

**£20**

See  
**SHOP  
TALK**  
Page

## BOX MOUNTING

The two boards, when completed, are mounted one above the other as shown in Fig. 7, using 45mm. 6BA screws or studding with plain spacers and the fixing holes provided on the boards. Care must be taken to ensure that the spacers, if metal types are used, do not touch the copper foil.

With the board interconnection made, this assembly is mounted in the ABS case; two Terry clips of appropriate size are then bolted under the box, using the fixing points of the board screws, so that the box can be clipped to the crossbar or to some other part of the bike.

The two leads to the wheel switch are brought out by way of two one millimetre type miniature sockets at the side of the box. The holes for these should be drilled before the boards are fitted.

It is now necessary to prepare the lid of the box. The switch and display positions are indicated in Fig. 8. The exact position for the display cut-out cannot be given as there will be small variations in the board positions from one project to another.

However, having mounted the boards in the box, there should be no problem in marking out the correct position of the cut-out and taking it out with an ordinary fret saw. Obtain a piece of display filter material (or a thin piece of red Perspex, which is cheaper) and glue it behind the cut-out, taking care not to get the glue on the viewing area.

Now mount the three switches in the positions shown in the back panel view of Fig. 9. With the lid now positioned close to the box, wire up the switches to the board leads, leaving these just slack enough to

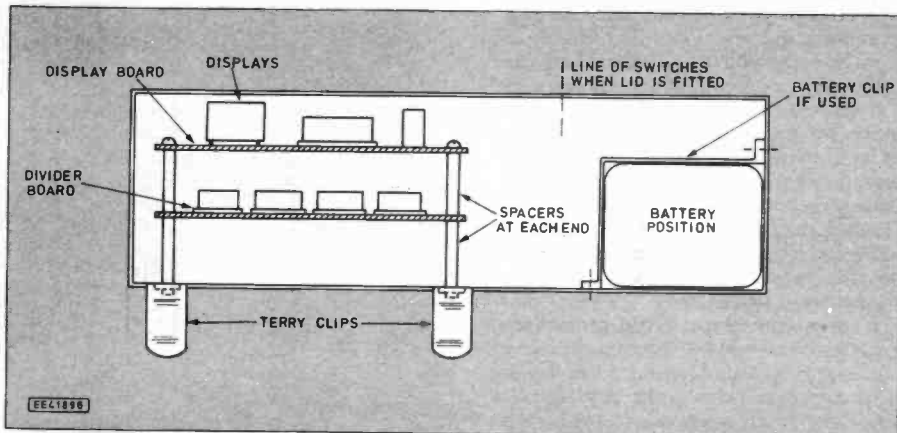

Fig. 7. See-through view of the board and battery mounting in the case. The face of the displays should be about 1mm below the top of the case.

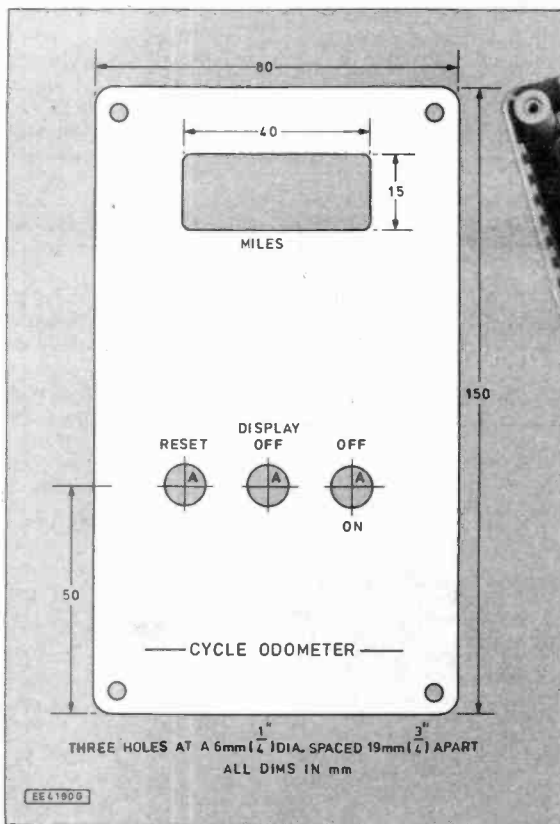

Fig. 8. Cut-out, drilling and legends for the front panel.

enable the lid to be turned over and screwed to the box once the wiring is complete.

Be especially careful in the wiring to the two switches (S1a and S1b) which are in a single push-button switch unit. There are four tags on this switch, opposite pairs of which go to one normally-open (N/O) switch and one normally-closed (N/C) switch. Which is which is easily checked with a continuity tester, and they must be wired in accordance with the circuit diagram or resetting will be impossible. Don't forget to wire the side terminals which will later connect the wheel switch.

The 6V battery, if it is to be mounted in the box, can be a PP6 type or 4 x AA cells in a suitable holder. This fits into the lower end of the box and can be held by a simple metal clip or by a couple of adhesive pads.

## TESTING

The Odometer can be bench tested by connecting the wheel switch (a roller-lever type microswitch) to the side terminals. Switch the unit on; the display and the single decimal point should light up, and by pressing the Reset button, the reading should show 00.0. Check, using the Display Off switch, that the display can be blanked but that the decimal point remains on to act as a reminder that the unit is still "live".

Return the display and now operate the microswitch by hand, counting the number of contacts made. On reaching 77, the display should indicate 00.1, representing one-tenth of a mile.

Carrying on in this way, the next total of 77 operations should bring up a reading of 00.2 and so on. There is no need to carry this tedious procedure too far; if the changes take place up to, say, 00.3, it is most likely that there is no fault on the unit.

To check things quickly, of course, the input can be derived from a pulse gener-

Layout of components inside the case and wiring from the front panel switches to the circuit boards.

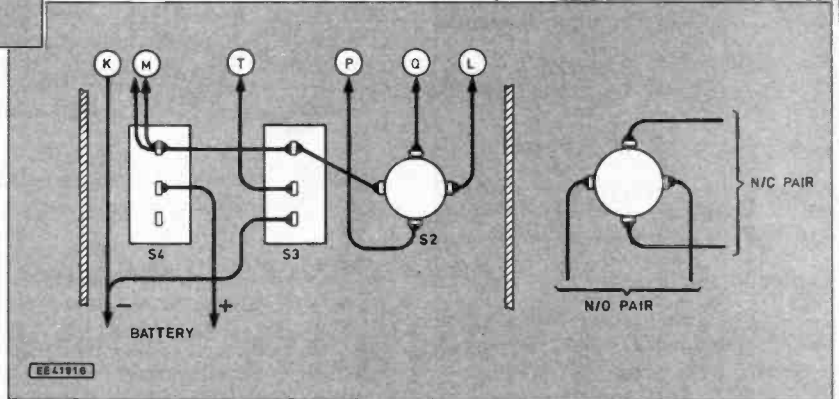
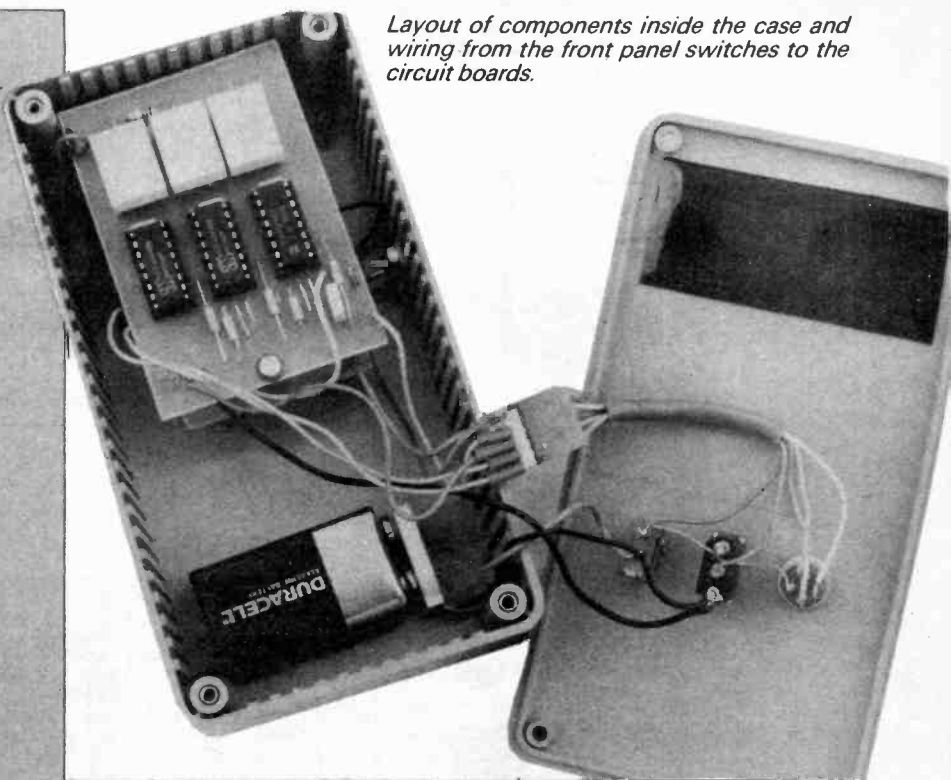
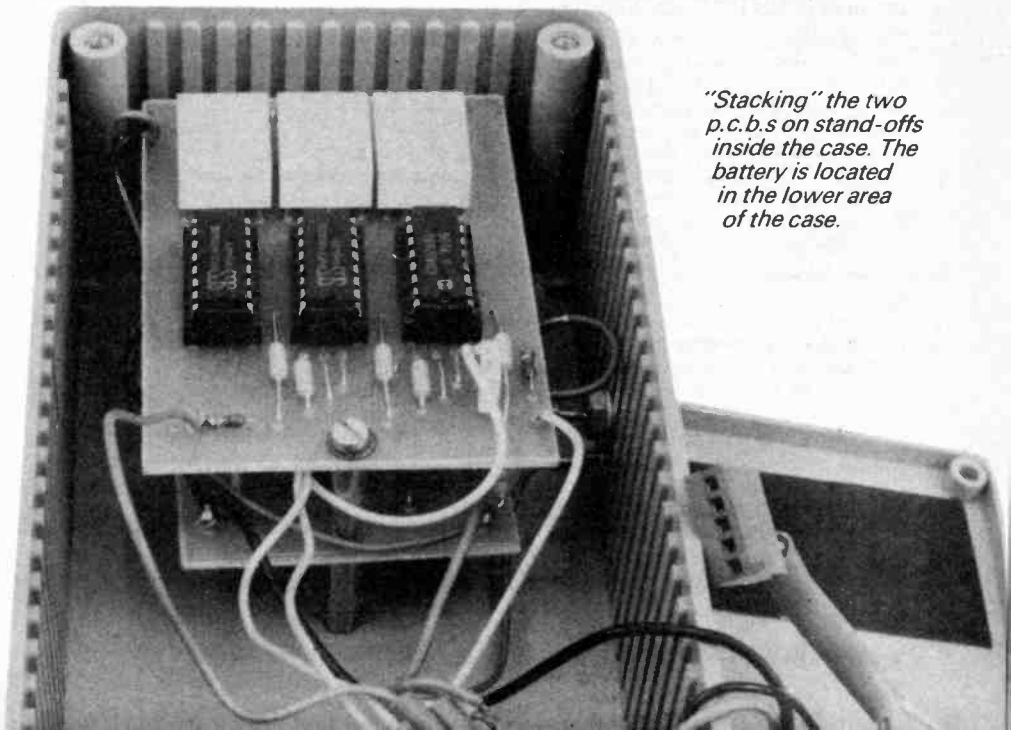

Fig. 9. Wiring to the switches on the rear of the front panel. The letters refer to locations on the two p.c.b.s.

ator giving an output of about 5V at a frequency of some 10Hz to 50Hz, and this will check the display reading right through to 99.9. But it is *still essential* to make sure (by the hand-operated switch method) that the display moves up for each group of 77 input pulses.

## OTHER WHEEL SIZES

If you are making your own board, it is not too difficult to make small changes to the Divider section so that other wheel sizes can be accommodated in the design.



"Stacking" the two p.c.b.s on stand-offs inside the case. The battery is located in the lower area of the case.

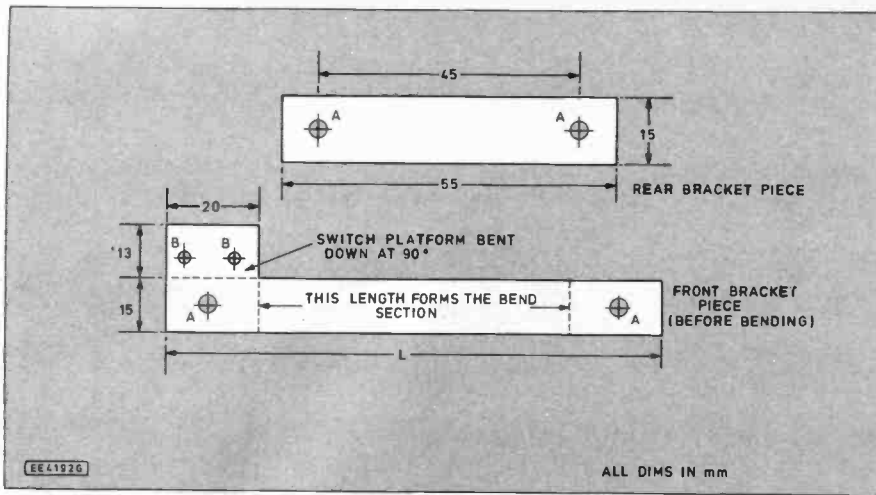

Fig. 10. The two bracket pieces made from 18s.w.g. aluminium. The bend position can be judged from Fig. 11. Length *L* to suit size of fork but approx. total length before bending is 80mm. Four holes at "A" are matched after bending front bracket piece (4BA). Two holes at "B" drilled to suit microswitch.

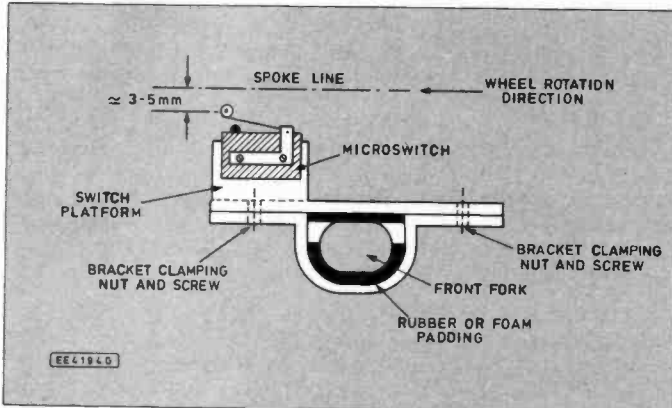

Fig. 12. How the completed bracket and microswitch are fitted to the front fork. The roller should clear the nearer spokes by the amount indicated.

This involves alternative arrangements to the inputs of the AND gate, IC4, hence the necessity of modifying the board.

Suppose we have a 21-inch wheel, then the circumference will be  $21\pi$  or 66-inches and the number of revolutions made in 6336-inches (0.1 mile) is 96. We can write this as 1001 0110 in binary groups, hence we need to connect the A and D outputs of IC2 (which are high on 9) to two of the AND gate inputs; and the B and C outputs of IC3 (which are high on 6) to two other IC4 inputs.

The actual inputs are not important. The remaining inputs to IC4 are all held high by way of resistor R3 as in the circuit diagram. Note that the D output (most significant digit) of the counter i.c.s is pin 11. In a similar way, other wheel sizes can be accommodated.

It is also possible to "fine tune" the display readout on the 26-inch wheel circuit by such adjustments to IC4 inputs as outlined above. If, for example, you find on a test ride over a known mileage (possibly checked by a car drive) is over or under the correct figure by, say, more or less than 0.2 mile and you would like to be closer, then the count of wheel revolutions can be altered slightly to compensate for the error.

Instead of counting to 77, a count of perhaps 76 or 78 will make the necessary adjustment. To do this, use the same method as already described for different wheel sizes. The equivalent group binary for 76, for example, will be 0111 0110; the count by IC2 will be unaffected but the ABC outputs of IC3 will be 011 which means that only the BC outputs will go to

inputs on IC4 while the then unused input which otherwise accepted the A output is strapped to the positive line via R3.

## WHEEL SWITCH

This is that part of the project where individual ideas can prosper. We need a device that will give us an output pulse for each wheel revolution. The two most obvious systems that come to mind are a magnetically operated reed switch (a non-contacting method) and a microswitch operated by some kind of stud on the wheel (a contacting system).

I did get a reed switch to work successfully but the setting and the consequent assembly was critical and, I felt, not really capable of being described in a manner that would be repeatable for every situation or style of machine. This does not mean that any constructor has to abandon this method; once again there is scope for the enthusiast to dabble for himself.

A possible objection to the mechanically operated switch is that it makes a clicking sound as the wheel rotates. With the method used here, the sound output is negligible as the contact is very light and any frictional effect on the rotation of the wheel is infinitesimal.

The use of a roller-lever microswitch helps in this way; avoid cheap devices which have a primitive form of hinge for the lever and which results in a floppy free movement of the lever. This can lead to problems when cycling at speed (but nothing dangerous!) as rebounds of the lever could strike the spokes and lead to false counting and a wrecked microswitch.

A two-piece bracket has to be made to position the switch properly, but this is easy to fabricate and fit and can be formed from a piece of 18s.w.g. aluminium. In the diagrams illustrating this bracket the fixing hole positions are approximate and must be adjusted as necessary to suit your own machine, but large variations are very unlikely to be needed.

The two pieces needed to fabricate the wheel switch bracket are shown in Fig. 10, these being cut out neatly from the aluminium sheet and any burrs or rough edges smoothed off with a fine file. Now the switch actuator is most conveniently fitted to the wheel reflector, so the right position for mounting the bracket on the fork is in line with the reflector as the wheel rotates. Fig. 11 illustrates this point.

So, using a piece of wood or tube simi-

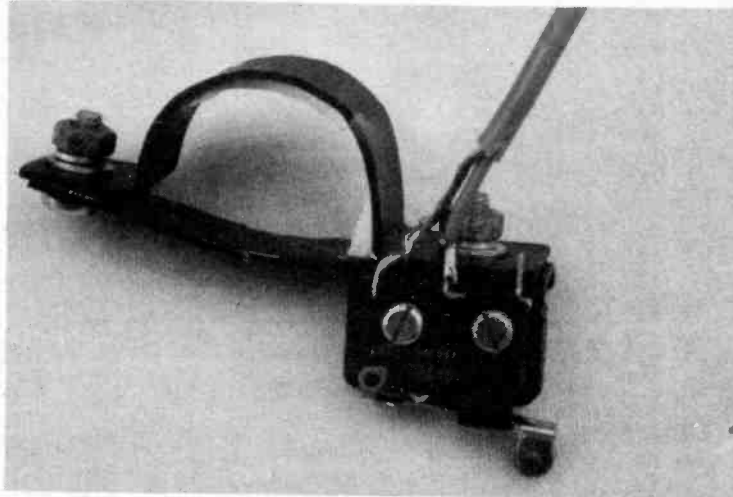

The wheel microswitch mounted on the completed fork bracket.

lar in size and shape to the wheel fork at the correct position (I used the left-hand front fork) shape the front bracket piece around it to conform finally to the configuration shown in Fig. 12. Line the inside of the loop and the mid-part of the back bracket piece with rubber or foam protective padding (as indicated); this takes care of any slight inaccuracies or slackness and prevents damage to the paintwork. It was found that draught excluder strip, sticky on one side, was ideal.

The bracket is secured to the fork by two 4BA screws with nuts and spring washers; try the fitting out before fitting the microswitch and ensure that it will clamp on to the fork very firmly with no tendency to slide or rotate. The rear piece of aluminium will bow *slightly* as the nuts are tightened

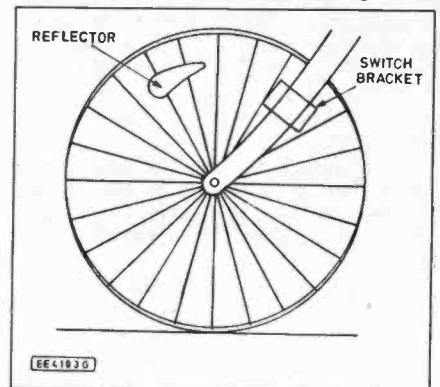

Fig. 11. The switch bracket should be positional on the same radius as the reflector.

but this helps the tightness of the assembly.

Any severe bowing will indicate that your front bracket piece needs readjusting to match the shape of the fork better. Aim for a good job, poor and inaccurate work must be avoided.

Now fit the microswitch to the platform in such a position that the roller, when it is in its normal "rest" position, clears the nearer spokes as the wheel is rotated by some 3mm to 5mm.

## ON STRIKE

All that remains now is to provide some kind of "striker" mechanism which will close the microswitch momentarily on each rotation of the wheel. This is where the wheel reflector comes in; by fitting a shaped piece of material on to the reflector, a ready made support is available, so avoiding any

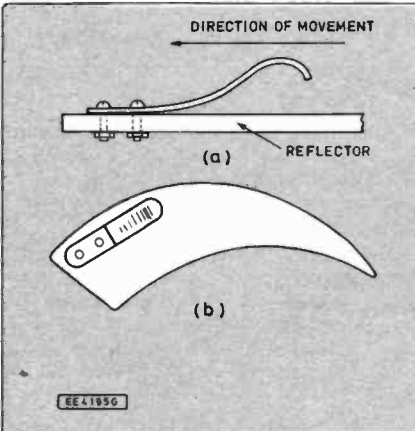
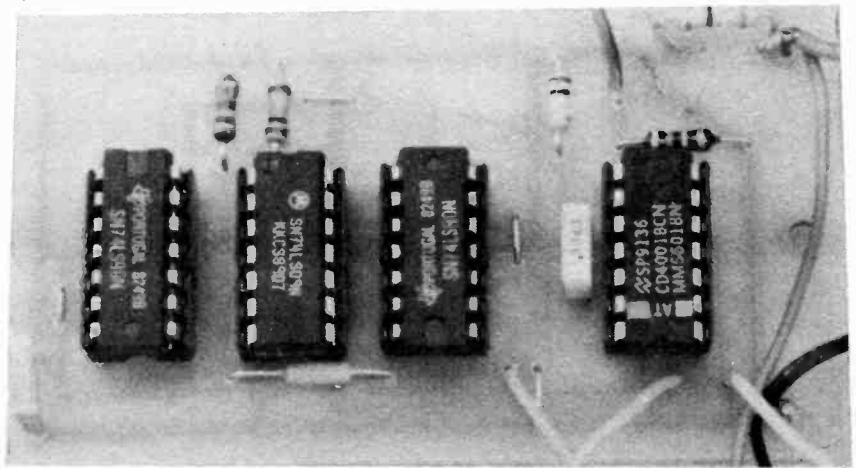

Fig. 13. General configuration of the "striker peg" and its attachment to the wheel reflector.



Layout of components on the completed Divider board. Do not forget the link under IC2.

other form of fixing the striker to the spokes.

A springy striker is best and a piece of 30s.w.g. brass did the job admirably and has so far survived for several hundred miles of travel. A piece of spring steel, salvaged from an old electric bell, and some 26s.w.g. aluminium have been tried and these have worked successfully as well. There is nothing too critical about either the material used or its thickness (within reason, that is) for this application.

The general shape needed for the striker and its mode of fixing is shown in Fig. 13a. Two fixing holes are necessary, and the final degree of bending is best done after assembly.

The reflector is drilled through 6BA and the striker screwed to it as shown in Fig.

13b). Make sure that the striker is in line with the microswitch lever as it passes and not at some oblique angle.

The bend of the striker is finally adjusted in situ; arrange the contact with the roller of the microswitch so that only the *minimum* movement of the lever occurs to close the switch contacts as the striker passes by. This need be no more than 2mm to 3mm; the lever *must not* be forced down to make contact with the body of the switch or both the striker and the lever will soon be distorted.

Having finalised the fitting, two leads are then soldered to the normally-open contact tags on the microswitch and taped to the frame as they are brought up to the side terminals on the main box. Happy cycling!

## CAMBRIDGE COMPUTER SCIENCE LIMITED

Borland C++ 2.0 for DOS & Windows complete with mouse	£45.00
LCD modules	16 char by 1: £4.00, 20 char by 2: £6.00, 40 char by 1: £6.00
3.5" 720K Diskette Drives	£25.00 each
Used hard disk drives	112MByte £110, 70MByte £75, 40MByte £45
20MByte £29, 10MByte £14, Limited quantities, phone before ordering	
Used PC memory/IO card AST six pack with 584k RAM	£15.00 each
Used IBM PC hard disk controller, 8 bit MFM	£5.00 each
Used Tseng labs, multi I/O + mono video card for PCs	£10.00 each
Used Compaq Enhanced Colour Graphics Card	£5.00 each
Lucky Dip PC cards, untested, no warranty, various types	£1.00 each
5.25" Disk Drives, 1.2MByte Slimline PC	£19.00 each
5.25" Disk Drives, 80 Tk, DSDD	£19.00 each
5.25" Disk Drives, 80 Tk, DSDD Used, No Wty.	£7.00 each
(The £7.00 drives are sold on a strictly "as is" basis)	
5.25" Disks, DSDD, 48tpi, boxes of 10	£2.00/box
Digital multimeter, 14 ranges, inc. leads & manual	£9.00 each
Apricot Disk drive PSU 5V @ 2.5A, 12V @ 2A	£10.00 each
5V @ 6A PSU	£4.00 each
5V @ 10A PSU	£5.00 each
Disk Drive Data lead BBC Micro to Disk Drive(s)	Single 2.00 Dual £4.00 each
Disk Drive Power lead BBC Micro to Disk Drive(s)	Single 2.00 Dual £4.00 each
68000 CPUs 8MHz	£2.50 each
8086 CPU chips	£2.00 each
Z80A CPU, CTC, PIO	£1.20each; DMA £2.00; £4.50 all 4
74LS TTL, pick and mix, buy 10 or more for	£0.12 each
Types available: '00 '02 '04 '08 '10 '11 '12 '13 '14 '15 '20 '21 '26 '27 '30 '32 '33 '37	
'38 '42 '74 '83 '85 '86 '96 '107 '109 '122 '125 '132 '136 '138 '139 '145 '151 '153	
'157 '158 '160 '162 '163 '164 '165 '174 '191 '193 '240 '253 '257 '260 '298 '353	
'365 '366 '373 '385 '390 '399 '670 '682	
27128 EPROMs (Ex Equipment)	£1.20 each or £5.00/5
27128 EPROMs	£2.50 each
27C256 EPROMs (Ex Equipment)	£1.40 each
27256 EPROMs	£2.60 each
27C256-25 EPROMs	£3.50 each
27C512 EPROMs (Ex Equipment)	£1.40 each
256K DRAM (Ex Equipment)	£0.40 each
1MBit-10 Byte SRAM	£1.40 each
6116-2K Byte SRAM	£1.10 each
6264-12 8K Byte SRAM	£3.80 each
62256-10 32K Byte SRAM	£5.00 each
65256 32K Byte rams	£4.00 each
8K Byte NV ram chips	£3.00 each or £10.00 four
16, 18 & 20 pin dil low profile IC sockets 0.3" wide	£0.40/10; £3.00/100
22 & 24 pin dil low profile IC sockets 0.4" wide	£0.40/10; £3.00/100
24, 28, 32, 40 & 48 pin dil low profile IC sockets 0.6" wide	£0.40/10; £3.00/100
Circuit tester, finds faults in TTL & CMOS logic circuits, inc leads	£6.00 each
Metal project boxes drilled & painted but unused 28 x 32.5 x 5cm	£4.00 each
Eurocard Racks	£10.00 each
Smoke detectors	£4.00 each
Used computer cards many useful components (large ones socketed)	
Wini controller (WD HDC chip)	£1.00 each
CPU card (8088, 280 & EPROMs)	£3.00 each
Keyboards, full Qwerty, number pad and LCD	£8.00 each
Desktop computer case with 200W mains PSU (used)	£19.00 each
Used IBM PC Cases with PSU	£30.00 each

Prices include postage. Add £1 (plus VAT) to orders below £5.00. All items new unless stated. Add 17.5% VAT to all prices. Send an SAE for our latest list or for more info.

Dept EE, 374 Milton Road, Cambridge CB4 1SU  
Tel: 0223 424602, 0831 430496 or 0831 430552 (Mail order only)

## OMNI ELECTRONICS

174 Dalkeith Road, Edinburgh EH16 5DX ★ 031 667 2611

The supplier to use if you're looking for:-

A WIDE RANGE OF

★ COMPONENTS AIMED AT THE ★  
HOBBYIST

★ COMPETITIVE VAT INCLUSIVE ★  
PRICES

★ MAIL ORDER - generally by ★  
RETURN OF POST

★ FRIENDLY SERVICE ★

OPEN:

Monday-Thursday 9.15 - 6.00

Friday 9.15-5.00

Saturday 9.30-5.00.



**At last, a fully functional upgradeable PCB CAD system to suit any budget. Substantial trade-in discounts are available against other "professional" PCB design packages ...**

**... call now for details.**

## Board Capture

*Schematic Capture Design Tool*

**£395**

- Direct netlist link to BoardMaker2
- Forward annotation with part values
- Full undo/redo facility (50 operations)
- Single-sheet, multi-paged and hierarchical designs
- Smooth scrolling
- Intelligent wires (automatic junctions)
- Dynamic connectivity information
- Automatic on-line annotation
- Integrated on-the-fly library editor
- Context sensitive editing
- Extensive component-based power control
- Back annotation from BoardMaker2

## BoardMaker

*BoardMaker1 - Entry level*

**£95**

- PCB and schematic drafting
- Easy and intuitive to use
- Surface mount and metric support
- 90, 45 and curved track corners
- Ground plane fill
- Copper highlight and clearance checking

*BoardMaker2 - Advanced level*

**£295**

- All the features of BoardMaker1 +
- Full netlist support - BoardCapture, OrCad, Schema, Tango, CadStar and others
- Full Design Rule Checking both mechanical and electrical
- Top down modification from the schematic
- Component renumber with back annotation
- Report generator - Database ASCII, BOM
- Thermal power plane support with full DRC

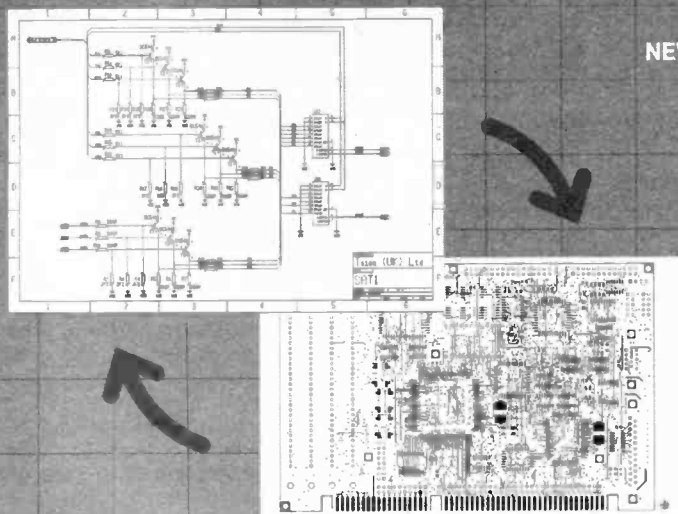

NEW

## Board Router

*Gridless re-entrant autorouter*

**£200**

- Simultaneous multi-layer routing
- SMD and analogue support
- Full interrupt, resume, pan and zoom while routing

*Output drivers - Included as standard*

- Printers - 9 & 24 pin Dot matrix, HPLaserjet and PostScript
- Penplotters - HP, Graphtec & Houston
- Photoplotters - All Gerber 3X00 and 4X00
- Excellon NC Drill and Annotated drill drawings (BM2)

Call, write or fax for more information or a free evaluation kit :

Tsien (UK) Limited  
 Cambridge Research Labs  
 181A Huntingdon Road  
 Cambridge CB3 0DJ  
 Phone : (0223) 277 777  
 Fax : (0223) 277 747

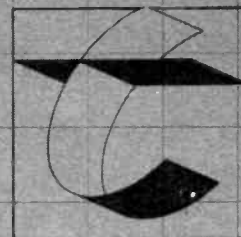

**tsien**

# Innovations

A roundup of the latest Everyday News from the world of electronics

## SORTING OUT TRAFFIC JAMS

### TRAFFICMASTER TO THE RESCUE

By Hazel Cavendish

A British firm has scored an important world first with "Trafficmaster", a novel electronically-based in-car traffic information service, extended nationwide in Spring this year after a triumphphant two-year pilot scheme which proved itself on the M25 – an area suitably chosen for its monumental traffic snarl-ups at peak times. General Logistics is the UK company behind this innovative system which is designed to help drivers avoid time-wasting traffic jams and escape dangers ahead.

The Trafficmaster unit is a specially-designed, purpose-built portable radio receiver with a clear, easy-to-read screen showing a map of the motorways covered, which fits neatly into a subscriber's car or lorry. A simple group of control buttons enables details to be viewed in close-up and there is a supporting narrative which can be reviewed as required. It provides an information system which tells the motorway user accurately, quickly and simply when the road is clear and when it is congested, showing the extent of the congestion and the average speed of the traffic.

With this information available the driver can schedule journeys when the roads are at their least crowded, can choose alternative routes when likely delays are shown up on his screen, and know the extent of the delay if there is no option but to sit it out.

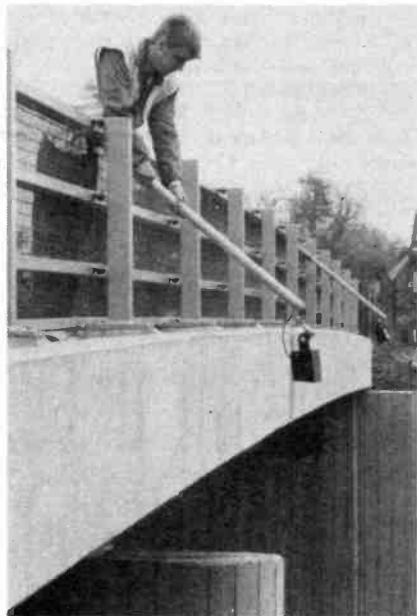

IR sensors being fitted to a motorway bridge.



Trafficmaster display inside a vehicle.

### SPEED MONITORS

The key to the system is the installation of traffic speed monitors on 450 motorway bridges and gantries across the country's motorway system at a cost of £3 million over the last two years. These high-tech sensors are mounted in groups, for each direction, on motorway bridges and gantries, or on lamp-posts and signposts in more urban situations. Unlike Gatso speed-check cameras used by the police, these all-weather infra-red devices sense the vehicles passing underneath and measure their speed, although it is emphasised they cannot identify individual vehicles.

In order to give comprehensive coverage, the sites are on average only two miles apart. Each bridge site has its own micro-processor which calculates a three-minute rolling average speed of traffic, providing an accurate measurement of speed of flow as well as measuring the number of vehicles passing along the motorway.

Every bridge site is programmed to send information to the Control Centre in Luton when the average speed drops below a preset threshold of 30 m.p.h., the speed at which it is estimated congestion and delay build up on a busy road. Police, motoring organisations, road repair contractors and local government supply the information for the accompanying narrative which indicates speed, direction and extent of

congestion, and will also give a reason for the problem occurring – "red Mini overturned at final roundabout before entering Norwich" – giving a driver the opportunity to re-route their journey.

### DISPLAY

When motorway information is transmitted from the sensor via the Control Centre to the Trafficmaster the problem is displayed on the map as a flashing square. In this square an arrow indicates the direction of the hold-up and a number which is the average speed in miles per hour of the traffic at that point. This information is updated every three minutes. The speeds shown in the squares start at 25 m.p.h. and range down in units of 5 m.p.h. to zero. The user should soon become adept at assessing the delay a particular hazard may imply; the length of the tailback can be assessed by the number of squares flashing.

As an optional extra, Trafficmaster can double as a message pager, storing messages that can be read at a convenient time. On the large screen complete messages can be seen at a glance, making reading simple. As the Trafficmaster is portable – each unit being located in a specially-installed holster from which it can be removed for security – paging messages can be received in the office, at meetings or in restaurants and can



be automatically transferred from a cellular phone to the screen.

A supplementary service covering the London area inside the M25 provides a comprehensive view of closures and serious incidents, showing the location of major accidents on the screen with supporting information in a separate "memory" which can be recalled on demand.

## U.S. BELTWAY

Already used by a quarter of the FT-SE 100 index companies in Britain – the list reads like an inventory of Britain's top companies ranging from Grand Met and ICI to Virgin Atlantic and Marks and Spencer – Trafficmaster's technology and expertise has been seized upon by the Americans for their equivalent of our M25 – The Washington DC "Beltway" – which will try out the scheme in September this year following a significant deal with Westinghouse Electric Corporation of Baltimore. This gives the American company exclusive use of General Logistics' technology on a 15-year licence.

Trafficmaster is poised to benefit from a worldwide expansion into driver information systems as public authorities use their road allocation funds more effectively. These systems are known as Road Traffic Informatics (RTI) and Intelligent Vehicle Highway Systems (IVHS). A recent report estimated that the UK RTI market will be worth £5 billion by the year 2010, and the Clinton administration has funded IVHS with \$925 million over the next four years. General Logistics would seem to be in on a winning ticket.

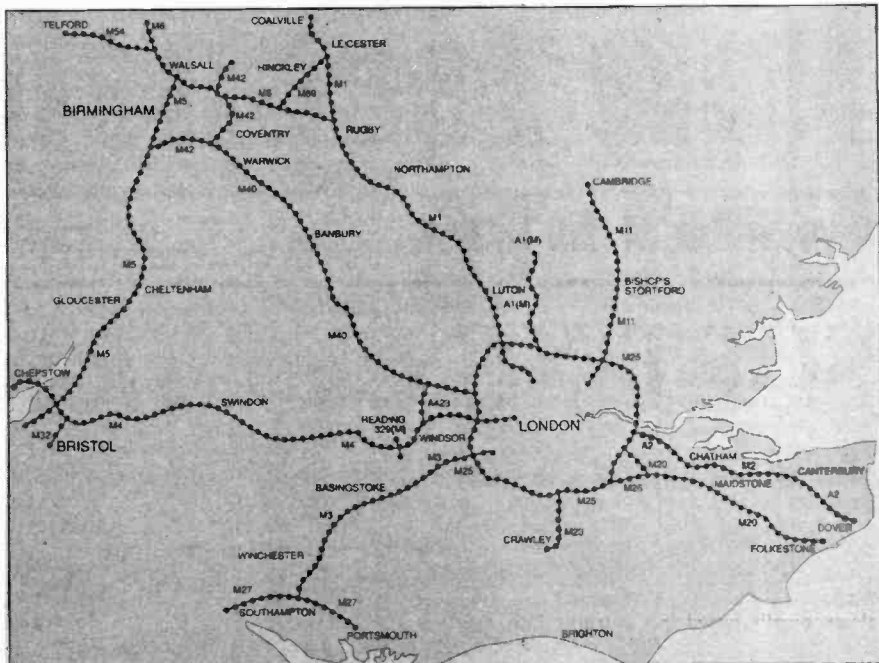

The present Trafficmaster network.

In his capacity as Secretary of State for Transport, John MacGregor praised Trafficmaster as a remarkable private sector initiative, saying "Trafficmaster is a major breakthrough in driver information systems which many other countries are watching closely. It is an important aid to business efficiency, and helps to reduce costs and stress."

In the UK General Logistics has this year extended the M25 trial scheme to cover more than 1,000 miles of motorway in the south and midlands, including the M27 between Portsmouth and Southampton, and is planning a substantial development in Scotland over the next two years. It is also involved in RTI projects in Europe, the Middle East and the Far East.

## THE THINGS PEOPLE PATENT!

The following abstracts are taken from recent UK patent applications in the general electrical/electronics area. British Patent Specifications can be ordered from the Patent Office, Sales Branch, Unit 6, Nine Mile Point, Cwmfelinfach, Cross Keys, Newport, Gwent, NP1 7HZ.

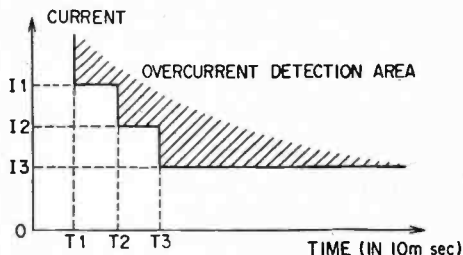

### Detecting overcurrent

In UK patent 2257314 Kabushiki Kaisha Toyoda Jidoshokki Seisakusho describe a means of detecting with high accuracy a current which may adversely affect an electric circuit if continued for an extended time. The apparatus periodically samples an output of a current sensor connected to the circuit and includes a memory, storing data of current values, (I1 to I3) regarded as representing overcurrents, in consideration of their respective durations, T1 to T3.

The current values are stored in pairs with time values of the durations. The sampled value is compared sequentially with the current values stored in the memory while duration of the sampled value is compared with the time value paired with that current value in order to determine whether or not an overcurrent has occurred. The circuit may be used to drive the motor of a battery-powered fork lift truck.

### Motor control system

In UK patent 2258094 Racial Health & Safety Ltd. describe a control system for an electric motor driving a fluid moving device, such as the air fan in a powered respirator. The system senses the speed of the motor by the back e.m.f. which it produces and senses the running current of the motor by the voltage drop across a fixed series resistor.

From these parameters, the prevailing rate of flow from the fan can be calculated in a microprocessor and compared with a specified value. The resultant error signal is used to modulate the widths of power pulses supplied from a drive to the motor so that the fan is controlled to produce a substantially constant rate of flow, in spite of variations of flow resistance caused by progressive blockage of associated filters.

### COVER PIC

**Acknowledgement:** we apologise for forgetting to credit David Lee of Barton-on-Humber with last month's excellent front cover photograph of the Micro Lab.

## TOOL-UP

A recent price reduction makes a good value 15 Piece Students Tool Kit from Maplin a real bargain. The kit includes a 25W soldering iron with two interchangeable bits (flat and pointed), a detachable hook and small fold-up stand, desoldering tool, a supply of solder and a pot of flux.

For working on p.c.b.s and delicate equipment, a "helping hands", "scraper" and a wire wrap tool are included. To help in assembly and repair of projects, two crosspoint screwdrivers, two standard screwdrivers, a pair of pliers, a pair of wire cutters and a pair of tweezers are also supplied.

All the tools are housed in a smart, tough carrying case with preformed sockets to hold them in place during transit. The cost of this kit is now £14.95 including VAT, it is available from Maplin shops and by mail order Tel. 0702 554161.



# New Technology Update

Ian Poole reports on developments in battery technology.

INCREASING demands are being placed on battery technology nowadays. People who use batteries want new types which pack more power into a smaller space whilst being cheaper and environmentally friendly.

It is this last point which is becoming increasingly important. Virtually all batteries in use at the moment include chemicals which can be hazardous in one way or another. Even the standard zinc-carbon battery contains an acidic electrolyte which can be quite corrosive as anyone who has had them leak into a radio will know. They also contain manganese dioxide which is toxic.

## NiCad

NiCad cells seem to be the answer to many problems. They can be recharged time after time thereby reducing the amount of chemicals which are needed. However even these cells do not last forever. It is quoted that they can have up to 1000 charge/discharge cycles, but in reality their life is somewhat less.

They are seldom used under ideal conditions: they may be overcharged, totally discharged, or used in a battery where it is possible for one or more cells to become reverse charged. All of these factors will lead to a reduction in the life of the cell by a considerable degree. There are very few applications where a cell will reach its maximum expected life.

Environmentally NiCad cells are much worse than standard cells. They contain potassium hydroxide which is corrosive. Worse than this is the cadmium they contain. Such are the fears about the disposal of these cells that some countries are considering a ban on their use. A number states in the USA are actively considering this, and the European Community is legislating to control their disposal.

Whilst NiCad cells are one of the worse environmental offenders other types of bat-

tery in everyday use also cause problems. The lead acid battery used in every car uses a corrosive electrolyte as owners of older cars can testify from the rust around the battery. In addition to this the lead is also a significant hazard.

Lithium cells are not particularly good either because they use some strong oxidising agents. In fact many of today's batteries give cause for concern in one way or another.

## Green

The green lobby is growing rapidly but there is also an increasing reliance on batteries for everything from cam-corders and personal stereos to professional test equipment. These factors mean that there is a great need for new, safe batteries.

This presents a magnificent opportunity for any company which can develop a suitable battery to fill the need. As a result a number of organisations are investing large amounts of money into this field.

## NMH

Already there are a number of new batteries which are being developed. Some years ago rechargeable lithium cells appeared on the horizon as the solution to the problem, but despite all the coverage in the technical media they have not reached the market.

Now another type of cell called the Nickel Metal Hydride or NMH cell has appeared and it is already being used in some applications. The cell has several advantages, but as the NiCad has been in use over 20 years and has been well refined, there is still a way to go before the NMH cell can perform as well in all respects.

Fortunately the NMH cell is very similar to a NiCad in its performance. This means that given enough development it could actually replace the NiCad in the

near future, it has the advantage of being far more environmentally friendly. In addition to this it is much lighter and has a higher storage capacity. As an example a typical NiCad type AA cell has a capacity of around 0.5Ah whereas the new NMH cell can store just over 1Ah.

The output voltage is very similar to that of a NiCad. The open circuit voltage is between 1.3V and 1.4V falling to just over 1.2V under moderate loads. In fact the output voltage is only about 0.05 volts higher than a NiCad. The cell also maintains its output voltage well through the discharge cycle, falling rapidly once it becomes discharged as shown in Fig. 1. The main difference between the two cells is the additional charge which the NMH cell can hold.

The charge profiles are also very similar. One feature which is very useful for NiCad chargers is an increase in the cell voltage once full charge is reached. This is often used by so called intelligent chargers to detect when a cell is fully charged. A similar effect is also exhibited by the NMH cell, but it is less marked (Fig. 2).

## Drawbacks

Whilst these new cells may seem ideal in many respects there are a number of drawbacks and problems which still need to be solved. The first is that NMH cells surprisingly have small traces of cadmium in them at the moment. This should not remain the case for much longer because manufacturers have stated that this will be removed shortly, enabling these cells to be disposed of without any major environmental concerns.

A more serious long term problem is their cost. Currently they are about two and a half times the price of an equivalent NiCad. However when the increased capacity and cell life-time is considered the cost seems more reasonable.

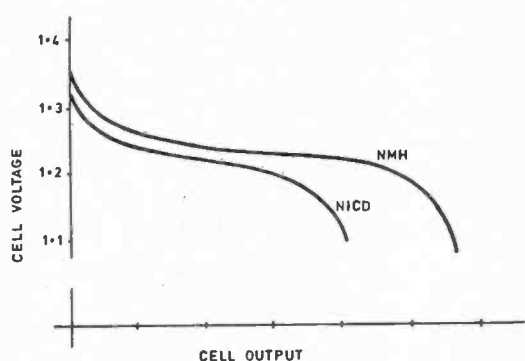

Fig. 1. Discharge profiles of NMH and NiCad cells.

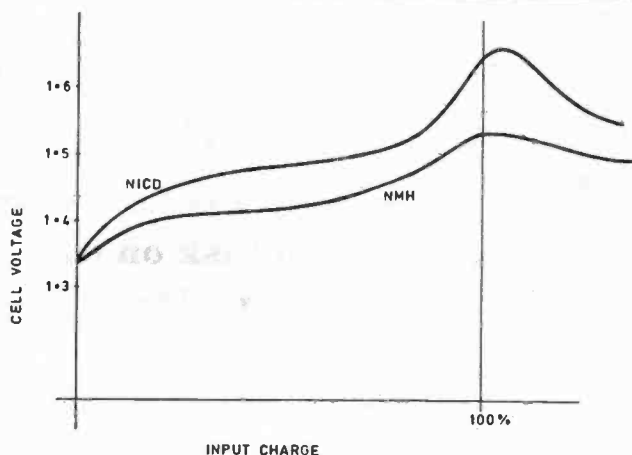

Fig. 2 (right). Charge profiles of NMH and NiCad cells.

One area which is receiving the most development is that associated with loss of charge over a period of time when the cell is not in use. Currently NMH cells discharge at about twice the rate of NiCads which in turn is much higher than that for ordinary non-rechargeables. Fortunately development is beginning to bear fruit and it is expected that it will be possible to reduce self-discharge rates to acceptable levels within the foreseeable future.

Charging of these new cells also creates a problem. Whilst standard NiCad rechargers can almost always be used, great care has to be taken not to overcharge them. If this is done then the capacity of the cells is greatly reduced.

As a result of the dangers of overcharging, these cells are not available as

separate items. Instead they are built into manufactured equipments which contain intelligent chargers to prevent overcharging. Currently the main users are lap-top computers and mobile phones. In both of these applications weight and capacity are of great importance. On both of these counts the new NMH cells win over NiCads.

Whether NMH cells become as widely used as the standard NiCad cells depends to a large extent on other battery developments. At the moment a number of industrial battery manufacturers are making them or developing their own versions. However as yet there are none available separately on the domestic market.

Like any cell, whether rechargeable or primary, the new NMH cell has two

electrodes, one positive, one negative, and between them there is an electrolyte.

From the name of the cell it can be deduced that one electrode (the positive one) is made from nickel compounds. In fact it is very similar to that used in a NiCad. The electrolyte is also very similar, being an alkaline solution.

The main difference occurs in the area of the negative electrode. Instead of using cadmium the new cells use a new alloy which can store hydrogen. The reason for this is that towards the end of the charge cycle, oxygen and hydrogen are given off. To overcome this problem a secondary electrode is added to absorb the oxygen, whilst the hydride in the primary electrode is able to store the hydrogen. In this way the cell can be sealed, only having a vent for emergencies.

**Call us now! We have the widest range of components available - At competitive prices!**

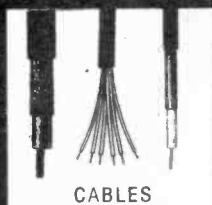

CABLES

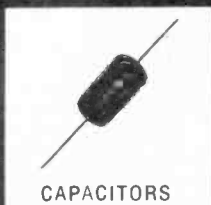

CAPACITORS

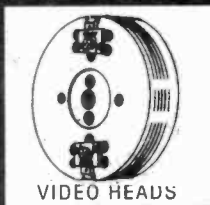

VIDEO HEADS

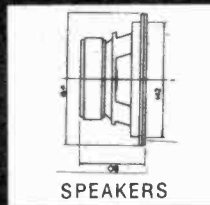

SPEAKERS

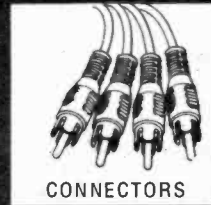

CONNECTORS

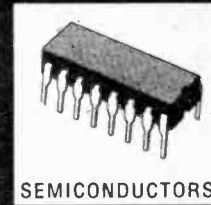

SEMICONDUCTORS

**CRICKLEWOOD**  
ELECTRONICS

Cricklewood Electronics Ltd. 40 Cricklewood Broadway, London NW2 3ET  
Telephone: 081 452 0161 Fax: 081 208 1441

All Major Credit Cards Accepted



## LOW COST RANGER1 PCB DESIGN FROM SEETRAX

- Circuit Schematic
  - Circuit Capture
  - PCB Design
  - Host Of Outputs
- All-In-One Design System**

**£100**

**Fully Integrated Auto Router**

**£50**

**Ask Us About Trade-In Deals**

**Call Now For Demo Disk on 0705 591037**

Seetrax CAE • Hinton Daubnay House  
Broadway Lane • Lovedean • Hants • PO8 0SG  
Tel: 0705 591037 • Fax: 0705 599036

**REDUCED PRICE!**

**What The Press Said About RANGER1**  
For most small users, Seetrax Ranger1 provides a sophisticated system at an affordable price. It is better than EasyPC or Tsien's Boardmaker since it provides a lot more automation and takes the design all the way from schematic to PCB - other packages separate designs for both, that is, no schematic capture. It is more expensive but the ability to draw in the circuit diagram and quickly turn it into a board design easily makes up for this.  
**Source JUNE 1991 Practical Electronics**

Pay by Visa or Access



# TRI-STATE THERMOMETER

T.R. de VAUX-BALBIRNIE

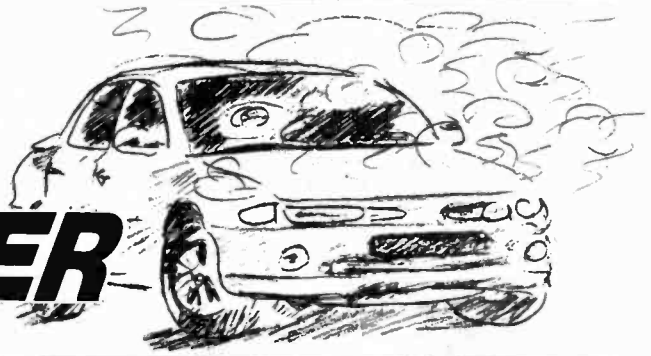

Don't get all steamed up!  
Stay cool - build this  
overheating alert for your car.

ONE are the days when car dashboards sported an array of chrome-bezelled instruments to monitor the engine's state of health. Along with the fuel gauge, there was often an ammeter, oil pressure gauge, water temperature gauge and possibly a voltmeter.

There may have been others indicating inlet manifold vacuum, oil temperature and so on. Car manufacturers tell us that today's motorist does not want or need such instruments and many drivers would not understand the readings anyway.

## ILLUMINATING

Pointer-type instruments were always something of a problem since the driver's eyes had to be taken off the road to see and interpret the readings properly. Also, traditional instruments do not positively signal attention - for example, a slowly decreasing engine oil pressure reading

would probably be missed. A further point is that these instruments were not very effective at night.

In most cars warning lights are now provided. These remain normally *off* unless there is a fault. Thus, a red light comes on when the battery is not charging, another if the engine overheats and so on. There may be other lights to indicate worn brake pads, etc.

Lights have the advantage of attracting attention much more readily than a meter and are also more effective at night. However, unlike instruments, most warning lights have only two states - *on* and *off*.

In the case of a water temperature warning light, the operating point often appears to be set on the high side (so that it usually remains off to avoid alarming the driver). Unfortunately, instead of providing a timely warning, the light comes on when it is obvious - in the form of boiling

noises and steam seen issuing from beneath the bonnet - that overheating has already taken place.

It may not be possible to stop the car there and then yet driving even a short distance may have serious and expensive consequences - indeed, damage may already have been caused. If the cylinder head is made of light alloy - very common in today's cars - even moderate overheating can cause distortion which, in turn, can lead to loss of compression and water entering the cylinders past the cylinder head gasket.

The cost of dismantling, possibly having the cylinder head machined true, cleaning and re-assembling can be very high. If the warning had been given earlier - that is, at a slightly lower temperature, the car could have been driven gently off the road and the cause investigated. This may turn out to be simply due to an inexpensive radiator hose having burst but the problem could be compounded into a costly repair.

## COLOURFUL VIEW

This project is a type of thermometer but instead of a pointer-on-scale meter, it uses a special tri-colour l.e.d. for the display. This lights up *green* for "cool", *yellow* to signify "normal" operating temperature and *red* to warn of "overheating". The only part on view is the l.e.d. in a small plastic box so the appearance of the project is very small and neat.

The operating temperatures are freely adjustable at the setting-up stage. In the prototype unit, yellow may be made to show at any temperature between 35°C and 70°C and red from 70°C onwards. The red l.e.d. will normally be set to operate just a few degrees above normal engine operating temperature.

The Tri-State Thermometer draws current from the 12V car supply and is only active while the ignition is switched on. Current consumption is about 10mA which may be regarded as negligible.

## CIRCUIT DESCRIPTION

The full circuit diagram for the Tri-State Thermometer is shown in Fig. 1. Before going on to explain how it works, it will be helpful to understand the operation of the tri-colour l.e.d., D1. This device contains two separate l.e.d.'s - one red and one green - connected with common cathode (k) in a milky white package.

When the l.e.d.'s are used individually, they emit red or green light in the usual way but if they are operated *together*, the impression given to the eye is that of *yellow* light. This is because red and green are

Fig. 1. Complete circuit diagram for the Tri-State Thermometer.

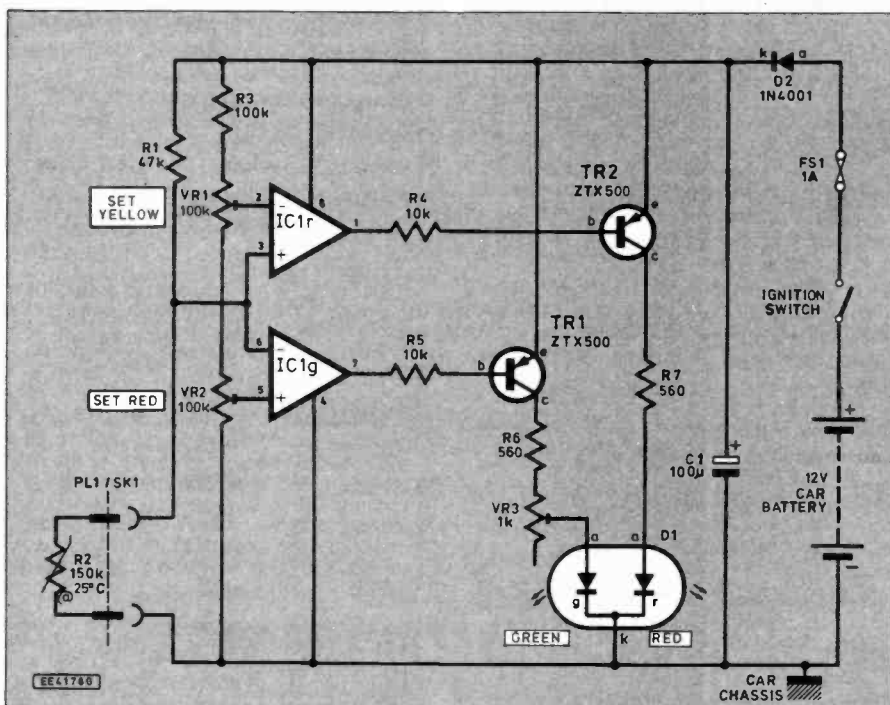

primary colours and these add to give a secondary colour – in this case, yellow.

In the following description, D1g refers to the green l.e.d. and D1r, the red one. Referring to Fig. 1, the temperature is detected by thermistor, R2, which is placed in thermal contact with a suitable part of the engine which becomes hot in operation (details for this are given later).

The thermistor has a negative temperature coefficient – that is, as its temperature increases, its resistance falls. The way in which it does this is shown graphically in Fig. 2 and it will be noted that the response is non-linear, that is, it does not provide equal changes in resistance for equal changes in temperature.

Thermistor R2, in conjunction with fixed value resistor, R1 form a potential divider connected across the nominal 12V supply. Thus, as the temperature of R2 rises, the voltage across it falls and this is applied to IC1 pins 3 and 6. It is this changing voltage which operates the rest of the circuit.

## IN COMPARISON

Integrated circuit, IC1, contains two identical voltage comparators (a comparator is a form of operation amplifier). These are referred to in the text as the red and green sections (IC1r and IC1g respectively) according to which l.e.d. the output is responsible for.

Each comparator has two inputs; an inverting (–) and a non-inverting (+) one (pins 2 and 3 respectively for IC1r, and pins 6 and 5 respectively for IC1g). It also has an output (pin 1 for the red and pin 7 for the green). The voltages applied to the two pairs of inputs are compared – hence the name of the device – comparator.

If the voltage applied to an inverting input exceeds that at the corresponding non-inverting one, the respective output will be low. In fact, the situation is slightly complicated because the output of this particular device is in the form of an open collector transistor which becomes low when the device is actuated.

This fact demanded certain considerations in design. With either comparator output low, the transistor for which it is responsible, TR1 or TR2, will switch on and light the appropriate l.e.d., D1r or D1g. This is because the transistors are of the pnp type and operate when the base is low compared with the emitter which

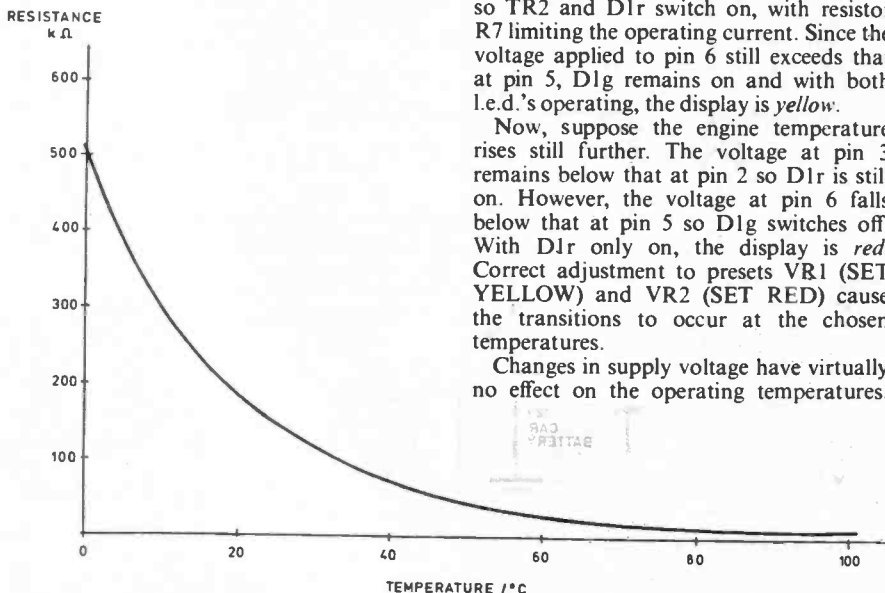
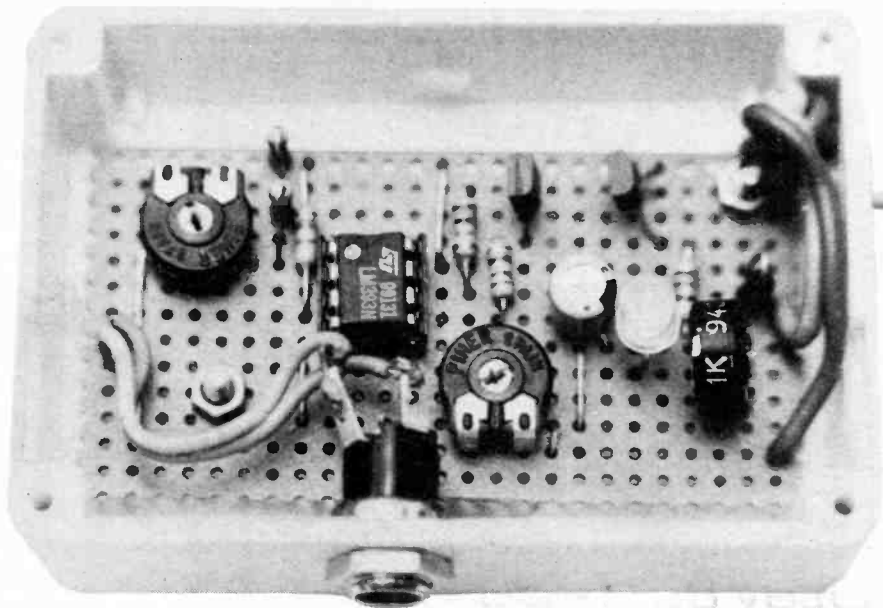

Fig. 2. Response of the thermistor resistance to change in temperature.



Layout of components inside the small plastic case.

is maintained at supply positive voltage. Resistors R4 and R5 limit the base current.

## HOW IT WORKS

Suppose thermistor, R2, is at a low temperature (the car has only just had its engine started and has not warmed up yet). The voltage applied to pin 3 will be fairly high (approaching supply positive voltage). Presets VR1 and VR2 form potential dividers whose sliding contacts apply certain voltages to pins 2 and 5 respectively according to their adjustment.

With a cold thermistor and with VR2 correctly adjusted, the voltage applied to pin 6 will exceed that at pin 5 so IC1g output, pin 7, will be low. Transistor TR1 hence D1g will therefore operate. Fixed resistor, R6, in conjunction with preset potentiometer, VR3, limit the operating current.

Meanwhile, with VR1 correctly adjusted the voltage applied to pin 3 (the same as that at pin 6) will exceed that at pin 2 so transistor TR2 and hence D1r will remain off. With D1g on and D1r off, the display is green.

As the temperature sensed by R2 rises, the voltage applied to pin 3 falls below that at pin 2. IC1r pin 1 therefore becomes low so TR2 and D1r switch on, with resistor R7 limiting the operating current. Since the voltage applied to pin 6 still exceeds that at pin 5, D1g remains on and with both l.e.d.'s operating, the display is yellow.

Now, suppose the engine temperature rises still further. The voltage at pin 3 remains below that at pin 2 so D1r is still on. However, the voltage at pin 6 falls below that at pin 5 so D1g switches off. With D1r only on, the display is red. Correct adjustment to presets VR1 (SET YELLOW) and VR2 (SET RED) cause the transitions to occur at the chosen temperatures.

Changes in supply voltage have virtually no effect on the operating temperatures.

This is because IC1 is comparing pairs of voltages applied to its inverting and non-inverting inputs. Since these are all derived from the same supply they will all rise and fall with supply variations in like manner. Thus, the operating conditions remain unchanged.

With the arrangement of presets VR1 and VR2 as shown, the green l.e.d. goes off

## COMPONENTS

### Resistors

- R1 47k
  - R2 miniature bead thermistor, nominal resistance at 25°C 150k
  - R3 100k
  - R4, R5 10k (2 off)
  - R6, R7 560 (2 off)
- All 0.25W carbon, except R2

See  
SHOP  
TALK  
Page

### Capacitors

- C1 100µ radial elect., 16V

### Potentiometers

- VR1, VR2 100k sub-min preset, horizontal (2 off)
- VR3 1k sub-min preset, vertical

### Semiconductors

- D1 5mm tri-colour common cathode l.e.d.
- D2 1N4001 50V 1A rect. diode
- TR1, TR2 ZTX500 pnp silicon (2 off)
- IC1 LM393 dual comparator

### Miscellaneous

- PL1/SK1 2.1mm power-type plug and matching socket or 2.5mm mono jack plug and socket – see text

- FS1 In-line car-type fuseholder and 1A fuse to fit

Stripboard 0.1in. matrix, size 13 strips x 25 holes; 8-pin d.i.l. socket; plastic box, size 75mm x 50mm x 25mm; potting box size 28mm x 18mm x 14mm; 3A auto-type wire; light-duty stranded wire; car-type connectors; rubber grommets as required; fibreglass insulation; quick-setting epoxy resin adhesive; solder; etc.

Approx cost  
guidance only

£9

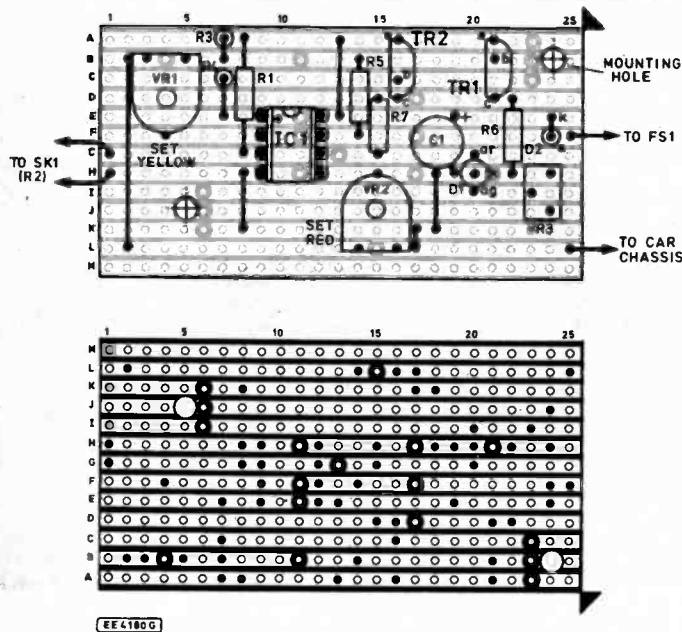

Fig. 3. Stripboard component layout and details of breaks required in the underside copper tracks. Note that there is NO break between pins 3 and 6 of IC1.

after the red one has come on – that is, on rising temperature the sequence will always be green, yellow and red. Preset VR3 allows for some adjustment to D1g operating current and this will be used to provide the best yellow colour at the end of construction. It seemed in tests that the green l.e.d. always appeared brighter than the red one so VR3 allows the current through D1g to be reduced so allowing the brightness levels to be balanced.

Diode D2, in conjunction with capacitor, C1, smooth the supply obtained from the car charging system. D2 also prevents damage if the supply is connected with the wrong polarity. Fuse FS1 provides protection in the event of faulty connections or a short-circuit.

A plug and socket arrangement, PL1/SK1 is used to connect the remote thermistor sensor to the main unit. In the prototype a 2.1mm power-type connector was used but it would be possible to use a 2.5mm mono jack plug and socket or any other similar connector.

## CONSTRUCTION

Construction of the Tri-State Thermometer is based on a circuit board made from a piece of 0.1in. matrix stripboard, size 13 strips x 25 holes (see Fig. 3). Cut the material to size, drill the two mounting holes and make all track breaks as indicated. Note the intact copper strip between IC1 pins 3 and 6.

Follow with the topside inter-strip link wires and finally add the soldered on-board components including the i.c. socket. Do not insert the i.c. at this stage, however.

Take care to observe the polarities of the electrolytic capacitor C1, and diodes D1, D2. Note that the tri-colour l.e.d. D1 has its two outer leads bent in different shapes to denote the red and green anodes. The common cathode (k) is the centre lead – see Fig. 4.

The l.e.d. should be soldered in position so that it stands with its tip 20mm approximately above the circuit board. This should ensure that the end will protrude through a hole which will be drilled in the lid of the

box later. It would be possible to mount the l.e.d. remotely if desired so that the box containing the circuit panel could be placed out of sight and the l.e.d. mounted alone on a small bracket.

Solder 5cm pieces of light-duty stranded wire to strips G and H on the left-hand side of the circuit panel. Solder a 20cm piece of light-duty red stranded wire to copper strip F and a similar piece of black wire to strip L on the right-hand side.

Solder one section of fuseholder, FS1, to the free end of the red wire. Make a careful check for errors particularly to ensure that all cut racks are completely broken and that there are no solder “bridges” formed between adjacent copper strips.

## CASE DETAILS

Drill the circuit board mounting holes in the base of the box and the hole in the side for the two supply wires leading through from the circuit board. Drill the hole for the thermistor connecting socket SK1 (see photograph).

Mount the circuit panel temporarily and measure the position of the l.e.d. carefully. Drill a hole in the lid, having the same diameter as the l.e.d., to correspond with it.

Fig. 5. Interwiring from the circuit board. The “earth” wire is taken to a metal chassis point.

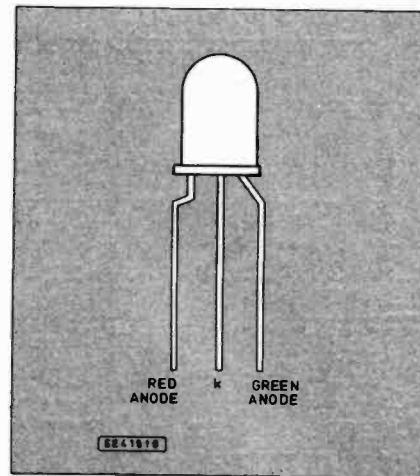
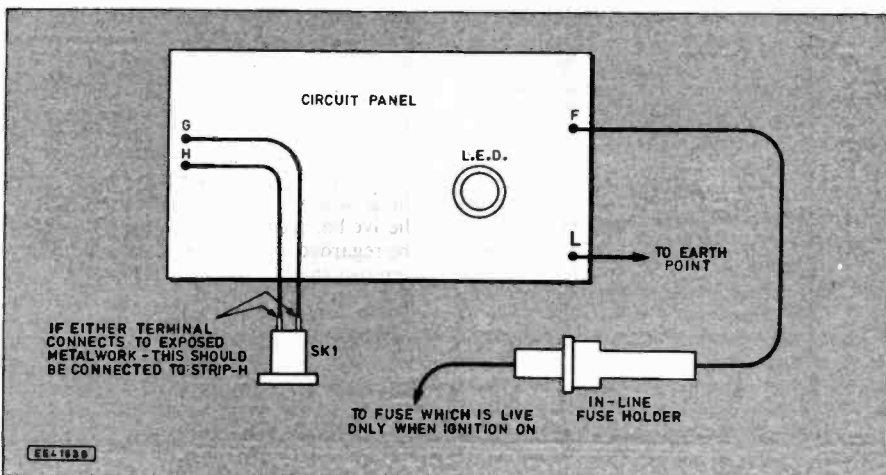

Fig. 4. Pin connection details for the tri-colour l.e.d.

An alternative method is to put a dot of ink on the top of the l.e.d. using a felt-tip pen. Immediately place the lid on top aligned with the correct position. The ink will mark the box at the point to be drilled.

Check that the l.e.d. will protrude through the hole when the lid is in position. Careful bending of the l.e.d. leads is permissible to provide small adjustments.

Only the tip of the l.e.d. should show through the case. If it protrudes through the hole too far, the separate glow of the green and red l.e.d.'s will be seen when the device is viewed at an angle and this will spoil the effect.

Measure the positions of presets VR1 and VR2. Drill two small holes in the lid to correspond with these positions so that these presets may be adjusted using a small screwdriver when the lid of the box is in place.

Mount the circuit panel on piece of thin cardboard to provide some padding. Attach the thermistor connecting socket and wire it up. The terminal connected to any exposed metal should be wired to supply negative – i.e. to strip H on the circuit panel (see Fig. 5).

Make sure all connections remain clear of VR2 and other components. Tie a knot in the supply wires to provide some strain relief and pass them through the hole in the box drilled for the purpose leaving a little slack.

Adjust all three presets to approximately mid-track position. Finally, insert the i.c. into its socket observing the orientation.

Use a short piece of light-duty twin wire to make a temporary connecting lead for the thermistor. Fit one end with the plug

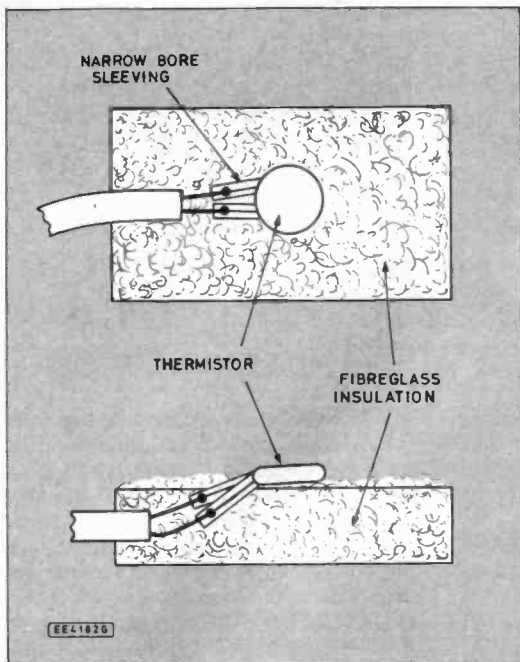
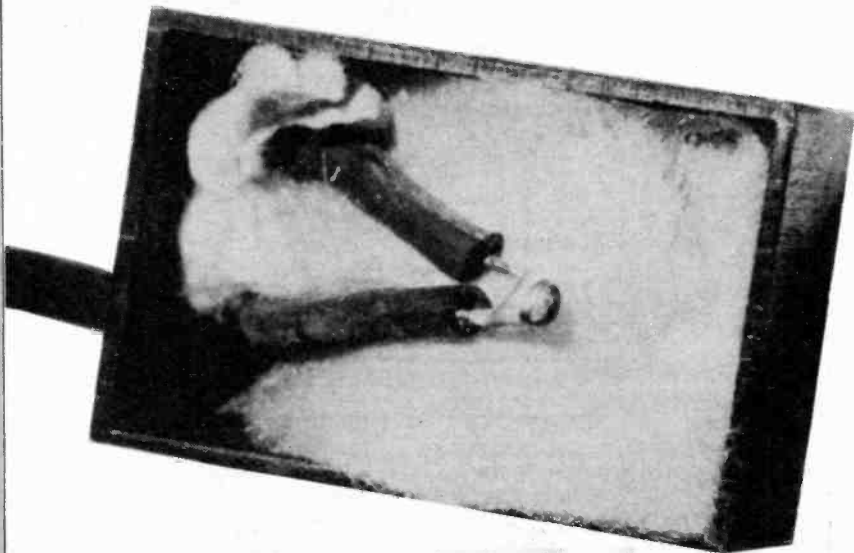

Fig. 6. Suggested method of housing the thermistor inside a small "potting" box.



The thermistor housed in a potting box on a bed of fibreglass insulation.

and twist the other ends on to the thermistor wires. Take care since the thermistor is a delicate component and the wire ends are easily broken off.

## TESTING

Initial testing and setting-up are made using a 9V battery instead of the car supply. If a thermometer which reads up to 100°C is available, this may help but is not essential. Testing on the bench is convenient since any small problems which may have arisen are more easily corrected.

Connect the battery with the positive terminal to the red wire and the negative to the black one. The l.e.d. should glow green although a little less brightly than it will be when connected to the car's 12V system.

Warm the thermistor R2 by dipping it in hot water. The l.e.d. should go to the yellow stage (with preset VR1 at mid-track position this should occur at 50°C approximately) and eventually show red towards boiling point.

This is only a basic test – there is no point in trying to set the operating temperatures this way since water conducts electricity well enough to disturb the operating points. In any case, the exact temperatures can only be set with the thermistor under true working conditions.

Instead of using hot water for testing purposes, it would be possible to use a hair dryer instead. With the l.e.d. showing yellow, adjust preset VR3 to provide the best colour and replace the lid of the box.

If all is well, attention may be given to the thermistor housing. The thermistor cannot be simply attached to the engine block in its present form because the wire ends would soon break off.

Also, cool air circulating around the engine would lower the temperature of the thermistor and alter the operating points. This would lead to unpredictable results with the transitions depending on the air temperature, the speed of the car and so on.

It is therefore necessary to provide mechanical protection and also some insulation. This was achieved in the prototype using the arrangement shown in Fig. 6.

Obtain a piece of light-duty stranded twin wire sufficiently long to reach from the unit to the thermistor position. In the prototype, 4-core burglar alarm wire was used with two of the wires cut off short.

The small plastic box used for the thermistor housing is a *potting box* (see components list). This needs a small hole drilled in the side to accommodate the connecting wire.

One end of the connecting lead is passed through to the inside. The thermistor is then soldered to the free ends with the connections insulated with narrow-bore sleeving or (better) heat-shrinkable sleeving. Some strain relief is needed for the wire inside the box – a piece of thin string tied tightly around it is adequate.

The box is now stuffed with fibreglass – such as a little roof or pipe insulation. The thermistor is left on this bed of fibreglass with the top level or slightly higher than the open end of the box (see photograph).

A suitable site on the engine block now needs to be found which becomes hot in operation. This must be clear of *all mechanical parts* and be easily accessible. The thermistor unit *must not* be placed on or near the exhaust system. The local garage will probably help in advising on a suitable place if necessary.

The area is carefully cleaned of all oil and dirt and then roughened using emery paper. The engine should then be run until the attachment site is warm so that the adhesive will set quickly.

Quick-setting epoxy resin adhesive is applied to the face of the thermistor (this is important to provide good thermal contact between the thermistor and the engine block) and around the rim of the box. Take care to avoid putting adhesive on to the fibreglass. The box is then pressed firmly in position and supported until the adhesive has hardened. The attachment must be regarded as permanent – any attempt to remove the box will probably destroy the thermistor.

## INSTALLATION

*Before installing the unit, you must disconnect the car battery.*

Installation is simply a matter of connecting the thermistor wire to the unit in-

side the car and making the power supply connections. Choose a suitable site for the unit. With care, the position may be chosen so that only the lower part of the box with the l.e.d. shows.

Pass the thermistor connecting wire to the unit position inside the car. It saves time to use an existing hole and grommet by pushing the new wire through alongside the existing ones but if a new one needs to be drilled make sure a rubber grommet is used to avoid damage.

Leave a little slack in the connecting wire to allow for engine vibration. Cut off any excess wire and solder the plug PL1 to the end (polarity unimportant).

Using a piece of red auto-type wire of 3A rating minimum, connect one end to the output side of a fuse which is live only when the ignition is switched on. Use a proper connector here – *do not rely on twisted connections*. Often a "piggy-back" converter may be used to add a wire to an existing terminal.

Cut the wire to the correct length and connect the remaining half of the in-line fuseholder – see Fig. 5. Assemble this with a 1A fuse inside.

Connect the black wire to an "earth" chassis point. If no existing earth point can be found drill a small hole in a metal part and use an eyelet secured with a self-tapping screw. Support the unit temporarily using a piece of string or an elastic band.

## ADJUSTMENT

Re-connect the car battery then switch on the ignition. The l.e.d. should show green.

Run the car until the engine is warm – rather less than normal operating temperature – and adjust preset VR1 (SET YELLOW) using a small screwdriver through the hole in the lid so that the l.e.d. just shows yellow. Run the car until the engine is at normal operating temperature and adjust VR2 (SET RED) so that the l.e.d. just fails to show red under all normal driving conditions. Note that with both VR1 and VR2, clockwise rotation increases the operating temperature.

If the red l.e.d. tends to come on when driving uphill or when waiting in a traffic queue with the engine running, further small adjustments may be made to prevent this from happening. It only remains to attach the unit permanently in position using a small bracket. □

# FOX

# REPORT

by Barry Fox



## INTERFERING INTERFERENCE

In the good old days, anyone suffering radio or TV interference went to the local Post Office to fill in a form for a free check. After the split and privatisation of British Telecom, responsibility shifted to the Radiocommunications Agency, in Waterloo. If someone knows for sure where interference is coming from, the RCA will act free. If the RCA has to track down interference the fee payable is a still-reasonable £31.

The RCA has recently announced that it now has a Central Enquiry number for sufferers to ring (071 215 2150). This made me check back on the previous situation. I checked both the telephone directory and BT's Phone Disc CD-ROM. Neither listed either the RCA or Radiocommunications Agency.

I now learn that this was not a mistake. Although the RCA and its enquiry number will now be listed, the Agency has for all these years not been entered under its own name. To find the number a member of the public has needed to know that the RCA is an Executive Agency of the DTI, and then phone the DTI's main enquiry number, 071 215 5000.

Perhaps everyone did know this. Or just perhaps this little oversight had the happy effect of shielding the RCA from a lot of interfering phone calls from people suffering interference.

## MS-DOS PATENT BATTLE

Microsoft announced Version 6 of the MS-DOS operating system on 30 March. The launch went ahead despite the fact that Microsoft is being sued for infringement of patents on the data compression system, called DoubleSpace, which Microsoft bought in from Vertisoft and modified to bundle with DOS 6.

Stac Electronics, the owner of the patents and vendor of third party compression system Stacker, has been only too happy to talk about the legal case. Although Microsoft has refused to comment on the case, I read, and reported, a message circulated on electronic bulletin boards by a consultant employed by Microsoft which told how the company is trying to break Stac's patents. Although I normally get all Microsoft's press releases and invites, by some mysterious quirk of the mail I got no invite to the launch "party" for DOS 6.

IBM chose Microsoft, in the early eighties, to provide the operating system for its then-new range of personal computers. Apple's stubborn refusal to

licence its much more friendly Lisa and Mac operating systems guaranteed the PC's success and made Microsoft's founder Bill Gates the richest man in America. Despite the user-hostility of DOS, over 100 million IBM and IBM-compatible PCs already use it and Microsoft ships more than 20 million units a year. Microsoft earns around \$3 billion a year and employs 12,000 people in 27 countries. But Microsoft knows the market will shrink in the future, because existing owners of PCs will not upgrade their operating system, unless there is a real incentive to do so.

Microsoft believes the best incentive to buy a new version of DOS, is to build in data compression. There are already several third party data compression systems available, with Stac's Stacker one of the most popular. Stac has grown from a company with 25 employees and a revenue of less than \$1 million in 1989 to a company with over 200 employees and revenue of \$150 million. Stacker takes advantage of the fact that all computer files contain redundant information, for instance repeated use of the same characters, which need not be fully coded.

## STACKER STALL?

Stac claims that in late 1991 Microsoft's founder, Chairman and Chief Executive Officer, Bill Gates, saw Stacker winning computer industry awards, and asked Stac's President Gary Clow, about including Stacker technology in MS-DOS. During six months of negotiation Microsoft showed Stac a spreadsheet analysis, which predicted that if MS-DOS 6 incorporated data compression, Stac's sales of Stacker would stall. This view is shared by the computer industry.

In the February 1993 issue of *Personal Computer World*, a review of Stacker predicted that MS-DOS with compression would make the "market for utilities like Stacker... disappear", and suggested to anyone thinking of buying a data compression system that "waiting for MS-DOS 6 may be no bad thing".

Stac says that Microsoft has refused to pay Stac "reasonable compensation" for using Stacker technology in DOS 6, with negotiations between the two companies breaking down, re-starting and failing several times during 1992. In the second half of the year Microsoft released a Beta test version of MS-DOS 6 for software developers to check for problems or "bugs".

Stac checked this and claims that although Microsoft's DoubleSpace may

vary slightly from Stacker, it still infringes its two master patents, US patents 4 701 745 and 5 016 009. The first was filed by John Waterworth of Ferranti of the UK, but is now owned by Stac. Microsoft has retained a consultant who describes it as the "king pin" of a tree of patents on compression, but says he is "completely convinced of the patent's triviality" and that it is "ludicrous" that the patent was ever granted.

The consultant warns that the stakes are high. If a company as large as Microsoft wins, then the whole tree of patents will fall; if Microsoft loses, then it is unlikely the patent will be challenged again and will thus be massively strengthened.

Microsoft's difficulty is that it must now prove that what appears trivial now, was trivial when John Waterworth filed his application in March 1985. The patent claims the basic idea of searching data for sequences of bytes which are identical to sequences already processed, and then storing only code which identifies the location of previously stored identical sequences.

"This is a fundamental and obvious technique in data compression and it is ludicrous that it should be anywhere but in the public domain", claims Microsoft's consultant who has been posting notices on electronic bulletin boards for computer engineers and enthusiasts all round the world to read. "If you know of any prior art . . . please contact me" pleads Microsoft's aid.

## WILFUL

Microsoft's informal line now is that only 10% of DoubleSpace derives from Vertisoft's original work, and 90% comes from Microsoft's ongoing development; and DoubleSpace, like all compression systems, builds on the same common foundation that Stac is claiming to monopolise. Stac hopes to convince the court in Los Angeles that because Microsoft asked for a licence under its patents, Microsoft's infringement is "wilful". Everything now hangs on the legal validity of Stac's patents.

Stac is now promising a new version of Stacker to be available within 30-60 days from the release of DOS 6. This, says Stac, will hook onto DOS and integrate itself into Microsoft's operating system, by replacing whatever DoubleSpace system comes with DOS 6. The 30-60 day delay was needed because until the official launch of DOS 6, no-one could be sure exactly what DoubleSpace would look like.



# Teach-In '93

with Alan Winstanley  
Keith Dye B.Eng(Tech)AMIEE and  
Geoff MacDonald B.Sc(Hons) AMIEE

Part 10

*Teach-In '93 continues a tradition of offering an interesting and thorough tutorial series aimed specifically at the novice or complete beginner in electronics. The series is designed to support those undertaking either GCSE Electronics or GCE Advanced Levels.*

**L**AST month we introduced lots of new terms that are used in the world of microprocessors and their operating programs. We'll now focus on programming and try to avoid too many new terms. We will not be able to delve into complex programming techniques, but hope to provide an interesting overview to commonly used programming techniques. Don't worry if you find it difficult to grasp the idea of programming on your first reading. If you have built the *Micro Lab* have a go at entering programs – you can't damage anything by pressing the keys!

## INTRODUCTION TO PROGRAMMING

Machine Code is the basic language understood by the Microprocessor (or machine). It is made up of *byte instructions* followed by *data* or *address locations*. This is the form that a program is stored in a computer's memory, and will be used to enter instructions into the *Micro Lab*. Unfortunately, it is not easy to understand code written in this way as it just appears as a stream on hexadecimal numbers. Higher level languages are easier to use and understand because they use English to describe the program operations. See the separate section on *High Level Languages*.

An improvement on machine code is an *Assembler Language*

program. Assembler language is the preferred method of entering microprocessor code because it uses the three-character mnemonics from the *instruction set*. As the mnemonic represents the function of the instruction, it helps you to understand a program that has been written by someone else (or yourself if you have an average memory!).

All microprocessors have an instruction set with a set of mnemonics. The instruction sets are different for each manufacturer's devices, although there are families of devices that use similar types of code. Instructions written in "assembler" cannot run on the microprocessor in that form and must be converted into machine code. This is achieved either by hand, or with a program that converts the assembler into the machine code of the target microprocessor. Most desk top computers (e.g. the BBC and IBM machines) come with software that allows a program written in assembler to be converted to machine code.

An example of the program listing from our 6502 assembler is shown in Fig. 10.1. This shows the result after the assembler has been converted into machine code. Assemblers come with some other useful features that allow a programmer to choose where the converted code will be placed in the microprocessor's memory map. In this example the code has been placed at 8080h.

## Fig. 10.1 Description of 6502 Program Listings

All the programs written in 6502 assembler language are shown in this format. This is the output of the assembler translation software that produces the 6502 machine code. All the programs can be run on the *Micro Lab*, but must be entered in machine code. To do this enter the *MODify* command and type in the memory location – say \$0200 – then press enter. The program is then entered as A9 00 85 90 A9 02 etc.

```
8080 A900 D_DEMO0: LDA #S00 ;Set up start address of table
8082 8590          STA S90
8084 A902          LDA #S02
```

↑	↑	↑	↑	↑	↑
Memory Address	Op-Codes (Machine Code)	Labels	Mnemonic (Assembler Language)	Operands	Comments

### Numbers

In computer programs we need to know how to distinguish between decimal and hexadecimal numbers. We will always place an *(H)* or *h* after hexadecimal numbers to distinguish them from decimal numbers. Unfortunately, the output from the 6502 assembler uses a different convention to indicate Hexadecimal numbers. A *\$* is placed in front of hexadecimal numbers as:

Hex number      \$200

### Memory Address

The memory address is the location of the program in the microprocessor memory map. On the *Micro Lab* address locations from

\$8000 to \$FFFF are contained in the EPROM. You cannot alter these memory locations.

### Op-Codes

The op-codes are the machine code instructions that the 6502 microprocessor follows. In the first line the op-code for the LDA (Load Accumulator) instruction is A9. The value to be loaded into the accumulator follows the op-code – in this case decimal 00.

### Labels

Labels are names given by the writer of the program to identify particular points in the program. The assembler language can recognise the names as locations to branch to within the program. In this example D\_DEMO0 is at address \$8080. An instruction to jump or branch to D\_DEMO0 will load the program counter with 8080 and the program will run from this address.

### Assembler Language

The instructions entered by the programmer are these assembler language descriptions of the program. The mnemonic is a three character abbreviation of the instruction command name. The operand is the data or address that the instruction applies to. In the second line the accumulator is stored at address 0090. (This is a zero page instruction and only two bytes are needed to describe the memory location.)

### Comments

The comments are an optional description that the programmer can enter. They are used to describe the instruction or process operation. Good programmers use extensive comments to aid others to understand their programs.

# Fig. 10.2 - 6502 Instructions

## BCC - Branch on Carry Clear

NV-BDIZC  
-----

Tests the carry flag for 0. If clear, the program will branch forward or backwards by the number of bytes specified. If set, the next program instruction is executed. Displacement range from +127 to -128 from the next instruction after BCC.

Address Mode	Op-Code	Example
Relative	90	90 20 BCC PC + 20h

## BEQ - Branch on Z = 1

NV-BDIZC  
-----

Tests the zero flag for 1. If set, the program will branch forward or backwards by the number of bytes specified. If clear, the next program instruction is executed. Displacement range from +127 to -128 from the next instruction after BCC.

Address Mode	Op-Code	Example
Relative	F0	F0 20 BEQ PC + 20h

## BNE - Branch on Not Equal to Zero

NV-BDIZC  
-----

Tests the Z flag for 0. If clear, the program will branch forward or backwards by the number of bytes specified. If set, the next program instruction is executed. Displacement range from +127 to -128 from the next instruction after BCC.

Address Mode	Op-Code	Example
Relative	D0	D0 20 BNE PC + 20h

## BRK - Break

NV-BDIZC  
---|----

A software interrupt of the program. The PCL is set to the value stored at FFFE and the PCH is set to the value stored at FFFF. The B flag in the status register is set, and the status register is saved on the stack.

Address Mode	Op-Code	Example
Implied	00	00 BRK

## CPY - Compare to Y Register

NV-BDIZC  
x-----xx

Compares the contents of the specified memory or immediate data from the Y register. If the result is zero Z is set. If bit 7 = 1 (positive) then N is set to 1. If the register equals or is greater than the data (negative) the C flag is set. The memory and accumulator contents are unchanged.

Address Mode	Op-Code	Example
Immediate	C0	C0 20 CPY #20h
Absolute	CC	CC 34 12 CPY 1234h
Zero Page	C4	C4 20 CPY 20h

## DEX - Decrement X Register

NV-BDIZC  
x-----x-

Decrements 1 from the X register.

Address Mode	Op-Code	Example
Implied	CA	CA DEX

## INY - Increment Y Register

NV-BDIZC  
x-----x-

Adds 1 to the contents of the Y register.

Address Mode	Op-Code	Example
Implied	C8	C8 INY

## JMP - Jump to Address

NV-BDIZC  
-----

Loads the program counter with the address specified. The program will jump to the new address.

Address Mode	Op-Code	Example
Absolute	4C	4C 34 12 JMP 1234h
Indirect	6C	6C 34 12 JMP (1234h)

## JSR - Jump to Subroutine

NV-BDIZC  
-----

Stores the program counter + 2 onto the stack, and loads a new address into the program counter. The program jumps to that address. An RTS is used to return to address stored in the stack.

Address Mode	Op-Code	Example
Absolute	20	20 34 12 JSR 1234h

## LDA - Load the Accumulator

NV-BDIZC  
x-----x-

Loads the data into the accumulator.

Address Mode	Op-Code	Example
Immediate	A9	A9 20 LDA #20h
Absolute	AD	AD 34 12 LDA 1234h
Zero Page	A5	A5 20 LDA 20h
(Indirect,X)	A1	A1 20 LDA (20h,X)
(Indirect),Y	B1	B1 20 LDA (20h),Y
Zero Page,X	B5	B5 20 LDA 20h,X
Absolute,X	BD	BD 34 12 LDA 1234h,X
Absolute,Y	B9	B9 34 12 LDA 1234h,Y

## LDX - Load the X Register

NV-BDIZC  
x-----x-

Loads the data into the X register

Address Mode	Op-Code	Example
Immediate	A2	A2 20 LDX #20h
Absolute	AE	AE 34 12 LDX 1234h
Zero Page	A6	A6 20 LDX 20h
Absolute,Y	BE	BE 34 12 LDX 1234h,Y
Zero Page,Y	B6	B6 20 LDY 20h,Y

## LDY - Load the Y Register

NV-BDIZC  
x-----x-

Loads the data into the Y register

Address Mode	Op-Code	Example
Immediate	A0	A0 20 LDY #20h
Absolute	AC	AC 34 12 LDY 1234h
Zero Page	A4	A4 20 LDY 20h
Zero Page,X	B4	B4 20 LDY 20h,X
Absolute,X	BC	BC 34 12 LDY 1234h,X

## LSR - Logical Shift Right

NV-BDIZC  
x-----xx

Shifts the contents of the memory or accumulator 1 bit to the right, and saves the result. Bit 7 is set to 0. Bit 0 is stored in the C flag.

Address Mode	Op-Code	Example
Absolute	4E	4E 34 12 LSR 1234h
Zero Page	46	46 20 LSR 20h
Accumulator	4A	4A LSR A
Zero Page,X	56	56 20 LSR 20h,X
Absolute,X	5E	5E 34 12 LSR 1234h,X

## PHA - Push Accumulator onto Stack

NV-BDIZC  
-----

Copies the contents of the accumulator onto the stack and decrements the stack pointer.

Address Mode	Op-Code	Example
Implied	48	48 PHA

## PLA - Pull Accumulator from Stack

NV-BDIZC  
x-----x-

Loads the top byte from the stack into the accumulator and increments the stack pointer.

Address Mode	Op-Code	Example
Implied	68	68 PLA

## STA - Store Accumulator in Memory

NV-BDIZC  
-----

Copies the accumulator to the specified memory location.

Address Mode	Op-Code	Example
Absolute	8D	8D 34 12 STA 1234h
Zero Page	85	85 20 STA 20h
(Indirect,X)	81	81 20 STA (20h,X)
(Indirect),Y	91	91 20 STA (20h),Y
Zero Page,X	95	95 20 STA 20h,X
Absolute,X	9D	9D 34 12 STA 1234h,X
Absolute,Y	99	99 34 12 STA 1234h,Y

## Instruction Sets

Every microprocessor is designed to follow a set of instructions. Unfortunately every manufacturer uses a different set of instructions for their products. This means that a program written for one type of processor will not run on another without some alterations. As more powerful processors are developed, some manufacturers have tried to provide an upward compatibility for existing programs. In the case of Intel's 86xxx series of microprocessors used in IBM compatible personal computers, programs written for the early microprocessors will run on the latest devices. The process does not work in reverse, as later devices usually have additional features built in and programs written to use these will have commands that the early devices cannot understand.

As we have used the 6502 microprocessor for the *Micro Lab* we have to use its instruction set. Some of the instructions we use this month are shown in Fig. 10.2. The instructions are all given in the same format and we have given examples of how the commands are used.

All the instructions have a one byte code which is the command that the microprocessor understands. This is called the *Operation Code*, or more usually the *Op-Code*. A sequence of op-codes make a program that a microprocessor will follow - it can only operate on one op-code at a time.

As one byte is used for the Op-Code there are theoretically 256 different instructions that could be used. The 6502 only uses 150 instructions - codes that are not valid instructions are ignored.

There are only 56 basic instructions for the 6502, but some of these have different ways of being used within programs. Each basic instruction type is given a three letter "name" or mnemonic that helps you to remember the instruction. For example the instruction Branch on Carry Clear is called BCC. If you look at the instruction set you can see that this instruction has only one mode of use. Some of the instructions have eight modes of operation, and we will look at some of these different modes.

## Addressing Modes

A computer program will usually spend most of its time reading and writing data to and from memory. There are a number of ways in which the program may need to do this. For example, you may need to set a register to a particular value. This is called *immediate addressing*, as the register is immediately loaded with the value specified. If you have a program that needs to repeat a section of the program a set number of times you will first have to store the repeat value in a register. As the computer completes this section of the program it will subtract one from the register. If the register is not zero the program will jump to the start of that section again. We will look at these techniques again later.

There are several other ways in which you may want to load and store data to and from registers and memory depending on what you want your program to do. Each different way of accessing the memory is called an *addressing mode*. The addressing modes available depend upon the micro processor being used, although they all provide the same basic facilities. Each addressing mode of the 6502 is described below. As with most things, some addressing modes are more useful than others and will therefore be used more often. An example is given with each mode. The examples given are of usable programs and may contain several addressing modes.

If you have successfully constructed the *Micro Lab*, have a go now at entering the programs. The *Micro Lab* User Manual contains comprehensive details of how to enter your own code and see it operate. Remember, you cannot damage the *Micro Lab* if you press the wrong keys, just try again! If you have a 6502 based computer (like the BBC B and Acorn Master series) you could try to enter the code in assembler or machine code. (Note: the programs may not run as the memory map will be different on these machines.)

A table of Hexadecimal and Decimal numbers and their ASCII equivalents is given in opposite. Use this to help you understand some of the numbers being entered in the programs.

### Immediate Addressing

Loads a register (not a memory location) with an immediate value.

**0200 A9 20 LDA #20h ;Load accumulator with 20h**

The example loads the accumulator immediately with the value 20h.

### Implied Addressing

This term is used for instructions which do not have an addressing mode specified. For example pushing the contents of the accumulator onto the stack:

**0200 48 PHA ;Save accumulator**

# ASCII TABLE

HEX	DEC	ASCII
00	0	NUL
01	1	SCH
02	2	STX
03	3	ETX
04	4	EOT
05	5	ENQ
06	6	ACK
07	7	BEL
08	8	BS
09	9	HT
0A	10	LF
0B	11	VT
0C	12	FF
0D	13	CR
0E	14	SO
0F	15	SI
10	16	DLE
11	17	DC1
12	18	DC2
13	19	DC3
14	20	DC4
15	21	NAK
16	22	SYN
17	23	ETB
18	24	CAN
19	25	EM
1A	26	SUB
1B	27	ESC
1C	29	FS
1D	29	GS
1E	30	RS
1F	31	US
20	32	SPACE
21	33	!
22	34	"
23	35	#
24	36	\$
25	37	%
26	38	&
27	39	'
28	40	(
28	41	)
2A	42	*
2B	43	+
2C	44	,
2D	45	-
2E	46	.
2F	47	/
30	48	0
31	49	1
32	50	2
33	51	3
34	52	4
35	53	5
36	54	6
37	55	7
38	56	8
39	57	9
3A	58	:
3B	59	;
3C	60	<
3D	61	=
3E	62	>
3F	63	?

HEX	DEC	ASCII
40	64	@
41	65	A
42	66	B
43	67	C
44	68	D
45	69	E
46	70	F
47	71	G
48	72	H
49	73	I
4A	74	J
4B	75	K
4C	76	L
4D	77	M
4E	78	N
4F	79	O
50	80	P
51	81	Q
52	82	R
53	83	S
54	84	T
55	85	U
56	86	V
57	87	W
58	88	X
59	89	Y
5A	90	Z
5B	91	[
5C	92	\
5D	93	]
5E	94	^
5F	95	-
60	96	`
61	97	a
62	98	b
63	99	c
64	100	d
65	101	e
66	102	f
67	103	g
68	104	h
69	105	i
6A	106	j
6B	107	k
6C	108	l
6D	109	m
6E	110	n
6F	111	o
70	112	p
71	113	q
72	114	r
73	115	s
74	116	t
75	117	u
76	118	v
77	119	w
78	120	x
79	121	y
7A	122	z
7B	123	{
7C	124	
7D	125	}
7E	126	~
7F	127	DEL

### Absolute Addressing

This is used to access a particular memory location to either load a register with the location's value or store the register value in the memory location. This may be used to access *peripherals* such as the keyboard, display, I.e.d.s etc. or using memory for storage of program *variables* (for example the number of ships the player has left in a game of space invaders, today's date, etc.).

```
0200 A9 AA LDA #AAh ;Load accumulator with AAh
0202 8D 00 80 STA 8000h ;Store accumulator in LEDs
```

This loads the accumulator with AAh (10101010 in binary) and stores it at the memory location used by the I.e.d.s. This has the effect of turning on every other I.e.d. Try this out on the *Micro Lab* and see the I.e.d.s light up.

### Offset Addressing

Offset addressing is only used by the 6502 *branch* instructions. These instructions change the program counter if a particular condition is true or false (e.g. if the last arithmetic result was zero). If the condition is met, the program counter is added to the parameter. Note that when the instruction is read from memory, the program counter is pointing to the first byte of the next instruction. This means that an offset of zero will have no effect. An offset of three will branch forwards, skipping three bytes. An offset of -2 (or FEh) will branch to the start of the branch instruction – looping continuously if the condition is met.

```
0200 A9 00 LDA #00h ;Load acc. with zero
0202 F0 03 BEQ 0207h ;Jump to 0207h if ZF is set
0204 4C 00 03 JMP 0300h ;Jump to 0300h
0207 00 BRK ;Stop program
```

The above example will always jump to address 0207h then stop.

```
0200 A0 10 LDY #16 ;Load IY with 16
0202 88 DEY ;Subtract one from IY
0203 D0 FD BNE 0202h ;Jump to 0202h if not zero
0204 00 BRK ;Stop program
```

The above example will loop for sixteen (10h) times then stop.

### Zero Page Addressing

Zero page addressing is a subset of absolute addressing. The address specified is only eight bits wide. The upper eight bits of the address are set to zero (hence the name). Therefore, only addresses between 0000h and 00FFh may be accessed with this addressing mode. The advantage of using zero page addressing is that the instruction uses less memory (a considerable advantage a few years ago when memory was very expensive, but not so today). Using less memory means that the processor can read the instruction from the program faster.

```
0200 A5 90 LDA 90h ;Load accumulator with the
;contents of address 0090h
```

### Absolute Indexed Addressing

This is a more complex addressing mode than those previously described, but it is probably one of the most often used. A *base address* is specified, along with an index register (either IX or IY). The value held by the index register is added to the base address and the resulting address is the one used by the instruction.

The following example stores 12h in address 0410h using absolute indexed addressing. This may seem pointless, as the same result can be obtained using simple absolute addressing, however a better use of this addressing mode will be described later when we talk about *program loops*. This addressing mode is denoted by a "X" or "Y" after the base address.

```
0200 A9 12 LDA #12h ;Load accumulator with 12h
0202 A0 10 LDY #10h ;Load IY with 10h
0204 99 00 04 STA 0400h,Y ;Store acc. at 0410h
```

### Zero Page Indexed

Again, this is a subset of the absolute indexed addressing mode. The base address specified must be in the range 00h to FFh and the upper eight bits of the resultant address are always 00h. This means that, for example, if the base address is F0h and the IX register is 20h, the address accessed will be 0010h, *not* 0110h.

```
0200 A2 20 LDX #20h ;Load IX with 20h
0202 XX F0 LDA F0h,X ;Load acc. with contents
;of address 0010h
```

### Indirect Addressing

This one's a bit more complicated! The processor looks at the

contents memory at the address specified and then at the contents of the one after it. The two values read are then used as the resultant address. This is best shown by an example. Indirect addressing is shown by placing the address in brackets.

```
If
  Address 0400h holds the value 00h
  Address 0401h holds the value 05h
Then the instruction
0200 6C 00 04 JMP (0400h)
Will make the program jump to address 0500h
```

### Indexed Indirect Addressing

Indexed Indirect Addressing simply adds the value of the IX register to the address which is to be looked at to get the resultant address! This is shown by inserting a "X" after the address.

```
If
  Address 0096h holds the value 00h
  Address 0097h holds the value 05h
  Address 0500h holds the value 34h
Then the instructions
0200 A2 06 LDX #06h
0202 XX 90 LDA (90h,X)
Will load the accumulator with the value 34h (held at
address 0500h).
```

### Indirect Indexed Addressing

This mode looks at contents of the two bytes specified (as with indexed addressing) and then adds the value of the IY register. This addressing mode is shown by placing a "Y" after the close bracket.

```
If
  Address 0090h holds the value 00h
  Address 0091h holds the value 05h
  Address 0504h holds the value 56h
Then the instructions
0200 A0 04 LDY #04h
0202 XX 90 LDA (90h),Y
Will load the accumulator with the value 56h.
```

The last three addressing modes may seem a bit complicated at first, but you'll soon get the hang of it! They may also seem a bit pointless, but they do have their uses, especially when you are using *text strings*, *look-up tables* or large areas of memory (greater than 256 bytes). Again, we will go into this in more detail later. Don't worry if it seems a bit incomprehensible at the moment. We hope that the *Micro Lab* will help you to clarify things.

## REGISTERS

In order to run a program, the microprocessor needs to keep track of such things as where the next program instruction can be found, or the result of the last arithmetic operation, etc. These values are stored in *registers*. There are two types of register – *user registers* may be used by the user's program to store values, pass information, etc. *Specific registers* are used to control the way in which the processor operates or are set by the processor to inform the user program of various events.

The 6502 has six registers, five of which are eight bits wide. (See last month's Fig. 9.10 – CPU Internal Architecture.) So, binary numbers between 00000000 and 11111111 may be stored in them. In decimal, the range is 0 to 255. The exception to this is the *program counter* register. This register is sixteen bits wide (as the address bus is sixteen bits wide) and, thus, may store decimal values between 0 and 65535.

There are three specific registers, the *program counter* (PC), the *processor status word* (PSW) and the *stack pointer* (SP).

The program counter holds the memory address of the next instruction that the processor is to execute. As each byte of the instruction is read from memory, the value in the PC is incremented by one. The user may set the PC to a specific value when required. This has the effect of making the program *branch* or *jump* to a new address.

Unlike the other registers, processor status word is not used as an eight bit number. Instead is a collection of single bit *flags* which indicate various states within the processor. For example, the N flag is set to a 1 if the result of the last arithmetic operation was negative (less than zero) – one way in which this could happen is if a register containing zero was *decremented* by one.

The stack pointer holds the lower eight bits of the next free stack address. The upper eight bits of the stack address are always 00000001 (i.e., the stack is stored in *page one* of the memory

# MACHINE CODE AND HIGH LEVEL LANGUAGES

Computer languages come in all shapes and sizes. Most of you will be aware of languages such as BASIC, Pascal and C, which are examples of *high level languages*. Conversely, machine code is known as a *low level language*. A high level language uses complex language to describe the program. This makes the program easier to understand as it reads like a description of the operations to be performed. A low level language uses terse instructions made from the basic computer commands. These are often difficult to follow and understand as they have no easy flow of language, and the instructions are not easily remembered.

A computer can not directly run programs written in a high level language, they must first be translated into machine code. This can happen in one of two ways - *interpreting and compiling*. To illustrate the difference, consider a piece of text written in French which a person who only understands English wishes to read. An interpreter may be hired to read the text to the person every time he or she wishes to read it, or a translator may be hired to rewrite it in English.

Although the second option has an initial time overhead whilst the translator rewrites the text, the text may then be read quickly by the English speaking person and, indeed, any other English speaking person without the need for a translator. This is equivalent to *compiling* a program, the first option is equivalent to *interpreting* it. Compiled programs run faster than interpreted ones but there is a time penalty each time the program is compiled which can slow down program development. Additionally, interpreted programs need the interpreter present on every computer in which they are to run. With modern computers, the time taken to compile a program is quite small and, so, there are very few interpreted programming languages around today.

There are several advantages to writing programs in a high level language instead of machine code:

Program development is much easier and quicker

It is easier for other people to understand your programs

A program may be made to run on a system with a different processor by passing it through a compiler for that processor (similar to using a different translator to rewrite the French text in German). A machine code program will need to be completely rewritten for the new processor.

However, programs written directly in machine code will run *much* faster than their compiled counterpart and the final code will also be much smaller. Computer games tend to be written mainly in machine code for these reasons, as they are very demanding on the microprocessor as they are continually calculating new positions and updating the display whereas a word processor, for example, spends most of its time waiting for the user to press a key.

The choice of high level language or machine code depends upon the application. You should remember, however, that it is always possible to mix the two.

space). The stack is used to temporarily store numbers and addresses. When a number is *pushed* onto the stack, the number is stored at this address and the address is decremented by one. For example, if SP = FFh and the value 05h was pushed onto the stack, then address 01FFh would hold the value 05h and the SP would be FEh. When a number is *pulled* from the stack, the opposite occurs - i.e., SP is incremented by one and the contents of the stack address are read. This type of stack is known as a *last in, first out (LIFO) stack*. This means that the last item pushed onto the stack will be the first item pulled from it. This is similar to placing dinner plates in a pile. You only place a new plate on the top of the pile and may only remove the top plate in the pile.

The three remaining registers are the user registers. These are named the *accumulator (A)*, the *X index register (IX)* and the *Y index register (IY)*. These registers may be used in any way by the user's program, the only restriction being that the 6502 uses only the accumulator for the arithmetic and logic functions.

For example, when adding two numbers together, the first number must be stored or *loaded* into the accumulator and the second must then be added to it. The result is then placed back in the accumulator.

## COMPARISONS AND LOOPS

A useful computer program will often need to skip sections of code or jump to particular sections depending upon one or more *conditions*. As an example, to set memory locations between 0400h and 044Fh to zero, you could use a program like this:

```
0200 A9 00 LDA #00h ;Load acc. with zero
0202 8D 00 04 STA 0400h ;Set address 0400h to zero
0205 8D 01 04 STA 0401h ;Set address 0401h to zero
```

```
02F2 8D 4F 04 STA 044Fh ;Set address 044Fh to zero
02F5 00 BRK ;Stop program execution
```

And so on, until every memory location is set to zero. But, obviously, you wouldn't want to do it this way! Instead, you would write a program which would repeat the code to store the accumulator at a particular memory location the required number of times:

```
0200 A9 00 LDA #00h ;Load acc. with zero
0202 A2 00 LDX #00h ;Load IX with zero
0204 8E 00 04 STA 0400h,X ;Set loc. 0400h + IX to zero
0207 E8 INX ;Add 1 to IX
0208 E0 50 CPX #50h ;IX = 50h?
020A D0 F8 BNE 0204h ;No - Jump to 0204h
020C 00 BRK ;Stop program execution
```

Note the use of indexed addressing to store the accumulator in memory and offset addressing to branch back in the program.

The comparison is performed by the CPX instruction. This instruction compares the IX register with the immediate value of 50h. If the two are equal, then the *zero flag* in the PSW is set, otherwise it is cleared. The BNE instruction looks at the zero flag and jumps to the specified address if it is clear (i.e. IX is not equal to 50h). The opposite of this is the BEQ instruction which jumps if the zero flag is set.

Branch instructions on the 6502 always use an offset addressing mode. This addressing mode restricts you to branching forwards by a maximum of 127 bytes and backwards by a maximum of 128 bytes. There will be occasions when this range is not adequate. So, it is normal to test for the opposite condition to skip over an absolute jump to the address required. As an example, the following program looks at the DIPswitches on the *Micro Lab* and jumps to address 0500 if they are all on.

```
0200 AD 10 80 LDA 8010 ;Get switch settings
0203 C9 FF CMP #FFh ;Switches all on?
0205 D0 03 BNE 020Ah ;No - skip over the jump
0207 4C 00 05 JMP 0500h ;Yes - jump to 0500h
020A 00 BRK ;Stop program
```

## LOOK-UP TABLES

Look-up tables are used at some point by most programs - for writing text, reading keyboards, determining the number of days in a month, etc. In 6502 machine code, a look-up table is normally accessed using absolute indexed addressing.

To demonstrate this, we will first show you how to determine the number of days in a month then how to write a text string to the I.c.d.

### Determining the Number of Days in a Month

A table of twelve numbers is generated. The first number being the

number of days in January and the last being the number of days in December (we will ignore leap years).

In decimal, this table is:

31, 28, 31, 30, 31, 30, 31, 31, 30, 31, 30, 31

Converting this into hexadecimal, we get:

1F, 1C, 1F, 1E, 1F, 1E, 1F, 1F, 1E, 1F, 1E, 1F

This table must be stored in memory at a known start location, say 0300h.

If the IX register is loaded with the number of the month we wish to look at (from 0 to 11), a single instruction may be used to load the accumulator with the number of days in that month. You may use the REQS command on the *Micro Lab* to set the IX register before running the program.

```
0200 BD 00 03 LDA 0300h,X ;Get no. of days in month
0203 00 BRK ;Stop program
```

When the program has been run, the I.c.d. on the *Micro Lab* shows the register values, the IX register will contain the number of the month and the accumulator will contain the number of days in this month.

There are two ways to change the program to number the months from 1 to 12:

The first is to set the base address of the table to one less than the real start of the table:

```
0200 BD FF 02 LDA 02FF,X ;Get no. of days in month
0203 00 BRK ;Stop program
```

The second is to subtract one from the IX register before looking at the table:

```
0200 CA DEX ;Subtract one from IX
0201 BD 00 03 LDA 0300h,X ;Get no. of days in month
0204 00 BRK ;Stop program
```

### Writing Text to an LCD

To write text to an l.c.d. (or, indeed, any type of display) you need to make a table containing the ASCII values of the characters which you wish to write. (See the table in Fig. 10.10 for a list of ASCII characters.) The l.c.d. on the *Micro Lab* will not display all of the ASCII codes, as some are only used in controlling computer terminals. Try some of them out – you can't damage the l.c.d. by giving it characters it cannot display.

An index register is set to zero so that the first character from the table may be read. This character is then sent to the l.c.d. The index register is then incremented by one to point to the next character. This character is also sent to the l.c.d. This is repeated as many times as necessary. For text with a known size, you can compare the index register with the number of characters which you are to display in order to end the cycle, however it is normal to place a byte which does not represent a display character (say 00h) at the end of the text table:

```
0200 A2 00 LDX #00h ;Point to start of table
0202 BD 00 03 LDA 0300h,X ;Get next character
0205 F0 07 BEQ 020Eh ;If Char. = 00h, end loop.
0207 20 06 00 JSR 0006h ;No - Send char. to l.c.d.
020A E8 INX ;Point to next char.
020B 4C 02 02 JMP 0202h ;Loop back
020E 4C 0E 02 JMP 020Eh ;Loop forever

0300 48 65 6C ;Text table for "Hello"
0303 6C 6F 00 ;With a 00h at the end.
```

Note that unlike previous examples, there is not a BRK instruction at the end of the program. This is because a BRK instruction returns the user to the *Micro Lab monitor* program, which displays the CPU registers on the l.c.d., overwriting the previous display. The JMP 020Eh instruction simply loops back to itself so that the only way to stop it is to reset the processor or press STOP on the *Micro Lab* keyboard.

This program can only display text beginning at a particular area of memory (0300h). Next month, we will show you how to write a *subroutine* which can be called by your programs to display text from anywhere in the computer's memory, using indirect indexed addressing.

## MICRO LAB INPUT AND OUTPUT CIRCUITS

That's enough programming technique for this month! Lets take a look at some *Micro Lab* Input and Output (I/O) circuits to see how data can be transferred to and from a computer system.

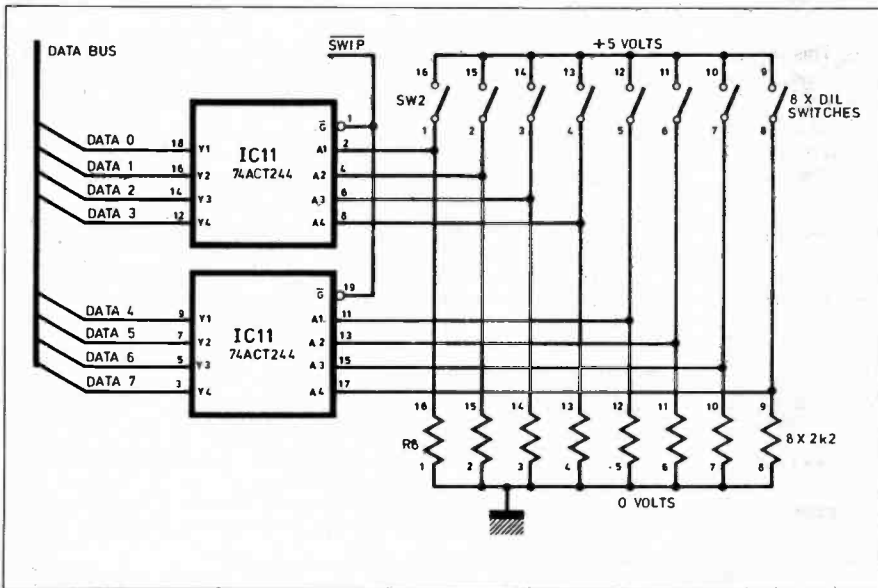

Fig. 10.3. Input switches

### Switch Input Circuit

The switch input circuit is shown in Fig. 10.3. This allows the microprocessor to "read" the state of the eight input switches. The eight inputs are pulled to ground via eight 2k2 resistors. When the switches are closed the voltage across the resistors rises to five volts. IC11 is an octal tri-state line receiver whose outputs (O/Ps) are connected to the computer's data bus. The switch data can only pass through the tri-state receiver when the enable input on pin 1 and pin 19 is taken low. This is driven by the address decoding circuits and synchronised to allow the switch data to be placed on the data bus when no other data is present.

The SWIP enable signal is activated when the CPU reads from addresses 8010h. This "read" instruction allows the CPU to load the contents of the data bus into the accumulator, and the only data on the bus will be the switch settings.

### L.E.D. Output Circuit

The LED output (O/P) circuit of the *Micro Lab* is shown in Fig. 10.4. In this case the CPU writes data to IC10 – an octal tri-state latch. The data is loaded into the latch when the LEDCS control line goes low. Again this is synchronised by the decoding circuit to only allow data intended for the l.e.d.s to be latched.

The eight outputs drive the high efficiency l.e.d.s via eight 2k2 current limiting resistors. The outputs are connected to both 8 separate l.e.d.s and a 7 segment display. A link is used to apply five volts to the required display.

The LEDCS signal is activated when the CPU writes to address 8000h.

### Keyboard Input Circuit

The keyboard I/P circuit for the *Micro Lab* is shown in Fig. 10.5. This circuit uses a dedicated keyboard scanning i.c. (IC4) to constantly check the keypad for a key press. When a key is pressed IC4 generates an interrupt signal from its IRQ output. This goes to the CPU's Non Maskable Interrupt (NMI). When the NMI goes low the CPU enters an interrupt program to read IC4 and determine which key has been pressed.

The keys are arranged in a matrix of rows and columns. Pressing any key links a row to

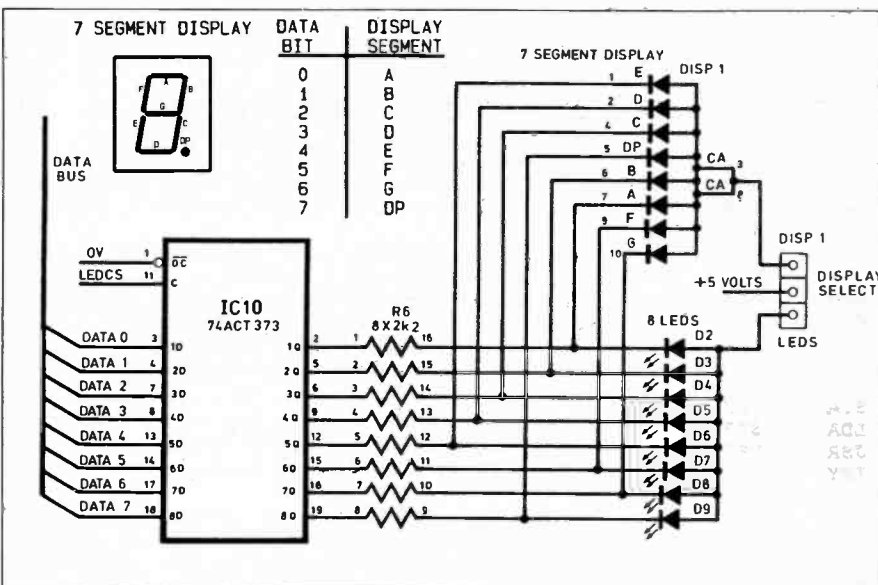

Fig. 10.4. Output LEDs

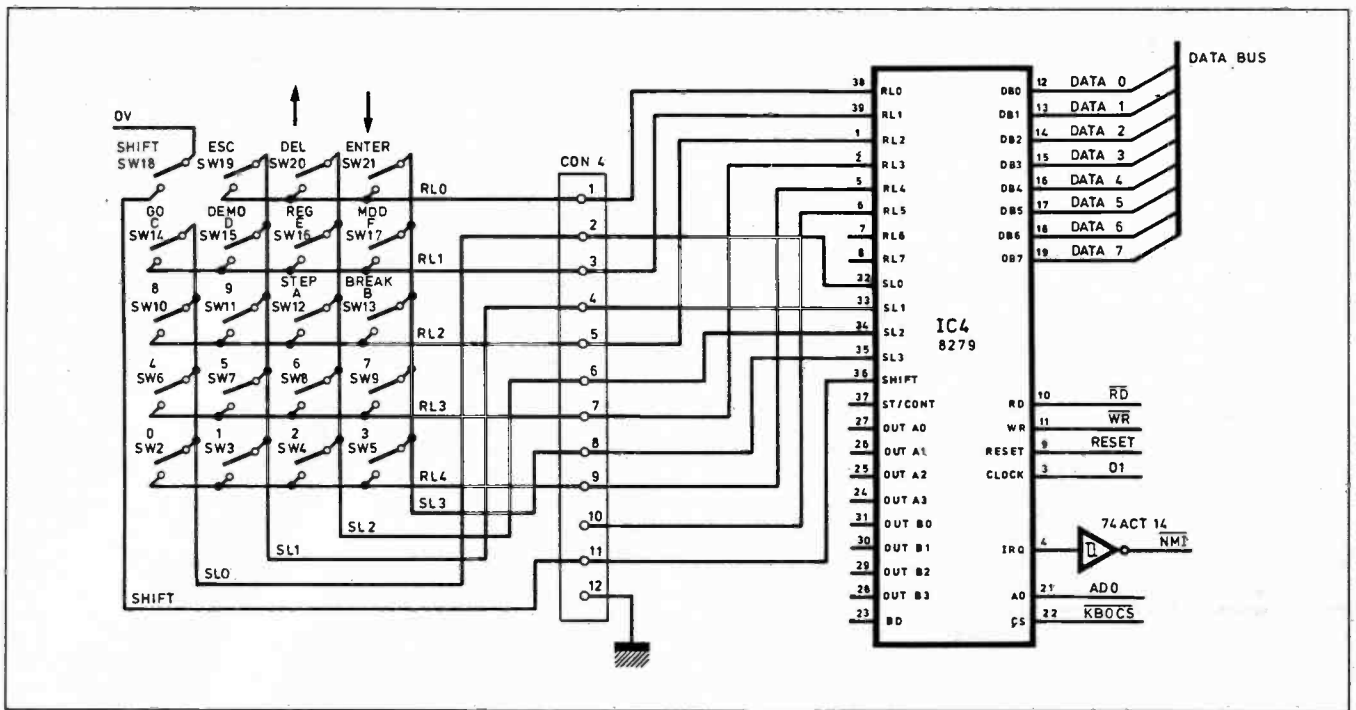

Fig. 10.5. Keyboard input.

a column and this is decoded in IC4 into a binary value. This is read from IC4 via the data bus when decoder O/P (KBDCS) goes low. Again the decoder circuit ensures that only the data from IC4 will be on the data bus during this read operation. The keyboard registers are located at 8060h and 8061h. IC4 can also drive I.e.d.s and has a separate write (WR) line to allow data to be written to the display registers. We do not use this feature on the *Micro Lab*.

## INTERFACING MICROPROCESSORS TO THE "REAL WORLD"

We are now at the stage where we can apply some of the topics discussed. This month, we will cover simple input and output (I/O) devices – switches and I.e.d.s. The programs used are already con-

tained within the *Micro Lab* monitor. Three topics are covered which drive simple I.e.d.s and 7-Segment displays and read multiple switch inputs. These use the I/O circuits previously described.

### Demonstration 0:

This program shows you how to illuminate eight LEDs in a pre-defined sequence. The use of look up tables, indirect indexed addressing, comparisons and branching is demonstrated. Fig. 10.6 gives the program listing.

On the *Micro Lab*, the LEDs are mapped to address 8000h. Writing a number to this address will change the pattern displayed. Each number will produce a different pattern. Some examples are given below:

Fig. 10.6. Demonstration 0

```

8080 ;*****
8080 ;***
8080 ;*** Everyday Electronics Micro-Lab
8080 ;***
8080 ;*** Name: Demonstration 0
8080 ;*** Version: 1.0
8080 ;*** Author: Geoff MacDonald
8080 ;*** Date: 13/01/1993
8080 ;*** Last Update:
8080 ;***
8080 ;*****
8080
8080 ;Read a sequence beginning at address $0200, of length
8080 ;stored at $0300 and send the sequence to the LEDs, with
8080 ;a delay stored in $0301 (in 1/100 sec) between each output.
8080
8080 A900 D_DEMO0: LDA # $00 ;Set up start address of table
8082 8590 STA $90
8084 A902 LDA # $02
8086 8591 STA $91
8088 A000 DEMO0A: LDY # $00 ;Get byte to send to LEDs
808A A55D DEMO0B: LDA KBSIZE ;Key pressed?
808C D014 BNE DEMO0C ;Yes - terminate demonstration
808E CC0003 CPY $0300 ;End of table?
8091 F0F5 BEQ DEMO0A ;Yes - restart sequence
8093 B190 LDA ($90),Y
8095 8D0080 STA LED ;Set up LEDs
8098 AD0103 LDA $0301 ;Delay for specified time
809B 201800 JSR DELAY
809E C8 INY ;Point to next value
809F 4C8A80 JMP DEMO0B
80A2 202100 DEMO0C: JSR KBCLR ;Clear keyboard buffer
80A5 A9FF LDA # $FF ;Switch LEDs off
80A7 8D0080 STA LED
80AA 00 BRK

```

Number Written

00h  
01h  
FEh  
FDh  
FBh  
F7h  
55h  
AAh

Pattern Displayed

```

. . . . .
. . . . .
. . . . .
. . . . .
. . . . .
. . . . .
. . . . .
. . . . .

```

where "." = LED off  
"." = LED on

Writing a sequence of numbers to the LEDs, pausing between each, will produce a changing pattern. The following sequence will produce a single dot moving from left to right:

7Fh, BFh, DFh, EFh, F7h, FBh, FDh, FEh

- Referring to listing 1, the first four lines of the program store the address of the look up table in locations 90h and 91h.
- The table will be read using an LDA (90h),Y instruction. So, the next line sets the Y register to zero so that the first value in the table will be read.
- The program then checks to see if a key has been pressed. If one has, then it jumps to the end of the program, where the key is read, then i.e.d.s are turned off and the program stops (the BRK instruction).

**Fig. 10.7. Demonstration 1**

```

80AB ;*****
80AB ;***
80AB ;*** Everyday Electronics Micro-Lab ***
80AB ;***
80AB ;*** Name: Demonstration 1 ***
80AB ;*** Version: 1.0 ***
80AB ;*** Author: Geoff MacDonald ***
80AB ;*** Date: 13/01/1993 ***
80AB ;*** Last Update: ***
80AB ;***
80AB ;*****
80AB ;Read a sequence beginning at address $0200, of length
80AB ;stored at $0300 and send the sequence to the 7 segment LED
80AB ;waiting for a key press between each output.
80AB
80AB A900 D_DEMO1: LDA $00 ;Set up start address of table
80AD 8590 STA $90
80AF A902 LDA $02
80B1 8591 STA $91
80B3 A000 LDY $00 ;Get byte to send to LEDs
80B5 CC0003 DEMO1A: CPY $0300 ;End of table?
80B8 F00C BEQ DEMO1B ;Yes - terminate
80BA B190 LDA ($90),Y
80BC 8D0080 STA LED ;Set up segment LEDs
80BF 201B00 JSR KWAIT ;Wait for key to be pressed
80C2 C8 INY ;Point to next value
80C3 4CB580 JMP DEMO1A
80C6 A9FF DEMO1B: LDA $FF ;Clear 7-segment LED
80C8 8D0080 STA LED
80CB 00 BRK

```

**Fig. 10.8. Demonstration 2**

```

80CC ;*****
80CC ;***
80CC ;*** Everyday Electronics Micro-Lab ***
80CC ;***
80CC ;*** Name: Demonstration 2 ***
80CC ;*** Version: 1.0 ***
80CC ;*** Author: Geoff MacDonald ***
80CC ;*** Date: 13/01/1993 ***
80CC ;*** Last Update: ***
80CC ;***
80CC ;*****
80CC ;This demonstration reads the settings on the DIP-switches
80CC ;and displays the states on the LCD
80CC
80CC A200 D_DEMO2: LDX #0 ;Position cursor at left side
80CE A001 LDY #1 ;of bottom row
80D0 A900 LDA #0 ;Turn cursor off
80D2 200900 JSR CURSOR
80D5 AD1080 LDA DIPSW ;Read the DIP switch states
80D8 A208 LDX #8 ;Set up number of switches
80DA 4A DEMO2A: LSR A ;Get state of single switch
80DB 48 PHA
80DC 9004 BCC DEMO2B
80DE A94F LDA #$4F ;Switch is on - display "O"
80E0 D002 BNE DEMO2C
80E2 A92D DEMO2B: LDA #$2D ;Switch is off - display "-"
80E4 200600 DEMO2C: JSR OPCHAR
80E7 68 PLA
80E8 CA DEX
80E9 D0EF BNE DEMO2A ;Decrement number of switches left
80EB A90A LDA #10 ;Repeat if not finished
80ED 201800 JSR DELAY ;Delay for 1/10 sec.
80F0 A55D LDA KBSIZE ;Key pressed?
80F2 F0D8 BEQ D_DEMO2 ;No - start again
80F4 202100 JSR KBCLR ;Empty keyboard buffer
80F7 00 BRK

```



- If no key has been pressed, then the IY register is compared with address 0300h. This address holds the number of values in the table. If the IY register equals this value, the program jumps back to the line where it is loaded with zero.
- Next, the accumulator is loaded with the IYth number in the table. This is then copied to the I.e.d. address.
- The program then pauses by calling the monitor's DELAY routine.
- Finally, the IY register is incremented by one and the program jumps back to the line which checks for a key press,

Before running the demonstration, you should use the *Modify* command to store the desired sequence beginning at address 0200h. Next, the length of the sequence should be stored at address 0300h and the delay between changes (in 0.01 seconds) should be stored at address 0301h. Then enter *Demo 0* and the I.e.d.s will show the entered sequence.

There is no danger of accidentally damaging these demo programs stored in the EPROM. This is a read only device, and cannot be changed by the user. If you get into a muddle just press the reset button to start again!

## DEMONSTRATION 1

Segment displays, as used in digital clocks, etc. are made from seven I.e.d.s arranged in an "8" and another I.e.d. forming a decimal point to the right. These I.e.d.s may be driven in the same way as normal I.e.d.s as shown earlier. The *Micro Lab* seven-segment I.e.d.s are addressed at 8000h (a link is used to select between the normal I.e.d.s and the seven-segment display). Fig. 10.4 shows which bit of the data bus controls which segment. You should note that setting a bit to 1 will turn the corresponding segment off.

Demonstration program 1 is similar to demonstration program 0, except that it waits for you to press a key after copying a value from the look up table to the I.e.d.s and it stops when the end of the table has been reached. Fig. 10.7 gives the program listing.

Before running this program, you should set up the look up table starting at address 0200h, storing the length of the table in 0300h, to output the numbers 0 through to 9 (address 0300h should be set to 0Ah in this case).

To get you started, the number "0" is displayed with binary 00111111 (or 3Fh) and "1" is displayed with binary 00000110 (or 06h).

## DEMONSTRATION 2

In order to be useful, a computer system must have some form of input. On the *Micro Lab*, there are four basic input devices – the keyboard, the DIP switches, the analogue input and the 6522 VIA. The simplest of these to use are the DIP switches, which are mapped directly into memory at address 8010h. Fig. 10.8 gives the program listing.

To read the switches, all you need to do is load a register with the contents of address 8010h (e.g. with *LDA 8010h*).

The following program simply reads the switches and copies the result to the I.e.d.s:

```

0200 AD 10 80 LDA 8010 ;Get switch value
0203 8D 00 80 STA 8000h ;Store in I.e.d.s
0206 4C 00 02 JMP 0200 ;Repeat forever

```

Demonstration program 2 is similar to this, except that the switch settings are displayed on the I.c.d. (a "." means that the switch is off, and a "0" means that the switch is on). Monitor routines are called to write to the display. Unlike the simple program shown above, to display the switch settings on the I.c.d., each switch setting must be displayed separately. There are two ways to do this. One way is to AND the switch reading with 01h (to read the left most switch) and compare the result with zero. Next, you would AND the switch settings with 02h and compare with zero again. You would copy this for all eight switches.

This method is most useful when you are only interested in the value of one particular switch at a time (if you were writing a game and the switches were push buttons – left, right and fire – then you would use this method to test each switch in turn), however, it is not really suited to this particular task. A neater way is to load the switch settings into the accumulator then use the LSR instruction to shift the lowest order bit into the carry then test the carry flag (using BCC or BCS) to read the state of the left most switch and display it on the I.c.d. This is repeated eight times in a loop, once for each switch. The resulting program is much smaller and does not contain large amounts of repeated code.

**Next month:** We take a look at data logging, analogue measurement and controls, and digital-to-analogue conversion. We demonstrate further routines to help you grasp further principals of microprocessor systems.

## SYSTEM 200 DEVICE PROGRAMMER

**SYSTEM:** Programs 24, 28, 32 pin EPROMS, EE-PROMS, FLASH and Emulators as standard, quickly, reliably and at low cost.

Expandable to cover virtually any programmable part including serial E<sup>2</sup>, PALS, GALS, EPLD's and microcontrollers from all manufacturers.

**DESIGN:** Not a plug in card but connects to the PC serial or parallel port; it comes complete with powerful yet easy to control software, cable and manual.

**SUPPORT:** UK design, manufacture and support. Same day dispatch, 12 month warranty. 10 day money back guarantee.

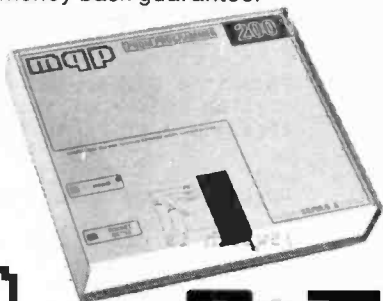

ASK FOR FREE  
INFORMATION  
PACK

**mqp**



GERMANY 089/4602071  
NORWAY 071-17890  
ITALY 02 92 10 3554  
FRANCE (1)69.41.28.01  
Also from VEROSPEED UK

MQP ELECTRONICS Ltd.  
Unit 2, Park Road Centre,  
Malmesbury, Wiltshire, SN16 0BX UK  
TEL. 0666 825146 FAX. 0666 825141

## FREE P.C.B. TRANSMITTERS

**AT LAST.** A fully comprehensive, easy to follow guide to building and using short/medium range micro transmitters. Packed with useful information and **USABLE** circuits.



- ★ How to build micro surveillance devices.
- ★ Radio mics.
- ★ Tracking and signaling transmitters.
- ★ Infra red communication links.
- ★ Plans for **AM** and **FM**.
- ★ **FREE** micro transmitter pcb included.

ONLY  
**£3.95**  
inc. p&p

Send cheques/P.O.s to:

JCG  
3 Bainbrigge Road, Headingley, Leeds LS6 3AD.

# EXPERIMENTAL ELECTRONIC PIPE DESCALER



ANDY FLIND

*A mains powered "black box" to make your calcium less sticky and, in time, your water flow more freely.*

**D**O YOU suffer from furry pipes? Clogged conduits? Calcified kettles? Quite a few readers do, it seems. The problem, of course, is due to "hard" water containing calcium, which tends to precipitate onto the surfaces of pipes, kettles, etc, forming the familiar "scale". In addition it can cause scum and lack of lather, resulting in the need for extra detergent and other problems.

Not so long ago the only cure was a large and expensive chemical filter, but

recently several new claimed solutions have appeared. Some of these are electronic, mains-powered "black boxes" supplying a signal to a coil of wire placed around the incoming water pipe. Since these are usually expensive, EPE has received enquiries from readers concerning the possibility of constructing one for a more modest outlay.

## RESEARCH

Following "extensive research" the

design presented here was arrived at. At the time of writing no definitive results have been obtained as to whether it actually works, but as it is cheap and simple to construct it was decided to publish forthwith for interested readers to try for themselves.

Commercial units produce a square wave output, with frequency swinging between 1400Hz and 2000Hz at a rate of about five Hertz. The output power is surprisingly low.

The wire used for winding around the pipe tends to be thick, around 2.5mm, so it could be assumed that the current would be several amps. However, the output is a twelve-volt peak-to-peak source from a resistance of 10k, so operating into the virtual short-circuit of the short wire coil this gives an average current of just 0.6mA!

It's hard to see how this tiny current produces significant effects of any kind, but suppliers of commercial units state that it most certainly does. The output, by the way, is purely a.c., there is no d.c. component at all. This suggests a blocking capacitor in the output circuit.

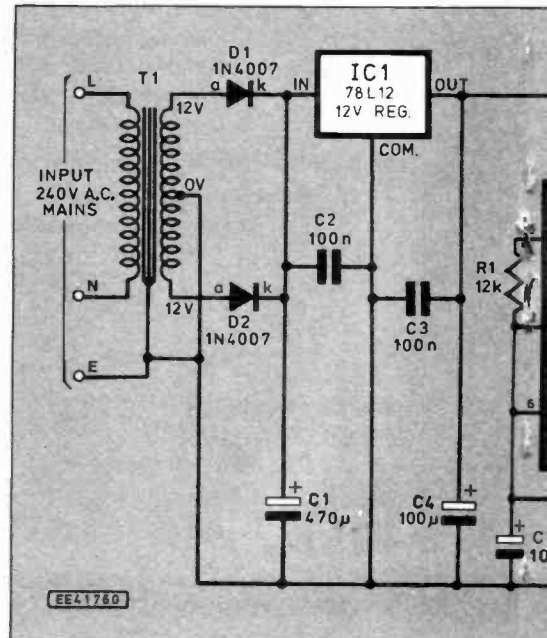
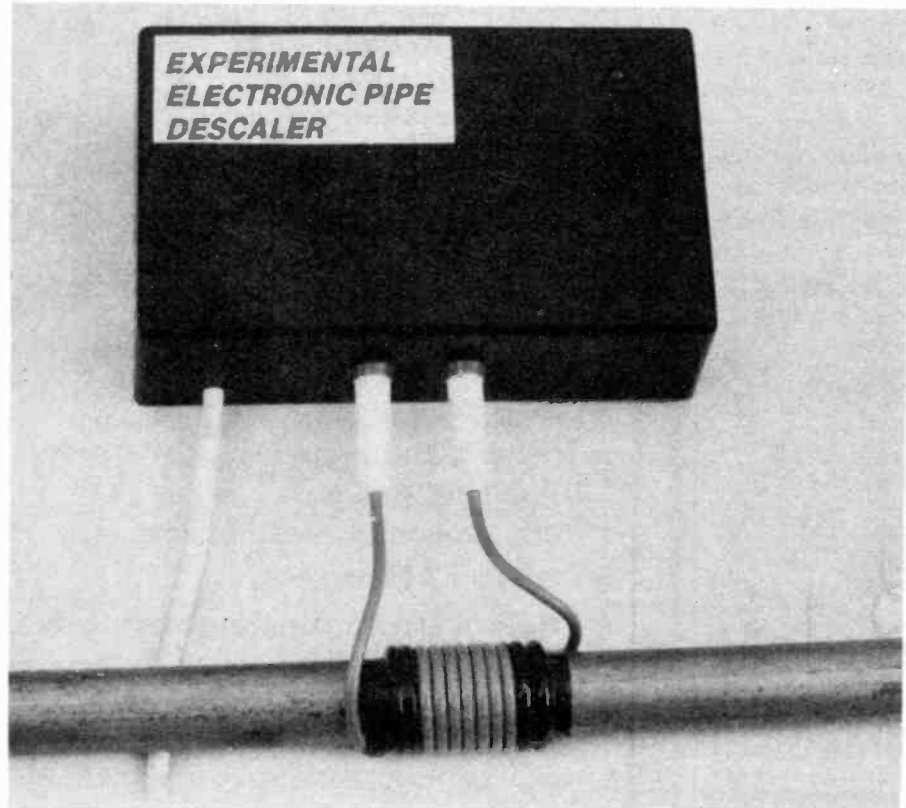

## Resistors

R1	12k
R2	22k
R3	47k
R4, R5	10k (2 off)
R6, R7,	
R9	100k (3 off)
R8	8k2 (see text)
R10	470k
R11	1k

## Capacitors

C1	470µ axial elect. 25V
C2, C3,	
C8, C9,	
C10	100n polyester layer (5 off)
C4, C7	100µ axial elect. 25V
C5	10µ axial elect. 25V
C6	4n7 close tolerance polystyrene, 1% type
C11	10n polyester layer
C12	470p min. disc ceramic

## Semiconductors

D1, D2	1N4007 diode (2 off)
D3, D4,	
D5	1N4148 diode (3 off)
D6	green l.e.d.
TR1, TR3	BC184L <i>nnp</i> silicon transistor (2 off)
TR2	BC214L <i>pnp</i> silicon transistor
IC1	78L12 12-volt positive regulator
IC2	ICM7556 CMOS 555 dual timer
IC3	4024B CMOS divider

## Miscellaneous

T1	12-0-12 volt 100mA sec., mains transformer
----	--

4mm plugs and sockets; case, ABS plastic box 158mm x 95mm x 54mm; p.c.b. available from the *EPE PCB Service*, order code 839; 2-core mains lead; wire for coil - see text; strain relief bush for mains cable.

Approx cost guidance only

**£18**

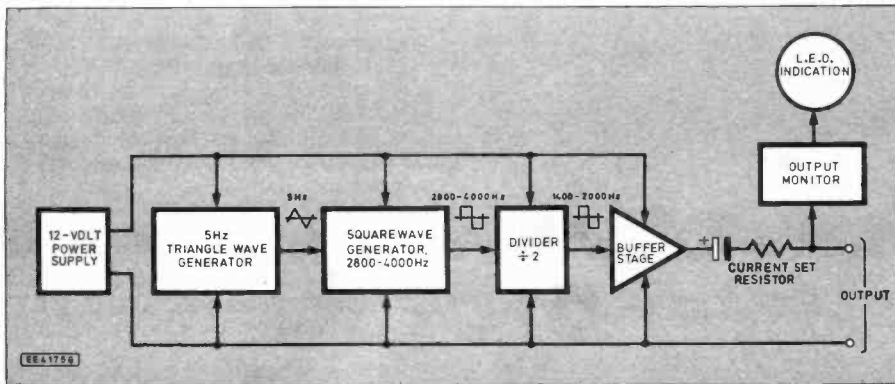

Fig. 1. Block diagram of the Experimental Electronic Pipe Descaler.

## ACTION

The claimed action is to render dissolved calcium in the water less "sticky". In other words it's still present, but has less tendency to precipitate out and stick to the surfaces it comes into contact with.

The effect of current passing through a coil of wire around a water pipe is twofold. It produces electrostatic and magnetic fields, both alternating at the frequency of the current.

A metal pipe of any kind would block an electrostatic field. This leaves the magnetic one, which would be significant at this low frequency, although still very small given the tiny current used. However, a lot of older houses (the author's included) have iron supply pipes, which would also attenuate the magnetic field to some extent. It might be worth a mention in passing that other descaling devices on sale consist of a powerful permanent magnet designed for fitting around the water pipe.

## CIRCUIT

The aim of this project therefore, is to produce a signal varying at 5Hz between 1400Hz and 2000Hz, initially at 0.6mA, though provision is made for experimenting with increased current. The design has an output buffer stage capable of higher output, controlled by the value of one resistor.

A simple block diagram, Fig. 1, shows the complete arrangement. Power from a small mains transformer is regulated to twelve volts. A 5Hz triangle-wave generator controls the squarewave generator. Since the output mark-space ratio of this is uneven and variable with frequency, it is produced at double the required rate and then halved by a divider, resulting in a perfectly even output signal.

A buffer stage provides output power, a capacitor blocks the d.c. voltage and a resistor sets the current supplied to the coil around the pipe. A monitor circuit confirms that the oscillator is working and that output connections are intact.

The circuit diagram of Fig. 2 shows how these functions are achieved in practice. Power is supplied by the mains transformer T1 and maintained at a constant twelve volts by regulator IC1. IC2 is an ICM7556, a dual low-power version of the popular 555 timer. Both are used as astable oscillators, although in slightly different ways.

The first has the output, pin 5, connected through R1 to input pins-2 and 6, with R1 and C5 setting the output frequency to about 5Hz. The signal across capacitor C5 is approximately triangular with an amplitude of 4V peak-to-peak, and this is applied directly to pin 11, the control input of the second timer. This uses the conventional astable timer circuit.

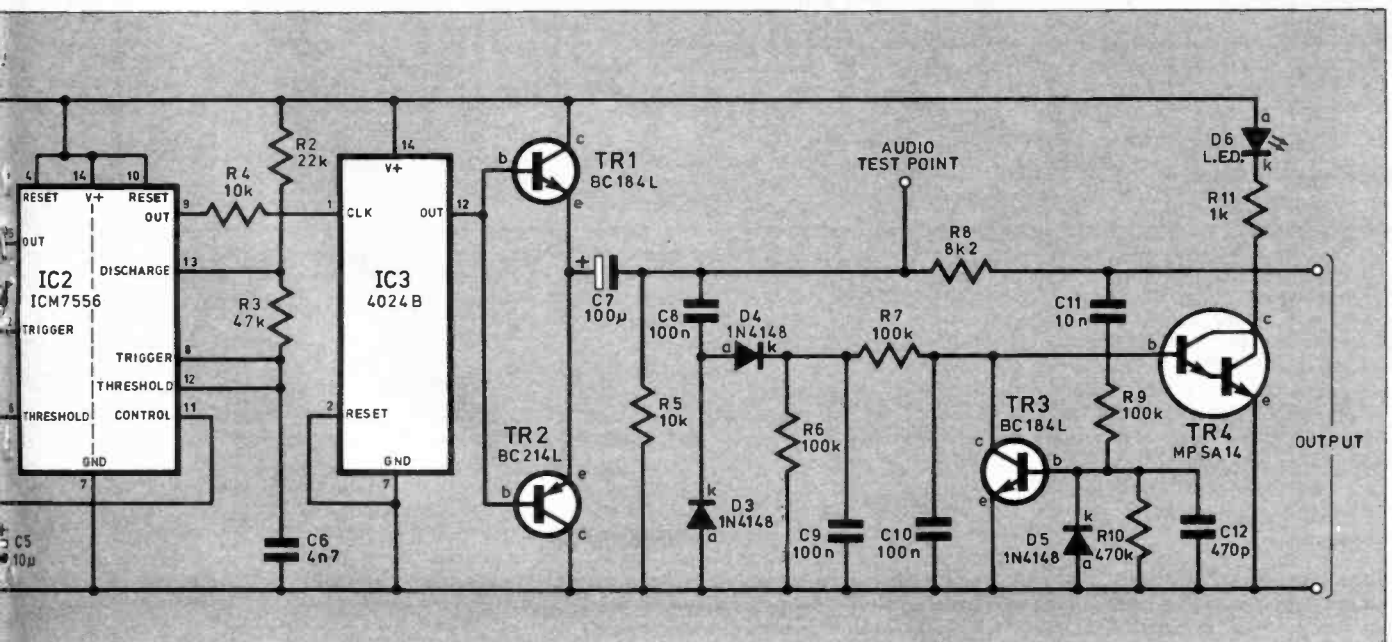
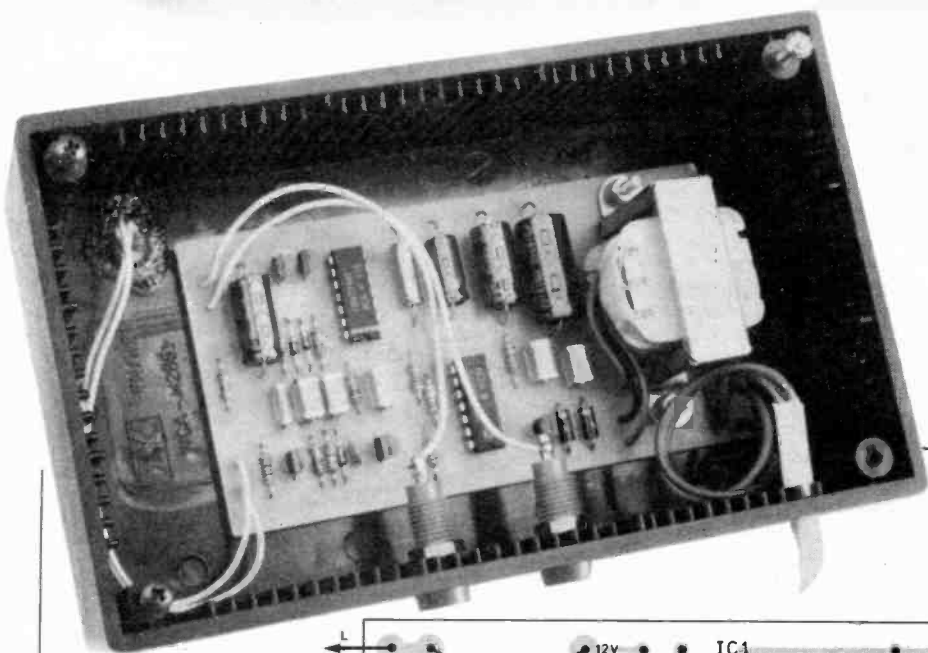

Fig. 2. Complete circuit diagram of the Experimental Electronic Pipe Descaler.



C11 will cause TR3 to conduct on alternate half-cycles. This discharges C10 and there is insufficient time between half-cycles for R7 to charge this capacitor and turn on TR4 again. This means that the output signal must be present and connections to the coil around the pipe must be sound for the indicator to be lit.

A "Darlington" transistor was chosen for TR4 for two reasons. The very high gain ensures adequate drive for the l.e.d. from a small base current, and double the base-emitter voltage of a normal transistor is needed before it will conduct. These

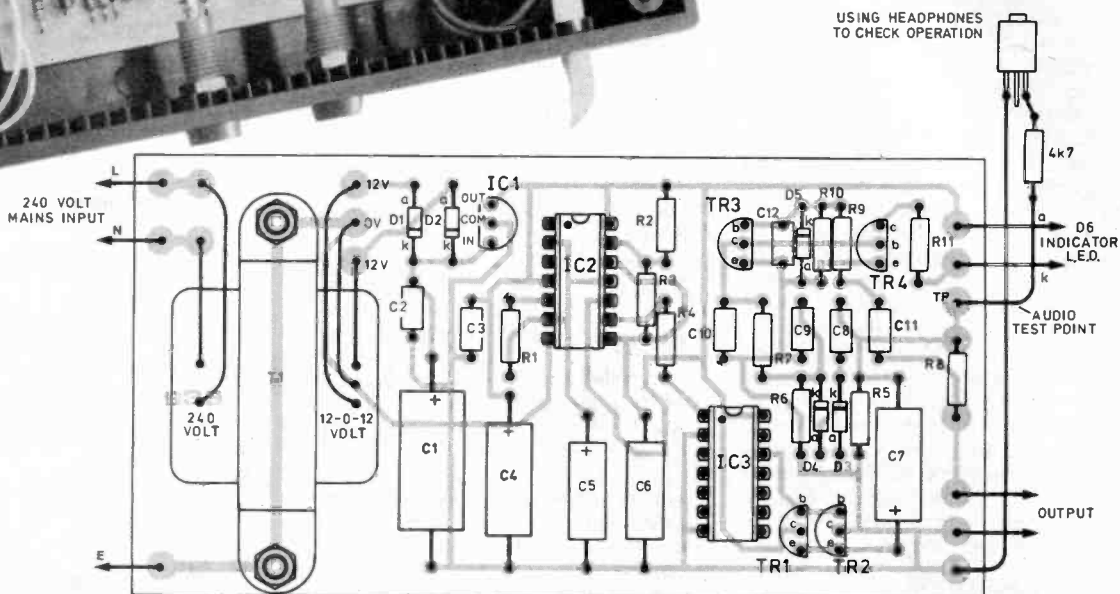
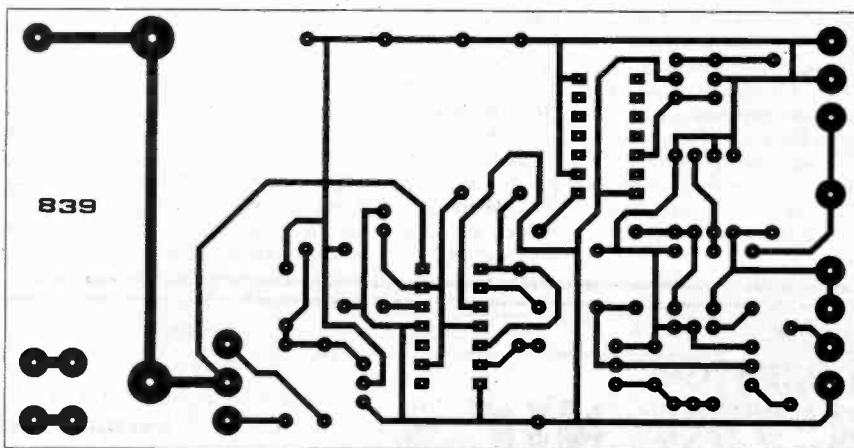

Fig. 3. P.C.B. layout and construction of the Descaler. The p.c.b. is available from the EPE PCB Service, order code 839.

Headphone socket. Note "common" not used, placing headphones in series.



With the values of R2, R3 and C6 used the output, from pin 9, varies between about 2600Hz and 4000Hz. Capacitor C6 is a close-tolerance (one per cent) type to ensure adequate accuracy of these frequencies. As the control voltage affects only half of the output waveform the mark-space ratio varies quite a bit, but passing the signal through divider IC3 results in a final output of 1300Hz to 2000Hz with a perfectly even ratio.

### OUTPUT

The buffer transistors TR1 and TR2, provide additional output drive capability. Whilst not really necessary for 0-6mA, it was felt that constructors might wish to experiment with higher currents so this stage can provide over 50mA if desired. C7

blocks d.c. voltage from the output, leaving a pure a.c. signal. Again, the value of 100μ is excessive for the small current, but provides for use of a much higher one.

The output current is set by R8. The value of 8k2 in this design compensates for the small voltage drop across TR1 and TR2. Reducing the value of this resistor increases the output.

The remainder of the circuit provides monitoring to ensure that the unit is working. The a.c. output signal charges C9 through the rectifier circuit D3 and D4. As long as the output is present and the coil connections are sound, d.c. current from C9 passes through R7 to TR4, causing this to conduct and illuminate the l.e.d. D6.

If the output connections become faulty, the resulting increase in voltage applied to

two factors permit practical resistor and capacitor values to be used in this part of the circuit.

Although this monitoring is fairly complex, it was considered necessary as it will normally be the only indication that the unit is actually working. Astute readers will realise that there is still one item not covered, namely operation of the 5Hz oscillator. It's unlikely that this will fail, but the simple addition of a resistor and stereo socket shown in Fig.4 will allow an occasional check with a pair of headphones, as the output has a very distinctive sound.

### CONSTRUCTION

All the components of this project are mounted on the circuit board so construc-



# Audio Amplifier Design, Engineering or Alchemy?

JOHN LINSLEY HOOD **PART 1**

*Can you trust performance tests?*

**T**HERE are two fundamental, but mutually contradictory beliefs in the field of audio, and these can be summarised as:

1. "All competently designed audio amplifiers, used within their ratings, will sound the same," and:

2. "All things in an audio system are important – so that even the nature of the wiring which is used to interconnect the pieces will alter the sound of the system."

By and large the first of these beliefs is that held by professional audio engineers and designers, and the second by the readers and a majority of the editorial staff and contributors to "Hi-Fi" magazines, who I will call the "subjectivists", simply as a convenient group label.

Both of these groups are willing to demonstrate the validity of their points of view – the "engineers" by carefully arranged group listening trials, using "double blind" tests, (those in which neither the listening panel nor the person doing the switching actually knows which amplifier they are listening to at the time) – and the "subjectivists" by "one to one" demonstrations in the comfort of their own homes, on a "now, just listen to this" basis.

## **SANDWICHED**

As an audio amplifier designer, I find myself uncomfortably sandwiched between these two opposing views. Obviously, the possession of test instruments, and some measure of faith in the results they give, is just as essential a requirement for any serious design work as a good understanding of the nature of the technology and its theoretical basis, if only because it is in the nature of mankind to make occasional mistakes, and instruments are helpful in drawing attention to these errors.

On the other hand, it is impossible to predict with absolute confidence just how audible some of the residual performance shortcomings of the hardware – and there always are some, in even the best of designs – will prove to be.

Our understanding of what the human ear is prepared to accept as "accurate" is getting better, but we're not there yet, and I note, with regret, that one still comes across engineers who will flatly deny the existence of technical faults in a system, even when these are so glaring that their own ears object to the nature of the sound they are hearing.

## **HEAD IN THE SAND**

As a relatively recent example of this "head in the sand" approach, I have a book on digital audio systems, written in the mid-'80s, soon after the introduction of the compact disc, in which the author says "of course, digital sound sounds entirely different from analogue, because it is so much more 'accurate'. However, in time we will get used to this different and superior sound quality, and accept it for what it is."

In reality, the big difference, at that time, between, for example, the sound of an LP (analogue) and a CD (digital) replay was due to the unwanted presence of large h.f. phase errors, which ruined transient response, and the pre- and post-transient "ringing" caused by the primitive "brick-wall" (steep-cut anti-imaging) filters on the output of the CD players. Because of these problems, some of the early machines really did sound different from analogue systems: they were harsh and strident, and not at all pleasant to live with.

Fortunately, some of the engineers working in this field were prepared to accept that the deficiencies in the sound produced by these early CD systems were real, and were due to measurable technical faults, and they worked to improve things.

So now, with a multiple "over-sampling" type of CD player, which can give good replay phase linearity, and a decent transient response, due to relatively gentle h.f. filter slope characteristics, the only significant audible difference between a CD and an LP of the same music, when the LP is replayed in synchronism on a good turntable (so that the listener can switch over directly from one to the other), will be the greater freedom from "rumble", "clicks" and surface noise on the CD. However, this certainly wasn't the case ten years ago.

## **PERFECTION?**

The history of audio is full of instances when new ideas were introduced, but which didn't work as well as they should, and, because the errors in the design were not apparent in the test results, or were noted but not thought to be particularly important, their designers or manufacturers claimed that perfection had been attained.

Since the more perceptive of the listeners, and you might not need to be very percep-

tive at that, were very aware that things were wrong, the mistaken claims of the engineers tended to undermine the validity of the very measurements they quoted, and this, sadly, is now the climate of popular opinion in which we audio engineers must work. I say "sadly" because it is essential to make measurements, and the idea that test results are of no value to anybody undermines the whole basis of technical progress.

However, one needs to measure the right things. For example, the one measurement that Joe Public will trust, when he goes into the showroom of his local "hi-fi" discount warehouse, is the quoted "Total Harmonic Distortion" (THD) figure, and this, unless you know the specific conditions of the test, really is pretty meaningless. I will explain, later.

## **SUBJECTIVISTS**

Taking the side of the "subjectivists" for a moment, one of the first areas of conflict was about the influence of loudspeaker connecting leads. The hi-fi devotees noted, and tested out for themselves, and supported, the claim that different kinds of loudspeaker connecting wires "sounded different". "Rubbish" retorted the engineers, "provided that the loudspeaker lead resistance is less than a tenth of an ohm, or thereabouts, it can't possibly have any effect with an eight ohm loudspeaker unit".

Indeed, so it shouldn't. But, if you have a pair of adequately low resistance leads and you decide that one of them doesn't need to be as long as the other, and so you chop off a length of it, you will find that you have now altered the apparent position of the centre of the stereo image, and this is evident as the new position required from the amplifier balance control.

Of course, part of this effect is due to the fact that "transient" type signals are very important to the human ear, particularly in assessing the position of the sound source, and most modern loudspeaker units have a very low input impedance to transient type input signals. This just means that we had measured our "eight ohm" loudspeaker impedance in the wrong way. Indeed with an impedance vs. frequency curve that usually looks like a Sherpa's eye view of the Himalayas, it seems a pretty meaningless measurement anyway.

## **THE PSYCHOLOGY OF TINKERING**

I have a close friend with a professional interest in human psychology, and he assures me that it is well known that most

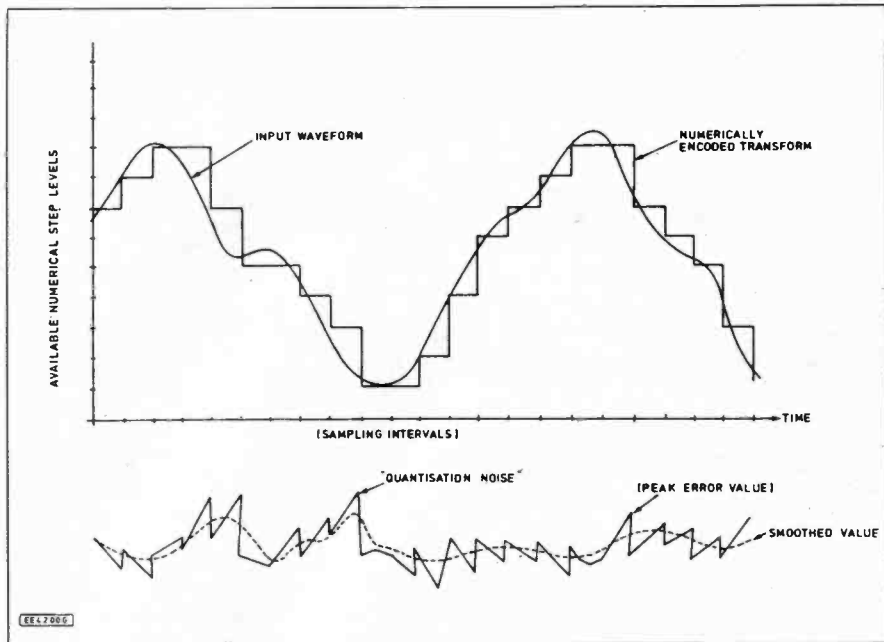

Fig. 1. The origins of "Quantisation Noise" in a digitally encoded signal.

people get great satisfaction from adding their own contributions to any system, and will, because of this, be predisposed to believe that if they make a mod. to their audio system, it will sound better as a result of any changes they have made.

Of course, most hi-fi users will hesitate to take snips or soldering iron within the entrails of their expensive kit, so most of the changes they will be inclined to try will be restricted to various "bolt on" external bits and pieces, to go on their input, loudspeaker or mains power leads, and the difficulty here is the fugitive nature of the acoustic memory, in the interval between one trial and the next.

It is helpful if one has a balanced pair of stereo channels, so one can try one's new gizmo just in one channel, so the two can be given a simultaneous trial, but even this begs the question of what one means by "better".

## WHICH WAY IS "UP"?

Some years ago, a highly respected audio systems reviewer set up, as an experiment, an arrangement by which he could introduce controlled amounts of harmonic distortion into his normal listening system, and invited his various visitors and sundry local friends to listen to some music, and indicate which "amplifier" they preferred.

The results he obtained indicated that most of his ad hoc listening panel actually liked the effect produced by the addition of relatively small amounts, say 0.5 per cent, of second harmonic distortion – they said it sounded "richer" – and it so happens to be the kind of distortion that one finds in most traditional valve amplifier systems, which are so much liked for their "rich" sound quality.

The problem, therefore, with basing one's judgment solely on listening tests, is that one's ear can often tell you what it likes best, but not always what is actually better from a technical point of view. Since 0.5 per cent of second harmonic distortion may lead – depending on the conditions of the test and the nature of the system – to one per cent or more of "intermodulation distortion" (which is the kind of distortion which muddles up the sound), the

author of these tests might have got a different answer if he had asked which of his "amplifiers" sounded "clearer".

The fact that people like to fiddle with their gear, and will often "hear" improvements in sound as a result of using some gadget or other has, I suspect, made a few small fortunes for the inventors of various magic boxes.

## ARE ANY OF THE DIFFERENCES REAL?

It is very easy for the "engineers" – including me – to dismiss the claims of the "subjectivists" that there really are audibly significant effects, in the face of the invariably negative results given by carefully arranged "double blind" listening tests. These negative results have been obtained even when the listening panel was deliberately chosen to include "subjectivists" who had publicly declared their belief that there were big differences between the very amplifiers which were being tested, and they could hear these differences without the slightest difficulty.

Is there any plausible explanation for this? I think there is, and that it is based on the length of the tests and on familiarity.

Another friend of mine is a professional recording engineer, of perfectionist inclinations, and he was concerned at the time that he was about to adopt a digital recording system to supplement, and eventually replace, his tried and trusted 15in./sec. analogue tape recorder, that the results from his new digital system might be audibly less good. I was lucky to be one of those he asked to sit, individually, in judgment on this contest, for which the same musical performance had been recorded simultaneously on both analogue and digital recorders, to either of which I could listen, at the flick of a switch, when they were replayed simultaneously in synchronism.

Given a sufficiently long duration sample of each system I was correct in my identification every time, but with 5 to 10 second samples I really could not tell the one from the other. And the reason why? Because, given time, I could hear the differences between the types of

background noise characteristics of the two systems. Digital audio encoding and decoding processes lead to the kind of noise called "quantisation noise", shown in Fig. 1, due to the inability of the "staircase" waveform to follow the smooth curve of the input signal.

(What I have shown in the diagram would correspond, approximately, to an audio signal at about 2kHz sampled at 44.1kHz, using a "4-bit" encoding resolution. A thing to be noted in relation to this is that this sampling error will decrease if the sampling interval is reduced or if there are a greater number of permissible quantisation levels – with the example chosen the error "noise" could be as much as 10 per cent of the signal, though this would be reduced by subsequent filtering.)

In digital audio, this kind of noise always accompanies the signal, but it stops when the signal stops. In analogue systems the noise is there all the time. And this was the difference I listened for.

## ALL OF A DITHER

Of course, in the early '80's, the modern technique of adding "dither" (a synthesized, amplitude limited, random noise voltage), to the replay signal was not common practice. If it had been used in my friends' relatively early digital set-up I really wouldn't have been able to identify them.

However, "dither" is not simply added to baffle attempts to tell digital from analogue, it really does improve the ability of the digital decoding process to resolve fine detail, and reduce the "granularity" (staircase characteristic) of the replay signal, particularly if the sampling frequency is increased. For optimum results, the added dither voltage should be between a half and a third of the size of the decoding voltage step.

The other point about even carefully arranged statistical tests is that small differences in sound quality may become more noticeable if one lives with a system for a little while, and this is an aspect which cannot be included in the inevitably brief "listening panel" trials.

## DO COMPONENTS MATTER?

Apart from the claimed importance of connecting leads, the other main plank of the "subjectivists" platform is the difference in sound quality caused by the choice of component type or construction used in the circuitry. Once again, I find myself sandwiched between the "yes there is" and "no there isn't" schools of thought.

Some of the effects are indeed real, and there are good reasons why they should be, and I propose to have a look at these in the next article.



*"Most people get great satisfaction from adding their own contributions..."*

# AMSTRAD PCW 8-CHANNEL A/D CONVERTER

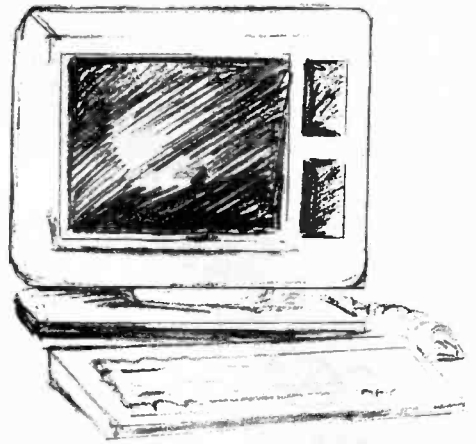

JASON SHARPE

- Eight buffered analogue inputs
- Built in Sample/Hold Function
- Fast  $2.5\mu\text{S}$  conversion time (0.4 MSPS)

THE WORLD we live in is continuous, for example, seconds can be divided into tenths of seconds, hundredths of seconds, etc. to infinity. But the world of the digital computer is discrete, its shortest time period determined by the clock rate.

Our world is also analogue, for example, it can be very bright, bright, dim, dark etc. In the computer's world it would be either dark or not dark.

## A-to-D CONVERTER

The A/D converter enables a digital computer to take discrete samples of the continuous world. The Amstrad PCW 8-Channel ADC circuit is based on the popular AD7828 (IC2), an 8-channel ADC i.c., which contains an 8-channel analogue multiplexer, a sample and hold function, a half flash analogue-to-digital converter, and I/O control logic.

## QUICK AS A FLASH

The 7828 uses a half-flash technique to digitise the input signal. A 2-bit flash A/D converter is shown in Fig. 1. The analog input is compared simultaneously with  $2^n - 1$  (where  $n$  is the number of bits) equally spaced voltage reference voltages.

The comparator outputs are fed into a  $2^n$  bit priority encoder, which outputs the digital value. This is the fastest method of A/D conversion, using this method speeds of 300 million samples per second (MSPS) can be achieved.

The main problem with the Flash ADC is its price (e.g. an 8-bit, 20 MSPS flash ADC costs approx. £70, 150 MSPS costs approx. £125) this is because of the large number of comparators required ( $2^{\text{No. Bits}} - 1$ ). Half-flash conversion is the second fastest conversion technique, it provides near flash speed with a much lower cost, thanks to a neat trick.

The block diagram for an eight-bit half-flash converter is shown in Fig. 2. The input voltage and the resulting voltage is digitised by another  $n/2$  bit flash converter, which provides the least significant part of the output. Using this method speeds of up to 20MSPS can be achieved. An eight-bit flash converter would need 255 comparators, but with this method only 30 comparators are required.

## CIRCUIT DESCRIPTION

The circuit diagram for the 8-channel A/D Converter is shown in Fig. 3. The circuit for the buffer i.c.s, IC3 to IC10, is repeated for each stage.

Address decoding is performed by IC1 (74HC688), a high speed CMOS 8-bit comparator. When each P-input is in the same state as the corresponding Q-input, pin 19

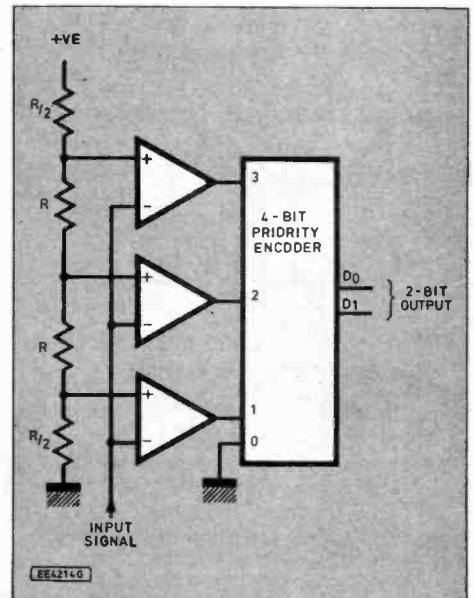

Fig. 1. Two-bit flash converter.

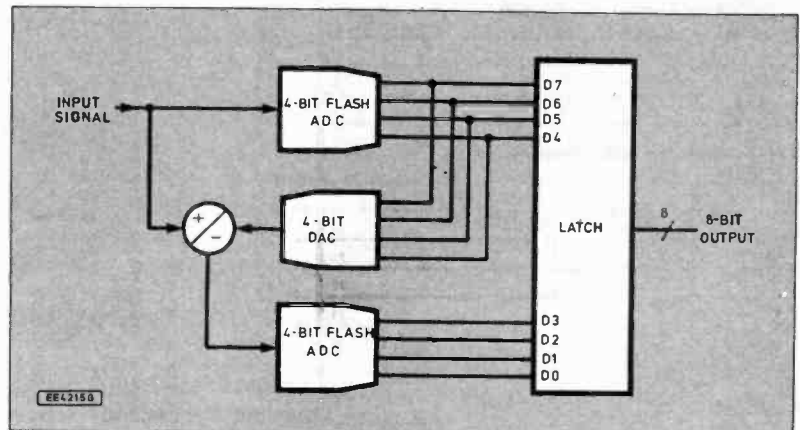

Fig. 2. Block diagram for 8-bit half flash ADC.



( $\overline{P=Q}$ ) goes low enabling IC2. When NOT IOREquest goes low and the low byte of the address bus (A0→A7) contain an address in the range 176 to 183 (Inclusive) the ADC i.c. is enabled.

As the ADC unit runs from a separate supply, the PCW's 5V line is also fed into IC1 to make sure the unit is disabled when the PCW is turned off. The PCWs pull up resistors R4 to R7 are used to bring the TTL level outputs upto CMOS levels ( $\overline{IORQ}$  and A7 are tied high inside the PCW).

The AD7828, IC2, is set to mode 1. In this mode a conversion is started by reading from a port in the range 176 to 183 (B0 to B7 Hex), the channel on which the conversion is performed is determined by the address on lines A0, A1, A2.

Reading from port 176 starts a conversion on Channel 0, through to port 183 which starts a conversion on Channel 7. To get the results of the conversion just read from one of the eight ports, this will also start a conversion on the selected channel.

It was mentioned above that the 7828 has a track/hold function, this is basically achieved by charging 31 internal 1pF capacitors. These capacitors, plus about 14pF of stray capacitance must be charged to the input voltage through the resistance of the input multiplexer (approx. 5k $\Omega$ ) in

approximately 1 $\mu$ S. The higher the source resistance the longer it takes for the input capacitance to charge.

To make sure the capacitance is charged in time, unity gain buffers IC3 to IC10 draw their power from a  $\pm 12$ V supply to allow a full output voltage swing of 0V to 5V. The output of the op-amps are capable of going within a few volts of the supply, so if say 7V was placed on an input the output would swing to 7V destroying the input of IC2!

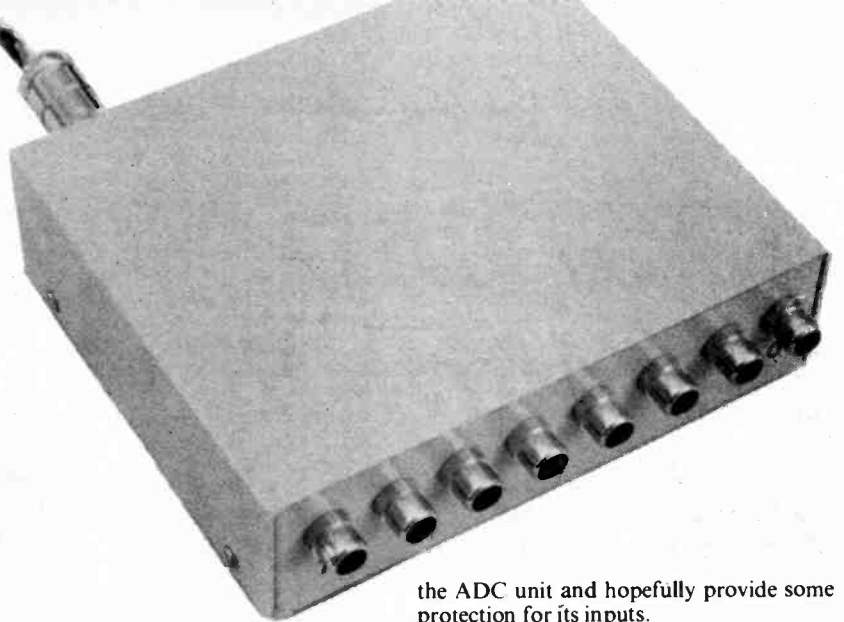

the ADC unit and hopefully provide some protection for its inputs.

The op.amps IC3 to IC10 draw their power from a  $\pm 12$ V supply to allow a full output voltage swing of 0V to 5V. The output of the op-amps are capable of going within a few volts of the supply, so if say 7V was placed on an input the output would swing to 7V destroying the input of IC2!

Fig. 3. Circuit diagram for the Amstrad PCW 8-Channel A/D Converter

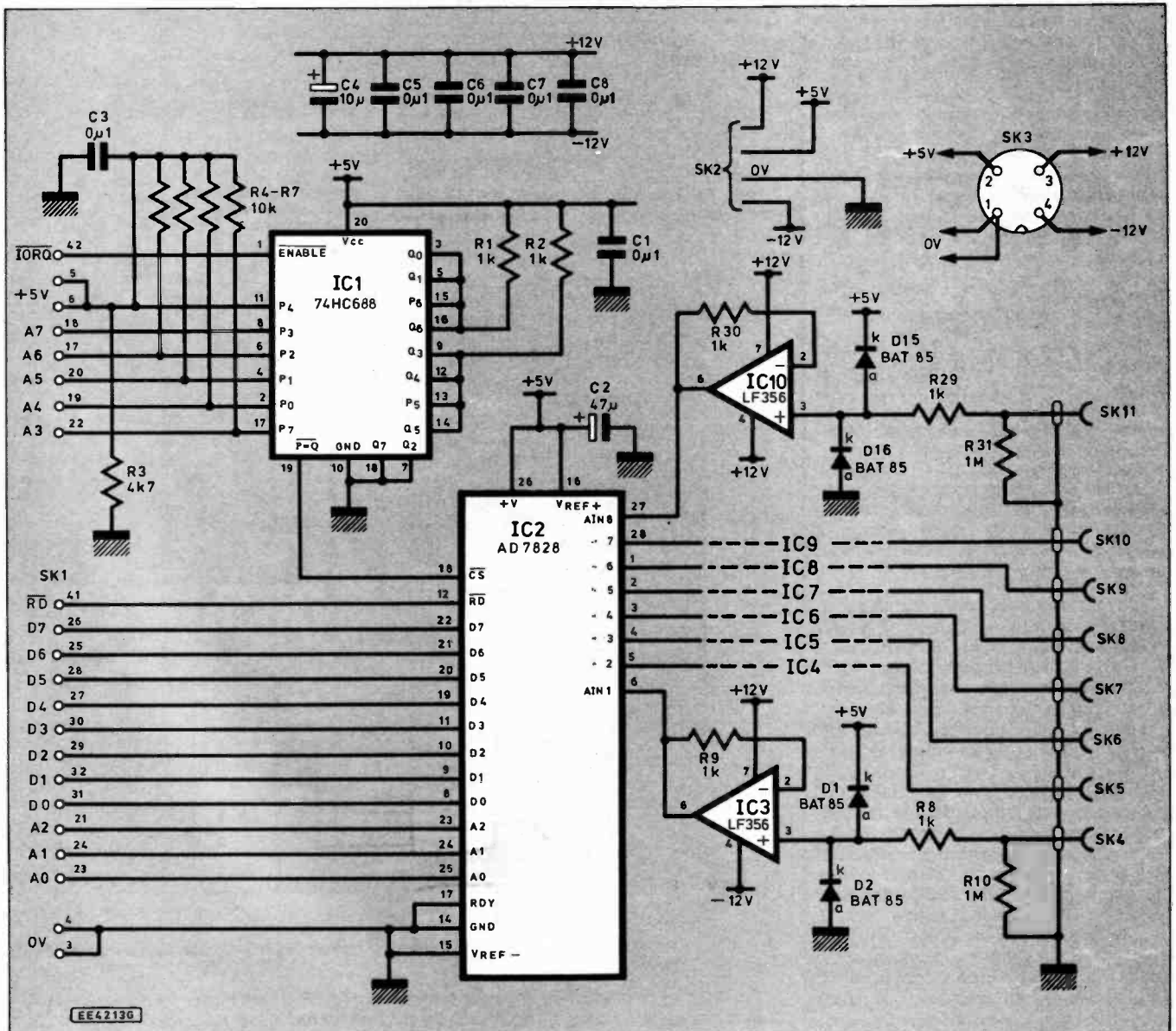

To provide some protection, diodes D1 to D16 were added to prevent the input of the buffers from going outside the 0V to 5V range. Schottky diodes are used as these have a low forward voltage drop and fast "reaction time." *These diodes only provide limited protection, and care should still be taken to keep the input voltage in the 0V to 5V range.*

The op-amps chosen for the buffers have low input offset voltages, so they require no trimming.

## CONSTRUCTION

The 8-channel A/D Converter is constructed on a double-sided printed circuit board (p.c.b.). The board component layout, top and underside full size copper foil master patterns are shown in Fig. 4. This board is available from the *EPE PCB Service*, code EPE838.

Track pins are used to connect tracks from one side of the p.c.b. to the other. These should be inserted into the holes (without components) marked ● on the component overlay. Push them in from the top of the p.c.b. and solder them, then turn the board over and solder them to the other side of the board - see Fig. 5a. After you have finished this check the tracks are actually connected with a multimeter.

Insert and solder the remaining components in height order, flattest up to tallest. The leads marked ⊙ on the component overlay should be soldered to the top layer as well as the bottom - see Fig. 5b. Be careful not to over heat the diodes, also when bending the leads make sure you do not damage the glass cases.

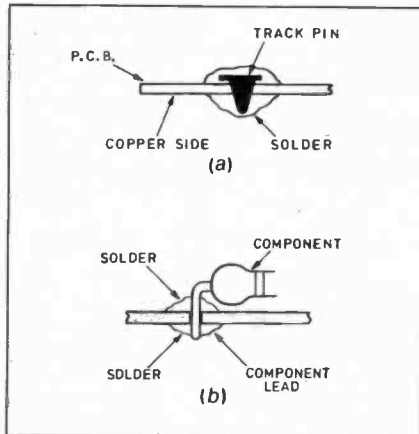
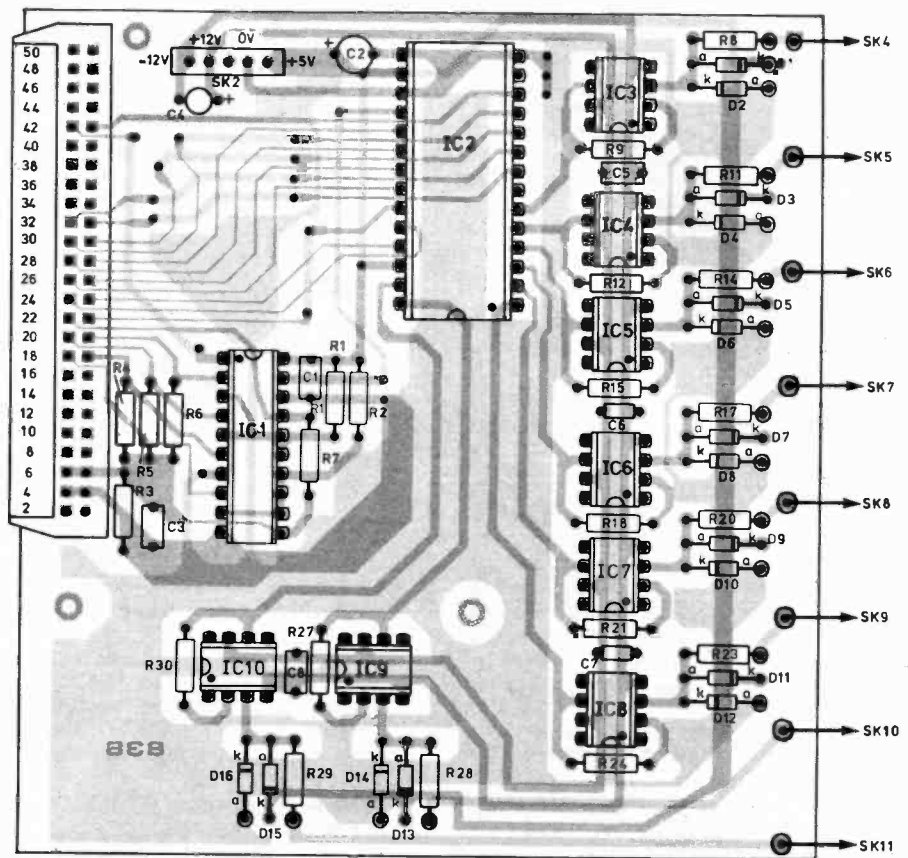

Fig. 5 (a) Connecting one side of p.c.b. to the other with "track pins". (b) soldering component to both sides of board.

Power is connected to the board using a "Minicon" connector. Strip about 5mm of insulation from the end of the wire, and tin it. The wire can then be crimped to the metal connector, this can be carried out using a pair of thin nose pliers. Then push the assembly into the plastic housing until the locking pin clicks into place, as shown in Fig. 6.

The one megohm (R10 to R31) between the inputs and "ground" are soldered between the input phono sockets SK4 to SK11 and their solder tags. One end of the lead is used to connect the p.c.b. input to the phono socket. One of the solder tags should also be connected to the 0V input.

Case construction is shown in Fig. 7. Make the hole for the 50-way connector quite high so that some "grommet strip" can be used to cover the sharp edges and prevent damage to the ribbon cable.



EE42190

● = Track solder pin.

⊙ = Solder to top and bottom tracks.

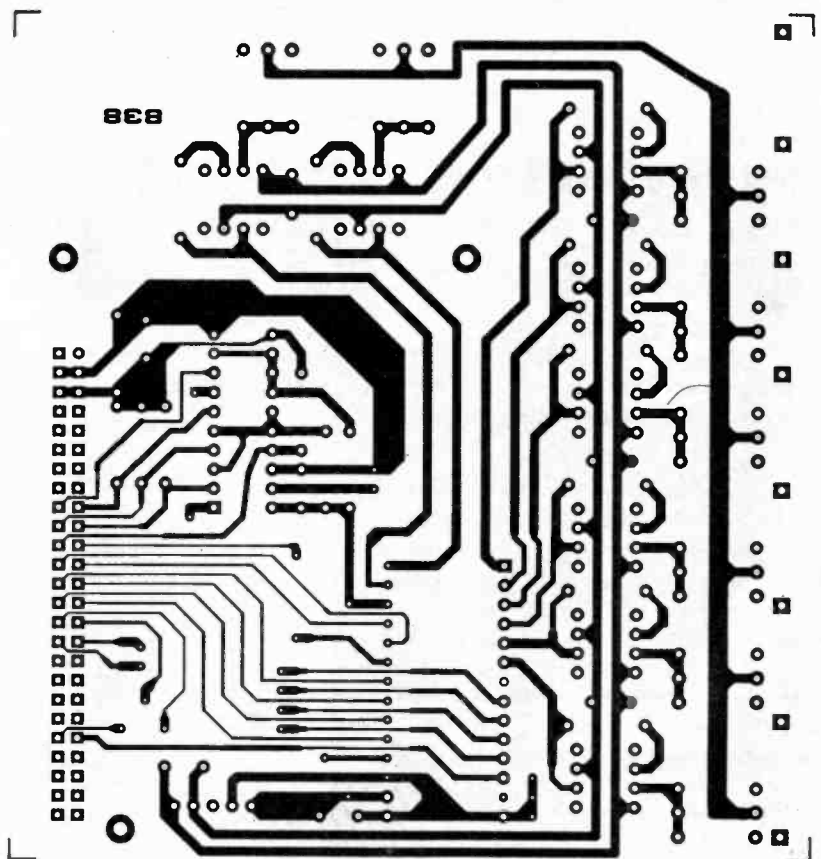
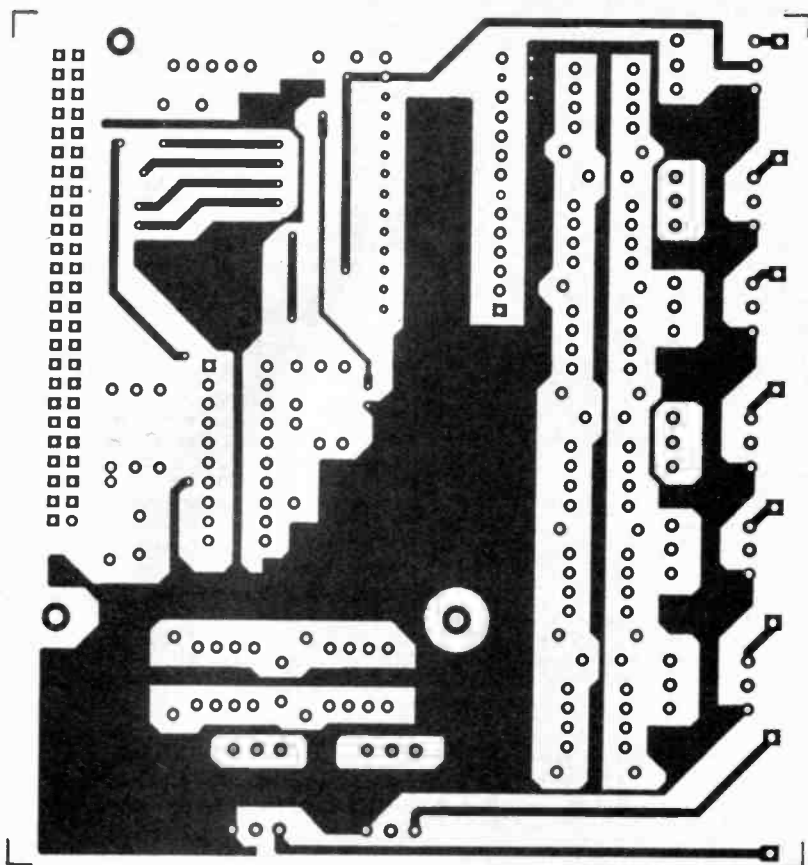

Fig. 4. (top) Printed Circuit board component layout, (top right) full size component side copper foil pattern, (above) full size underside copper foil master pattern.



The unit should be connected to the PCW using ribbon cable terminated at one end with a 50-way IDC connector, and at the other with a 50-way IDC edge connector (check when assembling the lead that pin one of the edge connector is connected to pin one of the IDC socket).

The cable should be kept as short as possible (less than 50cm). If longer, ringing and cross-talk may become a problem.

### TESTING

Check all joints and connections and make sure there are no shorts caused by

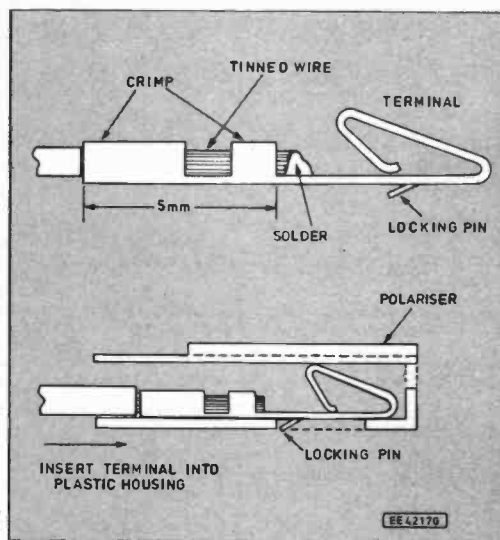

Fig. 6. Assembly of the "Minicon" connector.

## COMPONENTS

### Resistors

R1, R2, R8, R9,  
R11, R12, R14,  
R15, R17, R18,  
R20, R21, R23  
R24, R26, R27  
R29, R30 } 1k (18 off)

R3 } 47k  
R4 to R7 } 10k (4 off)

R10, R13, R16,  
R19, R22, R25,  
R28, R31 } 1M (8 off)

All 0-25W  
5% carbon film

See  
**SHOP  
TALK**  
Page

### Capacitors

C1, C3, C5,  
C6, C7, C8 } 0μ1 polyester (6 off)  
C2 } 47μ tantalum bead,  
16V  
C4 } 10μ tantalum bead,  
35V

### Semiconductors

D1 to D16 } BAT85 Schottky  
diode (16 off)  
IC1 } 74HC688 CMOS  
8-bit comparator  
IC2 } AD7828 High speed  
8-bit 8-channel  
analogue-to-digital  
converter  
IC3 to IC10 } LF356N f.e.t.-input  
wideband op.amp  
(8 off)

### Miscellaneous

SK4 to SK11 } Phono or BNC socket  
(8 off)

Aluminium case, size approx. 125mm x 105mm x 35mm; double-sided printed circuit board available from *EPE PCB Service*, code 838; Minicon connector; 50-way IDC socket and R/A plug; 50-way IDC edge connector; 50-way ribbon cable; 4-pin locking chassis plug and line socket; 8-pin low-profile d.i.l. socket (8 off); 10-pin low-profile d.i.l. socket; 28-pin low-profile d.i.l. socket; interconnecting wire; plastic self-adhesive p.c.b. stand-off pillars (3 off); stick-on rubber feet (4 off); plastic edging; solder etc.

Approx cost  
guidance only

**£56**

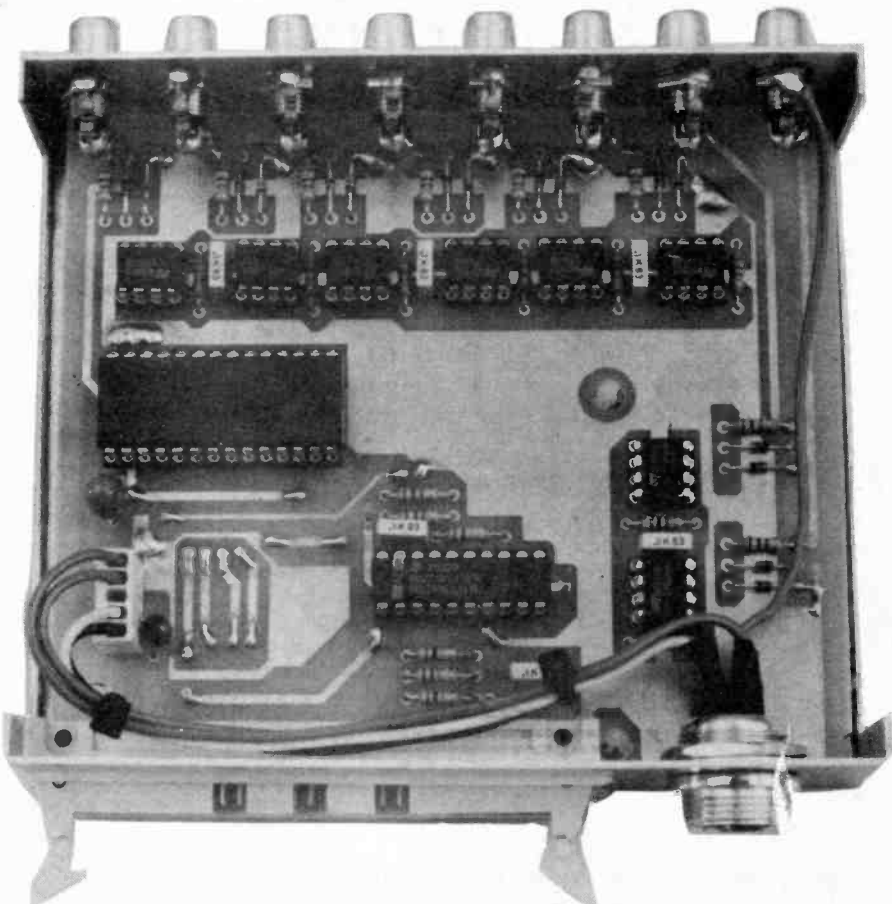

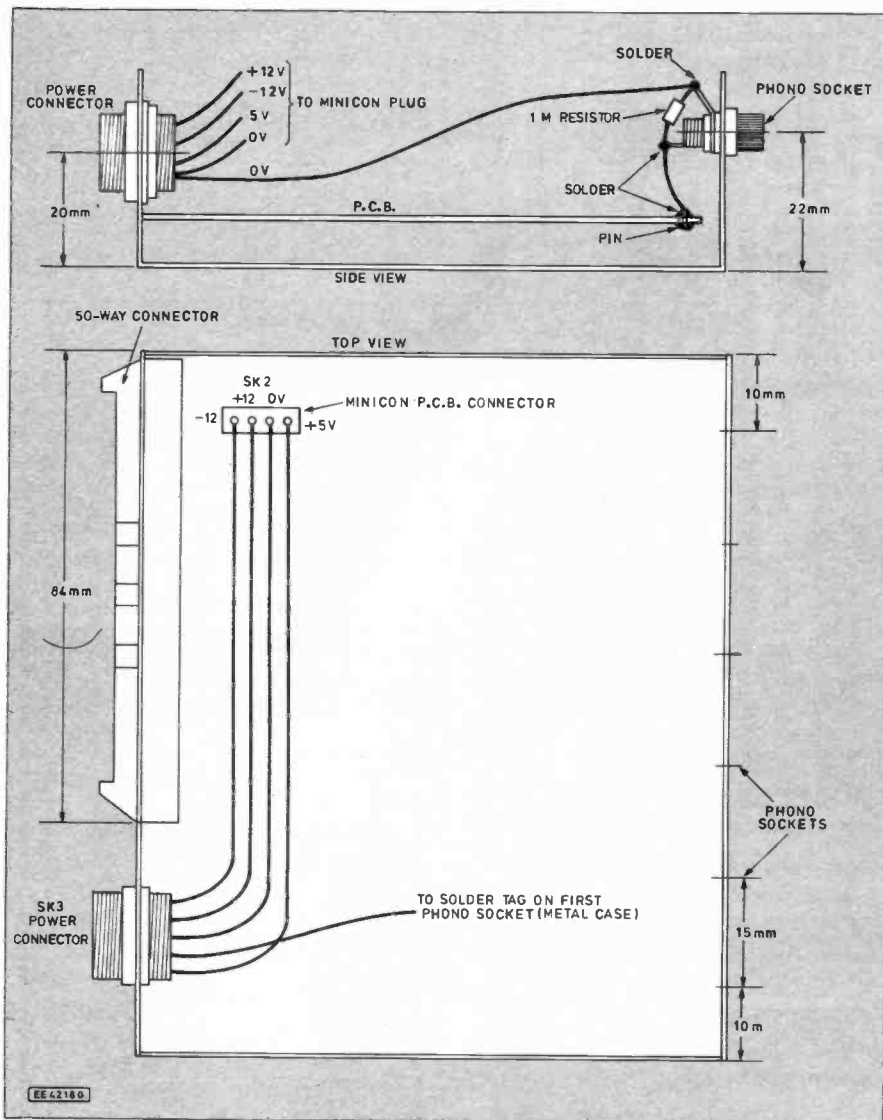
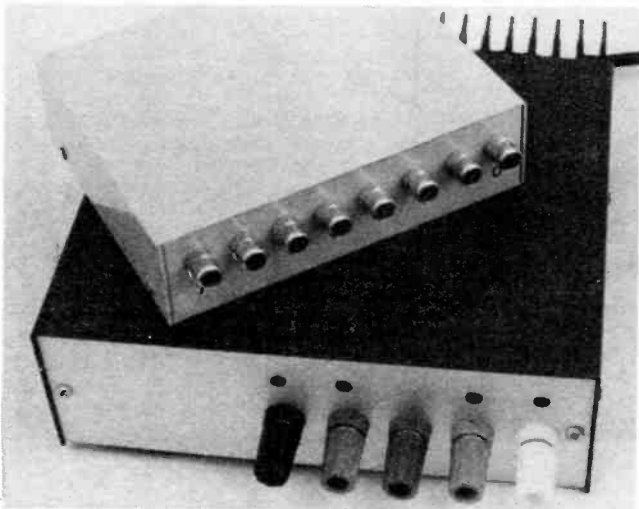

Fig. 7. Interwiring, installation and case drilling details.

excess solder. Before inserting the i.c.s or connecting to the PCW, connect the power supply and check the voltages at the Minicon connector are correct (with a circuit containing a £20 i.c. this is worth doing!).

If all is okay insert the i.c.s. The 7828 and 74HC688 are both CMOS and so should be handled carefully (wearing an anti-static wrist-strap is recommended).

The completed unit sitting on the "Linear" Power Supply (future project).



Connect the unit to the PCW and the power supply. First switch on the external supply, then switch on the computer and "boot up" as normal. If the computer will not boot up or does anything abnormal turn off the PCW then the power supply, unplug the unit and check all joints, orientation of the i.c.s etc.

To test the inputs connect a 10 kilohm or

20 kilohm potentiometer (multi-turn are best as they give better resolution per turn) between the 0V and +5V outputs of the power supply and the wiper to Channel 0 of the ADC to form a variable voltage source. Enter the test program, Program 1, and then run it.

Enter 0 when the prompt "Which Channel" appears. A list of values will scroll up the screen, which should vary between 0 and 255 as the potentiometer is turned. If the values don't change check you are using the correct channel. The other 7 channels can also be tested in this way.

#### Program 1: Test Program

```
10 Input "Which Channel (0 to 7):"
   channel
20 REM **Read last result, and start next
   conversion, then repeat**
30 PRINT INP(176+channel):GOTO 30
```

### TAKE CARE

Phono connectors were used for the input sockets SK4 to SK11 as they are widely available and are quite low cost compared to most other screened connectors. Care should be taken when connecting things to the ADC using phono plugs as the centre conductor mates before the screen (this is not really a very good design). Unless the ADC and the source it is being connected to have a common ground this could cause damage to the ADC unit.

The best ways around these possible problems are:

- To connect the phono socket first and then connect the source (with another type of connector).
- Use a common earth for the units (only connect the screen to the ground at one end).
- Make all the connections before the power is switched on.

### PROGRAMMING

This unit is very simple to use. The main thing you must remember is that the value read from the port is the result of the last conversion.

The conversion program, Program 2, is an example of the above, it prints the values of Channels 7 and 0 repeatedly on the screen. First (line 20) the old value is cleared from the ADC and discarded, this also starts a conversion on Channel 7 (port 183).

The result of this conversion is printed at line 40, which also starts a conversion on channel 0 (port 176). The result of this conversion is printed at line 60, which also starts a conversion on channel 7. The program then loops round to line 40.

#### Program 2

```
10 REM **Start conversion on channel 7 (discard value read from
   port)**
20 Discard%=INP(183)
30 REM **Start conversion on channel 0 and print result of last
   conversion**
40 PRINT "Value of Channel 7 < ";INP(176);
50 REM **Start conversion on channel 7 and print result of last
   conversion**
60 PRINT "> Value of Channel 0 < ";INP(183)" > "
70 GOTO 40:REM Repeat
```

There are many uses for this compact analogue-to-digital converter unit. In Part Two, next month, more programming details and some possible applications will be given when we set out and give information on "Using The ADC Unit". For example, how to use the ADC for monitoring/data logging - with simple sensors, its use for sampling signals at higher sampling rates and some elementary signal processing will be outlined.

Also, a future article will present a "Linear" Power Supply designed especially for the A/D Converter. However, the outputs of +12V at 1A; +5V at 1.5A; -12V and -5V at 0.5A make it ideal for many general purpose uses and an invaluable acquisition for the "test gear" collection. □

# HART

## HART AUDIO KITS – YOUR VALUE FOR MONEY ROUTE TO ULTIMATE HI-FI

HART KITS give you the opportunity to build the very best engineered hi-fi equipment there is, designed by the leaders in their field, using the best components that are available.

Every HART KIT is not just a new equipment acquisition but a valuable investment in knowledge, giving you guided hands-on experience of modern electronic techniques.

In short HART is your 'friend in the trade' giving you, as a knowledgeable constructor, access to better equipment at lower prices than the man in the street.

You can buy the reprints and construction manual for any kit to see how easy it is to build your own equipment the HART way. The FULL cost can be credited against your subsequent kit purchase. Our list will give you fuller details of all our Audio Kits, components and special offers.

### AUDIO DESIGN 80 WATT POWER AMPLIFIER.



This fantastic John Linsley Hood designed amplifier is the flagship of our range, and the ideal powerhouse for your ultimate hi-fi system. This kit is your way to get £K performance for a few tenths of the cost! Featured on the front cover of 'Electronics Today International' this complete stereo power amplifier offers World Class performance allied to the famous HART quality and ease of construction. John Linsley Hood's comments on seeing a complete unit were enthusiastic:- "The external view is that of a thoroughly professional piece of audio gear, neat elegant and functional. This impression is greatly reinforced by the internal appearance, which is redolent of quality, both in components and in layout." Options include a stereo LED power meter and a versatile passive front end glowing switched inputs using ALPS precision, low-noise volume and balance controls. A new relay switched front end option also gives a tape input and output facility so that for use with tuners, tape and CD players, or indeed any other 'flat' inputs the power amplifier may be used on its own, without the need for any external signal handling stages. 'Slave' and 'monobloc' versions without the passive input stage and power meter are also available. All versions fit within our standard 420 x 260 x 75mm case to match our 400 Series Tuner range. ALL six power supply rails are fully stabilised, and the complete power supply, using a toroidal transformer, is contained within a heavy gauge aluminium chassis/heatsink fitted with IEC mains input and output sockets. All the circuitry is on professional grade printed circuit boards with roller tinned finish and green solder resist on the component ident side, the power amplifiers feature an advanced double sided layout for maximum performance. All wiring in this kit is pre-terminated, ready for instant use!

RLH11 Reprints of latest articles.....£1.80  
K1100CM HART Construction Manual.....£5.50

### LINSLEY HOOD 1400 SERIES ULTRA HIGH-QUALITY PREAMP

Joining our magnificent 80 Watt power amplifier now is the most advanced preamplifier ever offered on the kit, or indeed made-up marketplace. Facilities include separate tape signal selection to enable you to listen to one programme while recording another, up to 7 inputs, cross recording facilities, class A headphone amplifier, cancellable 3-level tone controls and many other useful functions, all selected by high quality relays. For full details see our list.

### LINSLEY HOOD 'SHUNT FEEDBACK' R.I.A.A. MOVING COIL & MOVING MAGNET PICKUP PREAMPLIFIERS



Modern, ultimate sound systems are evolving towards built-in preamplifiers within or near the turntable unit. This keeps noise pickup and treble loss to a minimum. We now offer two units, both having the sonically preferred shunt feedback configuration to give an accurate and musical sound, and both having the ability to use both moving magnet and moving coil cartridges.

Kit K1500 uses modern integrated circuits to achieve outstanding sound quality at minimal cost. The very low power requirements enable this unit to be operated from dry batteries and the kit comes with very detailed instructions making it ideal for the beginner. K1500 Complete kit with all components, printed circuit board, full instructions and fully finished case.....£67.99

Instructions only.....£2.80  
Kit K1450 is a fully discrete component implementation of the shunt feedback concept and used with the right cartridge offers the discerning user the ultimate in sound quality from vinyl disks. Can be fitted inside our 1400 Preamp, used externally or as a standalone unit. It has a higher power requirement and needs to be powered from our 1400 Series preamplifier or its own dedicated power supply. K1450 Complete Discrete Component RIAA Phono Preamp.....£109.58

Factory Assembled and Tested.....£159.58  
K1565 Matching Audio Grade Power Supply with potted toroidal transformer and limited shift earthing system.....£79.42  
Factory Assembled and Tested.....£118.42  
U1115 Power Interconnect Cable.....£7.29

### ALPS PRECISION LOW-NOISE STEREO POTS



Super Savings with our "3 for the price of 2" Offer. Now back in stock our range of the fabulous ALPS range of High Grade Audio Pots fulfill the need for no compromise quality controls as used in HART Kits and other World Class Amplifiers. This exciting range covers the values needed for most quality amplifier applications.

Now you can throw out those noisy ill-matched carbon pots and replace with the real hi-fi components. The improvement in track accuracy and matching really is incredible giving better tonal balance between channels and rock solid image stability.

All pots are 2-gang stereo format, with 20mm long 6mm diam. steel shafts. Overall size of the manual pot is 27mm wide x 24mm high x 27mm deep, motorised versions are 72.4mm deep from the mounting face. Mounting bush for both types is 8mm diameter. Motorised versions have 5V d.c. drive motor.

MANUAL POTENTIOMETERS  
2-Gang 100K Lin.....£15.67  
2-Gang 10K, 50K or 100K Log.....£16.40  
2-Gang 10K Special Balance, zero crosstalk and zero centre loss.....£17.48  
MOTORISED POTENTIOMETERS  
2-Gang 20K Log Volume Control.....£26.20

2-Gang 10K RD Special Balance, zero crosstalk and less than 10% loss in centre position.....£26.98  
OUR SPECIAL OFFER ON ALPS POTS. Buy any two and get the third FREE. (The third must be the same or a cheaper type).

### STUART REEL-TO-REEL TAPE RECORDER CIRCUITS

Complete stereo record, replay and bias circuit system for reel-to-reel recorders. These circuits will give studio quality with a good tape deck. Separate sections for record and replay give optimum performance and allows a third head monitoring system to be used where the deck has this fitted. Standard 250mV input and output levels. Ideal for bringing that old valve tape recorder back to life. Suitable stereo heads are in our head list. This basic kit is suitable for advanced constructors only. K900W Stereo Kit with Wound Coils and Twin Meter Drive.....£123.93  
RJS1 Reprints of Original Descriptive Articles.....£3.60

### LINSLEY-HOOD CASSETTE RECORDER CIRCUITS

Complete record and replay circuits for very high quality low noise stereo cassette recorder. Circuits are suitable for use with any high quality cassette deck. Switched bias and equalisation to cater for chrome and ferric tapes. Very versatile, with separate record and play circuits and easy to assemble on plug-in PCBs. Complete with full instructions. Complete Stereo Record/Play Kit.....£62.58  
VU Meters to suit.....(Each) £3.99  
RLH1 & 2 Reprints of original Articles.....£2.70

### HIGH QUALITY REPLACEMENT CASSETTE HEADS



Do your tapes lack treble? A worn head could be the problem. For top performance cassette recorder heads should be replaced every 1,500 hours. Fitting one of our high quality replacement heads could restore performance to better than new! Standard inductances and mountings make fitting easy on nearly all machines (Sony are special dimensions, we do not stock) and our TC1 Test Cassette helps you set the azimuth spot on. As we are the actual importers you get prime parts at lower prices, compare our prices with other suppliers and see! All our heads are suitable for use with any Dolby system and are normally available ex stock. We also stock a wide range of special heads for home construction and Industrial users.

HC80 NEW RANGE High Beta Permalloy Stereo head. Modern space saver design for easy fitting and lower cost. Suitable for chrome metal and ferric tapes, truly a universal replacement head for everything from hi-fi decks to car players and at an incredible price too!.....£8.30

HRP373 Downstream Monitor Stereo Combination Head.....£53.90  
HQ551S 4-Track Record/Play Head  
Sony Mtg.....£14.90  
HM120 Standard Mono R/P Head.....£3.44  
H524 Standard Erase Head.....£1.90  
H561 Hi Field Erase Head for METAL Tapes.....£3.49  
SM150 2/2 (Double Mono) DC Erase Head.....£5.20  
HO751E 4/4 True 4-Track Erase Head.....£57.06

### REEL TO REEL HEADS

999R 2/4 Record/Play 110mH. Suits Stuart Tape Circuits.....£13.34  
998E 2/4 Erase Head 1mH. Universal Mount. Suits Stuart.....£11.96

### HART TC1D Triple Purpose TEST CASSETTE

Now available again and even better than before! Our famous triple purpose test cassette will help you set up your recorder for peak performance after fitting a new record/play head. This quality precision Test Cassette is digitally mastered in real time to give you an accurate standard to set the head azimuth, Dolby/VU level and tape speed, all easily done without test equipment.  
TC1D Triple Purpose Test Cassette.....£14.99

### TAPE RECORDER CARE PRODUCTS

DEM1 Mains Powered Tape Head Demagnetizer, prevents noise on playback due to residual head magnetisation.....£4.08  
DEM115 Electronic, Cassette Type, demagnetizer.....£8.61

Send or 'phone for your copy of our List (50p) of these and many other Kits & Components. Enquiries from Overseas customers are equally welcome, but PLEASE send 2 IRCs if you want a list sent surface post, or 5 for Airmail.

Ordering is easy. Just write or telephone your requirements to sample the friendly and efficient HART service. Payment by cheque, cash or credit card. A telephoned order with your credit card number will get your order on its way to you THAT DAY.

Please add part cost of carriage and insurance as follows:-INLAND Orders up to £20 - £1.50, Orders over £20 - £3.50. Express Courier, next working day £10.

OVERSEAS - Please see the ordering information with our lists.



QUALITY AUDIO KITS

24 hr. SALES LINE (0691) 652894

ALL PRICES INCLUDE VAT AT 17.5%

# HART

HART ELECTRONIC KITS LTD  
6 PENYLAN MILL  
OSWESTRY, SHROPSHIRE  
SY10 9AF

# INTERFACE

**Robert Penfold**

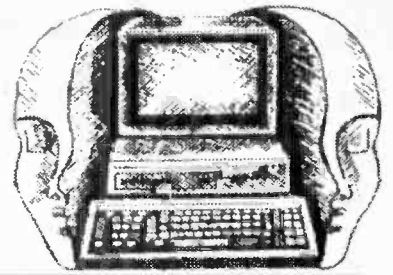

**A**S MOST readers who own PCs will probably be aware, upgrades to MS/DOS version 6.0 have recently become available. This version of DOS has a number of new features, but the most interesting of these is undoubtedly the "DoubleSpace" program. This is a disk compression program which can be used with any disks, but is primarily intended to be a means of effectively doubling the size of a hard disk drive.

Although some reports in the computer press seemed to suggest that this program had been withdrawn from MS/DOS 6.0 due to legal reasons, it is definitely included in the package. It is the utility program that can convert disks compressed using "Superstore" to "DoubleSpace" format that has been withdrawn. Apparently this conversion program is available separately from Microsoft for a small fee.

## Crash Drive

Hard disk compression programs have rather poor reputations, and many users seem to run into trouble when using them. On the other hand, other users seem to experience no real difficulties at all.

I tried a hard disk compression program about a year ago, but was far from impressed. When the hard disk became more than half full, and the program started to provide extra disk capacity, the system would seriously crash. In fact it was difficult to regain control of the computer again, and this was only possible by reformatting the disk and restoring all the files from the backup disks.

Another problem is that the way in which most of these programs operate is something less than convenient. The usual arrangement is for drive C: to contain the usual start-up files, plus a huge file generated by the compression program. This huge file takes up practically all of drive C:'s capacity.

A notional drive D: is generated, and this has a capacity of around double the hard disk's actual capacity. It is here that the programs and data are stored. Of course, the huge file on drive C: and the notional drive D: are one and the same.

The problem with this arrangement is that moving the programs and other files from drive C: to drive D: can cause malfunctions, with files not being where programs expect them to be. It is a system that works best if it is used from the start, rather than being applied to a hard disk which is already loaded with your programs and data.

A program such as "DoubleSpace", which is part of the operating system, has a big advantage over an add-on program.

The fact that the disk has been subjected to compression can be completely hidden from the user, with drive C: seeming to increase in capacity after the compression program has been run. The programs and other files remain on drive C:.

The only peculiarity of the "DoubleSpace" program is that it generates a drive H:, which has a capacity of about eight megabytes. No compression is used on this drive, and its main purpose seems to be as temporary storage space for Windows. It can also be used for other files that must not be subjected to any compression.

## Installation

I obtained the 3.5 inch version of the MS/DOS 6.0 upgrade, which is supplied on three high density disks. If necessary, a set of 720k disks can be obtained by sending off the appropriate card to Microsoft.

Installation is easy since a setup program is provided. Unless a custom installation is required, it is basically just a matter of pressing the right key when requested, and changing disks at the appropriate times.

Like the MS/DOS 5.0 upgrade, some existing files can be automatically loaded onto an "uninstall" disk. This makes it possible to return to the old version of DOS if required.

The "DoubleSpace" program is loaded into the DOS directory, but it is not run during the installation process. If hard disk compression is required, "DoubleSpace" must be run once the installation procedure has been completed.

It is very straightforward to use, and for most users it is just a matter of accepting the defaults. The compression process takes a while, and it took just over an hour to compress my 105 megabyte hard disk drive which was almost full. This includes the time taken for the program to defragment the disk.

Like most programs of this type, "DoubleSpace" provides what in most cases is something less than a two-to-one compression of the data on the disk. However, it still provides a very worthwhile increase in effective disk capacity. With a 105 megabyte hard disk drive I gain about 70 megabytes on drive C:, plus the eight megabytes or so of decompressed space on drive H:.

The amount of space gained by compression depends very much on the contents of the disk. Compression programs mostly use more than one compression technique.

The most popular forms of compression rely on a certain amount of repetition in each file. A long string of binary 1s or 0s might be present, and it will then be possible

to save disk space by coding these as X number of 1s or 0s.

This process can be taken a stage further, with repeated binary patterns being coded in much the same way. The longer the binary patterns, and the more often they are repeated, the greater the space saving that can be achieved. After compression, many programs repeat the processing on a second pass in an attempt to produce further space saving.

Compression techniques mostly work quite well with program files, but give much more variable results with data files. Bit maps generally offer excellent scope for quite high degrees of compression, while ASCII and similar files generally lend themselves to moderate amounts of compression.

However, many programs apply one or more compression techniques to saved data, it is probably this factor that results in programs like "DoubleSpace" tending to fall short of their design aim of two-to-one compression. I achieved a compression ratio of about 1.8 to 1, which seems to be fairly typical of these programs.

As anyone who used PC shareware in the early 1980s will remember all too well, not all compression programs manage to decompress files with 100 per cent accuracy. Many of the early efforts crashed half way through the decompression process, or produced errors in the decompressed files.

There was a lot of shareware in circulation which did not run due to decompression errors. Fortunately, modern disk compression programs seem to be totally reliable, and I have certainly not experienced any problems when using "DoubleSpace".

## Half Time

There is a potential problem with disk compression programs that work "on-the-fly", and this is that they can seriously slow down disk accesses. Every time something is written to disk, or read back from the disk, it must be processed by the compression/decompression program. This process is "transparent" to the user, but it goes on in the background every time the hard disk is accessed, and it takes time.

In practice the problem is less severe than one might think. It has to be borne in mind that hard disks tend to be quite slow by the standards of the rest of the computer. Processing the data takes extra time, but having less data to read and write saves time.

Using disk compression can speed up disk accesses, or slow them down. It all depends on the access time, etc. of the disk, and the speed the data processing is carried out.

In my experience of these programs they do not seem to have much effect one way or the other.

Using a 33MHz 80386 based computer and an IDE drive with a quoted 14ms access time, loading large programs is definitely somewhat slower using the "DoubleSpace" program.

Loading large data files into programs seems to give a less significant difference. Overall, any slowing down of the computer would not seem to be of great significance.

MS/DOS 6.0 has several other new features, including a program which helps to free more RAM, an anti-virus utility, a defragmenter program, an undelete utility, and improved backup programs. Incidentally, the "DoubleSpace" program can be used to compress data on floppy disks, and it is not restricted to use on hard disks.

The MS/DOS 6.0 is available from most PC software retailers, and it currently has a recommended retail price of £49 plus VAT. It is worth shopping around though, since it can be obtained for about this price, inclusive of VAT.

Either way, it represents very good value for money. Note that this is an upgrade program which can only be installed on a computer which is running an earlier version of DOS, or Microsoft's OS/2 operating system.

### Joystick Port

From time to time I receive letters concerning the PC joystick ports. Some readers

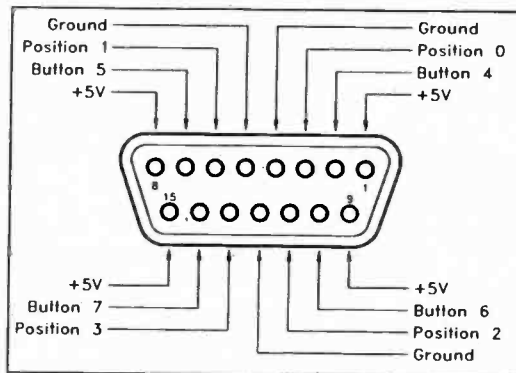

Fig. 1. Pin functions of the joystick port.

wish to use this as a mouse port. As explained in a previous *Interface* article, this is not a practical proposition because the joystick port is incompatible with all the normal types of mice. Most of the others wish to use this port for interface temperature probes, light sensors, or other analogue devices.

This seems to be a more realistic proposition, since the PC joystick port is an analogue type. In this respect it is quite like the BBC computer's analogue port. Unfortunately, it seems to work in a rather different fashion to the BBC computer's analogue port. The latter utilizes a four-channel 12-bit analogue-to-digital converter which is easily interfaced to various analogue devices.

The PC joystick port does not use a proper analogue-to-digital converter. It seems to work on the basis of using the

resistance of each joystick potentiometer in a timer circuit.

Presumably a software counter operates until the end of the each timing pulse. The higher the joystick resistance, the longer the pulse duration, and the higher the count. A resistance of around zero to 140k or so seems to be required.

The standard connector for the joystick port is a 15-way D-type socket. The pin functions for this port are shown in Fig.1.

The two potentiometers for joystick 1 connect from +5V to the "Position 1" and "Position 2" terminals. Presumably the potentiometers in a second joystick connect from +5V to the "Position 2" and "Position 3" terminals.

It might be possible to use these four inputs with some types of sensors, but the sensors would have to provide varying resistances, and not varying voltages. Also, the linearity of these inputs does not seem to be particularly good. The joystick port can only be used for very basic analogue sensing applications, but it is potentially useful.

There are two firebutton inputs for each joystick. These inputs are "Button 4" to "Button 7", and in normal use they are connected to the earth rail via the firebutton switches. These seem to be four conventional TTL digital inputs which could be used for other purposes.

The interfacing possibilities of the PC games port will be covered in more detail next month.

# MCB SUPERB SYSTEMS - UNBEATABLE VALUE!



All our computer systems are complete with:- Mini Tower Case, 2mb RAM, 16 bit VGA card, 40mb HDD, 1.44mb (3.5") floppy disc drive, 14" (.28 dot pitch) SVGA colour monitor, 2S/1P/1G, 102 key UK keyboard and a **LIFETIME** return to base warranty (1st year parts and labour, then labour only).

**386SX-40**  
£499

**386DX-40**  
£569

**486SX-25**  
£669

**486DX-33**  
£789

**486DX-50**  
£899

**SYSTEM OPTIONS:-** Ram £23 per mb, 1mb SVGA card £25, 5.25" FDD £45, MSDOS6 £45, Windows 3.1 £45, 120mb Tape Streamer £129, CD ROM £159, Joystick £12, Orchid Sound Producer £59, Mouse £12, NE200 compatible £59. **HARD DRIVE UPGRADES** 120 mb add £85, 210 mb add £135.

### DO IT YOURSELF!

Boards etc  
386sx40 £69  
386dx40 £119  
486sx25 £189  
486dx33 £299  
486dx50 £379  
1mb SIMMS £24  
1.44mb FDD £30  
Mini Tower Case £45

### "TAILOR MADE"

As we manufacture **all** of our own computers we can build any system to your exact specification. Quotations a pleasure!  
Prices quoted are for cash/cheque with order and exclude carriage and VAT. Credit card surcharges apply to hardware sales.

**MCB Computing Group**  
24 Mill Lane, Buckley, Clwyd CH7 3HB  
Tel 0244 544063 Fax 0244 543926

### OTHER SPARES!

256k VGA £20  
1mb Trident SVGA £47  
120mb HDD £129  
212mb HDD £179  
102 keyboard £19  
Parallel Printer Cable £2.75  
Much More Available!  
All with 12 month warranty

# Those Amazing Barcodes

**ALAN WINSTANLEY**

*The product "identity card" that's scanned by lasers and interpreted by computers.*

**M**ANY advances in terms of technological applications, speed of operation, capacity, power and size have been made within the last decade. For example, the computer age is well and truly upon us, as immensely powerful personal computers can now be found in the home, in the office, and even in the briefcase.

## DEVELOPMENTS

Facsimile ("fax") machines, which were exclusively sported by the wealthiest of companies six or seven years ago, have tumbled in price, even finding their way into domestic homes as they can now be bought in the high street for as little as £229. A fax machine can even be purchased which is not much larger than an ordinary telephone.

Miniaturisation continues unabated as the manufacturers now proffer pocket-sized colour televisions, talking language translators no bigger than a calculator, electronic diaries and address books, palm-sized video cameras and hi-fi equipment which is a fraction of the size of its predecessors.

One of our more amazing electronic developments is now taken very much for granted. They pop up all around us in everyday life. Checking out at the supermarket, buying a magazine at a newsagent, selecting a programme to be taped by our video recorder, those striped symbols are now familiar to us all.

Barcodes seem very innocuous. They adorn almost every product you can buy in every store and supermarket. There are thousands of millions of them in circulation, each bearing a computerised code which has revolutionised the way we do our shopping.

## CHECK THIS OUT

Queuing up at that supermarket "scanning" check-out (electronics still hasn't solved the problem of those interminable delays at the cash register!), you will now hear the monotonous of a computerised cash register which "reads" the barcodes of the produce as the check-out assistant passes it over a **laser scanner**. Each electronic beep is a confirmation that the laser has "seen" the barcode – whether it's on a bag of crisps, a tin of soup or lengths of timber.

In the surface of each check-out counter you may see a small window, probably less than twelve inches square. Look carefully

at the window and you may often observe the laser light itself, in the form of a red pin-prick of light. Adjacent you may see both a small red and a green indicator lamp. The green lamp briefly flashes, accompanied by a beep, to confirm that the goods have been scanned correctly by the barcode reader. A price and product description then flashes up on an alphanumeric display nearby. The red indicator lamp occasionally warns the operator to repeat the scanning process.

The laser scanner is quite capable of reading the barcode forwards or backwards, as they scan over the barcode with a matrix of low-power light beams which can be directed by mirrors mounted internally under the window. Thus, the way in which the operator presents the goods to the scanner is not critical, because the multi-directional beams are bound to register the barcode no matter which way the product is presented. The check-out assistant merely passes the goods over the scanner in a casual manner which belies the complexities of the light-directional mechanism and the electronic deciphering system being used behind the scenes.

How does a check-out scanner actually "read" this barcode? When the item is passed over the scanner window, a precise laser light beam is directed by a series of lenses and mirrors over the merchandise and so over the barcode. This beam of laser



light – which, unlike those fictional ones which James Bond encountered in the movies, is completely harmless – is actually absorbed by the dark bars of the barcode, but reflected back by the lighter sections.

The image which bounces off the barcode is directed back into an electronic detector which decodes the reflection, see Fig. 1. Thus, the check-out computer obtains the product's *digital code* by deciphering the barcode from the series of light pulses which are received by the detector and decoding system.

## MEMORIES ARE MADE OF THIS

The barcode is in effect a unique "I.D. card" for that particular line of merchandise. The cash register system then reads through its database, looking for a code number which matches the number it has just deciphered from the barcode, see Fig. 2. The system's memory then instantly flashes back to the cash register with a product description, and, more importantly to the housewife, the price to be charged. In addition, the computer now knows that a particular product has just been purchased, and so it also updates its stock records accordingly.

In an instant, the cash register has been updated with a product description, and the product name is printed onto the till receipt along with its price. The customer now has a clear record of the purchase, instead of an unhelpful roll of paper indicating nothing but a string of prices.

Even more amazingly, the senior staff back at the head office – which could be

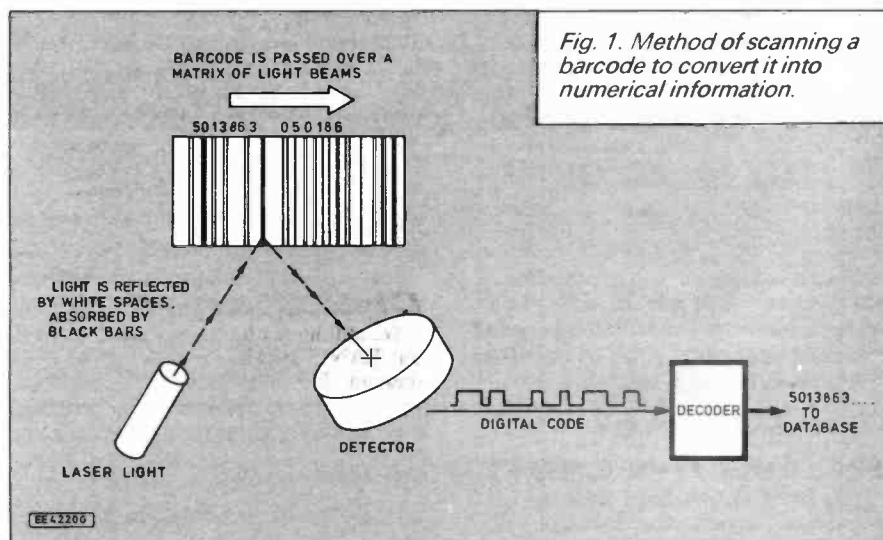
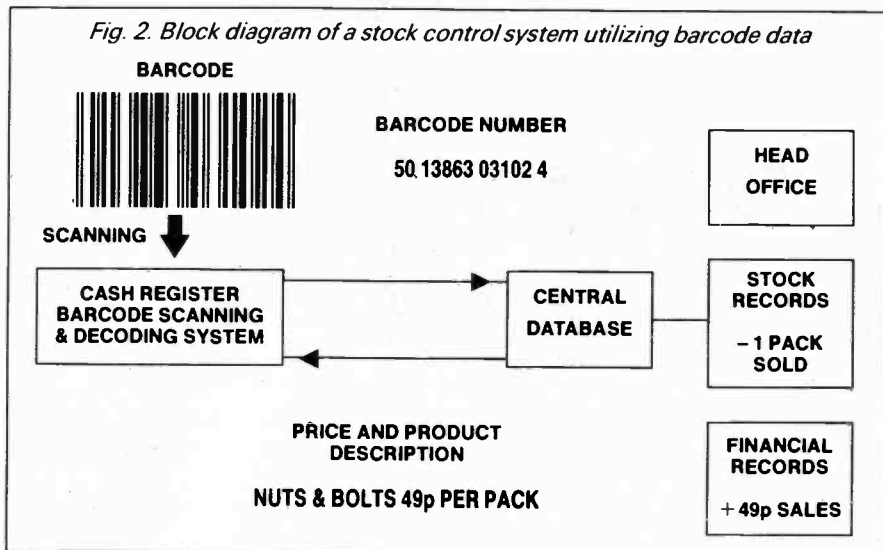



Fig. 2. Block diagram of a stock control system utilizing barcode data



anywhere in the country – can also be connected into the system by a network of computer links, and by using their own computer terminal they are able to watch the sales figures of their merchandise clocking up.

Computers analyse product sales by the hour, or offer summaries based on the number of units sold this week if wanted. They can also forecast whether it will be possible to meet any forthcoming demand for a product.

## STOCK

Buyers whose responsibility it is to source and replenish stocks, can obtain virtually instantaneous information on sales so that their suppliers can be instructed to deliver replacement stocks. Slow-moving lines are also highlighted to be considered for deletion. Indeed a retailer's entire operation centres around the movement of stocks. Over-stocking means that cash is tied up needlessly in stocks when it could be better utilised in other aspects of their business – so the raw data provided by those barcodes is actually critical for efficient stock control and market planning.

If the products concerned are of a less manageable nature, such as certain lines found in d.i.y. superstores then it's obviously impossible to pass the cumbersome goods over the scanner window – unless you relish heaving lengths of timber onto the counter! As you may have experienced yourselves at a check-out, in these cases the operator is armed with an electronic "gun" which is "fired" at the barcode label attached to the goods.

A precision light-beam scans over the barcode and then the decoded data is transmitted instantly into the store's computer system, which responds with the product description and value. The useful range of the "gun" can be many centimetres, which enables the cashier to "shoot" the barcode label affixed to the goods in the customer's shopping trolley.

An alternative system is for the check-out operator to hold a book with the barcodes of various bulky items (e.g. bags of potting compost) all printed inside. Whenever a customer buys one of these items, the operator simply scans the appropriate barcode from the book.

## SEEING THE LIGHT

Have you ever wondered what the barcode actually means? There are some two dozen or more different types of barcode in

common use, but the system which the consumer will mostly see in retail stores is known as the "EAN" system, short for European Article Number. This is generally based on a thirteen-digit code number – the EAN13 format – which is unique to that product. A different system is used for magazine sales.



Fig. 3. A typical EAN13 barcode.

A typical EAN13 barcode is shown in Fig. 3. The thirteen digits of the code can be divided into four groups. Firstly, two digits placed at the beginning of the code indicate the country of origin of the barcode. You will see "50" at the start of all codes originating in the United Kingdom.

Each manufacturer who subscribes to the barcode number system is allocated a unique five-digit code number by the Article Number Association. This number represents their company and cannot be used by any other. That of my own firm is 13863. The code belonging to Halfords Ltd., for example, is 15025. These five numerals follow the country of origin code. So the first half of the code number may be 5013863 or 5015025, for instance.

The supplier or manufacturer is free to allocate another five digit code entirely of their own choice to the product. The code will take into account the packaging of the product: the maker of a particular chocolate bar may offer several sizes, perhaps packed in units of half a dozen bars, as well as individually. Whilst one barcode may appear on the individual bar's wrapper, a different one will appear on the outer wrapping of the six-pack.

## CHECK DIGIT

We still have one digit to account for in our EAN13 system – the numeral right at the end. This **check digit** is included as a built-in test which tells the barcode scanner that it has read the rest of the code correctly. A simple algorithm is utilised in order to validate that the barcode is sound. The panel on the right shows how the algorithm works for the EAN13 system. By ignoring the last (check) digit of the

EAN13 code, work backwards through the code number, right to left, adding up every other numeral in the code. Multiply the total by three.

Go back to the end of the code, and work through the barcode again, adding to your total each digit which you omitted in your initial calculation, and make a grand total. Now simply determine the *next whole multiple of ten* up from your grand total, and calculate the *difference* between your grand total and this multiple of ten.

Your result will be a single numeral which is the check digit. This is appended at the end of the twelve digits to make thirteen in all. It is an in-built check which confirms that the scanner has read the barcode correctly. Have a look at any thirteen-digit barcode and work out the final check digit for yourself.

The EAN13 digital sequence which results is encoded into a precise pattern of stripes, which are reproduced on the packaging to fine tolerances. The width of the bars is precisely controlled, but also has to take into account the fact that printing ink might spread or "bleed" during the printing process – so barcodes might be deliberately printed very slightly narrower than required (using a bar width reduction factor, measured in microns), because they will expand somewhat when the wet ink spreads.

## Key to Barcode Numbers

Example Barcode Number (EAN-13 format)

50	13863	03102	4
UK	COMPANY	PRODUCT	CHECK
I.D.		CODE	DIGIT

"PRODUCT IDENTITY CARD"

The barcode number is unique to that line of merchandise and represents the "I.D. card" for that product. The numerical information contains the country of origin of the barcode (*not* the product), company (*not necessarily the manufacturer*) and product codes and a "check digit".

### How the check digit is calculated:

A modulo-10 algorithm is used to calculate the final check digit. It can be proved as follows. Starting at the end of the product code (before the "check digit"), go back from right to left and add up every other numeral.

$$2 + 1 + 0 + 6 + 3 + 0 = 12$$

Multiply your answer by 3:

$$3 \times 12 = 36$$

Now go back and add up the numbers which you missed first time:

$$0 + 3 + 3 + 8 + 1 + 5 = 20$$

Add your result to the answer from the first calculation:

$$20 + 36 = 56$$

Find the next whole multiple of 10 up from this answer (= 60).

The difference between your final answer and the multiple is the check digit:

$$60 - 56 = 4.$$

## COME ON DOWN...

It will not have gone unnoticed that no price has so far been mentioned in the barcode itself. In fact, the price of the goods is not denoted by the barcode as such. Whilst a product designer will allow for the EAN13 code to be shown on the packaging, it is left to the retailer to allocate a price on their computer's database. The retailer can change the retail prices (e.g. reduce them in a sale) by altering the computer records of that product code number. *Otherwise the barcode contains no price information at all – it's simply a product identifier.*

Sometimes you might observe a shorter code, one which contains not thirteen but just eight digits – this is not surprisingly called the EAN8 format. You might see it on small items which are not physically big enough to carry a large EAN13 barcode – a packet of "Polo" mints, for instance. Because the eight digit system cannot accommodate a great number of individual manufacturers and products (the system would soon be filled to capacity), the EAN8 format is only employed by a select few manufacturers who have been lucky enough to be allocated an abbreviated code number.

Barcodes often appear on the edges of shelves of supermarkets, too. A portable computer scanner will be used by a store assistant to read each product designation. Then the assistant will count the stock which is adjacent to the shelf barcode, and type this figure into the portable computer.

The machine may transmit the barcode and stock check figures back to the office computer by remote control, which will then update its "actual" stock level information for that product code. In other systems, the terminal may be plugged into a computer inlet once the stock count has been completed by the operator, thereby transferring the entire stock check into the central computer.

## PROBLEMS

Of course, no system is entirely infallible. It is still possible for sophisticated barcode scanners to become a bit confused. Whilst the barcodes themselves are printed to very exact standards – the width of each line and the gap between them is absolutely critical, and has to take the weaknesses of the printing process into account – scanners may sometimes have difficulty reading a shiny object such as a bag of frozen peas.

Alternatively, the barcode may have been damaged or soiled in the store. In these instances, the operator is then able to manually enter the digital product code as printed underneath the barcode: the computer can then "look up" the price and description as normal. That's why there is always a "human recognisable" numerical code underneath the otherwise incomprehensible barcode.

## BAH! CODES

Whilst the technology of barcodes has been highly refined over the past few years, problems with the machinery itself, though thankfully rare, can give rise to nightmarish headaches for system users. It was reported that shortly after a new supermarket opened its doors for the first time, the computer system unfortunately "crashed". The system was soon crippled through a fault or "bug" in the scanning equipment.

Because the store used a barcode scanning system, their check-out cashiers

## Magazine Barcoding System

Magazines are regularly barcoded in order to speed the pricing-up process at check-outs. A barcode on the front cover is scanned by a hand-held pen-like "wand" which reads the barcode into the decoding system. This generates a digital code which can be referred to a computer "look-up" table as usual.

Magazines and serial journals use the ISSN system – the International Standard Serial Numbering system, where every barcode number begins with the digits 977. Then seven digits are used to indicate the ISSN reference number for that journal; two spare digits follow, which can contain the price if needed and a check digit appears at the end. Finally two extra digits can indicate the issue number i.e. 08 for the August issue.

In addition to helping at the check-out the barcode on a magazine is also used for sale or return (S.O.R.) processing. Unsold magazines being returned to the wholesaler are scanned and the "sales" level for each issue stored on the wholesalers' and distributor's computer systems are corrected and credits given by the distributor.



were unable to ascertain the prices of the customers' purchases: of course, the goods did not bear any price labels! Instead, paralysed by the loss of their computer, the staff were instructed to ask the customers to make a reasonable offer for each item – perhaps the management considered it was worth making a loss if necessary rather than alienate its new patrons!

Apart from retailing, barcodes also crop up in other applications. Recently, the writer was invited to an exhibition of leisure products, and was sent a lapel badge beforehand. This badge, apart from bearing my name, also included a barcode. At the entrance to the exhibition, the barcode on the badge was quickly scanned by a receptionist holding a "wand" scanner like a large pen. This informed the organiser's central computer that I had attended the exhibition.

From the barcode the computer could also determine my company name and address, not to mention my position, and the organisers will then write to me next year with another invitation to the show knowing that I visited their last one.

Additionally, when I called on to an exhibitor's stand, each exhibitor, instead of accepting a business card would scan the barcode on the badge: after the show, they could then decode the information and follow up with a visit or a written quotation to my business address.

## SELF PARKING

A Japanese car manufacturer is reported to have designed and built a prototype car which will automatically park itself in the garage: it looks for barcodes fixed to various locations on the garage walls, in

order that it can find its "bearings" and correct its position accordingly!

It was recently announced that pension and allowance books will include a barcode, unique to the book-holder, in an attempt to foil any attempts to fraudulently claim an allowance by using another person's book. Each Post Office will probably become equipped with a barcode wand unit so that they can scan the identifying barcode. A false claim will become immediately apparent if the allowance book has been reported as stolen, and a "stop" can be applied instantly by the authorities.

In industry as well as warehousing, barcode information systems are being increasingly used to help central computers to monitor the throughput of stocks or products. By automatically reading a special-format barcode which has been allocated to, say, a motor car during assembly, the progress of the product can be controlled as each unit is logged into and out of various processes.

## AUTOMATIC

One large retailer I visited holds some £30 million of stocks stored in Europe's largest automatic warehouse which is integrated into a highly efficient stock control system, but it still depends on barcode systems to monitor the throughput of stock. Merchandise which is destined for a particular store is loaded into plastic miniskips, each box having a unique barcode label on the side. Infra-red detectors read the barcode as the box travels automatically through the warehousing system on an assortment of conveyors and robotic transporters.

Gradually the box is filled with a variety of products all destined for one particular store. An impressive, fully automatic sorting process then eventually diverts these boxes to a suitable loading bay, ready for despatch by lorry. The automated warehouse system sorts the boxes into *reverse order*: The system is aware of the route which the vehicle will take when it travels around the country, so that the first box to be loaded onto the vehicle will always be the last one off!

A new hand-held l.c.d. game – the Barcode Battler (reviewed last month) – actually utilises barcodes in order to allocate a number of points to a player. Barcodes are "swiped" into the games unit like a credit card at a checkout. The barcode is then transformed into points and the game commences. This has led to a craze in Japan where merchandise is bought simply to snip off and scan the barcode into the machine!

Next time you visit a supermarket, spare a thought for those often overlooked, incongruous barcodes: the electronic industry's little miracles which hold the key to the entire merchandising system. □

## More Information

Any party considering becoming involved with the barcoding of merchandise for the first time might find the following useful:

The Article Numbering Association controls the issue of company codes, and every supplier using a barcode on packages needs to subscribe with this body.

Article Numbering Association (UK) Ltd., 11 Kingsway, London WC2B 6AR  
Tel. 071 240 3056, Fax. 071 240 8149

# Low cost data acquisition for IBM PCs & compatibles...

A unique range of low cost data acquisition products for IBM PCs and compatibles. Installed in seconds they simply plug directly into either the serial or parallel port. They are completely self contained, require no external power supply and take up no expansion slots.

Each device comes with an easy to use software package (PicoScope, PicoLog or both). C, Pascal, and Basic drivers are supplied for those who want to develop their own software, as is a manual giving full details of the hardware and software. All software supplied on 3.5" disk.

**ADC-10** Up to 24kHz sampling rate from a 386/33MHz machine  
0-5V Input range  
BNC input connector allows use of standard scope probes  
30V overload protection  
Parallel port connection  
Includes PicoScope software

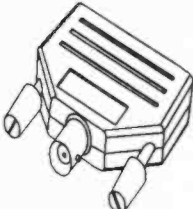

Single Channel 8 bit ADC **£49**

**ADC-16** Software selectable single ended or differential inputs  
Resolution programmable between 8 and 16 bits + sign  
 $\pm 2.5V$  input range  
5V reference output  
Connects to serial port  
Includes PicoLog software

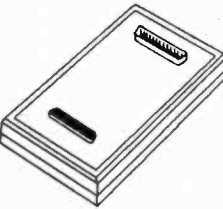

8 Channel 16 bit + sign ADC **£99**

**ADC-11** 15K samples per second  
0-2.5V Input range  
Digital output  
D25 input connector  
30V overload protection  
Parallel port connection  
Includes both PicoScope and PicoLog software

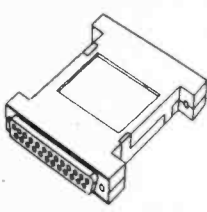

11 Channel 10 bit ADC **£75**

**PicoScope** 'Virtual instrument' software package for the ADC-10, ADC-11 and ADC-12.

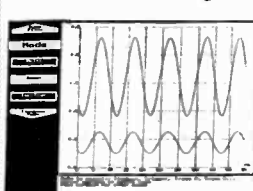

Scope, voltmeter, spectrum analyser

Storage oscilloscope with trigger and timebase. Traces can be printed and saved. Multiple meters onscreen. Real time spectrum analysis.

**ADC-12** Up to 18kHz sampling rate  
0-5V Input range  
BNC input connector allows use of standard scope probes  
30V overload protection  
Parallel port connection  
Includes both PicoScope and PicoLog software

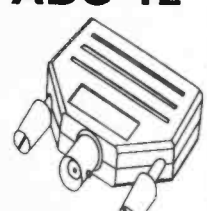

Single Channel 12 bit ADC **£85**

**PicoLog** Collect samples from 1 per ms to one per day. Scale samples linearly, by equation or by table look-up. Graphical (against time or XY) and text reports can be displayed, printed or exported.

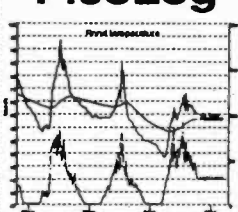

Advanced data logging software

Picolog is also available for the ADC-10: call for details.

Typical application	ADC-10	ADC-11	ADC-12	ADC-16
Oscilloscope	●	●	●	
Voltmeter	●	●	●	●
Spectrum analyser	●	●	●	
Audio sampling	●		●	
Chart recorder emulation		●		●
Temperature measurement	●	●	●	●
Pressure measurement	●	●	●	●
Chromatography				●
Automotive monitoring		●		●
Medical research		●	●	●
Education	●	●	●	●

## PICO BENEFITS

- 30 day no quibble money back policy
- Full 1 year guarantee
- 1 year's free software upgrades
- Free technical support
- Free user newsletter
- Same day dispatch

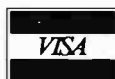

Pico Technology Ltd. Broadway House, 149-151 St Neots Road, Hardwick, Cambridge. CB3 7QJ.

**TEL: 0954-211716 FAX: 0954-211880**

Phone or FAX for sales, ordering information, data sheets, technical support. All prices exclusive of VAT.



PICO TECHNOLOGY

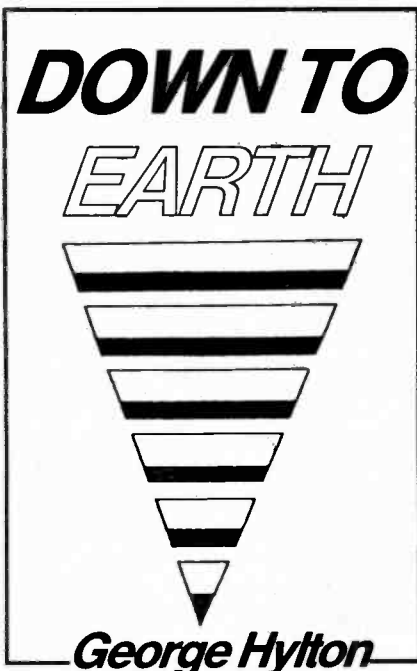

## CONDUCTANCE

EVERYBODY is familiar with the idea of resistance in an electrical circuit. We feel happy with "resistance" in an electrical circuit because we are so accustomed to hearing it in everyday, non-technical situations.

This is not true of the technical relatives of resistance: impedance, reactance, conductance, admittance. They bear some resemblance to familiar words but have no obvious meanings. Let's have a look at one of them: *Conductance*.

### EARLY DAYS

At one time, there were no volts, ohms, and amperes, only something vague, called "electricity". Electrical researchers were struggling to discover whether the sort of electricity you made by rubbing amber with a dry cloth was the same as the sort that you got from one of Volta's new-fangled piles. In present-day words, they were trying to find out whether static (frictional) electricity and current electricity were two aspects of the same thing or two different things.

Georg Simon Ohm was a pioneer researcher in this field. His now classic paper was called (in German) "The Galvanic Chain". We would now say "The Electric Circuit".

## CONDUCTANCE

Ohm was trying to get answers to the question: do some things conduct electrical currents better than others? Note that it was the ability to conduct that Ohm set out to research, not the ability to resist conduction. Resistance hadn't been thought of!

He showed, to his own satisfaction (though for a long time to nobody else's) that "ability to conduct" is a measurable quantity, expressible in precise terms (known to us as Ohm's Law). If the ability of a circuit to conduct is called its conductance, what determines the amount of current that flows?

### OHM'S LAW AS HE SAW IT

Ohm saw the current as something governed by the number of cells in his battery and the circuit's ability to conduct. A battery provides an electromotive force ( $E$ ) and the ability to conduct can be called the conductance.

The intensity ( $I$ ) of the current is then given by the product of these two quantities. Current = electromotive force times conductance.

That may not look like the Ohm's Law you know and love. That says: Current = Voltage divided by Resistance:  $I = E/R$  (or  $V/R$  if you call the electromotive force the voltage).

If two things are each equal to a third thing then they must also be equal to one another. In the present case we have two things each equal to the current. It follows that one of them (conductance) must be equal to the other. But what *is* the other? Not  $R$ , but  $1$  divided by  $R$ . Conductance is just a  $1/R$ .

For convenience, to avoid having to write  $1/R$  every time, electrical engineers usually give it an alternative symbol,  $G$ . So  $I = E.G$ . Conductance is a sort of mirror image of resistance.

When Ohm started his work nobody really knew whether one conductor was different from another in any electrically important way. The first electrical circuits were just batteries or cells whose terminals were connected together via a length of wire. They were virtually short-circuits.

What limited the current wasn't so much the resistance of the wire as the internal resistance of the battery, which was usually very much larger. It was only as a result of Ohm's painstaking research that the idea of resistance was born.

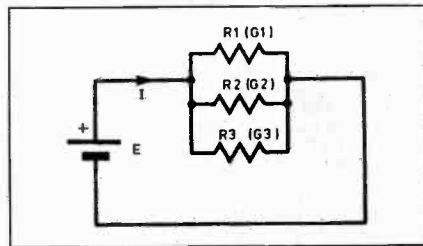

Fig. 1. Simple electrical circuit.

### PARALLEL CONNECTION

A circuit like Fig. 1 is easier to understand if the elements are thought of as conductances rather than resistances. Common sense tells you that the more parallel paths there are the more current flows.

In other words the conductances add. The total conductance is  $G1 + G2 + G3$ . Writing  $1/R$  for  $G$ , the total conductance is  $1/R1 + 1/R2 + 1/R3$ .

Before the computer age these  $1/R$ s were mathematically a bit awkward. Pocket calculators have now made things easy, and you can work out a conductance by entering the resistance then using the reciprocal ( $1/X$ ) key.

What is the conductance of a circuit with 29 ohms, 97 ohms and 133 ohms all in parallel? My calculator says 0.00523...

Inverting this ( $1/X$ ) gives 19.11, which is the equivalent resistance in ohms. (Since conductance is the inverse of resistance, then by inverting again you get back to resistance.)

### UNITS

Conductance, as we've seen, is a measure of a circuit's ability to pass current when a voltage is applied. The more volts, the more amps. This leads straight to one unit of conductance, amperes-per-volt. A resistance of 1 ohm, when connected to 2 volts, allows 2A to flow. The corresponding conductance is one amperes-per-volt.

This is a bit clumsy. Back in the Victorian age, William Thompson (Lord Kelvin) made a rather whimsical suggestion. By then, the unit of resistance had been named: the Ohm. Since conductance is the inverse of resistance, said Kelvin, let's just invert the word Ohm and call the unit of conductance the mho. The mho = one ampere-per-volt.

The matter might have rested there. But scientists decided that they must honour another electrical pioneer, Siemens (pronounced ZEE-MENS). So they changed

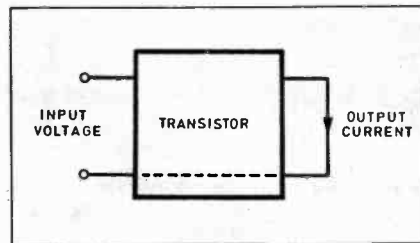

Fig. 2. "Black Box" transistor.

the mho to the Siemens. The result is that, depending mainly on the age of the books you use, you'll find conductance expressed in three ways: amperes-per-volt, mhos, or Siemens. Small wonder that people find it confusing!

### MUTUAL CONDUCTANCE

You are most likely to encounter conductance in transistor data. A transistor of any kind can be regarded as a "black box" with input and output terminals (Fig. 2). When a voltage is applied to the input terminals a corresponding amount of current flows (from the battery) through the output terminals.

Voltage causing current flow is what conductance is all about. So conductance is happening in the transistor.

Applying one volt to the input of a silicon power transistor might cause a collector current of 3A to flow. So the conductance here is three amperes-per-volt, or 3mhos, or, nowadays, three Siemens.

However, there's something odd about this conductance. The 3A does not come directly from the 1V at the input. All the 1V does is drive a relatively small base current. This base current then makes the collector current flow.

Processes which link input and output in this way are often labelled with the word "transfer conductance". In the example just given the transfer conductance is 3S.)

You may find that the transistor data adds the word "forward" and quote the "forward transfer conductance" as 3S. "Forward" just means that we are talking about the normal use of the transistor with an input to the base (or gate, if it's a f.e.t.) and output at the collector (or drain). Transfer conductance is often telescoped to make "transconductance".

Some transistor data call the forward transfer conductance the mutual conductance. This is an old term used to describe the same effect in radio valves.

A Siemens is rather a large conductance, and for convenience it can be divided in the usual way, into a thousand milliSiemens (mS) or a million microSiemens ( $\mu$ S). In the case of *pnp* or *npn* transistors (but not f.e.t.s) there is a useful way of estimating the transconductance.

If the emitter current is 1mA the transconductance is about 40mS. For other emitter currents the transconductance rises or falls in proportion. So for an emitter current of  $100\mu$ A (0.1mA) the transconductance is about 4mS.

The accuracy of the estimate diminishes as the emitter current becomes much larger or smaller than its typical value for the transistor in question. For power transistors, the estimated value is often higher than the real value. The transconductance is more or less independent of the current amplification factor.

This quick estimate enables you to work out the voltage gain of a one-transistor amplifier. The gain is: transconductance in mS times load in kilohms. So an *npn* transistor with a load of 2k and an emitter current of 1mA has a voltage gain of 80.

In multistage amplifiers the d.c. collector load is shunted by the input impedance of the next stage. This reduces the voltage gain.

Surplus always wanted for cash!

# THE ORIGINAL SURPLUS WONDERLAND!

Surplus always wanted for cash!

## LOW COST PC SPECIALISTS - ALL EXPANDABLE - ALL PC COMPATIBLE

### 8088 XT - PC99



- 256k RAM - expandable to 640k
- 4.7 Mhz speed
- 360k 5-1/4" floppy
- 2 serial & 1 parallel ports
- MS-DOS 4.01
- Factory burnt-in
- Standard 84 key keyboard
- 12" green screen included
- In good used condition

Optional FITTED extras: 640k RAM £39, 12" CGA colour monitor with card £39, 2nd 5-1/4" 360K floppy £29.95, 20 mbyte MFM hard drive £99.

Only **£99.00** (F)

### FLOPPY DISK DRIVES

5 1/4" from £22.95 - 3 1/2" from £21.95!

Massive purchases of standard 5 1/4" and 3 1/2" drives enables us to present prime product at industry beating low prices! All units (unless stated) are removed from often brand new equipment and are fully tested, aligned and shipped to you with a 90 day guarantee and operate from standard voltages and are of standard size. All are IBM-PC compatible (if 3 1/2" supported).

- 3.5" Panasonic JU363/4 720k or equivalent £29.95(B)
- 3.5" Mitsubishi MF355C-L, 1.4 Meg. Laptops only £29.95(B)
- 3.5" Mitsubishi MF355C-D, 1.4 Meg. Non laptop £29.95(B)
- 5.25" EXTRA SPECIAL BRAND NEW Mitsubishi MF501B 360K. Absolutely standard fits most computers £22.95(B)

\* Data cable included in price.

- Shugart 800/801 SS refurbished & tested £175.00(E)
- Shugart 851 double sided refurbished & tested £275.00(E)
- Mitsubishi M2894-63 double sided switchable hard or soft sectors- BRAND NEW £250.00(E)
- Dual 8" drives with 2 mbyte capacity housed in a smart case with built in power supply! Ideal as exterior drives! £499.00(F)
- End of line purchase scoop! Brand new NEC D2246 8" 85 megabyte of hard disk storage! Full CPU control and industry standard SMD interface. Ultra! High speed transfer and access time leaves the good old ST506 interface standing. In mint condition and comes complete with manual. Only...£299(E)

### THE AMAZING TELEBOX!

Converts your colour monitor into a QUALITY COLOUR TV!!



TV SOUND & VIDEO TUNER!

The TELEBOX consists of an attractive fully cased mains powered unit, containing all electronics ready to plug into a host of video monitors made by manufacturers such as MICROVITEC, ATARI, SANYO, SONY, COMMODORE, PHILIPS, TATUNG, AMSTRAD and many more. The composite video output will also plug directly into most video recorders, allowing reception of TV channels not normally receivable on most television receivers (TELEBOX MB). Push button controls on the front panel allow reception of 8 fully tuneable 'off air' UHF colour television or video channels. TELEBOX MB covers virtually all television frequencies VHF and UHF including the HYPERBAND as used by most cable TV operators. Composite and RGB video outputs are located on the rear panel for direct connection to most makes of monitor. For complete compatibility - even for monitors without sound - an integral 4 watt audio amplifier and low level Hi Fi audio output are provided as standard.

Telebox ST for composite video input monitors £32.95  
 Telebox ST as ST but with integral speaker £36.50  
 Telebox STL as ST with Multiband tuner VHF-UHF-Cable, & hyperband For overseas PAL versions state 5.5 or 6mhz sound specification. £69.95  
 Telebox RGB for analogue RGB monitors (15kHz) £69.95  
 Shipping code on all Teleboxes is (B)

RGB Telebox also suitable for IBM multisync monitors with RGB analog and composite sync. Overseas versions VHF & UHF call. SECAM/NTSC not available.

### No Break Uninterruptable PSU's

Brand new and boxed 230 volts uninterruptable power supplies from **Densel**. Model MUK 0565-AUAF is 0.5 kva and MUD 1085-AHBH is 1 kva. Both have sealed lead acid batteries. MUK are internal, MUD has them in a matching case. Times from interrupt are 5 and 15 minutes respectively. Complete with full operation manuals.....MUK.....£249 (F) MUD.....£525 (G)

### 286 AT - PC286



- 640k RAM expandable with standard SIMMS
- 12 Mhz Landmark speed
- 20 meg hard disk
- 1.2 meg 5-1/4" floppy
- 1.4 meg 3-1/2" floppy
- EGA driver on board
- 2 serial & 1 parallel ports
- MS-DOS 4.01
- Co-processor socket
- Enhanced 102 key keyboard
- Clock & calendar with battery back up

BRAND NEW AND BOXED!

Only **£249.00** (F)

The Philips 9CM073 is suggested for the PC286 and the CM8873 for the PC386. Either may use the SVGA MTS-9600 if a suitable card is installed. We can fit this at a cost of £49.00 for the PC286 and £39.00 for the PC386.

### POWER SUPPLIES

- Power One SPL200-5200P 200 watt (250 w peak). Semi open frame giving +5v 35a, -5v 1.5a, +12v 4a (8a peak), -12v 1.5a, +24v 4a (6a peak). All outputs fully regulated with over voltage protection on the +5v output. AC input selectable for 110/240 vac. Dims: 13" x 5" x 2.5". Fully guaranteed RFE. £85.00 (B)
- Power One SPL130. 130 watts. Selectable for 12v (4A) or 24v (2A). 5v @ 20A. ±12v @ 1.5A. Switch mode. New. £59.95(B)
- Astec AC-8151 40 watts. Switch mode. +5v @ 2.5a. +12v @ 2a. -12v @ 0.1a. 6-1/4" x 4" x 1-3/4". New £22.95(B)
- Greendale RA80E 60 watts switch mode. +5v @ 6a. ±12v @ 1a. +15v @ 1a. RFE and fully tested. 11 x 20 x 5.5cms. £24.95(C)
- Conver AC130. 130 watt hi-grade VDE spec. Switch mode. +5v @ 15a. -5v @ 1a. ±12v @ 6a. 27 x 12.5 x 6.5cms. New. £49.95(C)
- Boshert 13090. Switch mode. Ideal for drives & system. +5v @ 6a. +12v @ 2.5a. -12v @ 0.5a. -5v @ 0.5a. £29.95(B)
- Farnell G6/40A. Switch mode. 5v @ 40a. Encased £95.00(C)
- Farnell G24/5S. As above but 24v @ 5a. £65.00(C)

### BBC Model B APM Board



£100 CASH FOR THE MOST NOVEL DEMONSTRABLE APPLICATION!

BBC Model B type computer on a board. A major purchase allows us to offer you the PROFESSIONAL version of the BBC computer at a parts only price. Used as a front end graphics system on large networked systems the architecture of the BBC board has so many similarities to the regular BBC model B that we are sure that with a bit of experimentation and ingenuity many useful applications will be found for this board! It is supplied complete with a connector panel which brings all the I/O to 'D' and BNC type connectors - all you have to do is provide +5 and ±12 v DC. The APM consists of a single PCB with most major ic's socketed. The ic's are too numerous to list but include a 6502, RAM and an SAA5050 teletext chip. Three 27128 EPROMS contain the custom operating system on which we have no data. On application of DC power the system boots and provides diagnostic information on the video output. On board DIP switches and jumpers select the ECONET address and enable the four extra EPROM sockets for user software. Appx. dims: main board 13" x 10". I/O board 14" x 3". Supplied tested with circuit diagram, data and competition entry form.

Only **£29.95** or 2 for **£53** (B)

### SPECIAL INTEREST

- Trio 0-18 vdc bench PSU. 30 amps. New £ 470
- Fujitsu M3041 600 LPM band printer £295
- DEC LS/02 CPU board £ 150
- Rhode & Schwarz SBUF TV test transmitter 25-1000mhz. Complete with SBTf2 Modulator £6500
- Calcomp 1036 large drum 3 pen plotter £ 650
- Thurlby LA 160B logic analyser £ 375
- 1.5kw 115v 60hz power source £ 950
- Anton Pillar 400 Hz 3 phase frequency converter 75kw POA
- Newton Derby 400 Hz 70 Kw converter POA
- Nikon PL-2 Projection lens meter/scope £750
- Sekonic SD 150H 18 channel Hybrid recorder £2000
- HP 7580A A1 8 hen high speed drum plotter £1850
- Kenwood DA-3501 CD tester, laser pickup simulator £ 350

### BRAND NEW PRINTERS

- Microline 183. NLQ 17x17 dot matrix. Full width. £139 (D)
- Hyundai HDP-920. NLQ 24x18 dot matrix full width. £149 (D)
- Qume LetterPro 20 daisy. Qume QS-3 Interface. £39.95 (D)
- Centronics 152-2 9 x 7 dot matrix. Full width. £149 (D)
- Centronics 159-4 9 x 7 dot matrix. Serial. 9-1/2" width £ 99 (D)

### 386 AT - PC386



- 2 meg RAM expanded by slots
- 20 Mhz with 32k cache. Expandable to 64k
- 40 meg hard disk
- 1.2 meg 5-1/4" floppy
- VGA card installed
- 2 serial & 1 parallel ports
- MS-DOS 4.01
- Co-processor socket
- Enhanced 102 keyboard
- Kwik Disk Accelerator Software - FREE

BRAND NEW AND BOXED!

Only **£425.00** (F)

### MONITORS

- 14" Forefront Model MTS-9600 SVGA multisync with resolution of 1024 x 768. 0.28 pitch. "Text" switch for word processing etc. Overscan switch included. Ideal for the PC-386 or PC-286 with SVGA card added. Also compatible with BBC, Amiga, Atari (including the monochrome high resolution mode), Archimedes etc. In good used condition (possible minor screen bums). 90 day guarantee. 15" x 14" x 12". Only.....£159(E)
- 14" Philips Model CM8873 VGA multisync with 640 x 480 resolution. CGA, EGA or VGA, digital/analog, switch selectable. Sound with volume control. There is also a special "Text" switch for word processing, spreadsheets and the like. Compatible with IBM PC's, Amiga, Atari (excluding the monochrome high resolution mode), BBC, Archimedes etc. Good used condition (possible minor screen bums) 90 day guarantee. 15" x 14" x 12". Only.....£139(E)
- Philips 9CM073 similar (not identical) to above for EGA/CGA PC and compats. 640 x 350 resolution. With Text switch with amber or green screen selection. 14" x 12" x 13-1/2". £99(E)
- KME 10" high definition colour monitors. Nice tight 0.28" dot pitch for superb clarity and modern styling. Operates from any 15.625 khz sync RGB video source, with RGB analog and composite sync such as Atari, Commodore Amiga, Acorn Archimedes & BBC. Measures only 13.5" x 12" x 11". Also works as quality TV with our HiB Telebox. Good used condition. 90 day guarantee. Only...£125 (E)
- KME as above for PC EGA standard.....£145 (E)
- Brand new Centronic 14" monitor for IBM PC and compatibles at a lower than ever price! Completely CGA equivalent. Hi-res Mitsubishi 0.42 dot pitch giving 669 x 507 pixels. Big 28 Mhz bandwidth. A super monitor in attractive style moulded case. Full 90 day guarantee. Only.....£129 (E)
- NEC CGA 12" IBM-PC compatible. High quality ex-equipment fully tested with a 90 day guarantee. In an attractive tone ribbed grey plastic case measuring 15"L x 13"W x 12"H. The front cosmetic bezel has been removed for contractual £69 (E)

### 20", 22" and 26" AV SPECIALS

Superbly made UK manufacture. PIL all solid state colour monitors, complete with composite video & sound inputs. Attractive teak style case. Perfect for Schools, Shops, Disco, Clubs. In EXCELLENT little used condition with full 90 day guarantee. 20"....£135 22"....£155 26"....£185 (F)

CALL FOR PRICING ON NTSC VERSIONS!  
**Superb Quality 6 foot 40u**

### 19" Rack Cabinets

Massive Reductions  
 Virtually New, Ultra Smart!  
 Less Than Half Price!



Top quality 19" rack cabinets made in UK by Optima Enclosures Ltd. Units feature designer, smoked acrylic lockable front door, full height lockable half louvered back door and removable side panels. Fully adjustable internal fixing struts, ready punched for any configuration of equipment mounting plus ready mounted integral 12 way 13 amp socket switched mains distribution strip make these racks some of the most versatile we have ever sold. Racks may be stacked side by side and therefore require only two side panels or stand singly. Overall dimensions are 77-1/2"H x 32-1/2"D x 22"W. Order as:  
 Rack1 Complete with removable side panels.....£275.00 (G)  
 Rack2 Less side panels.....£145.00 (G)

1992 Winter Issue of *Display News* now available - send large SAE - PACKED with bargains!

**DISPLAY**

MAIL ORDER & OFFICES  
 Open Mon-Fri 9.00-5.30  
 Dept EE, 32 Biggin Way,  
 Upper Norwood,  
 London SE19 3XF.

LONDON SHOP  
 Open Mon-Sat 9-5.30  
 Thursday till 9.00pm  
 215 Whitehorse Lane,  
 South Norwood,  
 London, SE25.

DISTEL © The Original  
 Free dial-up database!  
 1000's of items+info on line  
 V21, V22 & V22 bis  
**081-679-1888**

ALL ENQUIRIES  
**081-679-4414**  
 Fax - 081-679-1927



**-ELECTRONICS-** All prices for UK Mainland. UK customers add 17.5% VAT to TOTAL order amount. Minimum order £10. PO orders from Government, Universities, Schools & Local Authorities welcome-minimum account order £30. Carriage charges (A)=£2.00, (A1)=£3.75, (B)=£5.50, (C)=£8.50, (D)=£11.50, (E)=£14.00, (F)=£18.00, (G)=Call. Scotland surcharge: call. All goods supplied subject to our standard Conditions of Sale and unless otherwise stated guaranteed for 90 days. All guarantees on a return to base basis. Rights reserved to change prices & specifications without prior notice. Orders subject to stock. Quotations willingly given for higher quantities than those stated. Bulk surplus always wanted for cash.

# Techniques

## ACTUALLY DOING IT!

by Robert Penfold

**T**HIS is a piece of advice which has been given in *Everyday With Practical Electronics* many times before, but is one which seems to be more important now than in the past. "Make sure that you can obtain *all* the components for a project before you start buying any of the parts."

Be especially careful if you are building an old design. If a project requires anything that is at all out of the ordinary, it is not a bad idea to obtain the unusual components first, and to progress to the mundane components only when the awkward ones have been obtained.

Difficulties in obtaining components seem to have increased significantly over the last year or so, with a number of components having suddenly disappeared from the market. I have certainly noticed a recent increase in the number of readers letters concerning problems with obtaining components. Some of the problem components are ones which went off the market quite recently, while others have not been available for years but still bring in a steady flow of letters.

### Has Beens

I find it surprising that components which have been available for as long as I can remember can suddenly disappear from the market. It seems to be a fact of modern commercial life that unless something can be manufactured and sold in vast quantities, it is often not worthwhile producing it.

This has led to the demise of several components that seemed to be selling quite well. Unfortunately, the specialist nature of many of these "ex" components means that there is no possibility of using substitute components. In a few cases there are suitable alternatives available, for the time being anyway.

The number of readers' letters received concerning problems with defunct components suggest that it would be well worthwhile mentioning some of the components which are now causing problems. Hopefully, this will deter some constructors from starting projects that can never be finished, and will help others to find alternative components where suitable substitutes are still available.

### Springline Units

As far as I am aware, the last of the springline units were sold last year and they are no longer in production. It seems unlikely that they will become available again unless some surplus units appear.

A reverberation unit based on a c.c.d. device would seem to be the only alternative. This requires a completely different type of circuit though (a c.c.d. reverberation project appeared in the June 1992 issue of *Everyday Electronics*).

### Dual Gate MOSFETS

Popular dual gate MOSFETs of the past such as the MEM616, 40673, 3N140, and 3N141 now seem to be obsolete. Some of the more recent surface-mount types could be used in place of "wired" devices without too much difficulty, but many of these now also seem to be unobtainable. Dual gate MOSFETs appear on the surplus market from time to time, but are often at quite high prices.

The MFE201 from *Circuit* is new stock, quite cheap, and is pin for pin compatible with the 40673, etc. Electrically it is not an exact equivalent to any of the devices mentioned above, but in practice it seems to work well as a substitute for any of them. Apart from surplus devices, it is quite possibly the only dual gate MOSFET currently available to amateur users.

### Bucket Brigades

The Mullard TDA1022 and TDA1097 c.c.d. delay line ("bucket brigade") chips used to be very popular, but despite this the manufacture of both chips was ceased. Readers sometimes enquire about the possibility of using the Hitachi MN30\*\* series of chips in place of the TDA10\*\* devices.

Due to physical and electrical differences there no easy way of achieving such a substitution. However, surplus Mullard "bucket brigade" devices are often available from *Cricklewood Electronics*, who are able to supply many semiconductor devices which have been out of production for some time.

A number of other integrated circuits have gone out of production in recent years. Due to their specialist nature there is little chance of finding a proper substitute for any of these components. Searching for a surplus device is the only course of action which is likely to end in success.

### BC650

The BC650 is a very high gain, very low noise, npn silicon transistor which was very popular about ten to fifteen years ago. Unfortunately, it has been out of production for some time now, and it is unlikely that any BC650s are still available.

As far as I can gather, no true equivalent to this device is currently available. However, using a BC549 seems to give only a marginal reduction in performance in most applications.

A number of transistors that were quite popular in the 1970s now seem to be unobtainable or in short supply. It is worth bearing in mind that for most low power, low frequency applications, a BC549 (nnp) or BC559 (pnp) transistor will provide satisfactory results. More careful substitution is needed if high frequencies, high currents, or high voltages are likely to be involved.

### Denco Coils

The famous Denco Coils have been out of production and unavailable for many years. It is possible to use Toko ready-made coils or home wound coils in place of many Denco coils, and this was covered in a previous *Actually Doing It* article.

However, it is now probably best to seek out modern designs which use readily available components, rather than try to resurrect old designs based on Denco components.

### TIL209/TIL220

When i.e.d.s first appeared they were mainly sold under type numbers, like most other semiconductors. These days they are normally sold as i.e.d.s of certain sizes, shapes, colours, and efficiencies.

The TIL209 and TIL220 are "bog standard" red i.e.d.s having diameters of 3mm and 5mm respectively. Any modern low cost red i.e.d.s of the correct diameters should be suitable replacements for these devices.

### In Stock

I think that it is worth pointing out, yet again, that many readers still complain of difficulties in obtaining components that are readily available. In some cases the problem is simply due to a minor misunderstanding which is easily cleared up. In other cases a source of supply is provided in either the article or the *Shop Talk* feature which is included in every issue of this magazine. Studying the article concerned and the relevant section of the *Shop Talk* feature could save a lot of wasted time and effort!

Many component buying problems seem to be the result of readers not being equipped with a few of the larger component catalogues. With the vast range of components that are currently available, a few large mail order catalogues have to be regarded as an essential part of the hobby. Many of these catalogues are worth the money for the general data and information that they contain. - Not forgetting the ones given *Free* with this magazine from time to time - *Ed*.

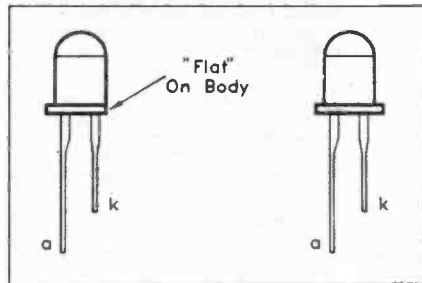

Fig. 1. The polarity of i.e.d.s is normally indicated by a "flat" on the body, and (or) a shorter cathode ("k") lead.

### LED Polarity

Determining the correct polarity of i.e.d.s is a subject which crops up from time to time. In the past, most i.e.d.s have had the polarity indicated by a "flat" on the body of the component next to the cathode ("k") terminal. Additionally, the cathode leadout wire is usually shorter than the anode leadout.

Wiring diagrams in magazines and books often indicate the polarity of i.e.d.s by showing the flat on the cathode side of the body. However, many real i.e.d.s now seem to lack the flat on the body, but many still have the shorter cathode leadout wire (Fig.1).

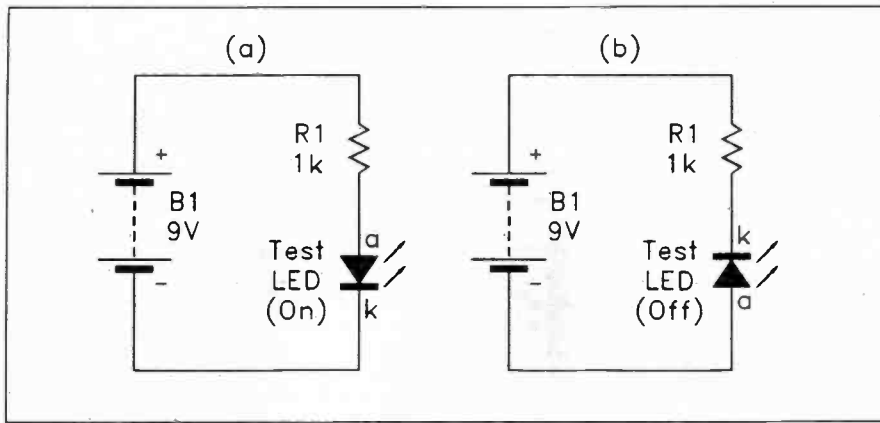

Fig. 2. A simple method of testing I.e.d. polarity.

In fact all the I.e.d.s I have bought in the last year or two have lacked the flat. Looking on the bright side, one advantage is that these I.e.d.s fit into some types of panel holder much more reliably than those which have the flat.

Rather unhelpfully, some I.e.d.s seem to lack both the flat and the shorter cathode leadout wire! It is only fair to point out that a few I.e.d.s having the anode lead as the shorter one have been produced. Consequently, it is not 100 per cent safe to assume that the shorter lead is the cathode terminal.

The only certain way of determining the polarity of a I.e.d. is to connect it into a simple test circuit. I generally use the circuit of Fig.2 which can be quickly breadboarded, or put together with the aid of a couple of crocodile clip leads. The I.e.d. lights up if it has the polarity shown in Fig.2(a), or remains off if it has the polarity shown in Fig.2(b).

An analogue multimeter set to a low ohms range (about 500 $\Omega$  mid-scale) can also be used to check the polarity of I.e.d.s. When the I.e.d. lights up, its cathode is connected to the positive test prod. When

it fails to switch on, the cathode is connected to the negative test prod.

A digital multimeter can also be used, but if it has high and low test voltage settings it must be set to the "low" position. Modern digital multimeters seem to use low test currents, so even using the lowest resistance range the I.e.d. might not light up very brightly. Note that with a digital multimeter the cathode is connected to the negative test prod when the I.e.d. lights up, and to the positive test prod when the I.e.d. fails to switch on.

I give all newly received I.e.d.s a quick check of this type to ensure that they are working properly, and that the polarity is as I think it is. Where the leadouts are the same length it is a good idea to determine the polarity of the I.e.d., and then trim the cathode leadout slightly so that the polarity is obvious when it is time to connect the device into a circuit.

If a I.e.d. should be connected into circuit the wrong way round, it is highly unlikely that it will sustain any damage. Consequently, if a project has only one or two I.e.d.s, the correct method of connection can, if necessary, be found by trial and error. With projects that contain numerous I.e.d.s this is not a practical proposition, and it is then essential to determine the polarity of the I.e.d.s before starting to wire them into circuit.

## READOUT

### MINI DILEMMA

Dear Ed.,

Examining notes on your *Micro Lab* project, I have noticed a frequent reference to another project i.e. *Mini Lab* described in Feb. '92 issue, however there is no circuit diagram hence it's difficult to understand its usefulness in connection with *Micro Lab* (the 5V/1A supply can be provided by any other means).

However the 34 way ribbon cable used between both units makes me think that there are some other uses of *Mini Lab* not so obvious without the above mentioned circuit diagram.

Could you perhaps kindly advise.

E. du Puget  
Oadby

Thank you for your letter concerning the *Teach-In Mini and Micro Labs*. We hope we can clarify the position for you.

The *Teach-In* tutorial series lasts for twelve months and is designed to support those undertaking GCSE and GCE "A" Level Electronics studies. Additionally we have tried to frame the material such that it would have broad appeal to regular readers too. In order to demonstrate the basic principles of micro-electronics, we designed a special tutorial unit - the *Teach-In Mini Lab*.

This is a large printed circuit board roughly the size of a page of *EPE Magazine*. It is modular in nature, where one section of the p.c.b. is assembled every month to form a handy piece of test equipment relevant to that month's material.

The immensely popular *Mini Lab* has without a doubt captured the imagination of the beginner in electronics and is the ideal learning centre, to be used in conjunction with the experiments carefully

detailed in our *Teach-In* series. A photo of the *Mini Lab* appears in the *Magenta* advertisement, who incidentally retail a full kit of parts for both *Labs*.

Because the *Mini Lab* consists of many sections, each connected to a versatile power supply, it's not possible to reproduce the individual circuit of the *Mini Lab* as such, but it should still be possible to obtain the relevant back-numbers starting with Part 1 back in November 1992.

(Unfortunately we have sold out of Dec. '92, Jan and Feb '93 issues but we can provide photostats of the relevant parts for the same price as back numbers - see page 565 for ordering details. Ed.)

After completion, the *Mini Lab* forms a great test bed for demonstrating and testing electronic circuits, especially as it incorporates a breadboard, simple voltmeter, fixed and variable power supply, signal generator, logic probe, audio amplifier and radio tuner amongst other useful items - everything you need for project development!

In order to demonstrate the function of the microprocessor, a separate *Micro Lab* has been designed for more advanced readers. We soon saw though that the *Micro Lab* would not only demonstrate m.p.u.'s but could also act as a stand-alone unit which could be programmed to function as a dedicated m.p.u. controller.

Hence, the *Micro Lab* can be powered either from a *Mini Lab* (which incorporates a 5V and 12V supply) where the supply voltage is fed through the ribbon cable; alternatively, experienced readers who are seeking a dedicated stand-alone flexible microprocessor controller for a particular task, would not need the *Mini Lab* (which includes many features that may not be relevant in many microprocessor applications) and so we included a separate 5V terminal also.

However, the *Mini and Micro Lab* systems can combine together via the ribbon cable to form an extremely versatile microprocessor demonstration and applications unit. If you are interested in

actually learning about and demonstrating microprocessors then the idea is to use the *Micro Lab* in conjunction with the *Mini Lab*.

The reason you might need both *Labs* is that the *Mini Lab* includes several input/output peripheral devices (e.g. the breadboard, potentiometers, switches etc.) as well as useful modules like the *Audio Amplifier*, and these will be hooked up via the ribbon cable to the *Micro Lab* for use in certain demonstrations. Most of the microprocessor input/output information is accessible via the 34 way ribbon cable, apart from separate D/A and A/D signals which are carried through the 4-way screw terminal block. The I.c.d. display shows alphanumeric data too.

To summarise, our *Teach-In* series can help you as follows:-

- If you are a beginner in electronics (apologies if you aren't), consider the *Mini Lab* only, in order to gain a basic foundation. The *Micro Lab* is not really suitable for assembly by beginners.
- If you have a little experience of microprocessors and would like to see how they operate, you will need both the *Mini and Micro Labs* if you are to benefit from the series fully.
- If you are already familiar with microprocessors (especially the 6502) and would like a versatile 8-bit m.p.u. controller, build the *Micro Lab* on its own, in which case you will need a separate 5V power supply.

Please note, the *Micro Lab* is a finely-detailed p.c.b. and it is necessary to be able to use a fine-tipped soldering iron skilfully. Other than that, expect the *Micro Lab* to work first time if it is soldered neatly - our own models did!

We hope this will help and encourage you to join all our regular readers around the world who enjoy following *Teach-In*.

Best wishes for your success.

Alan Winstanley and Keith Dye  
- *Teach-In '93* Team  
Micro Lab Software Author:  
Geoff MacDonald

# Home Base

Jottings of an electronics hobbyist—Terry Pinnell

## To Catch a Mouse

"We've definitely got mice," said my friend Annie. "They're getting into the pantry somehow. But even if I could bring myself to do it, there's no way the kids will let me use poison or a mousetrap."

It was a Sunday lunchtime and we were sitting at a table in the sun outside the local pub.

"Maybe I could make you an electronic mousetrap," I said, looking up from my newspaper, always alert for a chance to slip into my Eccentric Inventor role.

Oblivious to the tolerant smiles exchanged between the others around the table, my mind was already on the grand design as I reached for my pint. Making a device which would allow overnight capture and morning release would not really be all that complex, but I thought I might stretch it out to a few days if I worked at it.

Although it went against the grain, I did even fleetingly consider an idea that wouldn't actually need any electronics. Suitably lured onto the top of a box, the unsuspecting mouse would step onto a piece of tissue paper or cloth covering a hole, fall through and be unable to climb out. (I probably got the idea as a kid watching Tarzan movies, in which they always seemed to be digging holes in the jungle – to trap man-eating tigers or Tarzan, I don't exactly remember). However, I decided it was most unlikely that a mouse with the minimal survival skills that had got it this far would be stupid enough to fall for (or fall through) such an obvious ambush.

No, it was clear that what I would need was an open box, into which I would lure the unwanted rodent, then trap it. But how to persuade it to venture inside?

## Attraction

Focussing now on an all-electronic design, I first consulted the Sound Effects section of my ageing Circuit References Binder, but this yielded no Rodent Attractors or such-like. The closest was a Fish Caller in a late '70s magazine – a multivibrator in a watertight jar – but I dismissed that as unpromising for my more discriminating mammal target. Anyway, why look further than the traditional piece of cheese?

Needless to say my mousetrap had to be electrically operated – a merely mechanical contrivance was not an option for an electronics hobbyist. Battery operation was another obvious criterion; mains sockets aren't usually sited with mouse catching in mind, and the idea of an extension reel was abandoned quickly.

It was clear that I would need a door of some sort which would close when the mouse was about to start its one course meal, remaining shut until its merciful release by A Kind Human some time later, presumably the following morning. So the first interesting design questions were: what sort of door and how to close it?

A vertical freely-sliding type was the obvious choice, given that it had to close quickly. Our small guest was unlikely to linger over the

cheddar, watching with interest as a hinged type slowly closed in conventional manner. I decided to use a piece of thin hardboard suspended at the sides in grooves, so that when suitably released it would fall quickly downwards.

## Sting in the Tail

This prompted some rough calculations as to how long the box should be. I did not want news of successful capture to be marred by hearing that the mouse's nether extremity had been amputated – a sting in the tail as it were. Unsure as to the upper size bounds of the local mouse populace, I was inclined to be generous. After all, I could limit its width to discourage larger nocturnal prowlers like cats or the occasional hedgehog. The box eventually built was about 35cm long.

The next question was how to contrive the door's release. I decided in favour of a small strip of wood glued to its inner side and resting on a sliding rod of some kind. It would have to allow for the trapdoor to be raised again of course, so this 'ledge' was bevelled as shown in Fig. 1.

For withdrawing the rod so that the trapdoor could fall, a solenoid was my first thought. But I knew that the only ones I had were specified as 24V types. So for a while I experimented with a small d.c. motor, winding a length of nylon line around its spindle so that on powering the motor the line would pull in the rod. However, the snag was that the rod needed to be returned to its holding position.

A light spring was not strong enough to pull it back against the motor's resistance, and a stronger spring would have prevented the rod pulling inwards. Anyway, I decided that this approach was basically inelegant and fault-prone, so abandoned it.

I then experimented with one of my surplus solenoids and found that satisfactory operation could be obtained using an 18V supply made from two 9V batteries, despite the

24V specification. This depended on ensuring that friction between the solenoid's rod and the wooden catch was minimised by careful smoothing, and avoiding too heavy a trapdoor.

## Triggering

Then I turned to the method of triggering the solenoid. To minimise current consumption it should only be held in long enough to fully release the trapdoor. This indicated that a monostable would probably be needed. Also, it should only be triggered once; further operation once the door was shut would be redundant and waste power. This indicated using a bistable as well as the monostable.

Triggering should occur when the mouse was fully inside, so that its tail would not be under the falling door. This meant positioning whatever switch was chosen well inside the box and ensuring reliable triggering.

Simplicity and reliability were the main reasons I selected a microswitch as the method of activation. I did briefly consider an interrupted light beam, but widely varying ambient light levels would add complexity and encourage spurious triggering.

## Micifarads

One other option was a proximity switch, which I considered because it could be made relatively unobtrusive. I had in mind something similar to the circuit I'd built into lamps around the house. When you touch or come very close to the antenna of one of these, a piece of metal or metal foil, it is triggered by capacitive attenuation to ground of an h.f. oscillator (around 100kHz). So a small piece of aluminium cooking foil covered with some cloth could possibly activate the solenoid driver circuit.

However, although I was familiar with the sensitivity of this circuit to human proximity, I was by no means sure how it would perform with a mouse. What is the capacitance of mice anyway? (In Micifarads of course.)

Anyway, such a high-tech trigger circuit would have needed continuous current, limiting useful battery life. It was better to go for a circuit with negligible standby current.

So as seen in Fig. 1 I arranged a microswitch with its lever in such a way that when the mouse was on the hinged base section it would close the contacts.

Perhaps next month I'll cover the simple electronic circuit and describe its exciting inauguration in my friend's pantry.

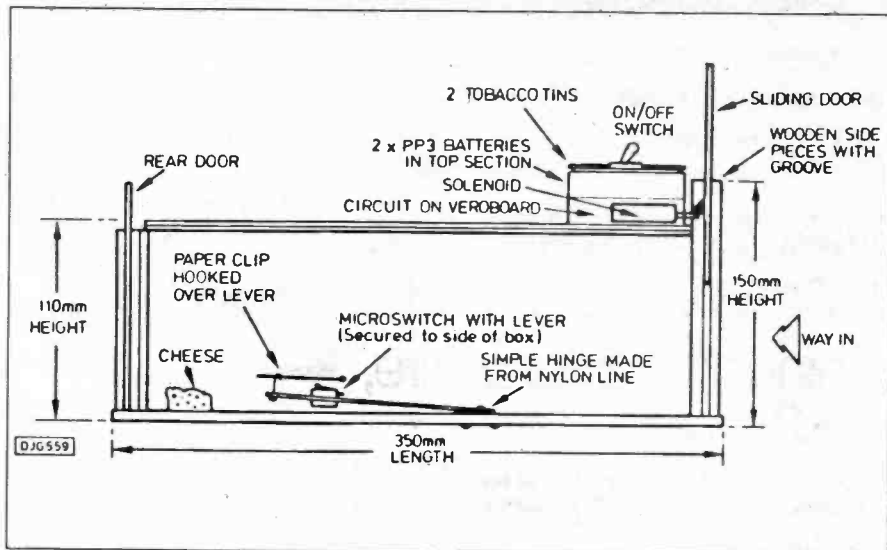

Fig. 1. Basic construction of the electronic mousetrap.



# MAURITRON TECHNICAL PUBLICATIONS

*A selection from our range of Technical Books and Guides for the TV & Video Trade*

TELEVISION EQUIVALENTS.	<i>New Book lists Exact Equivalent for Many different Makes.</i>	Order MP-150. £5.00
TELEVISION CHASSIS GUIDE.	<i>Identify your TV chassis from the model number.</i>	Order MP-18. £5.00
VIDEO RECORDER & CAMCORDER EQUIVALENTS.		Makes A - J. Order MP-217. £5.00
	<i>Lists all known models and their Equivalents. New 2 Volume Set.</i>	Makes K - Z. Order MP-218. £5.00
VIDEO RECORDER FAULTS	<i>Repair Guide for Beginners. Know where to start looking!</i>	Order MP-5. £3.00
VHS VIDEO RECORDER PRINCIPLES	<i>Essential Theory on the Principles of operation of VHS</i>	Order MP-58. £3.00
CMOS DATABOOK	<i>Detailed Specification on the 4000 Series with circuits.</i>	Order MP-10. £5.00
TTL DATABOOK.	<i>Detailed Specification on the 7400 Series with circuits.</i>	Order MP-34. £5.00
TRANSISTOR EQUIVALENTS AND TESTING MANUAL.	<i>Includes Testing Procedure.</i>	Order MP-24. £3.00
POWER SUPPLIES, STABILISERS & VOLTAGE REGULATORS.	<i>Includes Circuits</i>	Order MP-9. £3.00
REMOTE CONTROL CIRCUITS - TV.	<i>Dozens of Remote Control Circuits for Colour TV's.</i>	Order MP-167. £10.00
MANUFACTURERS EQUIVALENTS.	<i>Know which Makers Trade Names are the Same.</i>	Order MP-220. £3.00
VIDEO HEAD CLEANING KIT.	<i>Unique Kit with Comprehensive Instructions on how to do it right.</i>	Order VHCK. £4.00
VIDEO TEST JIG.	<i>Run the machine and gain access to the mechanics as well.</i>	Order VTJ. £15.00
SCART EUROCONNECTOR SYSTEM.	<i>Detailed Pinout Specifications of this interface.</i>	Order MP-21. £3.00
SWITCH MODE PSU IC TYPE TDA-4600.	<i>Comprehensive Details of this popular TV PSU IC.</i>	Order MP-37. £6.00
TELETEXT REPAIR MANUAL.	<i>Covers the SAA range as used in many Sets.</i>	Order MP-38. £6.00
P.C. HARD DISC DRIVE REFERENCE MANUAL.	<i>Specifications of Hundreds of Hard Discs.</i>	Order MP-84. £5.00
CITIZENS BAND RADIO CIRCUITS MANUAL.	<i>Covers Dozens of popular models.</i>	Order MP-40. £10.00
RECORD PLAYER SPEED DISC.	<i>Lets you accurately align any turntable speed.</i>	Order MP-8. £1.00
CITIZENS BAND RADIO DATA REFERENCE BOOK.	<i>Technical Specifications of C.B. IC's.</i>	Order MP-165. £5.00
TELEPHONE CODE LOCATION GUIDE.	<i>Find the Town from the Phone Code.</i>	Order MP-19. £5.00
VALVE AMPLIFIERS CONSTRUCTION MANUAL.	<i>Full Building Details for Vintage Buffs.</i>	Order MP-173. £5.00
VINTAGE WIRELESS SERVICING.	<i>2 Volume set covers Vintage Servicing in detail.</i>	Order MP-22+35. £6.00
OFFICE EQUIPMENT EQUIVALENTS.	<i>Complete Cross Reference for all Photocopier or Fax.</i>	Order MP-200. £6.00
REEL TO REEL TAPE RECORDER SERVICING.	<i>Details on Reel Servicing for Collectors.</i>	Order MP-201. £5.00

## SERVICE MANUALS

WE HAVE THE MOST COMPREHENSIVE LIBRARY OF SERVICE MANUALS AVAILABLE ANYWHERE  
From the Earliest Valve Wireless to the Latest Video Recorder. Originals or Photostats as available.

Colour Televisions, Video Recorders, Test Gear, Audio, Computers, in fact practically anything.

If you need a Service Manual, Give us a call.

### MAURITRON PUBLICATIONS (TV)

8 Cherry Tree Road,  
Chinnor, Oxfordshire,  
OX9 4QY



Phone your Credit Card Order  
for Immediate Despatch



Access, Visa, Mastercard, Eurocard, Connect.

Tel:- (0844) 351694

Fax:- (0844) 352554

*Further Titles detailed in our FREE Catalogue. Send A5 S.A.E for your copy TODAY!*

# CIRCUIT SURGERY

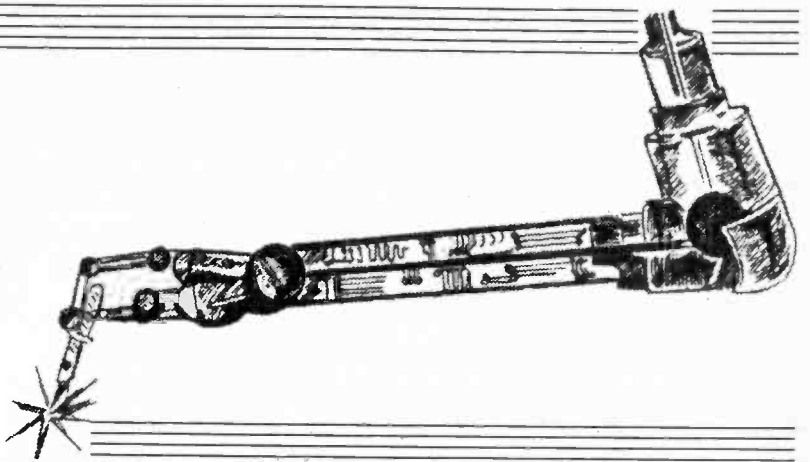

MIKE TOOLEY B.A.

Welcome once again to Circuit Surgery, our regular clinic devoted to readers' problems. This month we return to the world of digital electronics and some interesting and useful circuits. We begin with a fairly common logic problem. . .

## No coincidence?

D. Salmon from Benfleet, Essex, writes: "Logic gates like AND and NAND provide an output whenever both inputs are the same, either both 0 or both 1. I need a circuit which will operate an audible alarm when two input signals (both standard TTL levels) are different (i.e., 0 and 1 together or 1 and 0 together). There doesn't seem to be a standard logic gate that provides this function - can you help?"

Well, Mr Salmon, there is a standard TTL logic gate that provides this 'anti-

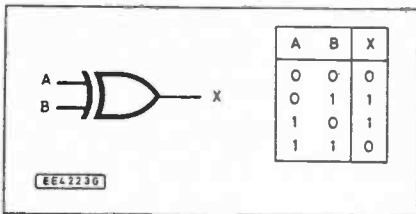

Fig. 1. Symbol and truth table for an exclusive-OR gate.

'coincidence' function. You actually need an exclusive-OR gate, the truth table and ANSI logic symbol of which is shown in Fig. 1. A standard 74LS86 TTL chip provides four exclusive-OR gates and can be used, together with an external transistor along the lines shown in Fig. 2, to provide an audible warning whenever the two logic states differ. The audible transducer can be any piezoelectric sounder.

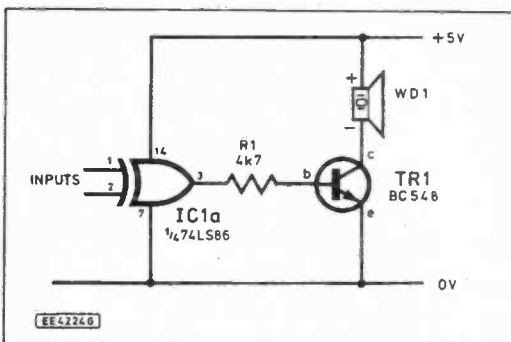

Fig. 2. Complete anti-coincidence alarm circuit.

Fig. 3 (right). Simple pulse generator with individually adjustable "mark" and "space" times.

## Simple Pulse Generator

Regular reader, Matthew Hume, is looking for a simple variable duty-cycle pulse generator. Matthew writes:

"I have used the 555 timer as a source of square wave pulses but I wonder if there is any way in which I can vary the duty cycle over, say a 10:1 range?"

The 555 must surely be one of the most useful and versatile chips ever invented and, yes, there is a way to vary the duty-cycle using two variable resistors and a couple of diodes, as shown in Fig. 3. VR1 adjusts the "mark" time whilst VR2 sets the "space" time. It is, however, worth noting that the output pulse repetition frequency (p.r.f.) depends on the setting of both controls.

The value specified for C1 will produce a p.r.f. of between 1.4kHz (VR1 and VR2 both set to maximum) and 66kHz (VR1 and VR2 both set to minimum). C1 can be scaled up or down to provide different p.r.f.'s alternatively decade-values could be selected by means of a simple rotary switch (e.g., 10μ, 1μ, 100n) to produce outputs over the entire range from 14Hz to 66kHz.

It is also worth pointing out that the circuit in Fig. 3 will produce a reasonable square wave output whenever both controls have identical settings (assuming that they both obey a similar law).

## RAM equivalents

Several readers have asked me to provide data on semiconductor memories and,

## COMPONENTS

### Resistors

R1, R2 1k (2 off)  
R3 10  
All 0.25W ±5%

### Potentiometers

VR1, VR2 47k linear carbon (2 off)

### Capacitors

C1 10n (see text)  
C2, C3 100n polyester (2 off)  
C4 10μ radial elect. 35V

### Semiconductors

D1, D2 1N4148 diode (2 off)  
IC1 555 timer

### Miscellaneous

SK1 50 ohm panel mounting BNC socket  
S1 S.P.S.T. or s.p.d.t. miniature toggle switch

Battery holder (to accept 9V battery); knobs (two required); 8-pin low-profile d.i.l. socket; small metal or ABS enclosure (approx. 140mm x 80mm x 45mm); small piece of matrix board (approx. 75mm x 60mm); terminal pins (as required).

Approx cost guidance only

£8

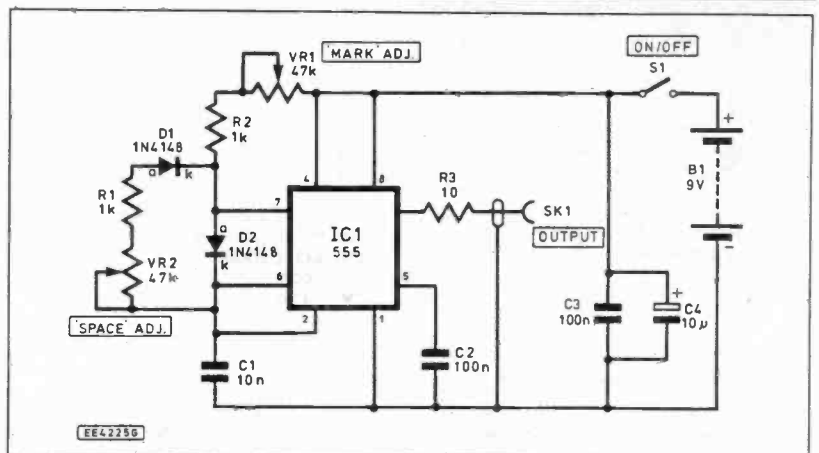

in particular, to recommend equivalent devices. It is important to note that RAM devices are supplied with particular access times. Devices with different access times should not be mixed. Furthermore, access times must be selected correctly to match the speed and timing characteristics of the equipment in which the RAM is to be used. In this respect, devices with very fast access times might be just as unsatisfactory as those with very slow access times.

The following data refers to two of the most popular d.i.l. encapsulated RAM types:

Type	Near equivalents
64K x 1bit	9064/8264/4164/4264/4564
256K x 1bit	4256/6256/41256/37256/50256

## Play it again SAM!

Whilst on the subject of RAM, I was interested to see that Texas Instruments (TI) has just announced the first 4Mbit RAM device. This clever chip integrates a 256K x 16 bit dynamic RAM array and a 256 x 16 bit serial access memory (SAM). The chip is

supplied in a 64-pin package and volume production should be well under way by the time you read this. Doubtless it won't be too long before we see 8, 16 and 32Mbit devices appearing!

## What's in a name?

Andrew Pennington writes from West Sussex with a query concerning the type numbers of TTL logic devices.

"I have some integrated circuits marked '74ALS...', '74LS...', '74C...', etc. Can you explain the meaning of the letters and also the significance of the final letter 'N'?"

Thanks, Andrew for this useful question. To put the record straight, the major 74-TTL sub-families are as follows:

Device Type	Sub-family
AC	Advanced CMOS technology (improved CMOS device)
LS	Low-power Schottky (the 'standard')
ALS	Advanced low-power Schottky (improved LS device)
C	CMOS (CMOS version of the TTL gate)

HC	High-speed CMOS technology
HCT	High-power CMOS (LS replacement)
F	Fast (high-speed TTL replacement)
BCT	BiCMOS technology (high-speed, low-power)
LVT	Low voltage technology (3.3V supply)

The letter 'N' simply denotes the dual-inline version of the device (i.e., the chip is supplied in a standard d.i.l. package). Actually, I have never understood why the 'N' is included in the package marking. After all, isn't the package style obvious?

**Next month:** We describe a versatile power amplifier which can be configured for single-ended and bridge operation. In the meantime, if you have any comments or suggestions for inclusion in *Circuit Surgery*, please drop me a line at: Faculty of Technology, Brooklands College, Heath Road, Weybridge, Surrey, KT13 8TT. Please note that I cannot undertake to reply to individual queries from readers however I will do my best to answer all questions from readers through the medium of this column.



with David Barrington

## Experimental Electronic Pipe Descaler

All components required to build the *Experimental Electronic Pipe Descaler* are standard "off-the-shelf" items and should be available locally. Even the one per cent polystyrene capacitor should be generally available.

If you change the value of resistor R8 to run the unit at a higher output current you are advised to increase the wattage rating for safety. Talking of safety, you must be careful when handling the circuit board as mains voltages are present on the track pads linking up with the mains transformer primary winding leads.

The printed circuit board for the pipe descaler is available from the *EPE PCB Service*, code 839.

## Bike Odometer

A couple of items called for in the *Bike Odometer* will need particular attention when ordering parts for this project. The "two-in-one" pushbutton Reset switch, for instance, was ordered from Electromail (☎ 0536 204555), code 332-830. Other non-locking types can be used provided the contact sets are identical.

The 0.56in. common cathode displays (type HDSP 5303), used in the prototype, were also ordered from the above company. Most of our regular advertisers will be able to offer suitable devices at very competitive prices.

Seven-segment, 0.5in. high displays can be used without board changes but the body length of these is slightly greater than those of the 0.56in. types, being 19mm instead of 17mm. The width and pin spacings are identical and there is no reason why 0.5in. displays cannot be used in place of those specified in the parts list.

Some constructors may prefer to use low-current, high-intensity displays; 0.5in. and 0.6in. types are available with compatible pin spacings, for example, the HDSP-E103 in 0.5in. or the HDSP-H103 on 0.56in. but these are of course more expensive than the ordinary types. Most advertisers list comparable types.

Roller-lever microswitches are fairly widely available, avoid devices which have a primitive hinge arrangement for the lever mechanism - check before purchasing. Likewise, the Terry clips will, of course, have to be chosen to suit the dimensions of the particular bike structure.

The two small printed circuit boards (Divider-836 and Display 837) are available as a pair from the *EPE PCB Service*. See page 627.

## Cupboard Guard

For some reason the "micropower" op.amp. type ICL7611, called for in the Cupboard Guard project does not appear in many catalogues. However, it does seem to be appearing on more retailers shelves and is certainly listed by Cricklewood (☎ 081 452 0167). The ORP12 light dependent resistor is another device which seldom appears on retailers lists, but they can usually offer it, or an equivalent, from their current stocks.

The piezoelectric warning device used in the prototype is the "High Power buzzer" from Maplin, code FK84F. Other types may certainly be used in this circuit, but bear in mind that the Darlington transistor collector current should not exceed 300mA. Also, sounders which require external drive circuitry are NOT suitable and this point should be checked when ordering.

Finally, if the "Guard" is used to signal that a young child has tampered with the medicine cabinet, it must not be used in isolation. All the usual "safety code" procedures must be followed at all times.

## Amstrad PCW 8-Channel A/D Converter

The only listings we have come across for the BAT85 Schottky diode used in the *Amstrad PCW 8-Channel A/D Converter* is from Electromail, code 300-978. Any readers finding it difficult to source the AD7828 high speed 8-bit analogue-to-digital chip will find it is also listed by the above company under order code 635-482. This CMOS device is not cheap, around the £20 mark, so take special care when handling it.

When ordering the LF356N i.c., make sure you emphasise the letter *N* as this designates the d.i.l. package version. Most of the "computer connectors" are standard times now and should be readily available.

The double-sided printed circuit board for the Amstrad A/D Converter is obtainable from the *EPE PCB Service*, code 838.

## Tri-State Thermometer

The miniature bead thermistor used in the *Tri-State Thermometer* is one from the more popular temperature range types and should

be generally stocked. The tri-colour, common cathode i.e.d. now appears in most component suppliers catalogues and should also be readily available.

The LM393 dual comparator i.c. may be a little difficult to track down locally, but it is currently on the Maplin, Cricklewood, Greenwell and Cirkit lists.

The fibreglass insulation wadding will have to be purchased from your local DIY store and the auto connectors and wire will mean a trip to a local garage or motorspares shop.

## Teach-In '93 (Micro Lab)

Those readers who have been following the *Teach-In '93* series and undertaking the "practical experiments" have now reached the micro-processor stage and will, no doubt, have been highly impressed by the quality of the back-up *Micro Lab* project described last month. Although the price tag may, at first, seem high, when compared against a commercial counterpart it stands up very favourably and is excellent value.

There is one small but worthwhile update to the design, the battery life of the SRAM supply can be substantially improved with the following modification: To place the SRAM in minimum power consumption mode the CS pin 20 must be within 0.2 volts of the battery voltage on pin 28. To ensure that this happens an additional pull up resistor of 15k is recommended to be fitted between pin 20 and pin 28 of IC3. This can be soldered onto the back of the printed circuit board, attaching the resistor directly to the pins. Place some insulation onto the resistor leads to ensure they do not touch any other pins of IC3.

Two companies have agreed to produce complete kits for the *Micro Lab* and are selling these for £149.95 per kit; which in view of the complexity of the project seems a very reasonable price. The two companies are: Greenwell Electronic Components, 27D Park Road, Southampton, Hants SO1 3TB and Magenta Electronics, 135 Hunter Street, Burton-on-Trent, Staffs DE14 2ST. A ready built, inspected and tested version, with full back-up service, is also being offered by Magenta for the sum of £179.95.

Both the specially-programmed EPROM and PAL device are produced solely by Dytronics and are supplied with the *Micro Lab* p.c.b., from the *EPE PCB Service*. The "Micro Lab User Manual" is also supplied with the board, and contains useful information.

## PLEASE TAKE NOTE

### Barcode Battler (July 1993)

In last month's review on the latest handheld game entitled Barcode Battler, we gave a Tomy "Customer Careline" phone number.

The Tomy Customer Careline number has changed, and is now ☎ 0703 872 267.

# CUPBOARD GUARD

T.R. de VAUX-BALBIRNIE

Audible protection for cupboards, drawers and filing cabinets.



**A** LOUD tone a few seconds after a door has been opened is provided by the Cupboard Guard. One possible application for this is to signal that a child has opened a "prohibited" drawer or cupboard. Another use is to provide a warning when a filing cabinet, desk drawer, drinks cupboard, etc. has been opened without permission.

Since the unit is very small, self-contained and battery-operated, it may be moved from place to place as the need arises. In use, Cupboard Guard is simply placed inside the drawer or cupboard to be protected and switched on. Carrying cases and bags may also be monitored providing they are dark inside when closed.

The on-off switch may be key-operated to prevent an unauthorised person from switching off the warning but for low-security everyday applications an ordinary switch may be used as in the prototype unit (see photograph).

## OPERATING TIME

While switched on in standby mode, the current requirement is less than  $10\mu\text{A}$  ( $6\mu\text{A}$  approximately in the prototype unit). This may be regarded as negligible and the internal battery will provide many months of service providing the device is not called upon to sound very often.

The delay time (that is, the time elapsing between opening the door and the alarm sounding) is adjustable between limits of two and 20 seconds approximately and this will be set for best effect at the end of construction. This time will be a compromise between being sufficient for legitimate access yet short enough to provide a timely warning.

**Important Note:** If this circuit is used to signal that a child has opened a medicine cabinet or similar application, it must not be used in isolation. All other safety procedures must be followed and the Cupboard Guard used only as additional "last resort" protection. Also, for any such serious application, the loudness of the sounding device must be checked to ensure that it is sufficient.

The Guard operates by sensing light levels. While a door remains closed there will be little light inside the cupboard. When opened, the light level will rise and it is this change which operates the alarm. In cases where there is no such change – or only a small one – this circuit is unsuitable. Note that fairly dim room lighting is sufficient to trigger the device.

## CIRCUIT DESCRIPTION

The complete circuit diagram for the Cupboard Guard is shown in Fig. 1.

The principle component is the micro-power op-amp, IC1. This has been specially chosen for its extremely low quiescent current requirement. This is important because the unit draws current all the time it is switched on and so imposes a drain on the battery.

The op-amp IC1 is used in *comparator mode* and operated without feedback. Thus, if the voltage applied to pin 3 (the non-inverting or + input) exceeds that at pin 2 (the inverting or - input), the output at pin 6 will be *high* (positive battery voltage). In other cases it will be *low* – that is, switched off.

The voltage applied to the non-inverting input pin 3 is set to a value which depends on the adjustment of preset potentiometer, VR1. This operates in conjunction with fixed resistor, R1, to provide a voltage lying between 0V and 4.5V approximately.

The voltage applied to the inverting input pin 2 is derived from the potential divider consisting of fixed resistor R2, in the upper section, in conjunction with the light dependent resistor (LDR), R3, and fixed resistor R4 in the lower one. With the light-dependent resistor dimly illuminated, its resistance is very high but when extra light shines on it, as when a cupboard or drawer is opened, its resistance becomes much lower.

The effect of this is that the voltage applied to IC1 pin 2 will be high with the door closed and low with it open. With preset VR1 suitably adjusted and with the cupboard door closed, the voltage at pin 2 will exceed that at pin 3 so the output will be off.

Under *light* conditions (cupboard open), the conditions are reversed and the voltage at pin 3 now exceeds that at pin 2. The op-amp switches on and the output goes high.

Current now flows into the base of Darlington transistor, TR1, through preset potentiometer, VR2 (connected as a variable resistor), fixed resistor R5, and diode, D1. The transistor is thus turned on and collector current flows through the audible warning device, WD1. The purpose of capacitor C1 and fixed resistor R6 will be explained presently.

## SOUND-OFF

The specified audible warning device was loud enough to be heard throughout a medium-sized room. However, as stated previously, the sounder should be chosen according to the application. Using a more powerful one will probably necessitate using a larger box so this must be borne in mind when ordering components. A pulse-tone may be found more effective in

Fig. 1. Full circuit diagram for the Cupboard Guard.

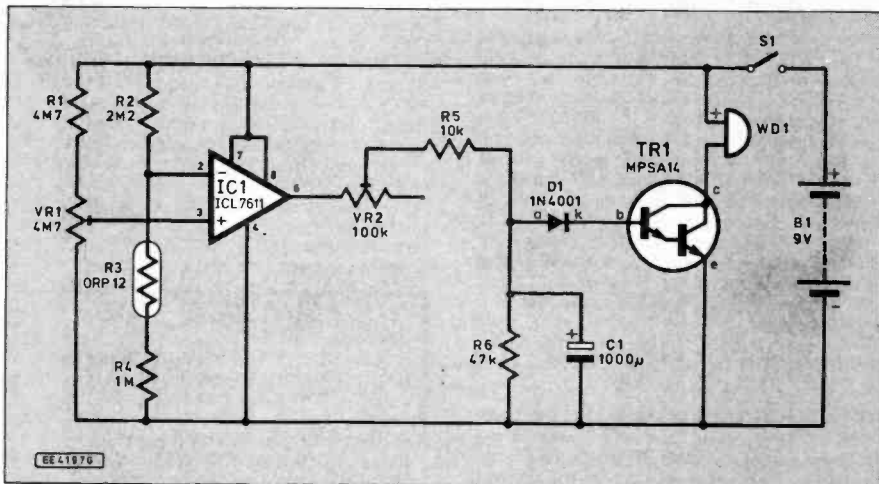

attracting attention than a steady-tone type although this was not thought worthwhile in the prototype unit.

The buzzer should be of the piezoelectric type and may draw up to 300mA – this being the maximum collector current allowed for the specified Darlington transistor, TR1. This allows a good choice of devices including some very loud mini-sirens. Note that sounders requiring external drive circuitry are unsuitable so this point must be checked before ordering

### HOLD-OFF

To prevent the warning from sounding immediately the door is opened, capacitor C1 and associated components are called into play. When the circuit is triggered and IC1 pin 6 is high, C1 charges through preset VR2 and resistor R5. The voltage across it then rises from zero at a rate determined by its value and the adjustment of VR2.

The base of the Darlington transistor TR1 requires 1.4V to turn on and diode D1 introduces a further voltage drop of 0.7V approximately (i.e. the forward voltage drop). The result is that TR1 is held off until C1 develops 2V approximately across its ends.

With the value of C1 specified and with VR2 set to minimum resistance, the hold-off time is two seconds approximately. At maximum resistance, it is around 20 seconds. Resistor, R6, provides a discharge path for C1 so that the circuit, having operated, will be ready for further use after a minute or two.

The light level at which the unit operates depends on the relative voltages at the

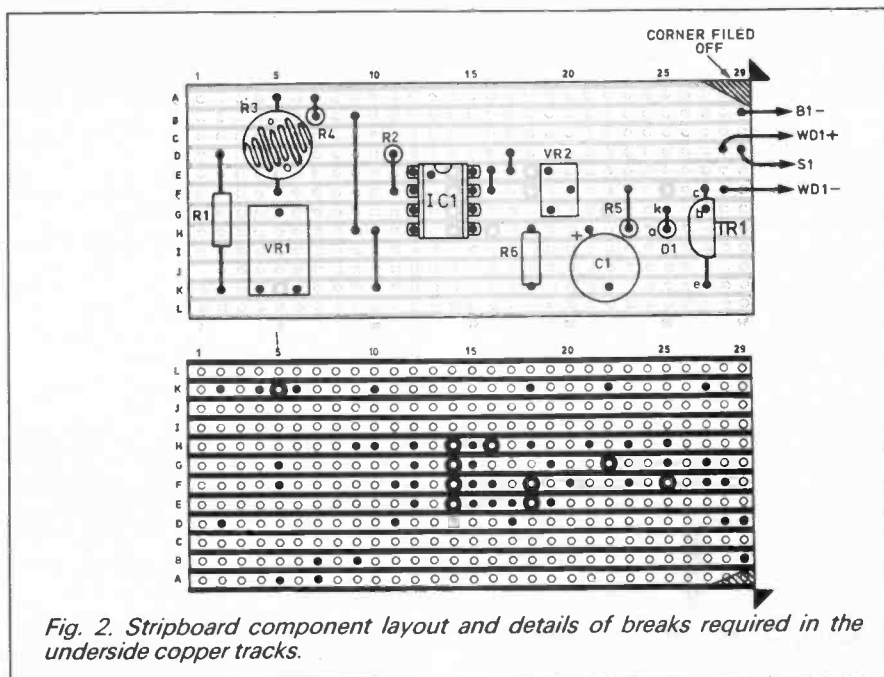

Fig. 2. Stripboard component layout and details of breaks required in the underside copper tracks.

two op-amp inputs and not their absolute values. This means, in practice, that the circuit will trigger at the same light intensity whatever the state of the battery. There will come a time, of course, where the battery is unable to operate the buzzer properly – the circuit should be tested frequently and the battery replaced when the buzzer is not as loud as it should be.

### MINIMISING POWER

As mentioned previously, it is essential for the continuous current drain to be kept as low as practicable. It is therefore necessary to reduce the current flowing through the potential dividers consisting of R1 and VR1 on the one hand and R2, R3 and R4 on the other. This is done by keeping all resistor values in this section of the circuit high.

### CONSTRUCTION

Construction of the Cupboard Guard is based on a circuit panel made from a piece of 0.1in. matrix stripboard, size 12 strips

x 29 holes. Topside component layout and details of underside track breaks and inter-strip links are shown in Fig. 2.

Begin by cutting the stripboard to size and filing it to fit the slots if using the specified box. Make all track breaks then solder the inter-track link wires in position as indicated. File off one corner, as shown, to allow clearance for connecting wires to pass over the top later.

After a careful check for errors – particularly that breaks in tracks are complete – the on-board components including IC1 socket may be soldered into position. The LDR should be soldered to provide approximately 10mm clearance from the circuit board.

Note that C1, D1 and WD1 are polarized components and, as such, must be connected into the circuit the correct way round. Do not insert IC1 into its socket at this stage.

Solder the following wires to the right-hand edge of the circuit panel: the negative battery connector wire to strip B, the positive audible warning device wire (red wire)

## COMPONENTS

### Resistors

R1	4M7
R2	2M2
R3	ORP12 light dependent resistor (LDR)
R4	1M
R5	10k
R6	47k

See  
**SHOP  
TALK**  
Page

All 0.25W 5% carbon film, except R3.

### Potentiometers

VR1	4M7 sub-miniature preset, horizontal
VR2	100k sub-miniature preset, vertical

### Semiconductors

D1	1N4001 50V 1A rect. diode
TR1	MPSA14 npn Darlington transistor
IC1	ICL7611 micropower op-amp

### Capacitor

C1	1000µ radial elect., 16V
----	--------------------------

### Miscellaneous

WD1	Piezoelectric audible warning device. 6V to 9V operation 300mA maximum – see text.
B1	PP3 9V battery and battery connector.
S1	Miniature s.p.s.t. rocker or toggle switch.

Stripboard 0.1in. matrix size 12 strips x 29 holes; 8-pin d.i.l. socket; plastic box, size 79mm x 61mm x 40mm approximately – see text; small fixings for buzzer; solder; stranded wire, etc.

Approx cost  
guidance only

**£9.50**

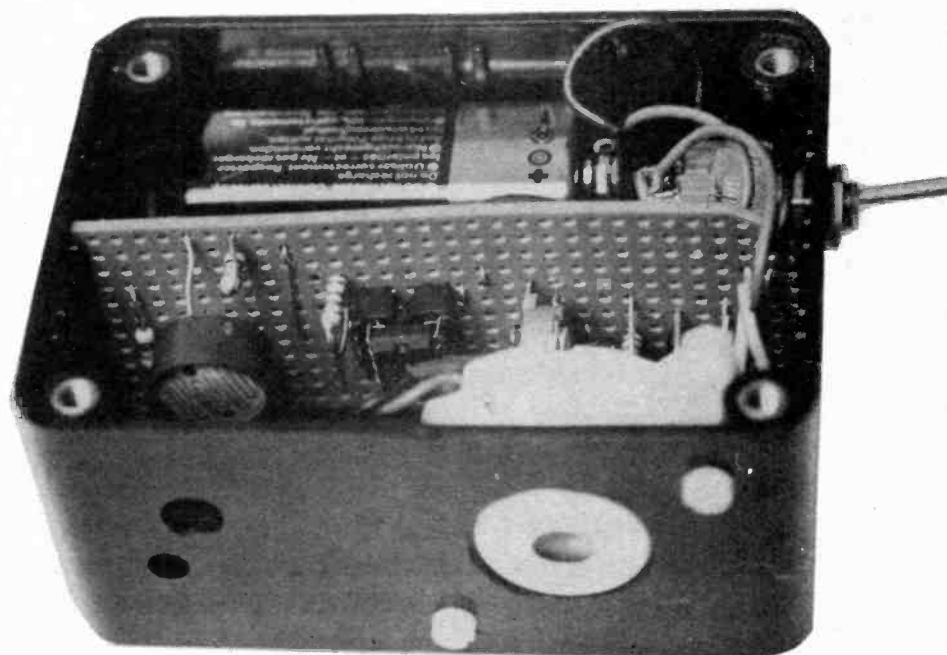

and a short piece of stranded connecting wire to strip *D* and the negative audible warning device wire to strip *F*.

Complete construction of the circuit panel by adjusting preset VR1 fully anti-clockwise also VR2 fully clockwise – as viewed from IC1 position – to provide minimum hold-off time. This will simplify the setting-up procedure.

## PREPARING THE BOX

Carefully measure the positions of the LDR and preset VR1 on the circuit panel. Drill holes of 6mm and 4mm diameter respectively in the side of the case to correspond with these positions (see photograph).

Slide the circuit panel into position temporarily to ensure that the holes are in the correct place. Check that VR1 may be adjusted using a small screwdriver through the 4mm hole. Remove the circuit panel again and drill holes for the audible warning device and on-off switch mounting.

Referring to Fig. 3, mount all remaining components and complete the interwiring. Insert IC1 into its socket observing the orientation. Slide the circuit panel into position again and check that the battery cannot cause short-circuits with the copper tracks when in position; if necessary make a cardboard or plastic shield. Secure the battery using an adhesive fixing pad.

Perform a rough check on the system by switching on – the buzzer should sound after a short delay – and rotating preset VR1 sliding contact slowly clockwise. A point should be reached when the sound stops.

If all is well, switch off and return VR1 fully anti-clockwise again. Pass the power supply wires through the space left by the filed-off corner of the circuit panel. Fit the lid before proceeding since this will affect the amount of light reaching the LDR, and hence the optimum setting for VR1.

## SETTING-UP AND TESTING

Commence testing by switching on the unit – the audible warning device should sound in normal room lighting. Cover the LDR hole with a finger and adjust preset VR1 clockwise so that the buzzer stops sounding. Note that the response time for the LDR under these conditions is very slow and it will take several seconds for the buzzer to begin sounding or stop as the case may be.

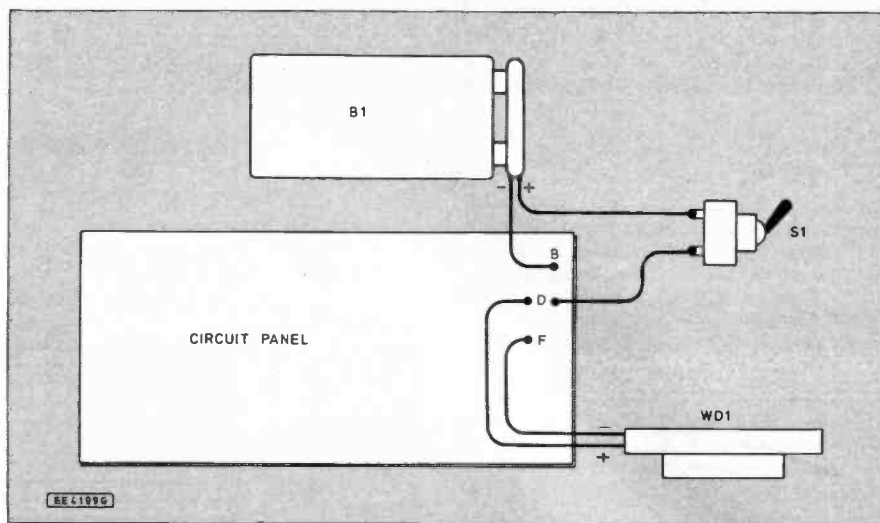
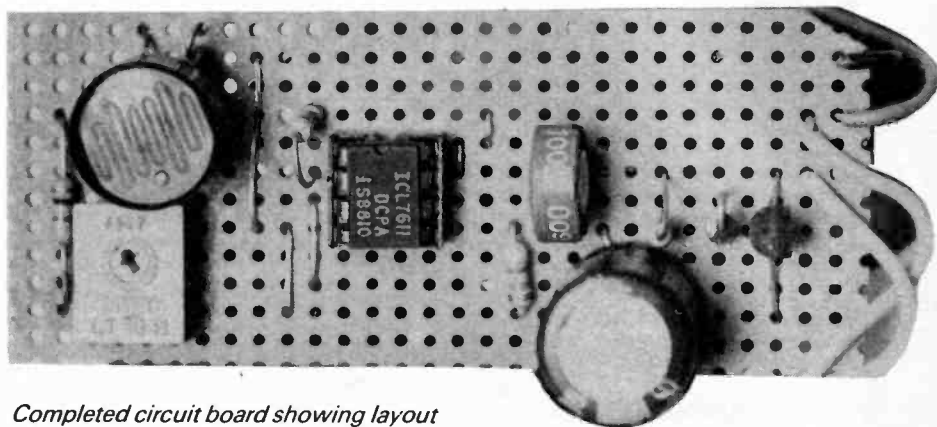

Fig. 3. Interwiring from circuit board to battery, warning switch and alarm buzzer.



Completed circuit board showing layout of components.

It is quite normal for the buzzer to take a few seconds to reach full volume. It may also change its pitch during this time. Correct adjustment to VR1 is therefore a rather tedious process but it is worth taking time over.

Remove the lid, slide out the circuit panel and adjust VR2 for the required hold-off time – anti-clockwise adjustment (as viewed from the i.c.) increases the timing. If it is adjusted to approximately mid-track position, it should provide a delay of 10 seconds approximately. Note that a minute or two must be allowed between operations for capacitor C1 to discharge otherwise the timing will be too short.

Re-fit the circuit panel and check operation. Over the next few days, further small changes to VR1/VR2 settings may be made for best results.

## ON GUARD

Since the LDR R3 is situated several millimetres below the hole in the box, the response is directional. Normally, the unit will be placed in the drawer or cupboard with the buzzer and LDR facing directly outwards or upwards. However, some experimentation may be needed to find the best position.

Your belongings will always be kept safe with the Cupboard Guard! □

# Typefit

THE TYPESETTING BUREAU  
PC page make-up software and typesetter output bureau

6 Church Street, Wimborne  
Dorset BH21 1JH  
Tel: (0202) 882299  
Fax: (0202) 841692  
Modem: (0202) 882270  
DX: 45314 Wimborne

**A Full DTP package with over 200 Monotype Fonts only £225 + VAT**

**Used to produce Everyday with Practical Electronics, Modern Electronics Manual, Brochures, Books and general typesetting for customers throughout the UK using the Typefit programme through our Bureau.**

# BARGAINS – Many New Ones This Month

## MOTORS – BATTERY 1-12V

3 Different model motors, £1, Order Ref. 35.  
Spin to start 3V d.c. motors for model aircraft etc., 5 for £1, Order Ref. 134.  
Cassette motor 1.5V-12V, powerful, speed increases with voltage, £1, Order Ref. 224.  
1½V High efficiency motor for solar cell working, £1, Order Ref. 643.  
12V motor ex BSR record player, £1, Order Ref. 687.  
9V cassette motor, brushless, £1.50, Order Ref. 1.5P14.  
Tape motor by EMI 2 speed & reversible, £2, Order Ref. 2P70.  
1/10hp 12V d.c. motor Smiths, £4, Order Ref. 4P22.  
1/8hp 12V motor, Smiths, £6, Order Ref. 6P1.  
1/6hp 12V motor, Smiths, £8, Order Ref. 8P14.  
1/3hp motor (Sinclair C5), £15, Order Ref. 15P8.

## MAINS MOTORS WITH GEARBOXES

5rpm 60W, £5, Order Ref. 5P54.  
40rpm 100W, £6, Order Ref. 6P21.  
50rpm 60W, £5, Order Ref. 5P168.  
60rpm 60W, £5, Order Ref. 5P171.  
110rpm 60W, £5, Order Ref. 5P172.  
150rpm 60W, £5, Order Ref. 5P169.  
500W motor with gearbox & variable speed selector, 100rpm upwards, £3, Order Ref. 3P8.  
1 rev per 24 hours 2W motor, £1, Order Ref. 89.  
1 rev per 12 hours 2W motor, £1, Order Ref. 90.  
1 rev per 4 hours 2W motor, £2, Order Ref. 2P239.  
1 rev per hour 2W extra small motor, 2 for £1, Order Ref. 500.  
½ rpm miniature motor, £3, Order Ref. 3P64.  
4 rpm 2W motor, £1, Order Ref. 446.  
15rpm 2W motor, £2, Order Ref. 2P321.  
25rpm 2W motor, £2, Order Ref. 2P322.  
200rpm 2W motor, £1, Order Ref. 175.  
250rpm 2W motor, £1, Order Ref. 750.

## MAINS MOTORS

¾ stack motor with ¼" spindle, £1, Order Ref. 85.  
Motor 1½" stack with good length spindle from each side, £2, Order Ref. 2P55.  
Shaded pole motor with 4" long spindle, £2, Order Ref. 2P203.  
Motor by Crompton .06hp but little soiled, £3, Order Ref. 3P4.  
Jap made precision motor balanced rotor 15000rpm, £2, Order Ref. 2P12.

## MOTOR – STEPPER

Mini motor 12V – 7.5 degree step, £1, Order Ref. 910.  
Motor by Eastern Air Devices, £2, Order Ref. 2P266.  
Very powerful motor by American Philips 10-14V 7.56 degree step, £5, Order Ref. 5P81.

## LOUDSPEAKERS

2" round 50 ohm coil ½W, 2 for £1, Order Ref. 908.  
2 ¼" 8 ohm, 2 for £1, Order Ref. 454.  
2 ½" 35 ohm, 2 for £1, Order Ref. 514.  
3 ¼" 8 ohm, 2 for £1, Order Ref. 682.  
5" 4 ohm, 2 for £1, Order Ref. 136.  
6 ½" 4 ohm, with tweeter, £1, Order Ref. 895.  
6 ½" 6 ohm, £1, Order Ref. 896.  
6 ½" 8 ohm, with tweeter, £1, Order Ref. 897.  
6" x 4" 4 ohm, £1, Order Ref. 242.  
5" x 5" 15 ohm, £1, Order Ref. 906.  
5" x 3" 16 ohm, £1, Order Ref. 725.  
7" x 4" 16 ohm, 2 for £1, Order Ref. 684.  
8" 15 ohm audax, £1, Order Ref. 504.  
9" x 3" 8 ohm, 5W, £1, Order Ref. 138.  
3" 4 ohm, tweeter, £1, Order Ref. 433.  
Sanyo 6 ½" 4 ohm, 10W, £1.50, Order Ref. 1.5P11.  
Goodmans 6 ½" 10W 4 ohm, £2, Order Ref. 2P27.  
6" x 4" 15 ohm 10W, £2, Order Ref. 2P167.  
Horn speaker, £3, Order Ref. 3P82.  
20W 5" by Goodmans, £3, Order Ref. 3P145.  
20W 4 ohm tweeter, £1.50, Order Ref. 1.5P9.  
Amstrad 8" 15W 8 ohm with matching tweeter, £4, Order Ref. 4P57.  
Cased pair of stereo speakers by Bush 4 ohms £5 per pair, Order Ref. 5P141.  
Double wound voice coil 25W, ITT, £7, Order Ref. 7P12.  
Bulkhead speaker, metal cased, £10, Order Ref. 1043.  
25W 2 way crossover, 2 for £1, Order Ref. 22.  
40W 3 way crossover, £1, Order Ref. 23.

## OUR MOST POPULAR BARGAINS

AMSTRAD 3" DISK DRIVE. Brand new. Standard replacement or why not have an extra one? £20, Order Ref. 20P28.  
THIS COULD SAVE YOU EXPENSIVE BATTERIES an in-car unit for operating 6V radio, cassette player, etc from car lighter socket, £2, Order Ref. 2P318.  
SILENT EFFORTLESS MOVEMENT with our 14cm ballrace complete with removable spindle. 4 for £1, Order Ref. 912.  
FULLY ENCLOSED MAINS TRANSFORMER on a 2m 3 core lead terminating with a 13A plug. Secondary rated at 6V 4A. Brought out on a well insulated 2 core lead terminating with insulated push on tags, £3, Order Ref. 3P152. Ditto but 8A, £4, Order Ref. 4P69.  
STEPPER MOTOR BARGAIN. This is a mini motor, 12V operated and 7.5° step angle. Offered at the very low price of £1, Order Ref. 910.  
STOP THOSE PEAKS as they come through the mains, they can damage your equipment. 2A unit is a combination of cores and caps, gives complete protection. £2, Order Ref. 2P315.  
DIGITAL MULTI TESTER M3800 single switching covers 30 ranges including 20A a.c. and d.c. 10meg input impedance, 3½ LCD display. Complete with lead. Currently advertised by many dealers at nearly £40, our price only £25, Order Ref. 25P14.  
ANALOGUE TESTER. Input impedance 2K ohms per volt. It has 14 ranges, a.c. volts 0-500 d.c. volts 0-500, d.c. current 500 micro amps at 250 milliamp, resistance 0-1 meg-ohm, decibels 20 – +56 dB. Fitted diode protection, overall size 90 x 60 x 30mm. Complete with test leads, price £7.50, Order Ref. 7.5P8.  
LCD CLOCK MODULE. 1.5V battery operated, fits nicely into our 50p project box, Order Ref. 876. Only £2, Order Ref. 2P307.  
SENTINEL COMPONENT BOARD amongst hundreds of other parts, this has 15 ICs all plug in so don't need de-soldering. Cost well over £100, yours for £4, Order Ref. 4P67.  
AMSTRAD KEYBOARD MODEL KB5. This is a most comprehensive keyboard, having over 100 keys including, of course, full numerical and qwerty. Brand new, still in maker's packing, £5, Order Ref. 5P202.

## £1 SUPER BARGAIN

12V axial fan for only £1. Ideal for equipment cooling, brand new, made by West German company. Brushless so virtually everlasting. Supplied complete with simple 12V transistor circuit. Only £1, Order Ref. 919. When we supply this we will include a list of approximately 800 of our other £1 bargains.

FM CORDLESS RADIO MIKE hand held, battery operated model. Very good performer and really professional looking, has usual shaped body and head and is tuneable to transmit and be picked up on the FM band of any radio. Yours for only £8.50, Order Ref. 8.5P1.

PROJECT BOX a first-class, Japanese two-part moulding size 95mm x 66mm x 23mm. Will hold a PP3 battery and a PCB and is ideal for many projects. Nicely finished and very substantial, 2 for £1, Order Ref. 876.

ULTRA SONIC TRANSDUCERS 2 metal cased units, one transmits, one receives. Built to operate around 40kHz. £1.50 the pair, Order Ref. 1.5P4.

PHILIPS 9" HIGH RESOLUTION MONITOR black & white in metal frame for easy mounting, brand new, still in maker's packing, offered at less than price of tube alone, only £15, Order Ref. 15P1.

INSULATION TESTER WITH MULTIMETER internally generates voltages which enables you to read insulation directly in megohms. The multimeter has 4 ranges a.c./d.c. volts, 3 ranges d.c. milliamps, 3 ranges resistance and 5 amps. These instruments are ex BT but in very good condition, tested and guaranteed OK, probably cost at least £50 each, yours for only £7.50, with leads, carrying case £2 extra, Order Ref. 7.5P4.

MAINS ISOLATION TRANSFORMER stops you getting "to earth shocks". 230V in and 230V out. 150W upright mounting, £7.50, Order Ref. 7.5P5 and a 250W version is £10, Order Ref. 10P79.

MINI MONO AMP on pcb. Size 4" x 2" with front panel holding volume control and with spare hole for switch or tone control. Output is 4W into 4 ohm speaker using 12V or 1W into 8 ohm using 9V. Brand new and perfect, only £1 each, Order Ref. 495.

EXPERIMENTING WITH VALVES don't spend a fortune on a mains transformer, we can supply one with standard mains input and secs. of 250-0-250V at 75mA and 6.3V at 3A, £5, Order Ref. 5P167.

15W 8 OHM 8" SPEAKER & 3" TWEETER made for a discontinued high quality music centre, gives real hi-fi and only £4 per pair, Order Ref. 4P57.

0-1MA FULL VISION PANEL METER 2¾" square, scaled 0-100 but scale easily removed for re-writing, £1 each, Order Ref. 756.

PCB DRILLS 12 assorted sizes between .75 and 1.5mm, £1 the lot, Order Ref. 128.

## POWER SUPPLIES – SWITCH MODE

(all 230V mains operated)

Astec ref. B51052 with outputs +12V .5A, –12V .1A, +5V 3A, +10V .05A, +5V .02A, unboxed on pcb, size 180 x 130mm, £5, Order Ref. 5P188.  
Astec ref. BM4 1004 with outputs +5V 3½A, +12V 1.5A, –12V 1.5A, £5, Order Ref. 5P199.  
Astec No. 12530, +12V 1A, –12V .1A, +5V 3A, uncased on pcb, size 160 x 100mm, £3, Order Ref. 3P141.  
Astec No. BM41001 110W 38V 2.5A 25.1V 3A part metal cased with instrument type main input socket & on/off dp rocker switch, size 354 x 118 x 84mm, £8.50, Order Ref. 8.5P2.  
Astec Model No. BM135-3302 +12V 4A, +5V 16A, –12V 0.5A totally encased in plated steel with mains input plug, mains output socket & double pole on/off switch size 400 x 130 x 65mm, £9.50 Order Ref. 9.5P4.  
Deltron Model No. 512104 mains input can be 230V or 115V one output 12V @ 10.4A. Not cased but its pcb is enclosed on 3 sides by heavy gauge ai chassis. £20, Order Ref. 20P3.

## POWER SUPPLIES – LINEAR

(all cased unless stated)

4.5V d.c. 150mA, £1, Order Ref. 104.  
5V d.c. 2½A psu with filtering & volt regulation, uncased, £4, Order Ref. 4P63.  
6V d.c. 700mA, £1, Order Ref. 103.  
6V d.c. 200mA output in 13A case, £2, Order Ref. 2P112.  
6-12V d.c. for models with switch to vary voltage and reverse polarity, £2, Order Ref. 2P3.  
9V d.c. 150mA, £1, Order Ref. 762.  
9V d.c. 500mA output in 13A case, £2, Order Ref. 2P113.  
9V d.c. 250mA in 13A case, £2, Order Ref. 2P209.  
9V 2.1A by Sinclair, £3, Order Ref. 3P151.  
9V d.c. 100mA, £1, Order Ref. 733.  
12V d.c. 200mA output in 13A case, £2, Order Ref. 2P114.  
12V 500mA on 13A base, £2.50, Order Ref. 2.5P4.  
12V 1A filtered & regulated on p.c.b. with relays & Piezo sander, uncased, £3, Order Ref. 3P80.  
Amstrad 13.5V or 12V 2A, £6, Order Ref. 6P23.  
24V d.c. with 200mA stereo outputs by Mullard ref. 900, £2, Order Ref. 2P4.  
9.5V a.c. 60mA made for BT, £1.50, Order Ref. 1.5P7.  
15V 500mA a.c. on 13A base, £2, Order Ref. 2P281.  
A.C. out 9.8V @ 60mA & 15.3V @ 150mA, £1, Order Ref. 751.  
BT power supply unit 206A. Trickle charges and cuts out should voltage fall below pre-set. £16, Order Ref. 16P6.  
Sinclair microvision psu, £5, Order Ref. 5P148.

## LASERS & LASER BITS

2mW laser, helium neon by Philips, full spec. £30, Order Ref. 30P1.  
Power supply for this in kit form with case is £15, Order Ref. 15P16, or in larger case to house tube as well, £18, Order Ref. 18P2.  
The larger unit, made up, tested and ready to use, complete with laser tube, £69, Order Ref. 69P1.

Prices include V.A.T. Send cheque/postal order or ring and quote credit card number. Add £3 post and packing.

Orders over £50 post free.

If intending to call please phone first.

## M & B ELECTRICAL SUPPLIES LTD

Pilgrim Works (Dept. E.E.)  
Stairbridge Lane  
Bolney, Sussex RH17 5PA

Telephone: 0444 881965  
(Also fax but phone first)

# REPORTING AMATEUR RADIO

**Tony Smith G4FAI**

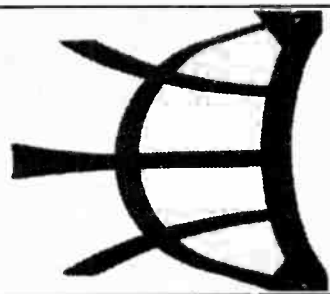

## MORE SPACE EXPERIMENTS

The space shuttle *Columbia* (STS-55), launched on April 26, had five licensed radio amateurs in its crew of seven. Once again SAREX, the Shuttle Amateur Radio Experiment, was a secondary payload with a programme of prearranged contacts with school radio stations during the mission.

SAREX operations included contacts by voice and packet on 2-metres and a second amateur station was installed in the German spacelab module on board. This was designated SAFEX, the Spacelab Amateurfunk-Experiment, and was operated by two German payload specialists who made a number of scheduled contacts with European schools with this equipment.

SAFEX had a 2-metre f.m. downlink and a 70cm f.m. uplink, using a dual band external antenna mounted on the German module, and this gave the SAREX team the opportunity to compare the performance of their window mounted antenna with the German externally mounted antenna. During orbit 61, they transmitted using the window antenna and on orbit 62 they used the external antenna, asking amateurs in the south-eastern United States to participate in the test by taking signal strength readings of the received signal during both orbit passes.

The externally mounted antenna - basically a quarter-wave whip with an airtight feedthrough - proved to be the better of the two, with a significant signal boost compared to the window antenna. Later, when the window antenna failed the shuttle crew moved their packet TNC and Motorola 2-meter hand-held into the German spacelab to continue operations using the external antenna. (*W5YI Report*).

SWLs may like to note that special QSL cards are available for reception of the SAREX transmissions. Reports on the STS-55 mission should be sent to IBM Amateur Radio Club/1993, PO Box 1328, Boca Raton, FL 33429-1328, USA, marking the envelope STS-55 SWL, enclosing a self-addressed envelope, minimum 10cm x 24cm, and sufficient IRCs to cover return postage.

## REMEMBER THE 1-V-1?

The first electronic project I ever tackled was a single valve 0-V-0 regenerative detector receiver which very quickly hooked me on shortwave radio. I was amazed at what I could hear from around the world on this little set but soon realized it could be improved.

The addition of two extra valves, one as an r.f. stage, one as an audio amplifier, made it a 1-V-1 and this set provided me with my sole listening facility for a number of years.

Eventually, and as more funds became available, I moved on to modern, more sophisticated, equipment but I never forgot that exciting sense of involvement which comes from pulling stations in with a set that needs personal operating skill to get the best from it.

Such circuitry is considered vintage today and undoubtedly the performance obtainable at the time cannot compare with that of some of today's remarkable receivers. I have long held the belief, however, that abandoned techniques of the past could benefit from present-day knowledge, techniques and components to produce performance not far short of some of the ultra-sophisticated circuits that have replaced them.

## RADIO BYGONES

An example of this is contained in a recent three-part article in *Radio Bygones* by T.S. Christian. His research into the TRF (tuned radio frequency) techniques of the 1930s and developments of the 1940s, combined with the potential of last-generation frame-grid valves - plus help from a modern computer - has produced a 1-V-1 design claimed to be at least as useful as a solid-state direct conversion receiver. He claims it provides good a.m. performance for broadcast listening, better strong-signal performance, and gives the operator control over all performance characteristics.

He comments, "The comparative simplicity of the TRF ensured that it remained popular with shortwave enthusiasts after it had been displaced in professional and domestic applications. However, as so often happens, its very simplicity could have contributed to its downfall... it may have been neglected rather than developed; skimmed rather than elaborated."

In a review of the prototype, Tony Green G00JJ comments "this radio had a performance I would not have believed possible from a set of such seemingly simple design. Its selectivity is more than adequate for serious CW listening, which its built-in 1kHz note filter brought up to communications receiver quality."

"With a little practice, resolving SSB became easy and careful use of the reaction control allowed many stations way down in the noise to become perfectly readable - allowing me to hear my first Japanese amateur station on 40m which was unreadable on my transceiver... a very usable radio with a degree of performance comparable to many communications receivers I have used."

"It is not a 'turn on and tune in' radio but more a 'sit down and fiddle' receiver giving it an appeal which has all but disappeared in recent years... it wouldn't impress the key-pad entry radio user, but

could be a firm favourite with someone prepared to learn how to use it properly."

The first part of this article was in the February/March 1993 issue of *Radio Bygones*. This bimonthly magazine provides a fascinating mix covering domestic, amateur and professional radio "from yesterday backwards". Available by post only, it costs £17.00 a year, (Eire and overseas £18.00), sample copy £3.00, from G.C. Arnold Partners, 9 Wetherby Close, Broadstone, Dorset BH18 8JB.

## REPEATER LICENSING CHANGES

As from April 1st, licences for amateur repeater stations have been in the hands of individual repeater keepers. Previously, the Radio Society of Great Britain has been the licensee for all amateur repeater stations and there has been a general prohibition on individual amateurs operating a repeater.

The new arrangement lifts that prohibition but the repeater keeper will now be responsible for the correct operation of the repeater, for monitoring its use and taking steps to limit unauthorised transmissions. He/she must also provide effective close-down facilities when interference is caused to the repeater.

Amateur radio repeaters are stations located at advantageous sites throughout the country, intended to extend the range of communications between amateurs operating "mobile" by automatically receiving and re-transmitting their messages.

Unfortunately, they are frequently subject to interference, abuse, and unacceptable operating practices and there has been much debate on the best way to deal with the problem, sometimes culminating in the Radiocommunications Agency stepping in to close-down a repeater for a period of time. The RA is obviously hoping that by devolving the licences they are also devolving the problem.

## SUMMER BROADCAST GUIDE

The International Short Wave League's *Guide to English Language Short Wave Broadcasts to Europe*, covering current summer schedules, is now available. This helpful booklet, published twice a year to reflect broadcasters' seasonal scheduling and other changes, gives details of transmissions receivable round the clock listed by time, frequency and nature of programme. A new feature is the inclusion of details of English language transmissions not intended for, but audible in, Europe.

Extremely useful for both the dedicated and casual short wave listener, it is available from ISWL HQ, 10 Clyde Crescent, Wharton, Winsford, Cheshire CW7 3LA, and represents amazing value at just £1.00, (or two IRCs, or £1 in stamps), post paid.



# DIRECT BOOK SERVICE

The books listed have been selected by Everyday with Practical Electronics editorial staff as being of special interest to everyone involved in electronics and computing. They are supplied by mail order direct to your door. Full ordering details are given on the last book page. For another selection of books see next month's issue.

## Special Everyday Electronics Books

### ELECTRONICS TEACH-IN No.4 INTRODUCING DIGITAL ELECTRONICS (published by *Everyday Electronics*)

**Michael J. Cockcroft**  
Although this book is primarily a City & Guilds Introductory level course (726/301), approximately 80% of the information forms a very basic introduction to electronics in general, it therefore provides an excellent introductory text for beginners and a course and reference book for GCSE students.

Full details on registering for C&G assessment, details of assessment centres, components required and information on the course in general are given.

The City & Guilds introduction to module 726/301 reads: "A candidate who satisfactorily completes this module will have a competence to identify basic components and digital integrated circuits and connect them together to form simple working circuits and logic units." This provides an excellent introduction to the book.

112 pages (A4 size) **Order code T14** £2.95

### ELECTRONIC PROJECTS - BOOK 1 Published by *Everyday Electronics* in association with *Magenta Electronics*.

Contains twenty of the best projects from previous issues of EE each backed with a kit of components. The projects are: Seashell Sea Synthesiser, EE Treasure Hunter, Mini Strobe, Digital Capacitance Meter, Three Channel Sound to Light, BBC 16K Sideways Ram, Simple Short Wave Radio, Insulation Tester, Stepper Motor interface, Eprom Eraser, 200MHz Digital Frequency Meter, Infra Red Alarm, EE Equaliser Isolator, Bat Detector, Acoustic Probe, Mains Tester and Fuse Finder, Light Rider - (Lapel Badge, Disco Lights, Chaser Light), Musical Doorbell, Function Generator, Tilt Alarm, 10W Audio Amplifier, EE Buccaneer Induction Balance Metal Detector, BBC Midi Interface, Variable Bench Power Supply, Pet Scarer, Audio Signal Generator.

128 pages (A4 size) **Order code EP1** £2.45

### ELECTRONICS TEACH-IN No.5 GUIDE TO BUILDING ELECTRONIC PROJECTS

Published by *EVERYDAY ELECTRONICS*  
Due to the demand from students, teachers and hobbyists we have put together a range of articles from past issues of *Everyday Electronics* that will assist those involved with the construction of electronic projects.

The book contains the complete *Project Development for GCSE* series.

**Contents: Features** - First Steps in Project Building; Building with Verob; Project Development for GCSE; Getting your Project Working; Guide to Printed Circuit Boards; Choosing and Using Test Equipment - The Multimeter, The Oscilloscope, P.S.U.s, Logic Probes, Digital Frequency Meters, Signal Generators, etc; **Data** - Circuit Symbols; Component Codes; Resistors; Identifying Components; Capacitors; Actually Doing It - Understanding the Circuit Diagram, Component Codes, Mounting circuit boards and controls, Understanding Capacitors; **Projects** - Lie Detector; Personal Stereo Amplifier; Digital Experiments Unit; Quizmaster; Siren Effects Unit; UV Exposure Unit; Low-cost Capacitance Meter; Personal Radio.

88 pages (A4 size) **Order code T15** £2.95

### ELECTRONICS TEACH-IN 88/89 - INTRODUCING MICROPROCESSORS

**Mike Tooley BA** (published by *Everyday Electronics*)  
A complete course that can lead successful readers to the award of a City and Guilds Certificate in Introductory Microprocessors (726/303). The book contains everything you need to know including full details on registering for assessment, etc. Starting with basic terminology, integrated circuits, logic families and numbering systems the text builds in stages, with revision and assessments built in, up to programming, languages, flow charts, etc. The course is ideal for the newcomer to the subject.

80 pages (A4 size) **Order code T16** £2.45

### EVERYDAY ELECTRONICS DATA BOOK

**Mike Tooley BA**  
(published by *EE* in association with *PC Publishing*)  
This book is an invaluable source of information of everyday relevance in the world of electronics. It contains not only sections which deal with the essential theory of electronic circuits, but also deals with a wide range of practical electronic applications.

It is ideal for the hobbyist, student, technician and engineer. The information is presented in the form of a basic electronic recipe book with numerous examples showing how theory can be put into practice using a range of commonly available "industry standard" components and devices.

A must for everyone involved in electronics!  
256 pages **Order code DATA** £8.95

### ELECTRONICS TEACH-IN No. 3 - EXPLORING ELECTRONICS (published by *Everyday Electronics*)

**Owen Bishop**  
Another EE value for money publication aimed at students of electronics. The course is designed to explain the workings of electronic components and circuits by involving the reader in experimenting with them. The book does not contain masses of theory or formulae but straightforward explanations and circuits to build and experiment with.

Exploring Electronics contains more than 25 useful projects, assumes no previous knowledge of electronics and is split into 28 easily digestible sections.  
88 pages (A4 size) **Order code T13** £2.45



## Computers and Computing

### HOW TO CHOOSE A SMALL BUSINESS COMPUTER SYSTEM

**D. Weale**  
This book is for anyone intending to buy an IBM compatible computer system, whether it is their first system or a replacement. There are sections on hardware, application and systems programs and how to actually make your choice as well as sections on the law, ergonomics and a glossary of common terms.

The text contains many useful tips and some warnings (which could save much effort and expense).  
114 pages **Order code BP323** £4.95

### UNDERSTANDING PC SPECIFICATIONS

**R. A. Penfold**  
If you require a microcomputer for business applications, or a high quality home computer, an IBM PC or compatible is often the obvious choice. They are competitively priced, and are backed up by an enormous range of applications programs, hardware add-ons, etc. The main difficulty for the uninitiated is deciding on the specification that will best suit his or her needs. PCs range from simple systems of limited capabilities up to complex systems that can happily run applications that would have been considered beyond the abilities of a microcomputer not so long ago. It would be very easy to choose a PC system that is inadequate to run your applications efficiently, or one which goes beyond your needs and consequently represents poor value for money.

This book explains PC specifications in detail, and the subjects covered include the following: Differences between types of PC (XT, AT, 80386, etc); Maths co-processors; Input devices (keyboards, mice, and digitisers); Memory, including both expanded (EMS) and extended RAM; RAM disks and disk caches; Floppy disk drive formats and compatibility; Hard disk drives (including interleave factors and access times); Display adaptors, including all standard PC types (CGA, Hercules, Super VGA, etc). Contains everything you need to know if you can't tell your EMS from your EGA!

104 pages **Order code BP282** £3.95

### AN INTRODUCTION TO 68000 ASSEMBLY LANGUAGE

**R. A. & J. W. Penfold**  
Obtain a vast increase in running speed by writing programs for 6800 based micros such as the Commodore Amiga, Atari ST range or Apple Macintosh range etc., in assembly language. It is not as difficult as one might think and this book covers the fundamentals.  
112 pages **Order code BP184** £2.95

### THE ART OF PROGRAMMING THE ZX SPECTRUM

**M. James, B.Sc., M.B.C.S.**  
It is one thing to have learnt how to use all the Spectrum's commands and functions, but a very different one to be able to combine them into programs that do exactly what you want them to. This is just what this book is all about - teaching you the art of effective programming with your Spectrum.  
144 pages **Order code B119** £2.50

### A CONCISE INTRODUCTION TO MS-DOS

**N. Xantaris**  
This guide is written with the non-expert, busy person in mind and, as such, it has an underlying structure based on "what you need to know first, appears first". Nonetheless, the guide is also designed to be circular, which means that you don't have to start at the beginning and go to the end. The more experienced user can start from any section.

The guide covers versions 3.0, 3.1 and 3.2 of both PC-DOS and MS-DOS as implemented by IBM and other manufacturers of "compatible" microcomputers, including the AMSTRAD PC's. It covers both floppy disc-based systems and hard disc-based systems.  
64 pages **Order code BP232** £2.95

### MAKING MS-DOS WORK FOR YOU

**N. Kantanis & P. R. M. Oliver**  
This book was written with the busy person in mind and, as such, it has an underlying structure based on "what you need to know first, appears first". Nonetheless, the

book has also been designed to be circular, which means that you don't have to start at the beginning and go to the end.

The book explains: How to write customised batch files which allow you to display what you want on your screen, and in the form and order you want it, instead of being forced to use the DOS prompt on a blank screen. How to design and set up a fast interactive and professional looking menu system, so that you or anyone else can run utility applications or commercial software packages easily. How the ANSI.SYS display and keyboard commands can be used to position the cursor on any part of the screen, change the intensity of the displayed characters or change their colour. How the Edit screen editor or the Edlin line editor can be used to enter ESCAPE (ANSI.SYS) commands into simple ASCII files to allow control of both your screen display and your printer. How to control the operation of the two main types of printers in use today, Epson compatible dot matrix and HP compatible laser printers. How to use several useful routines, such as moving and finding files, protecting files from accidental erasure, a simplified backup process, a screen saver, and a disc cataloguing system.

The Debug program and how it can be used to create, see and change the contents of any file, including those of programs written in assembler code. This includes how to find your way around the names and tasks of the CPU registers and the meaning of some simple assembler mnemonics.

182 pages **Order code BP319** £4.95

### AN INTRODUCTION TO CP/M

**R. A. Penfold**  
In order to run and use programs operating under CP/M it is not essential to have an understanding of the system, but a reasonable knowledge of the subject can certainly be of immense help when minor problems occur, and also in fully exploiting the possible potential of the system. This book tells the story!  
84 pages **Order code BP183** £2.95

# Audio and Music

## ACOUSTIC FEEDBACK - HOW TO AVOID IT

Feedback is the bane of all public address systems. While feedback cannot be completely eliminated, many things can be done to reduce it to a level at which it is no longer a problem.

Much of the trouble is often the hall itself, not the equipment, but there is a simple and practical way of greatly improving acoustics. Some microphones are prone to feedback while others are not. Certain loudspeaker systems are much better than others, and the way the units are positioned can produce or reduce feedback. All these matters are fully explored as well as electronic aids such as equalizers, frequency-shifters and notch filters.

The special requirements of live group concerts are considered, and also the related problem of instability that is sometimes encountered with large set-ups. We even take a look at some unsuccessful attempts to cure feedback so as to save readers wasted time and effort duplicating them.

Also included is the circuit and layout of an inexpensive but highly successful twin-notch filter, and how to operate it. **92 pages** **Order code BP310** **£3.95**

## PRACTICAL MIDI HANDBOOK

**R. A. Penfold**  
The Musical Instrument Digital Interface (MIDI) is surrounded by a great deal of misunderstanding, and many of the user manuals that accompany MIDI equipment are quite incomprehensible to the reader.

The Practical MIDI Handbook is aimed primarily at musicians, enthusiasts and technicians who want to exploit the vast capabilities of MIDI, but who have no previous knowledge of electronics or computing. The majority of the book is devoted to an explanation of what MIDI can do and how to exploit it to the full, with practical advice on connecting up a MIDI system and getting it to work, as well as deciphering the technical information in those manuals. **128 pages** **Order code PC101** **£6.95**

## PREAMPLIFIER AND FILTER CIRCUITS

**R. A. Penfold**  
This book provides circuits and background information for a range of preamplifiers, plus tone controls, filters, mixers, etc. The use of modern low noise operational amplifiers and a specialist high performance audio preamplifier i.c. results in circuits that have excellent performance, but which are still quite simple. All the circuits featured can be built at quite low cost (just a few pounds in most cases).

The preamplifier circuits featured include:- Microphone preamplifiers (low impedance, high impedance, and crystal). Magnetic cartridge pick-up preamplifiers with R.I.A.A. equalisation. Crystal/ceramic pick-up preamplifier. Guitar pick-up preamplifier. Tape head preamplifier (for use with compact cassette systems).

Other circuits include:- Audio limiter to prevent overloading of power amplifiers. Passive tone controls. Active tone controls. PA filters (highpass and lowpass). Scratch and rumble filters. Loudness filter. Audio mixers. Volume and balance controls **92 pages** **Order code BP309** **£3.95**

## AN INTRODUCTION TO LOUSPEAKERS AND ENCLOSURE DESIGN

**V. Capel**  
This book explores the various features, good points and snags of speaker designs. It examines the whys and wherefores so that the reader can understand the principles involved and so make an informed choice of design, or even design loudspeaker enclosures for him or herself. Crossover units are also explained, the various types, how they work, the distortions they produce and how to avoid them. Finally there is a step-by-step description of the construction of the *Kapellmeister* loudspeaker enclosure. **148 pages** **Temporarily out of print**

## COMPUTERS AND MUSIC - AN INTRODUCTION

**R. A. Penfold**  
Computers are playing an increasingly important part in the world of music, and the days when computerised music was strictly for the fanatical few are long gone.

If you are more used to the black and white keys of a synth keyboard than the QWERTY keyboard of a computer, you may be understandably confused by the jargon and terminology bandied about by computer buffs. But fear not, setting up and using a computer-based music making system is not as difficult as you might think.

This book will help you learn the basics of computing, running applications programs, wiring up a MIDI system and using the system to good effect, in fact just about everything you need to know about hardware and the programs, with no previous knowledge of computing needed or assumed. This book will help you to choose the right components for a system to suit your personal needs, and equip you to exploit that system fully. **174 pages** **Order code PC117** **£8.95**

## ELECTRONIC PROJECTS FOR GUITAR

**R. A. Penfold**  
This book contains a collection of guitar effects and some general purpose effects units, many of which are suitable for beginners to project building. An introductory chapter gives guidance on construction.

Each project has an introduction, an explanation of how it works, a circuit diagram, complete instructions on strip-board layout and assembly, as well as notes on setting up and using the units. Contents include: Guitar tuner; Guitar preamplifier; Guitar headphone amplifier; Soft distortion unit; Compressor; Envelope waa waa; Phaser; Dual tracking effects unit; Noise gate/expander; Treble booster; Dynamic treble booster; Envelope modifier; Tremolo unit; DI box. **110 pages** **Order code PC110** **£8.95**

## HIGH POWER AUDIO AMPLIFIER CONSTRUCTION

**R. A. Penfold**  
Practical constructional details of how to build a number of audio power amplifiers ranging from about 50 to 300/400 watts r.m.s. Includes MOSFET and bipolar transistor designs. **96 pages** **Order code BP277** **£3.95**

# Theory and Reference

## ELECTRONIC HOBBYISTS HANDBOOK

**R. A. Penfold**  
Provides an inexpensive single source of easily located information that the amateur electronics enthusiast is likely to need for the day-to-day pursuance of this fascinating hobby. Covers common component colour codes. Details the characteristics and pinouts of many popular semiconductor devices, including various types of logic ICs, operational amplifiers, transistors, FETs, unijunctions, diodes, rectifiers, SCRs, diacs, triacs, regulators and SMDs, etc. Illustrates many useful types of circuits, such as timers and oscillators, audio amplifiers and filters, as well as including a separate section on power supplies. Also contains a multitude of other useful data. **88 pages** **Order code BP233** **£4.95**

## NEWNES ELECTRONICS POCKET BOOK

**E. A. Parr**  
Newnes Electronics Pocket Book has been in print for over twenty years and has covered the development of electronics from valve to semiconductor technology and from transistors to LSI integrated circuits and microprocessors. To keep up to date with the rapidly changing world of electronics, continuous revision has been necessary. This new Fifth Edition takes account of recent changes and includes material suggested by readers of previous editions. New descriptions of op.amp. applications and the design of digital circuits have been added, along with a totally new chapter on computing, plus other revisions throughout. **315 pages (hard cover)** **Order code NE02** **£10.95**

## ELECTRONIC MODULES AND SYSTEMS FOR BEGINNERS

**Owen Bishop**  
This book describes over 60 modular electronic circuits - how they work, how to build them, and how to use them. The modules may be wired together to make hundreds of different electronic systems, both analogue and digital. To show the reader how to begin building systems from modules, a selection of over 25 electronic systems are described in detail, covering such widely differing applications as timing, home security, measurement, audio (including a simple radio receiver), games and remote control. **200 pages** **Order code BP266** **£3.95**

## FROM ATOMS TO AMPERES

**F. A. Wilson**  
Explains in crystal clear terms the absolute fundamentals behind electricity and electronics. Really helps you to discover and understand the subject, perhaps for the first time ever.

Have you ever: Wondered about the true link between electricity and magnetism? Felt you could never understand the work of Einstein, Newton, Boltzmann, Planck and other early scientists? Just accepted that an electron is like a little black ball? Got mixed up with e.m.f. and p.d.? Thought the idea of holes in semiconductors is a bit much?

Then help is at hand with this inexpensive book, in as simple a way as possible and without too much complex mathematics and formulae. **244 pages** **Order code BP254** **£3.50**

## PRACTICAL DIGITAL ELECTRONICS HANDBOOK

**Mike Toolay (Published in association with Everyday Electronics)**  
The vast majority of modern electronic systems rely heavily on the application of digital electronics, and the *Practical Digital Electronics Handbook* aims to provide readers with a practically based introduction to this subject. The book will prove invaluable to anyone involved with the design, manufacture or servicing of digital circuitry, as well as to those wishing to update their knowledge of modern digital devices and techniques. Contents: Introduction to integrated circuits; basic logic gates, monostable and bistable devices; timers; microprocessors; memories; input and output devices; interfaces; microprocessor buses. Appendix 1: Data. Appendix 2: Digital test gear projects; tools and test equipment; regulated bench power supply, logic pulser, versatile pulse generator, digital IC tester, current tracer, audio logic tracer; RS-232C breakout box, versatile digital counter/frequency meter. Appendix 3: The oscilloscope. Appendix 4: Suggested reading. Appendix 5: Further study. **208 pages** **Order code PC100** **£6.95**

## ELECTRONICS - A "MADE SIMPLE" BOOK

**G. H. Olsen**  
This book provides excellent background reading for our *Introducing Digital Electronics Teach-In Book* and will be of interest to everyone studying electronics. The subject is simply explained and well illustrated and the book assumes only a very basic knowledge of electricity. **330 pages** **Order code NE10** **£5.95**

# Project Building

## HOW TO GET YOUR ELECTRONIC PROJECTS WORKING

**R. A. Penfold**  
We have all built projects only to find that they did not work correctly, or at all, when first switched on. The aim of this book is to help the reader overcome just these problems by indicating how and where to start looking for many of the common faults that can occur when building up projects. **96 pages** **Order code BP110** **£2.95**

## HOW TO DESIGN AND MAKE YOUR OWN P.C.B.s

**R. A. Penfold**  
Deals with the simple methods of copying printed circuit board designs from magazines and books and covers all aspects of simple p.c.b. construction including photographic methods and designing your own p.c.b.s. **80 pages** **Order code BP121** **£2.50**

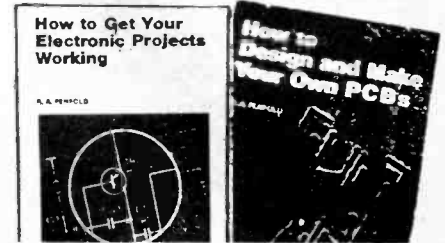

## A BEGINNERS GUIDE TO MODERN ELECTRONIC COMPONENTS

**R. A. Penfold**  
The purpose of this book is to provide practical information to help the reader sort out the bewildering array of components currently on offer. An advanced knowledge of the theory of electronics is not needed, and this book is not intended to be a course in electronic theory. The main aim is to explain the differences between components of the same basic type (e.g. carbon, carbon film, metal film, and wire-wound resistors) so that the right component for a given application can be selected. A wide range of components are included, with the emphasis firmly on those components that are used a great deal in projects for the home constructor. **166 pages** **Order code BP285** **£3.95**

## BEGINNER'S GUIDE TO BUILDING ELECTRONIC PROJECTS

**R. A. Penfold**  
Shows the complete beginner how to tackle the practical side of electronics, so that he or she can confidently build the electronic projects that are regularly featured in magazines and books. Also include examples in the form of simple projects. **112 pages** **Order code 227** **£1.95**

## ELECTRONICS SIMPLIFIED - CRYSTAL SET CONSTRUCTION

**F. A. Wilson, C.G.I.A., C.Eng., F.I.E.E., F.I.E.R.E., F.B.I.M.**  
Especially written for those who wish to participate in the intricacies of electronics more through practical construction than by theoretical study. It is designed for all ages upwards from the day one can read intelligently and handle simple tools. **80 pages** **Order code BP92** **£1.75**

## GUIDE TO BUILDING ELECTRONIC PROJECTS

Published by *Everyday Electronics*  
See the first page of books - ELECTRONICS TEACH-IN No.5 - for full details.

## ELECTRONICS PROJECT BOOK

Published by *Everyday Electronics* in association with *Magenta Electronics*.  
See the first page of books for full details.

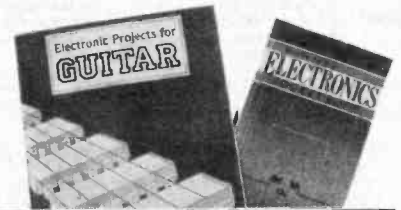

# Testing and Test Gear

## HOW TO USE OSCILLOSCOPES AND OTHER TEST EQUIPMENT

**R. A. Penfold**  
This book explains the basic function of an oscilloscope, gives a detailed explanation of all the standard controls, and provides advice on buying. A separate chapter deals with using an oscilloscope for fault finding on linear and logic circuits. Plenty of example waveforms help to illustrate the control functions and the effects of various fault conditions. The function and use of various other pieces of test equipment are also covered, including signal generators, logic probes, logic pulsers, and crystal calibrators. **104 pages** **Order code BP267** **£3.50**

# Circuits and Design

## PRACTICAL ELECTRONIC BUILDING BLOCKS - BOOK 2

R. A. Penfold

This book is designed to aid electronic enthusiasts who like to experiment with circuits and produce their own projects, rather than simply following published project designs.

Contains: Amplifiers - low level discrete and op-amp circuits, voltage and buffer amplifiers including d.c. types. Also low-noise audio and voltage controller amplifiers. Filters - high-pass, low-pass, 6, 12, and 24dB per octave types. Miscellaneous - i.c. power amplifiers, mixers, voltage and current regulators, etc.

112 pages Order code BP118 £1.95

## PRACTICAL ELECTRONIC FILTERS

Owen Bishop

This book deals with the subject in a non-mathematical way. It reviews the main types of filter, explaining in simple terms how each type works and how it is used.

The book also presents a dozen filter-based projects with applications in and around the home or in the constructor's workshop. These include a number of audio projects such as a rhythm sequencer and a multi-voiced electronic organ.

Concluding the book is a practical step-by-step guide to designing simple filters for a wide range of purposes, with circuit diagrams and worked examples.

192 pages Order code BP299 £4.95

## ELECTRONIC ALARM CIRCUITS MANUAL

R. M. Marston

One hundred and forty useful alarm circuits, of a variety of types, are shown in this volume. The operating principle of each one is explained in concise but comprehensive terms, and brief construction notes are given where necessary.

Aimed at the practical design engineer, technician and experimenter, as well as the electronics student and amateur.

124 pages Order code BP111 £13.95

## ELECTRONIC CIRCUITS FOR THE COMPUTER CONTROL OF MODEL RAILWAYS

R. A. Penfold

The projects consist of various types of interface and controllers, including a high quality pulse type, as well as circuits for train position sensing, signal and electric points control etc.

The use of computers does not have to be restricted to massive layouts. Something as simple as an oval track with

a single siding can be given a new dimension by adding computer control and much fun can be had from these relatively simple set ups.

88 pages Order code BP180 £2.95

## DIGITAL LOGIC GATES AND FLIP-FLOPS

Ian R. Sinclair

This book, intended for enthusiasts, students and technicians, seeks to establish a firm foundation in digital electronics by treating the topics of gates and flip-flops thoroughly and from the beginning.

Topics such as Boolean algebra and Karnaugh mapping are explained, demonstrated and used extensively, and more attention is paid to the subject of synchronous counters than to the simple but less important ripple counters.

No background other than a basic knowledge of electronics is assumed, and the more theoretical topics are explained from the beginning, as also are many working practices. The book concludes with an explanation of microprocessor techniques as applied to digital logic.

200 pages Order code PC106 £8.95

## ELECTRONIC CIRCUITS FOR THE COMPUTER CONTROL OF ROBOTS

Robert Penfold

Robots and robotics offer one of the most interesting areas for the electronics hobbyist to experiment in. Today the mechanical side of robots is not too difficult, as there are robotics kit and a wide range of mechanical components available. The micro controller is not too much of a problem either, since the software need not be terribly complex and many inexpensive home computers are well suited to the task.

The main stumbling block for most would-be robot builders is the electronics to interface the computer to the motors, and the sensors which provide feedback from the robot to the computer. The purpose of this book is to explain and provide some relatively simple electronic circuits which bridge this gap.

92 pages Temporarily out of print

## ELECTRONIC POWER SUPPLY HANDBOOK

Ian R. Sinclair

This book covers the often neglected topic of electronic power supplies. All types of supplies that are used for electronics purposes are covered in detail, starting with cells and batteries and extending by way of rectified supplies and linear stabilisers to modern switch-mode systems, IC switch-mode regulators, DC-DC converters and inverters.

The devices, their operating principles and typical cir-

cuits are all dealt with in detail. The action of rectifiers and the reservoir capacitor is emphasised, and the subject of stabilisation is covered. The book includes some useful formulae for assessing the likely hum level of a conventional rectifier reservoir supply.

136 pages Order code PC108 £7.95

## HOW TO USE OP-AMPS

E. A. Parr

This book has been written as a designer's guide covering many operational amplifiers, serving both as a source book of circuits and a reference book for design calculations. The approach has been made as non-mathematical as possible.

160 pages Order code BP88 £2.95

## MICRO INTERFACING CIRCUITS - BOOK 1

### MICRO INTERFACING CIRCUITS - BOOK 2

R. A. Penfold

Both books include practical circuits together with details of the circuit operation and useful background information. Any special constructional points are covered but p.c.b. layouts and other detailed constructional information are not included.

Book 1 is mainly concerned with getting signals in and out of the computer; Book 2 deals primarily with circuits for practical applications.

BOOK 1 112 pages Order code BP130 £2.75

BOOK 2 112 pages Order code BP131 £2.75

## 50 SIMPLE LED CIRCUITS

R. N. Soar

Contains 50 interesting and useful circuits and applications, covering many different branches of electronics, using one of the most inexpensive and freely available components - the light-emitting diode (LED). Also includes circuits for the 707 common anode display.

64 pages Order code BP42 £1.95

BOOK 2 50 more l.e.d. circuits Order code BP87 £1.95

## CIRCUIT SOURCE BOOK 1

R. A. Penfold

Written to help you create and experiment with your own electronic designs by combining and using the various standard "building block" circuits provided. Where applicable, advice on how to alter the circuit parameters is given.

The circuits covered in this book are mainly concerned with analogue signal processing and include: Audio amplifiers (op.amp and bipolar transistors); audio power amplifiers; d.c. amplifiers; highpass, lowpass, bandpass and notch filters; tone controls; voltage controlled amplifiers and filters; triggers and voltage comparators; gates and electronic switching; bargraphs; mixers; phase shifters, current mirrors, hold circuits, etc.

Over 150 circuits are provided, which it is hoped will be useful to all those involved in circuit design and application, be they professionals, students or hobbyists.

182 pages Order code BP321 £4.95

# Radio, TV, Satellite

## PROJECTS FOR RADIO AMATEURS AND S.W.L.S.

R. A. Penfold

This book describes a number of electronic circuits, most of which are quite simple, which can be used to enhance the performance of most short wave radio systems.

The circuits covered include:- An aerial tuning unit; A simple active aerial; An add-on b.f.o. for portable sets; A wavetramp for combat signals on spurious responses; An audio notch filter; A parametric equaliser; C.W. and S.S.B. audio filters; Simple noise limiters; A speech processor; A volume expander.

Other useful circuits include a crystal oscillator, and RTTY/C.W. tone decoder, and a RTTY serial to parallel converter. A full range of interesting and useful circuits for short wave enthusiasts.

92 pages Order code BP304 £3.95

## AN INTRODUCTION TO AMATEUR RADIO.

I. D. Poole

Amateur radio is a unique and fascinating hobby which has attracted thousands of people since it began at the turn of the century.

This book gives the newcomer a comprehensive and easy to understand guide through the subject so that the reader can gain the most from the hobby. It then remains an essential reference volume to be used time and again. Topics covered include the basic aspects of the hobby, such as operating procedures, jargon and setting up a station. Technical topics covered include propagation, receivers, transmitters and aeriels etc.

150 pages Order code BP257 £3.50

## SIMPLE SHORT WAVE RECEIVER CONSTRUCTION

R. A. Penfold

Short wave radio is a fascinating hobby, but one that seems to be regarded by many as an expensive pastime these days. In fact it is possible to pursue this hobby for a minimal monetary outlay if you are prepared to undertake a bit of i.d.y., and the receivers described in this book can all be built at low cost. All the sets are easy to construct, full wiring diagrams etc. are provided, and they are suitable for complete beginners. The receivers only require simple aeriels, and do not need any complex alignment or other difficult setting up procedures.

The topics covered in this book include: The broadcast bands and their characteristics; The amateur bands and their characteristics; The propagation of radio signals; Simple aeriels; Making an earth connection; Short wave crystal set, Simple t.r.f. receivers; Single sideband reception; Direct conversion receiver.

Contains everything you need to know in order to get started in this absorbing hobby.

88 pages Order code BP275 £3.95

## AN INTRODUCTION TO SATELLITE TELEVISION

F. A. Wilson

As a definitive introduction to the subject this book is presented on two levels. For the absolute beginner or anyone thinking about purchasing or hiring a satellite TV system, the story is told as simply as such a complex one can be in the main text.

For the professional engineer, electronics enthusiast, student or others with technical backgrounds, there are numerous appendices backing up the main text with additional technical and scientific detail formulae, calculations, tables etc. There is also plenty for the DIY enthusiast with practical advice on choosing and installing the most problematic part of the system - the dish antenna.

104 pages Temporarily out of print

## AN INTRODUCTION TO AMATEUR COMMUNICATIONS SATELLITES

A. Pickford

Communications and broadcast satellites are normally inaccessible to individuals unless they are actively involved in their technicalities by working for organisations such as British Telecom, the various space agencies or military bodies, even those who possess a satellite television receiver system do not participate in the technical aspects of these highly technological systems.

There are a large number of amateur communications satellites in orbit around the world, traversing the globe continuously and they can be tracked and their signals received with relatively inexpensive equipment. This equipment can be connected to a home computer such as the BBC Micro or IBM compatible PCs, for the decoding of received signals.

This book describes several currently available systems, their connection to an appropriate computer and how they can be operated with suitable software.

102 pages Order code BP290 £3.95

## AERIAL PROJECTS

R. A. Penfold

The subject of aeriels is vast but in this book the author has considered practical aerial designs, including active, loop and ferrite aeriels which give good performances and are relatively simple and inexpensive to build. The complex theory and mathematics of aerial design have been avoided.

Also included are constructional details of a number of aerial accessories including a pre-selector, attenuator, filters and tuning unit.

96 pages Order code BP105 £2.50

## INTERNATIONAL RADIO STATIONS GUIDE

P. Shore

Provides the casual listener, amateur radio DXer and the professional radio monitor with an essential reference work designed to guide him or her around the ever more complex radio bands. This new edition has been completely revised and rewritten and incorporates much more information which is divided into the following sections:

Listening to Short Wave Radio; Choosing a Short Wave Radio Receiver; How to Use the IRSG; Abbreviations; Country Codes; Worldwide Short Wave Radio Stations; European, Middle Eastern and African Long Wave Radio Stations; European, Near and Middle Eastern and African Medium Wave Radio Stations; Canadian Medium Wave Radio Stations; USA Medium Wave Radio Stations; Broadcasts in English; Programmes for DXers and Short Wave Listeners; UK FM Radio Stations; Time Differences From GMT; Wavelength/Frequency Conversion.

226 pages Order code BP259 £5.95

# DIRECT BOOK SERVICE

## ORDERING DETAILS

Please state the title and order code clearly, print your name and address and add the required postage to the total order.

Add £1 to your total order for postage and packing (overseas readers add £2 for countries in Europe, or add £5 for all countries outside Europe, surface mail postage) and send a PO, cheque, international money order, (£ sterling only) made payable to Direct Book Service or credit card details (including the card expiry date), Visa or Mastercard (Access) - minimum credit card order is £5 - quoting your name and address, the order code and quantities required to DIRECT BOOK SERVICE, 33 GRAVEL HILL, WIMBORNE, DORSET BH21 1RW (mail order only).

Although books are normally sent within seven days of receipt of your order, please allow a maximum of 28 days for delivery. Overseas readers allow extra time for surface mail post.

Please check price and availability (see latest issue of Everyday with Practical Electronics) before ordering from old lists.

Note - our postage charge is the same for one book or one hundred books!

## MORE BOOKS NEXT MONTH

Direct Book Service is a division of Wimborne Publishing Ltd

# BABANI BOOKS

We now supply *all* the books published by Bernard Babani (Publishing) Ltd. We have always supplied a selected list of Babani books and you will find many of them described on the previous pages or in next months issue of *Everyday with Practical Electronics* (the books with a BP prefix to the order code are Babani books).

Many readers have asked us to also supply various other Babani books, which have a reputation for value for money. Our customers tell us they appreciate our speedy service and low postage charge and they

would like to be able to purchase all the books from us and thus keep the postage charge to an absolute minimum (£1 for UK p&p no matter how many books you buy). We are pleased to be able to respond; with the aid of Michael Babani (M.D.) we are now able to meet all your requirements for their books. *If it's Babani and in print we can supply it.* Babani presently list over 180 different technical titles those *not* described in detail on the previous *Direct Book Service* pages or in next months issue are listed below:

Code	Title	Price	Code	Title	Price	Code	Title	Price
BP28	Resistor Selection Handbook	£0.60	BP153	An Introduction to Programming the Amstrad CPC 464 & 664	£2.50	BP258	Learning to Program in C	£4.95
BP37	50 Projects using Relays, SCRs and TRIACs	£2.95	BP154	An Introduction to MSX BASIC	£2.50	BP259	A Concise Introduction to UNIX	£2.95
BP39	50 (FET) Field Effect Transistor Projects	£2.95	BP156	An Introduction to QL Machine Code	£2.50	BP260	A Concise Introduction to OS/2	£2.95
BP44	IC 555 Projects	£2.95	BP157	How to Write ZX Spectrum & Spectrum+ Games Programs	£2.50	BP261	A Concise Introduction to Lotus 1-2-3 (Revised Edition)	£3.95
BP48	Electronic Projects for Beginners	£1.95	BP158	An Introduction to Programming the Commodore 16 & Plus 4	£2.50	BP262	A Concise Introduction to Wordperfect (Revised Edition)	£3.95
BP49	Popular Electronic Projects	£2.50	BP159	How to Write Amstrad CPC464 Games Programs	£2.50	BP263	A Concise Introduction to dBASE	O.O.P.
BP56	Electronic Security Devices	£2.50	BP161	Into the QL Archive	£2.50	BP264	A Concise Advanced User's Guide to MS-DOS	O.O.P.
BP58	50 Circuits Using 7400 Series IC's	O.O.P.	BP162	Counting on QL Abacus	£2.50	BP269	An Introduction to Desktop Publishing	O.O.P.
BP63	Alternating Current Theory (Elements of Electronics - Book 2)	£3.50	BP171	Easy Add-on Projects for Amstrad CPC 464, 664, 6128 and MSX Computers	£2.95	BP270	A Concise Introduction to Symphony	£3.95
BP68	Choosing and Using Your Hi-Fi	£1.65	BP174	More Advanced Electronic Music Projects	O.O.P.	BP272	Interfacing PC's & Compatibles	£3.95
BP74	Electronic Music Projects	£2.95	BP175	How to Write Word Game Programs for the Amstrad CPC 464, 664 and 6128	£2.95	BP273	Practical Electronic Sensors	£4.95
BP76	Power Supply Projects	£2.50	BP182	MIDI Projects	£2.95	BP274	A Concise Introduction to SuperCal5	£3.95
BP78	Practical Computer Experiments	£1.75	BP187	A Practical Reference Guide to Word Processing on the Amstrad PCW8256 and PCW8512	£5.95	BP276	Short Wave Superhet Receiver Construction	£2.95
BP84	Digital IC Projects	£1.95	BP190	More Advanced Electronic Security Projects	£2.95	BP279	A Concise Introduction to Excel	£3.95
BP86	An Introduction to BASIC Programming Techniques	£1.95	BP191	Simple Application of the Amstrad CPCs for Writers	£2.95	BP280	Getting the Most From Your PC's Hard Disc	£3.95
BP90	Audio Projects	£2.50	BP192	More Advanced Power Supply Projects	£2.95	BP283	A Concise Introduction to SmartWare II	£4.95
BP94	Electronic Projects for Cars and Boats	£1.95	BP193	LOGO for Beginners	£2.95	BP284	Programming in QuickBASIC	£4.95
BP95	Model Railway Projects	£2.95	BP196	BASIC & LOGO in Parallel	£2.95	BP287	A Reference Guide to Practical Electronics Terms	£5.95
BP97	IC Projects for Beginners	£2.50	BP197	An Introduction to the Amstrad PC's	£5.95	BP288	A Concise Introduction to Windows 3.0	£3.95
BP99	Mini-matrix Board Projects	£1.95	BP198	An Introduction to Antenna Theory	£2.95	BP291	A Concise Introduction to Ventura	£3.95
BP109	The Art of Programming the 1K ZX81	£1.95	BP203	A Concise Introduction to GEM	£2.95	BP292	Public Address Loudspeaker Systems	£3.95
BP114	The Art of Programming the 16K ZX81	£2.50	BP243	BBC BASIC86 on the Amstrad PC's and IBM Compatibles - Book 1: Language	£3.95	BP293	An Introduction to Radio Wave Propagation	£3.95
BP122	Audio Amplifier Construction	£2.95	BP244	BBC BASIC86 on the Amstrad PC's and IBM Compatibles - Book 2: Graphics and Disk Files	£3.95	BP294	A Concise Introduction to Microsoft Works	O.O.P.
BP125	25 Simple Amateur Band Aerials	£1.95	BP245	Digital Audio Projects	£2.95	BP298	A Concise Introduction to the Mac System & Finder	£3.95
BP126	BASIC & PASCAL in Parallel	£1.50	BP246	Musical Applications of the Atari ST's	£5.95	BP302	A Concise Users Guide to Lotus 1-2-3 Release 3.1	£3.95
BP128	20 Programs for the ZX Spectrum & 16K ZX81	£1.95	BP247	More Advanced MIDI Projects	£2.95	BP303	Understanding PC Software	£4.95
BP129	An Introduction to Programming the ORIC-1	£1.95	BP249	More Advanced Test Equipment Construction	£3.50	BP306	A Concise Introduction to AmiPro 3	£4.95
BP132	25 Simple SW Broadcast Band Aerials	£1.95	BP250	Programming in FORTRAN 77	£4.95	BP307	A Concise Introduction to QuarkXPress	£4.95
BP133	An Introduction to Programming the Dragon 32	£1.95	BP251	Computer Hobbyists Handbook	£5.95	BP311	An Introduction to Scanners and Scanning	£4.95
BP136	25 Simple Indoor and Window Aerials	£1.75				BP312	An Introduction to Microwaves	£3.95
BP137	BASIC & FORTRAN in Parallel	£1.95				BP313	A Concise Introduction to Sage	£3.95
BP138	BASIC & FORTH in Parallel	£1.95				BP314	A Concise Introduction to Quattro Pro	£4.95
BP143	An Introduction to Programming the Atari 600/800XL	£1.95				BP315	An Introduction to the Electromagnetic Wave	£4.95
BP144	Further Practical Electronics Calculations & Formulae	O.O.P.				BP322	Circuits Source Book 2	£4.95
BP145	25 Simple Tropical and MW Band Aerials	£1.75				BP324	The Art of Soldering	£3.95
BP148	Computer Terminology Explained	£1.95				BP330	A Concise user's Guide to Lotus 1-2-3 Release 2.4	£4.95
BP149	A Concise Introduction to the Language of BBC Basic	£1.95						

IF NO PRICE IS SHOWN THE BOOK IS OUT OF PRINT (O.O.P.)  
SEE PREVIOUS PAGE FOR FULL ORDERING DETAILS

## PCB SERVICE

Printed circuit boards for certain EPE constructional projects are available from the PCB Service, see list. These are fabricated in glass fibre, and are fully drilled and roller tinned. All prices include VAT and postage and packing. Add £1 per board for airmail outside of Europe. Remittances should be sent to The PCB Service, *Everyday with Practical Electronics*, 6 Church Street, Wimborne, Dorset BH21 1JH. Cheques should be crossed and made payable to *Everyday with Practical Electronics* (Payment in £ sterling only).

NOTE: While 95% of our boards are now held in stock and are dispatched within seven days of receipt of order, please allow a maximum of 28 days for delivery - overseas readers allow extra if ordered by surface mail.

Please check price and availability in the latest issue.

Boards can only be supplied on a payment with order basis.

**SALE!** All p.c.b.s on this page reduced to **1/2 PRICE**

(Just send half the price shown, while stocks last.)  
PCBS ON OPPOSITE PAGE PRICES AS SHOWN

PROJECT TITLE	Order Code	Cost
Video Guard Alarm	556	£3.80
Fridge Alarm	565	£3.00
Multi-Chan Remote Light Dim Relay/Decoder	601	£4.86
Power Supply	603	£3.00
Tea Tune Thermostat	609	£3.00
Time Switch	614	£4.84
Suntan Timer	610	£3.07
Car Alarm	615	£3.12
Eprom Eraser	620	£4.07
Doorbell Delay	616	£3.56
Sound-to-Light Interface	637	£6.24
Midi Pedal	639	£7.00
Midi Merge	640	£3.00
Audio Lead Tester	641	£5.77

PROJECT TITLE	Order Code	Cost
Light Sentinel: Main Board	632	£9.20
4-Channel Auto-Fader Interface	642	£6.80
Electron A/D Interface	645	£4.84
Programmable Pocket Timer	648	£3.82
Electronic Spirit Level	649	£3.85
Distance Recorder	651	£5.23
Power Supplies: Fixed Voltage	654	£4.08
Music on Hold	646	£3.85
Power Supplies - 25V 700mA	656	£4.35
EE Seismograph - Control board only	658	£4.08
Wash Pro	643	£3.83
Logo/lego & Spectrum Interface	664	£5.60
Biofeedback Signal Generator	666	£4.08
Quick Cap Tester	668	£3.92
Superhet Receiver/Tuner/Amp	679/680	£4.22
Stereo Noise Generator	681	£4.24
Digital Experimenter's Unit - Pulse Generator	682	£4.46
Power Supply	683	£3.66
Amstrad Speech Synthesiser	684	£4.68
80 Metre Direct Conversion Radio	691	£4.95
Mains Appliance Remote Control		
Encoder Board A	694	£6.61
Encoder Board B	695	£4.78
The Tester	696	£4.15
Mains Appliance Remote Control		
Mains ON/OFF Decoder	697	£4.55
(5 or more 697's ordered together)		£3.25 each
Hand Tally: Main Bd and Display Bd	699, 700	£10.95
Alarm Bell Time-Out	701	£4.10
Mains Appliance Remote Control		
Temperature Controller (p.c.b. only)	702	£5.20
Ghost Waker		
Frequency Meter	703	£4.32
	704	£5.25
Freq. Meter/Tachometer		
	705	£3.98
EE Musketeer (TV/Video/Audio)	706	£5.78
Microcontroller Light Sequencer		
Versatile Bench Power Supply Unit	708/709	£10.90
Teach-In '91, Part 1 - L200 Module	710	£4.24
	711	£3.93
Dual Output Module		Sorry sold out
LM723 Module	713	£4.21



# VIDEOS ON ELECTRONICS

Everyday with Practical Electronics is pleased to announce the availability of a range of videos designed to provide instruction on electronics theory. Each video gives a sound introduction and grounding in a specialised area of the subject. The tapes make learning both easier and more enjoyable than pure textbook or magazine study. They should prove particularly useful in schools, colleges, training departments and electronics clubs as well as to general hobbyists and those following distance learning courses etc.

**VT201 to VT206 is a basic electronics course and is designed to be used as a complete series, if required.**

**VT201** 54 minutes. Part one; D.C. Circuits. This video is an absolute must for the beginner. Series circuits, parallel circuits, Ohms law, how to use the digital multimeter and much more. **Order Code VT201**

**VT202** 62 minutes. Part two; A.C. Circuits. This is your next step in understanding the basics of electronics. You will learn about how coils, transformers, capacitors, etc are used in common circuits. **Order Code VT202**

**VT203** 57 minutes. Part three; Semiconductors. Gives you an exciting look into the world of semiconductors. With basic semiconductor theory. Plus 15 different semiconductor devices explained. **Order Code VT203**

**VT204** 56 minutes. Part four; Power Supplies. Guides you step by step through different sections of a power supply. **Order Code VT204**

**VT205** 57 minutes. Part five; Amplifiers. Shows you how amplifiers work as you have never seen them before. Class A, class B, class C, op.amps. etc. **Order Code VT205**

**VT206** 56 minutes. Part six; Oscillators. Oscillators are found in both linear and digital circuits. Gives a good basic background in oscillator circuits. **Order Code VT206**

By the time you have completed VT206 you have completed the basic electronics course and should have a good understanding of the operation of basic circuit elements.

**Now for the digital series of six videos. This series is designed to provide a good grounding in computer technology.**

**VT301** 56 minutes. Digital One begins with the basics as you learn about seven of the most common gates which are used in almost every digital circuit, plus Binary notation. **Order Code VT301**

**VT302** 55 minutes. Digital Two will further enhance your knowledge of digital basics. You will learn about Octal and Hexadecimal notation groups, flip-flops, counters, etc. **Order Code VT302**

**VT303** 56 minutes. Digital Three is your next step in obtaining a solid understanding of the basic circuits found in today's digital design. Gets into multiplexers, registers, display devices, etc. **Order Code VT303**

**VT304** 57 minutes. Digital Four shows you how the computer is able to communicate with the real world. You will learn about digital to analogue and analogue to digital converter circuits. **Order Code VT304**

**VT305** 56 minutes. Digital Five introduces you to the technology used in many of today's memory devices. You will learn all about ROM devices and then proceed into PROM, EPROM, EEPROM, SRAM, DRAM, and MBM devices. **Order Code VT305**

**VT306** 56 minutes. Digital Six gives you a thorough understanding in the basics of the central processing unit and the input/output circuits used to make the system work. **Order Code VT306**

By now you should have a good understanding of computer technology and what makes computers work. This series is also invaluable to the computer technician to understand the basics and thus aid troubleshooting.

## NEW NEW NEW

**VT102** 84 minutes: Introduction to VCR Repair. Warning, not for the beginner. Through the use of block diagrams this video will take you through the various circuits found in the VHS system. You will follow the signal from the input to the audio/video heads then from the heads back to the output. **Order Code VT102**

**VT103** 35 minutes: A step-by-step easy to follow procedure for professionally cleaning the tape path and replacing many of the belts in most VHS VCR's. The viewer will also become familiar with the various parts found in the tape path. **Order Code VT103**

Each video uses a mixture of animated current flow in circuits plus text, plus cartoon instruction etc., and a very full commentary to get the points across. The tapes are imported by us and originate from VCR Educational Products Co, an American supplier.

(All videos are to the UK PAL standard on VHS tapes)

## ORDERING

To order see our *Direct Book Service* "Ordering Details" - the postage for tapes is the same as for our range of books and you can order tapes and books at the same time and pay only one lot of postage. Each video costs £29.95 inc. VAT. If ordering eight or more together we will give you an extra video FREE, just indicate on your order which extra one you would like.

**£29.95**  
each inc. VAT

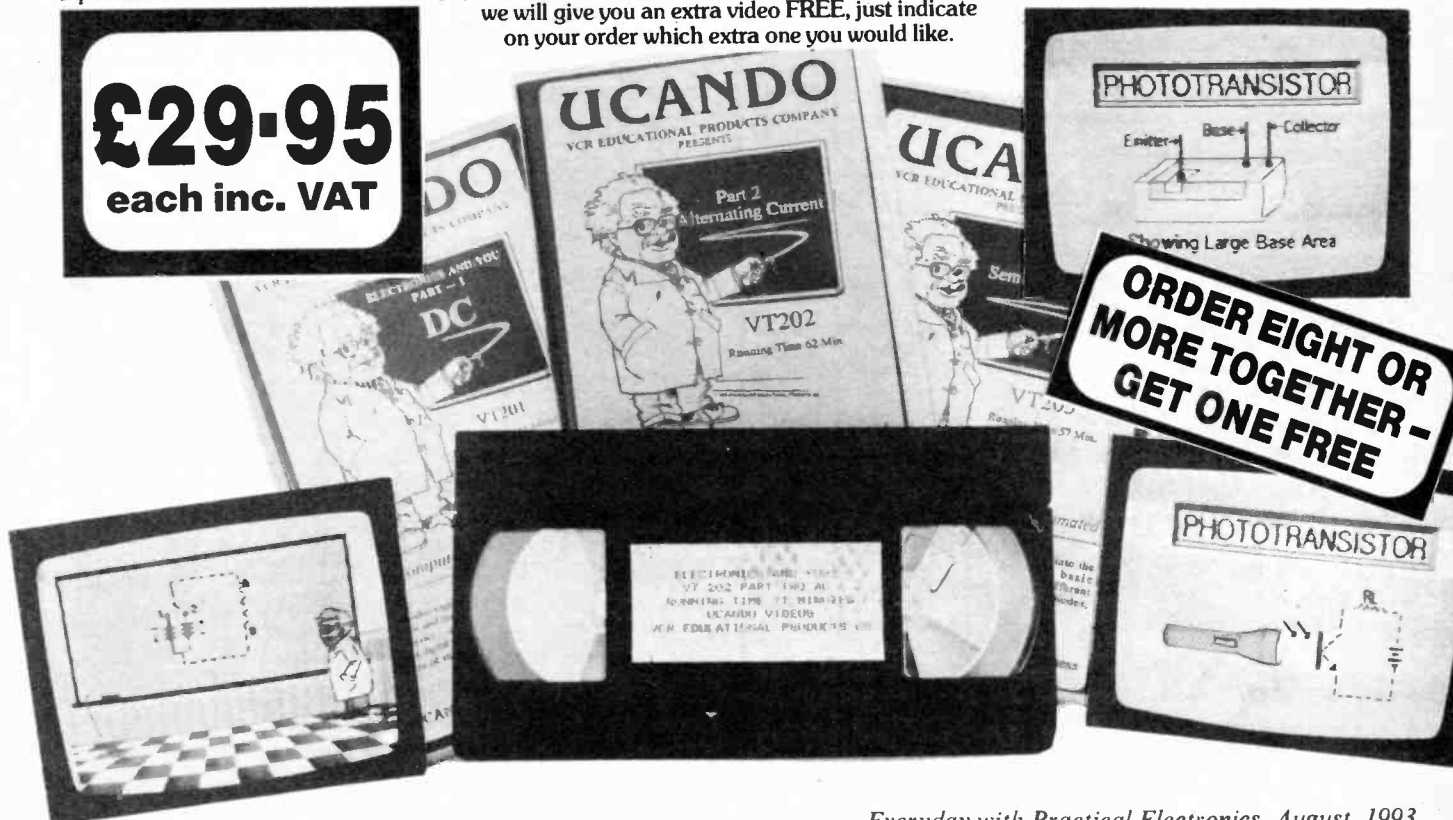

## VARIABLE VOLTAGE TRANSFORMERS

INPUT 220/240V AC 50/60 OUTPUT 0-260V

	Price	P&P
0.5KVA 2.5 amp max	£29.00	£4.65
	(£39.54 inc VAT)	
1KVA 5 amp max	£37.40	£6.25
	(£51.29 inc VAT)	
2KVA 10 amp max	£54.00	£7.80
	(£72.62 inc VAT)	
3KVA 15 amp max	£71.50	£7.80
	(£93.18 inc VAT)	
5KVA 25 amp max	£126.50	
	(Plus Carriage)	

Buy direct from the Importers. Keenest prices in the country

### COMPREHENSIVE RANGE OF TRANSFORMERS—LT-ISOLATION & AUTO

110-240V Auto transfer either cased with American socket and mains lead or open frame type. Available for immediate delivery.

### WIDE RANGE OF XENON FLASH TUBES

Write/Phone your enquiries

#### ULTRA VIOLET BLACK LIGHT FLUORESCENT TUBES

4ft 40 watt	£12.00 (callers only)	(£14.10 inc VAT)
2ft 20 watt	£7.44 + £1.25 p&p	(£10.21 inc VAT)
12in 8 watt	£4.90 + 75p p&p	(£6.52 inc VAT)
6in 4 watt	£3.96 + 50p p&p	(£5.24 inc VAT)
6in 4 watt	£3.96 + 50p p&p	(£5.24 inc VAT)

#### 230V AC BALLAST KIT

For either 6in, 9in or 12in tubes £6.05 + £1.40 p&p (£8.75 inc VAT)

#### 400 WATT UV LAMP

Only £38.00 + £4.00 p&p (£49.35 inc VAT)

#### 160 WATT SELF BALLASTED BLACK LIGHT MERCURY BULB

Available with B.C. or E.S. fitting  
Price inc VAT & p&p £25.55

#### 12V D.C. BILGE PUMPS

500 GPH 15ft head 3 amp £19.98  
1750 GPH 15ft head 9 amp £34.55  
Also now available.  
24V D.C. 1750 GPH 15ft head 5 amp £36.55  
All designed to be used submerged.  
PRICES INCLUDE P&P & VAT

#### EPROM ERASURE KIT

Build your own EPROM ERASURE for a fraction of the price of a made-up unit kit of parts less case includes 12in 8 watt 2537 Angstrom Tube Ballast unit, pair of bi-pin leads, neon indicator, on/off switch, safety microswitch and circuit £14.00 + £2.00 p&p (£18.80 inc VAT)

#### SUPER HY-LIGHT STROBE KIT

Designed for Disco, Theatrical use etc.  
Approx 16 joules. Adjustable speed £50.00 + £3.00 p&p (£62.28 inc VAT)  
Case and reflector £24.00 + £3.00 p&p (£31.73 inc VAT)  
SAE for further details including Hy-Light and industrial Strobe Kits.

## "BOFFINS SPECIAL" — UNIQUE OFFER

Surplus Precision Medical Unit, internally in excellent condition. Designed primarily to eject a precise controllable amount of fluid from a medical syringe (latter not supplied). Contains the following removable components: Dual Micro Processor Boards and EPROMS. Escap Precision 12V DC Motor with 300:1 Gear Box and optical encoder coupled to a precision threaded drive mechanism. Mains supply with 6 x 1.5V Ni-Cad A.A. calls back-up. L.C.D. Digital read-out 17mm high with legends Audible warning.

These are sold for the dismantling of the exceptional quality components. Regret no Circuits available. Ridiculously low price: **£16.00 + £4.00 p&p (£23.50 inc VAT)**

#### 12V D.C. GEARED MOTOR

12V D.C. Reversible precision-built Motor Output speeds no load approx. 12V-26 rpm; 9V-20 rpm; 6V-12 rpm. Will work at lower voltages and still retain a reasonable torque. Ideal for robotics etc. Size: L 40mm W 29 mm H 39mm. Shaft: 3mm dia x 10mm long. Price: **£8.00 + 50p p&p (£8.50 inc VAT)**

#### TORIN CENTRIFUGAL BLOWER

230V AC, 2.800 RPM, 0.9 amp. 130mm diameter, impeller outlet 63 x 37mm, overall size 195 x 160 x 150mm. long. Price **£17.50 + £2.50 p&p (£23.50 inc VAT)**

#### SOLID STATE RELAY

7 amp @ 240V A.C. when mounted on suitable Heat-sink. Can be driven from T.T.L. or Computer output between 3-10V D.C. Size 24mm x 17mm x 15mm high. Fixing centres 30mm (TO-3). Price: **£3.00 + 40p p&p (£4.00 inc VAT)**

#### GEARED MOTORS

71 RPM 20lb inch torque reversible 115V AC input including capacitor and transformer for 240V AC operation. Price inc VAT & p&p **£27.73**

#### SOLID STATE EHT UNIT

Input 230/240V AC. Output approx 15KV. Producing 10mm spark. Built-in 10 sec timer. Easily modified for 20 sec, 30 sec to continuous. Designed for boiler ignition. Dozens of uses in the field of physics and electronics. eg supplying neon or argon tubes etc. Price less case **£8.50 + £2.40 p&p (£12.81 inc VAT) NMS**

#### SAVE POUNDS !!!

Build your own forged bank note detector. Can detect counterfeiters amongst a quantity of notes. Complete kit of parts less case. 240v a.c. including 6" µV black light tube, starter and holder, a pair, b1-pin tube holders. Total price including p&p & VAT only **£13.99**

#### MICROSWITCH

Pye 15 amp changeover lever microswitch, type 171. Brand new. price 5 for £7.05 inc VAT & p&p

#### WASHING MACHINE WATER PUMP

Brand new 240V AC fan cooled. Can be used for a variety of purposes. Inlet 1 1/2in, outlet 1in. Price includes p&p & VAT. **£11.20 each or 2 for £20.50 inc. vat.**

LEDs 3mm or 5mm red or green 6p each, yellow 11p each. High intensity red, green or yellow. 5mm 30p each.  
Cable ties 1p each. **£5.95 per 1000, £49.50 per 10,000.**

Stepping motor 4 phase 12V 7.5 step 50 ohms **£8.95**  
SAA1027 stepping motor driver chip **£3.95**  
FM Transmitter kit, good quality sound **£8.60**

High quality photo resist copper clad epoxy glass boards

Dimensions	single sided	double sided
3x4 inches	£0.95	£1.07
4x8 inches	£2.40	£2.88
6x12 inches	£5.37	£6.44
12x12 inches	£10.66	—

#### Rechargeable Batteries

AA (HP7) 500mAh	£0.99
AA 700mAh	£1.95
C 2AH with solder tags	£3.60
D 4AH with solder tags	£4.95
1/2AA with solder tags	£1.55
AAA (HP16) 150mAh	£1.75
AA 500mAh with solder tags	£1.55
C (HP11) 1.8AH	£2.20
D (HP2) 1.2AH	£2.60
PP3 8.4V 110mAh	£4.95
Sub C with solder tags	£2.50
1/3 D with tags (Philips CTV)	£1.95

Standard charger, charges 4 AA cells in 5 hours or 4Cs or Ds in 12-14 hours + 1xPP3 (1, 2, 3 or 4 cells may be charged at a time) **£5.95**

High power charger, as above but charges the Cs and Ds in 5 hours; AAs, Cs and Ds must be charged in 2s or 4s **£10.95**

Special offers — please check for availability

F cells 320mAh x 37mm	£3.95
4 cell with solder tags 1.2V	£4.30
42mm x 16mm dia. 1.2V	£1.45
Stick of 4 171mm x 16mm dia., with red & black leads 4.8V	£5.95
4 cell battery 34mm x 25mm dia.	£3.50
Computer grade capacitors with screw terminals.	
38000µf 20V £2.50; 87000µf 10V £1.50;	
68000µf 15V £2.95; 10000µf 16V £1.50	
7 segment common anode led display, 12mm	£0.45
LM231AT 5.0 low drop out 5V regulator TO220 package	£0.85
7812 and 7912 12V 1A regulators	£20.00 per 100
LM337T TO3 case variable regulator	£1.60
100 + £1.10	
BS250 P channel mosfet 45p. BC559 transistor (1/2C cells)	per 100 £3.95
74LS05 hex inverter	£10.00 per 100
Used 8748 Microcontroller	£3.50
SL952 UHF Limiting amplifier LC 16 surface mounting package with data sheet	£1.95
AM27502	£1.25 each; 90p 100 +
CV4007UB	10p 100 +, 6p 1000 +
TV Mains switch, 4A double pole with momentum contacts for remote control, pack of 10	£3.95
box of 60	£19.95
DC-DC converter, Reliability model, V12P5, 12V in 5V 200mA out, 300V Input to output. Isolation with data. £4.95 each or pack of 10	£39.50
Hour counter used 7 digit 240V ac 50Hz	£1.45
Resistor pack 2500 resistors 1/8-2W 50 different values	£8.95

Resistor jumbo pack 25000, 1/4 and 1/2W resistors our choice of values and size, will be mainly in boxes or rolls of 1000, 2000 and 5000 of one type **£25.00**  
Qwerty keyboard, 58 key good quality switches, new **£5.00**  
Qwerty keyboard with serial output, no data (used) **£8.00**  
Polyester capacitors, box type, 22.5mm lead pitch  
1µf 250V dc 20p each, 15p 100 +, 10p 1000 +  
2.2µf 250V dc 30p each, 20p 100 +, 15p 1000 +  
3.3µf 100V dc 30p each, 20p 100 +, 15p 1000 +  
1µf 50V bipolar electrolytic axial leads, 15p each, 7.5p 1000 +  
0.22µf 260V polyester axial leads, 15p each, 100 + 7.5p each

Philips 123 series solid aluminium axial leads.  
33µf 10V & 2.2µf 40V 40p each, 25p 100 +  
Multilayer AVX cerami capacitors, all 5mm pitch, 15p 100pf, 150pf, 220pf, 10,000pf (10n) 10p each, 5p 100 +, 3.5p 1000 +  
Waiwyn W23 9W 120 ohm 35p each, 20p 100 + 680 ohm 2W metal film resistor, 4p 100 +, 2p 1000 +

Solid carbon resistors, very low inductance, ideal for RF circuits, 270hm 2W, 680hm 2W 25p each, 15p each 100 +, we have a range of 0.25W, 0.5w, 1w and 2w solid carbon resistors — please send SAE for list

Intelligent 4 digit alphanumeric (5x7 dot 0.145") red LED display, 12 pin 0.6 inch wide package.  
Siemens type DL1R1414 £2.50 each, £2.00 30 +, data sheets £1.00

AMD 27256-3 Eproms £2.00 each, £1.25 100 +  
DIP switch 3PCO 12 pin (ERG SDC-3-023) 60p each, 40p 100 +  
Disk Drive Boxes for a 5.25 disk drive with room for a power supply light, grey plastic 67mm x 268mm x 247mm £7.96 or £49.50 for 10  
Hand Held Ultrasonic remote controller **£3.95**  
Computer grade 58000µf 60V capacitors with screw terminals **£4.95**  
CV2486 gas relay 30mm x 10mm dia with 3 wire terminals, will also work as a neon light, 20p each, £7.50 per 100  
A23 12V car alarm remote control and lighter battery 75p each, £50.00 100 +  
40µf 370V a.c. motor start capacitor (dielectric type containing no PCBs) **£5.95 each or £49.50 for 10**

All products advertised are new and unused unless otherwise stated.

Wide range of CMOS TTL 74HC 74F Linear Transistors kits, rechargeable batteries, capacitors, tools etc. always in stock

Please add 95p towards P&P  
VAT included in all prices

## JPG ELECTRONICS

276-278 Chatsworth Road  
Chesterfield S40 2BH  
Access/Visa Orders:  
(0246) 211202  
Callers welcome

# NEW STYLE EPE BINDERS

A totally new type of binder is now available to hold and protect twelve issues of *Everyday with Practical Electronics*. This new ring binder uses a special system to allow the issues to be easily removed and reinserted without any damage. A nylon strip slips over each issue and this passes over the four rings, thus holding the magazine in place (see photo).

The new binders are finished in hard wearing royal blue p.v.c. with the magazine logo in gold on the spine. We were hoping to keep the price the same as the previous binders but unfortunately the postage cost has defeated us as they are much heavier than the previous ones. The price is £4.95 plus £3.50 post and packing (for overseas readers the postage is

£6.00 to everywhere except Australia and Papua New Guinea which costs £10.50).

Send your payment in £'s sterling to Everyday with Practical Electronics, 6 Church Street, Wimborne, Dorset BH21 1JH. Tel: 0202 881749. Fax: 0202 841692.

We also accept credit card payments Mastercard (Access) or Visa (minimum credit card order £5). Send your card number and card expiry date plus cardholders address (if different to the delivery address).



# EVERYDAY WITH PRACTICAL ELECTRONICS

CLASSIFIED

Everyday with Practical Electronics reaches twice as many UK readers as any other independent monthly hobby electronics magazine, our audited sales figures prove it. We have been the leading independent monthly magazine in this market for the last eight years

If you want your advertisements to be seen by the largest readership at the most economical price our classified and semi-display pages offer the best value. The prepaid rate for semi-display space is £8 (+VAT) per single column centimetre (minimum 2.5cm). The prepaid rate for classified adverts is 30p (+VAT) per word (minimum 12 words).

All cheques, postal orders, etc., to be made payable to Everyday with Practical Electronics. VAT must be added. Advertisements, together with remittance, should be sent to Advertisements, Everyday with Practical Electronics, Holland Wood House, Church Lane, Great Holland, Essex CO13 0JS. Phone/Fax (0255) 850596.

For rates and information on display and classified advertising please contact our Advertisement Manager, Peter Mew as above.

**SUPER FM MICROTRANSMITTERS**  
 HEAR ON ANY FM RADIO FULL INSTRUCTIONS BUILT-IN MICROPHONE LONG RANGE ENCASED EASY TO USE  
  
 HIGHLY SENSITIVE READY TO USE FULLY TUNEABLE 74-115MHz ON/OFF SWITCH MATCHBOX SIZE GUARANTEED  
 £9.50 Post free. Cheques, PO's. Tel. 0205 362003  
 Mr. B. Hicks, 24 Brewster Rd., Boston, Lincs PE21 0DY

**PC TECHNICAL SHAREWARE**  
 Would you like to see the best range of low cost technical and scientific public domain & shareware for IBM PC in the UK? HUGE RANGE includes: - PACKET, FAX, RX/TX control, PCB design, Circuits and ANTENNA analysis, QSO logging, CAD ELECTRONIC & MECH engineering, SCIENTIFIC, MATHS & STATS, MEDICAL, PROGRAMMING, SOURCE CODE, DATA, EDUCATIONAL, WINDOWS, BUSINESS and lots more  
 Write, phone or fax today for your free 124 page printed catalogue  
  
 The Public Domain Software Library  
 Winscombe House, Beacon Road  
 Crowborough, Sussex TN6 1UL  
 Tel 0892 663298, Fax 0892 667473  
 ASP Approved Vendor

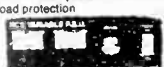
**RCS VARIABLE VOLTAGE D.C. BENCH POWER SUPPLY**  
 1 to 24 volts up to 1/2 amp. 1 to 20 volts up to 1 amp. 1 to 16 volts up to 1 1/2 amps d.c. Fully stabilised. Twin panel meters for instant voltage and current readings. Overload protection  
  
 Fully variable Operates from 240V a.c. Compact unit. Size 9 x 5 x 3in.  
**£45 inc. VAT**  
 + Post and insurance £4  
 NEW MODEL. Up to 38volts d.c. at 6 amps 10 amps peak. Fully variable Twin panel meters. Size 14 1/2 x 11 x 4 3/4in. £66 inc VAT. Can £6.

**RADIO COMPONENT SPECIALISTS**  
 337 WHITEHORSE ROAD, CROYDON  
 SURREY, U.K. Tel: 081-684 1665  
  
 List. Large SAE. Delivery 7 days. Callers welcome. Closed Wednesday

This 3cm space in  
 Everyday with  
 Practical Electronics  
 Will ONLY cost you  
**£24 + VAT**

**VACUUM PUMP DESOLDERER**  
 Easily made for £10-£30. Revolutionize servicing. Strip i.c.'s from plated thru boards and save £££s. Plans £2.00. Parts available.  
 Details s.a.e. (UK or IR)  
 V. Carroll, Castle Lane, Dillonstown, Dunleer, Co. Louth, Ireland.  
 Tel: 010 353 4151419

**QUALITY 30W SWITCH MODE POWER SUPPLY**  
 Multi output: -12V at 0.3A, +12V at 1.2A + 5V at 3A 110/240V operation, dimensions, 160 x 100 x 40mm  
 Prices: Used £5. New £10 plus P&P  
 Cheques payable to  
**CUBE ELECTRONIC SYSTEMS LTD**  
 26 Park Road, Bingley  
 West Yorkshire BD16 4JD  
 Tel 0274 551159. Fax: 0274 551416

**SOLAR PANELS**  
 Special offer 12V nom (20V o/c) 80mA. 12"x6" pre-wired Amorphous Silicon panel £4.50 (5 for £18) plus £1.50 p&p per order. Many other sizes, wind generators and other products. Orders to (Catalogue 2 x 1st class stamps)  
**Keysolar Systems, 4 Glanmor Crescent Newport, Gwent NP9 8AX**

IT PAYS TO ADVERTISE IN  
**EVERYDAY**  
 with **PRACTICAL**  
**ELECTRONICS**  
 Your advert will reach twice as many UK readers than with any other independent monthly hobby electronics magazine

**SURVEILLANCE KITS**  
 MICRO TRANSMITTER, tuneable 70-115MHz. 500M range. 40mm x 20mm including microphone. 3-12V. Kit £5.95, Assembled £9.95. Order Code KT1.  
 TELEPHONE TRANSMITTER, 30mm x 10mm. powered from line, transmits both sides of conversation, 500M range. 88-130MHz. Kit £7.95, Assembled £12.95. Order Code KT3.  
 3 WATT TRANSMITTER, 80-110MHz, 12-15V, adjustable input sensitivity, varicap controlled, several miles range. Kit £15.95, Assembled £25.95. Order Code KT4.  
 All prices include p&p.  
 Credit card orders telephone 021 486 3092.  
 Send 2x1st class stamps for Catalogue. Cheques/P.O.s payable to:  
**QUANTEK ELECTRONICS**  
 Kits Dept. (EPE), 3 Houldrey Road, West Heath, Birmingham B31 3HL

**THE BRITISH AMATEUR ELECTRONICS CLUB**  
 exists to help electronics enthusiasts by personal contact and through a quarterly Newsletter. For membership details, write to the Secretary  
**Mr J. S. Hind, 7 Carlyle Road**  
**West Bridgford, Nottingham NG2 7NS**  
 Space donated by Everyday with Practical Electronics

**Typefit**  
 The Typesetting programme for all your Typesetting needs.  
 If you need typesetting for your Adverts, Brochures, etc. Typefit can help you. Please telephone  
**0202 882299**

**EVERYDAY WITH PRACTICAL ELECTRONICS**  
**SUBSCRIPTION ORDER FORM**  
 Annual subscription rates (1993):  
 UK £20.00.  
 Overseas £26 (surface mail).  
 £43.50 (airmail)  
 To: Everyday with Practical Electronics  
 6 Church Street, Wimborne  
 Dorset BH21 1JH  
  

**Miscellaneous**  
**G.C.S.E. ELECTRONICS KITS** at pocket money prices. S.A.E. for FREE catalogue. **SIR-KIT ELECTRONICS**, 70 Oxford Road, Clacton CO15 3TE.  
**PROTOTYPE PRINTED CIRCUIT BOARDS** one offs and quantities, for details send s.a.e. to B. M. Ansbro, 38 Poynings Drive, Sussex BN3 8GR, or phone Brighton 883871.  
**THE HOMEBUILT DYNAMO** (Plans). Reviewed 1989 in PE January and Model Engineer December 15th. Price £42 post paid airmail from Alfred Forbes, PO Box 3919, Auckland, New Zealand. Tel (09) 818-8967.  
**ELECTRONIC KITS**, Consultancy & Design: Send £5 Pounds (IN ENGLISH NOTES) With A4 Addressed Envelope; For List & 44 Unusual Circuits: Mr. Lucas P.O. Box 755, Saint Helier, Jersey JE4 8ZZ Channel Islands, UK.  
**MOST UNUSUAL ELECTRONIC KITS**. Worldwide Source, Lasers/Metal Detectors/Night Vision/Test EQ; For list, See Advert Mr Lucas P.O. Box 755.  
**Z8 MICROCONTROLLERS**, components, boards, kits, and support. Examples Z8681 £4.25, p.c.b. £8. Phone for details 0642 480620.  
**PLDs and EPROMS** copied or programmed. 25p each + set up and postage. We supply logic devices/convert discrete logic to PLDs. Also PCBs designed. Send for details to PO Box 1561 Bath, or phone 0225-444467 (evenings).  
**EPROMs**, secondhand but erased and fully functional. 27C16/27C32 @ £2 and 27C64/27C512 @ £2.25 + £1.50 P&P to Academic Designs Ltd., PO Box 1561 Bath.  
**EPE MINI LAB** professionally constructed. Working Order. Power unit included. £99. 0670 367526.  
**SOLAR PANELS** 48W £265, 52W £285, many more sizes, with lights, fans, pumps, fridges, portable rechargeable lamps, various solar gifts and a wide range of DIY components. Send £5 for catalogue (£10 overseas). £3 refund with order and quarterly newsletter. Solar Products (Ref EPE), 4 The Mount, Guildford GU2 5HN.  
**VALVE AMPLIFIERS**, ex Ministry also spare EF86s, ECC83s, 6BW6s. Projector lenses, motors, and DMMs. SAE for latest list, W. Jarvis, 6 Peggy's Mill Rd., Edinburgh EH4 6JY.  
**PHILIPS P.M.** 3240 50 MHz dual trace oscilloscope, £180. Phone 0283 69331 for details, private sale.  
**WANTED**, Eddystone Receivers, any model in good working order and condition. Contact Lepino, Tel. 0374 128170, Fax. 0372 454381.  
**100 WATT AMPLIFIER MODULES**, £8. TO3 Heatsink, built + leads. KIA, 1 Regent Road, Ilkley - SAE.

Name .....

Address .....

M8/93

I enclose payment of £.....  
 (cheque/PO in £ sterling only, payable to Everyday with Practical Electronics). Alternatively send Access or Visa number and card expiry date.

Signature .....

Please supply name and address of card-holder if different from the subscription address shown above. Subscriptions can only start with the next available issue. For back numbers see the Editorial page.



**COMPONENTS**  
For TV ★ Video  
Audio ★ Computer

WE CAN SUPPLY A VAST RANGE OF SPARES for many makes of TV, Video, Computer & Audio Equipment. **WRITE** (Encl. s.a.e. please) or **PHONE** FOR A "PRICE & AVAILABILITY" on your requirements. **0452 526883**

VIDEO BELT KITS		COMPUTER SPARES	
AMSTRAD VCR4600/4700/5200	£3.19	<b>PHILIPS MONITORS</b>	<b>ATARI</b>
FISHER FVHP905/906/908	£3.03	BM7513 Serv. Manual	CS25913 DMA (ST)
JVC HR3300/3330/3660	£3.30	CM8833 Serv. Manual	Serv. Manual (ST520)
Large range of Pinch Rollers, Idlers, Heads, etc. from stock.		CM8833 Line O/P Tx.	PC900V/H11L3 (ST)
<b>SERVICE MANUALS</b>		CM11342 Line O/P Tx.	ROM Basic (XE/L)
PHILIPS CST427	£4.50	<b>AMSTRAD/SINCLAIR</b>	
TOSHIBA STU2LZL Tuner	£6.99	CPC464 User Manual	PC137V (STE-PSU)
Many other Manuals available.		PC1640 Serv. Manual	25C2331 (ST-PSU)
<b>SEMICONDUCTORS</b>		PCW 9512 Serv. Manual	£14.99
BU508A	£1.50	TY38912	£7.06
BUV48A	£4.99	SED9420 AC	£14.93
LM733CN	£2.43	STK7356	£13.81
P8255A	£2.85	TEA2000	£5.63
STK41411	£8.79	TMS4532-NL4	£1.72
TA7280P	£6.88	ULA6C001E	£18.48
TA8210H	£8.52	ZTK650	£9.49
This is just a very small sample of our stock.		ZX8302(OL)	£10.98
Send £1.25 for our Selected Spares CATALOGUE. Includes voucher spendable on future orders.		ZX8401	£7.94
		Spec. + 2 ROM	£16.69
		Spec./QL Modulator	£7.36
		Spec. 48K Speaker	£1.74
		STOCK - Please enquire!	

Order by Post or Phone. We accept payment by VISA, ACCESS, DELTA, SWITCH, Cheque or P.O. Post & Packing is £1.20. No VAT to add on.  
All items subject to availability. Prices can change without notice.



MARAPET (EEH)  
1 HORNBEAM MEWS  
GLOUCESTER GL2 0UE

**Millions of quality components at lowest ever prices!**

Plus Tools, Watches, Fancy Goods, Toys. Mail order UK only.

All inclusive prices - **NO VAT** to add on.

Send 34p stamped self addressed label or envelope for catalogue/clearance list.

At least 2,100 offers to amaze you.

**Brian J Reed**

**6 Queensmead Avenue, East Ewell  
Epsom, Surrey KT17 3EQ  
Tel: 081-393 9055**

**COURSES**

Study Electronics, CAD, Design and Test techniques. A new 2 year Full-Time

**HND in Electronics**

at Bromley College of Further and Higher Education.

Entry requirement is normally one 'A' level plus four GCSEs or a BTEC National Cert. or National Dip., but mature students are welcome and actively encouraged if there is evidence of good motivation.

Please phone us on

**081 295 7001**

Rookery Lane, Bromley, Kent BR2 8HE



BROMLEY COLLEGE

**MAKE YOUR INTERESTS PAY!**

Over the past 100 years more than 10 million students throughout the world have found it worth their while! An ICS home-study course can help you get a better job, make more money and have more fun out of life! ICS has over 100 years experience in home-study courses and is the largest correspondence school in the world. You learn at your own pace, when and where you want under the guidance of expert personal tutors. Find out now we can help YOU. Post or phone today for **FREE INFORMATION** on the course of your choice. (Tick one box only!)

Electronics	<input type="checkbox"/>	TV, Video & Hi-Fi Servicing	<input type="checkbox"/>
Basic Electronic Engineering (City & Guilds)	<input type="checkbox"/>	Refrigeration & Air Conditioning	<input type="checkbox"/>
Electrical Engineering	<input type="checkbox"/>	Car Mechanics	<input type="checkbox"/>
Electrical Contracting/Installation	<input type="checkbox"/>	Computer Programming	<input type="checkbox"/>
<b>GCSE/GCE/SCE</b> over 40 examination subjects to choose from			

Name \_\_\_\_\_ Address \_\_\_\_\_  
**ICS** International Correspondence Schools Dept ECS 83  
312/314 High Street, Sutton, Surrey SM1 1PR or 041-221 7373 (24 hours).

Carbon Film resistors 1/4W 5% E24 series 0.51 R to 10MΩ	1p
100 off per value - 75p, even hundreds per value totalling 1000	£6.00p
Metal Film resistors 1/4W 10R to 1 MΩ 5% E12 series - 2p, 1% E24 series	3p
Mixed metal/carbon film resistors 1/4W E24 series 1R0 to 10MΩ	11p
1 watt mixed metal/Carbon Film 5% E12 series 4R7 to 10 Megohms	5p
Linear Carbon pre-sets 100mW and 1/4W 100R to 4M7 E6 series	7p
<b>Miniature polyester capacitors 250V working for vertical mounting</b>	
.015, .022, .033, .047, .068-4p, 0.1 - 5p, 0.12, 0.15, 0.22 - 6p, 0.47 - 8p, 0.68 - 8p, 1.0 - 12p	
<b>Mylar (polyester) capacitors 100V working E12 series vertical mounting</b>	
1000p to 8200p - 3p, .01 to .068 - 4p, 0.1 - 5p, 0.12, 0.15, 0.22 - 6p, 0.47/50V - 8p	
<b>Submin ceramic plate capacitors 100V wkg vertical mountings. E12 series</b>	
2% 1.8pf to 47pf - 3p, 2% 56pf to 330pf - 4p, 10% 390p-4700p	4p
Disc/plate ceramics 50V E12 series 1P0 to 1000P	2p
<b>Polystyrene capacitors 63V working E12 series long axial wires</b>	
10pf to 820pf - 5p, 1000pf to 10,000pf - 6p, 12,000pf	7p
741 Op Amp - 20p, 555 Timer - 20p, LM3900	80p
cmos 4001 - 20p, 4011 - 22p, 4017 - 40p, 4069UB unbuffered	20p
<b>ALUMINIUM ELECTROLYTICS (Mfds/Volts)</b>	
1/50, 2.2/50, 4.7/50, 10/25, 10/50	5p
22/16, 22/25, 22/50, 33/16, 47/16, 47/25, 47/50	6p
100/16, 100/25 7p, 100/50	12p
220/16 8p, 220/25, 220/50 10p, 470/16, 470/25	11p
1000/25 25p, 1000/35, 2200/25 35p, 4700/25	70p
<b>Submin. tantalum bead electrolytics (Mfds/Volts)</b>	
0.1/35, 0.22/35, 0.47/35, 1.0/35, 3.3/16, 4.7/16	14p
2.2/35, 4.7/25, 4.7/35, 6.8/16 15p, 10/16, 2/26	20p
33/10, 47/6, 22/16 30p, 47/10 35p, 47/16 60p, 47/35	80p
<b>VOLTAGE REGULATORS</b>	
1A + or - 5V, 8V, 12V, 15V, 18V & 24V - 55p, 100mA 5.8, 12, 15, V +	30p
<b>DIODES (piv/amps)</b>	
75/25mA 1N4148 2p, 800/1A 1N4006 41/2p, 400/3A 1N5404 14p, 115/15mA OA91	8p
100/1A 1N4002 31/2p, 1000/1A 1N4007 5p, 60/1.5A 51M1 5p, 100/1A bridge	25p
400/1A 1N4004 4p, 1250/1A BY 127 10p, 30/150mA OA47 gold bonded	18p
Zener diodes E24 series 3V3 to 33V 40mW - 8p, 1 watt	12p
Battery snaps for PP3 - 6p for PP9	12p
L.E.D.'s 3mm, & 5mm, Red, Green, Yellow - 10p, Grommets 3mm - 2p, 5mm	2p
Red flashing L.E.D.'s require 9-12V supply only	50p
Mains indicator neons with 220k resistor	10p
20mm fuses 100mA to 5A, 0. blow 6p, A/surge 10p, Holders, chassis, mounting	6p
High speed pc drill 0.8, 1.0, 1.3, 1.5, 2.0mm - 40p, Machines 12V dc	£15.00
HELPING HANDS 6 ball joints and 2 croc clips to hold awkward jobs	£3.50
AA/HP7 Nicad rechargeable cells 90p each, Universal charger unit	£6.50
AA/HP7 zinc/carbon batteries in packs of 4	£1.10 per pack
Glass reed switches with single pole make contacts - 8p, Magnets	15p
0.1" Stripboard 2 1/2" x 1" 9 rows 25 holes - 25p, 3 1/4" x 2 1/2" 24 rows 37 holes	70p
Jack plugs 2.5 & 3.5mm - 14p, Sockets Panel Mtg. 2.5 & 3.5mm	10p
Ear pieces 2.5 & 3.5mm, dynamic - 20p, 3.5mm crystal	£1.50
Multi cored solder, 22G - 8p yard, 18G - 14p yard.	
<b>TRANSISTORS</b>	
BC107/8/9 - 12p, BC547/8/9 - 8p, BC557/8/9 - 8p, BC182, 182L, BC183, 183L, BC184, 184L, BC212, 212L - 10p,	
BC327, 337, 337L - 12p, BC727, 737 - 12p, BD135/6/7/8/9 - 25p, BCY70 - 18p, BFY50/51/52 - 20p,	
BFX88 - 15p, 2N3055 - 55p, TIP31, 32 - 30p, TIP41, 42 - 40p, BU208A - £1.50, BF195, 197 - 12p	
lonisers with seven year guarantee, list price £16.95	£12.50
All prices are inclusive of VAT. Postage 30p (free over £5). Stamp for list.	

**VOLTAGE REGULATORS**

**DIODES (piv/amps)**

**TRANSISTORS**

**THE CR SUPPLY CO**

127 Chesterfield Rd., Sheffield S8 0RN  
Tel: 0742 557771 Return posting

**SHERWOOD ELECTRONICS**

9 Lower Birchwood, Somercotes, Derbyshire DE55 4NG

\*\*\*\*\* SPECIAL OFFER \*\*\*\*\*

£1 Special Packs - select 2 packs **FREE** for every 10 purchased

SP1	15 x 5mm Red Leds	SP36	25 x 10uF/25V radial elect caps
SP2	15 x 5mm Green Leds	SP38	25 x 47uF/25V radial elect caps
SP3	12 x 5mm Yellow Leds	SP39	12 x 470uF/16V radial elect caps
SP6	15 x 3mm Red Leds	SP42	200 x Mixed 0.25W C.Film resistors
SP7	12 x 3mm Green Leds	SP47	5 x Min. push button switches
SP8	10 x 3mm Yellow Leds	SP102	20 x 8 pin DIL sockets
SP10	100 x 1N4148 diodes	SP103	15 x 14 pin DIL sockets
SP11	30 x 1N4001 diodes	SP104	15 x 16 pin DIL sockets
SP12	30 x 1N4002 diodes	SP112	6 x Cmos 4093
SP18	20 x BC182 transistors	SP124	20 x Assorted ceramic caps
SP20	20 x BC184 transistors	SP130	100 x Mixed 0.5W C.Film resistors
SP22	20 x BC214 transistors	SP133	20 x 1N4004 diodes
SP23	20 x BC549 transistors	SP136	10 x OA90 diodes
SP25	5 x 555 timers	SP137	4 x W005 bridge rectifiers
SP26	5 x 741 Op-amps	SP138	20 x 2.2uF/50V radial elect caps
SP28	6 x Cmos 4011	SP139	12 x 1000uF/10V radial elect caps

**RESISTOR PACKS**

RP3	5 each value - total 365	£2.50
RP7	10 each value - total 730	£3.95
RP10	1000 popular values	£5.30

Catalogue available £1 or **FREE** with first order over £5

Cheques or P.O. to **NO VAT** Please add £1 P&P to all orders  
**SHERWOOD ELECTRONICS**

**Technical Information Services**

76 CHURCH STREET, LARKHALL, LANARKSHIRE, ML9 1HE  
Tel. (0698) 884585 Mon-Fri 8.30am - 5.00pm

Tel. (0698) 883334 Outwith business hours  
FAX facility available all day on both lines

Write now with an SAE for your **FREE QUOTE FREE VOUCHERS & FREE CATALOGUE**

Remember, not only do we have EVERY service sheet ever produced, but we also have

**THE WORLDS LARGEST COLLECTION OF SERVICE MANUALS**

& WE ARE SOLE SUPPLIERS OF VARIOUS FAULT-FINDING GUIDES REPAIR MANUALS & TECHNICAL MANUALS

CTV, Video, CD, Hi-Fi, Camcorder, Satellites, Computers, Domestic Equip., etc.

DATA REFERENCE MANUAL ".....essential for the serious electrician"  
FREE updating and a 10% discount voucher only £5.95  
Incorporates Unique Model Identification and Chassis Data

Metal detector boards with Data has tuner, mode, discriminate, headphone jack, on/off volume & push button facilities. **£7.95 ea\***

35mm Camera returns with auto flash, wind on etc. **£6 ea or 2 for £10**

Dictaphone cassette, mech/record erase playback heads, 6V solenoid, motor, half effect switch. **£2.00 ea\***

Dot matrix LCD 10x2 lines. **£3.75 ea\***

40 characters x 1 line dot matrix LCD with data. **£6.95\***

2 digit 16 segment VF display with data. **£2.95 ea\***

17 segment V.F. display with driver board and data. **£2.99 ea\***

8 digit liquid crystal display. **£1.75 ea\***

4 digit LCD with 7211 driver chip. **£3.50 ea\***

Digital clock display. **£2.50\***

19" 3U sub rack enclosures. **£8.95**

12V stepper motor, 48 steps per rev, 7.3" step angle. **£3.95 ea\***

Stepper motor board with 2 slotted opto + 2 mercury tilt switches. **£3.95 ea\***

1000 mixed 1/4 watt 1% resistors. **£4.95 ea\***

250 electrolytic axial + radial caps. **£4.95 ea\***

200 off mixed polyester caps. **£7.95\***

100 Mixed trimmer caps popular values. **£4.95\***

100 off Phono plugs (red/black/grey). **£3.50\***

50 Mixed terminal blocks. **£2.95\***

25 off asst. buzzers & sounders. **£4.95\***

Cable box UHF modulator/video preamp/transformer/R's + C's/leads. **£6.95**

1000 off mixed Multilayer Ceramic Caps. **£7.95**

SM P.S.U. 115-240V input +5V 5-5A +12V 1.5A -12V 0.3A -5V 0.3A with IEC inlet and outlet, fully cased. **£6.95 ea\***

UM1233 Video Modulators. **£3.50 ea\***

Universal bell timer, both 10 min. delay and 20 min. cut off functions. **£4.95**

Spectrum 128k + 2 PSU's. **£6.95**

STC P.S.U. 240V input 5V 6A output (converts to 12V 3A details available). **£5.95 ea\***

3 to 16V Piezoelectric sounders. **50p\***

DIL switches PCB MT 3/4/6 way. **35p\***

5V SPCO SIL reed relay. **40p\***

5V 2PCO DIL miniature relay. **60p\***

12V 2PCO or 4PCO continental relay. **60p\***

12V 10A PCB MT (to make contact) relay. **95p\***

3 to 12V electro magnetic acoustic transducer with data. **75p\***

2.4576/8.8329/21.10 MHz crystals. **50p ea\***

31b Mixed components pack. **£4.95**

25 off mixed relays. **£5.95\***

40 off mixed toggle switches. **£9.95\***

50 off mixed switches, toggle, rocker, slide, micro. **£9.95**

250 off 16/22/24/40 way IC Skts. **£4.95\***

Crystal Oscillators 10/24/48 MHz. **£1 ea\***

#### TOOLS

40 pce socket set **£7.95**

16 pce socket set **£3.50**

Hand Rivet Gun **£6.95**

Crimping tool **£2.95**

Safety goggles **£1.50\***

Baby bench vice **£4.95**

3m retractable tape **£2.50**

5 pce wood carving set **£2.50**

6" utility knife **£1.95**

25 pce allen key set **£3.95**

7 pce powerbit set **£2.50**

Conerclamps **£2.50**

4" adj wrench **£1.50\***

6" adj wrench **£1.50\***

8" adj wrench **£2.50**

21 pce mini precision wrench crosspoint hex screwdriver set **£5.95**

Universal test lead kit **£3.95\***

10 crocodile clip leads **£3.50**

10 AA rechargeable ni-cads **£7.50**

Glue gun glue sticks **36/£4.50\***

#### QUANTITY DISCOUNTS AVAILABLE PLEASE RING

We also buy all forms of electronic components, p.s.u.'s, disk drives etc. Lists to below address.

**ALL PRICES INCLUDE V.A.T. PLEASE ADD £2.00 p&p EXCEPT ITEMS MARKED \* WHICH ARE 50P. SAE FOR BULK BUYING LIST PAYMENT WITH ORDER TO:**

**Dept EE, COMPELEC, 14 Constable Road, St. Ives, Huntingdon, Cambs PE17 6EQ Tel/Fax: 0480 300819**

## ADVERTISERS INDEX

N. R. BARDWELL..... 632

B. K. ELECTRONICS..... Cover (iii)

BRIAN J. REED..... 631

BROMLEY COLLEGE..... 631

BULL ELECTRICAL..... Cover (ii)

CAMBRIDGE COMP. SCIENCE..... 572

CHATWIN GUITARS (JCG)..... 591

CIRKIT DISTRIBUTION..... 558

COMPELEC..... 632

COOKE INTERNATIONAL..... 632

CRICKLEWOOD ELECTRONICS..... 577

CR SUPPLY COMPANY..... 631

DISPLAY ELECTRONICS..... 611

DIY ELECTRONICS..... 560

ELECTRONIZE DESIGN..... 560

ESR ELECTRONIC COMPONENTS..... 564

HART ELECTRONIC KITS..... 603

HESING TECHNOLOGY..... 560

ICS..... 631

JAYTEE ELECTRONIC SERVICES..... 558, 560

JPG ELECTRONICS..... 629

LABCENTER ELECTRONICS..... 559

MAGENTA ELECTRONICS..... 562/563

MAILTECH..... 557

MAPLIN ELECTRONICS..... Cover (iv)

MARAPET..... 631

MARCO..... 561

MAURITRON..... 615

M&B ELECTRICAL SUPPLIES..... 621

MCB COMPUTING GROUP..... 605

MQP ELECTRONICS..... 591

NUMBER ONE SYSTEMS..... 554

OMNI ELECTRONICS..... 572

PICO TECHNOLOGY..... 609

PROFILE ELECTRONICS..... 632

SEETRAX CAE..... 577

SERVICE TRADING..... 629

SHERWOOD ELECTRONICS..... 631

STEWART OF READING..... 558

SUMA DESIGNS..... 556

TECHNICAL INFORMATION SERVICES..... 631

TSIEN..... 573

#### ADVERTISEMENT MANAGER:

PETER J. MEW

#### ADVERTISEMENT OFFICES:

EVERYDAY with PRACTICAL ELECTRONICS ADVERTISEMENTS, HOLLAND WOOD HOUSE, CHURCH LANE, GREAT HOLLAND, ESSEX CO13 0JS. Phone/Fax: (0255) 850596

For Editorial address and phone numbers see page 565.

## N. R. BARDWELL LTD (EPE)

200 Signal diodes 1N4148.....	£1.00	200 Printed circuit board 20mm fuse clips.....	£1.00
75 Rectifier Diodes 1N4001.....	£1.00	200 Ass'd. disc ceramic capacitors.....	£1.00
50 Rectifier Diodes 1N4007.....	£1.00	80 Ass'd. capacitors 1nf to 1uf.....	£1.00
50 Rectifier Diodes 1N5401.....	£1.00	80 Ass'd. electrolytic capacitors.....	£1.00
100 Ass'd. Zeners.....	£1.00	80 1UF 16V Radial electrolytics.....	£1.00
10 NE555 Timer ICs.....	£1.00	80 4.7UF 16V Radial electrolytics.....	£1.00
8 C1065 400V 6 amp thyristors.....	£1.00	75 4.7UF 63V Radial electrolytics.....	£1.00
30 BFY51 Transistors.....	£1.00	80 10UF 16V Radial electrolytics.....	£1.00
30 BC478 Transistors.....	£1.00	50 10UF 50V Radial electrolytics.....	£1.00
30 MPSA42 Transistors.....	£1.00	80 22UF 25V Radial electrolytics.....	£1.00
30 5mm red l.e.d.s.....	£1.00	60 33UF 16V Radial electrolytics.....	£1.00
25 Ass'd. high brightness l.e.d.s.....	£1.00	80 100UF 10V Radial electrolytics.....	£1.00
24 Miniature red l.e.d.s 3mm dia.....	£1.00	50 220UF 16V Radial electrolytics.....	£1.00
50 Axial l.e.d.s (Dfode package) wide angle l.e.d.s.....	£1.00	60 470UF 10V Radial electrolytics.....	£1.00
12 Ass'd. seven segment displays.....	£1.00	40 1000UF 10V Axial electrolytics.....	£1.00
30 Ass'd. IF transformers.....	£1.00	12 1000UF 25V Axial electrolytics.....	£1.00
100 Ass'd. RF chokes (inductors).....	£1.00	1 1 Farad 5.5V memory back up capacitor.....	£1.00
30 Ass'd. connectors edge-dill-sil etc.....	£1.00	100 4N7 Mini Axial capacitors.....	60p
10 4P3W MBB min. rotary switches.....	£1.00	1 10 watt Stereo amplifier, 4 controls plus data.....	£2.95
20 1 inch Glass reed switches.....	£1.00		
20 Magnetic ear pips plus lead & plug.....	£1.00		
20 Min SP/CO slide switches.....	£1.00		
30 Ass'd. d.i.l. sockets up to 40 pin.....	£1.00		
20 24-way turned pin IC sockets.....	£1.00		
16 40 pin d.i.l. wire wrap IC sockets.....	£1.00		
2 ORP12 light dependant resistors.....	£1.00		

Prices include VAT, postage £1.25. Stamp for Lists 288 Abbeydale Road, Sheffield S7 1FL Phone (0742) 552886 Fax (0742) 500689

VISA



## Cooke International

SUPPLIER OF QUALITY USED TEST INSTRUMENTS

ANALYSERS, BRIDGES, CALIBRATORS, VOLTMETERS, GENERATORS, OSCILLOSCOPES, POWER METERS, ETC ALWAYS AVAILABLE

ORIGINAL SERVICE MANUALS FOR SALE COPY SERVICE ALSO AVAILABLE

EXPORT, TRADE AND U.K. ENQUIRIES WELCOME SEND S.A.E. FOR LISTS OF EQUIPMENT AND MANUALS ALL PRICES EXCLUDE VAT AND CARRIAGE

DISCOUNT FOR BULK ORDERS SHIPPING ARRANGED

OPEN MONDAY TO FRIDAY 9AM-5PM

Unit Four, Fordingbridge Site, Main Road, Barnham, Bognor Regis, West Sussex, PO22 0EB

Tel (+ 44) 0243 545111/2 Fax (+ 44) 0243 542457

SHAREWARE is the TRY-BEFORE-YOU-BUY APPROACH TO SOFTWARE:

You pay a nominal charge for program distribution to cover disks, copying, carriage, etc. ONLY IF YOU FIND A PACKAGE USEFUL ARE YOU THEN REQUIRED TO PAY A REGISTRATION FEE (to the software author), which allows you to continue using it. THIS CAN WORK OUT CONSIDERABLY LESS EXPENSIVE THAN BUYING SIMILAR SOFTWARE IN THE CONVENTIONAL WAY.

ENGINEERING - GRAPHICS - BUSINESS - PC-TUTORIALS - CALCULATIONS - SCIENCE - EDUCATION

### Electronics CAD/CAM

- Now simple & AFFORDABLE!

CAD/CAM - PCB DESIGN - CIRCUIT EMULATION & TEST - PC-ENGINEERING - RADIO - COMM'S

Choosing from the many 1000's of excellent Shareware & Public Domain programs on offer can be a daunting task for anyone outside the "initiated" fraternity of computer programmers, bulletin board users, etc. To simplify evaluation we have grouped together sets of distribution disks according to function, e.g. Electronics Design & Simulation, Wordprocessing, Printing Utilities, etc. In this way we are also able to keep costs down, allowing us to offer HIGH QUALITY DISKS AT THE LOWEST DISTRIBUTION PRICES AROUND.

Ask for our free IBM-PC Shareware/PD guide TODAY - AND SAVE £££'!!!

Profile Electronics (EPE)

"Your APPROACHABLE supplier."

100-102 Woodhouse Road, Leytonstone, London, E11 3NA. Telephone 081-470 2038

**POWER AMPLIFIER MODULES-TURNABLES-DIMMERS-LOUDSPEAKERS-19 INCH STEREO RACK AMPLIFIERS**

\*PRICES INCLUDE V.A.T.\* PROMPT DELIVERIES \*FRIENDLY SERVICE \*LARGE (A4) S.A.E., 60p STAMPED FOR CATALOGUE\*

**OMP MOS-FET POWER AMPLIFIERS HIGH POWER, TWO CHANNEL 19 INCH RACK**

**THOUSANDS PURCHASED BY PROFESSIONAL USERS**



**THE RENOWNED MXF SERIES OF POWER AMPLIFIERS FOUR MODELS:- MXF200 (100W + 100W) MXF400 (200W + 200W) MXF600 (300W + 300W) MXF900 (450W + 450W)**

ALL POWER RATINGS R.M.S. INTO 4 OHMS, BOTH CHANNELS DRIVEN

**FEATURES:** ★Independent power supplies with two toroidal transformers ★ Twin L.E.D. Vu meters ★ Level controls ★ Illuminated on/off switch ★ XLR connectors ★ Standard 775mV inputs ★ Open and short circuit proof ★ Latest Mos-Fets for stress free power delivery into virtually any load ★ High slew rate ★ Very low distortion ★ Aluminium cases ★ MXF600 & MXF900 fan cooled with D.C. loudspeaker and thermal protection.

**USED THE WORLD OVER IN CLUBS, PUBS, CINEMAS, DISCOS ETC.**

**SIZES:-** MXF200 W19" xH3 1/2" (2U)xD11"  
MXF400 W19" xH5 1/4" (3U)xD12"  
MXF600 W19" xH5 1/4" (3U)xD13"  
MXF900 W19" xH5 1/4" (3U)xD14 1/2"

**PRICES:-** MXF200 £175.00 MXF400 £233.85  
MXF600 £329.00 MXF900 £449.15  
SPECIALIST CARRIER DEL. £12.50 EACH



**OMP XO3 STEREO 3-WAY ACTIVE CROSS-OVER**



Advanced 3-Way Stereo Active Cross-over, housed in a 19" x 1U case. Each channel has three level controls: bass, mid & top. The removable front fascia allows access to the programmable DIL switches to adjust the cross-over frequency: Bass-Mid 250/500/800Hz. Mid-Top 1.8/3/5KHz, all at 24dB per octave. Bass invert switches on each bass channel. Nominal 775mV input/output. Fully compatible with OMP rack amplifier and modules.

**Price £117.44 + £5.00 P&P**

**STEREO DISCO MIXER SDJ3400SE ★ ECHO & SOUND EFFECTS ★**

**STEREO DISCO MIXER** with 2 x 7 band L & R graphic equalisers with bar graph LED Vu meters. **MANY OUTSTANDING FEATURES:-** including Echo with repeat & speed control, DJ Mic with talk-over switch, 6 Channels with individual faders plus cross fade, Cue Headphone Monitor, 8 Sound Effects. Useful combination of the following inputs:- 3 turntables (mag), 3 mics, 5 Line for CD, Tape, Video etc.



**Price £144.99 + £5.00 P&P**

**SIZE: 482 x 240 x 120mm**

**PIEZO ELECTRIC TWEETERS - MOTOROLA**

Join the Piezo revolution! The low dynamic mass (no voice coil) of a Piezo tweeter produces an improved transient response with a lower distortion level than ordinary dynamic tweeters. As a crossover is not required these units can be added to existing speaker systems of up to 100 watts (more if two are put in series). **FREE EXPLANATORY LEAFLETS ARE SUPPLIED WITH EACH TWEETER.**

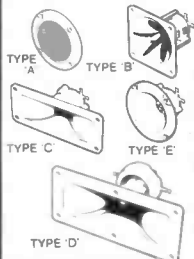

**TYPE 'A' (KSN1036A)** 3" round with protective wire mesh. Ideal for bookshelf and medium sized Hi-Fi speakers. Price £4.90 + 50p P&P.  
**TYPE 'B' (KSN1005A)** 3 1/2" super horn for general purpose speakers, disco and P.A. systems etc. Price £5.99 + 50p P&P.  
**TYPE 'C' (KSN1016A)** 2" x 5" wide dispersion horn for quality Hi-Fi systems and quality discos etc. Price £6.99 + 50p P&P.  
**TYPE 'D' (KSN1025A)** 2" x 6" wide dispersion horn. Upper frequency response retained extending down to mid-range (2KHz). Suitable for high quality Hi-Fi systems and quality discos. Price £9.99 + 50p P&P.  
**TYPE 'E' (KSN1038A)** 3 3/4" horn tweeter with attractive silver finish trim. Suitable for Hi-Fi monitor systems etc. Price £5.99 + 50p P&P.  
**LEVEL CONTROL** Combines, on a recessed mounting plate, level control and cabinet input jack socket. 85x85mm. Price £4.10 + 50p P&P.

**IBI FLIGHT CASED LOUDSPEAKERS**

A new range of quality loudspeakers, designed to take advantage of the latest speaker technology and enclosure designs. Both models utilize studio quality 12" cast aluminium loudspeakers with factory fitted grilles, wide dispersion constant directivity horns, extruded aluminium corner protection and steel ball corners, complemented with heavy duty black covering. The enclosures are fitted as standard with top hats for optional loudspeaker stands.



**POWER RATINGS QUOTED IN WATTS RMS FOR EACH CABINET FREQUENCY RESPONSE FULL RANGE 45Hz - 20KHz**

**ibi FC 12-100WATTS (100dB) PRICE £159.00 PER PAIR**  
**ibi FC 12-200WATTS (100dB) PRICE £175.00 PER PAIR**

SPECIALIST CARRIER DEL. £12.50 PER PAIR

**OPTIONAL STANDS PRICE PER PAIR £49.00**  
Delivery £6.00 per pair

**IN-CAR STEREO BOOSTER AMPS**



**PRICES: 150W £49.99 250W £99.99**  
**400W £109.95 P&P £2.00 EACH**

**THREE SUPERB HIGH POWER CAR STEREO BOOSTER AMPLIFIERS**

150 WATTS (75 + 75) Stereo, 150W Bridged Mono  
250 WATTS (125 + 125) Stereo, 250W Bridged Mono  
400 WATTS (200 + 200) Stereo, 400W Bridged Mono  
**ALL POWERS INTO 4 OHMS**

**Features:**  
★ Stereo, bridgable mono ★ Choice of high & low level inputs ★ L & R level controls ★ Remote on-off ★ Speaker & thermal protection.

**OMP MOS-FET POWER AMPLIFIER MODULES SUPPLIED READY BUILT AND TESTED.**

These modules now enjoy a world-wide reputation for quality, reliability and performance at a realistic price. Four models are available to suit the needs of the professional and hobby market i.e. Industry, Leisure, Instrumental and Hi-Fi etc. When comparing prices, NOTE that all models include toroidal power supply, integral heat sink, glass fibre P.C.B. and drive circuits to power a compatible Vu meter. All models are open and short circuit proof.

**THOUSANDS OF MODULES PURCHASED BY PROFESSIONAL USERS**



**OMP/MF 100 Mos-Fet** Output power 110 watts R.M.S. into 4 ohms, frequency response 1Hz - 100KHz -3dB, Damping Factor > 300, Slew Rate 45V/uS, T.H.D. typical 0.002%, Input Sensitivity 500mV, S.N.R. -110 dB. Size 300 x 123 x 60mm.  
**PRICE £40.85 + £3.50 P&P**



**OMP/MF 200 Mos-Fet** Output power 200 watts R.M.S. into 4 ohms, frequency response 1Hz - 100KHz -3dB, Damping Factor > 300, Slew Rate 50V/uS, T.H.D. typical 0.001%, Input Sensitivity 500mV, S.N.R. -110 dB. Size 300 x 155 x 100mm.  
**PRICE £64.35 + £4.00 P&P**



**OMP/MF 300 Mos-Fet** Output power 300 watts R.M.S. into 4 ohms, frequency response 1Hz - 100KHz -3dB, Damping Factor > 300, Slew Rate 75V/uS, T.H.D. typical 0.001%, Input Sensitivity 500mV, S.N.R. -110 dB. Size 330 x 175 x 100mm.  
**PRICE £81.75 + £5.00 P&P**



**OMP/MF 450 Mos-Fet** Output power 450 watts R.M.S. into 4 ohms, frequency response 1Hz - 100KHz -3dB, Damping Factor > 300, Slew Rate 75V/uS, T.H.D. typical 0.001%, Input Sensitivity 500mV, S.N.R. -110 dB, Fan Cooled, D.C. Loudspeaker Protection, 2 Second Anti-Thump Delay. Size 385 x 210 x 105mm.  
**PRICE £132.85 + £5.00 P&P**



**OMP/MF 1000 Mos-Fet** Output power 1000 watts R.M.S. into 2 ohms, 725 watts R.M.S. into 4 ohms, frequency response 1Hz - 100KHz -3dB, Damping Factor > 300, Slew Rate 75V/uS, T.H.D. typical 0.002%, Input Sensitivity 500mV, S.N.R. -110 dB, Fan Cooled, D.C. Loudspeaker Protection, 2 Second Anti-Thump Delay. Size 422 x 300 x 125mm.  
**PRICE £259.00 + £12.00 P&P**

**NOTE: MOS-FET MODULES ARE AVAILABLE IN TWO VERSIONS: STANDARD - INPUT SENS 500mV, BAND WIDTH 100KHz. PRO (PROFESSIONAL EQUIPMENT COMPATIBLE) - INPUT SENS 775mV, BAND WIDTH 50KHz. ORDER STANDARD OR PEC.**

**LOUDSPEAKERS**



**LARGE SELECTION OF SPECIALIST LOUDSPEAKERS AVAILABLE, INCLUDING CABINET FITTINGS, SPEAKER GRILLES, CROSS-OVERS AND HIGH POWER, HIGH FREQUENCY BULLETS AND HORNS, LARGE (A4) S.A.E. (60p STAMPED) FOR COMPLETE LIST.**

McKenzie and Fane Loudspeakers are also available.

**EMINENCE:- INSTRUMENTS, P.A., DISCO, ETC**

**ALL EMINENCE UNITS 8 OHMS IMPEDANCE**  
8" 100 WATT R.M.S. ME8-100 GEN. PURPOSE, LEAD GUITAR, EXCELLENT MID, DISCO. PRICE £32.71 + £2.00 P&P  
RES. FREQ. 72Hz, FREQ. RESP. TO 4KHz, SENS 97dB.  
10" 100 WATT R.M.S. ME10-100 GUITAR, VOCAL, KEYBOARD, DISCO, EXCELLENT MID. PRICE £33.74 + £2.50 P&P  
RES. FREQ. 71Hz, FREQ. RESP. TO 7KHz, SENS 97dB.  
10" 200 WATT R.M.S. ME10-200 GUITAR, KEY'D, DISCO, VOCAL, EXCELLENT HIGH POWER MID. PRICE £43.47 + £2.50 P&P  
RES. FREQ. 65Hz, FREQ. RESP. TO 3.5KHz, SENS 99dB.  
12" 100 WATT R.M.S. ME12-100LE GEN. PURPOSE, LEAD GUITAR, DISCO, STAGE MONITOR. PRICE £35.64 + £3.50 P&P  
RES. FREQ. 49Hz, FREQ. RESP. TO 6KHz, SENS 100dB.  
12" 100 WATT R.M.S. ME12-100LT (TWIN CONE) WIDE RESPONSE, P.A., VOCAL, STAGE MONITOR. RES. FREQ. 42Hz, FREQ. RESP. TO 10KHz, SENS 98dB. PRICE £36.67 + £3.50 P&P  
12" 200 WATT R.M.S. ME12-200 GEN. PURPOSE, GUITAR, DISCO, VOCAL, EXCELLENT MID. PRICE £46.71 + £3.50 P&P  
RES. FREQ. 58Hz, FREQ. RESP. TO 6KHz, SENS 98dB.  
12" 300 WATT R.M.S. ME12-300GP HIGH POWER BASS, LEAD GUITAR, KEYBOARD, DISCO ETC. PRICE £70.19 + £3.50 P&P  
RES. FREQ. 47Hz, FREQ. RESP. TO 5KHz, SENS 103dB.  
15" 200 WATT R.M.S. ME15-200 GEN. PURPOSE BASS, INCLUDING BASS GUITAR. PRICE £50.72 + £4.00 P&P  
RES. FREQ. 46Hz, FREQ. RESP. TO 5KHz, SENS 99dB.  
15" 300 WATT R.M.S. ME15-300 HIGH POWER BASS, INCLUDING BASS GUITAR. PRICE £73.34 + £4.00 P&P  
RES. FREQ. 39Hz, FREQ. RESP. TO 3KHz, SENS 103dB.

**EARBENDERS:- HI-FI, STUDIO, IN-CAR, ETC**

**ALL EARBENDER UNITS 8 OHMS (Except EB8-50 & EB10-50 which are dual impedance tapped @ 4 & 8 ohm)**  
**BASS, SINGLE CONE, HIGH COMPLIANCE, ROLLED SURROUND**  
8" 50watt EB8-50 DUAL IMPEDANCE, TAPPED 4/8 OHM BASS, HI-FI, IN-CAR. PRICE £8.90 + £2.00 P&P  
RES. FREQ. 40Hz, FREQ. RESP. TO 7KHz SENS 97dB.  
10" 50watt EB10-50 DUAL IMPEDANCE, TAPPED 4/8 OHM BASS, HI-FI, IN-CAR. PRICE £13.65 + £2.50 P&P  
RES. FREQ. 40Hz, FREQ. RESP. TO 5KHz, SENS. 99dB.  
10" 100watt EB10-100 BASS, HI-FI, STUDIO. PRICE £30.39 + £3.50 P&P  
RES. FREQ. 35Hz, FREQ. RESP. TO 3KHz, SENS 96dB.  
12" 100watt EB12-100 BASS, STUDIO, HI-FI, EXCELLENT DISCO. PRICE £42.12 + £3.50 P&P  
RES. FREQ. 26Hz, FREQ. RESP. TO 3 KHz, SENS 93dB.  
**FULL RANGE TWIN CONE, HIGH COMPLIANCE, ROLLED SURROUND**  
5 1/2" 60WATT EB5-60TC (TWIN CONE) HI-FI, MULTI-ARRAY DISCO ETC. PRICE £9.99 + £1.50 P&P  
RES. FREQ. 63Hz, FREQ. RESP. TO 20KHz, SENS 92dB.  
6 1/2" 60WATT EB6-60TC (TWIN CONE) HI-FI, MULTI-ARRAY DISCO ETC. PRICE £10.99 + 1.50 P&P  
RES. FREQ. 38Hz, FREQ. RESP. TO 20KHz, SENS 94dB.  
8" 60WATT EB8-60TC (TWIN CONE) HI-FI, MULTI-ARRAY DISCO ETC. PRICE £12.99 + £1.50 P&P  
RES. FREQ. 40Hz, FREQ. RESP. TO 18KHz, SENS 89dB.  
10" 60WATT EB10-60TC (TWIN CONE) HI-FI, MULTI ARRAY DISCO ETC. PRICE £16.49 + £2.00 P&P  
RES. FREQ. 35Hz, FREQ. RESP. TO 12KHz, SENS 98dB.

**TRANSMITTER HOBBY KITS**

**PROVEN TRANSMITTER DESIGNS INCLUDING GLASS FIBRE PRINTED CIRCUIT BOARD AND HIGH QUALITY COMPONENTS COMPLETE WITH CIRCUIT AND INSTRUCTIONS**

**3W TRANSMITTER** 80-108MHz, VARICAP CONTROLLED PROFESSIONAL PERFORMANCE, RANGE UP TO 3 MILES, SIZE 38 x 123mm. SUPPLY 12V @ 0.5AMP. PRICE £14.85 + £1.00 P&P

**FM MICRO TRANSMITTER** 100-108MHz, VARICAP TUNED, COMPLETE WITH VERY SENS FET MIC, RANGE 100-300m, SIZE 56 x 46mm, SUPPLY 9V BATTERY. PRICE £8.80 + £1.00 P&P



PHOTO: 3W FM TRANSMITTER

**B.K. ELECTRONICS**

**UNITS 1 & 5 COMET WAY, SOUTHDON-ON-SEA, ESSEX. SS2 6TR.**  
**Tel.: 0702 - 527572 Fax.: 0702 - 420243**

POSTAL CHARGES PER ORDER £10.00 MINIMUM. OFFICIAL ORDERS FROM SCHOOLS, COLLEGES, GOVT. BODIES, PLCs ETC. PRICES INCLUSIVE OF V.A.T. SALES COUNTER. VISA AND ACCESS ACCEPTED BY POST, PHONE OR FAX.



**NEW**

**FULL COLOUR GUIDE TO ELECTRONIC PRODUCTS**

# Maplin



BS 5750  
Part 2 1987

Level B:  
Quality Assurance  
RS12750

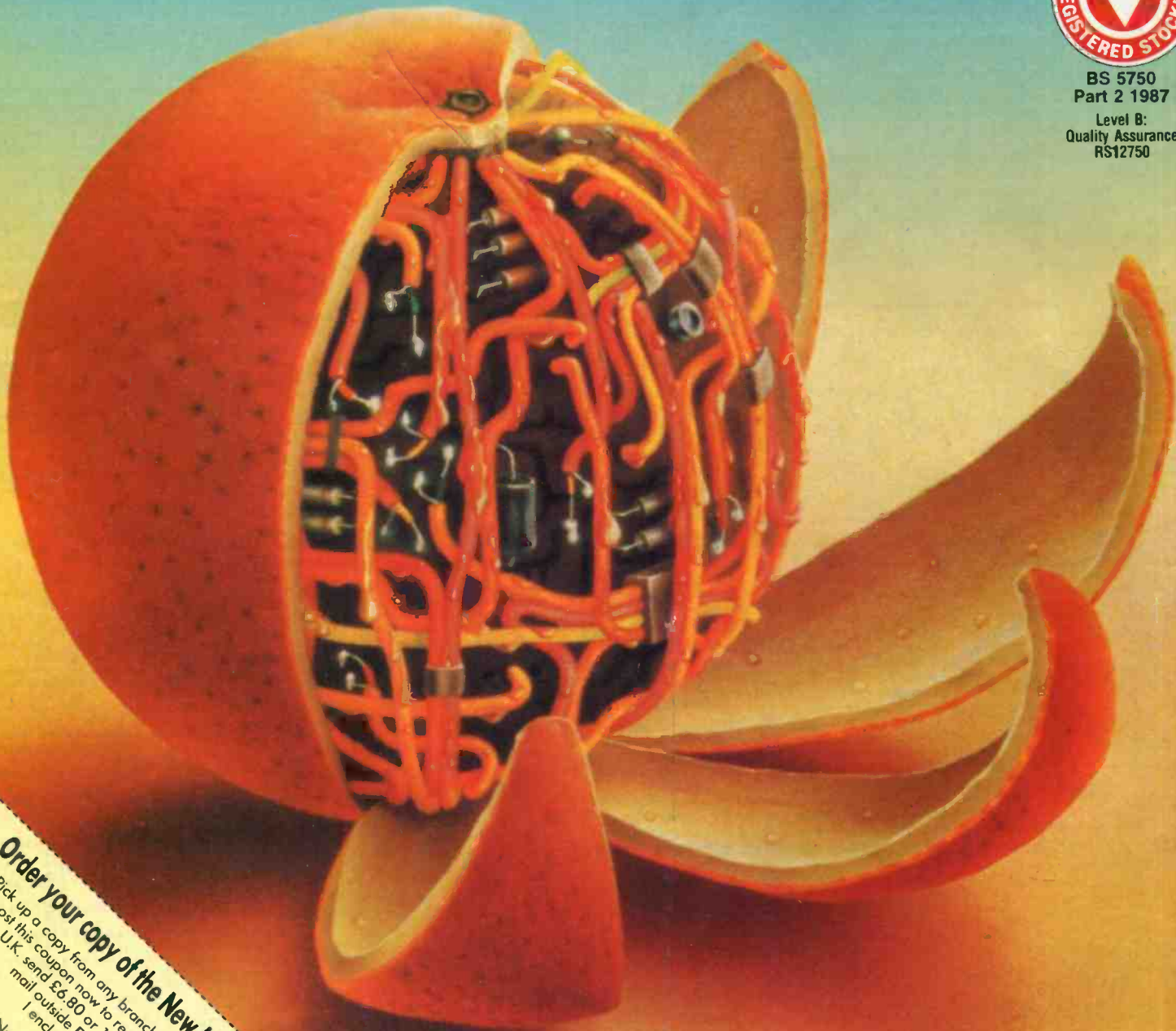

**Order your copy of the New MAPLIN Catalogue on sale 3rd September!**

Pick up a copy from any branch of WHSMITH or from our chain of stores for just £2.95 or post this coupon now to receive your copy for just £3.45 inc. p&p. If you live outside the U.K. send £6.80 or 18 IRC's for Airmail in Europe/£5.20 or 13 IRC's for surface mail outside Europe, or £11.50 or 30 IRC's for Airmail outside Europe. I enclose £3.45/£6.80/£5.20/£11.50 (delete as applicable).

Name.....

Address.....

Post Code.....

Send to Maplin Electronics,  
P.O. Box 3, Rayleigh,  
Essex, England  
SS6 8LR.

EE94

Over 700 colour packed pages with hundreds of brand New Products at Super Low Prices on sale from 3rd September, only £2.95

Available from all branches of WHSMITH and Maplin stores nationwide. The Maplin Electronics 1994 Catalogue - **UNIQUELY DIFFERENT**