

EVERYDAY MAY 1988 **ELECTRONICS**

INCORPORATING ELECTRONICS MONTHLY

£1.30

Free! 24 page
GUIDE TO TESTING
& TEST GEAR

SUPER
SOUND
EFFECTS
GENERATOR

FREE DATA CARD

DOOR SENTINEL

FUNCTION GENERATOR



The Magazine for Electronic & Computer Projects



POPULAR BAKERS DOZEN PACKS (still available)

All packs are £1 each, if you order 12 then you are entitled to another free. Please state which one you want. Note the figure on the extreme left of the pack ref number and the next figure is the quantity of items in the pack, finally a short description.

- BD1 5 13A junction boxes for adding extra points to your ring main circuit.
- BD2 5 13A spurs provide a fused outlet to a ring main where devices such as a clock must not be switched off.
- BD7 4 In flex switches with neon on/off lights, saves leaving things switched on.
- BD9 2 6V 1A mains transformers upright mounting with fixed clamps.
- BD11 1 6 1/2" speaker cabinet ideal for extensions, takes our speaker. Ref BD137.
- BD13 12 30 watt reed switches, it's surprising what you can make with these—burglar alarms, secret switches, relay, etc., etc.
- BD22 2 25 watt loudspeaker two unit crossovers.
- BD29 1 B.O.A.C. stereo unit is wonderful value.
- BD30 2 Nicad constant current chargers adapt to charge almost any nicad battery.
- BD32 2 Humidity switches, as the air becomes damper the membrane stretches and operates a microswitch.
- BD34 48 2 meter length of connecting wire all colour coded.
- BD42 5 13A rocker switch three tags so on/off, or change over with centre off.
- BD45 1 24hr time switch, ex-Electricity Board, automatically adjust for lengthening and shortening day. original cost £40 each.
- BD49 10 Neon valves, with series resistor, these make good night lights.
- BD56 1 Mini uniselector, one use is for an electric jigsaw puzzle, we give circuit diagram for this. One pulse into motor, moves switch through one pole.
- BD59 2 Flat solenoids—you could make your multi-tester read AC amps with this.
- BD67 1 Suck or blow operated pressure switch, or it can be operated by any low pressure variation such as water level in water tanks.
- BD91 2 Mains operated motors with gearbox. Final speed 16 rpm, 2 watt rated.
- BD103A 1 6V 750mA power supply, nicely cased with mains input and 6V output leads.
- BD120 2 Stripper boards, each contains a 400V 2A bridge rectifier and 14 other diodes and rectifiers as well as dozens of condensers, etc.
- BD122 10m Twin screened flex with white pvc cover.
- BD128 10 Very fine drills for pcb boards etc. Normal cost about 80p each.
- BD132 2 Plastic boxes approx 3in cube with square hole through top so ideal for interrupted beam switch.
- BD134 10 Motors for model aeroplanes, spin to start so needs no switch.
- BD139 6 Microphone inserts—magnetic 400 ohm also act as speakers.
- BD148 4 Reed relay kits, you get 16 reed switches and 4 coil sets with notes on making c/o relays and other gadgets.
- BD149 6 Safety cover for 13A sockets—prevent those inquisitive little fingers getting nasty shocks.
- BD180 6 Neon indicators in panel mounting holders with lens.
- BD193 6 5 amp 3 pin flush mounting sockets make a low cost disco panel.
- BD196 1 in flex simmerstat—keeps your soldering iron etc. always at the ready.
- BD199 1 Mains solenoid, very powerful, has 1in pull or could push if modified.
- BD200 8 Keyboard switches—made for computers but have many other applications.
- BD210 4 Transistors type 2N3055, probably the most useful power transistor.
- BD211 1 Electric clock, mains operated, put this in a box and you need never be late.
- BD221 5 12V alarms, make a noise about as loud as a car horn. Slightly soiled but OK.
- BD242 2 6in x 4in speakers, 4 ohm made from Radiomobile so very good quality.
- BD246 2 Tacho generators, generate one volt per 100 revs.
- BD252 1 Panostat, controls output of boiling ring from simmer up boil.
- BD259 50 Leads with push-on 1/4in tags—a must for hook-ups—mains connections etc.
- BD263 2 Oblong push switches for bell or chimes, these can mains up to 5 amps so could be foot switch if fitted into pattress.
- BD268 1 Min 1 watt amp for record player. Will also change speed of record player motor.
- BD275 1 Guitar mic—clip-on type suits most amps.
- BD283 3 Mild steel boxes approx 3in x 3in x 1in deep—standard electrical.
- BD293 50 Mixed silicon diodes.
- BD296 3 Car plugs with lead, fit into lighter socket.
- BD305 1 Tubular dynamic mic with optional table rest.

Most other packs still available and you can choose any as your free one.

5A BATTERY CHARGER KIT
All parts, including case, Only £5 plus £1 postage

OVER 400 GIFTS YOU CAN CHOOSE FROM
There is a total of over 400 packs in our Baker's Dozen range and you become entitled to a free gift with each dozen packs.
A classified list of these packs and our latest "News Letter" will be enclosed with your goods, and you will automatically receive our next news letter.



THIS MONTH'S SNIP

3 1/2" Floppy Disc Drive, made by the Chicon Company of Japan. Beautifully made and probably the most compact device of its kind as it weighs only 600g and measures only 104mm wide, 162mm deep and has a height of only 32mm. Other features are high precision head positioning—single push loading and eject—direct drive brushless motor—Shugart compatible interface—standard connections—interchangeable with most other 3 1/2" and 5 1/4" drives. Brand new with copy of maker's manual. Offered this month at £28.50 post and VAT included.

CASE—adaptable for 3" or 3 1/2" FDD, has room for power supply components. Price only £4 includes circuit of PSU. Our Ref 4P8.

POWER SUPPLY FOR FDD—5V and 12V voltage regulated outputs, complete kit of parts will fit into case 4P8 price £8 or with case £11.

MULLARD UNILEX AMPLIFIERS
We are probably the only firm in the country with these now in stock. Although only four watts per channel, these give superb reproduction. We now offer the 4 Mullard modules—i.e. Mains power unit (EP9002) Pre-amp module (EP9001) and two amplifier modules (EP9000) all for £6.00 plus £2 postage. For prices of modules bought separately see TWO POUNDERS.

25A ELECTRICAL PROGRAMMER
Learn in your sleep. Have radio playing and kettle boiling as you wake—switch on lights to warn off intruders—have a warm house to come home to. You can do all these and more. By a famous maker with 25 amp on/off switch. A beautiful unit at £2.50.

MINI MONO AMP on p.c.b. size 4" x 2" (app.)
Fitted volume control and a hole for a tone control should you require it. The amplifier has three transistors and we estimate the output to be 3W rms. More technical data will be included with the amp. Brand new, perfect condition, offered at the very low price of £1.15 each, or £13 for 12.

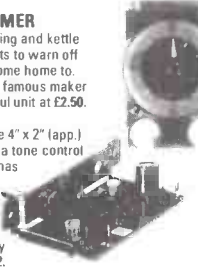

LIGHT BOX
This when completed measures approximately 15" x 14". The light source is the Philips fluorescent "W" tube. Above the light a sheet of fibreglass and through this should be sufficient light to enable you to follow the circuit on fibreglass PCBs. Price for the complete kit, that is the box, choke, starter, tube and switch, and fibreglass is £5 plus £2 post. Order Ref. 5P69.

VENNER TIME SWITCH
Mains operated with 20 amp switch, one on and one off per 24 hrs, repeats daily automatically correcting for the lengthening or shortening day. An expensive time switch but you can have it for only £2.95 without case, metal case—£2.95, adaptor kit to convert this into a normal 24hr time switch but with the added advantage of up to 12 on/offers per 24hrs. This makes an ideal controller for the immersion heater. Price of the adaptor kit is £2.30.

FANS & BLOWERS
5"£5+£1.25 post. 6" £6+£1.50 post.
4" x 4" Muffin equipment cooling fan 115V £2.00
4" x 4" Muffin equipment cooling fan 230/240V £5.00
3" Extractor or blower 115V supplied with 230 to 115V adaptor £9.50+£2 post.
All above are ex-computers but guaranteed for 12 months.
10" x 3" Tangential blower. New, very quiet—supplied with 230 to 115V adaptor to use two in series to give long blow £2.00+£1.50 post or £4.00+£2.00 post for two.

9" MONITOR
Ideal to work with computer or video camera uses Philips black and white tube ref M24306W. Which tube is explosion and X-ray radiation protected. VDU is brand new and has a time base and EHT circuitry. Requires only a 16V dc supply to set it going. It's made up in a lacquered metal framework but has open sides so should be cased. The VDU comes complete with circuit diagram and has been line tested and has our six months guarantee. Offered a lot less than some firms are asking for the tube alone, only £16 plus £5 post.

12 volt MOTOR BY SMITHS
Made for use in cars, etc. these are very powerful and easily reversible. Size 3 1/2" long by 3" dia. They have a good length of 1/4" spindle—1/10hp £3.45
1/8hp £5.75. 1/6hp £7.50

TELEPHONE LEAD
3 mtrs long terminating one end with new BT flat plug and the other end with 4 correctly colour coded wires to fit to phone or appliance. Replaces the lead on old phone making it suitable for new BT socket. Price £1 rebr B0552 or 3 for £2 re2P164

COMPACT FLOPPY DISC DRIVE EME-101
The EME-101 drives a 3" disc of the new standard which despite its small size provides a capacity of 500k per disc, which is equivalent to the 3 1/2" and 5 1/4" discs. We supply the Operators Manual and other information showing how to use this with popular computers: BBC, Spectrum, Amstrad etc. All at a special snip price of £27.50 including post and VAT. Data available separately £2, refundable if you purchase the drive.

POWERFUL IONISER
Generates approx. 10 times more IONS than the ET1 and similar circuits. Will refresh your home, office, workshop etc. Makes you feel better and work harder—a complete mains operated kit, case included. £11.50+£3 P&P

J & N BULL ELECTRICAL
Dept. E.E., 250 PORTLAND ROAD, HOVE, BRIGHTON, SUSSEX BN1 5QT
MAIL ORDER TERMS: Cash, PD or cheque with order. Orders under £20 add £1 service charge. Monthly account orders accepted from schools and public companies. Access and Barclay orders accepted. Brighton (0273) 734648 or 203500

NEW ITEMS

Some of the many items described in our current list which you will receive with your parcel

- 13A PLUGS** Good British make complete with fuse, parcel of 5 for £2. Order ref. 2P185.
- 13A ADAPTERS** Takes 2 13A plugs, good British make, packet of 5 for £2. Order ref. 2P187.
- 20V-0-20V** Mains transformers 2 1/2 amp (100 watt) loading, tapped primary, 200-245 upright mountings £4. Order ref. 4P24.
- BENCH ISOLATION TRANSFORMERS** 250 watt 230V in and out with plenty of tappings to give exact volts. £5 plus £2. Order ref. 5P5.
- POWERFUL 12V MOTOR**—was intended for Sinclair car, rating approx 1/3hp. Price £15. Ref. 15P8.
- BURGLAR ALARM BELL**—6" gong OK for outside use if protected from rain. Mains or 12V battery operated, state which required. Price £8. Ref. 8P2.
- 24 HOR TIME SWITCH**—16A changeover contacts, up to 6 on/off per day. Nicely cased, intended for wall mounting. Price £8. Ref. 8P6.
- CAPACITOR BARGAIN**—axial ended, 4700µF at 25V. Jap made, normally 50p each, you get 4 for £1. Our ref. 613.
- AGAIN AVAILABLE**—12" mini fluorescent tubes. Price £1 each. Ref. BD314.
- POWER PACK OR AMPLIFIER CASE**—Size approx. 10" x 8 1/4" x 4 3/4" plated steel—with ample perforations for cooling. Front panel has on/off switch and EEC mains inlet plug with built-in RF filter—undoubtedly a very fine case which would cost at least £50 from regular sources. Our price is £5 each and £3 post. Ref. 5P111.
- MINIATURE BCD THUMB WHEEL SWITCH**—Matt black edge switch engraved white on black—gold plated, make before break contacts. Size approx 25mm high, 8mm wide, 20mm deep, made by the famous Cherry Company and designed for easy stacking. Price £1 each. Ref. BD601.
- EDGE METER**—Miniature, whole size approx 37mm x 13mm 100µa fsd, centre zero scaled 0 to -10 and 0 to +10. Price £1 each. Ref. BD602.
- CLEANING FLUID**—Extra good quality—intended for video and tape heads. Regular price £1.50 per spray can. Our price 2 cans for £1. Ref. BD604.
- PIEZO ELECTRIC FAN**—An unusual fan, more like the one used by Madame Butterfly than the conventional type, it does not rotate. The air movement is caused by two vibrating arms. It is American made, mains operated, very economical and causes no interference, so is ideal for computer and instrument cooling. Price is only £1 each. Ref. BD605.
- SPRING LOADED TEST PRODS**—Heavy duty, made by the famous Bulgin company, very good quality. Price 4 for £1. Ref. BD599.
- TELEPHONE BELLS**—These will work off our standard mains through a transformer, but to sound exactly like a telephone, they then must be fed with 25Hz 50V. So with these bells we give a circuit for a suitable power supply. Price 2 bells for £1. Ref. BD600.
- ULTRA-SENSITIVE POCKET MULTIMETER**—4k ohms per volt—11 ranges—carry one of these and so be always ready to test ac/dc volts to 1000 DC milliamps and have an ohms range for circuit testing. Will earn its cost in no time. Price only £7. Ref. 7P2.
- BLOW YOUR ROOF OFF!**—40 watt speaker systems—new type you must not hide! They have golden cones and golden surrounds and look really "bootiful". 12" Woofers, Midrange and tweeter and comes with a crossover at a special introductory price of £49 carriage paid. Two sets for £95 carriage paid. 140w Woofer only £35 carriage paid.
- ASTEC P.S.U.**—Switch mode type. Input set for +230V. Output 3.5 amps at +5V, 1.5 amps at +12V, and 3 amps at +5V. Should be OK for floppy disc drives. Regular price £30. Our price only £10. Ref. 10T34. Brand new and unused.
- APPLIANCE THERMOSTATS**—Spindle adjust type suitable for convector heaters or similar. Price 2 for £1. Ref. BD582.
- COMPOSITE VIDEO INPUT UNIT**—For our 9" monitor with notes on suppression of fly back lines and improving "hold" makes our monitor ideal for use with any computer or camera. Kit contains p.c.b. and all components. Price £4. Ref. 4P23.
- 3-CORE FLEX BARGAIN No. 1**—Core size 5mm so ideal for long extension leads carrying up to 5 amps or short leads up to 10 amps. 15mm for £2. Ref. 2P189.
- 3-CORE FLEX BARGAIN No. 2**—Core size 1.25mm so suitable for long extension leads carrying up to 13 amps, or short leads up to 25A. 10m for £2. Ref. 2P190.
- NOVEL NIGHT LIGHT**—Plugs into a 13A socket. Gives out a surprising amount of light, certainly enough to navigate along passages at night or to keep a nervous child happy, very low consumption, probably not enough to move the meter. Price £1. Ref. BD563.
- CASE WITH 13A PRONGS**—To go into 13A socket, nice size and suitable for plenty of projects such as battery trickle charger, speed controller, time switch, night light, noise suppressor, dimmers etc. Price—2 for £1. Ref. BD565.
- SPEAKER EXTENSION CABLE**—Twin 0.7mm conductors so you can have long runs with minimum sound loss and for telephone extensions or burglar alarms, bells, intercoms etc. 250m coil only £3 plus £1 post. Ref. 3P28.
- ALPHA-NUMERIC KEYBOARD**—This keyboard has 73 keys with contactless capacitance switches giving trouble free life and no contact bounce. The keys are arranged in two groups, the main area field is a QWERTY array and on the right is a 15 key number pad, board size is approx. 13" x 4"—brand new but offered at only a fraction of its cost, namely £3, plus £1 post. Ref. 3P27.
- TELEPHONE EXTENSIONS**—It is now legal for you to undertake the wiring of telephone extensions. For this we can supply 4-core telephone cable, 100m coil £8.50. Extension BT sockets £2.95. Packet of 50 plastic headed staples £2. Dual adaptor for taking two appliances from one socket £3.95. Leads with BT plug for changing old phones, 3 for £2.
- MODULAR SWITCH**—Panel mounting highest quality and ideal where extra special front panel appearance is required, can be illuminated if required d.p.d.t. and latching. Price 2 for £1. Ref. BD607.
- WIRE BARGAIN**—500 metres 0.7mm solid copper tinned and p.v.c. covered. Only £3 plus £1 post. Ref. 3P31—also that's well under 1p per metre, and this wire is ideal for push on connections.
- INTERRUPTED BEAM KIT**—This kit enables you to make a switch that will trigger when a steady beam of infra-red or ordinary light is broken. Main components—relay, photo transistor, resistors and caps, etc. Circuit diagram but no case. Price £2. Ref. 2P15.
- 3-30V VARIABLE VOLTAGE POWER SUPPLY UNIT**—with 1 amp DC output. Intended for use on the bench for experimenters, students, inventors, service engineers etc. This is probably the most important piece of equipment you can own (after a multi range test meter). It gives a variable output from 3-30 volts and has an automatic short circuit and overload protection, which operates at 1.1 amp approximately. Other features are very low ripple output, a typical ripple is 3mV pk-pk, 1mV rms. Mounted in a metal fronted plastic case, this has a voltmeter on the front panel in addition to the output control knob and the output terminals. Price for complete kit with full instructions is £15. Ref. 15P7.
- TRANSMITTER SURVEILLANCE (BUG)**—Tiny, easily hidden, but which will enable conversation to be picked up with FM radio. Can be housed in a matchbox, all electronic parts and circuit. Price £2. Ref. 2P52.

EVERYDAY ELECTRONICS

INCORPORATING ELECTRONICS MONTHLY

ABC

VOL 17 No 5

MAY '88

The Magazine for Electronic & Computer Projects

ISSN 0262-3617

PROJECTS ... THEORY ... NEWS ...
COMMENT ... POPULAR FEATURES ...

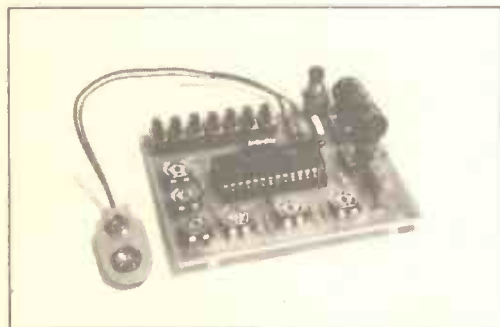
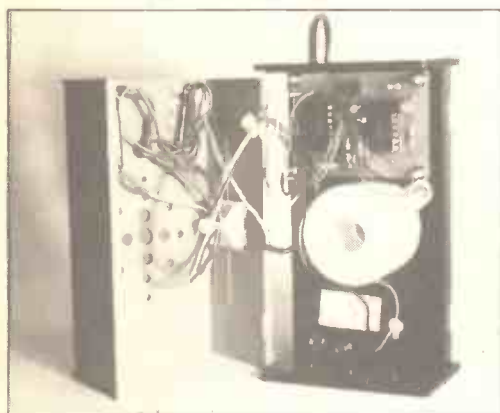

© Wimborne Publishing Ltd 1988. Copyright in all drawings, photographs and articles published in EVERYDAY ELECTRONICS is fully protected, and reproduction or imitations in whole or in part are expressly forbidden.

Our June '88 issue will be published on Friday, 6 May 1988. See page 299 for details.

Everyday Electronics, May 1988

Projects

- FUNCTION GENERATOR** by Mike Feather 264
Provides sine, square and triangular waveforms from 1Hz to 100kHz at up to 20V p-p output
- MULTI-CHANNEL REMOTE LIGHT DIMMER** by Barry Robinson 268
Control up to six (or more) lamps from the comfort of your armchair. Part One: Infra-Red Transmitter and Receiver
- DIGITAL-TO-ANALOGUE CONVERTER** 280
Demonstration circuit for Exploring Electronics
- DOOR SENTINEL** by A. R. Winstanley 284
Protects doors and windows from uninvited guests—sounds a piercing warning on unlawful entry.
- SUPER SOUND EFFECTS GENERATOR** by Mark Stuart 292
Creates passable imitations of steam trains, helicopters, birds, phaser guns and vehicle sirens.
- AUDIBLE SMOOTHNESS TESTER** by A. H. Robson 302
Novel electronic device that will detect the unevenness of surfaces.

Series

- ACTUALLY DOING IT** by Robert Penfold 272
Making the right connection—jack plugs
- BBC MICRO** by R. A. & J. W. Penfold 274
Regular spot for Beeb fanatics
- INTRODUCING MICROPROCESSORS** by Mike Tooley BA 276
Part Seven: Interfacing to the parallel I/O port of microprocessor systems
- EXPLORING ELECTRONICS** by Owen N. Bishop 280
Part Twenty-Three: Op. Amp Summer and Digital-to-Analogue Converter
- ON SPEC** by Mike Tooley 288
Readers Sinclair Spectrum page
- ROBOT ROUNDUP** by Nigel Clark 296
Investigating the world of robotics
- AMATEUR RADIO** by Tony Smith G4FA1 298
Celebrations; Say it in Russian; Question Corner

Features

- EDITORIAL** 263
- CROSSWORD No. 4** 273
Some "light-hearted" brain teasers
- TRANSISTORS AS RECTIFIERS** 287
FOR YOUR ENTERTAINMENT by Barry Fox 290
Electromagnetic Anarchists; Radio Show; Pillow Talk
- SHOPTALK** by David Barrington 295
Product news and component buying
- NEW PRODUCTS** 300
Facts and photos of instruments, equipment and tools
- BOOK SERVICE** 304
Our own service to readers of EE
- PRINTED CIRCUIT BOARD SERVICE** 307
- DOWN TO EARTH** by George Hylton 308
Voltage doubling and power supplies
- ADVERTISER'S INDEX** 312

FREE

24-page guide to TESTING & TEST GEAR
DATA CARD

Readers' Services • Editorial and Advertisement Departments

263

257



MUSIC, EFFECTS COMPUTER AND SECURITY KITS

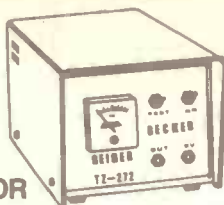

LOW COST GEIGER COUNTERS



★ POPULAR PROJECTS FROM A LEADING AUTHOR

BURGLAR ALARM CONTROLLERS DETECTORS DETER DELINQUENTS

**MULTIZONE CONTROL
(PE) SET280 £22.77**

Two entry-zones, anti-tamper loop, personal attack, entry-exit timing, timed duration, automatic resetting, latching LED monitors.

**SINGLE ZONE CONTROL
(PE) SET279 £9.32**
With timed duration control and latching LED monitor.

Both units can be used with any standard detection devices, such as contact or magnetic switches, pressure pads, tremblers, ultrasonics, infrared etc, and will activate standard bells, strobes or sirens.

CHIP TESTER (PE) SET258F £39.30
Computer controlled logic and chip analyser

CHORUS-FLANGER (PE) SET235 £59.99
Mono-stereo. Superb dual-mode effects.

CYBERVOX (EE) SET228 £44.76
Amazing robot type voice unit, with ring-modulator and reverb.

DISCO-LIGHTS (PE) SET245F £62.50
3 chan sound to light, chasers, auto level.

ECHO-REVERB (PE) SET218 £57.66
Mono-stereo. 200ms echo, lengthy reverb, switchable multitracking.

**EPROM PROGRAMMER
(PE) SET277 £25.25**
Computer controlled unit for 4K Eproms.

EVENT COUNTER (PE) SET278 £31.50
4-digit display counting for any logic source.

MICRO-CHAT (PE) SET276 £64.50
Computer controlled speech synthesiser.

MICRO-SCOPE (PE) SET247 £44.50
Turns a computer into an oscilloscope.

MICRO-TUNER (PE) SET257 £55.32
Computer controlled, tuning aid and freq counter.

MORSE DECODER (EE) SET269 £22.16
Computer controlled morse code-decoder.

POLYWHATSITI! (PE) SET252 £122.69
Amazing effects unit, echo, reverb, double tracking, phasing, flanging, looping, pitch change, REVERSE tracking! 8K memory.

REVERB (EE) SET232 £27.35
Mono, with reverb to 4 secs, echo to 60ms.

RING MODULATOR (PE) SET231 £45.58
Fabulous effects generation, with ALC and VCO.

STORMSI (PE) £29.50 each unit
Raw nature under panel control! Wind & Rain SET250W. Thunder & Lightning SET250T.

★COMPUTER KITS
The software listing published with the computer kit projects are for use with C64, PET and BBC computers.

MANY MORE KITS IN CATALOGUE
KITS include PCBs and instructions. Further details in catalogue. PCBs also available separately.

NUCLEAR FREE ZONES? CHECK THEM OUT – GET A GEIGER

Detectors for environmental and geological monitoring.

THE PE GEIGER was shown on BBC TV "Take Nobody's Word For It" program.

METERED GEIGER (PE MK2)
Built-in probe, speaker, meter, digital output. Detector tube options – ZP1310 for normal sensitivity. ZP1320 for extra-sensitivity.

Kit-form – SET 264 – (ZP1310) £59.50, (ZP1320) £79.50

GEIGER-MITE SET271 £39.50
Miniature geiger with ZP1310 tube, LED displays radiation impacts. Socket for headphones or digital monitoring. Kit-form only.

**WEATHER CENTRE
DETAILS IN CATALOGUE**

Send SAE for detailed catalogue, and with all enquiries (overseas send £1.00 or 5 I.R.C.'s). Add 15% VAT. Add P&P – Sets over £50 add £2.50. Others add £1.50. Overseas P&P in catalogue. Text photocopies – Geigers 264 & 272 £1.50 each, others 50p, plus 50p post or large SAE. Insurance 50p per £50. MAIL ORDER, CWO, CHQ, PO, ACCESS VISA. Telephone orders: Mon-Fri, 9am – 6pm. 0689 37821. (Usually answering machine).

PHONOSONICS, DEPT EE85, 8 FINUCANE DRIVE, ORPINGTON, KENT BR5 4ED. MAIL ORDER



(0983) 292847 Xen-Electronics (0983) 292847



Just a sample of stock. Ask for items not listed.

Super Project Kit Bargains

IC's	Red	.13	J112	.57	15W Skt	1.02	0.010µF 100V	.08
4001UB	Green	.12	MTPBN10	1.44	15W Plug	.39	0.022µF 63V	.08
4011UB	Orange	.21	TIP121	.34	25W Plug	2.15	0.047µF 100V	.08
4011	Yellow	.15	TIP126	.34	Capacitors		0.1µF 63V	.08
4017	3mm dia		TIP31C	.30	Radial Lead		0.15µF 63V	.17
4028	Red	.13	TIP32C	.30	2.2µF 50V	.06	0.33µF 63V	.33
4040	Green	.13	2N2646	1.18	2.2µF 63V	.11	0.47µF 63V	.17
4053	Orange	.21	2N3055	.47	4.7µF 63V	.06	Disc Ceramic	
4066	Yellow	.13	I.C. Sockets		33µF 16V	.04	10pF 63V	.05
4081	Fixed Voltage		Low Cost		47µF 10V	.06	100pF 50V	.06
Z80ACPU	Regulators		6Way	.06	47µF 25V	.06	150pF 50V	.05
Z80APIO	+5V 1A	.36	8Way	.07	47µF 35V	.08	220pF 50V	.05
7217IPI	+8V 1.5A	.68	14Way	.11	47µF 63V	.08	0.01µF 25/50V	.05
84021PL	+12V 1.5A	.36	16Way	.13	47µF 100V	.15	0.01µF 1kV	.27
555	+15V 1A	.36	18Way	.15	10µF 35V	.06	0.022µF 63V	.10
558	+24V 1A	.68	20Way	.16	10µF 63V	.06	0.047µF 50V	.12
741	-5V 1A	.39	22Way	.18	22µF 100V	.21	0.1µF 25V	.06
LM380N	-12V 1A	2.10	24Way	.20	100µF 10V	.06	0.1µF 50V	.07
TLA3810	-15V 1A	.39	28Way	.23	100µF 16V	.07	Resistors	
TL074CP	-24V 1A	.39	40Way	.33	100µF 25V	.07	Carbon Film	
SG3526N	+5V 0.1A	.28	Turned Pin		100µF 35V	.08	0.25 Watt 5%	
SG3526J	+8V 0.1A	.28	6Way	.12	100µF 50V	.19	1 to 10kΩ	.02 each
SL4860P	+12V 0.1A	.28	8Way	.16	100µF 63V	.21	0.5 Watt 5%	
SL4900P	+15V 0.1A	.36	14Way	.28	220µF 10V	.06	10kΩ to 10MΩ	.04 each
ML5260P	-5V 0.1A	.30	16Way	.32	330µF 16V	.19		
1N4001	-12V 0.1A	.30	18Way	.36	470µF 16V	.25	Thermistor Bead	
1N4001	-15V 0.1A	.30	20Way	.40	470µF 50V	.40	(NTC)	
1N4002	Transistors		22Way	.44	470µF 63V	.63	GM472W (4.7kΩ)	1.95
1N4003	BC107	.18	24Way	.48	1000µF 10V	.23		
1N4004	BC108	.21	28Way	.56	1000µF 16V	.27		
1N4005	BC109C	.19	40Way	.80	2200µF 16V	.45		
1N4007	BC182	.06	Connectors		Axial Lead			
1N5401	BC212	.05	D-Type solder		4.7µF 63V	.06	Potentiometers	
1N5406	BC546B	.04	9W Skt	.43	10µF 35V	.11	PCB Mount	
Zener Diodes	BC556A	.04	9W Plug	.38	47µF 25V	.10	Carmel Top Adj	
2V7 4W	BD233	.27	9W Cover	.96	100µF 25V	.18	1KΩ	.30
5V1 4W	BD675A	.32	15W Skt	.50	100µF 100V	.18	1KΩ	.30
7V5 4W	BD676A	.32	15W Plug	.53	470µF 10V	.22	5KΩ	.30
9V1 4W	BFY51	.54	15W Cover	1.07	1000µF 10V	.31	10KΩ	.50
10V 4W	BF259	.58	25W Skt	.60	Metalised		20KΩ	.50
11V 4W	BSR50	.49	25W Plug	.53	Polyester		100KΩ	.50
L.E.D.'s	IRF520	1.61	25W Cover	1.16	5/7.5mm Pitch		200KΩ	.50
5mm dia	IRF840	4.10	PCB Mount		3.3nF 400V	.08		

Z80 BASED CONTROLLER BOARD

This super little micro board using the very powerful Z80A CPU running at 4Mhz has all the necessary hardware to control mental to the most complex tasks. The PTH PCB measuring only 107 x 118 comprises 2K EPROM (empty), 2K static RAM, 16 input lines using two 74LS244 and 16 output lines using two 74LS373. The port connections are via four 10W pin strips, each having eight data lines, one ground and either NMI, INT, WAIT or RESET. A must for the small application.

Order as: Z80A-CTRL/K Kit Form £20.45
 Z80A-CTRL/B Built and Tested £24.95
 Z84C-CTRL/K Cmos Kit Form £26.95
 Z84C-CTRL/B Cmos Built and Tested £31.45

RS232 TO CENTRONICS CONVERTER

This handy little interface is ideal for running parallel printers from a serial port, the low cost way out of buying expensive parallel ports for your computer. Originally designed for the Sinclair QL and Northstar Dimension in mind. The PCB measuring 60 x 62 comprises of the 6402 UART, Baud rate generator and all necessary logic, comes complete with wire and ribbon cable and 36W Centronics plug. (For 'D' Type connector and hoods see selection on left. Sinclair QL SER1 Plug available extra at £1.68, order as 900-71052F).

Order as: RS232-8/K Kit Form £18.40
 RS232-8/B Built and Tested £23.90

DISTANCE MEASURING INSTRUMENT

An invaluable handy instrument ideal for quickly measuring rooms no bigger than 50 feet sq. The ultrasonic processing PTH PCB measuring only 77 x 85 has all the necessary components to output the distance in four digit BCD (multiplexed) reflecting either feet, meters or yards selectable by a three position switch. The kit comes complete with Parabolic reflector and transducer. Available extra is a liquid crystal display board measuring 51 x 101 which can be wired to the BCD output to the above board directly to display the distance in 0.5 inch high digits.

Order as: UDMI26/K Kit form £24.95
 UDMI26/B Built and Tested £34.95
 LCDM4/K LCD Kit form £14.30
 LCDM4/B LCD Built and Tested £16.95

Mail or Telephone Orders only please to:
 Dept 14, Samuel Whites Estate, Bridge Road, Cowes, Isle of Wight PO31 7LP. Please add £1 for 1st class post and packaging, and 15% VAT to total. Stock listing available soon, please send SAE to be put on the mail list.

JOIN UP WITH LITESOLD

Professional Soldering Equipment at Special Mail-Order Prices.

EC50 Mains Electronic Iron. £29.99



Features spike-free, solid state

proportional electronic temperature control inside the handle. Adjustable 280° to 400°C. Burn-proof 3-wire mains lead. Fitted 3.2mm Long-Life bit. 1.6, 2.4 and 4.7mm available. 240v a.c.

SK18 Soldering Kit. £16.70

Build or repair any electronic project. LC18 240v 18w iron with 3.2, 2.4, and 1.6mm bits. Pack of 18 swg flux-cored 60/40 solder. Tweezers. 3 soldering aids. Reel of De-Solder braid. In PVC presentation wallet.



ADAMIN Miniature Iron £7.69

Possibly smallest mains iron in the world. Ideal for fine work. Slim

nylon handle with finger grip. Interchangeable bits available 1.2, 1.6, 2.4, 3.4 and 4.7mm. Fitted with 2.4mm. 240v 12w (12v available). Presentation wallet.

'L' Series Lightweight Irons. 12w £7.68

High efficiency irons for all electronic hobby work. Non-roll handles with finger guards.

Stainless-steel element shafts. Screw-connected elements. Slip-on bits available from 1.6 to 4.7mm. LA12



model, 12w, 2.4mm bit. LC18 Model, 18w, 3.2mm bit. 240v Std - 12v available. Presentation wallet.

Soldering Iron

Stands 3&4

£6.06

No. 5

£6.28

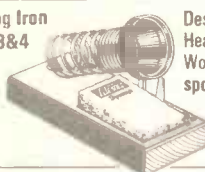

Designed specially for LITESOLD irons. Heavy, solid-plastic base with non-slip pads. Won't tip over, holds iron safely. With wiping sponge and location for spare (hot) bits.

No 5 stand for EC50 iron No 4 stand for ADAMIN miniature Iron No 3 stand for LA12 and LC18 irons.

Replacement Bits

For all above irons. Non-stick designs, machined from special copper alloy, with Inconel retaining rings. Two types - Chromium plated with copper face (for economy and ease of use) and Iron plated with

Pre-tinned face (Long Life). State tip size, iron and type.

	Copper	L/L
EC50	£1.92	
Adamin 12 and	£1.06	£1.90
LA12	£1.20	£2.09
LC18		

Yellow £1.38 Green £1.44



Blue £1.50 per Reel

For simple, safe and effective de-soldering of all types of joint, using a standard soldering iron. Handy colour-coded packs of 1.5 metres in 3 widths: Yellow - 1.5mm, Green - 2mm, Blue - 3mm.

De-Solder Pumps £7.71

High Quality version of increasingly popular type of tool. Precision made anodised aluminium body, plunger guard and high-seal piston. Easy



thumb operation. Automatic solder ejection. Conductive PTFE nozzle - no static problems.

Tool Sets

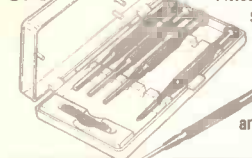

Top quality Japanese metric hardened and tempered tools. Swivel-top chrome plated brass handles. Fitted plastic cases. 113 set - 6 miniature screwdrivers 0.9 to 3.5mm £3.60

305 set 2 crosspoint and 3 hex wrenches 1.5 to 2.5mm £2.56

228 set 20 piece combination:

5 open, 5 skt spanners, 2 crosspoint, 3 hex and 3 plain drivers, scriber, handle/holder £8.46

Microcutters. £5.39 Light weight hardened and precision ground. Flush cutting. Screw joint, return spring, cushion-grip handles. Safety wire-retaining clip.



Soldering Aids.



Set of 3 £4.22
Scraper/Knife, Hook/Probe, Brush/Fork. 3 useful double-ended aids to soldering/desoldering/assembly. In plastic wallet.

ADAMIN Electric Stylus. £16.71

Writes like a ballpoint in Gold, Silver, Copper or 6 colours, on card, plastics, leather etc. Personalise wallets, bags, albums, books,

models... Operates at 4.5v from its own plug transformer - totally safe. Supplied with coloured foils.



SEND FOR OUR ORDER FORM TODAY AND JOIN UP WITH THE PROFESSIONALS

Prices include p&g and VAT. Send order with Cheque PO. Ring for Access Visa sales or ask for order forms

LIGHT SOLDERING DEVELOPMENTS LTD. DEPT. EE
97-99 GLOUCESTER ROAD, CROYDON CR0 2DN. 01 689 0574

AMPLIFIERS FROM

JAYTEE

The UK Distributor for the complete ILP Audio Range



BIPOLAR AND MOSFET MODULES

The unique range of encapsulated amplifier modules with integral heatsink.

HY30 15W Bipolar amp.	£11.30	HY248 120W Bipolar amp (8ohm)	£24.15
HY60 30W Bipolar amp	£11.30	HY364 180W Bipolar amp (4ohm)	£36.00
HY6060 30W Stereo Bipolar amp	£23.65	HY368 180W Bipolar amp (8ohm)	£37.55
HY124 60W Bipolar amp (4ohm)	£18.50	MOS128 60W Mosfet amp	£40.70
HY128 60W Bipolar amp (8ohm)	£18.50	MOS248 120W Mosfet amp	£46.35
HY244 120W Bipolar amp (4ohm)	£24.15	MOS364 180W Mosfet amp	£75.75

POWER SUPPLIES

Comprising toroidal transformer and DC board to power the ILP amplifier modules.

Application	Price	Application	Price
PSU30 Pre-amplifier	£ 9.75	PSU532 MOS128 (2)	£25.40
PSU212 1 or 2 HY30	£17.70	PSU642 HY248	£25.40
PSU412 HY6060, HY24, 1 or 2 HY60	£19.95	PSU552 MOS248	£27.45
PSU422 HY128	£22.00	PSU712 HY244 (2)	£29.20
PSU432 MOS128	£23.00	PSU722 HY248 (2)	£30.20
PSU512 HY244, HY128 (2)	£24.40	PSU732 HY364	£30.20
PSU522 HY124 (2)	£24.40	PSU742 HY368	£32.20
		PSU752 MOS364, MOS248 (2)	£32.20

PRE-AMP AND MIXER MODULES

These encapsulated modules are supplied with in-line connectors but require potentiometers, switches etc. Individual data sheets on request.

HY6 Mono pre-amp with bass & treble	£ 9.25
HY7 Mono mixer 8 channel	£ 8.75
HY8 Stereo mixer 5 channel	£ 8.75
HY9 Stereo pre-amp	£ 9.30
HY11 Mono mixer 5 channel with bass & treble	£ 9.75
HY12 Mono pre-amp 4 channel with bass, mid & treble	£ 9.30
HY13 Mono VU meter driver	£ 8.75
HY66 Stereo pre-amp with bass & treble	£15.00
HY67 Stereo headphone driver	£16.60
HY68 Stereo mixer 10 channel	£11.30
HY69 Mono pre-amp 2 channel with bass & treble	£15.40
HY71 Dual pre-amp	£14.95
HY73 Guitar pre-amp with bass & treble	£15.00
HY74 Stereo mixer 5 channel with bass & treble	£15.95
HY75 Stereo pre-amp with bass, mid & treble	£15.40
HY76 Stereo switch matrix	£19.50
HY77 Stereo VU meter driver	£14.35
HY78 Stereo pre-amp	£14.70
HY83 Guitar pre-amp with special effects	£18.95
B6 Mounting board	£ 1.15
B66 Mounting board	£ 1.75

LOUDSPEAKERS

312B 350W 12" Bass loudspeaker	£78.65
312WB 200W 12" Wideband bass loudspeaker	£78.65

POWER SLAVES

These cases amplifiers are supplied assembled and tested in 60 and 120 watt Bipolar or Mosfet versions.

US12 60 watt Bipolar (4ohm)	£75.00	US32 60 watt Mosfet	£99.95
US22 120 watt Bipolar (4ohm)	£83.75	US42 120 watt Mosfet	£108.35

Prices include VAT and carriage



Quantity prices available on request
Write or phone for free Data Pack

Jaytee Electronic Services

143 Reculver Road, Beltinge, Herne Bay, Kent CT6 6PL

Telephone: (0227) 375254 Fax: 0227 365104

Full Kits inc. PCBs, or veroboard, hardware, electronics, cases (unless stated). Less batteries.
If you do not have the issue of EE which includes the project—you will need to order the instruction reprint as an extra—80p each. Reprints available separately 80p each plus p&p £1.

THIS MONTH'S KITS

(see or 'phone for prices)

SUPER SOUND EFFECTS GENERATOR May 88	£12.99	FUNCTION GENERATOR Feb 86	£23.66
STEREO NOISE GATE April 88	£26.98	POWER SUPPLY FOR ABOVE TOUCH CONTROLLER Feb 86	£7.82
CABLE & PIPE LOCATOR April 88	£15.35	MUSICAL DOOR BELL Jan 86	£12.25
INDUCTIVE PROXIMITY DET. April 88	£8.63	SPECTRUM OUTPUT PORT Feb 86	£10.72
LOW FUEL ALERT April 88	£6.43	TACHOMETER Jan 86	£24.57
SEMICONDUCTOR TESTER Mar 88	£23.51	ONE CRIP ALARM Jan 86	£9.29
LE DETECTOR Mar 88	£11.80	TTL LOGIC PROBE Dec 85	£17.67
ENVELOPE SHAPER Mar 88	£14.99	DIGITAL CAPACITANCE METER Dec 85	£38.45
SOS ALERT Mar 88	£9.36	SOLOERING IRON CONTROLLER Oct 85	£5.21
AUTO-WAGGLE JOYSTICK ADAPTOR Mar 88	£3.99	VOLTAGE REGULATOR Sept 85	£7.46
VARIABLE 25V-2A BENCH POWER SUPPLY Feb 88	£49.73	PERSONAL STEREO P.S.U. Sept 85	£9.80
CAR LAMP CHECKING SYST. Feb 88	£7.10	R.I.A.A. PRE-AMP Sept 85	£16.94
GAME TIMER Feb 88	£14.32	FRIDGE ALARM Sept 85	£7.50
QUIZMASTER Jan 88	£18.96	LOW COST POWER SUPPLY UNIT Aug 85	£18.38
CAPACITANCE METER Jan 88	£29.35	TRI-STATE THERMOMETER (Bart) Aug 85	£6.66
TRANSISTOR CURVE TRACER (BBC) CONTINUITY TESTER Jan 88	£3.67	TREMLO/VIBRATO Aug 85	£37.92
AUDIO SIGNAL GENERATOR Dec 87	£12.99	STEPPER MOTOR INTERFACE FOR THE BBC COMPUTER less case Aug 85	£13.99
DUAL MAINS LIGHTS FLASHER Dec 87	£19.98	1035 STEPPER MOTOR EXTRA OPTIONAL POWER SUPPLY PARTS CONTINUITY TESTER July 85	£5.90
ACCENTED BEAT METRONOME Nov 87	£19.95	TRAIN SIGNAL CONTROLLER July 85	£9.66
ACOUSTIC PROBE Nov 87 (less bolt & probe)	£15.49	AMSTRAD USER PORT July 85	£16.83
BBC SIDEWAYS RAM/ROM Nov 87	£28.22	ACROSS THE RIVER June 85	£19.77
VIDEO CONTROLLER Oct 87	£27.75	ELECTRONIC DOORBELL June 85	£7.20
TRANSISTOR TESTER Oct 87	£9.24	GRAPHIC EQUALISER June 85	£26.66
AUTOMATIC PORCH LIGHT Oct 87	£16.35	AUTO PHASE May 85	£17.98
CARAVAN FRIDGE ALERT Oct 87	£5.18	INSULATION TESTER Apr 85	£16.65
STATIC MONITOR Oct 87	£8.25	LOAD SIMPLIFIER Feb 85	£16.68
ELECTRONIC MULTIMETER Sept 87	£44.72	GAMES TIMER Jan 85	£8.39
NOISE GATE Sept 87	£22.14	SPECTRUM AMPLIFIER Jan 85	£6.58
PERSONAL STEREO AMP Sept 87	£13.63	TV AERIAL PRE-AMP Dec 84	£14.83
CAR OVERHEATING ALARM Sept 87	£8.21	Optional PSU 12V £2.44	240V £11.83
BURST-FIRE MAINS CONTROLLER Sept 87	£12.91	DOOR CHIME Dec 84	£17.89
SUPER SOUND ADAPTOR Aug 87	£16.58	BBC MICRO AUDIO STORAGE SCOPE INTERFACE Nov 84	£34.52
IMMERSION HEATER TIMER Aug 87	£17.99	PROXIMITY ALARM Nov 84	£21.58
3 BAND 1.6-30MHz RADIO Aug 87	£25.27	MAINS CABLE DETECTOR Oct 84	£5.27
BUCCAMEER I.B. METAL DETECTOR inc. coils and case, less handle and hardware July 87	£25.19	MICRO MEMORY SYNTHESISER Oct 84	£67.57
DIGITAL COUNTER/FREQ METER (10MHz) inc. case July 87	£67.07	ORILL SPEED CONTROLLER Oct 84	£8.27
MONOMIX July 87	£20.00	GUITAR HEAD PHONE AMPLIFIER Sept 84	£7.58
FERMOSTAT July 87	£11.56	SOUND OPERATED FLASH less lead Sept 84	£6.98
VISUAL GUITAR TUNER Jun 87	£21.99	TEMPERATURE INTERFACE FOR BBC AUG 84	£23.64
MINI DISCO LIGHT Jun 87	£11.99	CAR RADIO BOOSTER Aug 84	£16.64
WINDSCREEN WASHER WARNING May 87	£4.88	CAR LIGHTS WARNING July 84	£9.58
FRIDGE ALARM May 87	£9.41	VARICAP AM RADIO May 84	£12.52
EQUALIZER (DISMISER) May 87	£14.79	EXPERIMENTAL POWER SUPPLY May 84	£22.46
BULB LIFE EXTENDER April 87 (less case)	£4.99	SIMPLE LOOP BURGLAR ALARM May 84	£16.34
EXP. SPEECH RECOGNITION April 87	£19.98	MASTERMINGO TIMER May 84	£6.52
COMPUTER BUFFER INTERFACE Mar 87	£11.96	FUSE/DIODE CHECKER Apr 84	£4.14
ACTIVE I/R BURGLAR ALARM Mar 87	£33.85	QUASI STEREO ADAPTOR Apr 84	£13.08
VIDEO GUARD Feb 87	£7.99	MI-CAD BATTERY CHARGER Mar 84	£11.82
MINI-AMP Feb 87	£14.99	REVERSING BLEEPER Mar 84	£8.14
CAR VOLTAGE MONITOR Feb 87	£11.98	PIPE FINDER Mar 84	£4.32
SPECTRUM SPEECH SYNTH. (no case) Feb 87	£19.92	SIGNAL TRACER Feb 84	£17.88
SPECTRUM I/O PORT less case, Feb 87	£8.99	CAR LIGHT WARNING Feb 84	£4.51
STEPPING MOTOR BOOSTER (for above) Feb 87	£5.19	BIOLOGICAL AMPLIFIER Jan 84	£22.99
STEPPING MOTOR MD200 Feb 87	£16.80	CONTINUITY TESTER Dec 83	£11.98
HANDS-OFF INTERCOM (per station) inc. case Jan 87	£9.99	CHILDREN'S DISCO LIGHTS Dec 83	£8.42
CAR ALARM Dec 86	£10.97	NOVEL EGG TIMER Dec 83 inc. case	£12.29
DUAL READING THERMOMETER (less case) Dec 86	£39.98	SPEECH SYNTHESIZER FOR THE BBC MICRO NOV 83 less cable + sockets	£26.38
RANDOM NUMBER GENERATOR Dec 86	£14.97	HOME INTERCOM less link wire Oct 83	£17.26
8 CHANNEL A-O (SPECTRUM) CONVERTER Dec 86	£34.29	STORAGE 'SCOPE' INTERFACE FOR BBC MICRO Aug 83 less software	£18.42
BBC 16K SIDEWAYS RAM Dec 86	£12.35	HIGH POWER INTERFACE BOARD Aug 83 no case	£12.45
MODEM TONE DECODER Nov 86	£18.99	USER PORT I/O BOARD less cable + plug	£12.59
OPTICALLY ISOLATED SWITCH Nov 86	£11.99	USER PORT CONTROL BOARD July 83 less cable + plug + case	£30.16
CAR FLASHER WARNING Nov 86	£7.82	NEW PERSONAL RADIO less case, May 83	£9.14
200MHz DIG. FREQUENCY METER Nov 86	£59.98	MOISTURE DETECTOR May 83	£6.55
10 WATT AUDIO AMPLIFIER Oct 86	£34.95	NOVELTY EGG TIMER April 83 less case	£6.58
LIGHT RIDER LAPEL BADGE Oct 86	£9.71	BUZZ OFF March 83	£5.41
LIGHT RIDER DISCO VERSION	£18.69	PUSH BIKE ALARM Feb 83	£14.07
LIGHT RIDER 16 LED VERSION	£12.99	ZX TAPE CONTROL Nov 82	£8.55
SCRATCH BLANKER Sept 86	£53.17	2-WAY INTERCOM July 82 no case	£5.42
INFRA-RED BEAM ALARM Sept 86	£26.99	REFLEX TESTER July 82	£8.32
FREZZER FAILURE ALARM Sept 86	£14.78	SEAT BELT REMINDER Jun 82	£4.92
CAR TIMER Sept 86	£8.30	EGG TIMER June 82	£6.53
BATTERY TESTER Aug 86	£6.85	CAR LED VOLT METER less case, May 82	£3.81
TILT ALARM July 86	£7.45	V.C.D. SOUND EFFECTS UNIT Apr 82	£15.25
HEADPHONE MIXER July 86	£27.69	CAMERA OR FLASH GUN TRIGGER Mar 82 less tripod bushes	£16.38
CARAVAN BATTERY MONITOR July 86	£16.35	MINI EGG TIMER Jan 82	£5.20
SQUEEKEY CONTINUITY TESTER July 86	£3.35	SIMPLE INFRA RED REMOTE CONTROL Nov 81	£22.44
ELECTRONIC SCARECROW July 86	£8.45	TAPE NOISE LIMITER Oct 81	£6.97
VOX BOX AMP July 86	£12.73	HEADS AND TAILS GAME Oct 81	£3.30
PERCUSSION SYNTH June 86	£28.98	PHOTO FLASH SLAVE Oct 81	£6.56
LIGHT PEN (less case) June 86	£5.80	FUZZ BOX Oct 81	£8.57
PERSONAL RADIO June 86	£10.98	SOIL MOISTURE UNIT Oct 81	£7.56
WATCHDOG June 86	£7.85	0-12V POWER SUPPLY Sept 81	£23.38
MINI STROBE May 86	£13.11	SOIL MOISTURE INDICATOR E.E. May 81	£5.39
PA AMPLIFIER May 86	£24.95	PHONE BELL REPEATER/BABY ALARM May 81	£7.38
LOGIC SWITCH May 86	£14.93	MODULATED TONE DOORBELL Mar 81	£8.82
STEREO REVERB Apr 86	£25.18	2 NOTE DOOR CHIME Dec 80	£13.62
VERSATILE PSU Apr 86	£23.51	LIVE WIRE GAME Dec 80	£16.44
FREELoader Apr 86	£8.08	GUITAR PRACTICE AMPLIFIER Nov 80 £14.10 less case, Standard case extra	£6.98
STEPPER MOTOR DRIVER Apr 86	£4.89	SOUND TO LIGHT Nov. 80 3 channel	£28.08
BBC MIDI INTERFACE Mar 86	£26.61	SPRING LINE REVERB UNIT Jan 80	£32.84
INTERVAL TIMER Mar 86	£17.87	UNIBOARD BURGLAR ALARM Dec 79	£7.99
STEREO HI-FI PRE-AMP	£46.85	DARKROOM TIMER July 79	£3.84
MAINS TESTER & FUSE FINDER Mar 86	£8.40	MICROCHIME DOORBELL Feb 79	£20.98
		SOUND TO LIGHT Sept 78	£10.98
		IN SITU TRANSISTOR TESTER Jun 78	£9.00
		WEIRD SOUND EFFECTS GENI Mar 78	£7.44
		ELECTRONIC DICE Mar 77	£6.97

ANTEX MODEL CIRCON	£9.98	LOW COST PLIERS	£1.98	DIGITAL	£39.98
ANTEX XS SOLDERING IRON 25W	£7.25	LOW COST CUTTERS	£1.99	DESOLDER PUMP	£5.48
ST4 STAND FOR IRONS	£2.85	BENT NOSE PLIERS	£1.88	SIGNAL INJECTOR	£2.98
HEAT SINK TWEEZERS	£5p	MINI DRILL 12V (M01)	£8.38	CIRCUIT TESTER	78c
SOLDER HANOY SIZE 5	£1.38	MULTIMETER TYPE 1 10000pV	£3.98	HELPING HANDS JIG & MAGNIFIER	£7.98
SOLDER CARTEL	£2.50	MULTIMETER TYPE 2 20,000pV	£17.98	MINIATURE VICE (PLASTIC)	£1.85
SOLDER REEL SIZE 10	£8.87	MULTIMETER TYPE 3 30,000pV	£27.98		
		MULTIMETER TYPE 4 10M			

EE PROJECT KITS MAGENTA

DIGITAL TROUBLESHOOTING

Top quality kits & parts for this new series. Our excellent technical back-up service helps to ensure that your projects succeed every time.
PART 1 BENCH POWER SUPPLY—Full kit £24.98.
LOGIC PROBE—£7.58 including case.
LOGIC PULSER—£7.48 including case.
VERSATILE PULSE GENERATOR—£29.98 including case.
DIGITAL I.C. TESTER—£29.21 (case different).
CURRENT TRACER—£20.56.
AUDIO LOGIC TRACER—£8.99.

EXPLORING ELECTRONICS

A full set of parts including the Verobloc breadboard to follow the series right up to Aug. 87 issue, £29.43.
Follow this excellent beginners series. Full set of reprints £5.00 or 80p per issue.
SEPT PARTS 72p OCT PARTS £2.56
NOV PARTS £3.32 DEC PARTS £4.77
JAN PARTS £5.58 FEB PARTS £1.14
MAR PARTS £1.98 APR PARTS £5.49
Extra Verobloc (Used in part 17) £7.99

INTRODUCTION TO ELECTRONICS

An introduction to the basic principles of electronics. With lots of simple experiments. Uses soldering. Lots of full colour illustrations and simple explanations. A lovely book. Ideal for all ages.
INTRODUCTION TO ELECTRONICS COMPONENT PACK £10.99
BOOK EXTRA £2.45
Book also available separately.

TEACH IN 86

MULTIMETER TYPE M102BZ as specified. Guaranteed. Top quality. 20k/V, with battery check, continuity tester buzzer and fuse and diode protection. 10A dc range. Complete with leads, battery and manual. £14.98
VEROBLOC BREADBOARD, DESIGN PAD, MOUNTING PANEL AND 10 CROCODILE CLIP CONNECTING LEADS £9.98
REGULATOR UNIT AND SAFE POWER SUPPLY. All components including the specified case. Specially re-designed by Magenta. No external transformer or adaptor required. PCB design for complete safety and ease of assembly. £26.84
COMPONENTS FOR PRACTICAL ASSIGNMENTS. Full set. £16.84

TEACH IN 86 PROJECTS

UNIVERSAL LCR BRIDGE Nov 85	£25.83
DIODE/TRANSISTOR TESTER Dec 85	£18.89
USEFUL AUDIO SIGNAL TRACER Jun 86	£16.75
AUDIO SIGNAL GENERATOR Feb 86	£26.21
R.F. SIGNAL GENERATOR March 86	£24.48
FET VOLT METER Apr 86	£21.48
DIGITAL PULSE GENERATOR May 86	£16.68

NEW
MINI MODEL MOTORS
1½-3V, 2 TYPES. MM1—59p MM2—61p

MOTOR — GEARBOX ASSEMBLIES

Miniature precision made. Complete with quality electric motor. Variable reduction ratios achieved by fitting from 1-6 gearwheels (supplied) as required. Operates from 1.5V to 4.5V. Small unit type MGS speed range 3rpm-2200rpm depending on voltage & gear ratio. Large unit type MGL (higher torque motor) 200r-1150rpm. Long 3mm dia output shafts. Ideal for robots and buggies.
Small Unit (MGS) £3.49. Large Unit (MGL) £3.98.
PULLEY WHEELS. New Range—PLASTIC WITH BRASS BUSH ⅜" dia. hole—easily drilled to 3 or 4mm. ⅜" dia. 35p. ⅜" dia. 36p. ⅜" dia. 44p. 1" dia. 44p.
Metal collar with fixing screw. 3mm bore 24p. Flexible spring coupling 5mm. Length 31mm 68p.
Flexible metal coupling (universal) 3mm £2.98; 2mm £3.34.

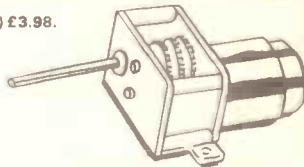

CATALOGUE

Brief details of each kit, our books, & illustrations of our range of tools & components. Also stepper motor, interface kit & simple robotics. Plus circuit ideas for you to build. If you read Everyday Electronics then you need a copy of the MAGENTA catalogue.

CATALOGUE & PRICE LIST — Send £1 in stamps or add £1 to your order. Price list — 9x4 4p. Catalogue FREE TO SCHOOLS/COLLEGES REQUESTED ON OFFICIAL LETTERHEAD.

MAGENTA ELECTRONICS LTD.
66A, 135 HUNTER STREET,
BURTON-ON-TRENT,
STAFFS. DE14 2ST
(0283 65435, Mon-Fri 9-5.
Access/B Barclaycard (Visa) by phone or post.
24 hr Answerphone for credit card orders.
Our prices include VAT.

SHOP NOW OPEN—CALLERS WELCOME
ADD £1 P&P TO ALL ORDERS.
PRICES INCLUDE VAT.
SAFE ALL ENQUIRIES.
OFFICIAL ORDERS WELCOME.
OVERSEAS: Payment must be sterling.
IRISH REPUBLIC and BFPO: UK PRICES.
EUROPE: UK PRICES plus 10%.
ELSEWHERE: write for quote.
SHOP HOURS: 9-5 MON-FRI.

NEW BOOKS

Modern Opto Device Projects	£2.95
Electronic Circuits for the Control of Model Railways	£2.95
A T.V.-DXers Handbook	£5.95
BP176	£2.95
Midi Projects. Penfold	£2.95
Getting The Most From Your Printer. Penfold	£2.95
More Advanced Electronic Music Projects. Penfold	£2.95



BOOKS

How to Get Your Electronic Projects Working. Penfold	£2.15
A practical Introduction to Microprocessors. Penfold	£2.10
Basic Electronics. Hodder & Stoughton	£8.88
Beginners Guide to Building Electronic Projects. Penfold	£2.25
DIY Robotics & Sensors Billingsley, BBC Commodore 64	£7.95
Elementary Electronics. Sladdin	£6.98
Science Experiments with Your Computer	£2.43
How to Design & Make Your Own PCBs BP121	£2.15
How to Make Computer Controlled Robots. Potter	£3.20
How to Make Computer Model Controllers. Potter	£3.19
Interfacing to Microprocessors & Microcomputers	£6.50
Machine Code for Beginners. Usborne	£2.45
Micro Interfacing Circuits Book 1	£2.45
Microprocessors for Hobbyists. Coles	£4.98
Practical Computer Experiments. Parr	£1.95
Practical Things to do With a Microcomputer. Usborne	£2.19
Questions & Answers — Electronics. Hickman	£3.45
Understanding the Micro. Usborne	£1.95

* JUST A SMALL SELECTION. LOTS MORE IN OUR PRICE LIST *

LEGO Technic Sets
TEACHERS WE ARE STOCKISTS OF THE WHOLE RANGE. CONTACT US FOR BROCHURES. VERY COMPETITIVE PRICES AND QUICK DELIVERIES.

STEPPING MOTORS 12 VOLT

48 STEPS	1035	200 STEPS	
	MD200		
£14.50		£16.80	

ADVENTURES WITH ELECTRONICS

An easy to follow book suitable for all ages. Ideal for beginners. No soldering, uses an S-Dec Breadboard. Gives clear instructions with lots of pictures. 16 projects — including three radios, siren, metronome, organ, intercom, timer, etc. Helps you learn about electronic components and how circuits work. Component pack includes an S-Dec breadboard and all the components for the projects.
Adventures with Electronics £3.88.
Component pack £20.88 less battery.

TOP KITS

A SELECTION OF OUR BEST PROJECT KITS

As usual these kits come complete with printed circuit boards, cases, all components, nuts, screws, wire etc. All have been tested by our engineers (many of them are our own designs) to ensure that you get excellent results.

INSULATION TESTER

An electronic High Voltage tester for mains appliances and wiring. An inverter circuit produces 500 volts from a PP3 battery and applies it to the circuit under test. Reads insulation up to 100 Megohms. Completely safe in use.



OUR KIT REF E444 £18.65

DIGITAL CAPACITANCE METER

Simple and accurate (1%) measurements of capacitors from a few pF up to 1,000 uF. Clear 5 digit LED display indicates exact value. Three ranges - pF, nF, and uF. Just connect the capacitor, press the button and read the value.



£39.57
OUR KIT
REF E493

3 BAND SHORTWAVE RADIO

Covers 1.6-30 MHz in 3 bands using modern miniature coils. Audio output is via a built-in loudspeaker. Advanced design gives excellent stability, sensitivity and selectivity. Simple to build.



OUR KIT REF E718 £25.27

DIGITAL FREQUENCY METER 200 MHz

An 8 digit meter reading from A.F. up to 200 MHz in two ranges. Large 0.5" Red LED display. Ideal for AF and RF measurements, Amateur and C.B. frequencies.

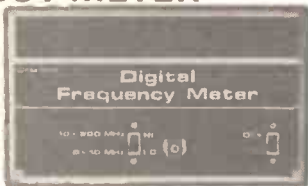

KIT REF E 563 £59.98

'EQUALISER' IONISER

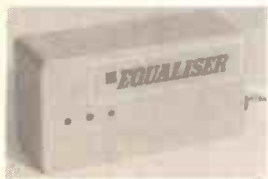

A mains powered ioniser that produces a breeze of negative ions in the air. A compact, safe, simple unit that uses a negligible amount of electricity.

KIT REF E707 £14.79

VISUAL GUITAR TUNER



A crystal controlled tuner with a New type of 'rotating' LED display. Clockwise or Anticlockwise rotation indicates high or low frequency. Perfect tuning is obtained when the pattern is stationary. Suitable for electric guitar pick-ups or may be used with a microphone for acoustic instruments. Also has an audio 'pitch pipe' output.

KIT REF E711 £21.99

NEW 1988/9 CATALOGUE
FROM MAGENTA

ELECTRONICS TEACH-IN

£1.95

A comprehensive background to electronics, including practical experiments, plus full construction details of eight test gear projects.



From the
Publishers of
EVERYDAY
ELECTRONICS

ELECTRONICS TEACH-IN ONLY £1.95

By Michael Tooley BA and
David Whitfield MA MSc CEng MIEE

A COMPREHENSIVE background to modern electronics including test gear projects. This 104 page, A4 size book forms a complete course in basic electronics; designed for the complete newcomer it will however also be of value to those with some previous experience of electronics. Wherever possible the course is related to "real life" working circuits and each part includes a set of detailed practical assignments.

To complement the course computer programs have been produced for the BBC Micro and Spectrum or Spectrum Plus. The software is designed to reinforce and consolidate important concepts and principles introduced in the course, it also allows readers to monitor their progress by means of a series of multi-choice tests.

The book includes details of eight items of related test gear giving full constructional information and diagrams for each one. The items of test gear described are: Safe Power Supply; Universal LCR Bridge; Diode/Transistor Tester; Audio Signal Tracer; Audio Signal Generator; RF Signal Generator; FET Voltmeter; Pulse Generator.

This book is an excellent companion for anyone interested in electronics and will be invaluable for those taking G.C.S.E. electronics courses.

Send a cheque, PO or bank draft for £1.95 (overseas readers please add 80p postage. Payment in £ sterling only) to **Wimborne Publishing Ltd., 6 Church Street, Wimborne, Dorset BH21 1JH. Tel: 0202 881749.**

For KITS & COMPONENTS -
Choose the easy way - with *refundable with first order*

Send 50p* & SAE for CATALOGUE

ORDERS: RING (01) 567 8910 - 24 HRS.



NEW ELECTRONIC GUARD DOG KIT



One of the best deterrents to a burglar is a guard dog and this new kit provides the barking without the bite! The kit when assembled can be connected to a doorbell, pressure mat or any other intruder detector and will produce a random series of threatening barks making the would be intruder think again and try his luck elsewhere. The kit is supplied complete with high quality PCB, transformer, all components and instructions. All you need is a mains supply, intruder detector and a little time. The kit even includes a horn speaker which is essential to produce the loud sound required. The "dog" can be adjusted to produce barks ranging from a Terrier to an Alsatian and contains circuitry to produce a random series of barks giving a more realistic effect.

XX125 Complete kit of parts £24.00

DISCO LIGHTING KITS

DL1000K - This value-for-money 4-way claser features bi-directional sequence and dimming. 1KW per channel **£19.25**
DL21000K - A lower cost uni-directional version of the above. Zero switching to reduce interference..... **£10.80**
DLA/1 (for DL & DL21000K) Optional opto input allowing audio "beat/light response" **77p**
DL3000K - 3-channel sound to light kit features zero voltage switching, automatic level control and built-in microphone. 1KW per channel **£15.60**
 The DL8000K is an 8-way sequencer kit with built in opto-isolated sound to light input which comes complete with a pre-programmed EPROM containing EIGHTY - YES 80! different sequences including standard flashing and chase routines. The KIT includes full instructions and all components (even the PCB connectors) and requires only a box and a control knob to complete. Other features include manual sequence speed adjustment, zero voltage switching, LED mimic lamps and sound to light LED and a 300 W output per channel.
 And the best thing about it is the price.

ONLY £31.50



TEN EXCITING PROJECTS FOR BEGINNERS

This Kit has been specially designed for the beginner and contains a **SOLDERLESS BREADBOARD, COMPONENTS, and a BOOKLET** with instructions to enable the absolute novice to build TEN fascinating projects including a light operated switch, intruder, burglar alarm, and electronic lock. Each project includes a circuit diagram, description of operation and an easy to follow layout diagram. A section on component identification and function is included, enabling the beginner to build the circuits with confidence.

ORDER NO. **XX118** £15.00

NEW XK102-3-NOTE DOOR CHIME

Based on the SAB0600 IC the kit is supplied with all components, including loudspeaker, printed circuit board, a pre-drilled box (95 x 71 x 35mm) and full instructions. Requires only a PP3 9V battery and push-switch to complete.

AN IDEAL PROJECT FOR BEGINNERS **£6.60**

NEW XK113 MW RADIO KIT

Based on ZN414 IC, kit includes PCB, wound aerial and crystal earpiece and all components to make a sensitive miniature radio. Size: 5.5 x 2.7 x 2cms. Requires PP3 9V battery. **IDEAL FOR BEGINNERS £6.60**

VERSATILE REMOTE CONTROL KIT

This kit includes all components (+ transformer) to make a sensitive IR receiver with 16 logic outputs (0-15V) which with suitable interface circuitry (relays, triacs, etc - details supplied) can be used to switch up to 16 items of equipment on or off remotely. The outputs may be latched (to the last received code) or momentary (on during transmission) by specifying the decoder IC and a 15V stabilised supply is available to power external circuits. Supply: 240V AC or 15-24V DC at 10mA. Size (excluding transformer) 9 x 4 x 2 cms. The companion transmitter is the MK18 which operates from a 9V PP3 battery and gives a range of up to 60ft. Two keyboards are available—MK9 (4-way) and MK10 (16-way), depending on the number of outputs to be used.

MK12 IR Receiver (incl. transformer)	£16.30
MK18 Transmitter.....	£7.50
MK9 4-Way Keyboard.....	£2.20
MK10 16-Way Keyboard.....	£6.55
601 133 Box for Transmitter.....	£2.60

HOME LIGHTING KITS

These kits contain all necessary components and full instructions and are designed to replace a standard wall switch and control up to 300W of lighting.

TDR300K Remote Control Dimmer	£18.00
MK6 Transmitter for above	£5.10
TD300K Touchdimmer	£9.30
TS300K Touchswitch	£9.30
TDE/K Extension kit for 2-way switching for TD300K	£2.95
LD 300K Light Dimmer	£4.75

NEW POWER STROBE KIT

Designed to produce a high intensity light pulse at a variable frequency of 1 to 15Hz this kit also includes circuitry to trigger the light from an external voltage source (eg. a loudspeaker) via an opto isolator. Instructions are also supplied on modifying the unit for manual triggering, as a slave flash in photographic applications or as a warning beacon in security applications. The kit includes a high quality pcb, components, connectors, 5W strobe tube and full assembly instructions. Supply: 240V ac. Size: 80 x 50 x 45.

XX124 STROBOSCOPE KIT £13.75

NEW HIGH SECURITY LOCK KIT

Designed for use with our lock mechanism (701 150) this kit will operate from a 9V to 15V supply drawing a standby current of only 50µA. There are over 5000 possible 4-digit combinations and the sequence can be easily changed. To make things even more difficult for an unauthorised user an alarm can be sounded after 3 to 9 incorrect entries—selectable by means of a link. The alarm can sound for a few seconds to over 3 minutes during which time the keyboard is disabled preventing further entries. A latched or momentary output is available making the unit ideal for door locks, burglar alarms, car immobilisers, etc. A membrane keyboard or pushbutton switches may be used and a beep sounds when a key is depressed. Kit includes high quality PCB, all components, connectors, high power piezo buzzer and full assembly and user instructions.

XX121 LOCK KIT	£15.95
350 118 Set of Keyboard Switches	£4.00
701 150 Electric Lock Mechanism 12 volt	£16.50

PROPORTIONAL TEMPERATURE CONTROLLER KIT

Uses "burst fire" technique to maintain temperature to within 0.5°C. Ideal for photography, incubators, wine-making, etc. Max. load 3kw (240V ac) Temp. range up to 90°C. Size: 7x4x2.5cms. **MK4 £7.80**

BARGAIN COMPONENT PACKS

Refill those empty component drawers at a fraction of the normal price and don't be caught without that odd resistor or capacitor to complete your project. All components supplied are full specification and not seconds or surplus stock.

PACK A: 650x0.25W resistors 47R to 10M **£4.25**
PACK B: 60xElectrolytics 1uF-1000uF **£3.25**
PACK C: 30xPolyester Capacitors 0.01-1uF **£4.50**
PACK D: 36xHorizontal presets 1k-1M **£3.00**
PACK E: 30xIC sockets 8, 14 & 16 Pin **£2.00**
PACK F: 25xRed LEDs 5mm **£1.75**
PACK G: 25xGreen LEDs 5mm **£2.00**
PACK H: 30x5mm LEDs—red, green, yellow **£2.50**
PACK J: 50x1N4148 Si. diodes **£1.00**
PACK K: 40xNPN/PPN transistors BC182/212 General Purpose **£2.25**

10% OFF when you buy ALL 10 PACKS

NEW SUPER-SENSITIVE FM MICROBUG



Highly sensitive FM transmitter measuring only 45x25x15mm, including the built-in microphone. Frequency 88-100MHz enabling reception on a standard domestic FM radio. Range approximately 300m depending on terrain. Powered by 9V PP3 (7mA). Its small size and highly sensitive electret microphone makes it ideal for surveillance, baby alarm, etc. **INTRODUCTORY PRICE £5.50**

LOW COST MULTIMETER

A versatile meter with 19 ranges including 10A DC & BATTERY TEST. Case is tilted for easy reading. Supplied complete with batteries, test leads and a manual. Ideal meter for the beginner. Input impedance 20K ohm per volt. AC Volts: 0-10-25-100V 5%. DC Volts: 0-2.5-20-25-250 + 1000V + 5%. DC Current: 0-2.5-25m 250mA-10A + 4%. Resistance: 0-10K-100K-10M. Battery test: 9V-1.5V AA-1.5V C & D. Protection: Fuse. Dimensions: 154 x 77 x 43mm. **£8.62**



Good quality tools selected to offer outstanding value for money.

650 004 6in mini. Snipe Nose Pliers. Serrated jaws and return spring. **£2.10**
650 005 6in lap jointed side cutters. Insulated handles and return spring. **£2.10**
650 008 Light duty cutters. Cutting capacity 0.22-1.2mm copper wire. **£1.60**
TOOL KIT - Contains: side cutters, snipe nose pliers, wire strippers, flat blade screwdriver, philips screwdriver in black textured, reinforced and padded case which when opened out measures 240x205mm **£6.80**

650 007 Self-adjustable automatic wire stripper with built-in cable cutter. **£3.95**
650 012 Watchmakers Screwdriver Set. 1.0/1.4/2.0/2.4/3.0/3.8mm **£1.75**
650 019 Set of 4 Stainless Steel Tweezers. Straight nosed, straight nosed-reverse action, bent nosed, flat nosed. 110mm long. **£3.65**
650 502 Reliant 9-12V dc Drill. **£6.90**
650 500 Titan 12V dc Drill. **£10.25**
650 570 Saturn Mains Drill. **£16.50**
WE ALSO STOCK ANTEX IRONS AND ACCESSORIES

LOGIC PROBE



A MUST for working with TTL & CMOS devices. Displays logic levels and pulses down to 25ns with LEDs and sound. Comprehensive instruction booklet supplied. Working voltage 4-16V dc. Input Impedance 1M. Max. I/p frequency 20MHz. **ONLY £9.50**

RECHARGEABLE SOLDERING IRON

Powerful cordless iron complete with table-top/wall-mounting charging bracket. Reaches soldering temperature in 10 seconds. Includes lamp which lights when soldering. Comes with mains charging unit and 12V car battery adaptor. **Special offer £15.95**

HELPING HANDS

Magnifier and crocodile clips on ball and socket joints mounted on a heavy base. Ideal for holding and inspecting PCBs during soldering, fault finding, etc. (650 035) **£3.95**



SOLAR POWERED NICAD CHARGER

Takes up to 4 x AA size. Charges 2 batteries in 4-6 hrs. depending on strength of sunlight. Ideal for boating, caravaning, modellers, etc. **£6.50**

ELECTRONIC WEIGHING SCALES

This kit contains a Single Chip Microprocessor, PCB, displays and all electronics to produce a digital readout of weight in Kgs. or Sts. and Lbs. In normal use a toothed wheel (pattern provided) is made to rotate when a weight is placed onto the scales, interrupting two infra-red beams. The processor counts the number of teeth passing the sensor (up or down, depending on which beam is broken first), and shows the reading on the LED display in Sts. and Lbs. or Kgs. A PCB link selects the scale for bathroom or two types of Kitchen Scales. A linear version of the toothed wheel could also be used. Other uses include up/down counters. A low cost digital ruler could be made by using a wheel with the correct tooth to diameter ratio. **ES1 £5.50**



TK ELECTRONICS
13 BOSTON RD
LONDON W7 3SJ
Tel: 01-567 8910

ORDERING INFORMATION: ALL PRICES EXCLUDE VAT
FREE P&P on orders over £20 (UK only), otherwise add 75p + VAT. Overseas P&P: Europe £2.75. Elsewhere £6.50. Send cheque/PO/Barclaycard/Access No. with order. Giro No. 529314002.
LOCAL AUTHORITY AND EXPORT ORDERS WELCOME
GOODS BY RETURN SUBJECT TO AVAILABILITY

EVERYDAY ELECTRONICS

INCORPORATING ELECTRONICS MONTHLY

The Magazine for Electronic & Computer Projects

VOL. 17 No. 5

May '88

Editorial Offices

EVERYDAY ELECTRONICS EDITORIAL,
6 CHURCH STREET, WIMBORNE,
DORSET BH21 1JH

Phone: Wimborne (0202) 881749

Fax: (0202) 841692

See notes on **Readers' Enquiries** below—we regret that lengthy technical enquiries cannot be answered over the telephone

Advertisement Offices

EVERYDAY ELECTRONICS ADVERTISEMENTS
4 NEASDEN AVE., CLACTON-ON-SEA, ESSEX
CO16 7HG. Clacton (0255) 436471

OLD FIRM

MANY readers will know what Veroboard is—we use it quite often for building projects on—in fact Veroboard has been used in virtually every issue since *Everyday Electronics* was first published in 1971. It is of course a very easy to use universal printed wiring board. Perhaps amateurs and those learning electronics—students, apprentices, trainees, etc., use more Veroboard than anyone else these days. Where does all this board come from?

Veroboard and other Vero products are made by BICC Vero at their factories around Southampton. BICC Vero make a large range of products aimed at the electronics industry. Their catalogue is massive, well over 400 pages size A4.

NEW PRODUCT

Why am I telling you all this? Because BICC Vero is about to launch a totally new wiring system that is easy to use, requires no soldering and allows the components and board to be re-used. It is called Easiwire and looks like revolutionising prototype wiring. Perhaps it will even replace Veroboard for prototyping.

We have tried Easiwire and believe it will be welcomed in schools and training establishments, it will also enable hobbyists to quickly build simple projects, projects that will not suffer from dry joints and where wiring mistakes can easily be corrected without applying heat to the components. Moreover it will allow all the components and the mounting board to be used again and again.

Next month we will review this new wiring system and hopefully publish a project using it. Once again BICC Vero are courting the hobbyist with a new product aimed directly at our market. Easiwire is so simple it makes one wonder why no-one has produced it before—isn't that the hallmark of all good inventions?

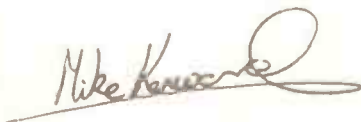

SUBSCRIPTIONS

Annual subscriptions for delivery direct to any address in the UK: £14.50. Overseas: £17.50 (£34 airmail). Cheques or bank drafts (in

£ sterling only) payable to Everyday Electronics and sent to EE Subscriptions Dept., 6 Church Street, Wimborne, Dorset BH21 1JH. **Subscriptions can only start with the next available issue.** For back numbers see below.

BACK ISSUES & BINDERS

Certain back issues of EVERYDAY ELECTRONICS are available price £1.50 (£2.00 overseas surface mail) inclusive of postage and packing per copy. Enquiries with remittance, made payable to Everyday Electronics, should be sent to Post Sales Department, Everyday Electronics, 6 Church Street, Wimborne, Dorset BH21 1JH. In the event of non-availability remittance will be returned. **Please allow 28 days for delivery. (We have sold out of Sept. Oct. & Nov. 85, April, May & Dec. 86, Jan. Feb. & April 87.)**

Binders to hold one volume (12 issues) are available from the above address for £4.95 (£9.00 overseas surface mail) inclusive of p&p. **Please allow 28 days for delivery.**

Payment in £ sterling only please.

Editor MIKE KENWARD

Secretary PAMELA BROWN

Deputy Editor

DAVID BARRINGTON

Editorial Assistant

COLETTE MCKENZIE

Editorial: WIMBORNE (0202) 881749

Advertisement Manager

PETER J. MEW Clacton (0255) 436471

Classified Advertisements

Wimborne (0202) 881749

READERS' ENQUIRIES

We are unable to offer any advice on the use, purchase, repair or modification of commercial equipment or the incorporation or modification of designs published in the magazine. We regret that we cannot provide data or answer queries on articles or projects that are more than five years old. Letters requiring a personal reply must be accompanied by a **stamped self-addressed envelope** or a **self-addressed envelope and international reply coupons**.

All reasonable precautions are taken to ensure that the advice and data given to readers is reliable. We cannot, however, guarantee it and we cannot accept legal responsibility for it.

COMPONENT SUPPLIES

We do not supply electronic components or kits for building the projects featured, these can be supplied by advertisers.

OLD PROJECTS

We advise readers to check that all parts are still available before commencing any project in a back-dated issue.

We regret that **we cannot provide data or answer queries on projects that are more than five years old.**

ADVERTISEMENTS

Although the proprietors and staff of EVERYDAY ELECTRONICS take reasonable precautions to protect the interests of readers by ensuring as far as practicable that advertisements are *bona fide*, the magazine and its Publishers cannot give any undertakings in respect of statements or claims made by advertisers, whether these advertisements are printed as part of the magazine, or are in the form of inserts.

The Publishers regret that under no circumstances will the magazine accept liability for non-receipt of goods ordered, or for late delivery, or for faults in manufacture. Legal remedies are available in respect of some of these circumstances, and readers who have complaints should address them to the advertiser or should consult a local trading standards office, or a Citizen's Advice Bureau, or a solicitor.

TRANSMITTERS

We would like to advise readers that certain items of radio transmitting equipment which may be advertised in our pages cannot be legally used in the U.K. Readers should check the law before using any transmitting equipment as a fine, confiscation of equipment and/or imprisonment can result from illegal use.

The law relating to this subject varies from country to country; overseas readers should check local laws.

WIDE RANGE FUNCTION GENERATOR

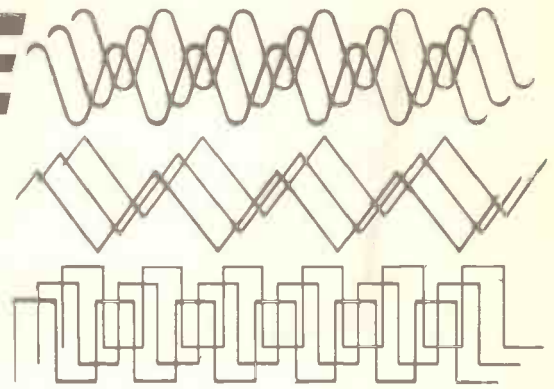

MIKE FEATHER

A very versatile generator providing sine, square and triangular waveforms from 1Hz to 100kHz at up to 20V peak-to-peak output.

THIS instrument provides the constructor with a versatile source of variable amplitude waveforms over a frequency range of 1Hz to 100kHz. Three types of output waveform are selectable by a switch—sine, triangle and square. The sine and triangle waveforms are useful for audio and other analogue testing, whilst the square-wave output, with its fast rise and fall times, is very convenient for use with digital circuitry.

The output waveform amplitude is continuously variable over a range of 0 to 20V

p/p, with a switchable attenuator providing a lower range of 0 to 2V p/p.

The design incorporates a built-in analogue frequency meter for ease of use and calibration

CIRCUIT DESCRIPTION

The principal section of the Function Generator circuit is shown in Fig. 1. The design is based upon IC1, a 8038 function generator chip which produces the sine, triangle and square wave outputs at pins 2, 3 and 9 respectively. An external capacitor connected

to pin 10 of the chip determines the overall frequency of oscillation, whilst the charge and discharge currents applied to this capacitor can be varied by altering the voltage at pin 8.

Five switchable decade ranges are provided by capacitors C1 to C5, switched into circuit by S1a. Fine frequency control over each decade is accomplished by VR1 which varies the voltage at pin 8 as described. VR2 and VR3 are presets which set the upper and lower frequency limits of each decade.

The basic square wave duty cycle can be adjusted by VR4; a 2k preset is used for this.

In order to minimise sine wave distortion, presets VR5 and VR6 are included. Careful adjustment of these produces an output sine waveform of typically 0.5% total harmonic distortion.

In order to prevent overloading the chip and consequent distortion of the output waveform, an output buffer/amplifier is incorporated. IC2, a 071 bifet operational

Fig. 1. Circuit diagram of the Wide Range Function Generator.

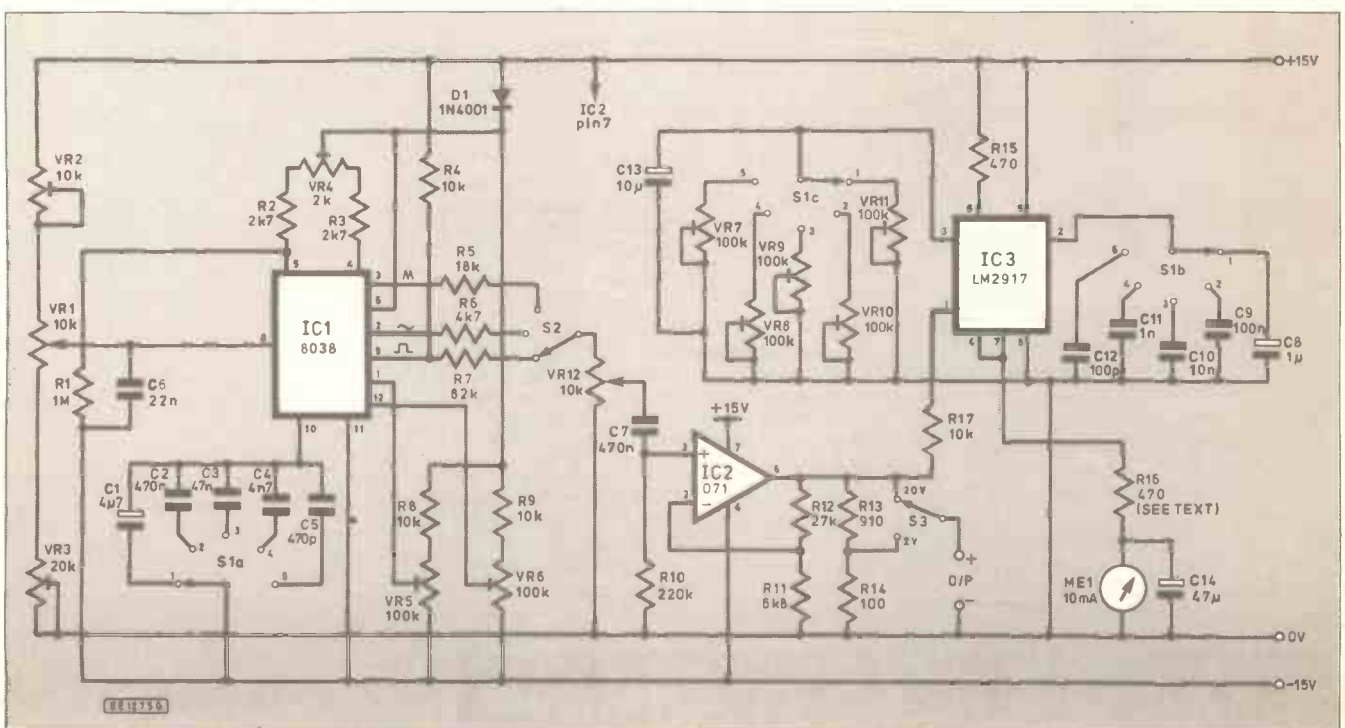

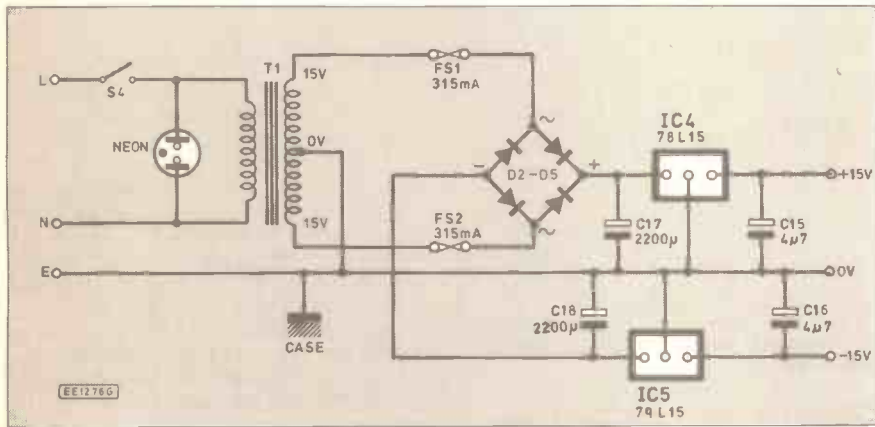

Fig. 2. Power supply for the generator.

amplifier is used here. This device was chosen mainly on account of its excellent full-power bandwidth characteristic of 150kHz. The use of some older bipolar operational amplifiers, such as the ubiquitous 741, is not recommended as its limited full power bandwidth would cause much reduced output at higher frequencies.

The input to the buffer/amplifier is via S2, which selects the waveform type and VR12, which provides the output amplitude control. The output attenuator circuitry comprises of S3/R13/R14.

The frequency meter section of the circuit is based upon IC3, an LM2917 tachometer chip. This 8-pin d.i.l. device is basically a frequency/voltage converter which employs the charge pump technique to develop an analogue output voltage which is proportional to the frequency of the input waveform. The chip contains internal circuitry for wave-shaping and level clamping and a Zener diode for supply voltage regulation.

The frequency measurement range is set by switch S1b which selects an appropriate timing capacitor from C8 to C12. Capacitor tolerances present a slight problem here and, in order to preserve continuity of calibration between the different ranges, switch S1c selects a preset potentiometer whose value can be adjusted for each frequency decade.

The power supply circuitry is fairly conventional and is shown in Fig. 2. The 8038 and the buffer/amplifier require $\pm 15V$ supplies and these are provided by IC4 and IC5 which are plus and minus 15V, 100 mA regulators.

CONSTRUCTION

The instrument is built on two printed circuit boards; one is used for the function generator/buffer/frequency meter circuitry, whilst the power supply occupies the smaller separate p.c.b. These boards are available from the *EE PCB Service*, code 606 and 607.

COMPONENTS

Resistors

R1	1M
R2, R3	2k7 (2 off)
R4, R8, R9, R17	10k (4 off)
R5	18k
R6	4k7
R7	82k
R10	220k
R11	6k8
R12	27k
R13	910
R14	100
R15	470
R16	470 see text

All resistors 1/4W 5%

Capacitors

C1	4µ7 elect. 16V
C2	470n 10% polyester
C3	47n 10% polyester
C4	4n7 10% polyester
C5	470p 5% ceramic
C6	22n 10% polyester
C7	470n 10% polyester
C8	1µ elect. 16V
C9	100n 10% Polyester
C10	10n 10% polyester
C11	1n 5% polystyrene
C12	100p 5% ceramic

C13 10µ elect. 16V

C14 47µ elect. 16V

C15, C16 4µ7 elect 25V (2 off)

C17, C18 2200µ elect. 63V (2 off)

**Shop
Talk**

See page 295

Potentiometers

VR1	10k lin. carbon
VR2	10k lin. min. multiturn
VR3	20k lin. min. multiturn
VR4	2k min. skeleton preset
VR5 to VR11	100k min. skel. preset (7 off)
VR12	10k log. carbon

Semiconductors

D1	1N4001 diode
D2 to D5	50V 1A bridge rectifier
IC1	8038 waveform generator
IC2	TL071 op. amp. 8-pin
IC3	LM2917 tachometer
IC4	78L15 +15V 100mA regulator
IC5	79L15 -15V 100mA regulator

Miscellaneous

S1	4-pole 6-way double wafer rotary switch
S2	1-pole 3-way rotary switch
S3	SPDT min. toggle switch
ME1	10mA f.s.d/100 ohm meter
T1	15/0/15V 100mA transformer

Min. mains connector; p.c.b. mount fuse holders (2 off); 315 mA anti-surge fuses (2 off); 4mm panel sockets (2 off); mains neon indicator; Veropins; suitable case; Printed circuit boards, available from *EE PCB Service*, code EE 606 and EE 607.

Note: miniature cermet multi-turns were used for VR2 and VR3 in the prototype. These do make adjustment of the range limits easier, but standard skeleton pots could be used (this would entail a slight modification to the p.c.b. or mounting on pins)

Approx. cost
Guidance only

£40 plus case

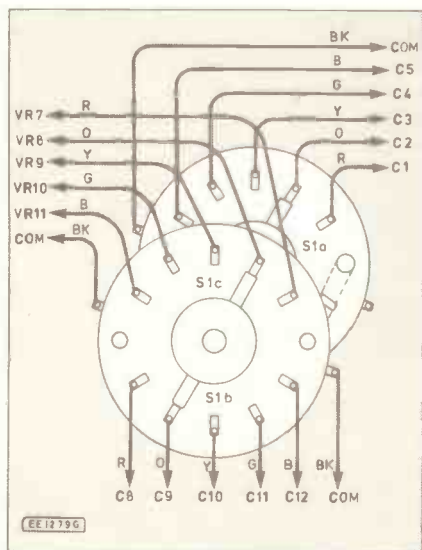
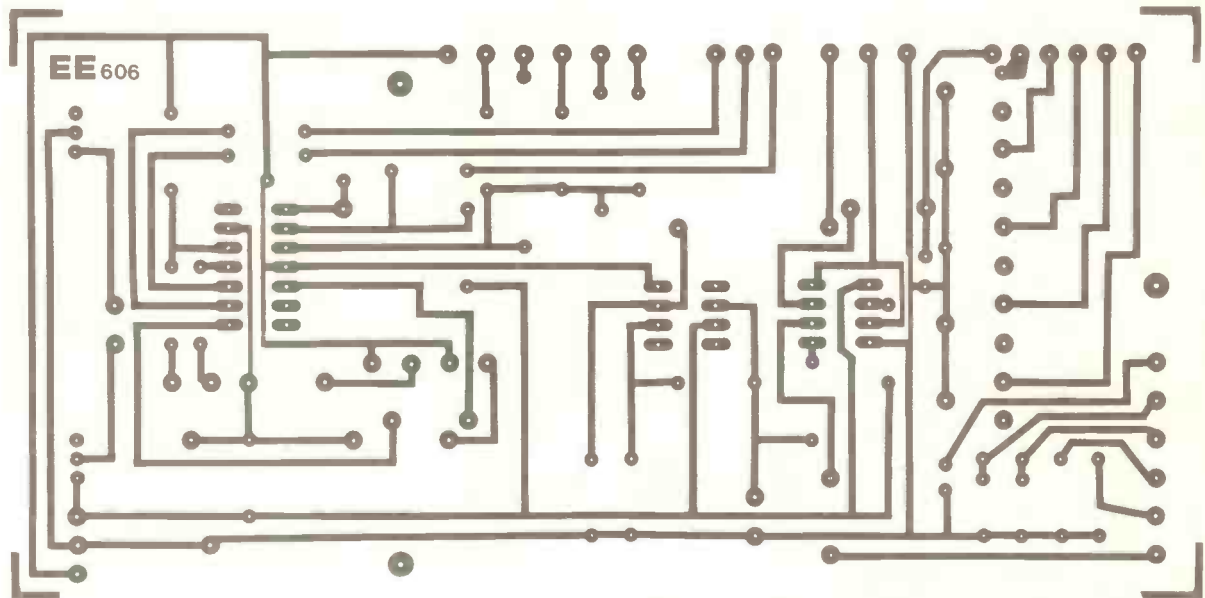
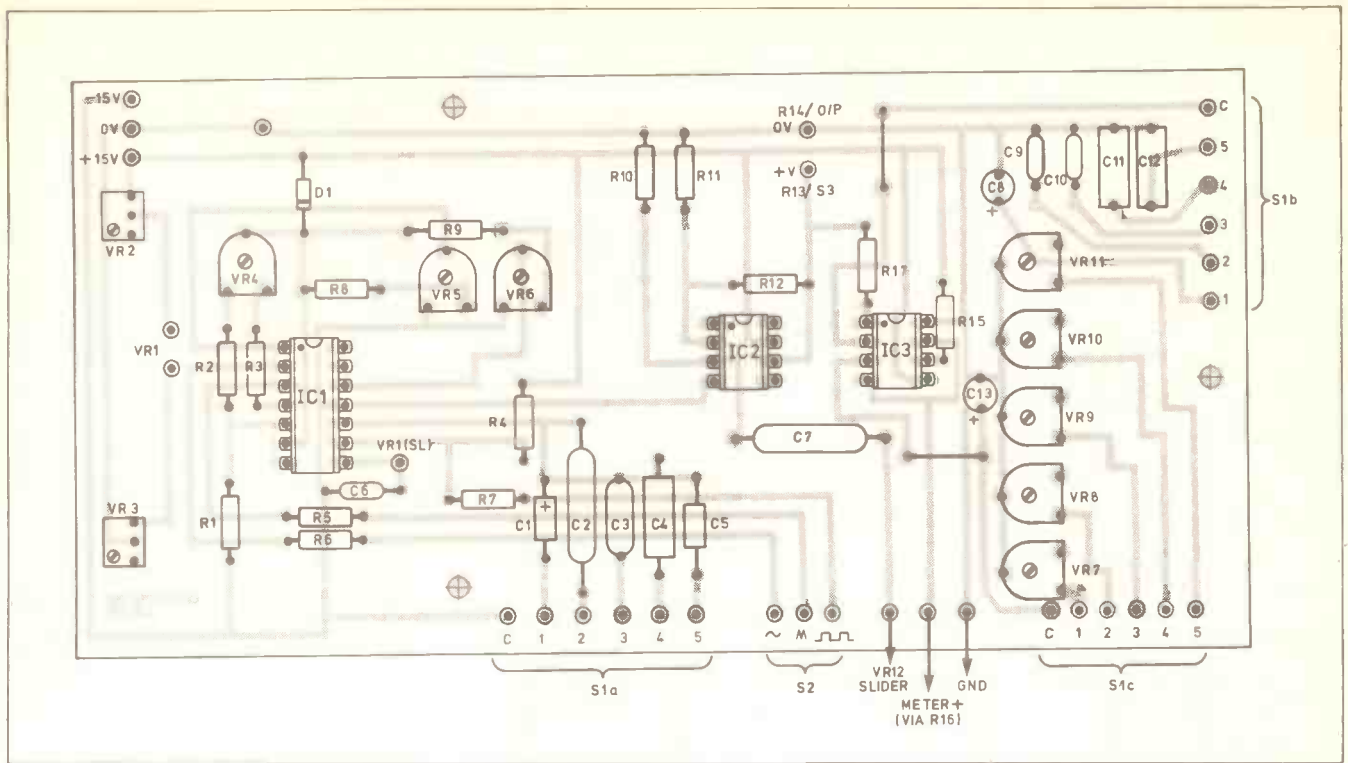

Fig. 5 (left). Wiring of S1 to the main p.c.b.

The foil patterns and components overlay diagrams for these boards are shown in Figs. 3 and 4. The main circuit board should be completed first.

Begin construction by inserting board pins and i.c. holders on the main board and then carefully soldering them in. Components are placed as shown in the overlay diagram of Fig.3, noting the orientation of polarised components. These are then soldered in and their leads cropped carefully on the underside of the board. Note that resistors should not be in contact with the board but should instead be positioned a millimetre or two above it. The integrated circuits can now be inserted into their holders noting the position of pin one in each.

The power supply p.c.b. should now be constructed, once again taking particular

Fig. 3 (above). Main p.c.b. for the function generator.

care with the orientation of polarised components. Finally, on completion of both boards, a careful inspection should be made of the copper side and any dry joints, solder bridges etc. rectified.

TESTING AND CALIBRATION

Preliminary testing and calibration of the unit is advisable before the boards are mounted in a case.

The power supply p.c.b. can first be tested by connecting the a.c. input pins to the mains transformer secondary terminals. The transformer primary should then be connected to the mains supply. Take care here with the exposed primary solder tags of the transformer. Measure the voltage at the output

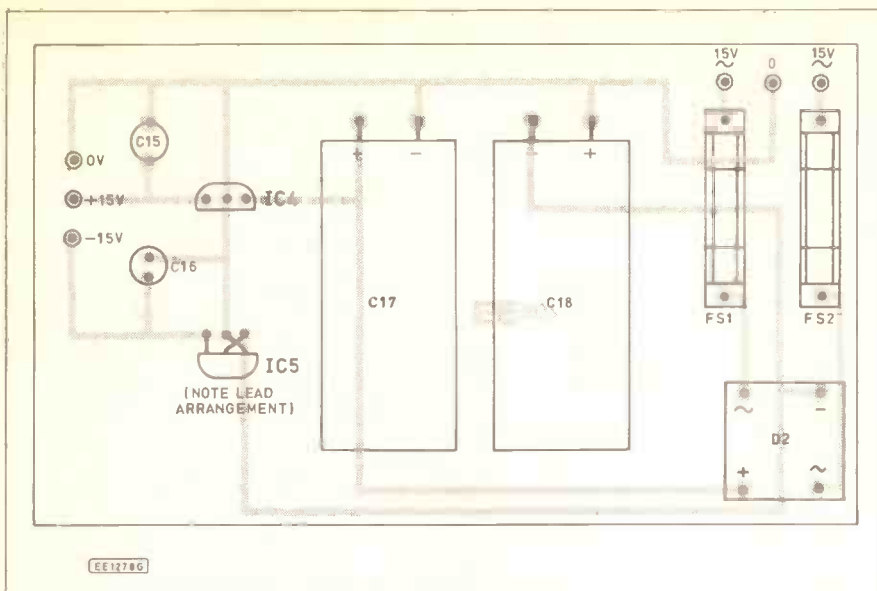
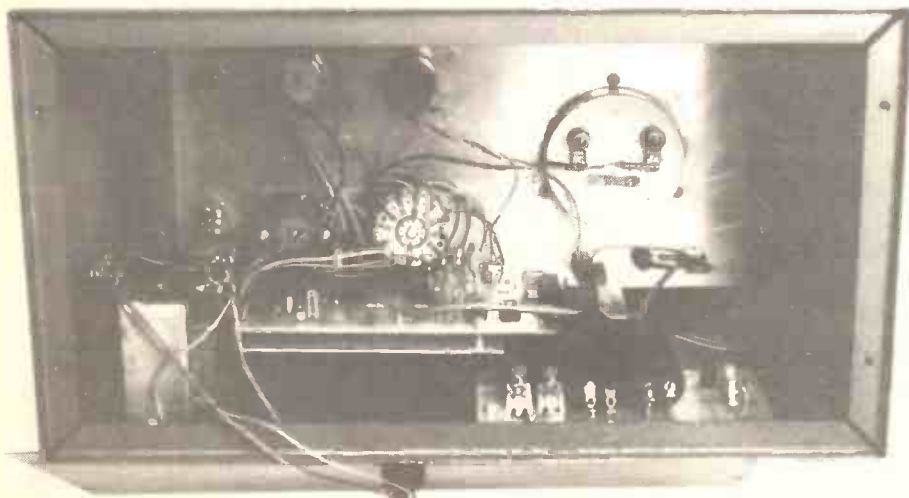
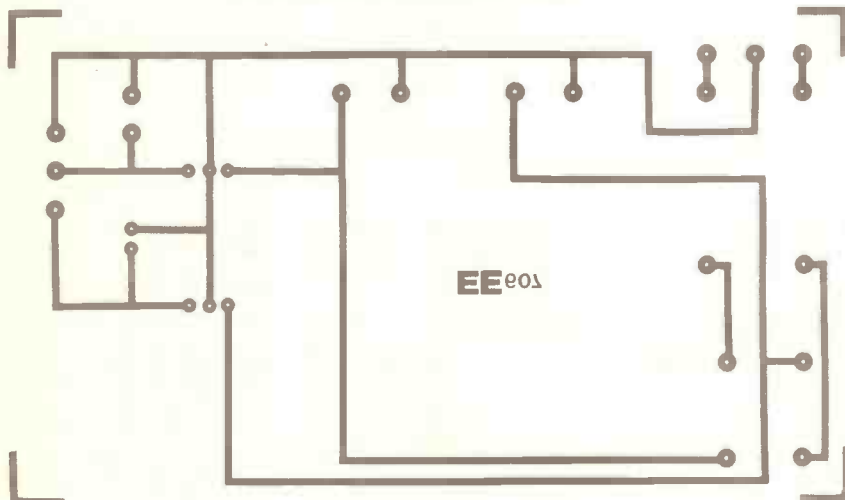

Fig. 4. Power supply p.c.b. layout.



pins of the board and check that they are approximately ± 15 V.

The main board external components S1, S2, VR1 and VR12 can be connected to the board pins. The connections to S1 are fairly tricky: use colour coded wire and consult Fig. 5. Note that the leads to VR12 (the output level control) use miniature screened cable. Take care here with the brading. The main board can now be connected to the power supply p.c.b. and power applied.

Testing and calibration of the unit is a little tricky and requires the use of an oscilloscope. With power applied to the main-board, set S1 to range 3 (100Hz-1kHz) and adjust VR1 to mid track. Make a preliminary test to confirm that the function generator i.c is running by connecting the 'scope input to pin 9 (the square wave output) of the 8038 i.c. Some form of rectangular waveform should be observed.

Assuming that all is well, the next job is to set the range limits. Adjust preset VR4 so as to produce a symmetrical (unity mark space) square wave at pin 9 of IC1. Now set VR1 to its fully clockwise position and adjust preset VR3 to give a square wave output frequency of 1kHz at pin 9. Turn VR1 to its fully anti-clockwise position and adjust VR2 until the output frequency is 100Hz.

The 1kHz setting should now be checked; it will probably have changed and the range limit adjustment procedure must be repeated until the limits are correct.

Sine wave purity now needs to be adjusted. Connect the scope input to pin two (the sine wave output) of IC1 and adjust presets VR5 and VR6 for the best visual symmetry of the sine wave.

The oscilloscope should now be connected to the output pin of the board and the buffer/amplifier circuitry tested. Varying the output level control VR12 should allow a maximum output signal amplitude of at least 20V p/p before sine wave clipping (or any other form of distortion) becomes apparent.

Finally, the frequency meter can be calibrated. Select each range in turn and, using the oscilloscope, adjust VR1 to give an output frequency at the mid-point of the range. Adjust the appropriate preset from VR7 to VR11 so as to give exactly half scale deflection of the meter.

FINAL ASSEMBLY

The style of case and front panel layout employed is not important and is left up to the choice of the constructor. Whatever form is used, however, you must allow adequate space for the two boards and the front panel components. A metal case is to be preferred and care should be taken with the earthing arrangements.

The meter used in the prototype was a 10mA f.s.d. 100 ohm type which, in combination with R16 acts as a 0 to 5V voltmeter. Other meters can be used, but this will entail the use of a different value of multiplier resistor R16.

USING THE FUNCTION GENERATOR

The commonest applications of the unit will probably be as a general purpose signal source. The sine wave output can be used for measuring the responses of amplifiers and filters whilst the triangle waveforms are very useful for examining crossover distortion in class AB amplifiers. The square wave signals are also useful in testing amplifier response and they will, of course, find applications with digital circuits. □

MULTI-CHANNEL REMOTE LIGHT DIMMER

PART ONE

B. ROBINSON



You've seen the effects in TV commercials, now build your own, finger tip, remote control lights dimmer.

A COLLEAGUE who has been building his own home was looking for something a little different in lighting for his lounge and after some discussion with a few friends, was persuaded to install remote control light dimmers. As his lounge is rather large, he decided that he would need at least six lights to provide adequate lighting, but the prospect of obtaining six separate remote control light dimmers each working independently of the others was daunting.

Apart from the difficulty of handling the separate remote control units, the cost would be prohibitive. Obviously what was needed was a remote control unit similar to those used on television sets with the ability to control many different functions. At this point the author offered to try to develop some sort of system, and this article describes the resulting controller.

SYSTEM

The block diagram, Fig. 1, shows the overall system. If one of the buttons on the keypad is pressed, the integrated circuit inside the handset generates a coded train of pulses which, after amplification are used to drive three infra red emitters.

These emitters produce a pulsed beam of infra red light which is received by the infra red detector in the main control unit. The signal from the detector is amplified and then decoded by the receiver electronics, and drives the required light dimmer, causing one of the lights to switch on or off, or to change brightness.

The range of the infra-red beam depends

IT IS VERY IMPORTANT TO SWITCH THE MAINS OFF BEFORE HANDLING ANY OF THE BOARDS, MAINS LAMP DIMMERS ARE POTENTIALLY LETHAL

TRANSMITTER CIRCUIT

The circuit diagram for the transmitter is shown in Fig. 2. The SL490 remote control transmitter integrated circuit IC1 produces the coded signal. It is a binary coded pulse position modulated signal (PPM), whose code is dependant upon which of the keypad switches is operated.

The device can handle up to thirty-two switches, producing a unique code for each switch, but in this application only six of

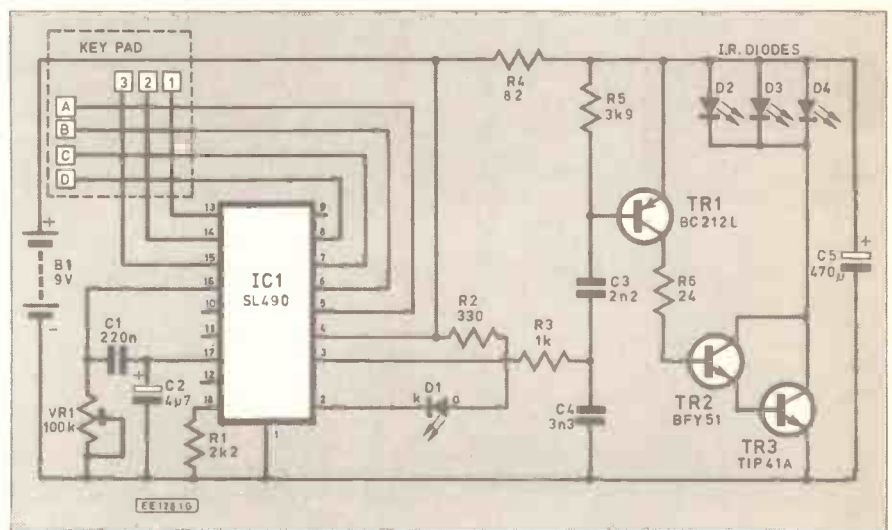

Fig. 2. Complete circuit diagram for the Infra-Red Transmitter.

upon room decoration, ambient light etc., but can be as high as ten metres—easily large enough for the biggest room. Although the system described here is designed for six lamps, it can be easily extended to operate more lamps or even to remote control other devices.

these codes will be used. The coded signals produced by the integrated circuit can be transmitted by several different methods, including ultrasound, fibre optics and infra-red, so the device can be used in a variety of applications.

In the present application, because the handset had to be portable, the transmission methods considered were ultrasound and infra-red. Ultrasound was rejected because of the large, fairly fragile transducers required compared to the small, low cost, robust infra-red light emitting diodes which are available now.

The transmitter has no power switch, so IC1 is always powered up, but it remains in the standby mode until one of the keypad switches is closed. The current consumption in the standby mode is a maximum of 10µA, and is typically 6µA, so the circuit may be powered from a PP3 battery for well over a

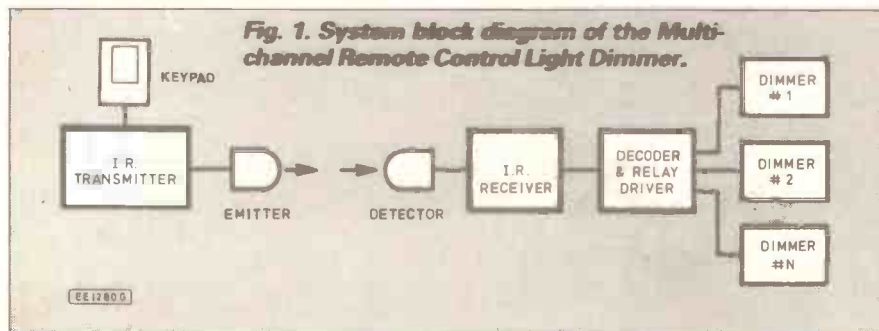

Fig. 1. System block diagram of the Multi-channel Remote Control Light Dimmer.

year when unused. Obviously the consumption is very much greater when operating, but the actual period of time when the transmitter is transmitting is very small and a life of one year for the battery should be quite possible.

OUTPUT PULSES

The output waveform from the device is shown in Fig. 3. IC1 transmits a group of six pulses for each codeword, and these pulses repeat for as long as a keyboard switch is closed, or if the switch is released before a group is transmitted, until the end of the group.

It is the interval between each pulse that carries the information, so that if the interval is short, then a "1" is being transmitted, and if the interval is long, a "0" is being sent. At the end of the group, a longer synchronizing

interval is sent to indicate the end of the code group.

Although the modulation rate can be changed, the ratio between the intervals representing a "1", "0" and the synchronizing interval are fixed at 2:3:6, and the width of the pulse is 1/6th of the "1" interval. Although IC1 sends six pulses, there are only five intervals and by using all possible permutations of "ones" and "zeros", 2⁵ or 32 unique codes can be produced.

As stated above, the modulation rate is variable and is set by the values of R_x and C_x according to the formula $TO = 1.4C_x R_x$ sec. where TO is the time for the "0" interval and R and C are in Ohms and Farads respectively. The values used give a "0" period of 27mS.

The pulses on pin 3 are amplified by the three transistors TR1, TR2 and TR3 to

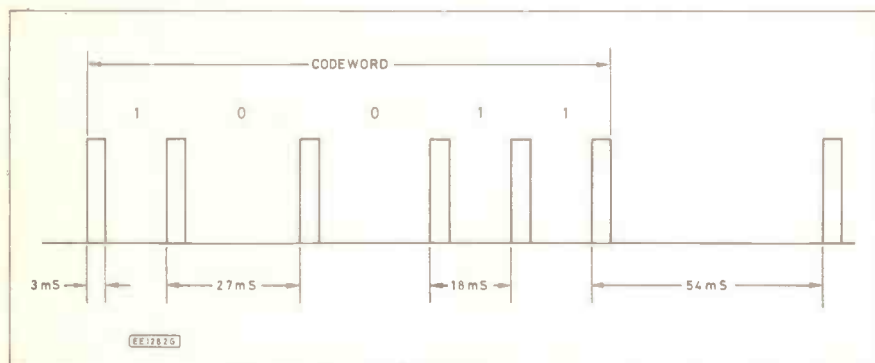
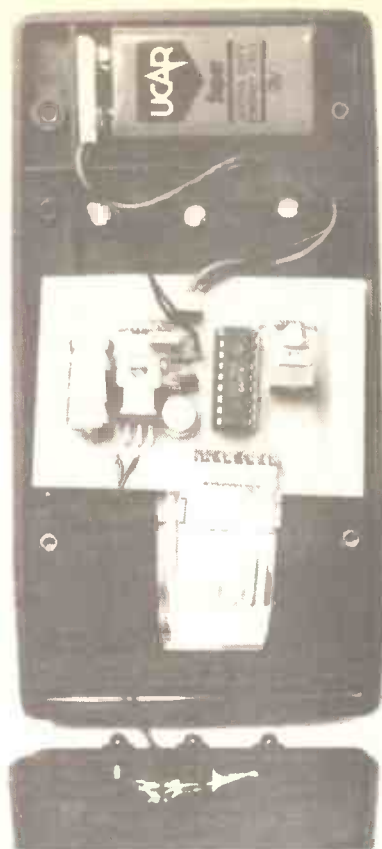

Fig. 3. Output waveform for the transmitter circuit.



The completed hand-held transmitter. The ribbon cable goes to the keypad connections.

COMPONENTS

Transmitter

Resistors

R1	2K2
R2	330
R3	1k
R4	82
R5	3k9
R6	24

**Shop
Talk**

See page 295

All 0.25W 5% carbon

Potentiometer

VR1	100k enclosed preset (vert.)
-----	------------------------------

Capacitors

C1	220n
C2	4μ7 elec. 35V
C3	2n2
C4	3n3
C5	470μ elec. 16V

Semiconductors

D1	Red l.e.d.
D2, D3, D4	I.R. Emitting diodes
TR1	BC212L
TR2	BFY51
TR3	TIP41A
IC1	SL 490 remote control trans.

Miscellaneous

Membrane keyboard; Case; PP3 Battery Connector; 7-pin right angle p.c.b. plug; printed circuit board, available from the *EE PCB Service*, code EE599.

Approx. cost **£18**
Guidance only

supply the high current pulses which drive the three infra-red diodes D2, D3, D4. Capacitor C5 provides the low impedance current source for the pulses and the printed circuit tracks around this part of the circuit are thick to provide the current carrying capacity.

Although the peak current through the diodes is many times their rated current, they survive because of the low duty cycle of the pulses. As a worst case example, if the integrated circuit was generating a code consisting of all "ones", the diodes would be on for only one sixth of the time each code group was transmitted.

The light emitting diode D1 on pin 2 is optional and merely provides a visual indication that the transmitter is working. The l.e.d. serves no useful purpose unless some-

thing goes wrong in the receiver part of the circuit and then it indicates that the fault is probably not in the transmitter. Capacitor C2 is used to decouple an internal voltage regulator which provides a constant voltage for the CR network and so maintains a stable modulation rate.

The keypad chosen was a tactile membrane type which is ideal for the job because of its low profile and its resistance to liquids which may come into contact with it. It is also easy to mount and requires only a slot for its ribbon cable to be cut in the transmitter case. It has twelve single-pole switches arranged in a four by three matrix, and although all twelve generate codes, only six are used in this design. This leaves six extra codes which could be used for other applications.



CONSTRUCTION

The construction of the transmitter is very simple, with all the components apart from the infra red diodes D2-D4 and the keypad, being mounted on a printed circuit board. This board is available from the *EE PCB Service*, code EE599.

The component layout for the transmitter board is shown in Fig. 4. The board is mounted in a low profile case which has a compartment to hold a PP3 battery. The keyboard requires a slot to be cut in the front panel of the case for the flexible connector ribbon to pass through.

The keypad has a sticky back and is merely pressed into place after positioning. The pad comes complete with a blank insert so that the user can label the switches himself. This is easily done with rub-down lettering and this gives quite a professional look to the transmitter.

Three holes were drilled in the end of the case of the prototype to hold the three infra red emitters D2-D4, but these could be mounted inside behind a cut-out in the case. The cut-out could then be covered with a red filter which is sold for use with l.e.d. displays.

SETTING-UP

Setting the transmitter to the correct operating frequency is done with the aid of an oscilloscope connected to pin 3 of the integrated circuit. The transmitter should be set to give the code "0000", this being achieved by shorting pin 5 to the zero volt line.

Bursts of pulses should now appear on pin 3 and the period of these bursts should be set to 27mS by adjusting VR1. (Note that the period is the time between the start or end of one burst and the start or end of the next burst, not the gap between them).

RECEIVER CIRCUIT

The infra-red receiver circuit diagram is shown in Fig. 5. The diode D1 receives the pulses of infra-red light, converts them to current pulses, and feeds them to the SL486 pre-amplifier IC2 which amplifies the signal.

The SL486 is a high gain amplifier with a differential input which is designed to reject signals which are common to both inputs. The result of this is that any noise which is picked up on both input wires is not amplified, whereas the wanted signal from the diode is amplified. This helps to reduce the effect of electrical pick-up on the amplifier. The input stage also provides a reverse bias voltage of about 0.65V which is essential for the correct operation of the diode.

The gain of the circuit at low frequencies is reduced by the decoupling effect of capacitors, C7 and C8 which minimise the low frequency noise. This low frequency roll off is essential to reduce the effects of mains pick-up which could otherwise swamp the amplifier. The capacitors C4, C6 and C5 decouple the first stage, second stage and fourth stage amplifiers respectively, each ensuring that the gain of its stage is reduced at low frequencies.

The output of the fourth amplifier drives a peak detector which provides an a.g.c. control signal. This signal is decoupled by capacitor C10 and is used to control the gain of the first three amplifier stages. The a.g.c. is designed to reduce the gain of the amplifiers quickly when a signal is received by the infra-red diode D1, thus ensuring that the weaker noise signals do not interfere with the coded information.

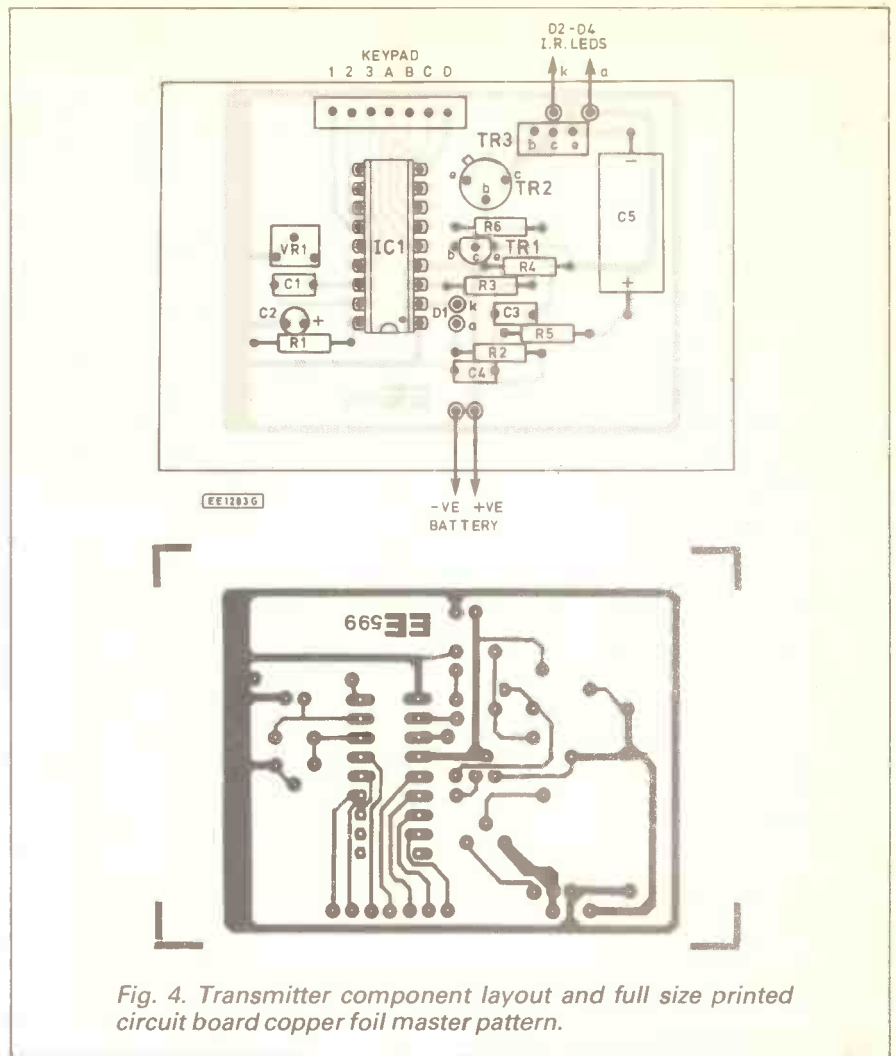

Fig. 4. Transmitter component layout and full size printed circuit board copper foil master pattern.

At the end of the data transmission, the gain of the amplifiers slowly returns to normal so that there is a delay before any noise appears at the output. The capacitors C3 and C2 are provided to further improve the noise immunity of the circuit.

All of these elaborate efforts to reduce noise may seem unnecessary, but it must be remembered that the signal received by the diode is very small and if a straightforward amplifier was used, the signal would be lost in the noise. The integrated circuit is designed to be run at a voltage of between

4.5V and 9V, but by utilising its built-in regulator, the supply voltage can be anywhere from 9V to 18V.

The output of the amplifier is fed to the PPM input (pin 3) of the ML926 receiver and decoder IC3, which responds to 15 of the possible 32 codewords that the transmitter can send. It detects the codes 00001 and 01111 and outputs these on the 4-bit binary outputs A, B, C and D. (There is a companion device, the ML927 which responds to the codes 10001 to 11111). The decoder IC3 has an internal oscillator whose frequency is

The prototype construction of the receiver was first built on stripboard prior to transferring to the final p.c.b. version.

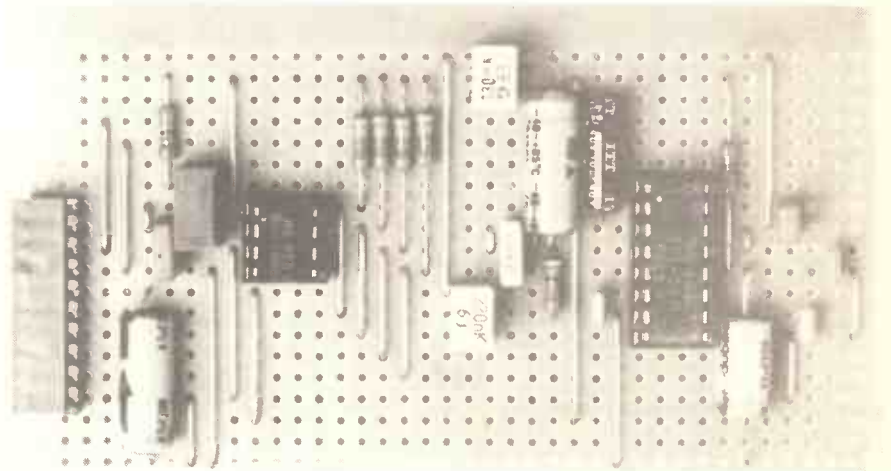

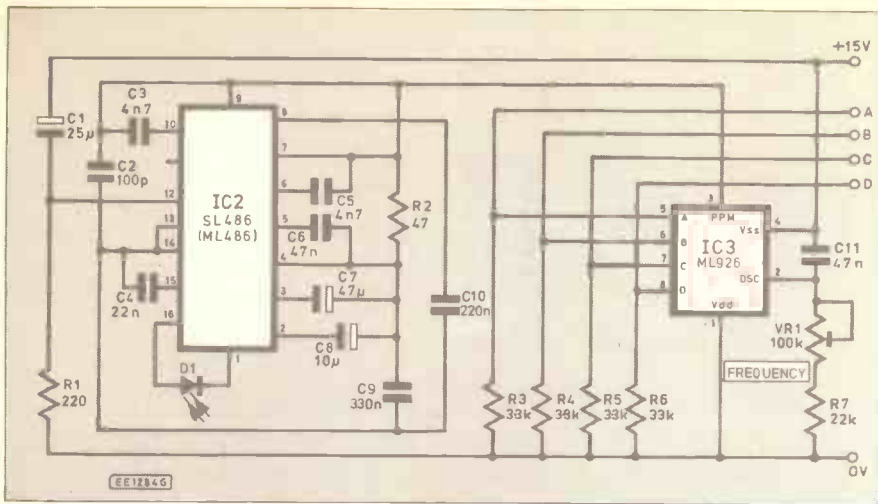

Fig. 5. Complete circuit diagram for the Infra-Red receiver.

adjusted to suit the transmitter frequency by the components capacitor C11, preset VR1 and resistor R7.

The receiver operation begins when the first pulse arrives at its input. This pulse resets an internal counter, which is then disabled for 20 oscillator periods to avoid the danger of the pulse echoes interfering with data. After this period, the circuit looks for the next pulse and by measuring the time interval between the first and second pulses, decides whether the data represents a "0" or a "1".

This resetting, disabling and measuring cycle is repeated until the receiver detects the longer interval representing the end of code group. The receiver then checks that six pulses have been received and if so the code is saved.

This process is repeated until a second code has been satisfactorily received, then the two codes are compared. If they are the same, the code is accepted and is passed to a decoder which produces the required output as defined by the code.

If the two codes are different, the first is disposed of, the second code becomes the reference code and the circuit continues to check incoming data for a match. The output of the device remains unchanged when the codes are different, so the circuit provides good security against incorrect operation.

The oscillator in the decoder IC3 is adjusted so that its period is one fortieth of the "0" interval. The method for doing this will be described later in the setting-up procedure.

CONSTRUCTION

The receiver circuit is built on a printed circuit board, the component layout of which is shown in Fig. 6. This board is available from the *EE PCB Service*, code EE600.

All the passive components should be mounted first to prevent damage to the integrated circuits. It is not essential to use sockets for the integrated circuits, but it is advisable. All of the output signals come to the edge of the board and go to a 10-way p.c.b. socket for connection to the rest of the circuit, thus enabling it to be unplugged for testing.

The connections to the infra-red detector diode D1 are taken from a 4-pin connector on the top of the board to minimise signal feedback from the output to the input. An "earthing" strip was provided in the layout between the first and second stages so that a screen could be fitted to reduce interaction, but this has not proved necessary in the prototype. The diode D1 should be wired to the board connector using twin screened cable with only the screen connected to the 0V pin on the connector.

SETTING-UP

To set up the receiver, place it approx 3 metres from the transmitter and apply 15V to its supply lines. It is best to run the transmitter from a power supply because in the few minutes it takes to set the receiver up, a large part of a PP3 battery's life would be used up.

Set the transmitter to give the code "0000" as described in the transmitter setting-up section. The variable resistor VR1 on the receiver board is then adjusted to give a period of 27ms/40 or 675µs at the oscillator (pin 2) of IC3. When this is done, the receiver has been set-up to match the transmitter.

Next Month: Decoder/Relay Drivers, Lamp Dimmers, PSU and Mother Board.

COMPONENTS

Receiver

Resistors

R1	220
R2	47
R3-R6	3k3 (4 off)
R7	22k

**Shop
Talk**

See page 295

Potentiometer

VR1	100k enclosed preset vert.
-----	-------------------------------

Capacitors

C1	25µ elec. 25V
C2	100p
C3	4n7
C4	22n
C5	4n7
C6	47n
C7	47µ elec. 25V
C8	10µ elec. 25V
C9	330n
C10	220n
C11	47n

Semiconductors

D1	I/R detector diode
IC1	SL486 I/R Receiver amp
IC2	ML926 PPM Decoder

Miscellaneous

SK1	10-way P.C.B. Skt
-----	-------------------

Printed circuit board, available from the *EE PCB Service*, code EE600.

Approx. cost
Guidance only

£12

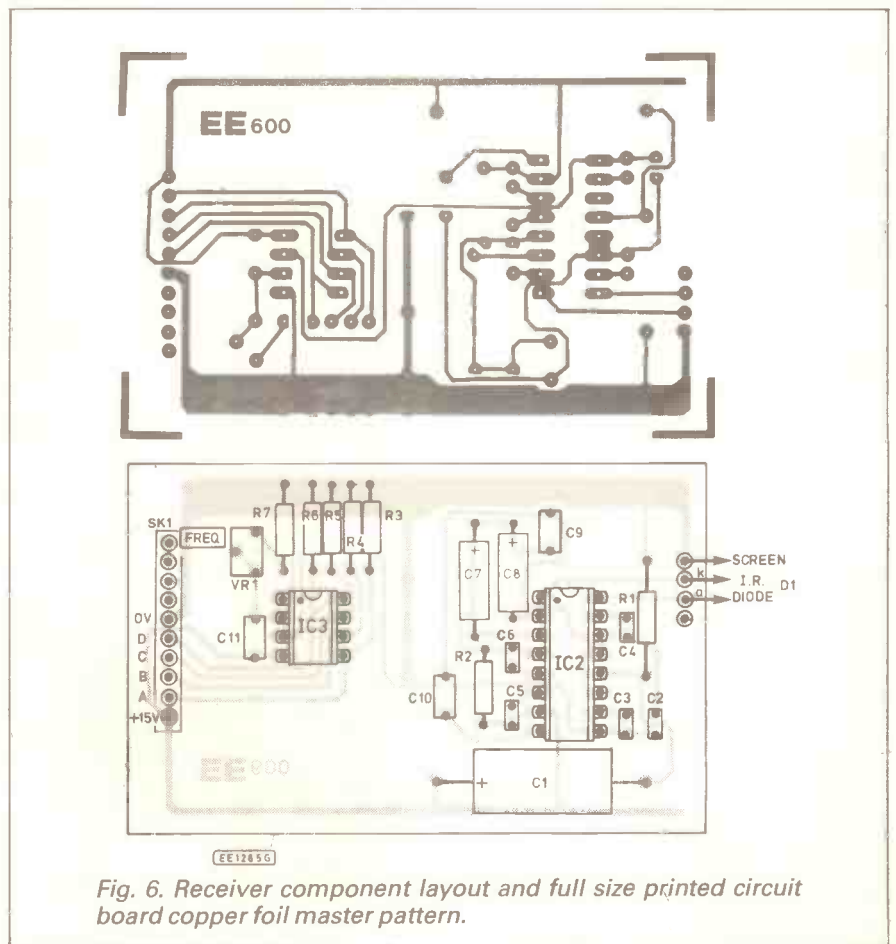

Fig. 6. Receiver component layout and full size printed circuit board copper foil master pattern.

Actually Doing it!!

IN LAST month's article we considered the various types of connector available, and what kind to use for a given application. As a follow-up to this we will look at the subject of wiring up sockets. This is often quite straightforward, and for constructional projects in *Everyday Electronics* there are normally connection diagrams which give detailed information on all the hard-wiring. Some sockets, particularly simple one and two way types, do not pose any real difficulties anyway. Where problems are most likely to occur are with switched types, which generally means jack sockets.

3.5mm SWITCHED

One of the most popular forms of connector is the 3.5 millimetre jack type. These were originally used for earphone sockets on pocket transistor radios of far-eastern origins, and were later joined by the smaller 2.5 millimetre variety. The latter do not seem to be very popular for home constructor designs, and in my experience they are not the strongest of connectors. Slight over-tightening of the fixing nut can easily result in one of these sockets breaking in two. Their small size can also make them rather awkward to connect up. By contrast, 3.5 millimetre jack plugs and sockets seem to be used in a wide range of electronic projects, and are much easier to use.

The main difficulty for a beginner when faced with wiring up a miniature jack socket is that in its standard form it is a two way connector (there are also stereo versions though), but almost all miniature jack sockets have three terminals. So just what is the point of the extra tag on these sockets?

In order to find the answer to this you have to go back to the original use for these sockets, which as explained previously, was as the earphone socket on portable radios. It is standard practice to have earphone and headphone sockets which automatically switch out the loudspeaker (or loudspeakers) when a plug is inserted into them. 3.5 millimetre jack sockets therefore have a built-in switch which opens when the plug is fitted. Incidentally, 2.5 millimetre jack sockets seem to be just the same, and are effectively just scaled-down 3.5 millimetre types.

I suppose that it would be reasonable to expect a two way socket plus single pole on/off switch to have four terminals,

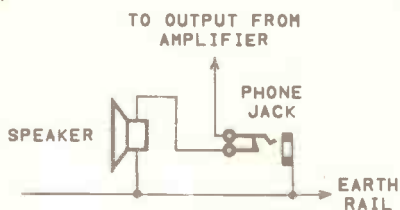

Fig. 1. The system of loudspeaker switching used in pocket radios etc.

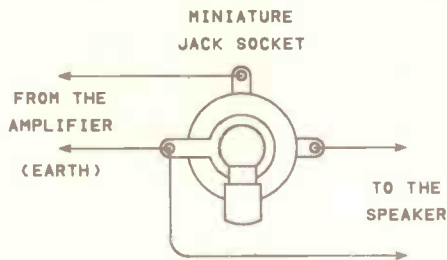

Fig. 2. The connections to a 3.5mm switched jack socket.

but three is sufficient since one tag is common to one side of the socket and to one terminal of the switch. Fig.1 shows the circuit for a miniature jack socket providing automatic switching of a loudspeaker, and Fig.2 shows the connections required in practice.

CHECKING

There has in the past been a lack of standardisation regarding the connections to miniature jack sockets, but all the types I have encountered in recent years have required this method of connection. If you are ever in any doubt about the connections to the switched socket, remember that a few quick checks with some form of continuity tester will soon reveal the role of each tag.

Taking a miniature switched jack socket as an example, with no plug inserted there should be continuity between two of the tags, and these are the switch connections. The other tag is the earth one. With the plug inserted there should be continuity between the non-earth tag of the plug and one of the switch tags of the socket. It is this tag to which the audio input signal is taken, while the output to the loudspeaker is taken from the other switched tag.

Continuity checks are often useful when sorting out connections to sockets, switches, and relays. I often use this method of testing to determine whether or not the likely looking method of connection is actually the correct one. Checking before connecting a component rather than after a project has failed to work can save a lot of time, and in some cases can prevent costly damage to components.

What probably causes the most confusion with miniature jack sockets is when they are used in a project which does not utilize the built-in switch. On looking at a few projects which are fitted with this type of connector, I discovered only one that did actually make use of the switch. When the switch is not required, simply use the earth and input tags, and ignore the one that would normally be used to take the switched output to the loudspeaker.

ON/OFF

If you build projects from some years

ago (which seems to be a growth industry!) you might encounter projects which use a normally open contact on a miniature jack socket to act as the on/off switch. In other words, plugging in the earphone switches the unit on, and unplugging it switches the unit off again.

There is a slight problem here in that these components are only readily available with normally closed contacts. The standard way round this was to modify

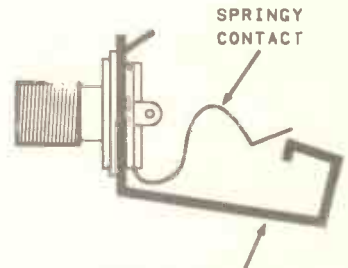

Fig. 3. Modifying a jack socket to give a normally open switching action.

an ordinary jack socket; as shown in Fig. 3. It is basically just a matter of bending the fixed contact around and underneath the springy contact. When the plug is inserted it then moves the springy contact onto the fixed one, rather than away from it. This is a useful dodge for small projects which use a miniature jack socket, and it is one which is well worth knowing about.

A point to note here is that the on/off switch is normally connected in the positive supply lead, but with this method of switching it will probably have to be connected in the negative supply lead. This is simply because one side of the switch connects to earth, and virtually all electronic equipment is of the negative earth variety. With positive earth equipment the switch would be connected in the positive supply lead.

This method of on/off switching is only suitable for small battery powered projects, and is quite definitely unsuitable for mains powered projects (where it could easily prove to be lethal).

STANDARD JACKS

Confusion sometimes occurs when using standard jack sockets as there are two types. Firstly, there is the "open" type, which are rather like scaled-up 3.5 millimetre jack sockets, but without the switch contacts. The second variety is the "closed", or "insulated" type. These are largely enclosed in a plastic case, and the mounting bush and nut are also made of plastic. Unlike the open style sockets, there is no electrical connection between the earth tag and the mounting bush. These jack sockets are sometimes specified for sensitive audio projects where they seem to give less problems with background "hum".

Another difference between the "open" and insulated sockets is that the insulated type always seem to have twin switch contacts built-in. These switches are very much like those of a 3.5 millimetre jack socket, but the additional contacts provide a switched "earth" output as well. Fig. 4 gives connection details for both styles of socket.

Incidentally, I recently encountered some 3.5 millimetre jack sockets that are

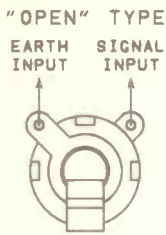
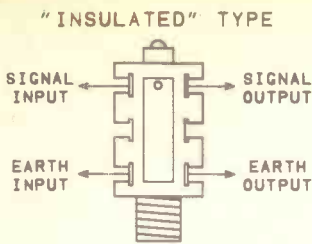

Fig. 4. There are two types of mono jack socket, the "insulated" and "open" varieties.

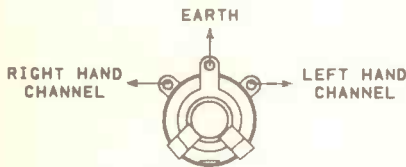

Fig. 5. Connection details for stereo jack sockets.

just like miniature versions of standard "insulated" sockets. These are usable in place of ordinary 3.5 millimetre jacks. Presumably the switched "earth" output will never be needed though, and this tag can simply be ignored.

Stereo jack sockets are mostly of the "open" variety, and are the standard connector for stereo headphone outputs on hi-fi equipment. They do not seem to be widely used outside this application. Fig. 5 shows the correct method of connection for "open" stereo jack sockets.

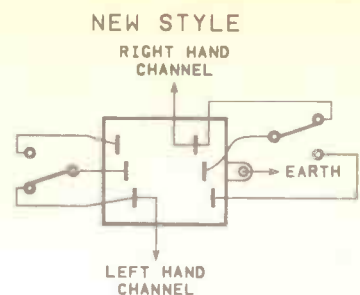
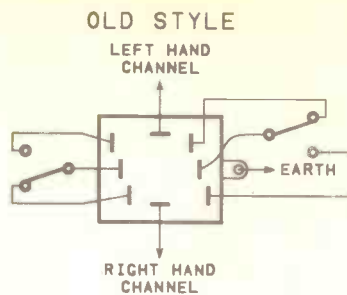

Fig. 6. Connection details for the old and new styles of d.p.d.t. jack socket.

SWITCHED

Quite a few electronic music projects use a switched standard jack socket to act as both an input socket and the on/off switch. This is the same idea as the one using a modified 3.5 millimetre jack socket that was described previously. However, standard jacks with normally open contacts are not readily available, and the closed construction of the "insulated" type makes modifying their contacts virtually impossible. In fact some jacks of this type are less than fully enclosed, but there is still no obvious way of modifying the contacts to give the desired action.

The usual solution is to use a stereo jack socket having d.p.d.t. switch contacts. This component is rather over-specified in that most applications that utilize this method of on/off switching do not require a stereo socket. Also, there are several more switch contacts than are really needed. This does not matter a great deal as these sockets are not excessively expensive when one takes into account that they replace a standard jack socket and an on/off switch. The unnecessary contacts can just be left unconnected.

Note that you can always use a stereo jack socket instead of a mono type simply by ignoring the "right hand" tag. This can be useful if you have some stereo sockets

in the spares box but require mono types, or if there are temporary supply difficulties with mono jack sockets.

NEW STYLE

Recently a different type of stereo jack socket with d.p.d.t. contacts seems to have come onto the market. Fig. 6 shows connection details for both the original and the new style sockets. They are obviously quite similar, but there is a crucial difference. The original style of socket is different to the switched types described earlier in that it has switch contacts that are electrically isolated from the other contacts of the socket. This gives greater freedom over how the switch contacts are used.

The new style socket has tags which are common to both the switch and the socket sections of the component. This puts some restrictions on the ways in which the switch contacts can be used. It should be possible to use the new type to provide on/off switching, but if in any doubt about the suitability of the new style sockets for a given project, or the correct method of connection, the safe option would be to use an ordinary socket plus a separate on/off switch

Robert Penfold

EE CROSSWORD 4

CLUES ACROSS

- 6 Subroutines that are enclosed within each other. (7)
- 7 A set of computer instructions which performs a limited task (7)
- 10 Machines that are virtually identical. (10)
- 11 In type setting, half an em. (2)
- 12 This feedback improves linearity. (8)
- 14 Hard copies. (6)
- 15 The noun of a series resonant circuit. (10)
- 19 Circuit triggered into action by a transient. (6)
- 20 and 22 Two types of parity. (3, 4)
- 23 A network for critical path analysis using computer techniques. (1.1.1.1)
- 24 This transient goes too far. (10)
- 26 A type of fixed resistor. (4)
- 27 Prefix for a normally closed switch. (2)
- 28 International business correspondence service. (7)

DOWN

- 1 Circuit that determines the meaning of a set of signals. (7)
- 2 Backwards past the pots puts an end to it. (4)
- 3 A precisely specified quantity. (4)
- 4 Method of operating. (4)
- 5 A not gate does this. (7)
- 8 A touch sensitive keyboard. (7)
- 9 Opposition to a basic program? (6, 4)
- 13 The period between asking and getting. (6, 4)

- 16 Data control technique ensuring that information is not lost when transferred. (3, 2, 3)
- 17 Type of keypad found on a calculator. (7)

For fun only - answers on page 279.

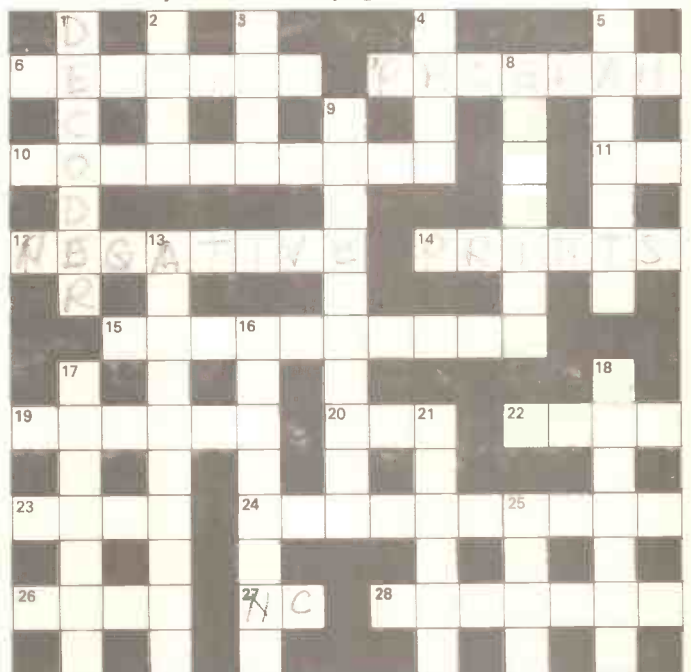

b...Beeb...Beeb...Beeb...Be

... 2764 and 27128 EPROMs ... EPROM Programmer ...

STAND-ALONE EPROM programmers are readily available, but even the lower cost types have price tags that put them well beyond the reach of most electronics hobbyists. Add-on units for home computers are a much more realistic proposition for most of us, and there are a number of these units available for several home and personal computers.

The BBC computers are probably the best served in this respect, with a bit of do-it-yourself the cost of an EPROM programmer can be reduced still further.

Add-On EPROMs

In this and the subsequent "Beeb Micro" article we will consider just what is involved in producing an add-on EPROM programmer for the BBC computers, together with some practical circuits and software. We will be concerned with the 2764 and 27128 EPROMs, which are the ones which are most likely to be of interest to BBC computer users. If you are into sideways ROMs for the BBC, these are the EPROMs which fit the sideways ROM sockets. If your interest is in projects that use EPROMs, then the 2764 and 27128 are still good choices.

The 2764 has a capacity of 64k bits which is organised as 8k of 8 bit bytes, and the 27128 has 128k bits organised as 16k of 8 bit bytes. These are probably the cheapest EPROMs currently available, presumably due to their popularity and large scale of manufacture. There is no obvious flaw in their specifications. For low power applications, CMOS versions are available at slightly higher cost. These devices are suitable for most project

applications that require an EPROM, and are likely to be the cheapest chips that will do the job.

EPROM Basics

EPROM stands for Erasable Programmable Read Only Memory. These devices are programmed electronically, but can only be erased by subjecting them to a strong dose of short wavelength ultra-violet light (via a "window" in the top of each device). For copying EPROMs only a programmer is required, but if you are going to develop your own ROM programs you will inevitably need to reprogramme devices. An eraser is then an essential as an EPROM must be erased before it can be properly reprogrammed.

A number of ready-made erasers are available at moderate cost, and with most types a 20 minute dose is sufficient to erase an EPROM. Some have built-in timers so that "over-cooking" is avoided. Apparently an excessive dose of ultra-violet can reduce the lifespan of an EPROM, or in an extreme case could destroy the device.

Figs. 1 and 2 show pinout details for the 2764 and 27128 respectively. A single five volt supply is required in normal use, but a higher voltage is required during programming. This is applied to the V_{pp} terminal (pin one), and the standard 2764/128 chips require a nominal voltage of 21V. Many component retailers now seem to sell the more recent versions which require a lower voltage of 12.5V. These are normally marked quite clearly to the effect that they require a 12.5V programming potential, and they can be damaged by a potential of more than 14V.

If you are in doubt as to which is the

correct programming voltage for a device, try the lower voltage first. If after a couple of attempts this fails to programme the device properly, try the higher voltage.

Programming

An EPROM normally has each bit of memory store set at logic 1. The programming voltage is used to break down insulation in the device and place a charge on the gate of a field effect transistor that sets selected bits at logic 0.

The normally high insulation resistances in the circuit prevent bits from programming themselves to logic 0, or leaking back to logic 1. More accurately, the insulation ensures that any unwanted changes in the programme take around ten years or more to develop.

The programming voltage must not be applied to memory cells for more than 78.75ms or the chip might be damaged. However, there is on-chip gating of V_{pp} , and the programming voltage can be fed to pin one continuously. It is effectively switched on and off via the PGM input (pin 27). This pin is briefly pulsed low when the correct bit pattern is set on 00 to 07.

Chip Enable

Pin 20 is the usual chip enable input, and this is taken low to make the device active. This must be taken low when reading the device, or when programming it. This terminal should not be confused with pin 22, which is the output enable terminal. This pin controls the tri-state outputs of the device, and is taken low to enable them. This is primarily intended as a read/write input, and although in use an EPROM is a read only device, this input is normally used as if the device was a read/write type. This enables addresses occupied by the EPROM to be used for output circuits, and it also minimises any slight risk of the device outputting data onto the data bus at the wrong time.

The chip enable input controls the chip as a whole, and its main use is to select the required memory device in a circuit that has two or more memory devices. Obviously the output enable pin should be high (inactive) when programming.

The only other pins are the 14 bit address bus (A0 to A13). However, pin 26 is unused on the 2764 which only requires a 13 bit address bus. This makes a programmer for the 27128 largely compatible with the 2764. The hardware can be identical as these devices are pin compatible, but obviously the software should be designed to stop after 8192 addresses have been programmed when the 2764 is in use.

There are smaller devices in the 27*** series, but these are 24 pin components which lack pin for pin compatibility with the larger types. There is also the 27256, which is a 32k by 8 bit type. This is virtually pin compatible with the 2764/128 EPROMs, but the PGM input is replaced with the extra line

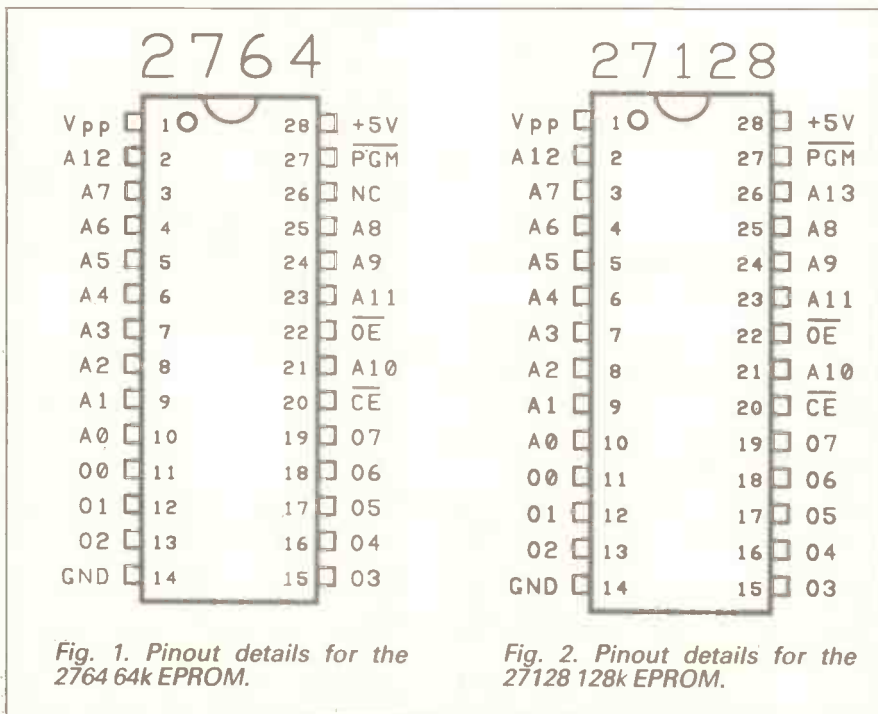

Fig. 1. Pinout details for the 2764 64k EPROM.

Fig. 2. Pinout details for the 27128 128k EPROM.

of the address bus (A14). Instead, the programming pulse is applied to the chip enable input. This gives a high degree of compatibility between the 27256 and the 2764/128 types, but an extra address output and some additional switching are needed to accommodate the larger device.

Programme Cycle

To program the 2764/128 EPROMs, first V_{pp} must be fed with the correct programming voltage, the chip enable input should be taken low, and the output enable pin should be taken high. With the first address set on the address bus, the correct bit pattern set on 00 to 07, and all these lines having had time to stabilise, PGM is pulsed low for typically about 50 milliseconds.

It is normal programming procedure to check that each byte has been programmed successfully. This is achieved by taking the output enable pin low, and checking the bit pattern on 00 to 07. This requires careful control of the lines connected to 00 to 07, which must be bidirectional. These lines must be set to the receive mode prior to the EPROM's outputs being enabled. The output enable input must be returned to the high state before the lines driving 00 to 07 are returned to the send mode. This avoids the potentially disastrous situation where two sets of outputs are connected together.

With the output enable terminal back in the high state and the data lines of the programmer set as outputs again, the address bus is advanced to the next address, the next bit pattern is set up on the data bus, and the whole procedure is repeated. It is repeated until all 8192 or 16384 bytes have been programmed. Fig. 3 shows typical waveforms for a programming cycle, and this might help to clarify the process.

Some EPROM programmers use a fast programming algorithm that differs slightly from the method described above. The programming pulse is made much shorter at about 1ms. If the verification process reveals that a byte has not been programmed properly, rather than simply halting the programming process with an error message, the byte is reprogrammed using further 1ms pulses. These are followed by a longer "over-programme" pulse if programming is still unsuccessful. This type of thing is probably of more value in commercial programming where large numbers of EPROMs are involved, than it is for amateur or professional lab use where most programming is of the one-off variety, and the amount of time spent programming EPROMs is likely to be quite short anyway.

Beeb Interfacing

There are a number of ways in which the ports of the BBC computer could be utilized for EPROM programming. The obvious method is to use the lines of the user port for the data lines, and to use an additional 6522 VIA on the 1MHz Bus to provide the address and control lines. With some rationalization it is possible to use a more simple and convenient setup.

On the face of it some thirteen or fourteen lines must be provided by the computer in order to drive the EPROM's address bus. This is not really the case though, as a large binary ripple counter can do the job. The computer then has to provide one output line to supply the clock pulses, plus perhaps a second one to control the reset input of the counter. This does not allow the EPROM programmer to jump almost instantly to any desired address, and the EPROM must be

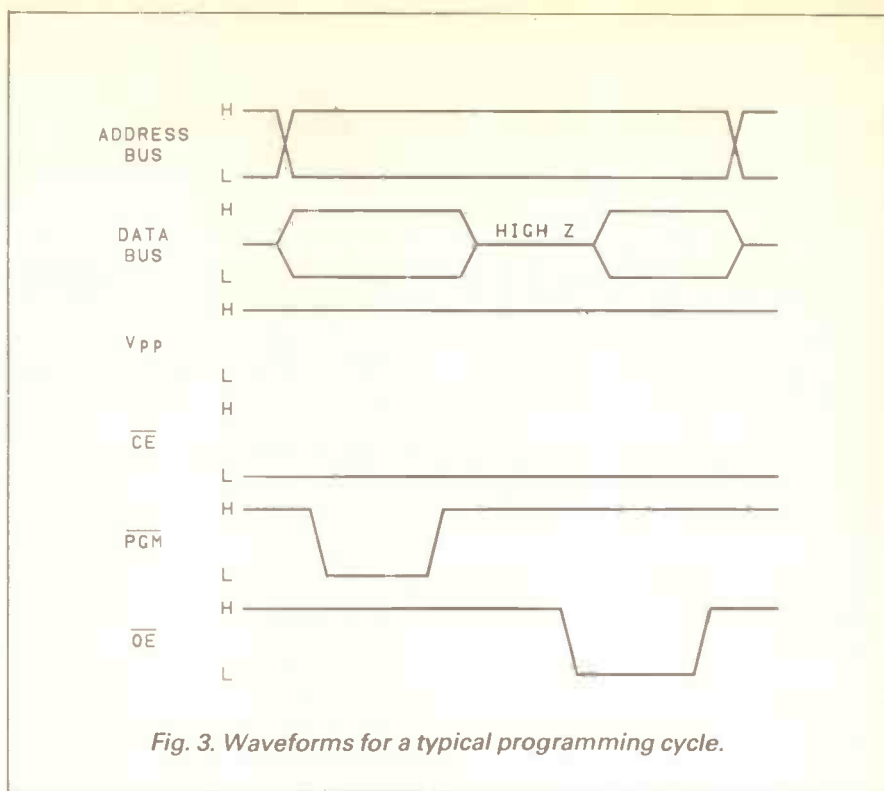

Fig. 3. Waveforms for a typical programming cycle.

taken from one address to the next, in sequence. This is not a significant drawback though, as programming is normally done in this manner anyway.

If desired, the counter can be incremented to any required address, with a software counter in the computer being used to track the external counter. It is unlikely that this random accessing would ever need to be used in practice though.

A similar method is possible with the data bus, but would be a slow and awkward way of handling things. Driving these inputs from eight bidirectional lines (such as PBO to PB7 of the user port) is a more practical way of handling things. Two more output lines are required in order to control the chip enable and output enable pins of the EPROM's.

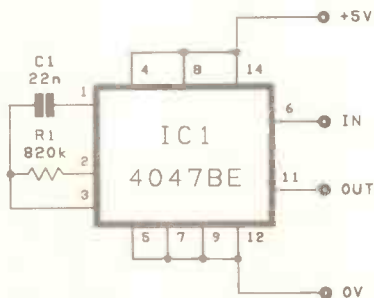

Fig. 4. Circuit diagram for a monostable to provide a 50ms program pulse.

Pulse Generator

The program pulse length could be controlled by software in the computer, or by hardware in the computer (i.e. the 6522 VIA's timers). On the other hand, an external monostable multivibrator might provide a safer means of producing the programming pulses, and should help to simplify the controlling software.

The circuit of a suitable monostable is shown in Fig. 4, and this is based on a CMOS

4047BE astable/monostable. CMOS devices seem well able to drive the inputs of 2764 and 27128 EPROMs (which are NMOS components). IC1 is connected in the negative edge triggered mode, and taking the input from logic 1 to logic 0 produces an output pulse of just under 50 milliseconds.

The length of the input pulse is irrelevant, except that it should not be so short that the monostable is not triggered properly. An input pulse duration of as little as 500ns should suffice. The not Q output of IC1 is used to provide the output pulse, which is consequently of the required polarity (i.e. logic 0).

Switch Mode Power Supply

An obvious problem when using the BBC computer for EPROM programming is that of obtaining the 12.5V or 21V programming potential. There is a 12V output on the power port which might suffice for 12.5V EPROMs, but this is the highest voltage available from the computer. One solution would be to give the programmer its own mains power supply, but a neater method is to use a switch mode power supply to step-up the 5V supply to 12.5V or 21V.

The degree of step-up involved and the currents required are beyond the capabilities of simple oscillator/diode d.c. to d.c. converters, but are well within the capabilities of circuits based on a small switch mode power supply integrated circuit such as the TL497. These can give efficient voltage step-ups that are analogous to a transformer giving an a.c. voltage step-up.

There is one minor difficulty with switch mode power supplies, and this is the need for a fairly high value inductor having a high Q value. Suitable ready-made components do not seem to be available, but they can be home constructed without too much difficulty.

Switch mode power supplies is a topic that we will consider in detail next month, together with some specific ways of using the BBC computer as an EPROM programmer.



City and Guilds

$$I = \frac{V}{R}$$

$$I = \frac{9.00}{\frac{700}{2030}}$$

$$R = \frac{5 - V_f}{I_f} = \frac{1.5}{0.015} = 260$$

$$R = \frac{5 - 2.4V}{0.015} \Rightarrow \frac{2.6V}{0.015} \Rightarrow \frac{26V}{0.15} \Rightarrow \frac{260V}{1.5}$$

INTRODUCING MICROPROCESSORS

MIKE TOOLEY B.A.

Part 7

INTERFACING

In part six we looked at methods used for input to and output from microprocessor systems and also examined the internal architecture and characteristics of a programmable parallel I/O device. In this part we develop this theme a little further by describing how such commonplace items as l.e.d.s and relays can be interfaced to the parallel I/O port of a microprocessor based system.

LEARNING OBJECTIVES

The general learning objective for Part Seven of *Introducing Microprocessors* is that readers should understand how a load such as an l.e.d. or relay can be interfaced to a microprocessor-based system. The specific objectives for Part Seven are as follows:

5.1 PERIPHERAL LINE DRIVING

- 5.1.1 Explain the electrical limitations of the port I/O lines of a typical programmable parallel I/O device.
- 5.1.2 Describe why an output driver is needed.
- 5.1.3 Describe how an output driver is connected.

LIMITATIONS OF PARALLEL I/O DEVICES

In part six we explained some of the virtues of a typical programmable parallel I/O device. Unfortunately, such devices also have a number of shortcomings not the least of which is associated with an inability to provide sufficient voltage and current drive to an external device or "load".

The maximum current which can be sourced from a typical programmable parallel I/O device is limited to approximately 1mA at a voltage of 1.5V and clearly this will be inadequate for directly driving all but the most modest of loads; in order to operate external devices (such as l.e.d.s or relays) an appreciable current and/or voltage may be required.

quate for directly driving all but the most modest of loads; in order to operate external devices (such as l.e.d.s or relays) an appreciable current and/or voltage may be required.

Electrical Characteristics of l.e.d.s

Before attempting to describe the driver circuitry needed to interface a microprocessor parallel port to an l.e.d. or relay, it is worth spending a little time to describe the salient electrical characteristics of each of these devices.

In order to provide a reasonably bright output, a single l.e.d. will generally require a current supply of around 8 to 12mA. Such a current is usually provided by simply wiring a resistor in series with the l.e.d. and connecting the resulting series circuit to a supply having a nominal voltage of typically 5V to 12V. As a general rule of thumb, a typical voltage drop of 2V appears across an l.e.d. in which a current of 10mA is flowing.

Greater light output can be produced from the l.e.d. by increasing the forward current and this can be achieved by either reducing the value of series resistor or raising the voltage of the supply (note that it is essential to keep within the manufacturer's recommended maximum ratings for the device!). A reduction of light output, on the other hand, can be achieved by increasing the resistance value or reducing the supply voltage.

As an example, let's consider the case of a standard red l.e.d. which is to operate from a conventional TTL supply voltage of +5V. The l.e.d. would be connected as shown in Fig. 7.1 and the value of series resistor calculated from the formula:

As an example, let's consider the case of a standard red l.e.d. which is to operate from a conventional TTL supply voltage of +5V. The l.e.d. would be connected as shown in Fig. 7.1 and the value of series resistor calculated from the formula:

$$R = \frac{5 - V_f}{I_f} \text{ ohm}$$

where V_f is the forward voltage of the diode and I_f is the value of forward current applied.

Assuming that the l.e.d. exhibits a nominal forward voltage of 2V at a

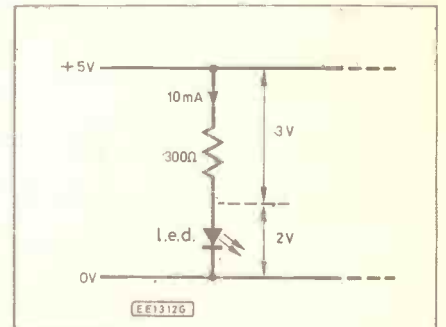

Fig. 7.1. L.E.D. operating from a +5V supply rail

$$\frac{5-2}{10} = \frac{3}{10} = 0.3$$

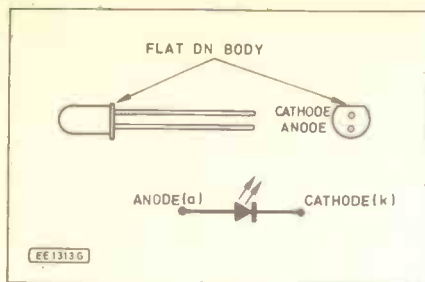

Fig. 7.2. Typical polarity markings for a round I.e.d.

forward current of 10mA, the required value of resistance is thus:

$$R = \frac{5-2}{0.010} = \frac{3}{0.010} \text{ ohm}$$

thus $R=300 \text{ ohm}$

The nearest preferred values are 270ohm or 330ohm and a 0.25W carbon resistor of either value will be perfectly adequate as the series resistance.

On a rather more practical note, it is essential to observe the polarity of an I.e.d. when connecting it into a circuit. Such devices cannot withstand reverse voltages of more than a few volts and failure to observe this precaution will often result in permanent damage to the I.e.d. The conventional polarity markings for a standard round I.e.d. are depicted in Fig. 7.2.

Electrical Characteristics of Relays

Electromechanical relays are available in a variety of forms including miniature dry-reed, dual-in-line, p.c.b. mounting and plug-in types. Low-voltage (d.c.) relays generally have coil resistances of between 100ohms and 3 kilohms and operate from voltages in the range 3.75V to 24V.

A typical relay for use with a microprocessor system will operate with a current of around 20mA and be capable of switching currents of up to 3A. The characteristics of some

representative relay types are shown in Table 7.1.

An important property of a relay is that it can offer a very high degree of electrical isolation between the microprocessor system and the controlled circuit. This is, of course, particularly important in applications where the controlled circuit is connected directly to the a.c. mains supply!

Problem 7.1

An I.e.d. is to be operated at the manufacturer's ratings which are:

$$V_f=2.4V \text{ and } I_f=15mA$$

Assuming that the I.e.d. is to be used with a 5V supply in the circuit of Fig. 7.1, determine the nearest value of preferred series resistance.

Problem 7.2

A relay has a coil resistance of 700ohm and requires a nominal operating voltage of 9V. Determine the current required to operate the relay.

$$12/3 \text{ mA}$$

TRANSISTOR DRIVERS

The simplest method of interfacing an I.e.d. or relay to a parallel I/O port is with the aid of an *n.p.n* switching transistor, as shown in Figs. 7.3 and 7.4. Transistors provide current amplification (typically of the order of 50, or more) and are also able to tolerate a much higher load voltage supply than would be possible with a conventional TTL device.

In the I.e.d. driver arrangement of Fig. 7.3, the transistor will be driven into conduction whenever a high (logic 1) level is produced by the port output line. The transistor is operated as a saturated switch and sufficient base current must be applied for the collector-emitter voltage to fall to a value which is very close to zero. In this condition, the collector current is governed by the supply voltage and the value of the load rather than by the current gain of the transistor.

A base current of approximately

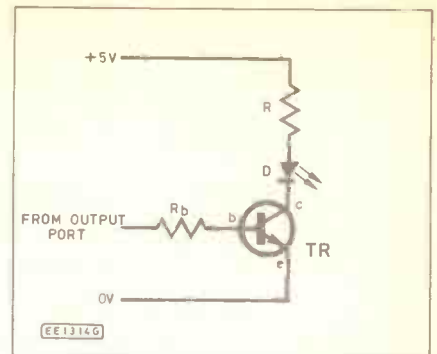

Fig. 7.3. Transistor I.e.d. driver

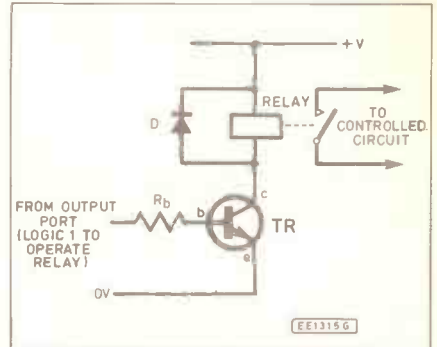

Fig. 7.4. Transistor relay driver

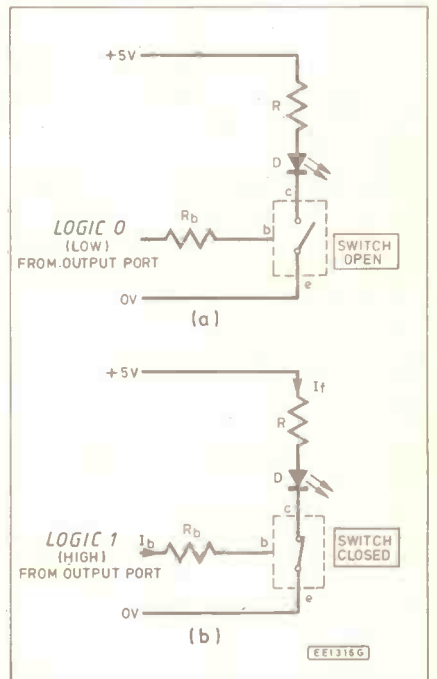

Fig. 7.5. Equivalent circuit of a transistor I.e.d. driver (a) Logic 0 from the output port (b) Logic 1 from the output port

1mA will produce saturated switching with the vast majority of modern silicon transistors and hence a typical value for the base resistance is 4k7. Figs. 7.5(a) and 7.5(b) show the equivalent circuit of a transistor I.e.d. driver in the non-conducting (logic 0 input) and conducting (logic 1 input) states respectively.

The operation of the transistor relay driver depicted in Fig. 7.4 is similar to that of the I.e.d. driver shown in Fig. 7.3, however an addi-

Table 7.1 Characteristics of some representative relays

Relay type:	Encapsulated reed	Miniature p.c.b.	Plug-in
Coil resistance:	1k	320 ohm	185 ohm
Operating voltage:	9V to 12V	8.4V to 14.4V	8V to 17V
Contacts:	Single pole	Single pole changeover	4-pole changeover
Contact rating (d.c.):	500mA/100V	1A/28V	1A/110V
Contact rating (a.c.):	500mA/120V	500mA/120V	2.5A/120V

tional diode is connected across the relay coil in order to protect the transistor from the effects of back e.m.f. (this is the reverse voltage generated by the collapse of current in the coil inductance whenever the transistor ceases to conduct).

OPEN-COLLECTOR LOGIC

Another method of increasing the current drive capability of an output port is with the aid of a TTL buffer. Six identical buffers are usually contained in a single dual-in-line package and each device has a single input and output.

Two types of buffer are available: inverting and non-inverting. An inverting buffer produces a low state output when its input is high and a high state output when its input is low. A non-inverting buffer, on the other hand, produces a high state output when its input is high and a low state output when its input is low.

Buffers are often fitted with open-collector output stages so that they can be used with external loads in a similar configuration to that adopted with the transistor drivers described earlier. Furthermore, the transistor output stage is usually designed so that the device can tolerate a high-voltage supply (note that the early stages of the TTL buffer still require a standard +5V supply rail). Details of some typical TTL buffers, both inverting and non-inverting, are given in Table 7.2 whilst Figs. 7.6 to 7.9 show the circuits and pin connections for two of the most popular types of inverting and non-inverting buffers.

Typical I.e.d. driver arrangements based on non-inverting and inverting open-collector buffers are shown in Figs. 7.10(a) and 7.10(b) respectively. Note that these two circuits require logical signals of opposite sense and allowance must be made for this in the software routines used to send data to the port.

REPRESENTATIVE OUTPUT DRIVER

A representative output driver

Table 7.2 Characteristics of some typical TTL buffers

Type	Logic function	Load current (max.)*	Load voltage (max.)
7406	Hex inverting buffer (open-collector)	40mA	30V
7407	Hex non-inverting buffer (open-collector)	40mA	30V
7416	Hex inverting buffer (open-collector)	40mA	15V
7417	Hex non-inverting buffer (open-collector)	40mA	15V

*measured with the output in the low state.

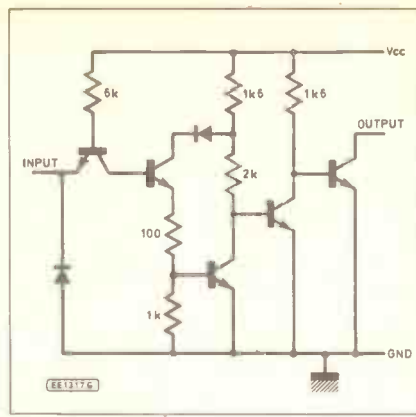

Fig. 7.6. Circuit of a single open-collector TTL inverting buffer (7406 or 7416)

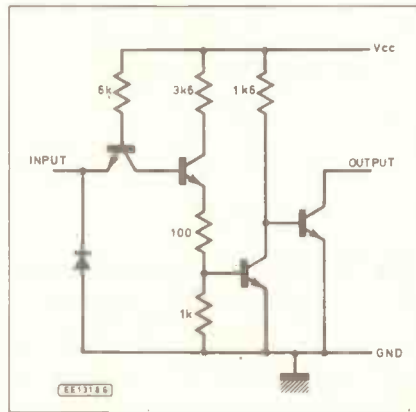

Fig. 7.7. Circuit of a single open-collector TTL non-inverting buffer (7407 or 7414)

arrangement is shown in Fig. 7.11. Port lines PA0 to PA7 of the programmable parallel I/O device are configured for output. Lines PA0 to PA5 are connected to the inputs of a hex. inverting buffer which is used to drive six I.e.d. indicators. The remaining port lines, PA6 and PA7, are connected to two n.p.n. silicon transistors which are used as relay drivers.

In order to operate the I.e.d.s and relays, a data byte is written to Port A. As an example, a binary value of 11000111 (hex. C7) written to Port A

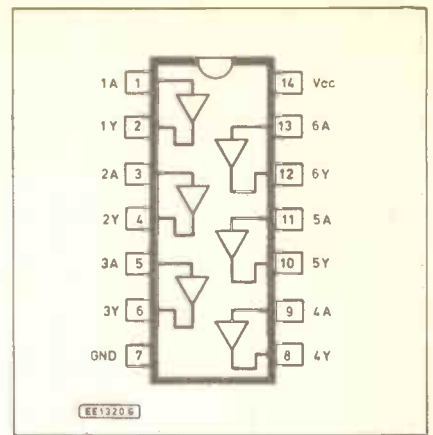

Fig. 7.8. Pin connections for 7406 and 7416 hex. open-collector inverting buffers

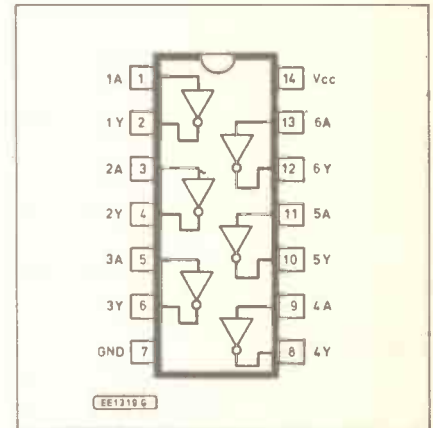

Fig. 7.9. Pin connections for 7407 and 7417 hex. open-collector non-inverting buffers

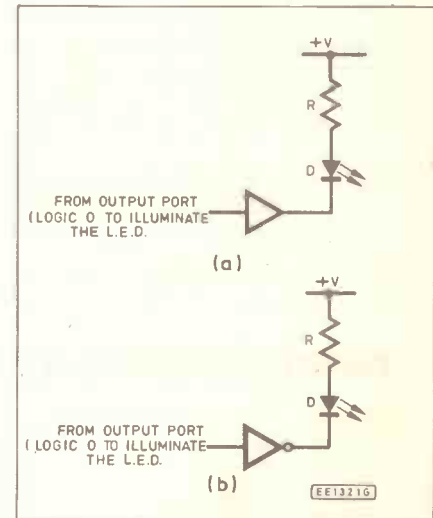

Fig. 7.10. L.E.D. driver using an open-collector TTL gate (a) non-inverting buffer (e.g. 7407 or 7417); (b) inverting buffer (e.g. 7406 or 7416)

will illuminate the three I.e.d.s connected to PA0, PA1 and PA2 and operate the relays connected to PA6 and PA7. To turn the I.e.d.s and relays off, a binary value of 00000000 (hex. 00) should be sent to Port A. This topic will be considered in

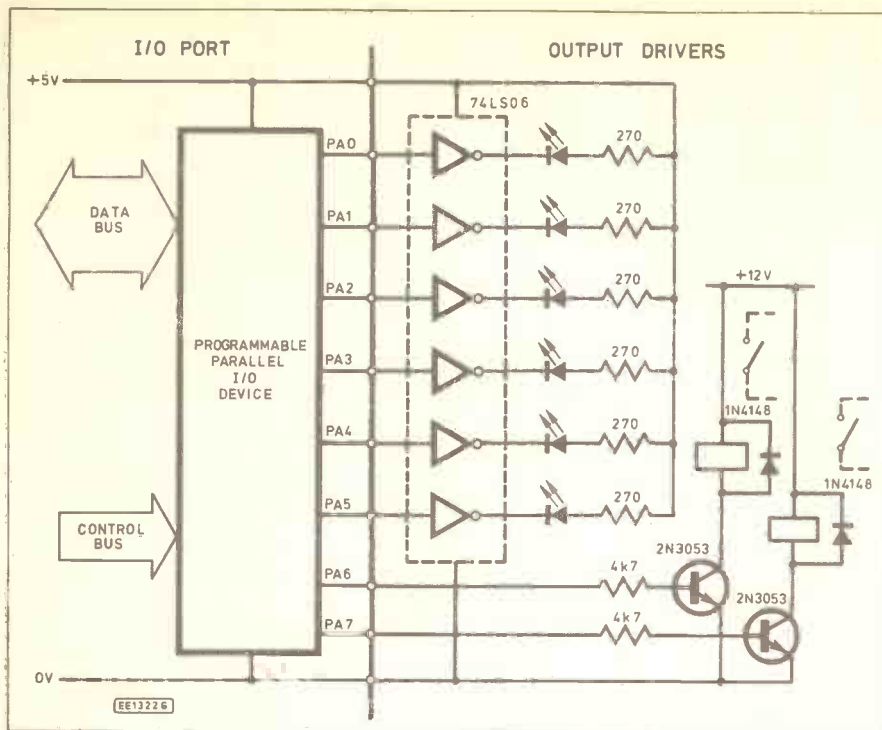

Fig. 7.11. Representative output driver arrangement

greater length in parts eight and nine of the series.

Problem 7.3

Refer to the representative microprocessor output shown in Fig. 7.11.

- What data value should be written to Port A in order to operate both relays and turn all I.e.d.s off. Express your answer in binary.
- What is the hexadecimal equivalent of the value in (a)?
- Determine the forward current of an I.e.d. when it is operating.
- What should be the nominal operating voltage rating for the relays?
- Determine the collector current for the transistors in the conducting (on) state.

NEXT MONTH: We shall be dealing with programming of microprocessor systems and will introduce flow charts and languages. We also provide details of the third Practical Assignment.

ANSWERS TO PROBLEMS

- 180ohm
- 13mA
- (a) 11000000
(b) C0
(c) 11 mA
(d) 12V
(e) 27 mA

BACKGROUND READING

The following background reading is recommended for Part Seven:

Chapter 7 (Applications of Microcomputers) of *Beginner's Guide to Microprocessors* by E.A. Parr, (a Newnes Technical Book published by Heinemann-Newnes) ISBN 0 408 00579 3. Available from the *EE Book Service*.

Chapter 7 (Interfacing) of *Microelectronic Systems 2* by R. Vears, (published by William Heinemann Ltd., ISBN 0 434 92194 7. Available from the *EE Book Service*

CORRESPONDENCE

Comments and queries from readers are welcome and should be sent directly to the author at the following address: Department of Technology, Brooklands Technical College, Heath Road, Weybridge, Surrey, KT13 8TT

Please include a stamped addressed envelope (and be prepared to wait a little!) if you require an individual reply. General queries will be dealt with in "Readers Forum" which will next appear in Part Nine of the series.

GLOSSARY FOR PART SEVEN

Light emitting diode I.e.d.

A diode which becomes illuminated when supplied with a specified voltage and current. L.E.D.s are commonly used as indicators and display devices and are also available in "seven segment" format for use as numeric displays.

Relay

A single or multiple switch is usually operated by electromagnetism. Relays provide a high degree of electrical isolation between a microprocessor and the circuit which it is being used to control. Relays are also capable of switching currents greatly in excess of those available from a microprocessor system.

EE CROSSWORD 4 ANSWERS

ACROSS

- NESTING
- ROUTINE
- COMPATIBLE
- EN
- NEGATIVE
- PRINTS
- ACCEPTANCE
- PULSED
- ODD/EVEN
- PERT
- OVERSHOOTS
- FILM
- NC
- TELETEXT

DOWN

- DECODER
- STOP
- UNIT
- MODE
- INVERTS
- TACTILE
- OBJECT CODE
- ACCESS TIME
- END TO END
- NUMERIC
- PELTIER
- DISHES
- OPEN

19" RACK MOUNTING EQUIPMENT CASES

This new range of 19" rack equipment cases have been designed with economy and versatility as their objective. These cases are supplied as a flat pack kit with assembly instructions.

The equipment cases feature a black coated finish 1/8" (3mm) aluminium frontpanel with the rest of the case constructed from 7mm or 9mm 'Stelvetite' PVC coated steel. All kits include front panel handles and rubber feet.

They are available in the following popular sizes with all the units having a standard front panel width of 19", and an enclosure width of 17 1/4" (438mm) by a depth of 10" (254mm).

ORDER CODE	HEIGHT	PRICE
U1	1 3/4" (44mm)	16.80
U2	3 1/2" (88mm)	18.90
U3	5 1/4" (133mm)	21.00
U4	7" (178mm)	23.00
M8U Stopped mixer console		£23.62

All prices exclude VAT
Please include £2.50 + VAT for post and packing.
Flat pack size=500 x 260 x 32
£2.75 plus VAT plus £150 for each additional item

Blanking Panels, Racking Consoles and Rack Cabinets also available
Please send SAE for further details
TRADE ENQUIRIES WELCOME

Tel 0275 823983 for Access/Visa card sales for immediate despatch or send cheque with order to:
RACKZ PRODUCTS, PO BOX No. 1402, MANGOTSFIELD, BRISTOL, ENGLAND BS17 3RY

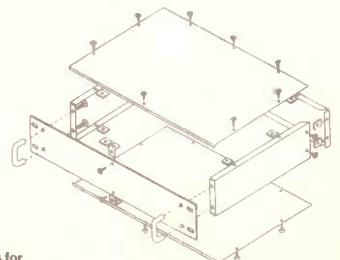

Exploring electronics

OWEN BISHOP

Part 23—Op. Amp Summer and Digital-to-Analogue Converter

A PHRASE commonly heard at this time of the year is: "One swallow doesn't make a summer". In this article we show you that one op. amp *does* make a summer! In fact, it is because op. amps were originally designed to perform mathematical operations in the early analogue computers (before digital computers stole the scene), that they were given their name.

You need a voltmeter for this month's circuits. A cheap one will do—provided it has a scale reading to 5V or 10V. Or use a multimeter set to a suitable voltage range.

INVERTING AMPLIFIER

An op. amp is often used in an *inverting amplifier*, as shown in Fig. 23.1. A positive voltage applied to the "inverting" input (the $-$ input) causes the output to swing to a negative voltage. Conversely, a negative voltage at the "non-inverting" input (the $+$ input) results in a negative output swing; though we are not concerned with this in this circuit.

When the output is negative, a current I flows from the input terminal of the circuit, through the input resistor R_1 and the feedback resistor R_F and into the output terminal of the op. amp. An interesting property of the op. amp is that it adjusts its output voltage (which may be negative, as in this case) until there is no difference between the voltages at its $(+)$ and $(-)$ inputs.

In Fig. 23.1 the $(+)$ input is held at 0V. So the op. amp adjusts its output until the $(-)$ input is 0V too. The output voltage falls until the current flowing through R_1 is exactly equal to the current flowing through R_F . Now no current enters or leaves the $(-)$ input; it is at 0V.

VIRTUAL EARTH

No matter what the value of V_{IN} (within limits), the voltage at the $(-)$

input steadily remains zero. The op. amp behaves as if the $(-)$ input terminal is connected directly to earth. We call it a *virtual earth*.

This property of the op.amp is made use of in several circuits, including this *summer*—a circuit that adds two or more quantities. The quantities to be

This series is designed to explain the workings of electronic components and circuits by involving the reader in experimenting with them. There will not be masses of theory or formulae but straightforward explanations and circuits to build and experiment with.

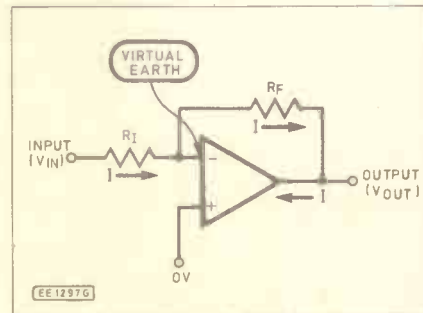

added are represented by two or more voltages applied to the $(-)$ input. Whatever voltages are applied, and however many voltages there are, the currents they produce are, in effect, "soaked up" by the virtual earth.

In practice, the currents all flow on through R_F and into the output terminal of the op. amp. The op.amp adjusts its negative output voltage so that *all* the currents flow in; the output voltage is thus proportional to the total or *sum* of the input voltages.

Fig. 23.1 (left). An operational amplifier, connected as an inverting amplifier.

Fig. 23.3 (below). Demonstration bread-board component layout for the Op. Amp Summer. If using a multimeter it should be set to the 10V range. Note that the positive terminal is connected to the 0V "rail".

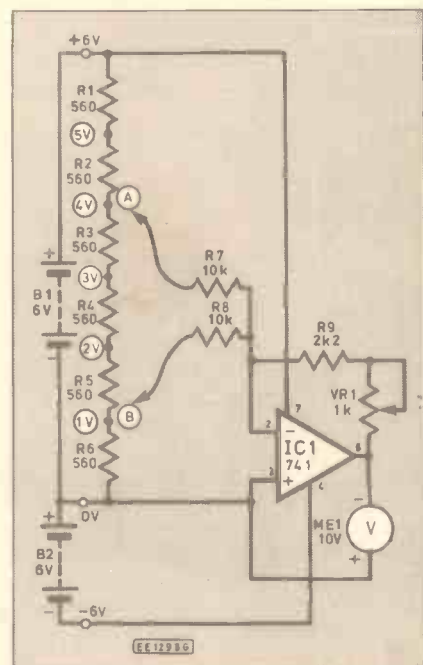
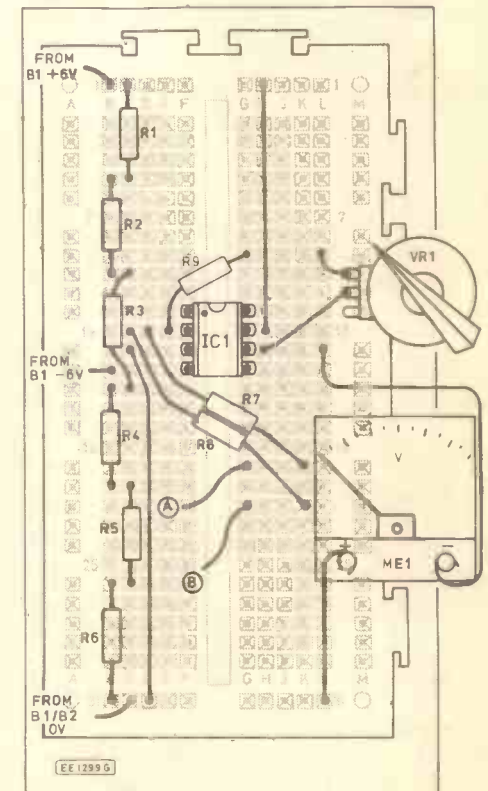
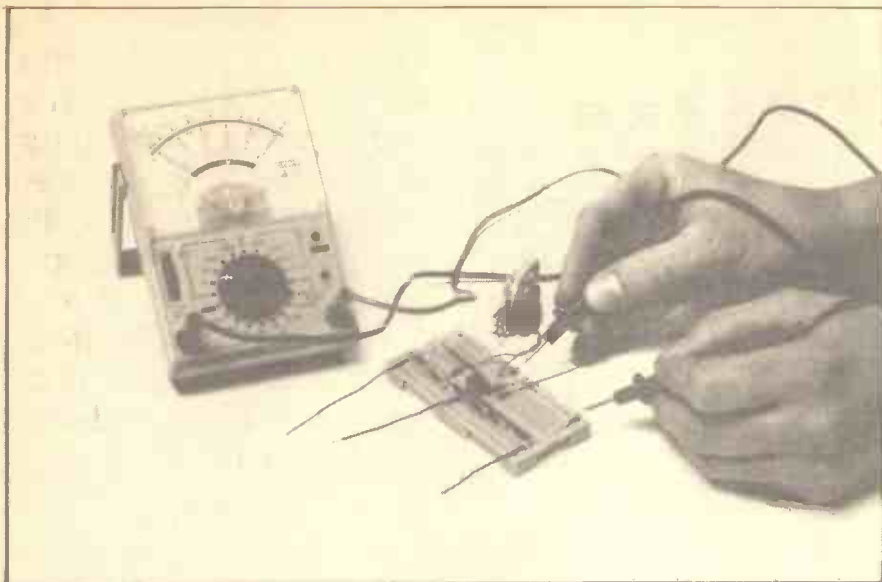

Fig. 23.2. Circuit diagram for the Op. Amp Summer.





OP.AMP SUMMER

The demonstration circuit diagram of the Op.Amp Summer is shown in Fig. 23.2. It uses a 741 op.amp i.c. connected as a summer, with two inputs (*A* and *B*) to its (-) input, pin 2. The circuit also includes a potential divider network consisting of resistors *R1* to *R6* (see EE Sept 1986), which supplies a range of voltages from 0V to +6V in steps of 1V.

CONSTRUCTION

The demonstration breadboard component layout for the Op. Amp Summer is shown in Fig. 23.3.

Commence construction by inserting all the resistors followed by the link wires and "test leads" *A* and *B* on the board. This should be followed by the supply leads and the potentiometer.

As the 741 op. amp i.c. is fairly robust you can insert this device on the board and build the rest of the circuit around it. However, as many i.c.s on the market are susceptible to damage from "static electricity" and to encourage good practice, it is recommended that i.c. sockets should always be used when building projects. This allows for the minimum of i.c. handling and, possibly more important, the circuit can be finally checked *before* powering-up.

Note that the meter or multimeter should be wired with the "positive" probe lead taken to the 0V line and the "negative" probe to the output "track", pin 6. If using a multimeter to monitor the circuit, the meter leads will not plug directly into the circuit block so two pieces of solid wire should be inserted first and the meter leads attached to these wires.

SETTING UP

To set up the circuit, connect both *A* and *B* to +6V by pushing the flying

leads into sockets in the top rail. We know that $6+6=12$, so adjust the potentiometer *VR1* until the output voltage is -2.4V. The meter is connected so that it gives positive readings for negative voltages, so we can forget about the output being negative from now on.

If the meter reads 2.4V when the sum is supposed to be 12, we can say that the value shown on the meter is one fifth of the sum. You could stick a piece of paper on the glass of the meter, marking it "12" at 2.4V on the meter's usual scale, "11" at 2.2V, "10" at 2.0V, and so on down to "0" at 0V.

Now let's test the circuit; for example, let's try to find the sum of 3 and 5. Push lead *A* into a socket in row 16 (3V), and lead *B* into a socket in row 5 (5V). The correct total should appear on the meter; $3+5=8$, so the meter reading should be one fifth of this, 1.6V. Try this with other combinations of inputs, or modify the circuit to add three or more numbers.

You are not likely to use an op. amp summer for keeping your accounts, but it does have a practical use in audio circuits. If input *A* comes from a tape deck, for example, and input *B* comes from a

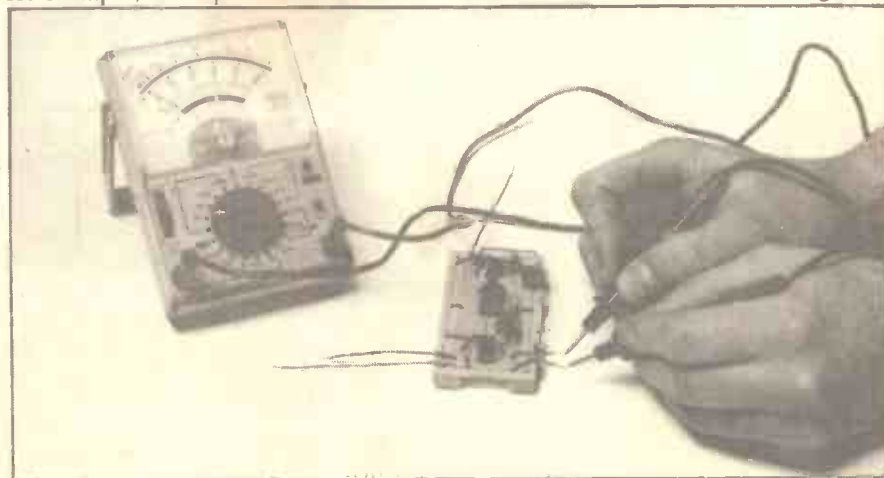

COMPONENTS

OP. AMP SUMMER

Resistors

R1-R6 560 (6 off)
R7, R8 10k (2 off)
R9 2k2
 All 0.25W 5% carbon

Potentiometer

VR1 1k lin.

Integrated circuit

IC1 741 operational amplifier

**Shop
Talk**

See page 295

Miscellaneous

B1, B2, 6V battery (2 off); Voltmeter (or Multimeter) 5V or 10V f.s.d.; Breadboard (Veroblock, etc.); 8-pin i.c. holder; connecting wire.

D-to-A CONVERTER

Resistors

R1, R2, R7 10k (5 off)
R8, R9 10k (5 off)
R3 33k ✓ *R6* 1k
R4 47k ✓ *R10* 2k7
R5 39k ✓ *R11* 18k (optional)
 All 0.25W 5% carbon (though 2% types would be better)

Capacitor

C1 10μ elec. 10V

Semiconductor

TR1 ZTX300 npn transistor (optional)

Integrated circuits

IC1 555 timer
IC2 7493 4-bit binary counter

Miscellaneous

B1, B2, 6V battery (2 off); Voltmeter (or Multimeter) 5V or 10V f.s.d.; Breadboard (Veroblock, etc.); LP1 Filament lamp 6V, 0.06A, and holder (optional); 8-pin i.c. holder (2 off); 14-pin i.c. holder; connecting wire.

Approx. cost
Guidance only

£5 (excluding meter)

microphone, the output of the op. amp is the sum of the two waveforms. The summer acts as a *mixer* of audio signals.

DIGITAL-TO-ANALOGUE CONVERTER

A basic Digital-to-Analogue Converter (DAC) demonstration circuit diagram is shown in Fig. 23.4 and has applications in converting a digital value, such as you get from the output port of a computer, to its analogue voltage equivalent. The varying voltage can be used to control the speed of a motor or the brightness of a lamp.

The inputs to the summer, IC3 pin 2, pass through a network of resistors (R3-R9) of different values. Here we use the various combinations of resistors to obtain input resistances equal to 10k, 20k, 40k and 80k.

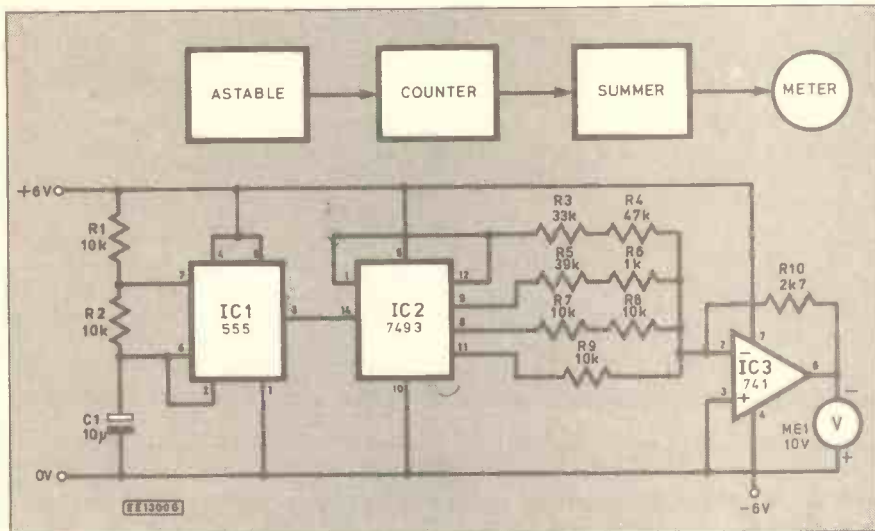
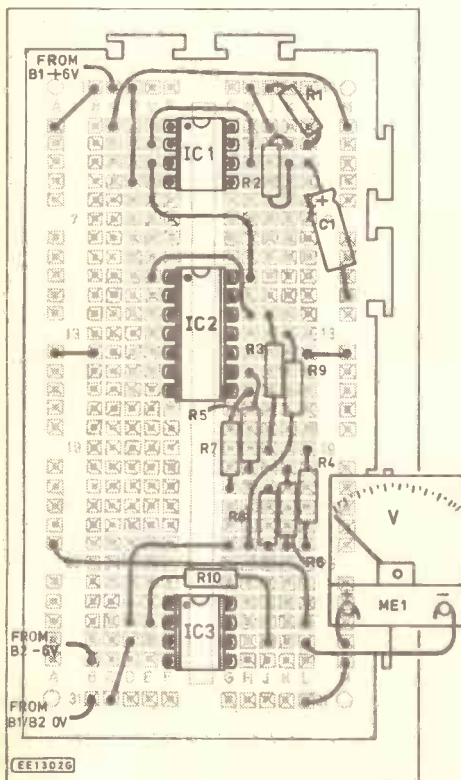

Fig. 23.4. Demonstration circuit diagram for a simple Digital-to-Analogue Converter.

Fig. 23.5 (below). Demonstration "test-bed" component layout for the Digital-to-Analogue Converter.



In this demonstration circuit we have a counter IC2 driven by IC1, an astable "clock" (EE May 1987). The clock or oscillator stage IC1 is built around the versatile 555 timer chip.

The D.C.B.A. outputs (pins 11,8,9,12) of IC2 run through all the binary values from 0000 to 1111, repeatedly. D is the most significant digit, since 1000 is equivalent to "8" in decimal.

When output D of the counter is high, the current to the virtual earth flows through a 10k resistor. If, for example, the high output voltage is 5V, the current flowing through resistor R9 is $5/10000=0.5\text{mA}$.

Output C is the next most significant digit, since 100 is equivalent to "4" in

decimal. Commence construction by first inserting i.c. holders in position on the board followed by all the link wires. Next the resistors and capacitor should be arranged around the i.c. holders.

The supply lead-off wires should now be inserted. Before adding the meter leads and plugging in the i.c.s the board should be given a final check over against the circuit diagram.

OPERATION

When the Digital-to-Analogue "test-bed" is switched on, the outputs of the counter IC2 run repeatedly through the sixteen values 0 to 15, counting at about 1 per second. The weighted input currents are summed and the output of the op. amp runs through a series of sixteen values.

At a first glance, the needle of the meter seems to swing slowly from 0 to about 3V, taking about 16 seconds to do so. Then the needle returns rapidly to 0V and starts again.

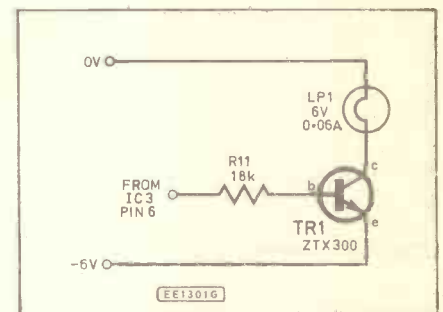

Fig. 23.6. An alternative output circuit.

The meter appears to show a smooth rise in voltage, i.e. it is an analogue quantity. However, if you examine it more closely you will see that it actually moves in a series of 16 steps.

As an alternative to the meter, you could use the output circuit of Fig. 23.6. The gradually increasing base current to TR1 gradually turns the transistor on. The collector current and, hence, the brightness of the lamp gradually increases as the counter output increases from 0000 to 1111.

You could extend the converter circuit by having an 8-output counter, counting from 0 to 255. You would need resistors of 160k, 320k, 640k and 1.28M. Then the needle would move in 256 much smaller steps and its motion would be indistinguishable from a truly smooth analogue motion.

The DAC circuit demonstrates how a D-to-A converter works. More convenient to use are the complete converters available as D-to-A i.c.s. These convert 8-digit or 12-digit inputs to the equivalent analogue voltage output.

NEXT MONTH: We conclude the series by looking at the op. amp comparator and building a Light-Triggered Alarm.

decimal. With the same high output voltage, the current flowing through the 20k combined resistance of resistors R7 and R8 is 0.25mA. So when both D and C are high (1100, equivalent to decimal 12), the total current is 0.75mA.

Output B is the third most significant digit, 10 being the equivalent of "2" in decimal. It represents only a quarter the value of digit D, so the resistance connected to B is 40k (R5/R6), four times that connected to D. This means that when B is high the current is only one quarter of that which flows when D is high.

Finally, the least significant digit, output A, value 1, has an 80k resistor (R3/R4), and the current it generates is only one eighth of that when D is high. The currents associated with each digit are thus weighted in proportion to the value represented by each digit.

CONSTRUCTION

The plug-in circuit board component layout and wiring for the simple Digital-to-Analogue Converter is shown in Fig. 23.5.

EQUIPMENT CASES

LEATHER-GRAIN
P.V.C.
COATED
STEEL

ALL-ALUMINIUM

DIMENSIONS			Price £
Height Ins.	Depth Ins.	Width Ins.	
2.0	2.25	4.5	1.50
2.0	4.0	6.0	2.00
2.0	5.5	8.0	2.70
2.0	11.0	11.0	4.70
2.5	3.0	4.0	1.70
2.5	3.0	6.0	2.10
2.5	4.0	8.0	2.60
2.5	5.25	9.0	3.00
3.0	6.0	5.0	2.70
3.0	6.0	8.0	3.20
3.0	8.0	8.0	3.80
3.0	6.0	11.0	4.20
3.5	7.5	11.0	4.90
3.5	7.5	17.0	7.20
4.0	4.0	6.0	2.70
4.0	6.0	6.0	3.20
4.0	9.0	6.0	4.20
4.0	7.0	8.0	4.20
4.0	6.0	8.0	4.30
5.0	6.0	11.0	5.20
5.0	6.0	15.0	6.20
5.0	11.0	8.0	5.90
5.0	11.0	11.0	7.60
5.0	11.0	15.0	9.40
7.0	10.0	7.0	6.80
7.0	10.0	10.0	8.40
7.0	10.0	17.0	11.90

LED 5mm

Red	1+	10+	100+
Green	9p	8p	5p
Amber	11p	9p	6p
Yellow	12p	10p	8p
Holders	12p	10p	8p
	4p	3p	2p

FLASHING LEDS

Red	45p	40p	35p
Amber	50p	45p	40p
Green	50p	45p	40p

ALL ORDERS +85p P&P +15% VAT UNLESS OTHERWISE STATED

24 HR. ANSWERING MACHINE

TRADING

THE MALTINGS, HIGH STREET, WEM
SHROPSHIRE. SY4 5EN.
DEPT. EE5

Tel: (0939)32763 Telex: 35565

ELECTRONIC COMPONENTS MAIL ORDER COMPANY - ESTABLISHED 1972
100+ PAGE CATALOGUE AVAILABLE - SEND £1 NOW FOR YOUR COPY INCLUDES DISCOUNT TICKETS 80P OFF £5+ ORDER, £1 OFF £10+ ORDER, £6 OFF £50+ ORDER.

MAY SPECIAL OFFER

MAINS ADAPTOR

USEFUL REPLACEMENT FOR BATTERY POWER

Mains powered adaptor housed in moulded case to plug into 13A socket. Unstabilised DC output switches between 3, 4.5, 6, 7.5, 9 & 12V at up to 300mA. Fitted with 4-way spider connector.

£2.99

RE-CHARGEABLE BATTERIES - EX-EQUIPMENT

C-Normal 1.8 Ah	10+ 100+	75p 65p
C-Tag Ended 1.8Ah		65p 55p

ELECTRICAL

Mains Switches		
13A single unswitched	£1.50	
13A single switched	£2.14	
13A twin unswitched	£2.50	
13A twin switched	£3.98	
Extension Sockets		
3-way fused	£3.80	
4-way fused (white)	£3.99	
4-way fused (orange)	£4.50	
4-way fused with lead and plug	£5.75	
Safebloc test connector	£6.99	
13A plug-fused	46p	
13A test plug	99p	
Twin and earth cable - white or grey		
1.0mm2	1m	100m
1.5mm2		Reel
2.5mm2	18p	£12.25
4.0mm2	25p	£15.50
6.0mm2	32p	£22.50
	65p	
	92p	

CHARGER FOR NI-CAD BATTERIES

Charges AAA, AA, C, D & PP3 NI-CADS

£4.50

NI-CAD RECHARGEABLE BATTERIES

AAA	£1.25 (10+£1.20ea.)
AA	90p (10+ 85p ea.)
C	£2.10 (10+£1.90ea.)
D	£2.50 (10+£2.20ea.)
PP3	£4.10 (10+£3.90ea.)

BT APPROVED EQUIPMENT

Master Socket (flush)	£2.90
Master Socket (surface)	£2.75
Secondary Socket (flush)	£1.90
Secondary Socket (surface)	£1.85
BT Cable (per metre)	15p
Line Jack Cord with plug	£1.25
Extension lead, 5mtr	£3.90
Wiring Tool	50p
Plug-431A	25p
Slimtel Phone	£17.35
Viscount Phone	£26.04
Conversion Kit with wiring diagram	£6.99

MARCO KITS

Ceramic 50V (125)	£3.50
Electrolytics Rad. (100)	£7.25
Fuse 20mm O/B (80)	£3.75
Fuse 20mm A/S (80)	£7.50
Nut and Bolt (800)	£3.00
Pre-set Pots. Horiz. (120)	£6.75
Pre-set Pots. Vert. (120)	£6.75
Resistors	
0.25W Popular (1000)	£6.50
0.25W 5 off (305)	£2.95
0.25W 10 off (610)	£4.50
0.5W Popular (1000)	£9.50
0.5W 5 off (365)	£4.70
0.5W 10 off (730)	£7.75
1W 5 off (365)	£13.75
2W 5 off (365)	£21.75
Zener Diodes 5 off (55)	£3.50
0.25W Resistors	1+ 2p, 10+ 1.5p
0.5W Resistors	1+ 2p, 10+ 1.5p

SOLDER AT A RIDICULOUSLY LOW PRICE

A 500g reel of 22 swg multi-core solder 60% tin, 40% alloy non-corrosive

ONLY £4.99

10+ £3.75

ANEX SOLDERING

C Iron 15W	£5.40	SK2 Kit £8.30
CS Iron 17W	£5.60	SK5 Kit £7.99
XS Iron 25W	£5.80	SK6 Kit £8.20
ST4 Stand	£2.20	
TCSU-D Soldering Station	£72.50	
Spare Elements from CS.50		
Spare Tips for above irons	£1.20	

DESOLDERING PUMP

£2.99

Spare nozzle for above - 60p

ORYX PORTASOL GAS SOLDERING IRON

Price (1+) £16.00
(5+) £15.30

Spare tips: 1, 2, 4, 3, 2, 4mm £4

TEST PROBES

Length 144mm, IA 1/4in fuse fitted	7805 36p 7905 38p
	7808 36p 7915 38p
	7812 36p 7918 38p
	7818 36p 7924 38p
	7824 36p
99p per pair (1 red, 1 black) Normally over £2 each	LM317K £2.40 LM317T 95p

VOLTAGE REGS

CONQUERING NEW HEIGHTS

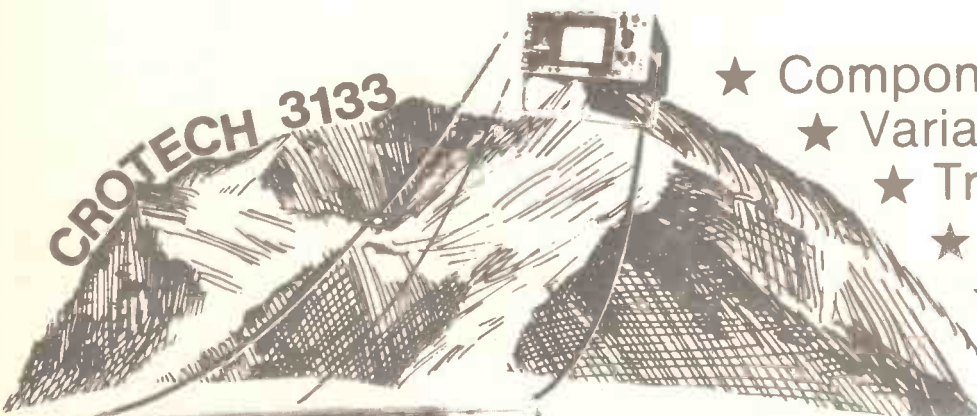

CROTECH 3133

- ★ Component Comparator
- ★ Variable Hold Off
- ★ Triple DC Source
- ★ DC - 25 MHz
- ★ 40ns/div
- ★ 2mV/div
- ★ Low Cost

£319*

Full 2 Year Warranty

To scale the heights, just call us for your FREE copy of our catalogue



*(Ex VAT & Delivery)

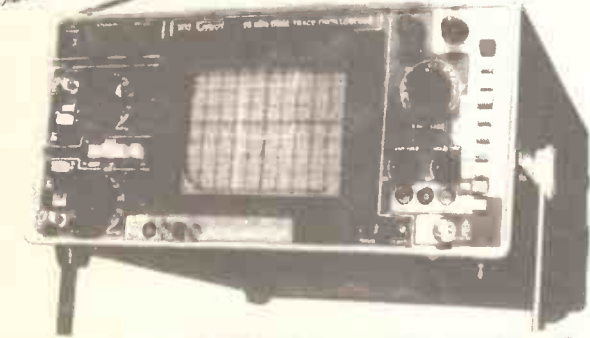

Yes its 25MHz for £319

Crotech Instruments Limited
2 Stephenson Road, St. Ives, Huntingdon, Cambs. PE17 4WJ
Telephone: (0480) 301818

DOOR SENTINEL

A. R. WINSTANLEY

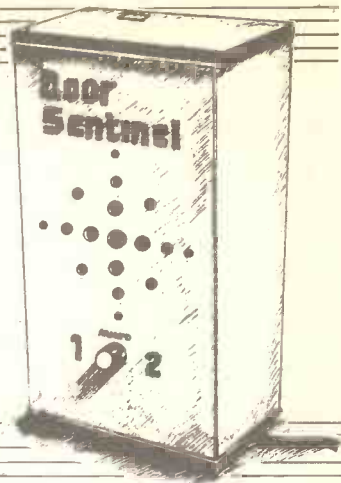

If you have not already heard, the government is mounting a campaign to prevent crime. This low-cost security project will not prevent crime, but the "high power" siren should put any would-be criminal to flight!—Can be used in the home, office or shop.

THE DOOR SENTINEL is a small battery operated alarm unit which monitors doors or windows and sounds a piercing alarm when the door or window is opened.

FEATURES

- Automatic resetting after two minutes.
- Hidden operating switches which are worked by a horseshoe magnet; tamperproof operation.
- Normally-closed protection loop.

With burglaries and break-ins seemingly on the increase, a widening variety of anti-theft devices is becoming available to help the householder to protect his property. Such countermeasures include window locks and alarm systems, and being economical and easily installed they are a worthwhile method of helping to combat the threat posed by opportunists and burglars.

More sophisticated electronic monitoring systems can also be installed to provide a comprehensive protection network which can be tailored to individual needs.

The *Door Sentinel* to be described here could form a useful adjunct to an existing system or can simply be installed as a totally independent deterrent to monitor any door or window. The Sentinel is a compact battery-operated alarm unit which provides closed-loop protection by means of a surface-mounting reed switch, and an outline of its operation follows.

OUTLINE DESCRIPTION

A reed switch with operating magnet is fixed to the desired door such that the reed is closed by the magnet when the door is shut, see Fig. 1. When the door is opened, the magnet is removed away from the reed, breaking the closed loop circuit, and this will trigger the alarm in the Sentinel.

This design incorporates a very piercing solid-state audible warning device, and once triggered, the unit will operate this alarm for approximately two minutes and will then automatically reset itself.

A further refinement is that there are no apparent switches showing on the unit, instead the Sentinel is either activated or

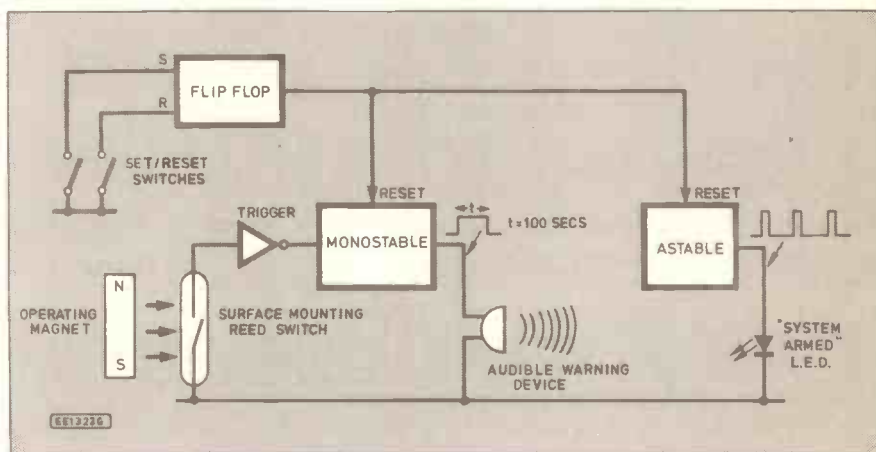

Fig. 1. Block diagram showing how the *Door Sentinel* operates.

turned off by built-in magnetic switches. The user turns the device on or off by touching a magnet to the appropriate place on the front panel. Therefore an intruder cannot easily disable the unit himself, since hopefully he won't have a magnet to hand at the time! Only someone with the appropriate know-how will be able to operate the alarm.

HOW IT WORKS

A flip-flop circuit interfaces two reed switches to the *Door Sentinel* circuit, the reeds being used to either "arm" or "reset" the alarm. The flip flop, when set, will enable both an astable and a monostable multivibrator. The astable flashes an l.e.d. which acts as a "power on" indicator, whilst the monostable timer drives an audible warning device through a transistor buffer.

A surface mounting reed switch is fixed to the door jamb and an operating magnet is positioned adjacently, such that when the door is closed, the magnet causes the reed switch to close also. This forms a "normally-closed" protection loop.

Opening the door will take away the magnet and this opens the reed. The signal so produced is inverted to trigger the monostable circuit, causing the audible warning

device to sound for a pre-determined period. After the period has ended, the alarm will reset itself, unless the reed switch is still open.

Interfering with the normally closed loop in any other manner will also sound the alarm. Since hidden reed switches are also employed to set or reset the unit, this makes the Sentinel tamperproof to a limited extent, since it is necessary to use a magnet to switch the unit on or off. There are no visible controls otherwise.

CIRCUIT DESCRIPTION

The circuit diagram of the unit appears in Fig. 2. This design employs the CMOS version of the popular twin timer chip, type ICM7556. One half IC2a is used as the alarm timer and IC2b is employed as an l.e.d. flasher. The CMOS version is utilised in order to reduce current consumption and so prolong battery life.

IC1a and IC1b are two CMOS NAND gates wired to form a bistable flip-flop. The inputs to the bistable are S1 and S2, two magnetic reed switches. Operating each switch in turn will cause the output of the arrangement to switch successively. The output is observed at pin 10 of IC1 and will

switch between a high and low, or approximately +9V and 0V respectively.

The flip-flop output connects to the "Reset" terminals of both timers, so when IC1 pin 10 is low, both timers are disabled and cannot operate. By operating S1 with a magnet, both timers are enabled since their "Reset" terminals are biased high.

IC2a is connected as a monostable multivibrator circuit; this is a circuit which once triggered, will deliver one output pulse only and will then reset itself. The length of the output pulse (observed at pin 5) is determined by R5 and C1. Multiplying their values together produce a time period of 100 seconds—in theory! However, since C1 has an inherently large tolerance and also a high leakage current, you can expect to realise a much longer time delay of, say, 200 seconds. In a non-critical timing application like this, such inaccuracies are of no consequence.

L.E.D. FLASHER

Integrated circuit IC2b is wired to form an astable multivibrator which produces a steady stream of output pulses. D1 is a light-emitting diode connected to the astable output through a voltage-dropping resistor R6,

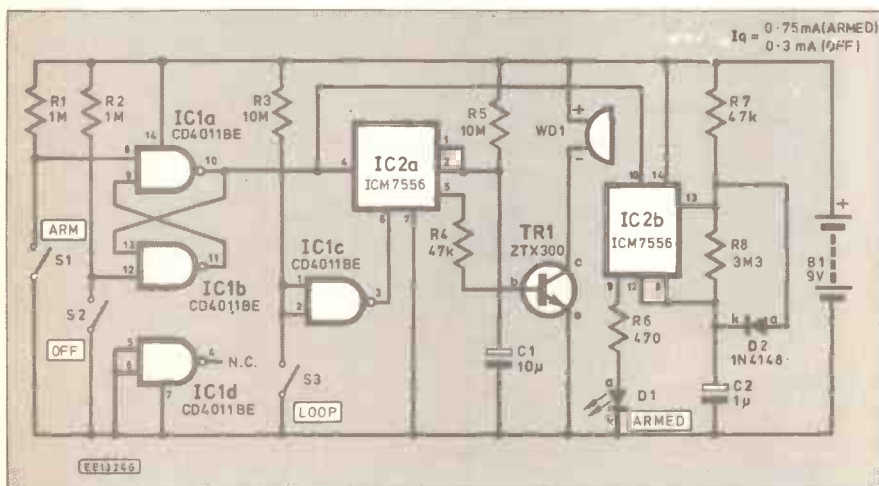

Fig. 2. Full circuit diagram for the Door Sentinel. Switches S1 and S2 are the glass reed types mounted in the circuit housing and S3 is the surface mounting reed which is attached to a door, window or cabinet together with a magnet.

and the l.e.d. will illuminate when the output is high.

The operation of the 556-type astable is well known but in brief it operates as follows. Assuming that the Reset terminal pin 10 is high, C2 will commence charging up through R7 and R8 until the voltage at pins 8 (trigger) and 12 (threshold) reaches two thirds the supply voltage. During this charge-up period the output is high.

When the capacitor is two thirds charged, the i.c. discharges the capacitor through an internal transistor via R8 until the potential across C2 drops to one third the supply voltage. The output is low when the capacitor is discharging but will switch high again when the voltage across C2 has dropped to one third supply voltage, at which point the capacitor starts to charge up again.

Basically then, C2 charges up to two thirds and then discharges down to one third the supply rail, switching the output high and low respectively.

However one drawback is the relatively long "on" time which in this application causes unnecessary power consumption, since the l.e.d. illuminates for longer than is really necessary. The inclusion of diode D2 across R8 greatly modifies the operational

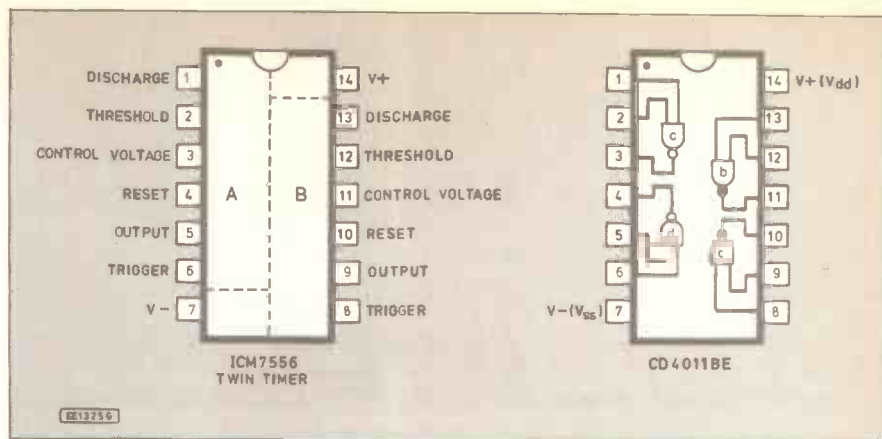

Fig. 3. Pin-out details for the twin timer and the quad NAND gate i.c.s.

cycle of the astable: C2 will now charge up almost straight away through R7 and D2 (which shunts R8) so that the "on" time or "mark" is very short.

When the potential across C2 has reached two thirds of the supply, the output goes low

produce a low signal at the trigger terminal of the monostable. IC2a therefore triggers and its output—pin 5—goes high for a period of (R5 (Ohms) X C1 (Farads)) seconds, as previously described. Even if S3 is now closed again the monostable will remain triggered but resets itself after the time period has lapsed.

TRANSISTOR BUFFER

Transistor TR1 is a transistor switch and when IC2a output goes high, (the monostable having triggered), TR1 will turn on, thereby completing the circuit to WD1. The audible warning device will sound for the monostable period.

Transistor TR1 is included to counteract the output characteristic of CMOS 555-type timers whereby the output voltage drops noticeably as output current increases. Technically IC2a could drive WD1 directly but TR1 ensures that the buzzer is driven by the full supply rail voltage, not a reduced voltage which would be present at the timer output.

Regarding the audible tone generator

and the capacitor discharges slowly through R8 into the i.c.—D2 now has no effect because it is reverse biased and so cannot conduct. The capacitor will charge quickly through R7 and D2 again, after it has discharged down to one third supply.

The result is that the l.e.d. will not so much flash on and off but will "strobe" in a manner which can be likened to a mini-stroboscope. Average current consumption is much reduced because the "on" time of D1 has been greatly shortened. Battery life will therefore be extended—all due to the addition of a diode costing a few pence! The addition of a shunting diode like D2 is not an uncommon method of modifying the mark to space ratio or duty cycle of 555-type astable multivibrators.

ALARM CIRCUIT

NAND gate IC1c is connected as a simple inverter so that when S3 is closed, the two inputs of IC1c are both low, thus its output (pin 3) will be high. Therefore the trigger terminal of IC2a (pin 6) is high, so the monostable will not operate.

If S3 is opened, even for a fraction of a second, then IC1c input will be biased high through R3. The NAND gate inverts this to



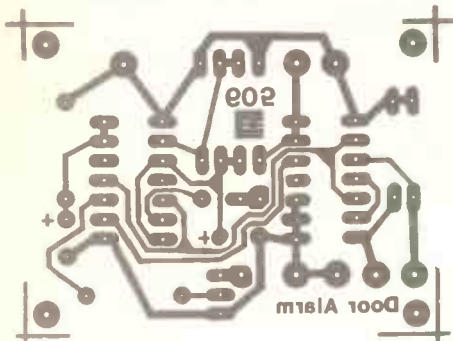
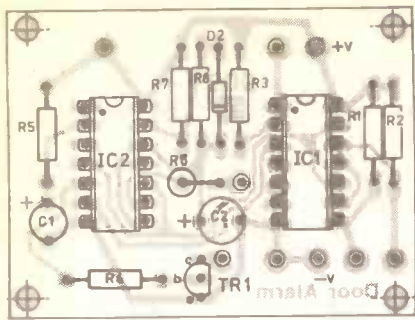

Fig. 4. Component layout and full size printed board copper foil master pattern for the Door Sentinel.

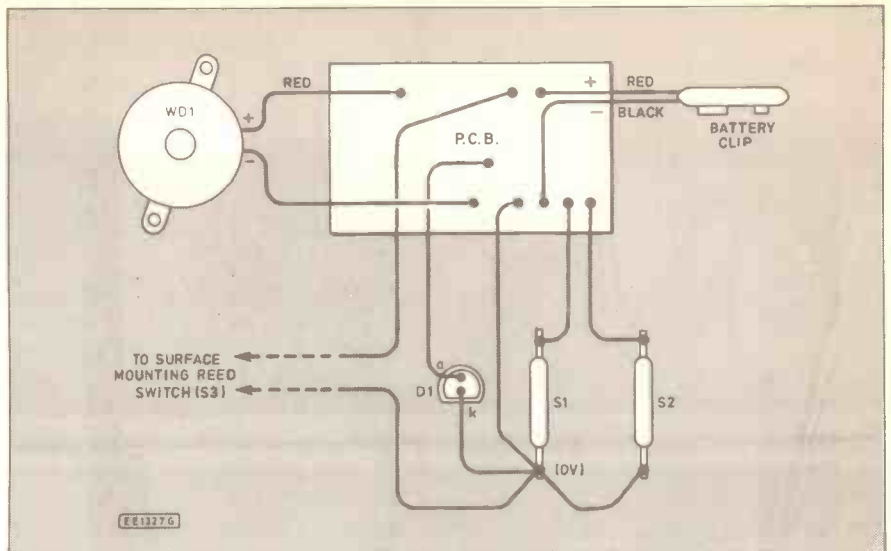
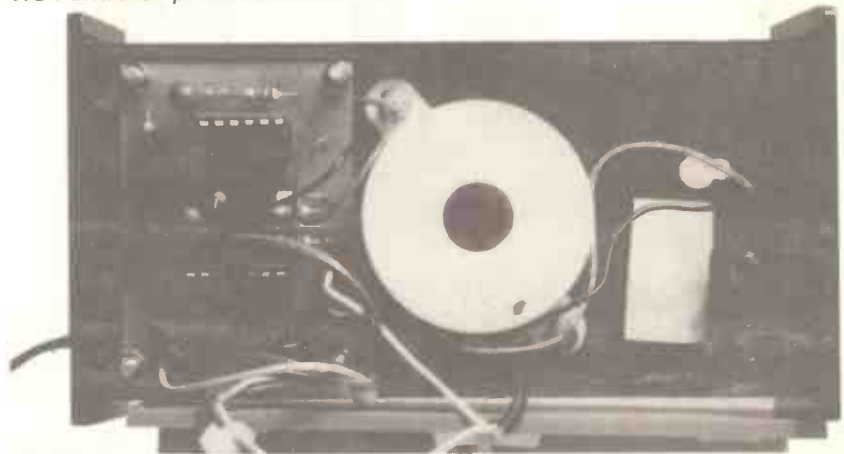

Fig. 5. Interwiring from the circuit board to the reed switches, warning buzzer WD1 and the "power on" i.e.d.



Positioning of the circuit board and warning buzzer in the bottom of the case.

COMPONENTS

Resistors

R1, R2	1M (2 off)
R3	10M
R4	47K
R5	10M
R6	470
R7	47k
R8	3M3

**Shop
Talk**

See page 295

All 1/4W
5% carbon film

Capacitors

C1	10μ tantalum bead 16V
C2	1μ tantalum bead 16V

Semiconductors

IC1	CD4011BE quad NAND
IC2	ICM7556 dual timer
TR1	ZTX300 silicon npn
D1	0.2" red i.e.d.
D2	1N4148 silicon diode

Miscellaneous

S1, S2	miniature glass reed switch (2 off)
S3	surface mounting reed switch with magnet
WD1	piezoelectric warning device (high power type)
B1	9V PP3-type alkaline battery with clip

Box, TEK0 Wall Housing 123×70×42mm, red/black; printed circuit board available from the *EE PCB Service*; 14-pin dil socket (2 off); i.e.d. lens-clip; interconnecting wire; mounting hardware; solder; etc.; small horseshoe magnet.

Approx. cost
Guidance only

£15

itself, a piezo electric type has been selected for its clarity of output tone coupled with low current consumption. Ordinary electromechanical buzzers cannot be substituted in this circuit.

Since WD1 will sound for as long as IC2a is triggered, the alarm tone will automatically cancel at the end of the monostable period, unless the trigger signal is still present. The only way to cancel the alarm manually is to operate S2. This will reset the Sentinel completely.

Switch S3 itself is a reed switch which is affixed on the door jamb. The operating magnet is placed on the door itself such that when the door is closed, the reed is closed by the magnet; opening the door will open S3 and the alarm will be triggered.

The whole system operates from a PP3-type 9V battery. There is of course no apparatus on-off switch since the unit is controlled through S1 and S2. When in a reset mode, the circuit consumes 0.3mA as measured on the prototype, most of this being drawn by the timer chip. The Sentinel draws 0.75mA (measured) when "armed". An alkaline battery is preferred for B1. Tests with the prototype would suggest a battery life of at least four months when the device is armed for a period of 12 hours per day.

CONSTRUCTION

The prototype unit was constructed in a TEK0 Wall Housing moulded in red and black ABS plastic and measuring 123×70×42mm. It is a simple clip-together

type and the two reeds S1 and S2 are fixed behind the removable cover, along with the light-emitting diode.

For greater security a screw-together plastic box of similar dimensions could be used, to make it more difficult for unauthorised people to gain access to the inner workings of the alarm.

The components themselves are mounted on a single-sided printed circuit board of dimensions 55×42mm, see Fig. 4. This can be manufactured by the home constructor in the normal manner, alternatively ready-made circuit boards are available from the *Everyday Electronics p.c.b. Service*.

Using a fine-tipped soldering iron, commence construction by soldering in the two 14 pin d.i.l. sockets to accommodate the integrated circuits. Follow on with all resistors, diodes and capacitors. Take care particularly to observe correct polarity of the diodes and tantalum capacitors. Also exercise caution when soldering the diodes and transistor as these are heat-sensitive semiconductors: if in doubt, employ a clip-on heat shunt to carry away excess heat which may be present during soldering.

The two CMOS chips are sensitive to excessive static electricity and must be retained in their anti-static packages until the last possible moment. Insert them—correctly orientated—only when all soldering has been completed.

The lid is prepared by carefully drilling a matrix of holes to permit sound from the internal audible warning device to pass through. The holes should be very carefully

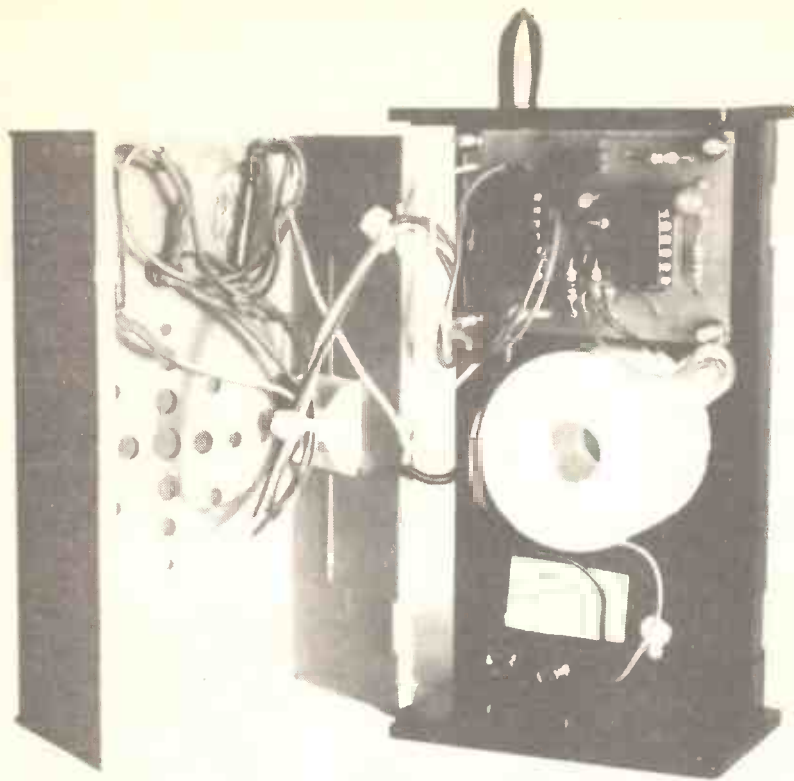

The completed Door Sentinel showing the glass reed switches mounted on the inside of the case lid.

drilled with a hand-held drill: the resultant holes can be chamfered with a countersinking bit in order to "soften" the appearance. A few gentle twists with the countersink bit will make the appearance of the matrix more acceptable. A further hole is required for the l.e.d., which can be fitted into position with a lens-clip.

FINISH

Finally embellish the front panel with rub-down transfer lettering as required, and finish off by spraying on a light coat or two of protective transparent lacquer.

On the prototype, the two glass reed switches were fixed into place on the inside of the lid by carefully applying a drop of

cianoacrylate adhesive gel, e.g. "Super Glue Xtra". Some care is required when dealing with the reed switches since they are relatively fragile. Do not bend their lead-outs too close to the glass bodies or the whole reed switch will fracture. Ideally use a pair of round-nose pliers when bending and forming the lead-outs of the switches.

Interwiring is then completed with general-purpose hook-up wire in accordance with Fig. 5. The use of different colours will assist with checking later on.

The trigger reed switch S3 is connected to the p.c.b. by a twin-core flying lead which passes through a hole in the case to the p.c.b. within the box. Complete construction by fitting the assembled printed circuit board to

the base of the cabinet using 6BA or M3 hardware. A battery can be fitted to the battery clip and can be retained in place with a small piece of double-sided adhesive foam strip.

With the operating magnet positioned next to S3, the l.e.d. may or may not be flashing when the battery is connected. Operating S1 with a horseshoe magnet (see Notes) should arm the unit and the l.e.d. will blink.

TESTING AND INSTALLATION

Separating S3 from its closing magnet will cause the alarm to sound—be warned, it's quite piercing! The alarm should reset itself after a period of several minutes, but only if S3 is closed again with the magnet. In the interim the only way to silence the alarm is to close S2 temporarily with the horseshoe magnet.

With testing complete, the Sentinel can be installed in its final position. The keyhole slots in the base of the plastic box can be knocked through to fix the alarm to any suitable surface by using screws. S3 should be fitted to the door jamb and the operating magnet screwed into place adjacently on the door itself.

The twin-core wire linking S3 to the alarm unit can be several metres long if required, so it is quite feasible to place the Sentinel within earshot of the occupants of the house. Furthermore, if this connection wire is cut in an attempt to disable the alarm system, the alarm will sound continuously until reset: one of the advantages of closed-loop protection.

APPLICATION NOTES

Since a normally-closed loop is employed as the basis of detection, it is possible to use certain other devices in conjunction with the Sentinel to form a small monitoring system. For example, window foil could perhaps be used instead of a trigger reed switch, to warn of a broken window. Alternatively, several reed switches could be wired in series to extend protection to several doors. Obviously the device could further be used to monitor any window in a similar manner to its principal use as a door alarm. □

TRANSISTORS AS RECTIFIERS

IN LOW-VOLTAGE rectifier circuits the voltage drop across the silicon diodes in common use can be a problem. A typical diode wastes about 1V. This may be all right if the mains transformer delivers enough voltage. But occasions arise where an existing transformer can't quite do the job.

In this case, it is possible to squeeze an extra half volt of d.c. output by substituting silicon Schottky diodes for the ordinary types. Schottky diodes are expensive, however. Germanium power rectifiers would do the same job, but appear to be no longer made.

An alternative is to use germanium power transistors connected as diodes. These transistors can often be salvaged from old amplifiers, etc., and you may well have some in your junk box.

The diagram Fig.1 shows a typical push-pull voltage rectifier whose diodes D1 and D2 can be germanium power tran-

sistors connected as shown. Most audio power transistors are usable.

The main limitation is the reverse emitter-base voltage (V_{EB}). This is twice the d.c. output voltage. (2.8 times the r.m.s. a.c. input voltage). A maximum V_{EB} rating of 10V applies to many germanium power transistors and limits the r.m.s. input voltage to about 3.5V.

Large pulses of current flow into capacitor C1. The peak collector current rating (ICM) should be at least twice the d.c. output current. Fortunately, many

germanium alloy power transistors have large ICM ratings so the requirement is easy to meet. A transistor big enough to do the job is likely to drop about 0.5V.

In the circuit shown each "diode" has to deliver half the load current. Its dissipation is then calculable. For example, if the load current is 2A the dissipation is likely to be about $1A \times 0.5V = 0.5W$ or 500mW. If the collector dissipation rating (free air, no heatsink) is more than this then no cooling arrangements may be needed.

Fig. 1. Arrangement for using Germanium power transistors as rectifier diodes in a low-voltage supply.

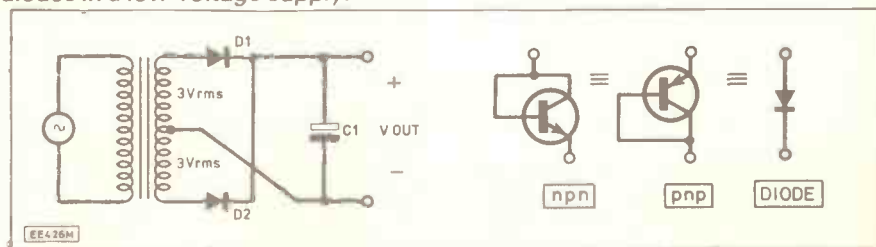

ON SPEC

*a regular
feature for
the Spectrum
Owner...*

by Mike Tooley BA

THIS month we attempt to throw some light on the Z80's restart instructions and, more particularly, the way in which the Spectrum takes advantage of them. We also show how the 8255's bit set/reset facility can be used to produce some practical I/O control routines for use with our versatile Add-on I/O Port (March/April '88). We also provide details of the minimal additional circuitry required to drive high-current d.c. and mains connected a.c. loads.

Restarts (and how to use them)

Andrew Swan from Bexhill has sent me a delightful letter which poses a number of questions including one concerning the Z80's restart instructions. Like many readers, Andrew is aware that the Z80 has a number of instructions known as "restarts" and wonders whether they can be of any use when developing programs for the machine.

The answer is a qualified "yes". The Z80's software restart instructions are a legacy from an earlier microprocessor (the 8080) and they provide a neat method of calling routines within the Spectrum's ROM. In fact, they act in a similar manner to a CALL instruction without the need to specify the address of the routine which is being called.

Each of the eight restart instructions has a different operation code and thus the Z80 can distinguish one from another and is thus able to determine the value to place in the program counter (i.e. the address at which program execution is to continue). The return address is saved on the stack so that the user's code can be resumed from the point at which it was left when the restart instruction was encountered.

Each of the restart instructions relates to the unique address in the lowest 256 bytes of memory (i.e. the Spectrum's ROM). These eight addresses are spaced eight bytes apart and provide entry points for a variety of often used ROM routines.

Restart	Op. code/(hex.)	Address (hex.)	Equivalent/ CALL
RST 0	C7	0000	CALL 0000
RST 8	CF	0008	CALL 0008
RST 10	D7	0010	CALL 0010
RST 18	DF	0018	CALL 0018
RST 20	E7	0020	CALL 0020
RST 28	EF	0028	CALL 0028
RST 30	F7	0030	CALL 0030
RST 38	FF	0038	CALL 0038

Notice that each of the RST instructions has an equivalent CALL instruction. The important difference is simply that the restart instruction requires only a single byte (i.e. the operation code alone) whereas the call instruction required three bytes (i.e. operation code plus two byte address). Where a routine is often used, the use of RST rather than CALL can be instrumental in making a significant saving in memory space occupied by a program.

Having explained what a restart is, it is worth mentioning how they are implemented in the Spectrum. Readers should be able to decide from this information whether or not they can be put to any worthwhile use!

RST 0

Since program execution is diverted to address 0000, RST 0 is equivalent to a reset and thus is of little use (any program resident in memory will be lost). Use RST 0 at your peril!

RST 8

RST 8 diverts program execution to the start of the ROM error routine. The routine, aptly known simply as the Spectrum "error restart", clears the machine stack and generates an appropriate error message.

RST 10

RST 10 is the entry point for the screen character print routine and is known as the "print character restart". The routine jumps forward immediately to a section of ROM code which starts at address 15F2. RST 10 is extremely useful as we shall demonstrate next month.

RST 18

RST 18 is known as the "collect character restart". The routine fetches the character which is pointed to by the system variable CH-ADD (two bytes at decimal address 23645). If the character is not printable, CH-ADD is incremented and the test for printable character is repeated.

RST 20

This restart is repeatedly executed as a line of BASIC is being interpreted. RST 20 is known as the "collect next character restart".

RST 28

RST 28 is the "calculator restart" and it immediately jumps forward to the entry point of the Spectrum's floating point calculator (address 335B).

RST 30

RST 30 is used to create work space. The number of locations to be reserved are contained in the BC register pair (which must be loaded prior to the execution of the restart) and thus the routine is somewhat cryptically referred to as the "make BC spaces restart".

RST 38

RST 38 is the "maskable interrupt" routine. This increments the Spectrum's real-time clock and scans the keyboard. Unless interrupts have been disabled for some reason, this routine is executed every 20ms.

Versatile Add-on I/O Port

In March *On Spec*, I mentioned that our Versatile Add-on I/O Port takes advantage of the 8255's bit set/reset facility which takes all of the hard work out of programming the device for output via the open-collector Darlington drivers fitted to Port C.

The secret is simply that the 8255 allows us to set or reset any of the Port C output lines without affecting any of the other lines. This saves quite a lot of code since we don't have to worry about masking the bits which are to be unaffected by an output command.

The bit set/reset facility is selected by sending a modified Control Word to the 8255's Control Register. Bit 7 in the Control Word is known as the bit set/reset flag; when set (1) it signifies a normal Control Word but when reset (0) it indicates that bit/reset mode is selected. In this mode, the state of bits 1 to 3 are used to determine which Port C line is being addressed whilst bit 0 indicates whether the line is to be set (1) or reset (0). This may sound a little complicated but it is really extremely straightforward!

The format of the Control Word is shown in Table 1. As an example, suppose that we wish to activate a load connected to PC4

Table 1. Control Word format (bit select mode)

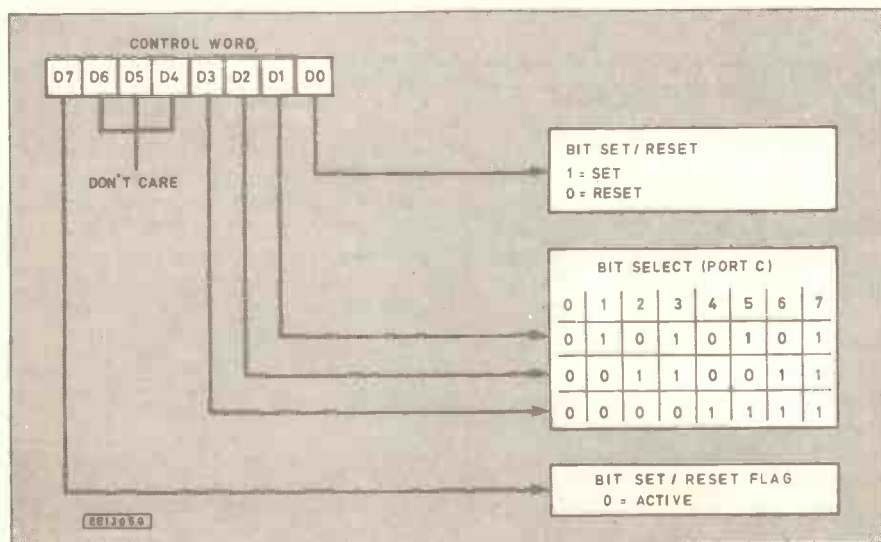

(pin-5 on SK3). First we need to select bit set/reset mode by making bit 7 of the Control Word a 0. Then, to address PC4 (i.e. bit 4 of Port C) we must make bits 3 to 1 of the Control Word 100 respectively. Finally, to set the line (i.e. pass current through the load) we must make bit 0 to 1. The required Control Word to output to the 8277 is thus:

D7 D6 D5 D4 D3 D2 D1 D0
0 0 0 0 1 0 0 1

(Note that bits 5 and 6 may be either a 1 or a 0)

To turn the same line "off", we need to reset bit 0. The new Control Word is thus:

D7 D6 D5 D4 D3 D2 D1 D0
0 0 0 0 1 0 0 0

(Again, bits 5 and 6 may be either a 1 or a 0)

Sending Control Words to the 8255 does not pose any problem and can be very simply achieved from BASIC, as shown in the following fragments of code:

```
1100 REM Turn PC4 on
1120 OUT 127,BIN 00001001
.....
2100 REM Turn PC4 off
2120 OUT 127,BIN 00001000
```

Note that, in either case, only line PC4 is affected. All of the other Port C lines remain in their previously defined states.

Table 2. Data values for setting/resetting Port C bits

Port Line	Pin No. SK3	Value of nn	
		Set Bit	Reset Bit
PC0	1	1	0
PC1	2	3	2
PC2	3	5	4
PC3	4	7	6
PC4	5	9	8
PC5	6	11	10
PC6	7	13	12
PC7	8	15	14

The foregoing fragments of BASIC make use of the Spectrum's ability to accept binary numbers using the BIN statement. In many cases, it may be more useful to have values presented in conventional decimal form and Table 2 shows Control Word values for setting and resetting each of the Port C lines in decimal using a BASIC line of the form:

220 OUT 127,nn
where nn is selected from the table.

High current/mains connected loads

Whilst the Darlington output driver fitted to Port C can support output load currents of up to 500mA, there may be some applications for which this is inadequate or for which a high degree of output isolation is required (as is the case with loads connected to the a.c. mains supply). In such cases some form of relay will be required between the Darlington driver and the load.

In low-voltage d.c. applications, a relay having a 400ohm coil rated at 12V (9.6V to 13V) and providing a single set of change-over contacts (s.p.s.t.) rated at 3A/28V d.c. will normally be quite adequate. Note that the Darlington driver is internally protected against inductive loads and thus it is not necessary to connect a shunt diode across the relay in order to limit the back e.m.f. produced.

For a.c. mains connected loads, a solid state relay should be employed. A typical p.c.b. mounting single-in-line solid state relay is capable of switching up to 280V r.m.s. a.c. at currents of up to 2.5A r.m.s. and thus should be able to cope with lighting systems, small a.c. motors and pumps. For higher current applications larger relays are available with ratings of up to 40A!

Figs. 1 and 2 respectively show how conventional and solid-state relays can be used with the versatile I/O Port. Note that it is essential to treat mains connected loads with great care. Do not, in any circumstances, attempt to solder or desolder any components to/from the interface whilst the load is connected to the mains; ensure that both the Spectrum and the load are disconnected from the mains BEFORE starting work.

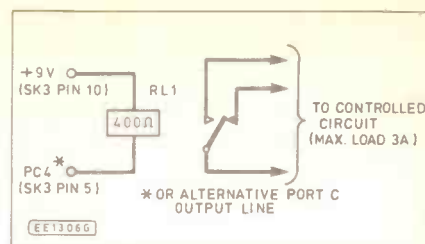

Fig. 1. Arrangement for driving a high current d.c. load

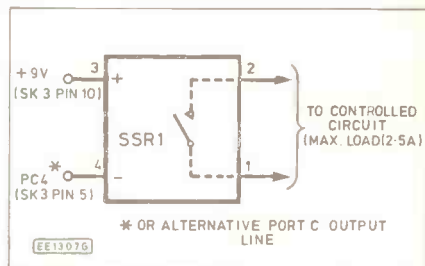

Fig. 2. Arrangement for driving a mains connected load

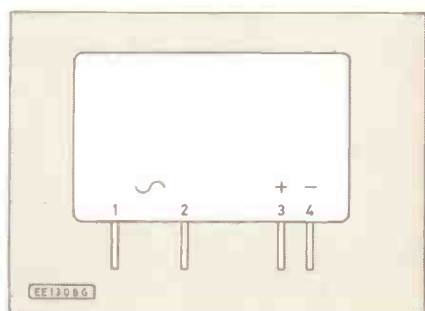

Fig. 3. Solid-state relay connections (in-line types)

Next Month: we shall be taking a look at books devoted to the Spectrum as well as providing some practical examples of the use of restart instructions. In the meantime, if you would like a copy of our *On Spec Update*, please drop me a line enclosing a large (250mm×300mm) stamped addressed envelope. Mike Tooley, Department of Technology, Brooklands Technical College, Heath Road, Weybridge, Surrey KT13 8TT.



SECURITY SECURITY SECURITY

<p>COMPLETE SECURITY SYSTEMS START AT</p> <p style="text-align: center; font-weight: bold; font-size: 1.2em;">ONLY £39.95 + VAT</p>	<p>PASSIVE INFRARED DETECTOR RP33</p> <p>Hi-tech Sensor which operates by detecting body heat. £23.95 + VAT</p>	<p>DIGITAL ULTRASONIC DETECTOR US5063</p> <p>For use in a wide range of movement detection applications. £13.95 + VAT</p>	<p>INFRARED BEAM SYSTEM IR1470</p> <p>For Security Photography or Lighting applications. £25.61 + VAT</p>	<p>ADVANCED CONTROL UNIT WITH AUTO LOOP TEST CA1382</p> <p>Available in kit form (fully built electronics) £39.95 + VAT Fully built and tested £44.95 + VAT</p>	<p>SEND OR TEL FOR FULL DETAILS OR CALL AT OUR SHOWROOM & SEE THE UNITS ON DEMONSTRATION. MON-FRI. 9-5. CLOSED SAT & SUN.</p> <p style="text-align: center; font-weight: bold; font-size: 0.8em;">FULL TECH. ADVISORY SERVICE</p>
<p>PLUS MAGNETIC CONTACTS, BELL BOXES, P.A. SWITCHES, etc. etc. ...</p>					
<p>RISCOMP LIMITED THE SECURITY SPECIALISTS</p>					
<p>Dept EE1, 51 Poppy Road, Princes Risborough, BUCKS HP17 9DB. Tel: (084 44) 6326</p>					

FOR YOUR ENTERTAINMENT

BY BARRY FOX

Electromagnetic Anarchists

If you are buying a new v.h.f. radio or installing a new aerial system it pays to know what Home Secretary Douglas Hurd announced early this year; Britain will get up to three new national commercial radio stations, independent local radio will be de-regulated and the Independent Broadcasting Authority's control over radio will be replaced by a "light touch" radio authority which will "regulate and assign frequencies for all non-BBC services".

"We have judged", said Hurd "that it would not be possible to ask the IBA to take on the task of developing a new and greatly expanded radio system".

Have Hurd, and the people clamouring for de-regulated radio, any idea of what will be involved in allocating frequencies and controlling transmission? I am not alone in doubting it. The IBA certainly have their doubts.

Most people welcome the idea of a wider choice of broadcasting, but not at the expense of interference. Radio tuning dials look like becoming a battleground for electromagnetic anarchists.

Anyone who has listened to v.h.f. radio in the London area will know what happens when the regulatory system runs out of control. Pirate stations, broadcasting with excess power and sloppy frequency control, crash into existing services.

The Facts

Now is a good time to take a cool look at a few facts.

The v.h.f. radio band, Band II, spreads between 88MHz and 108MHz. But Britain has not had full access to this band, because public service transmissions (like police, fire brigade and ambulance) have been sitting in the middle and upper regions.

So in practice entertainment radio has been squeezed into the band 88MHz-97.6MHz, with the three BBC national services between 88MHz-94.5MHz and the BBC and Independent Local Radio stations sharing a sub-band between 94.6MHz and 97.6MHz. There are two local radio sub-bands, each split between the BBC and ILR.

In 1979 a World Administrative Radio Conference said enough was enough, and the whole of Band II had to be released for entertainment broadcasting. In 1984 a Regional Administrative Conference in Geneva set a timescale—the band must be cleared by 1995.

Under the new plan, the BBC will have from 88.0MHz-94.6MHz for three network services, with a fourth BBC network at 97.7MHz-99.8MHz. A fifth national service, to be run by commercial networks, will sit between 99.9MHz-101.9MHz.

The other commercial network stations will be on the Medium Wave, using frequencies which the BBC will be told to vacate. As the m.w. is cluttered with inter-

ference from foreign stations after dark, the BBC will not be shedding too many tears about this.

At the top of the v.h.f. band, between 105.0MHz-107.9MHz, there will be five chunks of spectrum, each 600kHz wide, to fill in coverage gaps for the other services, and also to provide limited local cover for low power community radio stations.

The BBC and ILR stations will have similar shares: the BBC locals will have 94.6MHz-96.1MHz and 103.5MHz-104.9MHz, with ILR holding 96.1MHz-97.6MHz and 102.0MHz-103.4MHz.

Although the new frequency plan came into effect in July 1987, the public radio services are unlikely to move out of Band II until 1989, making a full entertainment spread unlikely before 1990. The top end of the band, between 105MHz-107.9MHz may well take longer to clear—but should be inside the Geneva deadline of 1995.

In other words the revolution in broadcasting will not happen overnight. Also it will take very careful planning to squeeze five national channels into the v.h.f. band.

The same frequencies will have to be re-used over and over again around the country at transmission powers carefully set to prevent mutual interference. If anyone gets greedy and increases their power, or gets clumsy and lets their signal frequency drift, the result will be a chaos of interference.

The Future

Anyone buying a new radio receiver, or installing an aerial, should start looking to the future now. Some portable and car radios do not tune past 104MHz or even past 100MHz. Be warned against buying any receiver which does not cover the entire range of 88MHz-108MHz. Inevitably there will be some enticing cheap offers in the future, with dealers trying to dump limited band receivers.

Not all v.h.f. loft or roof aerials cover the entire 88MHz-108MHz band. Some are tuned to 88MHz-100MHz and will give

Pillow Talk

If you think you have problems with other people's "Walkmen," you ain't heard nothing yet. Tai-Cal Enterprises of California is patenting the stereo pillow.

It's made from reinforced foam, with two acoustic chambers inside, one towards each end. A hi fi loudspeaker is mounted in each chamber, with a battery-powered stereo amplifier. When a portable stereo, like a Sony Walkman, is plugged into a side socket, the pillow reproduces stereo sound.

Anyone using it gets a dose of sound in each ear, as well as a rest for their head. Fellow passengers or bed mates may not be too enthusiastic, however. Inevitably the loudspeakers will leak more sound to the outside world than closed headphones. A

very hissy stereo for transmissions in the top 8MHz. Receivers will also have to have good tuning circuits, to ignore the powerful blind instrument landing radio transmissions which airports use at frequencies just above 108MHz.

Radio Data System

The long term future must surely be RDS, the BBC's Radio Data System. A digital code signal (with data rate 1187.5 bits/second) is broadcast piggy-back on the v.h.f. transmission (on an a.m. sub-carrier at 57kHz). This code positively identifies the programme on which it is riding.

An RDS receiver will have pre-set buttons marked only by station name, e.g. Radio One, ILR One, Radio Two, ILR Capital. The RDS circuitry looks for, and tunes into, the strongest frequency which corresponds to the code associated with whichever button is pressed. So RDS makes radio tuning a doddle.

Already the BBC v.h.f. transmitters are broadcasting RDS codes. But there are no RDS receivers in shops. The electronics manufacturers are being sluggish in providing equipment.

This is not surprising, because they have already invested heavily in the development of stereo TV sets, and stereo video recorders, believing that the BBC would start regular transmissions of stereo sound with television this Spring. But Michael Checkland, new Director General of the BBC, cut back the stereo project, leaving electronics manufacturers with stereo hardware ready to sell, and no regular programmes for customers to receive. So manufacturers are reluctant to spend more time and money on developing RDS receivers.

Radio Shows

The BBC's current plan is for a grand commercial launch of RDS at a Radio Show scheduled for Earl's Court in early October. Some firms welcome the Earl's Court Show as a way of reaching the public with help from the BBC; others think the BBC is relying on their help to reach the public and are playing a waiting game.

When I raised the matter of RDS and the Radio Show with one large Japanese firm, which has stereo TV equipment on the shelf, their reaction was unprintable. But if the BBC can get the Earl's Court ball rolling, the electronics firms may feel obliged to join in. The Radio Show could then provide the ideal launch pad for RDS and a new age of broadcasting.

cabin or carriage full of passengers with stereo pillows could be a noisy place.

The mind boggles at what will happen if Tai-Cal teams up with Skitronic of Hong Kong. Their man Siu Kwong Tse is patenting an idea to make hi fi systems more colourful.

The cone diaphragm of a loudspeaker is usually made from black plastic or paper. Siu Tse suggests making it from translucent coloured plastics.

Behind and around the diaphragm there are rings of coloured light emitting diodes. These glow with colour and brilliance governed by the strength and frequency content of the audio signal. For instance the louder the sound, the redder and more menacing the loudspeaker looks.

Brainwave

Are we about to create a race of Supermen?

B BETA - Concentration, problem solving, active thought. **A** ALPHA - Relaxation, pleasure, tranquility, positive feelings. **Θ** THETA - Imagination, creativity, hynagogic imagery.

monitor

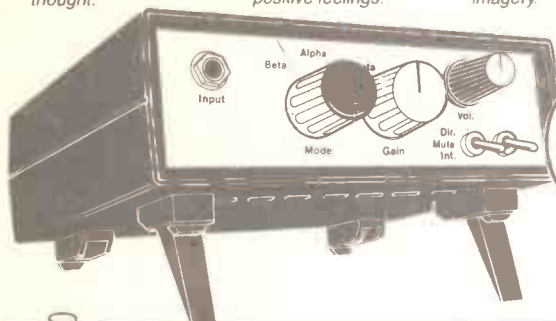

BRAINWAVE MONITOR PARTS SET ONLY
£36.90
+ VAT

The ETI Brainwave Monitor must be the most astonishing project ever to appear in the pages of an electronics magazine. It will allow you to hear your brainwaves and judge the relative levels of various types. It will also help you to control your mind more effectively, to be at peak performance in all situations.

Doesn't my mind work perfectly well when left to its own devices?

If you've ever been confused, unsure of yourself, shy, unable to pass exams or to impress people at interviews, you know perfectly well that it doesn't. Your mind (and everybody else's) is full of bad habits, inappropriate responses, feelings of inadequacy... all pulling you down. Why should you put up with it?

Mind training sounds like hard work!

It can be. If you want to do it the hard way, go and study under a Zen master for fifty years or so. You'll get there in the end. With the brainwave monitor it takes no effort at all. Just the opposite in fact - trying is the one thing you mustn't do!

How do I start?

At first you use the monitor's internal indicator to exercise your mind. In direct mode you improve the time percentage; in integrate you concentrate on the amplitude. After that, the choice of direction is yours. With the Alpha Plan you can reach the core of your personality to root out the weakness and replace it with inner strength. Otherwise you can just enjoy the feelings of pleasure and clear headedness that alpha training brings, or the creativity and imagery of the theta state.

A friend told me I can use brain power to control lights and things. I can't believe it!

As a matter of fact, you can do more than that! The interface sockets on the monitor allow you to turn lights on and off, control toys and electrical gadgets, play computer games... all with your mind! Are we about to create a race of Supermen? Only time will tell.

The Brainwave Monitor is featured in the September, October and November 1987 issues of ETI. The approved parts set contains: two PCBs, all components including three PMI precision amplifiers, shielded box for screening the bio-amplifier, attractive instrument case with tilting feet, controls, switches, knobs, plugs and sockets, leads and materials for electrodes, full instructions for assembly and use.

Parts are available separately. We also have a range of accessories, professional electrodes, books, etc. Please send a stamped, self-addressed envelope if you just want the lists. Otherwise, an SAE + £2 will bring you lists, construction details and further information.



SILVER SOLUTION

This powerful silver plating compound must be the greatest revolution in electronics since the IC! Just wipe on with a cloth to plate PCB tracks, connectors, wire, component leads, etc. with a layer of pure silver!

Essential for:

- RF circuits
- Top flight Hi-Fi
- Bio-electronic circuits and electrodes.

LARGE BOTTLE (150ml) SILVER SOLUTION £11.20 + VAT!

N.B. The solution will take to brass, copper, etc. but not to steel or pre-plated components



THE ALPHA PLAN

Can you really train your brain to think more effectively? Can you really achieve peak performance in things you're 'no good at'? Can you really overcome fear, shyness, uncertainty? ... And can you do it all without really trying?

Dr. David Lewis's famous Alpha Plan has all the answers. It was recently investigated by a QED television documentary (Alpha - How to Succeed Without Really Trying). And the conclusion? It works!

Dr. Lewis's book 'The Alpha Plan' is yours for only **£2.50 (no VAT)**. Your future is waiting.

Complete Parts Sets for Top Projects

FEATURED IN ETI, MARCH 1988

JUMPIN' JACK FLASH

is a

- Lighting wizard - brings any rock band's stage performance to life!
- Sound operated flash - photograph bullets in flight!
- Voice switch and sound to action controller with endless applications.

The parts set consists of a high quality PCB and all components. ICs, opto isolator, triac, heat sink, pots, etc. to build the circuit board. What you do next is up to you! The ETI article, supplied free with every set, shows how to make the most of J.F.'s capabilities.

JUMPING JACK FLASH £6.90 + VAT



KNIGHT RAIDER

FEATURED IN ETI, JULY 1987

The ultimate in lighting effects for your Lamborghini, Maserati, BMW (or any other car, for that matter). Picture this, eight powerful lights in line along the front and eight along the rear. You flick a switch on the dashboard control box and a point of light moves lazily from left to right leaving a comet's tail behind it. Flip the switch again and the point of light becomes a bar, bouncing backwards and forwards along the row. Press again and try one of the other six patterns. An LED display on the control box lets you see what the main lights are doing.

The Knight Raider can be fitted to any car. It makes an excellent fog light! Or with low powered bulbs it can turn any child's pedal car or bicycle into a spectacular TV-age toy!

The control box parts set consists of case, switches, LEDs, PCB components, hardware and instructions. The sequence board includes PCB, ICs, power FETs, components hardware and instructions.

KNIGHT RAIDER CONTROL BOX ONLY

£6.90 + VAT!

KNIGHT RAIDER SEQUENCE BOARD ONLY

£13.90 + VAT!

MATCHBOX AMPLIFIER

FEATURED IN ETI, APRIL 1986

No ordinary amplifiers, these. When our first customers took an interest, it was for the diminutive size (both modules will fit in a matchbox!), the total disregard for power supplies and speaker impedances, and the impressive power output from these little amplifiers. When they re-ordered, it was for the sound quality.

Two amplifier modules were described, both based on the powerful L165V IC. The single IC version will deliver over 20 Watts with a suitable speaker and power supply. The bridge version can provide up to 50W! Although the specified supply voltage and speaker impedance must be used to achieve maximum power, both modules are quite happy to work from any voltage between 12V and 32V, and will accommodate any type of speaker. The bridge version is ideal for giving a boost to car Hi-Fi systems, driving two 4 Ohm speakers in parallel on each channel for best effect.

Both designer-approved parts sets consist of a roller tinned printed circuit board and all components. The L165V ICs are also available individually, with a free mini data sheet giving specifications and suggested circuits.

SINGLE IC MATCHBOX AMPLIFIER SET (20W into 4 Ohms) **£6.50 + VAT**

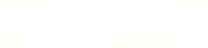
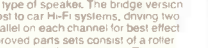
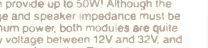
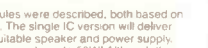
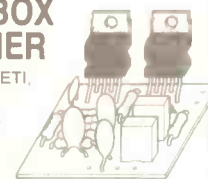

POWERFUL AIR IONISER

FEATURED IN ETI, JULY 1986

ions have been described as 'vitamins of the air' by the health magazines. air... have been credited with everything from curing hay fever and asthma to improving concentration and putting an end to insomnia. Although some of the claims may be exaggerated, there is no doubt that ionised air is much cleaner and purer, and seems much more invigorating than 'dead' air.

The DIRECT ION ioniser caused a great deal of excitement when it appeared as a constructional project in ETI. At last, an ioniser that was comparable with (better than?) commercial products, was reliable, good to build and fun! Apart from the serious applications, some of the suggested experiments were outrageous!

We can supply a matched set of parts, fully approved by the designer, to build this unique project. The set includes a roller tinned printed circuit board, 66 components, case, mains lead, and even the parts for the tester. According to one customer, the set costs about a third of the price of the individual components. What more can we say?

DIRECT ION PARTS SET WITH BLACK CASE **£11.50 + VAT**

WITH WHITE CASE **£11.80 + VAT**

Instructions are included



SPECIAL OFFERS

AD7541 Precision 12-bit multiplying DAC **£1.20 + VAT**
LM3524 Switch mode regulator IC **£0.80 + VAT**
CF585 Calculator IC **£1.00 + VAT**
LM339 Quad comparator IC **3 for: £1.00 + VAT**
MC1458 Dual op-amp **3 for: £1.00 + VAT**

All ICs supplied with FREE DATA. Prices apply only while stocks last.

LM2917 EXPERIMENTER SET

Consists of LM2917 IC, special printed circuit board and detailed instructions with data and circuits for eight different projects to build. Can be used to experiment with the circuits in the 'Next Great Little IC' feature (ETI, December 1986).

LM2917 Experimenter Set **£5.80 + VAT**

RUGGED PLASTIC CASE

suitable for mains conditioner and mains controller.

ONLY £1.65 + VAT



LEDs

Green rectangular LEDs for bar-graph displays.

50 for **£3.50** 500 for **£25**

100 for **£6** 1000 for **£45**

DIGITAL AND AUDIO EQUIPMENT LEDs

Assorted 3mm LEDs: red, green, yellow and orange. 25 of each (100 LEDs) for **£6.80**

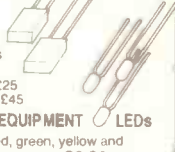

Prices shown are exclusive of VAT, so please add 15% to the order total. UK postage is 70p on any order. Carriage and insurance for overseas orders £4.50. Please allow up to 14 days for delivery.

Specialist
SEMICONDUCTORS
LIMITED

SALES DEPT
ROOM 111
FOUNDERS HOUSE
REDBROOK
MONMOUTH
GWENT

SUPER SOUND GENERATOR



MARK STUART

Bird chirps, sirens, helicopters, explosions, phasor guns, the nostalgic steam train and many more sound effects are all possible from this single-board project.

THIS versatile project is capable of producing a very wide range of siren, noise, and explosion effects. Six pre-set controls and seven selector switches enable a vast range of different sounds to be produced and altered at will.

Such sounds as a steam train chuffing, helicopters, bird chirps and machine guns are possible, as well as the usual police sirens, phasor guns and explosions.

The circuit is built on a simple printed circuit board and incorporates an amplifier giving 150mW output into a small loudspeaker. Alternatively, a separate amplifier system can be used for disco effects, car alarms etc. Continuous or "one shot" sounds are possible. For "one shot" sounds a push button switch is provided which can be mounted on the board or remotely, this switch can also be used to turn continuous sounds on and off.

CIRCUIT

The circuit diagram is shown in Fig. 1. A single integrated circuit SN76477 provides all of the sound generation circuits and drives a simple push-pull output stage consisting of

transistors TR1 and TR2 which drive a small loudspeaker via C6.

The internal workings of IC1 are quite complicated as shown in the functional block diagram (Fig. 2). The operation is best explained by describing each block in turn.

VOLTAGE REGULATOR

The voltage regulator takes a voltage from 7.5V to 9V on pin 14 and produces an output

TABLE 1

MIXER CONTROL SWITCHES

(0=OFF, 1=ON)

S3	S4	S5	OUTPUT
0	0	0	V.C.O.
0	1	0	S.L.F.
0	0	1	NOISE
0	1	1	V.C.O.+NOISE
1	0	0	S.L.F.+NOISE
1	1	0	S.L.F.+V.C.O.+NOISE
1	0	1	S.L.F.+V.C.O.
1	1	1	NO OUTPUT

of 5V to power the other sections of the i.c., and an optional extra 10mA which can be used for external circuits.

MIXER

Three separate circuits feed their outputs into the mixer which combines them in any combination according to the setting of switches S3, S4 and S5. Table 1 shows all eight possible settings of the switches and the outputs produced for each.

NOISE GENERATOR AND FILTER

A binary pseudo random noise generator in this block is followed by a low pass filter the frequency of which can be adjusted by C8 and VR4. Adjustment of VR4 changes the sound of the noise from a low frequency rumbling to a high frequency hiss.

SUPER L.F. OSCILLATOR

As its name suggests the super low frequency oscillator produces a very low frequency output set by the values of VR2 and C2. Frequencies from 0.1 to 30Hz are available depending on the setting of VR2.

Fig. 1. Full circuit diagram for the Super Sound Generator.

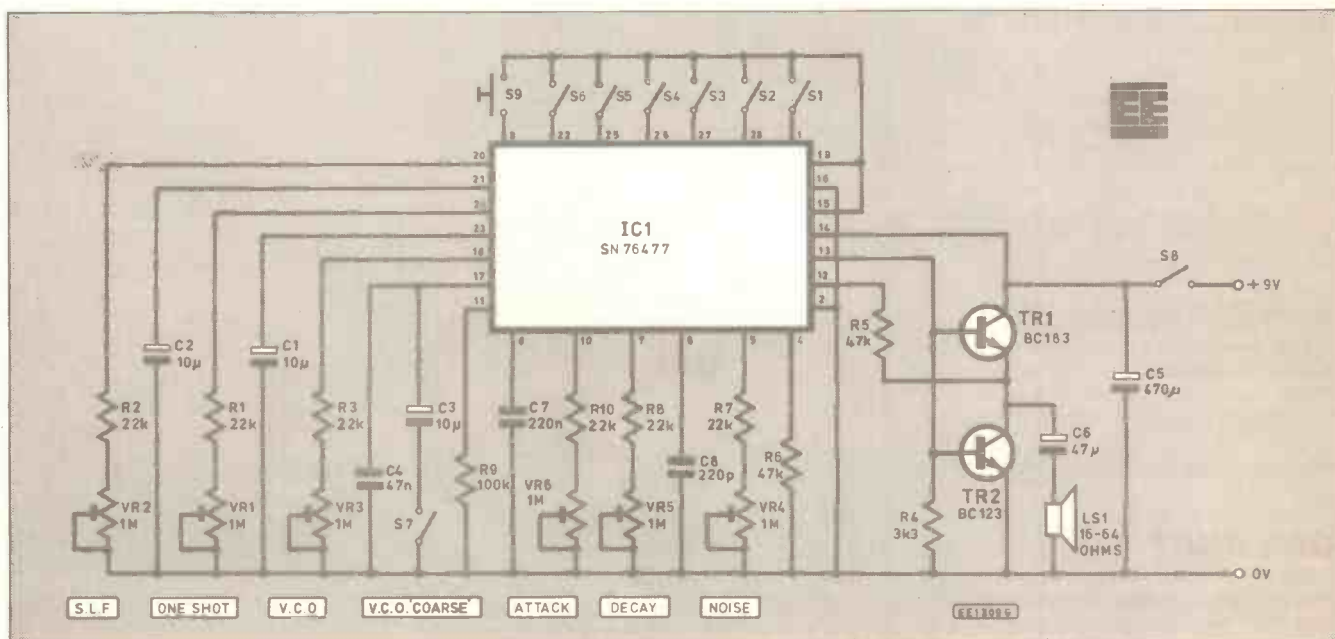

There are two outputs from this block, one is a square wave of 50 per cent mark-space ratio that is passed to the mixer block, the other is a triangular wave that passes via an on-off selector block (controlled by S6) to the V.C.O. block.

V.C.O.

V.C.O. stands for voltage controlled oscillator. This circuit generates audio frequencies over two ranges set by VR3, C4, and C3. Closing S7 adds C3 in parallel with C4 and so produces a lower frequency range. There are two outputs from this block, both are square waves, one output goes to the mixer, the other goes to the envelope select block.

TABLE 2

ENVELOPE SELECT SWITCHES (0=OFF, 1=ON)		
S1	S2	OUTPUT
0	0	V.C.O. controls envelope on one half cycle, off next half cycle
0	1	NO ENVELOPE—mixer output only
1	0	ONE SHOT CONTROL
1	1	V.C.O. controls envelope with opposite phase off one half cycle on next half cycle

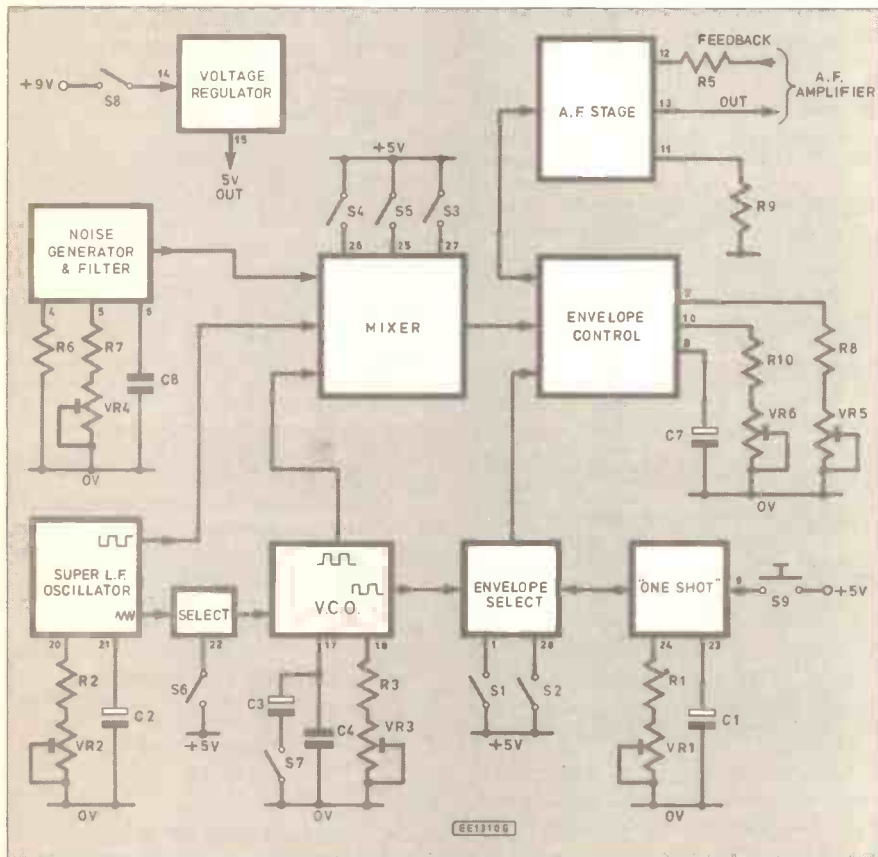

Fig. 2. Internal block diagram for the SN76477 sound generator chip.

ENVELOPE CONTROL

The output from the mixer passes into this block where its amplitude is controlled to give variable attack and decay characteristics. VR6 alters the attack time and VR5 the decay time. The value of C7 may be changed to give further control. The envelope waveform is activated either by the V.C.O. square wave output or by the "one-shot" block output. These two sources are selected by the envelope select block.

ENVELOPE SELECT

Two switches S1 and S2 determine which signals are passed to the envelope control block. Table 2 shows the settings of S1 and S2 and the four possible outputs. Each pulse from the envelope select block makes the envelope control block execute one complete attack—sustain—decay cycle.

ONE SHOT

The one shot circuit allows single bursts of sound to be produced each time a button S9 is pressed and released. The length of the

COMPONENTS

Resistors

R1, R2, R3, } 22k (6 off)
 R7, R8, R10 }
 R4 3k3
 R5, R6 47k
 R9 100k
 All 1/4W 5% carbon film

Shop
Talk

Potentiometer

VR1-VR6 1M min. presets horizontal (6 off)

Capacitors

C1 to C3 10μ axial elect. 10V
 C4 47n 100V polyester
 C5 470μ axial elect. 10V
 C6 47μ axial elect. 6V
 C7 0.22μ polyester 100V
 C8 220p ceramic plate or polystyrene

Semiconductors

TR1 BC183 or 184
 TR2 BC123 or 214
 IC1 SN76477

Switches

S1 to S8 Miniature p.c.b. mounting s.p.s.t. switch (8 off)
 S9 push-to-make switch

Miscellaneous

28-pin i.c. socket; printed circuit board, available from the *EE PCB Service*, code EE608; speaker 16-64 ohm min. type; PP3 battery clip; wire for speaker leads.

Approx. cost
Guidance only

£14

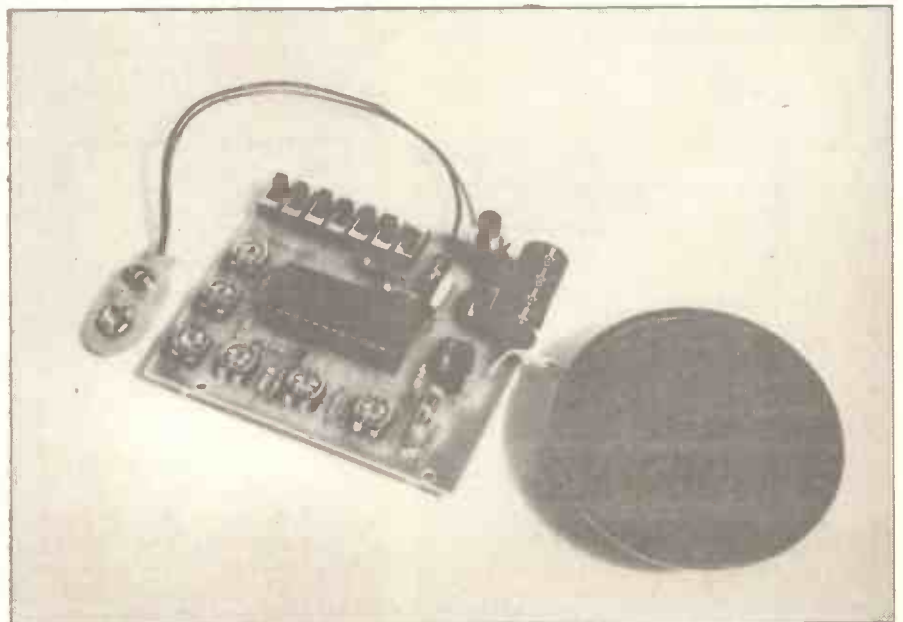

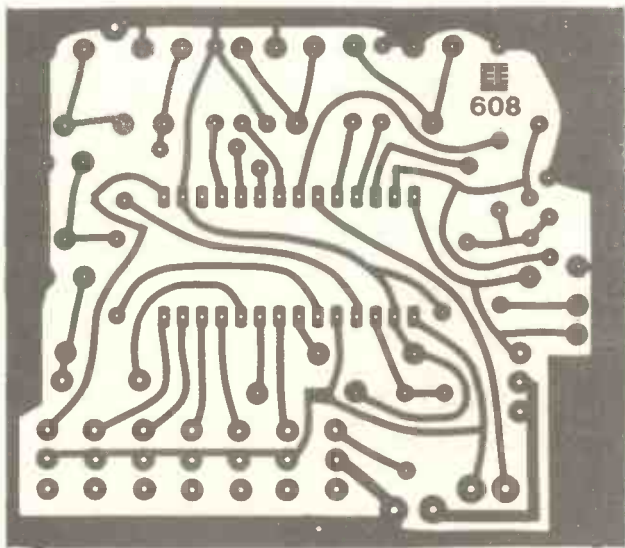
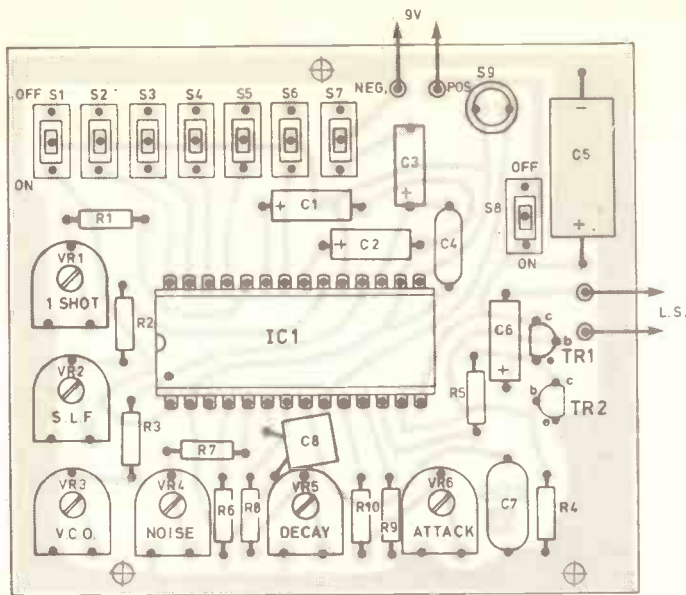
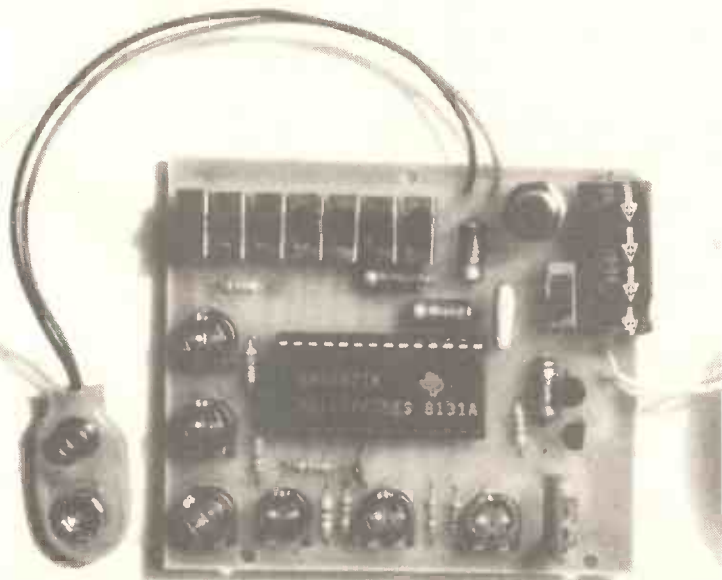

Fig. 3. Component layout and full size printed circuit copper foil master pattern. The completed sound generator (less speaker) is shown in the photo below. It is advisable to use an i.c. holder to mount the i.c. on the board.



pulse is set by VR1 in conjunction with C1. It is important to get the pulse length right, for the correct operation of the attack and decay functions.

A.F. STAGE

From the envelope control circuits the signal is amplified by the audio frequency and passed to the output transistors. Feedback resistor R9 sets the circuit gain and allows an unbiased complementary output stage to be used.

CONSTRUCTION

The circuit is built on a single printed circuit board. All of the controls are p.c.b. mounted presets and switches, and so the only off-board components are the battery and loudspeaker. The push button S9 which controls the one-shot circuit is also mounted on the board, but may be remotely wired if required.

The board copper foil pattern and the component layout are shown in Fig. 3. Fit all the resistors and small capacitors first, followed by the presets and larger capacitors. Note that C1, C2, C3, C5 and C6 are electrolytic types and must only be fitted one way round as shown. Next a socket should be fitted for IC1, followed by the transistors TR1 and TR2 (which are easily mixed up—so be careful). Finally fit the eight p.c.b. mounted switches and the push button S9. It may be necessary to drill out the board holes for S9, or alternatively short wire spills can be attached to it.

When everything has been fitted, check the soldering for dry joints and bridges, fit IC1 with the notch as shown and connect a loudspeaker of between 16 and 80 ohms impedance.

Set all of the presets to mid position and all switches to the OFF position except S8. Connect a 9V supply and a continuous steady tone should be heard. If you connect the supply the wrong way round, the i.c. should survive, but TR1 and TR2 will not—we know, we've tried.

If there is no tone, double check everything—there is little to go wrong with a single circuit board, but one common error is to accidentally bend one of the i.c. leads under itself so that it misses the socket. A lot of time can be spent looking for this sort of error, also; make sure that TR1 and TR2 are the correct types, those with the "L" suffix e.g. BC183L will not work as their pins come out in the wrong order. Once the tone has been obtained, move on to the next section and check each function in turn.

TESTING AND USE

Assuming that all presets are central and all switches are off, turn on S2 and S8. There should now be a continuous tone produced by the v.c.o. alone. Vary VR3 and check that the pitch varies. Next close S7 which switches C3 in parallel with C4 and so lowers the v.c.o. frequency which should produce a series of clicks variable in speed by VR3. Check that pressing S9 stops the sound.

Open S7 next and close S6. The frequency of the v.c.o. should now be ramping up and down as its frequency is controlled by the triangular wave output from the s.l.f. oscillator. Check that VR2 alters the s.l.f. speed. Adjusting VR3 and VR2 should produce a wide range of siren sounds.

Reset VR2 and VR3 to their central positions and open S6. Open S2, close S1 and press and release S9. The v.c.o. tone should

appear and then stop after a time set by VR1. The attack and decay of the signal are set by VR6 and VR5. Clockwise rotation gives slow times and anticlockwise rotation fast times. As before, adjusting VR3 will alter the pitch of the v.c.o. Close S6 and try adjusting VR1, VR2, VR3, VR5, and VR6. Pressing and releasing S9 each time.

NOISE CIRCUIT

The noise circuit can be checked by opening all switches except S2 and S5. The output should be continuous hissing sound, the nature of which can be changed by VR4 from rumbling to hissing. Open S2, close S1 and press and release S9. By adjusting VR1, VR5 and VR6 the noise envelope can be controlled as before, giving gunshots, explosions and chuffs.

Open S1 and close S5 and S7, the low frequency setting of the v.c.o. now controls the noise envelope giving excellent continuous steam train sounds which are adjustable by VR3, VR5, and VR6. Other sounds are also possible, including repetitive gunshots,

helicopters, and sounds resembling hammering. Note that the settings of VR3, VR5, and VR6 do have some interaction and need setting together to give the best effects.

Close S2 and open all other switches and check all of the combinations of S3, S4, and S5. With S4 closed the output is the square wave from the s.l.f. oscillator which sounds like a series of clicks variable in speed by VR2. Close S4 and S5 and the output should change to a combination of the v.c.o. and noise signals.

Open S4 and S5 and close S3. The output becomes a combination of the s.l.f. oscillator and noise.

Close S3 and S4 and all three signals (s.l.f., v.c.o., and noise) will be present in the output. Open S4 and close S3 and S5, and a pulsed tone output is produced as the s.l.f. square wave and v.c.o. outputs are mixed.

With all of these switch combinations and the settings of the six presets a vast number of sound effects can be produced. The output can be played through more powerful sound systems for more spectacular effects.

When experimenting with the prototype it was found that the resonance of the loud-speaker enclosure could be tuned to enhance many of the effects, especially where the noise outputs are used. In specific applications such as train chuffers, a length of cardboard tubing in front of the speaker cut to the appropriate length (by trial and error) will give excellent effects.

FINALLY

The applications mentioned so far are just a few of the possibilities. A simple voltage regulator will allow the circuit to be powered from a 12 volt electrical system so that it can be used in car alarms, reversing beepers, etc. If the circuit is to be dedicated to a single application, it is possible to remove the switches and use wire links where required. Also the presets could be exchanged for fixed resistors of suitable values.

For more advanced applications it is possible to use computer control in place of some of the switches and S9. No details are given here, but the SN6477 data sheet gives more information. □

SHOP TALK

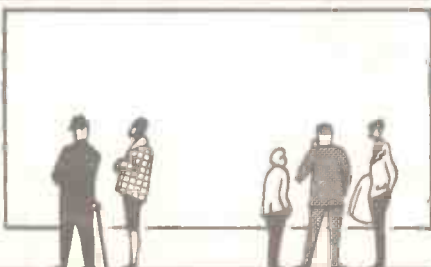

BY DAVID BARRINGTON

Door Sentinel

Most of the components called for in the *Door Sentinel* seem to be fairly standard items and should not cause too many purchasing problems.

The audible warning device WD1 used in the prototype was the "high power" piezo-electric buzzer from Maplin. This device will operate from voltages ranging from 3V to 24V and is listed as order code FK84F (HP Buzzer), price £2.20.

The CMOS dual timer type ICM7556 seems to be scarce, but is currently listed by Omega Electronics and Omni Electronics. The surface mounting reed switch and magnet were purchased from Maplin, code YW47B (Surface BA Reed).

The choice of case is left to the individual constructor, the one used in the prototype is a wall-mounting TEKO Wal.2 type available through stockists of West Hyde Developments products.

The small "horseshoe" magnets, used as the alarm key, should be available from most good hardware or d.i.y. stores. The small printed circuit board is available from the *EE PCB Service*, code EE605 (see page 307).

Super Sound Effects Generator

The sound effects generator chip type SN76477 used in the *Super Sound Effects Generator* appears to be only available from Magenta Electronics or Greenweld. Readers who are interested in the technical information on this i.c. may like to know that Magenta are also able to

supply a data sheet for the sum of £1.20.

For those constructors who experience difficulties in obtaining parts for this project, a complete kit (£12.99) may be purchased from Magenta Electronics, 135 Hunter Street, Burton-on-Trent, Staffs, DE14 2ST. Add £1 for post and packing per order.

Make sure that the transistors purchased are the correct types, those with the L suffix have different pinouts and will NOT work if inserted as shown in the article.

The printed circuit board is available through the *EE PCB Service*, code EE608 (see page 307).

Multi-Channel Remote Light Dimmer

We have had great difficulty locating a single source of supply for the semicon-

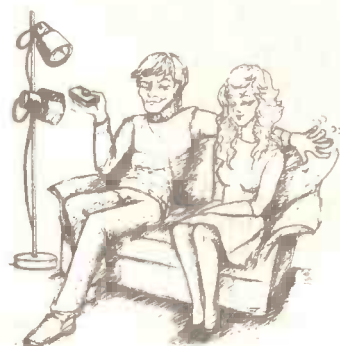

ductor devices called for in the *Multi-Channel Remote Light Dimmer* projects. These devices are currently stocked by TK Electronics (☎ 01-567 8910).

The infra-red emitting diodes seem to be fairly common items and most of our component advertisers will also supply a suitable infra-red detector diode to match. The membrane keypad switches are available from TK Electronics and Maplin, or you may wish to try an old calculator keyboard here.

The hand-held case was a low-profile type used for calculators, one of the "flip-top" series 600 Veroboxes would be ideal and is stocked by most advertisers. The main cabinet, housing the receiver and the other control boards, is left to individual choice and pocket, however, it must be a METAL type and be well "earthed".

The printed circuit boards for this project are available from the *EE PCB Service*, codes EE599 and EE600. We are currently trying to arrange a special discount price for a complete kit of boards, including six dimmer boards—more news next month.

Function Generator

We have been unable to locate a source of supply for the large panel meter used in the author's prototype *Function Generator*. This meter is obviously a very expensive item and we suggest that another less expensive type be used and, if necessary, change the value of the multiplier resistor R16.

The TLO71 low noise op. amp appears to be widely available and should not cause problems. However, the waveform generator i.c. type 8038 and the frequency-to-voltage converter LM2917 may take some locating but in case of difficulty they are currently listed by Maplin.

The two printed circuit boards for this project are also available from the *EE PCB Service*, codes EE606 and EE607.

We cannot foresee any component buying problems for the *Audible Smoothness Tester*, or the *Op. Amp Summer and Digital-to-Analogue Converter* (this month's *Exploring Electronics* test projects).

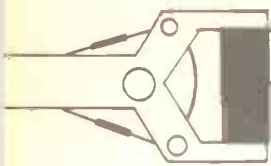

Robot Roundup



NIGEL CLARK

COMEBACK FOR ALFRED

FOLLOWING last month's story of the re-emergence of Colne Robotics' updated products under the guise of Concorde Robotique, comes news of another resilient little robot—Alfred. Alfred has long held a special place at EE since details of its construction were printed in the magazine a few years ago (*Nov/Dec '84 and Jan '85*—see below).

It almost disappeared last year when Robot City Technology got into trouble but at the British Education and Training Technology show at the beginning of the year it returned with a vengeance. Although it was not on the RML stand as expected it seemed to be everywhere else—the stands of Eagle Scientific, Feedback Instruments and Griffin and George. All have been signed up as distributors.

Research Development Associates is producing about 50 of the 5-axis articulated servo-driven arms a month from cluttered premises in Stevenage. And a number of further developments are planned.

Incidentally, the company has asked me to say that Alfred did make an appearance at the Craft Design and Technology Show at Birmingham last autumn, but I missed it.

Alan Green, who with Dave Doughty, another ex-Robot City man, set up RDA, said that exports were doing well with more going overseas than were being sold in Britain. The main market is Europe and there is a growing presence in North America. It is hoped that the distribution deals will help expand its exports with Eagle looking after Europe and Feedback increasing sales in North America.

Alfred is also joining the band of arms which feel undressed without a work cell to surround them. It is getting the usual rotary table and conveyor belt, taking small bars from a holder and sorting them into different boxes on the table. The complete system with software is being offered for £600.

The Feedback deal marks a change in its operations. Alfred is the only robot it sells which it does not make. It also makes the bottom of Feedback's range much cheaper, being sold at about £250 against the ESA 1010 which costs about £1,000. The company's other lower cost machine, the SIR-1 has been discontinued.

A spokesman for the company said that the SIR has been taken on as part-developed but when completed had not proved suitable. It had been suggested that the ESA might be stopped as well but the spokesman said that it had been selling well in the States and it was decided to continue producing it.

It was hoped that the Alfred might prove popular in the US as well. It is a very good machine at the price, he added.

Feedback is continuing to produce the HRA 934 hydraulic arm and the two Scaras, Ivax 901 and PW 801.

MODULAR SYSTEM

Meanwhile RDA is expanding in a variety of directions. As well as the work cell for Alfred, the new Modular Automation Robot System is being developed. Apart from being a good acronym the system is based on a series of modules which can be fitted together in a number of ways, including a SCARA arm and the usual five-axis articulated arm.

It is much stronger than Alfred and has greater accuracy and at a price of about £2,000 is meant for the higher education market. Driven by servos the articulated arm can lift 1kg.

Using the same on-board processor as Alfred it will accept all the existing Alfred software. Control is also available from all the popular micros such as the BBC, RML and IBM machines but not those from Atari.

Followers of Robot City Technology will recognise the MARS as the R-2000 with slight improvements. For the future there are further developments of Alfred and MARS with low-cost voice control high on the agenda.

The company is also putting the Alfred processor on the market as an independent controller with eight inputs and eight outputs. Called the Octopus it is selling for about £120.

Green said that it had been intended to add a teach pendant but found that the Psion Organiser worked just as well and they have decided to stay with that. Once the instructions have been entered via the Psion it can be disconnected and the processor left to its own devices.

In case Green and Doughty still find themselves with time on their hands RDA is offering a day course on Artificial Intelligence at about £100. It is designed as an introductory course giving broad outlines of the subject.

Another introductory course they offer is on the fundamentals of robotics. Again it is aimed at getting people interested in the subject, which can seem daunting at first but is less so when it is explained properly.

BACK LOG

Logotron is becoming circumspect about its RobotArm, launched with Resource of Doncaster last year. Although it does not appear in its latest catalogue the Cambridge-based company said that it was still selling it.

The problem, apparently is that it cannot get enough supplies to satisfy the demand. It is not that the sales are high, it is rather that they are only manufactured in small quantities. Logotron buys them in from Spectravideo which has them made in the Far East.

In the meantime anyone wanting a 5-axis arm which can be controlled either directly by joysticks or through a BBC computer using the Resource interface, and all at a cost of about £100 should contact Logotron or Resource. But they may have to wait some time before their order can be satisfied.

QUESTIONS AND ANSWERS

I have been receiving a number of enquiries lately about products mentioned in the column the replies to which I feel would be worth giving a wider audience.

The first answer is also in the way of being an apology to someone who wrote asking for the address of a number of suppliers. Unfortunately I have misplaced the letter but if they can obtain a copy of the October '87 issue of EE (see Back Numbers, page 000) they will find most of the companies listed in that month's column.

The only company which is not included is Tribotics and the company can be found at Unit 27, Crawley Mill Industrial Estate, Crawley, Witney, Oxfordshire, OX8 5TJ.

The other query concerns how to obtain the Fischertechnik kits. They are not sold through retail outlets but can be obtained on mail order from the UK Distributor Economatics, Epic House, Orgrave Road, Handsworth, Sheffield, S13 9LQ.

Our November '84 cover showed a drawing of the original Alfred—unfortunately this issue is now sold out.

EVERYDAY ELECTRONICS and computer PROJECTS
 NOVEMBER 1984 90p

Build Alfred!
the Hobby Robot



16 PAGE PULLOUT
robotics
SUPPLEMENT

New Series-FAULT FINDING
PROXIMITY ALARM

MULTIMETERS

BY
Cirkit

Affordable Accuracy

A comprehensive range of quality Multimeters at very competitive prices

DIGITAL

All models feature full ranges, large 3½ digit LCD, low battery indication, auto zero and auto polarity, strong ABS casing, 10 Amp range (except DM105), overload protection. Prices from £21.50 to £65.00. Battery, spare fuse, test leads and manual included with each model.

ANALOGUE

A choice of four meters with prices ranging from £5.50 to £21.00, with DC sensitivities from 2kΩ/V to 30kΩ/V. All models include battery, test leads and manual.

Please add 15% VAT to all prices and 70p for post and packing.



NEW LOW PRICE!

HC774 **£31.00**

A compact, pocket sized autoranging multimeter featuring: 200mV-1kV DC volts, 200mV-750V AC volts, 200mA and 10A DC or AC current, high and low current resistance ranges 2k-2MΩ and 200-200kΩ, 10mm LCD, display memory and hold, auto/manual range selection and basic accuracy of 0.5%.

Cirkit



Phone or write for full catalogue price £1.20 to

Cirkit Distribution Ltd.

Park Lane, Broxbourne, Herts EN10 7NQ.
Telephone (0992) 444111.

* SOLAR POWERED * BATTERY CHARGER

There is no need for mains supply. All you need to charge 4xAA (HP7) Ni-Cad batteries is natural day light or light from a lamp. The unit charges two batteries in 4 to 6 hours and four batteries in 10 to 14 hours, depending upon the strength of available light.

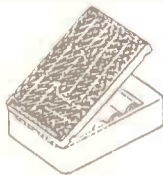

Only £10.99 (P & P £2)

* RECHARGEABLE *

* BATTERIES *

HP7	98 P
HP11	£1-90
HP2	£2-25
PP3	£5-00

(P & P 20P each)

* UNIVERSAL NI-CAD *

* BATTERY CHARGER *

£ 5.99

Battery charger complete with battery charge and test indicator charges 4xHP2-11-7 & 1PP3 batteries (P & P £2)

All prices include VAT. Send your orders with cheque/PO to:

A & G ELECTRONICS LTD.
P.O. BOX 443
LONDON E14 6JU

TEL: 01-519 6149

NEW THIS MONTH

RELAYS+LAMPS

Over 11,000 just arrived—details on Bargain List 38. E.g. Z255 6V DPCO plug-in relay 80p; Z327 6.5V 0.15A MES lamp 10/£1.

LCD+DRIVER PANEL

Z027 2 PCB's 93 x 42mm linked by ribbon cable. One has a 3½ digit LCD in holder, the other a ICM7211AM IPL+4070 (value over £14) **£5.00**

Z028 As above, but without display **£2.50**

CHIPS

INS8048/9/50 single chip micro with 1k/2k/4k ROM & 64/128/256 RAM, 27 I/O lines. 40 pin. Supplied with data sheet **£3/£4/£5**

SPEECH SYNTH KIT

Z315 All parts inc PCB to make a speech synth for the BBC micro **£4.99**

Z316 De-luxe version—also includes V216 case, 1m 20W cable plus connector **£7.99**

PRESSURE SWITCHES

Both types need only very low air pressure to operate—just blow down the tube!

Z024 80mm dia x 45mm thick. SPCO switch rated 16A 250V ac **80p**

Z025 Similar to above, but 37mm thick **80p**

TRANSFORMER

Z023 Philips, nicely cased. Mains input via 2m lead. 6V 35VA (6A) output to screw terminals **£3.20**



Z810 KEYBOARD. Really smart alpha numeric standard qwerty keyboard with separate numeric keypad, from ICL's 'One Per Desk'. Nicely laid out keys with good tactile feel. Not encoded—matrix output from PCB taken to 20-way ribbon cable. Made by Alps. Size 333x106mm. 73 keys. **£8.95**

FUSED SUPPRESSOR

Z003 Potted unit 60x45x30 has screw term i/p for mains, 20mm fuseholder and o/p tags for appliance **99p**

VIEWDATA LTU

Z597 Interface Panel 166x150 with 3xLM324, LM339, LM393, 4066, 11 transistors, 3 reed relays, etc. 3m lead with BT plug attached. Supplied with comprehensive data and ccts. **£2.90**

ENTERPRISE PANELS

Z658 PCB 325x158 with 64K of RAM (8x4864). Z80A microprocessor, 21 other chips, UHF modulator, speaker, etc. ROM and Nick and/or Dave chips missing, supplied with cct and data **£8.00**

'JIMMY'

Exciting electronic football game originally sold for £19.95, but this price included plastic grandstand, stickers, etc. We can supply the 420x93mm neatly cased electronics comprising keypad either end, 14x5mm red LED's ('players'), TMS1000 chip programmed to make odd noises whilst playing and a tune when a goal is scored, also 2x7seg LED's to keep score. Cardboard 'pitch' plus instructions supplied. **£5.00**

COMPASSES

Precision spring bow 88mm long. Max dia 70mm. Replaceable pencil lead and steel tip. **£1.00**

TOOLS

Scoop purchase of high quality surgical instruments ideal for electronics use.

Z308 5in lightweight long nose pliers 99p

Z309 5½in as above but with ratchet. This enables pliers to be locked together—for holding small components, or as heat shunts, etc. **£1.20**

JOYSTICK

Z004 Skeleton Joystick, switch type. Good quality, made by AB. Brass spindle has 44mm long black plastic handle attached. Body has 4 mounting holes. These really are a fantastic bargain!! **Only £1**

1988 CATALOGUE

OUT NOW—88 pages of bargains from resistors to disco mixers. Price includes latest bargain list, discount vouchers, order form. Don't be without your copy—send £1.00 now!

WINTER SALE LIST

A 16-page supplement combining Bargain Lists 33-35 plus the 50% off supplement, with prices further reduced to 66% off!! It's FREE—send large SAE for your copy now!!



Z811 Cumana Touch Pad for the BBC Computer. This remarkable add-on enables you to draw on the screen using a stylus with the touch sensitive pad. Supplied with two stylii, power/data connecting lead and demo tape with 4 programs, contains state-of-the-art electronics. Originally being sold at £79.95, later reduced to £49.95—but we can offer a limited quantity of these brand new and boxed for just **£19.95**

COIN ACCEPTOR MECHANISM

Z652 Made by Coin Controls, this will accept various size coins by simple adjustment of 4 screws. Incorporates various security features—magnet, bent coin rejector, etc. Microswitch rated 5A 240V. Front panel 115x64, depth 130mm. Cost £10.85. Our price **£4.00**

MICRO PANELS

Z620 68000 Panel. PCB 190x45 believed to be from ICL's 'One per Desk' computer containing MC68008P8 (8MHz 16/8 bit microprocessor, +4 ROMs, all in skts; TMP5220CNL, 74HCT245, 138, LS08, 38 etc. **£5.00**

Z625 32k Memory Board, PCB 170x170 with 16 2kx8 6116 static RAMs. Also 3.6V 100mA memopack nicad, 13 other HCLS devices, 96w edge plug, 8 way DIL switch, Rs, Cs etc. **£4.80**

SPEAKERS

Z578 Sub-min speaker 30x30x3mm thicl. by Fuji. 16R 0.4W, 60p each; 10 £3.70; 25 £7; 100 £22; 1000 £180. Z575 70x45mm 45R 0.5W 55p each, 10 £3.30; 25 £6; 100 £20.

SOLDER

500g reels resin cored, 18g **£5.95**
500g reels resin cored 22g **£7.95**

LOGIC PROBE

For TTL, CMOS etc LED and sound indication. Pulse enlargement capability allows pulse direction down to 25nsec. Max f=20 MHz 4-16V. I/P Z:1:M **£9.99**

SOLAR CELLS

Mega size—300x300mm. These incorporate a glass screen and backing panel with wires attached. 12V 200mA output. Ideal for charging nicads. **£24.00**

SOLDER SPECIAL!!

- ★ 15W 240V ac soldering iron
- ★ High power desolder pump
- ★ Large tube solder

ALL FOR
£7.95

SWITCHED MODE PSU's

Astec type AA7271. PCB 50x50mm has 5 transistor cct providing current overload protection, thermal cut-out and excellent filtering. Input 8-24V DC. Output 5V 2A. Regulation 0.2%. **£5.00**

Z026 Asteco model AC9355. 65W unit. 115/230V ac input. Outputs: +5V 6A; +12V 1.5A; +12V 2.1A; -12V 0.25A. Normally over £70. Our price **£24.95**

All prices include VAT; just add £1.00 P&P. Min. Access £5. No CWO min. Official orders from schools welcome—min. invoice charge £10. Our shop has enormous stocks of components and is open 9-5 Mon-Sat. Come and see us!
HOW TO CONTACT US:
By post using the address below, by phone (0703) 77501 or 783740 (ansaphone out of business hours); by FAX (0703) 787555; by Email Telecom Gold 72:MAG38026; by Telex 265871 MONREF G quoting 72:MAG38026.

GREENWELD
ELECTRONIC COMPONENTS

443D MILLBROOK ROAD, SOUTHAMPTON SO1 0HX



...REPORTING AMATEUR RADIO...

TONY SMITH G4FAI

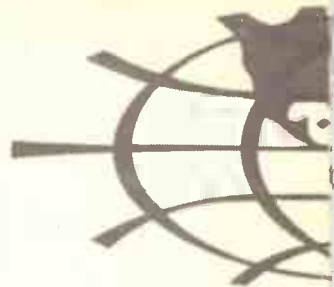

CELEBRATIONS

The Radio Society of Great Britain has announced its plans for the celebration of its 75th anniversary during 1988. The main events will take place in July, but throughout the year it will make a concerted effort to promote amateur radio to young people with a programme called *Youth into Electronics via Amateur Radio*, or **Y.E.A.R. 88**, designed to bring more young people into the hobby and, hopefully, steer them into a career in electronics.

The main celebrations start with the National Convention at the Birmingham NEC on 15-17 July. This will, says the Society, be bigger and better than ever with the usual large trade exhibition, a display of amateur equipment through the ages, and social events on site.

From 19-20 July there will be Open Days at RSGB Headquarters, Potters Bar, Herts, to allow members to see at first hand what the Society does. Visitors will have the opportunity to operate HQ stations GA75HQ and GB75HQ and to inspect a display of archival material and historic radio equipment.

On 22-23 July a Data Symposium will be held at Harrow School with a comprehensive lecture programme and demonstrations of various forms of data communication used by radio amateurs, and Sunday, 24 July, has been designated *Families and Activities Day*. This will be a nationwide celebration involving rail and river trips, club open days/parties, and a chain of amateur stations passing greetings messages from hilltop to hilltop in traditional bonfire-beacon fashion.

There will be an International Satellite Seminar on 28 July, at the University of Surrey, bringing together representatives from amateur satellite groups around the world. This will be followed over the next three days by the annual AMSAT Colloquium at the same location.

YOUNG AMATEUR OF THE YEAR AWARD

Linked with the RSGB's 75th anniversary, the DTI is making a special award for UK under-18s, whether licensed amateurs or not, to recognise an individual contribution of outstanding merit in any area of amateur radio. This award will be presented at the national convention in July and the prize will be £250 plus a day out visiting the Radiocommunications Division of the DTI.

LOCAL CELEBRATIONS

Throughout the year local clubs and societies will be holding open days, running demonstration stations with a special "75" prefix, or visiting schools, colleges and other youth-orientated areas with a view to encouraging more youth into the hobby. The RSGB is preparing a new recruitment video aimed at young-

sters, and this will be used by clubs during their various promotional activities.

Information about what's going on during the year can be obtained from the RSGB, Lambda House, Cranborne Road, Potters Bar, Herts EN6 3JE, and details of local events will also be found in local newspapers.

SAY IT IN RUSSIAN

It is often said that Morse code abbreviations form a sort of international language which enables amateurs of different nationalities to converse with each other without a knowledge of each other's language. This is certainly the case with exchanges of a fairly limited nature but enthusiastic Morse operators are always looking for means of improving their communication capability.

A smattering of other languages can be a great help, even if it is only the "Morse" language of another country. In the winter edition of *Morsum Magnificat*, the journal for Morse enthusiasts (of which I am editor!), Gus Taylor, G8PG, offers the opportunity to say a few words in Russian. Morse code transmission in that language normally involves the use of special Morse signals representing the Russian alphabet, but Russian words can be anglicised or abbreviated for use with the international Morse code to form the basis for communication with Russian operators.

For example, the normal Russian greeting is a word roughly pronounced as "Zdrasti", meaning, more or less, "Hello, how are you?" and in Morse this is abbreviated to ZDR. Often heard after ZDR is TOW which is an abbreviation of "Tovarich", equating for our purposes to the commonly used "OM" - "old man".

If you don't take it too seriously it's best to restrict exchanges in Russian to a few words at the end, for example, SPASIBO ZA QSO, QSL BUDET WAM BURO - "thanks for the contact, I will definitely send you a QSL card via the bureau". If you say anything too soon you are liable to get a flood of Russian back! Whether you treat it deeply or superficially, however, the other operator will almost certainly come back with an appreciative TKS FOR THE QSO AND THE RUSSIAN.

Gus seems to have started something. I have just received a similar article for future publication, offering help in communicating with Icelandic stations, while I already have in hand articles explaining the intricacies of both Chinese and Japanese Morse!

QUESTION CORNER

Q. What is a repeater?

A. A repeater is a device which will receive a radio signal on one frequency and simultaneously retransmit it on another. Its main purpose is to increase the range of a low power mobile station, from a few

miles to a much greater distance, depending on terrain and the frequency used.

Repeaters are unmanned stations sited on high ground or a tall mast to obtain a coverage area vastly superior to that of the stations transmitting through them. To make sure that other signals cannot be relayed through them, user transmitters are required to send a short toneburst of 1750Hz at the beginning of a transmission, which tells the repeater to switch on and start relaying the signal.

To keep overs short, there is a built-in timer to restrict continuous talk-through to 1½-2 minutes. When the user's transmission ceases stations replying automatically re-access the repeater without the need for a tone within a short delay period. Outside that period a further tone-access is required.

Repeaters identify themselves every 15 minutes, usually by sending their call-sign in Morse. They receive and transmit on frequencies close to each other, e.g. on the 2 metres band, they are 600kHz apart, and require careful design to ensure satisfactory isolation between the transmitting and receiving circuits.

When the first UK amateur repeaters were brought into use in the early 70's they were intended only for f.m. speech communication. Nowadays there are repeaters for radio-teletype (RTTY), data transmission, television, and packet radio, plus an experimental station relaying an interesting new mode-pilot carrier single sideband. Over the 144MHz, 430MHz and 1.3GHz bands there is now a network of approximately 250 repeaters.

Repeater Management

Local groups of amateurs design, erect and maintain individual repeaters and the RSGB's Repeater Management Group coordinates the network. The RMG advises on and vets applications for new repeaters, and collaborates with the DTI, which issues the repeater licences. In fact, the RSGB holds the licences issued, and is accountable to the DTI for the proper operation of the network.

Speech repeaters are provided for the benefit of low power mobile or portable stations and all amateurs within their coverage area are welcome to use their facilities. Strangers driving through an area can call through the local repeater for travel directions or seek help in an emergency.

Special operating techniques and specially made equipment are required for repeater operation, although nowadays all new v.h.f. and u.h.f. transceivers have frequency shift and toneburst facilities built into them. For anyone wishing to know more about repeater operation, the RSGB's booklet, *The ins and outs of Repeaters* covers the subject extremely well.



AUDIO MINI-BRICKS

When the circuit diagrams of audio effects are examined in detail, it is apparent that many use similar functions. Thus a number of different mini-circuit building bricks can be connected together in numerous different ways to produce all kinds of sound effects and audio units.

Over the next few issues some of these basic building bricks will be examined in detail and practical examples of their use will be discussed. With one exception, all of the circuits use identical i.c.s, and a multipurpose printed circuit board.

HOME SECURITY

In this series our main concern will be securing the home against intruders, but we shall also describe devices for securing it against fire. The system is modular, so that you can adapt it to your needs.

HEADLIGHT REMINDER

It is probably true that most motorists, at one time or another, have unwittingly left their car's headlights on, only to return to find the car's battery in a sad state of charge. The circuit presented here, then, is for almost all motorists, and the evening spent building and installing it could be repaid with interest.



BBC SOUND TO LIGHT UNIT

The project employs the analogue interface of the BBC "B" computer to produce a colourful display on a TV screen. The display pulses with sound fed via a microphone or audio system. The circuit may be driven by a wide variety of sources, including moving coil microphones.

POWER CONTROLLER

The article describes the construction of a multi-purpose phase-control power controller, based around a fully-integrated thick film triac and trigger circuit. Also included is a very effective suppression circuit which eliminates nearly all RFI.

FREE
DATA
CARD

EVERYDAY ELECTRONICS

JUNE ISSUE ON SALE FRIDAY MAY 6th

Everyday Electronics, May 1988

EVERYDAY
ELECTRONICS

NEW NEW NEW NEW NEW NEW PRODUCTS NEW NEW NEW NEW NEW NEW

DELAY LINES

DESIGNED to provide the timing accuracy required by computer-related applications, Cirkut Distribution are now stocking the Toko Picodelay delay line chips.

The devices feature an electromagnetic delay line and come housed in a dual in-line package. Giving total delay times of 2nSec and 5nSec respectively with ten taps, the delay per tap is 200pSec and 500pSec.

For full technical details and prices contact:

*Cirkut Distribution Ltd.,
Dept EE, Park Lane,
Broxbourne, Herts, EN10 7NQ.
☎0992 444111*

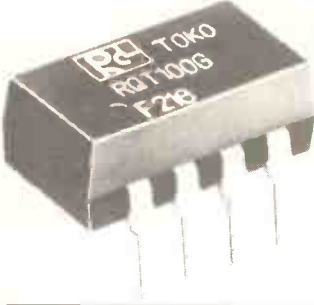

LIGHT METER

THE SL100 Digital Lux Meter is the latest product to be added to the already comprehensive range of Solex test and measurement equipment. It is claimed to be ideal for a diverse range of applications in the laboratory, factory floor and industry.

The unit is a neat, compact portable photometer which can be used for measuring a wide range of illumination levels (0-50,000 lux). It consists of a digital readout unit with a separate, plug-in, photo-electric cell.

The main features include the use of a LSI i.c. circuit, in-built low battery indicator, auto zero adjustment and an accurate easy-to-read digital readout. A carrying case is supplied as standard.

The SL100 Digital Lux Meter costs £55 and full specification and ordering details are available from:

*Solex International
Dept EE, 95 Main Street,
Broughton Astley,
Leics. LE9 6RE
☎0455 283486*

DUAL CHANNEL/ VOLTMETER

THE Trio Kenwood VT-165 dual channel a.c. voltmeter now available from Thurlby Electronics, features a dual pointer taut-band meter giving a claimed accuracy of ± 3 per cent at 1kHz. A channel selector allows either individual setting of voltage ranges or interlocking of the channels so that both ranges are controlled by the Channel 1 selector.



Full scale voltage ranges are from $300\mu\text{V}$ to 100V in 12 ranges. The meter is also scaled in dB and dBm (referenced to 1mW at 600ohm) in the range -90dB to +40dB (+42dBm). Measurements can be taken between frequencies of 5Hz and 1MHz.

Crosstalk for single channel is claimed to be better than -80dB (other channel terminated with 600ohm) and for dual channel better than -50dB with one channel terminated with

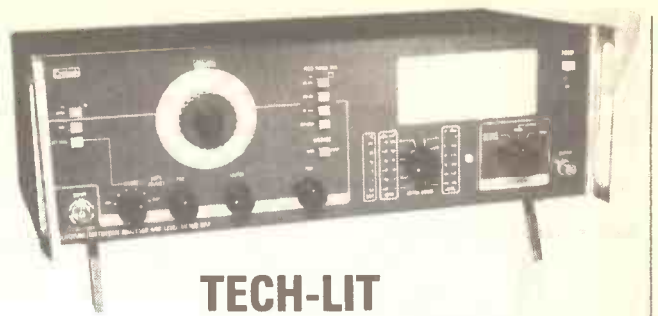

TECH-LIT

ELECTRONIC enthusiasts and engineers will find much of interest in Crotech's latest "Test and Measuring Instruments" 12-page colour brochure.

It contains a wide selection of cost-effective oscilloscopes, audio test equipment and accessories. Crotech's philosophy of providing equipment with an above-average specification, at a competitive price, is well known to most readers of EE and was one of the reasons for their selection in past oscilloscope "special offers".

The 'scope section includes their new model 3133, a dual-trace 25MHz instrument. This has such features as variable hold-off, built-in component comparator and a triple output d.c. source.

For testing and developing a.f. systems, they offer the type 2017 Auto-Tune Distortion Analyser/Level Meter. This is described along with a precision low-distortion signal generator and output power meter. These three items can be integrated to form a complete a.f. test system.

For further information and copies of the Crotech Test & Measuring Instruments catalogue write to the following address. A large stamped addressed envelope would be appreciated.

*Crotech Instruments Ltd.,
Dept EE, 2 Stephenson Road,
St Ives, Huntingdon,
Cambs. PE17 4WJ.
☎0480 301818*

600ohm. Line regulation is better than ± 5 per cent of full scale for a 10 per cent line change.

The instrument can also be used as a low distortion wide-band preamplifier, which gives a voltage gain of approximately 70dB with 0.5V output at full scale without load. Frequency response is 5Hz to 500kHz (-3dB) at 600ohm load. Output impedance is 600ohm with less than 1 per cent distortion at full scale (at 1kHz).

The VT-165 a.c. voltmeter weighs 3kg and costs £395 plus VAT. For further information contact:

*Thurlby Electronics Ltd.,
Dept EE, New Road,
St Ives, Huntingdon,
Cambs. PR17 4BG.
☎0480 63570*

SPARE PARTS



A COMPLETE spare parts facility for their WY Series of printed circuit board holder assemblies has just been announced by Wybar Electronics.

Spare parts as diverse as complete lid assemblies, with anti-static or conductive foam, to springs and ball bearings from the moving rails are stocked. Also available is a range of five sizes of complete units to suit most p.c.b.s in current production.

For further details and addresses of nearest stockists contact:

*Wybar Electronics
Dept EE, Unit M,
Portway Industrial Estate,
Andover, Hants. SP10 3LU.
☎0264 51347/8*

TWO GREAT HOBBIES

ONLY
£124.50!
INC VAT

... IN ONE GREAT KIT!

The K5000 Metal Detector Kit combines the challenge of DIY Electronics assembly with the reward and excitement of discovering Britain's buried past.

THE KIT — simplified assembly techniques require little technical knowledge and no complex electronic test equipment. All stages of assembly covered in a detailed 36 page manual.

THE DETECTOR — features Analytical Discrimination & Ground Exclusion, backed by the proven pedigree of C-Scope, Europe's leading detector manufacturer.

A comprehensive instruction book is available @ £5 (deductable from order).

Ask at your local Hobby/Electronics shop or contact C-Scope for a copy of a published Field Test Report.

CSCOPE

C-Scope International Ltd., Dept. EE86,
Wotton Road, Ashford, Kent TN23 2LN.
Telephone: 0233 29181.

MERLIN

SYSTEMS

MERLIN WAY, BOWERHILL,
MELKSHAM, WILTSHIRE
SN126TJ

Tel: 0225 706886

MISCELLANEOUS

1 x I.E.C. 1 amp mains filter socket	1.25
1 x I.E.C. 3 amp mains filter socket	1.50
1 x I.E.C. 6 amp mains filter socket	1.75
5 x push latching pcb switches	70p
5 x slide pcb switches	70p
10 x phono plugs	50p
5 x 240V panel neons	70p
5 x 24V panel lamps	70p
5 x MES lamp holders	50p
5 x 2-way 3-pole switches with knobs	1.20
4 x 4-way dill switches	30p
5 x 1.7 amp 200V bridge rectifiers	1.20
3 x 1 amp 50V bridge rectifiers	50p
10 x 5mm x 2mm red leds	1.00
10 x 5mm x 2mm green leds	1.00

MERLINS KIT PACKS

1 x mixed power capacitors	1.75
1 x mixed pf capacitors	1.50
1 x mixed axial electrolytics	1.50
1 x mixed wire wound resistors	2.20

NEW SYSTEM

Merlin Systems PC Turbo 256K RAM, 8088 CPU, 1 Disk Drive, Hires Mono Monitor, 84 Keyboard, Par printer port, Radio and MSDos software and Merlin Systems backup. £450.00 plus £15.00 P&P.

2nd USER SYSTEMS

Apple II+ with disk drive and software 150.00
Franklin with disk drive and software 150.00
Apple parts, S100 cards, IBM cards, disk drives, CPN systems, MSDos systems, IBM PC, and mono/colour monitors.

PAYMENT: Credit card, cheque, PO, cash. Post and packaging, £0.00 to £10.00 add £1.50; £10.00 to £20.00 add £1.00. Please add VAT to total.

Look out for Merlin Systems at the following rallies and exhibitions: RSGB VHF Convention at Sandown Park Racecourse on the 01/05/88. Doncaster Radio Rally at Bircotes Sports Centre, Bawtry on the 02/05/88. 31st Northern Mobile Rally at the Great Yorkshire Showground, Harrogate on the 15/05/88. You may also call at the Warehouse but please ring first.

RADIAL

ELECTROLYTICS		
10x4.7uf 25V	30p	
10x22uf 10V	30p	
10x22uf 25V	35p	
10x47uf 25V	35p	
10x47uf 35V	40p	
5x47uf 250V	60p	
10x100uf 10V	35p	
10x22uf 10V	35p	
10x22uf 15V	35p	
10x22uf 25V	40p	
10x22uf 40V	45p	
10x22uf 50V	45p	
10x47uf 25V	35p	
10x47uf 50V	50p	
10x100uf 25V	35p	

POWER

ELECTROLYTICS		
5x50ufx50uf 200V	60p	
2x22uf 315V	1.75	
2x22uf 400V	2.00	
2x47uf 200V	1.50	
2x1500uf 25V	1.75	
2x2200uf 25V	2.00	
5x330uf 25V	1.30	
2x340uf 40V	75p	

DIGITAL RESEARCH

MANUALS		
1xGSX Graphics	1.50	
PC CPM86	1.50	
1xDr Draw PC CPM86	1.50	
1xDr Net PC CPM86	1.50	
1xConcurrent CPM	1.50	
1xCPM86 user	1.50	

COMPUTER DESK

Up-Market Desk, L 102cm x W 74cm x H 74cm with keyboard recess and cabling trunking. New only £50.00 plus £16.00 P&P.

POWER SUPPLIES AND TRANSFORMERS

Bench power supply in blue case, with switched 240V mains input and HT output. Outputs, 6.3V ac at lamp and 250V dc stabilised at 50mA. H 115mm, W 185mm, D 125mm. Just the job for valves! AS NEW ONLY £9.50.

2nd USER TEST EQUIPMENT

SE Labs SN111 18MHz bandwidth, twin beam, mains or battery input. Only £160.00 plus £15.00 p&p. Ring for list.

ZENITH ELECTRONICS

KITS AND



* POWER SUPPLY KIT

- 25/30 Watt MOSFET Audio Power Amplifier 4-8 Ohms Kit **£21.97 R/Built £26.00**
- 10 Channel Variable Speed running light Kit drives LEDs or Mains lamps. Includes LED display board and LED lamps Kit **£15.89 R/Built £19.15**
- Mains Add-on interface board for controlling Mains lamps from our running light unit Kit **£4.95 R/Built £5.00**
- * Plus & Minus regulated power supply 1-Amp state 5, 12, 15, or 24v Kit **£11.82 R/Built £14.82**
- Variable Time Delay Relay unit Kit **£5.71 R/Built £7.71**
- 25/30 Watt 12-Volt opp. R.F. Linear Power Amplifier for Amateur Radio Kit **£26.66 R/Built £31.66**
- Selectable tone generator 9-12v operation Kit **£5.50 R/Built £7.50**
- 3 Note Electronic Door Chime unit, 9 volt operation, 3 melodious tones, variable frequency. Kit **£9.83 R/Built £12.00**
- Miniature FM Transmitter, 60-145MHz Kit **£6.95 R/Built £8.95**
- 3 Watt FM Transmitter, 80-108MHz Kit **£13.99 R/Built £18.99**
- 300 Watt Light Dimmer unit for 240 volt mains lights Kit **£6.95 R/Built £10.95**
- 4 Code Digital Code unit plus Key Pad - Select own code 9 volt Kit **£16.31 R/Built £19.95**
- 5-100 Watt Electronic Loudspeaker Overload protector, adjustable Kit **£11.40 R/Built £15.40**
- VU Meter 10 LED indicator, 5 to 12dB range Kit **£13.63 R/Built £18.63**
- 18 Watt Car/Home Power Amp 12-V Kit **£14.50 R/Built £16.80**
- Amplifier Power Meter; 10 LED indicator from 0.25-100 Watt Input - 9 volt operation Kit **£12.94 R/Built £14.94**
- Light sensitive relay unit; variable sensitivity trigger control; senses light or dark - selectable. Kit **£8.91 R/Built £10.91**

PRODUCTS

- Wireless FM Duplex telephone - sold in pairs for Office/Home **£54.00**
- 5mm LCD digital sports Chronograph hand held **£10.95**
- Digital Blood pressure meter/monitor LCD readout **£44.83**
- Digital LCD temperature module for panel mounting - 19°C to + 68°C **£16.82**
- 3 5" digital LCD Professional series digital multimeter, reads Capacitance, Temperature, Voltage, Conductance, Diodes, Transistors AC/DC voltages & Continuity **£63.25**
- Zenith Speech processor P-202 **£29.50**
- High quality touch dimmer 500W **£12.99**
- Mains Wiring and Metal Detector **£11.00**

ORDERING

■ All Kits contain full instructions PCBs and components ■ All prices include VAT and postage and packing ■ Overseas orders add 10% to above prices ■ Please send Cheque or Postal Order with Order.

Zenith Electronics Dept. 12
14 Cortlandt Business Centre
Hailsham, East Sussex, UK BN27 1AE
Telephone (0323) 847973
Telex 878334 FAX 647204



Access & Barclaycard
Orders
Telephone (0323) 847973

Send £1.00 for
Catalogue which
includes Postage
and Packing -
Refundable on
first order

AUDIBLE SMOOTHNESS TESTER

A. H. ROBSON

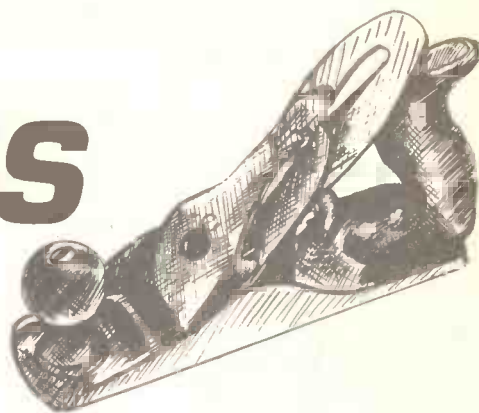

An extremely simple circuit combined with some basic mechanics to provide a useful function.

IT CAN be a problem when planing wood to know if you have ended up with a really smooth surface. The device to be described here will check the work and detect unevenness of the order of 0.25mm or 10 thousandths of an inch.

Construction is straightforward and average d.i.y. skills should see the project through. The electronic circuitry, based on the 555 i.c., uses readily available components.

CIRCUIT DESCRIPTION

The circuit diagram for the Audible Smoothness Tester is shown in Fig. 1 and is based on the 555 timer i.c. which acts as a tone generator.

The timer IC1 is triggered by a pulse to its input pin 2, at which time the output pin 3 goes from low to high. Until that instant, the capacitor C1 is held with a voltage approximately one-third of the supply voltage at the end connected to pin six.

As long as the i.c. is untriggered and the voltage at pin 6 is approximately one-third the supply, current flowing through VR2 and VR1 is drained away through pin 7. When the i.c. is triggered, current no longer passes into pin 7 and the voltage at pin 6 is allowed to rise. The rate at which it rises depends on the total resistance of VR2, VR1 and resistor R1.

The voltage rises until it reaches two-thirds of the supply voltage (4V). When pin six senses this increase, the output of IC1 goes low and the capacitor C1 is rapidly discharged through pin 7. This brings the voltage back to the one-third level.

The trigger pin 2 is also connected to the capacitor C1, so the sudden drop in voltage at discharge acts as a trigger pulse. In this way the circuit begins its cycle all over again.

The output pin 3 of the "multivibrator" is connected to a capacitor C2 and as the output rises and falls, a varying current passes through the loudspeaker causing a tone to be

heard. The frequency or pitch obtained depends on the values of the potentiometers, resistor and capacitor C1 used.

The potentiometer VR2 is wired in series with the preset VR1 and acts as the "surface sensor". The control of VR2 is spring-loaded and a "foot" attached to the spindle traces the contours of the worksurface and alters the pitch produced at the loudspeaker in unison.

COMPONENTS

Resistors

R1 15k
0.25W 5% carbon

Potentiometers

VR1 100 preset (horizontal)
VR2 1k rotary lin.

Capacitors

C1 0μ1 polyester
C2 10μ elec. 10V

Semiconductor

IC1 NE555

Miscellaneous

B1, 6V battery box, with 4 cells
S1, Min. toggle switch
LS1 Speaker 8 ohms, 4cm diam.
Stripboard, 20mm×4.5mm; control knob, diam. 1.5mm; softwood and 3mm thick plywood; bicycle spoke; nylon cable clips (2 off); Coiled spring; plastic case, 7.5mm×5mm×2.5mm.

Approx. cost
Guidance only

£5

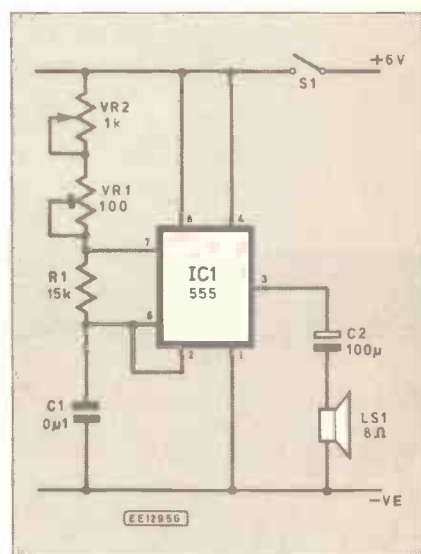
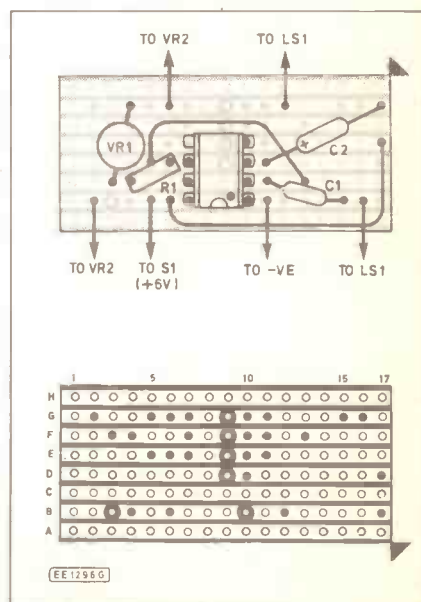
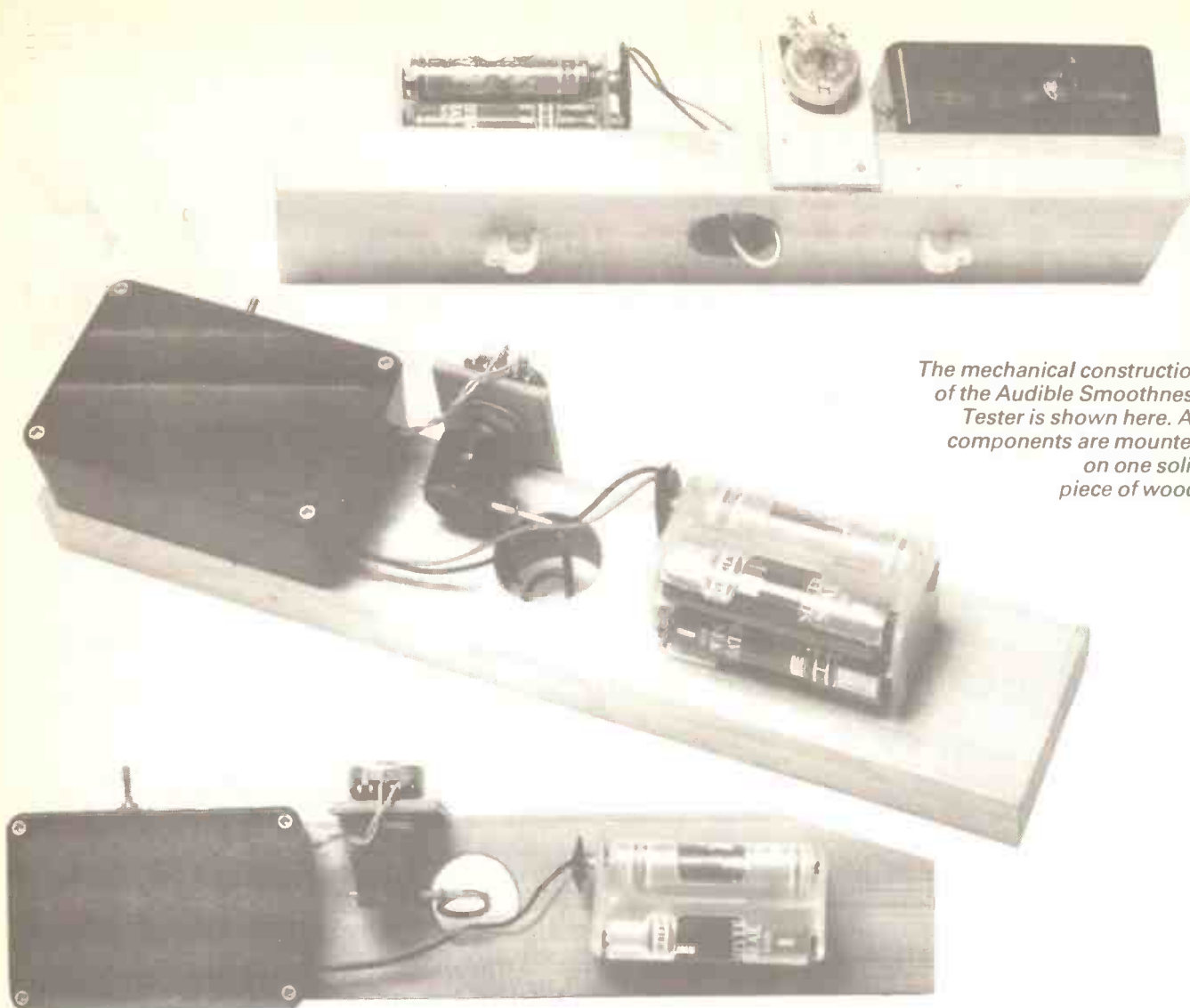

Fig. 1. Circuit diagram of the Audible Smoothness Tester.

Fig. 2. Veroboard layout and wiring.





The mechanical construction of the Audible Smoothness Tester is shown here. All components are mounted on one solid piece of wood.

CONSTRUCTION

Commence construction by first building up the small circuit board. The stripboard component layout and wiring details is shown in Fig. 2.

Note that six breaks are required in the copper foil tracks and these can be made using a sharp drill bit. When wiring the components on the board make sure that the i.c. holder is inserted correctly and that the polarity of capacitor C2 is observed.

The circuit board slots into two runners, made by gluing "matchsticks" to the sides of a small (50mm×75mm) plastics case. Also housed in the case is a 40mm diameter eight ohm loudspeaker. A few holes are drilled in the lid of the case to form a speaker grille, this is backed with a strip of material to protect the components from dust.

The battery leads from the case are taken to a battery holder, containing four A6 batteries, which is eventually mounted at one end of a small wooden beam, see photographs.

Once the circuit board has been completed and finally checked for any errors, carry out a preliminary test by switching on and rotating the spindle of VR2. Twisting the control spindle should alter the sound emitted from the speaker LS1.

Now that the circuit has been built up it should be put to one side and the woodwork and final construction commenced.

WOODWORK

Select a smooth piece of wood

20mm×50mm cross section and 240mm in length. Through the centre drill a 25mm hole with a power drill or brace and bit.

On either side of the hole, on the underside, pin and glue two nylon electrical cable clips which should be 55mm from the centre. These clips will allow the device to run smoothly over the test piece.

Cut out a 50mm×30mm rectangle of 3mm plywood and drill a hole 15mm from one end to take potentiometer VR2. Into the hole insert the potentiometer which should have a 18mm diameter plain control knob attached to its spindle.

A lever made from strong wire has now to be attached to the knob and this will be the sensing arm to relay any surface irregularities to the potentiometer. About 120mm of bicycle spoke wire is ideal for this purpose. Bend the wire through a right angle at 350mm from one end and at a further 45mm, bend the wire back on itself to form a loop. This curved section forms the sensor "foot" and will make contact with the wood surface.

The wire has now to be fixed in a hole driven through the body of the plastic control knob. Drill a tight fitting hole at right angles to the potentiometer shaft. Push in the straight end of the wire until the first bend is 25mm from the shaft centre.

Bolt VR2 onto its plywood strip and hold it temporarily on the side of the wood beam with the curved end of the wire protruding through the hole. Manoeuvre the strip until the wire is central in the hole and does not

catch the sides. Pin and glue the plywood mounting strip in this position.

Loop a short length of spring over the horizontal section of the wire and secure it to the side of the hole with a panel pin. This will keep the curved end of the lever firmly on the test piece.

The case containing the circuit board should now be secured with impact adhesive or sticky pads on one end of the wooden beam together with the battery box on the other.

SETTING UP AND USE

To set up the tester at maximum sensitivity, select a wood beam which is perfectly flat and some small pieces of paper and cardboard of known thickness. Ideally a micrometer should be used for this purpose, but as a guide a plain postcard is about 0.25mm or 10 thou. thick.

Adjust the preset to mid position and with the device resting on the flat beam, loosen the grub screw of VR2 and set the potentiometer at approximately 45 ohms. Retighten the screw and switch on.

Allow the Audible Smoothness Tester to run over the pieces of paper or card in turn and listen for changes in note from the speaker. If the sensitivity is not satisfactory, rotate VR2 and preset VR1 slightly.

By experimenting in this manner the tester can be made to pick up undulations down to 0.25mm. On long sections of uneven timber a warbling note will result. □

BOOK SERVICE

The books listed on these three pages have been selected as being of special interest to our readers, they are supplied from our editorial address direct to your door. Full ordering details are given on the last book page.

PROJECT CONSTRUCTION

HOW TO GET YOUR ELECTRONIC PROJECTS WORKING

R. A. Penfold

We have all built projects only to find that they did not work correctly, or at all, when first switched on. The aim of this book is to help the reader overcome just these problems by indicating how and where to start looking for many of the common faults that can occur when building up projects.

96 pages Temporarily out of print

HOW TO DESIGN AND MAKE YOUR OWN P.C.B.s

R. A. Penfold

Deals with the simple methods of copying printed circuit

board designs from magazines and books and covers all aspects of simple p.c.b. construction including photographic methods and designing your own p.c.b.s.
80 pages Order code BP121 £1.95

BEGINNER'S GUIDE TO BUILDING ELECTRONIC PROJECTS

R. A. Penfold

Shows the complete beginner how to tackle the practical side of electronics, so that he or she can confidently build the electronic projects that are regularly featured in magazines and books. Also includes examples in the form of simple projects.

112 pages Order code No. 227 £1.95

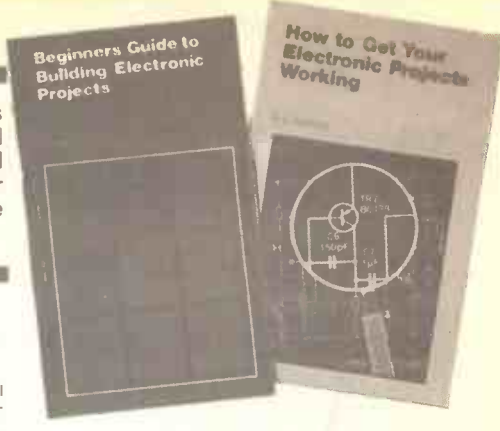

PRACTICAL ELECTRONIC BUILDING BLOCKS—BOOK 1 PRACTICAL ELECTRONIC BUILDING BLOCKS—BOOK 2

R. A. Penfold

These books are designed to aid electronic enthusiasts who like to experiment with circuits and produce their own projects, rather than simply following published project designs.

BOOK 1 contains: Oscillators—sinewave, triangular, squarewave, sawtooth, and pulse waveform generators operating at audio frequencies. Timers—simple monostable circuits using i.c.s, the 555 and 7555 devices, etc. Miscellaneous—noise generators, comparators, mixers and triggers, etc.

BOOK 2 contains: Amplifiers—low level discrete and op-amp circuits, voltage and buffer amplifiers including d.c. types. Also low-noise audio and voltage controlled amplifiers. Filters—high-pass, low-pass, 6, 12, and 24dB per octave types. Miscellaneous—i.c. power amplifiers, mixers, voltage and current regulators, etc.

BOOK 1 128 pages Order code BP117 £1.95
BOOK 2 112 pages Order code BP118 £1.95

CIRCUITS AND DESIGN

ELECTRONICS SIMPLIFIED—CRYSTAL SET CONSTRUCTION

F. A. Wilson, C.G.I.A., C.Eng., F.I.E.E., F.I.E.R.E., F.B.I.M.

Especially written for those who wish to participate in the intricacies of electronics more through practical construction than by theoretical study. It is designed for all ages upwards from the day one can read intelligently and handle simple tools.

80 pages Order Code BP92 £1.75

MICRO INTERFACING CIRCUITS—BOOK 1 MICRO INTERFACING CIRCUITS—BOOK 2

R. A. Penfold

Both books include practical circuits together with details of the circuit operation and useful background information. Any special constructional points are covered but p.c.b. layouts and other detailed constructional information are not included.

Book 1 is mainly concerned with getting signals in and out of the computer. Book 2 deals primarily with circuits for practical applications.

Book 1 112 pages Order code BP130 £2.25
Book 2 112 pages Order code BP131 £2.25

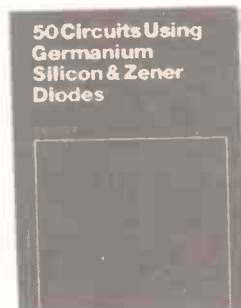

50 CIRCUITS USING GERMANIUM SILICON AND ZENER DIODES

R. N. Soar

Contains 50 interesting and useful circuits and applications, covering many different branches of electronics, using one of the most simple and inexpensive of components—the diode. Includes the use of germanium and silicon signal diodes, silicon rectifier diodes and Zener diodes, etc.

64 pages Order Code BP36 £1.50

A MICROPROCESSOR PRIMER

E. A. Parr, B.Sc., C.Eng., M.I.E.E.

Starts by designing a small computer which, because of its simplicity and logical structure, enables the language to be easily learnt and understood. The shortcomings are then discussed and the reader is shown how these can be overcome by changes and additions to the instruction set. In this way, such ideas as relative addressing, index registers, etc., are developed.

96 pages Order code BP72 £1.75

50 SIMPLE LED CIRCUITS

R. N. Soar

Contains 50 interesting and useful circuits and applications, covering many different branches of electronics, using one of the most inexpensive and freely available components—the light-emitting diode (LED). Also includes circuits for the 707 common anode display.

64 pages Order Code BP42 £1.95

A PRACTICAL INTRODUCTION TO MICROPROCESSORS

R. A. Penfold

Provides an introduction which includes a very simple microprocessor circuit which can be constructed so that the reader can experiment and gain practical experience.

96 pages Order code BP123 £1.95

ELECTRONIC CIRCUITS HANDBOOK

Michael Tooley BA

This book aims to explode two popular misconceptions concerning the design of electronic circuits: that only those with many years of experience should undertake circuit design and that the process relies on an understanding of advanced mathematics. Provided one is not too ambitious, neither of these popularly held beliefs is true.

Specifically, this book aims to provide the reader with a unique collection of practical working circuits together with supporting information so that circuits can be produced in the shortest possible time and without recourse to theoretical texts.

Furthermore, information has been included so that the circuits can readily be modified and extended by readers to meet their own individual needs. Related circuits have been grouped together and cross-referenced within the text (and also in the index) so that readers are aware of which circuits can be readily connected together to form more complex systems. As far as possible, a common range of supply voltages, signal levels and impedances has been adopted.

As a bonus, ten test gear projects have been included. These not only serve to illustrate the techniques described but also provide a range of test equipment which is useful in its own right.

277 pages Order code NE05 £14.95



COIL DESIGN AND CONSTRUCTION MANUAL

B. B. Babani

A complete book for the home constructor on "how to make" RF, IF, audio and power coils, chokes and transformers. Practically every possible type is discussed and calculations necessary are given and explained in detail. Although this book is now rather old, with the exception of toroids and pulse transformers little has changed in coil design since it was written.

96 pages Order Code 160 £2.50

HOW TO USE OP-AMPS

E. A. Parr

This book has been written as a designer's guide covering many operational amplifiers, serving both as a source book of circuits and a reference book for design calculations. The approach has been made as non-mathematical as possible.

160 pages Order code BP88 £2.95

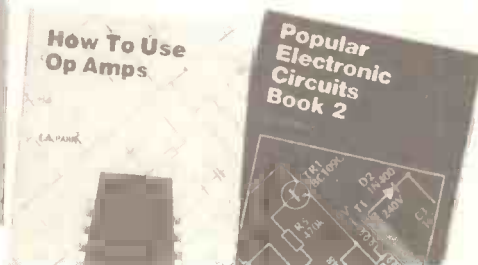

HOW TO DESIGN ELECTRONIC PROJECTS

R. A. Penfold

The aim of this book is to help the reader to put together projects from standard circuit blocks with a minimum of trial and error, but without resorting to any advanced mathematics. Hints on designing circuit blocks to meet your special requirements are also provided.

128 pages Order code BP127 £2.25

POPULAR ELECTRONIC CIRCUITS

—BOOK 1

POPULAR ELECTRONIC CIRCUITS

—BOOK 2

R. A. Penfold

Each book provides a wide range of designs for electronic enthusiasts who are capable of producing working projects from just a circuit diagram without the aid of detailed construction information. Any special setting-up procedures are described.

BOOK 1 160 pages Order code BP80 £1.95

BOOK 2 160 pages Order code BP98 £2.25

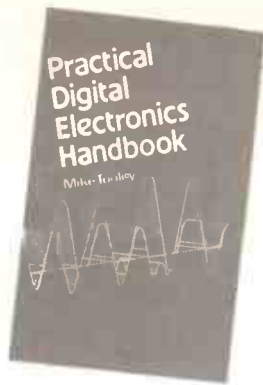

ELECTRONICS TEACH-IN

Michael Tooley BA and David Whitfield MA MSc
CEng MIEE (Published by EE)

This value for money EE book provides a comprehensive background to modern electronics including test gear projects. A complete course in basic electronics; designed for the complete newcomer it will however also be of value to those with some previous experience of electronics. Wherever possible the course is related to "real life" working circuits and each part includes a set of detailed practical assignments. Includes details of eight items of related test gear giving full constructional information and diagrams for each one. They are: Safe Power Supply; Universal LCR Bridge; Diode/Transistor Tester; Audio Signal Tracer; Audio Signal Generator; RF Signal Generator; FET Voltmeter; Pulse Generator. An excellent companion for anyone interested in electronics and invaluable for those taking G.C.S.E. electronics courses.
104 pages (A4 size) Order code EE/T-1 £1.95

PRACTICAL ELECTRONICS CALCULATIONS AND FORMULAE

F. A. Wilson, C.G.I.A., C.Eng., F.I.E.E., F.I.E.R.E., F.B.I.M.

Bridges the gap between complicated technical theory, and "cut-and-try" methods which may bring success in design but leave the experimenter unfulfilled. A strong practical bias—tedious and higher mathematics have been avoided where possible and many tables have been included.

The book is divided into six basic sections: Units and Constants, Direct-current Circuits, Passive Components, Alternating-current Circuits, Networks and Theorems, Measurements.
256 pages Order Code BP53 £2.95

ESSENTIAL THEORY FOR THE ELECTRONICS HOBBYIST

G. T. Rubaroc, T.Eng (C.E.I.), Assoc.I.E.R.E.

The object of this book is to supply the hobbyist with a background knowledge tailored to meet his or her specific requirements and the author has brought together the relevant material and presented it in a readable manner with minimum recourse to mathematics.
128 pages Order Code 228 £2.50

MICROPROCESSING SYSTEMS AND CIRCUITS

F. A. Wilson, C.G.I.A., C.Eng., F.I.E.E., F.I.E.R.E., F.B.I.M.

A truly comprehensive guide to the elements of micro-processing systems which really starts at the beginning. Teaches the reader the essential fundamentals that are so important for a sound understanding of the subject.
256 pages Order Code BP77 £2.95

COMMUNICATION

F. A. Wilson, C.G.I.A., C.Eng., F.I.E.E., F.I.E.R.E., F.B.I.M.

A look at the electronic fundamentals over the whole of the communication scene. This book aims to teach the important elements of each branch of the subject in a style as interesting and practical as possible. While not getting involved in the more complicated theory and mathematics, most of the modern transmission system techniques are examined including line, microwave, submarine, satellite and digital multiplex systems, radio and telegraphy. To assist in understanding these more thoroughly, chapters on signal processing, the electromagnetic wave, networks and transmissions assessment are included, finally a short chapter on optical transmission.
256 pages Order Code BP89 £2.95

ELECTRONIC HOBBYISTS HANDBOOK

R.A. Penfold

Provides an inexpensive single source of easily located information that the amateur electronics enthusiast is likely to need for the day-to-day pursuance of this fascinating hobby. Covers common component colour codes. Details the characteristics and pinouts of many popular semiconductor devices, including various types of logic ICs, operational amplifiers, transistors, FETs, unijunctions, diodes, rectifiers, SCRs, diacs, triacs, regulators and SMDs, etc. Illustrates many useful types of circuits, such as timers and oscillators, audio amplifiers and filters, as well as including a separate section on power supplies. Also contains a multitude of other useful data.
88 pages Order code BP233 £4.95

AUDIO

F. A. Wilson, C.G.I.A., C.Eng., F.I.E.E., F.I.E.R.E., F.B.I.M.

Analysis of the sound wave and an explanation of acoustical quantities prepare the way. These are followed by a study of the mechanism of hearing and examination of the various sounds we hear. A look at room acoustics with a subsequent chapter on microphones and loudspeakers then sets the scene for the main chapter on audio systems—amplifiers, oscillators, disc and magnetic recording and electronic music.
320 pages Order Code BP111 £3.50

HOW TO IDENTIFY UNMARKED ICs

K. H. Recorr

Shows the reader how, with just a test-meter, to go about recording the particular signature of an unmarked i.c. which should enable the i.c. to then be identified with reference to manufacturers' or other data. An i.c. signature is a specially plotted chart produced by measuring the resistances between all terminal pairs of an i.c.
Chart Order code BP101 £0.95

RADIO AND ELECTRONIC COLOUR CODES AND DATA CHART

B. B. Babani

Although this chart was first published in 1971 it provides basic information on many colour codes in use throughout the world, for most radio and electronic components. Includes resistors, capacitors, transformers, field coils, fuses, battery leads, speakers, etc. It is particularly useful for finding the values of old components.
Chart Order code BP7 £0.95

CHART OF RADIO, ELECTRONIC, SEMICONDUCTOR AND LOGIC SYMBOLS

M. H. Banani, B.Sc.(Eng.)

Illustrates the common, and many of the not-so-common, radio, electronic, semiconductor and logic symbols that are used in books, magazines and instruction manuals, etc., in most countries throughout the world.
Chart Order Code BP27 £0.95

INTERNATIONAL TRANSISTOR EQUIVALENTS GUIDE

A. Michaels

Helps the reader to find possible substitutes for a popular selection of European, American and Japanese transistors. Also shows material type, polarity, manufacturer and use.
320 pages Order Code BP85 £2.95

RECOMMENDED READING FOR...

INTRODUCING MICROPROCESSORS

PRACTICAL DIGITAL ELECTRONICS HANDBOOK

Mike Tooley (Published in association with EE)

The vast majority of modern electronic systems rely heavily on the application of digital electronics, and the *Practical Digital Electronics Handbook* aims to provide readers with a practically based introduction to this subject. The book will prove invaluable to anyone involved with the design, manufacture or servicing of digital circuitry, as well as to those wishing to update their knowledge of modern digital devices and techniques. Contents: Introduction to integrated circuits; basic logic gates; monostable and bistable devices; timers; microprocessors; memories; input and output devices; interfaces; microprocessor buses. Appendix 1: Data. Appendix 2: Digital test gear projects; tools and test equipment; regulated bench power supply; logic probe; logic pulser; versatile pulse generator; digital IC tester; current tracer; audio logic tracer; RS-232C breakout box; versatile digital counter/frequency meter. Appendix 3: The oscilloscope. Appendix 4: Suggested reading. Appendix 5: Further study.
208 pages Order code PC100 £6.95

TRANSISTOR SELECTOR GUIDE

This unique guide offers a range of selection tables compiled so as to be of maximum use to all electronics engineers, designers and hobbyists.

Section 1: Covers component markings, codings and standards, as well as explaining the symbols used.
Section 2: Tabulates in alpha-numeric sequence the comprehensive specifications of over 1400 devices.
Section 3: Tabulates the devices by case type.
Section 4: Considers particular limits to the electrical parameters when compiling the tables.
Section 5: Illustrates package outlines and leadouts.
Section 6: Consists of a surface mounting device markings conversion list.
192 pages Order code BP234 £4.95

TRANSISTOR RADIO FAULT-FINDING CHART

C. E. Miller

Used properly, should enable the reader to trace most common faults reasonably quickly. Across the top of the chart will be found four rectangles containing brief description of these faults, viz—sound weak but undistorted, set dead, sound loud or distorted and background noises. One then selects the most appropriate of these and following the arrows, carries out the suggested checks in sequence until the fault is cleared.
Chart Order code BP70 £0.95

DIGITAL IC EQUIVALENTS AND PIN CONNECTIONS

A. Michaels

Shows equivalents and pin connections of a popular selection of European, American and Japanese digital i.c.s. Also includes details of packaging, families, functions, manufacturer and country of origin.
256 pages Order Code BP140 £4.95

LINEAR IC EQUIVALENTS AND PIN CONNECTIONS

A. Michaels

Shows equivalents and pin connections of a popular selection of European, American and Japanese linear i.c.s. Also includes details of functions, manufacturer and country of origin.
320 pages Order code BP141 £4.95

INTERNATIONAL DIODE EQUIVALENTS GUIDE

A. Michaels

Designed to help the user in finding possible substitutes for a large selection of the many different types of diodes that are available. Besides simple rectifier diodes, also included are Zener diodes, I.e.d.s, diacs, triacs, thyristors, OCIs, photo and display diodes.
144 pages Order code BP108 £2.25

NEWNES ELECTRONICS POCKET BOOK

E. A. Parr

Newnes Electronics Pocket Book has been in print for over twenty years and has covered the development of electronics from valve to semiconductor technology and from transistors to LSI integrated circuits and microprocessors. To keep up to date with the rapidly changing world of electronics, continuous revision has been necessary. This new Fifth Edition takes account of recent changes and includes material suggested by readers of previous editions. New descriptions of op.amp. applications and the design of digital circuits have been added, along with a totally new chapter on computing, plus other revisions throughout.
315 pages (hard cover) Order Code NE02 £8.95

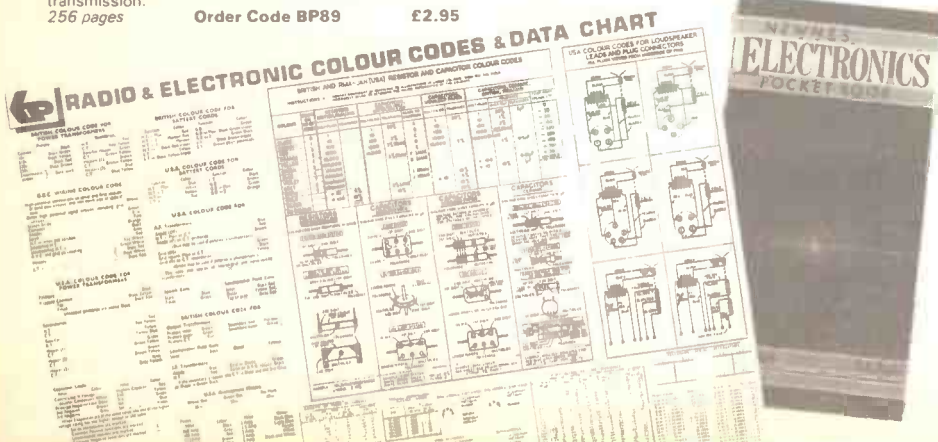

TO ORDER
Please see the following page for full ordering details

GETTING THE MOST FROM YOUR PRINTER

J. W. Penfold
Details how to use all the features provided on most dot-matrix printers from programs and popular word processor packages like Wordwise, Visawrite and Quill, etc. Shows exactly what must be typed in to achieve a given effect.
96 pages **Order Code BP181 £2.95**

A Z80 WORKSHOP MANUAL

E. A. Parr, B.Sc., C.Eng., M.I.E.E.
This book is intended for people who wish to progress beyond the stage of BASIC programming to topics such as machine code and assembly language programming, or need hardware details of a Z80 based computer.
192 pages **Order Code BP112 £3.50**

AN INTRODUCTION TO 68000 ASSEMBLY LANGUAGE

R. A. & J. W. Penfold
Obtain a vast increase in running speed by writing programs for 68000 based micros such as the Commodore Amiga, Atari ST range or Apple Macintosh range etc., in assembly language. It is not as difficult as one might think and this book covers the fundamentals.
172 pages **Order Code BP184 £2.95**

THE ART OF PROGRAMMING THE ZX SPECTRUM

M. James, B.Sc., M.B.C.S.
It is one thing to have learnt how to use all the Spectrum's commands and functions, but a very different one to be able to combine them into programs that do exactly what you want them to. This is just what this book is all about—teaching you the art of effective programming with your Spectrum.
144 pages **Order code BP119 £2.50**

AN INTRODUCTION TO PROGRAMMING THE COMMODORE 16 & PLUS 4

R. A. Penfold
Helps you to learn to use and program these two Commodore machines with the minimum of difficulty by expanding and complementing the information supplied in the manufacturer's own manuals.
128 pages **Order code BP158 £2.50**

AN INTRODUCTION TO PROGRAMMING THE BBC MODEL B MICRO

R. A. & J. W. Penfold
Written for readers wanting to learn more about programming and how to make best use of the incredibly powerful model B's versatile features. Most aspects of the BBC micro are covered, the omissions being where little could usefully be added to the information provided by the manufacturer's own manual.
144 pages **Order code BP139 £1.95**

AN INTRODUCTION TO PROGRAMMING THE ACORN ELECTRON

R. A. & J. W. Penfold
Designed to help the reader learn more about programming and to make best use of the Electron's many features. Adds considerably to the information already supplied in the manufacturer's own instruction manual.
144 pages **Order code BP142 £1.95**

AN INTRODUCTION TO PROGRAMMING THE ATARI 600/800 XL

R. A. & J. W. Penfold
Especially written to supplement the manufacturer's own handbook. The information supplied will help the reader to master BASIC programming and to make best use of the Atari's many powerful features.
128 pages **Order code BP143 £1.95**

AN INTRODUCTION TO PROGRAMMING THE AMSTRAD CPC 464 AND 664

R. A. & J. W. Penfold
The Amstrad CPC 464 or 664 running with Locomotive BASIC makes an extremely potent and versatile machine and this book is designed to help the reader get the most from this powerful combination. Written to complement rather than duplicate the information already given in the manufacturer's own manual. Also applicable to the CPC 6128.
144 pages **Order Code BP153 £2.50**

AN INTRODUCTION TO PROGRAMMING THE SINCLAIR QL

R. A. & J. W. Penfold
Helps the reader to make best use of the fantastic Sinclair QL's almost unlimited range of features. Designed to complement the manufacturer's handbook.
112 pages **Order code BP150 £1.95**

AN INTRODUCTION TO Z80 MACHINE CODE

R. A. & J. W. Penfold
Takes the reader through the basics of microprocessors and machine code programming with no previous knowledge of these being assumed. The Z80 is used in many popular home computers and simple programming examples are given for Z80-based machines including the Sinclair ZX-81 and Spectrum, Memotech and the Amstrad CPC 464. Also applicable to the Amstrad CPC 664 and 6128.
144 pages **Order code BP152 £2.75**

AN INTRODUCTION TO 6502 MACHINE CODE

R. A. & J. W. Penfold
No previous knowledge of microprocessors or machine code is assumed. Topics covered are: assembly language and assemblers, the register set and memory, binary and hexadecimal numbering systems, addressing modes and the instruction set, and also mixing machine code with BASIC. Some simple programming examples are given for 6502-based home computers like the VIC-20, ORIC-1/Atmos, Electron, BCC and also the Commodore 64.
112 pages **Order code BP147 £2.50**

THE PRE-BASIC BOOK

F. A. Wilson, C.G.I.A., C.ENG., F.I.E.E., F.I.E.R.E., F.B.I.M.
Another book on BASIC but with a difference. This one does not skip through the whole of the subject and thereby leave many would-be programmers floundering but instead concentrates on introducing the technique by looking in depth at the most frequently used and more easily understood computer instructions. For all new and potential micro users.
192 pages **Order code BP146 £2.95**

HOW TO GET YOUR COMPUTER PROGRAMS RUNNING

J. W. Penfold
Have you ever written your own programs only to find that they did not work? Help is now at hand with this book which shows you how to go about looking for your errors, and helps you to avoid the common bugs and pitfalls of program writing. Applicable to all dialects of the BASIC language.
144 pages **Order code BP169 £2.50**

AN INTRODUCTION TO COMPUTER COMMUNICATIONS

R. A. Penfold
Provides details of the various types of modem and their suitability for specific applications, plus details of connecting various computers to modems, and modems to the telephone system. Also information on common networking systems and RTTY.
96 pages **Order Code BP177 £2.95**

AN INTRODUCTION TO COMPUTER PERIPHERALS

J. W. Penfold
Covers such items as monitors, printers, disc drives, cassette recorders, modems, etc., explaining what they are, how to use them and the various types and standards. Helps you to make sure that the peripherals you buy will work with your computer.
80 pages **Order code BP170 £2.50**

COMPUTER TERMINOLOGY EXPLAINED

I. D. Poole
Explains a wide range of terms that form the computer jargon used by enthusiasts. Includes a reference guide to the more commonly used BASIC commands.
96 pages **Order code BP148 £1.95**

THE PRE-COMPUTER BOOK

F. A. Wilson
Aimed at the absolute beginner with no knowledge of computing. An entirely non-technical discussion of computer bits and pieces and programming.
96 pages **Order code BP115 £1.95**

NEWNES COMPUTER ENGINEER'S POCKETBOOK

Michael Tooley
An invaluable compendium of facts, figures, circuits and data, indispensable to the designer, student, service engineer and all those interested in computer and microcomputer systems. It will appeal equally to the hardware or software specialist and to the new band of "software engineers". This first edition covers a vast range of subjects at a practical level, with the necessary explanatory text. The data is presented in a succinct and rapidly accessible form so that the book can become part of an everyday toolkit.
205 pages (hard cover) **Order code NE01 £8.95**

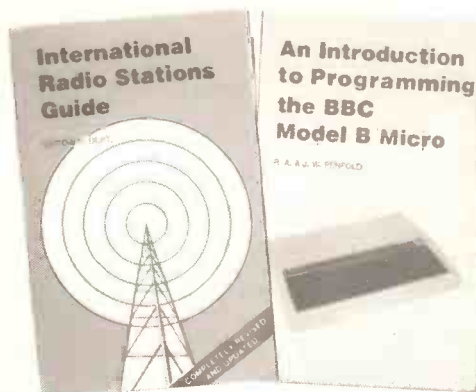

RADIO

AN INTRODUCTION TO RADIO DXING

R. A. Penfold
Anyone can switch on a short wave receiver and play with the controls until they pick up something, but to find a particular station, country or type of broadcast and to receive it as clearly as possible requires a little more skill and knowledge. The object of this book is to help the reader to do just that, which in essence is the fascinating hobby of radio DXing.
112 pages **Order code BP91 £1.95**

INTERNATIONAL RADIO STATIONS GUIDE

Completely revised and updated, this book is an invaluable aid in helping all those who have a radio receiver to obtain the maximum entertainment value and enjoyment from their sets.
Clearly shown are the station site, country, frequency and/or wavelength, as well as the effective radiation power of the transmitter.
128 pages **Order code BP155 £2.95**

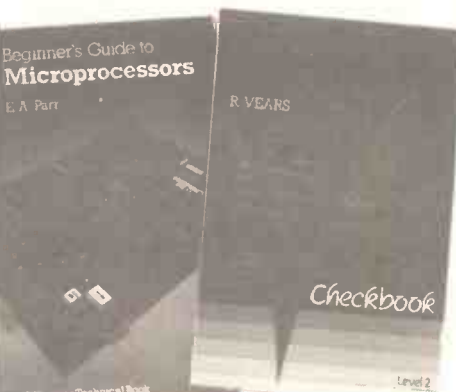

RECOMMENDED READING FOR . . . INTRODUCING MICROPROCESSORS

BEGINNERS GUIDE TO MICROPROCESSORS

E. A. Parr
An excellent grounding in microprocessors, this book is broadly relevant to the whole of our Introducing Microprocessors course. It is easy to read and well illustrated.
224 pages **Order code NE03 £4.95**

MICROELECTRONIC SYSTEMS 2 CHECKBOOK

R. Vears
The aim of this book is to provide a foundation in microcomputer hardware, software and interfacing techniques. Each topic is presented in a way that assumes only an elementary knowledge of microelectronic systems and logic functions. The book concentrates on 6502, Z80 and 6800 microprocessors and contains 60 tested programs, 160 worked problems and 250 further problems.
194 pages **Order code NE04 £4.95**

RECOMMENDED READING

EE BOOK SERVICE TO ORDER

Please check the latest issue of **Everyday Electronics** for price and availability.

Add 50p per order postage (overseas readers add £1, surface mail postage) and send a PO, cheque or international money order (£ sterling only) made payable to **Everyday Electronics** (quoting the order code and quantities required) to **EE BOOK SERVICE, 6 CHURCH STREET, WIMBORNE, DORSET BH21 1JH.**

Although books are normally sent within seven days of receipt of your order please allow a maximum of 28 days for delivery. Overseas readers allow extra time for surface mail post.

PCB SERVICE

Printed circuit boards for certain constructional projects (up to two years old) are available from the PCB Service, see list. These are fabricated in glass-fibre, and are fully drilled and roller tinned. All prices include VAT and postage and packing. Add £1 per board for overseas airmail. Remittances should be sent to: The PCB Service, *Everyday Electronics* Editorial Offices, 6 Church Street, Wimborne, Dorset BH21 1JH. Cheques should be crossed and made payable to *Everyday Electronics*. (Payment in £ sterling only.)

Readers are advised to check with prices appearing in the current issue before ordering.

NOTE: Boards for older projects – not listed here – can often be obtained from *Magenta Electronics*, 135 Hunter St., Burton-on-Trent, Staffs DE14 2ST. Tel: 0283 65435 or *Lake Electronics*, 7 Middleton Close, Nuthall, Nottingham NG16 1BX. Tel: 0602 382509.

NOTE: Please allow 28 days for delivery. We can only supply boards listed in the latest issue. Boards can only be supplied by mail order and on a payment with order basis.

PROJECT TITLE	Order Code	Cost
– FEB '86 –		
Touch Controller	510	£3.32
Function Generator	514	£3.54
Function Generator PSU Board	515	£2.56
pH Transducer – Transducers Series	516	£3.30
– MAR '86 –		
Mains Tester & Fuse Finder	517	£2.84
BBC Midi Interface	518	£4.08
Stereo Hi Fi Preamp	519	£7.13
Interval Timer	520	£2.95
– APRIL '86 –		
Stereo Reverb	521	£3.73
– MAY '86 –		
PA Amplifier	511	£3.34
Mini Strobe	522	£2.79
Auto Firing Joystick Adaptor	523	£3.42
– JUNE '86 –		
Watchdog	524	£3.51
Percussion Synthesiser	525	£7.06
Personal Radio	526	£2.58
– JULY '86 –		
Tilt Alarm	527	£2.65
Electronic Scarecrow	528	£2.86
VOX Box Amplifier	529	£2.93
Headphone Mixer	530	£5.71
– AUG '86 –		
Solar Heating Controller	533	£4.16
– SEPT '86 –		
Car Timer	538	£2.53
Freezer Failure Alarm	534	£2.38
Infra Red Beam Alarm (Trans)	536	£4.16
Infra Red Beam Alarm (Rec)	537	£4.16
Scratch Blanker	539	£6.80
– OCT '86 –		
10W Audio Amp (Power Amp) (Pre-Amp) £4.78 Pair	543	£3.23
	544	£3.97
Light Rider – Lapel Badge	540 & 541	£2.97
– Disco Lights	542	£5.12
– Chaser Light	546	£4.04
– NOV '86 –		
Modem Tone Decoder	547	£3.46
200MHz Digital Frequency Meter	548	£5.14
– DEC '86 –		
Dual Reading Thermometer	549	£7.34
Automatic Car Alarm	550	£2.93
BBC 16K Sideways RAM (Software Cassette)	551	£2.97
	551S	£3.88
– JAN '87 –		
Random Light Unit	552	£5.88
– FEB '87 –		
Car Voltage Monitor	553	£2.48
Mini Amp.	554 & 555	£5.68
Video Guard	556	£3.80
Spectrum I/O	557	£4.35
Spectrum Speech Synthesiser	558	£4.86

– MAR '87 –		
Computer Buffer/Interface	560	£3.32
Infra Red Alarm: Sensor head	561	£4.19
PSU/Relay Driver	562	£4.50
– APRIL '87 –		
Alarm Thermometer	559	£2.60
Experimental Speech Recognition	563	£4.75
Bulb Life Extender	564	£2.48
– MAY '87 –		
Fridge Alarm	565	£2.40
EE Equaliser – Ioniser	566	£4.10
– JUNE '87 –		
Mini Disco Light	567	£2.93
Visual Guitar/Instrument Tuner	568	£3.97
– JULY '87 –		
Fermostat	569	£3.34
EE Buccaneer Metal Detector	570	£4.10
Monomix	571	£4.75
– AUG '87 –		
Super Sound Adaptor, Main Board	572	£4.21
PSU Board	573	£3.32
Simple Shortwave Radio, Tuner	575	£3.15
Amplifier	576	£2.84
– SEPT '87 –		
Noise Gate	577	£4.41
Burst Fire Mains Controller	578	£3.31
Electronic Analogue/Digital Multimeter	579	£6.40
– OCT '87 –		
Transtest	580	£3.32
Video Controller	581	£4.83
– NOV '87 –		
Accented Metronome	582	£3.77
Acoustic Probe	584	£2.78
BBC Sideways RAM/ROM	585	£4.10
– DEC '87 –		
Pseudo Echo Unit	586	£4.60
Dual Mains Light Flasher	587	£3.66
Twinkling Star	588	£2.61
Audio Sine Wave Generator	559	£3.03
– JAN '88 –		
Capacitance Meter	590	£4.10
Bench Amplifier	591	£5.51
Transistor Curve Tracer	592	£2.84
– FEB '88 –		
Bench Power Supply Unit	593	£4.01
Game Timer	583	£3.55
– MARCH '88 –		
Semiconductor Tester	594	£3.19
SOS Alert	595	£2.78
Guitar/Keyboard Envelope Shaper	596	£4.23
– APRIL '88 –		
Stereo Noise Gate	597	£6.65
Pipe & Cable Locator	598	£2.72
Inductive Proximity Detector	574	£2.97
– MAY '88 –		
Multi-Channel remote Light Dimmer		
Transmitter	599	£2.78
Receiver	600	£3.07
Door Sentinel	605	£2.60
Function Generator – Main Board	606	£5.91
Function Generator – Power Supply	607	£4.19
Super sound Effects Generator	608	£4.78

Please note that when ordering it is important to give project title as well as order code. Please print name and address in Block Caps. Do not send any other correspondence with your order.

EE PRINTED CIRCUIT BOARD SERVICE			
Please send me the following p.c.b.s.			
Make cheques/PO payable to: Everyday Electronics			
(Payment in £ sterling only)			
Order Code	Project	Quantity	Price
.....
.....
.....
.....
I enclose cheque/PO for £.....			
Name			
Address			
.....			
.....			
Please allow 28 days for delivery			

BLOCK CAPITALS PLEASE

DOWN TO EARTH

BY GEORGE HYLTON

POWER supply circuits look simple. But their operation is a good deal more subtle than first appearances suggest. Here's a slightly unusual one which not only illustrates some of the points but provides a handy tool for the experimenter. It can double or quadruple the voltage and provide a centre-tapped d.c. supply from a mains transformer with only a single untapped secondary.

DOUBLING A BATTERY VOLTAGE

Before getting down to the real thing let's do a "thought experiment" which helps to introduce the general idea. Referring to Fig. 1: At (a), a 6-volt battery is used to charge a capacitor, C1. At (b), the charged capacitor is connected in series with the battery. The two voltages (charge voltage and battery voltage, each 6V) add. A voltmeter connected across A and B would read 12V d.c.

At (c), this 12V is used to charge a second capacitor, C2. Since the charge is now shared between two capacitors C2 cannot charge to the full 12V. But if the process (a,b,c) is repeated more charge is transferred. With continuous repetition C2 eventually becomes charged to 12V while C1 holds 6V. (If you don't believe me, try it—but with care.)

A.C. INPUT

In the half-wave voltage-doubling rectifier (HWVDR) circuit this process of using C1 as a bucket to empty more and more charge into C2 is carried out at mains frequency. The battery is replaced by a mains-derived a.c. voltage (usually from a transformer secondary winding).

In this way the charge on C2 is replenished every mains cycle, and the build-up of the voltage to twice the input is virtually instantaneous.

HWVDR CIRCUIT

In the real-life circuit (Fig. 2) operation can be visualised in two steps. The first (a) is to charge capacitor C1 via diode D1 as shown. That occupies one half cycle. C1 charges to roughly the peak value of the half-cycle indicated and that is about 1.4 times the nominal or r.m.s. voltage. Note that D1 can conduct only on the half-cycle marked. When the mains reverses on the next half-cycle D1 is reverse biased and nonconducting.

The second step (b) consists of removing D1 and connecting D2 and C2. D2, like D1, is a half-wave rectifier and can conduct only when the a.c. polarity is the reverse of (a). The a.c. input $V_{a.c.}$ now aids the charge on C1 and C2 charges to a higher voltage than C1.

As the process is repeated so C2 acquires a charge voltage which approaches the sum of the d.c. voltage stored in C1 and the peak of $V_{a.c.}$ This sum amounts to twice the peak of $V_{a.c.}$ which comes to 2.8 times the r.m.s. voltage. A simple half-wave circuit would provide only half this voltage.

In practice it would be inconvenient to have to keep disconnecting and reconnecting the diodes—especially at mains frequency! Fortunately it isn't necessary. Diodes D1 and D2 can be permanently connected without interfering with one another. (This is because when one is conducting the mains polarity is always such that the other is reverse biased and so is effectively out of circuit.)

This particular form of voltage-doubling rectifier is called "half wave" to distinguish it from a better known arrangement called "full-wave". However, the term "half-wave" is misleading. It's clear that current flows from the transformer winding during each and every half-cycle. So as far as the transformer is concerned the operation is full-wave.

That's important because with half-wave operation d.c. would be passed through the winding. This is bad practice because it can lead to core saturation and overheating.

The charge on capacitor C2 gets replenished only once per mains cycle. So the ripple on C2 is at mains frequency, as in a half-wave rectifier circuit, not twice mains frequency as in familiar forms of full-wave rectifier such as the bridge. This is perhaps the reason for calling our circuit "half-wave".

RATINGS

The HWVDR is obviously useful if you have a transformer which can't supply enough voltage for your need, when it's used to drive a bridge rectifier. It has other virtues, too, but before looking into these let's just see how to use the basic circuit sensibly.

Capacitor C1 receives half the voltage of C2, so it can have a lower voltage rating. But what? In theory the d.c. voltage on C1 is equal to 1.4 times the r.m.s. input $V_{a.c.}$. But off-load voltages are higher than the rated voltage so in practice C1 should be rated at no less than 1.5 times the r.m.s. input and preferably a bit more. In the same way C2 should be rated not just at a d.c. voltage of 2.8 times $V_{a.c.}$ but at least three times $V_{a.c.}$

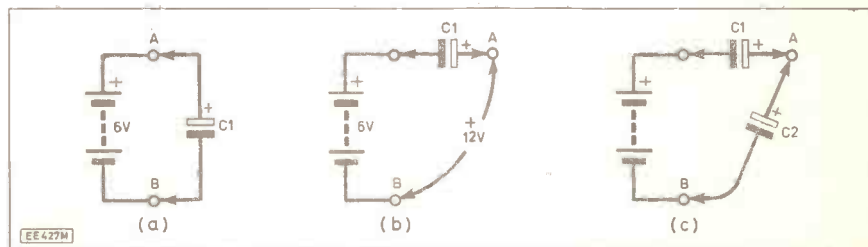
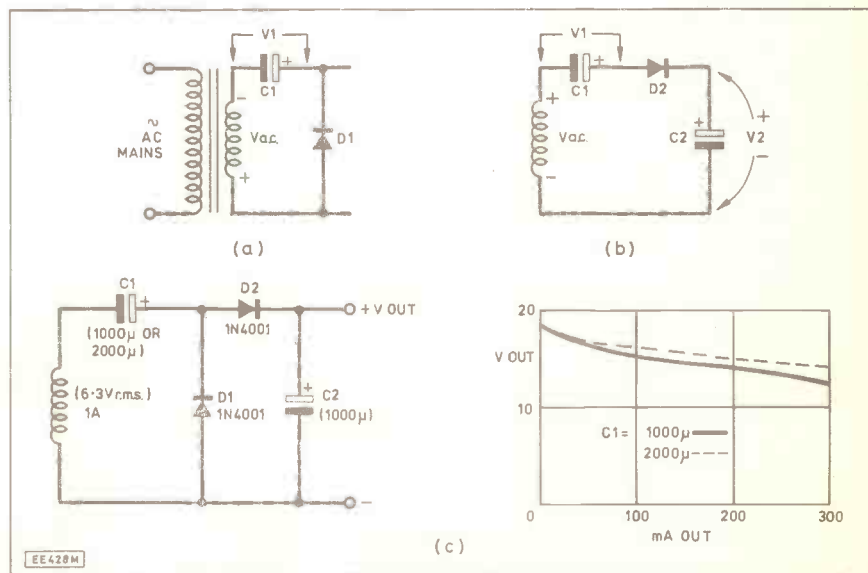

Fig. 1. How to double a battery voltage. (a) Charge C1 to 6V. (b) Reconnect C1 as shown. The voltage across AB is now 12V. (c) Charge C2 from this increased voltage. Repeat the process and C2 ends up charged to 12V.

Fig. 2. Steps in voltage-doubling with a.c. supply. (a) During the half-cycle shown C1 charges via D1 to about the peak value of the a.c. input $V_{a.c.}$ (b) When the polarity is as marked $V_{a.c.}$ and V1 are series-aiding. They drive current through D2 to charge C2 towards $V_{a.c.}$ peak plus V1. (c) In practice, D1 and D2 can be permanently connected. D1 conducts on one half-cycle, D2 on the next. Values in brackets refer to the practical circuit whose performance is graphed.



The transformer wattage (or VA) rating needs also to be kept in mind. It limits the output current allowable. For the same power doubling the voltage implies halving the current.

Suppose, for example, that the rectifier is driven by a transformer winding rated to deliver 6V r.m.s. at 1A a.c. The power (wattage, VA) rating is thus 6VA or 6W. If the HWVDR delivers a d.c. output of 18V then for 6W the current is 0.333A and this is the maximum safe d.c. output.

The graphs on Fig. 2c show my measurements using a valve heater transformer rated to deliver 6.3V r.m.s. at 1A. I tried two values of C1. You can see that doubling C1 improved the d.c. output a bit at the higher currents. It's also useful to increase C2 because this reduces output ripple voltage. Ripple on C2 is at mains frequency and on C1 at twice mains frequency.

VOLTAGE QUADRUPLING

A useful feature of the HWVDR is that one side of the a.c. input is common with the d.c. output. This makes it possible to connect a second HWVDR to give a second d.c. output, see Fig. 3.

If the diodes are connected as shown, with the reverse polarity to those in Fig. 2, this yields a negative output line. (The capacitor polarities are also reversed.) An input of around 6-7V r.m.s. will then give an output of +18V and -18V d.c. with the common output terminal as a zero line or centre tap if required.

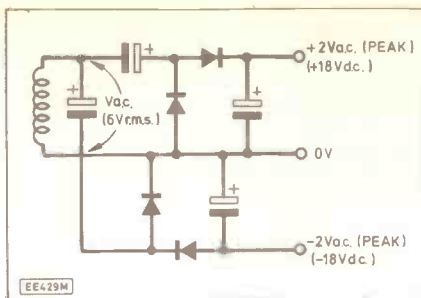

Fig. 3. Two half-wave voltage doublers can yield a centre-tapped supply when connected to a single untapped transformer winding. The total output is theoretically 5.6 times the r.m.s. input; i.e. 4 times the output voltage of a simple half-wave single diode rectifier.

In other words the circuit now delivers 36V centre-tapped. The d.c. output drawn from the positive and negative sides need not be equal but the total current times 18V must not exceed the transformer's VA rating.

CENTRE-TAPPED HWVDR

If you don't want a quadrupled voltage but would like a centre tap on the d.c. output of the simple voltage-doubler this can be arranged by a simple trick.

In Fig. 2, C1 and the transformer winding are in series, across D1. In a series circuit it doesn't matter what order the elements are connected in. We can

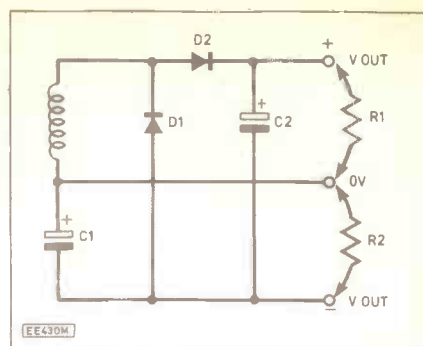

Fig. 4. The half-wave voltage doubler can be rearranged to provide a centre-tapped d.c. output but the d.c. loads R1 and R2 must be equal. Ripple on C1 is at twice the mains frequency.

reverse C1 and D1 (Fig. 4) without upsetting operation.

Now, as you know, C1 carries a d.c. voltage half that of C2. C1 now has a common terminal with C2. A load (R2) across C1 receives half the total output voltage. A load (R1) receives the difference between the voltage on C2 and the voltage on C1. As this is also half the total output we have a centre-tapped d.c. supply with the positive terminal of C1 common.

To avoid d.c. through the winding the currents drawn must be equal (i.e., $R1 = R2$). Note that C1 and C2 can be a twin capacitor with a common negative terminal (provided of course that the voltage rating is adequate).

The Archer Z80 SBC

The SDS ARCHER – The Z80 based single board computer chosen by professionals and OEM users.

- ★ Top quality board with 4 parallel and 2 serial ports, counter-timers, power-fail interrupt, watchdog timer, EPROM & battery backed RAM.
- ★ **OPTIONS:** on board power supply, smart case, ROMable BASIC, Debug Monitor, wide range of I/O & memory extension cards.

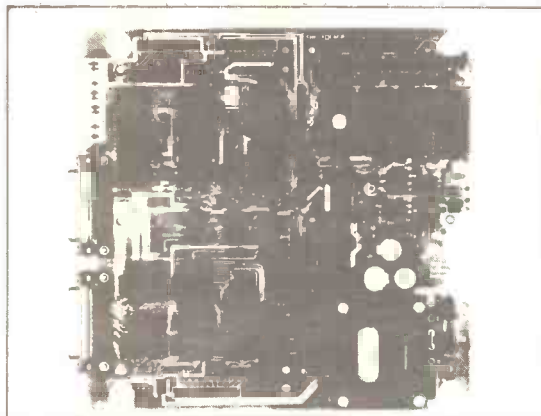

The Bowman 68000 SBC

The SDS BOWMAN – The 68000 based single board computer for advanced high speed applications.

- ★ Extended double Eurocard with 2 parallel & 2 serial ports, battery backed CMOS RAM, EPROM, 2 counter-timers, watchdog timer, powerfail interrupt, & an optional zero wait state half megabyte D-RAM.
- ★ Extended width versions with on board power supply and case.



Sherwood Data Systems Ltd

Sherwood House, The Avenue, Farnham Common, Slough SL2 3JX. Tel. 02814-5067

Reach effectively and economically today's enthusiasts anxious to know of your products and services through our semi-display and classified pages. The prepaid rate for semi-display spaces is £8.00 (plus VAT) per single column centimetre (minimum 2.5 cm). The prepaid rate for classified advertisements is 30 pence (plus VAT) per word (minimum 12 words), box number £1 extra. All cheques, postal orders, etc., to be made payable to Everyday Electronics. VAT must be added. Advertisements, together with remittance, should be sent to the Classified Advertisement Dept., Everyday Electronics, 6 Church Street, Wimborne, Dorset BH21 1JH. Tel: (0202) 881749.

Electronic Components

ESR ELECTRONIC COMPONENTS

- Velleman Electronic Kits
- Test Equipment & Tools • Instrument Cases

New 1988 Catalogue now available £1.85 incl. P&P

Station Road, Cullercoats, North Shields, Tyne & Wear NE30 4PG. Tel: 091-251 4363

WALTONS OF WOLVERHAMPTON

Established since 1947 - offering a complete range - I.C.s, transformers, switches, pots, capacitors, resistors, kits, speakers, test equipment, books and lots, lots more!

COME AND SEE US AT: MON-SAT 9-6.00 pm
55A WORCESTER STREET, WOLVERHAMPTON TEL: 0902 22039

Special Offers

PRINTED CIRCUIT BOARDS made to own requirements. For details send SAE Mr B. M. Ansbro, 38 Poynings Drive, Hove, Sussex BN3 8GR.

COPPER LAMINATE. In Nelco, Delektra, Paxolin. Thickness 0.004" to 1/8", copper weight, 1/2oz to 2oz, D/S or S/S. Telephone Tamworth 62416 for mail orders. Trade welcome.

FREE MEMBERSHIP to the National Components Club. For details and a free gift of components worth £10, send only £1 P&P to Higher Ansford, Castle Cary, Somerset BA7 7JG.

FIBREGLASS PROTOTYPING KIT for discretes. No daft pins! £5.00. Esaki Zartan, Box No. 111 (use EE address above).

Special Offers

COMPONENTS, Storage Cabinets, Electronic Horn, Helping Hands, other equipment, electronics and computer books and mags. Good condition. Contact David, Tel: 0904 85261.

OSCILLOSCOPE type cathode ray display, cased, with power supply and controls. 6 volt operation. Ideal for hobbyists/students/experimenters. new-£69.50. SAE for details first. Mail order only. N. W. Tinker, 123 Spinney Crescent, Toton, Beeston, Notts NG9 6GE.

Miscellaneous

TURN YOUR SURPLUS

ICS transistors etc., into cash, immediate settlement. We also welcome the opportunity to quote for complete factory clearance.

Contact **COLES-HARDING & CO,** 103 South Brink, Wisbech, Cambs.

ESTABLISHED OVER 10 YEARS
Tel: 0945 584188 Fax: 0945 588844

RCS VARIABLE VOLTAGE D.C. BENCH POWER SUPPLY
0 to 20 volts, up to 1.5 Amps d.c. Fully stabilised. Twin panel meters for instant voltage and current readings. Overload protection, fully variable. Operates from 240V a.c. Compact unit, size 9 x 5 1/2 x 3in. £36 plus post £2.



RADIO COMPONENT SPECIALISTS

337 WHITEHORSE ROAD, CROYDON, SURREY, U.K.
Tel: 01-684 1665
List, large SAE Delivery 7 days Callers welcome Closed Wednesday

QUALITY HAND TOOLS. Genuine Micro-Shear side cutters, Pliers, Screwdrivers at Competitive prices. SAE for listing. Quinton Tool Supplies, Dept. EE, 52 Grayswood Park Road, Birmingham, W. Midlands B32 1HE.

Service Manuals

TECHNICAL INFO SERVICES (EE)
76 Church St, Larkhall, Lanarkshire ML9 1HE
Phone 0630 884585 Mon-Fri, 9-5
any other time 0636 883334, FOR FAST QUOTES

WORLD'S LARGEST COLLECTION SERVICE MANUALS - Most unobtainable elsewhere. Prices range from only £4.50 - large s.a.e. any quotation, no obligation to buy.

WORLD'S SOLE Suppliers of TV & Video Repair manuals, etc. from TV TECHNIC, also such publishers as Heinemann, Newnes, TV Technic, Thorn etc. Every published service sheet in stock, supplied full size, not bits & pieces. CTV's or any combination £3.50 plus LSae; any other single item £2.50 plus LSae. Complete Circuit Sets for most Videorecorders only £7 set (no silly sets made).

LSAE for QUOTATIONS plus GIANT CATALOGUE - NEWSLETTERS - BARGAINS - FREE S/Sht as available.

Comprehensive TV Repair Manual £9.50. Complete Radio Service and Repair Course £9.50. Complete Repair & Service Manuals - Mono TV £12.50; CTV £17.00; Video £19.50. Complete Repair Data with circuit - Mono TV £9.50; CTV £12.50; Video £10.50.

£3.00 plus LSAE BRINGS THE ONLY COMPREHENSIVE SERVICE SHEETS & MANUALS, CATALOGUES plus FREE CHASSIS GUIDE and £4.00 OF VOUCHERS

CIRCUIT DIAGRAMS

Most Makes, Models, Types, Audio, Music Systems, Colour, Mono Televisions, Amateur Radio, Test Equipment, Vintage etc. £3.50 plus LSAE. State Make/Model/Type with order.

Full Workshop Manual prices on request with LSAE

MAURITRON (EE), 8 Cherry Tree Road, Chinnor, Oxfordshire OX9 4QY

Kits

GTI CAR COMPUTER (EE Jan. 88) gives MPG av. speed, trip, fuel etc. Kit £64.50, half kit £37.50. SAE to MSE, 11 Church Green Road, Bletchley, Milton Keynes. Tel (24 hrs) 0908 641548.

MICROTRANSMITTER - Matchbox size, 500 meter range, tunable 80-120MHz, receive on any VHF/FM receiver. ONLY £4.50.

TELEPHONE MONITOR - With the addition of a tape recorder will automatically record both sides of telephone conversations. ONLY £14.95. Please add 50p P&P per order. SAE for details. Cheques/POs payable to QUANTEK ELECTRONICS LTD. (Dept. EE), 267 Rednal Road, Kings Norton, Birmingham B38 8EB.

ORDER FORM PLEASE WRITE IN BLOCK CAPITALS

Please insert the advertisement below in the next available issue of **Everyday Electronics** for Insertions. I enclose Cheque/P.O. for £..... (Cheques and Postal Orders should be made payable to Everyday Electronics)

The advertisement must include an address, box number, or phone number as part of the paid wordage. Please remember to add VAT.

HEADING REQUIRED:

NAME

ADDRESS

EVERYDAY ELECTRONICS

Classified Advertisement Dept.,
6 Church Street, Wimborne, Dorset BH21 1JH.
Telephone (0202) 881749

RATE: 30p per word, minimum 12 words. Box No. £1 extra. VAT MUST BE ADDED

5/88

ATTENTION

Component buyers : Service engineers
Manufacturers : Project designers
Also hobbyists

SAVE TIME! SAVE MONEY!

We offer one of the largest ranges of semiconductor and passive components at low low prices! Also we are able to supply types from any major manufacturers

SO RING 01-965 5748

Next time you require components whatever the quantity you will be amazed at our service and prices!!

OMEGA ELECTRONICS 252A HIGH ST,
LONDON NW10 4TD

MAKE YOUR INTERESTS PAY!

More than 8 million students throughout the world have found it worth their while! An ICS home-study course can help you get a better job, make more money and have more fun out of life! ICS has over 90 years experience in home-study courses and is the largest correspondence school in the world. You learn at your own pace, when and where you want under the guidance of expert 'personal' tutors. Find out how we can help YOU. Post or phone today for your FREE INFORMATION PACK on the course of your choice. (Tick one box only!)

Electronics <input type="checkbox"/>	Radio, Audio and TV Servicing <input type="checkbox"/>
Basic Electronic Engineering (City & Guilds) <input type="checkbox"/>	Radio Amateur Licence Exam (City & Guilds) <input type="checkbox"/>
Electrical Engineering <input type="checkbox"/>	Car Mechanics <input type="checkbox"/>
Electrical Contracting/Installation <input type="checkbox"/>	Computer Programming <input type="checkbox"/>
GCE over 40 'O' and 'A' level subjects <input type="checkbox"/>	

ICS Name _____ P. Code _____
Address _____
International Correspondence Schools, Dept. EC558, 312/314 High St.,
Sutton, Surrey SM1 1PR. Tel: 01-643 9568 or 041-221 2926 (24 hrs)



NCT Ltd.

Calling all enthusiasts!

Now you have the opportunity to understand Digital Electronics from the beginning—use our Open Learning courses in the comfort of your own home—no previous experience is needed.

Just spend some time each week and enhance your skills in Digital Electronics—ideal for the hobbyist and industrialist alike—commence at any time—we'll send you the complete course package—no travelling is involved—work at your own pace—build exciting practical circuits on our unique PCB—tutor service is included.

Telephone (0296) 613067 now, or write for more information to:

NCT LTD.

**Bicester Hall, 5 London Road,
Bicester, Oxon OX6 7BU**

ELECTRONICS TECHNICIAN FULL-TIME TRAINING

(FULL TIME COURSES APPROVED BY THE BUSINESS & TECHNICIAN
EDUCATION COUNCIL)

2 YEAR
BTEC National Diploma (OND)
ELECTRONIC &
COMMUNICATIONS ENGINEERING
(Electronics, Computing, Television, Video, Testing & Fault Diagnosis)

1 YEAR
BTEC National Certificate (ONC)
ELECTRONIC ENGINEERING
1—INFORMATION TECHNOLOGY
(Electronics, Satellite TV, CD, Networks, Telecomms)

2—ELECTRONIC EQUIPMENT SERVICING
(Electronics, Television, Video Cassette Recorders, CCTV, Testing & Fault Diagnosis)

3—SOFTWARE ENGINEERING
(Electronics, Assembler, BASIC, PASCAL, CAD/CAM)

4—COMPUTING TECHNOLOGY
(Electronics, Computing Software/Hardware, Microelectronic Testing Methods)

10 MONTHS
BTEC Higher National Certificate (HNC)
COMPUTING TECHNOLOGY & ROBOTICS
(Microprocessor Based Systems, Fault Diagnosis, ATE, Robotics)

**THESE COURSES INCLUDE A HIGH PERCENTAGE OF COLLEGE BASED
PRACTICAL WORK TO ENHANCE FUTURE EMPLOYMENT PROSPECTS**
NO ADDITIONAL FEES FOR OVERSEAS STUDENTS
**SHORTENED COURSES OF FROM 3 TO 6 MONTHS CAN BE ARRANGED FOR
APPLICANTS WITH PREVIOUS ELECTRONICS KNOWLEDGE**

O.N.C. 19th September 1988

FULL PROSPECTUS FROM

LONDON ELECTRONICS COLLEGE (Dept EE)
20 PENYVERN ROAD, EARLS COURT,
LONDON SW5 9SU. Tel: 01-373 8721.

TRAINEE RADIO OFFICERS

Are you looking for a secure shore-based job which offers a rewarding career in the forefront of modern Telecommunications technology... then consider joining GCHQ as a Trainee Radio Officer. Training involves a 32 week residential course, (plus 6 weeks extra if you cannot touch type) after which you will be appointed RADIO OFFICER and undertake a variety of specialist duties covering the whole of the spectrum from DC to light.

We offer you: Job Security · Good Career prospects · Opportunities for Overseas Service · Attractive Salaries · and much more.

To be eligible you must hold or hope to obtain an MRGC or HNC in a Telecommunications subject with an ability to read Morse at 20 wpm.

(City and Guilds 7777 at advanced level incorporating morse transcription would be advantageous). Anyone with a PMG, MPT or 2 years relevant radio operating experience is also eligible.

The Civil Service is an equal opportunity employer.

Salaries: Starting pay for trainees is age pointed to 21 years. For those aged 21 or over entry will be at £7,162. After Training an RO will start at £10,684 rising by 5 annual increments to £15,753 inclusive of shift and weekend working allowance.

Write or telephone for an application form to:—



THE RECRUITMENT OFFICE, GCHQ, ROOM A/108
PRIORS ROAD, CHELTENHAM, GLOS GL52 5AJ
OR TELEPHONE (0242) 23292/3



THE VIRTUOSO POWER AMPLIFIER

INSIDE AN UPGRADED VIRTUOSO POWER AMPLIFIER

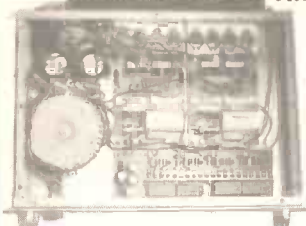

BUILD THIS SUPER POWER AMPLIFIER

**80-110W STEREO
150-300W BRIDGED MONO
2 SUPERBLY FINISHED CASE
SIZE 2U (above) & 3U (in black)**

TOP QUALITY COMPONENTS
For circuit details, specs, review, etc. see articles in Electronics Today International, April-June 1988.

For complete kits, cases, semiconductors and all parts used send 9in x 4in SAE (overseas 3 IRCs) to Audiokits.

APEX PREAMP AND POWER AMP

ACN16 updates on the Apex. Send £2.50 for 12-page Components Note which lists all known errors and amendments to text in March-June 1987 *Everyday Electronics* and offers ideas for upgrading the performance of the Apex Preamp and power Amp beyond the extremely high quality improved versions already built by many EE readers.



**AUDIOKITS PRECISION COMPONENTS 6 MILL CLOSE,
BORROWASH, DERBY DE7 3GU. Tel: 0332 67429**

OMNI ELECTRONICS

174 Dalkeith Road, Edinburgh EH16 5DX • 031 667 2611

The supplier to use if you're looking for
★ A WIDE RANGE of components aimed at the hobbyist ★
★ competitive VAT inclusive prices
★ mail order — generally by return of post ★
★ fast, friendly service ★

— by mail order, telephone order or personal call

Send 2 x 18p stamps for a copy of our latest catalogue — we do try to keep the goods we list in stock.

Whether you phone, write or call in we'll do our best to help you.



Open: Monday-Friday 9.00-6.00
Saturday 9.00-5.00



INDEX TO ADVERTISERS

A & G ELECTRONICS	297	MERLIN SYSTEMS	301
AUDIOKITS	312	MAURITRON	310
BI-PAK	312	NATIONAL COLLEGE	
B.K. ELECTRONICS	Cover iii	OF TECHNOLOGY	311
BULL, J. & N.	Cover ii	OMEGA ELECTRONICS	311
CIRKIT DISTRIBUTION	297	OMNI ELECTRONICS	312
CROTECH INSTRUMENTS	283	PHONOSONICS	258
C-SCOPE INT	301	RACKZ PRODUCTS	279
ESR COMPONENTS	310	RISCOMP LTD	289
GCHQ RECRUITMENT	311	SHERWOOD DATA	
GREENWELD ELECTRONICS	297	SYSTEMS	309
ICS	311	SPECIALIST	
JAYTEE ELEC. SERVICES	259	SEMICONDUCTORS	291
LIGHT SOLDERING DEVELOPMENTS	259	TK ELECTRONICS	262
LONDON ELECTRONIC COLL	311	WALTONS OF	
MAGENTA ELECTRONICS	260	WOLVERHAMPTON	310
MAPLIN ELECTRONICS	Cover iv	XEN ELECTRONICS	258
MARCO TRADING	283	ZENITH ELECTRONICS	301

THE UNDISPUTED PACK KING FOR OVER 20 YEARS, we offer you the very best in Electronic Components and Semiconductors that your money can buy. Look at our lists and prices, they are unbeatable in value and quantity and you always have our "Satisfaction or money back guarantee". For 1988 we offer more and more Super Value Packs. All goods advertised in stock at time of going to press. This is just a small part of our stocks. Send a stamped SAE for our full lists FREE. please note our new mail order address: BI-PAK, PO BOX 33, ROYSTON, HERTS SG8 5DF. Telephone 0763 48851.

RESISTORS			
Pak No	Qty	Description	Price
VP1	300	Assorted Resistors, mixed values & types	£1.00
VP2	300	Carbon Resistors, 1/4 watt, pre-formed, mixed	£1.00
VP4	200	1/2 watt Resistors, mixed values and types	£1.00
VP16	50	Wirewound Resistors, mixed watt values	£1.00
VP140	50	Precision Resistors, 1% tolerance	£1.00
VP181	100	1 and 2 watt Resistors, assorted values	£1.00
VP287	100	Close tolerance Resistors, 05-2%, 10-910 ohms, mixed	£1.50
VP288	100	Close tolerance Resistors, 05-2%, 1K-820K, mixed	£1.50
VP289	100	Metal oxide high stab. Resistors, 1/4w 2%, mixed values	£1.50

CAPACITORS			
Pak No	Qty	Description	Price
VP5	200	Assorted Capacitors, all types	£1.00
VP6	200	Ceramic Capacitors, Min. mixed values	£1.00
VP9	100	Assorted Polyester/Polystyrene Capacitors	£1.00
VP10	60	C280 Capacitors, metal foil, mixed values	£1.00
VP11	50	Electrolytics, all sorts	£1.00
VP12	40	Electrolytics, 0.47mf-150mf, mixed volts	£1.00
VP13	30	Electrolytics, 150mf-1000mf, mixed volts	£1.00
VP14	50	Silver Mica Caps, mixed values	£1.00
VP15	25	.01/250v Min. Layer Metal Caps	£1.00
VP180	25	Tantalum Bead Caps, assorted values	£1.00
VP182	4	1000uf 50v Electrolytics	£1.00
VP192	30	Min. Electrolytics, mixed values, 0.47mf-1000mf 6/16v	£1.00
VP193	6	Sub Min. Electrolytics, 2x 1000/2200/3300mf 10/16v	£1.00

OPTOS			
Pak No	Qty	Description	Price
VP24	10	.125" clear showing Red LEDs	£1.00
VP25	10	Mixed shape and colour LEDs	£1.00
VP26	15	Small 25 Red LEDs	£1.00
VP27	15	Large 2" Red LEDs	£1.00
VP28	10	Rectangular 2" Red LEDs	£1.00
VP57	25	Opto special pack, Assorted, Super Value	£3.00
VP129	6	RED 7 Seg. CA 5" LDP XAN6520 LED Display	£2.00
VP131	4	GREEN 7 Seg. CA 5" LDP XAN6520 LED Display	£2.00
VP133	6	RED Overflow 6" 3x CA 3x CC 6630/50 LED Display	£2.00
VP134	5	GREEN Overflow 6" CA XAN6530 LED Display	£2.00
VP138	20	Assorted LED Displays. Our mix, with data	£3.00
VP147	1	Pair Opto Coupled Modules	£0.40
VP199	4	LD707R LED Displays CA	£1.00
VP203	15	Triangular shape LEDs. Mixed colours	£1.00
VP204	10	Large Green LEDs, 5mm	£1.00
VP205	10	Small Green LEDs, 3mm	£1.00
VP206	10	Large Yellow LEDs, 5mm	£1.00
VP207	10	Small Yellow LEDs, 3mm	£1.00
VP208	10	Large LEDs clear showing Red, 2"	£1.00
VP241	2	ORP12 Light Dependent Resistor	£1.50
VP242	4	Tri-colour LEDs, 5mm Dia. 5mA 2v R.G.Y.	£1.00
VP243	3	Tri-colour LEDs, Rectangular 5mm R.G.Y.	£1.00
VP246	10	Orange LED's, 5mm large	£1.00
VP287	8	Stackable LED's, Rectangular, mixed, R.G.Y.	£1.00
VP288	15	LED Panel Mounting Clips, metal and plastic, 3-5mm	£1.00
VP289	2	Red Fishing LED's, 5mm	£1.00
VP284	2	Opto-isolator IL74-4N27, single	£1.00
VP285	1	Dual Opto-isolator ILD74	£1.00

TRANSISTORS			
Pak No	Qty	Description	Price
VP172	10	SM1502 PNP TO-39 Sil. Trans. 100v 100mA Hfa100+	£1.00
VP200	30	OC71 type germ. AF Transistors, uncodded	£1.00
VP201	25	OC46 germ. RF Transistors	£1.00
VP281	4	Programmable Unijunction Transistors, MEU22	£1.00
VP270	10	FEET's LMH/VHF Amplifiers, switching & choppers, data	£1.00
VP271	10	FEET's general purpose like 2N3819 2N5457, data	£1.00
VP272	10	MOS-FET's Signetics, SD304	£1.00
VP273	12	ZTA3200 NPN Silicon Transistors	£1.00
VP280	15	MPS406 Sil. Transistors. NPN 80v 500mA HFES0 - T092	£1.00
VP428	10	AC128K PNP Germanium Transistor, 1A 32v	£1.00
VP429	10	AC176K NPN Germanium Transistors, 1A 32v	£1.00
VP430	4	ZN3355 Sil. Power Transistors, full spec.	£2.00
VP431	25	PNP Sil. Transistors, TO-39 like 2N2954A	£1.00

I.C.S.			
Pak No	Qty	Description	Price
VP40	40	TTL I.C.s all new gates - Flip Flop - MSI. Data	£4.00
VP54	20	Assorted I.C. Diode Sockets, 8 - 40 pin	£2.50
VP59	20	Assorted I.C.s linear, etc. all coded	£2.00
VP208	12	74LS00	£2.00
VP210	12	74LS74	£2.00
VP211	10	CD4001B	£2.00
VP212	10	CD4011B	£2.00
VP214	10	CD4089B	£2.00
VP215	7	7419 P	£2.00
VP216	10	555 Timers 8 pin	£2.00
VP223	50	Asst 74 TTL I.C.s "ALL GATES" new and coded	£6.00
VP224	100	Asst 74 TTL I.C.s "ALL GATES" new and coded	£10.00
VP282	1	Prog. Sound Gen. Chip, AY-3-8912	£1.00
VP291	1	Z8002C Peripheral processor, 40 pin DIL	£2.00
VP282	1	Z80A10 Parallel Interface Controller, 40 pin DIL	£2.00
VP283	1	Z80A02 Counter Timer Circuit, 28 pin DIL	£2.00
VP294	1	Z8202 32K Eprom	£3.00
VP295	1	82C10 Peripheral Interface Adaptor (PIA)	£1.50
VP296	6	LM324 14 pin DIL Quad Op Amp	£2.00
VP287	5	CA3130E MOS-FET I/P. CMOS O/P. Op-Amp	£2.00
VP288	3	MC1310P Stereo Decoder, 14 pin DIL	£3.00
VP299	3	CA3308 Pos Volt. Regulator, 1.7v-46v, 8 pin TO5	£2.00
VP400	1	27128 128K Eprom	£2.50
VP401	2	LM317T Adjst. Voltage Regulator, 1.5A	£1.00
VP402	1	2714K Static Ram	£2.00
VP403	1	TA7204 Audio Amp I.C. 4.2w, 13v, 2.4 ohms	£1.00
VP404	1	TBA481 Audio Power Amp, 4.5w	£1.50
VP432	8	CD4018B	£2.00
VP433	6	CD4017B	£2.00
VP434	10	CD4024B	£2.00
VP435	10	CD4028B	£2.00
VP7413	4	7413 Dual Nand Schmitt Trigger, 4-input	£1.80
VP7480	4	7480 Dual 4-input, Positive Nand Flip	£1.80
VP7481	4	7481 16-bit Random Access memories	£1.00
VP7482	1	7482 Decade Counter	£1.00
VP7483	4	7483 B-BH Shift Register	£1.00

MISC.			
Pak No	Qty	Description	Price
VP177	1	Pack assorted Hardware, nuts, bolts, etc.	£1.00
VP178	5	Assorted Battery holders and clips PP3/9, AA/D, etc.	£1.00
VP223A	6	Tag Boards, 18 way parallel	£1.00
VP225	20	DIN Plugs, plastic 2.8 pin, 180°/240°/360° mixed	£2.50
VP226	20	DIN Chassis Skts, metal 2.8 pin 180°/240°/360° mixed	£2.50
VP227	18	DIN In-line Skts, plastic 2.8 pin 180°/240°/360° mixed	£2.50
VP228	10	C15 Computer Cassette Tapes, leadless	£3.00
VP232	1	Cassette Head Cleaner/Demagnetizer, in case	£2.50
VP233	1	Revolving Cassette Rack, holds 32, smokej perpass	£2.50
VP244	1	High Power Piezo Electric Iron. Emits earpiercing wailing sound. Ideal alarm. White plastic body with mounting bracket. Power 12VDC 150mA. Output 100db (A) at 1m typ. freq. 2.5KHz. Size: 57 x 42 x 37mm	£6.00
VP246	1	8" x 6" Elliptical 8ohms 10W RMS Speaker. Freq. Res. 50-10000 Hz, Gauss 10000. Centre HF cone	£4.50
VP280A	1	2" x Transducer Waterproof Speaker. Polyester film diaphragm. Moisture res. 8 ohms 300mW Freq. Res. 20-20000 Hz	£1.00
VP273	10	10k Lin. Rotary Potentiometers, aim/spindle	£1.00
VP281	4	Plug in Relays, Mixed volts, etc.	£1.00

TOOLS			
Pak No	Qty	Description	Price
VP95	1	Plastic Vice, small, with suction base	£1.75
VP97	1	Logic Probe/Tester, supply 4.5v-15v, DTL, TTL, CMOS	£8.50
VP99	1	Universal Tester, with ceramic buzzer	£3.00
VP103	1	6pc Stanley screwdriver set, flat and crosspoint	£3.50
VP138	1	Pick-up Tool, spring loaded	£1.75
VP217	1	Helping Hand	£4.00
VP218	1	Watchmakers Screwdriver Set, 6 pieces	£1.75
VP219	1	Miniature Side Cutters	£1.50
VP220	1	Miniature Bent-nose Pliers	£1.50
VP221	1	Miniature Long-nose Pliers	£1.50
VP227	1	Universal Ni-Cad Battery Charger, AA-HP11-HP2-PP3	£8.00
VP228	4	AA Ni-Cad Batteries, 1.25v 500mAh C/R mA	£4.00
VP229	2	C/HP11 Ni-Cad Batteries, Rechargeable	£3.50
VP240	2	D/HP2 Ni-Cad Batteries, Rechargeable	£4.00
VP246	1	25v Quality Low Cost Soldering Iron, 240V AC	£3.50
VP247	1	15w "Lightweight" Quality Low Cost Soldering Iron, 240V AC	£3.50
VP248	1	High Suction Desoldering Pump. Teflon nozzle. Auto eject. Heavy duty return spring	£4.00
VP250	1	Long Finger Grip, Soldering Aid. Heavy metal case, serrated jaws with rev. Trigger. Solder action. Ideal for holding small components. Fully adjustable	£3.00
VP254	1	250 grams Etchant Granules (Ferric Chloride) makes 1/2 pint	£1.00
VP255	1	Etching Pen, Etch resistant. Spare tip. Blue	£1.00
VP258	1	Multicore Solder, 5m total, 10 and 22 SWG	£1.00
VP259	1	PCB Holder. Fully adjustable from 0-320mm wide and to any angle. Comes with iron stand and sponge. Strong metal construction with rubber feet. Very high quality	£15.00
VP286	2	Etch Resist PCB Transfer Sheets. Assst. symbols/lines	£1.00
VP405	2	Steel Rules 1 x 4", 1 x 10", measuring ins and mm	£1.00
VP406	1	Junior Hack Saw & 3 blades-hobby knife & 2 blades	£1.00
VP407	1	10 Piece Needle File Set	£3.00
VP408	1	4 Piece Stainless Steel Tweezer Set	£4.00
VP409	1	Set of 4 pin. Iron cast Side & End Cutters, snip & combination Pliers, 5" insul. handles	£4.50

BI-PAK Send your orders to: BI-PAK DEPT EE, PO BOX 33, ROYSTON, HERTS
Terms: Cash with order. Personal cheques, Access and Barclaycard, Giro 388 7006. Same day despatch
Tel: 0763 48851. Add £1.50 P&P per order and 15% VAT

Published on approximately the first Friday of each month by Wimborne Publishing Ltd., 6 Church Street, Wimborne, Dorset BH21 1JH. Printed in England by Benham & Co. Limited, Colchester, Essex. Distributed by Seymour, 334 Brick Road, London SW9 7AG. Sole Agents for Australia and New Zealand - Gordon & Gotch (Aasia) Ltd., South Africa - Central News Agency Ltd. Subscriptions INLAND £14.50 and OVERSEAS £17.50 payable to "Everyday Electronics" Subscription Department, 6 Church Street, Wimborne, Dorset BH21 1JH. EVERYDAY ELECTRONICS is sold subject to the following conditions, namely that it shall not, without the written consent of the Publishers first having been given, be lent, resold, hired out or otherwise disposed of by way of Trade at more than the recommended selling price shown on the cover, and that it shall not be lent, resold, hired out or otherwise disposed of in a mutilated condition or in any unauthorised cover by way of Trade or affixed to or as part of any publication or advertising, literary or pictorial matter whatsoever.