

EVERYDAY **ELECTRONICS** and computer **PROJECTS**

DECEMBER 1984

90p



MINI WORKSHOP PSU - DOOR CHIME
New! **COMPUTER CLUB**

Australia \$1.60 New Zealand \$1.75 Malaysia \$4.95

EVERYDAY ELECTRONICS and computer PROJECTS

VOL. 13 No. 12 DECEMBER 1984

PROJECTS . . . THEORY . . . NEWS . . .
COMMENT . . . POPULAR FEATURES . . .

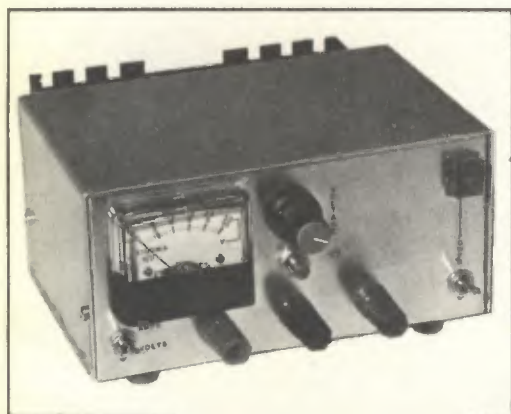

© IPC Magazines Limited 1984. Copyright in all drawings, photographs and articles published in **EVERYDAY ELECTRONICS** is fully protected, and reproduction or imitations in whole or in part are expressly forbidden.

Our January 1985 issue will be published on Friday, December 14. See page 736 for details.

PROJECTS

- ALFRED** by Alan Green 720
Part Two: Low cost hobby robot
- MINI WORKSHOP POWER SUPPLY** by William Leung 726
Variable-voltage unit with current limiting
- TV AERIAL PRE-AMP** by Mark Stuart 737
Improve the performance of your TV reception
- DIGITAL MULTIMETER** by I. A. Duncombe 748
Part Two: Construction and Testing
- DOORCHIME** by R. A. Penfold 758
Solid-state unit giving the effect of traditional chimes

SERIES

- DIGITAL ELECTRONICS** by D. W. Crabtree 732
Part Three: Combinational logic using LSI and MSI devices
- COMPUTER CLUB** by Thakery 740
A new fun outlook on computing
- FAULT FINDING** by E. A. Rule 756
Part Two: Fault analysis on newly built equipment

FEATURES

- EDITORIAL** 719
Electronics Education; Forum
- FOR YOUR ENTERTAINMENT** by Barry Fox 725
Electronic Scribe; Track Record; Mind Bender
- BOOK REVIEWS** 730
A selection of recent releases
- PLEASE TAKE NOTE** 730
Teach In '84—Pt12; Capacitance Comparator;
VIC-20 Light Pen (Circuit Exchange)
- SHOPTALK** by Dave Barrington 735
Product news and component buying
- SQUARE ONE** 742
Beginners' Page: Software
- EVERYDAY NEWS** 743
What's happening in the world of electronics
- NEW PRODUCTS** 744
Facts and photos of instruments, equipment and tools
- SPECIAL OFFER** 745
Radio Control Car
- COUNTER INTELLIGENCE** by Paul Young 746
A retailer comments
- RADIO WORLD** by Pat Hawker G3VA 755
Clear-Faced Sun; Grey-Line Propagation; Bringing In The Picture
- PRINTED CIRCUIT SERVICE** 762

- INDEX VOLUME 13** 763
January 1984 to December 1984

Readers' Services ● Editorial and Advertisement Departments 719

**Determine your
destiny with
dice and
dexterity**

with
the

NEW

**FANTASY
ADVENTURE GAME
"THE TOWER OF
TERROR"**

IN

**ON
SALE
NOW**

NEW

PROTEUS ^{65¢} **12!1**

A Complete Fantasy Adventure Game Magazine

COMPLETE GAME

Cirkit. Making it bigger and better.

Cirkit stock all the components, accessories and tools and the kits you're looking for. Designed and selected to offer the best possible standards at the best possible price.

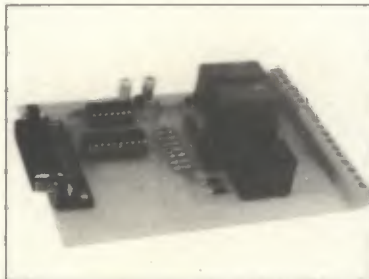

Centronics Interface

Cirkit Kits

CIRKIT ELECTRONICS TOOL KIT

Contains: 15W Soldering Iron 2 spare bits, heat shunt, solder, pliers, cutter, screwdriver

40-00007 15.56

AUDIO FUNCTION GENERATOR

Versatile waveform generator with sine, triangular and square wave outputs. On board mains PSU

41-01302 27.00

STEREO 40W AMPLIFIER

Single board 40W per channel stereo amplifier

41-01301 38.00

STEREO VU METER

5 LED per channel stereo VU meter for use with stereo amplifiers

41-01401 11.50

5W AUDIO AMP

A very compact audio output stage for use in a wide range of equipment

41-01406 4.60

UNIVERSAL AMP

A universal audio pre-amp with a gain of 10

41-01604 6.45

MONO REVERBERATION UNIT

Single channel, spring line reverb unit to add echo effects to tape recording etc.

41-01602 10.00

TONE GENERATOR AND DETECTOR

Very low distortion tone generator and signal detector for circuit fault finding

41-01603 10.46

10MHz DFM

8 Digit LED digital frequency meter and period measurement

41-01500 54.10

50MHz PRESCALER

Extend the range of the 10MHz DFM to 50MHz

41-01501 8.55

1-5MHz PRE AMP

Low frequency pre-amp and waveform shaper for the 10MHz DFM

41-01502 5.13

70cm PRE AMP

Low noise, miniature pre-amp for the 70cm amateur band

41-01506 4.78

70cm CONVERTER

70cm to 144MHz low noise converter featuring pre-aligned helical filter, schottky diode mixer and low noise transistors

41-01405 21.50

1-30V 1mA-2A PSU

Adjustable 1-30V Power supply with pre-settable current limit from 1mA-2A

41-01600 37.46

5-12V 1A PSU

Adjustable PSU from 5-12V with current protection, 1 amp max output

41-01504 6.45

1-30V 1.5A PSU

1-30 volt adjustable PSU with protected output up to 1.5 Amps

41-01402 10.45

3 DIGIT LED DVM

DVM to read up to 99.9 volts or configured as an ammeter to read up to 9.99 amps

41-01403 17.00

INFRA RED LINK

Single channel IR Link with relay output

41-01300 9.60

TEMPERATURE SENSOR

Thermistor based temperature sensor with relay output

41-01303 6.20

LOCOMOTIVE SOUND GENERATOR

Realistic steam sound and whistle for model railways

41-01304 9.20

LAMP DIMMER

Control lamps and drill speed

41-01305 5.70

WATER LEVEL ALARM

Alarm to indicate high water level or flooding

41-01601 2.70

3 NOTE CHIME

Doorbell chime with adjustable tones

41-01503 7.00

2M PRE AMP

Miniature low-noise MOSFET pre-amp for the 2m amateur band

41-01307 3.91

2M CONVERTER

Low noise 144MHz-28MHz amateur band converter

41-01306 17.35

2M POWER AMP

20W - 10dB gain - power amplifier for the 2m band. Automatic TX switch over, RX pre-amp, robust construction

41-01404 32.67

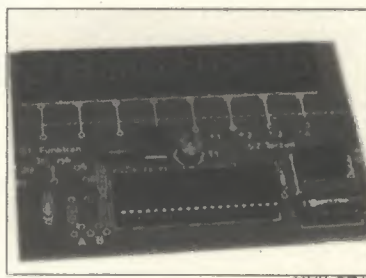

10MHz DFM

CRYSTAL CALIBRATOR

Crystal reference calibrator for alignment of receivers, outputs at 4, 2, 1MHz, 100, 50 AND 10KHz

41-00801 4.32

CB NOISE SQUELCH

Improves the mute performance of the majority of CB rigs

41-01605 5.40

CENTRONICS INTERFACE

Connect your personal computer to the outside world via the Centronics printer output

41-01406 22.50

70cm PA

10W Power amp to boost the output of handheld and portable 70cm transceivers

41-01505 33.82

Selected Lines

BBC to Centronics		
Connect Cable	03-10019	7.25
Dragon to Centronics		
Connect Cable	03-10017	7.25
C12 Computer Cassette interface 84 multiplexed Ram Card	21-00012	0.55
	40-84000	59.95
280A industrial controller	40-82000	54.95
EPROM Eraser 84T	40-82001	59.95
6502 Micro Controller	40-65020	54.95
6802 Micro Controller	40-68020	54.95
PB2720 80dB Piezo Buzzer	43-27201	0.55
10M15A 10.7 Center Freq.	20-10152	2.10
10M08AA 10.695 Center Freq.	20-11152	3.49
FC177 LCD (Freq.)	39-17700	20.00
CM161 LCD Clock	40-80161	8.25
8 x 0.3" IC socket	28-00800	0.12
14 x 0.3" IC socket	28-14000	0.13
16 x 0.3" IC socket	28-16000	0.13
6V KUIT-A Relay	46-80000	0.48
9V KUIT-A Relay	46-80001	0.48
12V KUIT-A Relay	46-80002	0.48
CX120P COAX Relay	46-90120	11.96
CX520D COAX Relay (N-type)	46-90520	26.98
CX540D COAX Relay (BNC)	46-90540	26.98

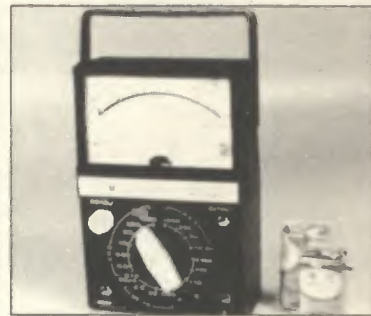

HT-320 Multimeter (20kΩ-V) 56-83201 14.00

Please add 15% VAT to all advertised prices and 60p post and packing. Minimum order value £5 please. We reserve the right to vary prices in accordance with market fluctuation.

Just send for our catalogue or visit one of our three outlets at:

200 North Service Road, Brentwood, Essex, CM14 4SG;
53 Burrfields Road, Portsmouth, Hampshire, PO3 5EB;
Park Lane, Broxbourne, Hertfordshire, EN10 7NQ.
Items in stock despatched within 48 hours

To: Cirkit Holdings PLC, Park Lane, Broxbourne, Hertfordshire, EN10 7NQ.

I enclose 85p. Please send me your latest catalogue and 3 x £1 discount vouchers!

If you have any enquiries please telephone us on Hoddesdon (0992) 444111.

Name

Address

Telephone

Area of Special Interest

EE12

Cirkit

Bigger Stock. Better Service.

New Winter Catalogue Out Now!

Heathkit - IT'S A PLEASURE TO BUILD

Bring the enjoyment back into your hobby with a kit from Heathkit. The beautifully illustrated documentation and step-by-step instructions make building a Heathkit a relaxing, absorbing pleasure! Every kit includes a constructors' guide covering soldering and component identification which makes construction straightforward even for a beginner.

The Heathkit range contains many kits ideal for beginners as well as amateur radio kits, computerised weather stations, a highly sophisticated robot, a 16-bit computer kit and a range of home (or classroom) learning courses that have easy-to-understand texts and illustrations, in sections so that you can progress at your own pace, whilst the hands-on experiments ensure long-term retention of the material covered.

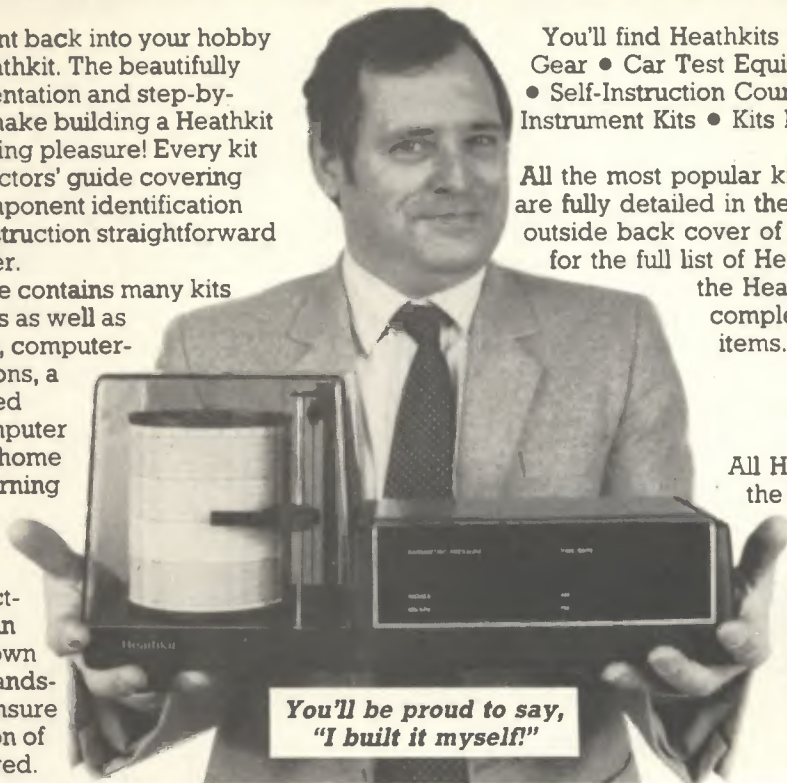

You'll be proud to say, "I built it myself!"

You'll find Heathkits available for Amateur Radio Gear • Car Test Equipment • Kits For The Home • Self-Instruction Courses • Computer Kits • Test Instrument Kits • Kits For Weather Measurements.

All the most popular kits and educational products are fully detailed in the 1984 Maplin catalogue (see outside back cover of this magazine for details) or for the full list of Heathkit products send 50p for the Heathkit International Catalogue complete with a UK price list of all items.

All Heathkit products available in the UK from:

Maplin Electronic Supplies Ltd.
P.O. Box 3, Rayleigh, Essex, SS6 8LR.
Tel: (0702) 552911.

(For shop addresses see back cover.)

ELECTROVALUE

Your **SPECIALIST SUPPLIERS** for **CAPACITORS** of all preferred types

POLYESTER LAYER (Siemens) B.32509 5mm PCM 10% tolerance 63V. In 13 values from 0.0047 to 0.47µF
B.32510 7.5mm PCM 10% tolerance 100V min. In 7 values from 0.0047 to 0.47µF
B.32512 15mm PCM 10% tolerance 100V 1µF, 2.2µF
B.32560 7.5mm PCM 26 types 10% tolerance 400V 0.001 to 0.0068µF
3% tolerance from 0.0082 to 0.68µF in 400, 250 & 100V

CERAMIC PLATE
Above 1000pF, in E6 values to 4700pF
C.333 100Vdc 1.8-4700pF - 10 types
B.37448 63Vdc 2.5mm PCM 0.01-0.68pF - 5 types
B.37449 63Vdc 5mm PCM 0.047, 0.68, 0.1µF
CERAMIC DISC
1nF-10nF, 300Vac
ELECTROLYTIC
Axial in 48 values from 1 to 10000µF, 10 to 53Vdc
Canned in 9 values from 2000 to 220000µF, voltages to 350

Reversible from 2 to 100µF
Low Leak, Almm. 0.1-100µF, 17 values, 6-50Vdc
Radial 15 values 1-1000µF, 16-63Vdc
TANTALUM BEADS
in 18 values from 0.1-100µF, 63-35Vdc
POLYSTYRENE (Siemens) 39 values 5pF to 18nF, 160Vdc.
The above ranges should meet the majority of current requirements. Mention EE when sending for our latest illustrated A-Z list showing very many more types.

BRITAINS No. 1 QUALITY COMPONENT SUPPLIERS
SEND FOR LATEST 44 PAGE A-Z LIST FREE
ATTRACTIVE DISCOUNTS-FREE POSTAGE-GOOD SERVICE & DELIVERY

ELECTROVALUE LTD 28 St. Jude's Rd, Englefield Green, Egham, Surrey TW20 0HB.
(0784) 33603. Telex 264475. (CALLERS ONLY) 680 Burnage Lane M/c (061-432 4945) EV Computing Shop, 700 Burnage Lane, Manchester M19 1NA (061-431 4866)

ACCESS AND BARCLAYCARD Phoned Orders Welcome

3

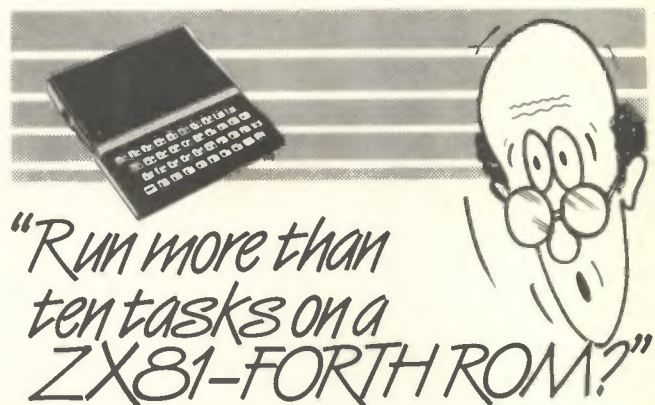

"Run more than ten tasks on a ZX81-FORTH ROM?"

Sure! More than 10 tasks simultaneously and, in some cases, up to 300 times faster! That's what replacing the basic ROM with the new FORTH does for the ZX81 - and more!

The brains behind the breakthrough belong to David Husband, and he's building Skywave Software on the strength of it. Already orders are flooding in and it's easy to see why.

The ZX81-FORTH ROM gives you a totally new system. In addition to multi-tasking and split screen window capability, you can also edit a program while three or four others are executing, schedule tasks to run from 50 times a second to once a year, and with a further modification switch between FORTH and BASIC whenever you like.

Return of post subject to availability.

The ZX81-FORTH ROM gives you a normal keyboard with a 64 character buffer and repeat, it supports the 16k, 32k, 64k RAM packs, it is fig-FORTH compatible and it supports the ZX printer.

The price, too, is almost unbelievable. As a "fit it yourself Eprom", complete with manual, it's just £25 + VAT. Add £2 p&p UK (£5 Europe, £10 outside Europe) and send your order to the address below.

Skywave SOFTWARE

David Husband
73 Curzon Road, Bournemouth, BH1 4PW, ENGLAND.
Tel: (0202) 302385.

International +44 202 302385.

EVERYDAY ELECTRONICS and computer PROJECTS

VOL. 13 NO. 12 DECEMBER 1984

Editor

MIKE KENWARD

Secretary

PAULINE MITCHELL

Consultant Editor

FRED BENNETT

Assistant Editors

DAVE BARRINGTON (Production)

DAVID SHORTLAND (Technical)

Technical Editor

MIKE ABBOTT

Projects Editor

DAVID BRUNSKILL

Technical Sub-Editors

RICHARD BARRON

BRIAN BUTLER

Art Editor

JACK POUNTNEY

Assistant Art Editor

KEITH WOODRUFF

Senior Technical Illustrator

JOHN PICKERING

Technical Illustrator

ISABELLE GREENAWAY

Editorial Offices

EVERYDAY ELECTRONICS EDITORIAL

WESTOVER HOUSE

WEST QUAY ROAD, POOLE, DORSET BH15 1JG

Phone: Poole (0202) 671191

We regret that lengthy technical enquiries cannot be answered over the telephone

Advertisement Manager

DAVID TILLEARD 01-261 6676

Secretary

CHRISTINE POCKNELL 01-261 6676

Advertisement Sales Executive

RICHARD WILLETT 01-261 6819

Classified Supervisor

BARBARA BLAKE 01-261 5897

Advert Make-Up and Copy Department

JULIE FISH 01-261 6615

Advertisement Offices

EVERYDAY ELECTRONICS ADVERTISEMENTS

KING'S REACH TOWER

STAMFORD STREET

LONDON SE1 9LS

Telex 915748 MAGDIV-G

Readers' Enquiries

We cannot undertake to answer readers' letters requesting modifications, designs or information on commercial equipment or subjects not published by us. All letters requiring a personal reply should be accompanied by a stamped self-addressed envelope or international reply coupons.

We cannot undertake to engage in lengthy discussions on the telephone.

Component Supplies

Readers should note that we do not supply electronic components for building the projects featured in EVERYDAY ELECTRONICS, but these requirements can be met by our advertisers.

All reasonable precautions are taken to ensure that the advice and data given to readers are reliable. We cannot, however, guarantee it and we cannot accept legal responsibility for it. Prices quoted are those current as we go to press.

WITH O/A level and college courses starting to peak again we note the increase in our postbag for information on certain projects or requests for p.c.b. and component supply. It is worrying to us that many requests made show a complete lack of understanding of the subject being dealt with, which does not lead one to have confidence in the future of high technology related industries in the UK.

Sad to say that as a nation we appear to have progressed little from my school days in the early sixties when the most we were taught was basic electricity and perhaps ohms law at 'O' level. Even the introduction of electronics as a recognised GCE subject has not brought forth floods of new recruit apprentices with a basic understanding of the subject. This is probably due to the fact that we have yet to train teachers in electronic theory and constructional techniques. Once again we have had no coherent policy to implement a new subject; a policy which should have been rooted in the development of electronics in the sixties, not twenty years later.

Of course it is easy to criticise with hindsight, but we must take urgent steps to overcome the problems now. I am sure that in many secondary schools students of electronics and computing are dragging their teaching staff into the eighties. My sympathy is with those staff members who have probably been forced to take a subject completely alien to their academic upbringing, staff that have to learn with their students, staff that have been ill-prepared for such subjects by the training colleges they attended.

During my days at school I knew the science master could not help me with the valve amplifier that failed to function or the transistor radio that oscillated, but modern youth should be able to call on such abilities from their tutors. The system has failed the students and the teachers.

We must put it right quickly. We must never go back to being a nation of shopkeepers, selling the world's high technology products. We must make sure that, while we interest our offspring in 'playing' with high technology product we also fire in them the search for understanding of the technology involved. Only with that interest, that investigative quest, that thirst for knowledge and the inventiveness it generates will our future in the progressive world be assured.

I hope that by publishing our various courses on electronics in EE—courses that have been running since 1971—we are playing our part in assisting the education of all students of electronics, be they teachers or pupils.

FORUM

Should there be any area where you feel we can do more, or should you simply wish to express a view on this subject, please write to EE. We would like our pages to provide a forum on electronics education which will hopefully benefit everyone.

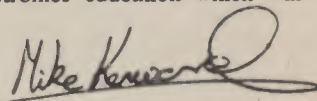

Back Issues

Certain back issues of EVERYDAY ELECTRONICS are available worldwide price £1.00 inclusive of postage and packing per copy. Enquiries with remittance should be sent to Post Sales Department, IPC Magazines Ltd., Lavington House, 25 Lavington Street, London SE1 0PF. In the event of non-availability remittances will be returned.

Binders

Binders to hold one volume (12 issues) are available from the above address for £4.60 inclusive of postage and packing worldwide. Please state which Volume.

Subscriptions

Annual subscription for delivery direct to any address in the UK: £12.00. Overseas: £13.00. Cheques should be made payable to IPC Magazines Ltd., and sent to Room 2613, King's Reach Tower, Stamford Street, London SE1 9LS.

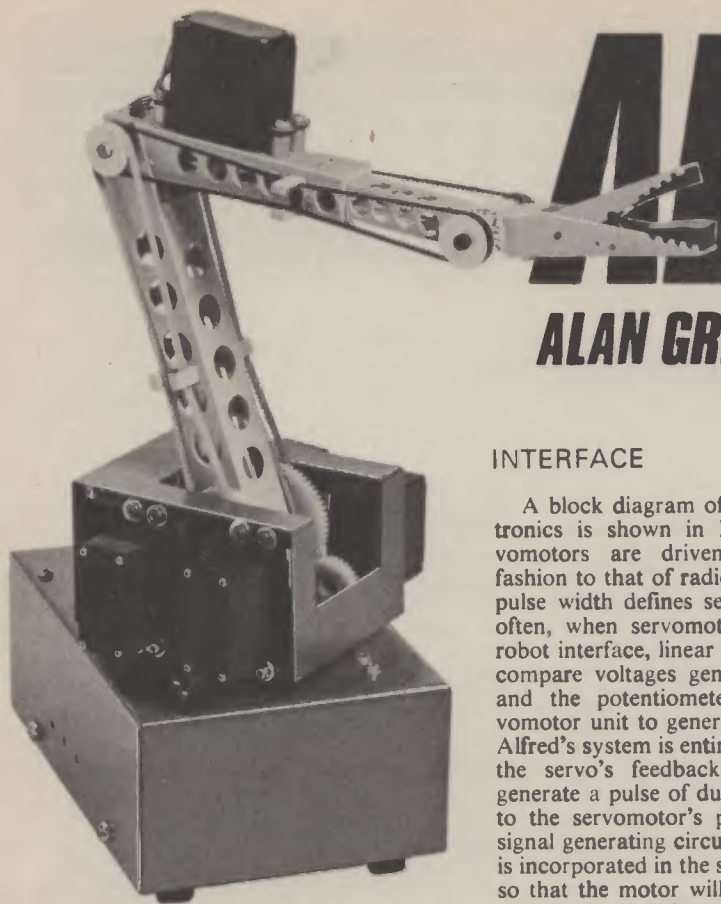

ALFRED

ALAN GREEN

PART TWO

INTERFACE

A block diagram of the interface electronics is shown in Fig. 2.2. The servomotors are driven in very similar fashion to that of radio control, in which pulse width defines servo position. Very often, when servomotors are used in a robot interface, linear circuitry is used to compare voltages generated by a DAC and the potentiometer within the servomotor unit to generate an error signal. Alfred's system is entirely digital and uses the servo's feedback potentiometer to generate a pulse of duration proportional to the servomotor's position. The error signal generating circuit and motor driver is incorporated in the servomotor housing so that the motor will automatically run in the right direction until the error signal is cancelled. All Alfred's interface board has to do is provide the motor units with pulses of width representing the positions selected by the user, through the controlling computer. RAM is needed to store the selected position for each axis.

You will notice that Alfred's gripper is likewise under this proportional control so that it may be fully opened, closed, or set *partially* to any position.

The full circuit diagram is shown in Fig. 2.3. Data is latched in to the 16 bytes of RAM (two 4-bit 40114s in parallel) to represent the position of each axis, these being divided into numerical positions in the range 1 to 255. Counting circuitry is used to cycle through the axes and generate the correct pulse widths for delivery to the servomotors themselves. An 8MHz crystal controlled clock signal is divided down to 800kHz and the counter outputs are used as one input arm to the comparator formed by IC11 and IC12. The 8-bit addressable latch, IC15, signals the servo's with pulses made up of ten microsecond steps, and set approximately 20ms apart. The nominal, or midway pulse, representing 128 numerically, is about 1.5ms in length.

The interface has a number of additional facilities; for example, there are eight servo lines which means two are

THIS month we take a look at the way in which Alfred's lower arm is assembled; that is, the revolving carriage with its four servomotors, and the fifth servomotor concealed within the base to provide rotation. Also we reveal the circuit diagram of the interface, along with the p.c.b. and its component layout.

CARRIAGE AND BASE UNIT

The carriage gear assembly is illustrated in Fig. 2.1. The exact 'nuts and bolts' details are not given here because these will depend upon the mouldings supplied with the kit. Indeed, the use of new 'snap together' moulded gear/pulley mouldings has greatly simplified the assembly procedure of Alfred's wrist over and above that described in Part One.

Alfred's carriage revolves on a sturdy ball-race. The carriage itself comprises two metal 'H' pieces held at a fixed distance from each other by two alloy cross-members, one of which is fixed to the ball-race. (See photographs.)

The printed circuit board mounts on four spacers inside the base unit. The board incorporates voltage regulators but no PSU proper, therefore it requires an unregulated low voltage (9-12V d.c.) supply. All connections to the board are made directly via p.c. mounted connectors. There are no plugs or sockets mounted on Alfred's metalwork.

Fig. 2.1. Carriage gear assembly showing location of the elbow, wrist and shoulder elevation servomotors together with the wrist rotation servo.

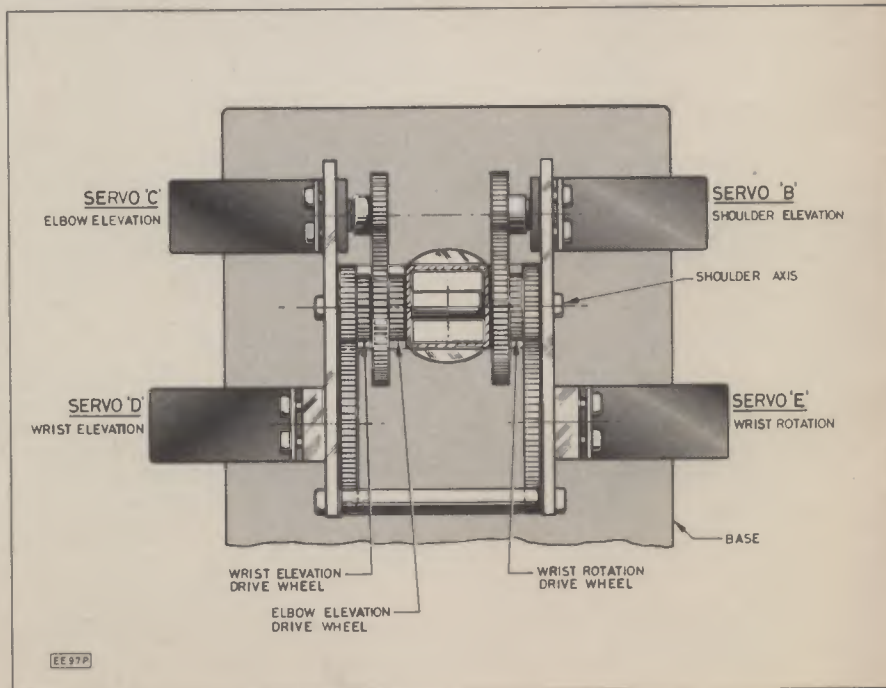

COMPONENTS

See
**Shop
Talk**

page 735

Resistors

R1,R3	47k (2 off)
R2,R8, R9, R10,R11, R12,R13, R14	4k7 (8 off)
R4,R6	220 (2 off)
R5	560
R7	1k8

Capacitors

C1,C2,C3,	47n disc ceramic
C5, C7-11	(9 off)
C4,C12,C13,	470n tant. bead
C14,C15	(5 off)
C6	100p ceramic

Integrated Circuits

IC1,IC2, IC4	74HC175 (3 off)
IC3, IC11, IC12	4585 (3 off)
IC5	74HC368
IC6, IC7	40114 (2 off)
IC8	4022
IC9 -	74LS290
IC10	74LS04
IC13	74HC4040
IC14	74HC32
IC15	74HC259
IC16-18	7805 Reg. (3 off)
IC19	7 x 3k3 s.i.l. res. pack
IC20	8 x 47k s.i.l. res. pack

Diodes

D1	1N4148
----	--------

Miscellaneous

XL1	8MHz crystal (HC18/U can)
PL1	20-way right-angle header (F145-028)
PL2	5-way angle plug (MS 1378)
PL4	4-way pin header (MS 1605)
PL5-10	8-way pin header (MS 1608) (6 off)
G	Wire wrap pin 1/100 (RS 434- 093)

Sockets 16-pin d.i.l. (12 off)
14-pin d.i.l. (3 off)
24 s.w.g. tinned copper wire
P.c.b.

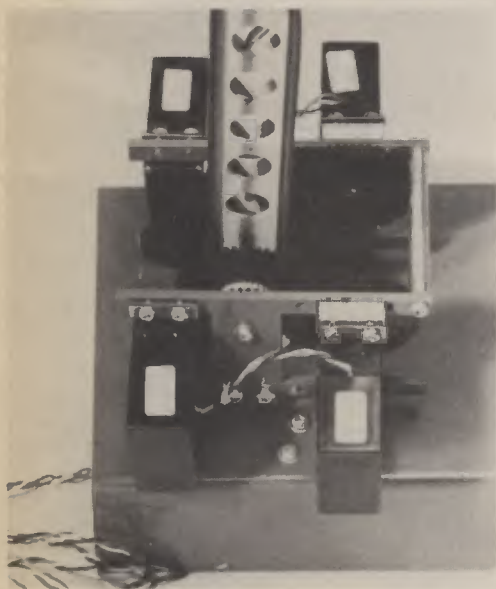

ALFRED CARRIAGE CONSTRUCTION

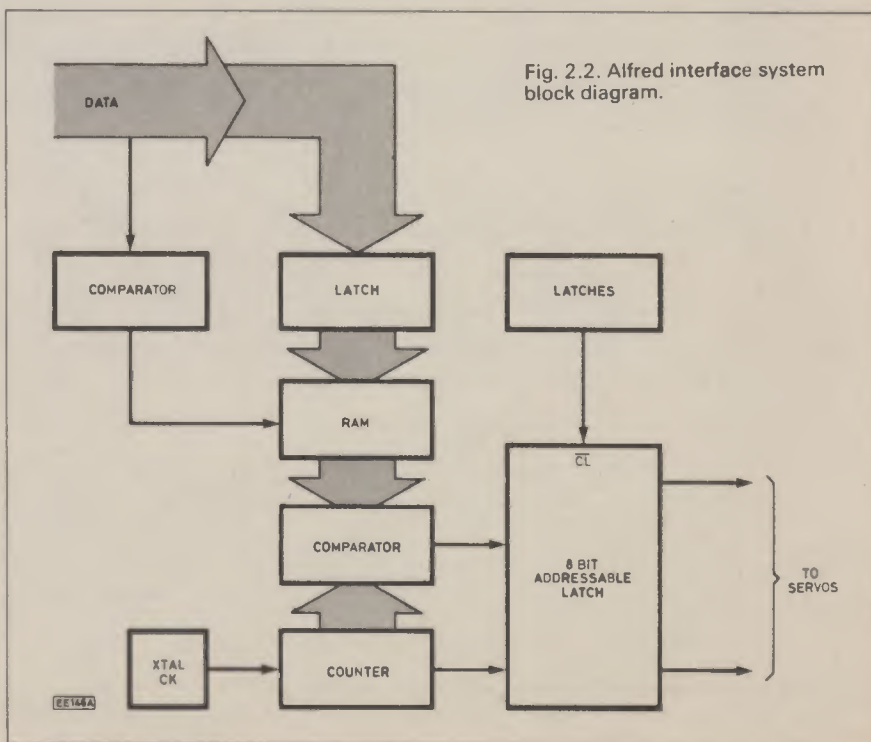

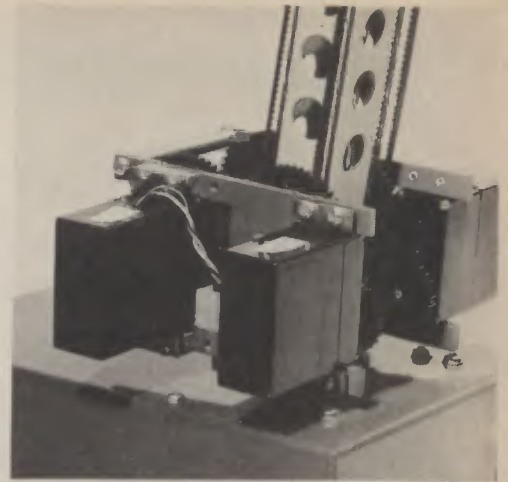
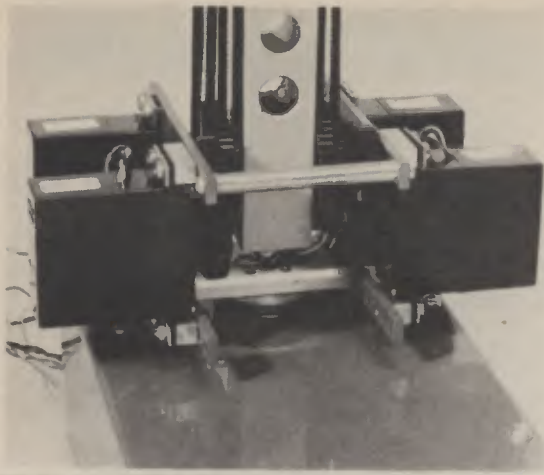
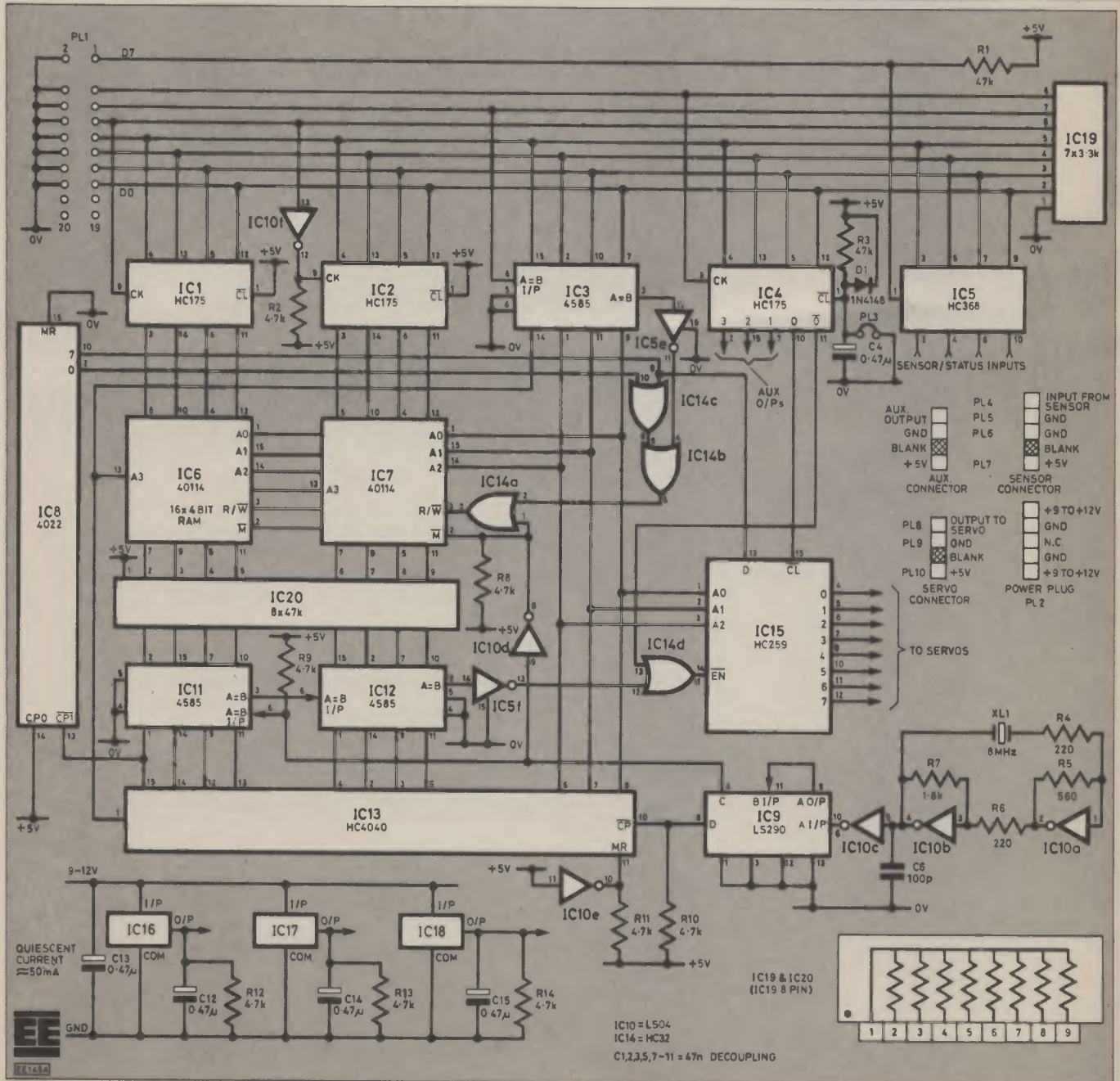
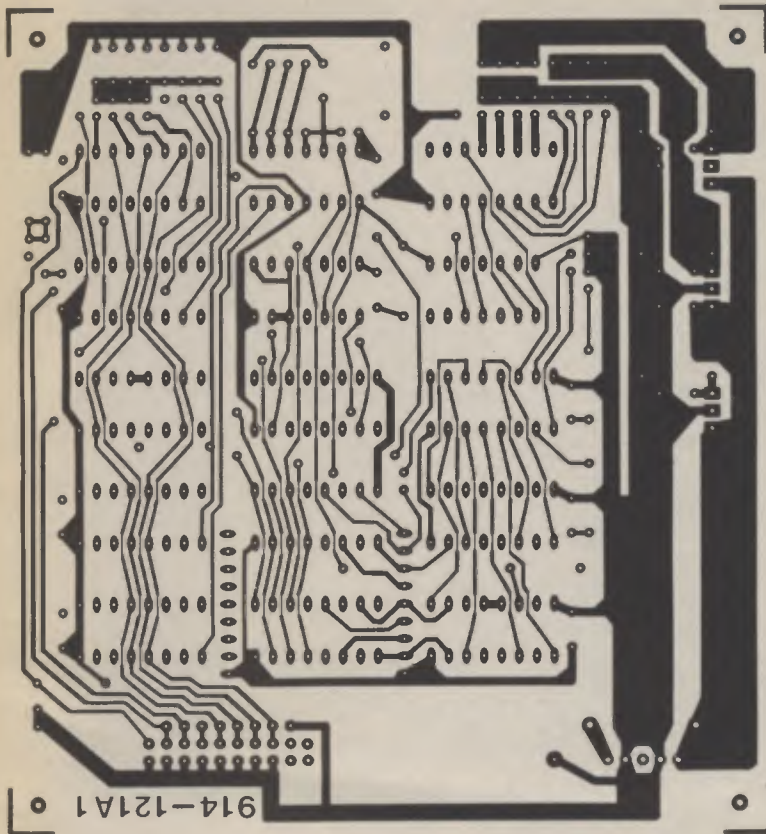

Fig. 2.3 (below). Full circuit diagram for Alfred Robot interface board.





ALFRED PRINTED CIRCUIT BOARD

Fig. 2.4 (above left). Trackside printed circuit board master pattern (actual size).

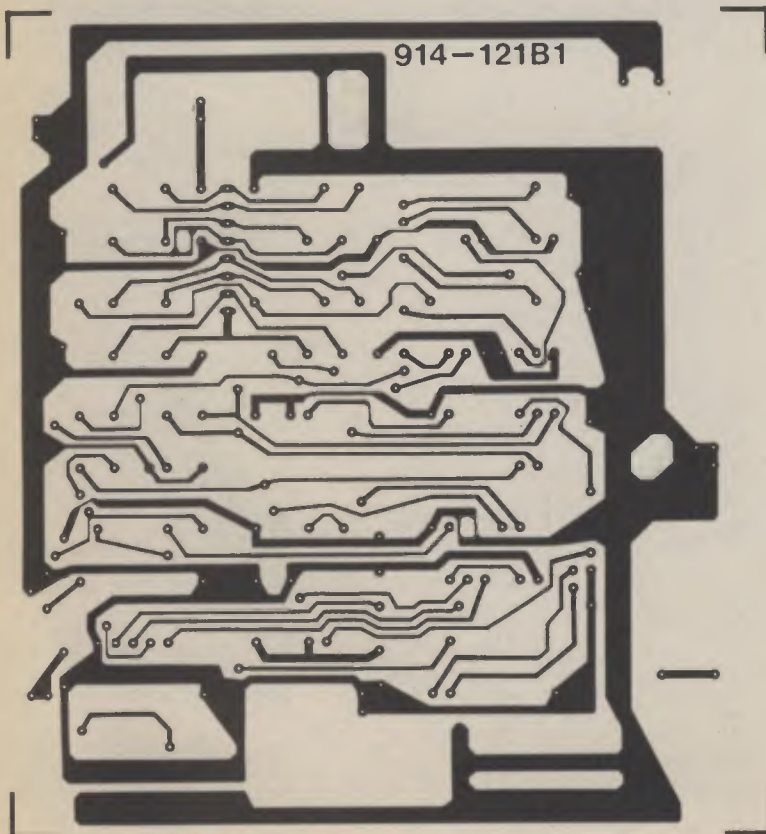
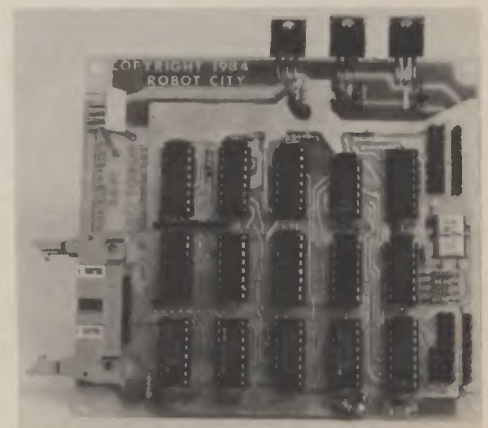

Fig. 2.5 (left). Component-side printed circuit board master pattern (actual size).



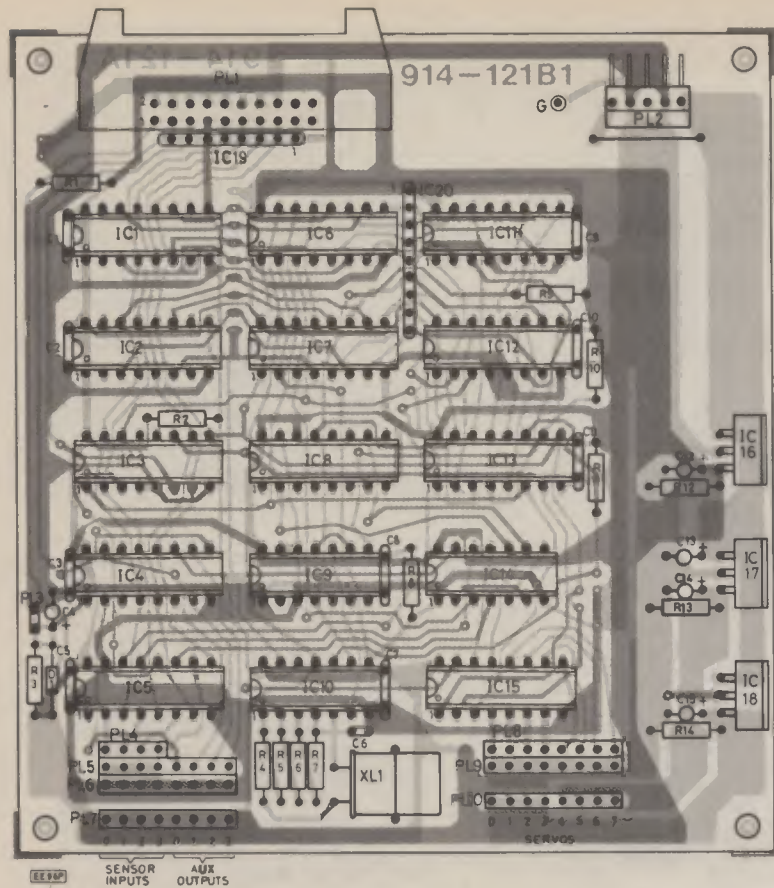

Fig. 2.6. Printed circuit board component layout. (P.c.b. copyright Robot City Technology Ltd.)

spare since Alfred only needs six of them. Also there are three spare control bits available at IC4. At IC5 there are four spare input bits and these, along with the other spare controls, will find applications in Alfred's planned mobile base, vision system and other add-ons.

PRINTED CIRCUIT BOARD

Construction of the printed circuit board is straightforward (see Figs. 2.4, 2.5 and 2.6). The order in which components are soldered is unimportant since i.c. sockets are used throughout. The i.c.s should be inserted last of all, *after* the board has been powered up to check that the supply voltages are correct. Take the usual precautions when handling the CMOS devices, and watch out for the polarity of i.c.s and tantalum bead capacitors. Also do not forget to solder the top-sides of components where necessary.

Note that if you intend to order the complete kit of parts from RCT you will receive a built and tested p.c.b.

NEXT MONTH: we describe some very useful and convenient-to-use software for Alfred that allows his movements to be programmed and edited. Also, full details of how to order a complete Alfred Kit.

SKYBRIDGE LIMITED

MAIL ORDER & SHOP, 441 PRINCES ROAD, DARTFORD, KENT DA1 1RB. Tel: (0322) 91454

Information: PIP 50p on orders less than £20 in value otherwise post free. All components full spec & guaranteed. Discounts available on orders over £50. Phone for details. For unlisted components - phone for prices. Goods normally despatched by return post.

<p>CABLE per metre</p> <p>Wire wrap 6p</p> <p>Red/White/Black Solid 1/6 3p</p> <p>11 colours 4p</p> <p>Hook-up 7/2 11 colours 3p</p> <p>Heavy Duty 32/2 4 colours 5p</p> <p>Extraflex Red/Black 15p</p> <p>Tinned Copper per 4oz reel</p> <p>SWG 16 80p SWG 22 95p</p> <p>SWG 18 85p SWG 24 95p</p> <p>SWG 20 95p</p> <p>En Copper per 2oz reel</p> <p>SWG 14 70p SWG 28 105p</p> <p>SWG 16 80p SWG 30 110p</p> <p>SWG 18 90p SWG 32 110p</p> <p>SWG 20 90p SWG 34 115p</p> <p>SWG 22 90p SWG 36 125p</p> <p>SWG 24 105p SWG 38 125p</p> <p>SWG 26 105p SWG 40 150p</p> <p>Figure 8 per metre 7/25 13p</p> <p>Coloured ribbon per foot</p> <p>20 way 20p</p> <p>20 way 40p</p> <p>34 way 80p</p> <p>Mains per metre 2/core</p> <p>Oval 3A 20p</p> <p>Round 6A 45p</p> <p>3 Core 1.0F 35p</p> <p>Round 3A 1.0F 50p</p> <p>Round 6A 1.0F 80p</p> <p>Round 13A 1.0F 80p</p> <p>POWER</p> <p>1mm T&E 40p</p> <p>1.5mm T&E 45p</p> <p>2.5mm T&E 60p</p> <p>6mm T&E 150p</p> <p>TV Coax 40p</p> <p>SCREENED</p> <p>Single Round 17p</p> <p>Twin Round 20p</p> <p>Figure 8 min 20p</p> <p>Figure 8 std 30p</p> <p>4 Core 70p</p> <p>Spiral Wrap 1/2 15p</p> <p>1/4 20p</p> <p>1/8 45p</p>	<p>Wide range of cable markers, sleeving, ties, fixings in stock - Phone for details.</p> <p>CAPACITORS</p> <p>Plate ceramic disc</p> <p>1.8pF-22nF 8p 2200pF 11p</p> <p>10pF 10p .01uF 5p</p> <p>47pF 15p .022uF 5p</p> <p>100pF 15p .047uF 8p</p> <p>470pF 15p .1uF 8p</p> <p>1000pF 11p .47uF 15p</p> <p>POYSTYRENE</p> <p>22pF 8p 1500pF 8p</p> <p>47pF 8p 2200pF 8p</p> <p>68pF 8p 3300pF 8p</p> <p>100pF 8p 4700pF 8p</p> <p>150pF 8p 5600pF 10p</p> <p>220pF 8p 6800pF 10p</p> <p>330pF 8p .01uF 14p</p> <p>470pF 8p .022uF 19p</p> <p>560pF 8p .047uF 25p</p> <p>680pF 8p .1uF 49p</p> <p>1000pF 8p</p> <p>POLYESTER</p> <p>.01uF 8p .15uF 15p</p> <p>.022uF 8p .22uF 11p</p> <p>.033uF 8p .33uF 16p</p> <p>.047uF 9p .47uF 16p</p> <p>.068uF 9p .1uF 26p</p> <p>.1uF 9p .22uF 49p</p> <p>ELECTROLYTIC uF/V</p> <p>1/63 8p 47/63 24p</p> <p>22/50 9p 100/10 11p</p> <p>47/63 9p 100/16 13p</p> <p>10/16 8p 100/25 15p</p> <p>10/25 8p 100/35 19p</p> <p>10/35 10p 100/63 25p</p> <p>10/63 10p 220/16 15p</p> <p>22/10 8p 220/25 20p</p> <p>22/16 10p 220/35 23p</p> <p>22/25 10p 220/63 33p</p> <p>22/35 11p 470/16 23p</p> <p>22/63 15p 470/25 27p</p> <p>47/10 10p 470/35 31p</p> <p>47/16 11p 470/63 48p</p> <p>47/25 13p 1000/10 24p</p> <p>47/35 15p 1000/16 29p</p>	<p>1000/25 41p 2200/35 74p</p> <p>1000/35 45p 3300/25 74p</p> <p>1000/63 75p 3300/35 92p</p> <p>2200/10 39p 4700/10 59p</p> <p>2200/16 46p 4700/16 74p</p> <p>2200/25 55p 4700/25 103p</p> <p>NON-POLARISED</p> <p>1uF 25p 10uF 25p</p> <p>2.2uF 25p 22uF 35p</p> <p>3.3uF 25p 33uF 40p</p> <p>4.7uF 25p 47uF 40p</p> <p>6.8uF 50p 100uF 70p</p> <p>Thousands of other capacitors in stock i.e. silvered mica, 1% polystyrene, polycarbonate, mylar, tantalum, trimmer, variable etc.</p> <p>CRYSTALS</p> <p>100k 460p 26.84m 200p</p> <p>1m 600p 26.69m 200p</p> <p>2m 220p 26.74m 200p</p> <p>3.2768m POA 26.79m 200p</p> <p>4m 180p 26.8m 200p</p> <p>4.19304m 320p 26.995m 200p</p> <p>4.433619m 320p 27.045m 200p</p> <p>6.144m 130p 27.095m 200p</p> <p>10m 200p 27.145m 200p</p> <p>18.432m 270p 27.195m 200p</p> <p>26.54m 200p 27.245m 200p</p> <p>26.59m 200p 27.255m 200p</p>	<p>Jack skt line 3.5mm 25p</p> <p>Jack plug 1/2 mono 20p</p> <p>Jack plug 1/2 stereo 30p</p> <p>Jack skt 1/2 mono 25p</p> <p>Jack skt 1/2 stereo 35p</p> <p>Jack skt line mono 25p</p> <p>Jack skt line stereo 30p</p> <p>Coax plug 15p</p> <p>Coax skt surf 30p</p> <p>Coax skt flush 25p</p> <p>Coax line skt 45p</p> <p>Coax coupler 45p</p> <p>Car aerial plug 15p</p> <p>FM aerial plug 20p</p> <p>BNC plug 100p</p> <p>BNC round skt 100p</p> <p>BNC square skt 100p</p> <p>BNC free skt 110p</p> <p>BNC str. adapt 140p</p> <p>BNC T. adapt 300p</p> <p>VHF plug PL259 50p</p> <p>Small reducer 20p</p> <p>Large reducer 20p</p> <p>PL259 rt. ang 90p</p> <p>VHF round skt 50p</p> <p>VHF square skt 50p</p> <p>Elbow adapt 50p</p> <p>Straight adapt 60p</p> <p>VHF T. adapt 160p</p> <p>Female T. adapt 180p</p> <p>XLR line plug 180p</p> <p>XLR chassis skt 330p</p> <p>XLR line skt 230p</p> <p>XLR chassis plug 160p</p> <p>DIN plugs 2 pin 10p</p> <p>3 pin 15p</p> <p>4 pin 35p</p> <p>5 pin A 15p</p> <p>5 pin 360° 30p</p> <p>6 pin 40p</p> <p>7 pin 20p</p> <p>8 pin 60p</p> <p>DIN skts 2 pin 10p</p> <p>3 pin 20p</p> <p>4 pin 15p</p> <p>5 pin A 15p</p> <p>5 pin B 20p</p>	<p>DIN skts 6 pin 20p</p> <p>7 pin 20p</p> <p>DIN line skt 2 pin 15p</p> <p>5 pin 30p</p> <p>D-type plug 9V 80p</p> <p>15W 150p</p> <p>25W 150p</p> <p>D-type skt 9W 140p</p> <p>15W 200p</p> <p>25W 450p</p> <p>D-type rt ang skt 9W POA</p> <p>15W POA</p> <p>25W POA</p> <p>D-type rt ang plug 9W POA</p> <p>15W POA</p> <p>25W POA</p> <p>Covers 9 120p</p> <p>15 120p</p> <p>25 130p</p> <p>Latches 9 30p</p> <p>15 50p</p> <p>25 60p</p> <p>Power plug 2.1mm 15p</p> <p>2.5mm 15p</p> <p>IEC line skt 90p</p> <p>IEC chassis plug 90p</p> <p>IEC chassis skt 90p</p> <p>IEC line plug 70p</p> <p>Bulgin P429 50p</p> <p>P46 165p</p> <p>P430 125p</p> <p>P49 135p</p> <p>P650 110p</p> <p>P635 100p</p> <p>P636 130p</p> <p>P551 300p</p> <p>P552 100p</p> <p>SA2403 160p</p> <p>SA2404 95p</p> <p>SA2190 50p</p> <p>SA1862 50p</p> <p>SA2111 200p</p> <p>SA2019A 150p</p> <p>SA2020 140p</p> <p>SA2367 180p</p> <p>SA2368 95p</p> <p>Many other connectors, adapters & leads in stock.</p>	<p>OPTO</p> <p>LED std red 10p</p> <p>green 18p</p> <p>yellow 15p</p> <p>LED min red 10p</p> <p>green 18p</p> <p>yellow 18p</p> <p>LED cup std 3p</p> <p>min 3p</p> <p>Large range of panel lampholders, de luxe LED's etc.</p> <p>FUSEWARE</p> <p>20mm panel holder 45p</p> <p>1 1/2" panel holder 50p</p> <p>20mm chassis holder 14p</p> <p>1 1/2" chassis holder 17p</p> <p>Line holder 14p</p> <p>Fuse cups 3p</p> <p>20mm fuses, 100mA, 150mA, 250mA, 500mA, 1A, 1.5A, 2A, 3A, 5A 9p</p> <p>20mm ant surges fuses, 500mA, 1A, 2A 12p</p> <p>1 1/2" fuses, 100mA, 150mA, 250mA, 500mA, 1A, 2A, 3A, 5A, 10A, 13A, 15A 9p</p> <p>1" Fuses 2A, 3A, 5A, 13A 15p</p> <p>RESISTORS</p> <p>1/4W 5% E24 2p</p> <p>1/4W 1% E24 7p</p> <p>1W 5% E12 10p</p> <p>3W WW R22-1R 30p</p> <p>10W WW 20p</p> <p>7W WW 30p</p> <p>10W WW 35p</p> <p>25W WW 170p</p> <p>WW pots 3W high quality 275p</p> <p>10R, 25R, 50R, 100R, 250R, 500R, 1K, 5K, 10K, 50K.</p> <p>SEMICONDUCTORS</p> <p>So extensive is the range of listed semiconductors. Please send large S.A.E. for details.</p> <p>TRANSISTOR MOUNTS</p> <p>T03 10p T066 10p</p> <p>DIL SOCKETS 16 pin 12p</p> <p>8 pin 9p 24 pin 21p</p> <p>14 pin 11p 40 pin 35p</p>
---	---	--	--	---	--

FOR YOUR ENTERTAINMENT

BY BARRY FOX

Electronic Scribe

We hear a lot about computer literacy in schools. We are breeding a generation which is as at home with keyboard and screen, as pen and paper.

This may not necessarily be a good thing. Several journalists I know are now using a portable computer with solid-state memory instead of pen and paper to make notes at press conferences. Although I own this equipment, and use it to send articles by electronic mail from abroad, I reckon there is still no substitute for pen or pencil and a wire-bound notebook.

I defy anyone to type as quickly as they can scribble, and think while they are doing it. The silent keyboards on these portables just aren't silent. They run out of memory and eat expensive batteries.

If the world had begun with portable battery powered computers and solid-state memory, we would now be heralding the invention of paper notebooks as a major breakthrough. No computer can give faster access than flipping through the pages of a notebook.

You save data by tearing out a page and keeping it; and erase data by tearing out a page and throwing it away. If you regret erasing something, you just rummage through the rubbish bin. If you run out of memory space, you can write on the backs of the paper pages or up the side margins. If a pencil breaks, you sharpen it.

Password

The British Library has woken up to the risk of training children in computer skills, but not following through with the necessary re-education on how to store and access data. The BL met recently with the American National Commission on Libraries and both bodies are now lobbying their governments to adopt a completely new approach to the school curriculum.

The libraries claim that knowing how to access a data base efficiently, instead of searching through paper, can double productivity. The obvious snag, of course, is that you have to know how to search a computer data base, rather than go to the library and take books off the shelves.

The hidden snag is that data base searching is by keyword. Even a seminal article will be lost forever in a digital memory if it does not contain a keyword that future searchers are likely to use.

But in true chicken and egg situation, the searchers cannot know what the crucial keywords are, without seeing the text. Journalists, scientists and academics will have to learn to use several obvious keywords, at least once, in each new text they write.

The legal profession already knows some of the pitfalls to its cost. It already has available a data base of legal precedents, for instance, who sued who over what tort and who won and lost.

The data base can be accessed by keywords, like name of the litigants or the legal tort at issue. Often, of course, lawyers

cannot remember the names of the people involved in an obscure case from donkey's years ago. So they have to search by tort.

Usually the only text stored is the judge's decision. Unfortunately, some judges have a warped sense of humour, which in this context is proving to be decidedly unfunny. Sometimes they refuse to use the standard legal jargon, and coin a new word of their own. So a search by normal keywords will fail to find the precedent.

Exactly the same thing will happen in the future if scientific discoveries are described in new words which the researcher has coined. Anyone writing a research report should think about this kind of problem now, because what you write today will end up in a data base of the future. No-one will have time to vet the text retrospectively, to make sure it includes logical keywords.

Track Record

If you are browsing in hi fi shops you may see an odd-looking turntable from NAD, the Massachusetts hi fi firm. NAD modestly called it L'GAT, the last great analogue turntable.

Although not too popular with hi fi buffs it has an interesting history. It was designed in Czechoslovakia, analysed by a Boston think-tank, refined by a German

Mind Bender

Earlier this year I was in Chicago for the Consumer Electronic Show (see October 1984 issue). Atari were drawing crowds and generating press and TV coverage with a very odd new video game.

The crowds round the Atari stand were queuing to play "Mindlink", Atari's new video game gimmick. Chicago television ran a news item on Mindlink; the Wall Street Journal wrote a report. I did not like what I saw.

Mindlink is a thick black band which clamps with Velcro touch-and-close fasteners round your forehead. A wire from the band plugs into an Atari video games unit, with some extra control software. The Mindlink system will sell at around 80 dollars and according to the Atari brochure "sends electronic impulses from your mind to your computer".

The demonstrator at Chicago, who claimed also to be the designer, said it worked by "EMG or electromyography". Atari's brochure says Mindlink "looks like magic, but works by relaxation" and lets users control their Atari video game "by the power of your mind alone".

What you do is look at the screen, pucker your forehead or eyebrows, and watch the graphics move as if under joystick control. This says Atari's literature "can reduce stress with biofeedback programs".

designer living in America and is being manufactured by the Tesla factory at Litovel, Czechoslovakia. The production tools were made in Yorkshire. And the technology in L'GAT is as confusing as its pedigree.

All hi fi gramophone designers face the same problem. The pick-up stylus must faithfully track groove undulations which are smaller than the wavelength of light. To stop the turntable behaving like a seismograph, it is suspended on isolating springs. But these have a natural resonant frequency and if it matches a natural resonance of the pick-up arm, there is a disastrous amplification of background noise.

To be really effective the turntable suspension should have a very low resonance, around 4Hz. The arm resonance varies with the compliance, or springiness, of the pick-up cartridge which the hi fi enthusiast fits. With bad luck the resonances match and interact.

Traditionally hi fi designers have used a rigid tube as the pick-up arm, to curb flexing. But good tubular arms are very expensive. In Czechoslovakia, where there's not much exotic hi fi available, enthusiast Jiri Janda designed a budget alternative. He used a thin flat arm that is laterally stiff but vertically flexible.

In Boston NAD came up with a sprung counterweight that can be adjusted to cancel the vertical resonance of the arm. The owner uses a calibration record supplied by NAD to fine tune the arm to a chosen cartridge.

L'GAT is being made by Tesla in Czechoslovakia which, says NAD, makes it the first East-West collaboration on a consumer electronics product. L'GAT costs £100, which is quarter the price of the best hi fi turntable. Audio experts are suspicious of the design theory.

Under Pressure

Frankly, I doubted that Mindlink worked as claimed. So I queued to play the game and then, while the demonstrator was not looking, took off the headband and fiddled around with it. Inside the band there are metal pads on soft squashy mounts. I found that if I put my hand across the metal pads, presumably to make electrical contact through my skin, and then squashed the mounts, the graphic pictures on screen dutifully moved.

At this point the demonstrator saw what I was doing and tetchily demanded that I stop. I suggested to him that Mindlink worked by straightforward electrical contact and mechanical pressure, rather than power of mind alone.

The demonstrator-designer vehemently denied this and promised to send full details, including patents, to prove that Mindlink works by sensing electronic impulses from the brain. Obviously the Wall Street Journal was convinced because its reporters wrote "positive and negative impulses from muscles in the forehead 'tell' the computer to move a playing figure..."

Despite reminders, I still have heard nothing from Atari and await with interest any attempt by the company to launch the product in Britain with a technical description as exotic as that spouted in Chicago.

MINI WORKSHOP POWER SUPPLY

WILLIAM LEUNG

A variable-voltage power supply is a basic requirement for the home constructor. This design offers output continuously variable from 3 to 30V, with built-in current limiting at 550mA.

THIS POWER SUPPLY UNIT is relatively cheap to build, and allows continuously adjustable output up to 30V, with current limiting. This means that the power supply is short-circuit protected—a useful feature. Thermal overload protection is also included.

The panel meter is switchable to read from 0 to 30V output, or 0 to 10V; alternatively, current can be measured on a scale from 0 to 1A.

THE CIRCUIT

The mains voltage is stepped down by transformer T1 to about 30 volts a.c. when both the secondary windings are connected in series. This is fed into the bridge rectifier REC1 which converts the alternating current into a pulsating direct current. See Fig. 1. Capacitor C1 smoothes out the pulses to give a nominal voltage of about 42 volts d.c.

The heart of the project is IC1, a 5-terminal adjustable voltage and current regulator, the output voltage of which is determined by the resistance of VR1:

$$V_{\text{out}} = 2.77 \left(1 + \frac{VR1}{R2} \right) \text{ volts}$$

Hence it can be seen that the higher the resistance of VR1, the higher the output voltage.

CURRENT LIMITING

The regulator features overload protection in the form of current limiting. To explain what current limiting is, an example is probably best. Suppose the output of the regulator was limited to a maximum of 500mA, and it was set to deliver 10 volts into a 100 ohm resistive load. By applying Ohm's Law:

$$V = I \times R \\ 10 = I \times 100$$

therefore $I = 0.1A$ or 100mA flows through the resistive load.

Now suppose that the load is changed to 5 ohms, then theoretically the current

flowing through this load would be:

$$V = I \times R \\ 10 = I \times 5$$

therefore $I = 2A$. However, because the maximum current allowed by the regulator is 500mA, the current which is actually delivered is in fact the preset 500mA. Hence the voltage across the load is:

$$V = I \times R \\ V = 0.5 \times 5$$

therefore $V = 2.5$ volts and not 10 volts as set. Referring back to Fig. 1, the combined value of R1a and R1b governs the maximum current which can be drawn from the power supply.

LIMITATIONS

Although the L200 regulator is capable of handling up to 2 amps as stated in the manufacturers' data sheets,

it is not however capable of delivering 2 amps over the entire range from 3 to 30 volts output for a given input voltage (e.g. 40 volts) into the regulator. (Likewise with any other similar voltage regulator.)

Even for 500mA flowing through the regulator, the maximum recommended voltage drop across the L200 according to the manufacturer's data sheet is about 25 volts for the regulator to operate properly. For our purposes, in order to cover the full 3 to 30 volts output at around 500mA, the input voltage would have to be at least 33 volts to cater for the maximum output voltage of 30 volts. At the other end of the scale, at 3 volts output delivering 500mA for the 33 volts input, there would be a voltage drop of about 30 volts across the regulator which obviously exceeds the maximum recommended value for the given current. However, the heat dissipated within the regulator will then cause the thermal

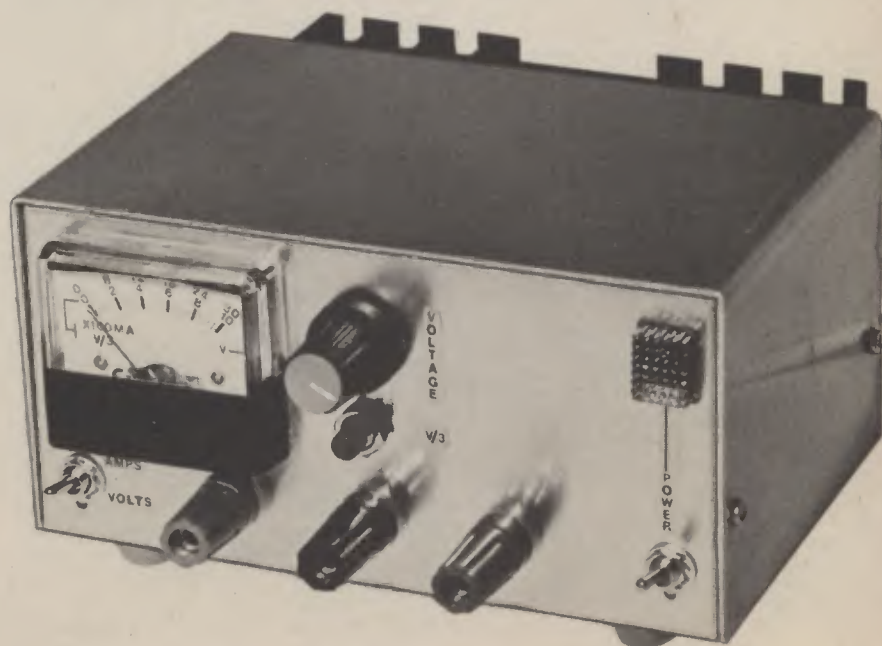

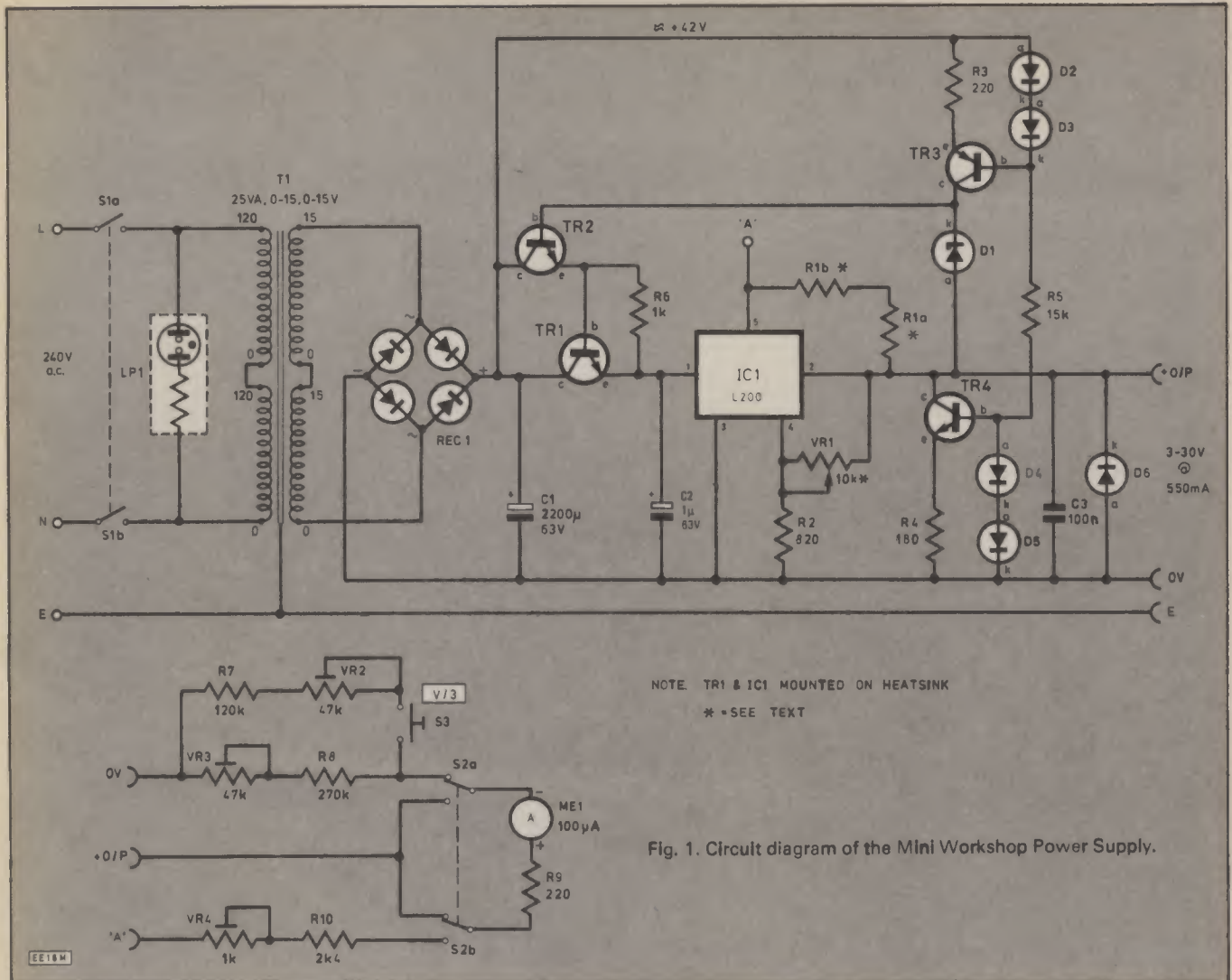

Fig. 1. Circuit diagram of the Mini Workshop Power Supply.

overload protection to trip in and thus shut down the regulator.

THERMAL PROTECTION

The remaining parts of the circuit are there to serve two inter-related purposes. The first is to solve the above problem by ensuring that at whatever output voltage, the voltage drop across the regulator will be around 4 to 4.4 volts. At such a low voltage drop across the regulator, the maximum dissipation which IC1 will experience is about 2.5 watts which can be handled quite easily. Hence IC1 does not require a large heatsink as most of the work in dissipating the heat is done by the series connected power transistor TR1.

This also means that the voltage reference at pin 4 of IC1 is unlikely to drift, causing the output voltage to drift in proportion, due to the excessive heat which IC1 would otherwise have had to deal with. Secondly, there is less likelihood of the regulator being damaged by an excessive voltage at its input when operating at 30 volts output. (The maximum continuous voltage input is 40 volts for the L200.)

The circuitry involved in carrying out the above task is fairly simple. D2, D3, TR3 and R3 form a simple constant current generator, whereby a constant current of about 3mA appears at the collector of TR3. This is sufficient to drive the Darlington configured pair TR1 and TR2 in addition to providing a suitable bias current for the Zener diode D1.

Because of the action of D1, the collector of TR3 will always be about 5.6 volts above the positive output terminal; and if the voltage difference between the base of TR2 and the emitter of TR1 is around 1.2 volts, then the input of IC1 will be about 4.4 volts ($5.6 - 1.2 = 4.4$) above the positive output terminal.

CONSTRUCTION

PRINTED CIRCUIT BOARD

Begin construction with the printed circuit board. See Figs. 2 and 3. Remember to insert the link, and to use Veropins for

“off board” connections. For the current limiting resistor(s), two Ω33 wirewound resistors in series can be used. If these are unobtainable, then a single Ω68 will suffice, with a link bridging the points where the other resistor would have gone. When inserting the semiconductors, make sure that they are fitted the correct way round, the same applying to the two electrolytic capacitors.

Once the circuit board has been completed, a suitable heatsink can be fitted to IC1 with a mounting kit smeared with heatsink compound.

METERING BOARD

For the specified panel meter, the two holes drilled in the board are correctly spaced for fixing to the terminals on the rear of the meter. Once the holes have been drilled and checked to see that they will actually fit onto the terminals, make the appropriate breaks and linking together of neighbouring tracks as illustrated in Fig. 4. Depending on whether

R1 consists of a single 0.68 ohm or two 0.33-ohm resistors, the value of R10 should be chosen to be either 2k7 or 2k4, respectively.

PANEL METER

With the specified panel meter, unclip the acrylic cover and carefully remove the two screws holding the faceplate in position. To add the "customised" scale, simply stick a white self-adhesive label over the original faceplate. (You should still just be able to make out the original scale markings beneath the label.) Then using a scalpel or something similar, carefully cut out as closely and as neatly as possible, the curved strip to reveal the graduations of the original scale underneath.

Once having done this, all that is now necessary is to use dry transfers to make up the new scale, and then to refit the revised faceplate and cover. Details of the customised scale used can be seen from the photograph. Finally, check that the meter movement is not obstructed.

HARDWARE

The case is a simple and inexpensive aluminium box of two "U"-shape pieces (150mm width, 100mm depth, 75mm high). For this case, the appropriate mounting holes for the front panel should be drilled as detailed in Fig. 5. If a panel meter other than the recommended one is used, and has a face larger than 50mm width by 45mm high, it will be necessary to alter the mounting positions of VR1 and S3 to allow for the same finger room between the control knob for VR1 and the panel meter.

The mounting position of the main circuit board, transformer and the rubber feet are shown in the final photograph.

Once all the appropriate holes have been drilled, including a suitable hole for passing the connecting leads from the power transistor TR1 to the main circuit board, follow the wiring diagram (Fig. 6) to complete the project. It is advisable to start with the "mains" potential wiring through to the main circuit board and finally the metering board. TR1 was mounted on the heatsink with a mounting kit smeared with heatsink compound.

The earth tag is connected to the case by fixing it to the nearby bolt which also fixes a rubber foot in place.

From the photograph of the inside of the power supply, it can be seen that the interconnecting leads are longer than actually necessary, so as to facilitate in the partial removal of the boards without having first to de-solder several leads from the board.

TESTING

Having completed all construction, re-check all interconnections paying particular attention to the mains wiring and to power transistor TR1. If satisfied, turn VR1 fully anti-clockwise, all internal presets fully clockwise and the "meter" switch set to VOLTS. Then connect a multimeter set to measure volts to the

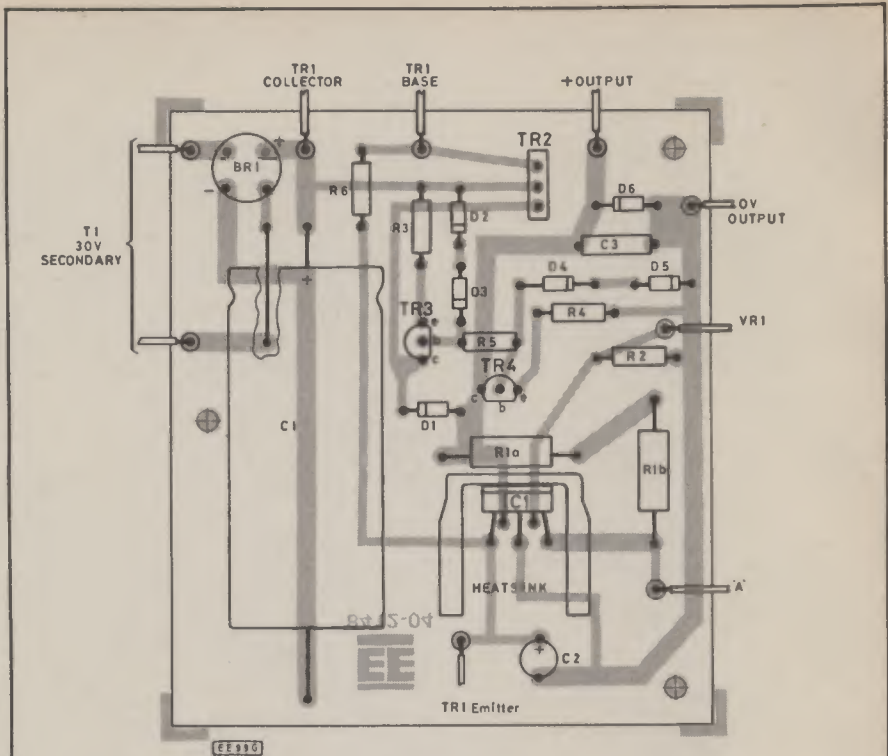

Fig. 2. Component layout.

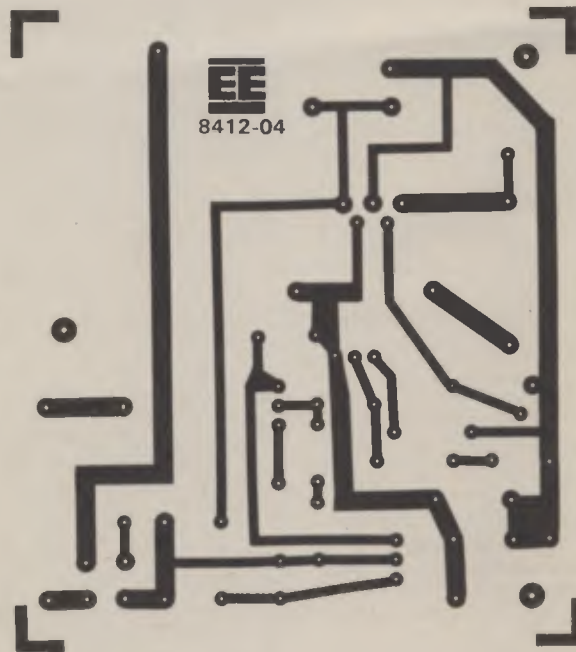

Fig. 3. Printed circuit board design.

output terminal posts and switch on the power supply. LPI should light up and the output voltage should be of the order of 2.7 to 3 volts, the panel meter reading slightly lower. If anything but this is obtained, immediately switch off the power and re-check your construction.

If all is well at this point, then slowly turn the voltage up by turning VR1

clockwise. The output voltage at fully clockwise position must NOT be greater than 34 volts, otherwise, damage to IC1 may result due to an excessive input voltage. To reduce the maximum capable output voltage, simply solder a resistor of around 100k across the two pins on VR1 which should already have connecting leads coming off them.

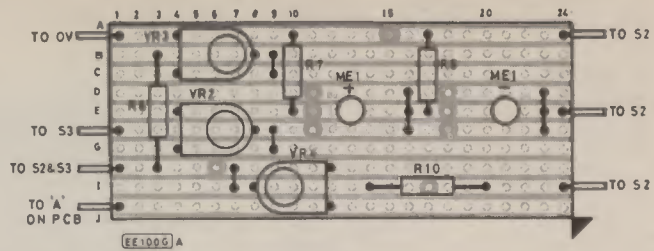
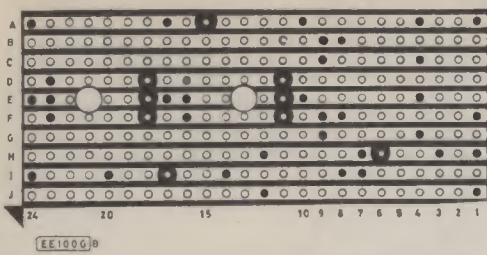

Fig. 4. Drilling details and component layout for matrix stripboard.

COMPONENTS

Resistors

- *R1a,b 0Ω33 (0Ω68) (2 (1) off)
1 watt wirewound
 - R2 820 R7 120k
 - R3 220 R8 270k
 - R4 180 *R10 2k4 (2k7)
 - R5 15k R9 220
 - R6 1k
- All ½W carbon ±5% except R1

Potentiometers

- VR1 10k linear
- VR2,3 47k (horizontal) sub miniature carbon preset (2 off)
- VR4 1k (horizontal) sub miniature carbon preset

Capacitors

- C1 2200µ/63V axial electrolytic
- C2 1µ/63V radial electrolytic
- C3 100n polyester

Semiconductors

- D1 BZY88C5V6 400mW Zener diode
- D2-5 1N4148 signal diode (4 off)
- D6 1N4002 rectifier diode
- REC1 W04 bridge rectifier
- TR1 2N3055 transistor (nnp)
- TR2 BD139 transistor (nnp)
- TR3 BC556 transistor (pnp)
- TR4 BC546 transistor (nnp)
- IC1 L200 voltage regulator

Miscellaneous

- T1 25VA: 0-15V, 0-15V transformer
 - S1,2 d.p.d.t. miniature toggle switch (2 off)
 - S3 push-to-make switch
 - ME1 100µA (3k5) panel meter (ALTAI)
 - LP1 mains neon indicator
- aluminium box (2B12), terminal posts (red, black, green), knob (VR1), heatsink for TR1 (4°C/W), heatsink for IC1 (17°C/W), main printed circuit board, Veroboard (10 strips of 24 holes), TO3 mounting kit, TO220 mounting kit, rubber feet (4), cable grommet, plus cable and mounting hardware.

Approx. cost
Guidance only

£25

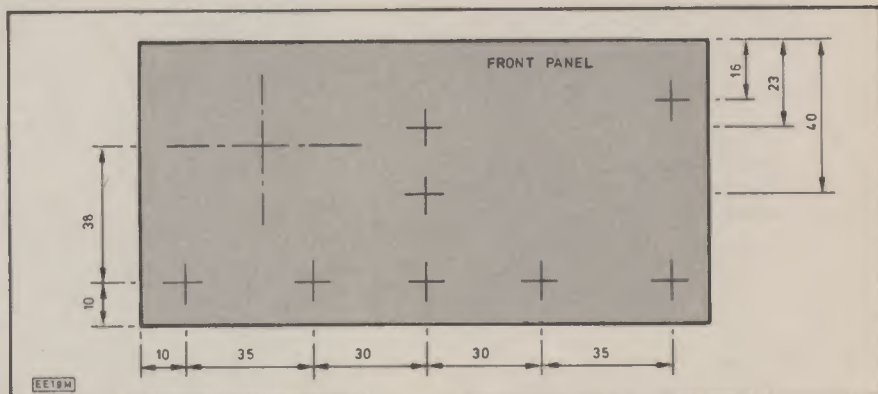

Fig. 5. Front panel dimensions.

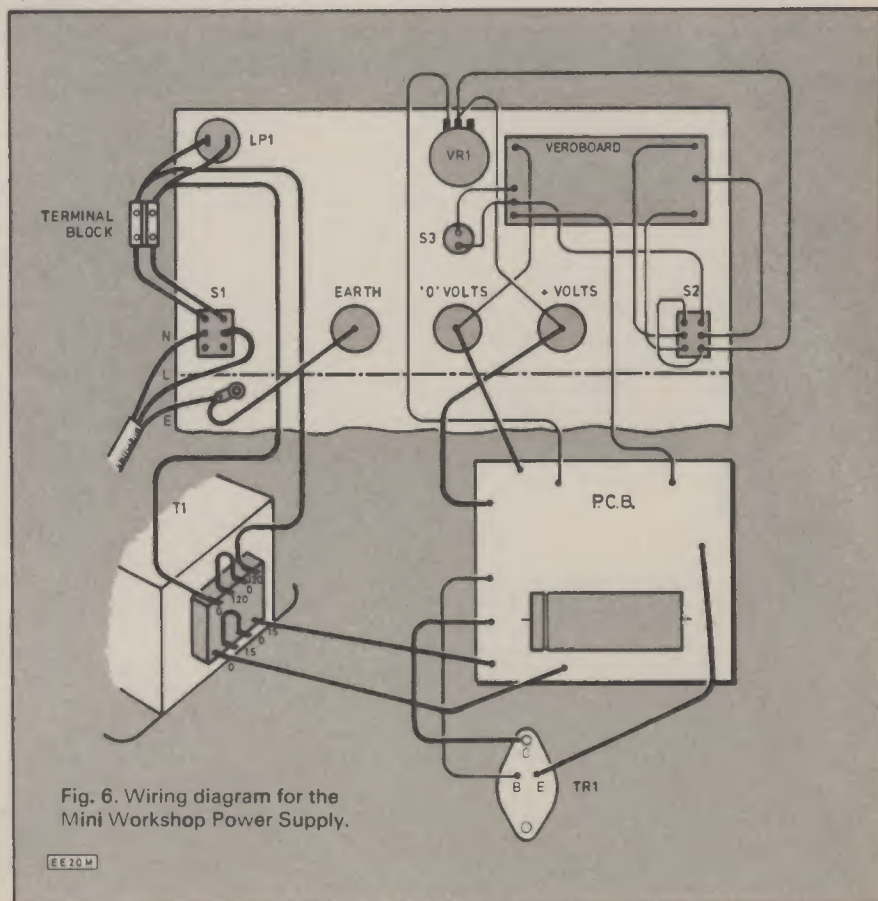

Fig. 6. Wiring diagram for the Mini Workshop Power Supply.

Once it is established that the desired voltage coverage is possible, then reconnect the multimeter to measure the input voltage of IC1 (connections to 0V terminal and the Veropin next to C2). Depending on the setting of VR1, the output voltage should be within the range 7 to 38 volts.

If all is still well, at this point, with VR1 fully anti-clockwise, connect the 10-ohm test resistor across the output terminals with a multimeter set on volts connected across the resistor. Advance VR1 slowly and at about 5.5 to 6 volts, however further VR1 is advanced, the voltage reading should remain constant. TR1 should also start warming up. If TR2 starts heating up, then switch off power immediately and check the connection between TR1 collector and the circuit board. (TR2 will probably need replacing.)

If no problems are experienced, then this test shows that the current limiting is working satisfactorily. If the value of the constant voltage obtained is significantly different from the value already mentioned, re-check your wiring and the physical condition of the current limiting resistor(s).

METER CALIBRATION

With the "meter" switch set to VOLTS and a multimeter connected across the output terminal posts set also to measure the voltage, adjust VR3 until the output voltage corresponds to the reading obtained on the upper scale of the panel meter. Next, ensuring that the output voltage is less than 10 volts, hold PB1 down and at the same time, adjust VR2 to calibrate the lower scale of the panel meter with the actual output voltage.

Finally, change the "meter" switch over to AMPS and with VR1 fully anti-

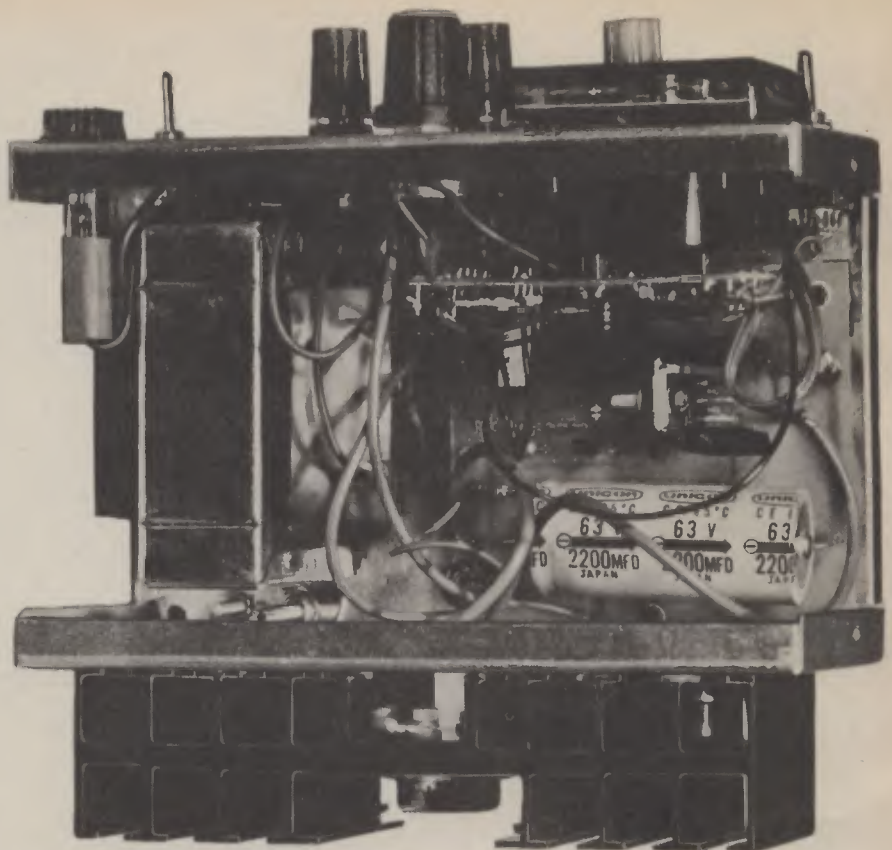

Photograph showing the internal wiring of the Mini Workshop Power Supply unit. Note that the Veroboard is mounted directly on the rear of the panel meter.

clockwise, connect the test resistor in series with your multimeter set to read up to 500mA, and adjust VR1 so as to obtain a suitable test current from which the lower scale of the panel meter can be calibrated by adjustment of VR4. If a suitable multimeter is not available, then

a similar technique used to check the current limiting of the power supply can be used, i.e., use Ohm's Law to calculate the actual current flowing through the test resistor. (Note: the accuracy of this method is also dependent on the tolerance of the test resistor used.) □

PLEASE TAKE NOTE

Teach In '84, Part 12 (Sept. '84)

On page 557, under COMPONENT CHECKING, the sentence in brackets in the second paragraph should read:

"For an old-fashioned germanium transistor the deflection is greater." (Not "less".)

Capacitance Comparator (July '84)

Owing to slight differences in the characteristics of i.c.s it may be found that the delay introduced by R7 and C4 is not great enough, causing D5 to light for any setting of VR1. If this is the case, the value of either R7 or C4 should be increased.

Vic-20 Light Pen (Circuit Exchange)

(September 1984)

The program and lines on page 565 should read:

Program 1; 20 PRINT Y

Program 2; 10 X=INT((PEEK(36870)-49)/4):

Y=INT((PEEK(36871)-32)/4)

30FOT T=1 TO 20: NEXT T

BOOK REVIEWS

MICRO INTERFACING CIRCUITS BOOK 1

Author	R. A. Penfold
Price	£2.25
Size	177 x 112mm. 96 pages
Publisher	Bernard Babani
ISBN	0-85934-105-4

THIS is a perfect starter book for amateurs in the electronics field wishing to build computer peripheral devices and add-ons. Despite being quite a small book, there is plenty of useful information on all aspects of interfacing techniques with many practical circuits described in detail.

Although some previous knowledge of electronics is necessary there is a fair amount of background information on computer hardware and digital circuitry included, which should enable most people to build simple interfaces without too much difficulty.

There are many aspects of interfacing which are often overlooked by newcomers to electronics, such as the use of magnitude comparators in address decoding and the intelligent use of control lines in device selection. All in all a very useful and interesting little book, but may be a little over-priced at £2.25.

R.M.B.

ELECTRONIC SIREN KIT

Produces an extremely loud piercing swept frequency tone from a 9-15V supply. Enable input for easy connection to alarm circuits. Includes 5in. Horn Speaker. £7.90

Mini Siren
As above, but with a small speaker (instead of horn speaker) for internal use. £4.30

SECURITY PRODUCTS

Protect your home and property and save by building your own burglar alarm system.

Stair Mat 23 x 7 In (950 120)	£1.70
Floor Mat 29 x 16 in (950 125)	£2.80
Tamper-proof connecting block (950 110)	£0.30
Door/Window Contacts. Flush mounting, 4 wire, Magnet/switch Per Pair. (950 140)	£1.05
Window Tape 0.5" wide 50cm. (950 145)	£2.50
Window Tape Terminations Per pair. (950 150)	£0.36
Key-operated Switch. 1.5A/250V (350 128)	£4.50
SPST Heavy chrome metal.	
Passive Infra-Red Detector	
Detects intruder's body heat. Range 10 metres. 12V DC, n/o & n/c contact. Size: 4 x 2 x 2 ins. (950 135)	£45.00
Alarm Control Unit. 4 input circuits, 2 instant and 2-delayed. Adjustable entry, exit and alarm times. Built and tested. Full instructions supplied. Size: 180 x 130 x 30mm Supply: 12V DC. (950 160)	£26.00
Ultrasonic Burglar Alarm. Self-contained mains or battery powered unit complete with horn and AC adaptor. £45.00 + p&p	£2.20
8W Horn Speaker. 5.5 ins. 8 ohm. Ideal for sirens, etc. 2.5m lead and 3.5mm jack plug. (403 148)	£6.15

IR GARAGE DOOR CONTROLLER KIT

For controlling motorised garage doors and switching garage and drive lights on/off up to a range of 40 ft.

Lots of applications like controlling lights and TVs, etc. in the home. Ideal for aged or disabled persons, this coded kit comprises of a mains-powered infra-red receiver with a normally open relay output plus two latched transmitter outputs, battery-powered transmitter and opto-isolated solid state mains switch.

KK103 £25.00
KK105 Extra transmitters £10.50

PANTEC KITS

PN2 FM Micro Transmitter	£7.50
PN3 Stabilised Power Supply	£13.70
PN5 2 x 10w Stereo Amplifier	£14.50
PN6 2 x 40w Stereo Amplifier	£24.95
PN7 Pushbutton Stereo Preamp	£12.90
PN8 Tone & Volume Control	£13.50
PN11 3w FM Transmitter	£11.95
PN13 Single Channel FM Transmitter	£9.80
PN14 Receiver for above	£15.50

TOP QUALITY... TOP SERVICE BOTTOM PRICES!

For FREE CATALOGUE send 9" x 6" SAE — contains full list of stock range all at very competitive prices. Cash with order (except account customers). Access or Barclaycard telephone orders welcome. Add 65p p&p + 15% VAT to all UK orders. Overseas customers add £2.50 p&p Europe, £6.00 elsewhere. Giro No. 529314002. Goods by return subject to availability. Shop open 9am — 5pm (Mon-Fri). 10am — 4pm (Sat). ALL PRICES EXCLUDE VAT

CHRISTMAS PRESENTS GALORE

BEGINNERS' PROJECTS PACK
Contains solderless breadboard, components and booklet with instructions to build TEN fascinating electronic projects, e.g. thermostat, burglar alarm, light operated switch, electronic lock, touchswitch, siren. Requires 9V PP3 battery. £12.50

MW RADIO KIT
Based on 2N414 IC, kit includes PCB, wound aerial and crystal earpiece and all components to make a sensitive miniature radio. Size: 5.5 x 2.7 x 2 cms. Requires PP3 9V battery. IDEAL FOR BEGINNERS. £5.50

3-NOTE DOOR CHIME
Based on SA80600 IC the kit includes all components, loudspeaker, PCB, pre-drilled box (95 x 71 x 35mm) and full instructions. Requires a 9V battery and pushswitch. IDEAL PROJECT FOR BEGINNERS. Order as XK102. £5.50

20kV MULTIMETER
19 ranges including 10A dc. Resistance to 10M, ac & dc volts to 1kV. Battery checker and continuity buzzer. Size: 135 x 89 x 40mm. (405 104) £11.75

DIGITAL MULTIMETER
19 ranges including dc current to 10A, resistance to 20M, ac & dc volts and npn/pnp transistor gain. Full overload protection. Comes with test leads, battery and case. Size: 175 x 93 x 42mm (405 204) £32.00

20kV MULTIMETER
23 range quality multimeter with 12A dc current, ac and dc volts to 1200V, resistance to 1M and dB scale. Transistor gain and leakage scales, battery tester. Size: 155 x 102 x 56mm. (405 105) £18.95

STOCKING FILLERS All full spec. branded devices.

PACK (1) 650 Resistors 47 ohm to 10Mohm — 10 per value	£4.00
PACK (2) 40 x 16V Electrolytic Capacitors 10µF to 1000µF	£3.25
PACK (3) 60 Polyester Capacitors 0.01 to 1µF/250V — 5 per value	£5.55
PACK (4) 45 Sub-miniature Presets 100 ohm to 1 Mohm — 5 per value	£2.90
PACK (5) 30 Low Profile IC Sockets 8, 14, and 16 pin — 10 of each	£2.40
PACK (6) 25 Red LEDs (5mm dia.)	£1.50

ANTEX SOLDERING IRONS

C240 15 Watt (650 100)	£5.60
CS230 17 Watt (650 103)	£5.80
XS240 25 Watts (650 104)	£6.90
ST4 Chrome-plated Bits	£1.90

BT STYLE PHONE CONNECTORS

Line Jack Units — Master Unit (first line unit) has bell capacitor and surge arrester. Flush or surface mounting. Screw connectors.

Master (flush)	(960 110) £3.00
Master (surface)	(960 112) £3.00
Master (mini surface)	(960 113) £3.00
Secondary (flush)	(960 114) £2.65
Secondary (surface)	(960 116) £2.65
Secondary (mini surf)	(960 117) £3.00
Dual outlet adaptor	(960 118) £4.20
4-way line cord — with plug to spade terminals	(960 120) £2.00
4-way line cord	(960 130) £0.20 per m

BOOKS

We stock BABANI, T.I. and ELEKTOR Books.

TEACH IN '84

Complete kit of top-quality components as specified by EE including TWO EBBO starter packs. £15.80
Reprints of projects — per Part 35p
+ S.A.E.

HELPING HANDS

Magnifier and crocodile clips on ball and socket joints mounted on a heavy base. Ideal for holding and inspecting PCBs during soldering, fault finding, etc. (650 035) £3.95

LVM/ULTRA SENSITIVE THERMOMETER KIT

Based on the ICL7126 and a 3 1/2 digit liquid crystal display, this kit will form the basis of a digital multimeter (only a few additional resistors and switches are required — details supplied), or a sensitive digital thermometer (—50°C to +150°C) reading to 0.1°C. The kit has a sensitivity of 200mV for a full-scale reading, automatic polarity and overload indication. Typical battery life of 2 years (PP3). £15.50

REMOTE CONTROL KITS

These uncoded kits are intended for low-cost single channel applications.
MK6 Infra-Red Transmitter Kit — for use with MK7 and MK17 receivers. Box supplied. Requires a 9V PP3 battery. Range approx. 20 ft. £4.50
MK7 Receiver Kit. Mains powered with triac output to switch up to 500W at 240V ac. Latched or momentary output available. Box not supplied. £10.50
MK16 Mains-powered Transmitter — continuous operation such as burglar alarms, etc. Range approx. 6ft. May also be powered from 9V dc. £3.50
MK17 12V DC Receiver — operates from 6-13V dc. Relay output with 3 Amp DPDT contacts. Latched, momentary or 'break beam' output. £10.50

ELECTRONIC LOCK KIT

With hundreds of uses indoors, garages, car anti-theft devices, electronic equipment, etc. Only the correct easily changed four-digit code will open it! Requires a 5-15V DC supply. Output 750mA. Fits into standard electrical wall box. Complete kit (except front panel) **XK101** £11.80
Electric Lock Mechanism for use with existing door locks and the above kit. (Requires relay.) 12V AC/DC coil. (701 150) £14.95

HOME LIGHTING KITS

These kits are designed to replace a standard wall switch to control up to 300w of lighting.

TDR300K Remote Controlled Light Dimmer	£14.95
MK6 Transmitter for above	£4.50
TD300K Touch Dimmer	£7.75
TS300K Touch Switch	£7.75
TDE/K 2-way extension for above kits	£2.50
LD300K Rotary controlled Light Dimmer	£3.95

DISCO LIGHTING KITS

DL1000K — This value-for-money 4-way chaser features bi-directional sequence and dimming. 1kW per channel. £18.95
DL21000K — A lower cost uni-directional version of the above. Zero switching to reduce interference. £8.95
Optional opto input allowing audio 'beat' / light response (DLA/1) 70p
DL3000K — 3-channel sound to light kit features zero voltage switching, automatic level control and built-in microphone. 1kW per channel. £12.95

24-HOUR CLOCK/ APPLIANCE TIMER KIT

Switches any appliance up to 1kW on and off at preset times once per day. Kit contains all components and full instructions. Red LED display. Triac output. Ideal for recording radio programmes.

CT1000K Basic Kit	£14.90
CT1000KB with white box (56 x 131 x 71mm)	£17.40
CT1000K Ready Built	£22.50

ELECTRONICS

11-13 Boston Road

London W7 3SJ

ORDERS 01-567 8910 ENQUIRIES 01-579 9794

01-579 2842 TECHNICAL AFTER 3pm



DIGITAL ELECTRONICS

D.W. CRABTREE BSc Tech Eng (CEI)

PART THREE

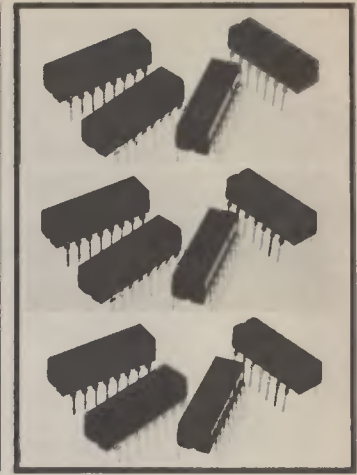

In the last article, we looked at how circuits could be created in their minimised form using techniques such as Karnaugh Mapping, by use of DeMorgan's laws and by use of "don't care", "zero-mapping" and Exclusive-OR implementation.

We will now continue with combinational logic methods using Medium and Large Scale Integration devices (MSI and LSI) instead of Small Scale Integration (SSI) devices.

MULTIPLE OUTPUT SYSTEMS

So far we have only dealt with systems where one output is required. If more than one output is required, that is, a multiple output system, and we are using the SSI chips that we have already looked at, then the design methods are exactly the same as before, with each output requirement being looked at individually but, where possible, using common inputs.

Here, however, great care must be taken to ensure that, where an input combination is designed to give one output and, at the same time, that combination has been part-utilised to give another output, no mal-operation occurs to give outputs when no outputs should be available.

Suppose we have a system that has four inputs, A, B, C and D, and four outputs, W, X, Y and Z. Now the requirements of the system may be as shown in the truth table below:

INPUTS				OUTPUTS			
D	C	B	A	W	X	Y	Z
0	0	0	0	0	0	0	0
0	0	0	1	1	0	0	0
0	0	1	0	1	0	0	0
0	0	1	1	0	1	0	0
0	1	0	0	1	0	0	0
0	1	0	1	0	1	0	0
0	1	1	0	0	1	0	0
0	1	1	1	0	0	1	0
1	0	0	0	1	0	0	0
1	0	0	1	0	1	0	0
1	0	1	0	0	1	0	0
1	0	1	1	0	0	1	0
1	1	0	0	0	1	0	0
1	1	0	1	0	0	1	0
1	1	1	0	0	0	1	0
1	1	1	1	0	0	0	1

This is just a suggested system but if observation is made of the truth table it can be seen that W has an output whenever there is just one input on A, B, C or D, X has an output with two inputs available, Y has an output with three inputs available and Z has an output with all four inputs.

It is a circuit that counts the inputs available and outputs the number of "true" inputs. It may or may not have any real applications but, nevertheless, is a good example of a multiple output system. Let us plot the outputs described above on Karnaugh maps, direct from the truth tables:

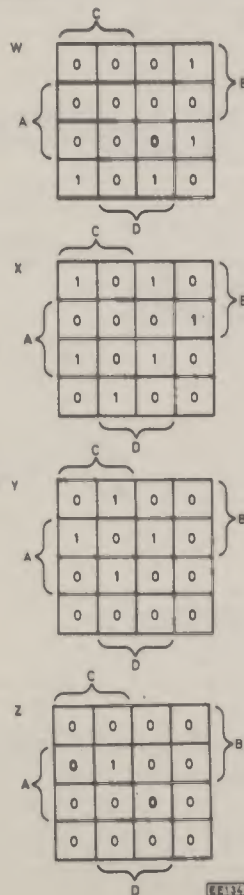

$$W = A\bar{B}\bar{C}\bar{D} + \bar{A}B\bar{C}\bar{D} + \bar{A}\bar{B}C\bar{D} + \bar{A}\bar{B}\bar{C}D$$

$$X = A\bar{B}\bar{C}\bar{D} + A\bar{B}C\bar{D} + \bar{A}B\bar{C}\bar{D} + \bar{A}B\bar{C}D + \bar{A}B\bar{C}D + \bar{A}B\bar{C}D$$

$$Y = A\bar{B}\bar{C}\bar{D} + A\bar{B}\bar{C}D + A\bar{B}C\bar{D} + A\bar{B}CD$$

$$Z = ABCD$$

Note that, after the last article in this series, when I discussed the use of Exclusive-OR gates, it should be possible to recognise that the Exclusive-OR pattern occurs, to some extent, in the map for X output. This can be shown thus:

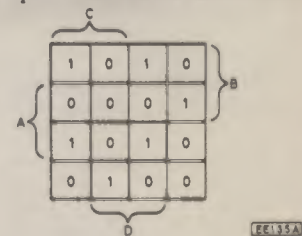

which is identically equal to:

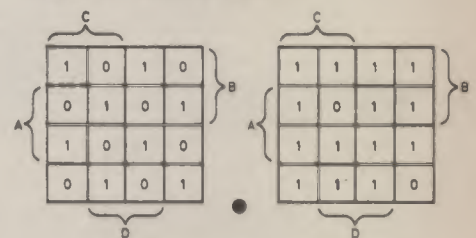

therefore

$$X \equiv A \oplus B \oplus C \oplus D$$

$$[(ABCD) + (A\bar{B}\bar{C}\bar{D})]$$

If the circuit for X is implemented using all-NAND components, the circuit becomes that shown in Fig. 1, which is seen to use four NAND packages. In order to obtain the "NOT" function, one hex-inverter package would be required, to give a total of five packages being used.

Now, if the circuit were to be implemented using Exclusive-OR functions as described above, there would be a total usage of only four packages, the circuit being as shown in Fig. 2.

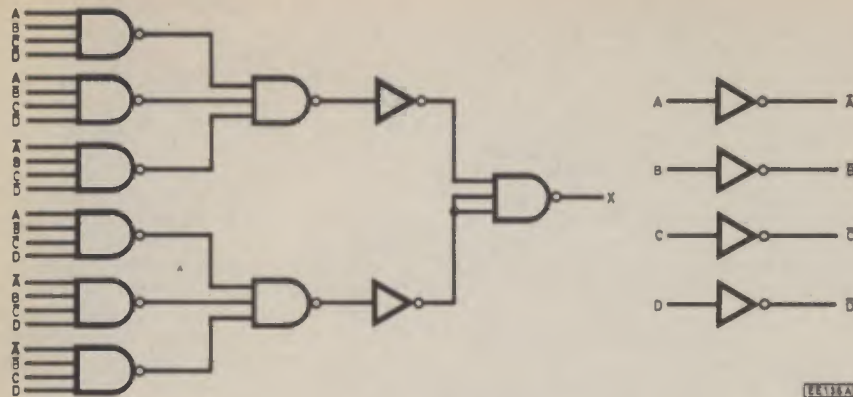

Fig. 1. All-NAND.

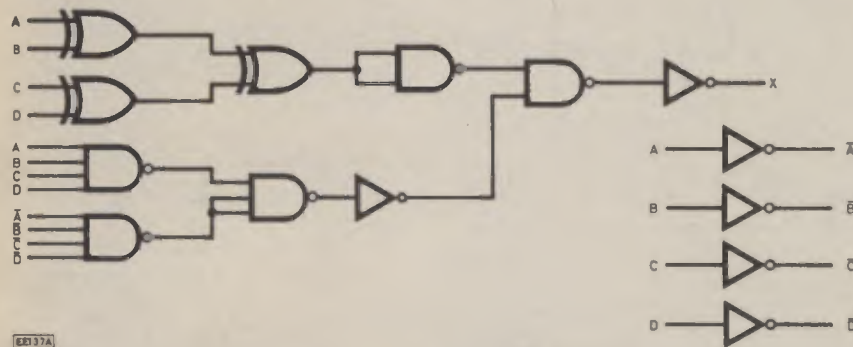

Fig. 2. Exclusive-OR. This saving of one package for the circuit may not be important for the one-off production of a board, but to a manufacturer considerable saving could be made.

LSI AND MSI DEVICE IN COMBINATIONAL LOGIC

So far we have only considered SSI chips—those chips which contain about 1 to 10 gates per chip. We should also be aware of MSI—those chips with about 10 to 100 gates per chip; LSI—those chips with more than 100 gates per chip, and VLSI (Very Large Scale Integration), which have over 1000 gates per chip.

We are now concerned with using MSI and LSI packages which can be used in combinational logic circuits and can be seen to have certain advantages.

Let us look again at the expression for X output previously considered. Now X was one of four outputs from a multiple output system but, for the purposes of this example, let us consider that it is just a single-output system, dependent upon four variables A, B, C and D. The logic expression is:

$$X = ABC\bar{D} + A\bar{B}C\bar{D} + \bar{A}BC\bar{D} + \bar{A}\bar{B}C\bar{D} + \bar{A}B\bar{C}D + \bar{A}\bar{B}\bar{C}D + \bar{A}\bar{B}CD$$

Now what is the decimal equivalent of each part of the above expression, if each part is taken in turn and converted into numerical form?

$$\begin{aligned} ABC\bar{D} &= 1100 = 3 \\ A\bar{B}C\bar{D} &= 1010 = 5 \\ \bar{A}BC\bar{D} &= 0110 = 6 \\ \bar{A}\bar{B}C\bar{D} &= 1001 = 9 \\ \bar{A}B\bar{C}D &= 0101 = 5 \\ \bar{A}\bar{B}CD &= 0011 = 12 \end{aligned}$$

Therefore X has to have an output whenever decimal 3, 5, 6, 9, 10 or 12 appears numerically on the inputs A, B, C and D, remembering that A is the *least significant* bit.

Now, this is all very well, but where has this got us? Well, let us look at the data selector or multiplexer chip, say the TTL device 74150 (below).

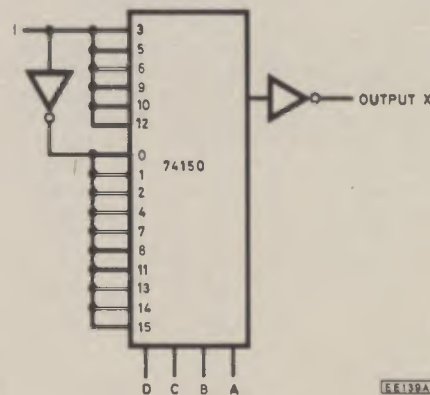

We can see that this chip has 16 inputs (0 to 15) and one output. Any one of the inputs can be "addressed" (i.e., selected) using four control input lines and whatever state is present on the addressed input will appear on the output.

For example, if the control lines have

0000 present on them, then input 0 will be selected and whatever is present on that input, say a "1", will appear on the output. In this example, "1" would be present on the output. Similarly if the control input has ABCD present (representative of decimal 7, numerically) then input 7 will be selected and its input state will be given at the output.

So how do we use the chip for our purpose, for the expression X? Well, in the example, we require an output with inputs of decimal 3, 5, 6, 9, 10 and 12. So we can therefore tie all these chip inputs to logic "1" and tie the remaining inputs (0, 1, 2, 4, 7, 8, 11, 13, 14 and 15) to logic "0".

If we then connect our system variables A, B, C and D direct to their corresponding control input terminals on the chip, we have the facility to switch the multiplexer output to the states that exist on the inputs when any of these inputs are addressed using the actual system variables connected to the control inputs on the chip.

Thus we will have a certain output from the system with the required variable combinations. However, the 74150 chip gives an inverted output, therefore an inverter must be used, as shown, to give the output X, otherwise \bar{X} would be obtained. (Note, however, that in many cases the \bar{X} would probably be used in any following circuits, thus saving the inverter.)

The advantage of using this system is that we have a way to implement the network using just a single package (or two packages if the \bar{X} output needs to be inverted). In the above example, four packages were previously used to implement the function. This represents quite a saving in space on a printed circuit board and a saving in costs.

One disadvantage is that glitches may be generated on an address change but by using the "strobe" function on the chip (see data books for further details) this problem can be eradicated. The "strobe" function can be used to only look at the control input word after it has been changed, not when changing.

To assist learning in the use of multiplexers for combinational logic purposes, it would be an idea to do an exercise in practical design, using such a device. The pin details given here are for use with Exercise (1).

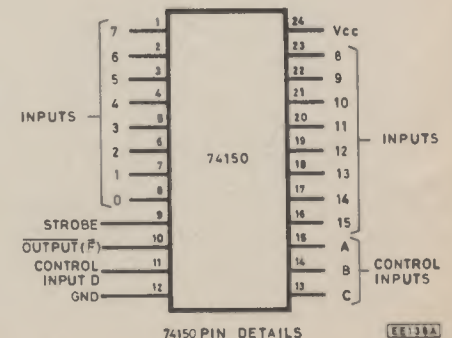

Exercise (1):

Design a circuit to implement the following expression, using a 74150 16-line multiplexer (pin details given).

$$W = \overline{A}\overline{B}\overline{C}\overline{D} + \overline{A}\overline{B}\overline{C}D + \overline{A}\overline{B}C\overline{D} + \overline{A}\overline{B}CD$$

Note:

- (1) VCC requires a 5-volt supply with respect to ground.
- (2) Strobe input requires to be a "0" to "enable" the inputs. Set the strobe to "0" and ignore any possible problems with glitches for this exercise.
- (3) Note that the output is inverted. This is the required output in this case.

The answers to exercises are given on the next page.

USE OF 8-1 LINE MULTIPLEXERS

We have looked at the use of a 16-1 line multiplexer, the 74150. (This is called a 16-1 multiplexer because it selects one only of 16 input lines and puts that line's logic level to the output line.) We should also be aware that other similar devices exist. For example, the 74151 is an 8-1 line multiplexer and can be used in exactly the same way as the 74150 in cases where eight or less inputs need selecting.

As stated previously, if, on the 74150, an inverted output is required, a separate inverter must be used. On the 74151 chip, this facility is already present since the device has two outputs, Y (which is the uninverted output) and W (which is the inverted output, equivalent to Y).

ADDING FURTHER SELECT INPUTS TO MULTIPLEXERS

We will now look at another use for the multiplexer. Suppose that we need to use a 74151, 8-1 line multiplexer, which has three control inputs, A, B and C, but our control word for the function in our expression has, say, four variables A, B, C and D. Then it would seem that the 74151 cannot be used. This is not the case and, in fact, it is still quite advantageous to use the 74151. Let us look at the truth table for the function X in our previous multiple output system.

$$X = \overline{A}\overline{B}\overline{C}\overline{D} + \overline{A}\overline{B}\overline{C}D + \overline{A}\overline{B}C\overline{D} + \overline{A}\overline{B}CD + \overline{A}B\overline{C}\overline{D} + \overline{A}B\overline{C}D + \overline{A}BC\overline{D} + \overline{A}BCD$$

C	B	A	D	X
0	0	0	(0 or 1)	0
0	0	1	1	1
0	1	0	1	1
0	1	1	0	1
1	0	0	1	1
1	0	1	0	1
1	1	0	0	1
1	1	1	(0 or 1)	0

As always, we put into the "D" column of the truth table the required state of "D" that would give the function output. For ABC all set to "0", or all set to "1", we would not require an output from X anyway, so it does not matter if X is a "0" or a "1" at that time (i.e., it becomes a "don't care" condition).

Using the 74151, we now have an easy way of implementing the function X, using only one inverter "extra" to give the \overline{D} function that is required in certain states of A, B and C.

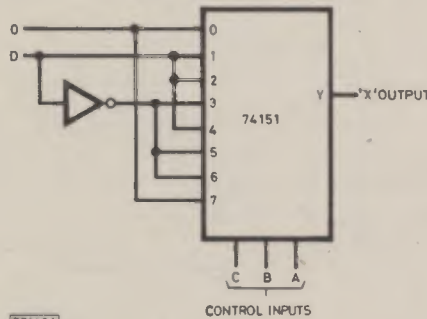

Again it can be seen that a multiplexing device like the 74151 can be used to save much inter-gate wiring that would otherwise have been necessary. In this example, the bulk of the wiring is between the pins of just one chip, the 74151, and it is likely that, in any real application, this would be in the printed circuit board design anyway.

DEMULTIPLEXER (DATA DISTRIBUTOR) USE IN COMBINATIONAL LOGIC

Sometimes in combinational logic we need a circuit that has the ability to interrogate a "control word" and, dependent upon the state of that word, select just one output. The demultiplexer chip fulfils that requirement. It is a "decoder" that looks at several input functions and gives a decoded output (i.e., the selection described above) that is representative of those input functions. It follows that only one output is available at any one time because one organisation of inputs is available at any one time. For example, a unique output for a unique input configuration.

A typical demultiplexer chip is the 74138 (TTL) which is a 16-pin

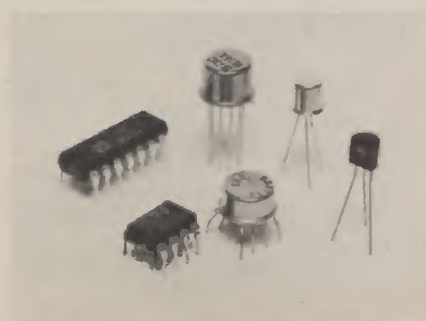

decoder/demultiplexer. Of these 16 pins, it carries two supply connections (VCC and ground), three "control" inputs (A0, A1 and A2) and eight output connections (inverted). The remaining three connections are "enable" pins and can be used to ensure that only steady state information is available on the control word inputs before interrogation of these inputs is carried out. Of those three enable lines, two are active low and one is active high.

Let us look at a possible use of the demultiplexer described above, using the 74138. Suppose we have an alarm system that is monitoring, say, some control process. If we have three outputs, from the process, on which a "fault signal" may be sent, it may be that we only wish to give an audible alarm (say a bell) when we get more than one alarm signal. To decode this information we may need to use many gates. With the 74138 we could reduce this number of gates as shown below:

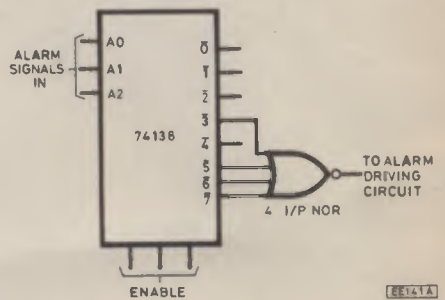

Truth Table			
A2	A1	A0	ALARM
0	0	0	0
0	0	1	0
0	1	0	0
0	1	1	1
1	0	0	0
1	0	1	1
1	1	0	1
1	1	1	1

Let us now look at some more examples of system design by doing two more exercises:

Exercise (2):

A system is required to monitor a counting circuit, the counting circuit counts items in boxes as they pass along a conveyor belt. An alarm is given if there are five or more items in a box. The output from this counting circuit is in the form of a 3-digit binary code with "A0" being the least significant bit and "A2" being the most significant bit. Using a 74138, design such a system to monitor the code and give the required output when five or more items are counted (ignore the "enable" pins of the 74138).

Exercise (3):

Modify the above circuit so that an alarm is given when there are three or less items in each box.

Answers to exercises

Exercise (1):

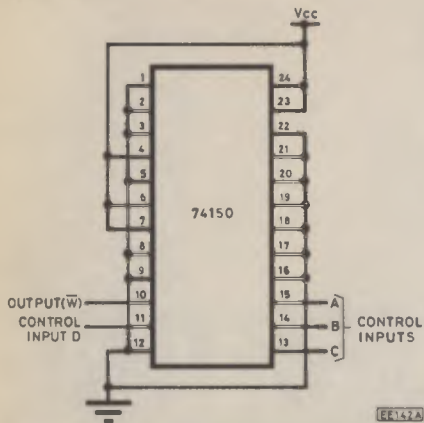

Exercise (2):

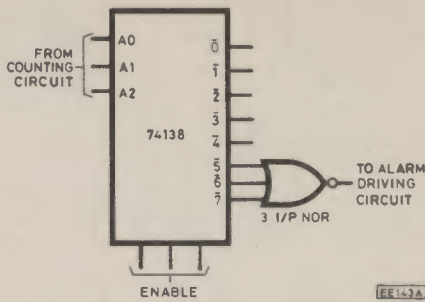

Exercise (3):

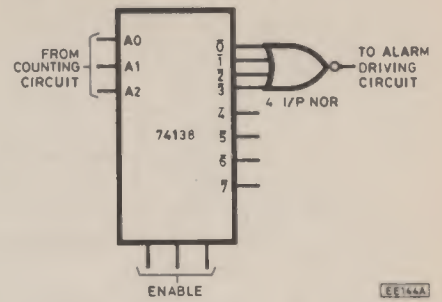

In the next article in this series, we will look at the basis of clock systems used in some digital electronic systems, giving definitions and descriptions of the timing characteristics that may be encountered when looking through various data books. Types and uses of bistable circuits will also be discussed.

SHOP TALK



BY DAVE BARRINGTON

Catalogue Received

With well over 200 pages, all fully illustrated and containing item prices, the first components catalogue from Cirkit certainly keeps up the traditions of excellence associated with its predecessor, namely Ambit.

Most ranges have been expanded and many new lines added to their already vast stocks of components. Amongst these are tool kits, car speakers, connectors, printer mechanism, specially designed switched mode power supplies and the very latest Modem for linking the computer and telephone.

Having now settled in their new premises at Broxbourne, Hertfordshire, Cirkit aims to offer customers a high degree of exclusivity. Many of the products listed in the new catalogue are not available from other sources, such as Toko coils and Alps switches.

Also, through its in-house resources it is developing a range of products to meet customers' future requirements. Typical of this research is the Modem mentioned above and radio tuning and audio modules. They were also deeply involved in the design work for the Amstrad CPC-464 home computer.

The catalogue is being released through leading newsagents, such as W.H.Smith, and costs 85p. It is also available, of course, from their three sales counters at Brentwood,

Portsmouth and Broxbourne. Each Cirkit catalogue contains three £1 redeemable discount vouchers for use with each order in excess of £15; one per order.

CONSTRUCTIONAL PROJECTS

Mini Workshop PSU

Difficulty may be experienced in purchasing some of the components for the *Mini Workshop PSU* project.

The panel meter used in the prototype is currently listed by Electrovalue and Greenweld Electronics. The latter is also able to supply the case.

The L200, 5-terminal adjustable voltage and current regulator, can be purchased from Maplin or Cirkit. The heatsink for the regulator is one of the commonly available twisted vane variety. The large 3.8°C/W aluminium heatsink for the power transistor, TR1, is available from Electrovalue; quote type 2P1.

TV Aerial Pre-Amp

The only component that will cause buying problems when constructing the *TV Aerial Pre-Amp* is the "hybrid amplifier" IC2.

This device consists of a mixture of miniature components connected together on a ceramic base and encapsulated in insulating material in a s.i.l. package form. It contains three transistors, fourteen resistors and seven capacitors.

The OM361 is available from Magenta Electronics. They are also able to supply a complete kit of parts for this project for the sum of £12.36. A 12V power supply will

cost £2.03 and a mains version will cost £9.86.

The printed circuit boards (main board and three pieces of "screening" laminate) may be purchased separately for the sum of £1.60.

All prices include VAT, but an extra 50p per order will have to be added for post and packing. They will, of course, sell all parts for this project individually as required.

For full details readers should contact Magenta Electronics, Dept EE, 135 Hunter Street, Burton-on-Trent, Staffs DE14 2ST.

Digital Multimeter

The 3½ digit liquid crystal display used in the *Digital Multimeter* is a fairly common item and should be stocked by most of our advertisers. The display should be mounted on the circuit board by means of Soldercon pins. The printed circuit board is available through our PCB Service, see page 762.

The Range and Mode switches are not available as single items, a system called "Maka-switch" is used where the switch mechanism and wafers are purchased as separate components. When purchasing the wafers you should specify: 2-pole 6-way (3 off) and 2-pole 6-way (2 off) wafers for S1 and S2 respectively. Maka-switches are held by Electrovalue and Maplin.

The precision resistors are specified as 0.5 per cent tolerance and should be purchased if reasonable accuracy is to be obtained. However, it is quite in order to use lower tolerance resistors, meaning about 1 per cent, provided, of course, a reduction in overall performance is acceptable.

Alfred

A complete kit of parts for *Alfred* would normally cost £170, plus VAT. However, special arrangements have been made with Robot City Technology whereby readers of EE may purchase a kit for the sum of £160, plus VAT. A saving of over £10.

Robot City Tech are also prepared to supply all components as individual items. This includes mechanical mechanisms and pulleys, servo motors and interface board.

For full details, readers should write to: Robot City Technology, Dept EE, 437B Midsummer House, Midsummer Boulevard, Central Milton Keynes, MK9 2HE.

We do not anticipate any component buying problems for the Doorchime.

JANUARY '85 FEATURES...

POWER LIGHTING INTERFACE

for SPECTRUM, BBC and RML 380Z

Synchronise mains-powered coloured lights to the words and music of songs, under the control of your computer. Ideal for parties, discos, or stage shows, new effects can be achieved simply by changing the program data.

SPECTRUM AMPLIFIER

An inexpensive and simple but effective amplifier for the Spectrum. Just plug it into the "EAR" socket and zap **louder** aliens.

GAMES TIMER

This simple timer was originally used to prevent arguments between contestants, whilst playing games, but has many other useful applications.

EVERYDAY
ELECTRONICS
and computer **PROJECTS**

JANUARY 1985 ISSUE ON SALE FRIDAY, DECEMBER 14

TV AERIAL PRE-AMP

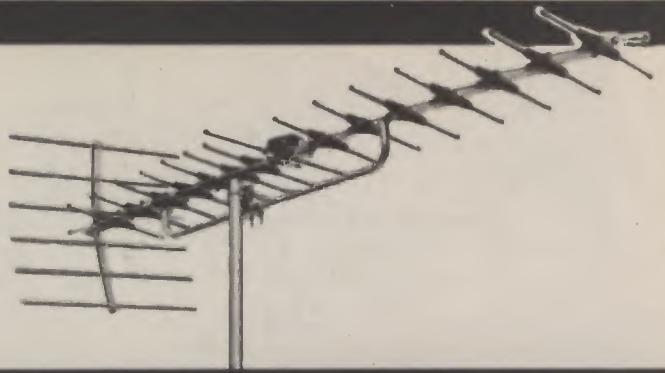

MARK STUART

THIS Antenna Pre-Amp. provides a high gain over the v.h.f. and u.h.f. bands. It requires a 12V d.c. power source at 50mA, so a car battery could be used. This makes it particularly suitable for use with portable TV sets in caravans and boats. An optional mains power supply allows the Pre-Amp. to be used with domestic TV sets. The Pre-Amp. may be used at the masthead with power supplied via its coaxial download. One further use of the Pre-Amp. is to allow several TV sets to share a common aerial.

amplification is provided by the hybrid i.c., OM361. A hybrid i.c. consists of a mixture of miniature components connected together on a ceramic base and encapsulated in insulating material. It is completely different from the more commonly used i.c.s in which the components are made in a single chip of silicon.

The advantage of a hybrid i.c. is, that it is capable of better high frequency performance than standard i.c.s. Fig. 2 shows the internal circuit of the OM361. The difference between this hybrid circuit and

two stages are powered via pin 8 which is also the output pin. The mixing of power and output signals is easily achieved by the use of r.f. chokes (inductors) and capacitors. Capacitors will pass the output signals but not d.c. Chokes will pass the d.c. power supply currents but not the output signals.

In Fig. 1, C5 and C4 couple the input and output signals respectively to their sockets. Chokes L2 and L3 provide d.c. supplies to pins 4 and 8 of the i.c. from the coaxial cable.

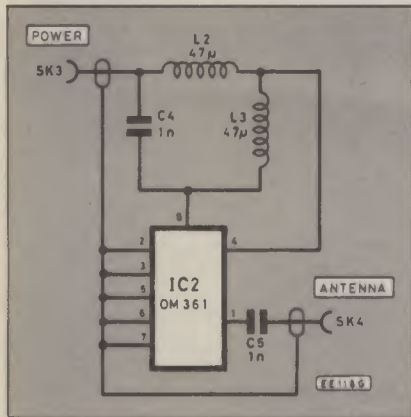

Fig. 1. The Masthead Amplifier.

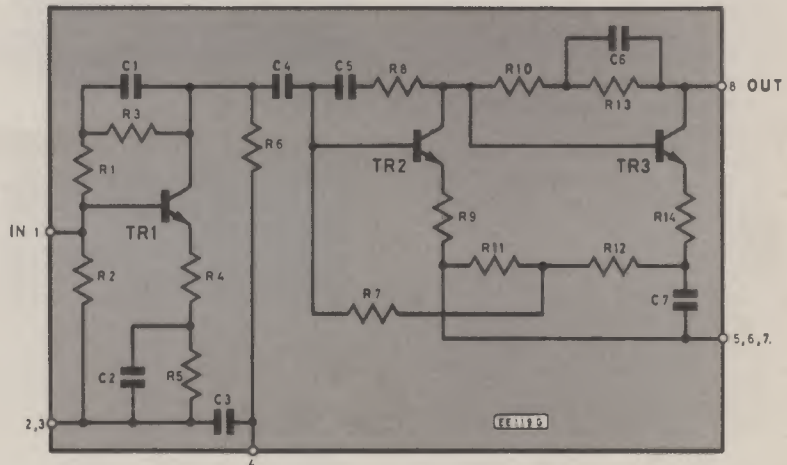

Fig. 2. Internal details of the OM361.

THE CIRCUIT

The circuit diagram of the pre-amplifier is shown in Fig. 1. All of the

Aerial shown in our Front Cover picture is by courtesy of TANDY



a standard i.c. op-amp circuit is worth noting. A standard op-amp normally has a large number of transistors (30 or more), a few resistors, and usually just one capacitor for frequency compensation. This hybrid circuit has just three transistors, fourteen resistors and seven capacitors. The three transistors operate as common emitter stages. TR1 is powered via pin 4 of the i.c. The second

CONSTRUCTION

The construction of the Pre-Amp. as with any circuit working at u.h.f. frequencies must be carried out carefully. The method of construction used proved to be completely stable. It was arrived at after a number of other designs had been rejected because of instability.

Begin construction by assembling the small double-sided main circuit board (Fig. 3). Be very careful to get the i.c. the right way round (pin 1 is identified on the side of the i.c.). The i.c. is inserted from the blank side of the board.

Ensure that the copper around pins 1, 4 and 8 has been cut away to avoid short circuits, and the grounded pins (2, 3, 5, 6 and 7) must be soldered on both sides of the board. Then fit L3 in position, exactly as shown in Fig. 3 and Fig. 5. The other components are fitted later.

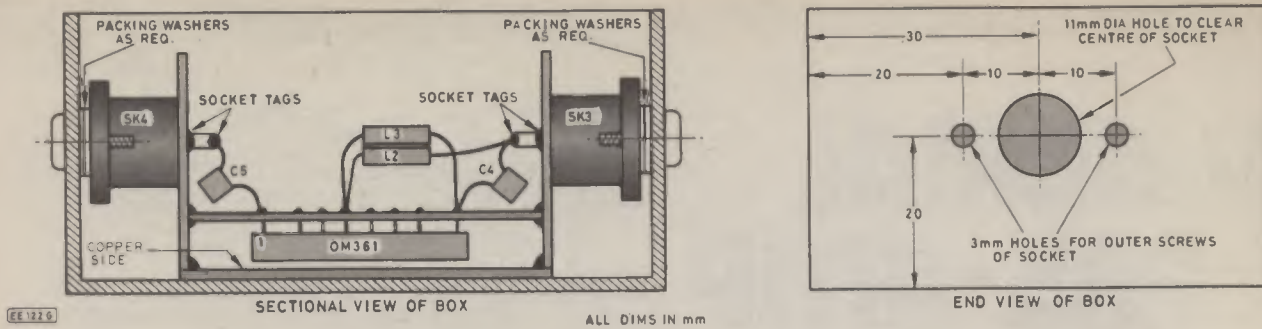

Fig. 5. Constructional details of the Amplifier housing (above and right).

Next drill the two end panels to suit the coaxial sockets that you are using. The two outer tags pass through the board and are bent over and soldered on the copper side. The centre tag should pass through the board without danger of short circuiting to the copper foil. It is advisable to slightly countersink this hole on the copper side just to be sure. Note some sockets have just one outer tag and the ends should be drilled accordingly. Fit both sockets and then assemble the two end panels to the base. The end panels should be fitted so that they are at right angles to the base with exactly the right gap between them for the main p.c.b. as shown in Fig. 5. To simplify this alignment it is best to just "tack" the two ends into place with a small amount of solder. When the ends are properly aligned the main p.c.b. should be fitted into position as shown in Fig. 5. The joints between the base, ends, and main board should be soldered along all edges to produce a good strong assembly.

Complete the assembly by fitting C4, C5 and L2 exactly as shown and the Pre-Amp. should now be mounted inside its case. The ends of the case should first be marked out and drilled with the large centre holes for the coaxial sockets. Insert the Pre-Amplifier chassis and check for alignment before drilling the socket mounting holes. The sockets are mounted with self-tapping screws. Washers should be fitted on the screws between the inside of the case and the sockets so that the sockets are not pulled away from the chassis when the screws are tightened.

POWER SUPPLY

As it stands the Pre-Amplifier requires a supply of 12V, 50mA via its output coaxial cable (positive inner). The circuit of a suitable mains supply unit is shown in Fig. 6. Power is fed out to the coaxial via the choke L1 which passes d.c. but blocks the incoming signals which are a.c. Capacitor C3 blocks the d.c. and couples the signals to the TV output socket SK2. The power supply is a conventional centre-tapped transformer design using a standard 12V regulator i.e., type 7812. Diodes D1 and D2 rectify alternate half-cycles from the transformer to provide a full-wave rectified output which is

smoothed by C1 and fed to the regulator input. The output capacitor C2 is necessary to prevent high frequency instability in the regulator.

The whole power supply is built in an ABS case with internal p.c.b. slots. All of the small components are mounted on a piece of tagboard which is cut to fit in the slots across the box. Fig. 7 shows the component layout. It is important to

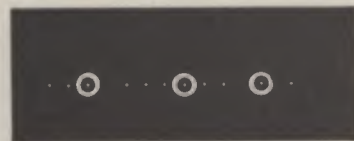

Fig. 4. P.c.b. (underside) design of the Pre-Amp.



Fig. 4a. P.c.b. design (topside) of the Pre-Amp.

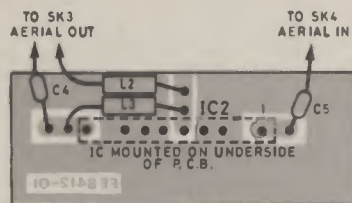
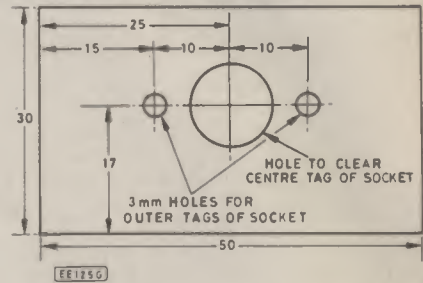

Fig. 3. Component layout of the Pre-Amp.



mount the two sockets SK1 and SK2 next to each other and to connect C3 as directly as possible between them.

To ensure safety, make sure that a good quality cool running transformer is used. Also ensure that the mains primary and secondary connections are well separated. The secondary circuits of the transformer are not earthed so be very careful with the wiring layout.

If the Pre-Amp. is to be used from a car battery, use only L1, C3, SK1 and SK2. The 12V supply is connected to points X (positive) and Y (negative). The whole unit can then be built into a small plastic case mounted on the rear of the TV if desired.

INTERFERENCE

As was previously stated, the p.c.b. and the Pre-Amplifier housing was carefully designed and modified to prevent the effects of interference. With this in mind, great care must be taken if a slightly different p.c.b. design is to be used. The housing of the unit is also important to its correct operation, and should be screened as shown in Fig. 5.

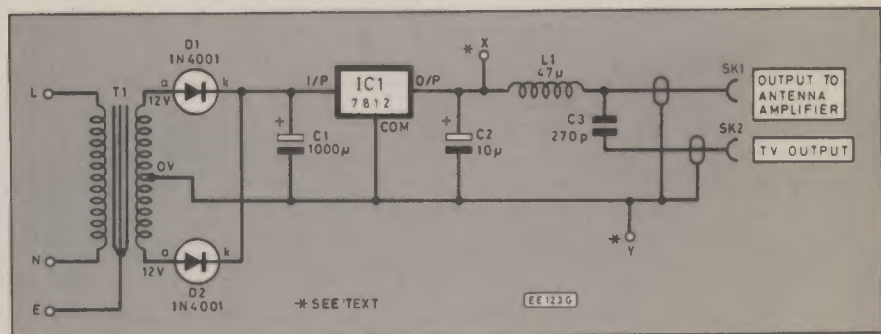

Fig. 6. Circuit diagram of the Power Supply.

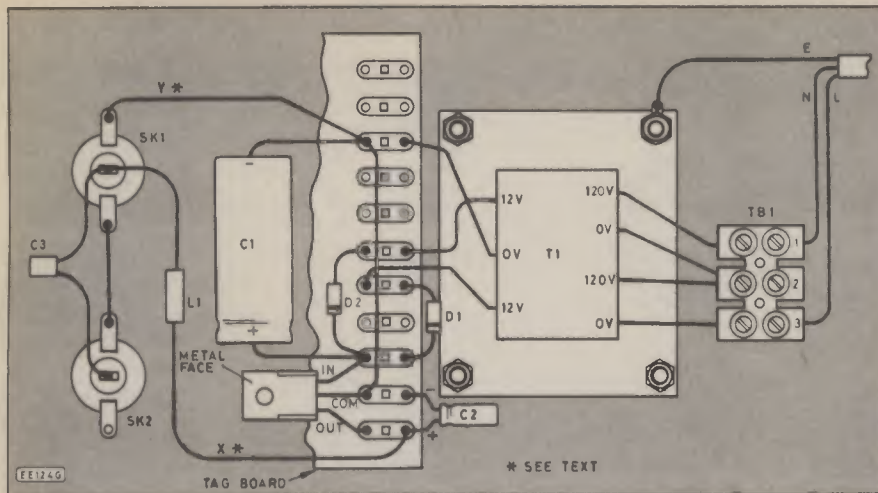
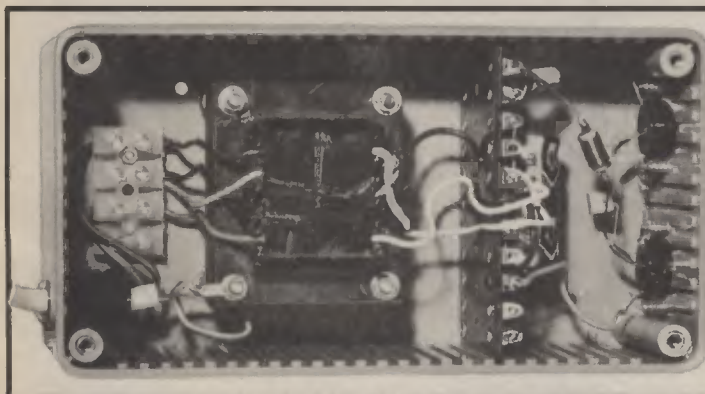

Fig. 7. Wiring details of the Power Supply.



See
**Shop
Talk**

page 735

Photograph illustrating the internal details of the Power Supply Unit.

COMPONENTS

Inductors

L1-L3 47 μ coaxial lead, mini choke (3 off)

Capacitors

C1 1000 μ 25V electrolytic axial
C2 10 μ 16V electrolytic radial
C3 270p mini ceramic plate
C4,C5 1n mini ceramic (2 off)

Semiconductors

IC1 7812 12V regulator
IC2 OM361 hybrid amplifier
D1,D2 IN4001 (2 off)

Transformer

T1 12V-0V-12V secondary

Sockets

SK1-SK4 plastic flush mounting coaxial (4 off)

Miscellaneous

Tagboard, wire, cable clip, screws and washers; plastic box, 80 x 62 x 60mm; p.c.b.; laminates 50 x 30mm (2 off), 50 x 50mm (1 off)

Approx. cost
Guidance only **£28.00**

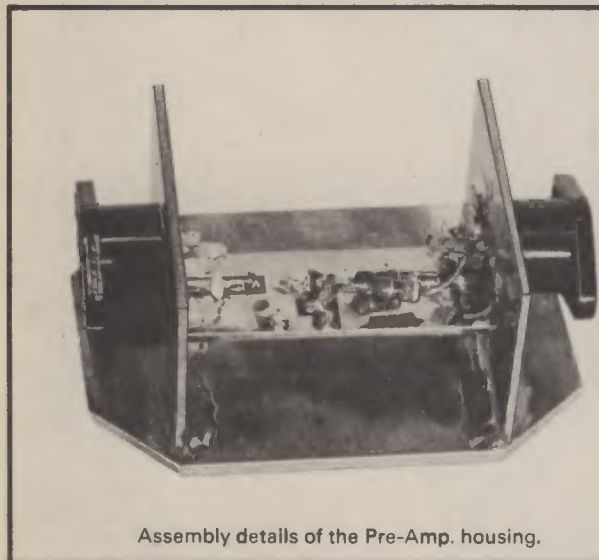

Assembly details of the Pre-Amp. housing.

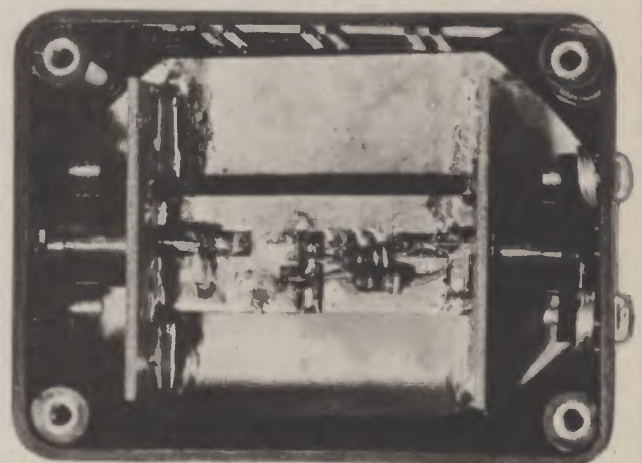

Internal view of the TV Pre-Amplifier.

TESTING AND USE

It is best to test the Pre-Amp. next to the set first, before embarking upon any ladder climbing. The effect of introducing the Pre-Amp. can be observed on any TV set. With a modern set and a good antenna there may not be much room for improvement. Older sets will show an instant improvement and it may be found to be possible to tune to other previously unobtainable TV regions.

Once it has been established that the circuit is working it can be moved nearer to the aerial and mounted in the loft, or even outside on the aerial mast. Good weatherproofing will be required for mast-head mounting, which can be achieved by the use of suitable plastic rainwater components. It is probably better to mount the Pre-Amp. in the loft if this can be arranged. The slight compromise in performance will not be noticeable, and the need to weatherproof is avoided. □

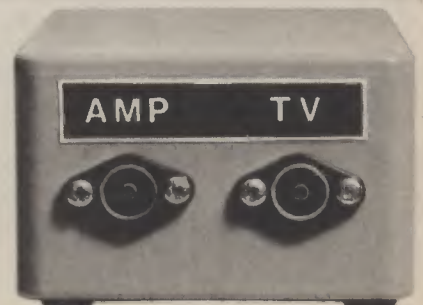

COMPUTER CLUB

Welcome to Computer Club! Everything we do here is about Computer Programming and how computers work. We'll be using the **BASIC** language on the BBC Computer (model 'B') for the Program Progress section. And we'll be starting at square one — the keyboard

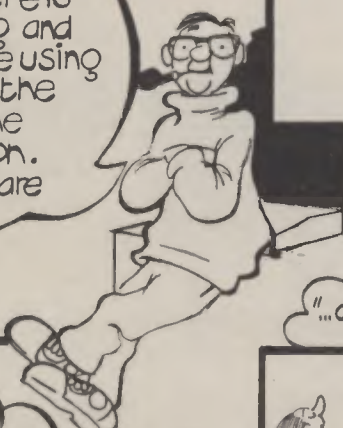

by Thakery

The SILICON story

Although the large scale development of the semiconductor didn't get under way until 1948, there was a wide use of crystals in rectifiers. The famous crystal set used a crystal of GALENA (lead ore) mounted in a device more than 5 cm long.

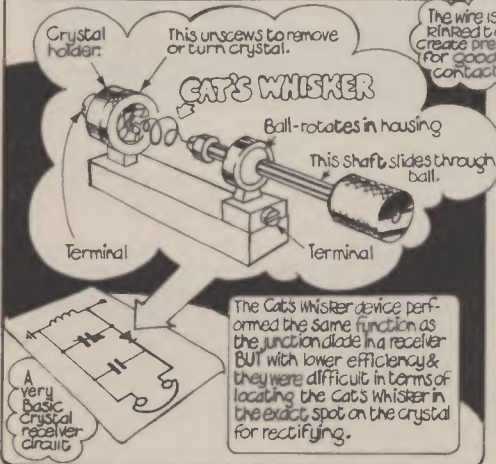

The Cat's Whisker device performed the same function as the junction diode in a receiver BUT with lower efficiency & they were difficult in terms of locating the Cat's Whisker in the exact spot on the crystal for rectifying.

An advancement of the early Galena crystal detector was the Point-contact diode. It was a very important development because it displays much the same electrical properties as the junctions between two types of semiconductor.

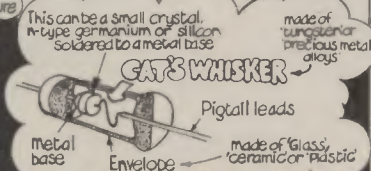

How the CONTACT is formed

A large current pulse of short duration is passed through the contact. This FORMING current melts a very small volume of the semiconductor near the tip of the wire which, if the semiconductor is n-type, recrystallizes as p-type. A very small area of p-n junction has thus formed under the point of the wire. If a p-type semiconductor is used then a n-p junction is formed.

PROGRAM Progress

```

10 REPEAT
20 Z=RND(2)+64
30 PRINT
40 PRINT "PRESS THE KEY"
"CHR$(Z)
50 T=TIME
60 REPEAT UNTIL GET=
70 PRINT "THAT TOOK
SECONDS
80 UNTIL Z=0
>RUN (PRESS RETURN KEY)
    
```

This program lets you to find a key
PRESS THE KEY MARKED
THAT TOOK YOU 44 SECONDS
...and tells you how long it
took you to find it

"...Can't stand these ex-concert pianists!"



TYPING is an ESSENTIAL SKILL to acquire before embarking on a course of writing programs

But what is a RECTIFIER?

Well, the RECTIFIER is something we'll be looking at very closely during the course of this series but basically it can be explained as follows...

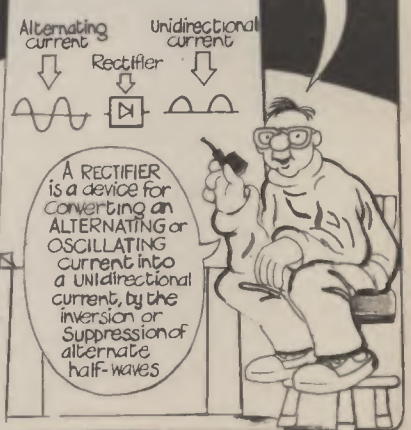

KEY GUIDE 1

1 Shift
Space
Return
Shift

In this program you must understand the SPACE, RETURN, and SHIFT keys

Have a look at key guide 2

This program only covers the ALPHABET. If you want to test yourself - If on the whole keyboard then have a look at Program 2

Press RETURN KEY

Program tells you to find a key

THE KEY MARKED Y
TAKES YOU 41 SECONDS

THIS shows how long it
takes you to find it

RENDEZVOUS

001 you can't move on a square TWICE

And you can't cross an agent's path

002

003

004

Message: AVOID BLACK SQUARES

If Agent 001 moves 25 squares
Agent 002 moves 14 squares
Agent 003 moves 15 squares
Agent 004 moves 17 squares
Where do they meet-up?

KEY GUIDE 2

To obtain the top mark, on any of the dual marked keys, press the SHIFT key and HOLD it pressed while you press the dual marked key.

Solutions on page 746

TYPING SPEED

an ESSENTIAL skill to acquire before embarking on a course of writing programs



"Can I start writing programs?"

PROGRAM 2 TYPE AGAINST THE CLOCK!

Step 1

Start by printing a random selection of all the key marks or if you like just a simple sentence on a sheet of paper about 8x10 inches

Step 2

Take sheet in step 1 onto monitor

Step 3

now just type in this simple program for lots of fun!

Step 4

Lift the sheet of marks and you'll see the results

This is where you improve on your speed by typing the list in step 1 onto the keyboard

and when you're finished press RETURN quickly

```

5 VDU 23;8202;0;0;0;
10 CLS
20 TIME=0
30 PRINT TAB(0,0); TIME DIV 100
40 INPUT LINE A$
50 PRINT TAB(0,10) "THAT TOOK"; TIME DIV 100
60 PRINT "PRESS SPACE BAR FOR NEXT TEST"
70 K% = GET
80 GOTO 10
RUN ...PRESS RETURN
  
```

▽=SPACE

Test result: ~~~~~~

Time taken: THAT TOOK 10 SECONDS PRESS SPACE BAR FOR NEXT TEST

SQUARE one FOR BEGINNERS

ANYONE who is considering buying a home computer will want to know what software is available for it. A magazine such as *Software Index* will allow the prospective buyer to evaluate the amount and type of software available for different machines, and the dealer will also have information.

CASSETTES

The program may be educational, or a game, or a business package. Whatever its purpose, the program itself will probably be supplied as a cassette tape (or perhaps a disc), which will need to be loaded into the computer.

Once the program is loaded and running, the actual tape can be removed from the cassette recorder. The program then exists as a sequence of instructions which the computer is currently carrying out, and also, in more permanent form, as a recording on the tape.

If the tape is played on the cassette recorder (as music is), a sequence of tones can be heard. There are a number of different ways of recording a program on tape, but all reflect the fact that the computer is a binary machine—the electronic circuits of which it is made are capable of responding only to a “high” or a “low” voltage level (“1” or “0”).

As a result, what is recorded on the tape will probably sound like two different tones, alternating. The “interfacing” circuits built-in to the computer convert these tones into “high” and “low” voltages and store them in the computer’s memory. The program is then loaded and ready to run.

BASIC

The majority of readers will have some familiarity with BASIC, and certainly there can be few who have not heard of it. BASIC is only one of dozens of “high-level languages” (see Table 1) and additionally there are many versions (or “dialects”) of BASIC.

The new feature in *EE, Computer Club*, which begins this month, will be helpful to those who are writing their own programs, as different aspects of the language are developed and explained.

A program in BASIC (or any other high-level language) is a long way removed from the noises on the tape explained above. For example, to add two numbers from the keyboard, and print the sum, one might type in:

```
10 INPUT A
20 INPUT B
30 LET C=A+B
40 PRINT C
50 END
```

This very simple program could then be saved on tape, or it could be run.

TRANSLATION

The Central Processing Unit (CPU) of the computer is a piece of electronic hardware which only responds to electrical signals. There is a need, then, for any program written in a high-level language to be “translated” into a sequence of electrical signals.

There are two ways of doing this. The first way, and the way all home computers achieve this translation, is by means of an “interpreter”. The alternative method is by means of a “compiler”.

An interpreter is itself a program, which takes each character input from the keyboard (including line numbers) and stores them in the computer’s memory. However, this cannot be done immediately. The character “A”, for example, is meaningless to the computer hardware. So between the keyboard and the CPU is hardware which converts each key pressed into an internationally-agreed pattern of “highs” and “lows”.

The character “A”, when pressed on the keyboard, causes the bit-pattern 01000001 to appear. This bit-pattern, as well as all the others corresponding to the letters and numbers in the BASIC program, is stored in the computer’s memory.

When the program is run, each bit-pattern has to be retrieved, in the right sequence, and interpreted into signals to enable the CPU to do the job that the programmer wants it to do.

The bit-patterns stored are not checked to ensure that the program is correct. Any errors will only show up when the program is actually run. For example, if line 10 of the program above read “IBPUT A” instead of “INPUT A”, then some kind of error message would be output when the program was executed. That is, the interpreter translates and checks the stored program at run-time.

An interpreter is obviously not a simple program; further, it has to be permanently “inside” the computer, whether the machine has power applied to it or not.

It normally resides as a sequence of bit-patterns in a Read-Only Memory chip (ROM). These chips are essentially grids of switches in which any given switch is either open or closed. Once set, the patterns are permanent. The sequence of preset bit-patterns is the “interpreter”. Such “software held in hardware” is often referred to as “firmware”.

OPERATING SYSTEMS

Any computer has to have an “Operating System” (OS) to enable it to accept input (usually from the keyboard), and provide output to the TV or printer.

When it is first switched on, the computer will go through a pre-determined sequence of operations, of which the user may be unaware—for example, there may be a routine (held in ROM) to check that the memory circuits are functioning properly.

The user will then see some kind of “prompt” character on the TV screen, such as “>” or “_”, or a message such as “Insert disc into drive A”. All these functions are part of the O.S. The O.S. is the whole program, written as a sequence of bit-patterns, and permanently stored in ROM, which allows the user to input a program in BASIC, edit it, and run it.

STANDARDS

Because of the problems caused by different O.S.s, business users have opted to buy machines which use a “standard” O.S. This means that a program written in BASIC, or another high-level language, on one machine, can be saved on tape or disc, and then loaded into a completely different machine, and run, so long as both machines have the same O.S.

Inevitably, there is competition among software manufacturers, and there are at present three different “standard” O.S.s, as well as dialects of them. However, it does mean that a business can decide on a particular O.S., and then ensure that every machine runs it.

COMPILERS

It was mentioned above that the alternative to an “interpreter” is a “compiler”. The compiler does essentially the same job as the interpreter, but it does it differently.

A compiler converts the high-level language into bit-patterns, but it also checks for errors in syntax or logic, and informs the user. The program cannot be run until it is error-free. This means that a program may have to be compiled several times, until all the errors are corrected. This process can be tedious; however, once the program has been successfully compiled, there is an excellent chance that it will run properly on the computer.

SYSTEMS

Any computing system is made up of the hardware, the software, the firmware, and the person operating the machine. Some high-level languages are easier to use than others, and some are more suitable to a particular application than others. However, all programs, ultimately, can be expressed as patterns of very simple electrical signals.

Table 1: Some common high-level languages

ALGOL	ALGOritmic Language. Used by scientists and mathematicians for problem-solving, as it is particularly well-suited to expressing mathematical formulae.	is used by mathematicians, especially, for problem-solving.
BASIC	Beginner's All-purpose Symbolic Instruction Code. See main text.	Named after the mathematician Blaise Pascal, the language was originally designed to teach people how to write readable programs which had a lower probability of error than those written in BASIC.
COBOL	COMmon Business Oriented Language. Designed for such purposes as payroll calculations, and looks very much like ordinary English.	
FORTRAN	FORMula TRANslation. As the name suggests, this language	FORTH, MODULA-2, and PROLOG may also become popular, and there are many other high-level languages, some designed for a particular purpose, such as programming a telephone exchange.
PASCAL		

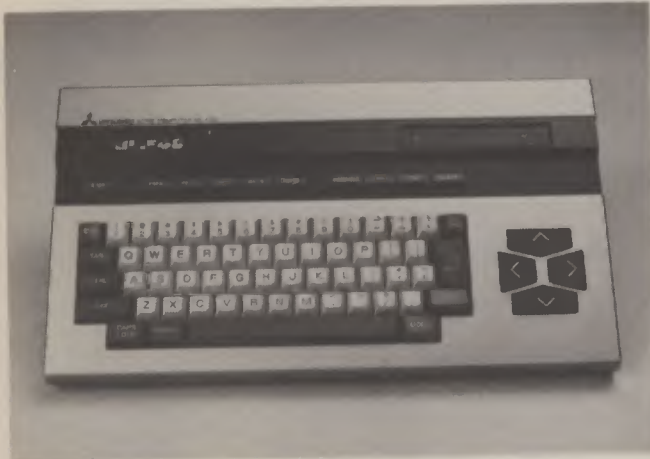

Golden Age of Droitwich

On September 6, 1984, the BBC commemorated the 50th Anniversary of the start of broadcasts from its Droitwich long-wave transmitter.

Derek East, the BBC's Chief Engineer, Transmission, said: "In the 30s Droitwich was a name on the listeners' radio dials. They knew the name Droitwich for its radio service as well as for its Spa. Numbers like Radios 1, 2, 3 and 4 do not

have the same local personality, but Droitwich continues as an honoured name in the transmitter world."

He went on to say, "This anniversary is especially appropriate at this time when we are installing only the second replacement transmitter since 1934. All three transmitters have been supplied by Marconi indicating the long association with British industry."

Top Jobs for Women

Women in London will have the opportunity to train for top engineering jobs in new technology thanks to £350,000 in grants from the Greater London Enterprise Board, the Greater London Training Board and the European Commission.

The grants are in recognition of the work being done by the GLEB-sponsored London New Technology Network (LNTN) based in Camden and will finance training courses for women to be supervisors and trainers in micro-electronic engineering.

TIMELY AWARD

The Federation of British Audio have presented their 1984 prestigious Hi Fi Accessory of the Year Award to The TEK Group of Cambridge for their Model T31 Timeswitch.

Awarded for the precise recording of programmes off the radio, TEK are keen to point out that the timeswitch is a versatile device with other applications. High on the list is that of security lighting and Economy 7 timeshift for dishwashers and washing machines.

A feature of the timeswitch is that it has a battery back-up for its electronic memory so that should there be a power failure, both clock and program settings are retained without need for adjustment. The unit is easy to set using four push-buttons and is claimed to be precise to the minute.

MSX Reaches UK

The UK manufacturing and marketing division of Mitsubishi has announced its versions of the MSX range of home computers. Developed in conjunction with Microsoft in America, the MSX system was conceived to provide a common standard in home computing so that other manufacturers' accessories/products are interchangeable.

Costing £249 the ML-F 48 has 32K byte of ROM and 32K byte of RAM. A range of software is now available, including home office programs—word processing, budgeting and database, language courses, educational programs and games.

Peripherals for the ML-F 48 include joysticks and a range of socket connectors allows the computer to be connected to a number of other units.

Mitsubishi is the only MSX supplier offering a choice of computers; the other is the ML-F 80 at £299, offering 64K byte of RAM. Both systems will be available from November.

Importers of computers and related peripherals face a new threat this autumn. From October this year VAT on imported goods must be paid at the docks.

It is claimed that the Chancellor's decision to abolish the VAT postponed accounting system (PAS) has seriously weakened importers' cash flow and could add a six-figure sum annually to their distribution bill.

A Rediffusion R2830 Telecentre system has been ordered by the London Borough of Brent for its education department. The contract is valued at about £85,000.

The world's first single-chip i.c. for processing all National Television System Committee (NTSC) standard colour TV signals has been developed by Mitsubishi Electric Co. of Japan.



NEW · NEW · NEW · NEW PRODUCTS NEW · NEW · NEW · NEW

BREAKFAST TV



THE Ingersoll XK510 television and radio alarm clock solves the problem of waking up in the morning. What could be more comforting than waking up to your favourite breakfast television programme and then staying in bed a few minutes more to watch the news?

This set can be programmed to wake you with either television or radio. It features a 4½in black and white TV, a m.w. and f.m. wave-band radio, a digital clock with 12-hour red l.e.d. display and indoor aerial.

The XK510 is truly portable

and has snooze and sleep facility. If you like watching late-night films in bed but normally fall asleep halfway through, the sleep button will switch the TV off at a pre-programmed time.

This set is ideal for the kitchen, playroom or even a caravan. The Ingersoll XK510 is priced at approximately £132.95 retail.

For details of nearest stockists contact:

*Heron Electronics Ltd.,
Dept EE, Heron House,
19 Marylebone Road,
London, NW1 5JL.*

CLEAN UP

THE Bib Audio/Video Products Computer Care Kit, comprises, audio cassette head cleaner, with cleaning fluid, air duster for cleaning dust and dirt away from keyboard and printer,

together with anti-static screen cleaning fluid, with cleaning cloth, at a recommended retail price of £8.74, including VAT. Bib Ref: BCC-9C.

*Bib Audio/Video Products Ltd.,
Dept EE, Kelsey House,
Wood Lane End, Hemel Hempstead,
Herts HP2 4RQ.*

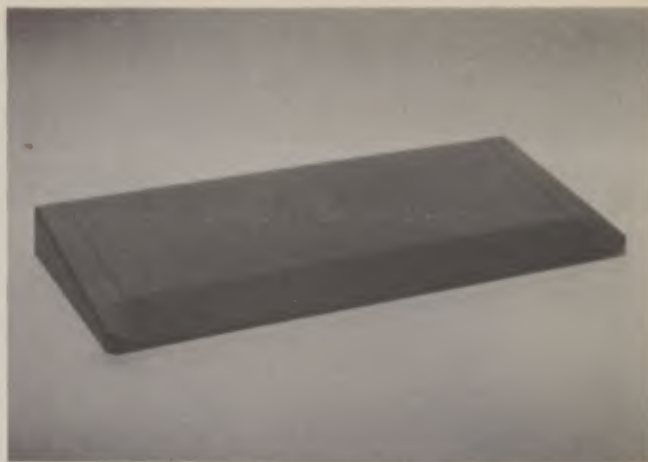

CASE FOR SLIMMING

A SLIM, modern design characterises the new "Manta" keyboard case now available from West Hyde.

The case is moulded in beige ABS and incorporates a shallow ledge at the front which provides a hand rest for the keyboard operator. It has moulded bosses to support a p.c.b. and cable clamps for both circular and ribbon cables.

The base plate is zinc steel

which aids rigidity and provides extra weight to prevent unintentional movement.

The Manta keyboard case is available in three widths and is supplied complete with a cable grommet, feet and screws. For further details and prices write to:

*West Hyde Developments Ltd.,
Dept EE, Unit 9,
Park Street Industrial Estate,
Aylesbury, Bucks HP20 1ET.*

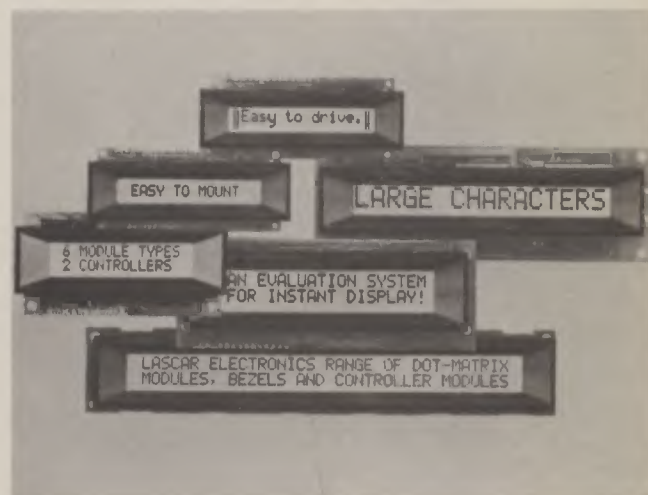

ON THE DOT

A RANGE of low-power Dot Matrix Display Modules has recently been introduced by Lascar Electronics. All DMX series module types are complete with a display bezel and mounting kit, claimed to be the first time this feature has been available on this type of product.

The range runs from 16-character 1-line—three different

modules—up to 40-character 2-line displays. All displays feature 5V operation, 4 or 8-bit data bus and on-board character generation. Full upper and lower case characters, display "blinking", display shift left and right and "custom" symbol generation are available.

*Lascar Electronics Ltd.,
Dept EE, Module House,
Whiteparish, Salisbury,
Wiltis SP5 2SJ.*

SPECIAL OFFER

RADIO CONTROLLED CAR

£10.95

INCLUDING VAT PLUS £1.50 P & P



Just in time for Christmas we are pleased to make this special EVERYDAY ELECTRONICS offer to readers. Using a proportional digital radio control system, the steering and speed of the car can be accurately varied, giving total manoeuvrability both going forwards and in reverse. The car measures 230 x 115 x 90mm high (approx.)

The neat package contains the complete radio control transmitter, battery-operated car with built-in radio control receiver and aerial, bollards, decorative labels, a motoring handbook and a sheet of obstacles and road signs to cut out. In short, everything you need to practise driving, except the batteries, at a special price for EE readers.

You can also order by telephone using Access:
Tel. 01-992 8430

To: RT-VC, 21B High Street, Acton, London W3 6NG

To: RT-VC, 21B High Street, Acton, London W3 6NG

Please send me car packs

One pack costs £10.95 plus £1.50 p&p (£12.45)

I enclose PO/Cheque No. Value

Name

Address

.....

.....

Please allow 28 days for delivery

OFFER CLOSSES FRIDAY, DECEMBER 14, 1984

Name

Address

.....

.....

Access orders: Tel. 01-992 8430

To: RT-VC, 21B High Street, Acton, London W3 6NG

Please complete both parts of the coupon in BLOCK CAPITALS

COUNTER INTELLIGENCE

BY PAUL YOUNG

FINAL WORD TO THE NOVIATIATES

In the last issue I dealt briefly with the best way of ordering components. As it is not the most inspiring subject to write about, I cut it down to a minimum, I would therefore like to add one or two further suggestions:

- (1) If the firm you are dealing with supplies a form for ordering goods, always use it, because it will have been tailored to meet their own special requirements and help speed delivery.
- (2) Write clearly, and if your longhand is anything like mine, and resembles a cross between Hieroglyphs and Cuniform, make sure you at least print your address in block capitals.
- (3) Never write queries on your order form, it is the surest way of delaying your order, always send a separate letter.
- (4) Plan ahead when it is practical to do so. That is, accumulating the parts for your next project while you are still working on the current one.

MURPHY'S LAW

Murphy's law about things going wrong is well known, but here is an extreme example. If my electric toaster goes wrong, it is always in mid summer. This means lighting our gas-operated grill, and while in the winter this gives a welcome added warmth to the kitchen, in summer with the temperatures up in the seventies, you feel inclined to settle for a toastless breakfast. Imagine my dismay, when halfway through July the element goes in my toaster. This happened once before about a year ago, and when I went to order a new one I was told it consisted of three parts, each one being different. To be on the safe side I ordered all three. I replaced the offending unit and kept the others as spares. Naturally I thought I had a two out of three chance, if the element goes again of having a replacement. I should have known better, it was the very same element that had blown again. I ordered one, and I am still awaiting delivery. Luckily, just as I was about to pass out from a combination of toast deficiency and dehydration an electrical friend came to my rescue and spot welded it for me.

CLIVE AND THE NEW COMPUTERS

I suppose in some degree the new fifth generation of computers are already with us. For example, there are now cars on the market, that, the moment you enter and switch on, start saying in a synthetic voice, sounding halfway between an off colour Dalek and a Nazi Interrogator, "You have not fastened your safety belt". This is all very fine, but it keeps repeating it for three or four minutes after you have fastened it, driving the car occupants mad. Here in a minor way we have the shape of things to

come. Sir Clive Sinclair has already started designing the fifth generation, which he assures us, will be a friend of all the family. Even this announcement starts me grinding my teeth together.

It will, states Sir Clive, have a vast intelligence and be the family Doctor, Lawyer, Teacher and companion. Here is my scenario for a home of the future:

Morning, and Paul Young yawns, and half asleep staggers downstairs. As he enters the dining room a voice booms out, "Good morning Paul, and how are we today?" It is his new friendly computer, named Charles Cope. Paul opens one bleary eye and gives him a malevolent stare that would have blown the main fuse of many lesser computers, and mutters imprecations under his breath. "Oh! my, we are in a bad mood today. What, was it a heavy night last night Paul?" Paul glares at him with both eyes.

"Listen mate, not so much of the Paul, Mr. Young to you."

"Very well Mr. Young," replies Charles adopting a sterner tone. "And by the way, last night you were inebriated and knocked off a policeman's helmet, if you plead guilty I can probably manage to get you off with a fine, but you better adopt a more conciliatory tone towards me, or I won't defend you".

"All right, Charles, you win this time, but don't forget," and Paul's hand moves towards the main switch. A roar of laughter is heard.

"Come off it Paul, you know you would be lost without me. Now, speaking as your Doctor, you are putting on too much weight, lay off the beer and chips".

"Yes Sir." Paul stands up, salutes and at the same time sticks his tongue out at his friendly computer. Paul makes for the door, "Goodbye Charles, and don't, if you want to remain in one piece, tell me "To have a nice day".

"I'm off now, I hope you can cope. Get it?"

"Oh! Paul, that's poor, even by your low standards of humour." Paul in an aside to his readers, "The truth is, that Charles is jealous of my talent, especially my humour and wit and is hoping to take over my job."

Well au revoir till next month. By the way readers, Paul has just gone out, so if you notice a marked improvement in the quality of the articles shortly, you will know the reason why.

Your sincere friend Charles Cope.

Computer Club Solution!

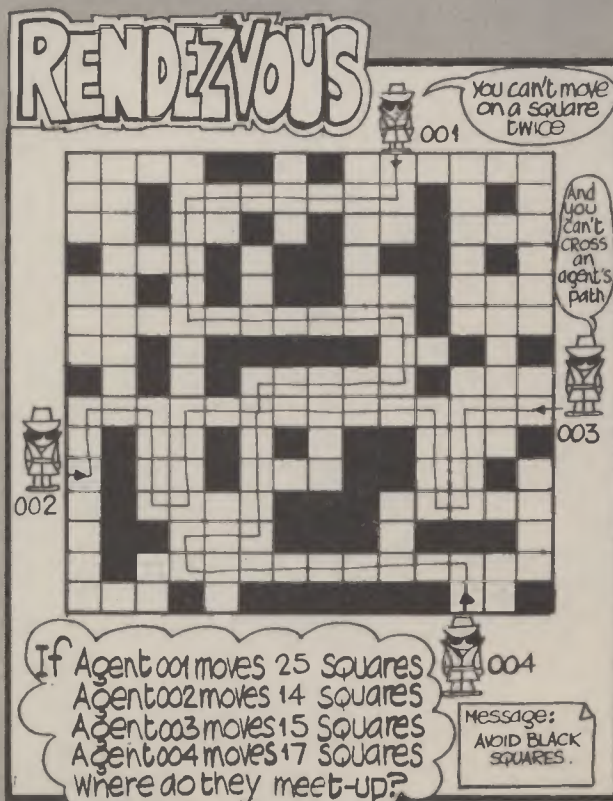

DIGITAL MULTIMETER

I. A. DUNCOMBE

PART TWO

For the beginner, the multimeter is fairly complex to construct but this is only confined to the wiring of the range and mode switches; however providing care is taken there should be little problems. It is suggested that the following procedure is adopted when constructing the multimeter.

- 1) Front and rear panel drilling;
- 2) Converter board construction;
- 3) Display board wiring;
- 4) Front panel and range/mode switch wiring;
- 5) Chassis drilling and final wiring.

FRONT/REAR PANEL DRILLING

Drilling details for the rear panel is shown in Fig. 14. The diameter of the holes depend on the type of components used.

The figures also shown are annotations and denote the mains fuse, the 2A protection fuse and the mains/battery switch S3.

Drilling details for the front panel are shown in Fig. 14. Once again the diameter of the circular holes depend on the components used. The cut-out for the display bezel should be as accurate as possible, there is very little leeway if the rectangular cut-out is not precise.

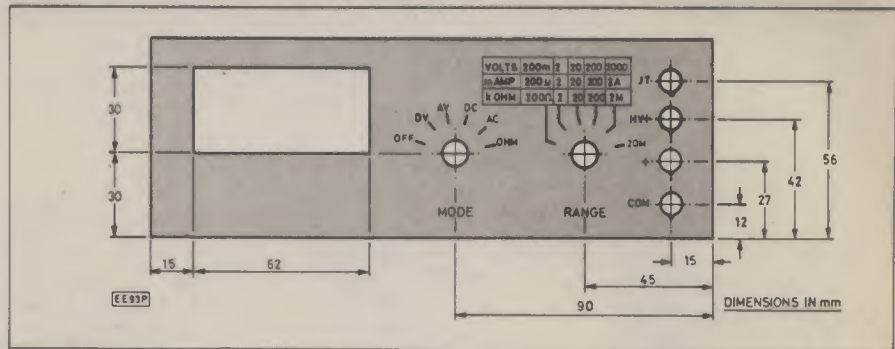

Fig. 14. Front panel drilling and (below) rear panel drilling.

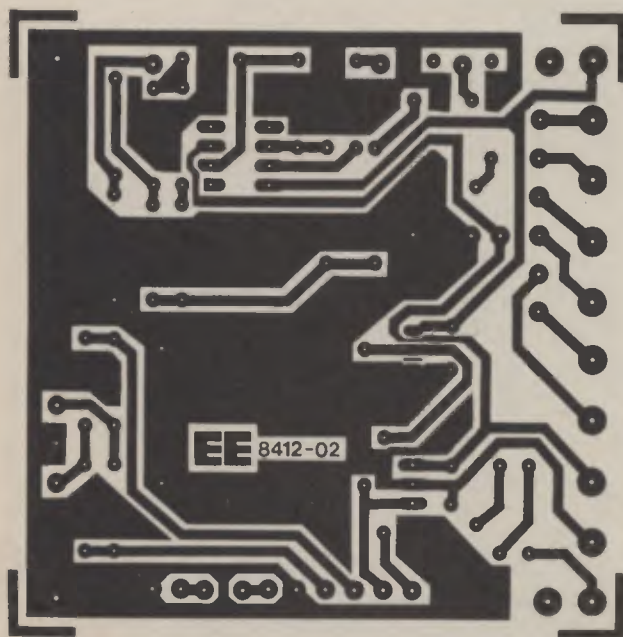
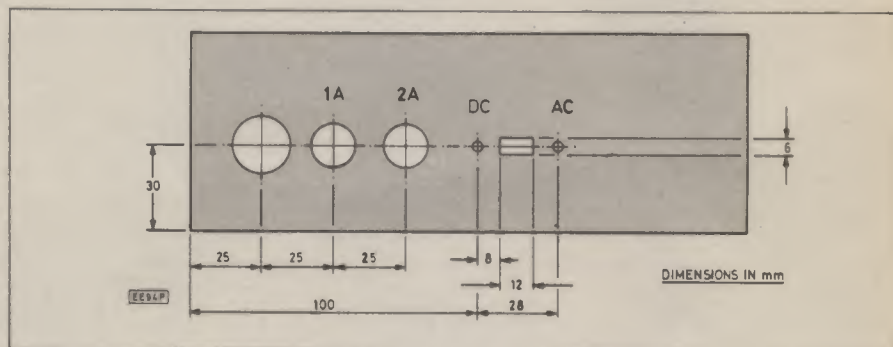
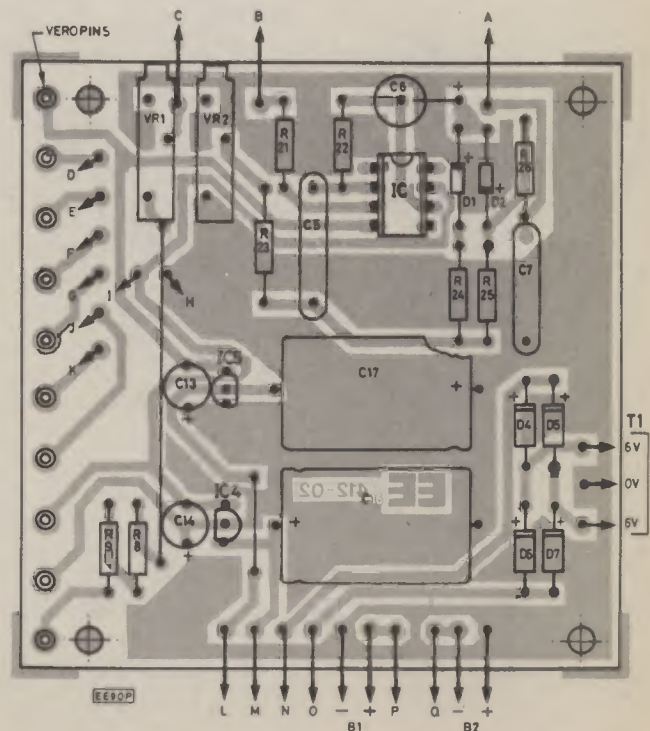

Fig. 15. Converter p.c.b. (actual size) and component layout.



It is best if the hole is made very much undersize so that the edges can be filed down in small steps. It is advisable therefore to have the display bezel to hand.

The lettering was done using Letraset, this includes the straight lines. If straight-line Letraset is not available, then a fine tipped felt pen may be used, an ink pen cannot be used as the surface of the panel does not take ink readily. The entire panel was covered over with a fairly thick clear film to protect the markings.

The four sockets with the bezel can now be mounted. The bezel was fixed using small amounts of clear adhesive, the clear plastic window was removed during this operation. Once both panels have been completed they may be set aside for later.

CONVERTER BOARD

The a.c./d.c. converter and power supply components are mounted on a printed circuit board 76 x 76mm. The underside foil pattern and the component topside are shown in Fig. 15. It is advisable to obtain a ready-made p.c.b. if possible, it is rather difficult to prepare this board using a Dalo etch pen. If the constructor has access to a photographic process then this can be used.

All component holes are drilled 1mm, or as appropriate, for the component leads. The ten holes at the top of the board are drilled to accept, as a tight fit, 0.15in Veropins, these should be single-sided and pushed through from the underside (copperside), at this stage insert and solder fully the two outermost pins, the pins between them can be inserted, but do not solder at this stage.

Note that several components are mounted side by side but have their positive ends opposite to each other. Note in particular the two small regulator i.c.s. Do not forget the single plain wire link at the top of the board.

There are 20 flying leads connected to the p.c.b. and all except the wire marked "A" should be lightweight standard connecting wire. The wire marked "A" should be a little thicker and capable of taking a current of 2A. All leads can be about 6in or so in length, and can be formed loosely in the position they will finally take. Do not insert the i.c., a socket is preferred for this device, and should be of reasonable quality.

Set the completed board aside for later.

DISPLAY BOARD

The display board, consisting of the logic i.c., IC3 and liquid crystal display and other components, is shown in Fig. 16. Here, both the copperside and component topside are shown. Once again it is preferable that a ready-made board is used, it cannot be made using a Dalo pen or even transfers. It is advisable before construction, that the ready-made board (if one is to be used), is free from defects, short-circuited tracks or open circuit tracks for example. For both the display board and the previous converter other forms of wiring are definitely not recommended.

There are eight plain wire links, four of these are under the i.c. and display, and these should be the first items to be soldered in place. A low profile socket is essential for IC3, Soldercon pins must not be used. Similarly, a low profile socket is required for IC2. Soldercon pins

should only be used in the liquid crystal display position, do not break the tops off at this stage. All components, especially the two large polyester capacitors should be mounted as close as possible to the p.c.b. surface. There are no Veropins or wire leadouts required on this board.

Before setting the board aside, take the l.c.d. and carefully offer it to the Soldercon pins, it may be necessary to bend either the pins on the l.c.d. (be very careful!), or the Soldercon pins themselves. Insure that the l.c.d. can be pushed into the pins with very little insertion force. A useful tip here is take a defective 16-pin i.c. and push one side into the Soldercon pins several times. This will remove some of the compression force from the pins, making it easier to fit the l.c.d. Having checked that the l.c.d. will fit easy, it can be removed and returned to its protective package. Both i.c.s and the l.c.d. are not fitted until later.

RANGE/MODE SWITCH WIRING

Because of the high number of wire links and interconnecting wires, the range and mode switches are perhaps the most complex to wire, so be prepared to set aside a single session of construction and not to break overnight!

The complete wiring diagram for these switches and the front panel are shown in Fig. 18.

To begin, it is necessary to make up the switches as they are normally supplied disassembled. Rotate both control spindles fully anti-clockwise as viewed from the front, remove all the mounting hardware and set the ident to position six.

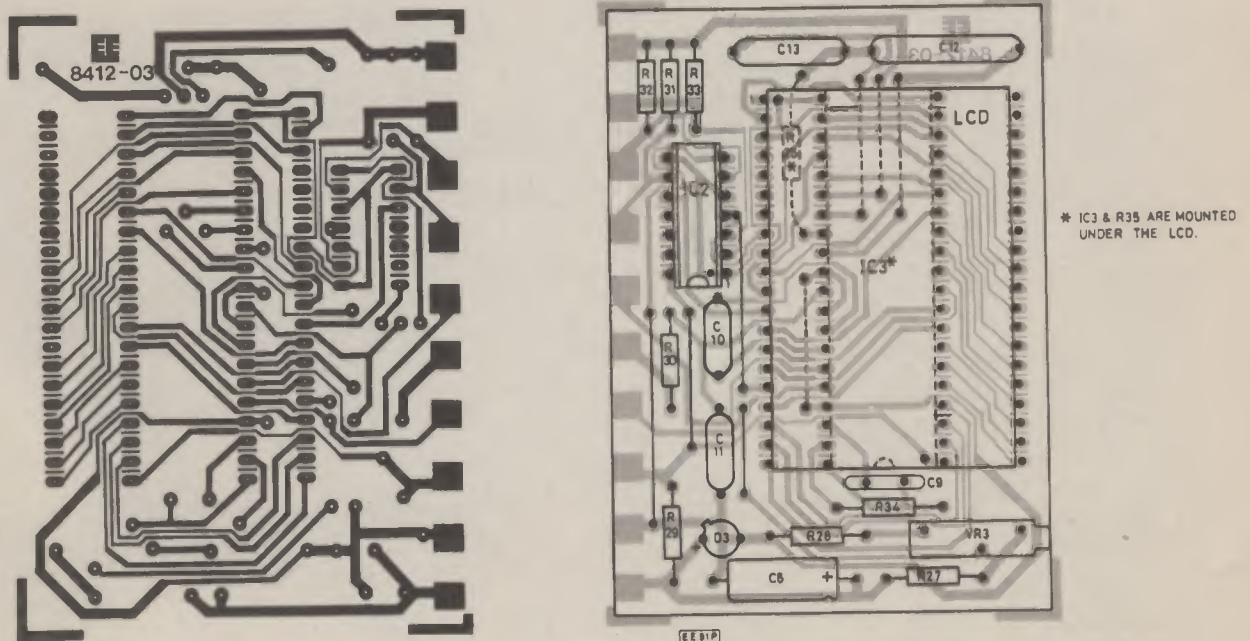

Fig. 16. Display p.c.b. (actual size) and component layout. This board is available from the EE PCB Service: Code 8412-03.

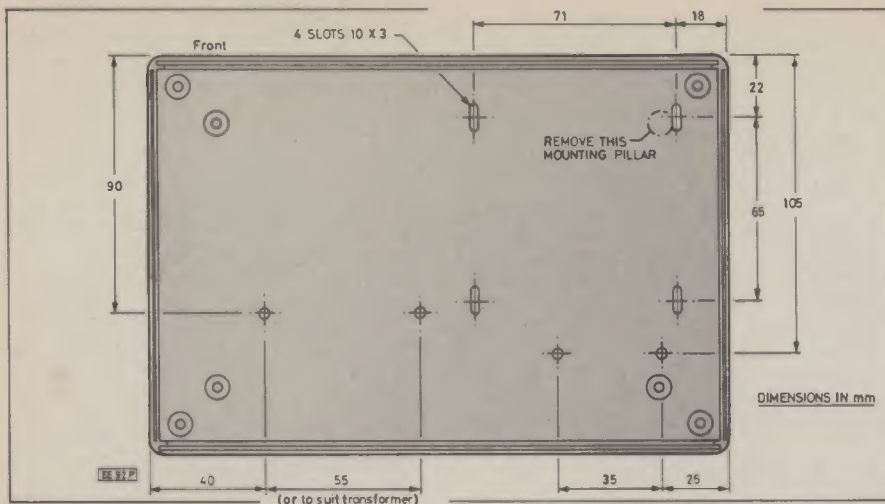

Fig. 17. Base drilling details.

Check that, with the spindle rotated, it stops after six positions, count the rest position as one. Providing the wafers have not been disturbed, it should be found they slip on the mechanism quite easily. They should take up the position shown in the diagram. On the mode switch leave off the rear wafer and mains switch. The wafers can be fitted by using 6BA hardware. Place the front wafers as near to the front as possible. It is not necessary to cut the mechanism. Finally, mount the switches on the front panel.

Before wiring the switches the following should be noted: Firstly, the leads emanating from the wafers labelled with a

letter, in fact go to the converter board and should not be connected at this stage. The tag to which the wire is attached should be left unsoldered. Secondly, the wires from the wafers labelled with numbers should be connected as they go to other parts of the multimeter. They should be 130mm or so long, remember that the wires marked "A", must be of 2-amp rating, ordinary connecting wire is rated lower and should not be used. Begin with the range switch.

Start with the front wafer and connect the input resistors, note the diagram has been "opened out" for clarity, the photographs show how the components

should be positioned. Continue with the rear wafer. A semi-circle of 18 s.w.g. tinned copper wire is used for the common connection on both the ohms and current range resistors, and is positioned as shown in the photographs. The trimmer capacitor's leads may need bending slightly to fit between the tags of the wafer.

The mode switch can next be wired, however before this is done the rear wafer (as yet unmounted) can first be wired up. Just two small pieces of tinned copper wire are required and are common to several tags on both halves of the wafer.

Continue with the front wafer and the middle wafer. Do not forget the high voltage d.c. blocking capacitor, it is advisable to insulate the leads with sleeving. Also insulate any interconnecting wires between wafers.

No wiring is made as yet to the mains switch, and this is put to one side.

CHASSIS DRILLING

Drilling details for the chassis are shown in Fig. 17 and apply only to the specified Verobox. If other forms of housing is used then the constructor will have to vary the dimensions accordingly. The two holes marked "A" are for the transformer and their positions may need to be varied depending on the type used. As shown in the diagram, one mounting pillar needs to be removed completely. The brass insert can be heated to aid its removal, the remaining part of the pillar is

Fig. 18. Front panel switch wiring.

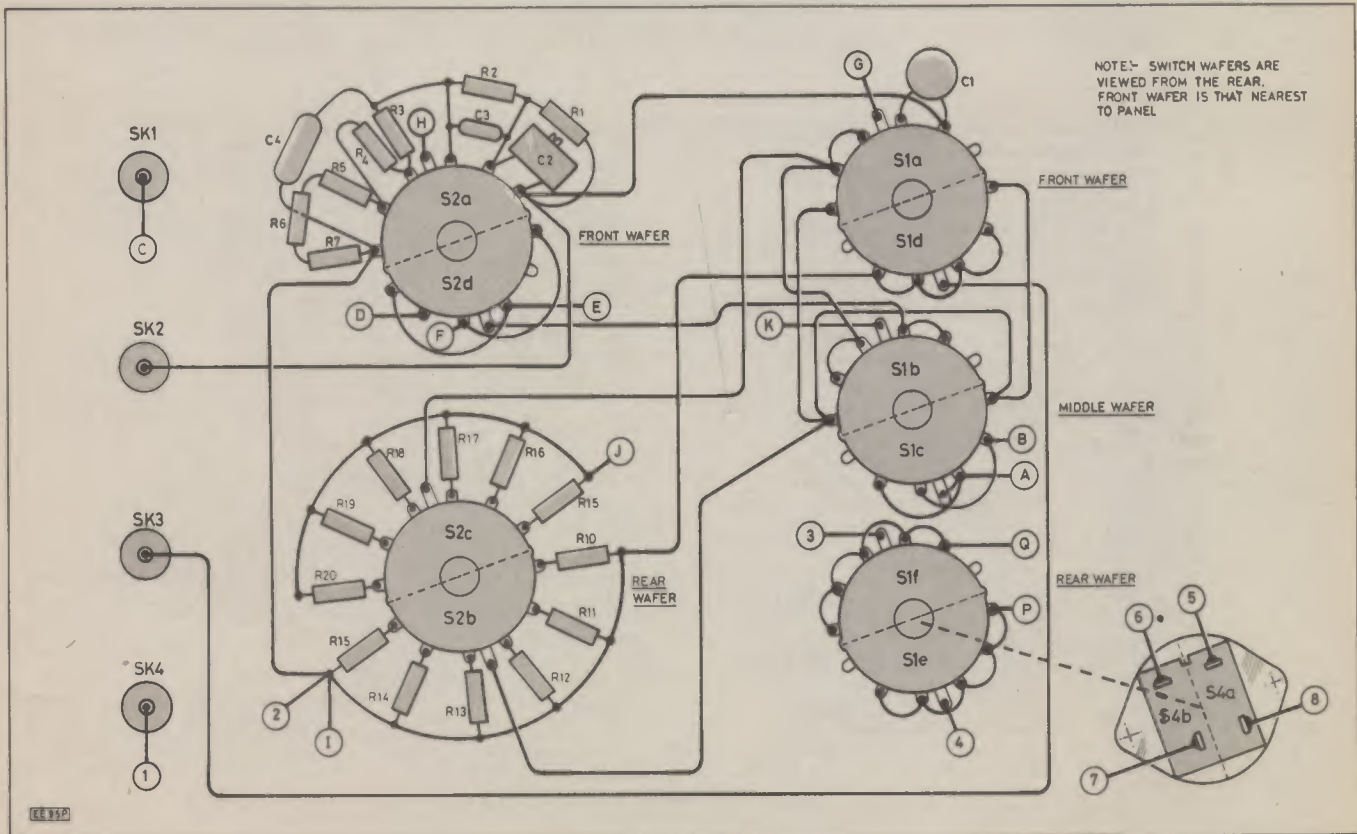

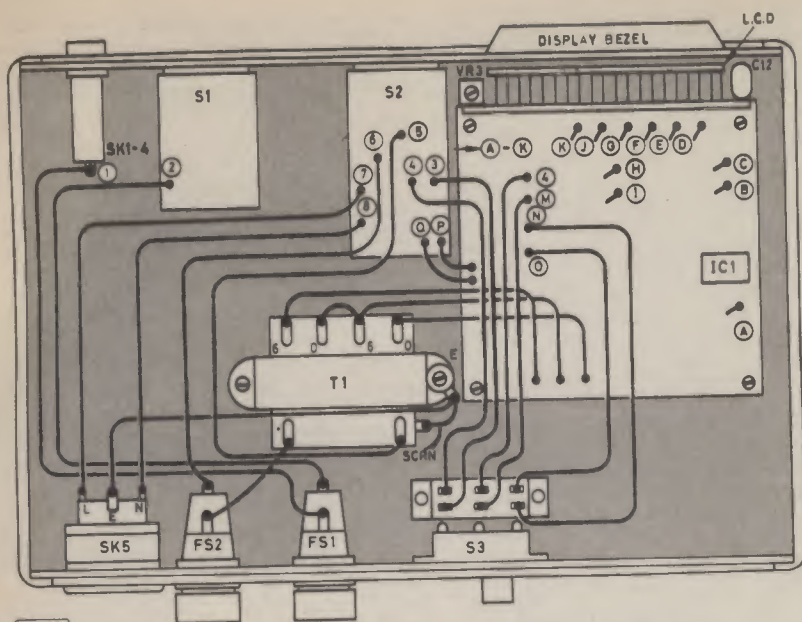

Fig. 19. Final wiring diagram of the Digital Multimeter.

cut off using a sharp knife. The position of the converter board mounting holes may need slight adjustment to compensate for minor variations in the height of the l.c.d. from the surface of the display board. Thus either four 6BA clear holes are drilled or four slots are filed out.

Proceed with the mounting of the rear panel components and transformer. The display board can now be attached to the converter board. Place the display board up against the two Veropins and lightly solder each pin to the copper pad. Check to ensure that both boards are at exactly 90 deg. to each other, if not, reheat the pins in turn and adjust the boards accordingly. Once the correct position has been found the remaining pins can be soldered. Mount the assembly on the chassis using 4in spaces, but do not fully tighten the nuts.

At this stage the assembly must be checked for any errors in wiring, etc. Carefully break off the tops of the solder-con pins, do not insert the i.c.s or l.c.d. Connect two PP3 batteries to the connectors and check that the following voltages appear as quoted: C14 positive lead: 5V, C15 negative lead: -5V, IC1 pin 7: 5V, pin 4: -5V there should be little or no voltage on any other pin, IC2 pin 14: -5V, IC3 pin 1: 5V, pin 26: -5V, pin 36 (0.5V): 1V there should be little or no voltage on any other pin.

The pins of the l.c.d. should show no voltage on any pin. If the above results are not obtained then there is most probably a fault, the batteries should be removed quickly as possible and the fault found and rectified. If all is well all three i.c.s can be inserted, be extra careful with IC3, and be sure it is well pushed into its socket. The l.c.d. can also be plugged in as far as it will go, it should lie flat on the i.c. underneath and be parallel with the

board. Remove all power when inserting the i.c.s.

Insert the front panel into its slot and while keeping it upright, move the display board towards the bezel so that it touches the clear plastic window. Once the correct position has been found the nuts retaining the assembly can be fully tightened.

FINAL WIRING

The final wiring diagram is shown in Fig. 19. Begin by connecting the wires from the converter board to the range and mode switches. Form the wires neatly, and use a length of spira-wrap to hold together the wires. There should be at this stage 13 wires from the converter board going to the switches. It may be necessary to remove the front panel to gain access to the underside of the wafers.

Having completed this part of the wiring, the rear wafer and the mains switch can be mounted. Continue by wiring up the rear wafer to both the converter board and the rear panel mounted slide switch, again spira-wrap can be used here. The mains wiring can now be completed as shown. Do not forget the three wires which connect to the transformer from the converter board. The final wiring is to connect up the wires to the 2A fuseholder, FS1.

TESTING

Before connecting the batteries it is important that the completed multimeter is checked thoroughly for any errors. If there are mistakes, they may prove costly when power is first applied. All testing and calibration is carried out for safety reasons using batteries, although once the multimeter is working mains operation can of course be checked.

Begin by turning all three presets to

their mid-positions, the mode switch to off and the range switch to 20V f.s.d. The slide switch should of course be in the battery (d.c.) position. Insert a 2A fuse in the correct holder and connect two PP3 batteries to their connectors, do not plug in any test leads at this stage.

Rotate the mode switch to the d.v. position, immediately the l.c.d. should come to life and show some random number, obviously if it does not, there is a fault and the multimeter should be switched off and rechecked for errors. Assuming all is well, connect a pair of test leads to the "+" and "com" terminals, short the two leads together, the display should read as close to all zeros as possible. If it in fact shows a small value, such as 0.8V for example with the minus sign also showing, then this is perfectly acceptable. Rotate the mode switch through the remaining positions, the display should remain unchanged. Leave the mode switch in the ohm position and remove the test leads, the display should overrange and show just 1. Remove the short and return the mode switch to the d.v. position.

CALIBRATION

If a second digital multimeter is available then the meter described here can be calibrated quite easily by comparing the reading of one to that of the other when connecting to various standard sources. However, if this is not the case, as it will most certainly be, the multimeter can be calibrated to quite good accuracy following the methods described below. The only item of test equipment required, will be a standard meter of reasonable accuracy covering both alternating and direct voltages up to 20V f.s.d. A source of a.c. voltage is also needed and can be supplied from a small low voltage transformer. A signal generator covering 20Hz to 50kHz is an advantage when adjusting the frequency compensated input resistor network but is not essential if a slight loss of accuracy at high audio frequencies can be tolerated.

DIRECT VOLTAGE

With an external meter connect the leads between the "com" and the "junction test" terminals, the voltage between them should be around 1.283V, the exact voltage will depend on component tolerances. Disconnect the leads, set the multimeter to the 2V d.c. range and connect the junction test terminal to the "+" terminal, no other connection is required. Adjust VR3 (on the display board) for the voltage previously noted. Do this adjustment as carefully as possible as all other functions of the meter depend on this adjustment to be accurate. If possible leave the multimeter connected in this manner for a while and recheck that the voltage has not significantly changed.

If an accurate known d.c. voltage source is available then the other ranges can be checked.

ALTERNATING VOLTAGE

Most analogue meters, and here we are referring to the small "pocket" type meters, are only accurate when used on alternating voltages of 50Hz, i.e., mains frequency. For this reason we must calibrate the multimeter at this frequency. Connect the output from the mains transformer to the terminals and set the range to the correct f.s.d. Also connect in parallel the analogue meter. Note the reading and adjust VR2 (nearest the back panel on the converter board) to show the same reading on the display.

The multimeter is now calibrated for alternating voltages at a frequency of 50Hz. For other frequencies the accuracy falls off the higher the frequency. To compensate for this we must adjust the small trimmer on the input resistive divider network. Connect an audio signal generator set for 50Hz and for a convenient output voltage, say 1.5V, to the multimeter terminals. Set the range for 2V f.s.d. Note carefully the reading on the display. Next re-adjust the signal generator to give an output of 5kHz, the display should show a drop in voltage,



adjust the trimmer to give the same reading as before. Return the signal generator to 50Hz and re-check the reading.

Finally the signal generator can be tuned from 20Hz to, say 20kHz and the voltage reading at various points noted, they should be within the limits shown in the specifications. If not, then slight readjustment of the trimmer will be required to flatten out the various peaks and dips which may occur.

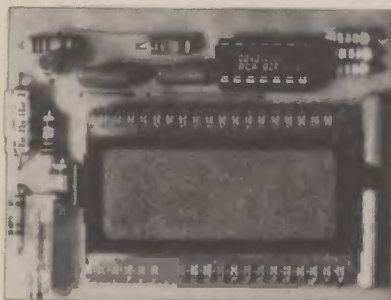

As explained earlier, this method is not the best, it does however increase the range of the a.v. ranges to cover most of the audio spectrum with reasonable accuracy. The meter is entirely accurate at 50Hz and this should prove adequate for most purposes.

DIRECT CURRENT

This particular range has no calibration components, and relies entirely on the accuracy of the range resistors. All that can be done is to apply currents of various values and check that the reading is accurate.

ALTERNATING CURRENT

Similarly, as above, this range relies on the ranging resistors and also the calibration accuracy of the converter. Again, checks can be made with various alternating currents.

OHMS RANGE

The Ohms range is self-calibrating in a manner of speaking, and relies on the accuracy of the range resistors.

Finally, as a last check, the multimeter can be switched over to mains operation and all modes and ranges checked once again, after which the meter is ready for use.

IN USE

The use of the multimeter should be apparent to all, however the following points should be remembered when using the instrument.

When using the meter to measure both direct and alternating voltages above 200V the high voltage terminal must be used—and with care. Protection against accidental overload is provided by the current limiting resistor, R30. In the worst case where say, 1000V is applied to the meter when switched to the 200mV range, the resistor will limit the current to about 1mA, but for only a short time as the resistor will eventually burn out and will probably result in a great deal of damage.

The current ranges, both direct and alternating are simple to use, and protection here is provided by a quick blow fuse which should give total protection in most cases.

The Ohms range is also self apparent, note as described earlier, it will not turn on transistor junctions. This makes it ideal for in-circuit resistance measurements. When measuring resistance, there is slight jitter effect, particularly on the 2M Ω and 20M Ω ranges. This is mainly due to the long test leads used but can easily be overcome by making the leads as short as possible. The effect completely disappears when a resistor is say, connected straight across the terminals. There is no protection for this range, so be sure to switch off the circuit under test.

JUNCTION TEST

For this mode, connect the junction test terminal to the "+" terminal, no other connection is required. Set the multimeter to read 200 μ A d.c. Adjust VR1 (nearest the front panel—converter board) for a reading of 100 μ A. This mode need not be particularly accurate, and a variation of a few microamps is quite acceptable.

NOTE! Some constructors may find when adjusting the presets above that the correct results are not obtained, this may be particularly noticed on the alternating ranges. This is mainly due to the low values of the presets needed to ensure fine adjustment. To provide for correct adjustment, the values of the following resistors may be increased or decreased in value as required, alternating ranges: R23, junction test: R9, and although it does not need variation, R27 applies to the direct ranges.

For example, if the junction test current cannot be brought below say 120 μ A then the value of R9 can be increased by an extra 800–1000 ohms or so.

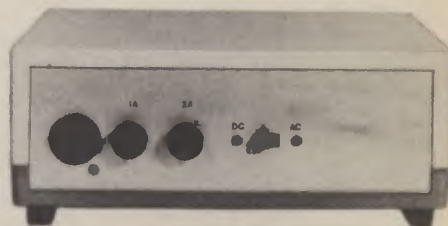

The final range is the junction test. This is used in much the same way when testing semiconductor junctions as with a normal analogue type meter. When measuring a diode for example, a good diode will give a reading of about 62.5 on the display when forward biased, and almost zero when reversed biased. An open-circuit diode will give a reading of zero, while a short-circuit diode will give a reading of 100.0. Again there is no protection for this mode, so any circuit under test must be switched off. □

T.V. SOUND TUNER

SERIES II BUILT AND TESTED Complete with case. £26.50 + £2.00 p&p.

In the cut-throat world of consumer electronics, one of the questions designers apparently ponder over is "Will anyone notice if we save money by chopping this out?" In the domestic TV set, one of the first casualties seems to be the sound quality. Small speakers and no tone controls are common and all this is really quite sad, as the TV companies do their best to transmit the highest quality sound. Given this background a compact and independent TV tuner that connects direct to your Hi-Fi is a must for quality reproduction. The unit is mains operated. This TV SOUND TUNER offers full UHF coverage with 5 pre-selected tuning controls. It can also be used in conjunction with your video recorder. Dimensions: 10½" x 7½" x 2½". E.T.I. kit version of above without chassis, case and hardware. £16.20 plus £1.50 p&p.



Also available with built-in headphone amp. ONLY £32.50 + £2.00 p&p.

HI-FI SPEAKER BARGAINS

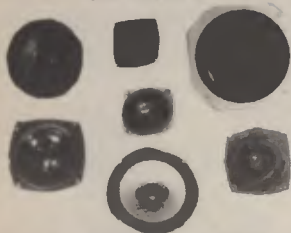

TOKUDEN — 8", 8 ohm full range 7½W twin cone speaker. £3.50 +£1.10 p&p.

7" 60W Bass/Mid. speaker. 8 ohm impedance. Freq. res.: 40 — 6,000Hz. 4½" x ½" magnet. £14.95 +£1.75 p&p.

4½" 25W Bass/Mid. speaker. 4 ohm impedance. With rolled surround. £4.95 +£1.50 p&p.

Tweeters: 8 ohm soft dome radiator type. (3½" sq.) For use in systems up to 40 watts. £3.95 ea. +£1 p&p. or £6.95 pr. +£1.50 p&p.

EAGLE
Full range 8" 20W, 8 ohm. Twin cone with rolled surround. £6.95 +£2.20 p&p.
Full range 6½" 15W, 8 ohm. Twin cone with rolled surround. £5.95 +£2.20 p&p.
Full range 4" 8W, 8 ohm. With rolled surround. £4.95 +£1.50 p&p.

125W HIGH POWER AMP MODULES

The power amp kit is a module for high power applications - disco units, guitar amplifiers, public address systems and even high power domestic systems. The unit is protected against short circuiting of the load and is safe in an open circuit condition. A large safety margin exists by use of generously rated components, result, a high powered rugged unit. The PC board is back printed, etched and ready to drill for ease of construction and the aluminium chassis is preformed and ready to use. Supplied with all parts, circuit diagrams and instructions.

Accessories: Stereo mains power supply kit with trans. £10.50 + £2 p&p. Mono: £7.50 + £2 p&p.

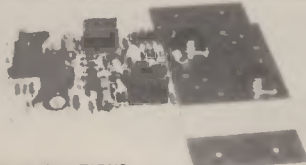

SPECIFICATIONS:
Max. output power (RMS): 125 W. Operating voltage (DC): 50 - 80 max. Loads: 4 - 16 ohm. Frequency response measured @ 100 watts: 25Hz - 20KHz. Sensitivity for 100w: 400mV @ 47K. Typical T.H.D. @ 50 watts, 4 ohms: 0.1%. Dimensions: 205x90 and 190x36mm.

KIT £12.00 +£1.15 p&p. BUILT £17.50 +£1.15 p&p.

NICAD CHARGERS/BATTERIES



SAFT/MAZDA BATTERIES:
RX6 (HP7/AA size) £1.10 ea. or 4 for £3.50.
RX14 (HP11/C size) £2.45 ea. or £4.10 a pair.
RX22 (PP3 size) 9 volt, £4.95 ea., £9.00 a pair.
50p p&p per order on batteries.

SAFT/MAZDA RX22 Charger (takes 2 PP3's) £2.75 + 80p p&p.

UNIVERSAL CHARGER, takes 4x AA's, or 4 C's or D's + 1 PP3. £5.50 + £1.40 p&p.

PAIR 10W SPEAKERS
Incorporates 4½" 10 watt speaker. Finished in teak veneer simulate. Built, ready to use. Ideal extension spkrs. 12½ x 7½ x 4¼ ins. £14.95 +£1.75 p&p.

STEREO TUNER KIT

SPECIAL OFFER!

£13.95 +£2.50 p&p.

This easy to build 3 band stereo AM/FM tuner kit is designed in conjunction with PE (July 81) For ease of construction and alignment it incorporates three Mullard modules and an I.C. IF System. Front scale size 10½" x 2½" approx. With diagram and instructions.



BSR RECORD DECKS

Auto-Changer model - takes up to 6 records with manual override. Supplied with stereo ceramic cartridge. £9.95 plus £1.75 p&p.



Manual and Auto-Changer record deck. Plays records individually or play automatically up to 6 records.

Manual single play record deck with auto return and cueing lever. Fitted with stereo ceramic cartridge 2 speeds with 45 rpm spindle adaptor ideally suited for home or disco. 13" x 11" approx. £14.95 plus £1.75 p&p.



All mail to: 21A HIGH ST, ACTON W3 6NG
Callers: Mon - Sat 9.30 - 5.30. Half day Wed.
Access phone orders on 01-992 8430.
Note: Goods despatched to U.K. postal addresses only. All items subject to availability. Prices correct at 31/9/84 and subject to change without notice.
Please allow 14 working days from receipt of order for despatch. RTVC Limited reserve the right to update their products without notice. All enquiries send S.A.E. Telephone or mail orders by ACCESS welcome.

MONO MIXER AMP

Ideal for halls and clubs. £45.00 + £2 p&p

50 Watt, six individually mixed inputs for 2 pickups (Cer. or mag), 2 moving coil microphones and 2 auxiliary for tape tuner, organs etc. Eight slider controls — 6 for level and 2 for master bass and treble, 4 extra treble controls for mic. and aux. inputs. Size: 13½" x 6½" x 3½" approx. Power output 50 W RMS (cont.) for use with 4 to 8 ohm speakers. Attractive black vinyl case with matching fascia and knobs. Ready to use.

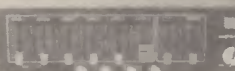

CALLERS TO: 323 EDGWARE ROAD, LONDON W2.
(5 minutes walk from Edgware Road Tube Station)
Now open 6 days a week 9 - 5.30. Prices include VAT.



TWO FABULOUS OFFERS FROM

ALCON

The incredible 'MINI 20'

28 ranges
20kΩ/V d.c. & 4kΩ/V a.c.
(With protective fuse)

Accuracy: 2% d.c. and resistance, 3% a.c.

28 ranges: d.c. V 100mV, 3V, 10V, 30V, 100V, 300V, 600V. d.c. 150μA, 600μA, 6mA, 600mA. a.c. V 15V, 50V, 150V, 500V, 1500V. a.c. 130mA, 300mA, 3.0A. Ohms 0-2kΩ, 0-2MΩ. dB from -10 to +62 in 6 ranges.

Dimensions: 105 x 130 x 40mm.

The 28 ranges cover all likely requirements. Operation is straightforward, just turn the selection switch to the required range.

This special offer is a wonderful opportunity to acquire an essential piece of test gear with a saving of nearly £10.00.

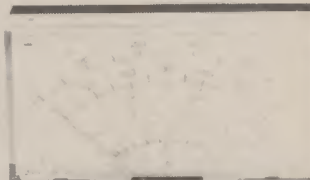

THE IDEAL INSTRUMENT FOR THE CONSTRUCTOR

ONLY £21.60

(complete with carrying case, leads and instructions)

'SUPER 20'

A SUPER PROTECTED UNIVERSAL MULTIMETER

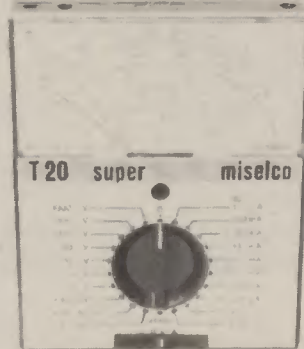

★ 20KΩ/V
AC AND DC

★ 39 RANGES

★ INDESTRUCTIBLE
(automatically protected on all ranges but 10A)

Accuracy: d.c. ranges and Ω 2% a.c. 3% (of f.s.d.)
39 ranges: d.c. V 100mV, 1-0V, 3-0V, 10V, 30V, 100V, 300V, 1000V.
d.c. 150μA, 100μA, 300μA, 1.0μmA, 3mA, 10mA, 30mA, 100mA, 1A, 10A
a.c. V 10, 30V, 100V, 300V, 1000V;
a.c. 1.3mA, 10mA, 30mA, 100mA, 1.0A, 10A.
Ω 0-5.0kΩ, 0-50kΩ, 0-500kΩ, 5MΩ, 50MΩ.
dB from -10 to +61 in 5 ranges.

Dimensions: 105 x 130 x 40mm.

These special offers is a wonderful opportunity to acquire an essential piece of test gear with a saving of nearly £20.00.

(complete with carrying case, leads and instructions)

ONLY £33.50

PRICES Our prices include VAT and postage and goods are normally despatched by return.

For details of these and the many other instruments in the Alcon range, including multimeters, components measuring, automotive and electronic instruments, please write or telephone:

ALCON Instruments Ltd.

19 MULBERRY WALK · LONDON SW3 6DZ · TEL: 01-352 1897 · TELEX: 918867

SECURITY

Assemble and install your own system and save pounds

SECURITY

A COMPLETE SECURITY SYSTEM FOR ONLY £39.95 + V.A.T.



Control Unit
Enclosure & mechanical fixings
Key Switch & 2 keys
L.E.D.'s
5 1/2" Horn Speaker
4 high quality surface mounting Magnetic Switches

CA 1250
HW 1250
KS 3901
LED 1
HS 588
MS 1025

With only a few hours of your time it is possible to assemble and install an effective security system to protect your family and property, at the amazingly low cost of £39.95 + V.A.T. No compromises have been made and no corners have been cut. The outstanding value results from volume production and direct supply. Assembly is straight forward with the detailed instructions provided. When installed you can enjoy the peace of mind that results from a secure home. Should you wish to increase the level of security, the system may be extended at any time with additional magnetic switches, pressure pads or ultrasonic sensors. Don't wait until it's too late - order today.
Order code: CS 1370.

EXTENDED SYSTEM CS 1480 Price £62.50 + V.A.T.

This system contains, in addition to the CS 1370, an ultrasonic detector type US 5063 & its enclosure, an additional horn speaker and a further 2 magnetic switches. This system represents outstanding value for money for the high level of security provided. Order Code: - CS 1480.

SELF-CONTAINED ULTRASONIC ALARM UNIT CK 5063

only £37.00 + V.A.T.



Requires no installation. Easily assembled using our professionally built and tested modules.
● Adjustable range up to 25 ft.
● Built-in entrance and exit delay
● Built-in timed alarm
● Key operated switch - Off, Test and Operate
● Provision for an extension speaker
● Fully self-contained
● Uses US 5063, PSL 1865, Key Switch 3901, 3" Speaker 3515

Now you can assemble a really effective intruder alarm at this low price using tried and tested Riscomp modules. Supplied with full instructions, the kit contains everything necessary to provide an effective warning system for your house or flat. With a built-in LED indicator and test position the unit is easily set-up requiring no installation. It may simply be placed on a cupboard or desk. Movement within its range will then cause the built-in siren to produce a penetrating 90dbas of sound, or even 110dbas with an additional speaker. All parts included and supplied with full instructions for ease of assembly. Size 200 x 180 x 70mm. Order as CK 5063

ALARM CONTROL UNIT CA 1250



Price £19.95 + V.A.T.

The heart of any alarm system is the control unit. The CA 1250 offers every possible feature that is likely to be required when constructing a system, whether a highly sophisticated installation or simply controlling a single magnetic switch on the front door.

- Built-in electronic siren drives 2 loud speakers
- Provides exit and entrance delays together with fixed alarm time
- Battery back-up with trickle charge facility
- Operates with magnetic switches, pressure pads, ultrasonic or IR units
- Anti-tamper and panic facility
- Stabilised output voltage
- 2 operating modes full alarm/anti tamper and panic facility
- Screw connections for ease of installation
- Separate relay contacts for external loads
- Test loop facility

HARDWARE KIT HW 1250

only £9.50 + V.A.T.



The attractive case is designed to house the control unit CA 1250, together with the appropriate LED indicators and key switch. Supplied with the necessary mounting pillars and punched front panel, the unit is given a professional appearance by an adhesive silk screened label. Size 200 by 180 by 70mm

Add 15% VAT to all prices
Add 70p post and packing to all orders
Units on demonstration
Shop hours 9.00 to 5.30 p.m.
Closed Wednesday
Saturday 9.00 to 1.00 p.m.
SAE with all enquiries
Order by telephone or post using your credit card

SIREN & POWER SUPPLY MODULE PSL 1865

only £9.95 + V.A.T.

A complete siren and power supply module which is capable of providing sound levels of 110dbas at 2 metres when used with a horn speaker. In addition, the unit provides a stabilised 12V output up to 100mA. A switching relay is also included so that the unit may be used in conjunction with the US 5063 to form a complete alarm.

POWER SUPPLY & RELAY UNIT PS 4012

Price £4.95 + V.A.T.

Provides stabilised 12V output at 85mA and contains a relay with 3 amp contacts. The unit is designed to operate with up to 2 ultrasonic units or 1 infra-red unit IR 1470.

SIREN MODULE SL 157

Produces a loud penetrating siren tone which, when coupled to a suitable horn speaker, produces S.P.L.'s of 110dbas at 2 metres. Operating from 9-15V. Price £2.95 + V.A.T.

5 1/2" HORN SPEAKER HS 588

This weather-proof horn speaker provides extremely high sound pressure levels (110dbas at 2 metres) when used with the CA 1250, PS 1865 or SL 157. Price £4.35 + V.A.T.

3-POS. KEY SWITCH 3901

Single pole, 3-key switch intended for use with the CA 1250. Price £2.43 + V.A.T.

MAGNETIC SWITCH MS 1025

Surface mounting superior quality. Price £1.17 + V.A.T.

US 4012 ULTRASONIC MODULE

Basic low cost ultrasonic detector suitable for wide range of movement detection applications featuring 2 LED indicators and having adjustable range 5-25 ft. Price £10.95 + V.A.T.

DIGITAL ULTRASONIC DETECTOR US 5063

only £13.95 + V.A.T.

- 3 levels of discrimination against false alarms
- Crystal control for greater stability
- Adjustable range up to 25ft.
- Built-in delays
- 12V operation

This advanced module uses digital signal processing to provide the highest level of sensitivity whilst discriminating against potential false alarm conditions.

ULTRASONIC MODULE ENCLOSURE

only £2.95 + V.A.T.

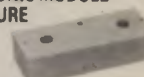

Suitable metal enclosure for housing an individual ultrasonic module type US 5063 or US 4012. Supplied with the necessary mounting pillars and screws etc. For US 5063 order SC 5063; for US 4012 order SC 4012.

INFRA-RED SYSTEM IR 1470

only £25.61 + V.A.T.



Consisting of separate transmitter and receiver both of which are housed in attractive moulded cases, the system provides an invisible modulated beam over distances of up to 50ft. operating a relay when the beam is broken. Intended for use in security systems, but also ideal for photographic and measurement applications. Size 80 by 50 by 35mm.

RISCOMP LIMITED

Dept EE24,
21 Duke Street,
Princes Risborough,
Bucks, HP17 0AT.
Princes Risborough (084 44) 6326
Please allow 7 days delivery

MASTER Electronics - Microprocessors - Now! The PRACTICAL Way!

- Electronics - Microprocessors - Computer Technology is the career and hobby of the future. We can train you at home in a simple, practical and interesting way.
- Recognise and handle all current electronic components and 'chips'.
- Carry out full programme of experimental work on electronic & computer circuits including modern digital technology.
- Build an oscilloscope and master circuit diagrams.
- Testing and servicing radio - T.V. - hi-fi and all types of electronic/computer/industrial equipment.

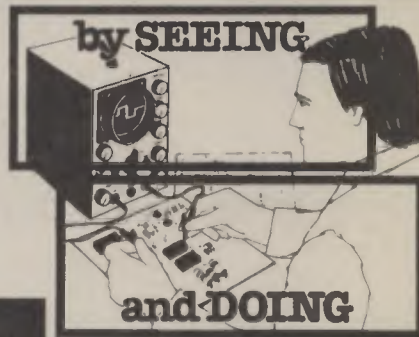

New Job? New Career? New Hobby?

Please send your brochure without any obligation to:-

I am interested in:

NAME _____

ADDRESS _____

_____ BLOCK CAPS PLEASE

- SEND THIS COUPON NOW.
- ELECTRONICS
 MICROPROCESSORS
 RADIO AMATEUR LICENCE
 CITY & GUILDS EXAMS

Other Subjects _____

British National Radio & Electronics School Reading, Berks. RG1 1BR



OR TELEPHONE US
0734 51515 OR
TELEX 22758
(24 HR SERVICE)

RADIO WORLD



BY PAT HAWKER G3VA

Clear-Faced Sun

For all those who are concerned with that fascinating, yet often frustrating part of the radio-frequency spectrum—the "h.f." band between 3 and 30MHz (traditionally the short waves)—the outlook for the next few years is less than cheerful. The "cloud" on the horizon is the latest sun-spot-cycle minimum.

This is now looming up rather earlier than expected, although this winter is almost halfway along the 11-year cycle which last peaked in 1979-80. Indeed there was a period of some 12 days in late autumn when *no* sunspots could be observed on the usually blemished face of Old Sol.

The prime result of sunspot activity in so far as it affects professional communicators, h.f. broadcasters, radio amateurs, "CB" enthusiasts and short-wave listeners is that it enhances the ionisation of the layers (or more accurately travelling "clouds" of ionisation) in the upper atmosphere. This results in the long-distance reflection of the higher frequencies for a longer period of each day.

Sunspots and H.F.

Around the sunspot maximum years (1937, 1947, 1958, 1969, 1979-80) at about 11-year intervals, the daytime *F2* layer, roughly 200-400 miles above the surface of the Earth, can often open long-distance paths on frequencies up to and beyond 50MHz. However, in the periods of low sunspot activity very few long-distance paths are open above 25MHz except very occasionally in a north-south direction towards southern Africa and South America.

Even the reliable 14MHz band goes "dead" for many hours of the night. Similarly, at sunspot maximum periods, 27MHz CB channels can bring in voices from afar, whereas in the minimum years the only sky-wave signals are likely to be from Europe, brought about by daytime Sporadic E anomalous propagation which cannot be predicted with any accuracy and is less-directly linked with the sunspots.

This does not mean that h.f. "conditions" become unsuitable for long-distance transmission and reception, but rather that such paths require the use of lower frequencies. Short-wave broadcast listeners need to pay more attention at such times to the 90-metre (3.3MHz), 75-metre (3.9MHz), 60-metre (5MHz) and 49-metre (6MHz) bands (some reserved for "tropical broadcasting").

Radio amateurs tend to migrate to the 3.5 or 7MHz bands although unfortunately the 7.0 to 7.1MHz (41 metres) "exclusive" amateur band is still cluttered with high-power broadcasting stations.

Grey-Line Propagation

The concentration of so much activity, particularly by broadcasters, into the lower segments of h.f. instead of spreading out as high as the 11-metre (26MHz) band means that the usable bands become even more over-crowded than usual. Also the large directional aerial arrays tend to produce less gain at lower frequencies.

It also becomes increasingly difficult to transmit or receive across the night/day barrier due to the sharper difference between daytime and night-time maximum usable frequencies. Radio amateurs, whose transmitters are so much less powerful than those used for broadcasting, have come to recognise the importance of what is called "grey-line" propagation, particularly on the lower part of the h.f. spectrum.

This takes the form of the reliable but brief long-distance paths that open between places where the times of dawn and dusk, dawn and dawn or dusk and dusk roughly coincide, giving rise to the

Bringing In The Pictures

For television broadcasters concerned with news and sports programmes a major problem is bringing the pictures from the event into the studio centre. Whereas a radio outside broadcast can use "music lines" or normal telephone circuits, for video a broadband link capable of carrying frequencies up to about 5MHz without too much phase-differential or amplitude-differential distortion is needed. This requires a special coaxial cable or microwave radio link since telephone circuits could only be used, even with equalisation, over very short distances, for such broadband signals.

Stadia and places from which television broadcasts are frequently made have permanently installed broadband facilities. Elsewhere, at distances up to about 30 miles from a studio centre or from a point at which pictures can be fed into BT's inter-city or EBU's Eurovision broadband circuits it is the usual practice to install temporary microwave links, but this takes time and planning.

The development of lightweight electronic cameras and portable video recorders in the 1970s still depends to a considerable extent on bringing the tape cassettes to the studios or nearest broadband circuit by motorcycle or car, although large cities, particularly in the USA, have sophisticated installations on the top of tall buildings for picking up temporary microwave links from communications vehicles, etc. To facilitate "live" broadcasts from portable cameras very short-range links between the cameraman and his vehicle use microwave frequencies around 13GHz (13,000MHz) and even 40GHz where tiny "horn" aerials can be used.

possibility of extended "one-hop" propagation due to layer entrapment ("chordal hop"), etc., brought about by tilts in the *F* layer, as the lower *F1* and higher *F2* layers combine or separate.

Grey-line propagation can for example result in lower power transmissions on 1.8, 3.5 or 7MHz being received for short periods in Australia or New Zealand, but requires some careful study of the times of sunrise and sunset in the target areas.

Predicting Sunspots

The appearance of visible dark spots on the Sun has been observed and recorded for many centuries, initially by the Chinese but for some 300 years in Europe. Although the regularity of the sun-spot cycle of roughly 11 years (or 22 years if you take into account the magnetic cycle) is well-established, the shape and peak amplitude of each cycle varies widely.

Despite much speculation and many hypotheses, it is still not possible to predict future activity with any certainty, although for some 50 years efforts have been made to turn h.f. propagation predictions, like weather forecasting, into a more exact science. The fact remains however that just as our weather forecasters, even with the great help of satellite photographs, still cannot tell us with any certainty whether it will rain tomorrow, and can make little more than an educated guess whether this winter will be colder or warmer than average, so one has to take all propagation and path-opening forecasts (other possibly than for grey-line times), with more than a pinch of salt. I cannot be certain, as I write these notes, whether the transatlantic path on say 7MHz will be good, very good, poor or impossible this evening!

To permit newsmen to roam further afield both ITN and BBC have made some use of transportable satellite up-links bouncing the news via space satellites. The design of these up-link terminals however has been made more demanding by the decision to permit satellites to be packed closer together in the increasingly crowded geostationary orbit.

At the recent International Broadcasting Convention at Brighton GEC-McMichael introduced some new ideas into the field of satellite news gathering, including the use of elliptical shaped reflectors that combine low height with high frequency. They can meet the new 2° satellite spacing requirement and in some versions can fit into the cargo hold of an aircraft.

By adopting bit-rate-reduced digital transmission much lower transmitter power is possible, permitting the use of solid-state rather than power klystrons. The satellite news gathering (SNG) unit operates at the low bit-rate of 2Mbit/s using the codec equipment developed for BT's video conferencing.

As demonstrated at Brighton surprisingly good pictures can be transmitted at 2Mbit/s (digital studio bit rates can be over 200Mbit/s). Unfortunately there is a penalty that must be paid. A 2Mbit/s system just cannot follow fast movement without severe blurring of the picture.

The system would thus be fine for talking-head interviews, etc., but could not really cope with a fast-moving news or sporting scene. But the new design is virtually a world first and the firm hopes to sell into the tough American TV market, where being first with news pictures, even if less than perfect, is much prized.

FAULT FINDING

E.A. Rule Part 2

LAST month we introduced this series of short articles with a general introduction to fault finding and mentioned the three main groups of fault types. In this issue we are going to take a look at faults in group one: New equipment that has either never worked or only partly worked since it was constructed. It has to be assumed that the item has been constructed according to the instructions given, and that the fault is due to a genuine mistake or a faulty component, and not due to poor workmanship or failing to *fully* read the instructions. It must be said however, that many of the problems with new equipment are simply due to a failure on the part of the constructor to take care during the building process or failing to understand any special instructions. In view of this we shall make a few general points concerning newly constructed equipment.

SIMPLE CHECKS

Contrary to common belief, poor soldering is not the main reason for the majority of problems, in actual fact, most kits received for repair by the author have been built to a very high standard of workmanship. Of course there are always exceptions, but in the main, problems are generally due to faulty components or wrong components, there are also those components that are correct and in the right place but simply inserted into the printed circuit board the wrong way around, diodes, electrolytics etc. When a piece of equipment is finished and ready for its initial testing, this is a good time to stop work and take a very detailed look at the finished item. A few simple checks *before* switching on will avoid major problems, like burnt out components etc. First, check that there are no short-circuits across the power supply lines. This check can be carried out with a simple Ohm meter. Depending on the circuit, a value of resistance will be obtained, this may be of a low value in a high current circuit but a study of the circuit diagram should give an indication of what to expect. The main thing is that you avoid switching on for the first time with a short circuit across the supply lines, because this could damage transformers, rectifiers and other components due to excessive current.

If all seems well, switch the meter to a suitable voltage range and connect it across the main supply rail, switch the equipment on and monitor the rise in voltage against what you expect it to be. If it is normal, testing can proceed, but if it is excessively high or low, switch off

and check the circuit for mistakes. A fairly common fault is when the centre tapped secondary of a mains transformer has been incorrectly wired, this can produce excessive voltage which could damage other components. Fig. 1 shows the correct and incorrect wiring to a secondary and how this produces excessive voltage. It is a good idea to disconnect the main part of the circuit from the power supply, until the voltages from the supply have been checked, then if there is a fault, damage to other components will be avoided. Often the supply can be disconnected simply by leaving a fuse out. Once you have established that the main supply voltage is satisfactory, a full voltage check should be made around the circuit and compared with any voltage table supplied by the manufacturer or author. Expect variations, it is not often that voltages agree exactly with the original design, for these are intended as a guide only. Depending on the type of circuit, variations of 25% can be found and these will not cause any problems. In other circuits a variation of 1% may be critical, only experience, or the instructions provided, will enable you to judge this. Once a piece of equipment is working satisfactorily, you should make up a table of the voltages found so that at a later date if a fault develops you can compare with what was actually present before the fault appeared.

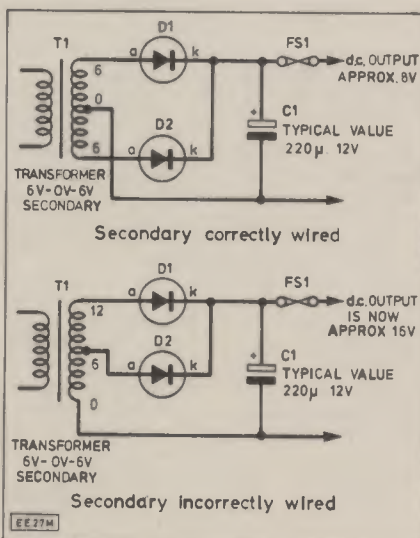

Fig. 1. Correct and incorrect wiring to a transformer secondary. Incorrect wiring results in twice the voltage being present at the output. This could of course damage other components.

CAPACITORS

The next check is to measure the voltage present at *each end* of the electrolytic capacitors in the circuit. Check that the positive end of the capacitor is in fact positive compared with its negative end. In other words, if the chassis is negative, the positive end of all electrolytics will have a higher positive voltage than the negative end. Take great care when checking circuits using a 'split-rail' supply because, depending on which side of the supply rail you are checking, the chassis may be the positive or negative line. Fig. 2 shows an example of this. With one meter lead connected to chassis (common) the meter will indicate either positive or negative polarity depending what part of the circuit is being measured. Note in particular the polarity of C4 and C5. In one case the positive terminal is connected to chassis and in the other, the negative terminal. If C1 was an electrolytic its polarity would depend on the input circuit as one end is to the common rail via R1 and therefore at zero volts.

Depending on the actual voltages present, an electrolytic capacitor may work for months or even years with its polarity wrong. It will however, steadily increase its leakage current until either it breaks down completely or causes damage to other components. In a power supply circuit the wrong polarity can cause an explosion due to the excessive leakage current within the capacitor. Excessive heating causes gases to be given off, these gases create a high pressure within the can which may explode. The author has witnessed a 14 s.w.g. steel front panel bulge out due to such an explosion, and has also seen a hole in the top of a cabinet where the metal top of a capacitor had blown through due to these internal pressures. Most modern capacitors have a safety vent which avoids dangerous situations like those mentioned, but the electrolyte which is discharged can cause corrosion problems to chassis and other components. Always check that electrolytics are correctly polarised and should you find a capacitor that is 'hot' to the touch, keep away until it has cooled down. The equipment must of course be switched off at once.

SETTING UP PROCEDURE

Having made these simple checks and found that all seems OK we can continue with the setting up procedure laid down in the instructions. Always carry these out exactly as specified, do not be tempted to

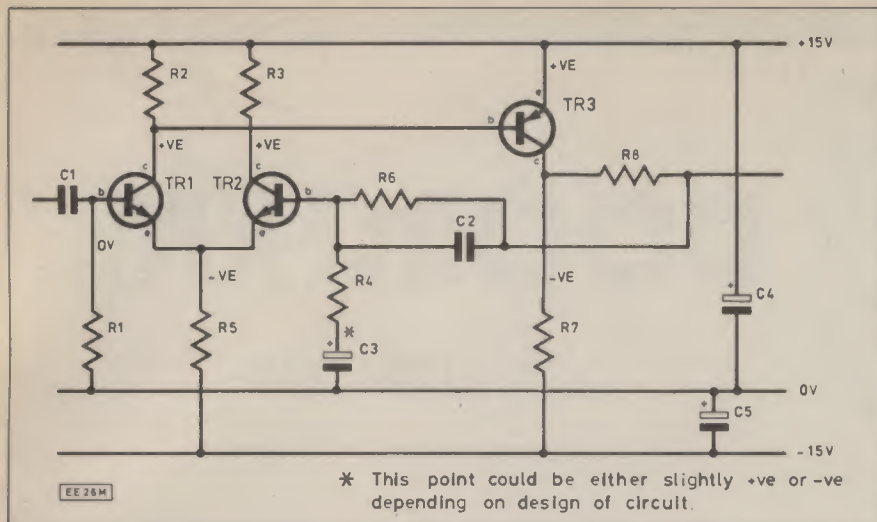

Fig. 2. The 'split-rail' supply.

take short cuts as often these procedures are arranged in a way that will expose faults in a section before passing on to the next step. Once these setting up procedures have been carried out we should have either a unit which is working satisfactorily or one that has one or more faults and needs further work carried out.

At this stage (assuming a faulty unit), recheck all the relevant components for correct type, value, and polarity. If the fault is known to be in one section of the circuit, then of course only that section need be given a careful check. Start by rechecking the voltages, note any that vary widely from those expected, look for clues as you proceed. For example, a higher than expected collector voltage may mean that the transistor is not conducting, check its Base and Emitter voltages, if these are correct, suspect the transistor, it could of course be a faulty or incorrect collector load resistor etc. Assuming that all the voltages are as expected and that all the components are correct (also wiring etc), we must now say that we are looking for a faulty component. One common fault, found with polystyrene capacitors, is that they are very easy to damage with excessive heat when soldering and the author has often found these with short circuits in many of the kits received for service. If these are in a signal path, the fact that they are short circuited may not affect any d.c. voltages present but could well prevent a signal voltage getting through. For example, Fig. 3 shows an i.f. amplifier stage, C1 is most likely a polystyrene type, and if it is shorted, it will prevent any signal being transferred. It may be possible to check it in circuit with an Ohm meter but often the coil resistance is very low so it is best to disconnect one end of the capacitor and measure across its ends. In Fig. 4 a similar short will prevent the circuit oscillating, and in Fig. 5 will short out the audio signal.

COMPONENT DEFINITION

Another common fault found in new equipment is due to the transistors having a different pin layout to those specified. Take as an example the BC184. This device can be obtained as a BC184 (TO18) or a BC184L (TO92) or a BC184-L-TO5 (TO5). The first has the connections the same as the last but with different spacing. The second has the Collector and Base connections interchanged, needless to say this change of connection can affect the results obtained! So do not just ask for a BC184, make sure you obtain *exactly* the type specified for the circuit layout. The same can be said for certain i.c.s. The same basic number is used for d.i.l. types and metal can types. It is important to know if (for example) a ZN459CP or a ZN459C or a ZN459 is specified. The ZN459 and ZN459C are metal can types with the same connections but the ZN459CP is a military specification and much more expensive (it has a wider temperature range) the ZN459CP is an 8 lead d.i.l. package. This type number is mentioned as an example because if for instance the letters 'CP' were omitted from the parts list, great confusion could ensue. A simple error in itself but very confusing to a constructor who has an 8 lead d.i.l. socket in the p.c.b. and gets a 6 lead component with seemingly the correct number. This is an extreme case but it serves to show what can happen. The point is that this type of error can be the cause of a number of peculiar faults found in newly built equipment and should be watched out for.

Another fairly common fault is due to confusion between the colours Red and Orange. Resistors have a colour code and many manufacturers' idea of what is Red or Orange seems to differ. The author has had a number of faults due to these colours being confused and for example a 6k8 resistor fitted instead of a 68k, or a 1k instead of 10k etc. If in doubt, measure a sample before fitting into

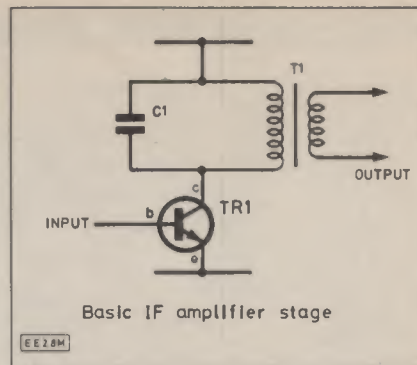

Fig. 3. The basic i.f. amplifier stage. A short circuit in C1 prevents a signal passing, without affecting d.c. voltage measurements.

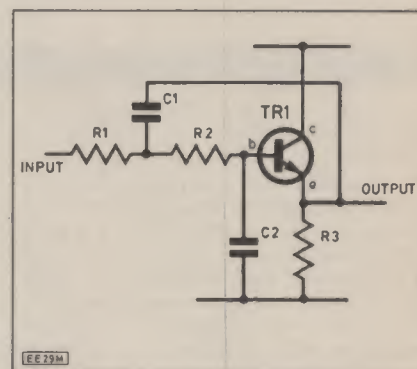

Fig. 4. Basic low pass filter stage.

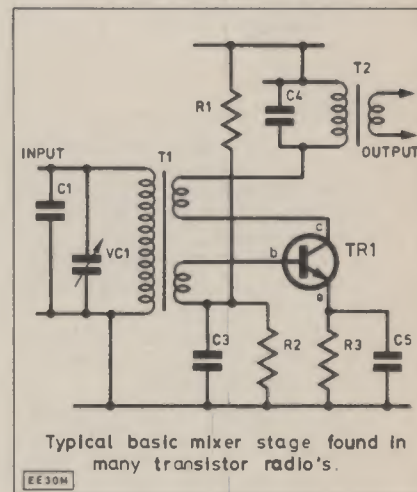

Fig. 5. Basic mixer stage. In this case a short circuit in C1 will prevent the circuit oscillating as well as preventing signal passage.

equipment. It is not something that is easy to spot when mounted on the p.c.b. Diodes can also be mixed up, it is easy to confuse a Zener with a normal diode unless you check the actual type number. Minutes spent checking components before assembly can save hours of frustration trying to find an obscure fault later.

In next month's issue we will continue the series with some actual faults on newly built equipment.



DOORCHIME

R.A. PENFOLD

A NUMBER of electronic doorbell designs have been published over the years, and these usually give either a simple two-tone effect or are of the microprocessor multi-tune variety. This circuit is a little different, and it produces a gong-like chime sound. Although the unit was primarily designed for its novelty value, it is nevertheless quite effective in practice. The circuit is battery powered, and as the unit will only be used intermittently each battery should have virtually its shelf life.

BLOCK DIAGRAM

Metallic chiming sounds consist of a complex set of component frequencies which are not all harmonically related. In other words, there is not just a fundamental frequency plus harmonics (multiples) of that frequency. A signal of this type cannot be generated using a simple tone generator as no matter what output waveform is generated, a repetitive waveform always gives only harmonically related output frequencies.

The block diagram of Fig. 1 shows the arrangement used in the Electronic Doorchime, and how the required non-harmonically related signals are generated.

There are two audio frequency oscillators, but they must operate at different frequencies if the right effect is to be obtained. The frequency of one oscillator is adjustable so that it can be set to give the best effect. The output of one oscillator is amplitude modulated by the

second oscillator, and in this case a fairly crude form of modulation is used with the output of oscillator 1 being switched on and off by oscillator 2. This gives the heterodyne effect where the sum and difference frequencies of the two input signals are generated at the output. For example, if the input frequencies are 500Hz and 600Hz, the new frequencies produced at the output are 1100Hz and 100Hz ($500 + 600 = 1100$ and $600 - 500 = 100$). In practice the input signals are not pure sinewaves and contain strong harmonics. These are also heterodyned to produce a very complex output signal.

Not only the new frequencies appear at the output, but the two input frequencies break through to the output quite strongly. A better effect can be obtained by balancing out one or both of the input signals. In this case oscillator 1 produces the strongest breakthrough, and it is this signal which is phased out. This is achieved by inverting the output of the modulator and feeding this signal to one input of a simple passive mixer circuit.

The other input is fed direct from the output of oscillator 1. Any breakthrough of oscillator 1 at the output of the modulator is therefore fed to the mixer out-of-phase with the direct output, and the two signals have a cancelling effect on one another. In practice the mixer has a balance control so that the level of breakthrough can be controlled, and reduced to practically zero if desired. The modulator, inverter and mixer, form what is really a sort of simple "ring modulator" type circuit.

In order to produce a reasonably realistic simulation of gong type sounds it is necessary to control the volume of the sound in the appropriate fashion. Very simple envelope shaping is adequate, and it is just a matter of giving a high initial volume level, and then gradually fading out the sound. This is achieved using a voltage controlled amplifier (VCA) plus a simple control voltage generator. The latter merely produces a falling voltage which gives the required decreasing gain from the VCA.

The final stage is a power amplifier which boosts the output of the circuit to a

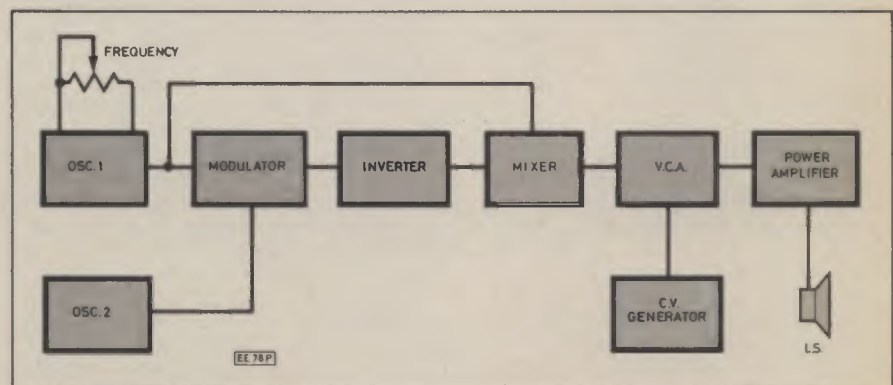

Fig. 1. Block diagram for the Electronic Doorchime.

COMPONENTS
approximate
cost **£10.50**

high enough level to drive a loudspeaker at good volume.

THE CIRCUIT

Fig. 2 shows the full circuit diagram of the Electronic Doorchime unit.

Both of the oscillators are standard 555 astables, and the frequency of the oscillator based on IC1 can be adjusted by means of VR1. The oscillator which uses IC2 is used to switch TR1 on and off,

The voltage controlled amplifier uses transconductance operational amplifier IC4. The gain of this device is controlled by the bias current fed to the amplifier bias input at pin 5, but in this circuit R16 has been added in series with this input so that the input current is roughly proportional to the applied voltage, and voltage control is produced.

A suitable falling control voltage is generated by the simple R-C timing network, C5 and R17. When the bell

as C5 charges via R17 the voltage developed across R17 (and fed to the control input of the VCA), falls. D1 ensures that C5 quickly discharges when the bell push is released so that the circuit operates properly if it is quickly operated again.

The power amplifier is a straight-forward circuit based on the popular LM380N device. This gives an output power of around 500mW r.m.s. into a 8 ohm loudspeaker, and around 1 watt

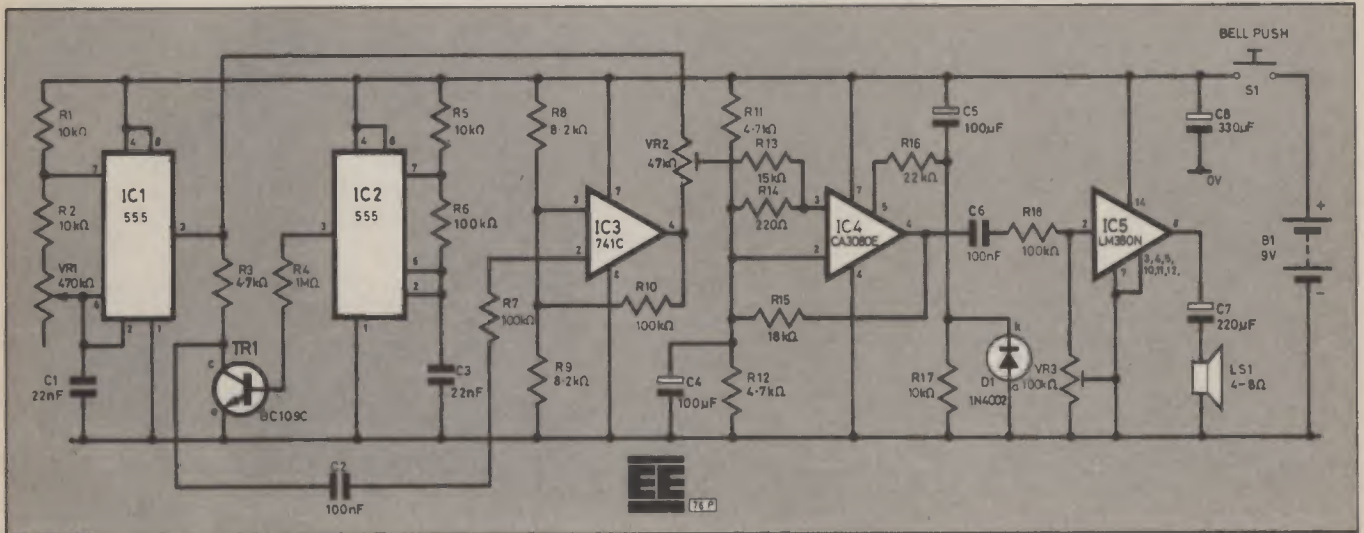

Fig. 2. Circuit diagram of the Electronic Doorchime.

while the output of IC1 is fed to the collector of TR1 via R3. When TR1 is switched on it effectively places a short circuit from R3 to the negative supply rail, and cuts off the signal from IC1. When TR1 is switched off it has a very high collector-to-emitter resistance, and the signal from IC1 is allowed to pass through R3 to the next stage of the circuit. In this way a crude but adequate form of amplitude modulation is obtained. The output waveform of both oscillators is roughly square. This gives signals which are rich in harmonics, and this gives excellent results in this application.

INVERTER AND MIXER STAGES

The inverter stage comprises IC3 and associated components, and this is a straightforward operational amplifier. In this application it acts as a unity voltage gain inverting amplifier. A passive mixer consists of just two resistors. This simple design is perfectly adequate for this project, and in this case it is formed by the two sections of VR2's track, and adjustment of this component enables the breakthrough from IC1 to be balanced out to the desired degree.

push is operated and power is first applied to the circuit, C5 will be uncharged and the full supply voltage will be fed to the control input of the VCA. However,

r.m.s. into a 4 ohm component. This should give more than adequate volume in most situations. VR3 is a preset volume control.

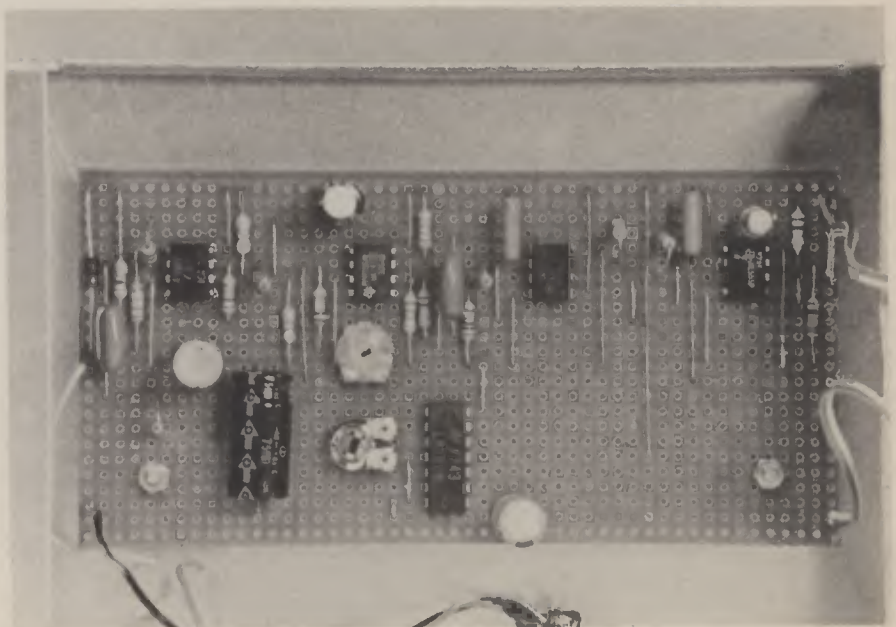

Component layout.

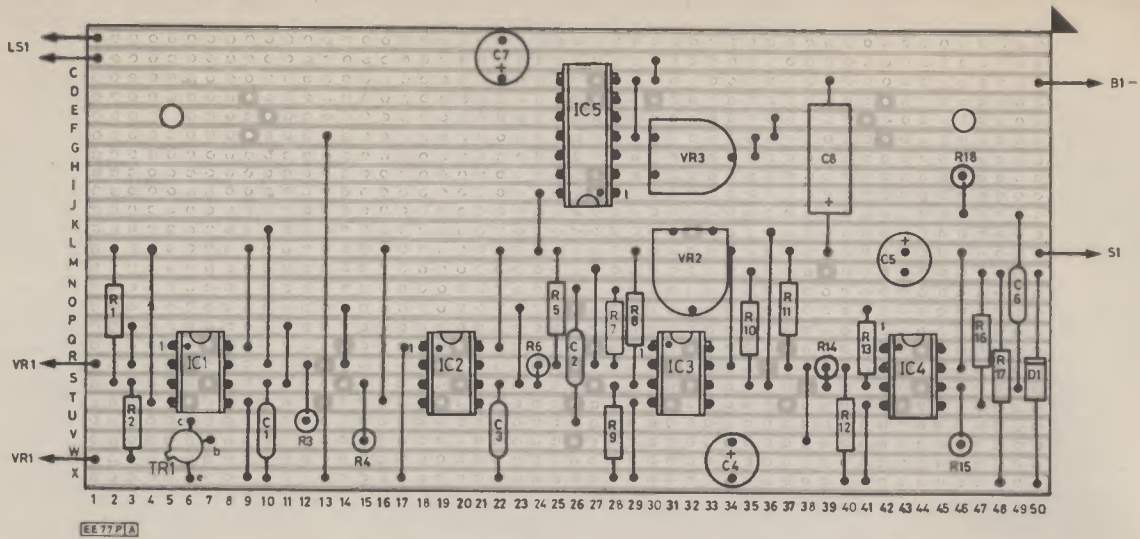

Fig. 3. Component side of stripboard.

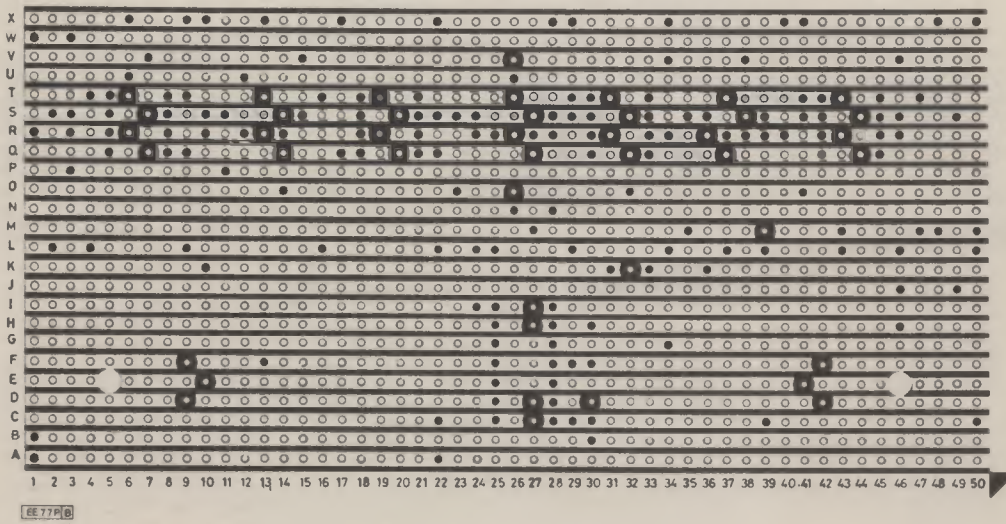
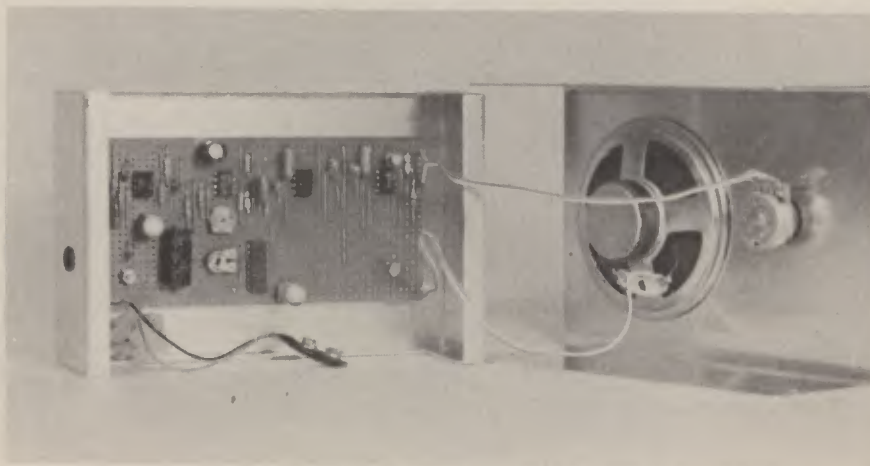

Fig. 4. Drilling details of matrix stripboard.



Circuit and speaker mounted in case.

CONSTRUCTION starts here

ASSEMBLY

All the components are mounted on a 0.1 inch matrix stripboard which has 50 holes by 36 copper strips. Incidentally, this is a standard size (5 x 3.75 inches) in which the board is sold. Details of the board are provided in Figs. 3 and 4.

Start construction of the board by making the breaks in the copper strips. Ideally the special tool should be used when doing this, but a small, hand held twist drill bit can be used instead. Next the two mounting holes are drilled. These are 3.3mm in diameter and will accept M3 or 6BA bolts.

The board is then ready for the components and link wires to be soldered in place. Begin with the resistors, link wires and capacitors, and then add in the semiconductors. Be careful to connect the electrolytic capacitors and semiconductors the right way round, and note that IC1 and IC5 have the opposite orientation to the other three integrated circuits. As all the integrated circuits are fairly inexpensive types, and none are vulnerable to damage by static charges, it is probably not worthwhile using sockets for them unless you are a complete beginner. The two preset resistors must be the specified miniature horizontal types if they are to fit into the component layout properly. To complete the board add Veropins at the points where connections to VR1, LS1, B1, and the bell push, will eventually be made.

CASE

A case having dimensions of about 150 x 100 x 50mm should be satisfactory unless a fairly large loudspeaker is used. An 8 ohm loudspeaker of about 75mm in diameter will give sufficient volume for most purposes, but a 4 ohm impedance type of around 120mm in diameter should be used if a high volume level is needed for some reason.

VR1 and the loudspeaker are mounted on the front panel. A speaker grille is required, and this can consist of a matrix of holes about 6mm in diameter, but drill these carefully as it can be quite difficult to make a neat job of it. If a fairly large loudspeaker is used it will probably have provision for screw fixing, but with most miniature types it is a matter of gluing them in place using a high quality general purpose adhesive.

The component board is mounted on the rear panel, and if a metal case is used

COMPONENTS

Resistors

R1,2,5,17	10k Ω (4 off)
R3,11,12	4.7k Ω (3 off)
R4	1M Ω
R6,7	100k Ω (4 off)
10,18	
R8,9	8.2k Ω (2 off)
R13	15k Ω
R14	220 Ω
R15	18k Ω
R16	22k Ω
All	$\frac{1}{4}$ W carbon \pm 5%

Potentiometers

VR1	470k Ω linear carbon
VR2	47k Ω 0.1W horizontal preset
VR3	100k Ω 0.1W horizontal preset

Capacitors

C1,3	22nF polyester (2 off)
C2,6	100nF polyester (2 off)
C4,5	100 μ F 10V radial elect.
C7	220 μ F 10V radial elect.
C8	330 μ F 10V axial elect.

Semiconductors

IC1,2	555 timer i.c. (2 off)
IC3	741C op-amp
IC4	CA3080E transconductance op-amp
IC5	LM380N audio power amp.
TR1	BC109C silicon <i>n</i> p <i>n</i>
D1	1N4002 silicon rectifier

Miscellaneous

S1	bell push
B1	9 volt, PP9 or 6 x HP7 in holder
LS1	4 or 8 ohm impedance loudspeaker, about 76mm or more in diameter
Case	about 152 x 102 x 51mm, battery connector, 50 holes by 36 strips, 0.1 inch matrix Veroboard, control knob, 2-way connector block, wire, fixings, etc.

See
**Shop
Talk**
page 735

spacers about 3 to 6mm long should be used over the mounting bolts so that the connections on the underside of the board are not short circuited through the case. Even with a plastic case the use of spacers is advisable, as it avoids having the board buckle and possibly break (due to the protruding connections on the underside) when the mounting nuts are tightened.

Finally, the unit is completed by wiring the component panel to the rest of the unit. It is probably easiest to make the connections to the bell push by means of a 2-way connector block. These are usually sold as 12-way strips, but a 2-way block can easily be cut from one of these using a sharp knife. An entrance hole for the lead to the bell push is made in one side of the case. The prototype is powered by six HP7 size batteries fitted in a plastic battery holder, and this is connected to the rest of the unit using a PP3-type battery connector. A large 9-volt battery such as a PP9 can be used as the power source, provided the case used is large enough to accommodate them, but as the circuit has a fairly high maximum current consumption of more than 100mA, small 9-volt batteries are not suitable.

ADJUSTMENT

Satisfactory results should be obtained with VR2 and VR3 placed at a roughly mid-way setting. The best effects are ob-

tained with VR1 set so that the two oscillators are some musical interval apart, but just slightly off tune so that a beat note is produced. However, in practice, it is really just a matter of trying VR1 at various settings to find the one that gives the effect which you like best. Quite a range of interesting sounds can be obtained, and if you get tired of one sound VR1 can be reset for a different effect.

The sound can be altered somewhat by adjusting VR2, and again, this is just a matter of trying various settings in order to determine which you find the most suitable. The other preset potentiometer, VR3, is adjusted to give the highest volume level which does not lead to overloading and severe distortion when the bell push is initially operated (which is when the output from the unit is at its maximum level). □

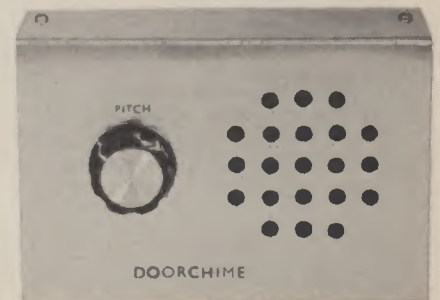

EVERYDAY ELECTRONICS PRINTED CIRCUIT BOARD SERVICE

Printed circuit boards for certain EE constructional projects are now available from the EE PCB Service, see list. These are fabricated in glass-fibre, and are fully drilled and roller tinned. All prices include VAT and postage and packing. Add £1 per board for overseas airmail. Remittances should be sent to: EE PCB Service, Everyday Electronics Editorial Offices, Westover House, West Quay Road, Poole, Dorset BH15 1JG. Cheques should be crossed and made payable to IPC Magazines Ltd.

Please note that when ordering it is important to give project title as well as order code. Please print name and address in Block Caps. Do not send any other correspondence with your order.

Readers ordering both p.c.b.s and software cassettes may send a single cheque/PO for the combined amounts listed.

Readers are advised to check with prices appearing in the current issue before ordering.

NOTE: Please allow 28 days for delivery. We can only supply boards listed here.

PROJECT TITLE	Order Code	Cost
— JUNE '83 —		
Eprom Programmer, TRS-80	8306-01	£9.31
Eprom Programmer, Genie	8306-02	£9.31
Eprom Programmer, TRS-80 & Genie	8306-03	£1.98
— JULY '83 —		
User Port Input/Output <i>M.I.T. Part 1</i>	8307-01	£4.82
User Port Control <i>M.I.T. Part 1</i>	8307-02	£5.17
— AUGUST '83 —		
Storage 'Scope Interface, BBC Micro	8308-01	£3.20
Car Intruder Alarm	8308-02	£5.15
High Power Interface <i>M.I.T. Part 2</i>	8308-03	£5.08
Pedestrian Crossing Simulation <i>M.I.T. Part 2</i>	8308-04	£3.56
Electronic Die	8308-05	£4.56
— SEPTEMBER '83 —		
High Speed A-to-D Converter <i>M.I.T. Part 3</i>	8309-01	£4.53
Signal Conditioning Amplifier <i>M.I.T. Part 3</i>	8309-02	£4.48
Stylus Organ	8309-03	£6.84
Distress Beacon	*8309-04	£5.36
Distress Beacon Pocket Version	8309-05	£3.98
— OCTOBER '83 —		
D-to-A Converter <i>M.I.T. Part 4</i>	8310-01	£5.77
High Power DAC Driver <i>M.I.T. Part 4</i>	8310-02	£5.13
Electronic Pendulum	8310-03	£5.43
— NOVEMBER '83 —		
TTL/Power Interface for Stepper Motor <i>M.I.T. Part 5</i>	8311-01	£5.46
Stepper Motor Manual Controller <i>M.I.T. Part 5</i>	8311-02	£5.70
Digital Gauss Meter	8311-03	£4.45
Speech Synthesiser for BBC Micro	8311-04	£3.93
Car On/Off Touch Switch	8311-05	£3.11
— DECEMBER '83 —		
4-Channel High Speed ADC (Analogue) <i>M.I.T. Part 6</i>	8312-01	£5.72
4-Channel High Speed ADC (Digital) <i>M.I.T. Part 6</i>	8312-02	£5.29
TRS-80 Twin Cassette Interface	8312-03/09	£7.43
Environmental Data Recorder	8312-04	£7.24
Touch Operated Die (Dot matrix)	8312-05/06	£4.34
Touch Operated Die (7-segment)	8312-05/07	£4.34
Continuity Tester	8312-08	£3.41

*Complete set of boards. **Calibrated with C1, VR1 and IC3 fitted. *M.I.T.*—Microcomputer Interfacing Techniques, 12-Part Series.

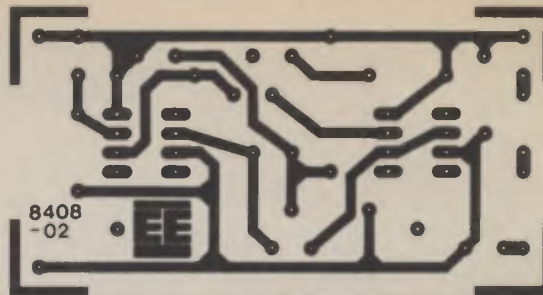

— JANUARY '84 —		
Central Heating Pump Delay	8401-01	£3.33
Biological Amplifier <i>M.I.T. Part 7</i>	8401-02	£6.27
Temp. Measure & Control for ZX Compr		
Analogue Thermometer Unit	8401-03	£2.35
Analogue-to-Digital Unit	8401-04	£2.56
Games Scoreboard	8401-06/07	£9.60
— FEBRUARY '84 —		
Eprom Programmer/ROM Card for ZX81	**8402-01	£7.84
Oric Port Board <i>M.I.T. Part 8</i>	8402-02	£9.56
Negative Ion Generator	*8402-03	£8.95
Temp. Measure & Control for ZX Compr		
Relay Driver	8402-04	£3.52
— MARCH '84 —		
Latched Output Port <i>M.I.T. Part 9</i>	8403-01	£5.30
Buffered Input Port <i>M.I.T. Part 9</i>	8403-02	£4.80
VIC-20 Extension Port Connector <i>M.I.T. Part 9</i>	8403-03	£4.42
Commodore 64 Extension Port Connector <i>M.I.T. Part 9</i>	8403-04	£4.71
Digital Multimeter Add-On for BBC Micro	8403-05	£4.63
— APRIL '84 —		
Multipurpose Interface for Computers	8404-01	£5.72
Data Acquisition "Input" <i>M.I.T. Part 10</i>	8404-02	£5.20
Data Acquisition "Output" <i>M.I.T. Part 10</i>	8404-03	£5.20
Data Acquisition "PSU" <i>M.I.T. Part 10</i>	8404-04	£3.09
Timer Module	8404-05	£3.58
A.F. Sweep Generator	8404-06	£3.55
Quasi Stereo Adaptor	8404-07	£3.56
— MAY '84 —		
Simple Loop Burglar Alarm	8405-01	£3.07
Computer Controlled Buggy <i>M.I.T. Part 11</i>		
Interface/Motor Drive	8405-02	£5.17
Collision Sensing	8405-03	£3.20
Power Supply	8405-04	£4.93
— JUNE '84 —		
Infra-Red Alarm System	8406-01	£2.55
Spectrum Bench PSU	8406-02	£3.99
Speech Synthesiser <i>M.I.T. Part 12</i>	8406-03	£4.85
Train Walt	8406-04	£3.42
— JULY '84 —		
Ultrasonic Alarm System	8407-01	£4.72
Atom EPROM Simulator	8407-02	£3.08
Electronic Code Lock		
Main board	8407-03	£2.70
Keyboard	8407-04	£3.24
— AUGUST '84 —		
Microwave Alarm System	8408-01	£4.36
Temperature Interface—BBC Micro	8408-02	£2.24
— SEPTEMBER '84 —		
Op-Amp Power Supply	8409-01	£3.45
— OCTOBER '84 —		
Micro Memory Synthesiser	*8410-01	£8.20
Drill Speed Controller	8410-04	£1.60
— NOVEMBER '84 —		
BBC Audio Storage Scope Interface	8411-01	£2.90
Proximity Alarm	8411-02	£2.65
— DECEMBER '84 —		
TV Aerial Pre-Amp	*8412-01	£1.60
Digital Multimeter	*8412-02/03	£5.20
Mini Workshop Power Supply	8412-04	£2.78

EVERYDAY ELECTRONICS and computer PROJECTS

VOLUME 13 INDEX

JANUARY 1984 TO DECEMBER 1984

Pages	Issue	Pages	Issue
1-72	January	417-480	July
73-144	February	481-544	August
145-216	March	545-600	September
217-288	April	601-656	October
289-352	May	657-712	November
353-416	June	713-768	December

CONSTRUCTIONAL PROJECTS

ACORN ATOM, EXTRA 1K RAM	326	GAMES SCOREBOARD <i>by P. Dooley</i>	43, 268
ACORN ATOM, EXTRA UTILITY PROM	327	GUITAR HEADPHONE AMPLIFIER <i>by M. G. Argent</i>	554
A/D CONVERTER	14	GUITAR TUNER <i>by R. A. Penfold</i>	60
AERIAL PRE-AMP, TV	737		
ALFRED <i>by Alan Green</i>	664, 720	HOT WATER TANK INDICATOR <i>by A. H. Robson</i>	394
AMPLIFIER, LOW POWER STEREO	192	INFRA-RED ALARM SYSTEM <i>by I. F. M. Goult</i>	366
ANALOGUE THERMOMETER UNIT	12	KITCHEN APPLIANCE TIMER <i>by T. R. de Vaux-Balbirnie</i>	488
ATOM EPROM SIMULATOR <i>by R. A. Penfold</i>	492	LATCHED OUTPUT PORT <i>by J. Adams and G. M. Feather</i>	180
AUDIO SINEWAVE SWEEP GENERATOR <i>by R. E. Liddiard</i>	226	LOUDSPEAKER PROTECTION UNIT <i>by J. Duffy</i>	88
BBC MICRO AUDIO STORAGE SCOPE INTERFACE <i>by R. A. Penfold</i>	677	LOW POWER STEREO AMPLIFIER <i>by D. J. Edwards</i>	192
BBC MICRO TEMPERATURE INTERFACE <i>by R. A. Penfold</i>	492	MAINS CABLE DETECTOR <i>by D. Corder</i>	644
BIOLOGICAL AMPLIFIER <i>by J. Adams and G. M. Feather</i>	54	MASTERMIND TIMER <i>by L. A. Privett</i>	330
BUFFERED INPUT PORT <i>by J. Adams and G. M. Feather</i>	183	MICROCOMPUTER DIGITISER <i>by J. Howden Ph.D</i>	550
BUGGY, COMPUTER CONTROLLED	317	MICRO MEMORY SYNTHESISER <i>by M. Stuart</i>	610
CAPACITANCE COMPARATOR <i>by L. S. Cook</i>	431, 728	MICROWAVE ALARM SYSTEM <i>by I. F. H. Goult</i>	516
CARAVAN DIPSTICK <i>by T. R. de Vaux-Balbirnie</i>	582	MINI WORKSHOP PSU <i>by W. Leung</i>	726
CAR LIGHTS WARNING <i>by A. Burnett</i>	122	MULTIMETER, DIGITAL	694, 748
CAR LIGHTS WARNING <i>by H.B. Foster</i>	472	MULTIPURPOSE INTERFACE FOR COMPUTERS <i>by M. P. Horsey</i>	260
CAR RADIO BOOSTER <i>by R. A. Penfold</i>	504	NEGATIVE ION GENERATOR <i>by A. Flind</i>	82
CB MINI POWER SUPPLY <i>by T. R. de Vaux-Balbirnie</i>	470	NI-CAD BATTERY CHARGER <i>by R. H. Marco</i>	154
CENTRAL HEATING PUMP DELAY <i>by A. Gray</i>	50	OP-AMP POWER SUPPLY <i>by T. J. Johnson</i>	563
CHANNEL SELECTION SWITCH <i>by P. Balley</i>	404	ORIC PORT BOARD <i>by J. Adams and G. M. Feather</i>	118, 268
COMPUTER-CONTROLLED BUGGY <i>by J. Adams and G. M. Feather</i>	317	PIPE FINDER <i>by George Hylton</i>	198
DATA ACQUISITION SYSTEM <i>by J. Adams and G. M. Feather</i>	244	PROXIMITY ALARM <i>by R. A. Penfold</i>	702
DIGITAL MULTIMETER <i>by I. A. Duncombe</i>	694, 748	QUASI-STEREO ADAPTOR <i>by R. A. Penfold</i>	270
DIGITAL MULTIMETER ADD-ON FOR COMPUTERS <i>by R. A. Penfold</i>	157	QUIZ-MASTER II <i>by S. Lyons</i>	250
DIN LEAD TESTER <i>by L. A. Privett</i>	186	RADIO BOOSTER, CAR	504
DOORCHIME <i>by R. A. Penfold</i>	758	RADIO, VARICAP A.M.	302
DRILL SPEED CONTROLLER <i>by M. Stuart</i>	610	REVERSING BLEEPER <i>by T. R. de Vaux-Balbirnie</i>	202
DUAL MAINS SWITCH <i>by M. Sales</i>	606	ROBOT, ALFRED	664, 720
ELECTRONIC CODE LOCK <i>by Dr. W. D. Phillips</i>	426	SCOREBOARD—JUDGES POINTS INDICATOR <i>by L. A. Privett</i>	636
EPROM PROGRAMMER/ROM CARD FOR ZX81 <i>by B. W. Terrell and J. W. Terrell</i>	92	SIGNAL TRACER <i>by R. A. Penfold</i>	126
EXPERIMENTER'S POWER SUPPLY <i>by S. Niewiadomski</i>	298	SIMPLE LOOP BURGLAR ALARM <i>by C. Lare</i>	338
EXTRA 1K RAM for the ACORN ATOM <i>by A. J. Presnall</i>	326	SOUND OPERATED FLASH <i>by M. G. Argent</i>	574
EXTRA UTILITY PROM for the ACORN ATOM <i>by A. J. Presnall</i>	327	SPECTRUM BENCH PSU <i>by R. A. Penfold</i>	372, 513
FLUID DETECTOR <i>by I. A. Duncombe</i>	672	SPEECH SYNTHESISER <i>by J. Adams and G. M. Feather</i>	384
FUSE/DIODE CHECKER <i>by L. A. Privett</i>	232		

TEMPERATURE MEASUREMENT AND CONTROL SYSTEM FOR ZX COMPUTERS <i>by M. Plant</i>	10, 106
THERMOSTATIC SEED PROPAGATOR <i>by J. Lewis</i>	538
TIMER MODULE FOR CENTRAL HEATING SYSTEMS <i>by S. Ibbs</i>	274
TRAIN WAIT <i>by C. J. Bowes</i>	390
TV AERIAL PRE-AMP <i>by M. Stuart</i>	737
ULTRASONIC BURGLAR ALARM <i>by I. H. F. Goult</i>	454

VARI-CAP A.M. RADIO <i>by R. A. Penfold</i>	302
WASHER FLUID MONITOR <i>by A. R. Winstanley</i>	532
ZX81, EPROM PROGRAMMER/ROM CARD	92
2 to 12V POWER SUPPLY	298
4-CHANNEL GAS AND SMOKE SENTINEL <i>by A. R. Winstanley</i>	17

SPECIAL SERIES

ANATOMY OF YOUR MICRO <i>by Owen Bishop</i>	448, 508, 566
1: Introduction—The Microprocessor	448
2: Data flow and memory	508
3: Video, disc and TV interfacing	566
CIRCUIT EXCHANGE	26, 27, 35, 66, 99, 121, 123, 124, 131, 132, 191, 200, 276, 277, 345, 407, 410, 441, 475, 536, 540, 555, 565, 621, 637, 730
COMPUTER AIDED EXPERIMENTS <i>by A. A. Chanerley</i>	64, 134, 206
4: Capacitor charge/dscharge with variable constant	64
5: V/I Characteristic of a p-n junction	134
6: Ohmic and non-Ohmic conductors	206
COMPUTER CLUB <i>by Thakery</i>	740
DIGITAL ELECTRONICS <i>by D. W. Crabtree</i>	618, 669, 732
1: Basics	618
2: Karnaugh maps and DeMorgan's rules	669
3: Combinational logic using LSI and MSI	732
FAULT FINDING <i>by E. A. Rule</i>	692, 756
1: Routine procedures and fault analysis	692
2: Fault analysis on ready-built equipment	756
FUNTRONICS <i>by Thakery</i>	572, 614, 684
1: The Decibel	572
2: Current	614
3: The Battery	684
MICROCOMPUTER INTERFACING TECHNIQUES <i>by J. Adams and G. M. Feather</i>	54, 116, 176, 240, 314, 382
7: Human and plant physiology signal processing	54
8: Direct Bus Interfacing	116
9: Direct Bus Interfacing	176
10: Data monitoring, acquisition and control	240
11: Computer control of small vehicles	314
12: Speech Synthesis	382

OSCILLATORS <i>by J. R. Davies</i>	400, 463, 524, 593
1: The Symmetric Multivibrator	400
2: Using the 555 and ICM7555	463
3: Digital CMOS Devices	524
4: Hysteresis Oscillators	593
SPECIAL REPORTS	28, 174, 622
BBC Microcomputer Model B <i>by R. A. Penfold</i>	28
Oric 1 Microcomputer <i>by R. A. Penfold</i>	174
Sinclair QL <i>by R. Barron</i>	622
SQUARE ONE	133, 205, 279, 344, 409, 474, 515, 646, 674, 742
Equipment Wire	133
Project Housings	205
Capacitors	279
Logic Symbols	344
Truth Tables and Logic Circuits	409
Integrated Circuits	474
CMOS Devices	515
EE Component Designations	646
Home Computers	674
Software	742
TEACH-IN 84 <i>by George Hylton</i>	30, 100, 168, 234, 306, 376, 436, 498, 556
4: Transistors and Capacitors	30
5: Audio Amplifiers	100
6: Operational Amplifiers	168
7: Waveforms and Distortion	234
8: Power in General	306
9: Radio Systems	376
10: Digital Circuits	436
11: New Developments	498
12: Aids to Design	556, 728
WHAT IS RADIATION? <i>by A. J. Bentley</i>	512, 578, 638
1: Introduction, types of radiation	512
2: Fission and Fusion	578
3: Radiation Detectors	638
WHY NARROW BAND F.M.? <i>by E. A. Rule</i>	266, 334
1: Modulation systems compared	266
2: Different systems compared	334

GENERAL FEATURES

BACK NUMBERS	115, 209
BOOK REVIEWS	63, 99, 204, 337, 365, 730
BRIGHT IDEAS	197
CONSUMER ELECTRONICS CHICAGO <i>by Barrh</i>	648
COUNTER INTELLIGENCE	27, 121, 208, 239, 346, 395, 446, 530, 580, 640, 746
ECONOMICAL ELECTRONIC <i>by L. J. Stean</i>	25
EDITORIAL	9, 81, 153, 225, 297, 361, 425, 487, 549, 605, 663, 719
ELECTRIC HAZARDS	104
ELECTRONIC SURVEILLANCE SYSTEMS <i>by I. F. H. Goult</i>	362
EVERYDAY NEWS	40, 112, 188, 256, 324, 388, 452, 502, 586, 632, 686, 743
FOR YOUR ENTERTAINMENT <i>by Barry Fox</i>	42, 91, 186, 249, 312, 398, 442, 507, 577, 641, 688, 725
NEW PRODUCTS	36, 130, 201, 278, 342, 460, 497, 634, 744

PLEASE TAKE NOTE	268, 513, 730
Capacitance Comparator (Dec '84)	730
Games Scoreboard (Jan '84)	268
Oric Port Board (Feb '84)	268
Spectrum Bench Power Supply (June '84)	513
Teach-In '84 Part 12 (Dec '84)	730
VIC-20 Light Pen (Dec '84)	730
PRINTED CIRCUIT BOARD SERVICE	59, 105, 165, 280, 343, 396, 443, 541, 597, 653, 708, 762
RADIO WORLD <i>by Pat Hawker G3VA</i>	49, 114, 190, 258, 329, 408, 462, 523, 576, 616, 707, 755
READERS' LETTERS	237, 332, 381
SCHOOLS COMPETITION	588
SHOP TALK <i>by Dave Barrington</i>	16, 87, 164, 231, 313, 371, 434, 560, 642, 690, 735
SOFTWARE SERVICE	59, 131, 156, 239, 387

SPECIAL OFFER

RADIO CONTROLLED CAR	689, 745
----------------------	----------

SPECIAL SUPPLEMENT

ROBOTICS <i>by Tom Ival</i>	between pages 684/685
-----------------------------	-----------------------

EVERYDAY ELECTRONICS AT YOUR and computer PROJECTS

Reach effectively and economically to-days enthusiasts anxious to know of your through our semi-display and classified pages. Semi-display spaces may be booked at timetre (minimum 2.5cm). The prepaid rate for classified advertisements is 33 pence per word number 60p extra. All cheques, postal orders, etc., to be made payable to Everyday Electronics crossed "Lloyds Bank Ltd." Treasury notes should always be sent registered post. Advertisement, should be sent to the Classified Advertisement Department, Everyday Electronics and 2612, IPC Magazines Limited, King's Reach Tower, Stamford St., London SE1 9LS. (Telephone

Receivers & Components

TURN YOUR SURPLUS capacitors, transistors, etc., into cash. Contact Coles Harding & Co., 103 South Brink, Wisbech, Cambs. 0945-584188. Immediate settlement.

NEED A SPECIAL MAINS TRANSFORMER?

Use one of our Transformer Kits

SAE for details:

TIDMAN MAIL ORDER LTD (Dept EE)
236 Sandycombe Road, Richmond, Surrey.
Phone 01-948 3702.

Services

INVENTORS

Think of something new?
Write it down!

American industry offers potential royalties for you innovations and new products. We offer free confidential disclosure registration and initial consultation in London regarding your idea's potential value. Write without delay for your free information package.

American Inventors Corporation
82 Broad Street, Dept. EV,
Westfield, Massachusetts 01086,
United States of America
A fee based marketing company

Service Sheets

FULL SIZE TOP QUALITY Service Sheets £2.50 + l.s.a.e. CTV/Music centres £3.50 + l.s.a.e. Repair data almost any named TV/video £10.50 in circuits. L.s.a.e. brings any quite-free magazine/pricelists. TISEE, 76 Churches, Larkhall, Lanarkshire. Tel. 0698 883334.

BELL'S TELEVISION SERVICE for service sheets on Radio, TV etc. £1.50 plus S.A.E. Service Manuals on Colour TV and Video Recorders, prices on request. S.A.E. with enquiries to: BTS, 190 King's Road, Harrogate, N. Yorkshire. Tel: 0423 55885.

Tuition

IMPROVE YOUR PROSPECTS

with skills that employers want - learn the easy way with modern home study courses from Ideal Schools.

MODERN ELECTRONICS

Train for success in the fastest ever growing industrial sector.

COMPUTER PROGRAMMING

The demand for Programmers is increasing constantly - don't miss out!

For free booklet write today to



IDEAL SCHOOLS
(Ref. EE2)
60 St. Enoch Sq.
Glasgow G1 UK.
Tel: 041-248 5200

Wanted

WANTED. BI-PAK S450 FM stereo push button tuner. AYRES, 31 Barr Common Road, Walsall. Tel. 0922 51591.

Software

COMPUTER SPARES. Spectrum ZX81, etc. Send S.A.E. or call in for price list. MINNIE MICRO ELECTRONICS (Dept EE), 12 Eastern Esplanade, Southend On Sea, Essex.

Hardware

SPECTRUM INPUT OUTPUT PORTS. Fully programmable £15.95 + £1.50 pp. J. MATHER, 62 Shadwell Walk, Leeds LS17 6EG.

Security

SECURITY Alarm Systems

FREE COMPREHENSIVE CATALOGUE!

- LOWEST DISCOUNT PRICES
- HIGHEST QUALITY EQUIPMENT
- FREE DIY DESIGN GUIDE
- FULLY ILLUSTRATED
- MICROCHIP CIRCUITRY
- QUICK DESPATCH SERVICE
- FULL INSTRUCTIONS

SEND SAE OR PHONE

C-TEC SECURITY, Dept EE,
60 Market St, Wigan WN1 1HX.
Telephone (0942) 42444

Trade Enquiries Welcome

ORDER FORM PLEASE WRITE IN BLOCK CAPITALS

Please insert the advertisement below in the next available issue of Everyday Electronics for Insertions. I enclose Cheque/P.D. for £

(Cheques and Postal Orders should be crossed Lloyds Bank Ltd. and made payable to Everyday Electronics)

HEADING REQUIRED:

NAME
ADDRESS

**EVERYDAY ELECTRONICS and
COMPUTER PROJECTS**

Classified Advertisement Dept., Room 2612,
King's Reach Tower, Stamford Street, London SE1 9LS
Telephone 01-261 5942

Rate:

33p per word, minimum 12 words. Box No. 60p extra.

Company registered in England. Registered No. 53626 Registered Office: King's Reach Tower, Stamford Street, London SE1 9LS.

12/84

WHO CAN PUT A PRICE ON A PEACE OF MIND
PROFESSIONAL EQUIPMENT AT LOW! LOW! PRICES.
HOME SECURITY IS NOW AVAILABLE AT TRADE PRICES
ADVANCED SECURITY PRODUCTS LTD
2 Ealing Road, Aintree,
Liverpool L9 0HU, Merseyside.
Tel: 051-525 3440
FREE CATALOGUE
PHONE OR S.A.E.

FREE CAREER BOOKLET

Train for success, for a better job, better pay

Enjoy all the advantages of an ICS Diploma Course, training you ready for a new, higher paid, more exciting career. Learn in your own home, in your own time, at your own pace, through ICS home study, used by over 8 million already! Look at the wide range of opportunities awaiting you. Whatever your interest or skill, there's an ICS Diploma Course there for you to use.

Send for your FREE CAREER BOOKLET today—no cost or obligation at all.

GCE Over 40 'O' & 'A' Level subjects from which to choose. Your vital passport to career success. <input type="checkbox"/>	RADIO AMATEUR'S LICENCE <input type="checkbox"/>
COMPUTER PROGRAMMING <input type="checkbox"/>	INTERIOR DESIGN <input type="checkbox"/>
ELECTRONICS <input type="checkbox"/>	WRITING FOR PROFIT <input type="checkbox"/>
COMMERCIAL ART <input type="checkbox"/>	CAR MECHANICS <input type="checkbox"/>
TV, RADIO & AUDIO SERVICING <input type="checkbox"/>	RUNNING YOUR OWN BUSINESS <input type="checkbox"/>

Name
Address

P.Code



ICS Dept ECSC4
160 Stewarts Road,
London SW8 4UJ.

01-622 9911
(all hours)



SUPER AUDIO EFFECTS KITS



NEWLY PUBLISHED

MONO-STEREO ECHO-REVERB (PF, SEP84) : 200ms echo, Infinite reverb, multi-tracking, mono & stereo compatibility : SET 218BK £55.66
FILTER-SHIFT PHASER (PE OCT84) : Enhanced phasing with modulated filter shifting : SET 226BK £39.13
RING MODULATOR (PE NOV84) : With multi-waveform VCO, Noise Gate & Auto-level Control : SET 231BK £39.99

POPULAR FAVOURITES

CHORUS UNIT : A solo voice or instrument sounds like more! SET 162BK £34.90
COMPRESSOR : Limits & levels maximum signal strength SET 133BK £13.86
EQUALISER : Ten channels fully variable SET 134BK £41.83
FLANGER : Fascinating resonance effects & simple phasing SET 153BK £26.24
FREQUENCY DOUBLER : Guitar octave raiser & tone changer SET 98BK £12.80
FUZZ : Smooth distortion, retains attack & decay SET 91BK £13.57
GUITAR OVERDRIVE : Heavy fuzz with selectable qualities SET 56BK £23.23
GUITAR TO SYNTH INTERFACE : With voltage & trig outputs SET 173BK £36.37
MUSIC MODULO : 8 variable tremoloe & wah effects SET 196BK £21.79
RHYTHM GENERATOR : Computer driven, 9 drum effects SET 185BK £34.64
RHYTHM GENERATOR : 15 pre-programmed rhythms, 9 drum effects SET 170BK £39.14
ROBOVOX : Versatile robot type voice modifier SET 165BK £24.53
STORM EFFECTS : Auto & manual wind, rain & surf effects SET 154BK £19.36
SUSTAIN : Extends guitar note decay time, with noise gate SET 222BK £25.31
VOCODAVOX : Modular vocoder, 7 channels, extendable SET 152BK £68.31

FOOT OPERATED STAGE UNITS

(MATCHED LINKING ROBUST DIECAST BOXES)

LINKAFEX CHORUS : Variable rate, depth, intensity, feedback SET 204DC £42.96
LINKAFEX DELAY : Delay 10ms-450ms, plus repeat, feedback SET 206DC £42.09
LINKAFEX FLANGE : Variable rate, depth, intensity, feedback SET 207DC £34.92
LINKAFEX PHASER : Variable rate, depth, intensity, feedback SET 205DC £34.33
LINKAFEX SUSTAIN : Extends note decay, plus noise gate SET 223DC £26.47

ALL SETS INCLUDE PCB'S, PARTS, INSTRUCTIONS, BOXES, WIRE, SOLDER, AND ARE FOR USE WITH 9 VOLT BATTERIES. MORE DETAILS & KITS IN CATALOGUE SEND S.A.E. WITH ALL ENQUIRIES. (OVERSEAS SEND £1 OR 5 IRC'S). DETAILS CORRECT AT PRESS. E&OE.

ADD 15% & £1 P&P TO ALL ORDERS. (OVERSEAS DETAILS IN CAT.) PAYMENT CWO, CHQ, PO, ACCESS, VISA, OR PRE-ARRANGED COLLECTION.

PHONOSONICS

DEPT. EE4D, 8 FINUCANE DRIVE, ORPINGTON, KENT BR5 4ED.
ORPINGTON 37821 (STD 0689, LONDON 66), MON.-FRI. 10-7.



METERS: 110 x 82 x 35mm
30µA, 50µA, 100µA. £8.45
Post 50p.

METERS: 45 x 50 x 34mm
50µA, 100µA, 1mA, 5mA, 10mA, 25v, 1A, 2A, 5A, 25V. £4.32. Post 30p.

METERS: 60 x 47 x 33mm
50µA, 100µA, 1mA, 5mA, 10mA, 100mA, 1A, 2A, 25v, 50v, 50-0-50µA, 100-0-100µA. £7.25. VU meters £8.04.
Post on above meters 30p.

Silicone grease 50g £1.32.
Post 16p.

NI-CAD BATTERY CHARGER
Led indicators charge-test switch. For PP3, HP7, HP11 & HP2 size batteries. Price £6.40. Post 94p.

Motorola Piezo Ceramic Tweeter
£5.52 Post 33p

METERS: 60x46x33mm
illuminated. Require 6V supply.
50µA, 100µA, 500µA,
100-0100µA,
1mA, 1A, 2A, 25V, 30V & VU.
£5.44 post 30p

ALSO IN STOCK
2, 3, 4, 6 & 8A Transformers

TRANSFORMERS
240v Primary

3-0-3v	100mA	85p
6-0-6v	100mA	£1.38
6-0-6v	250mA	£1.52
12-0-12v	50mA	£1.32
12-0-12v	100mA	£1.40
9-0-9v	75mA	£1.40
9-0-9v	250mA	£1.52

Post on above transformers 48p.

9-0-9v	1A	£2.37
12-0-12v	1A	£2.95
15-0-15v	1A	£3.45
6-0-6v	1½A	£2.38

Post on above transformers 94p.

Rotary Switches: 1 Pole 12
Way 2P6W, 3P4Way, 4P3W 42p
Post 16p

Illuminated Rocker Switch
240V 6A Red 88p Post 16p

All above prices include V.A.T. Send £1 for a new comprehensive 1983/84 fully illustrated catalogue with a new price list. Send S.A.E. with all enquiries. Special prices for quantity on request.

All goods despatched within 3 days from receipt of the order.
Catalogue Owners: Please send large s.a.e. for new prices coming in force 1.11.84

M. DZIUBAS

158 Bradshawgate, Bolton,
Lancs. BL2 1BA.

INDEX TO ADVERTISERS

AC/DC Electronics	767
Advance Security Products	766
Alcon Instruments	753
Bib Audio	747
BK Electronics	Cover III
B.N.R.E.S.	754
Bull, J.	765
C-Tec Security	766
Cirkit Holdings	715
Dziubas, M.	768
Electrovalve	716
Enfield Electronics	Cover II
Experimental Electronics	767
Grandata Limited	747
Henrys Electronics	747
ICS Intertext	768
Ideal Schools	766
Magenta Electronics	718
Maplin Electronics	Cover IV, 716
Phonosonics	768
Proteus	714
PS Supplies	767
Radio Component Specialists	767
Rapid Electronics	717
Riscomp Ltd	754
Roden Products	767
R.T.V.C.	753
Skybridge Ltd	724
Skywave Software	716
Tidman Mail Order	766
T.K. Electronics	731

HUNDREDS OF NEW LINES



The amazing Maplin Catalogue is here again! The new edition is packed with hundreds and hundreds of new electronic components to bring you right up to date with all the latest developments. As all home constructors agree (and a good many professionals too) the Maplin Catalogue is the one essential piece of equipment they really need. And now with all our **prices on the page** the Maplin Catalogue is better value than ever.

On Sale From 10th November 1984.

Pick up a copy as soon as it's published at any branch of W.H. Smith or in one of our shops. The price is still just £1.35, or £1.75 by post from our Rayleigh address (quote CA02C).

Post this coupon now for your copy of the 1985 catalogue.
Price £1.35 + 40p post and packing. If you live outside the U.K.
send £2.40 or 11 International Reply Coupons.
I enclose £1.75.

Name

Address

.....

EE12/84



MAPLIN
ELECTRONIC SUPPLIES LTD

Maplin Electronic Supplies Ltd. Mail Order: P.O. Box 3, Rayleigh, Essex SS6 8LR.
Tel: Southend (0702) 552911. • Shops at: 159-161 King Street, Hammersmith, London W6. Tel: 01-748 0926. • 8 Oxford Road, Manchester. Tel: 061-236 0281.
• Lynton Square, Perry Barr, Birmingham. Tel: 021-356 7292.
• 282-284 London Road, Westcliff-on-Sea, Essex. Tel: 0702-554000.
• 46-48 Bevois Valley Road, Southampton. Tel: 0703-25831. All shops closed all day Monday.