

Easy to build projects for everyone

Everday ELECTRONICS

AUG 80
50p

KIOSKS
McLeary

WEATHER CENTRE



HOWZAT!

BOWL 'EM
OVER WITH OUR
CRICKET GAME

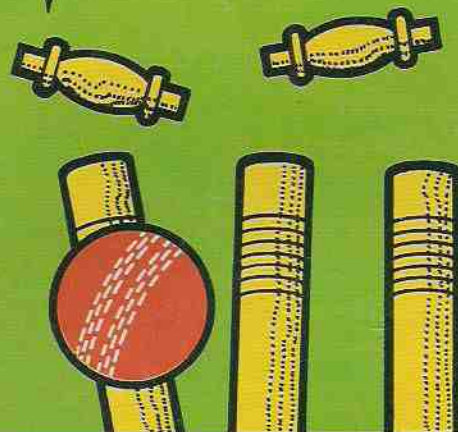

AUDIO MILLIVOLTMETER



BRAKESAFE MONITOR

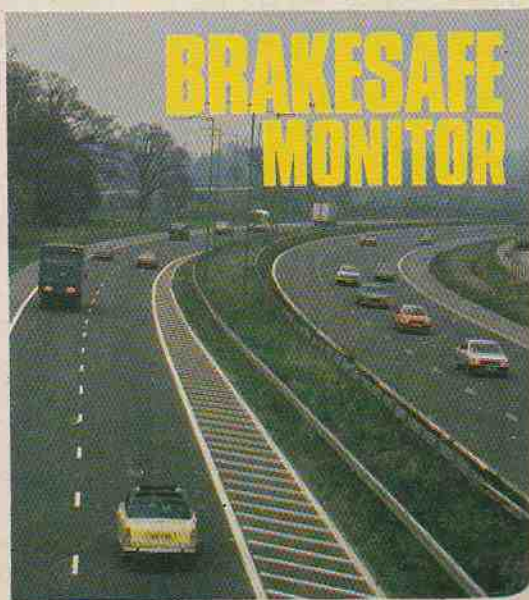

NEW GIANT SUPERPRINTS PLUS FREE FILM

for every one you send for processing
by the Everyday Electronics
Colour Print Service

**GIANT
SUPERPRINTS**
30% more print area
for only 1p extra



Photography can cost you a lot less these days if you know how to go about it. Hundreds of thousands of magazine readers are delighted with this reliable Colour Print Service—and the replacement films that come FREE every time they use it! So why don't you give it a try? Here's what you do. Send any make of colour print film inside the envelope enclosed in this issue. Or fill in the coupon below and send it with your film in a strong envelope to: Everyday Electronics Colour Print Service, Freepost, Teddington, Middlesex, TW11 8BR. No stamp is required.

Send no money

We are so confident in the reliability of the service and the quality of our prints, every one of which is checked by professionals at our laboratories, that you don't pay until you have received them!

Luxury colour prints

You will be amazed at the crisp, sharp, hi-definition sheen finish of the prints we supply...with elegant rounded corners and borderless to give you maximum picture area. And now with the new Giant Superprints you get 30% more picture area for just 1p extra per print.

Unbeatable value

Prices are much less than those you would pay in most shops—quite apart from the FREE Kodak Colour film, worth at least £1.44*. The FREE film is the same size as the one you sent for processing.

The new Giant Superprints cost you only 17p each, compared with 16p for the standard enprints available with this service. A further charge of £1 is made towards development, postage and packing. The offer is limited to the UK. For Eire, CI and BFPO a handling surcharge will be made.

Free Album Sheets

One album voucher is sent with each film we process. Collect 3 vouchers and we send you a set of FREE album sheets.

More benefits to you

You benefit in two additional ways. Firstly, you enjoy a personal service with every care taken over each individual order. And secondly, you pay only for what you get—with no credit vouchers as with many other companies. An invoice comes with your prints, so it is a straight business transaction.

*Kodak Recommended Retail Prices: 110/20—£1.44; 135/20—£1.51; 135/24—£1.67; 135/36—£2.12.

Offer exc. Minolta & Sub-miniature. Roll film 20p surcharge. 400 ASA 20p surcharge. Superprints can only be produced from Kodacolor II, C41 and Agfa CNS cassette and cartridge film. Prices correct at time of going to press.

**USE THIS LABEL
IF YOU HAVE NO
ENVELOPE,
OR PASS IT TO A
FRIEND. IT IS
USED TO SEND
YOUR PRINTS
& FREE FILM**

From: Everyday Electronics Colour Print Service, Freepost, Teddington, Middlesex, TW11 8BR. Please print my film Superprint/Standard Enprint size (delete size which is not required).

Mr/Ms _____

Address _____

Postcode _____

Prints are normally despatched within four working days of receipt of film.

Make sure
of your
Heathkit
catalogue...
write now.



Keep up to date with the world's finest electronic kits—with the Heathkit catalogue. 48 product packed pages contain photographs and specifications of the widest possible range of kits. Everything from doorbells to digital clocks, multimeters to microcomputers.

Heathkit make it easy to build, easy on your pocket, and, as with 13 million Heathkit builders over 34 years, your success is guaranteed.

Make sure of your copy of the Heathkit catalogue. Send the coupon today, plus 25p in stamps and beat the demand.

To: Heath Electronics (U.K.) Limited, Dept (EE 8), Bristol Road, Gloucester, GL2 6EE.

Please send me a copy of the Heathkit catalogue.

I enclose 25p in stamps.

Name _____

Address _____

N.B. If you are already on the Heathkit mailing list you will automatically receive a copy of the Heathkit catalogue without having to use this coupon. When you receive your catalogue you will get details of this free offer.

HEATHKIT HEATH
ZED

ELECTROVALUE

SUPPLIERS OF COMPONENTS THAT COUNT

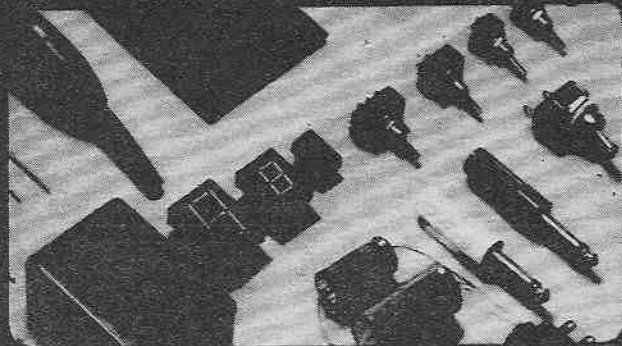

| | | |
|------------------------------------------------------------|--------------------------------------------------------|-------------------------------------------|
| SIEMENS SEMI-CONDUCTOR CAPACITORS FERRITES | NASCOM MICRO COMPUTERS AND ANCILLARIES | VERO BOARDS CASES & KITS |
| ISKRA RESISTORS | RADIOHM POTENTIOMETERS | BREADBOARDS SOLDER TOOLS |
| | OPTO-ELECTRONICS | SWITCHES CATALOGUE 10 |

GOOD DISCOUNTS AND FREE POSTAGE ON SUBSTANTIAL C.W.O. U.K. ORDERS

COMPUTER-CONTROLLED SERVICE AIDS PROMPT DELIVERY
128-PAGE CATALOGUE No. 10 FREE FOR THE ASKING

ELECTROVALUE LTD., 28 (EE7), St. Jude's Road, Englefield Green, Egham, Surrey TW20 0HB.
Phone: 33603 (London 87) STD 0784.

Telex 264475.

NORTHERN BRANCH (Personal Shoppers Only): 680 Burnage Lane, Burnage, Manchester M19 1NA. Phone (061) 432 4945.

INTERESTED IN ELECTRONICS?

TRY A ZEDPACK!

COMPONENTS AT A PRICE
EVERYONE CAN AFFORD

Z1 300 mixed $\frac{1}{2}$ and $\frac{1}{4}$ watt resistors £1-50
Z2 150 mixed 1 and 2 watt resistors £1-50
Z3 300 mixed capacitors, most types £3-30

Z4 100 mixed electrolytics £2-20
Z5 100 mixed polystyrene caps £2-20
Z6 300 mixed printed circuit components £1-50

Z7 300 mixed printed circuit resistors £1-50
Z8 100 mixed high wattage resistors, wire-wound etc. £2-20

Z9 100 mixed miniature ceramic and plate caps £1-20
Z10 25 assorted pots. £1-50

Z11 25 assorted presets, skeleton etc. £1
Z12 20 assorted vdr's and thermistors. £1-20

Z13 400 mixed FILM RESISTORS only £1-20
£2-60

Z14 100 mixed, new and marked, full spec. transistors. Pack includes: BC148, BF154, BF274, BC212L, BC238, BC181L, MEO412 and, or lots of similar types £4-95

Z15 100 mixed diodes including: zener, power, bridge, signal, germanium, silicon etc. All full spec. £4-95

Z16 20 1N4148 £3

Z17 20 1N4003/10D2 £1

Z18 20 assorted zeners, 1 watt and 400mw £1-50

Z20 6 BR100 diac. £1

20mm antisure fuses. 630ma

800ma, 1a, 1.25a, 1.5a, 2a, 2.5a, 3, 15a. 12

of one type £1. 100 of £7.

ULTRASONIC TRANSDUCERS, trans-

mitter and receiver. 40KHz. 14mm diam,

£3-95 pair

Deluxe FIBREGLASS printed circuit

etching kits.

Includes 100 sq ins. of copperclad F/G

board, 1lb ferric chloride, (made for U.S.

army to MIL, SPEC.), 1 dalo etch resist pen,

abrasive cleaner, etch resist dish and

instructions. OUR PRICE £4-95

250uA Miniature level/batt. meters, as

fitted to many cassette recorders. 90p

1lb of FeCl. £1-25. 5lb. £5.
150 sq. ins. single sided board. £2-20
150 sq. ins. double sided board. £3-30
Dalo pen. £1

UHF, Transistors T.V. TUNER with slow motion drive, AE.skt. and leads £1-95
100 Miniature reed switches. £3-30

P/B SWITCH BANKS

These cost a fortune! Were made for various music centres. Includes independent and interdependent latching types multi pole c/o etc. Can be modified. Can't be repeated. 3 Banks for £1.

KNOBBS for Switch Banks 10 for £1. Chrome or spun aluminium finish.

MINIATURE MAINS TRANSFORMERS

Top quality. Split bobbin construction will give 4-5V-0-4-5V at 250MA, 12" x 12" x 12", all sorts of uses. ONLY 90p

1000 uf, 100V, Radial, 1 1/2" x 2". ONLY 70p. 3 for £2-20.

Don't Let Your Environment Dehydrate You!

Buy our Honeywell Humidity Controller, Membrane actuated, very sensitive, 1/2" shaft, 250V, 3-75A Contacts. Ideal for greenhouses, centrally heated homes, offices etc. Build your own humidifiers or alarms. Fraction of original cost 90p ea. 3 for £2.

TRANSISTOR PUSHBUTTON TUNERS

For UHF Television (Decca Bradford or Rigonda chassis) 5 P/B Type (one for tuning). Only £2-50.

ALTERNATOR RECTIFIERS

Make lovely 60 amp bridges. Ideal for High Power Battery Chargers. Type 4AFI. Set of 4 (2 neg. case + 2 pos. case) £2.

Special Purchase enables us to offer Mullard C280 Polyester Capacitors (Liquorice Allsorts) at the unbeatable price of £2 for 100 mixed.

£15 for 1000. These consist of factory clearance lots i.e. spillages, floor sweepings, cosmetic rejects etc.

Also Mullard miniature electrolytics 100 mixed £1-50, 1000 for £10. Pack of each £3. 1000 of each £30.

To: "GEMINI ELECTRONIC COMPONENTS"
"THE WAREHOUSE" SPEEDWELL ST. LONDON S.E.8.

Please Quote ZED Code. Where shown. Send Cheque* or Postal Order. Plus 40p P&P.
*Schools etc. SEND OFFICIAL ORDER

Britain's first com puter kit.

The Sinclair ZX80.

£79.95

Price breakdown
ZX80 and manual: £69.52
VAT: £10.43
Post and packing FREE

Please note: many kit makers quote VAT-exclusive prices.

You've seen the reviews... you've heard the excitement... now make the kit!

This is the ZX80. 'Personal Computer World' gave it 5 stars for 'excellent value.' Benchmark tests say it's faster than all previous personal computers. And the response from kit enthusiasts has been tremendous.

To help you appreciate its value, the price is shown above with and without VAT. This is so you can compare the ZX80 with competitive kits that don't appear with inclusive prices.

'Excellent value' indeed!

For just £79.95 (including VAT and p&p) you get everything you need to build a personal computer at home... PCB, with IC sockets for all ICs; case; leads for direct connection to a cassette recorder and television (black and white or colour); *everything!*

Yet the ZX80 really is a complete, powerful, full-facility computer, matching or surpassing other personal computers at several times the price.

The ZX80 is programmed in BASIC, and you can use it to do quite literally anything from playing chess to managing a business.

The ZX80 is pleasantly straightforward to assemble, using a fine-tipped soldering iron. It immediately proves what a good job you've done: connect it to your TV... link it to an appropriate power source*... and you're ready to go.

Your ZX80 kit contains...

- Printed circuit board, with IC sockets for all ICs.
- Complete components set, including all ICs - all manufactured by selected world-leading suppliers.
- New rugged Sinclair keyboard, touch-sensitive, wipe-clean.
- Ready-moulded case.
- Leads and plugs for connection to domestic TV and cassette recorder. (Programs can be SAVED and LOADED on to a portable cassette recorder.)
- FREE course in BASIC programming and user manual.

Optional extras

- Mains adaptor of 600 mA at 9 V DC nominal unregulated (available separately - see coupon).
- Additional memory expansion boards allowing up to 16K bytes RAM. (Extra RAM chips also available - see coupon).

*Use a 600 mA at 9 V DC nominal unregulated mains adaptor. Available from Sinclair if desired (see coupon).



The unique and valuable components of the Sinclair ZX80.

The Sinclair ZX80 is not just another personal computer. Quite apart from its exceptionally low price, the ZX80 has two uniquely advanced components: the Sinclair BASIC interpreter; and the Sinclair teach-yourself BASIC manual.

The unique Sinclair BASIC interpreter offers remarkable programming advantages:

- Unique 'one-touch' key word entry: the ZX80 eliminates a great deal of tiresome typing. Key words (RUN, PRINT, LIST, etc.) have their own single-key entry.
- Unique syntax check. Only lines with correct syntax are accepted into programs. A cursor identifies errors immediately. This prevents entry of long and complicated programs with faults only discovered when you try to run them.
- Excellent string-handling capability - takes up to 26 string variables of any length. All strings can undergo all relational tests (e.g. comparison). The ZX80 also has string input to request a line of text when necessary. Strings do not need to be dimensioned.
- Up to 26 single dimension arrays.
- FOR/NEXT loops nested up to 26.
- Variable names of any length.
- BASIC language also handles full Boolean arithmetic, conditional expressions, etc.
- Exceptionally powerful edit facilities, allows modification of existing program lines.
- Randomise function, useful for games and secret codes, as well as more serious applications.
- Timer under program control.
- PEEK and POKE enable entry of machine code instructions, USR causes jump to a user's machine language sub-routine.
- High-resolution graphics with 22 standard graphic symbols.
- All characters printable in reverse under program control.
- Lines of unlimited length.

Fewer chips, compact design, volume production - more power per pound!

The ZX80 owes its remarkable low price to its remarkable design: the whole system is packed on to fewer, newer, more powerful and advanced LSI chips. A single SUPER ROM, for instance, contains the BASIC interpreter, the character set, operating system, and monitor. And the ZX80's 1K byte RAM is roughly equivalent to 4K bytes in a conventional computer - typically storing 100 lines of BASIC. (Key words occupy only a single byte.)

The display shows 32 characters by 24 lines. And Benchmark tests show that the ZX80 is faster than all other personal computers.

No other personal computer offers this unique combination of high capability and low price.

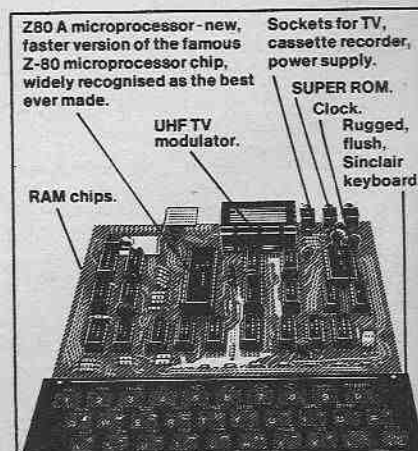

plete

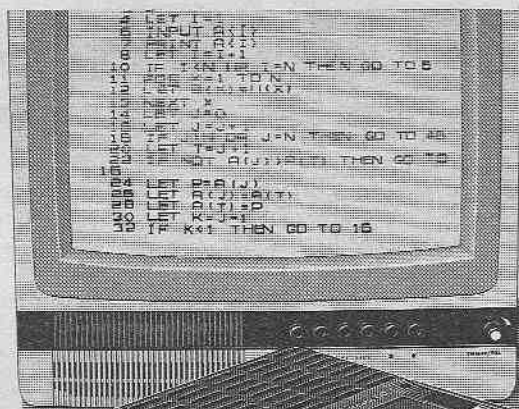

ZX80 software - now available!

See the advertisements in Personal Computer World (June) and Electronics Today International (July).

New dedicated software - developed independently of Science of Cambridge - reflects the enormous interest in the ZX80. More software available soon - from leading consultancies and software houses.

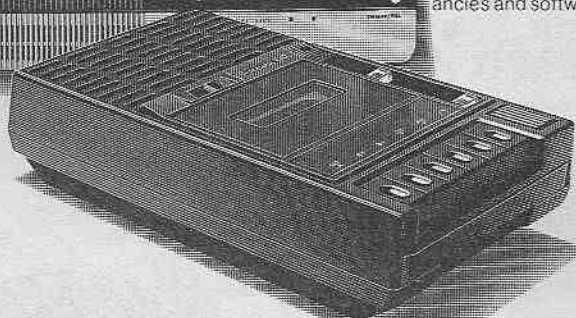

The Sinclair teach-yourself BASIC manual.

If the specifications of the Sinclair ZX80 mean little to you - don't worry. They're all explained in the specially-written 128-page book *free* with every kit! The book makes learning easy, exciting and enjoyable, and represents a complete course in BASIC programming - from first principles to complex programs. (Available separately - purchase price refunded if you buy a ZX80 later.) A hardware manual is also included with every kit.

The Sinclair ZX80. Kit: £79.95. Assembled: £99.95. Complete!

The ZX80 kit costs a mere £79.95. Can't wait to have a ZX80 up and running? No problem! It's also available, ready assembled, for only £99.95.

Demand for the ZX80 is very high: use the coupon to order today for the earliest possible delivery. All orders will be despatched in strict rotation. We'll acknowledge each order by return, and tell you exactly when your ZX80 will be delivered. If you choose not to wait, you can cancel your order immediately, and your money will be refunded at once. Again, of course, you may return your ZX80 as received within 14 days for a full refund. We want you to be satisfied beyond all doubt - and we have no doubt that you will be.

sinclair
ZX80
Science of Cambridge Ltd

6 Kings Parade, Cambridge, Cambs., CB2 1SN.
Tel: 0223 311488.

ORDER FORM

To: Science of Cambridge Ltd, 6 Kings Parade, Cambridge, Cambs., CB2 1SN.
Remember: all prices shown include VAT, postage and packing. No hidden extras.
Please send me:

| Quantity | Item | Item price £ | Total £ |
|----------|---------------------------------------------------------------------------------------------------------------|-----------------|------------|
| | Sinclair ZX80 Personal Computer kit(s). Price includes ZX80 BASIC manual, excludes mains adaptor. | £79.95 | |
| | Ready-assembled Sinclair ZX80 Personal Computer(s). Price includes ZX80 BASIC manual, excludes mains adaptor. | £99.95 | |
| | Mains Adaptor(s) (600mA at 9VDC nominal unregulated). | 8.95 | |
| | Memory Expansion Board(s) (each one takes up to 3K bytes). | 12.00 | |
| | RAM Memory chips - standard 1K bytes capacity. | 16.00 | |
| | Sinclair ZX80 Manual(s) (manual free with every ZX80 kit or ready-made computer). | 5.00 | |
| | | TOTAL | £ |

NB. Your Sinclair ZX80 may qualify as a business expense.

I enclose a cheque/postal order payable to Science of Cambridge Ltd for £ _____
Please print
Name: Mr/Mrs/Miss _____
Address _____

EE

JOIN UP WITH LITESOLD.

New 'L' series irons, designed to latest safety standards. Outstanding performance, lightweight and easy maintenance. New non-roll GRP safety handles. Ceramic and mica insulated elements enclosed in stainless steel shafts.

Fully earthed with screw connected 3-core leads. Interchangeable, non-seize long-life bits.

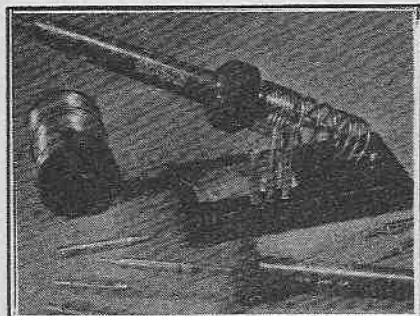

MODEL LC18 18 watts

Lightweight, high-performance iron for all soldering from calculators to T.V. sets. Fitted with 3.2 mm long-life bit and complete with

spare bits 1.6, 2.4 and 4.7 mm. £9.78 including P&P and VAT. 240 volts standard but also available 12 and 24 volts. Iron only £5.96 including P&P and VAT.

MODEL LA12 12 watts

Similar to LC18 but with extra slim shaft and bits for fine work. Fitted with 2.4 mm long-life bit and complete with spare bits 1.2 mm and 3.2 mm. £8.15 including P&P and VAT. 240 volts standard also available 6, 12 and 24 volts. Iron only £5.83 including P&P and VAT.

No. 3 SAFETY SPRING STAND for LC18 & LA12

Complete with sponge and location for spare bits £4.41 including P&P and VAT.

LOLA DE-SOLDERING PUMPS

Removes solder from pcb joints quickly, with no fuss. Simple one-handed operation leaves other hand free to hold soldering iron heat source. Needs no external power. Has replaceable PTFE nozzle. Thousands in daily use in major manufacturing companies. Two sizes to choose from.

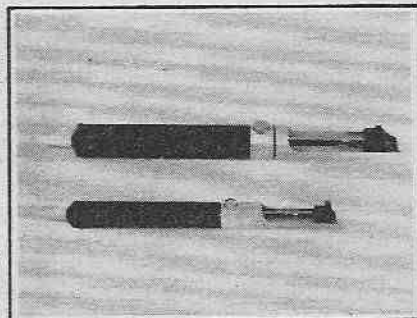

Lola A 215 mm long x 20 mm dia. £6.89 (including VAT, P&P)

Lola B 165 mm long x 14 mm dia. £5.03 (including VAT, P&P)

LITESOLD

LIGHT SOLDERING DEVELOPMENTS

97/99 Gloucester Rd. Croydon Surrey CR0 2DN Tel. 01-689 0574 Telex 8811945

TRADE ENQUIRIES: MICRO-MOLD, STATION RD., EAST PRESTON, WEST SUSSEX BN16 3AG

vero
vero
vero

Card Frames

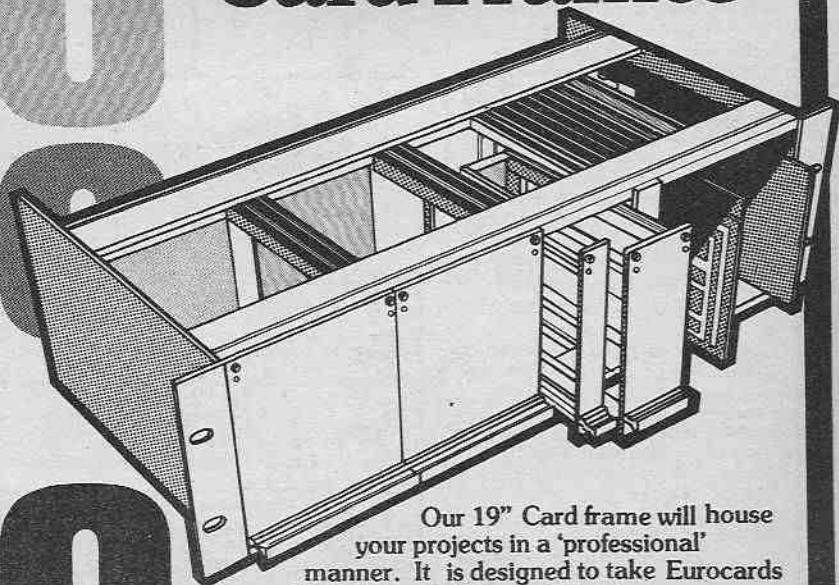

Our 19" Card frame will house your projects in a 'professional' manner. It is designed to take Eurocards or Modules and offers facilities for interconnection through 2-part DIN 41612 or direct edge connectors.

A full range of compatible items are available — all selected from the established range of industrial products — boards, accessories, cases etc. Just send 40p. and we'll send you our catalogue by return — it's got the lot!

VERO ELECTRONICS LTD RETAIL DEPT.
Industrial Estate, Chandler's Ford,
Hampshire SO5 3ZR
Tel: (04215) 62829



1

GENTS QUARTZ LCD, 5-function. Hours, minutes, secs, month, date, backlight. **ONLY £4.95**

2

GENTS QUARTZ LCD. SAME AS 1 - Alternative style. **ONLY £4.95**

3

QUARTZ LCD Slim Chronograph. 11-function. Hours, mins, secs, 6 digit-month, date, day of week, 1/100 sec stopwatch, split and lap modes, backlight. **ONLY £7.95**

4

QUARTZ LCD ALARM. 6 digit, hours, mins, secs, day, date. 24-hour alarm with on/off indicator. **ONLY £8.95**

5

QUARTZ LCD Alarm/Chronograph. 22 functions. Hours, mins, secs, day, date, month, 1/10 sec stopwatch, split and lap modes, 12 and 24 hour modes, 24 hour alarm. **ONLY £12.95**

We don't believe you can find better value combined with quality, than these - our special introductory prices. Compare the savings we offer and order now.

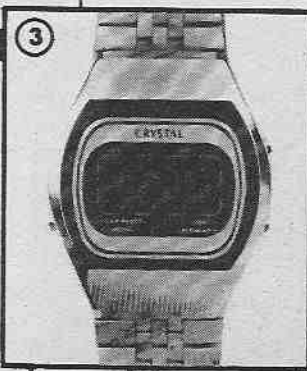

6 **QUARTZ LCD Musical Multi-Alarm/Chronograph.** 6-digit. Hours, mins, secs, day, date, 1/100 second stopwatch, split and lap modes, 24 hour alarm, dual time zone. **ONLY £13.45**

14 **CREDIT CARD CALCULATOR.** Very slim with standard 4 functions plus memory, percentage and square root. Complete with a mock leather wallet with credit card pocket. **ONLY £6.95**

13 **BELTIME 29F. Alarm/Chrono.** Advanced and accurate, this watch has 8 time functions, 4 alarm functions and 17 chronograph functions. Complete with backlight and stainless steel bracelet. **ONLY £19.95**

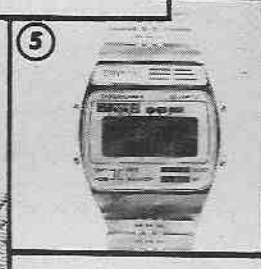
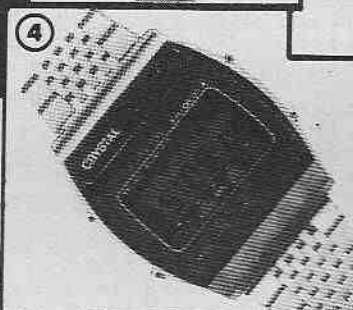

7 **SINCLAIR PROGRAMMABLE SCIENTIFIC CALCULATOR**
Genuine programmable model using micro processor technology, this amazing device is more like a computer than a calculator. Complete with programme library book containing approx. 370 programmes for ELECTRONICS, MATHS, PHYSICS, ENGINEERING ETC. Limited quantity available. **ONLY £7.95** + 75p carriage.

12 **GENTS ANALOGUE QUARTZ.** Conventional display, accuracy normally associated with digital watches. Automatic calendar, elegant and robust. **ONLY £19.95**

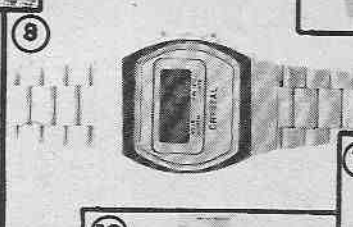
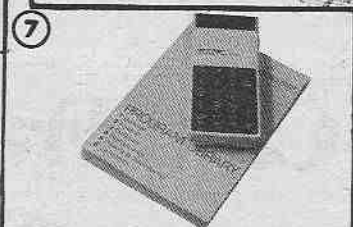

8 **LADIES QUARTZ LCD.** 5-function as Gents No. 1. Available with black or white face. **ONLY £5.95**

11 **LADIES QUARTZ LCD SAME AS 10.** Alternative "Round" shape. Available in gold or silver colour. **ONLY £8.95**

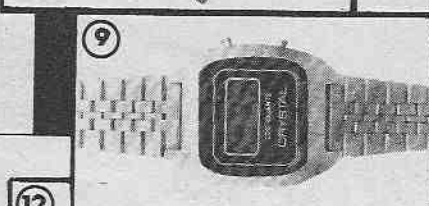

9 **LADIES QUARTZ LCD. SAME FUNCTIONS AS 8 - Alternative style.** Available with black or white face. **ONLY £5.95**

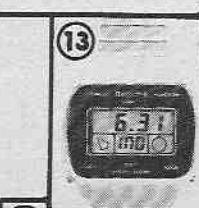

All watches have fully adjustable, matching stainless steel straps, and demonstration battery fitted (this battery is not guaranteed). Please add 60p for each spare battery required.

All products carry a Full 7-Day Money-Back Reassurance, plus 12-Month Guarantee. Prices include VAT.

10 **LADIES QUARTZ LCD.** 5 functions. Dress Style. Functions same as 1. Available in gold or silver colour. **ONLY £8.95**

Send stamped addressed envelope for Colour Brochure of 120 other bargains.

WHEELMOOR LTD

78 CASTLE STREET, MELBOURNE, DERBY, DE7 1DY

Please send me items..... (list numbers)
I enclose cheques/P.O.s for £.....
NAME.....
ADDRESS.....

Please add 35p P/P per item

EE 3

Simply ahead...

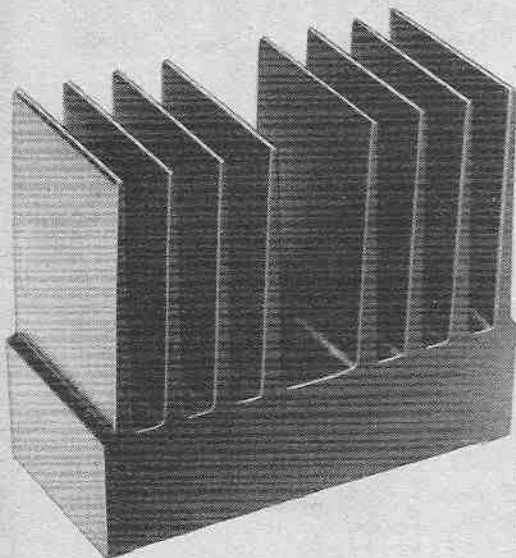

POWER AMPLIFIERS

ILP Power Amplifiers are encapsulated within heatsinks designed to meet total heat dissipation needs. They are rugged and made to last a lifetime. Advanced circuitry ensures their suitability for use with the finest loudspeakers, pickups, tuners, etc. using digital or analogue sound sources.

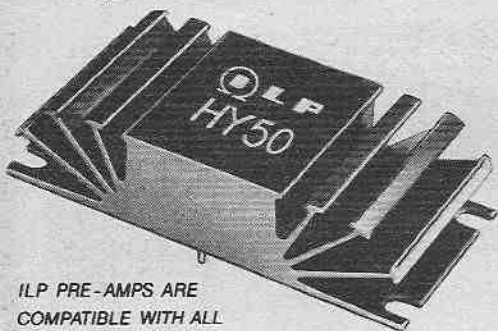
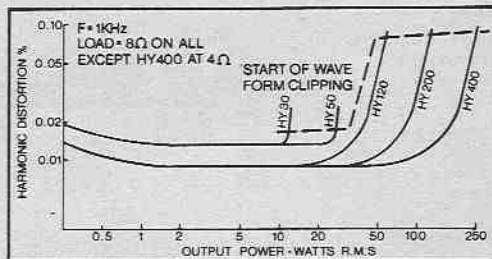

ILP PRE-AMPS ARE
COMPATIBLE WITH ALL
ILP POWER AMPS AND PSUs

| Model | Output Power R.M.S. | Distortion Typical at 1KHz | Minimum Signal/Noise Ratio | Power Supply Voltage | Size in mm | Weight in gms | Price + V.A.T. |
|-------|---------------------|----------------------------|----------------------------|----------------------|------------|---------------|----------------|
| HY30 | 15 W into 8 Ω | 0.02% | 100 dB | -20 -0 +20 | 105x50x25 | 155 | £6.34 + 95p |
| HY50 | 30 W into 8 Ω | 0.02% | 100 dB | -25 -0 +25 | 105x50x25 | 155 | £7.24 + £1.09 |
| HY120 | 60 W into 8 Ω | 0.01% | 100 dB | -35 -0 +35 | 114x50x85 | 575 | £15.20 + £2.28 |
| HY200 | 120 W into 8 Ω | 0.01% | 100 dB | -45 -0 +45 | 114x50x85 | 575 | £18.44 + £2.77 |
| HY400 | 240 W into 4 Ω | 0.01% | 100 dB | -45 -0 +45 | 114x100x85 | 1.15Kg | £27.68 + £4.15 |

Load impedance - all models 4 Ω - ∞
Input sensitivity - all models 500 mV
Input impedance - all models 100K Ω
Frequency response - all models 10Hz - 45 KHz - 3dB

POWER SUPPLY UNITS



ILP Power Supply Units with transformers made in our own factory are designed specifically for use with ILP power amplifiers and are in two basic forms - one with circuit panel mounted on conventionally styled laminated transformer, for smaller PSU's - in the other, for larger PSU's, ILP toroidal transformers are used which are half the size and weight of laminated equivalents, are more efficient and have greatly reduced radiation.

PSU 30 ± 15V at 100mA to drive up to 12 x HY6 or 6 x HY66] £4.50 + £0.68 VAT

THE FOLLOWING WILL ALSO DRIVE ILP PRE-AMPS

PSU 36 for 1 or 2 HY30's £8.10 + £1.22 VAT

PSU 50 for 1 or 2 HY50's £8.10 + £1.22 VAT

PSU 60 with toroidal transformer for

1 HY 120 £9.75 + £1.46 VAT

PSU 70 with toroidal transformer for 1 or

2 HY120's £13.61 + £2.04 VAT

PSU 90 with toroidal transformer for

1 HY200 £13.61 + £2.04 VAT

PSU 180 with toroidal transformer for

1 HY400 or 2 x HY200 £23.02 + £3.45 VAT



AVAILABLE ALSO FROM WATFORD ELECTRONICS, MARSHALLS AND CERTAIN OTHER SELECTED STOCKISTS.

this time with two new pre-amps

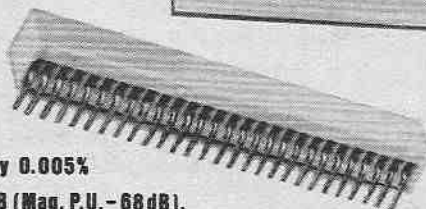
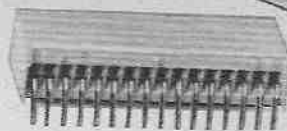
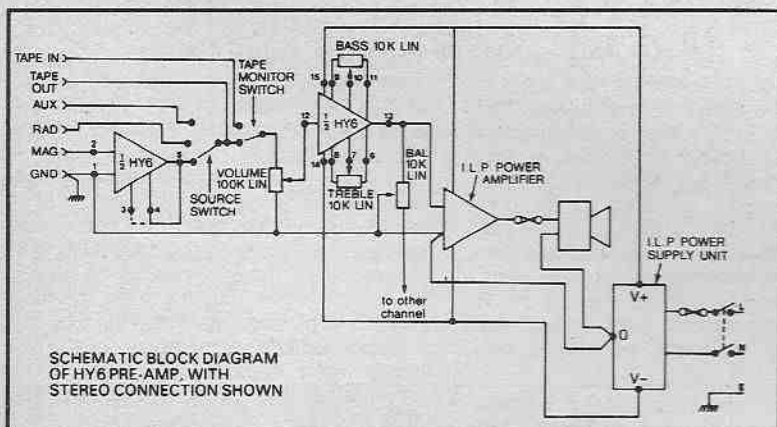

HY6 mono HY66 stereo

When ILP add a new design to their audio-module range, there have to be very special reasons for doing so. You expect even better results. We have achieved this with two new pre-amplifiers - HY6 for mono operation, HY66 for stereo. We have simplified connections, and improved performance figures all round. Our new pre-amps are short-circuit and polarity protected; mounting boards are available to simplify construction.

Sizes - HY6 - 45 x 20 x 40 mm. HY66 - 90 x 20 x 40 mm. Active Tone Control circuits provide ± 12 dB cut and boost. Inputs Sensitivity - Mag. P.U. - 3mV. Mic - selectable 1-12mV. All others 100mV. Tape O/P - 100mV. Main O/P - 500mV. Frequency response - D.C. to 100kHz - 3dB.

HY6 mono

£5.60

+VAT 84p

HY66 stereo

£10.60

+VAT £1.59

Connectors included

B6 Mounting Board
78p + 12p VAT

B66 Mounting Board
99p + 15p VAT

- LOW DISTORTION - Typically 0.005%
- S/N RATIO - Typically 90dB (Mag. P.U. - 68dB).
- HIGH OVERLOAD FACTOR - 38dB on Mag. P.U.
- LATEST DESIGN HIGH QUALITY CONNECTORS.
- REQUIRE ONLY POTS, SWITCHES, PLUGS AND SOCKETS.
- COMPATIBLE WITH ALL ILP POWER AMPS AND PSUs.
- NEEDS ONLY UNREGULATED POWER SUPPLY ± 15 V to ± 50 V.

NO QUIBBLE
5 YEAR GUARANTEE
7-DAY DESPATCH ON ALL ORDERS
BRITISH DESIGN AND MANUFACTURE
FREEPOST SERVICE
- see below

★ ALL U.K. ORDERS DESPATCHED POST PAID

HOW TO ORDER, USING FREEPOST SYSTEM

Simply fill in order coupon with payment or credit card instructions. Post to address as below but do not stamp envelope - we pay postage on all letters sent to us by readers of this journal.

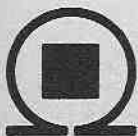

ILP
ELECTRONICS LTD.

FREEPOST Graham Bell House, Roper Close,
Canterbury, Kent CT2 7EP.
Telephone (0227) 54778 Telex 965780

Please supply
..... Total purchase price £.....
I enclose Cheque Postal Orders International Money Order
Please debit my Access/Barclaycard Account No.
NAME
ADDRESS
Signature

EDITOR

F. E. BENNETT

ASSISTANT EDITOR

B. W. TERRELL B.Sc.

PRODUCTION EDITOR

D. G. BARRINGTON

TECHNICAL SUB-EDITOR

S. E. DOLLIN B.Sc.

ART EDITOR

R. F. PALMER

ASSISTANT ART EDITOR

P. A. LOATES

TECHNICAL ILLUSTRATOR

D. J. GOODING

EDITORIAL OFFICES

Kings Reach Tower,
Stamford Street,
London SE1 9LS
Phone: 01-261 6873

ADVERTISEMENT MANAGER

R. SMITH
Phone: 01-261 6671

REPRESENTATIVE

N. BELLWOOD
Phone: 01-261 6865

CLASSIFIED MANAGER

C. R. BROWN
Phone: 01-261 5762

MAKE-UP AND COPY DEPARTMENT

Phone 01-261 6615

ADVERTISEMENT OFFICES

Kings Reach Tower
Stamford Street,
London SE1 9LS

Projects... Theory... and Popular Features ...

Our *Weather Centre* is one of the larger kind of projects that appear from time to time in our pages. The "largeness" in this case is not entirely due to electronics. A project of this nature inevitably involves a fair amount of metal working in the construction of the sensing apparatus. Nevertheless, this should not be beyond the capabilities of the average handyman. But if necessary it should be possible to enlist the services of a friend who is a dab hand at metal work.

The *Weather Centre* is a natural for a school or other establishment where a team composed of individuals having different handicraft talents can be engaged upon this task. Genuine side benefits arise: permanent display of the team's achievement, and the acquisition by the school of a useful aid for natural science studies at a minimum expenditure. In these days of stringent economies enforced upon our Education Authorities, the do-it-yourself philosophy assumes greater relevance at school, no less, indeed, than it does at home.

More than this though; a deeper purpose is served by any stimulation of interest in technical creative work amongst students, especially in difficult times like the present.

Today countless youngsters face an unpredictable future. Job prospects for the school leaver are not good.

The older, traditional industries are contracting, if not vanishing. The almost universal gloom is pierced only by light emitted from the high-technology-based industries. It is therefore a reasonable presumption that skilled personnel will be in constant demand to instal, maintain and service the growing electronic-based systems and equipments which (seen or unseen) are playing ever increasing parts in our lives.

Thus today's youngsters could do much worse than to acquire a lively interest in electronics whilst they are still at school. Knowledge and practical experience so acquired could stand them in good stead in the search for a job with some prospects in the future.

This month we are including an extra part of the *Teach-In* series, but less the experiments. These will be published next month together with the final part of this series.



Our September issue will be published on Friday, August 15. See page 497 for details.

Readers' Enquiries

We cannot undertake to answer readers' letters requesting modifications, designs or information on commercial equipment or subjects not published by us. All letters requiring a personal reply should be accompanied by a stamped self-addressed envelope.

We cannot undertake to engage in discussions on the telephone.

Component Supplies

Readers should note that we do not supply electronic components for building the projects featured in **EVERYDAY ELECTRONICS**, but these requirements can be met by our advertisers.

All reasonable precautions are taken to ensure that the advice and data given to readers are reliable. We cannot however guarantee it, and we cannot accept legal responsibility for it. Prices quoted are those current as we go to press.

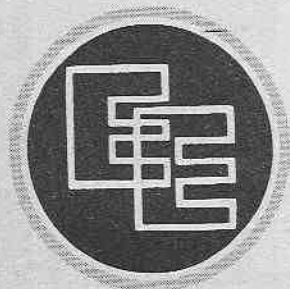

Everyday ELECTRONICS

VOL. 9 NO. 7

AUGUST 1980

CONSTRUCTIONAL PROJECTS

- CRICKET GAME** For entertainment off the pitch by D. Kenyon 476
BRAKESAFE MONITOR Teaches you to keep your distance by O. N. Bishop 482
WEATHER CENTRE Part 1: The system explained and construction of display unit by F. C. Judd 498
AUDIO MILLIVOLTMETER An instrument for the audiophile by R. A. Penfold 512
AUTO LIGHTING-UP WARNING Tells you when to switch-on by K. B. Whapples 525

GENERAL FEATURES

- EDITORIAL** 474
SHOP TALK Product news and component buying by Dave Barrington 481
BOOK REVIEWS Some recent releases 481
COUNTER INTELLIGENCE A retailer comments by Paul Young 485
TEACH-IN 80 Part 10: Feedback and oscillators by S. R. Lewis, B.Sc. 486
Part 11: Sinusoidal and switching oscillators; modulation by S. R. Lewis, B.Sc. 492
JACK PLUG AND FAMILY Cartoon by Doug Baker 496
FOR YOUR ENTERTAINMENT Digital data via f.m. broadcasts; access to pre-recorded material via telephone line by Adrian Hope 506
RADIO WORLD A commentary by Pat Hawker 509
EVERYDAY NEWS What's happening in the world of electronics 510
SQUARE ONE Beginner's Page: Ohm's Law 518
WORKSHOP MATTERS Care in handling components by Harry T. Kitchen 521
PLEASE TAKE NOTE Dual-Line Game; Kitchen Timer 521
DOWN TO EARTH Re-winding mains transformers by George Hilton 522

Back Issues

Certain back issues* of EVERYDAY ELECTRONICS are available worldwide price 70p inclusive of postage and packing per copy. Enquiries with remittance should be sent to Post-Sales Department, IPC Magazines Ltd., Lavington House, 25 Lavington Street, London SE1 0PF. In the event of non-availability remittances will be returned.

* Not available: October 1978 to May 1979.

Binders

Binders to hold one volume (12 issues) are available from the above address for £4.40 (home and overseas) inclusive of postage and packing. Please state which Volume.

Subscriptions

Annual subscription for delivery direct to any address in the UK: £9.00, overseas: £10.00. Cheques should be made payable to IPC Magazines Ltd., and sent to Room 2613 Kings Reach Tower, Stamford Street, London SE1 9LS.

© IPC Magazines Limited 1980. Copyright in all drawings, photographs and articles published in EVERYDAY ELECTRONICS is fully protected, and reproductions or imitations in whole or in part are expressly forbidden.

**OUR
REGULAR
FEATURE
FOR
BEGINNERS**

See Page 518

SQUARE
One

THE game of cricket is traditionally played outdoors in fine weather, but the electronic version to be described here can be played at anytime, in or out-of-doors in all weathers. This portable game is suitable for two or more players. It can also provide amusement for a single player.

The batsman can be either bowled or caught out. No facility has been incorporated for an "l.b.w." but rules for this could be concocted if desired.

CIRCUIT DESCRIPTION

The complete circuit diagram of the Cricket Game is shown in Fig. 1.

Gates IC6a and IC6b are wired to form a square wave oscillator, the frequency of which is controlled by

C3 and the resistor chain R5 to R9. This is the clock for the system and feeds the counters IC7, and IC3b. Decade counter IC7 has ten outputs (only eight used here). Only one is on at any one time changing with the number of pulses fed to pin 14. The effect therefore of a train of pulses to IC7 pin 14 is to produce a running light from D1 to D8. This simulates the moving cricket ball.

Although the clock is running all the time that power is applied, the running output is only produced when the clock enable input, pin 13, is low. The clock enable inputs of IC7 and IC3a are both controlled by the Q output from IC4, a D-type flip-flop.

The function of IC3a is to cause the clock rate to change during the game as the BAT button is pressed. Any "bounce" this push button may have is removed by the monostable composed of IC1a and IC1b. Thus each time S1 is pushed, a clean single pulse is produced at IC1b pin 4 to the input of IC2a.

The other input to IC2a is from the seventh output of IC7, the ball position closest to the wicket (D8). When this goes high, and the BAT button pressed simultaneously, an output results at IC2a pin 3 which is counted by IC3a. This causes the binary count from IC3a to advance and close one or more switches within IC5, a quad-bilateral switch i.c. This alters the effective resistance in the oscillator circuit thus changing its rate.

DISPLAY

At the same time this pulse from IC2a, is fed to a second monostable composed of IC1c and IC1d which is turned on (output goes high) for a time set by R3 and C2. The high output enables IC3b and allows the pulses from the oscillator to be counted by IC3b, decoded by IC8 and displayed on X1. When the output from IC1d goes low, IC3b count is frozen and its value displayed on X1. The falling monostable output triggers IC4 which produces a low on the Q output to freeze the count on IC7 and IC3a.

Gates IC2b and IC2c reset IC3b after a count of six.

If the BAT button is not pressed while IC7 pin 5 is high, then pin 6 goes high and D8 lights up and stays on to show that the wicket has been struck by the ball. No output therefore is produced from IC2a. This high level at pin 6 sets IC4 (pin 6) and resets IC3a (binary 0 output). The setting of IC4 results in Q changing which freezes the condition of IC7; D8 remains lit.

The RESET button returns the ball to the bowling end (D1) and D8 is extinguished.

Pressing S2 resets IC4 whose output enables IC7 (causing the ball to be bowled) and IC3a (allowing the BAT switch to be effective).

MAKE A BIG
HIT WITH
YOUR
FELLOW
PLAYERS

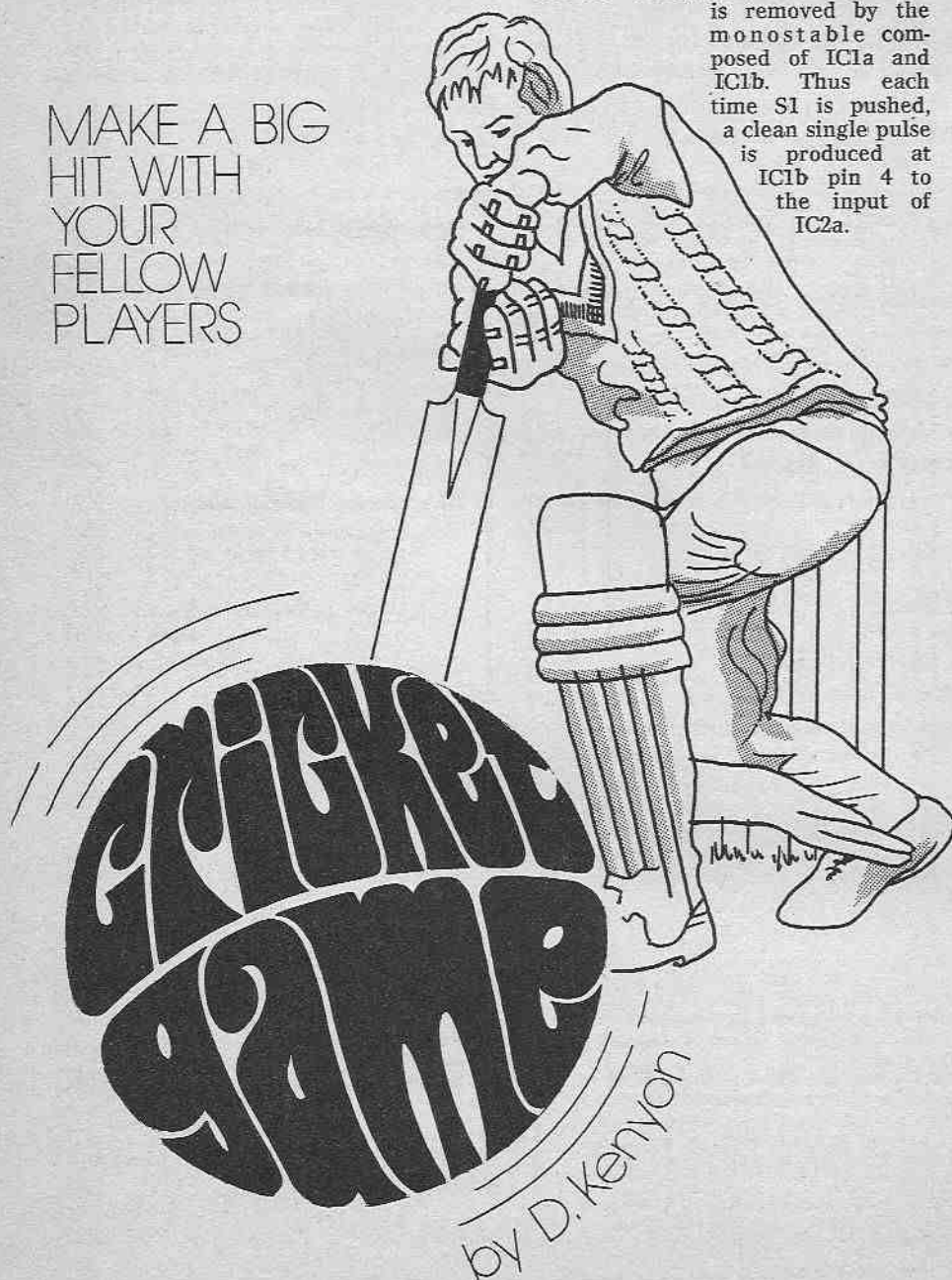

CONSTRUCTION
starts here

CIRCUIT BOARDS

The prototype unit was constructed using four separate 0.1 inch plain matrix boards mounted in tiers. This method of construction is by no means essential and may be replaced by a single board layout. However, it is required that the opto components i.e. l.e.d.s and display, be mounted high enough above the board to allow them to protrude through the lid.

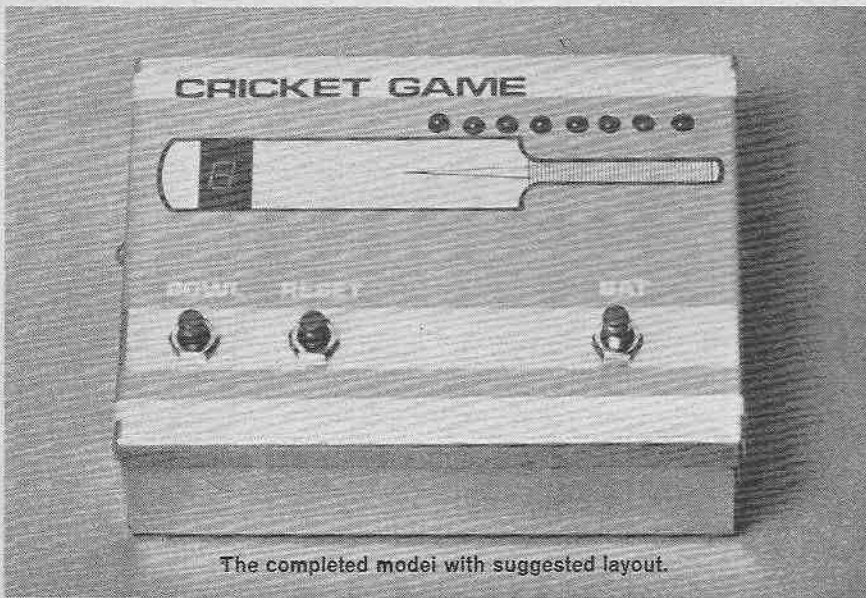

The completed model with suggested layout.

POWER SUPPLY

In the author's unit, the battery was not incorporated in the case as use with a battery eliminator was planned. A larger case than seen will need to be selected if an integral battery is desired. It is unlikely that a PP5 will provide a satisfactory power source. A PP6 battery will be better without the need for a very much larger case.

The layout of the components on the topside of the boards and the interconnections on the underside are shown in Figs. 2 and 3. All inter-board connections are made via Veropins; double-sided types are required in some positions and it is advised that these are used throughout. The i.c.s are mounted in sockets.

Begin by drilling the board fixing holes and inserting the Veropins and i.c. sockets. The latter can be held in place by bending over two diagonally opposite pins. Assemble components

Fig. 1. The complete circuit diagram of the Cricket Game.

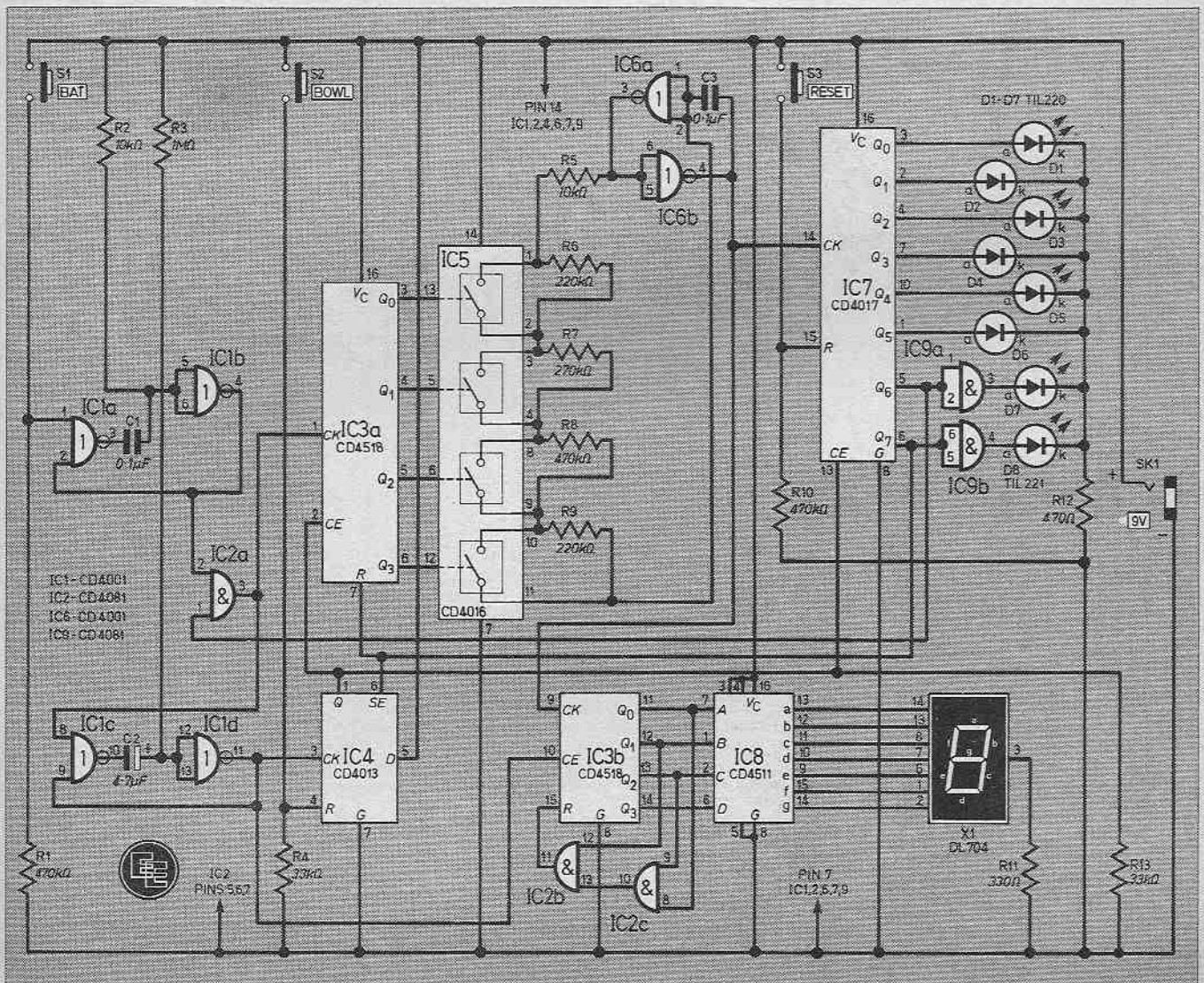
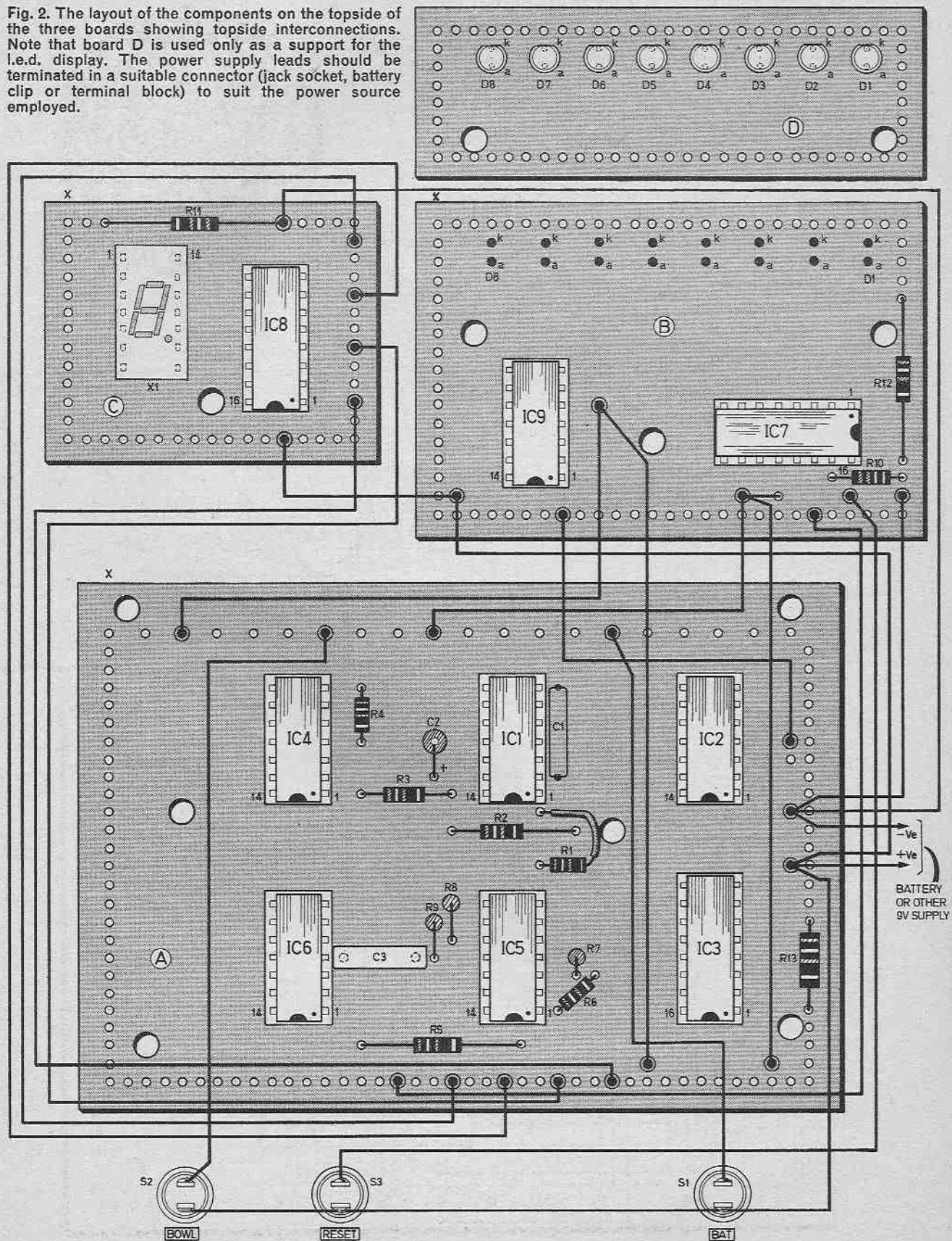

Fig. 2. The layout of the components on the topside of the three boards showing topside interconnections. Note that board D is used only as a support for the i.e.d. display. The power supply leads should be terminated in a suitable connector (jack socket, battery clip or terminal block) to suit the power source employed.



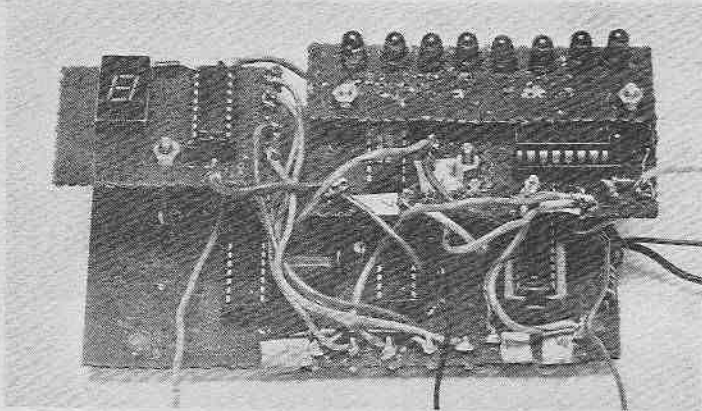

Fig. 4. Tier arrangement of circuit boards in the prototype.

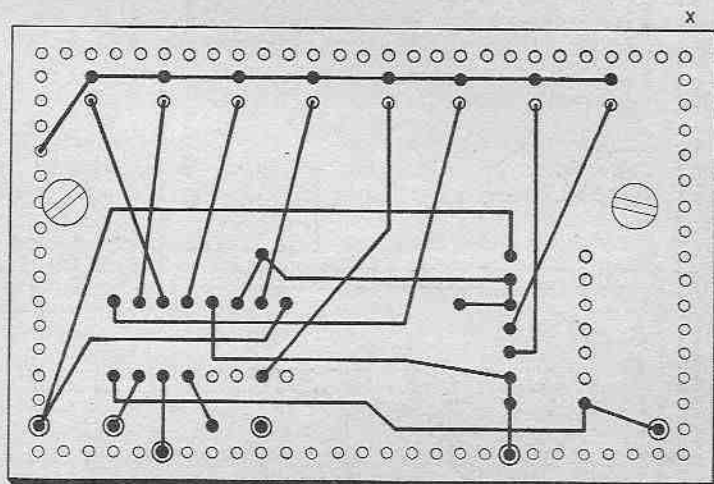
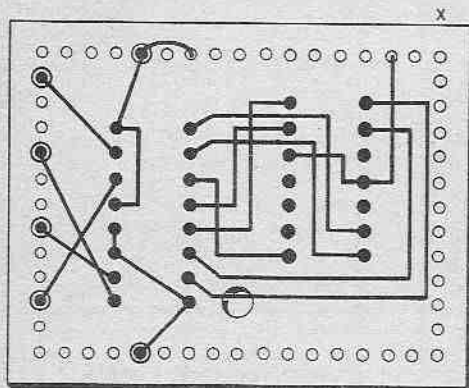
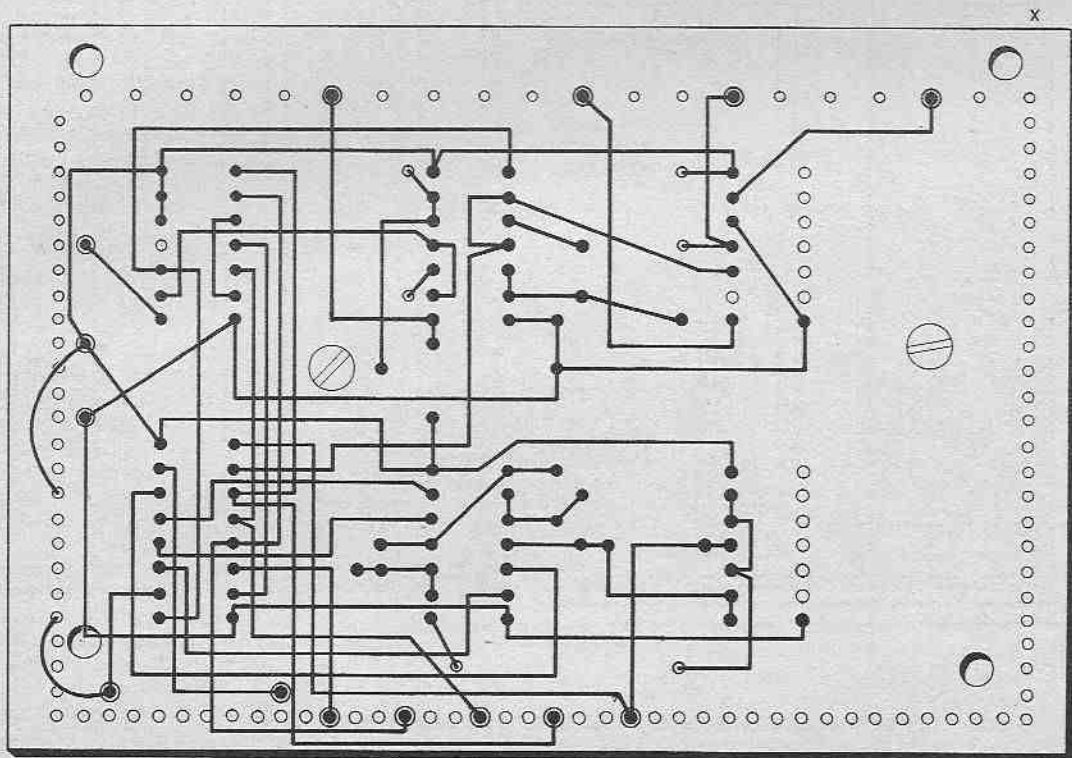
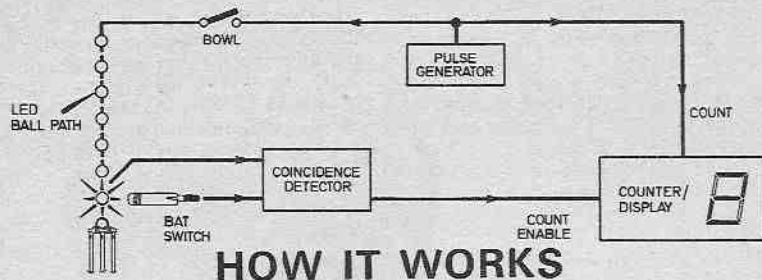

Fig. 3. Wiring on the underside of each of the three boards; p.v.c. covered wire is advised for all interconnections.





HOW IT WORKS

When the BOWL switch is closed pulses from the generator are fed to the pitch to simulate a ball moving towards the batsman. If the BAT switch is operated at the same time that the ball reaches its last position, this is detected and a signal produced to allow the generator pulses to be counted. This signal lasts for about two seconds resulting in a frozen displayed number after this time, and equal to the "runs" made. If the BAT switch is not operated within the time that the last ball l.e.d. is on (lit), then the very last l.e.d. in the chain lights up indicating a fallen wicket.

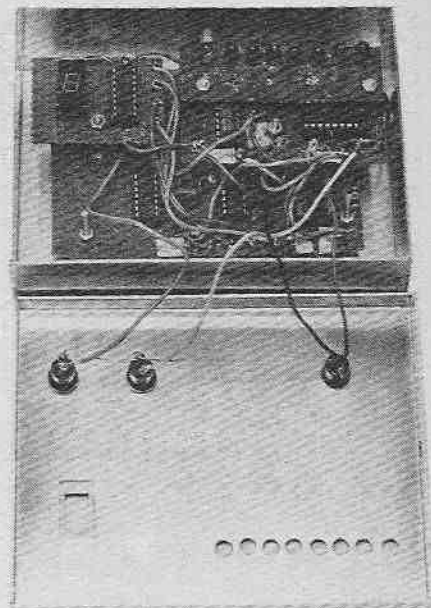

Final stages of construction.

on each board and interwire the underside as detailed. There are many connections to be made on the undersides of the boards, especially board A. It is therefore essential that p.v.c. sleeved wire is used here as there are numerous "crossings" of these conductors. Do not connect any flying leads at this stage.

When the individual boards are complete and thoroughly checked, mount them as shown in Fig. 4. It is a good idea at this stage to position the assembly in its drilled case and adjust the positions of the boards to

site the opto boards at the correct height. When satisfied, the securing nuts and shakeproof washers can be tightened.

The inter-board wiring can now be carried out. Stranded wire is recommended, 7/0.2mm p.v.c. covered is suitable. It is wise to use as many different wire colours as possible to enable easier fault tracing should this be necessary. As each connection is made, it should be crossed off in Fig. 2, or better still traced with a coloured pencil of the same colour as the wire used.

When complete, wire the switches to the boards and connect a suitable voltage source which can be in the range 6 to 12 volts.

PLAYING THE GAME

Three push buttons appear on the front panel labelled BAT, RESET and BOWL. When the unit is first switched on, pressing the RESET button places the ball at the bowler's end (extreme right).

The ball is bowled by pressing BOWL and is seen to move down the pitch towards the wicket by the string of l.e.d.s turning on and off. When the ball reaches the position just before the wicket (green l.e.d.), the batsman can make his play by pressing BAT. If a successful hit is made, the display will indicate the runs made from his strike. If he misses, the wicket will be hit by the ball and indicated by the green l.e.d. lighting up. The batsman is then out.

The display will indicate a number between 0 to 6 inclusive. All numbers with the exception of "5" are regular "runs" to be made, although 5 runs are possible, such as might result from an overthrow, it is very rarely seen. A display of 5 can therefore be used to indicate that the batsman has been caught out.

The RESET button must be pressed after the result of each "delivery" to return the ball to the bowling end.

To introduce an l.b.w. the reset gates (IC2b and c) could be modified to allow the display to count up to 7, this count indicating an l.b.w. Alternatively a sequence of runs, e.g. 2, 2, 2, or 1, 2, 3, or some other could be used for this.

COMPONENTS



Resistors

| | | |
|----------|-----------|----------|
| R1 470kΩ | R6 220kΩ | R11 330Ω |
| R2 10kΩ | R7 270kΩ | R12 470Ω |
| R3 1MΩ | R8 470kΩ | R13 33kΩ |
| R4 33kΩ | R9 220kΩ | |
| R5 10kΩ | R10 470kΩ | |

All ¼W carbon ± 5%

Capacitors

| |
|-----------------------------|
| C1 0.1μF plastic or ceramic |
| C2 4.7μF 12V elect. |
| C3 0.1μF plastic or ceramic |

Semiconductors

| |
|-------------------------------------------------------|
| IC1 CD4001 CMOS quad 2-input OR gates |
| IC2 CD4081 CMOS quad 2-input AND gates |
| IC3 CD4518 CMOS dual b.c.d. up-counter |
| IC4 CD4013 CMOS dual D-type flip-flop |
| IC5 CD4016 CMOS quad bilateral switch |
| IC6 CD4001 CMOS quad 2-input OR gates |
| IC7 CD4017 CMOS decade counter/divider |
| IC8 CD4511 CMOS b.c.d./7-segment latch/decoder/driver |
| IC9 CD4081 CMOS quad 2-input AND gates |
| X1 DL 704 common cathode 7-segment display |
| D1-D7 TIL220 red l.e.d. |
| D8 TIL221 green l.e.d. |

Miscellaneous

| |
|-------------------------------------------------------------------------------------------------------------------------------------------------------------------------------------------------------|
| SK1 miniature jack socket (optional) |
| S1-S3 momentary action push-to-make switch (3 off) |
| Plain matrix board; 0.1 inch pitch, 40 × 26, 27 × 17, 17 × 13, 27 × 8mm; i.c. sockets, 16 pin (3 off), 14 pin (6 off); double sided Veropins; 6BA fixings; case to suit; battery connector (optional) |

COMPONENTS
approximate
cost £11
excluding case

See
**Shop
Talk**

page 481



By Dave Barrington

Aerial

Using experience gained in designing TV aerials for confined locations, such as caravans, Maxview Aerials have introduced a new 6-element array intended for viewers where space is at a premium.

Known as the Colour-Max the aerial is claimed to cover the entire u.h.f./TV spectrum and is supplied with an angled fitment terminating in two suction pads to enable it to be fitted to any smooth surface, such as a window or tiled wall. When the bracket has been secured the aerial is rotated towards the direction of best reception and locked in position by tightening a wing nut.

The aerial pack comes complete with 5 metres of low-loss coaxial cable, including plug, and a station guide leaflet to assist correct aerial orientation. For further details readers should contact Maxview Aerials Ltd., Dept EE, Maxview Works, Setch, King's Lynn, Norfolk, PE33 0AT.

BOOK REVIEWS

INTRODUCTORY CIRCUIT THEORY

Author J. K. Fidler
Price £5.95
Size 227 × 152mm 214 pages
Publisher McGraw-Hill Ltd.
ISBN 0 07 084095 4

BACK in the days of steam radio and the BBC Light Programme, the answer to the question "How are you at mathematics?", would always seem to be "I speak it like a native!"

Unfortunately few of us have quite the same assurance and any undergraduate text that leads the student through the mathematical minefield of electrical theory is usually well received.

This book provides a logically developed introduction to a subject that lies at the foundation of electrical science.

Circuit analysis techniques for both linear and non-linear circuits are described and a thorough grounding in the basics of time domain and frequency domain analysis is also provided.

S.E.D.

CONSTRUCTIONAL PROJECTS

Rumour has it that there is a general shortage of components in the market place at the moment and readers are advised, in cases of delayed orders, to check supplies with our advertisers. This is due, we are informed, to the increase prices of replacement stocks and shortages from some manufacturers.

Weather Centre

Our major project this month is the *Weather Centre* and calls for some special items.

The mains transformer type MT150 and the panel meter are available from Bi-Pak Semiconductors. Order as 2025 for the transformer and 1303 for the meter.

The reed switches and magnet are RS Components types and should be ordered through RS stockists. This also applies to the flashing l.e.d.

The infra red detector (TIL78) and the infra red emitter (TIL32) seems to be available from various sources and should not be difficult to obtain.

The rectangular l.e.d.s required for the compass points are stocked by Watford Electronics, price 36p each. However, as eight are required they are prepared to supply them at 30p each, including mounting clips. These devices are available in red, green or yellow.

To give the centre a professional appearance most of the electronics were housed in a Contil CON127 series case available from West Hyde Developments, Unit 9, Dept EE, Park Street Industrial Estate, Aylesbury, Bucks, HP20 1ET. These cases are fairly expensive and any similar dimensioned case may be used, at the cost of the final appearance of course.

Cricket Game

The 4000 series of CMOS integrated circuits for the *Cricket Game* are stocked by most component suppliers and should not give any problems.

The 7-segment display is the DL704 and is a fairly common device stocked by most advertisers. Any seven segment common cathode display can be used but the wiring may need altering to cater for the differing pinning arrangements.

As the unit is likely to be used where easy access to mains supply for a battery eliminator could be a problem, we suggest a larger case be used to incorporate a PP6 battery to power the circuit. This will make the game truly portable and help to pass the time during the usual "rain stopped play" intervals.

Auto Lighting-Up Warning

The "heart" of the circuit for the *Auto Lighting-Up Warning* is a silicon controlled switch type BRV39. This device may prove troublesome to locate but is listed in the Ace Mailtronix and Electrovalue catalogues. Also, it appears in the latest Watford Electronics advertisement and can be purchased through RS Component stockists.

The rest of the items for this project should be readily available from most sources.

Audio Millivoltmeter

The close tolerance resistors called for in the *Audio Millivoltmeter* are from the E24 range stocked by most suppliers. However, some advertisers may supply resistors rated at $\frac{1}{2}$ watt, these are quite suitable provided their resistance values are 2 per cent or better.

Although this project uses an edgewise meter there is no reason why an ordinary standard 1mA moving coil meter could not be used, making sure of course it will fit in the case.

Brakesafe Monitor

No buying problems are envisaged for the *Brakesafe Monitor*. The buzzer used in the prototype was a 6V type obtained from Maplin.

TWO-METRE ANTENNA HANDBOOK

Author F. C. Judd, G2BCX
Price £3.95 paperback
Size 185 × 120mm 160 pages
Publisher Newnes Technical Books
ISBN 0 408 00402 9

THIS compact book is intended primarily for newcomers to the highly popular 144-146MHz amateur band which, because of the impact of the Class B v.h.f.-only (no Morse) licences, is undoubtedly the most popular of all amateur bands in the UK and most other European countries. It provides a thoroughly practical guide to v.h.f. propagation, transmission lines, antenna tuning and matching units, the by no means easy task of measuring antenna performance, plus full constructional details of a number of useful omnidirectional (including colinear types) and beam antennas, including the installation of the associated rotor mechanisms. The directional designs include a number of Yagi arrays of varying complexity, v.h.f. "quad" (double diamond) arrays and several "driven" arrays such as the HB9CV and ZL-Special designs with which the author has been associated for many years.

The treatment is essentially non-mathematical but there is little doubt that this little book will be found useful (and not only by beginners) to those listening or transmitting on "two metres".

P.H.

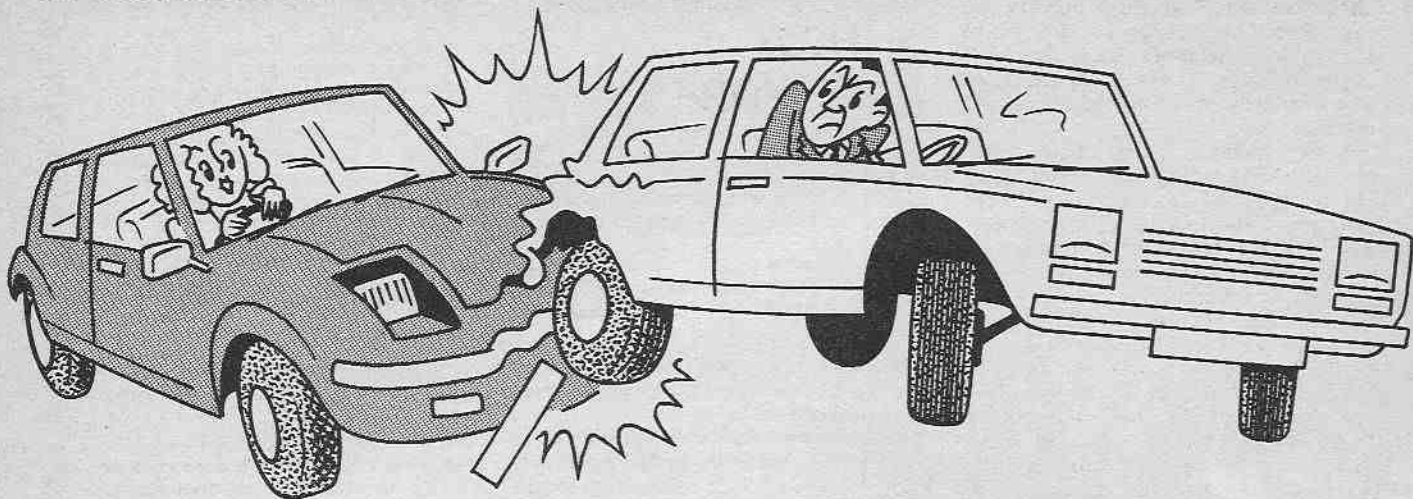

BRAKESAFE MONITOR

BY O.N. BISHOP

How good are your reflexes? Even if they are as good as they should be, it is not safe for you to drive less than 60 yards behind another car when you are both travelling at 60 m.p.h. Sixty yards is about 13 average car lengths yet we frequently see cars travelling at high speed with much less than this distance between them.

Presumably the following driver is relying on the low chance that the driver in front will suddenly apply his brakes, but what happens if he does?

REACTION TIME

If you are too close to the car in front and it begins to decelerate then you may well be in trouble. It takes a few moments to become aware of the deceleration of the car in front, then you have to decide to apply the brakes, then there is a time delay during which your brain activates your leg muscles to press on the brake pedal and finally the brake mechanism requires time before the braking force begins to act.

This period is known as the reaction time and is usually about two seconds in fine conditions. Under bad conditions such as rain, fog, snow or darkness this can be extended as far as five seconds.

At 60 m.p.h. you will travel about 60 yards in two seconds. This means that if you are following the car in

TABLE 1
Braking Distances
and Stopping Times

| Speed (m.p.h.) | Braking Distance (yards) | Time to Stop (secs) |
|-------------------|--------------------------------|---------------------------|
| 10 | 5 | 2.0 |
| 20 | 15 | 2.7 |
| 30 | 25 | 3.4 |
| 40 | 40 | 4.1 |
| 50 | 58 | 4.8 |
| 60 | 80 | 5.4 |
| 70 | 105 | 6.1 |

front closer than 60 yards and it brakes suddenly, you will not have time to brake before you run into it.

The important thing to remember is that it is the time difference between you and the car in front (measured in seconds) that matters and not the distance. If your time difference is less than two seconds you can only avoid a collision by steering to one side.

BAD VISIBILITY

Another type of problem arises when driving in conditions of bad visibility, especially in fog. Drivers are often unable to brake and halt

Fig. 1. Complete circuit diagram of the Brakesafe Monitor.

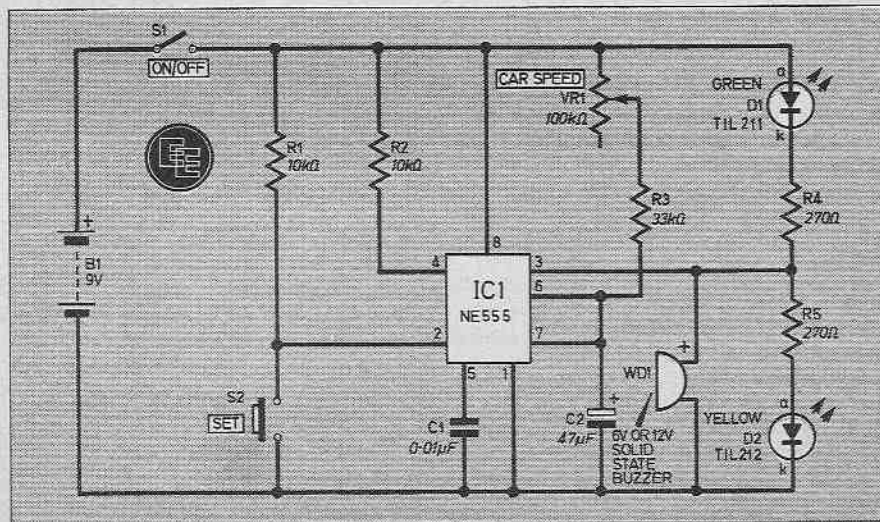

when an obstruction on the road ahead suddenly appears out of the fog. Motoring handbooks list tables of braking distances such as those shown in Table 1. This lists the times and distances necessary to come to a complete halt.

In fog, distance matters because we are usually heading for a stationary object, and not, as in the previous example, following a decelerating car. The object is standing stationary on the road from the moment you see it.

Given the braking distances calculated by experts, and assuming that deceleration is at a uniform rate, we can calculate how long it takes to bring the car to a halt. These times are shown in the third column of Table 1, and include reaction time. At 10 m.p.h. we can stop the car practically as soon as we have had time to react to the sight of the obstruction.

At 70 m.p.h. however several seconds elapse while the car is decelerating, no matter how good the brakes may be. We need to be able to see over 100 yards ahead.

The Brakesafe Distance Monitor can be set to sound for various times ranging from two seconds to seven seconds. The extra 0.9 seconds at 70 m.p.h. allows a little extra for safety, especially necessary as many drivers do not brake fully when first seeing an obstruction.

The Brakesafe Distance Monitor therefore measures time difference. It is a training aid to help you get the feel of driving with a safe distance between you and the car in front and also to help maintain a safe speed in foggy conditions.

Reckoning in time rather than in distance has the advantage that we can use an electronic timer operated from within the car.

CIRCUIT

The full circuit of the unit is shown in Fig. 1. This consists basically of a 555 timer i.c. connected in the mono-stable mode. When S1 is first turned on, the output of IC1 (pin 3) is low, that is at 0V. Current flows through D1, the green l.e.d. and into the i.c. at pin 3.

When the SET button, S2, is briefly pressed, the trigger input, pin 2, which was formerly held high by current flowing through R1, is briefly grounded. This triggers IC1 and timing begins. Current flows through VR1 and R3 to charge capacitor C2. The time taken to charge C2 depends on its value, the value of R3 and the setting of VR1.

While charging is taking place, the output of the i.c. goes high, that is to nine volts. The l.e.d. D1 is extinguished and now a current flows through D2, the yellow l.e.d. and through the buzzer.

HOW IT WORKS

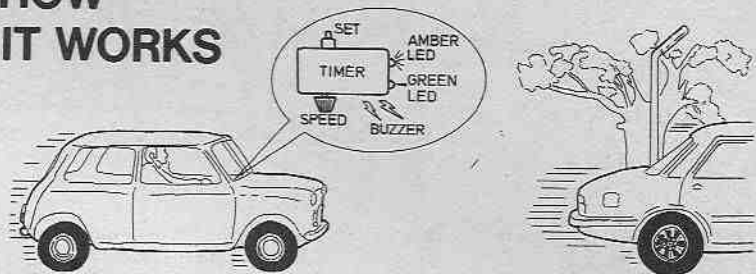

A simple timer i.c. forms the basis of this unit. An external variable resistor controls the timing period and the circuit is used to drive a buzzer and l.e.d.

To gauge the following distance the unit is set for a two second timing period and a roadside object, such as a lamppost, is used for reference.

To gauge the correct speed in poor conditions, such as fog, the unit is set to a time period corresponding to the speed of the vehicle. If the alarm remains on after a reference point is passed then the vehicle is travelling too fast and should slow down.

When the capacitor is charged to two-thirds of the supply voltage, which in this case would be six volts, the i.c. rapidly grounds pin 7, discharging the capacitor. The l.e.d. D1 comes on once again and D2 is extinguished, turning off the buzzer.

The recommended buzzer is a solid state device so the leads must be connected up the right way round, the red wire being the positive connection.

When the circuit board is finished, the off-board components can be mounted in the case and interwiring completed.

CONSTRUCTION
starts here

TESTING

When VR1 is at or near its minimum setting, the yellow l.e.d. D2 should be on for about two seconds. With VR1 at its maximum setting, D2 should be on for seven seconds. The buzzer may be disconnected while performing these tests and whilst calibration is being carried out. The range of two to seven seconds should preferably take the whole sweep of VR1.

Since the capacitance of C2 may differ by as much as 20 per cent from its nominal value you may not be able to get a time as short as two

STRIPBOARD

The circuit may be accommodated on a small piece of 0.1 inch matrix stripboard, 29 holes by 8 strips, with the exception of the push buttons, battery buzzer and variable resistor. This is shown in Fig. 2.

First cut the stripboard and check that it fits into the chosen case. In the prototype a Verobox, type 202-21028-A, was used although any small enclosure will be just as good. Make the breaks in the copper strips and then solder the components in place, leaving the i.c. until last. The two l.e.d.s should be left with long leads so that they stand off the board.

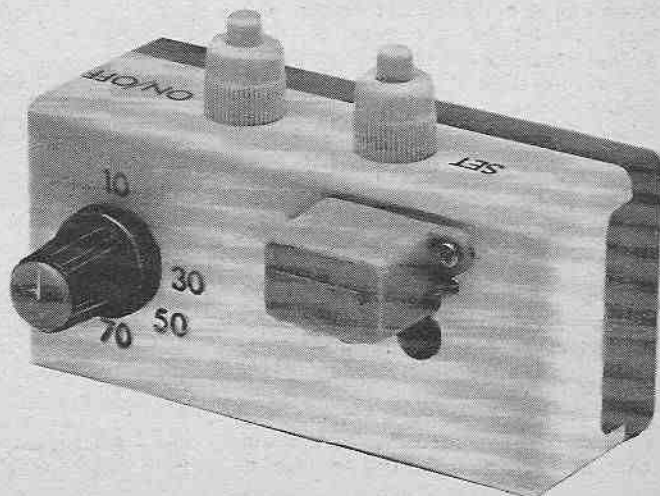

BRAKESAFE MONITOR

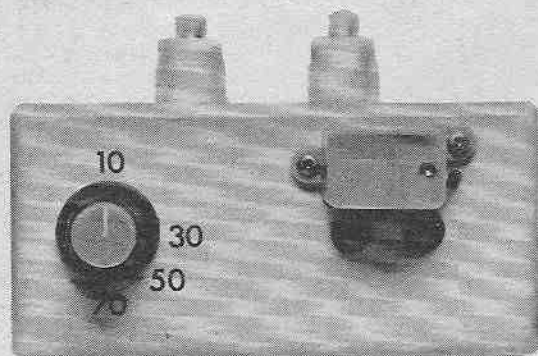

Outside view of the finished unit. Note position of I.e.d.s and calibration of speed control

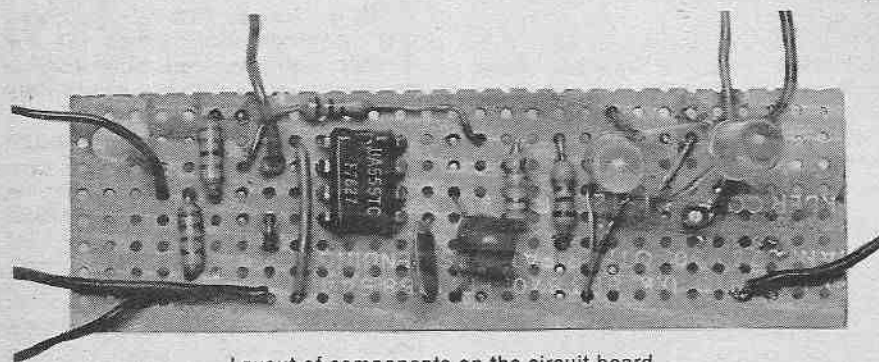

Layout of components on the circuit board

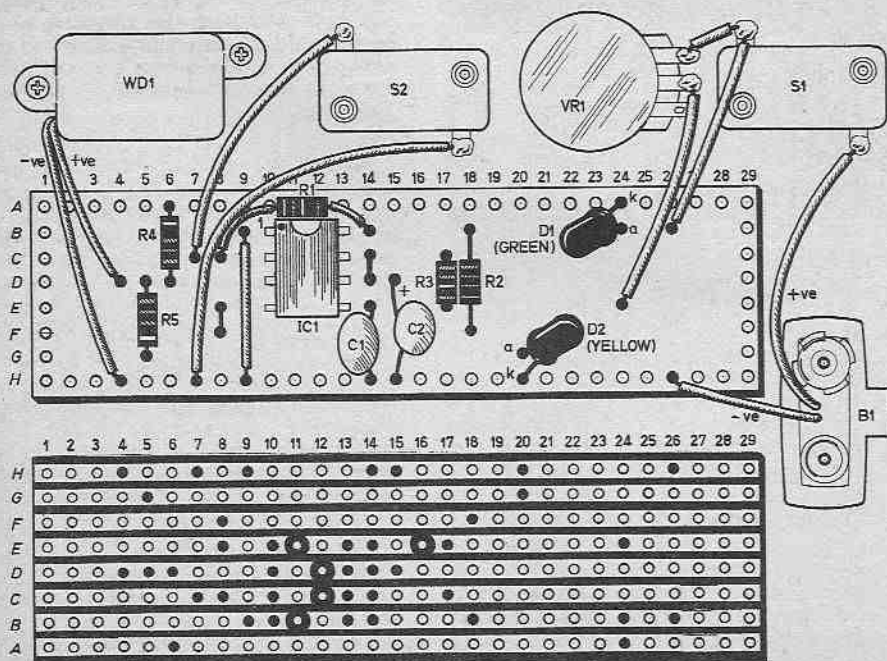

Fig. 2 (left). The completed circuit board. Note that the off-board components are not in their final mounting positions and that the I.e.d.'s D1 and D2 stand up off the board.

COMPONENTS

Resistors

- R1 10k Ω
- R2 10k Ω
- R3 33k Ω
- R4 270 Ω
- R5 270 Ω

All $\frac{1}{4}$ W carbon \pm 5% page 481

See
**Shop
Talk**

Capacitors

- C1 0.01 μ F ceramic disc
- C2 47 μ F 16V tantalum bead

Semiconductors

- IC1 NE555 timer i.c.
- D1 TIL211 green I.e.d.
- D2 TIL212 yellow I.e.d.

Miscellaneous

- VR1 100k Ω miniature linear potentiometer
- S1 push-on/push-off switch (Castelco type 2634)
- S2 push-to-make release-to-break switch (Castelco type 2644)
- B1 9V PP3 type
- WD1 solid state buzzer, 6V or 12V type

Stripboard: 0.1inch matrix, 29 holes \times 8 strips; case, 100 \times 50 \times 40mm (Vero-box type 202-21028A or similar); control knob; battery connector; mounting bushes for I.e.d.s; connecting wire; foam packing.

COMPONENTS
Approximate
cost **£6.00**

seconds or as long as seven seconds. If this occurs, try using another capacitor of the same nominal value.

Alternatively try changing R3. Using a higher value will increase the time, and vice versa.

As can be seen from the accompanying photographs, the l.e.d.s are mounted directly onto the circuit board. These protrude through holes in the front of the case with the circuit board just resting inside the case and held in position with foam packing.

Before joining the two halves of the case together, check the alignment of the l.e.d.s so that they slide smoothly into the holes provided for them. The leads may be bent as required to align them correctly but beware that they do not touch or short circuit against any metal parts.

CALIBRATION

This is simply a matter of marking a scale on the front panel to show the correct settings of VR1 for the various times listed in Table 1. Working out the precise location of each calibration mark is largely a matter of trial and error and precise times are not essential. If in doubt, err on the side of a slightly longer time rather than a slightly shorter one. In the prototype only settings for 10, 30,

50 and 70 m.p.h. were marked. Intermediate speeds can be set by estimation.

USING THE DEVICE

The Monitor has two push buttons, one for on/off and the other for starting the timing sequence. The unit is first switched on by pressing S1. The green l.e.d. D1 lights up.

Suppose you wish to check whether you are too close to the car in front. The speed control, VR1, is set to minimum and the operator watches the car in front. At the exact instant that it passes some clearly defined object on the road side ahead, like a tree for example, the SET button is pressed and released.

This extinguishes D1 and lights up D2. At the same time the buzzer emits a loud tone. If your car passes the same point on the road while the l.e.d. is on and the buzzer is still sounding, then you are too close to the car in front and should drop back at once.

Your time difference is less than two seconds and if the car ahead were to break sharply you would need to swerve in order to avoid hitting it.

If the yellow l.e.d. goes out and the buzzer stops sounding before you get to that point on the road all is well.

If conditions are bad (for example heavy rain or snow), the reaction time

needs to be rather longer—about five seconds. This can be achieved by turning VR1 to the 50 m.p.h. mark.

DRIVING IN FOG

When checking your stopping distance in fog you should proceed as follows.

The operator first sets the knob to the speed of the car. When some object close beside the road ahead just appears out of the fog, the operator presses the SET button. If the car passes the object while the buzzer is still sounding and D2 lit up, then the car is going too fast for the existing conditions.

If that object had been a fallen tree across the road, it would have been impossible to stop the car before hitting it.

Remember that fog near the ground is often more dense than that at tree top level. It is best to use sightings of objects close to ground level.

Also remember that the fog ahead may be much denser than the fog through which you are travelling so give yourself a little extra safety margin.

It is not suggested that you should use the Monitor every time you take the car out. Use it once or twice every month or so for an occasional check on your driving habits. ☐



Innovators

I am certain that among our readers, there are plenty of potential inventors. This is a welcome sign, because if there is one thing that the British are really good at, it is innovation.

However, when you have invented something, you are then faced with the agonising dilemma as to whether you should patent it or not. If you want my personal opinion, for what it is worth, I would give you the advice that Mr. Punch gave to those about to get married. "Don't"!!

Let me give you my reasons. The cost of taking out a provisional Patent, followed by a full Patent would be astronomical today. When you have done it, you cannot be sure it will sell in sufficient quantities, and even if it is a winner, some bright but unscrupulous firm will usually find a way round the Patent.

I have some personal experience of taking out Patents. Several years ago, I

designed and patented a small pocket sized Course and Ground Speed Calculator for light aircraft. It was quite unique at the time, due to its size. Did the World beat a path to my door? It did not, and I still have several boxes full of them in my attic.

I think today, I would just register the design and hope for the best. You have been warned!

Old and New

Fashions, especially ladies fashions, are simply a rotation of styles, skirts go up and come down, trousers go from wide to narrow and back again. This is a splendid argument for telling your wife to hang on to what she already has and not waste your money, but I am glad to say that to a lesser degree it also happens in electronics. For example, the chaps who

stuck with their valve amplifiers are now having the last laugh.

If like me, you find the rate of progress too fast, the best thing to do occasionally, is to say, "I will sit this one out". What you do then, is to scan the electronic journals, particularly the American ones, for the next new development. When you spot a likely one, you mug it up and bring it out at the right moment to astonish your friends.

I am in the process of doing this now, and am only waiting for a friend I dislike sufficiently, to say to me, "I say old boy, this new silicon chip XYZ is simply the last word, it can——". At this juncture I shall break into his conversation, giving him a pitying smile, and say, "Really old man, silicon chips! You are way behind the times, they are far too slow, gallium arsenide is the thing now, it's twice as fast as silicon." "Really old man you must get with it." Collapse of old man, or it should be.

It is interesting to see how things change even with well established items such as transistors. Several years ago the Ladybird book publishers brought out an excellent little book on constructing transistor receivers. It is still on sale today, but unfortunately it was designed around the OC71 and OC45 and everything has now swung from germanium to silicon. OC71s and OC45s are fast becoming obsolete.

I wrote to the publishers and suggested they redesign it around BC108s or similar. In view of what I said previously, perhaps I should have just told them to shelve it for a few years and then bring it out again.

Part 10
By S. R. Lewis,
B.Sc.

ENTER THE EXCITING
WORLD OF ELECTRONICS

TEACH-IN 80

ONE of the key concepts in modern electronics is that of **feedback**. An understanding of the basic principles of feedback enable a circuit designer to apply it to enhance the performance of a circuit or to avoid it where it could cause problems. In this part of the series we will look at the controlled use of feedback to give us amplifiers with stable and predictable gain.

THE BASIC CONCEPT

Feedback in its most general form can be defined quite simply: it occurs when part of the *effect* is used to modify the *cause*.

Feedback takes place in all sorts of systems; mechanical, chemical, biological, social, and of course electrical. It can be a force for both good and evil. One of the "evil" aspects that occurs in public

address systems is when part of the output of the loudspeakers reaches the microphone causing the characteristic wail to be produced.

There are two types of feedback which are given the names positive and negative feedback. **Negative feedback** occurs when the part of the output which is fed back causes the input to be *reduced*. **Positive feedback** is when the part of the output which is fed back causes the input to be *increased*.

Except in oscillators, positive feedback is seldom used so let us begin by looking at negative feedback, what it is and why it is so important.

NEGATIVE FEEDBACK

Consider the following problem: You are given a box which you are told contains a circuit which will

amplify an input signal without distortion by a factor of 10,000 (Fig. 10.1). An amplifier with a gain of only 10 is required so what components must be added to the amplifier to do this?

A simple solution is to precede the amplifying block by a potential divider which divides the input signal by 1000 to give an overall gain of 10 (Fig. 10.2). This seems to fulfil the requirements with only two components and there are no obvious drawbacks.

The circuit of Fig. 10.3 shows a radically different approach to the problem. Again a potential divider has been used but this time it is put at the output and only divides by 10. The voltage which appears at the output of the potential divider has been fed back to a block which subtracts this voltage from the original input voltage.

The input voltage to the amplifying block is thus $V_{in} - (V_{out}/10)$ and this is amplified by 10,000 to produce the output voltage V_{out} . Equating the two voltages gives

$$V_{out} = 10,000 \times (V_{in} - (V_{out}/10))$$

$$= (10,000 \times V_{in}) - (1000 \times V_{out})$$

thus $V_{out} = \frac{10,000}{1,001} \times V_{in}$

Thus V_{out} is very nearly $10 \times V_{in}$ (within one part in 10,000).

The two circuits produce virtually the same output for a given input so what is all the fuss about negative feedback?

Suppose I now come along and tell you that instead of a gain of 10,000, the amplifying box only produces a gain of 9,000. How do the two circuits now compare?

The first circuit will simply divide the input signal by 1,000 and then amplify it by 9,000 giving an overall gain of 9, thus the drop in overall gain is equal to the drop in the gain of the amplifying block.

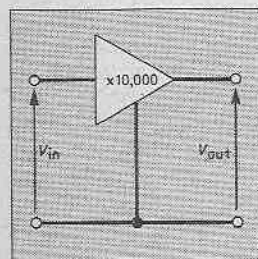

Fig. 10.1. A simple amplifier which takes a voltage and multiplies it by 10,000.

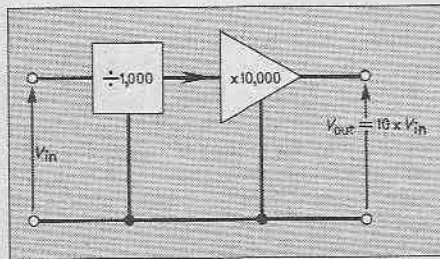

Fig. 10.2. To produce an overall gain of 10, the simple amplifier could be preceded by a potential divider to divide by 1,000.

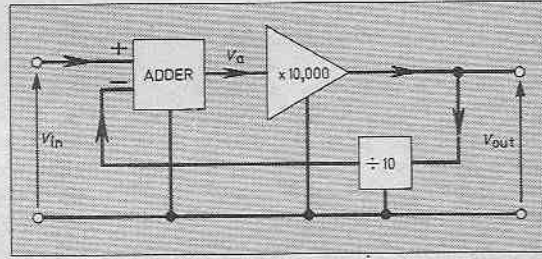

Fig. 10.3. A more complex solution is to use feedback as shown here though its implementation does not necessarily mean more components.

The other circuit however still feeds back one-tenth of the output voltage to be subtracted from the input voltage. Evaluating V_{out} as before:

$$V_{out} = 9,000 \times (V_{in} - V_{out}/10)$$

$$= (9,000 \times V_{in}) - (900 \times V_{out})$$

thus $V_{in} = \frac{9,000}{901} \times V_{out}$

The output voltage is still virtually ten times the input voltage, the error now being one part in 9,000. A really dramatic improvement on the first circuit!

The circuit of Fig. 10.3 is the basic negative feedback circuit and what we have been investigating in the previous exercise was the way in which negative feedback improves gain stability of a circuit.

We could have carried out a similar exercise to investigate how the two circuits compare when the amplifying block adds a distortion voltage to the amplified input voltage. Here again we would discover that the feedback circuit performs outstandingly better, the distortion voltage at the output being about a thousand times less than that with the simple circuit.

Real amplifiers inevitably vary in their gains since transistors cannot be made to all have the same gain. They also produce distortion so the use of negative feedback is really advantageous for producing amplifiers with predictable gain and low distortion.

FACTOR OF IMPROVEMENT

The factor of improvement can be calculated to be one plus the gain of the amplifying block divided by the overall gain of the circuit. The gain of the amplifying block is referred to as the **open loop gain** of the circuit and the overall gain is called the **closed loop gain**. It can be seen therefore that the amplifying block should be designed with as high a gain as possible so that the closed loop gain can take useful values.

The disadvantage of negative feedback when comparing the circuits of Figs. 10.2 and 10.3 seems to be that it requires an extra bit of circuitry: the subtractor. However, in many circuits the potential divider can be connected in such a way as to automatically subtract the portion of the output voltage from the input.

CIRCUITS WITH FEEDBACK

A very simple circuit which we have already looked at is in fact a negative feedback circuit. It is the simple emitter follower (Fig. 10.4).

In the emitter follower negative feedback is applied since the output voltage (that developed across the emitter resistor) is effectively in series with the input voltage so that any increase in the output voltage is subtracted from the input. In fact the feedback voltage is virtually all the output voltage so the closed loop gain of the circuit is virtually unity.

Another circuit which we have already looked at and which makes use of the negative feedback is the bias stabilisation circuit where the bias resistor is connected from the collector back to base (Fig. 10.5).

Here the situation is slightly more complex since one needs to use both voltages and currents to describe the feedback action. However on a qualitative basis one can see that the circuit uses negative feedback since an increase in base current from an external source produces a drop in collector voltage which, in turn, produces a drop in the current fed back to the base, thus reducing the original base current.

These two circuits in fact illustrate two ways in which negative feedback can be applied without using a specific subtractor. The emitter follower places the output in series with the input so that it opposes the input. The bias circuit makes use of the fact that the common emitter circuit is an inverting amplifier so that an increase at the input produces a decrease in the output.

OPERATIONAL AMPLIFIERS

At the end of the article last month the idea of operational amplifiers was introduced. We will now look in more detail at how they can be used with feedback components.

The operational amplifier itself is equivalent to the imaginary amplifying block which was discussed earlier. Its gain is extremely high so that closed loop gains of say 1,000 can be used whilst still getting the benefits of negative feedback.

The operational amplifier has two inputs which can either be

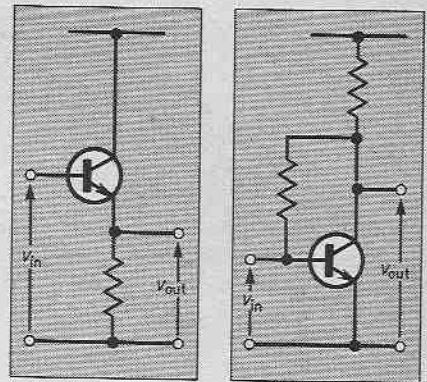

Fig. 10.4. An emitter follower can be thought of as an amplifier with heavy negative feedback.

Fig. 10.5. (right) The feedback resistor is used to stabilise the operating point of this simple amplifier.

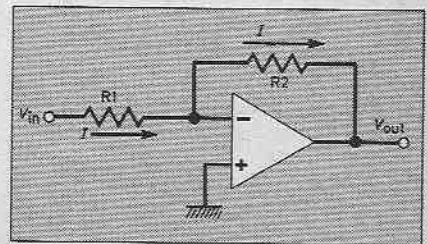

Fig. 10.6. An op-amp connected as an inverting amplifier. The same current flows through both the resistors.

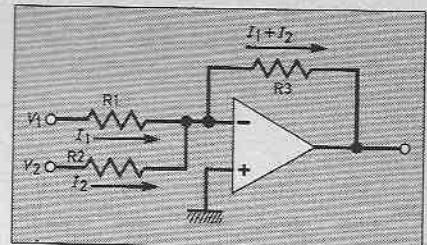

Fig. 10.7. Adding another input resistor converts the inverting amplifier into a summing amplifier.

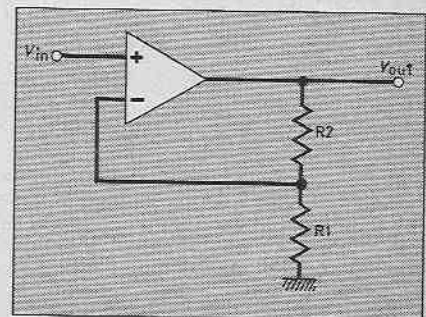

Fig. 10.8. Using the non-inverting input and connecting the feedback to the inverting input produces the non-inverting amplifier.

used individually by grounding the input which is not used, or together in which case the output voltage is the difference in the two input voltages multiplied by the gain of the amplifier.

INVERTING AMPLIFIER

Fig. 10.6 shows an operational amplifier with its non-inverting input grounded and two resistors added.

A perfect operational amplifier has an infinite input impedance so it would take no current at its input. Modern "op-amps" take so little current that we can ignore it.

The gain we take to be very high so for a voltage up to the maximum capability of the op-amp to exist at the output, the voltage at the input will be so small as to be negligible. For instance even with 15V at the output of a CA3140 op-amp the input is only 15/300,000V (about 50μV).

Since the op-amp input does not take any current, all the current flowing through R1 must flow through R2. The current in R1 is simply $V_{in}/R1$ since the voltage at the input to the op-amp we said was as good as zero.

This same current flowing in R2 produces a voltage across R2 of $R2 \times V_{in}/R1$ and the voltage at the output must be negative since the direction of the current is from input to output. Thus for Fig. 10-6 the output voltage is given by

$$V_{out} = - \frac{R2}{R1} \times V_{in}$$

This circuit is the classic inverting op-amp circuit with gain simply the ratio of the two resistors.

SUMMING AMPLIFIER

Fig. 10.7 shows the same circuit but now with two input voltages and two input resistors. The voltage at the op-amp input will still be virtually zero but now the current flowing through the feedback resistor R3 will be the sum of the currents in the two input resistors, that is $V_1/R1 + V_2/R2$.

The output voltage is now

$$V_{out} = - \left(V_1 \frac{R3}{R1} + V_2 \frac{R3}{R2} \right)$$

If all resistors are the same value then this equation reduces to

$$V_{out} = - (V_1 + V_2)$$

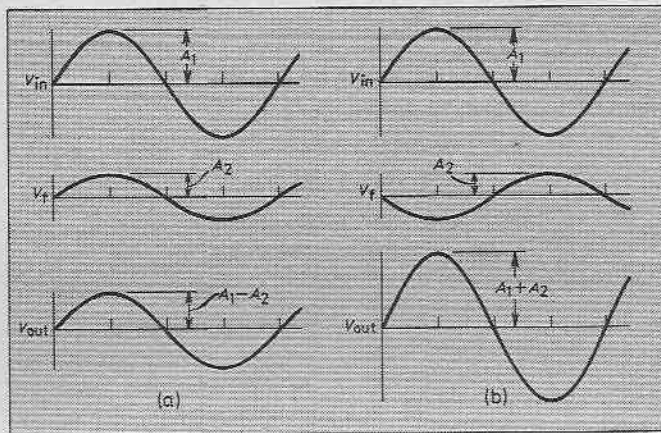

Fig. 10.9. Applying a.c. feedback in the wrong phase can produce the opposite effect to that desired. (a) shows the effect when the feedback voltage is in phase with the input and (b) when it is 180 degrees out of phase.

The circuit is known as the op-amp **summing** circuit since it produces an output voltage which is the sum of the two input voltages, though inverted. More input voltages and input resistors can be added so that the circuit can be used to add any number of voltages together.

NON-INVERTING AMPLIFIER

The circuit shown in Fig. 10.8 uses both inputs of the op-amp. A potential divider is placed at the output of the op-amp and the junction of the divider is taken to the inverting (-) input of the op-amp. Input voltage is applied directly to the non-inverting input (+).

To produce any reasonable voltage at the output, the difference between the two inputs (+ and -) is virtually zero so we can say the voltage at the junction of the potential divider is equal to the input voltage. This gives:

$$V_{out} \times \frac{R1}{R1 + R2} = V_{in}$$

$$\begin{aligned} \text{So, } V_{out} &= \frac{R1 + R2}{R1} \times V_{in} \\ &= \left(1 + \frac{R2}{R1} \right) \times V_{in} \end{aligned}$$

What we have is a circuit which is virtually the implementation in real components of the circuit of Fig. 10.3. It is a non-inverting op-amp circuit with the gain given by one plus R2 divided by R1.

These few circuits illustrate how easy it is to use op-amps to produce accurate and reliable circuits.

FREQUENCY SELECTIVE FEEDBACK

So far all the circuits that we have looked at have used **d.c. feedback** but other types of feedback can be used. However when we come to look at **a.c. feedback** we have to be much more careful as it is not only the amplitude of the voltage or current that is fed back that is important, its phase relationship with the input must also be considered.

To understand why phase is important let us look at two feedback circuits which both generate exactly the same feedback voltage, the only difference being the phase relationship with the input (see Fig. 10.9).

In case (a) the feedback voltage is exactly the same phase as the input. When the feedback voltage is subtracted from the input voltage one will have a reduced input thus *negative* feedback takes place.

In case (b) the feedback voltage is 180 degrees out of phase with the input. When this is subtracted from the input the resultant voltage is bigger than the input so where we thought we had negative feedback we have in fact positive feedback!

One of the most useful forms of a.c. feedback circuit is the set of circuits known as **filters**. An electronic filter may be defined as a circuit which allows only a subset of a given set of input signals to pass through it. The most widely used filters discriminate between the frequencies of the input signals.

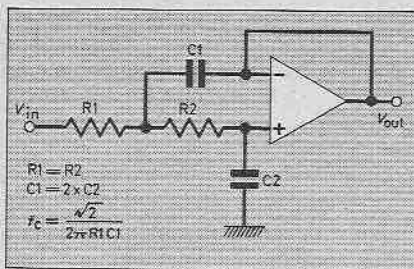

Fig. 10.10. A low pass active filter using an op-amp. This has unity gain until the cut-off frequency f_c is approached.

Low pass filters allow only frequencies below a pre-set value to pass through whilst high pass allow only those above a given frequency to pass. Band pass filters allow only frequencies between two values to pass through.

Inductors or capacitors are used to form the frequency discriminating circuits though the trend today is away from inductors (which tend to be bulky at audio frequencies) and towards capacitors which, with clever circuit design can be made to do any job that an inductor can.

Figs. 10.10 and 10.11 show op-amp circuits for low pass and high pass filters respectively with the equations for the cut-off frequency, this being the frequency at which the output amplitude is half the input amplitude.

Connecting these two circuits so that the output of the low pass becomes the input of the high pass produces a band pass filter providing the cut-off frequency of the high pass section is greater than the cut-off frequency of the low-pass section.

The operation of these two circuits has not been described in detail since this would involve some complicated mathematics.

POSITIVE FEEDBACK CIRCUITS

It was stated earlier that positive feedback is seldom used but one area where it does find a use is in switching circuits where it can be put to use in speeding the switching action, that is making the transition from one state to the other as quick as possible.

A circuit which is very useful in taking slowly rising voltages and converting them into rapid changes at the output is known as the Schmitt trigger.

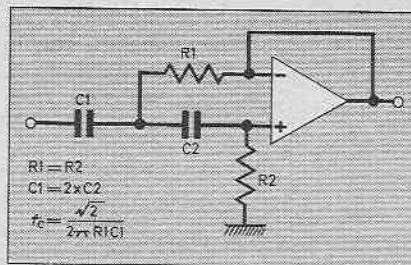

Fig. 10.11. A high pass active filter again with unity gain until the cut-off is approached.

The op-amp version of the Schmitt trigger will be described since the feedback paths are more obvious than in the transistor version (Fig. 10.12).

First note that two Zener diodes are connected back-to-back at the output. This is so that a fixed voltage which cannot be exceeded will be produced at the output.

One resistor (R_2) is connected from the "new" output back to the non-inverting input and another (R_1) is connected to an imaginary voltage reference V_i .

Imagine first of all that the output of the op-amp is at its maximum positive value (this will be governed by the power supplies). The voltage on the Zeners will therefore be V_z . The voltage at the non-inverting input will be

$$\frac{R_2 V_i + R_1 V_z}{R_1 + R_2}$$

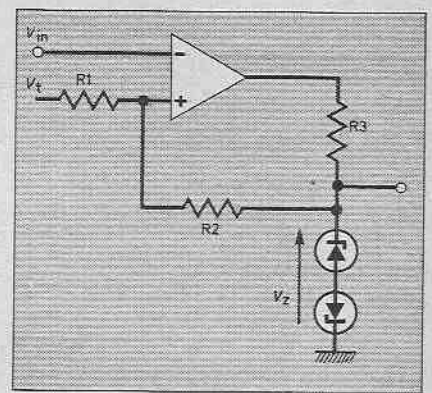

Fig. 10.12. Applying positive feedback around the op-amp causes a rapid transition from one state to the other. The Zener diodes are used to "clamp" the output at a known voltage.

In order for the output of the op-amp to indeed be positive then V_{in} must be less than this voltage, which we will call V_a . What happens as V_{in} is increased?

As soon as V_{in} becomes slightly higher than V_a the voltage at the output of the op-amp will switch very rapidly to its maximum negative value causing the voltage at the top of the two Zeners to go to $-V_z$. As the voltage V_a begins to fall the difference between V_{in} and V_a will increase causing V_a to fall even more quickly. Positive feedback is causing a rapid change at the output with a slow change at the input.

PART 10 QUESTIONS

10.1. In Fig. 10.6 R_1 is set to $10k\Omega$ and R_2 to $100k\Omega$. What is the gain of the circuit:

- 1
- 10
- 100
- 1,000

10.2. In Fig. 10.8 R_1 is $10k\Omega$. What value must R_2 be in order to give a gain of 5:

- $50k\Omega$
- $40k\Omega$
- $30k\Omega$
- $5k\Omega$

10.3. What is the cut-off frequency of Fig. 10.11 if C_1 is $0.02\mu F$, C_2 $0.01\mu F$ and $R_1 = R_2 = 110k\Omega$:

- 100Hz
- 150Hz
- 10Hz
- 15Hz

10.4. What is the cut-off frequency of Fig. 10.10 when $C_1 = 940pF$, $C_2 = 470pF$, $R_1 = R_2 = 24k\Omega$:

- 1,000Hz
- 10kHz
- 20kHz
- 25kHz

10.5. In Fig. 10.7 $R_1 = R_2 = 10k\Omega$ and $R_3 = 50k\Omega$. What will the output voltage be when $V_1 = 2V$ and $V_2 = 1V$:

- 15V
- 1.5V
- 3V
- 30V

PART 9 ANSWERS

9.1 a). 9.2 b). 9.3 c). 9.4 b). 9.5 a).

NOTE: Question 9.4b) should read "2,500"

EXPERIMENT 10.1:

OP AMP ADDER

Components needed: $33k\Omega$ $\frac{1}{4}W$ resistors (2 off), $10k\Omega$ $\frac{1}{4}W$ resistor, CA3140 operational amplifier.

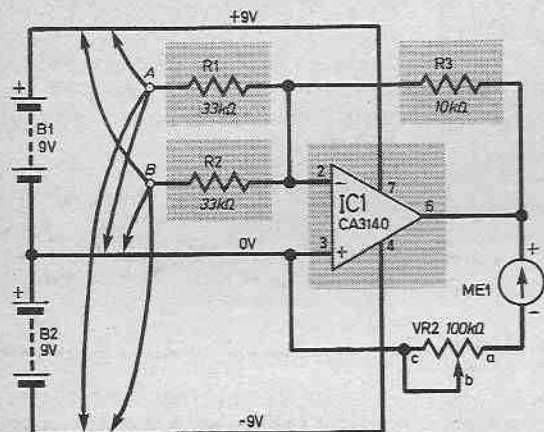

Fig. 10.14a. The circuit of Experiment 10.1.

A simple adder circuit illustrating feedback around an operational amplifier is shown in Fig. 10.14a with the Tutor Deck layout in Fig. 10.14b.

First connect wires from inputs A and B to the $-9V$ line (X2). Now adjust the

$100k\Omega$ potentiometer until the meter just reads full scale. Move the wires from A and B to different power rails in all different combinations noting the meter reading for each case.

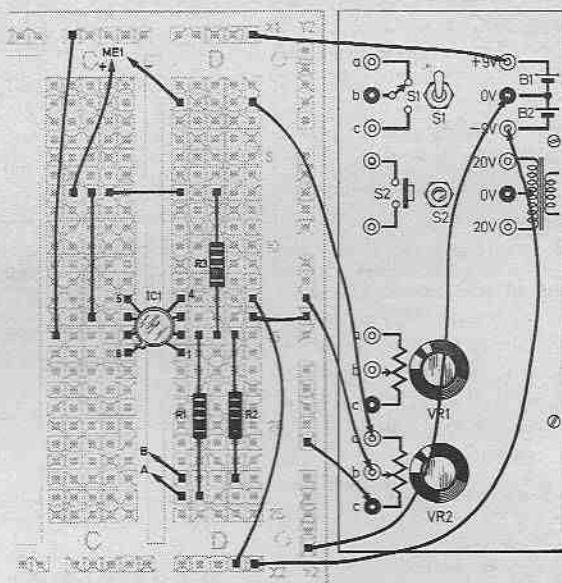

Fig. 10.14b. Layout of Experimental 10.1 on the Tutor Deck.

Connecting an input to the 0V rail will be found equivalent to leaving it open circuit since both conditions cause no current to flow in the respective resistor.

It should be found that one input the $+9V$ gives half full scale meter reading.

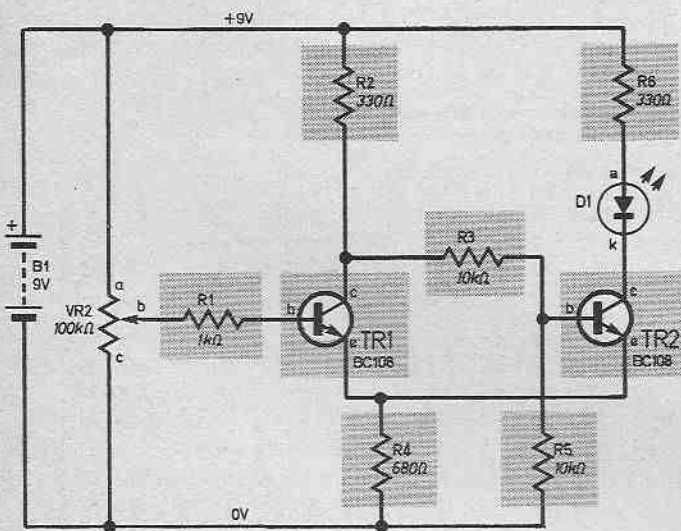

Fig. 10.15a. The circuit of Experiment 10.2.

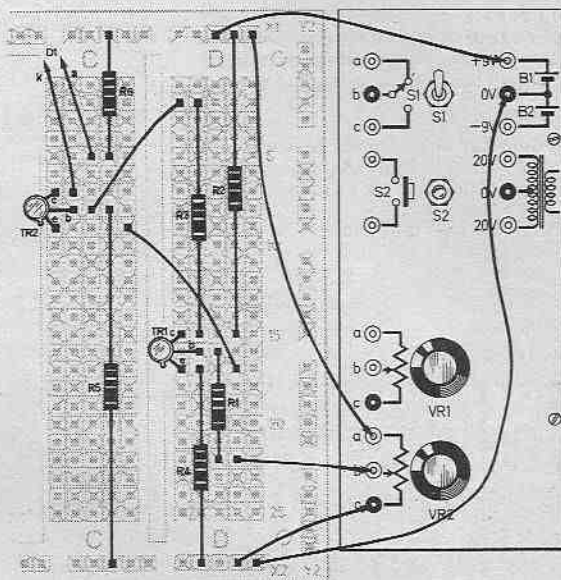

Fig. 10.15b. The layout of Experiment 10.2 on the Tutor Deck.

EXPERIMENT 10.2:

SCHMITT TRIGGER

Components needed: $1k\Omega$ $\frac{1}{4}W$ resistor, 330Ω $\frac{1}{4}W$ resistor (2 off), 680Ω $\frac{1}{4}W$ resistor, $10k\Omega$ $\frac{1}{4}W$ resistor (2 off), BC108 transistor (2 off).

A Schmitt trigger circuit which is used to drive a light-emitting diode is shown in Fig. 10.15a and the layout on the Tutor Deck in Fig. 10.15b.

The threshold point of the circuit can be found by first setting the potentiometer fully clockwise. TR1 will be cut off and

TR2 conducting so the l.e.d. will be on. Slowly turn down the potentiometer and note how the l.e.d. suddenly goes off. The potentiometer has to be turned back a little to make the l.e.d. come on again illustrating the circuit's hysteresis.

To make the output switch back to its positive condition the input has to fall to a new value before the switching action occurs in the opposite way. Thus there is a difference between the voltages at which the output changes from high to low to that at which it changes from low to high.

HYSTERESIS

The difference between these two voltages is known as the **hysteresis** of the circuit. Hysteresis is a very useful property since it means that tiny changes in the input voltage will not produce wild fluctuations at the output.

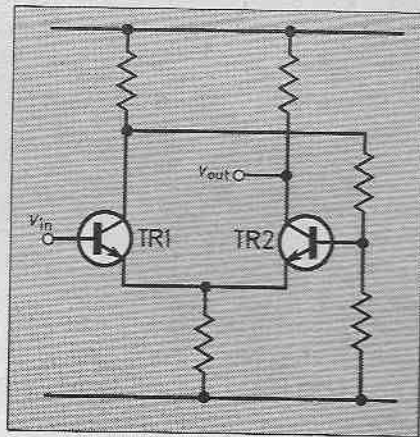

Fig. 10.13. A transistor Schmitt trigger based on the long-tailed pair

A transistor version of the Schmitt trigger is shown in Fig. 10.13. Note that it is basically the "long-tailed pair" circuit with feedback added from one of the outputs to one of the inputs. It has two states: one with TR1 conducting and TR2 cut-off, and the other with TR2 conducting and TR1 cut-off.

Again this circuit switches rapidly from one state to the other and also it can be designed with hysteresis.

Other important types of circuit where positive feedback is used are sinusoidal oscillators. These, together with other types of oscillator, will be described in Part II.

EXPERIMENT 10.3: OP AMP INTEGRATOR

Components needed: 1MΩ ½W resistor, 68kΩ ½W resistor, 1μF 25V capacitor (2 off), CA3140 operational amplifier.

The circuit of Fig. 10.16a shows what is known as an integrating circuit using an op-amp and the layout on the Tutor Deck is shown in Fig. 10.16b.

Two capacitors have been used "back-to-back" so that the voltage at the output of the op-amp can go either negative or positive without harming the dielectric of the capacitors. Pressing the pushbutton switch S2 momentarily will cause the meter reading to go to zero. When S2 is released the voltage at the output of the op-amp will be seen to either rise or fall steadily depending on the position of S1. A point will be reached where the

voltage does not change any more since the output of the op-amp is virtually at the power supply voltage.

This circuit works by using the current through R1 to charge the capacitor C1

(or C2). Note that unlike the normal resistor-capacitor charging, the voltage on the capacitor rises linearly since the current is always the same and does not decrease as it does in the R-C circuit.

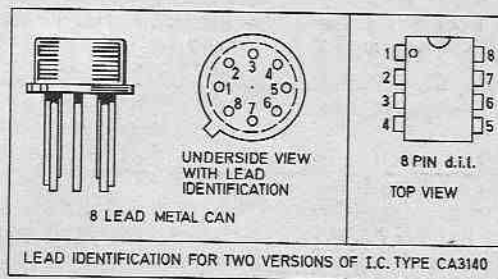

LEAD IDENTIFICATION FOR TWO VERSIONS OF I.C. TYPE CA3140

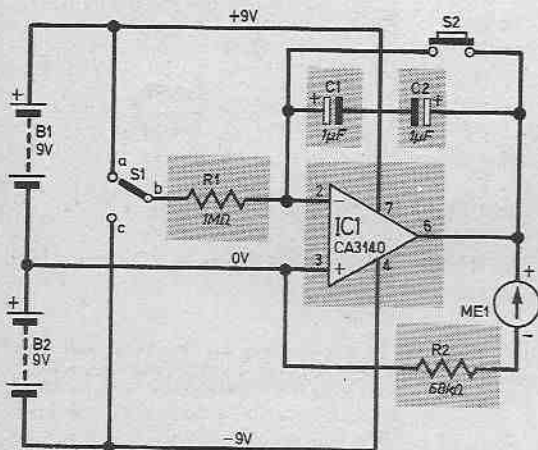

Fig. 10.16a. The circuit of Experiment 10.3.

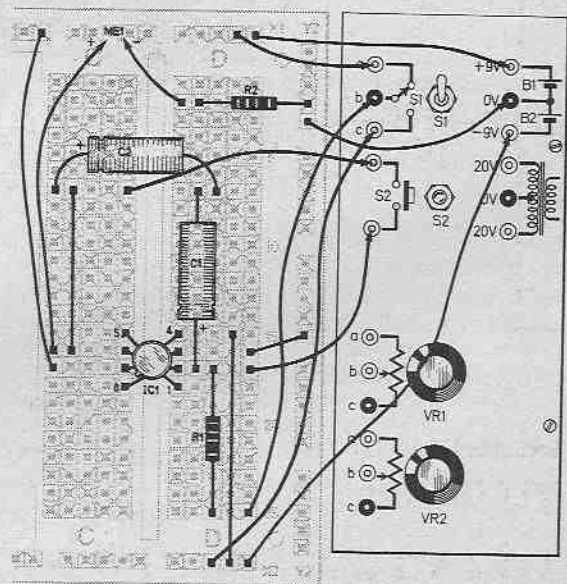

Fig. 10.16b. The layout of Experiment 10.3 on the Tutor Deck.



Part 11

By S. R. Lewis,
B.Sc.

ENTER THE EXCITING
WORLD OF ELECTRONICS

TEACH~IN 80

OSCILLATORS ARE circuits which continually alternate between two states. Many types of oscillator exist, but they may roughly be divided into two main groups: **sinusoidal** and **switching** (or non-sinusoidal).

Oscillations can occur in circuits which were designed as amplifiers if the designer is not aware of how oscillations can be produced. An example of this is the microphone - amplifier - loudspeaker arrangement where part of the output of the speaker gets back to the microphone causing a horrible wail to be produced. In this case the result of the unwanted oscillations is mainly annoyance but in certain circuits the unwanted oscillations can be disastrous.

OSCILLATOR WAVEFORMS

As an oscillator changes from one state to the other the voltages and currents go through changes. Oscillators can be designed so that the voltages are precisely defined functions and we will look at a few of the more common waveforms that are produced by different types of oscillator.

The most basic waveform is the **sinusoid** or **sine** wave as shown in Fig. 11.1(a). The changes are smooth and continuous and if converted into sound waves at an audible frequency the result is a very pure but uninteresting sound.

A waveform which sounds much more interesting at audible frequencies is the triangular shape illustrated in Fig. 11.1(b). The much "richer" sound is explained by the fact that the triangular waveform can be analysed into a whole series of sinewaves, each of which is a multiple of the basic frequency. We call these components of the waveform **harmonics**.

Another waveform rich in harmonics but slightly different ones is the **sawtooth** waveform of Fig. 11.1(c). At one point in the cycle there is a rapid transition from one voltage to another and this is always an indication that the waveform is rich in harmonics.

The **square** waveform of Fig. 11.1(d) simply consists of transitions from one voltage to another. This has a very interesting sound and can be filtered, as indeed can the triangular and sawtooth waveforms, to give a wide variety of pleasant sounds.

Other waveforms which may be encountered are shown in Fig. 11.1(e) and (f), these being the **pulse** waveform and the **trapezoidal** waveform.

SINUSOIDAL OSCILLATORS

It was mentioned how a microphone - amplifier - speaker system can sometimes give a horrible wail when the output is allowed to get back to the input.

What is happening in this situation is that positive feedback is occurring but because of the resonances of the hall and the amplifying system, a certain frequency tends to dominate, thus converting what is supposed to be an amplifier into an oscillator.

By controlling the frequencies of the signals which are fed back in a positive feedback circuit such as has been described, and also by controlling the gain of the amplifier, sinusoidal oscillations can be sustained without either building up or decaying away.

The conditions for oscillation are that the signal which is fed back to the input should be exactly 360 degrees out of phase with the input which is producing it at only one frequency. The gain of the system must be exactly one to just maintain oscillation; if it is below one the oscillations will die away and if it is over one they will gradually build up in amplitude.

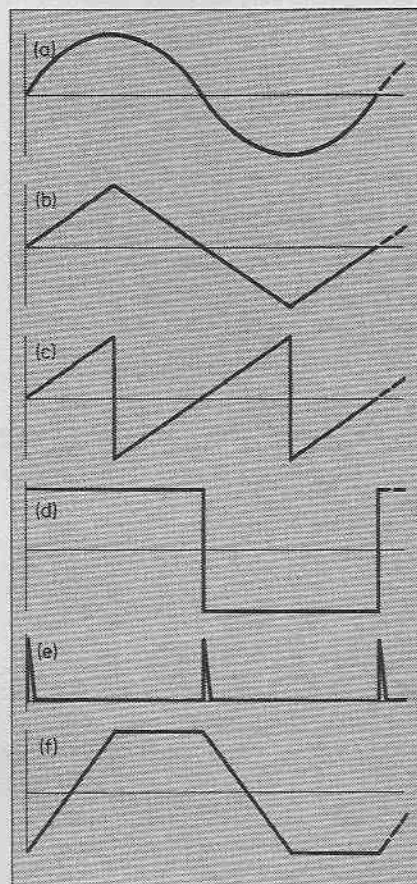
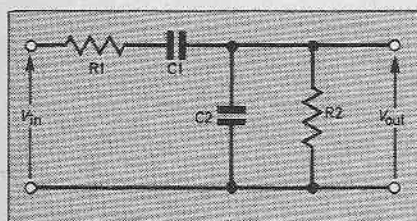

Fig. 11.1. Typical waveforms that are produced by oscillators. (a) shows a sine wave (b) a triangular wave (c) a sawtooth (d) a square wave (e) a pulse and (f) a trapezoidal waveform.

Fig. 11.2 shows a network which produces a 360 degree phase shift at the output at only one particular frequency. At this frequency the amplitude at the output will be one-third the input amplitude.

We can make use of this network in conjunction with an op-amp as shown in Fig. 11.3.

Here the network has been connected to the output of the op-amp and the output of the network has been connected to the non-inverting input of the op-amp. Because the network reduces the amplitude of the signal by one-third, the op-amp must be made to have a gain of three so that the closed loop gain is one.



In a real oscillator a voltage stabilisation circuit is sometimes included so that if the oscillations tend to build up or decay then the amplification factor is automatically changed to compensate.

Another sinusoidal oscillator circuit is shown in Fig. 11.4. In this, three R-C networks are cascaded so that the overall phase shift is 180 degrees. The transistor is connected as an inverter so it supplies the other 180 degrees shift to bring the output 360 degrees out of phase with the input.

The transistor is arranged to have sufficient gain to overcome the loss of amplitude through the R-C network.

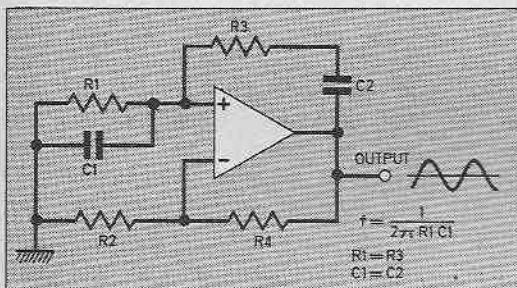

Fig. 11.3. The network of Fig. 11.2 has been connected around an op amp with the loss in amplitude compensated by the gain produced by R4 and R3 to form a Wien Bridge oscillator.

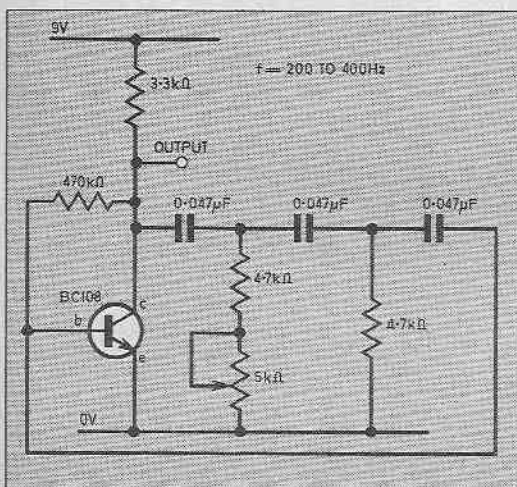

Fig. 11.4. This circuit is known as a phase shift oscillator. The capacitor-resistor network produces a phase shift of 180 degrees at a frequency in the range 200 to 400Hz, dependent on the setting of the 5 kilohm potentiometer. The attenuation is compensated by the gain of the transistor.

SWITCHING OSCILLATORS

The oscillators described in the preceding section used the linear amplifying properties of an op-amp or transistor, but oscillators can be produced which make use of the two-state capability of transistors (or indeed op-amps).

In Fig. 11.5(a) there is shown a switching circuit using two transistors in two identical stages which are connected to a switch. When the switch is moved from the 5V rail to the 0V rail the capacitor cannot change its state of charge instantaneously so the voltage at the base of TR1 drops by 5V to -4.3V thus switching it off and causing the collector voltage to rise to 5V.

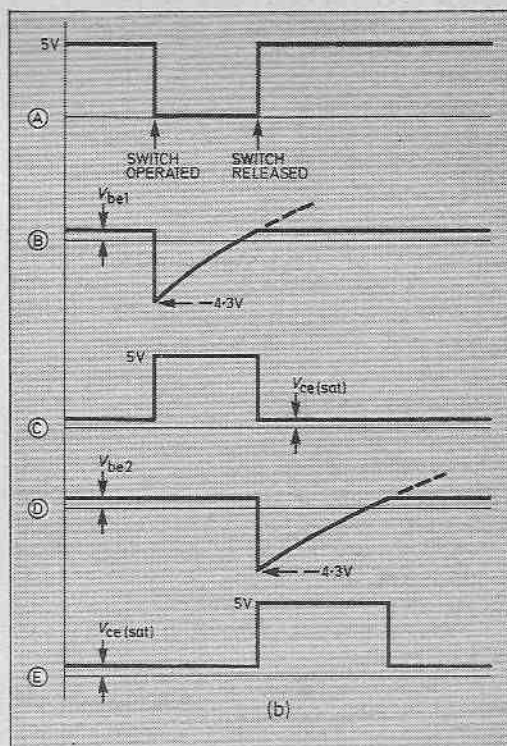
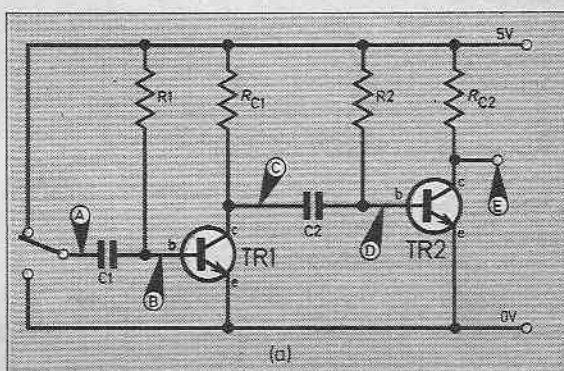

Fig. 11.5. This two-stage circuit with a switch shows how a delayed pulse can be produced at the collector of TR2. The waveforms at various points in the circuit are shown at (b).

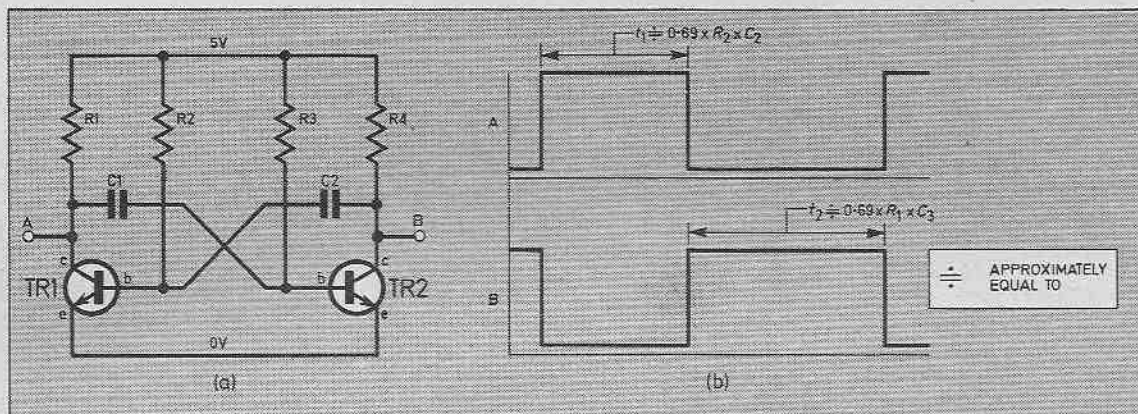

Fig. 11.6. The circuit of Fig. 11.5 without the switch has been redrawn in the conventional multivibrator configuration. The timing of the output waveforms is shown at (b). Note that the waveform at B is the inverse of that at A.

C1 begins to charge through R1, its voltage rising towards 5V but as soon as it reaches 0.7V TR1 is forward biased and switches on again making its collector voltage drop to about 0.2V.

Capacitor C2 will pull TR2 base to -4.3V when TR1 collector goes low, switching off TR2 until C2 has charged up via R2 to 0.7V at which point TR2 will switch on again. Fig. 11.5(b) shows the waveforms present at various points in the circuit.

If we now couple the transition at TR2 collector back to C1 then the circuit would continue oscillating between the two states indefinitely. Fig. 11.6(a) shows the same circuit redrawn in its more usual form.

The circuit that has been described is known as an **astable multivibrator** circuit and is so versatile and easy to use that it appears many times in designs.

RELAXATION OSCILLATORS

Another class of oscillators makes use of a special property of some devices or circuits known as **negative resistance**.

We are all familiar with **positive resistance** as it is the property possessed by the common or garden resistor: an increasing current through a positive resistance produces an increasing voltage. Some circuits or devices can be made to go into a state where an increasing current produces a falling voltage. Usually this state is reached at some threshold voltage.

The block diagram in Fig. 11.7(a) shows how such a component can be used to make an oscillator. Imagine that the device draws no current when the voltage at its input is below the threshold. On switching on, the capacitor begins to charge towards the power supply rail.

When the threshold is reached the device goes into a negative resistance region so that as current begins to increase through it the voltage at the input actually drops. This will go on until the capacitor has discharged all its voltage.

The device now has not enough voltage across it to maintain the negative resistance state and so switches back to its high impedance condition. The capacitor

begins to charge and the cycle starts again.

The circuit described is useful for producing sawtooth waveforms as shown in Fig. 11.7(b). This type of waveform is useful as it contains a large number of harmonics.

The two types of semiconductor component most often used in relaxation oscillator circuits are unijunction transistor, which is a cheap simple device most suitable for relatively low frequency work, and the **tunnel diode** useful at radio frequencies. These two devices will not be described in detail here but their circuit symbols are shown in Fig. 11.8.

MODULATION

Modulation is the process whereby the amplitude or frequency (or any other parameter) of an oscillation is varied under the influence of another signal.

Modulation is used extensively in radio circuits and in musical synthesizers. In radios use is made of the fact that high frequency electromagnetic waves can be propagated long distances and received with fairly simple equipment.

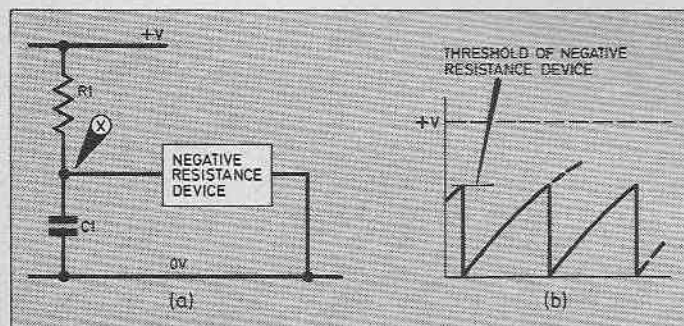

Fig. 11.7. This diagram (a) illustrates the use of a negative resistance device to form a relaxation oscillator. When the threshold voltage is reached the device goes into its negative resistance region and discharges the capacitor. This action is shown graphically at (b).

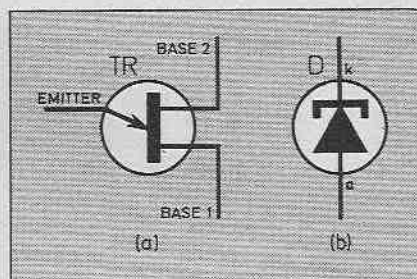

Fig. 11.8 (a) shows the symbol for a unijunction transistor and (b) the symbol for a tunnel diode. Both devices have negative resistance regions.

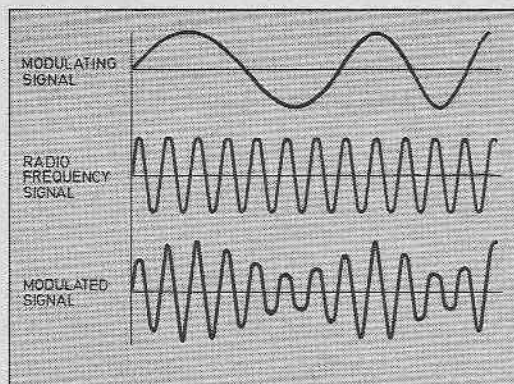

Fig. 11.9. A typical set of waveforms in an a.m. system.

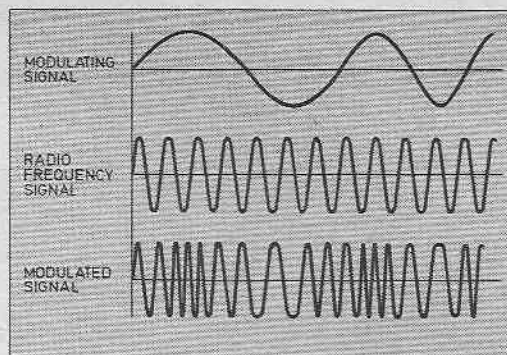

Fig. 11.10. A typical set of waveforms illustrating f.m. modulation.

There are two principal ways in which **audio frequencies**, which most often make up the information which we want to transmit, can be superimposed upon the **radio frequency waves**. The two methods are known as **amplitude modulation (a.m.)** and **frequency modulation (f.m.)**.

In amplitude modulation the instantaneous value of the amplitude of the audio signal is used to control the amplitude of the radio frequency oscillations whose frequency is kept constant. Fig. 11.9 shows a typical set of waveforms.

At the receiver a circuit is used which takes the amplitude of the radio frequency signals and uses it to recreate the audio signal for amplification.

Frequency modulation uses the instantaneous amplitude of the audio signal to control the frequency of the radio frequency signal. A typical set of waveforms is shown in Fig. 11.10. Note that the amplitude of the frequency modulated wave is constant.

Amplitude modulated radio signals are much more prone to interference than frequency modulated signals although the receiving equipment is less complicated and thus less expensive. The trend today is towards f.m. radio since more and more people are demanding the quality of reception that is only achievable with f.m.

Of course, a simple audio signal is not the only signal that can be used as the modulating signal. In television transmissions the modulating signal is a combination of the brightness of the particular portion of the scene which the camera is viewing together with information about the colour.

In stereo transmissions two separated microphones produce signals from different parts of the studio. Two signals are then produced from this information: a left-right signal and a left+right signal. Both of these are used to modulate the radio frequency signal. Normal mono receivers use only the left+right information whilst stereo receivers regenerate the left and right signals by adding and subtracting the left+right and left-right signals.

Normal telephone cables have a very small frequency range, sufficient to carry voice signals only, rather than the full audio spec-

trum. In these days of digital computers, the need arises to be able to pass digital signals along the telephone lines.

The method that is used is to use two frequencies, both within the bandwidth of the telephone lines, but well separated. One frequency is used to represent a logic 1 and the other to represent a logic 0. The digital signal therefore sounds like a warbling note as the signal is passed along the line. This is a form of frequency modulation since the amplitude of the signals does not vary but the frequency is modulated by the digital signal.

PART 11 QUESTIONS

11.1. Which of the following waveforms has no harmonics:

- a) square wave
- b) sine wave
- c) triangular wave
- d) sawtooth wave

11.2. What is the frequency of oscillation of a Wien Bridge oscillator with both resistors = 200k Ω and both capacitors 0.01 μ F:

- a) 800Hz
- b) 8kHz
- c) 80Hz
- d) 8Hz

11.3. A multivibrator is constructed as in Fig. 11-6 with R2 = 100k Ω , R3 = 100k Ω , C1 = 0.01 μ F and C2 = 0.03 μ F. What is the frequency of the oscillations:

- a) 357Hz
- b) 3,570Hz
- c) 1,428Hz
- d) 476Hz

11.4. What is the ratio of the on-time of TR1 to the on-time of TR2 in the multivibrator of the previous question:

- a) 3:1
- b) 1:3
- c) 4:1
- d) 1:4

11.5. What value of C1 would increase the frequency of the multivibrator in 11.3 to twice its original value:

- a) 0.01 μ F
- b) 0.02 μ F
- c) 0.03 μ F
- d) 0.04 μ F

PART 10 ANSWERS

10.1 b). 10.2 b). 10.3 a). 10.4 b). 10.5 a).

MUSICAL SYNTHESISERS

Musical synthesisers are used to generate a wide variety of sounds under the control of the operator.

There are usually separate modules for controlling the frequency, the amplitude and the waveform. The basic sound generator is most often the oscillator, though many sounds are based on random noise.

Either frequency modulation or amplitude modulation or a combination of the two effects can be achieved simply by inter-connecting modules. The frequency modulation is carried out in units called **voltage controlled oscillators (v.c.o.s)**.

These are oscillators which produce constant amplitude oscillations, the frequency of which is completely determined by the voltage at their input. The voltage can be either a d.c. signal (so that the frequency is always the same) or a varying signal to produce interesting effects.

Amplitude modulation is carried out in units called **voltage controlled amplifiers (v.c.a.s)**. Again the modulating signal can be either d.c. (which gives a constant amplitude output) or a varying signal. We call the amplitude of the modulated signal the **envelope** and voltage controlled amplifiers are often referred to as **envelope controllers**.

The waveform of the signal depends to a large extent on the waveform of the signal produced by the oscillator. It can be a simple sine wave or a square or triangular

wave. Both the square and triangular waveforms have a large number of harmonics and these can be modified by passing the signals through another module, a **voltage controlled filter (v.c.f.)**.

Voltage controlled filters can be low pass, band pass or high pass, but the thing that they all have in common is that the cut-off frequency is under the control of an external voltage. Passing a square wave into a voltage controlled filter and rapidly changing the cut-off frequency produces the characteristic "waa-waa" sound, often used with electric guitars.

UNWANTED OSCILLATIONS

It has been pointed out that unwanted oscillations can occur in amplifiers. How can a designer make sure that they do not occur?

Oscillations will take place if there is positive feedback around a circuit with a 360 degree phase shift and the loop gain is at least one. The answer to the problem is therefore to make sure that no signals at any frequency can be fed back to the input of the amplifier with 360 degree phase shift and with a loop gain of one. The phrase "at any frequency" is the important point since it may be the very high frequency response of the amplifier that allows oscillations to occur.

In the case of integrated circuit amplifiers, the manufacturers may include special components inside the package such that positive feedback cannot occur. However,

this means that the bandwidth of the amplifier is restricted.

On the other hand the makers may supply a diagram of the frequency response of their amplifier so that the designer can choose his external components to give maximum bandwidth whilst never allowing oscillations to occur.

The position is much more difficult in the case of multistage discrete transistor amplifiers. It becomes very complicated to analyse the frequency response of the whole system and it may depend a lot on the physical layout of the components. The designer can either add components at every stage of the circuit so that when they are joined up he can easily predict what frequencies, if any, are critical, or else he may add components across the whole system making sure that oscillations cannot occur.

The sort of components that are added will vary, but often they consist of small value capacitors (a few picofarads or so) connected so as to change the frequency characteristic of the stage. Very high frequency oscillations can often be eliminated by using **ferrite beads** in certain lines. These increase the inductance of the lines and act so as to oppose rapid changes in current.

In the end it sometimes comes down to trial and error, but of course designers try to avoid this situation.

Next month: Experiments for Part 11 will appear in the September issue, which will also include the entire Part 12 of this series.

JACK PLUG & FAMILY...

BY DOUG BAKER



**IT ALL FITS TOGETHER
NEXT MONTH**

DUO - DECI TIMER

TTL POWER SUPPLY UNIT

LOGIC PROBE

SEPTEMBER 1980
ISSUE ON SALE
FRIDAY, AUGUST 15

Everyday
ELECTRONICS



PART ONE

BY F.C. JUDD

WEATHER CENTRE



has been simplified as much as possible and each unit was made with only an electric drill and ordinary metal work tools such as a hacksaw and files.

The cost of the system has been kept to a minimum by adopting an analogue readout for temperature and wind speed. The fairly large extra cost involved by having digital readout was considered not to be worthwhile. The system permits indoor and outdoor temperature over the range -40 to +60 degrees Celsius, wind speed up to 100 m.p.h. and wind direction with a 16-point indication.

BLOCK DIAGRAM

The Weather Centre can be broken down into several distinct and separate stages, as can be seen in the block diagram, Fig. 1. There are two temperature detectors, one for internal temperature, one for external, which produce a d.c. voltage proportional to the temperature being observed. These are connected via a selector switch to a d.c. amplifier and from there the signal voltage passes via another selector switch to the meter.

Another section of the unit deals with wind speed indication. Here we have a beam of infra-red light passing from a special l.e.d. to a special phototransistor, in between which, is a disc containing a number of holes. This disc, which is attached to the same shaft as the rotating anemometer cups, interrupts the light beam causing a series of pulses of light to fall on the phototransistor. This in turn produces a series of electrical pulses, the frequency of which is proportional to the speed of rotation of the disc and hence the wind speed. These pulses are processed and arrive at the meter where they are integrated and can be directly measured.

The final section of the unit is the wind direction indicator. This consists basically of a set of switches connected directly to a corresponding set of l.e.d.s on the front panel. These switches, which are in fact reed relays, are activated by a magnet attached to the wind vane shaft. There is no actual signal processing or electronics involved here.

CIRCUITRY AND SYSTEM

In the full circuit, Fig. 2, the transistors TR1 and TR2 and associated temperature sensing diodes D1 and D7 cater for inside and outside temperature. As each circuit is identical, operation for TR1/D1 only will be explained. TR1 is a pnp transistor used as a constant current source in the bridge circuit formed by itself, D1, and the network R4, VR1 and R5.

METEOROLOGY, like many other sciences, depends on detailed observation and measurement. Unfortunately for the amateur weather watcher, this means either using precise but expensive recording equipment, or the rather less reliable method of thermometer and wet finger.

The Weather Centre described here will give the user a reliable indication of wind speed and direction and also temperature, both interior and exterior, at reasonable cost. Schools

and colleges should find the unit very useful in helping them to complete the practical side of their meteorological courses.

Although the circuitry may appear a little complex, this is only made so by the switching involved to obtain temperature read out from two different sensors and also wind speed with one meter.

Naturally, some mechanical work is necessary in making the anemometer and wind direction indicator, as can be seen in the photographs, but this

Voltage at the collector of TR1 is set at zero by VR1 in conjunction with the diode resistance at a temperature of zero degrees Celsius. The resistance of a silicon diode changes linearly with temperature so at any temperature other than zero degrees, a positive or negative voltage will be produced across R6/VR2. This voltage is d.c. amplified by IC1 and used to drive the meter, ME1.

OFF-SET CONTROL

The meter must be made to read zero degrees at a suitable part of the scale (normally 0 to 100) so that a negative indication (that is a temperature below zero degrees) or positive indication (that is a temperature above zero degrees) can be displayed.

To achieve this the off-set control VR3 is used to set the meter reading for zero degrees. In effect this means that if the selected temperature detector is at zero degrees then a voltage will appear across the meter terminals, the size of which depends on the setting of VR3. The total range of the meter for temperature from either sensor is -40 to +60 degrees Celsius.

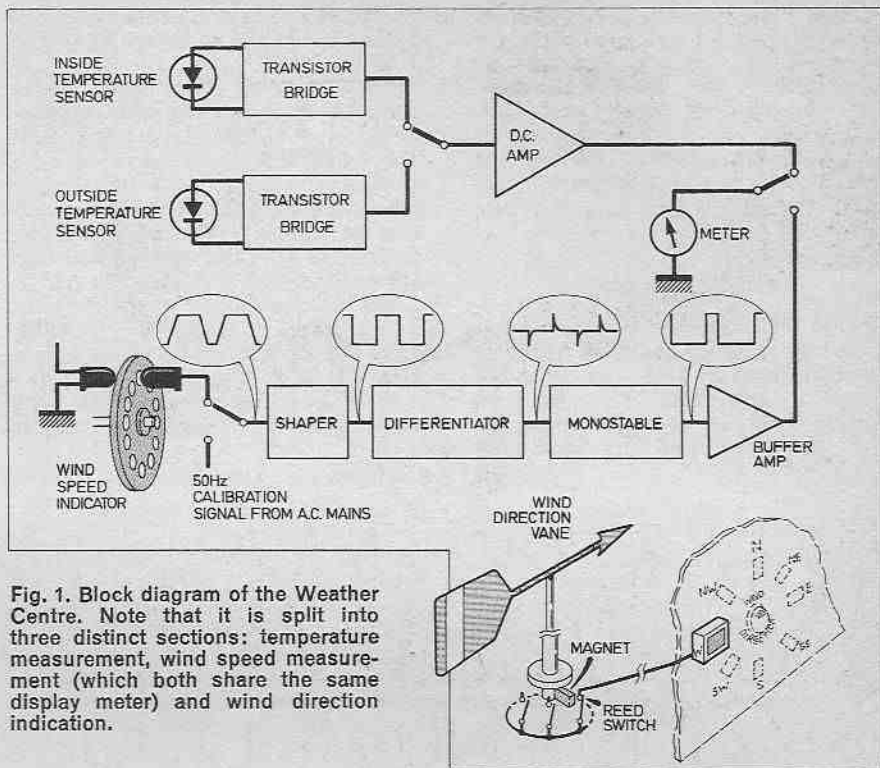

Fig. 1. Block diagram of the Weather Centre. Note that it is split into three distinct sections: temperature measurement, wind speed measurement (which both share the same display meter) and wind direction indication.

COMPONENTS

Resistors

| | | | |
|-----|---------------|-----|---------------|
| R1 | 3.9k Ω | R29 | 12k Ω |
| R2 | 5.6k Ω | R30 | 1.2k Ω |
| R3 | 680 Ω | R31 | 120k Ω |
| R4 | 1k Ω | R32 | 10k Ω |
| R5 | 68 Ω | R33 | 1.2k Ω |
| R6 | 1.2k Ω | R34 | 5.6k Ω |
| R7 | 100k Ω | R35 | 100k Ω |
| R8 | 68k Ω | R36 | 56k Ω |
| R9 | 12k Ω | R37 | 5.6k Ω |
| R10 | 12k Ω | R38 | 5.6k Ω |
| R11 | 5.6k Ω | R39 | 2.2k Ω |
| R12 | 5.6k Ω | R40 | 2.2k Ω |
| R13 | 680 Ω | | |
| R14 | 3.9k Ω | | |
| R15 | 5.6k Ω | | |
| R16 | 680 Ω | | |
| R17 | 1k Ω | | |
| R18 | 68 Ω | | |
| R19 | 1.2k Ω | | |
| R20 | 220 Ω | | |
| R21 | 220 Ω | | |
| R22 | 200 Ω | | |
| R23 | 180 Ω | | |
| R24 | 58 Ω | | |
| R25 | 100 Ω | | |
| R26 | 6.8k Ω | | |
| R27 | 6.8k Ω | | |
| R28 | 1.2k Ω | | |

All $\frac{1}{4}$ W carbon $\pm 5\%$

See
**Shop
Talk**
page 481

Potentiometers

| | |
|-----|-------------------------------------------|
| VR1 | 200 Ω multiturn trimmer |
| VR2 | 100k Ω miniature horizontal preset |
| VR3 | 10k Ω miniature vertical preset |
| VR4 | 200 Ω multiturn trimmer |
| VR5 | 100k Ω miniature horizontal preset |
| VR6 | 100k Ω miniature horizontal preset |

Capacitors

| | | | |
|----|-------------------------|-----|------------------------|
| C1 | 2200 μ F 25V elect. | C7 | 0.1 μ F polyester |
| C2 | 2200 μ F 25V elect. | C8 | 100 μ F 25V elect. |
| C3 | 1000 μ F 25V elect. | C9 | 4.7nF ceramic |
| C4 | 2200 μ F 25V elect. | C10 | 100 μ F 25V elect. |
| C5 | 1000 μ F 25V elect. | C11 | 0.02 μ F polyester |
| C6 | 1000 μ F 25V elect. | | |

Semiconductors

| | |
|---------|-------------------------------------|
| TR1 | BC158 <i>npn</i> silicon |
| TR2 | BC158 <i>npn</i> silicon |
| TR3 | TIL78 infra-red phototransistor |
| TR4 | BC108 <i>npn</i> silicon |
| TR5 | 2N2926G <i>npn</i> silicon |
| TR6 | 2N2926G <i>npn</i> silicon |
| TR7 | BC108 <i>npn</i> silicon |
| IC1 | μ A741 op-amp 8 pin d.i.l. |
| D1 | 1N4148 small signal silicon diode |
| D2 | BZX61C9V1 9.1V 1.3W Zener diode |
| D3-D6 | W005 type 50V 1A bridge rectifier |
| D7 | 1N4148 small signal silicon diode |
| D8 | flashing l.e.d. (R.S. type 587-080) |
| D9 | BZX85C5V1 5.1V 1.3W Zener diode |
| D10-D13 | W005 type 50V 1A bridge rectifier |
| D14 | TIL32 infra-red l.e.d. |
| D15-D22 | square-faced red l.e.d. (8 off) |

Miscellaneous

| | |
|--------|----------------------------------------------------------------------------|
| T1 | mains primary with two 12V 150mA secondaries (Bi-Pak type 2025 or similar) |
| ME1 | 100 μ A f.s.d. panel meter (Bi-Pak 1303 or similar) |
| S1, S3 | 4-pole, 3-way rotary switch (2 off) |
| S2 | s.p.s.t. mains toggle |
| S4-S11 | dry reed type reed relay with normally open contacts (8 off) |
| LP1 | mains neon indicator with integral series resistor |

Case for display unit size 305 x 178 x 178mm (Contil Eyebrow type with front panel and chassis or similar); small plastic containers for D1 and D7; four pieces of 0.1 inch matrix perforated s.r.b.p. board, one 73 x 81mm, one 88 x 32mm, one 117 x 67mm and one 80mm square; one piece 0.15 inch matrix perforated s.r.b.p. board 120 x 95mm; two knobs; Perspex for wind direction indicator panel; magnet to suit reed-relays; 12-way connector blocks (3 off); interconnecting wire; 10-way ribbon cable; single core screened cable; twin-core stranded wire.

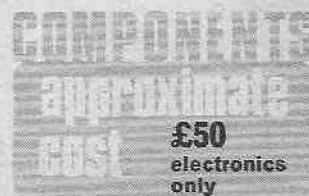

Note that the 741 op-amp is isolated from the common earth and the negative supply rail of the remainder of the circuitry. It therefore has its own Zener diode controlled supply of 9V from diode bridge D3-D6 which is divided into $\pm 4.5V$. A "set temperature" calibrate facility is also provided (see later).

WIND SPEED INDICATOR

The wind speed indicator circuitry consists first of D14 (an infra-red emitter) and TR3 (an infra-red detector) which are built into the

anemometer unit and provide the pulses necessary to drive TR4, TR5, TR6 and TR7.

The infra-red beam from D14 is chopped by a rotating disc attached to the shaft of the anemometer cups. This disc has 18 holes around its periphery so the same number of pulses are generated for one revolution of the disc. The pulses picked up by TR3 are fully squared and then differentiated by TR4 (see Fig. 3).

The positive going short duration pulses from this are then used to drive the monostable circuit formed by TR5 and TR6. The output from this is a fairly narrow square wave with a recurrence frequency which is

dependent on the speed of rotation of the anemometer. This is then buffered by TR7 and fed directly to the meter ME1 where it is integrated and shown as a d.c. level. Variable resistor VR6 is used as a "zero-adjust" control.

Facility for calibration of the meter for wind speed is provided by using the 50Hz pulses from one of the 12 volt secondary windings of T1. This is taken from the junction of R26 and R27 via C4 and S3c and fed into the base of TR4. The procedure for setting up and calibrating this part of the unit will be given later on.

The 12 volt power supply for this circuitry is derived from the diode bridge D10-D13.

Fig. 2. The complete circuit diagram of the Weather Centre.

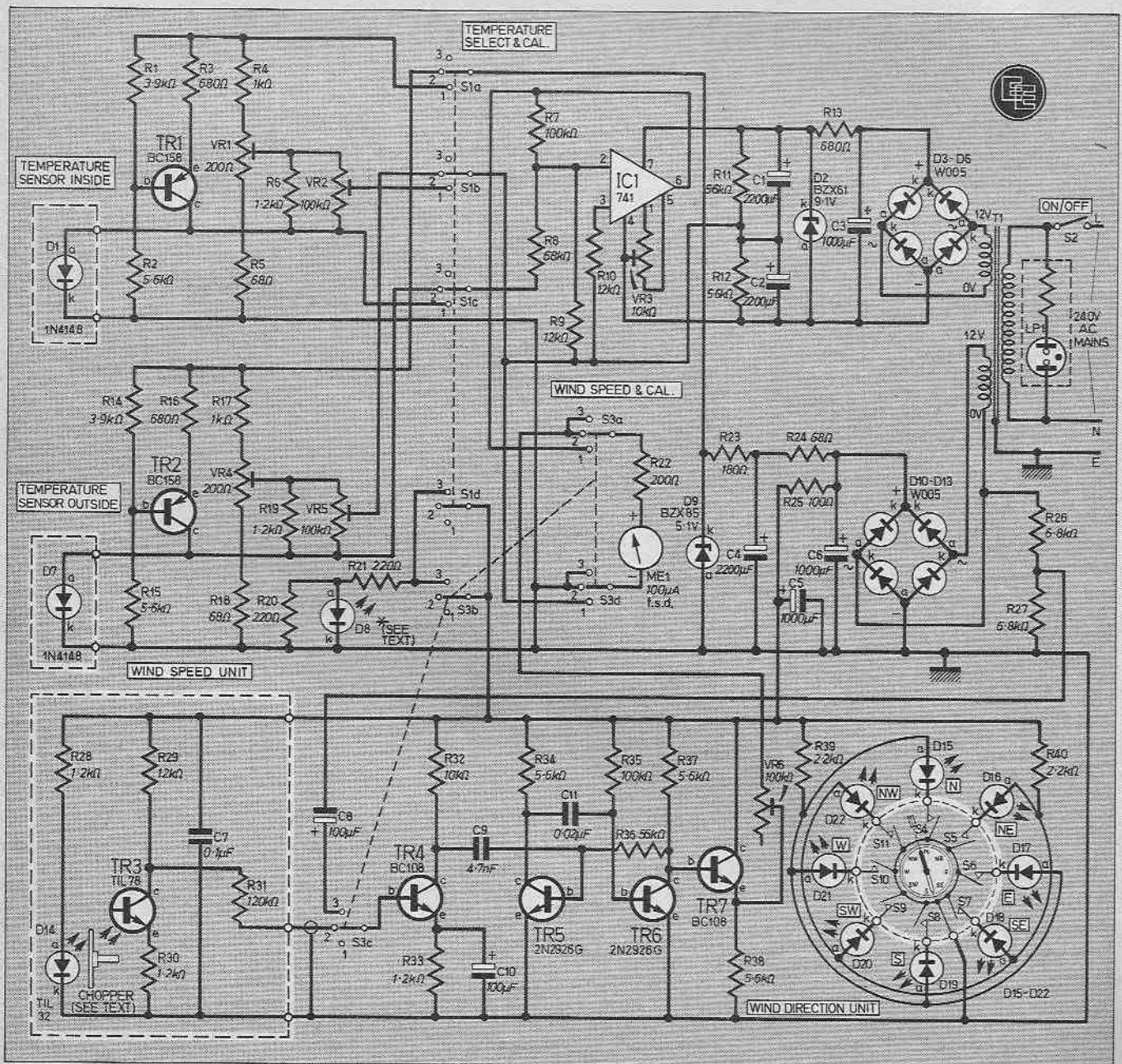

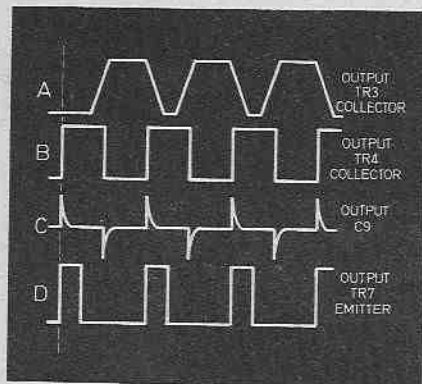

Fig. 3. Sample waveforms from the wind speed measurement part of the circuit. Note how the rough incoming square wave is converted into a narrow pulse train.

WIND DIRECTION

The wind direction indicator employs a series of reed relays which are actuated by a magnet attached to a shaft of the wind vane. Each reed relay is used to activate either one or two of the l.e.d.s on the instrument panel, these being arranged in a circle to provide eight compass points.

However, the magnet is arranged so that for a point, half way between any two reed switches, both will actuate providing a sixteen compass point readout, that is: N, NNE, NE, ENE, E and so on. Some observations on wind direction will be made later.

POWER SUPPLY

The power supply consists of two separate bridge rectifiers, D3-D6, and D10-D13, each fed from a separate 12V secondary winding on the transformer T1. The rectifier D3-D6 provides a stabilised 9V split rail for IC1. The 12V rail from D10-D13 supplies the wind speed circuitry and wind direction indicators, and also a 5V stabilised rail for the temperature bridge circuits. Zener diode D9 is used to clamp the output at 5V.

The l.e.d. D8 is a self-flashing type and used as a panel indicator to show when S1 or S2 are left in a calibrate position. A standard l.e.d. could be used here if preferred.

DISPLAY UNIT

Like any other weather monitoring system, the Weather Centre has two basic sections—a set of detectors and a display system. The construction of the sensors is described next month but for the moment we will concentrate on the display unit.

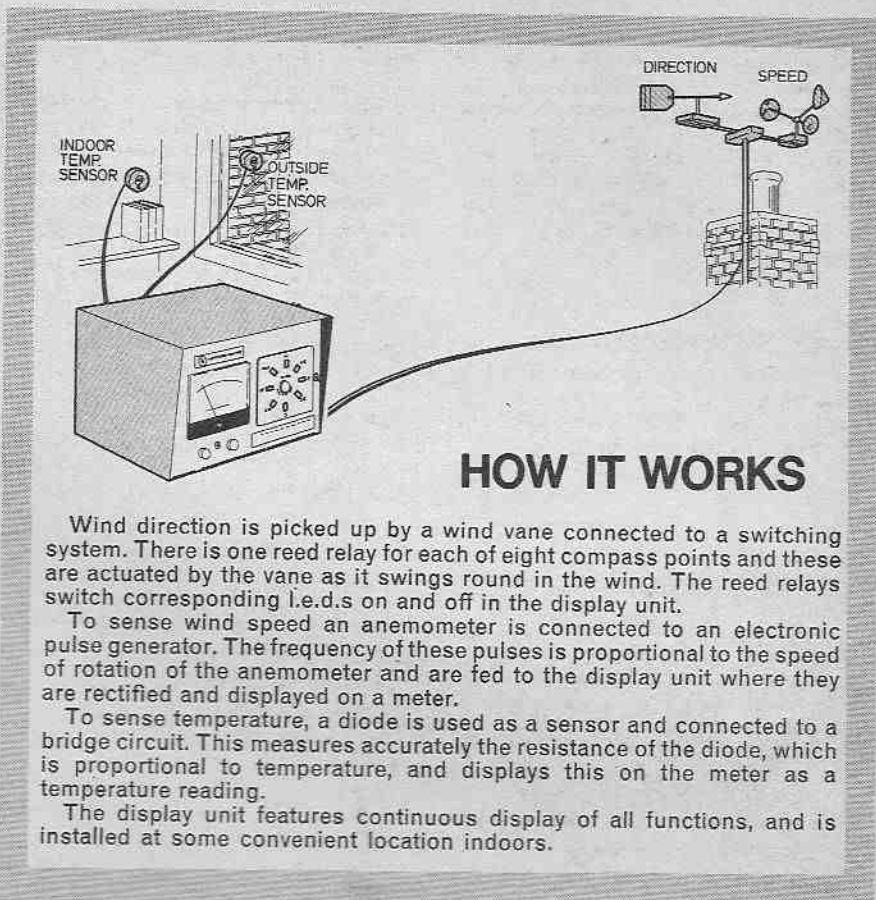

HOW IT WORKS

Wind direction is picked up by a wind vane connected to a switching system. There is one reed relay for each of eight compass points and these are actuated by the vane as it swings round in the wind. The reed relays switch corresponding l.e.d.s on and off in the display unit.

To sense wind speed an anemometer is connected to an electronic pulse generator. The frequency of these pulses is proportional to the speed of rotation of the anemometer and are fed to the display unit where they are rectified and displayed on a meter.

To sense temperature, a diode is used as a sensor and connected to a bridge circuit. This measures accurately the resistance of the diode, which is proportional to temperature, and displays this on the meter as a temperature reading.

The display unit features continuous display of all functions, and is installed at some convenient location indoors.



and will depend to some extent on the actual components used.

However, the layout used in the prototype works very well and little would be gained by changing it. Note that the wind direction display assembly will need a 80mm square cutout.

CHASSIS COMPONENTS

Once all the drilling and cutting has been completed, the chassis mounted components, that is the meter, transformer, connector block and switches, can be mounted in their respective positions. Don't bolt the circuit board brackets to the chassis at this stage. You will find it easier to fix the boards in position if the brackets are actually bolted to the boards first.

WIND DIRECTION PANEL

The next job to tackle is the wind direction indicator panel (see Fig. 4). This consists of a front panel of Perspex, a sub-panel of aluminium on which the l.e.d.s are mounted, and a rear panel of plain 0.1 inch matrix perforated board on which connections to the l.e.d.s are made, all arranged in a form of sandwich and held together with 6BA nuts, bolts and spacers.



This is housed in a Contil Eyebrow type case, size 305 x 178 x 178mm, and a look at the accompanying photographs will give a good idea of the general layout.

The first stage in construction is to mark up the chassis and front panel for drilling and cutting. The exact location of components is not critical

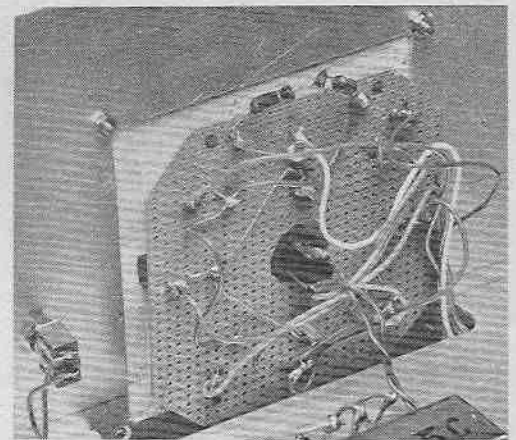
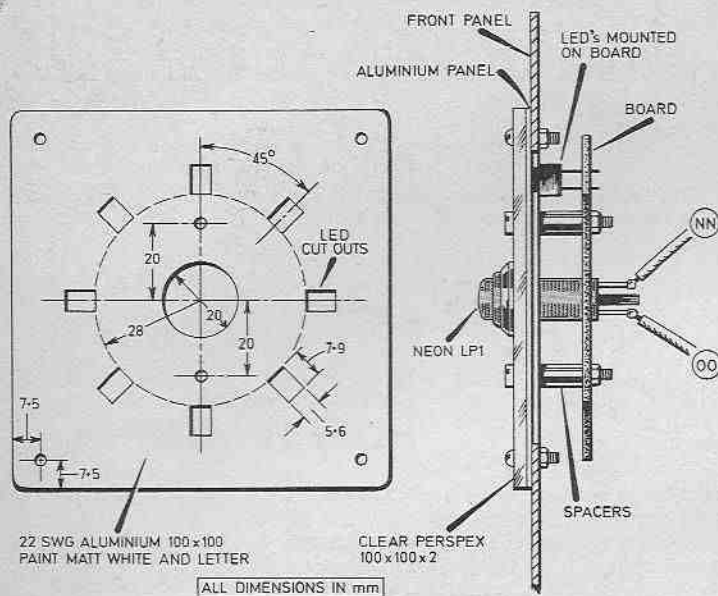

Completed wind direction display assembly in position.

Fig. 4 (above). Cutting details and mechanical construction of wind direction display panel. (below) Layout and wiring of the circuit board section of the wind direction display panel. Note the wires identified by numbers go via the connector block in the display unit to the terminal block location with the same number on the remote sensing unit.

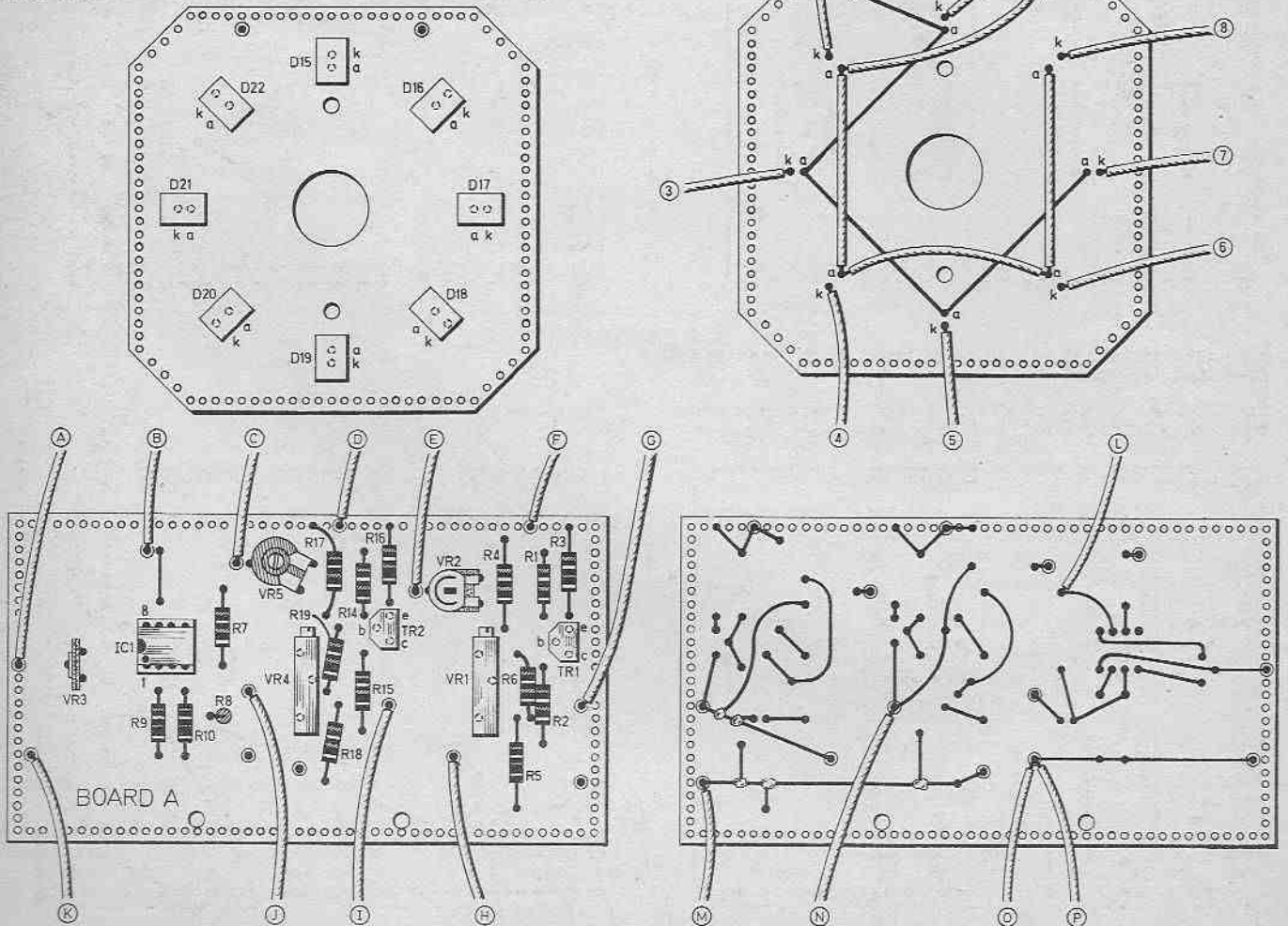
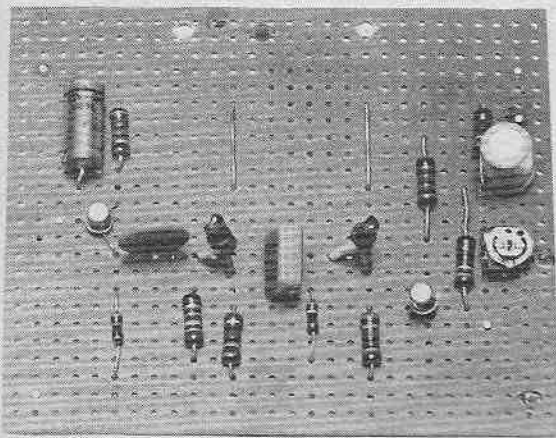
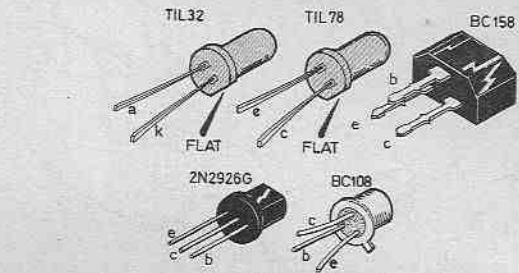

Fig. 5. Layout and wiring of board A, the temperature measurement board.

WEATHER CENTRE



Topside view of Board B.



Connection details of the discrete semiconductor devices used in this project.

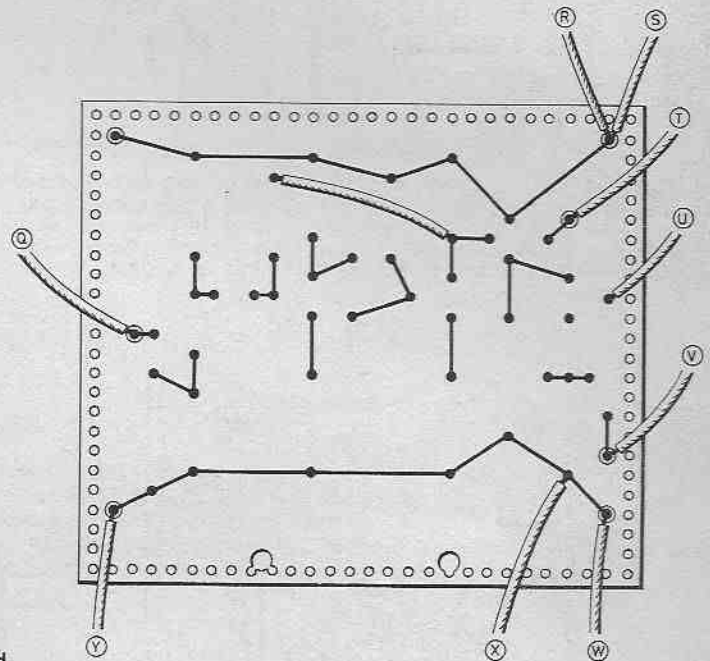
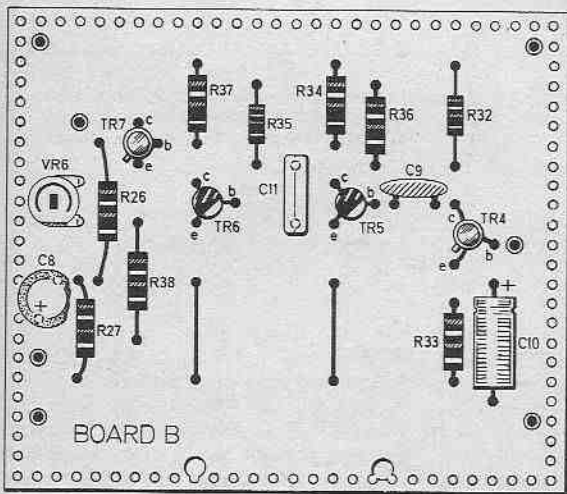
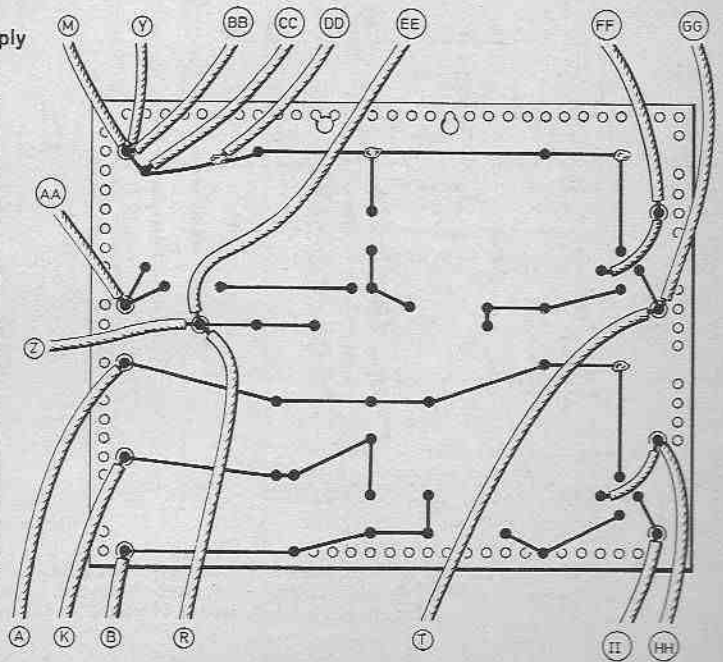
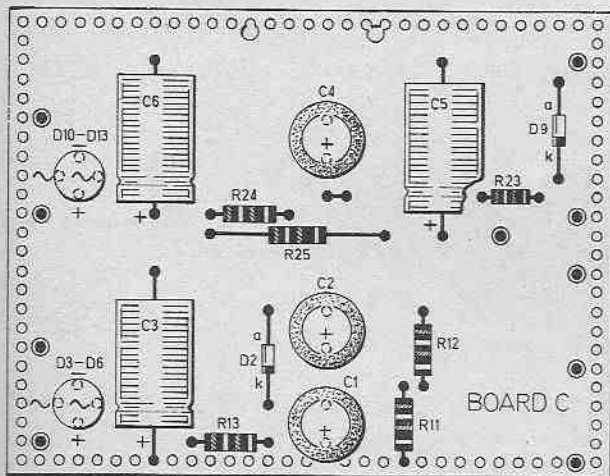

Fig. 6 (above). Layout and wiring of board B, the wind speed measurement board.

Fig. 7 (below). Layout and wiring of board C, the power supply board. Note that this is built on 0.15 inch stripboard.



WEATHER CENTRE

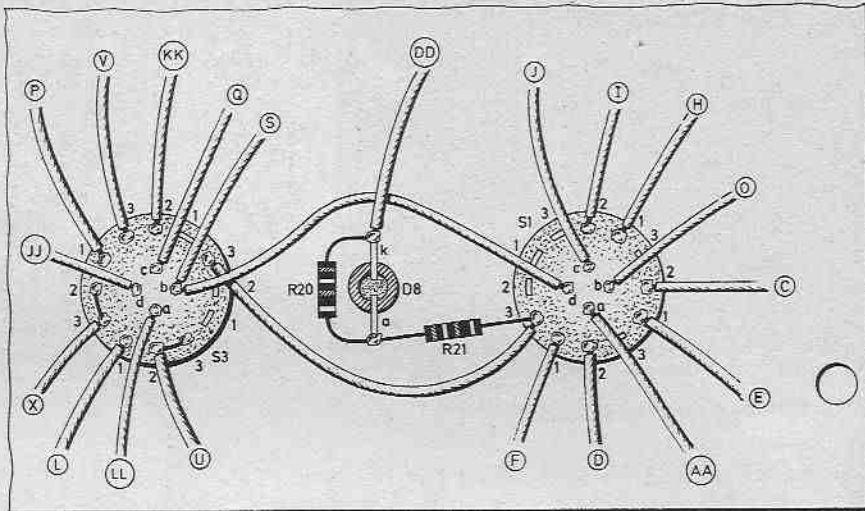

Fig. 8 (above). Wiring details for the selector switches S1 and S2. Note that these are mounted underneath the main chassis. Diode D8 is a flashing I.e.d.

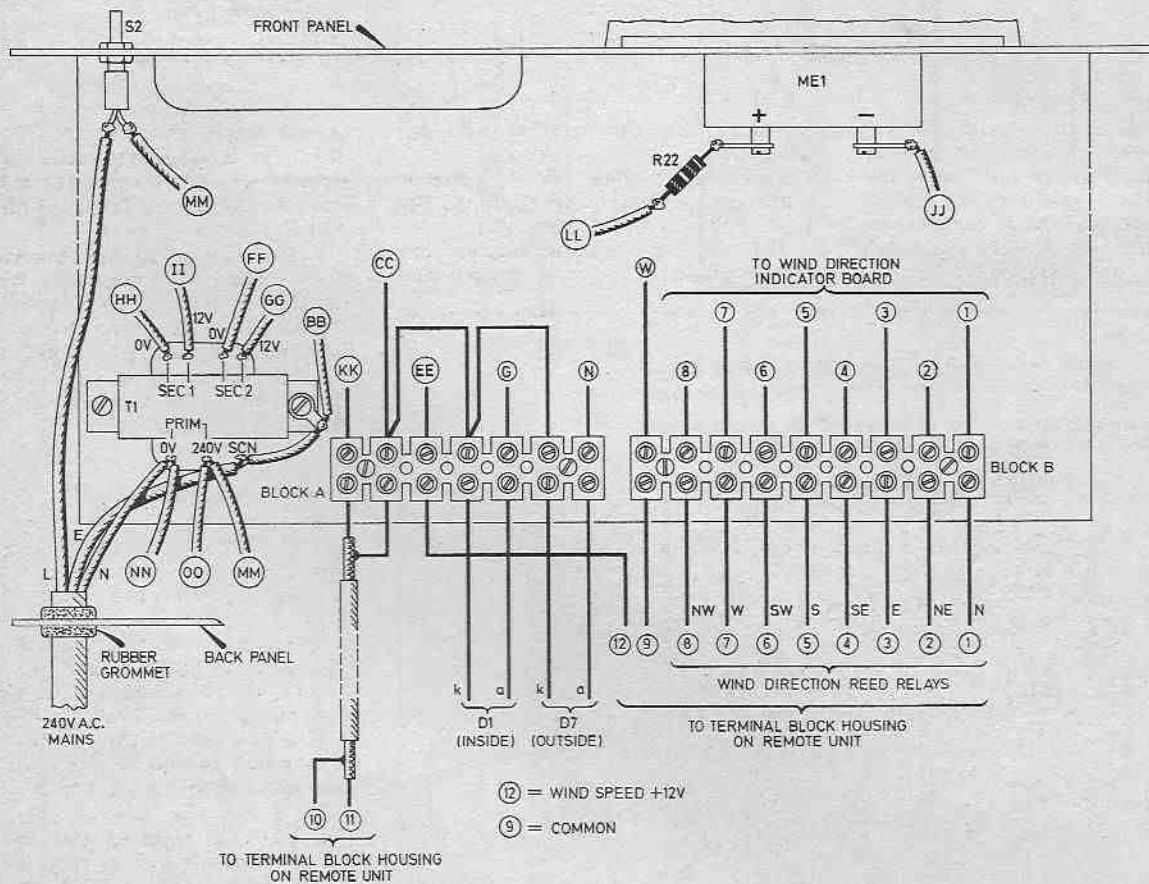
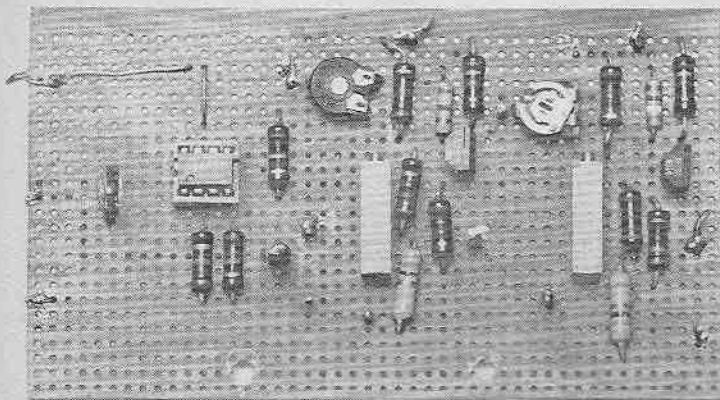
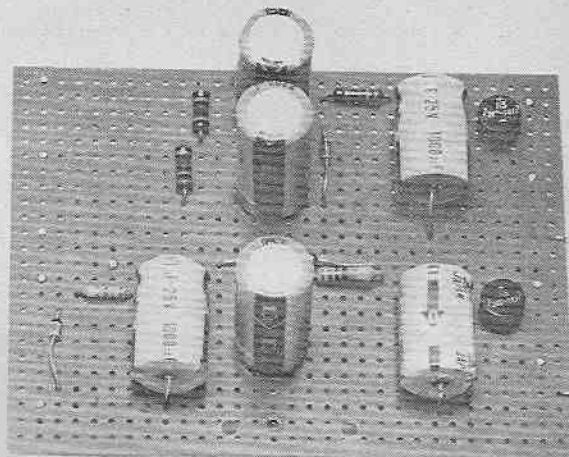

Fig. 9. Layout and wiring details of the chassis mounted components of the Weather Centre. The circuit boards have been omitted for clarity. Note that numbered leads go to the same numbered location at the terminal block on the remote sensor unit.



Topside view of Board A.



Topside view of Board C.

Fig. 10. Wind Speed Conversion and information chart. This can be fastened onto the front panel of the completed display unit.

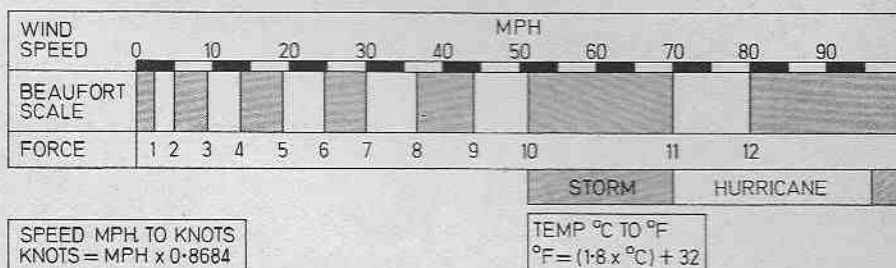

The design and layout of the indicator panel can be clearly seen from the illustrations and the lettering and other finishing is applied directly to the surface of the aluminium sub-panel. As a finishing touch the "mains on" indicator, LP1, is

mounted in the centre of this assembly.

Once completed, this indicator panel can be bolted directly onto the front panel of the display unit.

The separate circuit boards can now be made up. Order of construction

is not important but at this stage the flying leads should be left off. Full details of component layout and inter-wiring are given in Figs. 5, 6 and 7.

Before mounting the boards onto the chassis, the mounting brackets should be bolted onto the boards themselves. Note that board C has been made up using 0.15 inch matrix board. This is to make it easier to mount the larger components used in this part of the circuit.

FINAL ASSEMBLY

Final construction can now begin. Board A should be fixed in position first and wired up to the rest of the chassis mounted components. Other flying leads should also be soldered in position at this stage. Board B is next mounted in position and wired up. Finally, the third board is bolted down and wiring is completed. At this stage it is a good idea to give all the wiring a thorough inspection for errors and bad joints (see Figs. 8 and 9).

To finish the job off, the front panel can be labelled and the wind speed conversion chart (Fig. 10) fixed to the front panel behind a strip of Perspex. This can be cut out of the magazine.

Next month: Building the wind speed/direction and temperature sensors and setting up and using the Weather Centre.

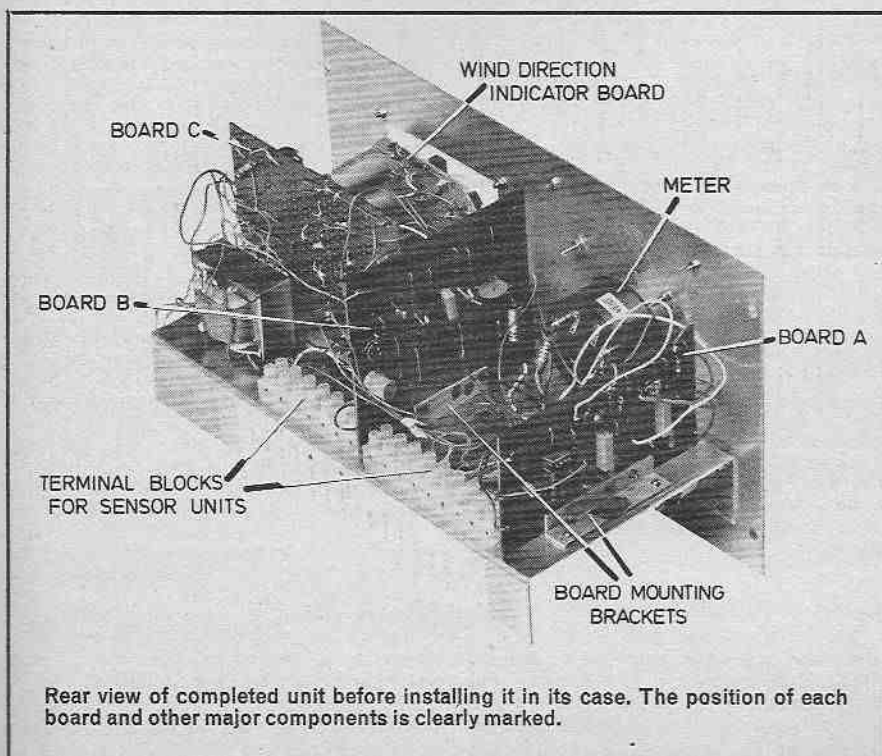

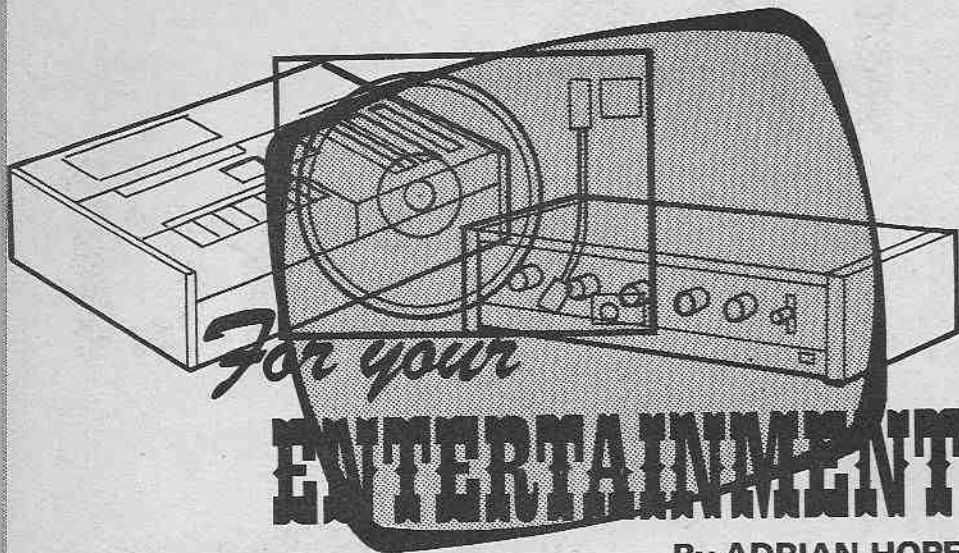

By ADRIAN HOPE

Digital Radio Service

Despite the much publicised financial problems facing the BBC, the Corporation has very wisely not cut down on research and publicity for its technical achievements. If anything the BBC has recently stepped up the amount of outgoing research information.

The BBC plans to replace Electricity Board "white meters" by switching signals transmitted with radio programmes on the medium and long wave bands have been much publicised. But the system proposed by the BBC for carrying inaudible digital data "piggy-back" on v.h.f./f.m. broadcasts has tended to attract very little public interest.

Just such a system is already in use in Sweden, as I found out when I visited the Swedish national radio and TV stations in Stockholm recently. The Swedish system, called PI for Public Information, was developed by the Swedish Telecommunications Administration (Post Office) and makes it possible to transmit an extraordinary amount of data along with a conventional v.h.f./f.m. broadcast.

This data can be used to provide a visual readout on an i.c.d. or l.e.d. display, or to physically control a receiver or tape recorder so that it switches on and off at the beginning and end of a pre-selected programme. The data can also be used to send short text messages, such as traffic information, and even to page citizens anywhere within reasonable reception distance of a v.h.f. transmitter broadcasting ordinary radio.

The data, whether programme identification, text or paging signals, is binary coded, i.e. into "ones and zeros". These one/zero pulses are then used to phase shift a 1-2kHz signal on an extra sub-carrier (57kHz) transmitted along with the main mono carrier and stereo sub-carrier.

Quite simply a "one" phase shifts the signal by 180 degrees, while a "zero" pulse leaves its phase unaltered. The bit rate is thus 1200 Baud or bits per second.

In other words it's fairly slow but this doesn't matter because only simple messages need be carried, for instance the name of the station being received, the frequency and perhaps the time of day.

Even the paging system relies on very simple messages and since Autumn 1978 Swedish Radio and the Post Office have actually been operating a scheme which has a capacity of a third of a million subscribers.

How it Works

The subscriber to the paging network carries a small receiver, with an i.c.d. or l.e.d. display, which is permanently tuned to the national radio station. But it only responds when a paging message is transmitted on the PI subcarrier which carries an address code that matches a similar code built into the receiver.

Every receiver has a different code so each paging message only triggers the receiver for which it is intended. On receipt of the intended message the receiver beeps and the display shows either a pre-arranged code, or a specific telephone number which the paged subscriber must call. The whole system is automatic and paging messages can be dialled in from any telephone in Sweden.

If Mr. A wants to get in touch with Mr. B but doesn't know where he is, he goes to the nearest telephone and dials the paging service computer. He then dials the number of Mr B's paging receiver and finally dials either a pre-arranged code (like 1234 to designate "please call your wife") or a telephone number. Provided Mr. B is anywhere in Sweden that can receive ordinary v.h.f. radio programmes his paging receiver will emit bleep tones and he will then proceed to the nearest telephone to answer the paged message.

All this happens while the rest of Sweden simply listens to their v.h.f. radios, completely unaware of the data signals which are being simultaneously transmitted.

Dial-a-Disc Library

As the 70's ended and the 80's began, everyone and their dog had a stab at predicting technology trends over the next decade.

Most long term predictions centred round the high density solid state storage

of audio and video material, or the so called "sugar lump" dream. According to this dream all the works of Shakespeare or Beethoven are stored, either magnetically, holographically or in some other unspecified fashion, in a solid state block the size of a sugar lump.

This may one day be possible, but not in the eighties. Much more realistic in the short term is an idea voiced by a European visitor to the Audio Engineering Society convention held earlier this year in London.

Until sugar lump storage, and ready replay access, is feasible, why not keep all pre-recorded programme material in a central or even local library store which the user can dial up by high quality telephone line? That way no one need store any programme material in their own home.

In many respects the idea is an extension of Viewdata, whereby telephone subscribers with a Viewdata TV set can interrogate the Post Office Prestel computer. Of course one obvious objection springs immediately to mind. What happens if two people want the same programme at almost, but not quite, the same time, i.e. you dial up Boulez conducting *The Firebird* five minutes before I do—what happens, do I miss the first five minutes? No because here is the clever part.

All over the world, Post Offices are developing the use of cheap optical fibres instead of expensive copper wires to carry telephone calls. By beaming laser lights down an optical fibre link it's possible to carry a large number of telephone calls at the same time. And this is possible because the optical link has a very wide bandwidth capability, of many megahertz.

Floppy Recording

Imagine the library copy of the *Firebird* recording, probably stored on digital tape or disc. When the recording is dialled up by a subscriber it is automatically replayed in the library at very high speed. So the entire musical performance is fed down the line in just a few seconds.

The optical fibre link has sufficient bandwidth to accept the very high frequency signals created by such rapid replay. At the receiving end, in the home, a high density magnetic recording medium such as a modified computer floppy disc, captures all the incoming information as it arrives at high speed. The disc then replays at much lower speed to produce the *Firebird* at the correct speed in "real time".

There seems no reason why this system shouldn't work or indeed why it shouldn't be commercially viable. All the technology is already available. What's more it could offer the answer to several problems currently suffered by the record industry.

Record buyers would no longer need to suffer with bad pressings or bad quality tapes, because they would no longer actually be buying a record. Instead they would buy the temporary use of an incoming signal from a technically perfect library copy.

The record industry currently claims that it is losing sales through unauthorized copying of commercial recordings. If each subscriber dialling a programme had to pay a royalty for the service, then the record industry would be assured a constant source of revenue.

The Proto-Board[®]

Now circuit designing is as easy as pushing a lead into a hole . . .
 No soldering
 No de-soldering
 No heat-spoilt components
 No manual labour
 No wasted time



For quick signal tracing and circuit modification
 For quick circuit analysis and diagramming
 With or without built-in regulated power supplies
 Use with virtually all parts — most plug in directly, in seconds.
 Ideal for design, prototype and hobby

| NO | MODEL NO | NO. OF SOLDERLESS TIE-POINTS | IC CAPACITY (14pin DIP's) | UNIT PRICE | PRICE INC. P&P 15% VAT | OTHER FEATURES |
|----|----------|------------------------------|---------------------------|------------|------------------------|----------------|
| 1 | PB 6 | 630 | 6 | 9.20 | 11.73 | Kit |
| 2 | PB 100 | 760 | 10 | 11.80 | 14.72 | Kit |
| 3 | PB 101 | 940 | 10 | 17.20 | 21.21 | |
| 4 | PB 102 | 1240 | 12 | 22.95 | 27.83 | |
| 5 | PB 103 | 2250 | 24 | 34.45 | 41.34 | |
| 6 | PB 104 | 3060 | 32 | 45.95 | 54.56 | |
| 7 | PB 203 | 2250 | 24 | 55.15 | 65.14 | 5V @ 1A |
| 8 | PB 203A | 2250 | 24 | 74.70 | 87.63 | 5V ± 15V |
| 9 | PB 203AK | 2250 | 24 | 59.00 | 69.57 | 5V ± 15V & Kit |

Tomorrows tools for todays problems

CONTINENTAL SPECIALTIES CORPORATION

C.S.C. (UK) Ltd., Dept 4U Unit 1, Shire Hill Industrial Estate, Saffron Walden Essex. CB11 3AQ

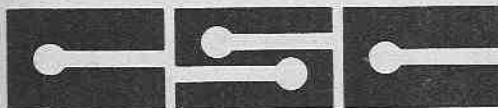

C.S.C. (UK) Limited, Dept. 4U
 Unit 1, Shire Hill Industrial Estate,
 Saffron Walden, Essex. CB11 3AQ.
 Telephone: Saffron Walden (0799) 21682
 Telex: 817477.

| | | | | | | | | |
|-----------|-----------|-----------|-----------|-----------|-----------|-----------|-----------|-----------|
| 1 Qty Req | 2 Qty Req | 3 Qty Req | 4 Qty Req | 5 Qty Req | 6 Qty Req | 7 Qty Req | 8 Qty Req | 9 Qty Req |
|-----------|-----------|-----------|-----------|-----------|-----------|-----------|-----------|-----------|

Name _____ Address _____

I enclose Cheque/P.O. for £ _____ or debit my Barclaycard, Access,
 American Express card no. _____ exp. date _____

FOR IMMEDIATE ACTION — The C.S.C. 24 hour 5 day a week service
 Telephone (0799) 21682 and give us your Barclaycard, Access,
 American Express number and your order will be in the post immediately

For FREE catalogue tick box

NEW ★★ Star Buys ★★ FROM CASIO

We predict that this stylish watch will be a best seller!

CASIO F.300

SPORTS CHRONO

RRP £14-95
ONLY
£12-95



Hours, minutes, seconds, am/pm day and date. Automatic four year calendar. 1/100 second chronograph to 12 hours, measuring net, lap and first and second place times. Backlight. 2 year lithium battery. Water resistant, resin case with stainless steel trim. Mineral glass. A rugged, light-weight watch and chronograph for the sportsman.

Something to sing about with twelve programmed melodies!

CASIO ML-90

MELODY MAKER

RRP £21-95
ONLY
£19-95



Clock, hourly chimes, calendar to 1999. Alarm 1: 7 different melodies changing daily, a fixed melody or buzzer. Alarm 2: a fixed melody or buzzer. Date memory 1: "Happy Birthday". Date memory 2: "Wedding March" or "Drinking Song". On December 24/25 plays "Jingle Bells". Calculator with 11 note keyboard, full access memory, square roots, $\frac{\%}{\%}$, $7/32 \times 2\frac{1}{2} \times 4\frac{1}{2}$ inches. Wallet. 1 year batteries.

You asked for a metal version of the best selling C-80. Here it is!

CASIO C-801

Watch
Calculator
Stopwatch
Dual time

RRP £34-95
ONLY
£29-95



Finger touch keyboard. Hours, minutes, seconds, am/pm and day. Day, date, month, calendar pre-programmed to 2001. Professional 24 hour stopwatch measuring net, lap and first and second place times to 1/100 second. Dual time (24 hour). 8 digit calculator. Backlight. Water resistant chrome plated case, with stainless steel bracelet. C-80 black resin cased version £24-95.



CASIO 110QS-37B

As F-300 above but with chrome plated case and stainless steel bracelet.

RRP £19-95
ONLY
£17-95

111QS-34B similar to above but without stopwatch function. £14-95.
F-8C Resin cased version. NOW ONLY £8-95

NEW SEIKOS

SOLAR Alarm Chrono DER 028

Personal specification "Silver Wave" 100m water resistant. O.K. for swimming, skiing etc. Comprehensive display, programmable weekly alarm, interval countdown alarm, hourly chimes. 1/100 sec stopwatch. 10 year rechargeable battery.



ONLY £69-95

DFT-030 "Silver Wave" alarm chrono £49-95.
OTHER NEW SEIKOS - SAE for details.

Another chance to buy one of these superb alarm chronographs.

THE CASIO 81QS-35B

We have managed to obtain another shipment of this best selling watch and it is now available from stock.



Stainless, steel, mineral glass. Water resistant. 5 YEAR BATTERY. Hours, minutes, seconds, day: and year. 12 or 24 hour display. 24 hour alarm, hourly chimes. Stopwatch from 1/100 second to 7 hours: net, lap and place times.

(£34-95) £29-95

81QS-35B

Solid stainless steel case 81QGS-35B
Gold plated £34-95

OTHER STAR BUYS

1/100 second chronographs

F-200 Black resin case and strap.

NOW ONLY £10-95

95QS-36B 12 or 24 hour, dual time, solid stainless steel. £19-95

Alarm chronographs with hourly chimes

83QS-41B 1/10 second chronograph £24-95

83QGS-41B Gold plated version £29-95

81QS-40B 1/100 sec. 12 or 24 hr. Chrome £24-95

Scientific clock/calculators

FX-7100 £24-95.

FX-8100 £24-95.

SUMMERTIME SPECIAL OFFERS

FREE on request with order

With any purchase made from this section before 30th September, 1980. GENTLEMEN'S DIGITAL WATCH, with comprehensive display, from world famous manufacturer. VALUE AROUND £12.

Offers subject to availability

Watches with chronograph (stopwatch):

95QS-42B 12 or 24 hour, dual time £17-95

56QS-36B Digital/analogue, chrome £24-95

C-80 Dual time, calculator. Resin. £24-95

Calculators with clock:

PW-81 £14-95. MQ-6 £19-95. AQ-1500 £14-95. AQ-2200 £19-95.

MQ-12 £19-95.

Musical: ML-82 £19-95. ML-71, ML-81 £22-95.

Ultra slim scientific: FX-3200 £21-95.

FREE on request with order

With any purchase made from this section before 30th September 1980. From world famous manufacturer, approximate values are given.

GENT'S DIGITAL WATCH £17

or LADIES DIGITAL WATCH £15

or CLOCK CALCULATOR £17

Offers subject to availability

Watches:

56QS-50B Chrono. Digital/analogue. S/S £34-95

79QS-39B Alarm chronograph. Chrome. £29-95

79CS-51B Alarm chronograph. S/S. £39-95

59CS-33B Alarm dress watch. £44-95

Scientific calculator: With stopwatch, countdown alarm timers. £31-95

FX-8000

OVER 35 WATCHES TO CHOOSE FROM!

ILLUSTRATED CATALOGUE

Casio and Seiko products. Send 25p to: TEMPUS (Information and Service Centre), 19-21 Fitzroy Street, Cambridge CB1 1FH. (Refundable on purchase).

RETURN OF POST SERVICE

Postal and telephone orders received before 4.00 p.m. will normally be despatched the same day by FIRST CLASS POST.

Send your order by FREEPOST (2nd class post — no stamp required). Please phone urgent orders or use first class mail.

PRICE includes VAT, P & P. Send your Company Order, Cheque or P.O. or phone your ACCESS or B'CARD number to:

TEMPUS

Tempus (Dept. E.E.)
FREEPOST, 164-167 East Road, Cambridge
CB1 1BR. Tel. 0223 312866

RADIO WORLD

By Pat Hawker, G3VA

Power and broadcasting

Broadcasters today make use of an extraordinary wide range of transmitter powers: from under 0.0005kW to over 1000kW. The lowest power units are mostly those for the local u.h.f. relays, many of which have a peak output of only 0.5 watts, with an effective radiated power of from about 6 to 10 watts depending on the gain of the aerial.

The highest power transmitters currently being used for British television are the two paralleled 40kW transmitters installed for each channel radiated from the Crystal Palace. Local radio stations are mostly under 1kW, while the highest power medium-wave transmitter in the UK has been, for many years, the old wartime 600kW "Aspidistra" transmitter at Crowborough, Sussex.

Overseas there are 110kW u.h.f. television transmitters in the United States and some medium and long-wave transmitters in Europe and the Middle East of between about 1000 and 2000kW.

Solid-state transmitters

Most of the modern radio and television transmitters now being installed for local services are of "all-solid-state" design, using modular multi-unit final power amplifier stages. Currently, for ILR services, the IBA are installing Redifon solid-state m.f. transmitters suitable for powers up to 1kW (or 2kW by using two in parallel) and Harris 0.3kW v.h.f./f.m. solid-state transmitters. Last year they put on the Hebrides the highest power all-solid-state u.h.f. television transmitter so far used in the UK—200 watts peak.

But I see that in Japan manufacturers are now developing all-solid-state designs of 5—10kW (m.f. and v.h.f. radio) and 3kW (u.h.f. television).

Experience since about 1974 has shown that the all-solid-state approach offers useful advantages for "unattended" operation since such equipment can almost be considered "fit and forget"—at least for many months at a time. The same trend is beginning to show up also in h.f. amateur radio transceivers.

A number of recent h.f. designs provide up to about 100 watts output from transistors, often incorporating broadband techniques that eliminate the need for any retuning of the power amplifier when changing bands: It also seems that in future we are likely to see similar powers from the more recent VMOS power field effect devices which should prove less vulnerable to mismatched loads, etc. Circuits providing 100 watts from two VMOS devices in push-pull have already appeared.

Power race

Recently the Prime Minister hinted at a big increase in British "propaganda" to be directed at the USSR. A few weeks

earlier it had been announced that BBC External Services are to be re-equipped with a number of 500kW h.f. transmitters—double the power of some earlier 250kW units, and many times more powerful than the bulk of the older transmitters.

While this may be necessary politically, it is rather sad news for those concerned with the poor state of the h.f. broadcasting bands and reflects the fact that the recent World Administrative Radio Conference did not produce any firm guidelines on the maximum power of h.f. broadcast transmitters. In an ideal world nobody would need 500kW on h.f.

Much of the present band congestion has been brought about by the "power race", by the many channels carrying the same programme directed at the same targets in the hope that at least one will get through the interference and "jammers" and the general overcrowding. Another conference is to be held in a few years time to try and plan the additional frequencies that have been allotted to h.f. broadcasting, but the chances that this will prove successful must be regarded as slim.

The BBC would, of course, deny that they are engaged in "propaganda" broadcasts but endeavour (with considerable success) to reflect the British "way of life". But then has it not been said that "propaganda is that branch of lying which consists in very nearly deceiving your friends without quite deceiving your enemies"?

Curiously enough, I once had a good reason to be grateful to BBC News for getting things wrong. About August 22, 1944 they announced that Paris had been "liberated" by the French Resistance; in fact this did not happen until August 25.

For rather complicated reasons, this resulted in my arrival in the city very soon after the real liberation, a privilege not accorded to many British service personnel—and I spent six interesting weeks there as a radio operator. Indeed on August 29, while in the Champs d'Elysee, I actually watched a very controversial American-French "victory parade" that afterwards was formally denied (on BBC and in the British and American press) as having ever taken place! It was clearly one of those occasions that merited Churchill's famous phrase that, in wartime, "Truth is so precious she should always be attended by a bodyguard of lies."

Space television

There has been a remarkable growth of public interest in the idea of direct-broadcast satellites since the Home Office announcement that serious consideration is to be given to the implementation by the UK of the 1977 ITU Plan which permits the British to operate up to five channels of television in the 12GHz band from an orbital position of 31 degrees

West. France and West Germany are currently planning two three-channel direct-broadcast satellites for a "pre-operational" phase starting in 1983-84.

Comsat in the USA have stated their wish to put up a direct-broadcast satellite (although so far have not filed a formal plan with the FCC) to join the massive use of the 4/6GHz 5 to 10 watt satellites as "distribution links" for cable networks. These are already in full swing throughout North America with some 2000 receive-only terminals and a sprinkling of enthusiasts with equipment capable of receiving directly from these satellites.

Several years ago it was noted that the television situation in the UK is different to that found elsewhere. This is mainly because of our very sophisticated (and unique) u.h.f. terrestrial system which has been designed to provide four different programme channels to over 99 per cent of the population. The American aim of providing cable systems carrying 24 or even 48 programme channels could not easily be met in Europe by direct-broadcast satellites, even if a satisfactory way of paying for such enormous programme choice could be devised.

As others have pointed out: "The question of broadcasting from spacecraft (in the UK) will be one of need, desire or choice, rather than technological possibility or timescale". In other words, with our four-channel u.h.f. system due to be fully implemented in the course of the next five years or so, will we need to rush into orbit before say 1990 or so? The aerospace and electronics industry, however, may feel their future depends on space.

Footprints

There is, of course, the argument that if we don't then British audiences will be won away from the BBC and IBA by the space sirens of France, Germany and Luxembourg, although this argument seems less convincing than it is sometimes made out to be. Still, I suspect that in the months ahead we shall all be hearing a good deal about "footprints" (areas covered from satellites), "overspill" (areas of neighbouring countries that a satellite is virtually bound to cover even if fully conforming to the ITU 1977 Plan), and the European Space Agency's "L-Sat" (the large space platform which, with the help of the later Ariane launchers, could put a fully-equipped direct-broadcast satellite into geostationary orbit).

Meanwhile, by the time these notes appear, the Second Ariane launch from French Guiana, on or about May 23, may have put the first of the Phase 3A Oscar amateur radio satellites into a highly elliptical orbit taking it up to almost 36,000km above Earth (perigee 200km). If all goes well it will be able to provide long-distance two-way contacts on s.s.b. telephony or morse.

Amateurs will be able to transmit "up" on or about 435.2MHz, with the "down" signals on or about 145MHz. By comparison, all the previous eight Oscar amateur radio satellites have been in relatively low orbits, limiting the distance covered and also the time during which the satellite is available on each orbit.

However, it will need a transmitter of medium power and a fairly sensitive receiver. Beacons will operate on frequencies of 145.810 and 145.990MHz.

Everyday News

COMPUTER THAT TALKS

A LEADING micro-chip manufacturer, Texas Instruments, announced recently the availability in the UK of a new computer called the TI-99/4 Home Computer. The system is based on the 9900 Family microprocessor, and is the first 16-bit machine to be aimed at the UK domestic market.

Primarily intended for use in the home by all the family, this powerful and versatile device will also find many uses and applications in the office, at schools and colleges and in the laboratory.

The brain of the unit is located in a streamlined main Console fitted with a staggered Qwerty keyboard. Total on-board memory supplied is 42 kbytes divided up as 16 kbytes of RAM and 26 kbytes of ROM; 14 kbytes of the latter are devoted to an extremely powerful TI BASIC interpreter. Additional memory can be added.

Basic/Graphics

The in-built TI-BASIC has full floating point 15-digit expanded BASIC fully compatible with ASCII and the basic specifications of ANSI, has 33 statements, 19 system functions and 14 commands. There are powerful editing facilities incorporated, colour graphics, sound and music, and an equation calculator for maths and complex scientific calculations.

The graphical capabilities need to be seen to be believed. The user is able to specify the colour of graphic characters and screen background from a choice of 16 different colours. All 16 colours can be used on the screen at one time. Video resolution is 192 x 256 producing very clearcut displays and this with the colour abilities makes charts and graphs much easier to read and games more exciting and realistic.

Graphic "priority" facility allows graphics to pass behind or in front of others. Most effective for games.

If your graphical requirements are not met by those contained in in-built ROM, you can easily "paint" your own shapes, drawings, pictures and gameboards by calling a special in-built sub-program.

The in-built sound generator permits tunes to be

"composed" when a CALL SOUND program is called up. The notes can cover a five octave range (within 110Hz to 40kHz) with simultaneous 3-note generation to allow chords. A noise source is also included to produce sound effects. All these sounds can be heard through the speaker in the Console.

Even those without programming experience can immediately use the computer to solve problems, use it for personal finance, record keeping, education for the children and entertainment for all the family by using the TI Solid State Software Command Modules. These contain programs in ROM (up to 30 kbytes) and are contained in a cassette-like box which plugs into a slot on the Console. This is not a tape and has no moving parts. The program is available immediately the module is inserted and instructs you what to do. Modules are available for Personal Record Keeping, Statistics, Household Money Management, Pre-school Early Learning Fun, Number Magic, Beginning Grammar, Video Games, and Video Chess. TI are committed to continuing development of "module" programs to meet many needs and interests.

Audio/Visual

The Educational programs for children are of particular interest, where colourful displays are supplemented by sounds and tunes. Even young children after initial instruction can use the machine for learning number, the alphabet and grammar by an audio/visual method.

Accessories for the 99/4 are a pair of 8-position joysticks with action button—ideal for games; a 32-column

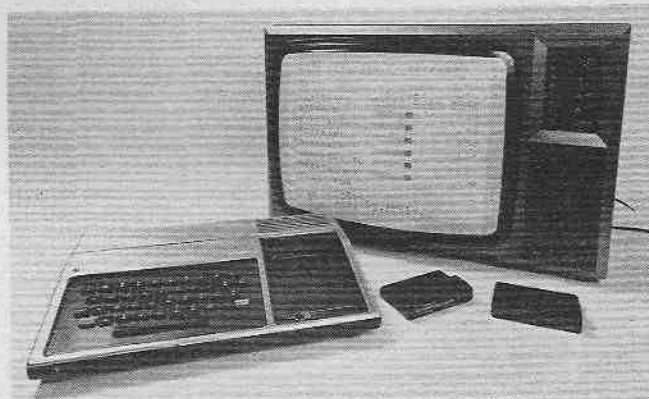

Shown here is the first talking computer for the home. Designed by Texas Instruments, it brings push-button computing power into the home for education, personal finance, record keeping and entertainment.



thermal printer with upper and lower case characters, graphics including user defined; floppy disc storage system; a peripheral adaptor for industry standard printers, remote keyboards, acoustic couplers etc; and last but by no means least, a speech synthesizer.

Speech

The speech synthesiser allows your computer to literally speak by simulating the human voice, in a very clear and precise manner. It has a vocabulary of 373 words which can be used as verbal instructions and prompts within programs, and for message purposes, from typed in material. Plug-in

word modules will allow, e.g., medical, legal, technical and other specialised vocabularies to be handled as well as foreign languages.

A noteworthy design feature of the TI peripherals is the elimination of inter-connecting cables. Peripherals simply plug into the side of an adjoining one.

The computer can be connected to a video colour monitor or a colour TV set equipped with an NTSC video input connector. These will be available from 99/4 stockists.

The Home Computer Console is guaranteed for a period of 12 months and will cost from £990 including the TV set. The unit can be purchased separately for £650.



ANALYSIS

JUST LIKE REAL

One of the big boom activities in electronics is the simulator, a faked-up but realistic version of an operational equipment and its functions. The idea is not new. The Link trainer for teaching blind-flying to pilots was popular over 40 years ago. You sat in a hooded cockpit and "flew" entirely by instruments under the supervision of an instructor. If you "crashed" it might cost you the price of a drink for the instructor. But you lived to try again.

Today, with the ready availability of cheap computing power and other electronic aids the flight simulator is virtually indistinguishable from the real thing. Climb into the British Airways simulator in Aberdeen, for example, and you can fly a complete mission by S-61N helicopter to a North Sea oil rig without leaving the ground.

Open the throttles and the engine noise increases. Lift off and watch the ground recede. Six hydraulic jacks provide the sensations of pitch and roll, surge and sway. All the instruments and navigational aids operate as in real life.

Approach to the oil rig platform may be in daylight, twilight or darkness and practice landings made in wind speeds of 50 or 60 knots, typical of tough North Sea conditions. This particular simulator cost £1.8 million and is worth every penny in fuel saved and real aircraft released for revenue earning operations.

You can buy a simulator for almost any activity, both civil and military. Trains, cars, ships, power stations, weapons of all sorts. Mostly they are used for training.

The British Army uses Marconi's Master Gunner for classroom training of forward observation officers. A full colour panoramic view of the battlefield is projected and computer-generated animated targets, shell-bursts, rising dust and smoke are superimposed. Four loudspeakers provide noise effects of own and enemy gunfire. It is highly realistic and recovers its cost many times over in saving on live ammunition.

But so realistic and flexible is the modern simulator that it can also be used for operational research. In an electronic warfare scenario the effects of various types of jamming on one's own or on enemy radars can be assessed and suitable countermeasures developed.

Brian G. Peck

Dental History

A dental management system designed by Racial Information Systems gives dentists instant access on a c.r.t. display to a patient's clinical notes and a graphical reproduction of his or her tooth chart.

The largest system can accommodate 64,000 patient records. A keyboard entry up-dates the record after each treatment.

UK Trinitrons

Production of Sony Trinitron colour TV tubes will start next year in a new plant at Bridgend, South Wales. The new factory will be complementary to the present TV assembly plant and an annual production rate of 150,000 sets is planned.

Sony, although Japanese owned, received a Queen's Award for export achievement this year with over 50 percent of production sent overseas. Sony is expected to employ 1,000 people at Bridgend by 1981.

CHIPS AT WORK

At a recent conference in Birmingham organised by the University of Aston most specialist speakers agreed that unemployment predictions following widespread introduction of the "chip" were grossly exaggerated.

FOUR-COLOUR LED

A light emitting diode that can emit red, yellow, orange or green light has been developed by Sanyo. It uses four layers of gallium phosphate, the colour required being determined by the current through the device.

No Lead Guitar

No trailing leads are needed with electric guitars for users of the Rello TXGT Guitar Radio Transmitter System. The short-range radio is the size of a cigarette packet and can be slipped in a pocket. The equipment is made by Martello Sound, Rye, East Sussex.

Stereo radio on the medium waveband is being made available in the United States following the choice of one of six proposed systems. That chosen was developed by Magnavox, a US subsidiary of the European Philips company.

VHF Up-Date

After 25 years' of service the BBC's first v.h.f. broadcast transmitters at Wrotham, Kent, are being retired and replaced with six new transmitters supplied by Marconi.

Advances in technology over 2½ decades have resulted in the new transmitters being less than one-eighth of the size of the originals and they consume less input power for the same output.

Euro-TV

Europe could have its first commercial TV service by satellite by 1983. Radio Luxembourg is planning a service. So is a Swiss-based consortium in which Britain might have a stake through Thorn-EMI.

Political difficulties could cause delay but few observers doubt that satellite TV giving blanket coverage of large areas of Europe will be with us by the mid-80s—will we need a European TV licence?

SOLAR COOLING

We usually think of solar energy for heating. Now an American company is experimenting with two types of solar-powered air-conditioning cooling units.

These coolers are to be tested in Phoenix, Arizona, where it is anticipated that they will handle 60-70 percent of the building's cooling needs. The experiments are part of a joint US/Saudi Arabian project.

NUCLEAR BODY SCANNING

A new type of medical diagnostic body scanner is under development and will be used experimentally at Hamner-Smith Hospital, London. If successful it could supplant the conventional X-ray type scanner now in use. Instead of X-rays the new machine exploits nuclear magnetic resonance (NMR) techniques to build up a picture of the condition of body tissues.

The technique of NMR spectroscopy has been used for chemical analysis for years. Now, with advanced superconducting magnets it can be applied to larger areas such as a human body and will allow better examination of soft tissues as well as being safer for the patient than X-ray techniques.

Audio Millivoltmeter

BY R. A. PENFOLD



FOR SIGNAL MEASUREMENT
ON AUDIO EQUIPMENT DOWN TO
10mV R.M.S FULL SCALE

AN audio millivoltmeter is really just a form of a.c. voltmeter, and it only differs from an ordinary multimeter switched to read a.c. volts in that it is much more sensitive.

Whereas the a.c. voltage ranges of a multimeter usually start at a few volts f.s.d. (full scale deflection), the ranges of a millivoltmeter usually start at a few millivolts f.s.d. and often go no higher than a few volts f.s.d. In other words, a millivoltmeter carries on in the high sensitivity direction where a multimeter leaves off.

An a.f. millivoltmeter can be invaluable when dealing with audio equipment, and also when working with many other items of equipment such as electronic musical instruments, radio receivers, ultrasonic systems; in fact any electronic gear which handles small, low frequency signals.

It can be used for such measurements as signal to noise ratio, determining output signal levels, frequency response, and voltage gain. For the last two types of measurement an a.f. signal generator is also required, and these two items of test gear should be regarded as virtually essential for anyone seriously interested in the practical side of audio.

It is not uncommon for audio millivoltmeter designs to be rather complicated, but the design featured here performs quite well despite the fact that it uses only one active component plus a few passive devices.

It has six measuring ranges which are as follows: Range 1 0-10mV; Range 2 0-20mV; Range 3 0-100mV; Range 4 0-200mV; Range 5 0-1V; Range 6 0-2V. The input impedance of the circuit is 1 megohm.

PRECISION RECTIFIERS

A moving-coil meter cannot be used to directly measure a.c. voltages as it will only give a positive deflection if the input signal is of the correct polarity. If an a.c. signal is applied to a moving coil meter, one set of half cycles will produce a positive deflection and the other set will produce a reverse deflection.

In practice the inertia of the meter pointer will prevent it from following each half cycle and it will instead respond to the average input voltage, which is zero since the positive and negative half cycles cancel out one another.

This problem can be overcome by adding a diode in series with the meter, as shown in Fig. 1(a). In theory this is quite acceptable as a theoretically perfect diode will have zero or a fairly low and fixed forward resistance, and an infinite or at least very high reverse resistance.

This would result in the elimination of half cycles of the wrong polarity and would not affect the linearity of the circuit.

DIODE LINEARITY

Unfortunately, practical diodes tend to have a resistance which varies with the applied forward bias. At most voltages the forward resistance is quite low, but with only a small forward bias (say a few hundred millivolts or less) this resistance increases considerably.

When measuring fairly high voltages this does not really affect linearity much since there is a reasonably high voltage applied to the circuit for a large proportion of the time. However, when measuring small voltages the non-linearity of the diode will obviously have a profound effect on results.

It is for this reason that some multi-meters do not have very low a.c. voltage ranges, and those that do have a separate non-linear scale for the lowest range(s).

The conventional way of overcoming this problem in an audio millivoltmeter circuit is to use the basic configuration shown in Fig. 1(b). Here the diode is included in the negative feedback loop of an amplifier.

The gain of the amplifier without any feedback applied, or open loop gain as it is termed, must be very high. The voltage gain of the circuit with feedback applied, or closed loop gain, is controlled by the resistances of $D1$, $R2$ and $R1$. The higher the resistance of $D1$ and $R2$ in series compared with that of $R1$, the higher the closed loop gain of the circuit.

PRINCIPLE OF OPERATION

The action of the circuit is quite simple. Negative input half cycles have no effect on the circuit as $D1$

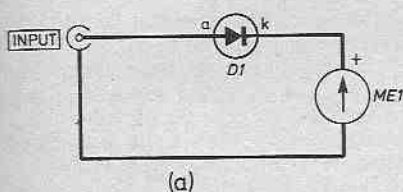

(a)

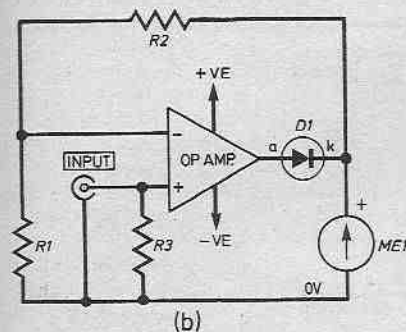

(b)

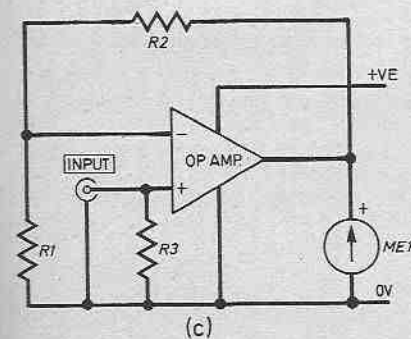

(c)

Fig. 1. (a) Simple rectifier circuit (b) operational amplifier rectifier and meter circuit (c) single rail supply a.c. voltage measuring circuit.

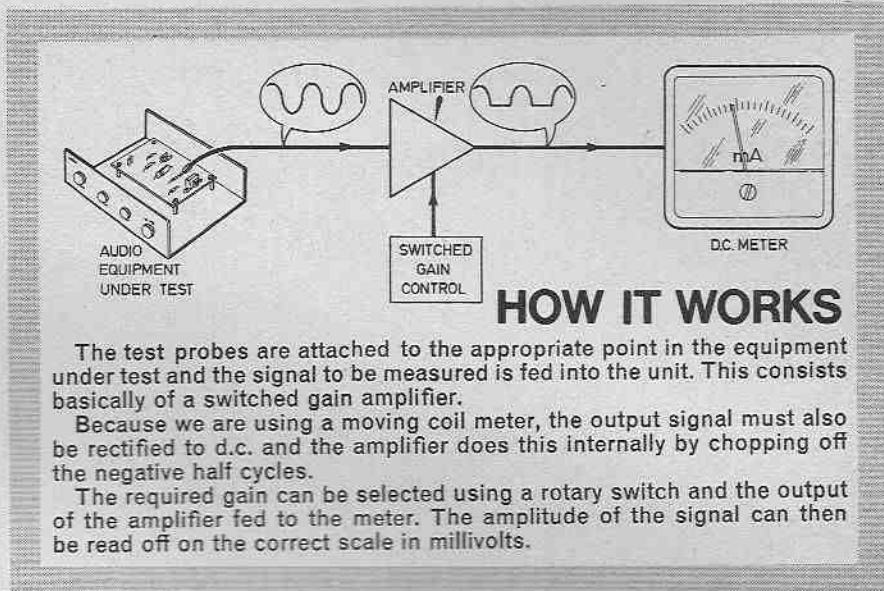

The test probes are attached to the appropriate point in the equipment under test and the signal to be measured is fed into the unit. This consists basically of a switched gain amplifier.

Because we are using a moving coil meter, the output signal must also be rectified to d.c. and the amplifier does this internally by chopping off the negative half cycles.

The required gain can be selected using a rotary switch and the output of the amplifier fed to the meter. The amplitude of the signal can then be read off on the correct scale in millivolts.

will block negative output signals from the meter. On positive input half cycles the gain of the circuit will initially be very high because the forward resistance of $D1$ will be high, and little feedback will be applied to the circuit.

This results in quite a large rise in the output voltage, and this compensates for the high resistance of $D1$. Once the initial high resistance of $D1$ has been overcome, the gain of the circuit falls to a level set by $R1$ and $R2$.

Therefore, the higher the resistance of $D1$, the higher the gain of the circuit, and thus a linear relationship between input voltage and meter reading is obtained.

SLEW RATE

One problem with this circuit is that because the amplifier has a very high level of gain at the beginning and end of each output half cycle when the resistance of $D1$ will be high, the output voltage is called upon to change very rapidly on these occasions, far more rapidly than if it was used as a straight forward amplifier.

The maximum rate at which the output potential of an amplifier can change is known as the slew rate, and is normally expressed in terms of the maximum voltage change that can occur in one microsecond.

Modern operational amplifiers have quite high slew rates, but even so, they usually prove inadequate in this type of circuit at high input frequencies with a resultant loss of linearity.

OP-AMP RECTIFIER

In theory it is possible to use an operational amplifier itself as a precision rectifier using the configuration

given in Fig. 1(c). Here the device is used in what is basically a straight forward amplifier, but the usual (for op-amp circuits) dual balanced positive and negative supplies have been replaced by a single positive supply.

On positive input half cycles the circuit operates in the normal way, but on negative going half cycles there is no effect on the circuit. The output cannot go negative of the 0V rail as there is no negative supply.

Thus the circuit operates as a precision halfwave rectifier, and it is this configuration which is used in the audio millivoltmeter described in this article.

THE CIRCUIT

The complete circuit diagram of the Audio Millivoltmeter appears in Fig. 2. The non-inverting (+) input of IC1 is biased by $R1$ to the earth rail voltage, and this component sets the input impedance of the circuit at about 1 megohm.

It is normal for equipment of this type to have a high input impedance so that it has little loading effect on any circuit to which it is connected. C1 provides d.c. blocking at the input.

The output of IC1 connects to the meter via VR2, R11 and S2, and VR2 enables the sensitivity of the circuit to be set to the correct level. When S2 is in the BATTERY CHECK position the meter is connected across the supply lines via R12, and the latter converts the meter to a 10 volt f.s.d. d.c. voltmeter. This enables the battery condition to be checked.

VOLTAGE GAIN

The voltage gain of IC1 (closed loop) is determined by the feedback resistors, and is equal to the resistance

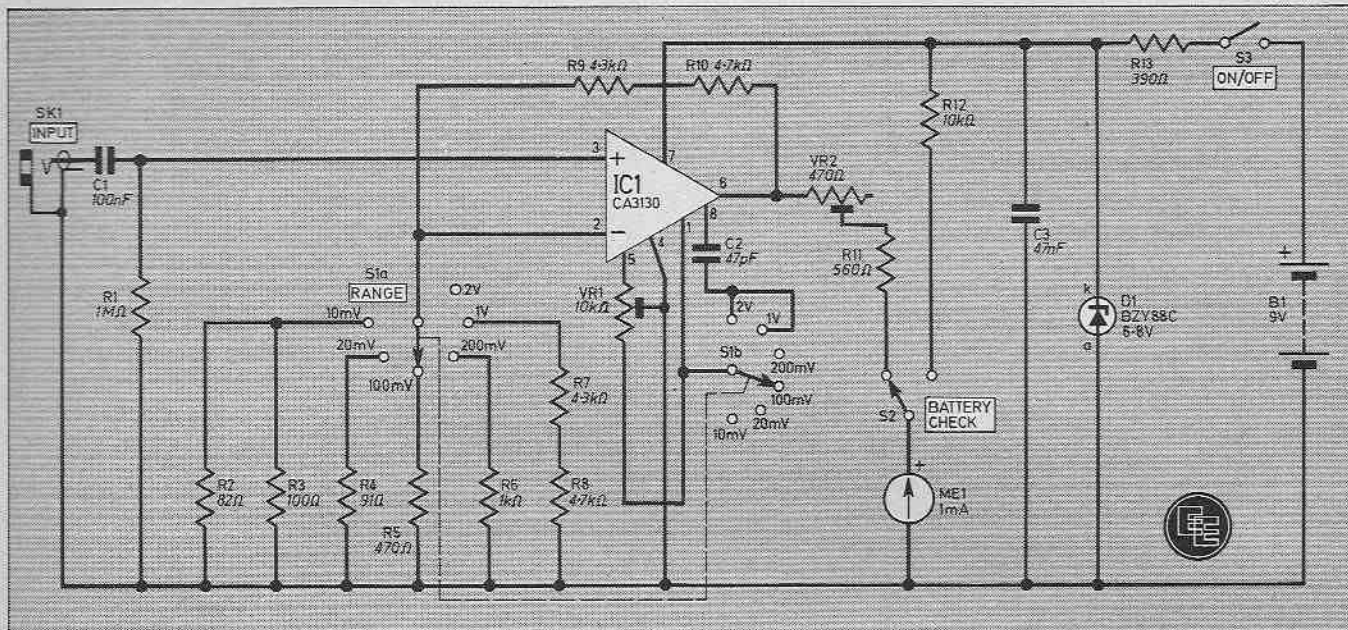

Fig. 2. Complete circuit diagram of the Audio Millivoltmeter.

between the output and inverting input plus the resistance between this input and earth, divided by the resistance between the inverting input and earth.

Thus in the 1V position of S1 the circuit has a gain of two. In the 200mV position the gain is ten times, the gain being increased by a factor of five, and the sensitivity being similarly increased. By having six switched gain levels the six measuring ranges are produced.

Capacitor C2 is a compensation device and this is needed in order to aid the stability of the circuit. This is only needed on the 2 and 1 volt ranges, and is switched out of circuit by S1b on the other ranges. Leaving it in circuit on these ranges would result in a comparatively poor high frequency response.

The frequency response of the unit is flat over the audio frequency spectrum on any range, and on most ranges it extends well beyond the upper audio limit (about 20kHz).

Capacitor C3 is needed in order to aid stability and decouple the power supply.

OFFSET VOLTAGE

Theoretically, under quiescent conditions the output will be at the 0V supply potential, but in a practical circuit a small output voltage or 'offset' voltage is produced.

This voltage is only a few millivolts at most, but is multiplied by the voltage gain of the circuit and is therefore quite substantial on the most sensitive ranges. This would obviously produce a strong indication

on the meter unless steps were taken to compensate for the offset voltage.

Preset VR1 is what is known as an "offset null control", and this can be used to remove the offset voltage and zero the meter. The offset null circuitry is affected to some degree by variations in the supply voltage, and so a simple zener regulator circuit

consisting of R13 and D1 is used to stabilise the supply voltage.

It should perhaps be pointed out that most operational amplifiers will not operate in this circuit since they cannot operate with their input and output terminals at and very close to the negative supply rail. Do not use a substitute for the CA3130T.

COMPONENTS

Resistors

| | |
|------------------------------|-----------|
| R1 1MΩ | R7 4.3kΩ |
| R2 82Ω | R8 4.7kΩ |
| R3 100Ω | R9 4.3kΩ |
| R4 91Ω | R10 4.7kΩ |
| R5 470Ω | R11 560Ω |
| R6 1kΩ | R12 10kΩ |
| All ½W carbon ± 2% or better | R13 390Ω |

Potentiometers

| |
|-----------------------------------------|
| VR1 10kΩ subminiature horizontal preset |
| VR2 470Ω subminiature horizontal preset |

Capacitors

| |
|--------------------|
| C1 100nF polyester |
| C2 47pF ceramic |
| C3 47nF ceramic |

Semiconductors

| |
|-------------------------------------|
| IC1 CA3130T operational amplifier |
| D1 BZY88C6V8 6.8V 400mW Zener diode |

Miscellaneous

| |
|---------------------------------------------|
| ME1 1mA f.s.d. moving coil meter (see text) |
| S1 2-pole, 6-way rotary switch |
| S2 s.p.d.t. miniature toggle |
| S3 rotary on/off |
| SK1 3.5mm jack socket |
| B1 9V type PP3 |

Case, 205 × 140 × 75mm, Verocase 75-1411-D or similar; plain 0.1 inch matrix s.r.b.p. board, 16 × 18 holes; control knobs (2 off); PP3 battery connector; connecting wire; screened cable.

See
**Shop
Talk**

Page 481

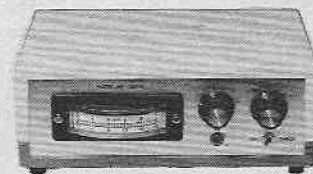

COMPONENTS
approximate
cost **£14**

CONSTRUCTION starts here

CASE

A Verocase type I (205×140×75mm) or similar cabinet will provide a suitable housing for this project. A case of all metal construction would have the advantage of screening the circuitry, but this is by no means essential.

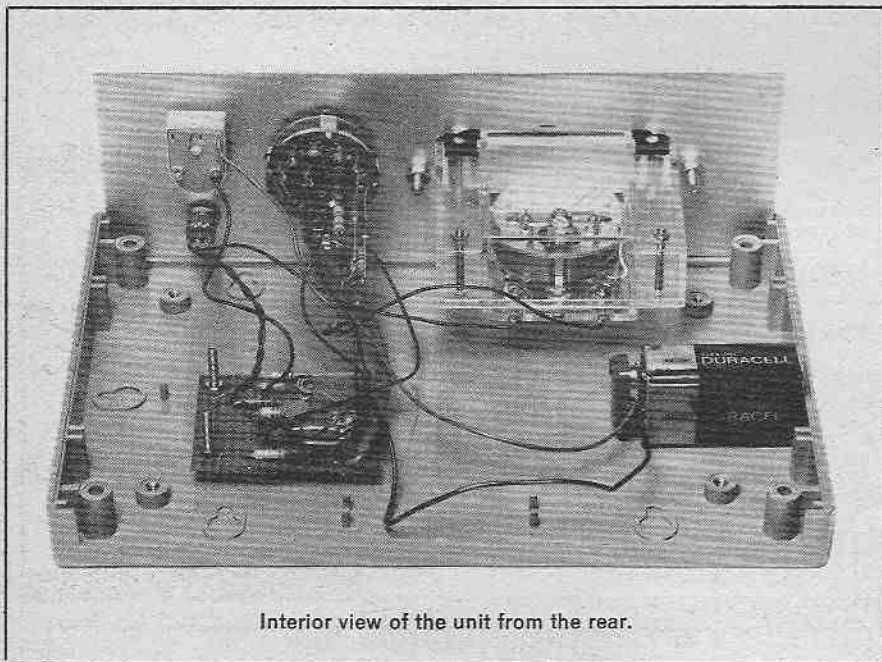

Interior view of the unit from the rear.

The front panel layout can be seen from the accompanying photographs, but is not critical. An edgewise panel meter is used on the prototype, but any moving coil meter of the correct sensitivity should be suitable, provided it is physically small enough to fit the case selected of course.

Whatever type of meter is chosen, it will require a large cutout which can be made using a fretsaw or a needle file. The input socket is a 3.5mm jack type.

CIRCUIT BOARD

Much of the circuitry is wired up on a 0.1 inch plain matrix board, and details of this are given in Fig. 4. It is strongly recommended that this layout should be used as component layout is quite critical, and poor design work here could easily lead to instability in the finished unit. Stripboard is far from ideal for this type of circuit and should not be used.

Start by cutting out a panel having 16×18 holes using a hacksaw and then drill the two 3.2mm diameter mounting holes. Next begin to mount the components in the positions indicated in the diagram. Bend their lead-out wires and tags flat against the underside of the panel, cut the lead-outs to length, and solder them together to conform to the underside view of Fig. 4. Continue this process until the panel is completed.

Resistors R2 to R8 are not mounted on the panel, but are wired direct to S1, as shown in Fig. 3. Next the point to point wiring is completed, as detailed in Figs. 3 and 4 and finally, the component panel is mounted on the base of the cabinet to the rear of the controls using 6BA or M3 nuts

and bolts. Note that a screened lead should be used to connect the input socket to the component panel.

ADJUSTMENT AND USE

At the outset VR1 should be adjusted in an almost fully anticlockwise position, and VR2 should be put in a fully clockwise setting. An ordinary screened test lead with suitable prods is connected to the input, and initially the two test prods are shorted together. When the unit is switched on there should be no deflection of the meter.

Set S1 to the 10mV range and slowly adjust VR1 in a clockwise direction. At roughly a midpoint setting of VR1 this should begin to produce a positive deflection of the meter pointer. The potentiometer should be adjusted as far as possible in a clockwise direction without any significant deflection of the pointer being produced.

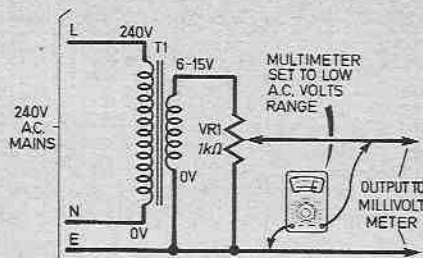

Fig. 5. The circuit for obtaining a calibration signal from the mains.

In order to calibrate the unit an a.c. signal of known amplitude (and which falls within the coverage of the millivoltmeter) is required.

Such a signal could, for example, be obtained from an a.f. signal generator set for sinewave output at a frequency of a few hundred hertz. If the signal generator has some form of accurate output level calibration, it is simply a matter of adjusting it to produce an output of say 1 or 2 volts r.m.s., switching S1 to the appropriate range, coupling the signal generator to the millivoltmeter, and finally adjusting VR2 for a full scale reading on the meter.

If the signal generator does not have suitable calibration, the output amplitude can be set to the required level with in aid of a multimeter set to a low a.c. volts range and used to monitor the output from the signal generator.

If a suitable signal generator is not available it is possible to use some other signal source. For instance, a mains transformer having a secondary voltage of something in the region of 6 to 15 volts can be used in the manner illustrated in Fig. 5, where VR1 is used to set the required output voltage.

Do not try to obtain a calibration signal direct from the mains. This can be very dangerous.

On the prototype a 0 to 20 scale was added to the meter for greater convenience when taking readings on the 20mV, 200mV, and 2V ranges, but as it is quite easy to convert the meter reading into terms of actual voltage anyway, this is not essential. ☐



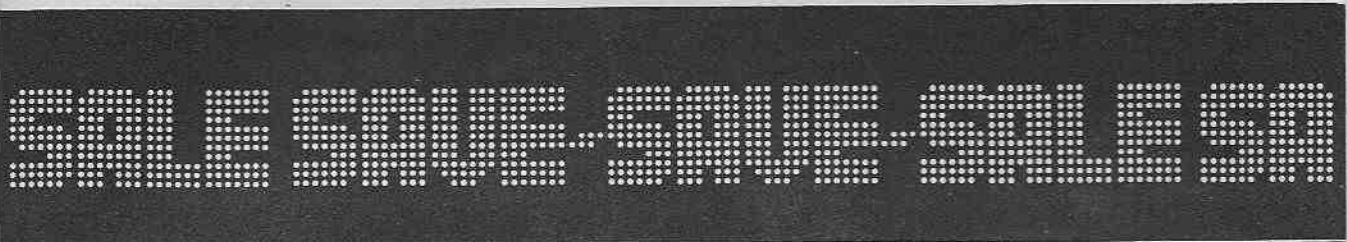

| | | | |
|--------------------------------------------------------------------------------------------------------------------------------------------------------------------------------------------|------------------------------------------------------------------------------------------------------------------------------------------------------|------------------------------------------------------------------------------------------------------------------------------------------------------------------------------------------------------|---------------------------------------------------------------------------------------------------------------------------------------------------------------------------------------------------------------------------------------------|
| <p>GERM. DIODES</p> <p>200 Mixed Diodes—mainly Germ OA81-91-1N34/60 GC61/62 etc. Case DO-7. Coded and uncoded—You to test—Value all the way!</p> <p>O/No. SJ127. £1-00 per Pak.</p> | <p>BC108 FALLOUTS</p> <p>Manufacturers out of spec on volts or gain or neither—Metal TO18 case—You test.</p> <p>O/No. SJ124. 50 for £1-00</p> | <p>NPN</p> <p>BD131 TO-128-NPN untested. O/No. SJ84. 25 for £1-00</p> <p>SCR'S</p> <p>TO60 SCR'S 5 Amp—ALL good—untested for volt—good yield 400+. O/No. SJ130. 10 for £1.</p> | <p>IC SOCKET PAKS</p> <p>SJ36 14 8 pin SJ37 12 14 pin SJ38 11 16 pin SJ39 8 18 pin SJ40 7 20 pin</p> <p>SJ41 6 22 pin SJ42 5 24 pin SJ43 4 28 pin SJ44 3 40 pin</p> <p>ALL AT ONLY £1-00 each</p> |
|--------------------------------------------------------------------------------------------------------------------------------------------------------------------------------------------|------------------------------------------------------------------------------------------------------------------------------------------------------|------------------------------------------------------------------------------------------------------------------------------------------------------------------------------------------------------|---------------------------------------------------------------------------------------------------------------------------------------------------------------------------------------------------------------------------------------------|

| | | | | | | | | | | | | | | | |
|-----------------------------------------------------------------------------------------------------------------------------------------------------------------------------------------------------------|---------------------------------------------------------------------------------------------------------------------------------------------------------------------------------------------------------------------------------------------|-----------------------------------------------------------------------------------------------------------------------------------------------------------------------------------------------------------------------|---------------------------------------------------------------------------------------------------------------------------------------------------------------------------------------------------------------------------------------------------------------------------------------------------------------------------------------------------------------------------------------------------------------------------------------|-----------------|-----------------|--------------|--------------|--------------|--------------|--------------|--------------|--------------|--------------|--------------|--------------|
| <p>SIL DIODES</p> <p>200 Mixed Diodes—mainly SILICON case DO-7 OA200/202 General purpose 200mA marked and uncoded—you to sort & test—Outstanding Value!</p> <p>O/No. SJ128. £1-00 per Pak.</p> | <p>DIODES</p> <p>300 IN4148 Type—uncoded Silicon Diodes Case DO-35—you to test. O/No. SJ129. £1-00 per Pak.</p> <p>Silicon Fast Switch NPN—like 2N706/2N2369 You select by test!</p> <p>O/No. SJ125. 50 for £1-00</p> | <p>AERIALS</p> <p>FM Indoor Tape/Ribbon Aerial O/No. 107. 40p each.</p> <p>HI-FI CAR AERIAL 4-section fully retractable & locking</p> <p>SPECIAL PRICE O/No. 109. £1-40 each</p> | <p>VOLTAGE REGULATORS</p> <p>Cast TO220</p> <table border="0"> <tr> <td>Positive</td> <td>Negative</td> </tr> <tr> <td>uA8705 £0-65</td> <td>uA7905 £0-70</td> </tr> <tr> <td>uA7812 £0-65</td> <td>uA7912 £0-70</td> </tr> <tr> <td>uA7815 £0-65</td> <td>uA7915 £0-70</td> </tr> <tr> <td>uA7818 £0-65</td> <td>uA7918 £0-70</td> </tr> <tr> <td>uA7824 £0-65</td> <td>uA7924 £0-70</td> </tr> </table> | Positive | Negative | uA8705 £0-65 | uA7905 £0-70 | uA7812 £0-65 | uA7912 £0-70 | uA7815 £0-65 | uA7915 £0-70 | uA7818 £0-65 | uA7918 £0-70 | uA7824 £0-65 | uA7924 £0-70 |
| Positive | Negative | | | | | | | | | | | | | | |
| uA8705 £0-65 | uA7905 £0-70 | | | | | | | | | | | | | | |
| uA7812 £0-65 | uA7912 £0-70 | | | | | | | | | | | | | | |
| uA7815 £0-65 | uA7915 £0-70 | | | | | | | | | | | | | | |
| uA7818 £0-65 | uA7918 £0-70 | | | | | | | | | | | | | | |
| uA7824 £0-65 | uA7924 £0-70 | | | | | | | | | | | | | | |

| | | | |
|------------------------------------------------------------------------------------------------------------------------------|------------------------------------------------------------------------------------------------------------------------------------------------------------------------------------------------------------------------------------------------------------------------------------|----------------------------------------------------------------------------------------------------------------------------------------------------------------------------------------------------------------------|----------------------------------------------------------------------------------------------------------------------------------------------------------------------------|
| <p>AUDIO AMPLIFIER</p> <p>5 watt Audio Amplifier Module. Special Clearance Offer.</p> <p>O/No. AL20. £2-50</p> | <p>GERM. TRANSISTORS</p> <p>The last of the Germanium PNP—OC71-71-75 etc. Mullard Black/Glass Type—You test (5 could cost you that!) O/No. SJ125. 50 pcs £1-00</p> <p>GERM. POWER TRANS.</p> <p>AD149-OC26-AD140 £0-50 each AD142-OC29-2N2614 £0-65 each</p> | <p>STEREO 30</p> <p>Complete 7 watt per channel Stereo Amplifier Board—includes amps, pre-amp, power supply, front panel, knobs etc. PLUS transformer and real Teak Cabinet for that professional finish.</p> | <p>TEXAS NPN</p> <p>Texas NPN silicon transistors metal can—perfect and coded. 2S503=BC108 TO-18. O/No. SJ29. 50 off £2-50 100 off £4-00. 1,000 off £35-00.</p> |
|------------------------------------------------------------------------------------------------------------------------------|------------------------------------------------------------------------------------------------------------------------------------------------------------------------------------------------------------------------------------------------------------------------------------|----------------------------------------------------------------------------------------------------------------------------------------------------------------------------------------------------------------------|----------------------------------------------------------------------------------------------------------------------------------------------------------------------------|

| | | | |
|------------------------------------------------------------------------------------------------------------------------------------------------------------------------------------------------------------------------------------------------------------------------------------------------------------------------|----------------------------------------------------------------------------------------------------------------------------------------------------|-------------------------------------------------------------------------------------|--------------------------------------------------------------------------------------------------------------------------------------------------------------------------------------------------------------------------------------------------------------------------------------------------------------------------------------------------------------------------|
| <p>HEADPHONES</p> <p>NEW Improved Lightweight Stereo Headphones Including double headband and padded earcups—impedance 8 ohms—Frequency 30-18000HZ ALL Black. O/No. 885. £4-00</p> <p>As above but with coiled lead. As above but with coiled lead and rotary volume controls. O/No. 884. £7-00</p> | <p>VERO PLASTIC CASE</p> <p>Complete with lid and fixing screws. Finished white. Size: 72mm x 50mm x 25mm.</p> <p>O/No. 173. £0-35 each</p> | <p>SPECIAL SALE PRICE</p> <p>SAVING £5!</p> <p>ONLY £25-00</p> | <p>AUDIO ACCESSORIES</p> <p>SJ75. FM coax cable—plain copper conduction cellular polythene insulated & plain copper braided PVC sheath—impedance 75 ohms £0-10 per metre</p> <p>SJ76. 1 Board containing 2 x 5 pin DIN sockets 180° 02-2 pin DIN loudspeaker sockets £0-30.</p> <p>SJ77. A 5-pin DIN 180° chassis/normal socket incl. DPDT switch. £0-20.</p> |
|------------------------------------------------------------------------------------------------------------------------------------------------------------------------------------------------------------------------------------------------------------------------------------------------------------------------|----------------------------------------------------------------------------------------------------------------------------------------------------|-------------------------------------------------------------------------------------|--------------------------------------------------------------------------------------------------------------------------------------------------------------------------------------------------------------------------------------------------------------------------------------------------------------------------------------------------------------------------|

HEADPHONE ACCESSORIES

7 metre Headphone Extension Lead
O/No. 136. £1-50.

HEADPHONE JUNCTION BOX

Gives facility for using Stereo Headphones with amplifiers and radiograms which do not have a headphone outlet. **TO CLEAR!**
O/No. 881. £1-20 each

ANTEX

Antex X25 Iron—25 watt soldering iron. **OUR SUPER SALE PRICE** Great reduction
O/No. 1931. £4-00

ST3 Iron Stand—Suitable for above—**OUR Sale Price**
O/No. 1939. £1-25 each.

BI-PAK'S OPTO BARGAIN OF THE YEAR!

Valued at over £18—Normal Retail—we offer you a pack of 25 Opto devices to include LED's Large and Small in Red, Green, Yellow & Clear. 7 Segment Displays both Common Cathode and Common Anode PLUS bubble type displays—like DL-33. Photo Transistors—similar to OCP71 Photo Detectors—like MEL11-12. This whole pack of 25 devices will cost you just... **£4-00!**

AND we guarantee your money back if you are not completely satisfied. FULL data etc included
O/No. SJ120.

METERS

23mm Level Meter **Special Sale Price.**
O/No. 1320 £1-00

40mm V.U. Meter **OUR SPECIAL PRICE.**
O/No. 1321 £1-50.

SILICON TRANS.

SJ25. 100 Silicon NPN transistors all perfect & coded—mixed types with data & equivalent sheet—no rejects. £2-50

SJ26. 100 Silicon PNP transistors all perfect & coded—mixed types and cases, data & equivalent sheet £2-50

SJ27. 50 Assorted pieces of SCR's, diodes & rectifiers incl. stud types, all perfect—no rejects, fully coded—data incl. £2-50

PRECISION VOM MULTITESTER

20,000ohms/volts DC Complete with test leads & Instructions. **OUR SPECIAL OFFER PRICE £11-00** each. Use your Barclay or Access Card!

LED

2nd Quality Paks

1507. 10 Assorted colours & sizes £0-65
S122. 10. 125 RED. £0-50
S123. 10. 2 RED. £0-50

LED CLIPS

1508/125. 125. 5 for £0-10
1508/2. 2. 5 for 10-12

PLUGS & SOCKETS

Set of 4 1-metre Colour coiled leads with phono plug ends—ideal for audio and test use. **Outstanding Value.**
O/No. SJ122. £1-00 per Pak

1mm Plugs & Sockets in Red & Black
O/No. SJ123. 5prs £1-00

TTL's

SJ28. 20 TTL74 series gates—assorted 7401—7460. £1-00

SJ53. Mammoth IC Pak Approx. 200 pcs assorted fall-out integrated circuits including logic 74 series—Linear audio and DTL many coded devices but some unmarked—you to identify. £1-00

NPN TRANSISTORS

SJ68. 30 ZTX300 type transistors NPN preformed for P/C Board colour coded Blue—£1-00

SJ70. 25 BC107 NPN TO106 case perfect transistors code C1359. £1-00

SJ71. 25 BC177 PNP TO106 case perfect transistors code C1395 £1-00

SJ72. 4 2N3055 silicon power NPN transistors TO3 £1-00

MISCELLANEOUS

SJ20. 2 Large croc clips 25A rated—ideal for battery chargers etc. £0-30

SJ21. Large 7 1/2" Mains Neon Tester—screw-driver chrome finish. £0-85

SJ22. Small pocket size Mains Neon Tester screwdriver. £0-55

SJ23. Siemens 220V AC relay DPDT contacts 10 amp rating—housed in plastic case. £1-00

SJ24. Black PVC tape (3) 15mm x 25m—strong tape for electrical & household use. £0-35 per roll.

CAPACITORS

SJ11. 150 Capacitors mixed types & values. £0-50

SJ12. 60 Electrolytics all sorts mixed. £0-50

SJ13. 40 Polyester/polystyrene capacitors mixed. £0-50

SJ14. 50 C280 type capacitors mixed. £1-00

SJ15. 40 High quality electrolytics 100-470µfd. £1-00

SJ16. 40 Low volts electrolytics mixed values up to 10v. £0-50

RESISTORS

SJ1. 200 Resistors mixed values. £0-50

SJ2. 200 Carbon resistors 1/2 watt preformed. £0-50

SJ3. 100 1/2 watt miniature resistors mixed values. £0-50

SJ4. 50 1/2 watt resistors mixed values £0-50

SJ5. 50 1-2 watt resistors mixed pot values. £0-50

SJ7. 30 5-10 watt wirewound resistors mixed. £0-50

POTENTIOMETERS

16173 15 Assorted Pots £0-50

SJ54. 20 Assorted Slider Pots £1-00

SJ56. 10 100C Lin Slider Pots 40mm. £0-50

16186 25 Pre-sets Assorted. £0-50

SJ49. 8 Dual gang carbon pots log and lin mixed values. £1-00

SJ50. 20 Assorted slider knobs—chrome/black. £1-00

ODDMENTS

16170. 50 metres asst. colours single strand wire. £0-50

16187. 30 metres stranded wire mixed colours. £0-50

16178. 5 Main slider switches assorted. £0-50

SJ76. 1 Board containing 2 x 5-pin DIN sockets 180° & 2 x 2-pin DIN loudspeaker sockets. £0-30

TRANSFORMERS

MINIATURE MAINS Primary 240V

| | |
|---------------------------------------|-------|
| No. Secondary | £0-35 |
| 2021. 6v-0-6v 100mA | £0-75 |
| 2022. 9v-0-9v 100mA | £0-95 |
| 2023. 12v-0-12v 100mA | £0-95 |
| 2035. 240v Primary 0-55v 2A Secondary | £5-50 |

CASSETTES

SUPER VALUE and a GREAT SAVING!!

C120 Dinky Cassettes—Low noise—astounding value and sound

O/No. SJ32. 10 for £3-50

METAL SLIDERS

Metal Case Dual Slider Pots: 45mm travel

SJ65. 10K log £0-25 each
SJ66. 100K lin £0-25 each
SJ87. Chrome slider knobs to fit £0-10 each

KNOBBS

SJ82. 5 15mm chrome knobs standard push fit. £0-50

SJ63. Instrument knob—black winged (29 x 20mm) with pointer. 1/4" standard screw fit. £0-15

SJ64. Instrument knob—black/silver aluminium top (17 x 15mm). 1/4" standard screw fit. £0-12

BI-PAK

Send your orders to Dept EE8, BI-PAK PO BOX 6, WARE, HERTS. SHOP AT: 3 BALDOCK ST, WARE, HERTS. TERMS: CASH WITH ORDER, SAME DAY DESPATCH, ACCESS. BARCLAYCARD ALSO ACCEPTED. TEL: (0920) 3182. GIRO 388 7006 ADD 15% VAT AND 50p PER ORDER POSTAGE AND PACKING.

SQUARE one

FOR BEGINNERS

OHM'S LAW

THE current that flows through a circuit is proportional to the voltage applied to that circuit and inversely proportional to the total resistance in that circuit—as contributed by components and wires.

This is a most important fundamental law governing all electric and electronic circuit theory. It is known as **Ohm's Law**.

Voltage is measured in volts (V).

Current is measured in amperes (A).

Resistance is measured in ohms (Ω).

Voltage is a term that expresses potential difference. The potential difference (p.d.) existing between the terminals of a battery is measured in volts.

When a current is flowing through a circuit, a p.d. is developed across any component that has resistance, and this is measured in volts.

If a 2 ohm resistor is connected across a 9 volt battery the current flowing through the circuit will be $9 \div 2 = 4.5$ amperes.

(A resistor is a component that has a definite known value of resistance. It is the most widely-used type of electronic component.)

The relationship between volts, amperes and ohms is clearly seen if we draw a triangle:



These capital letters are the symbols for voltage (V), current (I) and resistance (R). Note: the units in which these quantities are measured are as detailed after the second paragraph of this article.

If two quantities are known the third can be easily calculated. Cover the symbol of the unknown quantity with the finger and then the required formula will be exposed in the triangle:

$$\begin{aligned} V &= I \times R \\ I &= V \div R \\ R &= V \div I \end{aligned}$$

POWER

The power developed in any circuit is measured in watts (W), and is the product of the voltage and the current.

So 9×4.5 equals 40.5 watts.

A similar triangle can be drawn for watts, volts and current:



$$\begin{aligned} W &= V \times I \\ V &= W \div I \\ I &= W \div V \end{aligned}$$

PRACTICAL VALUES

A 9 volt battery is commonly used to provide power for electronic circuits. Typical resistor values are, however, much larger than the 2 ohms used in the example above. Values generally range from several hundred ohms to tens of thousands of ohms.

Some typical values are: 100, 220, 330, 680, 1,000, 1,500, 47,000, 100,000, 1,000,000 ohms. This is only a small selection from the large range of "preferred" values which are readily available.

The currents flowing through typical electronic circuits are thus very small, and sub-units of the ampere are used, such as milliamp (mA) which is one-thousandth of an ampere.

Sometimes it is necessary to employ an even smaller sub-unit, like the microamp (μA) which is one-thousandth of a milliamp.

TABLE 1

| Ohms | Current | |
|-----------|---------|---------|
| | mA | μA |
| 100 | 90 | 90,000 |
| 1,000 | 9 | 9,000 |
| 10,000 | 0.9 | 900 |
| 100,000 | 0.09 | 90 |
| 1,000,000 | 0.009 | 9 |

Table 1 shows the ohms-current relationship with the current from a 9V battery expressed both in mA and μA .

In practical circuits there will usually be several resistors or other circuit devices with ohmic properties, all of which influence or determine the actual current flowing.

MULTIPLES AND SUBMULTIPLES

Like current, voltages and wattages are sometimes expressed as sub-multiples of the Unit:

millivolt (mV) one-thousandth of a volt
milliwatt (mW) one-thousandth of a watt.

Resistance values are frequently expressed as multiples of the Unit:

kilohm (k Ω) 1,000 ohms
megohm (M Ω) 1,000,000 ohms

Bind it

It's so easy and tidy with the Easibind to file your copies away. Each binder is designed to hold approximately 12 issues and is bound and blocked with the Everyday Electronics logo. Gold lettraset supplied for self blocking of volume numbers and years.

Price £4.40 including postage, packing and V.A.T. Why not place your order now and send the completed coupon below with remittance to: IPC Magazines Ltd, Post Sales Dept, Lavington House, 25 Lavington St, London SE1 0PF

it's easy with **EASIBIND**

Order Form

**Everyday
ELECTRONICS**

I enclose p.o./cheque value
for binders. Years required

(BLOCK LETTERS PLEASE)

Name

Address

Date

Complete Audio/Tuner Kits

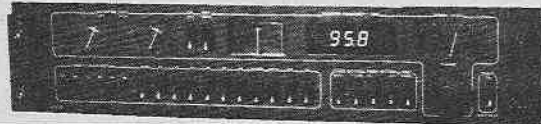

Mk III FM Tuner series

Carriage for Mk III tuner £3 inc

The Mark III series FM tuner has been updated, and now includes a centre zero tuning meter as standard. The instruction manual has been meticulously revised, enabling easy assembly by constructors of various levels of experience - a preview copy may be purchased for £1.00.

Mark III A series 'Reference series' tuner modules£171.35 inc.
Mark III B series 'Hyperfi' modules, with switched IF BW, pilot cancel decoder£198.95 inc.

A matching synthesiser unit will be made available later this year, and can be retrofitted to either version. All versions include digital frequency readout/clock, VU deviation meters, 6 preset stations, 10 turn pot manual tuning, toroidal PSU, output level adjustment, 110/240V AC input. Full alignment service available.

Power Amplifier

Style and performance - with a real 'belt and braces' PSU design.

After a couple of preview comments, it seems that many of you are waiting to hear about the matching HMOSET power amplifier for the Mk III tuner. Well, it's out at last - complete with twin toroidal PSUs for comfortable 80W RMS per channel, over 100W peak, but limited by thermal shutdown of the HMOS. 10W-100W log LED output peak indicator, DC offset protection and switch-on pause relay. AC or DC input coupling, direct or relay protected output terminals. The works. Only one version of this item: Complete kit£178.25 inc. Carr. £5.

Preamplifier

More features and facilities, thanks to DC switching and control design

Previewing the most comprehensive audio preamplifier yet..... DC switching of 7 inputs, plus two tape in/out. 2 low pass, 2 high pass active filters, genuine volume related loudness, 1dB channel matching, with DC volume, balance, bass and treble controls. Suitable for bus/remote control, tape dubbing, switched monitor etc. 80dB S/N+, THD -75dB or better. Pluggable PU equalization boards, tone control override. Price for complete unit about £149 ex VAT.

Semiconductors

Radio/Communications ICs

FOR COMPLETE LISTINGS - SEE OUR NEW PRICELIST

| | | | | | |
|---------|------|---------|------|---------|------|
| CA3089E | 2.11 | HA1197 | 1.61 | SD8000 | 4.31 |
| CA3189E | 2.53 | CA3123E | 1.61 | TD44420 | 2.59 |
| HA1137W | 1.95 | TDA1072 | 3.09 | MC1330P | 1.38 |
| HA1225 | 2.47 | TBA651 | 2.53 | MC1350P | 1.38 |
| HA12412 | 2.81 | TDA1090 | 3.51 | KB4412 | 2.24 |
| KB4420 | 1.95 | TDA1220 | 1.61 | KB4413 | 2.24 |
| TBA120S | 1.15 | TDA1083 | 2.24 | KB4417 | 2.53 |
| KB4406 | 0.80 | TDA1062 | 2.24 | MC3357P | 3.16 |

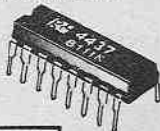

VARICAP DIODES.....

A section from our PL:

| | | | |
|--------|------|--------|------|
| SL1610 | 1.84 | SL1626 | 2.80 |
| SL1611 | 1.84 | SL1630 | 1.86 |
| SL1612 | 1.84 | SL1640 | 2.17 |
| SL1613 | 2.17 | SL1641 | 2.17 |
| SL1620 | 2.50 | SL6600 | 4.31 |
| SL1623 | 2.80 | SL6640 | 3.16 |
| SL1624 | 3.77 | SL6690 | 3.68 |
| SL1625 | 2.50 | MC1496 | 1.44 |

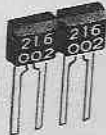

POWER MOSFETS

100W PA's made simple

Since pioneering the 100W complementary MOSFET technique - Hitachi have developed a range of output devices and drivers that ought to revolutionise opinions and attitudes towards the design of all LF amplification systems. We have a new 48 page application note (£1.50 inc) and complete sets of parts, modules and now the new complete PA system (see above).

2SK133 120v N-ch 100W MOSFET £6.33 2SJ48 Pch complement £6.33
2SK135 160v N-ch 100W MOSFET £7.29 2SJ50 Pch complement £7.39
PA101B Kit for 100W MOSFET PA less Heatsink £16.10. (£23 inc heatsink/bkt)

ULTRA LOW NOISE PU PREAMPLIFIER

The HA12017 is the last word in PU preamps, and general low noise audio design. It is an SIL IC, with 86dB S/N in RIAA configuration, 10v RMS output capability, 0.002% typ THD at 10v RMS output (imagine the overload margin !!). It comfortably supercedes discrete circuit designs in terms of price/performance, and takes the art beyond the TDA1042's capabilities. (Replaces HA1457) £1.80 each - or an RIAA applications PCB with two ICs for £5.75. Complete with Rs&Cs £9.95.

Radio Control ICs

We have various RC ICs, including NE544 NE5044, and two new ones from OKI

| | |
|----------------|------------------------------------------------------------------|
| KB4445 | - 4 channel dig.prop. FM TX IC. 30mW out (amplifiable) £2.30 inc |
| KB4446 | - 4/5 ch. dig. prop FM RX IC. Suits KB4445 or RCME syst. £2.65 |
| KB4445/6 pair: | £4.75. New 8 page data sheet 35p + SAE. More RC ICs in list |

CMOS, LPSNTTL, TTL, MPU:

Most CMOS is available in low volume - also LPSN. Standard linears and TTL OK.

Listings in the new pricelist.

Things like ICM7216B, ICL8038, 8080A, 6800P, 2708, NE555, NE556, etc

Coming Soon..... Contain yourselves, RF fans! Not yet ready for a full launch until autumn, but previewed here:-

SSB transceiver system : 10kHz to 1000MHz !!

A modular VLF to UHF SSB TX/RX system at last. With the correct first mixer, the basic PCB covers 10kHz to 1000MHz - using LO fed from ext. source (Our 2 IC Mullard synth for instance) and RF PA for TX. OP. 0.2uV basic sensitivity in HF, Typ cost for HF synth SSB RX will be less than £200. Add an RF PA for full TRX for another £50. See one in our foyer, and marvel.

Please send an SAE with all enquiries. Phone orders by ACCESS - but minimum £5. Callers welcome

PLEASE NOTE: All prices are in pounds sterling. Prices shown here include VAT. Postage extra. Orders over £50

ambit
INTERNATIONAL

200 North Service Road, Brentwood, Essex

TELEPHONE (STD 0277) 230909 TELEX 995194 AMBIT G POSTCODE CM14 4SG

Parts 1-3 AMBIT catalogues 60p ea, or £1.60 the lot.

Radio/Audio/Communications Modules

LW-MW-SW-DC tuned and switched

91072- All switching of bands by a single pin to gnd. Varicap tuned, with LO output for synth. MW/LW version or MW/LW plus 1 or 2 SW bands
MW/LW: £15.58 +1SW £16.73

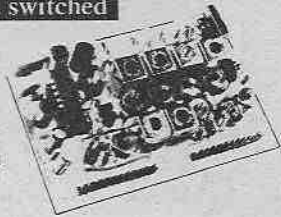

VHF Tunerheads

Europe's largest stock range for broadcast and communications. Probably also the world's - details in the catalogues and PL. Specials are also supplied in the region 30-220MHz.

Pilot Cancel PLL Stereo decoders

Again, Europe's widest range of stereo decoders including pilot cancel PLL types. The pic shows the 944378 - pilot cancel including post decoder 26/38kHz filtering and muting preamp output



944378-2 £26.45

Switched bandwidth FM IF strips

Broadcast FM IF strips for all occasions, including the new 911225 - with diode switched narrow filter option, ultra linear phase ceramic filters, 84dB S/N, and 0.04% THD (40kHz deviation). Plus usual things like AGC, AFC, dev. mute, level meter drive. £23.95 (supplied in screen can with 0.1 edge connection system) Also the 7230 hyperfi series - as the 911225, but with slope controlled AFC that operates in conjunction with signal level - and an extra IF amp stage for DXing.

Various digital frequency displays

The World's largest range of receiver DFM's is now joined by the DFM7 (shown) - and L shaped version of the DFM3 with remote display mount connector possibility. 1kHz SW resolution with 455kHz or 10.7MHz offsets, 100Hz res up to 3.9999MHz, and VHF to 299.99 MHz in 10kHz steps : £41.75



Components

Crystal Filters

Most popular types are available ex-stock, and in quantity.

| | | |
|----------|--------------------------------------------------------|----------|
| 10.7MHz | 25kHz Channel spacing 8pole | £16.67 |
| | 12½kHz .. | £17.82 |
| | 2.4kHz SSB | £19.78 |
| | Monolithic dual roofing filter | £2.30 |
| 34.5MHz | 1.3dB loss, 80dB stopband HF first filter in synth. RX | £36.80 |
| RC XTALS | FM pairs (no splits) | £3.74 |
| | AM pairs | £3.57 |
| USB/LSB | Xtals for 10.7SSB filter | £2.88 ea |



Piezo Sounders

The most efficient warning sounders yet

The latest thing in electro-acoustic efficiency. 1mA of drive from CMOS will give an SPL of 83dB - 10v RMS drive from CMOS uses 3mA for 100dB SPL at 4.8kHz (88dB at 1.65kHz) The data sheets shows various drive circuits, and give full specifications with regard to broadband responses and power consumption etc. 1 off 44p inc. 100 off 28.75p (25p ex vat)



Keyboard switches and caps

From the world's most widely used switch manufacturers - ALPS - come the biggest and best range of keyswitches, and data entry keyboard switches. The SCMB1101 is shown here, with the KT5 2-part cap (with clear top, to enable easy fitting of your chosen legend. Other types are available with built in LED, 90° mounting etc. SCMB1101: 17p, KT5: 16p or 29p/pair

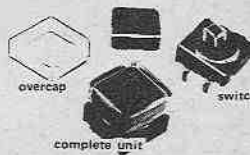

LCD CLOCKS

Clocks use 1.5v at 150A only

LCD DVM

DVM 9v/1mA

| | | |
|----------|-------------------------------|-------------|
| CM161: | 7mm LCD 12/24hr, alarms etc | £11.44 each |
| CM172: | 13mm, 12hr, alarms, timer etc | £14.32 each |
| CM174: | 13mm, 12hr, min/sec stopwatch | £14.32 ea |
| DVM 176: | ICM7106 based LCD 3½digit | £22.36 each |



WHAT'S NEW at AMBIT

NEW PRICELIST/SHORTFORM:- 28 pages, FOC with A5 SAE pse

Bigger print than our recent one page list - and vastly extended

If you still need convincing to invest £1.60 in the cats, be mean and get this first.

POWER MOSFET APPLICATIONS HANDBOOK by HITACHI :

£1.50 each - or free with pairs of HMOS and the PA101B.

Everything you should know about HMOSET devices theory and applications.

PLEASE NOTE: Commercial BSA terms on application. Goods are offered subject to availability, prices subject to change - so please phone and check it in detail.

You will not be too late

For most of the bargains listed in the newsletter reprinted below, even though it is our June/July issue, because the part of the newsletter with the items in short supply is not reprinted. However, you will receive the whole or our Aug/Sept newsletter if you send us an order this month and as an extra inducement we will send you our Oct/Nov newsletter directly if it is printed, which is usually about two months before it can appear in this magazine.

FOUR NEW KITS THIS MONTH

One is an anti-mugging device which you can carry in your pocket or handbag. Secondly we have a portable practice outfit. Thirdly we have a surveillance transmitter which can be made in a matchbox and fourthly a radio mike. The last two are given for interest purposes as at present it is illegal to use this type of equipment but in view of the fact that legislation due to come into Parliament shortly may legalise these or similar transmitters, we are making the kits available. It is of course not illegal to own them.

MORSE TRAINER KIT

This kit consists of 5 items, morse tone module, morse key, battery connector, case and instructions. Price £2.60 + 39p.

MUG STOP

With mugging on the increase we think more and more of our customers will want their womenfolk to carry a deterrent, hence this kit. Very easy to make up, only 4 items. Alarm push on push off switch, battery connector and case. £2.00 + 39p.

TRANSMITTER SURVEILLANCE

Tiny but easily hidden but which will enable conversations to be picked up with FM radio. Can be made in a matchbox—all electronic parts and circuit £2.00 + 39p.

RADIO MIKE

Ideal for discos and garden parties. Allows complete freedom of movement. Play through FM radio or tuner amp. All parts, mike and case £6.00 + 99p.

PHILIPS ELECTRONIC KITS

Despite the fact that these were very fine kits they have been discontinued by Philips Electric. We have purchased the unsold stock and these are available now at very reasonable prices. A double page of details can be obtained in all cases. Stocks are limited so prompt action on your part is essential.

WORKSHOP HINT

If you have to work on a mains operated device which has a metal case or chassis then do not connect the earth wire until you have found and repaired the fault. You will save yourself lots of fuses, shocks and damaged tools. Of course a final test should always be with earth connected and in all cases a neon tester to ensure that the earth is properly connected. Note: our mains quick connector is a real time saver, if you do repairs you will find that it will save its cost in no time at all and it's cheap at only £1.95.

THIS MONTH'S SNIP

is a Bush mains, battery, portable radio offered at a very low price but with full maker's guarantee. Bush Radio Model No. BWS776 is a medium sized radio covering the FM, Medium and Long Wavebands. A portable so of course it is battery operated (four SP11) but with the ever increasing cost of batteries the makers wisely built a power pack into the radio. You will use it from the mains whenever possible thus saving the batteries for when you go camping or picnicking etc. Price £13.25 + £1.39 post £1.00.

VERSATILE PLIERS

Insulated handles. Long nose, serrated jaws. With side cutter £1.50 + 22p.

ALWAYS USEFUL CUTTERS

Insulated handles. Ideal for electronics. Approx. 5 1/2" £1.60 + 25p.

NEON SCREWDRIVERS

Large, 60p + 8p, medium and 50p + 7p.

MAINS TRANSFORMERS MORE TYPES THIS MONTH

500 WATT TYPE

18v-0-18v at 15 amp or 36v at 15 amp or 18v at 30v. This big transformer has a double wound primary so can be used as 500 watt auto as well. There is also a second secondary 24v tapped at 6v but of course any load you put on this should not be allowed to take the load beyond 500 watt. Upright mounting with fixing lugs, ex-equipment but fully guaranteed £10 + £1.50 each postage £2.00. Note: our stock is approx. 200. 6V-0-6V @ 100 mA. This will be a regular stock line, miniature with feet and flying leads. £1.00 + 15p.

12V 1 AMP

Primary and secondary are on separate bobbins with feet and tag connections. £1.80 + 15p.

POWER MOTORS

Most of our motors come from or were intended for computers, many have had little or no use, most are American makes and all are excellent quality and test before despatch. Most are capacitor run and reversible, prices depend on the actual motor but price for standard models 1/2 h.p. £7.50, 1 h.p. £12.50, 1 1/2 h.p. £15.50. All with 15v or 25v carriage.

SERVICEABLE SNIP—10 POTS IN ONE ONLY 20p

Four gang pots 4 x 50k load; miniature types with 1/2 spindle. By combining the sections in series or parallel at least 10 types and values can be substituted i.e. singles—0-12k, 0-18k, 0-25k, 0-50k, 0-100k, 0-150k and 0-200k. Stereos 0-50k & 0-100k. It will definitely be worth you having a few of these in stock. Price 10 for £2.00 + 39p.

THIS MONTH'S ELECTRICIAN'S SNIP

is still the M.E.M. parcel but what a bargain this is you will soon realise at current prices its value is over £80. You get for only £28 + £4.20p white accessories—10 double 13 amp sockets and 5 single 13 Sw sockets with neons, 15 power (20 amp) dpt switches and spurs some with neons) 10 single one way, two way and interlocking switches and super free gift (worth £3). If not collecting please add £2.00.

FLUORESCENT LANTERN

Hand held or free standing for car, boat, caravan or home use, gives excellent non-directional light, operates from its internal batteries or through its cable from car cigar socket. Price £5.50 + 84p post £2.

FLUORESCENT LIGHT

12v inverter with the holder attached and lead for batteries which can be HP2s or a car battery complete with 12" fluorescent tube £4.50 + 69p post 80p. Plastic holder for 8 HP2s 60p + 9p.

EXTRACTOR FANS

Mains operated ex-computer, 3" Woods extractor £5 + 75p post 70p. 6" Woods extractor £20 + 30p post 80p. Planair extractor £6.50 + 87p post 90p. 4" x 4" Muffin 115v £4.00 + 60p. 230v £5.00 + 75p.

BLOWERS

Mains operated, mostly new, we still have large stocks prices from £3.00. Note the Torrin Price £4.50 + 67p + £1.00 postage, makes a good desk fan (beat the heat-wave).

TOGGLE SWITCHES

250v 2 amp chrome toggle—S.P.S.T. 30p + 5p dptd 45p + 7p.

SUB MIN TOGGLES

250v 2 amp S.P.S.T. 40p + 6p dptd 60p + 9p.

PHILIPS ELECTRONIC KITS

All kits have a properly prepared printed circuit board and this with all the other parts is nicely packaged in printed presentation boxes and are complete with ample data.

1000Hz GENERATOR

Gives a pure sine shaped signal and is ideal for Morse Code trainer, balance control in stereo chain, 'whistling' of amplifiers, modulation of signal-generator signals, audible zero-point indication, in bridging-circuits, summoning signals, etc. The size of the load does not affect the operation of the generator. The output is provided with an 'emitter follower'. Complete factory packed kit £2.00 + 39p. Ref. R6830.

ELECTRONIC TRANSISTOR AND DIODE TESTER

All types of transistors can be tested dynamically under operating conditions in an earthed emitter circuit at a collector DC current of 1mA and the small signal gain is determined. The method compares two signals originating from the same oscillator and consequently the measurement is independent of oscillator frequency or voltage and the supply voltage and ambient temperature over the temperature range -5° to +70° C. Diodes can be checked for good or faulty operation. Complete factory packed kit £3.00 + 45p. Ref. R6831.

ELECTRONIC SWITCH

Is very versatile and suitable for switching, with changing temperatures, light, darkness, humidity, dryness, etc. A signal lamp, an electric buzzer and an electric motor, for example, can be connected directly with the switch. Extension with a holding circuit is possible in a very simple way. A simple time switch also requires only an extra capacitor and push-button. Complete factory packed kit £2.50 + 37p. Ref. H6715.

ELECTRONIC BUZZER

Generates an alternating voltage which is converted into sound by a loudspeaker. The alternating voltage consists of several frequencies, from which a penetrating tone is produced. The buzzer can be used in the same manner, for example, as an electric doorbell and thus be operated by means of a push-button switch. There are many possibilities if the buzzer is combined with an electronic switch type H6715. Switch ON and OFF will be possible by means of temperature, light, darkness, moisture, drought etc. It is also possible to use the electronic switch as a time-switch, so that the buzzer will continue to operate for some time. The buzzer can also be switched directly with light, darkness or temperature. The switching point is not adjustable, but in many applications this will not matter. Complete factory boxed kit £2.90 + 39p. Ref. H6714.

STEREO CARTRIDGE PRE-AMPLIFIER

is designed to use a modern stereo cartridge with an ordinary amplifier. Magneto-dynamic, electro-dynamic or Hi-Fi ceramic are all suitable cartridges. The response from the record will be corrected according to RIAA standards. As the distortion is very low, this pre-amplifier is ideal for Hi-Fi equipment. Complete factory packed kit £3.00 + 45p. Ref. NL3403.

2 x 40 WATT HI-FI STEREO POWER AMPLIFIER

Will supply high power over a broad frequency range at very low distortion. The output stages are safeguarded in such a way that the use of a too low load impedance and short-circuits in the loudspeaker leads cannot cause the amplifier to break down. The four output transistors are mounted on two heat sinks. Complete factory packed kit £10.00 + £1.50p. Ref. NL6920.

60 WATT HI-FI POWER AMPLIFIER

This amplifier is specially designed to perform at high power over a broad frequency range with low distortion. A modern component line-up is incorporated in the circuit configuration, including Darlington transistors. A double protection circuit is built-in using five transistors, to guard against accidental overheating and short-circuiting of the amplifier. With the exception of the two power transistors and an NTC resistor, all the components are mounted on the printed circuit board. The heat sinks should be positioned as close as possible to the p.c.b. For stereo applications two units are, of course, necessary. Complete factory packed kit £8.00 + £1.20p. Ref. NL3606.

UNIVERSAL TRANSISTORISED PRE-AMPLIFIER

Can be used for many purposes, because the amplification and the input impedance can be adjusted within wide limits and you can select between amplification with RIAA correction (for pick-up elements) and 'straight' amplification (for microphones and other signal sources). Two different supply voltages can be used (9V and 18V) and the output impedance is low. A few examples of applications are: a) pre-amplifier for microphones and/or Hi-Fi pick-up elements for use with power amplifiers which are not designed for that purpose, b) complete Hi-Fi preamplifier in combination with one control unit R6903 and noise and rumble filter NL6913. c) mixer-preamplifier, with tone-control unit R6903 and noise and rumble filter NL6913. d) bass or intercom installation with loudspeaker functioning as a microphone. Complete factory packed kit £2.50 + 37p. Ref. R6905.

PLEASE NOTE: The "+" sign after the amount shows the amount V.A.T. The postage, if quoted, is based upon the amount the article costs to send if it forms part of a larger parcel. Should your order be less than £10.00 however, please send an additional 50p. BARCLAYCARD & ACCESS WELCOMED. Phone 01-688 1833.

J. BULL (ELECTRICAL) LTD

34-36 AMERICA LANE,
NEW ENGLAND ROAD,
HAYWARDS HEATH,
SUSSEX.

2 WATT I.C. AMPLIFIER KIT

A small amplifier, with a proportionally large power output, is suitable for many purposes. As an A.F. amplifier in a radio combined with a tuner unit for example, or as an amplifier for a record-player with a crystal ceramic pick-up head. All semi-conductors (transistors and diodes) and many resistors have been incorporated into one simple integrated circuit (IC) TCA100C. The other components on the printed circuit board are mainly for the alignment of the I.C. and alignment of the pick-up element, the tuner and the loudspeaker. Complete factory boxed kit £3.00 + 45p.

1WATT I.C. AMPLIFIER KIT

Similar to NL3402 but smaller output. Complete factory boxed kit £2.00 + 39p. Ref. NL6833.

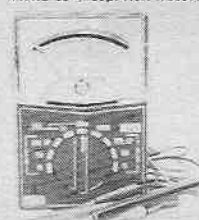

MINI-MULTI TESTER

Deluxe pocket size precision moving coil instrument, jewelled bearings - 2000 c.p.v. mirrored scale.
11 instant ranges measure:
DC volts 10, 50, 250, 1000.
AC volts 10, 50, 250, 1000.
DC amps 0-100 mA.
Continuity and resistance 0-1 meg ohms in two ranges.
Complete with Test Prods and instruction book showing how to measure capacity and inductance as well.
Unbelievable value only £6.75 - 50p post and insurance.

FREE Amps ranges kit to enable you to read DC current from 0-10 amps, directly on the 0-10 scale. It's free if you purchase quickly but if you already own a mini tester and would like one send £2.50p.

3 CHANNEL SOUND TO LIGHT KIT Complete kit of parts for a three channel sound to light unit controlling over 2000 watts of lighting. Use this at home if you wish but it is plenty rugged enough for Disco work.

The unit is housed in an attractive two-tone metal case and has controls for each channel, and a master on/off. The audio input and output are by 1/2" sockets and three panel mounting fuse holders provide thyristor protection. A four pin plug and socket facilitate ease of connecting lamps. Special slip price is £13.50 in kit form or £16.50 assembled and tested.

REMOTE CONTROL for Sound to Light (ours or any other circuit) saves connecting to speaker or amp—kit consists of 1 watt amplifier, crystal mike, case, sundries and diagram. Price £3.95.

LIGHT EXPANDER AND LATCH for Sound to Light, enables 3000 watts of lighting to be controlled by single channel or each channel, and enables lights to be latched on. Kit consists of latching relay, control switch, case, sundries and diagram. Price £4.25.

SINGLE CHANNEL KIT still available. Price £5.18.

VERSA DRILL

A 12 volt battery operated power drill, not just suitable for printed circuit boards but will do all the jobs and is powerful enough to perform all the functions and operations normally expected of Black & Decker and other mains drills. Its chuck accepts up to 1/4" drills. Size approx. 150mm x 50mm. Price £16.75.

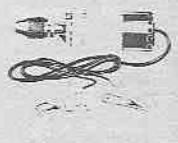

HEADPHONE AMPLIFIER (STEREO)

With volume, tone and balance control. 3v operation. All made up ready to go. Price £4.50.

SIREN OR BLEEPER

American Delta mechanical type works on 6 to 12v DC or 12 to 24v AC. Price 75p or £60 per 100. Electronic Bleeper TH35 emits high pitched wailing note of varying pitch. In red plastic case with fixing bracket. £9.00.



PUSH SWITCH

250v 2 amp push to make, release to break, standard size 40p + 6p miniature 25p + 4p. Push to make push to break 30p + 6p.

TV TURRET TUNER

A two transistor (BF180 & 2N3638) capacitively tuned U.H.F. tuner, designed to receive television signals. It is operated by four push buttons which are fully adjustable. Millions of these were used mainly in black and white but also in colour. It was very extensively used by set makers and it would probably still be used to-day were it not for the fact that the Varico tuner is so much easier and cheaper to make. Philips referenced the tuner U5. GEC gave it several numbers, M95228 M (5932) etc. BR called it AT838215. We have acquired a large quantity of these and offer them at only a fraction of their original cost. £1.50 + 22p + 50p postage less quantity discounts.

TV SOUND ONLY RECEIVER

We believe there is a demand for this and think the UHF tuner could be used for this. If any reader has already done work on this please let us know we will pay £100 for a good design. The same applies to any other device which could be made using the TV Turret tuner described above.

PRECISION MAINS OPERATED CLOCK

For only £1.50 + 22p. Sounds unbelievable but that's what you can have if you send your order right away. The clocks which have large clear dials were made by the cheapo Smiths Company. Come with their domestic cooker switch and are brand new and guaranteed and this batch have the 25 amp switches as well.

LOW VOLTAGE THERMOSTAT

With remote sensor joined to approx. 36" of capillary. Dial calibrated 10-0-+20 degrees C, change over contacts so it can be used to switch on or off £3.00 + 45p.

CAMBRIDGE INSTRUMENTS

This Company as many of you will know is famous for large dial remote operating temperature indicators. We have just received a small batch of these, assorted types covering temps such as 0-200c, 100°-500° etc., some have 6" dials others have 3" dials. Most have a thermostatic switch incorporated. If you are looking for something like this please let us know. The price will be reasonable.

LOW VOLTAGE REED RELAY

Normal 40 watt glass reed switch encased in metal tube which also holds the solenoid. 12 volt or 100mA will operate it. Ex G.P.O. equipment but unused 75p + 12p.

34 OHM 5 1/2A POWER RESISTOR

Slider type variable, made by Burco for machine control but also suitable for lamp dimming etc. ex-equipment but in very good order. £4.00 + 60p post £2.00.

WORKSHOP MATTERS

By Harry T. Kitchen

Good Practice

During constructional work most of us will have sat and stared at the work and wondered what to do next; except with the very simplest of circuits we will run out of inspiration. Or, perhaps, we have built up a circuit and have failed to get it to work.

Sometimes the cause is obvious; at others it is not. This month I intend to deal with a few dodges that can be most useful.

Shock Treatment

You have a circuit board in front of you, it little matters what sort. You slip component wires into the holes provided and you snip them off to the requisite lengths.

You may well think that that is the end of the matter. But is it? Where did the surplus bits fly off to? They can travel surprising distances and at surprisingly high speeds. They required, in comparative terms, large amounts of energy to propel them so far and so fast.

What of the other ends, those left on the components? They, too, were subjected to the same amount of energy, but in the opposite direction. They couldn't move—well, perhaps not much—and so had to absorb that energy.

Frequently, and most fortunately, absorbing that energy does the component no harm. But what if the component cannot safely absorb that energy and is damaged? You will be left wondering why your circuit does not work; perhaps immediately; perhaps some time in the future.

Components most at risk are those having glass/metal junctions or seals, and the shock of the wires being snipped may fracture these seals. Circuit failure depends upon the rate of ingress of air into the device—remember these are either evacuated or are filled with an inert gas. A pair of pliers interposed between the device and the wire cutters will absorb the energy, and should always be used with semiconductor devices, or wherever there is doubt.

Heat Shunts

From shock shunts we come to heat shunts. True, the use of these is fairly well known, but are they widely used? I believe not.

Silicon devices, with their high operating and storage temperatures have lulled many into a false sense of security. Why use a heat shunt when the junction can operate at 180°C, and the device can be safely stored at 200°C?

If you have an iron operating at the correct temperature, and your soldering technique is impeccable, then I believe you can probably dispense with a heat shunt. By "impeccable" I mean that the

iron is applied to the component for the absolute minimum amount of time, with the minimum amount of solder required for a good clean immaculate joint.

If your iron is "cold", i.e. takes an appreciable amount of time to melt solder, or your joints are dirty or greasy so that the solder does not take, then you stand an excellent chance of ruining your component through excess temperature applied for an excessive length of time.

Silicon devices are not alone in requiring protection from soldering irons. Almost anything used in constructing an electronic circuit can be damaged by excess heat applied too long. Copper pads will lift off p.c.b.s, resistor values will change, capacitors may become open circuit or short circuit. It behaves us, then, to take care whilst soldering, and the use of a heat shunt is I believe good practice at all times.

Boards and Sub-assemblies

Most circuit boards require attachment to something; so there will be holes in them. If not, it is simple to drill three or four holes where they will not interfere with the circuit, nor appear too unsightly.

Drill these holes, say, 6BA clearance. Then insert bolts from the copper, or conducting side, and add the nuts from the component side.

If the bolts are longer than the deepest component, the board can be manipulated in all directions and will be protected by the bolts. When the board is complete, these bolts can be removed.

Sub-assemblies are much used in industry, and with good reason. They can be built up where convenient, tested, and finally joined together to produce the whole—whatever that may be. In our case it means that it is safer to build up a complex circuit on separate boards, and then to join these together to form the complete circuit. Not only can individual circuits be tested more easily, but rectification or modification is more easily effected.

If you adopt this philosophy, try to achieve a situation where the individual boards can be joined together for final testing before assembly into its final cabinet, as there is nothing so annoying as connecting a number of boards into a cabinet, perhaps requiring considerable manipulative skill in the process, only to find that something does not work as planned. Taking this a stage further, the ideal situation would be one where the circuit boards could be connected up, tested, and then assembled into the cabinet en bloc.

This is one of those areas where, if you are doing all your own work, it pays to take your time, to think it out on paper. An error on paper is easily erased; on hardware it is not so easy.

Static Charge

I recently saw a colleague, one whom I had expected to know better, remove a chip from its protective conductive foam and pass it round for examination.

He was surprised when his circuit didn't work; I was not, for it was one of those that contained an input stage utilising IGFET'S (Insulated Gate Field Effect Transistors).

Some chips are as tough as old boots, others are not. Amongst these are the IGFET family.

Man-made fibres abound in our world and as a consequence we carry around with us static charges, charges that will easily puncture gates of such devices and render them quite useless. If you come across these devices, leave them in their protective conductive foam packing until the very last moment.

Pick each device up by the ends, being careful not to touch any pins, and insert it into its sockets—being wise you will, of course, use one, for to solder such a device is to compound your error. It is possible to purchase special insert tools, but unless you are into such devices in a big way they are hardly worth while.

It is a wise precaution when handling any such devices to ensure that your soldering iron is a low leakage type, well bonded to a good earth. Similarly, you yourself should be bonded to earth. You are not expected to strap your ankle to earth! but you can, and should, frequently touch a good earth to enable static charges to leak harmlessly away.

Use Sockets

It is good practice, to use sockets into which i.c.s can be plugged, rather than soldering them into position. It enables suspect i.c.s to be easily changed, whilst the i.c. itself is not subjected to soldering iron temperatures, for heat shunting can be very fiddling if not impossible.

Suspect i.c.s are not rare; it is quite possible that an i.c. will function well in one application, but not in another. Replace it with an identical i.c. and all is well. Manufacturing tolerances are largely to blame, but a "brand X" 741 can be superior to a "brand Y" 741, though ostensibly identical.

PLEASE TAKE NOTE

Dual-Line Game May 1980

The TIL209 i.e.d.s on the circuit diagram are incorrect and should be TIL220 types.

Similarly the correct Zener diode is the BZX85, as published in the components list.

Kitchen Timer March 1980

The values of C3 and C4 have been transposed in the components list. They are correct on the circuit diagram. Some readers have experienced problems with the turn-on reset. Capacitor C2 may be increased to 10nF to overcome this.

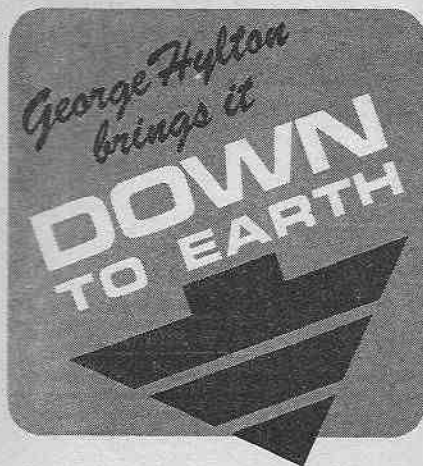

A READER from Malaysia asks about making mains transformers. How can you ensure that a transformer is capable of handling the required power? How many turns do you put on to obtain the desired voltages? Can you rewind an existing transformer to give a new output voltage?

I don't know if it was ever possible to walk into a shop and buy the parts needed for a power transformer. But I'm quite sure that it isn't possible now—not in the UK, anyway.

In any case, the cost of wire in small quantities is so high nowadays that it is probably quite uneconomic to make your own transformers from scratch. For this reason I'll concentrate on the possibilities of modifying an existing transformer.

Before discussing this, let me give my usual reminder that the *mains* can be lethal. Don't take chances.

Power Drive

Common sense tells you that the more power a component has to handle the bigger that component is likely to be. Mains transformers are no exception. The smallest ones in general use can handle about one watt. It is not very sensible to try to use such a miniature component to power a ten-watt amplifier.

Attempts to squeeze more power out of a transformer than it can really handle are sometimes made by professional engineers in cases where the power is extracted only for brief periods, with ample time for cooling off between uses. If a transformer were needed for a piece of equipment which gave a short time signal—sounding a hooter, say—once an hour it would be reasonable to work it fairly hard.

In the majority of applications of interest to readers of the magazine it will not be possible to use a short-time rating; we must assume that our transformers will have to work all the time and must be "continuously rated". So if you do salvage a transformer from equipment which operates only intermittently be sure to allow for

this by down-rating its power handling by at least half.

Watt Power

To find out the power handling capacity of a transformer multiply the output voltage by the rated output current. A transformer rated at 10V 2A is a 20 watt transformer.

If a transformer has several windings, all intended to be used simultaneously, the power handling capacity is found by working out the rated output power of each winding and adding them all together. Thus, a mains transformer from an old valve operated radio might have windings of 300-0-300V 100mA, 6·3V 3A, and 5V 2A.

A conservative estimate for the power from the 300-0-300V winding (designed to drive a push-pull rectifier) is obtained by taking the 300V of the half-winding rather than the 600V of the full winding; this gives a rating of $300V \times 0.1A = 30W$. To this is added the 18·9W of the 6·3V winding and the 10W of the 5V winding, making a total of 58·9W. This is the upper limit of power which can safely be drawn.

Turns Per Volt

Such a transformer is only capable of easy rewinding if the existing mains primary can be left intact on the bobbin with all its insulation undamaged.

For this to be possible requires two things. First it must be possible to remove the bobbin. This calls for dismantling the "stack" of core laminations; if they are stuck together with pitch etc. this may not be possible. Secondly it is only possible to leave the mains primary in situ if the secondary is wound on top of it so that the secondary can be stripped off without disturbing the primary; or if primary and secondary occupy different "slots" of a segmented bobbin, i.e. they lie side by side instead of one on top of the other.

Assuming that the bobbin is indeed accessible and the secondary stripable it is useful, before stripping, to make provision for counting the turns as they are unwound. A vital design parameter is the number of turns which would give an output of one volt. Armed with this information you can easily calculate how many turns to put on to give the output voltage you need.

If there is a low-voltage secondary the number of turns is easily counted as you unwind. For example, if the 5V winding on the transformer I just used as an example has 50 turns then you know that your transformer has ten turns per volt.

Large transformers have smaller turns per volt than small transformers. If your transformer has no convenient low-voltage secondary you are faced with the tedious problem of counting large numbers of turns. Do it in batches of say fifty, making a mark on a piece of paper for each batch.

Alternatively, if there is enough room between the bobbin and the core of the intact transformer you can put on an extra winding with a known number of turns, measure the voltage and work out the turns per volt figure from that.

If for example you manage to put on twelve turns and an a.c. voltmeter connected to this temporary winding reads 0·5V then your transformer has 24 turns per volt. If you want to get 10 volts from it you must use 240 turns when you rewind the secondary.

Wire Size

To work efficiently, the secondary winding you put on to replace the original secondary must occupy all the available space. That is you must use the thickest wire possible.

In theory the primary and secondary should each occupy half the available winding space. In practice the primary, which has to withstand the main voltage and needs good insulation often occupies rather more than half.

If the secondary has to deliver only a low voltage it is usually sufficient to wind it with enamelled wire, the enamel providing the insulation between turns and layers. (Nowadays primaries are also often wound this way too but the precision winding techniques needed make it impossible to hand-wind high-voltage windings safely without using insulation between layers).

If a winding does not fill the available space it will have a higher resistance than it should and this will cause the voltage to fall too much as the current taken is increased. Wire tables exist which show how many turns of different gauges of wire and different insulations can be packed into a given cross sectional area.

These tables assume perfect packing and in practice you will get rather fewer turns into the space than the tables suggest.

Laminations

Laminations are insulated on one by side an oxide coating. When the core is reassembled the laminations must be stacked so that there is a layer of oxide between adjacent laminations.

Also the laminations must be interleaved. If, as is usual, they are in the form of E_s and I_s , this means putting in an E , then an I , then an E and so on. If the stack of laminations is not packed tight and firmly clamped it will buzz.

Tricky Business

You may conclude from all this that rewinding and reassembling a mains transformer is a tricky business, not to be lightly undertaken. You are right. I gave up doing it many years ago when I realised it is usually just not worth the trouble.

First the EuroBreadBoard Now the EuroSolderBoard

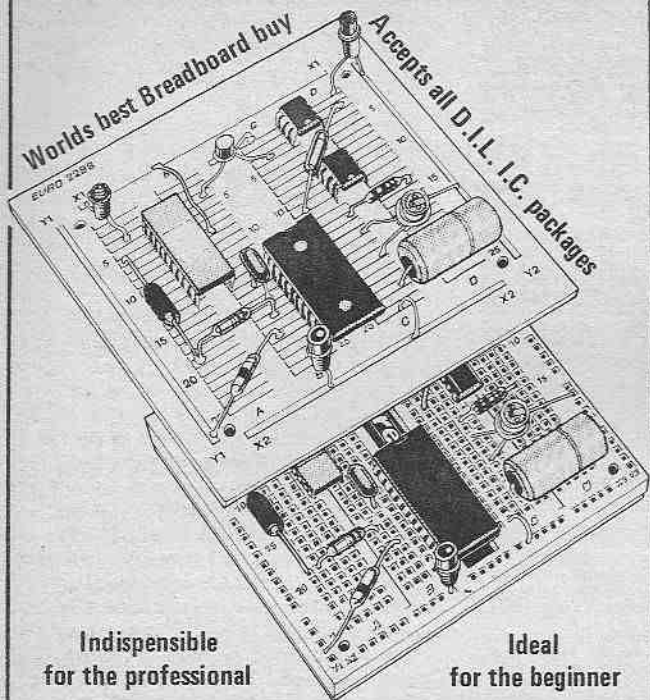

Design on a EuroBreadBoard — Instal on a EuroSolderBoard

First the EuroBreadBoard

Will accept 0.3" and 0.6" pitch DIL IC's, Capacitors, Resistors, LED's, Transistors and components with up to .85mm dia leads. 500 individual connections PLUS 4 integral Power Bus Strips along all edges for minimum inter-connection lengths. All rows and columns numbered or lettered for exact location indexing (ideal for educational projects). Long life, low resistance (<10m ohms) nickel silver contacts £6.20 each or £11.70 for 2

Now the EuroSolderBoard

New 100mm square, 1.6mm thick printed circuit board with pre-tinned tracks identically laid out, numbered and lettered to EuroBreadBoard pattern. Four 2.5mm dia fixing holes. £2.00 for set of three ESB's

And don't forget the EuroSolderSucker

Ideal for tidying up messy solder joints or freeing multi-pin IC's, this 195mm long, all metal, high suction desoldering tool has replaceable Teflon tip and enables removal of molten solder from all sizes of pcb pads and track. Primed and released by thumb, it costs only £7.25 including VAT & PP



Snip out and post to David George Sales, Unit 7, Higgs Industrial Estate, 2 Herne Hill Road, London SE24 0AU

David George Sales, Unit 7, Higgs Ind. Est., 2 Herne Hill Rd., London SE24 0AU. EE 8

Please send me:-

- | | | | |
|-----------------------|----------|-----------------------|--------|
| 1 EuroBreadBoard | @ £ 6.20 | <input type="radio"/> | |
| or 2 EuroBreadBoards | @ £11.70 | <input type="radio"/> | Please |
| or 3 EuroSolderBoards | @ £ 2.00 | <input type="radio"/> | Tick |
| or 1 EuroSolderSucker | @ £ 7.25 | <input type="radio"/> | |

All prices are applicable from Jan. 1st 1980 and include VAT and PP but add 15% for overseas orders.

Name

Company

Address

Tel. No.

Please make cheques/P.O. payable to David George Sales and allow 10 days for cheque clearance and order processing

GREENWELD

443D MILLBROOK ROAD, SOUTHAMPTON SO1 0HX
All prices include VAT—just add 40p post. Tel (0703) 772501

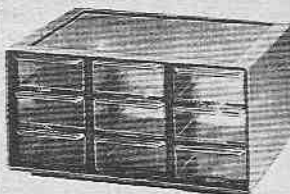

COMPONENT CABINET IDEAL FOR THE NEWCOMER TO ELECTRONICS

Contains hundreds of brand new resistors, capacitors, transistors diodes and I.C.'s. All useful values, carefully chosen to help the new constructor pursue his hobby without finding himself short of some vital parts

All parts contained in clearly marked bags in a plastic storage cabinet 232 x 121 x 165mm with 9 drawers into which all parts can be neatly located.

If bought individually parts plus case would cost over £47 but we are offering this for ONLY £21.95 + £1 p & p. Simply send a cheque or P/O for £32.95 for immediate despatch.

CONTENTS:

- 200 ½ watt resistors
- 20 Wire wound resistors
- 70 Ceramic Capacitors
- 70 Mylar Capacitors
- 50 Polyester Capacitors
- 55 Electrolytic Capacitors
- 61 Transistors
- 12 I.C.'s
- 20 L.E.D.'s
- 55 Diodes and rectifiers

Altogether 614 components.

Price includes current catalogue and GreenWeld pen for reordering supplies. Plus FREE surprise gift.

P.C. ETCHING KIT Mk IV

The best value in etching kits on the market—contains 100 sq ins copper clad board, 1lb Ferric Chloride, Etch resist pen, abrasive cleaner, two miniature drill bits, etching dish and instructions. All for £4.95

KITS OF BITS FOR EE PROJECTS

We're selling off many sets of components for EE projects from Aug. 78 to date. Send SAE for list of kits still available, many at greatly reduced prices.

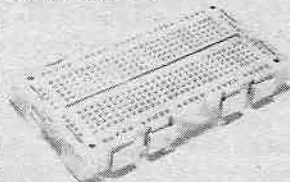

VEROBLOC BREADBOARD

New from Vero, this versatile aid for building and testing circuits can accommodate any size of IC. Blocks and be joined together. Bus strips on X & Y axis—total 360 connexion points for just £4.15.

VU METERS

V002 Twin type. 2 meters 40 x 40mm and driver board, supplied with circuit and connexion data, £3.50.
V003 New type, just in. Twin type moulded in one piece. 80 x 40mm (no driver board but suitable circuit supplied), £2.50.

THE NEW 1980 GREENWELD CATALOGUE

FEATURES INCLUDE:

- 60p Discount Vouchers
- Quantity prices for bulk buyers
- Bargain List Supplement
- Reply Paid Envelope
- Priority Order Form
- VAT inclusive prices

PRICE 40p + 20p POST

BARGAIN LIST NO. 10

This 10 page A4 size list is FREE—just send a SAE for your copy containing hundreds and hundreds of surplus bargains, many of them illustrated. Also included is a Catalogue News Sheet, featuring new lines and price changes.

WIRE & FLEX

Solid core—ideal for breadboards etc. 50 x 2m lengths many assorted colours, total 100m for £1.30.
Flex packs—5 x 5m lengths of multi-strand thin flex, ideal for wiring up circuits. Only 35p

EX-COMPUTER PANELS

Z528 Pack of boards containing 100's R's, C's diodes, including at least 50 transistors. Only £1.30.
Z529 TTL pack—Panels with 74 series on, together with code sheet. From simple gates to complex counters. 20 IC's £1; 100 IC's £4.

COMPONENT TRAY

Attractive yellow tray 285 x 165 x 42mm with clear hinged lid and movable compartments. Up to 15 can be made from dividers supplied. As an added bonus, a selection of new surplus components are included; all for the special low price of £3.95.

VEROCASE SALE

The green verocases we've been selling have now almost gone—we've just got a few hundred type 21051, size 180 x 120 x 65mm, still at £2.30 each.

ADVENTURES WITH ELECTRONICS

Book by Tom Duncan, written especially for the beginner. Lots of interesting projects all built on a breadboard. Book £1.50; Complete set of parts for all projects (battery required). Only £15.95.
Also "Adventures with Microelectronics" by the same author, £2.00. Both these books represent excellent value for money, and are highly recommended. Set of parts to go with this (latter) book available soon.

BUZZERS & MOTORS & RELAYS

Z401 Powerful 6V DC Buzzer all metal construction 50mm dia x 20mm 70p.
Z402 Miniature type Buzzer 6, 9 or 12V, only 22x15x15mm. Very neat 53p.
Z450 Miniature 6V DC motor, high quality type 32mm dia x 25mm high, with 12mm spindle. Only £1.
Z459 115/230V ac high torque motor with geared reduction down to 60 rpm. Sturdy construction, 70mm dia x 20mm. Spindle 6mm dia x 20mm long. Only £2.90.
W892 Heavy duty 12V relay, ideal for car use—single 15A make contact. Coil 23R. 85p.
W890 DIL reed relay—SPCO 2-4V-10V 200R coil. Only £2.20.
W847 Low profile PC mntg 10 x 33 x 20 mm 6V coil, SPFO 3A contacts. 83p.

TEACH IN 80

We are again supplying all parts required for this major series which started last October. The price for all the Tutor Deck parts is £19.50. Also supplied without breadboard for £13.50. The price for the additional components required for Parts 1-6 is £2.00 and Parts 7-12 £3.00. All prices include VAT and Postage. Reprints of parts 30p per month.

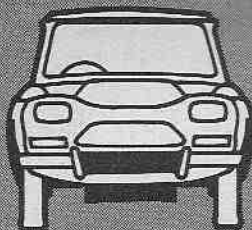

AUTO LIGHTING-UP WARNING

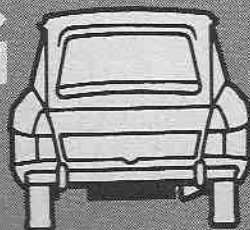

BY K. B. WHAPPLES

RECENT police campaigns over vehicle lighting have highlighted the growing concern about motorists who have defective lights or who fail to display lights early enough or during periods of poor daylight.

The human eye adapts itself automatically to slow variations in ambient light intensity but as individuals our subjective judgement of absolute light level is inconsistent and dependant on many psychological factors.

The unit described here indicates that the ambient light level has fallen below a preset level and the driver has failed to turn his lights on.

CIRCUIT

The complete circuit is shown in Fig. 1. In normal operation, with the ignition switch on, and the sidelight switch off, the circuit is effectively connected across the battery, the negative rail of the unit being connected to the chassis via the low resistance of the sidelamps.

Resistor R1 limits the current flowing through the Zener diode D1 to approximately 8mA, more than sufficient for the light sensing circuitry and low enough to have negligible current drain on the car battery.

The Zener diode provides 5.6 volts, stabilised against supply changes, for the light sensor, PCC1, which is an ORP12 light dependent resistor, or l.d.r. for short. The resistance of the l.d.r. increases as the level of light falling on its sensitised surface reduces.

TRIP LEVEL

In series with PCC1 are the resistor R2 and variable resistor VR1, whose values have been chosen to enable adjustment of the "trip level"

between "dull" and "quite dark" light levels.

When the voltage across the l.d.r. reaches approximately 0.6 volts, the silicon controlled switch, SCS1, switches on and illuminates the warning display l.e.d. D3. The l.d.r. derived voltage is applied to the cathode gate of SCS1 via a low-pass filter with a 30 second time constant comprising R3 and C1.

This ensures that random fluctuations in light level, such as driving through a tunnel or inadvertently obscuring the sensor with the hands, do not trigger the warning device,

whilst also decoupling the very sensitive gate from transients which would otherwise cause false triggering.

Resistor R4 also avoids false triggering at switch on and R5 limits current through D3 to about 20mA.

LIGHTS ON

When the vehicle lights are switched on, the negative rail is switched to the positive supply rail of the vehicle meaning that the unit is now short circuited and receives no supply voltage.

The purpose of D2 is two-fold. As the light level decreases and the l.d.r. voltage approaches 0.6 volts certain conditions, for example low sun shining through a row of roadside trees, with a lower "mean" level than the threshold setting may cause early triggering. However, each "bright" interval causes the l.d.r. voltage to fall thus forward biasing D2 and re-storing the voltage on C1 to the "bright" or true light level quickly.

The unit therefore responds to increases in light level far more quickly than reductions, further reducing the possibility of undesirable warnings. Also, when the lights are switched on and the unit is short circuited any voltage on C1 forward biases D2 and discharges C1. The shorting action of the switches also removes the supply from SCS1 which in turn resets it.

In the event of the warning lamp coming on when the driver feels that lights are not required, the unit is simply reset by switching the sidelights on and off. This extinguishes the warning l.e.d. D3.

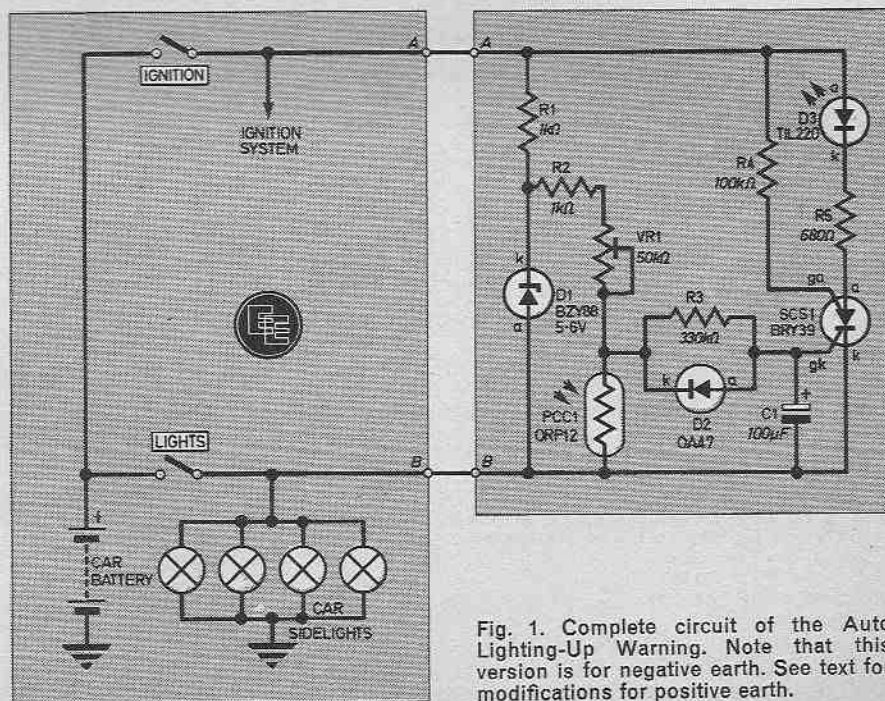

Fig. 1. Complete circuit of the Auto Lighting-Up Warning. Note that this version is for negative earth. See text for modifications for positive earth.

CONSTRUCTION starts here

CIRCUIT BOARD

Component layout is not critical and the unit can be constructed on any small off-cut of 0.1 inch matrix stripboard. However, in the prototype a small printed circuit board was used and the foil pattern and component mounting details are shown in Fig. 2. When considering how to mount the l.e.d. and the l.d.r. there are two approaches. The first is to mount them separately at strategic points on the dashboard. The second is to build the complete unit in a small box that can be mounted in a suitable position.

Whichever approach is used the constructor should observe the following. The l.d.r. performs better if it is mounted horizontally and in a position where daylight from the windscreen falls on its face as vertically as possible, as opposed to pointing it through the windscreen.

All soldering should be clean and strong in view of the high vibration environment. P.V.C. covered stranded wire is strongly advised. The p.c.b. may be used even if the sensor and/or warning l.e.d.s are mounted remotely, the p.c.b. positions of these

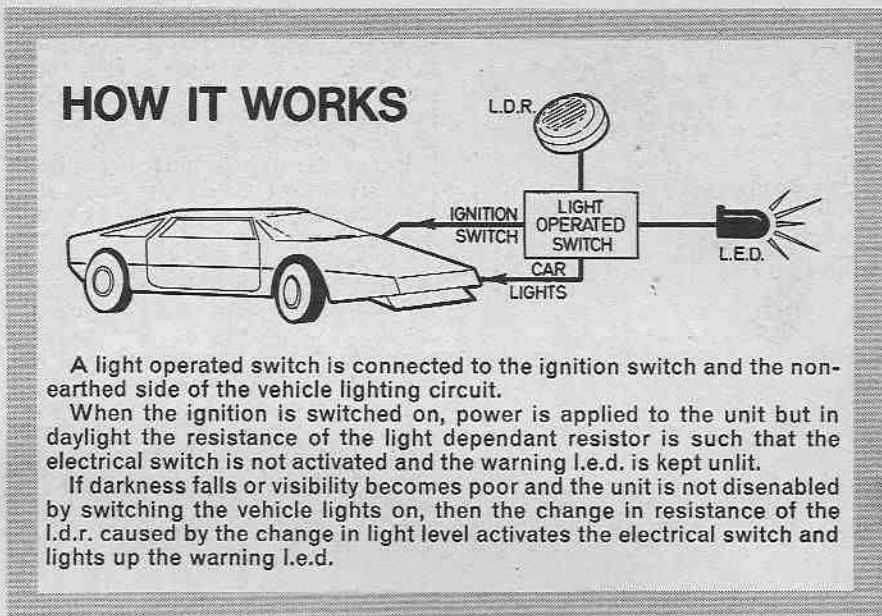

A light operated switch is connected to the ignition switch and the non-earthed side of the vehicle lighting circuit.

When the ignition is switched on, power is applied to the unit but in daylight the resistance of the light dependant resistor is such that the electrical switch is not activated and the warning l.e.d. is kept unlit.

If darkness falls or visibility becomes poor and the unit is not disenabled by switching the vehicle lights on, then the change in resistance of the l.d.r. caused by the change in light level activates the electrical switch and lights up the warning l.e.d.

components simply being used to connect the wires to these components.

CASE

If you take the option to build the complete unit into a box, then a small ABS plastic container 30 × 45 × 15mm in size will be required. Also a hole will have to be made in a suitable position in the box for the l.e.d. D3, above the circuit board.

The circuit board can be held in place with a piece of double

sided self adhesive foam strip. A good method of mounting PCC1 in a remote position is to solder it to a small piece of stripboard and attach the leads to the stripboard. This assembly can then be pushed through a suitable hole in the vehicle dashboard from behind and held in place by means of screws or epoxy resin glue.

Flexible stranded wire can be used for all leads and when all the components are wired in it is a good idea to test the unit before installing it in the vehicle.

COMPONENTS

Resistors

- R1 1k Ω
- R2 1k Ω
- R3 330k Ω
- R4 100k Ω
- R5 680 Ω
- *R6 470 Ω
- All $\frac{1}{2}$ W carbon \pm 5%

Capacitor

- C1 100 μ F 16V elect.

Semiconductors

- SCS1 BRY39 silicon controlled switch
- D1 BZY88C5V6 5.6V 400mW Zener diode
- D2 OA47 small signal germanium diode
- D3 TIL220 red l.e.d.
- *TR1 BD132 *pn*p silicon

Miscellaneous

- VR1 50k Ω miniature horizontal preset
 - PCC1 ORP 12 light dependent resistor
 - *WD1 12V warning device or incandescent bulb, 1.5A maximum
- Case, ABS plastic size 30 × 45 × 15mm or similar; printed circuit board or 0.1 inch matrix stripboard as above; stranded wire for off-board connections; bulb holder*.
- * components only required if larger warning device used (see text).

COMPONENTS
approximate
cost £3.50
excluding case

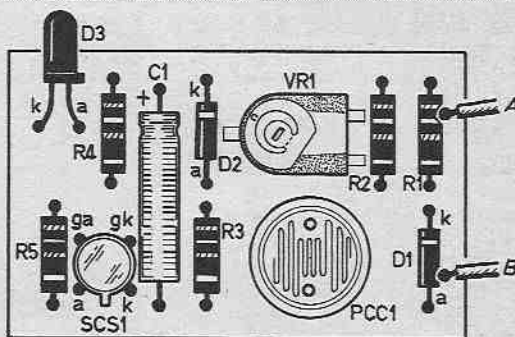

See
**Shop
Talk**
page 481

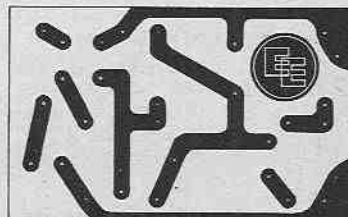
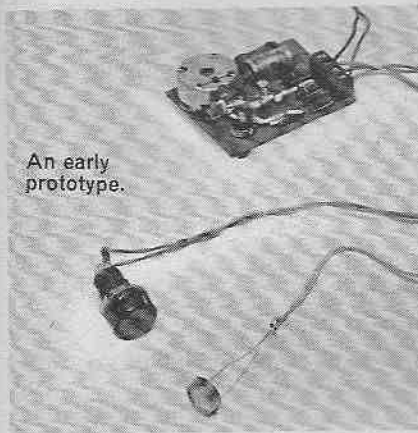

Fig. 2. Suggested p.c.b. layout of the unit. Note that modifications for high current warning device are not included on the board.



An early prototype.

Connect it up to a 12 volt supply and cover up PCC1 with your hand. If the warning l.e.d. comes on after about 15 to 20 seconds, then all is well.

INSTALLATION

The wiring of the unit is straightforward. The positive lead can be connected to any service on the vehicle that is only powered when the ignition is switched on, for example the car radio or cigarette lighter or alternatively direct to the ignition switch.

The negative lead must be connected to the light switch so that when the light switch is off the lead

must be connected to the switch contact that is connected to the sidelamp bulbs and not to the contact that goes straight to the battery. This provides the earth return for the unit; Fig. 1 should make this clear.

Mount the unit in such a position that it is unlikely that any items are going to be laid across the face of the l.d.r.

For negative earth vehicles the connections are as detailed above, and as in Fig. 1. For positive earth vehicles the connections are simply reversed, that is the positive lead of the unit goes to the lights and the negative lead to the ignition switch.

When installed in the unit, the variable resistor VR1 can be slowly adjusted to enable the warning indicator to trip at the required light level.

CONCLUSION

To reduce or increase the delay period, the value of R3 is altered accordingly and can be replaced by a 500 kilohm variable resistor if desired. Alternatively the value of C1 may be altered.

If an alternative type of l.d.r. is available then R2 and VR1 can be replaced with a single 100 kilohm variable resistor to give a wider range.

If you wish to incorporate a lamp or buzzer or other form of warning

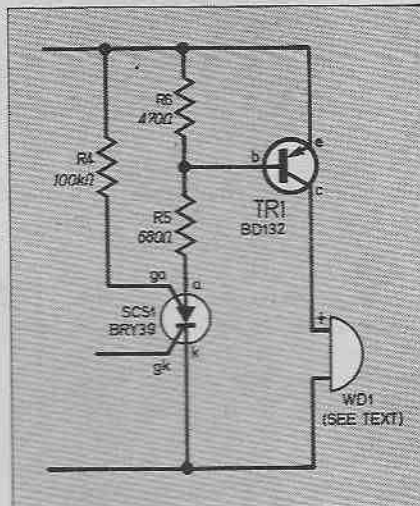

Fig. 3. Circuit modification for high current consumption warning devices

device in place of the l.e.d. then the circuit must be modified as in Fig. 3. Although the BRY39 controlled silicon switch will sink up to 150mA the cold resistance of virtually all incandescent lamps will allow a current in excess of this to pass at switch on and so destroy the device. This is true even of a 12 volt 1 watt Lilliput lamp. Therefore, the suggested output modification is necessary for virtually all sorts of lamp.

Casio's new SUPERCALC! TRIO HAMEG



CASIO FX-8100

46 scientific functions, clock calendar, alarm, countdown alarm, interval alarm timer, hourly chimes, 1/100 sec stopwatch
ONE YEAR BATTERY LIFE (approx. used continuously). LC Display; 8 digit mantissa plus 2 digit exponent. 5 level parenthesis. full access memory. Trigs, logs, hyperbolics, standard deviations, co-ordinate conversions, sexagesimal to decimal conversions, fractions, percentages, cube roots, sign change, register exchange, PI entry etc.
CLOCK displays hours, minutes, seconds, am/pm and day. **CALENDAR** pre-programmed to 1999; day, date, month and year, 24 hour **ALARM**, hourly chimes. **Countdown ALARM TIMER**, interval (repeater) **ALARM TIMER** or 1/100 second **STOPWATCH** measuring net, lap and first and second place times to 10 hours, 6.6 x 70 x 129mm (2 1/2 x 2 7/8 x 5 1/8 inches). Leatherette wallet, R.R.P. £27.95 **ONLY £24.45**

Mini SUPERCALC!

FX-7100

1 YEAR BATTERIES 30 scientific functions. As FX-8100 but 8 digits, without hyperbolics, fractions and calendar. Only 1 countdown alarm timer (repeat) or stopwatch function. Alarm and hourly chimes. 9/16 x 2 1/2 x 3 1/2". Leatherette wallet, R.R.P. (£27.95). **£24.45**



NEW SCIENTIFICS



Casio FX-200

LCD, 10 digits, 44 scientific functions as FX-8100 above but with 9 levels. **FIX, SCI, NORM, ENG, RND** and **RAN** in lieu of hyperbolics, %, 7,800 hours battery 1 1/2 x 3 x 5 1/2 inches. **£15.45**
R.R.P. (£17.95).

FX81 £12.45 FX-330 £16.45, FX 510 £19.45, FX-2800 £19.45, FX-3200 £21.45, FX-501P £52.45, FX502P £72.45, FA-1 £18.45.

TERMS OF BUSINESS: PLEASE NOTE ALL CASIO ITEMS PRICE INCLUDES VAT, P & P AND INSURANCE. PLEASE SEND CHEQUES OR P.O.s OR QUOTE BARCLAYCARD OR ACCESS NO. TO: B. BAMBER ELECTRONICS, 24 HOUR PHONE SERVICE (0353) 860185. CALLERS WELCOME TUES-SAT 9.00A.M.-5.30 P.M.



83QS-41B Alarm Chronograph.

S/S encased. Mineral glass. Water resistant. 3 YEAR BATTERY. Hours, minutes, seconds, date, am/pm; or hours, minutes, alpha day, date am/pm, 24 hour alarm, hourly chimes. Stopwatch from 1-10 seconds to 12 1/2 hours; net lap and 1st and 2nd place. Nightlight. R.R.P. (£27.95). **ONLY £24.45**

C-80 Calculator Watch

(Finger-touch keyboard) Hours, minutes, seconds, am/pm, day, date, month auto calendar pre-programmed to 2009. Professional 24 hour stopwatch, net, lap, 1st & 2nd place to 1/100 sec. Dual time, 8 digit calculator, Nightlight. Water resistant. Mineral Glass. Black resin, case/strap. R.R.P. (£29.95). **ONLY £24.45**



LADIES CASIO WATCHES from £12.45

Send 20p for full details of all Casio Watches & Calculators.

TRIO CS1566 20 MHz triggered sweep oscilloscope £339.00
TRIO CS1562A 10MHz triggered sweep oscilloscope £259.00

HAMEG Oscilloscope NM307 LPS triggering bandwidth d.c. to 10MHz component tester, timebase 0.2µs-0.2s/cm £149.00

HAMEG HZ36 Switchable probe for HM307 £11.00

DACTRON PX402 13-8d.c. 3 amp continuous 4 amp max. Fully stabilised power supply with overload protection £19.95

DACTRON PH 3000 13 d.c. 5 amp continuous. £39.50

DIN PANEL METERS DIN75; 0-5 amps, DIN715; 0-150 volts, DIN730; 0-300 volts, DIN 750; 0-500 volts 72 x 72mm range £8.00

EAGLE DD7 paging microphone, impedance 600 ohm or 50 Kohms, sensitivity 2.25mV at 50 Kohms, Frequency response 300-9000Hz. Desk or wall mounted. £24.85 + VAT

EAGLE MULTIMETER EM90 50,000 OPV d.c. volts; 0-1200 volts; a.c. volts; 0-1200 volts, d.c. current 0-6A, resistance 0-10 megohms. £19.95 + VAT

DRAPER SUPER CHROME 1/4" sq drive socket sets. 38 piece 9AF. hexagon, 3 A.F. bi-sq sockets, 11mm hexagon sockets, 9 B.A. hexagon sockets with 5 accessories. £12.75 + VAT

SPIRALUX metric nut spinner sets. Contains 8 nuts spinners 4, 4-5, 5, 5-5, 6, 7, 8, 9, 10mm. Packed in plastic wallet. £7.35 + VAT

WELLER TCP3 (rons, 24 volt series 3 wire power units. For application requiring earthed tip. Also PUSD power units. TCP3 £13.84 + VAT

PUD3 £24.12 + VAT

WELLER INSTANT HEAT GUNS model no 8100D £13.25 + VAT

WELLER CORDLESS model no WC100 £25.47 + VAT

SUPTON diethyl switch cleaner. £9.72 + VAT

MARYPLASS storage boxes SP2 combination draw pack (contains 1 x 600, 2 x 201, 5 x 10) Interlocking storage boxes. Per Pack £24.40 + VAT

ORYX DE-SOLDER TOOLS model SR3A, desoldering pump with built in safety guard. Price £24.50 plus V.A.T.

IC TEST CLIPS, clip over IC while still soldered to pcb or in socket. Gold plated pins. Ideal for experimenters or service engineers, 28 pin DIL £1.75 40 pin DIL £2. Or save by buying one of each for £3.50.

IC AUDIO AMP, PCB output 2 watts into 3 ohms speaker. 12 volt d.c. supply. Size approx 5 1/2" x 1 1/2" x 1" high, with integral heatsink, complete with circuits £2 each + VAT.

CALL IN AND SEE US—OUR NEW SHOP IS OPEN

CATALOGUE 1980 Send 40p and you will receive our 104 page catalogue products by Eagle, Yaesu, Standard, Trio, Hameg, Microwave Modules, Amtron Kits & Boxes, Vero, Draper, Spiralux, Knipex, Weller, Servisol, Jaybeam, Books by Barnaro & Babani-News and many more.

TERMS OF BUSINESS: Cheques P.O.s or phone Access or Barclaycard No. 24 Hour Phone Service. Please add VAT AT 15% on all above goods. CARRIAGE and packing charges for all orders under £25.00 nett invoice value add 75p. Orders over £25.00 and under £20.00 add 50p. Orders over £20.00 carriage free. Callers welcome 9.00a.m.-5.30p.m. Tues.-Sat. (0353) 860185.

B. BAMBER ELECTRONICS, DEPT. E.E., 5 STATION ROAD, LITTLEPORT, CAMBS CB6 10E

CAMBRIDGE LEARNING ENTERPRISES

Self Instruction Courses

Microcomputers are coming - ride the wave! Learn to program.

Millions of jobs are threatened but millions will be created. Learn BASIC - the language of the small computer and the most easy-to-learn computer language in widespread use. Teach yourself with a course which takes you from complete ignorance step-by-step to real proficiency, with a unique style of graded hints. In 60 straightforward lessons you will learn the five essentials of programming: problem definition, flowcharting, coding the program, debugging, and clear documentation

BOOK 1 Computers and what they do well; READ, DATA, PRINT, powers, brackets, variable names; LET; errors; coding simple programs. BOOK 2 High and low level languages; flowcharting; functions; REM and documentation; INPUT, IF... THEN, GO TO; limitations of computers, problem definition. BOOK 3 Compilers and interpreters; loops, FOR...NEXT, RESTORE, debugging; arrays; bubble sorting. TAB BOOK 4 Advanced BASIC; subroutines; strings; files; complex programming; examples; glossary.

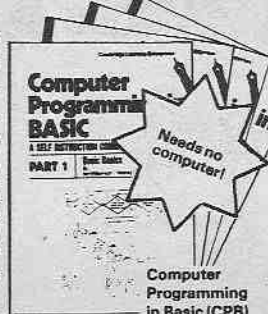

Computer Programming in Basic (CPB) £9.00

Also THE BASIC HANDBOOK (BHB) £11.50 An encyclopaedic guide to the major BASIC dialects. A must if you use other peoples' programs

and: ALGORITHM WRITER'S GUIDE (AWG) £4.00 Communicate by flow chart! Learn to use Yes/No questions for: procedures, system design, safety, legislation etc.

Understand Digital Electronics

Written for the student or enthusiast, this course is packed with information, diagrams, and questions designed to lead you step-by-step through number systems and Boolean algebra to memories, counters, and simple arithmetic circuits; and finally to an understanding of the design and operation of calculators and computers

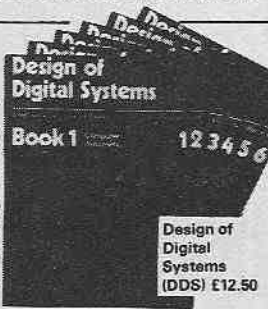

BOOK 1 Decimal, Octal, hexadecimal, and binary number systems and conversion between number systems; negative numbers; complementary systems. BOOK 2 OR and AND functions; multiple-input gates; truth tables; De Morgan's Laws; canonical forms; logic conventions; Karnaugh mapping; three-state and wired logic. BOOK 3 Half, full, serial, and parallel adders; subtraction; processors and ALU's; multiplication and division. BOOK 4 Flip flops; shift registers; asynchronous, synchronous, ring, Johnson, and exclusive-OR feedback counters; ROMS and RAMS. BOOK 5 Structure of calculators; keyboard encoding; decoding display-data; register systems; control unit; PROM; address de-coding. BOOK 6 CPU: memory organisation character representation; program storage; address modes; input/output systems; program interrupts; interrupt priorities; programming, assemblers; computers; executive programs; operating systems.

DIGITAL COMPUTER LOGIC & ELECTRONICS (DCL) £7.00 A course covering the material in italics above, but at a slower pace. (4 vols).

GUARANTEE—No risk to you. If you are not completely satisfied your money will be refunded without question, on return of the books in good condition.

Cambridge Learning Enterprises, Unit 63, River Mill Site, FREEPOST, St. Ives, Huntingdon, Cambs.

PLEASE SEND ME:—
 CPB (£9.00)
 BHB (£11.50)
 AWG (£4.00)
 DDS (£12.50)
 DCL (£7.00)

Quantity

| |
|--|
| |
| |
| |
| |
| |

FOUR WAYS TO PAY:
 1) A U.K. cheque or a U.K. postal order (Not Euro or overseas)
 2) A bank draft, in sterling on a London bank (available at any major bank)
 3) Please charge my Access/M.Ch Barclay/TrustC/Visa Am. Exp. Diners
 4) Or phone us with these credit card details - 0480 67446 (ansaphone) 24 hour service.

Card No. _____ Signed _____
 THESE PRICES COVER THE COST OF SURFACE MAIL WORLDWIDE. AIRMAIL: Eur. N.Af. Mid.E. add 1/2 to price of books: Jpn. Aus. N.Z. Pcfc add 1/2; elsewhere add 1/2

Name _____
 Address _____

U.K. Delivery: up to 21 days

Cambridge Learning Enterprises, Unit 63 Rivermill Site, FREEPOST, St. Ives, Huntingdon, Cambs PE17 4BR England.

Proprietors: Drayridge Ltd., address as above, Reg. in Eng. No. 1328762

ELECTRONIC BOOKS

| Ref. | Title | Price |
|------|-------------------------------------------------------|-------|
| 202 | HANDBOOK OF IC EQUIVALENTS AND SUBSTITUTES | 100p |
| 207 | PRACTICAL ELECTRONIC SCIENCE PROJECTS | 75p |
| 208 | PRACTICAL STEREO AND QUADROPHONY HANDBOOK | 75p |
| 218 | BUILD YOUR OWN ELECTRONIC EXPERIMENTERS LABORATORY | 85p |
| 221 | 28 TESTED TRANSISTOR PROJECTS | 85p |
| 224 | 50 CMOS IC PROJECTS | 95p |
| 225 | A PRACTICAL INTRODUCTION TO DIGITAL ICs | 85p |
| 226 | HOW TO BUILD ADVANCED SHORT WAVE RECEIVERS | 120p |
| 227 | BEGINNERS GUIDE TO BUILDING ELECTRONIC PROJECTS | 125p |
| RCC | RESISTOR COLOUR CODE DISC CALCULATOR | 20p |
| BP1 | FIRST BOOK OF TRANSISTOR EQUIVALENTS AND SUBSTITUTES | 60p |
| BP7 | RADIO AND ELECTRONIC COLOUR CODES AND DATA CHARTS | 25p |
| BP14 | SECOND BOOK OF TRANSISTOR EQUIVALENTS AND SUBSTITUTES | 110p |
| BP32 | HOW TO BUILD YOUR METAL AND TREASURE LOCATORS | 85p |
| BP43 | HOW TO MAKE WALKIE-TALKIES | 125p |
| BP48 | ELECTRONIC PROJECTS FOR BEGINNERS | 135p |
| BP58 | ELECTRONIC SECURITY DEVICES | 150p |
| BP57 | HOW TO BUILD YOUR OWN SOLID STATE OSCILLOSCOPE | 150p |
| BP58 | 50 CIRCUITS USING 7400 SERIES ICs | 135p |
| BP59 | SECOND BOOK OF CMOS ICs PROJECTS | 150p |
| BP61 | BEGINNERS GUIDE TO DIGITAL TECHNIQUES | 95p |
| BP65 | Single IC Projects | 150p |
| BP66 | Beginner's guide to Microprocessor & computing | 1-75p |
| BP69 | Electronic Games | 1-75p |

Please add 20p p & p per book. No VAT on books. Send SAE for full list of Babani Books

| DIL SOCKETS | | ANTEX SOLDERING IRONS | | VERO-BOARDS | |
|-------------|-----|-----------------------|------|-------------------|------|
| 8 pin | 10p | C-15W | 400p | 0-1 Copperclad | |
| 14 pin | 11p | CCN-15W | 415p | 2 1/2 x 5 | 75p |
| 16 pin | 12p | CX-17W | 420p | 3 1/2 x 2 1/2 | 60p |
| 18 pin | 24p | X25 | 420p | 3 1/2 x 5 | 80p |
| 20 pin | 26p | C-15W KIT | 570p | 3 1/2 x 3 1/2 | 75p |
| 24 pin | 30p | Spare Bits | 50p | 3 1/2 x 17 | 295p |
| 28 pin | 40p | Stand | 160p | V-Q Board for ICs | |
| 40 pin | 51p | | | No track cutting | 144p |
| | | | | Pkt. of 100 pins | 50p |
| | | | | Insertion Tool | 120p |
| | | | | S.F. Cutter | 45p |

| TRANSISTORS | | LINEAR ICs | | TTL/CMOS | |
|-------------|------|------------|-------|----------|------|
| AC128/7 | 25p | CA3046 | 70p | 7400 | 15p |
| AC128 | 25p | CA3080E | 72p | 7401 | 15p |
| AC176 | 25p | CA3089E | 225p | 7402 | 15p |
| AD148 | 70p | CA3390 | 375p | 7403 | 15p |
| AD161/2 | 45p | CA3140E | 80p | 7404 | 15p |
| BC107/8 | 11p | ICL8038 | 340p | 7408 | 19p |
| BC109 | 12p | LF358P | 85p | 7410 | 15p |
| BC177/8 | 17p | LM301A | 38p | 7413 | 30p |
| BC178 | 18p | LM309K | 135p | 7414 | 80p |
| BC182/3 | 10p | LM324 | 70p | 7416 | 27p |
| AC184 | 11p | LM339 | 75p | 7420 | 17p |
| BC212/3 | 11p | LM348 | 95p | 7427 | 34p |
| BC214 | 12p | LM377 | 175p | 7430 | 17p |
| BC548 | 16p | LM380 | 90p | 7432 | 30p |
| BCY71/2 | 22p | LM381AN | 180p | 7440 | 17p |
| BC131/2 | 50p | LM710 | 50p | 7447A | 75p |
| BD131/2 | 50p | LM741 | 20p | 7448 | 80p |
| BD241 | 70p | LM748 | 35p | 7450 | 17p |
| BFY50 | 30p | LM3900 | 70p | 7470 | 36p |
| BFY51 | 30p | LM3909 | 100p | 7473 | 30p |
| BU104 | 22p | LM3911 | 130p | 7474 | 24p |
| BU108 | 25p | LM3914 | 250p | 7475 | 36p |
| BU208 | 200p | LM4136 | 120p | 7476 | 35p |
| BU406 | 145p | MC1310P | 150p | 7483 | 90p |
| MPSA12 | 50p | MC1458 | 55p | 7486 | 34p |
| TIP31A | 80p | MC3340P | 120p | 7490 | 36p |
| TIP32A | 80p | NE531 | 140p | 7489 | 175p |
| TIP33A | 90p | NE555 | 22p | 7492A | 48p |
| TIP34A | 115p | NE556 | 70p | 7493 | 35p |
| TIP41A | 85p | NE567 | 175p | 74107 | 34p |
| TIP42A | 70p | SN7477 | 74121 | 28p | |
| TIP43A | 100p | TBA641B11 | 225p | 74123 | 35p |
| 2N2219A | 30p | TBA810S | 115p | 74124 | 35p |
| 2N2222A | 25p | TCA210 | 250p | 74154 | 100p |
| 2N2369A | 20p | TCA220 | 350p | 74157 | 70p |
| 2N2646 | 50p | TCA240E | 175p | 74160 | 100p |
| 2N2926 | 8p | TD1022 | 600p | 74161 | 100p |
| 2N3053 | 30p | TL072 | 90p | 74164 | 120p |
| 2N3055 | 48p | TL074 | 150p | 74198 | 150p |
| 2N3819 | 28p | TL081 | 48p | | |
| 2N3702/2 | 12p | TL084 | 130p | | |
| 2N5245 | 40p | TL082 | 90p | | |
| 2N5457/8 | 40p | XR2208 | 350p | | |
| 2N5459 | 40p | ZN414 | 100p | | |
| 40673 | 75p | ZN419C | 225p | | |
| 40871/2 | 90p | ZN425E | 400p | | |
| | | ZN1034E | 200p | | |

| OPTO-ELECTRONICS | | MULTIMETERS | |
|------------------|---------------|-------------------|------------------|
| Red Leds | Displays | Packet Multimeter | 5-00 |
| 0-125" 13p | DL707 130p | LT22 (20Kv) | 12-00 |
| 0-2" 14p | DL747 240p | Microtest 80R | 16-00 P & P 0-75 |
| Green | FND500 110p | Stabtester 680R | 33-50 P & P 1-00 |
| 0-125" 16p | FND507 110p | | |
| 0-2" 20p | ORP12 80p | | |
| Clips | 3p 2N5777 45p | | |

| EXPERIMENTOR BREADBOARDS | | STABILISED POWER SUPPLY | |
|-----------------------------------|------|-------------------------|---------------|
| No soldering suitable for DIL ICs | | 400mA | 3V 6V 7-5V 9V |
| EXP205 (1 IC up to 22 pin) | 170p | | 5-10 |
| EXP 300 (up to 5 x 14 pin) | 575p | | |
| EXP600 (up to 1 x 40 pin) | 630p | | |
| EXP350 (up to 2 x 14 pin) | 3-15 | | |

| PROTO BOARDS SOLDERLESS BOARDS | | ULTRASONIC TRANSDUCERS | |
|---------------------------------------------------------------------|---------------------|------------------------|----------|
| Socket Strips/Bus Strips/Binding Posts mounted on sturdy base plate | | Rx & Tx | 3-45 pr. |
| PB 6 | 5 x 14 pin DIL ICs | | |
| PB 100 | 10 x 14 pin DIL ICs | | |
| PB 102 | 12 x 14 pin DIL ICs | | |
| PB 103 | 24 x 14 pin DIL ICs | | |
| PB 104 | 32 x 14 pin DIL ICs | | |
| (The above boards are suitable for all DIL ICs) | | | |

| LOGIC PROBE | | SUBMINIATURE SWITCHES (Toggle) | |
|-----------------|--------|--------------------------------|-------------------|
| Logic Probe Kit | £18-00 | SPST 60p | SPDT 65p |
| | £15-75 | DPDT 70p | |
| | | Push to Make 15p | Push to Break 22p |
| | | Slide DPDT 18p | |

| LOUDSPEAKERS | |
|--------------|-----|
| 2 1/2" 8R | 85p |
| 1 1/2" 8R | 80p |
| 2 1/2" 64R | 80p |

VAT Rate. Please add 15% to your total. Please send SAE for full list. CALLERS WELCOME MON-FRI 9.30-5.30 SAT 10.30-4.30

Add 30p p & p (75p p & p for official orders)

TECHNOMATIC LTD

17 BURNLEY ROAD, LONDON NW10 (2 minutes from Dollis Hill Tube) Tel. 01-452 1500 Tlx. 922800

Conquer the chip.

Be it career, hobby or interest, like it or not the Silicon Chip will revolutionise every human activity over the next ten years.

Knowledge of its operation and its use is vital. Knowledge you can attain, through us, in simple, easy to understand stages.

Learn the technology of the future today in your own home.



ELECTRONICS

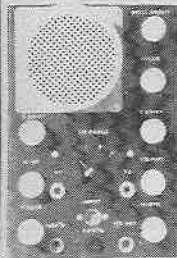

Build your own oscilloscope.

Learn to draw and understand circuits.

Carry out over 40 experiments.

DIGITAL TECHNIQUES

From watches to sophisticated instrumentation, Digital Electronics adds scope to hobby or career.



COMPUTER TECHNOLOGY

Learn to operate and programme your own home computer.

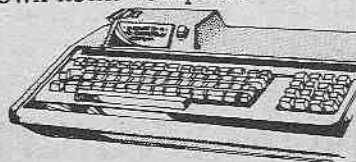

FREE BROCHURES



No previous knowledge is necessary.
- Just clip the coupon for a brochure

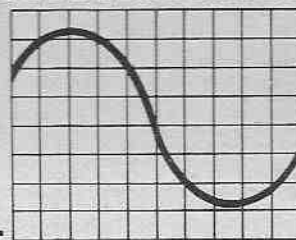

TUTORCOURSE ELECTRONICS

Please rush me details of your ELECTRONICS COURSE

Name _____

Address _____

EE.8.80

Block Caps. Please

Post now, without obligation to:

British National Radio & Electronics School.

P.O.Box 156, Jersey, Channel Isles

24 HOUR CLOCK TIMER KIT

LEDS

| | |
|-------------------|-----|
| 0.1" Red | 9p |
| 0.1" Green/Yellow | 12p |
| 0.2" Red | 9p |
| 0.2" Green/Yellow | 12p |
| 0.2" Clips | 3p |
| Rectangular Red | 20p |
| Rectangular Green | 25p |

DISPLAYS

| | |
|-------------------------------------------------------|-------|
| DL304 Red 0.3" c.c. Display pin compatible with DL707 | 70p |
| DL307 Red 0.3" c.a. pin comp. DL707 | 70p |
| DL727 Dual 0.5" c.a. Red Display | £1.50 |

D.V.M. THERMOMETER KIT



Based on the ICL7106. This kit contains a PCB, resistors, presets, capacitors, diodes, IC and 0.5" liquid crystal display. Components are also included to enable the basic DVM kit to be modified to a Digital Thermometer using a single diode as the sensor. Requires a 3mA 9V supply (PP3 battery). **£20.75**

MINI KITS

These Kits form useful subsystems which may be incorporated into larger designs or used alone. Kits include PCB, short instructions and all components.

MK1 TEMPERATURE CONTROLLER/THERMOSTAT
Uses LM3911 IC to sense temperature (80°C max), and triac to switch heater. **500W £3.20 1KW £3.50**

MK2 SOLID STATE RELAY
Ideal for switching motors, lights, heaters, etc. from logic. Operates isolated with zero voltage switching. Supplied without triac. Select the required triac from our range. **£2.60**

MK3 BAR/DOT DISPLAY
Displays an analogue voltage on a linear 10-element LED display as a bar or single dot. Ideal for thermometers, liquid indicators, etc. May be stacked to obtain 20 to 100 element displays. Requires 5-20V supply. **£4.75**

MK4 PROPORTIONAL TEMPERATURE CONTROLLER
Based on the TDA1024 Zero voltage switch, this kit may be wired to form a "burst fire" power controller or a "proportional temperature" controller enabling the temperature of an enclosure to be maintained to within 0.5°C. **1.5KW £5.25 3KW £5.55**

MK5 MAINS TIMER
Based on the ZN1034E Timer IC this kit will switch a mains load on (or off) for a preset time from 20 minutes to 35 hours. Longer or shorter periods may be realised by minor component changes. Maximum load 1KW **£4.50**

TOUCH CONTROL LIGHTING KITS

These KITS replace light switches and control up to 300 Watts of lighting. No rewiring, fit plaster depth boxes, insulated touchplates. Easy to follow instructions.

TD300K TOUCHDIMMER. Single touchplate with alternate action. Brief touch switches lamp on and off, longer touch dims or brightens lamps. Neon lamp helps find the switch in the dark. **£6.50**

TDE/K Extension kit for TD300K for 2-way switching, etc. **£1.50**

TSD300K TOUCHSWITCH & DIMMER. Single touchplate, small knob controls brightness. **£5.50**

TS300K TIME DELAY TOUCHSWITCH. Turns off after preset delay (2 secs. to 3½ mins.) **£4.30**

LD300K. Conventional light dimmer **£2.90**

INTEGRATED CIRCUITS

| | |
|------------------------------------------|-------|
| 555 Timer | 21p |
| 741 Op. Amp. | 19p |
| AY-5-1230/2 Clock/Timer | £2.60 |
| AY-3-1270 Thermometer | £8.20 |
| ICL7106 DVM (LCD drive) | £7.00 |
| LM377 Dual 2W Amp. | £1.45 |
| LM379S Dual 6W Amp. | £3.50 |
| LM380 2W Audio Amp. | 80p |
| LM382 Dual low noise Preamp | £1.00 |
| LM386 250mW low voltage Amp. | 75p |
| LM1830 Fluid Level Detector | £1.40 |
| LM2907 f-v Converter (8 pin) | £1.40 |
| LM2917 f-v Converter (14 pin) | £1.60 |
| LM3909 LED Flasher/Oscillator | 55p |
| LM3911 Thermometer | £1.20 |
| LM3914 Dot/Bar Driver | £2.10 |
| MM74C911 4 digit display controller | £6.50 |
| MM74C815 7 segment-BCD converter | 96p |
| MM74C926 4 digit counter with 7 seg. o/p | £4.50 |
| S566B Touchdimmer | £2.50 |
| S9263 Touchswitch 16-way | £4.85 |
| SN76477 Complex Sound Generator | £2.52 |
| TBA800 5W Audio Amp. | 58p |
| TBA810AS 7W Audio Amp. | 85p |
| TDA1024 Zero Voltage Switch | £1.20 |
| TDA2020 20W Audio Amp. | £2.85 |
| ZN1034E Timer | £1.80 |

All ICs supplied with data sheets. Data Sheets only. 5p each device.

DO MAGAZINE REMOTE CONTROL PROJECTS MAKE YOU SEE INFRA RED?



How many times have you considered building a remote control project but were put off by the dozens of ICs, special coils, lenses and other hard to get components, not to mention the need for a well equipped lab, to set the unit up. T. K. ELECTRONICS have changed all that. Three ICs can build a sophisticated system that requires only a capacitor and resistor to set the clock frequency (which can drift by up to 20% without affecting performance). Control radios, hi-fi (including base, treble and volume), lighting, toys, garage doors, etc. Still not convinced? then look at the prices!



| | |
|--------------------------------------------------------|-------|
| LD271 IR Emitting Diode | 36p |
| SF405 Photodiode Detector | 95p |
| SL480 IC Pulse Amplifier | £1.40 |
| SL490 Keyboard Controlled Encoder/Transmitter | £2.40 |
| ML922 10-channel Receiver & 3 Analogue Outputs | £4.20 |
| ML926 16-channel Receiver (4 Momentary binary outputs) | £1.40 |
| ML929 16-channel Receiver (4 latched binary outputs) | £1.40 |
| Data sheets (per device) | 5p |

These ICs can also be used with ultrasonic and radio links, depending on range, cost and speed of operation. For more details, why not give us a ring - we will be pleased to advise you.

NEW KIT

If you do not require a sophisticated multi-channel remote control, we have developed a simple single-channel ON/OFF infra red transmitter and receiver. The transmitter unit comes complete with a hand held box and requires a PP3 (3V) battery. The receiver includes a triac capable of switching up to 500W at 240V a.c. and comprises a preamplifier, bistable latch and a mains power supply, making the unit completely self-contained. The small size of the receiver enables the unit to be "built into" all kinds of equipment from lamps to tape recorders. The minimum range is 20 feet. A Order as RC 5-00p.

ONLY **£12.00**

TRIACS



| | |
|---------------------------|----------|
| 400V Plastic Case (Texas) | |
| 3A 49p | 16A 90p |
| 8A 58p | 20A 185p |
| 12A 88p | 25A 190p |
| 6A with trigger | 80p |
| 6A isolated tab | 85p |
| Diac | 18p |

ALL COMPONENTS ARE BRAND NEW AND TO SPECIFICATION ADD VAT AT CURRENT RATE TO ABOVE PRICES PLUS 40p P&P

MAIL ORDER - CALLERS WELCOME BY APPOINTMENT.

TK Electronics
(E.E.), 106 STUDLEY GRANGE ROAD,
LONDON W7 2LX. TEL. 01-5799794



TRADE ENQUIRY WELCOME

KITS FOR SOUND EFFECTS AND OTHER PROJECTS

PHONOSONICS

DEPT EE88, 22 HIGH STREET, SIDCUP, KENT DA14 6EH

MAIL ORDER SUPPLIERS OF QUALITY PRINTED CIRCUIT BOARDS, KITS AND COMPONENTS TO A WORLD-WIDE MARKET.

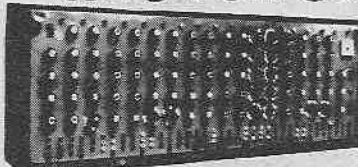

P.E. MINISONIC MK2 SYNTHESISER
A portable manual miniature keyboard synthesiser with keyboard controls. Although having slightly fewer facilities than the large Formant and P.E. synthesisers the functions offered by this design give it great scope and versatility. Set of basic component kits (excl. KBD R's & tuning pots - see list for options available) and PCBs (incl. layout charts) **KIT 98-25 £28.12**

"Sound Design" booklet **£1.00**

P.E. 128-NOTE SEQUENCER
Enables a voltage controlled synthesiser to automatically play pre-programmed tunes of up to 32 pitches and 128 notes long. Programs are keyboard initiated and note length and rhythmic pattern are externally variable. Basic comps, PCBs and charts **KIT 76-7 £35.56**
Set of text photocopies **£1.36**

P.E. GUITAR EFFECTS PEDAL
Modulates the attack, decay and filter characteristics of a signal from most audio sources, producing 8 different switchable effects that can be further modified by manual controls. Basic parts, PCB & chart **KIT 42-3 £10.37**
Text photocopy **£28**

P.E. GUITAR OVERDRIVE
Sophisticated versatile fuzz unit including variable controls affecting the fuzz quality whilst retaining the attack and decay, and also providing filtering. Can be used with other electronic instruments. Basic parts, PCB & chart **KIT 96-3 £11.82**
Text photocopy **£68**

P.E. GUITAR SUSTAIN
Maintains the natural attack whilst extending note duration. Basic comps, PCB & chart **KIT 75-1 £6.73**
Text photocopy **£38**

P.E. WAH-WAH UNIT
Can be controlled manually or by integral automatic control. Set of basic components, PCB & chart **KIT 91-1 £4.93**

COMPONENT SETS incl all necessary res, caps, s/cps, pots, t/formers. Hardware such as cases, skts, knobs, kds, etc. are not incl, but most can be bought separately. Fuller details in lists.

ADD: POST & HANDLING
U.K. orders; under £1 add 35p, under £20 add 70p, over £20 add £1. Recommended insurances against postal mishaps: add

50p for cover up to £50, £1 for £100 cover, etc., pro-rata, must be added to credit card orders. N.B. Eire, C.L., B.F.P.O. and other countries are subject to higher rates.

ADD 15% VAT (or current rate if changed). Must be added to full total of goods, post & handling on all U.K. orders. Does not apply to exports, or to photocopies.

P.E. AUTO-WAH UNIT
Automatic Wah or Swell sounds with each note played. Basic comps, PCB & chart **KIT 58-1 £9.68**
Text photocopy **£58**

ELEKTOR CHOROSYNTH
A 2½-Octave Chorus synthesiser with an amazing variety of sounds ranging from violin to cello and flute to clarinet, amongst many others. Experienced constructors can readily extend the octave coverage. Basic comps, PCBs & charts **KIT 100-8 £44.39**
Text photocopy **£70**

ELEKTOR FUNNY TALKER
Incorporates a ring modulator, chopper and frequency modulator to produce fascinating sounds when used with speech and music signals. Basic comps, PCB (as publ.) **KIT 99-1 £9.60**
Text photocopy **£40**

ELEKTOR FREQUENCY DOUBLER
For use with guitars and other electronic instruments to produce an output 1 octave higher than the input. Inputs and outputs may be mixed to give greater depth. Basic comps, PCB (as publ.) **KIT 98-1 £5.48**
Text photocopy **£20**

P.E. SPLIT-PHASE TREMOLO
Simple but effective substitute for a rotary cabinet. An internal generator is phase-split and modulated by the music input signal and fed to 1 or 2 amplifiers. Suitable for electronic guitars and other instruments. Basic comps, PCB & chart **KIT 102-3 £17.58**
Text photocopy **£65**

P.E. PHASER
An automatic 6-stage phasing unit with integralooscillator. Set of basic comps, PCB & chart **KIT 88-1 £10.69**
Text photocopy **£68**

ELEKTOR PHASING & VIBRATO UNIT
Includes manual and automatic control over the rate of phasing & vibrato, and has been slightly modified to also include a 2-input mixer stage. Set of basic comps, PCB & layout chart **KIT 70-2 £21.87**
Text photocopy **£67**

P.E. PHASING UNIT
A simple but effective manually controlled phasing unit. Set of basic comps PCB & chart **KIT 25-1 £4.06**
Text photocopy **£28**

P.E. SWITCHED TONE TREBLE BOOST
Provides switched selection of 4 preset tonal responses. Set of basic components, PCB & chart **KIT 89-1 £4.34**
Text photocopy **£78**

P.E. SMOOTH FUZZ
Set of basic components, PCB & chart **KIT 91-1 £6.40**
Text photocopy **£55**

P.E. TUNING FORK
Produces 84 switch-selected frequency-accurate tones with an LED monitor clearly displaying beat-note adjustments. Set of basic comps, PCB & chart **KIT 46-3 £23.32**
Text photocopy **£97**

P.E. CONSTANT DISPLAY FREQUENCY COUNTER
An improved version of the project published in P.E. Readout does not count visibly or flicker due to blanking. Set of basic components & PCB **KIT 79-4 £31.35**
Text photocopy **£78**

DYNAMIC NOISE LIMITER
Effectively reduces tape-recording hiss. Stereo Unit. Set of basic components, PCB & chart **KIT 97-1 £8.07**
Text photocopy **£75**

MANY MORE KITS
for synthesisers, Rhythm Generators, Electronic Pianos and other projects, big, small, simple or complex, are available, plus a range of keyboards, separate components and accessories. Details in our lists.

LIST: Send stamped addressed envelope with all U.K. requests for free list giving fuller details of our goods. Europe send 35p, other countries send 75p, or equivalent in international reply coupons

TERMS: C.W.O., MAIL ORDER OR COLLECTION BY APPOINTMENT (TEL: 01-302 6184)



PRECISION PETITE MINIATURE DRILLS AND ACCESSORIES for all your modelling needs



A choice of three power drills that fit snugly in the hand, so light they enable you to carry out the most intricate tasks — drilling, shaping, cutting, polishing etc in the minimum of time. There are two types of drill stand, S1 for P1 drill, S2 for all drills, plus all the necessary accessories in a remarkable range that fills every need. Fully illustrated literature is available and will be

gladly sent upon receipt of 9" x 4" stamped addressed envelope.

Access & Barclaycard welcome

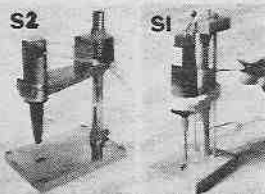

Sole UK Distributors **PRECISION PETITE LTD**
119a HIGH ST. TEDDINGTON, MDX. Tel: 01-977 0878

TUNE IN!

Build the World Famous
CHROMA-CHIME



Give your friends a warm welcome

This kit has been carefully prepared so that practically anyone capable of neat soldering will have complete success in building it. The kit manual contains step by step constructional details together with a fault finding guide, circuit description, installation details and operational instructions all well illustrated with numerous figures and diagrams.

- Handsome purpose built cabinet
- Easy to build and install
- Uses Texas Instruments TMS1000 microcomputer
- Absolutely all parts supplied including I.C. socket
- Ready drilled and legended PCB included
- Comprehensive kit manual with full circuit details
- No previous microcomputer experience necessary
- All programming permanently retained is on chip ROM
- Can be built in about 3 hours!
- Runs off 2 PP3 type batteries.
- Fully Guaranteed

ONLY
£11.95
+ 75p p&p
UK ONLY

* Save pounds on normal retail price by building yourself

OHIO SCIENTIFIC Superboard 2. Assembled 50 Hz model £159.95 + 15% vat post free. Colourboard 2 (the new colour version of Superboard 2) £205 + 15% vat.

★ Special offer:—if bought with ★
★ super board or colourboard these ★
★ items are at the reduced price ★
★ shown first. ★
★ Also sold separately at the bracketed ★
★ prices. Add 15% vat. Modulator ★
★ and power supply kit £7.95 (£11.4K) ★
★ extra ram £20 (£24). Case £23 (£26) ★
★ Cassette recorder £13 (£15). ★

SINCLAIR PRODUCTS New 10MHz scope £145, pfm 200 £51.95, case £2.07, adaptor £4.20, connector kit £13.95. Microvision tv £89, adaptor £8.88, pdm35 £34.23, adaptor £4.20, case £2.07, dm 350 £76.70, dm450 £102.17, dm235 £55.58, rechargeable batts £8, adaptor £4.20, case £8. enterprise prog calculator + accessories £19.95.

COMPUTER GAMES chess champion 6 £49.95, chess challenger 7 £75. New sensory Chess challenger 6 £109. Atari videocomputer £129. Cartridges £14.85.

TV GAMES AY-3-8500 + kit £10.21. AY-3-8600 + kit £14.98. stunt cycle ship + kit £14.09. Colour generator kit £9.05. **TRANSFORMERS** 6-0-6V 100ma 80p, 13a £2.60, 9-0-9V 75ma 80p, 1a £2.40, 2a £3.94 12-0-12V 100ma 99p, 1a £2.90. **IC AUDIO AMPS** with pcb. JC12 6W £2.68. JC20 10W £3.54. **BATTERY ELIMINATORS** 3-way type 6/7.5/9/300ma £3.14 100ma radio type with press-studs 9v £3.77, 9+9v £4.95. Car converter 12v input, output 4.5/6/7.5/9v 800ma £2.76. **BATTERY ELIMINATOR KITS** 100ma radio types with press-studs 4v £1.49, 6v £1.49, 9v £1.49, 4.5 + 4.5v £1.92, 6 + 6v £1.92, 9 + 9v £1.92. Stabilized 8-way types 3/4.5/6/7.5/9/12/15/18v 100ma £2.60, 1a £6.50. Stabilized power kits 2-18v 100ma £2.60, 1-30v 1a £6.75, 1-30v 2a £12.10. 12v car converter 6/7.5/9v 1a £1.35. **T-DEC AND CSC BREADBOARD S** s-dec £3.79, t-dec £4.58, u-dec £4.69, u-dec £7.16, exp4b £2.64, exp300 £6.61, exp350 £3.62, exp325 £1.84. Post 35p extra. Prices include VAT unless stated. Official and overseas orders welcome. Lists 7tp. post free. Mail order only.

SWANLEY ELECTRONICS
Dept. EE, 32 Goldsel Road., Swanley, Kent.

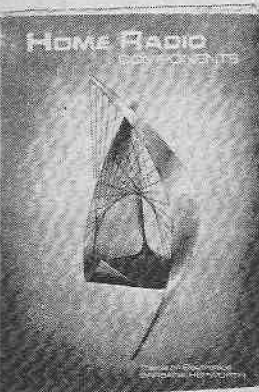

Top Priority for every constructor- HOME RADIO CATALOGUE

- Over 2,000 items clearly listed.
- Profusely illustrated throughout.
- Over 100 A-4 size pages.
- Bargain list included free.

Send cheque or P.O. for £1.30.

HOME RADIO Components LTD.
Dept. EE, P.O. Box 92, 215 London Rd.
Mitcham, Surrey. 01-648 8422

TMS 1000N

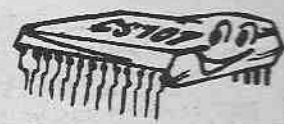

—MP0027A Micro-computer chip available separately if required. Full 24 tune spec device fully guaranteed.

This unique chip can be used not only for electronic door chimes but for other projects requiring musical output: New low price only

- Car Horns
- Musical Boxes
- Amusement Machines
- Alarms
- Public Address etc

£4.95 inc p & p.
Free applications manual and data supplied with device! (Or 30p separately)

ALL CHROMATRONICS PRODUCTS SUPPLIED WITH MONEY BACK GUARANTEE
PLEASE ALLOW 7-21 DAYS FOR DELIVERY

Please send me: EE 8/80
TO: CHROMATRONICS, RIVER WAY, HARLOW, ESSEX.
NAME _____
ADDRESS _____

I enclose cheque/PO value £ _____
or debit my ACCESS/BARCLAYCARD account no. _____

Signature _____

CHROMATRONICS

Marshall's

A. Marshall (London) Ltd., Kingsgate House, Kingsgate Place, London NW6 4TA
Industrial Sales: 01-328 1009
Mail Order: 01-624 8582
 Also retail shops: 325 Edgware Road, London W2.
 40 Crickwood Broadway, London NW2. 85 West Regent St., Glasgow.
 108A Stokes Croft, Bristol.

CAPACITORS:
 Mullard Ceramic 63v range
 1pF to 10,000pF E 24 range
 all at £0.06 each
 Siemens Ceramic 63v B37448/9
 .01: .022: .033: .047mF @ £0.06
 .068: .1mF @ £0.08: .22mF @ £0.11
 CSF High Voltage Ceramic Discs
 Prices £0.07 to £0.18 Range
 100pF to 10,000pF
 Voltage range up to 6Kv.
 See catalogue for details.
 Comprehensive range Siemens
 Layer Polyester Caps: .001 to
 3.3mF
 Prices £0.07 to £0.63.
 See catalogue for details.
 Large range of Mullard/Siemens
 Electrolytic Axial/Radial
 Capacitance values 1.0mF to
 10,000mF
 Voltage ranges 25v: 40v: 63v:
 100v:
 Prices and types as catalogue
 Also Mullard C280; Siemens
 B32231/4 and B32110. All prices
 net + VAT and postage/packaging.

BOXES & CASES
 See catalogue for full range.
 Aluminium boxes 13 sizes.
 Rexine Covered boxes 7 sizes.
NEW RANGE TMEC CASES
 Send S.A.E. for details & types
 Price range. £14.04 to £17.00
ABS PLASTIC BOXES
 3" x 2 1/2" x 1 3/8" Prices as
 3 1/2" x 2 1/2" x 1 3/8" catalogue
 4 1/2" x 3" x 1 1/2"
 8" x 4" x 3"
BAZELLI INSTRUMENT CASES
 5 sizes.
 Miscellaneous hardware
 including
 Vero Board; Superstrips;
 Vero Breadboard,
 Vero boxes (see catalogue for
 full range).



Card Frames: Fliptop boxes:
 etc etc.

TTL see catalogue for full range

| | | | |
|----------|-------|-----------|-------|
| SN7400N | ED.14 | SN7491AN | EO.54 |
| SN7401N | ED.14 | SN7492N | EO.31 |
| SN7402N | ED.14 | SN7493N | EO.32 |
| SN7403N | ED.14 | SN7494N | EO.80 |
| SN7404N | ED.14 | SN7495N | EO.55 |
| SN7405N | ED.15 | SN7496N | EO.34 |
| SN7406N | ED.24 | SN7497N | EO.80 |
| SN7407N | ED.26 | SN74100N | EO.10 |
| SN7408N | ED.15 | SN74107N | EO.21 |
| SN7409N | ED.16 | SN74118N | EO.76 |
| SN7410N | ED.16 | SN74119N | EO.20 |
| SN7411N | ED.15 | SN74121N | EO.25 |
| SN7412N | ED.20 | SN74122N | EO.48 |
| SN7413N | ED.28 | SN74123N | EO.42 |
| SN7414N | ED.47 | SN74124N | EO.53 |
| SN7416N | ED.22 | SN74125N | EO.40 |
| SN7417N | ED.22 | SN74141N | EO.90 |
| SN7420N | ED.45 | SN74150N | EO.72 |
| SN7421N | ED.18 | SN74148N | EO.05 |
| SN7425N | ED.19 | SN74150N | EO.79 |
| SN7426N | ED.19 | SN74151N | EO.56 |
| SN7427N | ED.19 | SN74152N | EO.55 |
| SN7430N | ED.15 | SN74154N | EO.90 |
| SN7432N | ED.17 | SN74155N | EO.80 |
| SN7437N | ED.21 | SN74157N | EO.58 |
| SN7438N | ED.21 | SN74158AN | EO.70 |
| SN7440N | ED.15 | SN74161AN | EO.70 |
| SN7441AN | ED.52 | SN74162AN | EO.70 |
| SN7442N | ED.40 | SN74163AN | EO.70 |
| SN7445N | ED.86 | SN74164N | EO.80 |
| SN7446AN | ED.48 | SN74165N | EO.80 |
| SN7447AN | ED.48 | SN74167N | EO.20 |
| SN7448N | ED.45 | SN74174N | EO.50 |
| SN7450N | ED.15 | SN74175N | EO.63 |
| SN7451N | ED.15 | SN74176N | EO.74 |
| SN7453N | ED.15 | SN74177N | EO.72 |
| SN7454AN | ED.15 | SN74180N | EO.72 |
| SN7460N | ED.15 | SN74181N | EO.65 |
| SN7470N | ED.26 | SN74182N | EO.83 |
| SN7472N | ED.24 | SN74183AN | EO.26 |
| SN7473N | ED.26 | SN74185AN | EO.10 |
| SN7474AN | ED.25 | SN74186N | EO.35 |
| SN7475N | ED.31 | SN74188AN | EO.84 |
| SN7476N | ED.26 | SN74189N | EO.26 |
| SN7480N | ED.39 | SN74190N | EO.74 |
| SN7481N | ED.71 | SN74191N | EO.79 |
| SN7482N | ED.66 | SN74192N | EO.79 |
| SN7483N | ED.60 | SN74193N | EO.55 |
| SN7484N | ED.95 | SN74196N | EO.74 |
| SN7485N | ED.70 | SN74197N | EO.74 |
| SN7486N | ED.25 | SN74198N | EO.09 |
| SN7489N | EO.66 | SN74199N | EO.09 |
| SN7490AN | EO.33 | | |

SOLDERING EQUIPMENT
IRONS-ANTEX
 15 watt C15 £3.95
 15 watt CCN £4.20
 17 watt CX17 £4.20
 25 watt X25 £4.20
 Stand £1.50



DESOLDERING TOOL
 Solder £6.50

SINCLAIR INSTRUMENTS
 Digital Multimeter
 " " PDM35 £ 34.50
 " " DM235 £ 52.50
 " " DM350 £ 72.50
 " " DM450 £ 99.00
 Digital Frequency Meter
 PFM200 £ 49.80
 Low Power Oscilloscope
 SC110 £139.00

CRIMSON ELEKTRIK HI FI
MODULES
 CE608 Power Amp £18.26
 CE1004 " " £21.30
 CE1008 " " £23.91
 CE1704 " " £30.43
 CE1708 " " £30.43
 CPS1 Power Unit £16.96
 CPS3 " " £20.43
 CPS6 " " £26.09
 CPR1 Pre Amp £29.57
 CPR1S Pre Amp £38.70
 All prices + VAT + postage/
 packaging

TOOLS BAHCO
 Side Cutter with Bezel.
 Side Cutter without Bezel.
 End Cutter without Bezel.
 Vero Metal Shears.
 Other items as catalogue.



1980 CATALOGUE
 U.K.: 65p post paid
 Europe 85p post paid
 Rest of World £1.25
 post paid
 Mail order: 01-624 8582



KNOBS & SWITCHES
 Big selection as catalogue
 Also Resistors; Presets; Pots;
 Opto; Semiconductors etc.

AIRSPACED VARIABLE CAPACITORS Direct Drive: 5pf @ 75p, 10pf @ 75p, 125 + 125pf @ 50p, 100 + 200pf @ 60p, 25 + 25 + 25pf @ 75p, 200 + 200 + 20 + 20pf @ 60p, With S.M. Drive: 250 + 250 + 20 + 20 + 20pf @ 75p, 500 + 500 + 25 + 25pf @ 60p. SUB-MINIATURE 25 + 25 + 25pf @ £1.
DAU FILM TRIMMERS 2 to 9pf, 7 to 35pf, 8 to 125pf. All at 15p each.
SOLDER-IN FEED THRU 6: 8pf, 27pf, 300pf, 1000pf. All 20p doz.
3/16" COIL FORMERS with core at 6 for 25p.
VHF SUB-MINIATURE TUBULAR TRIMMERS 0.5 to 3pf at 15p each.
MINIATURE 12 WAY CERAMIC TAG STRIPS at 15p.
6 to 12 VOLT RELAY Single Pole C.O. 5 amp Contacts @ 60p.
VHF-UHF FETS BF 256C @ 4 for 75p, E304 @ 30p, 4 for £1.
VHF RF CHOKES 30 U.H. Wire Ended, 25 for 50p.
ELECTRET MICROPHONE INSERTS with FET Pre-Amp @ £1.85.
TTL HOUSE CODED I.C.'s 7400, 7410, 74100, 7453, 7430. All at 6 for 50p.
VERNITRON 10.7 MHz FILTERS Type FM 4 @ 50p, 3 for £1.
50 SILVER MICA CAPACITORS assorted for 75p.
OP-TO ISOLATORS 1L-74 at 50p each.
CAR TYPE LONG DOLLY ON-OFF SWITCHES @ 35p each.
26 PHOTO AND DARLINGTON TRANSISTORS untested assorted @ £1.
50 1 AMP TO5 S.C.R.'s untested for £1.
IRON CORED L.F. CHOKE 2 M.H. 4 Amp for LT Smoothing @ 50p. P&P 25p.
100 ASSORTED C280 CAPACITORS for 60p.
NKT 274 or NKT 214 PNP TRANSISTORS @ 16p, 6 for 50p.
WIRE WOUND POTENTIOMETERS 2K, 5K, 10K, 2 Watt, 100K, 4 Watt. All at 30p each.
PLASTIC BC 108 or BC 212 at 6 for 50p.
10 AMP S.C.R.'s 100 PIV @ 25p, 400 PIV @ 55p, 900 PIV @ 65p.
50 BC 107-B-9 TRANSISTORS assorted untested @ 60p.
50 OC 71 TRANSISTORS untested for 75p.
50 AC 128 Branded but untested for 60p.
20 10 AMP STUD MOUNTING DIODES untested for 60p.
50 DISC CERAMICS assorted for 60p.
25 5 AMP STUD MOUNTING S.C.R.'s untested @ 75p.
10 20 AMP STUD MOUNTING DIODES untested @ 60p.
MURATA 65KHz FILTERS with data @ 50p each.
HF-VHF POWER TRANSISTOR Type 587 BLY SSB-FM 27 to 80 MHz 40 Watts out 28 volts with data @ £3 each.
BLY 55 175 MHz 4 Watt 13 Volt with data @ £2.50.
BLY 97 24 Volt 175 MHz 4 Watt with data @ £3.
BFR 64 470 MHz 13 Volt 3 Watt with data @ £4.
R.F. SIGNAL TRANSISTORS 2N 918 @ 25p, 2N 5179 @ 50p, 2N 5180 @ 50p, AF 239 @ 50p.
CERAMIC PLATE CAPACITORS 5-6, 6-8, 22, 33, 270, 330, .01µf 50 v.w.v., all 20p doz.
MAINS TRANSFORMERS 240 volt Input. Type 1. 24 volt tapped 14 volt 1 amp @ £1.30 (P&P 25p). Type 2. 30-0-30 volt 500 mA @ £1.30 (P&P 25p). Type 6. 16 volt 2 amp @ £1.60 (P&P 25p). Type 10. 12 volt 1 amp @ £1.60 (P&P 25p).
 Please add 20p for post and packing on UK orders under £2. Overseas postage charged at cost.

J. BIRKETT
RADIO COMPONENT SUPPLIERS
 25 The Strait, Lincoln LN2 1JF Tel. 20767

FM/AM STEREO TUNER AMPLIFIER CHASSIS
 Originally designed for installation into a music centre. Supplied as two separate built and tested units which are easily wired together, 240 volts A/C operation. Note Circuit diagram and inter-connecting wiring diagrams supplied.
Rotary Controls Tuning, volume, balance, treble and bass.
Push Button Controls Mono, Tape, Disc, A.F.C., FM(VHF), LW, MW, SW.
Power Output 7 watts RMS per channel into 8 ohms (10 watts music)
Tape Sensitivity output typically 150mV. Input 300mV for rated output.
Disc Sensitivity 100mV (ceramic cartridge).
Stereo Beacon Indicator LED or bulb.
Size Tuner—2 1/2" x 15" x 7 1/2" approx. Power amp.—2" x 7 1/2" x 4 1/2" approx.
 Price £22.00 + £2.50 Postage and Packing.

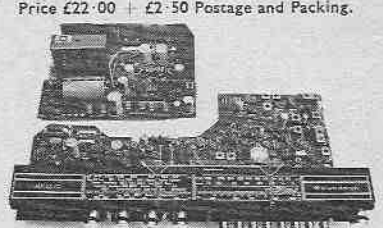

J.V.C. TURNTABLE CHASSIS
 J.V.C. Turntable supplied complete with an Audio Technica AT10 stereo magnetic cartridge.
 ★ 'S' shaped tone arm. ★ Belt driven. ★ Full size 12" platter. ★ Precision calibrated counter balance weight 0-3 grms). ★ Damped cueing lever.
 ★ Anti-skate (bias) device. Nylon thread weight. ★ Cut out template supplied.
 Size—12 1/2" x 15 1/2" (approx).
 Price £29.90 + £2.50 Postage and Packing.



B. K. ELECTRONICS (Dept. EE)
 37, Whitehouse Meadows, Eastwood, Leigh-on-Sea, Essex, SS9 5TY.
 ★ S.A.E. for components list etc. ★ Official orders welcome.
 ★ All prices include V.A.T. ★ Mail order only.
 ★ All items packed (where applicable) in special energy absorbing PU foam.

Newnes

constructors projects

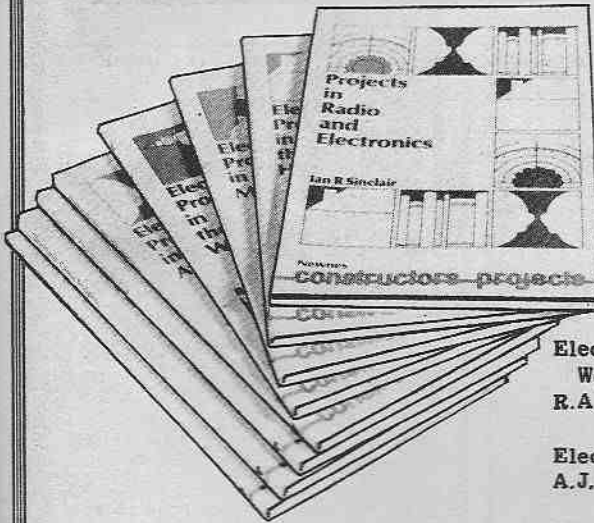

Each book presents a collection of constructional projects, giving details of how the circuit works, how it is assembled and how setting up and troubleshooting problems may be solved. There are eight titles in the series:

| | |
|-------------------------------------------------------------------------------|--------------------------------------------------------------------------------|
| Electronic Projects in the Workshop R.A.Penfold 0 408 00383 9 £2.50 | Electronic Projects in the Car M.George 0 408 00386 3 £2.50 |
| Electronic Projects in Music A.J.Flind 0 408 00391 X £2.50 | Electronic Game Projects F.G.Rayer 0 408 00379 0 £2.50 |
| Electronic Projects in Audio R.A.Penfold 0 408 00338 3 £2.50 | Electronic Projects in the Home Owen Bishop 0 408 00346 4 £2.50 |
| Electronic Projects in Hobbies F.G.Rayer 0 408 00354 5 £2.50 | Projects in Radio and Electronics Ian R.Sinclair 0 408 00345 6 £2.50 |

Available from your local bookshop
or in case of difficulty direct from —

Newnes Technical Books
Borough Green, Sevenoaks, Kent TN15 8PH

KITS FOR E.E. PROJECTS

| | | |
|----------------------------------|----------|--------|
| SLIDE TAPE SYNCHRONISER (ZB42) | Feb 80 | £11.50 |
| VARIACAP RADIO (ZB1) | Sept 79 | £8.50 |
| TRANSISTOR TESTER (ZB2) | Sept 79 | £5.00 |
| ONE ARMED BANDIT (ZB33) | Oct 79 | £21.00 |
| MORSE PRACTICE OSCILLATOR (ZB43) | Feb 80 | £6.00 |
| WARBLING TIMER (ZB5) | Aug 79 | £5.80 |
| MODULATED TONE GENERATOR (ZB50) | Dec 79 | £3.50 |
| ELECTRONIC TUNING FORK (ZB7) | Aug 79 | £8.90 |
| MICRO MUSIC BOX (ZB45) | Feb 80 | £17.00 |
| STEREO HEADPHONE AMP (ZB57) | March 80 | £15.25 |
| UNIBORAD BURGLAR ALARM (ZB51) | Dec 79 | £5.00 |
| KITCHEN TIMER (ZB55) | March 80 | £12.75 |
| UNIBORAD 9V POWER SUPPLY (ZB47) | Jan 80 | £4.50 |
| TREMOLO UNIT (ZB18) | June 79 | £10.00 |
| ELECTRONIC CANARY (ZB19) | June 79 | £4.50 |
| SIMPLE S.W. RECEIVER (ZB44) | Feb 80 | £18.00 |
| INTRUDER ALARM (ZB23) | May 79 | £23.00 |
| ELECTRONIC DICE (ZB24) | May 79 | £13.50 |
| MAINS ON/OFF TIMER (ZB48) | Jan 80 | £30.00 |
| BABY ALARM (ZB40) | Nov 79 | £8.50 |
| 5 RANGE CURRENT LIMITER (ZB53) | March 80 | £4.50 |
| CHASER LIGHT (ZB4) | Sept 79 | £17.50 |
| SHORT WAVE CONVERTER (ZB25) | May 79 | £13.75 |
| UNIBORAD TOUCH SWITCH (ZB56) | March 80 | £9.00 |
| FUNCTION GENERATOR (ZB52) | Nov 79 | £25.00 |
| OPTO ALARM (ZB41) | Nov 79 | £5.00 |
| POWER SUPPLY 9V (ZB6) | Aug 79 | £8.25 |
| CABLE & PIPE LOCATOR (ZB54) | March 80 | £3.75 |
| REVERB UNIT (ZB49) | Jan 80 | £29.00 |

All above kits include parts as described in articles i.e. veroboard, i.c. sockets connecting wire and cases where applicable.

TEACH-IN '80

New to electronics? Then start at the beginning. All electronic components for construction of Tutor Deck and Teach-In experiments during the first six parts of the series.

Lists A and B £20.00
List C £2.50

ALL PRICES INCLUDE V.A.T.
BARCLAY/VISA/ACCESS CARDS ACCEPTED.
MINIMUM TELEPHONE ORDER £5.00.

T. POWELL

306, ST. PAUL'S ROAD, LONDON N.1.
TELE: 01-226 1489.

SHOP HOURS: MON.—FRI. 9AM—5.30PM. SATURDAY 9AM—4.30PM

TECHNICAL TRAINING IN ELECTRONICS AND TELECOMMUNICATIONS

ICS can provide the technical knowledge that is so essential to your success; knowledge that will enable you to take advantage of the many opportunities open to you. Study in your own home, in your own time and at your own pace and if you are studying for an examination ICS guarantee coaching until you are successful.

City and Guilds Certificates:
Telecommunications Technicians
Radio, TV, Electronics Technicians
Technical Communications
Radio Servicing Theory
Radio Amateurs
Electrical Installation Work
MPT Radio Communications Certificate

Diploma Courses:
Colour TV Servicing
Electronic Engineering and Maintenance
Computer Engineering and Programming
Radio, TV, Audio Engineering and Servicing
Electrical Engineering, Installation
and Contracting

POST OR PHONE TODAY FOR FREE BOOKLET

ICS To: International Correspondence
Schools

Dept X268 Intertext House, London
SW8 4UJ or telephone 622 9911

Subject of Interest
Name
Address
Tel: Age:

Why not let
**EVERYDAY
ELECTRONICS
CLASSIFIED**

work for you

For details ring

01-261 5942

Receivers and Components

DISCOVER ELECTRONICS. Build forty easy projects including: Metal Detector; Breathalyser; Radios; Stethoscope; Lie Detector; Touch time-switches; Burglar Alarms, etc. Circuits, plans all for £1.50 including FREE circuit board. Mail only. **RIDLEY PHOTO/ELECTRONICS**, Box 62, 111 Rockspark Road, Uckfield, Sussex.

TURN YOUR SURPLUS capacitors, transistors, etc., into cash. Contact **COLESHARDING & CO**, 103 South Brink, Wisbech, Cambs, 0945 4188. Immediate settlement.

P.C.B.s Paxolin 10 1/2" x 4 1/2" £1-30 1 1/2" x 8" 80p. 16" x 1 1/2" £1-40 D.S. 10" x 8 1/2" 85p. Fibreglass 12" x 8" £1-70 8" x 5" 75p. D.S. 10 1/2" x 7" £1-35 8" x 7" £1-15 Panel with 40 assorted 74 series I.C.s £1-80. 20 Wire ended neons £1-90. Small 3 transistor Audio Ams 3-£1-20. 300 Small Components, Trans, Diodes £1-60. 7lbs Assorted Components £3-75 List 15p. refundable post 40p. Insurance add 20p.

J. W. B. RADIO

2, Barnfield Crescent, Sale, Cheshire. M33 1NL.

DIGITAL WATCH BATTERIES, any sort 75p each. Send SAE or 15p with number or old battery to Disclec, 511 Fulbridge Road, Werrington, Peterborough PE4 6SB.

100 DIODES 85p. 50 transistors 95p. 10 switches 90p. 10 Leads £1-15. All mixed. Lists 15p. Sole Electronics, E/E, 37 Stanley Street, Ormskirk, Lancs L39 2DH.

MUST SELL. Relays, motors, cam units, stepping units, solenoids, counters, coin rejectors and dispensers. All S/H but fully serviceable. SAE for lists. Marchant Surplus Electrical, 73 Devonshire Street, Bridgewater, Somerset TA6 5ES.

INTRODUCTION TO MICROPROCESSORS and computing (starter book) £2-30. Send SAE for descriptive list of micro, electronic IC project books and solderless breadboard. Educational Data and Technical Services, 59 Station Road, Cogenhoe, Northampton NN7 1LU.

WHY NOT START YOUR OWN BUSINESS REWINDING ELECTRIC MOTORS.

A genuine opportunity to success. LARGE PROFITS. You can't help but make money if you follow the easy, step by step, instructions in our fully illustrated Manual showing how to rewind Electric Motors, Armatures and Field coils as used in Vacuum Cleaners, Electric Drills and Power Tools. NO PREVIOUS KNOWLEDGE IS REQUIRED, as the Manual covers in 13 Chapters, where to obtain all the work you need, materials required, all instructions rewind charts and how to take data, etc. A goldmine of information. How to set up your home workshop and how to cost each job to your customer. £4-50 inclusive of P. & P. U.K. CWO to:

INDUSTRIAL SUPPLIES
102 Parrswood Road, Withington,
Manchester 20, Dept. EE

Service Sheets

BELL'S TELEVISION SERVICE for service sheets on Radio, TV etc. £1 plus SAE. Colour TV Service Manuals on request. SAE with enquiries to BTS, 190 King's Rd, Harrogate, N. Yorkshire. Tel: 0423 55885.

SERVICE SHEETS from 50p and SAE. Catalogue 25p and SAE. Hamilton Radio, 47 Bohemia Road, St. Leonards, Sussex.

Video

PORTABLE VIDEO HIRE

Complete VHS Colour Camera and Cassette Recorder with sound. £29 + VAT for the day.

FOR A DEMONSTRATION CALL
HOME VIDEO CAMERAS
01-731-4825

Situations Vacant

INDUSTRIAL ELECTRONICS: Are you an electronic wireman/tester or prototype wireman? Have you had an apprenticeship followed by at least 5 years practical experience? If so we can offer you employment as an instructor with good promotion opportunities and pensionable security at Bristol and Swindon Skillcentres. Starting salary £6,000 p.a. rising by two increments to £7,110 p.a. For more information contact Miss A. Curran MSC TSD, 11 Park Place, Clifton, Bristol. Telephone Bristol 20661.

ROYAL NATIONAL INSTITUTE FOR THE BLIND

ELECTRONICS ENGINEER

CIRCA £7,000+ p.a. (review July)

This post is for a practical, creative man or woman interested in keeping abreast of rapid development in electronics with a lively appreciation of their application rather than high academic qualifications. You should have had experience in semi-conductor technology in order to design and construct prototype aids for use by blind people, to initiate projects in external research establishments and manufacturing concerns, and to maintain familiarity with international research in this specialised field of work. Ability to provide verbal and written reports essential. Staff receive free lunch in our own restaurant, and there is an excellent RNIB Pension Scheme with transferability. Applications giving full c.v. including present post and salary to: Personnel Officer, RNIB, 224 Great Portland Street, London W1N 6AA.

INDUSTRIAL ELECTRONICS: Are you an electronic test technician or service mechanic? Have you had an apprenticeship followed by at least 5 years recent practical experience with a manufacturing or servicing organisation? If so we can offer you employment as an INSTRUCTOR, with good promotion opportunities and pensionable security, at Gloucester, Bristol and Swindon Skillcentres. Starting salary £6,000 p.a. rising by two increments to £7,110 p.a. For more information contact Miss A. Curran MSC TSD, 11 Park Place, Clifton, Bristol. Telephone Bristol 20661.

Miscellaneous

RECHARGEABLE BATTERIES

TRADE ENQUIRIES WELCOME

FULL RANGE AVAILABLE. SAE FOR LISTS. £1.45 for Booklet "Nickel Cadmium Power" plus catalogue. Write or call, Sandwell Plant Ltd, 2 Union Drive, Boldmere, Sutton Coldfield, West Midlands. 021-354 9764. Or see them at TLC, 32 Craven Street, Charing Cross, London WC2.

PRINTED CIRCUITS. Make your own simply, cheaply and quickly! Golden Fotoka Light Sensitive Lacquer—now greatly improved and very much faster. Aerosol cans with full instructions. £2-25. Developer 35p. Ferric Chloride 55p. Clear Acetate sheet for master 14p. Copper-clad Fibre-glass Board approx. 1mm thick £1-70 sq.ft. Post/packing 60p. **WHITE HOUSE ELECTRONICS**, PO Box 19, Castle Drive, Penzance, Cornwall.

MK14 CORNER. Interface Board, includes flag driven mains relays, Led Indicators for all Serial I/O, D/A and single step chips, and prototype area; also suitable for other Microcomputers; PCB and circuit £3-95. Replace calculator display with 1/2 in FND 500's; PCB, filter, instructions £1-95. Ready Built replacement Keyboard £11. Useful notes on MK14 75p. Rayner, 'Kismet', High Street, Colnbrook, Bucks.

LEARN ELECTRONICS WITHOUT SOLDER

Build electronic circuits without solder on a Roden S-Dec.

This has built-in contacts and holes into which you plug your components. Suitable for all ages. Can be used time after time. Ideal gift for students or experimenters. Full instructions and 2 circuit diagrams with each S-Dec.

Send cheque or P.O. to:
Roden Products, Dep EE
High March, Daventry,
Northants, NN11 4GE.

£3.85 plus 40p p.p. each



TUNBRIDGE WELLS COMPONENTS, BALLARD'S, 108 Camden Road, Tunbridge Wells, Phone 31803. No lists, enquiries S.A.E.

FREE 1980 AMTRON CATALOGUE with new range of kits and equipment cabinets. Send SAE. Amtron UK Ltd., 7 Hughenden Road, Hastings, Sussex TN34 3TG. Tel: Hastings 436004.

DIGITAL WATCH BATTERY REPLACEMENT KIT



These watches all require battery (power cell) replacement at regular intervals. This kit provides the means. We supply eyeglass, non-magnetic tweezers, watch screwdriver, case knife and screwback case opener. Also one doz. assort. push-pieces, full instructions and battery identification chart. We then supply replacement batteries—you fit them. Begin now. Send £9 for complete kit and get into a fast growing business. Prompt despatch.

BOLSTER INSTRUMENT CO. (EE17)
11 Percy Avenue, Ashford, Middx., TW15 2PB

ENAMELLED COPPER WIRE

| SWG | 1 lb | 1/2 lb | 1/4 lb |
|----------|------|--------|--------|
| 10 to 19 | 2-95 | 1-70 | 0-85 |
| 20 to 29 | 3-05 | 1-75 | 0-95 |
| 30 to 34 | 3-45 | 1-90 | 1-00 |
| 35 to 39 | 3-75 | 2-10 | 1-15 |
| 40 to 43 | 4-95 | 2-75 | 2-15 |
| 44 to 46 | 5-90 | 3-50 | 2-40 |

FREE WIRE TABLES WITH EACH ORDER
INDUSTRIAL SUPPLIES
102 Parrswood Road, Withington,
Manchester 20
Prices include P & P in UK

LEARN ELECTRONICS THE EASY WAY. Build—amplifiers, oscillators, detectors, testers, flashers, metronomes, etc., more than 25 projects, with our multi-kits, complete instructions manual supplied. Send £15-00 to—**MAJOR OAK SERVICES**, 33 Lillian Avenue, London W3.

THE SCIENTIFIC WIRE COMPANY

PO Box 39, London E4.
Reg. Office, 22 Coningsby Gardens.

ENAMELLED COPPER WIRE

| SWG | 1 lb | 8 oz | 4 oz | 2 oz |
|----------|-------|------|------|------|
| 10 to 29 | 3-10 | 1-86 | 1-10 | 0-80 |
| 30 to 34 | 3-50 | 2-00 | 1-15 | 0-80 |
| 35 to 39 | 3-95 | 2-36 | 1-34 | 0-98 |
| 40 to 42 | 5-10 | 2-97 | 2-28 | 1-42 |
| 44 to 46 | 6-00 | 3-80 | 2-50 | 1-91 |
| 47 | 8-87 | 5-32 | 3-19 | 2-80 |
| 48 to 49 | 15-96 | 9-58 | 6-38 | 3-69 |

SILVER PLATED COPPER WIRE.

| | 5-30 | 3-03 | 1-85 | 1-20 |
|----------|------|------|------|------|
| 14 to 22 | | | | |
| 24 to 30 | 6-50 | 3-75 | 2-20 | 1-40 |

Prices include P&P and VAT. Orders under £2 please add 20p SAE for list. Dealer enquiries welcome. Reg office 22 Coningsby Gardens.

Courses

CITY AND GUILDS RADIO AND TELEVISION PART-TIME COURSES SEPTEMBER 1980

224 Electronics Servicing Parts I and II

222 Electronics Mechanics Part III

Options at Part III

Television (Colour and Monochrome)

Additional Television (Colour and Mono-

chrome)

Digital Logic Techniques

Mature students working within the trade

will be given preference.

For details please contact the HEAD OF DEPART-
MENT OF ELECTRICAL ENGINEERING (Tele-
phone 01 985 8494)

Hackney College, Keltan House, 89-115
Mare Street, Hackney, London E8 4RG.

For Sale

NEW BACK ISSUES of "EVERYDAY
ELECTRONICS". Available 75p each Post
Free, open PO/Cheque returned if not in
stock. **BELL'S TELEVISION SERVICES** 190
Kings Road, Harrogate, Yorkshire. Tel:
(0423) 55885.

10-BAND MAPLIN graphic equaliser. Un-
beatable £40. Winton amplifier superb £60.
Going abroad. 01348 5214.

SECONDHAND SOLARTRON dual channel
oscilloscope for sale, £60. Will deliver
within 50 miles of Cardiff. Telephone 0222
28542.

Wanted

WANTED: ELECTRONIC COMPONENTS,
Redundant Stock, Test Equipment, Tools,
Machines, Hardware; Factories cleared.
Immediate cash decision. Contact: Mr.
Quirk, "Q" Services Electronic (Camber-
ley) Ltd, 29 Lawford Crescent, Yateley
871048, Camberley, Surrey.

MAINS INTERCOM



**NO
BATTERIES
NO WIRES
ONLY
£36.99
PER PAIR
+ VAT £5.55**

The modern way of instant 2-way communications. Just plug
into power socket. Ready to use. Crystal clear communications
from room to room. Range 1/2-mile on the same mains phase.
On/off switch. Volume control, with 'buzzer' call and light
indicator. Useful as inter-office intercom, between office and
warehouse, in surgery and in homes. P. & P. £1.75. Also
available P.M. 2 channel 'touch' model £47.95 + VAT
£7.20 + P & P £1.85

4-STATION INTERCOM

Solve your communication problems with this 4-Station
Transistor Intercom system (1 master and 3 Subs) in robust
plastic cabinets for desk or wall mounting. Call/talk/listen
from Master to Subs to Master. Ideally suitable for Business,
Surgery, Schools, Hospitals and Offices Operates on one 9V
battery. On/off switch. Volume control. Complete with 3 con-
necting wires each 86ft. Battery and other accessories.
PRICE £31.95 + VAT £4.60 + P. & P. £1.75.

NEW AMERICAN TYPE CRADLE TELEPHONE AMPLIFIER



**£18.95
+ VAT £2.85
+ P & P £1.15**

Latest transistorised Telephone Amplifier with detached plug-
in speaker. Placing the receiver on to the cradle activates a
switch for immediate two-way conversation without holding
the handset. Many people can listen at a time. Increase
efficiency in office, shop, workshop. Perfect for "conference"
calls: leaves the user's hands free to make notes, consult files.
No long waiting, saves time with long-distance calls. On/off
switch, volume control, conversation recording model at
£20.95 + VAT £3.15. P. & P. £1.15p.

DOOR ENTRY SYSTEM

No house/business/surgery should be without a **DOOR ENTRY
SYSTEM** in this day and age. The modern way to answer the
door in safety to unwanted callers. Talk to the caller and
admit him only if satisfied by pressing a remote control
button which will open the door electronically. A boom for the
invalid, the aged and busy housewife. Supplied complete
d.l.y. kit with one internal telephone, outside Speaker panel,
electric door lock release (for Yale type surface latch lock),
mains power unit, cable (8-way) 50 ft and wiring diagram.
Price £49.95 + VAT £7.50 + P. & P. £1.85. Kit with two
Telephones £59.95 + VAT £9.00 + P. & P. £1.95.

10-day price refund guarantee on all items.
WEST LONDON DIRECT SUPPLIES (B.E.S.)
109 KENSINGTON HIGH STREET, LONDON, W8

"SPECIAL PRICES" POST 1-50 BAKER LOUDSPEAKERS

| Model | Ohms | Size Inch | Power Watts | Type | Our Price |
|--------------|----------|--------------|----------------|-------|--------------|
| Major | 4, 8, 16 | 12 | 30 | Hi-Fi | £12 |
| Deluxe Mk II | 4, 8, 16 | 12 | 15 | Hi-Fi | £14 |
| Superb | 8, 16 | 12 | 30 | Hi-Fi | £22 |
| Auditorium | 8, 16 | 12 | 45 | Hi-Fi | £20 |
| Auditorium | 8, 16 | 15 | 60 | Hi-Fi | £30 |
| Group 35 | 8, 16 | 12 | 40 | PA | £12 |
| Group 45 | 4, 8, 16 | 12 | 45 | PA | £15 |
| Group 50 | 4, 8, 16 | 12 | 60 | PA | £20 |
| Group 50 | 8, 16 | 15 | 75 | PA | £30 |
| Group 75 | 4, 8, 16 | 12 | 75 | PA | £24 |
| Group 100 | 8, 16 | 12 | 100 | PA | £29 |
| Group 100 | 8, 16 | 15 | 100 | PA | £35 |
| Disco 100 | 8, 16 | 12 | 100 | Disco | £29 |
| Disco 100 | 8, 16 | 15 | 100 | Disco | £35 |

4 CHANNEL MIXERS £8.00
Add musical highlights and sound effects to recordings.
Will mix Microphone, records, tape and tuner with separate
controls into single output. 9 volt battery operated with
switch for four channel mono or two channel stereo working.

MINI MODULE BAFFLE KIT 10-95

EMI 15 x 8in. 3-way Loudspeaker System, 5in. Bass, 5in.
Middle, 3in. Tweeter; 3-way Crossover & Ready Cut Baffle.
Full assembly instructions supplied. Response 60 to
20,000 c.p.s. 12 watt RMS 8 ohms £10.95 per kit. Two kits
£20. Suitable Bookshelf Cabinet £29.95 each. Post £1.50



SINGLE RECORD PLAYER

Fitted with auto stop, stereo cartridge. Baseplate, Size 11
x 8in. Turntable size 7in. diameter, a.c. mains 240V 3
speeds plays all size records.
Two for £18. Post £1 on each. **£9.95**

NEW BSR SINGLE PLAYER £24.50

Model P182 3-speeds flared aluminium turntable "S"
shaped arm, cueing device, stereo ceramic cartridge.

B.S.R. DE-LUXE AUTOCHANGER £20

with stereo cartridge, plays all size records. Post £2

WOOD PLINTHS CUT FOR B.S.R. £4

Size: 16 x 14 1/2 x 3in. Teak Veneered.

METAL PLINTH CUT FOR B.S.R. OR GARRARD

Size: 16 x 14 x 3in. £4.50 Silver or Black finish. Post £2.

TINTED PLASTIC COVERS ALL POST £2

Sizes: 14 1/2 x 12 1/2 x 3in. £3.50 16 x 14 x 3 1/2 in. £4.
15 1/2 x 13 1/2 x 4in. £4. 17 1/2 x 9 1/2 x 3 1/2 in. £3.

18 x 13 1/2 x 3in. £5. 18 x 12 1/2 x 3in. £6.

18 x 13 1/2 x 3 1/2 in. with stand-up hinges £7.

R.C.S. LOW VOLTAGE STABILISED POWER PACK KITS £2.95 Post 45p

All parts and instructions with Zener diode printed circuit,
rectifiers and double wound mains transformer input 200-
240V a.c. Output voltages available 6 or 7, 5 or 9 or 12V d.c.
up to 100mA or less. Size 3 x 2 1/2 x 1 1/2 in.
Please state voltage required.

MAINS TRANSFORMERS POST 99p

250-0-250V 80mA 6.3V, 2A **£3.45**

250-0-250V 80mA 6.3V, 3.5A, 6.3V 1A **£4.60**

350-0-350V 250mA 6.3V 5 amp, 5V 2A **£12.50**

300-0-300V 120mA 2 x 6.3V 2A C.T., 6.3V 2A **£8.50**

220V 45mA, 6.3V 2A **£2.50**

HEATER TRANS 6.3V 3A £2.20 1/2 amp £2.00

GENERAL PURPOSE LOW VOLTAGE Tapped

outputs at:

2A, 3, 4, 5, 6, 8, 9, 10, 12, 15, 18, 24 and 30V **£8.00**

1A, 6, 8, 10, 12, 16, 18, 20, 24, 30, 36, 40, 48, 60 **£6.00**

2A, 6, 8, 10, 12, 16, 18, 20, 24, 30, 36, 40, 48, 60 **£9.50**

3A, 6, 8, 10, 12, 16, 18, 20, 24, 30, 36, 40, 48, 60 **£12.50**

5A, 6, 8, 10, 12, 16, 18, 20, 24, 30, 36, 40, 48, 60 **£18.00**

5, 8, 10, 16V 1A £2.50 12V 100mA £1.30 12V 300mA **£1.50**

£1.50 12V 750mA £1.75 40V 2 tapped 10V or 30V **£3.50**

£3.50 10-0-10V 2A £1.75 40V 2A £3.50 30V 5A + 30V **£4.00**

2A CT £4. 2 x 18V 6A £11. 12-0-12V 2 amp £3.50.

25-0-25V 2A £4.50 20-0-20V 1A £3.50 30V 1 1/2A £3.30.

20V 1A £3. 9V 3 amp £3.50 60V, 40V, 20V 1A £4.

15/0/15V 2A £3.75 32-0-32V 6A £11. 9V 250mA £1.50.

30V 2A £3.50.

AUTO TRANSFORMERS 115V to 230V or 230V to

115V 150W £7; 250W £8; 400W £9; 500W £10.

CHARGER TRANSFORMERS input 200/250V for 6

or 12V 1 1/2 amp £4.25 3 amp £4. 4 amp £7.25.

FULL WAVE BRIDGE CHARGER RECTIFIERS

6 or 12V outputs 1 1/2A 85p; 4A £1.60.

BLANK ALUMINIUM CHASSIS, 18 s.w.g. 2 1/2 in sides-

6 x 4in 95p; 8 x 6in £1.40; 10 x 7in £1.55; 14 x 9in £1.90;

16 x 6in £1.85; 12 x 3in £1.20; 16 x 10in £2.20; 12 x 8in

£1.70.

ALUMINIUM PANELS, 18 s.w.g. 6 x 4in. 24p; 8 x 6in.

38p; 10 x 7in. 54p; 12 x 5in. 50p; 12 x 8in. 70p; 16 x 6in.

70p; 14 x 9in. 94p; 12 x 12in. £1.16 x 10in. £1.16.

ALUMINIUM ANGLE BRACKET, 6 x 6 x 1/2 in. 25p.

ALUMINIUM BOXES, MANY OTHER SIZES IN

STOCK 4 x 2 x 2in. 85p; 3 x 2 x 1in. 65p; 6 x 4 x 2in.

55p; 8 x 6 x 3in. £1.50; 9 x 4 x 4in. £1.70; 10 x 7 x 3in.

£2.20; 12 x 8 x 3in. £2.50.

HIGH VOLTAGE ELECTROLYTICS

8/350V 35p 8+8/450V 75p 50+50/300V 80p

16/350V 45p 8+16/450V 75p 30+32/450V 85p

32/500V 75p 16+16/450V 75p 100+100/275V 85p

50/500V £1.20 32+32/350V 75p 150+200/275V 70p

8/800V £1.20 16/500V 85p 220/450V 95p

Rapid Mail Order Service. Callers Welcome.
Access-Barclay-Visa. Lists 20p. Closed Wed.

Radio Components Specialists

337 WHITEHORSE ROAD
CROYDON, SURREY, U.K. Tel. 01-684 1665

INDEX TO ADVERTISERS

| | | | |
|---------------------------------------------------|----------|-----------------------------------------|-----------|
| A.J.D. Direct Supplies (Silicon Shop) | 536 | Keelmoor | 471 |
| Ambit | 519 | Litesold | 470 |
| Bamber Electronics | 527 | Magenta Electronics | 523 |
| B.I.E.T. | 536 | Maplin Electronic Supplies Ltd. | Cover iv |
| Bi-Pak | 517 | Marshall's | 532 |
| Birkett J. | 532 | Metac | 467 |
| B.K. Electronics | 532 | Monolith | 536 |
| B.N.R.E.S. | 529 | Mullard | Cover iii |
| Bull J. | 520 | Phononics | 530 |
| Butterworth | 533 | Powell T. | 533 |
| Cambridge Learning | 528 | Precision Petite | 531 |
| Chromatronics | 531 | Radio Component Specialities | 535 |
| Colour Print Express | Cover ii | Science of Cambridge | 468, 469 |
| Continental Specialities Corpora- tion | 507 | Swanley Electronics | 531 |
| Electrovalue | 466 | Technomatic | 528 |
| Gemini | 466 | Tempus | 508 |
| George Sales David | 524 | T.K. Electronics | 530 |
| Greenweld | 524 | Vero Electronics | 470 |
| Heath kit | 466 | Watford Electronics | 465 |
| Home Radio | 531 | West London Direct Supplies | 535 |
| I.L.P. Electronics | 472, 473 | | |
| Intertext (ICS) | 533 | | |

ELECTRONIC GAMES

ATARI



SPECIAL PRICE
£86 + VAT

SPACE INVADERS

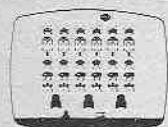

HAND HELD - CARTRIDGES
ATARI - ACETRONIC
PRINZTRONIC
RADOFIN - DATABASE etc.
We keep a full range!
Send for cartridge lists stating which machine you own.

INTELLIVISION MATTEL



£173.87 + VAT

Available August 1980
This is the most advanced TV game in the world. Expandable next year into a full microcomputer.
COLOUR CATALOGUE AVAILABLE WITH DETAILS ON ALL THE CARTRIDGES

BRIDGE

COMPUTER



- * Plays 1/2/3 or 4 Hands
- * Problem Mode
- * Audio Feedback
- * Instant Response
- * Auto scorekeeping

DRAUGHTS

COMPUTER

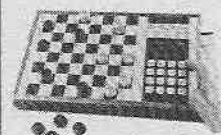

- * Solves Problems
- * Rejects illegal moves
- * 2 level machine £43 + VAT
- * 4 level machine £77.78 + VAT

CHESS

COMPUTERS

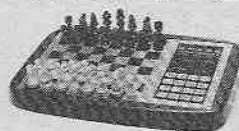

Send for further details.

NEW RANGE AVAILABLE
AUGUST 1980
We specialise in computer chess machines & stock over 13 different models from £20 to £300

BACKGAMMON

COMPUTERS



From £38 to £108. Send for further details.

- OMAR 1
- OMAR 2
- CHALLENGER
- GAMMONMASTER

LEISURE

- * CHEAP TV GAMES
- * TELEPHONE ANSWERING MACHINES
- * AUTO DIALLERS
- * CALCULATORS
- * DIGITAL WATCHES
- * PRESTEL
- * HAND HELD GAMES

TELETEXT



RADOFIN
TELETEXT
Add on Adaptor

£199 + VAT

27 TUNE DOOR BELL

£17.13 + VAT



FREE CATALOGUE

For a free copy of our 32 page catalogue, send a 12p stamp to Silica Shop Ltd or Telephone 01-301 1111

MAIL ORDER SERVICE - Free postage & Packing

TELEPHONE & MAIL ORDERS - accepted on:
Access * Barclaycard * American Express * Diners Club

CALLERS WELCOME - at our shop in Welling - Demonstrations daily
Open from 9am-5pm Mon-Sat (9am-1pm Wed)

GUARANTEE - Full 12 months + After Sales Support!

We have comprehensive brochures on all products. Please let us know what you are interested in and we will send you detailed brochures AND our own 32 page catalogue covering most games on the market.

SILICA SHOP

SILICA SHOP LTD., Dept. EE8
102 Bellegrave Road
Welling, Kent DA16 3QF
Tel: 01-301 1111

TRAIN AT HOME

Be an ELECTRONIC ENGINEER

Do something PRACTICAL about your future.
Firms all over Britain are crying out for qualified people. With the right training, you could take your pick of these jobs.

Now, the British Institute of Engineering Technology will train you in your spare time to be an Electrical Engineer.

You risk nothing! We promise to get you through your chosen course - or refund your fee!

So, join the thousands who have built a new future through home study Engineering courses.

Courses in
C & G Elect. Technicians
C & G Elect. Installations
Telecomms. Technicians Exams
*Television Servicing
Radio Maint. & Repairs (BIET)
Pract. Radio & Electronics
Plus over 60 other home study courses.

POST COUPON FOR FREE 44 PAGE GUIDE

BRITISH INSTITUTE OF ENGINEERING TECHNOLOGY

Aldermaston Court, Dept. TEE 53 - Reading RG7 4PF.

NAME (Block capitals please) _____

ADDRESS _____

POSTCODE _____

Other Subjects _____ AGE _____

Accredited by CACC Member of ABCC

MONOLITH

QUALITY REEL TO REEL & CASSETTE TAPE HEADS + MECHANISMS

POPULAR UNIVERSAL CASSETTE TAPE HEADS

| | | | |
|--------------------------------------|--------|----------------------------------------------|--------|
| B12-01 Mono Playback | £1.89 | C42RPH04 Stereo GLASS FERRITE R/P | £11.60 |
| B12-02 Mono Record/Playback | £4.02 | C42RPS16 Stereo TWIN GAP R/P | £25.21 |
| B24-01 Stereo Playback | £3.70 | E12-09 Mono/stereo erase | £ 1.85 |
| B24-02 Stereo Record/Playback | £5.65 | B22-02 Twin 1/2 track R/P | £ 5.97 |
| B24-07 Stereo R/P (Dolby Sstsm) | £7.87 | C44RPH03 Quad 1/2 track R/P | £13.17 |
| C42RPH20 Stereo SENDUST R/P | £9.28 | C44RPE01 Quad 1/2 track combined R/P + Erase | £26.45 |
| C42RPE01 Stereo combined R/P + Erase | £10.93 | G22ESD2 Twin half track erase | £ 4.72 |

SEND FOR OUR FULL CATALOGUE 50p including P. & P.

MONOLITH

THE MONOLITH ELECTRONICS CO. LTD.
57 CHURCH ST., CREWKERNE, SOMERSET, ENGLAND. (0460) 74321

PLEASE ENCLOSE 30p P&P WITH ORDER

ALL PRICES INCLUDE VAT

MAIL ORDER ADVERTISING

British Code of Advertising Practice

Advertisements in this publication are required to conform to the British Code of Advertising Practice. In respect of mail order advertisements where money is paid in advance, the code requires advertisers to fulfil orders within 28 days, unless a longer delivery period is stated. Where goods are returned undamaged within seven days, the purchaser's money must be refunded. Please retain proof of postage/despatch, as this may be needed.

Mail order Protection Scheme

If you order goods from Mail Order advertisements in this magazine and pay by post in advance of delivery, EVERYDAY ELECTRONICS will consider you for compensation if the Advertiser should become insolvent or bankrupt, provided:
(1) You have not received the goods or had your money returned; and
(2) You write to the Publisher of EVERYDAY ELECTRONICS summarising the situation not earlier than 28 days from the date you sent your order and not later than two months from that day.
Please do not wait until the last moment to inform us. When you write, we will tell you how to make your claims and what evidence of payment is required.
We guarantee to meet claims from readers made in accordance with the above procedure as soon as possible after the Advertiser has been declared bankrupt or insolvent.
This guarantee covers only advance payment sent in direct response to an advertisement in this magazine not, for example, payment made in response to catalogues etc. received as a result of answering such advertisements. Classified advertisements are excluded.

Hands off.

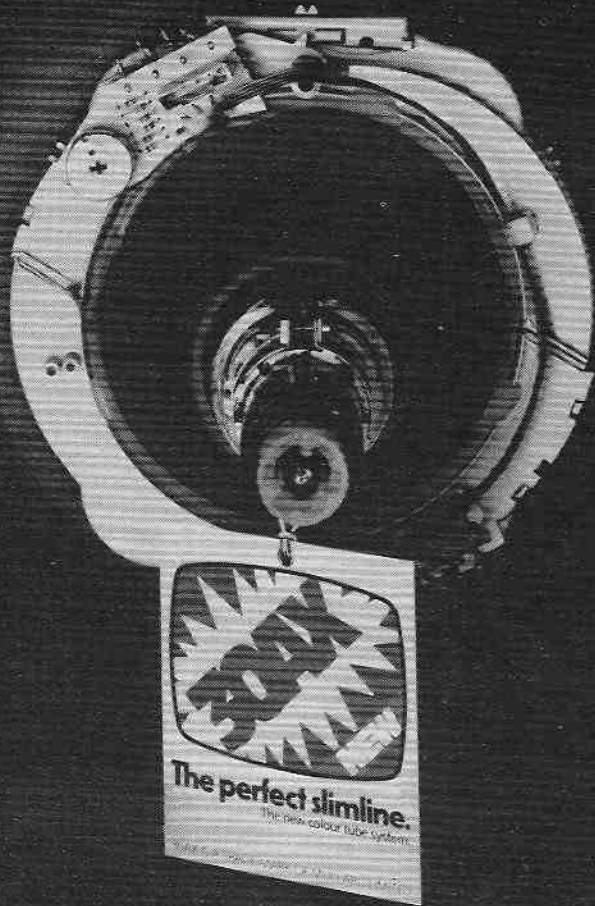

We mean it.

The new 30AX colour tube system from Mullard doesn't need innumerable twists and turns of a screwdriver to set it up.

It needs no adjustments at all. Because every one has been 'designed out'. Every tube that leaves our factory is completely pre-adjusted by us. Leaving only the turn of one screw to affix or remove the coil.

No dynamic convergence adjustments.

No colour purity adjustments.

And no raster orientation adjustment.

As for what it has to offer, the 30AX's focus is sharper and its definition greatly improved.

Its in-line guns and specially built coil provide the best picture shape yet.

And rest assured it'll stay that way. In a slim

110° package that trims about 3" off conventional 22" 90° TV cabinet depths.

Some features of the 30AX however, are a little more established.

Like its excellent colour registration.

High brightness. Soft flash protection. Fast warm-up. And of course, greater overall reliability. This is the new 30AX colour tube system.

If you'd like more information about it simply write to us here at Department MCG, Mullard Limited, Mullard House, Torrington Place, London, WC1E 7HD.

30AX is a trademark of Mullard Ltd.



Mullard
30AX. The perfect slimline.

STEP INTO A NEW WORLD WHEN YOU DISCOVER **MAPLIN**

For beginners or professionals, the Maplin catalogue will help you find just about everything you need for your project.

Over 5,000 of the most useful components — from resistors to microprocessors — clearly described and illustrated.

Send the coupon for your copy
and **STEP UP TO
MAPLIN SERVICE
NOW**



Post this coupon now for your copy of our 1979-80 catalogue price 70p.

Please send me a copy of your 280 page catalogue. I enclose 70p (plus 46p p&p). If I am not completely satisfied I may return the catalogue to you and have my money refunded. If you live outside the U.K. send £1.35 or ten International Reply Coupons. I enclose £1.16.

NAME _____

ADDRESS _____



E/E/8/80

MAPLIN

ELECTRONIC SUPPLIES LTD

All mail to:

P.O. Box 3, Rayleigh, Essex SS6 8LR.

Telephone: Southend (0702) 554155.

Shop: 284 London Road, Westcliff-on-Sea, Essex. (Closed on Monday).

Telephone: Southend (0702) 554000.

Catalogue now available in all branches of WHSMITH  Price £1.00