

Easy to build projects for everyone

Everyday ELECTRONICS

KIOSKS
McLeod

JULY 79
45p

CONFERENCE TIMER

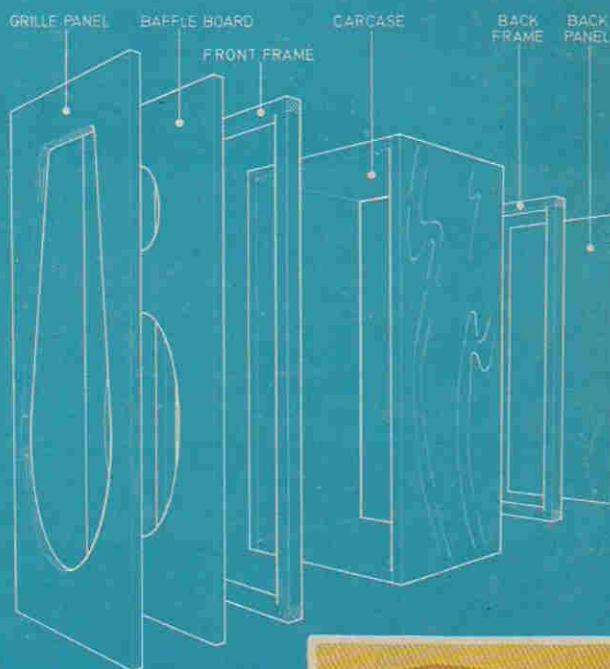

 **20**
ECONOMY
LOUDSPEAKER



WATER LEVEL INDICATOR

**Ideal for
Beginners**

DARKROOM TIMER



Come to the Great British Electronics Bazaar

"ALLY PALLY"
Thursday-Saturday
28th-30th June.

FREE!

(AND WAIT TILL YOU SEE OUR SEMINAR PROGRAMME)

The Great Big 'Bazaar' for the hobbyist, amateur, and small buyer.

There's never been an event like this before.

First, the very scale of the exhibition is huge. Virtually all the companies you're used to hearing about (and buying from) will be there. Companies like Fluke and Gould showing off their low cost multimeters; smaller but important manufacturers like Lektrokit and Chromasonics; and even the R.S.G.B. who will have a station 'on the air' throughout the 'Bazaar.'

Then there are the suppliers of low-cost components and equipment. Plus almost all the journals in the business. Plus, oh, so many more interesting people catering for your needs (including computer kits!).

And you get in FREE if you send an s.a.e. (see alongside).

Our Symbol.
We think it tells
you just what the
Bazaar is all about.



The Seminars.

If you would like to hear just what the experts have to tell you, a season ticket for three whole days can be yours for only £1.50.

Send an s.a.e. and we'll give you all the information (just use the coupon).



Our home for three days - Alexandra Palace, where it all began. (Our seminars are sited alongside the organ - for those who know this unique hall.)

SEMINAR TICKETS

£1.50.

I'd like to sit in at your seminars. (And like a free ticket to the exhibition.) Send me full details, please, and I enclose a large-ish s.a.e.

Name:

Address:

Post to: 'The Bazaar,' 34/36 High Street, Saffron Walden, Essex.

When?

Between Thursday to Saturday 28th-30th June.

You'll be in very good company; some ten thousand enthusiasts - and over a hundred stands displaying all that you want to see.

You'll come?

Eyes down for the appropriate coupon.

ADMISSION FREE

(or 50p on the door).

I'd like to see 'The Bazaar' FREE. I enclose a large-ish s.a.e. and will receive by return a ticket and full information.

Name:

Address:

Post to: 'The Bazaar,' 34-36 High Street, Saffron Walden, Essex. If you'd rather just pay 50p, go to Wood Green Tube Station and take a bus (every 3 minutes) to Alexandra Palace. We're open 10 am-6 pm daily, Thursday to Saturday, 28th-30th June.

MICRO CHIMES

FROM THE INVENTORS
OF MICROPROCESSOR
MUSICAL CHIMES

A COMPLETE
KIT FOR THE
EE
MICRO
CHIME

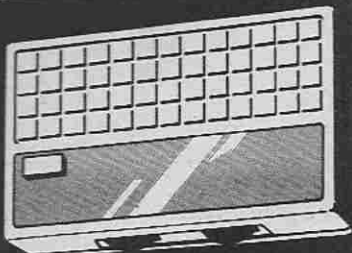

This easy to build kit includes:

- * TMS1000 Custom MPU Chip
- * Special purpose designed case
- * Fully drilled and legended PCB
- * All transistors, Resistors and Capacitors
- * Full set of mechanical parts
- * Smart fascia labels
- * IC Socket and Loudspeaker
- * Really Low Price!

only **£8.95** + 55p p&p

TMS 1000N - MP0027A Micro-computer chip available separately if required. Full 24 tune spec device supplied with data sheet and fully guaranteed.

New low price only **£4.95** inc. p&p

(Only present 24 tune repertoire currently available.)

New price for the original
CHROMA-CHIME 24 tune model!
Due to the fantastic success of this product right across the World we are able to offer it at

only **£9.95** + 75p p&p

Comes complete with:

- * TMS1000 Micro
- * Superb cabinet
- * All R's & C's
- * Switches & pots
- * Fully detailed kit manual
- * Fully prepared PCB
- * All semiconductors
- * Loudspeaker
- * Socket & Hardware

ALL CHROMATRONICS PRODUCTS
SUPPLIED WITH MONEY BACK REFUND
CHROMATRONICS River Way, Harlow Essex.

TO: CHROMATRONICS, RIVER WAY, HARLOW, ESSEX, UK.

NAME _____

ADDRESS _____

EE3

I enclose cheque/PO value £ _____
or debit my ACCESS/BARCLAYCARD account no. _____

Signature _____

CHROMATRONICS

TANTALUM BEAD CAPACITORS 4.7uf 16v.w. @ 9p, 10uf 10v.w. @ 9p, 33uf 10v.w. @ 9p, 100uf 10v.w. @ 25p.
LED'S TIL 209 @ 6 for 50p, 2" Red @ 6 for 70p, .2" Green @ 15p.
ERIE REDCAP .01uf 100v.w. **MINIATURE CAPACITORS** @ 5p each.
PLASTIC BC 108 TRANSISTORS with House Numbers @ 10 for 60p.
VARIABLE CAPACITORS. 25+25+25pf @ 75p.
MINIATURE ELECTROLYTICS 8uf 300v.w., 10uf 250v.w. Both at 10 for 80p.
50. OC 71 TRANSISTORS untested @ 75p.
VERNITRON FM4 10.7MHz CERAMIC FILTERS @ 50p, 3 for £1.
100 MULLARD C 280 CAPACITORS assorted @ 57p.
WIRE WOUND POTENTIOMETERS 2 watt 2K, 4 watt 100K. Both 30p each.
10 AMP S.C.R.'s 100 PIV @ 25p, 400 PIV @ 50p, 800 PIV @ 60p.
COIL FORMERS. 3/16" Dia. with core at 6 for 25p.
CRYSTALS. 10X type. 7010, 7038-88, 7040, 7070, 7080, 7090, 7100, 7500, 7900, 8000, 8007-89, 8018-82, 8021-54, 8035-38, 8036-25, 8061-18, 8068, 8076-82, 8089-09, 8090, 8092, 8092-5, 8510, 9720 KHz. All at 20p each. 6 for £1.
WIRE ENDED CRYSTALS. 28, 28-5, 29-75, 29-76, 31, 83-997 KH. All at 50p each.
50. BC 107-9-9 TRANSISTORS untested @ 57p.
200 RESISTORS 1/2 watt assorted values for 75p.
VARIABLE CAPACITORS. Direct Drive. 5pf @ 75p, 10pf @ 75p, 30pf @ 85p, 125+125pf @ 55p, 100+200pf @ 55p, 200+200+17+17pf @ 55p, 25+25+25pf @ 75p.
S.M. DRIVE. 500+500+25+25pf @ 55p, 250+250+20+20+20pf @ 75p.
SEMI-AIRSPACED TRIMMERS 2 To 9pf, 7 To 35pf, 6 To 45pf, 8 To 125pf, 8 To 140pf. All at 15p each.
R.F. TRANSISTORS MPS 6514 @ 15p, AF 239 @ 50p, 2N 5190 @ 50p, 8FY 90 @ 50p, 2N 5179 @ 50p, BF 224 @ 10p, BF 382 @ 25p.
VHF FETS. 2N 3819 @ 20p, J310 @ 20p, MF 131 @ 50p, BF 258 @ 25p, E111 @ 12p, E112 @ 10p, DUAL GATE TYPE 40673 @ 33p.
100 ASSORTED DISC CERAMICS for 57p.
MINIATURE POLYESTER CAPACITORS .1uf 125 v.w. @ 20p doz.
50. 1 AMP S.C.R.'s T05 Can untested for £1.
25. 5 AMP STUD MOUNTING S.C.R.'s untested for 75p.
20. 10 AMP STUD DIODES untested @ 57p.
3 PIN PLUG AND SOCKET like R.S. European 2M Cable @ 75p pair.
AUDIO AMP I.C.'s TCA 940 @ £1, TBA 820 @ 55p, TBA 810 @ £1, TBA 800 @ 80p, SN 7600IN @ 80p.
10 ASSORTED PUSH BUTTON BANKS less knobs @ £1-30.
MULLARD TRANSISTORS. BC 549 @ 10p, 8 for 50p.
400mW ZENERS unmarked good. 3-6v, 6-8v, 10. 11v, 12v, 16v, 18v, 24v, 30v, 33v, 36v. All at 10 for 40p.
MAINS TRANSFORMERS 240 volt input. Type 1. 24 volt Tapped at 14 volt 1 amp @ £1-30 (P&P 25p), Type 2. 30-0-30volt 500mA @ £1-30 (P&P 25p), Type 3. 45 volt 8 amp @ £4-50 (P&P 95p), Type 4. 20 volt 1 amp Twice 10 volt 1 amp Twice @ £4-50 (P&P 95p) Type 5. 45 volt 2 amp 45 volt 500mA @ £3-50 (P&P 85p), Type 6. 16 volt 2 amp @ £1-60 (P&P 25p), Type 7. 24 volt 1.75 amp @ £1-60 (P&P 25p), Type 8. 30 volt lamp @ £1-60 (P&P 25p).
MINIATURE NON POLARISED CAPACITORS 1uf 63v.w. @ 5p, 4.7uf 63 v.w. @ 10p, 10uf 63v.w. @ 15p.
MIDGET AIRSPACED TRIMMERS 3 To 20pf @ 15p each. Please add 20p for post and packing, unless otherwise stated, on U.K. orders under £2. Overseas orders postage at cost.

J. BIRKETT

RADIO COMPONENT SUPPLIERS

25 The Straff, Lincoln LN2 1JF Tel. 20767

C-MORE 2in1 DASHBOARD INSTALLATION BATTERY CONDITION DISPLAY & CHARGE RATE MONITOR

TAKES ONLY A FEW MINUTES TO FIT.

ONLY £6.20
INCLUDING VAT & P&P

The C-More mounts easily on the dash with adhesive pads (supplied), and connects to earth and an ignition wire through a quick connector (also supplied).

The battery voltage is electronically monitored immediately the ignition is switched on, and presented through a LED display using a novel split colour comparator.

Full fitting and operating instructions even highlight probable cause of faults when they occur. Helps prevent those unnecessary and expensive replacements.

2 YEAR GUARANTEE

HARVELEC 1 Formby Avenue, St. Helens, Merseyside, WA10 3HW.

HARVELEC

(Dept. EE), 1 Formby Avenue, St. Helens, Merseyside, WA10 3HW. (Registered no. 2121206)

Please send.....C-Mores at £6.20 ea. (inc.) (+ 25% for export please) to:

.....Cheque/P.O. Value:

I understand this order will be despatched within 4 days of receipt, and that if I'm not fully satisfied I can return the units within 10 days for a full refund of the purchase price.

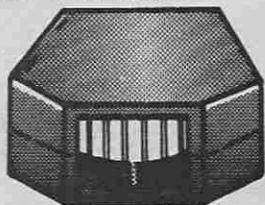

Shows Red when
Battery is Poor.
Yellow when Battery
is Overcharging
Red and Yellow
when all is Well

QUARTZ LCD 5 Function

Hours, mins., secs., month, date, auto calendar, back-light, quality metal bracelet.

£6.65

Guaranteed same day despatch.
Very slim, only 6mm thick.



M1

QUARTZ LCD 7 Function

Hours, mins., secs., month, date, auto calendar, back-light, seconds STOP WATCH.

£9.65

Guaranteed same day despatch.
Very slim, only 6mm thick.



M2

QUARTZ LCD 11 Function SLIM CHRONO

6 digit, 11 functions. Hours, mins., secs., day, date, day of week, 1/100th, 1/10th, secs., 10X secs., mins. Split and lap modes. Back-light, auto calendar. Only 8mm thick. Stainless steel bracelet and back. Adjustable bracelet. Metac Price

£12.65 Thousands sold!

Guaranteed same day despatch.



M3

QUARTZ LCD ALARM 6 Function

Hours, mins., secs., month, date, back-light, 24 hour ALARM. Adjustable stainless steel bracelet. Only 9mm thick.

£12.65

Guaranteed same day despatch.



M4

QUARTZ LCD ALARM 7 Function

Hours, mins., secs., day, date, alpha day, back-light, auto calendar. Adjustable stainless steel bracelet. Only 9mm thick.

£15.95

Guaranteed same day despatch.



M5

QUARTZ LCD Alarm Chronograph with Dual Time Zone Facility

Constant LCD display of hours and minutes, plus optional seconds or date display, plus day of the week and am/pm indication. Perpetual calendar, day, date, month and year. 24 hour alarm with on/off indication. 1/10 second chronograph measuring net, lap and first and second place times. Dual time zone facility night light. Only 9mm thick.

£22.65



M6

SOLAR QUARTZ LCD Chronograph with Alarm Time Zone Facility

Constant LCD display of hours and minutes, plus optional seconds or date display, plus day of the week and am/pm indication. Perpetual calendar, day, date, month and year. 24 hour alarm with on/off indication. 1/10 second chronograph measuring net, lap and first and second place times. Dual time zone facility night light. Only 9mm thick.

£25.65



M7

QUARTZ LCD Alarm Chrono

22 function, 6 digit. Hours, mins., secs., date, day of week, stopwatch, split time, alarm, second watch (dual time), back-light. FRONT BUTTON OPERATION.

£22.65

Guaranteed same day despatch.

METAC PRICE



M8

SOLAR QUARTZ LCD Chronograph

6 digit, 11 function. Hours, mins., secs. 1/100, 1/10 secs., mins. Split and lap modules. Auto calendar and back light. Powered from solar panel with battery back-up.

£13.95



M9

SEIKO Alarm Chrono

LCD, hours, mins., secs., day of week, month, day and date, 24 hour Alarm, 12 hour chronograph, 1/10th secs., and lap time. Back light, stainless steel, HARDLEX glass.

List Price £130.00

METAC PRICE

£105.00



M10

SEIKO Chronograph

LCD, hours, mins., secs., day of week, month, day, date, 12 hour chronograph, 1/10th secs. and lap-time. Back light, stainless steel water resistant, HARDLEX glass.

List Price £85.00

METAC PRICE

£68.00



M11

SOLAR QUARTZ LCD 5 Function

Genuine Solar Solar panel with battery back-up. Back light and auto calendar. Hours, mins., secs., day, date. Quality metal bracelet.

£8.95

Guaranteed same day despatch.



M12

HANIMEX Electronic LED Alarm Clock



Features and Specification:
Hour/minute display. Large LED display with p.m. and alarm on indicator. 24 Hours alarm with on/off control. Display flashing for power loss indication. Repeatable 9-minute snooze. Display bright/dim modes control. Size: 5.15" x 3.93" x 2.36" (131mm x 11mm x 60mm). Weight: 1.43 lbs (0.65 kg). AC power 220V.

£9.65 Thousands sold!

Guaranteed same day despatch.

M13

QUARTZ LCD Ladies Slim Bracelet

5 function. Hours, mins., secs., day, date and back light and auto calendar. Elegant metal bracelet in silver or gold. State preference.

£15.95

Guaranteed same day despatch.



M14

QUARTZ LCD Ladies 5 Function

Only 25 x 20mm and 6mm thick. 5 function. Hours, mins., secs., day, date and back light and auto calendar. Elegant metal bracelet in silver or gold. State preference.

£9.95

Guaranteed same day despatch.



M15

DIGITAL LED CLOCK



Automatic brightness control. Weekend alarm cancel.

Features and Specification:
Hour/minute display. Large LED display with p.m. and alarm on indicator. 24 Hours alarm with on-off control. Display flashing for power loss indicator. Repeatable 9-minute snooze. Automatic brightness control. Weekend alarm cancel.

£10.95

Guaranteed same day despatch.

M16

HOW TO ORDER

Payment can be made by sending cheque, postal order, Barclay, Access or American Express card numbers. Write your name, address and the order details clearly, enclose 30p for post and packing or the amount stated. We do not wait to clear your cheque before sending the goods so this will not delay delivery. All products carry 1 year guarantee and full money back 10 day reassurance. Battery fitting service is available at our shops. All prices include VAT.

Trade enquiries: Send for a complete list of trade prices - minimum order value £100. Telephone Orders: Credit card customers can telephone orders direct to Daventry or Edgware Rd., 24 hour phone service at both shops: 01-723 4753 03272-76545.



CALLERS WELCOME
Shops open 9.30 - 6.00.

Metac

ELECTRONICS
& TIME CENTRES

North & Midlands
67 High Street, DAVENTRY
Northamptonshire
Telephone: 03272 76545

South of England
327 Edgware Road
LONDON W.2
Telephone: (01) 723 4753

KITS FOR SOUND EFFECTS AND OTHER PROJECTS



GUITAR EFFECTS PEDAL (P.E. July 75)

Modulates the attack, decay and filter characteristics of an audio signal not only from a guitar but from any audio source producing 8 different switchable effects that can be further modified by manual controls. Possibly the most interesting of all the low-priced sound effects units in our range. Circuit does not duplicate effects from the Guitar Overdrive Unit. Component set with special foot operated switches £7.89
Alternative component set with panel switches £5.85
Printed circuit board £1.43

GUITAR FREQUENCY DOUBLER

(P.E. Aug. 77)

A modified and extended version of the circuit published. Component set and PCB £4.52

GUITAR OVERDRIVE UNIT (P.E. Aug. 76)

Sophisticated, versatile Fuzz unit, including variable and switchable controls affecting the fuzz quality whilst retaining the attack and decay and also providing filtering. Does not duplicate the effects from the Guitar Effects Pedal and can be used with it and with other electronic instruments. Component set using dual rotary pot £6.89
Printed circuit board £1.82

GUITAR SUSTAIN (P.E. Oct. 77)

Maintains the natural attack whilst extending note duration. Component set, PCB and foot switches £5.13
Component set, PCB and panel switches £3.71

WIND AND RAIN UNIT

A manually controlled unit for producing the above-named sounds. Component set (incl. PCB) £4.26

COMPONENTS SETS

include all necessary resistors, capacitors, semi-conductors, potentiometers and transistors. Hardware such as cases, sockets, knobs, keyboards, etc. are not included but most of these may be bought separately.

18% DISCOUNT VOUCHER (EEM)

TERMS: Goods in current adverts & lists over £30 goods value (excl. P.P. & V.A.T.). Correctly coded. C.W.O., U.K. orders only. This voucher must accompany order. Valid until end of month on cover of E.E.

ADD: POST & HANDLING

U.K. orders—Keyboards add £2.00 each plus VAT. Other goods: under £15 add 25p plus VAT; over £15 add 50p plus VAT. Recommended: optional insurance against postal mishaps, add 50p for cover up to £50, £1.00 for £100 cover, etc. pro-rata. N.B. Eire, C.I., B.F.P.O. and other countries are subject to higher export postage rates.

PHONOSONICS

MAIL ORDER SUPPLIERS OF QUALITY PRINTED CIRCUIT BOARDS, KITS AND COMPONENTS TO A WORLD-WIDE MARKET.

VOICE OPERATED FADER (P.E. Dec. 73)

For automatically reducing music volume during "talk-over"—particularly useful for Disco work or for home-movie shows. Component set (incl. PCB) £3.97

PHASING UNIT (P.E. Sept. 73)

A simple but effective manually controlled unit for introducing the phasing sound into live or recorded music. Component set (incl. PCB) £3.20

PHASING CONTROL UNIT (P.E. Oct. 74)

For use with the above Phasing Unit to automatically control the rate of phasing. Component set (incl. PCB) £4.74

TREMOLO UNIT

Based upon P.E. Sound Design circuit. Component set (incl. PCB) £2.94

TREBLE BOOST UNIT (P.E. Apr. 76)

Gives a much shriller quality to audio signals fed through it. The depth of boost is manually adjustable. Component set (incl. PCB) £2.51

WAH-WAH UNIT (P.E. Apr. 76)

The Wah-Wah effect produced by this unit can be controlled manually or by the integral automatic controller. Component set (incl. PCB) £3.63

AUTOWAH UNIT (P.E. Mar. 77)

Automatically produces Wah-pedal and Swell-pedal sounds each time a new note is played. Component set, PCB, special foot switches £7.57
Component set and PCB, with panel switches £4.83

PHOTOCOPIES OF TEXTS

for most of the kits are available—prices in our lists. LIST—Send stamped addressed envelope with all U.K. requests for free list giving fuller details of PCBs, kits and other components.

ADD 12% VAT

(or current rate if changed). Must be added to full total of goods. Discount, post & handling, on all U.K. orders. Does not apply to Exports.

FUZZ UNIT

Simple Fuzz unit based upon P.E. "Sound Design" circuit. Component set (incl. PCB) £2.05

P.E. TUNING FORK (P.E. Nov. 75)

Produces 84 switch-selected frequency-accurate tones. A LED monitor clearly displays all beat note adjustments. Ideal for tuning acoustic or electronic musical instruments. Main component set (incl. PCB) £14.93
Power supply set (incl. PCB) £5.28

SYNTHESIZER TUNING INDICATOR

(P.E. July 77)

A simple 4-octave frequency comparator for use with synthesizers and other instruments where the full versatility of the P.E. Tuning Fork is not required. Component and PCB (but excl. sw.) £7.45

DYNAMIC RANGE LIMITER (P.E. Apr. 77)

Automatically controls sound output to within a preset level. Component set (incl. PCB) £4.58

CONSTANT DISPLAY FREQUENCY

METER (P.E. Aug. 78)

A 5-digit frequency counter for 1Hz to 99999Hz with a 1Hz sampling rate. Readout does not count visibly or flicker due to display blanking. Component set £24.05*
Printed circuit board £3.03*

This kit & PCB are at 8% VAT (all others are 12%)

MANY MORE KITS

for Synthesizers, Rhythm Generators, Electronic Piano and other projects, big, small, simple or complex, are available, plus a range of keyboards, separate components and accessories. Details in our lists.

PHOTOGRAPHS

in this advertisement show two of our units containing some of the P.E. projects built from our kits and PCBs. The cases were built by ourselves and are not for sale, though a small selection of other cases is available.

EXPORT ORDERS ARE WELCOME

but to avoid delay we advise you to see our list for postage rates. All payments must be cash-with-order, in Sterling by International Money Order or through an English Bank. To obtain list—Europe send 20p, other countries send 50p.

PRICES ARE CORRECT AT TIME OF PRESS.

E.&O.E. DELIVERY SUBJECT TO AVAILABILITY.

PHONOSONICS • DEPT. EE94 • 22 HIGH STREET • SIDCUP • KENT DA14 6EH

TERMS: C.W.O., MAIL ORDER OR COLLECTION BY APPOINTMENT (TEL: 01-302 6184)

TECHNICAL TRAINING IN ELECTRONICS AND TELECOMMUNICATIONS

ICS can provide the technical knowledge that is so essential to your success: knowledge that will enable you to take advantage of the many opportunities open to you. Study in your own home, in your own time and at your own pace and if you are studying for an examination ICS guarantee coaching until you are successful.

City and Guilds Certificates:
Telecommunications Technicians
Radio, TV, Electronics Technicians
Technical Communications
Radio Servicing Theory
Radio Amateurs
Electrical Installation Work
MPT Radio Communications Certificate

Diploma Courses:
Colour TV Servicing
Electronic Engineering and Maintenance
Computer Engineering and Programming
Radio, TV, Audio Engineering and Servicing
Electrical Engineering, Installation and Contracting

POST OR PHONE TODAY FOR FREE BOOKLET

ICS To: International Correspondence Schools

Dept J268 Intertext House, London SW8 4UJ or telephone 622 9911

Subject of Interest

Name

Address

Tel: Age:

ELECTROVALUE

Your leading direct suppliers for

RESISTORS

Carbon Film ●

1/4 watt 1 to 10	E24 values (E12 over 1M)	ea. 2p
1/4 watt 47 to 4M7	E12 values	ea. 2p
1/2 watt 47 to 10	E24 values	ea. 2p
1 watt 4.7 to 10M	E12 values	ea. 5p

Metal Oxide

1/4 watt Electrofil TR5 10 to 1M	2% E24 values	ea. 5p
----------------------------------	---------------	--------

Metal Film

0.4 watt Mullard MR25 5.1 to 300K	2% E24	ea. 5p
-----------------------------------	--------	--------

Wirewound

1 watt 0.22 to 3.9	E12 values	ea. 15p
2.5 watt 1 to 1K	E12 values (vitreous)	ea. 25p
3 watt 1 to 10K	E12 values	ea. 15p
7 watt 1 to 10K	E12 values	ea. 15p

THERMISTORS ●

Discs - VA1039 19p, VA1040 13p, VA1100 19p, VA1104 59p.

Plate and Bead (vacuum) types also available from 22p to £4.80 each.

Buying from **Electrovalue** can cost you even less when purchased together with other items from our Catalogue 9 (See pages 85/86 and discounts scheme). You will find practically everything you want in our Catalogue at good prices backed by good service — so start buying the Electrovalue way today. Rates subject to amendments.

V.A.T. Add 8% to all prices quoted here except those marked ● which carry 12% VAT. Prices subject to alteration without prior notice.

Discounts non-allowable on Barclaycard or Access.

ELECTROVALUE LTD

Dept. EE7, 28 St. Judes Road, Englefield Green, Egham, Surrey, TW20 0HB.
Phone Egham 3603. Telex 264475
Northern Branch (Personal shoppers only), 680 Burnage Lane, Burnage, Manchester M19 1NA.
Phone (061) 432 4945.

● We pay postage.

In U.K. on cw orders list value £5 and over. If under add 27p handling charge.

● We give discounts

On cw orders only 5% on list value £10 or more. 10% on orders list value £25 or more. Not applicable to items shown net (or N).

● We stabilise prices

By keeping to our printed price lists which appear, but three or four times a year.

● We guarantee

All products brand new, clean and to makers specs. No seconds, no surplus.

● WE WILL SEND YOU OUR 100 PAGE CATALOGUE NO. 9 FREE ON REQUEST

Write, phone or call for your copy together with latest price list.

YOUR COMPLETE RANGE OF ELECTRONIC HARDWARE...

BIMENCLOSURES



ALL METAL BIMCASES

Red, Grey or Orange 14swg Aluminium removable top and bottom covers. 18 swg black mild steel chassis with fixing support brackets.

BIM 3000
(250x167.5x68.5mm)
£14.58



MINI DESK BIMCONSOLES

Orange, Blue, Black or Grey ABS body incorporates 1.8mm pcb guides, stand-off bosses in base with 4 BIMFEET supplied. 1mm Grey Aluminium panel sits recessed with fixing screws into integral brass bushes.

BIM 1005 (161 x 96 x 58mm) £2.18
BIM 1006 (215 x 130 x 75mm) £3.05



MULTI PURPOSE BIMBOXES

Orange, Blue, Black or Grey ABS with 1mm Grey Aluminium recessed front cover held by screws into integral brass bushes.

1.8mm pcb guides incorporated and 4 BIMFEET supplied.

BIM 4003 (85x56x28.5mm) £1.18
BIM 4004 (111x71x41.5mm) £1.62
BIM 4005 (161x96x52.5mm) £2.19

ALL METAL BIMCONSOLES

All aluminium, 2 piece desk consoles with either 15° or 30° sloping fronts, sit on 4 self-adhesive non-slip rubber feet. Ventilation slots in base and rear panel for excellent cooling. See latest catalogue for new styles and sizes



15° Sloping Panel

BIM7151 (102x140x51 [28] mm)
BIM7152 (165x140x51 [28] mm)
BIM7153 (165x216x51 [28] mm)
BIM7154 (165x211x76 [33] mm)
BIM7155 (254x211x76 [33] mm)
BIM7156 (254x287x76 [33] mm)
BIM7157 (356x211x76 [33] mm)
BIM7158 (356x287x76 [33] mm)

30° Sloping Panel

BIM7301 (102x140x76 [28] mm) £10.67
BIM7302 (165x140x76 [28] mm) £11.44
BIM7303 (165x183x102 [28] mm) £12.61
BIM7304 (254x140x76 [28] mm) £13.82
BIM7305 (254x183x102 [28] mm) £15.36
BIM7306 (254x259x102 [28] mm) £16.67
BIM7307 (356x183x102 [28] mm) £17.58
BIM7308 (356x259x102 [28] mm) £18.55

Colour Code	Top Panel	Base
A	Off White	Blue
B	Sand	Green
C	Satin Black	Gold

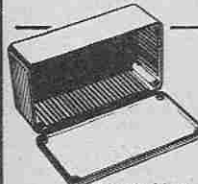

ABS & DIECAST BIMBOXES

6 sizes in ABS or Diecast Aluminium. ABS moulded in Orange, Blue, Black or Grey. Diecast Aluminium in Grey Hammetone or Natural. All boxes incorporate 1.8mm pcb guides, stand-off supports in base and have close fitting flanged lids held by screws into integral brass bushes (ABS) or tapped holes (Diecast).

	ABS	Diecast	Hammetone	Natural
(50x50x31mm)	N/A	BIM5001/11	TBA	£1.02
(100x50x25mm)	BIM2002/12	BIM5002/12	£1.46	£1.19
(112x62x31mm)	BIM2003/13	BIM5003/13	£1.78	£1.46
(120x65x40mm)	BIM2004/14	BIM5004/14	£2.24	£1.82
(150x80x50mm)	BIM2005/15	BIM5005/15	£2.84	£2.28
(190x110x60mm)	BIM2006/16	BIM5006/16	£3.94	£3.33

Also available in Grey Polystyrene with no slots and self-tapping screws
BIM 2007/17 (112x61x31mm) £1.00

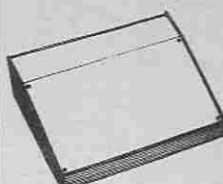

LOW PROFILE BIMCONSOLES

Orange, Blue, Black or Grey ABS body has ventilation slots as well as 1.8mm pcb guides and stand-off bosses in base. Double angle recessed front panel with 4 fixing screws into integral brass bushes. 4 BIMFEET supplied.

BIM 6005 (143 x 105 x 55.5 [31.5] mm) £2.37
BIM 6006 (143 x 170 x 55.5 [31.5] mm) £3.08
BIM 6007 (214 x 170 x 82.0 [31.5] mm) £4.12



EUROCARD BIMCONSOLES

Orange, Blue, Black or Grey ABS body accepts full or 1/2 size Eurocards, with bosses in the base for direct fixing. 1.8mm wide pcb guides incorporated and 4 BIMFEET supplied. 1mm Grey aluminium lid sits flush with body top and held by 4 screws into integral brass bushes.

BIM 8005 (169x127x70 [45] mm) £4.12
BIM 8007 (243x187x103 [66] mm) £6.10

BIMTOOLS + BIMACCESSORIES

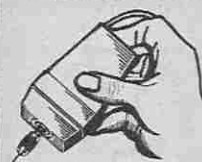

MAINS BIMDRILLS

Small, powerful 240V hand drill complete with 2 metres of cable and 2 pin DIN plug. Accepts all tools with 1mm, 2mm or .125" dia. shanks. Drills brass, steel, aluminium and pcb's. Under 250g, off load speed 7500 rpm. Orange ABS, high impact, fully insulated body with integral on/off switch £10.53

Mains Accessory Kit 1 includes 1mm, 2mm, .125" twist drills, 5 burrs and 2.4mm collet £2.48

Mains Kit 2 includes Mains BIMDRILL as above, 20 assorted drills, mops, burrs, grinding wheels and mounted points, 1mm, 2mm, 2.4mm and .125" collets. Complete in transparent case measuring 230x130x58mm £22.14

BIMDAPTORS

Allows pcb's to be flat mounted sandwich fashion in BIMBOXES, BIMCONSOLES, and all other enclosures having 1.5mm wide vertical guide slots. One plastic BIMDAPTOR on each corner of pcb(s) enables assembly to be simply slid into place. 54mm long, 10 slots on 5mm spacing and can be simply snapped off to length. £1.08 per pack of 25.

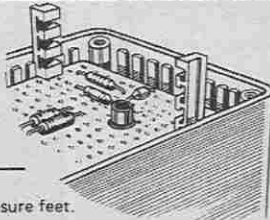

BIMFEET

11mm dia. 3mm high, grey rubber self-adhesive enclosure feet. £0.77 per pack of 24

12 VOLT BIMDRILLS

2 small, powerful drills easily hand held or used with lathe/stand adaptor. Integral on/off switch and 1 metre cable.

Mini BIMDRILL with 3 collets up to 2.4mm dia. £ 8.10
Major BIMDRILL with 4 collets up to 3mm dia. £13.60

Accessory Kits 1 have appropriate drills and collets as above plus 20 assorted tools. Mini Kit 1 - £15.12, Major Kit 1 - £19.44. Accessory Kits 2 have appropriate drills, collets plus 40 tools and mains-12V dc adaptor. Mini Kit 2 - £34.02, Major Kit 2 - £39.42. Accessory Kits 3 as appropriate Kits 2 plus stand/lathe unit. Mini Kit 3 - £45.36, Major Kit 3 - £50.76.

BIMPUMPS

2 all metal desoldering tools provide high suction power and have easily replaceable screw in Teflon tips. Primed and released by thumb operation with in-built safety guard and anti-recoil system.

BIMPUMP Major (180mm long) £7.99
BIMPUMP Minor (150mm long) £6.80

BIMIRONS

Type 30 General Purpose 27 watt iron with long life, rapid change element, screw on tip, stainless steel shaft and clip on hook. Styled handle with neon. £4.05

Type M3 Precision 17 watt iron, quick change tip, long life element, styled handle with clip on hook. £4.43

BIMBOARDS

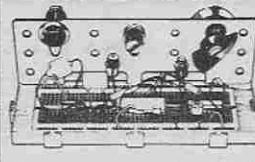

DIL COMPATIBLE BIMBOARDS

Accept all sizes (4-50 pin) of DIL IC packages as well as resistors, diodes, capacitors and LEDs. Integral Bus Strips up each side for power lines and Component Support Bracket for holding lamps, switches and fuses etc. Available as single or multiple units, the latter mounted on 1.5mm thick black aluminium back plate which stand on non slip rubber feet and have 4 screw terminals for incoming power.

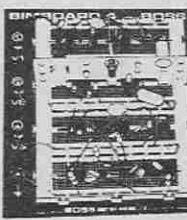

BIMBOARD 1 has 550 sockets, multiple units utilizing 2, 3 and 4 BIMBOARDS incorporate 1100, 1650 and 2200 sockets, all on 2.5mm (0.1") matrix.

BIMBOARD 1 £ 8.83
BIMBOARD 2 £21.01
BIMBOARD 3 £29.84
BIMBOARD 4 £38.79

DESIGNER PROTOTYPING SYSTEM

1, 2, or 3 BIMBOARDS mounted on BIM 6007 BIMCONSOLE with Integral Power Supply (±5 to ±15Vdc @ 100mA and fixed +5Vdc @ 1A) All O/P's fully isolated. Short circuit and fast fold back protection. Power rails brought out to cable clamps that accept stripped wire or 4mm plug.

DESIGNER 1 £55.62
DESIGNER 2 £61.02
DESIGNER 3 £66.42

...FROM **BOSS**
INDUSTRIAL MOULDINGS LIMITED

All quoted prices are 1 off and include Postage, Packing and VAT. Terms are strictly cash with order unless you have authorized BOSS account. For individual data sheets or short form catalogue on all BOSS products send stamped, self addressed 4" x 8" envelope.

2 Herne Hill Road, London SE24 0AU
Telephone: 01-737 2883
Telex: 919693 Answer Back: 'LITZEN G'
Cables & Telegrams: 'LITZEN LONDON SE24'
Cables & Telegrams: 'LITZEN LONDON SE24'

ALL PRICES IN PENCE EACH UNLESS OTHERWISE STATED

CAPACITORS				Electrolytic Can Type				Miniature Low Value							
Electrolytic Axial Leads -10% to +50% Tol				High Ripple, IEC Grade 1, Low E.S.R. Supplied complete with Vertical Fixing Clip				Polystyrene, Axial, ±1% Tol, > 63V D.C. Wkg Ceramic Plate, Radial, Low K, 1.2pF-8.2pF, ±25pF Tol, 10-330pF ±2% Tol, 100V D.C. Wkg Ceramic Plate, Radial, Med K, ±10% Tol, 100V D.C. Wkg Ceramic Plate, Radial, High K, ±20% to +80% Tol, 63V D.C. Wkg							
µF	V.d.c.	16	25	2200 µF	16V	2.6A	3.6A	µF	424	632	630	µF	424	632	630
1.0				4700 µF	16V	5.8A	8.1A	1				1			
1.5				10000 µF	16V	9.8A	13.7A	1.2				1.2			
2.2				22000 µF	16V	1.3A	1.8A	1.5				1.5			
3.3				2200 µF	25V	4.6A	6.4A	1.8				1.8			
4.7				4700 µF	25V	8.0A	11.2A	2.2				2.2			
6.8				10000 µF	25V	12.8A	17.9A	2.7				2.7			
10				22000 µF	25V	0.3A	0.4A	3.3				3.3			
15				1000 µF	40V	5.8A	7.8A	3.9				3.9			
22				2200 µF	40V	9.2A	12.8A	4.7				4.7			
33				4700 µF	40V	1.8A	2.5A	5.6				5.6			
47				10000 µF	40V	4.0A	5.6A	6.8				6.8			
68				4700 µF	70V	7.8A	10.9A	8.2				8.2			
100				10000 µF	70V	0.4A	0.5A	10				10			
150				2200 µF	100V	4.0A	5.6A	12				12			
220				4700 µF	100V	7.8A	10.9A	15				15			
330				10000 µF	100V	1.3A	1.8A	22				22			
470								27				27			
680								33				33			
1000								39				39			
1500								47				47			
2200								56				56			
								68				68			
								82				82			

Tantalum Bead				Order Code			
20% Tol				Cap PR + µF + Volts			
µF	V.d.c.	3.15	6.3	10	16	25	35
0.1				9			
0.15				9			
0.22				9			
0.33				9			
0.47				9			
0.68				9			
1				9			
1.5				9			
2.2				9			
3.3				9			
4.7				9			
6.8				9			
10				9			
15				9			
22				9			
33				9			
47				9			
68				9			
100				9			

Electrolytic Radial Leads				Order Code			
-10% to +50% Tol				Cap OR + µF + Volts			
µF	V.d.c.	6.3	10	16	25	35	50
47				6			
68				6			
1.0				6			
1.5				6			
2.2				6			
3.3				6			
4.7				6			
6.8				6			
10				6			
15				6			
22				6			
33				6			
47				6			
68				6			
100				6			
150				6			
220				6			

Polyester Radial Leads				Order Code			
Dipped Type, ±20% Tol, > 250V D.C. Wkg, C280/352 Style				Cap 352			
Moulded Type, ±10% Tol, > 100V D.C. Wkg, 10.2mm Pitch Centres				Cap 360			
Moulded Type, ±10% Tol, > 100V D.C. Wkg, 7.6mm Pitch Centres				Cap PHE280			
				+ Value			
µF	352	360	PHE280	µF	352	360	PHE280
0.01	5	6	6	0.1	6	8	9
0.015	5	6	6	0.15	7	9	
0.022	5	6	6	0.22	7	10	
0.033	5	6	6	0.33	7	10	
0.047	5	6	6	0.47	7	10	
0.068	5	6	6	0.68	7	10	
0.1	5	6	6	1.0	7	10	
0.15	5	6	6	1.5	7	10	
0.22	5	6	6	2.2	7	10	
0.33	5	6	6	3.3	7	10	
0.47	5	6	6	4.7	7	10	
0.68	5	6	6	6.8	7	10	
1.0	5	6	6	10	7	10	

CASES			
Small Desk Console - Boss Industrial Mouldings			
Slope Front Console, Recessed Top			
ABS Base, C/W Brass Bushes, In Orange			
1mm Aluminium Top Panel Finished Grey			
Order Code			
W161 D96 H39 (57)	186	Case BIM1005 OR	
W215 D130 H47 (73)	268	Case BIM1006 OR	
Plastic Boxes - Boss Industrial Mouldings			
Moulded Box and Close Fitting Flanged Lid			
ABS Box, C/W Brass Bushes, and Lid in Orange			
Order Code			
L112 W62 D31	87	Case BIM2003 OR	
L150 W60 D50	115	Case BIM2005 OR	
L190 W110 D60	195	Case BIM2006 OR	

VERO ELECTRONIC PRODUCTS			
2.5" x 5" .1" pitch Veroboard	59	VERO 21069J	
3.28" x 5" .1" pitch Veroboard	66	VERO 21072D	
2.5" x 1" .1" pitch Veroboard (5)	70/Pack	VERO 21078C	
3.75" x 5" .1" pitch Plain Board	56	VERO 21078E	
5.82" x 2.8" .1" pitch V-O DIP Board	111	VERO 21084E	
Spot Face Cutter	89	VERO 21012A	
Pin Insertion Tool for .040 type pin	122	VERO 21015F	
OS Pins .040 (100)	38/Pack	VERO 21087G	
SS Pins .040 (100)	38/Pack	VERO 21017H	
5mm Board Standoff (100)	181/Pack	VERO 21321K	
15mm Board Standoff (100)	215/Pack	VERO 21322J	
15mm Board Standoff (100)	226/Pack	VERO 21323D	
Verovire Kit (1-open, 2-wire, 25-comb)	375/Kit	VERO 21341D	
Verovire Combs (100)	407/Pack	VERO 21339F	
Verovire Wires (4)	228/Pack	VERO 21340G	
Flip Top Box, Small, Black	192	VERO 21317D	
Flip Top Box, Large, Black	250	VERO 21319J	

HARDWARE			
D.I.L. Sockets			
8 Pin Low Profile Socket Tin	11	DIL SKT 8	
14 Pin Low Profile Socket Tin	13	DIL SKT 14	
16 Pin Low Profile Socket Tin	14	DIL SKT 16	
24 Pin Low Profile Socket Gold	66	DIL SKT 24	
28 Pin Low Profile Socket Gold	78	DIL SKT 28	
40 Pin Low Profile Socket Gold	127	DIL SKT 40	
Heatinks			
Individual Type for 1 x T05 50°C/W	10	Sink 5F	
Individual Type for 1 x T06 10.5°C/W	26	Sink 2F	
Individual Type for 1 x T03 7.2°C/W	24	Sink TV3	
Individual Type for 1 x T0126 17°C/W	23	Sink TV4	
Individual Type for 1 x T0220 17°C/W	23	Sink TV5	
P.C.B. Components			
Defo Pen, Blue Ink, Slow Drying	92	Pen 33PC	
Fuseholders			
Suit 20mm x 5mm Fuses			
P.C.B. Mounting, Open Type	8	Fuse/H208	
Chassis Mounting, Open Type	17	Fuse/H20C	
Panel Mounting, Screwdriver Slot	71	Fuse/H20PT	
Panel Mounting, Finger Release	56	Fuse/H20P	
Fuses			
20mm x 5mm Glass			
Quick Blow, Range 100mA-5A	8	Fuse 20	
Slow Blow, Range 250mA-5A	22	A/S Fuse 20	
+ Rating			
Lampholders, Panel Mounting			
Similar in Style to Fuse/H20P			
Low Voltage Type Suits LES and M/F Bulbs			
Low Voltage, Red, Amber or Green	75	Lamp LV	
Internal Neon 200/240V Red or Amber	95	Lamp N	
+ Colour			
Bulbs, Low Voltage, L.E.S.			
6V, 0.36W, 6.5V, 1W, 14V, 0.75W	22	Bulb LES	
+ Voltage			

CASES			
Instrument Case - Boss Industrial Mouldings			
Slope Front Console, Recessed Top			
ABS Base, C/W Brass Bushes, In Orange			
1mm Aluminium Top Panel Finished Grey			
Order Code			
W250 D187.5 H 86.5 (Chassis 153mm Deep)	1480	Case BIM3000 OR	

CASES			
Small Desk Consoles - Boss Industrial Mouldings			
Slope Front Console, Recessed Top			
ABS Base, C/W Brass Bushes, In Orange			
1mm Aluminium Top Panel Finished Grey			
Ventilation Slots In Base			
Order Code			
W105 D143 H32 (56)	206	Case BIM6005 OR	
W170 D143 H32 (56)	271	Case BIM6006 OR	
W170 D214 H32 (82)	375	Case BIM6007 OR	

CASES			
Plastic Boxes with Metal Lids - Boss Industrial Mouldings			
Recessed Top Box			
ABS Base, C/W Brass Bushes, In Orange			
1mm Aluminium Top Panel Finished Grey			
Order Code			
L85 W56 D29	97	Case BIM4003 OR	
L111 W71 D42	136	Case BIM4004 OR	
L161 W96 D53	182	Case BIM4005 OR	

CASES			
Plastic Boxes with Metal Lids - Boss Industrial Mouldings			
Recessed Top Box			
ABS Base, C/W Brass Bushes, In Orange			
1mm Aluminium Top Panel Finished Grey			
Order Code			
L113 W63 D31	104	Case BIM5003 NA	
L152 W82 D50	181	Case BIM5005 NA	
L192 W113 D61	280	Case BIM5006 NA	

CASES			
All Metal Desk Consoles - Boss Industrial Mouldings			
Slope Front Console, Recessed Top			
Two Piece All Aluminium Construction			
Ventilation Slots In Rear and Base			
Choice of 15° or 30° Sloping Front			
Off White Top Panel, Blue Base			
Order Code			
W102 D140 H28 (51) 15° slope	1018	Case BIM7151A	
W165 D211 H33 (76) 15° slope	1350	Case BIM7154A	
W254 D287 H33 (76) 15° slope	1572	Case BIM7156A	
W356 D287 H33 (76) 15° slope	1823	Case BIM7158A	
W102 D140 H28 (76) 30° slope	1018	Case BIM7301A	
W165 D183 H28 (102) 30° slope	1202	Case BIM7303A	
W254 D258 H28 (102) 30° slope	1572	Case BIM7306A	
W356 D258 H28 (102) 30° slope	1823	Case BIM7308A	
Eurocard Size Desk Console - Boss Industrial Mouldings			
Slope Front Console			
ABS Base, C/W Brass Bushes, In Orange			
1mm Aluminium Top Panel, Finished Grey			
Order Code			
W189 D127 H45 (101)	375	Case BIM8006 OR	

CASES			
Decast Boxes - Boss Industrial Mouldings			
Decast Box and Flanged Lid			
Aluminium Box and Lid in Natural Finish			
Order Code			
L113 W63 D31	104	Case BIM5003 NA	
L152 W82 D50	181	Case BIM5005 NA	
L192 W113 D61	280	Case BIM5006 NA	

RESISTORS			
Carbon Film, Fixed			
0.25W, E24 Values 1R0-10M, 3% Tol.	1.5 ea.	90p/100 (Mult 10/Value)	E7.90/1000 (Mult 100/Value)
0.5W, E12 Values 1R0-4M7, 10% Tol.	2 ea.	1.25p/100 (Mult 10/Value)	E10.10/1000 (Mult 100/Value)
+ Value			
Metal Film, Fixed			
0.5W, E24 Values, SR1-IM, 2% Tol.	6 ea.	3.90/100 (Mult 10/Value)	E32.40/1000 (Mult 100/Value)
2.5W, E12 Values 10R-27K, 5% Tol.	13 ea.	7.90/100 (Mult 10/Value)	
+ Value			
Metal Glaze, Fixed			
0.5W, E24 Values, IM-33M, 5% Tol.	10 ea.	5.40/100 (Mult 10/Value)	
+ Value			

RESISTORS			
Skeleton Presets, Miniature			
0.1W, E3 Values, 100R-1M, Lin			

- ACCESS
- BARCLAYCARD
- CASH
- CHEQUE

- FREEPOST ON ORDERS
- VAT INCLUSIVE PRICES
- ADD 30p P&P
- 24 HR TELEPHONE ANSWERING SERVICE

GMT ELECTRONICS
Freepost
Birmingham B19 1BR
 TEL ORDERS WELCOME

DIGITAL INTEGRATED CIRCUITS

4000 Buffered C-MOS - High Speed
 5-15V 'B' Series, Up to 20MHz

7400 T.T.L.

HEF4000	14	HEF4046	80	HEF4514	260	N7400N	9	N7444N	83	N74122N	39	N74192N	60	N74LS28N	32	N74LS138N	85	N74LS253N	105
HEF4001	14	HEF4047	107	HEF4515	269	N7401N	11	N7445N	85	N74123N	37	N74194N	60	N74LS29N	16	N74LS139N	85	N74LS257N	104
HEF4002	14	HEF4048	28	HEF4516	270	N7402N	11	N7446N	86	N74124N	37	N74195N	60	N74LS30N	24	N74LS140N	85	N74LS259N	107
HEF4006	95	HEF4050	28	HEF4517	282	N7403N	11	N7447A2N	51	N74125N	32	N74196N	120	N74LS31N	32	N74LS141N	122	N74LS260N	26
HEF4007	14	HEF4051	69	HEF4518	69	N7404N	12	N7448A2N	44	N74126N	74	N74199N	139	N74LS32N	24	N74LS142N	80	N74LS261N	300
HEF4008	80	HEF4052	72	HEF4519	65	N7405N	12	N7449N	13	N74127N	46	N74221N	116	N74LS33N	24	N74LS143N	80	N74LS262N	40
HEF4011	14	HEF4053	72	HEF4520	65	N7406N	25	N7450N	13	N74128N	46	N74279N	116	N74LS34N	22	N74LS144N	80	N74LS263N	40
HEF4012	14	HEF4056	37	HEF4521	188	N7407N	27	N7453N	15	N74129N	75	N74147N	125	N74LS35N	53	N74LS145N	80	N74LS264N	40
HEF4013	32	HEF4057	390	HEF4522	95	N7408N	13	N7454N	13	N74130N	13	N74148N	125	N74LS36N	150	N74LS146N	80	N74LS265N	40
HEF4014	64	HEF4058	14	HEF4523	120	N7409N	13	N7455N	13	N74131N	13	N74150N	150	N74LS37N	150	N74LS147N	80	N74LS266N	40
HEF4015	60	HEF4059	14	HEF4524	110	N7410N	11	N7470N	26	N74132N	26	N74151N	150	N74LS38N	150	N74LS148N	130	N74LS267N	100
HEF4016	35	HEF4070	14	HEF4529	510	N7411N	18	N7472N	22	N74133N	55	N74152N	150	N74LS39N	29	N74LS149N	78	N74LS268N	100
HEF4017	55	HEF4071	14	HEF4534	155	N7412N	17	N7473N	23	N74134N	56	N74153N	150	N74LS40N	40	N74LS150N	80	N74LS269N	100
HEF4018	65	HEF4072	16	HEF4535	78	N7413N	23	N7474N	23	N74135N	56	N74154N	150	N74LS41N	33	N74LS151N	200	N74LS270N	170
HEF4019	46	HEF4073	16	HEF4536	78	N7414N	46	N7475N	28	N74136N	28	N74155N	48	N74LS42N	33	N74LS152N	100	N74LS271N	170
HEF4020	88	HEF4075	16	HEF4537	386	N7416N	22	N7476N	26	N74137N	26	N74156N	48	N74LS43N	33	N74LS153N	100	N74LS272N	170
HEF4021	85	HEF4076	85	HEF4538	97	N7417N	22	N7477N	43	N74138N	43	N74157N	49	N74LS44N	33	N74LS154N	100	N74LS273N	170
HEF4022	82	HEF4077	14	HEF4539	173	N7418N	11	N7478N	30	N74139N	63	N74158N	65	N74LS45N	33	N74LS155N	100	N74LS274N	170
HEF4023	14	HEF4078	16	HEF4540	90	N7419N	27	N7479N	31	N74140N	65	N74159N	74	N74LS46N	33	N74LS156N	100	N74LS275N	170
HEF4024	45	HEF4081	16	HEF4541	175	N7420N	27	N7480N	33	N74141N	74	N74160N	74	N74LS47N	16	N74LS157N	100	N74LS276N	170
HEF4025	14	HEF4082	16	HEF4542	162	N7421N	22	N7481N	30	N74142N	74	N74161N	74	N74LS48N	16	N74LS158N	100	N74LS277N	170
HEF4027	32	HEF4085	64	HEF4543	119	N7422N	22	N7482N	30	N74143N	80	N74162N	74	N74LS49N	16	N74LS159N	100	N74LS278N	170
HEF4028	52	HEF4086	64	HEF4544	119	N7423N	30	N7483N	33	N74144N	80	N74163N	74	N74LS50N	16	N74LS160N	100	N74LS279N	170
HEF4029	60	HEF4093	50	HEF4545	119	N7424N	11	N7484N	31	N74145N	82	N74164N	74	N74LS51N	16	N74LS161N	100	N74LS280N	170
HEF4030	46	HEF4094	175	HEF4546	119	N7425N	21	N7485N	31	N74146N	82	N74165N	74	N74LS52N	16	N74LS162N	100	N74LS281N	170
HEF4031	200	HEF4104	166	HEF4547	119	N7426N	22	N7486N	33	N74147N	111	N74166N	74	N74LS53N	16	N74LS163N	100	N74LS282N	170
HEF4035	110	HEF4502	91	HEF4548	119	N7427N	22	N7487N	48	N74148N	63	N74167N	74	N74LS54N	16	N74LS164N	100	N74LS283N	170
HEF4040	68	HEF4505	571	HEF4549	140	N7428N	21	N7488N	21	N74149N	86	N74168N	82	N74LS55N	16	N74LS165N	100	N74LS284N	170
HEF4041	75	HEF4508	161	HEF4550	140	N7429N	80	N7489N	20	N74150N	80	N74169N	80	N74LS56N	16	N74LS166N	100	N74LS285N	170
HEF4042	65	HEF4510	70	HEF4551	140	N7430N	11	N7490N	11	N74151N	82	N74170N	165	N74LS57N	16	N74LS167N	100	N74LS286N	170
HEF4043	79	HEF4511	110	HEF4552	117	N7431N	40	N7491N	148	N74152N	65	N74171N	148	N74LS58N	16	N74LS168N	100	N74LS287N	170
HEF4044	84	HEF4512	88			N7432N	79	N74121N	23	N74153N	69	N74172N	69	N74LS59N	16	N74LS169N	100	N74LS288N	170

LINEAR INTEGRATED CIRCUITS

CA3011	92	NE592K	162
CA3018	97	RC4136	130
CA3020	181	TBA1205	79
CA3023A	36	TCAS80	346
CA3046	76	TC4730	450
CA3048	245	TC4740	450
CA3080E	70	TDA1008	328
CA3089E	253	TDA1022	648
CA3130E	90	TDA1028	338
CA3140E	38	TDA1029	338
CA3189E	286	TDA10348	217
LM301AN	30	TDA2581	286
LM308N	95	TDA2640	292
LM318N	200	TL081CP	75
LM319N	216	TL384CN	140
LM324N	70	UA709CT	46
LM329N	71	UA709CN	40
LM381N	110	UA710CN	41
LM381AN	180	UA711CN	65
LM382	120	UA711CT	42
		UA711CN	18
		UA747CN	30
		UA748CN	55

OPTO ELECTRONICS

Light Emitting Diodes, Individual		Order Code
125" (3mm)	Red	14 CQY54
	Green	17 CQY95
	Yellow	19 CQY97
Panel Mounting Clip to suit.		3 LEDs Clip
2" (5mm)	Red	15 CQY24A
	Green	17 CQY94
	Yellow	19 CQY96
Panel Mounting Clip to suit.		5 LEDs Clip
Light Emitting Diodes - 7 Segment Display		
3" (17.6mm) C. Anode R.H. Decimal Pr.	Red	160 XAN3061
C. Anode R.H. Decimal Pr.	Green	199 XAN3051
C. Cathode R.H. Decimal	Pr. Red, Low current drain	160 XAN3074
5" (115.2mm) C. Anode L.H. Decimal	Pr. Red	230 XAN6520
C. Anode L.H. Decimal	Pr. Green	230 XAN6520
C. Cathode L.H. Decimal	Pr. Red	230 XAN6540
C. Cathode L.H. Decimal	Pr. Green	230 XAN6540
Photoreistors		
ORP12		90 ORP12
ORP61		90 ORP61
Phototransistors		
OCPT1		180 OCPT1
BPX25		175 BPX25
BPX29		175 BPX29
Photocoupler		
FCDS20		150 FCDS20

SWITCHES

Miniature Toggle - Honeywell		Order Code					
SPDT	C/O/H	2A/250V A.C., 5A/28V D.C.					
SPDT	Double Bias To Centre	58 SW BA1011					
SPDT	Single Bias To Centre	67 SW BA1021					
DPDT	Bias	75 SW BA1051					
DPDT		76 SW BA1061					
DPDT		86 SW BA2011					
DPDT	C/O/H	92 SW BA2021					
DPDT	Double Bias To Centre	102 SW BA2041					
DPDT	Single Bias To Centre	102 SW BA2051					
DPDT	Bias	96 SW BA2061					
Miniature Push - C & K							
SP	Push To Make, Momentary	0.5A/250V A.C., 1A/28V D.C.					
SP	Push To Break, Momentary	54 SW 8531					
		54 SW 8533					
Slide - Switchcraft							
DPDT	Standard Actuator	36 SW 48206					
DPDT	Slot Actuator, Voltage Change, Marked 110/240	43 SW 48206F					
SEMICONDUCTORS							
Diodes							
IN827	193	IN4006	7	8B110G	61	OA202	9
IN914	4	IN4007	8	8V12Z	15		
IN816	5	IN4148	3	8V206	34		
IN4001	4	IN5402	15	8VX110	10	Microware	
IN4002	6	IN5404	16	OA47	10		
IN4003	6	8AX13	5	OA90	7	SAW95D	1091
IN4004	6	8AY38	27	OA91	7	CL8980	2592
IN4005	7	8B108(4)	122	OA200	9	CXY11C	1280
Zener Diodes							
400mW CV7-C23		1.5W CV75-C75					
BZY88/BZX79 + Voltage	8	BZX81 + Voltage	16				
Transistors							
2N929	37	2N4427	206	8C478	24	8SX88	18
2N1893	30	2N4856	158	8C547	12	MJE340	107
2N2218A	26	2N4858	134	8C548	10	MPF102	32
2N2907	21	2N4860	122	8C549	15	OC38	48
2N2969	19	2N5204	43	8C549A	12	OC35	95
2N2389A	20	2N5416	108	8C549B	20	OC46	82
2N2646	42	2N5457	35	8C657	14	OCPT1	180
2N2894	48	2N5458	30	8C658	14	PI258A	41
2N2695	25	2N5459	32	8C659	17	PI259C	53
2N2904	24	2N6258	432	8C734	97	PI259A	44
2N2805	22	40673	80	8C730	14	PI290C	57
2N2906A	24	AD181	38	8C731	14	PI291A	43
2N2806	19	AD182	38	8D131	35	PI292A	45
2N2907	22	BC107	10	8D132	35	PI292C	63
2N2907A	25	BC107B	14	8D135	38	PI294	59
2N2918	330	8C108	10	8D136	37	PI294C	59
2N2925G	11	8C108B	14	8D137	38	PI295A	59
2N3053	17	8C108C	16	8D138	39	PI295B	68
2N3054	50	8C109	10	8D139	35	PI295S	54
		8C109B	17	8D140	35	PI2955	32
		8C109C	18	8F115	28	TI643	32
		8C147	7	8F180	37	ZTX109C	14
		8C148	9	8F181	37		
		8C149	8	8F257	35		
		8C157	10	8F258	32		
		8C158	9	8F259	36		
		8C159	11	8F990	303		
		8C177	15	8F921	428		
		8C178	15	8F922	428		
		8C179	16	8F923	428		
		8C182	10	8F924	26		
		8C182L	11	8F92			

ELECTRONI-KIT

"EDUCATIONAL KITS OF EXCEPTIONAL QUALITY"

(AUDIO magazine)

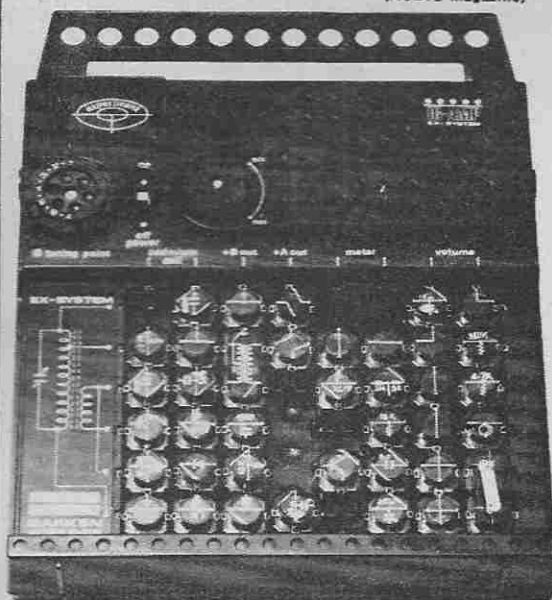

THIS IS A POWERFUL RADIO RECEIVER!

The same kit is also 150 other different actual working projects e.g.:

Computer & Logic Circuits, Electronic Organ, Timer, Light Control, Agility Tester, Lie Detector, Siren, Horn, Buzzer, Bird, Metronome, Cds cell light & sound control, Photogun, Light Oscillator, Light Switch, Light and Sound Morse Code, Field Strength Meter, Hygrometer, Sphygmometer, Etc., Etc.

Radio Receiver, Transmitter, Amplifier, Audio Generator, Signal Tracer & Injector, Continuity Tester, Telegraph, Photoradio Receiver, Radio Receiver/Microphone Mixer, Illuminometer, Voltmeter, Ammeter, Sound Level Meter, Ohmmeter, Diode & Transistor Tester, Transparency Indicator Etc., Etc.

The above is just a selection of the circuits available—you can also design your own circuits with these superb new Denshi-Gakken "EX" construction kits.

No previous experience of electronics is required but you learn as you construct and have a great deal of fun too. The kits are completely safe for anyone to use.

Kits are complete with very extensive construction manuals PLUS Hamlyn's "All-Colour" 160 page book "Electronics" (free of charge whilst stocks last).

ALL KITS ARE FULLY GUARANTEED. Add-on sets (to increase the scope of each kit) are available, plus spares and accessories as required.

150 PROJECT KIT £39.75 60 PROJECT KIT £25.75

120 PROJECT KIT £33.75 30 PROJECT KIT £18.95

100 PROJECT KIT £29.25 15 PROJECT KIT £16.75

Prices include educational manuals, free book, VAT, p & p (in the U.K.). Free introduction to the British Amateur Electronics Club. Free list of low price electronics books.

Trade and Educational enquiries invited.

Cheque/P.O./Barclaycard/Access No. (or 14p for illustrated literature) to DEPT. EE.

"I'm at the Great British Electronics Bazaar."

STAND No: 204/207



ELECTRONI-KIT LTD.

20 BRIDE LANE, LUDGATE CIRCUS,
LONDON EC4Y 8DX (01-353 6430)

ELECTRONIC BOOKS

Ref. No.	Title	Price
126	Boys Book of Crystal Sets	25p
138	How to Make Aerials for TV (Band 1-2-3)	25p
160	Coil Design and Construction Manual	75p
196	AF-RF Reactance-Frequency Chart for Constructors	15p
200	Handbook of Practical Electronic Musical Novelties	50p
201	Practical Transistorised Novelties for Hi-Fi Enthusiasts	35p
202	Handbook of Integrated Circuits (IC's) Equivalents and Substitutes	1.00p
203	IC's and Transistor Gadgets Construction Handbook	60p
205	First Book on Hi-Fi Loudspeaker Enclosures	75p
206	Practical Transistor Circuits for Modern Test Equipment	60p
207	Practical Electronic Science Projects	75p
208	Practical Stereo and Quadrophony Handbook	75p
210	The Complete Car Radio Manual	1.00p
211	First Book of Diode Characteristics Equivalents and Substitutes	95p
213	Electronic Circuits for Model Railways (Reprinting)	1.00p
214	Audio Enthusiasts Handbook	85p
215	Shortwave Circuits and Gear for Experimenters and Radio Hams	85p
216	Electronic Gadgets and Games	1.00p
217	Solid State Power Supply Handbook	85p
218	Build Your Own Electronic Experimenters Laboratory	85p
219	Solid State Novelty Projects	85p
220	Build Your Own Solid State Hi-Fi and Audio Accessories	85p
221	28 Tested Transistor Projects	95p
222	Solid State Short Wave Receivers for Beginners	95p
223	50 Projects Using IC CA 3130	95p
224	50 CMOS IC Projects	95p
225	A Practical Introduction to Digital IC's	95p
226	How to Build Advanced Short Wave Receivers	1.20p
227	Beginners Guide to Building Electronic Projects	1.25p
228	Essential Theory for the Electronics Hobbyist	1.25p
RCC	Resistor Colour Code Disc Calculator	10p
BP1	First Book of Transistor Equivalents and Substitutes	50p
BP2	Handbook of Radio, TV & Industrial & Transmitting Tube & Valve Equivalents	60p
BP6	Engineers and Machinists Reference Tables	50p
BP7	Radio and Electronic Colour Codes and Data Chart (Reprinting)	25p
BP11	Practical Transistor Novelty Circuits	40p
BP14	Second Book of Transistor Equivalents and Substitutes	1.10p
BP22	79 Electronic Novelty Circuits	75p
BP23	First Book of Practical Electronic Projects	75p
BP24	52 Projects Using IC741	95p
BP25	How to Build Your Own Electronic and Quartz Controlled Watches & Clocks	85p
BP26	Radio Antenna Handbook for Long Distance Reception and Transmission	85p
BP27	Giant Chart of Radio Electronic Semiconductor and Logic Symbols	60p
BP28	Resistor Selection Handbook (International Edition)	60p
BP29	Major Solid State Audio Hi-Fi Construction Projects	85p
BP30	Two Transistor Electronic Projects	85p
BP31	Practical Electrical Re-Wiring and Repairs	85p
BP32	How to Build Your Own Metal and Treasure Locators	1.00p
BP33	Electronic Calculator Users Handbook	95p
BP34	Practical Repair and Renovation of Colour TVs (Reprinting)	95p
BP35	Handbook of IC Audio Pre-amplifier and Power Amplifier Construction (Reprinting)	95p
BP36	50 Circuits Using Germanium Silicon and Zener Diodes	75p
BP37	50 Projects Using Relays, SCR's and TRIACS	1.10p
BP38	Fun and Games with your Electronic Calculator	75p
BP39	50 (FET) Field Effect Transistor Projects	1.25p
BP40	Digital IC Equivalents and Pin Connections	2.50p
BP41	Linear IC Equivalents and Pin Connections	2.75p
BP42	50 Simple L.E.D. Circuits	75p
BP43	How to Make Walkie-Talkies	1.25p
BP44	IC555 Projects	1.45p
BP45	Project in Opto-Electronics	1.25p
BP46	Radio Circuits Using IC's	1.35p
BP47	Mobile Discotheque Handbook	1.35p
BP48	Electronic Projects for Beginners	1.35p
BP49	Popular Electronic Projects	1.45p
BP50	IC LM3900 Projects	1.35p
BP51	Electronic Music and Creative Tape Recording	1.25p
BP52	Long Distance Television Reception (TV-DX) For The Enthusiast	1.45p
BP53	Practical Electronic Calculations and Formulae	2.25p
BP54	Your Electronic Calculator and Your Money	1.35p
BP55	Radio Stations Guide	1.45p

Please add 20p p. & p. per book
Send SAE for our large range of Components

TECHNOMATIC LTD

17 BURNLEY ROAD, LONDON NW10 1ED
(2 minutes from Dollis Hill Tube station)

(Ample parking space)

Telephone: 01-452 1500
Telex: 922800

RST VALVE MAIL ORDER CO. (EE 6)

CLIMAX HOUSE, FALLSBROOK ROAD, LONDON SW16 6ED

SPECIAL EXPRESS MAIL ORDER SERVICE

SEMICONDUCTORS

AA119 0-11	ASV26 0-43	BC159 0-11	BCY72 0-14	BF194 0-10	BZX61 0-19	OA70 0-32	OC82 0-70	ZS271 0-26	2N697 0-27	2N3055 0-76
AA30 0-29	ASV27 0-43	BC167 0-14	BCZ11 1-62	BF195 0-10	Series	OA79 0-32	OC83 0-70	ZS278 0-84	2N698 0-32	2N3440 0-85
AA33 0-45	ASZ16 1-35	BC170 0-12	BD115 0-49	BF196 0-11	BZY88 0-14	OA81 0-32	OC84 0-70	ZTX107 0-12	2N705 1-30	2N3441 0-86
AA35 0-37	ASZ17 1-35	BC171 0-11	BD121 1-30	BF197 0-14	Series	OA85 0-32	OC122 1-62	ZTX108 0-11	2N706 0-16	2N3442 1-89
AA37 0-29	ASZ20 1-62	BC173 0-13	BD124 1-40	BF224 0-23	CRS/140 0-65	OA90 0-09	OC123 1-89	ZTX109 0-14	2N708 0-22	2N3614 1-62
AC107 0-65	ASZ21 2-16	BC177 0-16	BD131 0-39	BF257 0-30	CRS/360 0-81	OA95 0-09	OC140 2-97	ZTX300 0-14	2N1131 0-28	2N3702 0-12
AC125 0-22	AU110 1-84	BC178 0-15	BD132 0-41	BF258 0-36	CRS/340 0-81	QA200 0-10	OC141 3-61	ZTX301 0-17	2N1132 0-28	2N3703 0-15
AC126 0-22	AU113 1-84	BC179 0-17	BD135 0-37	BF259 0-36	GEX66 1-62	QA202 0-10	OC170 1-08	ZTX302 0-19	2N1302 0-38	2N3704 0-16
AC127 0-22	AU110 1-84	BC182 0-12	BD136 0-37	BF259 0-36	GEX541 1-89	QA211 1-08	OC171 1-08	ZTX303 0-19	2N1303 0-38	2N3705 0-16
AC128 0-22	BA145 0-15	BC184 0-12	BD138 0-37	BF259 0-36	GJ3M 0-81	QA2200 1-08	OC200 1-62	ZTX304 0-21	2N1304 0-49	2N3706 0-15
AC141 0-27	BA148 0-15	BC212 0-14	BD139 0-48	BF336 0-32	GJ5M 0-81	QA2201 1-08	OC201 1-08	ZTX310 0-23	2N1305 0-49	2N3707 0-15
AC141K 0-38	BA154 0-10	BC213 0-14	BD139 0-48	BF337 0-32	GM0378A1-89	QA2202 1-08	OC202 1-89	ZTX500 0-15	2N1306 0-54	2N3708 0-11
AC142K 0-32	BA156 0-10	BC214 0-17	BD140 0-48	BF338 0-33	K5100A 0-51	QA2207 1-08	OC203 1-89	ZTX501 0-16	2N1307 0-54	2N3709 0-11
AC176 0-22	BAW62 0-06	BC237 0-10	BD142 2-16	BF528 0-28	MJ340 0-86	OC215 2-16	OC204 2-70	ZTX502 0-18	2N1308 0-59	2N3710 0-15
AC187 0-22	BAX13 0-07	BC238 0-14	BD144 2-16	BF561 0-23	MJ370 1-26	OC216 2-16	OC205 2-70	ZTX503 0-19	2N1309 0-59	2N3711 0-11
AC198 0-22	BAX16 0-10	BC301 0-27	BD181 1-19	BF562 0-23	MJ371 0-68	OC217 2-16	OC206 2-70	ZTX504 0-23	2N1813 0-27	2N3712 0-16
AC198 0-22	BAX16 0-10	BC301 0-27	BD182 1-27	BF562 0-23	MJ520 0-86	OC218 2-16	OC207 2-70	ZTX505 0-19	2N1814 0-27	2N3713 0-24
AC198 0-22	BAX16 0-10	BC301 0-27	BD182 1-27	BF562 0-23	MJ520 0-86	OC219 2-16	OC208 2-70	ZTX506 0-19	2N1815 0-27	2N3714 0-16
AC198 0-22	BAX16 0-10	BC301 0-27	BD182 1-27	BF562 0-23	MJ520 0-86	OC220 2-16	OC209 2-70	ZTX507 0-19	2N1816 0-27	2N3715 0-16
AC198 0-22	BAX16 0-10	BC301 0-27	BD182 1-27	BF562 0-23	MJ520 0-86	OC221 2-16	OC210 2-70	ZTX508 0-19	2N1817 0-27	2N3716 0-16
AC198 0-22	BAX16 0-10	BC301 0-27	BD182 1-27	BF562 0-23	MJ520 0-86	OC222 2-16	OC211 2-70	ZTX509 0-19	2N1818 0-27	2N3717 0-16
AC198 0-22	BAX16 0-10	BC301 0-27	BD182 1-27	BF562 0-23	MJ520 0-86	OC223 2-16	OC212 2-70	ZTX510 0-19	2N1819 0-27	2N3718 0-16
AC198 0-22	BAX16 0-10	BC301 0-27	BD182 1-27	BF562 0-23	MJ520 0-86	OC224 2-16	OC213 2-70	ZTX511 0-19	2N1820 0-27	2N3719 0-16
AC198 0-22	BAX16 0-10	BC301 0-27	BD182 1-27	BF562 0-23	MJ520 0-86	OC225 2-16	OC214 2-70	ZTX512 0-19	2N1821 0-27	2N3720 0-16
AC198 0-22	BAX16 0-10	BC301 0-27	BD182 1-27	BF562 0-23	MJ520 0-86	OC226 2-16	OC215 2-70	ZTX513 0-19	2N1822 0-27	2N3721 0-16
AC198 0-22	BAX16 0-10	BC301 0-27	BD182 1-27	BF562 0-23	MJ520 0-86	OC227 2-16	OC216 2-70	ZTX514 0-19	2N1823 0-27	2N3722 0-16
AC198 0-22	BAX16 0-10	BC301 0-27	BD182 1-27	BF562 0-23	MJ520 0-86	OC228 2-16	OC217 2-70	ZTX515 0-19	2N1824 0-27	2N3723 0-16
AC198 0-22	BAX16 0-10	BC301 0-27	BD182 1-27	BF562 0-23	MJ520 0-86	OC229 2-16	OC218 2-70	ZTX516 0-19	2N1825 0-27	2N3724 0-16
AC198 0-22	BAX16 0-10	BC301 0-27	BD182 1-27	BF562 0-23	MJ520 0-86	OC230 2-16	OC219 2-70	ZTX517 0-19	2N1826 0-27	2N3725 0-16
AC198 0-22	BAX16 0-10	BC301 0-27	BD182 1-27	BF562 0-23	MJ520 0-86	OC231 2-16	OC220 2-70	ZTX518 0-19	2N1827 0-27	2N3726 0-16
AC198 0-22	BAX16 0-10	BC301 0-27	BD182 1-27	BF562 0-23	MJ520 0-86	OC232 2-16	OC221 2-70	ZTX519 0-19	2N1828 0-27	2N3727 0-16
AC198 0-22	BAX16 0-10	BC301 0-27	BD182 1-27	BF562 0-23	MJ520 0-86	OC233 2-16	OC222 2-70	ZTX520 0-19	2N1829 0-27	2N3728 0-16
AC198 0-22	BAX16 0-10	BC301 0-27	BD182 1-27	BF562 0-23	MJ520 0-86	OC234 2-16	OC223 2-70	ZTX521 0-19	2N1830 0-27	2N3729 0-16
AC198 0-22	BAX16 0-10	BC301 0-27	BD182 1-27	BF562 0-23	MJ520 0-86	OC235 2-16	OC224 2-70	ZTX522 0-19	2N1831 0-27	2N3730 0-16
AC198 0-22	BAX16 0-10	BC301 0-27	BD182 1-27	BF562 0-23	MJ520 0-86	OC236 2-16	OC225 2-70	ZTX523 0-19	2N1832 0-27	2N3731 0-16
AC198 0-22	BAX16 0-10	BC301 0-27	BD182 1-27	BF562 0-23	MJ520 0-86	OC237 2-16	OC226 2-70	ZTX524 0-19	2N1833 0-27	2N3732 0-16
AC198 0-22	BAX16 0-10	BC301 0-27	BD182 1-27	BF562 0-23	MJ520 0-86	OC238 2-16	OC227 2-70	ZTX525 0-19	2N1834 0-27	2N3733 0-16
AC198 0-22	BAX16 0-10	BC301 0-27	BD182 1-27	BF562 0-23	MJ520 0-86	OC239 2-16	OC228 2-70	ZTX526 0-19	2N1835 0-27	2N3734 0-16
AC198 0-22	BAX16 0-10	BC301 0-27	BD182 1-27	BF562 0-23	MJ520 0-86	OC240 2-16	OC229 2-70	ZTX527 0-19	2N1836 0-27	2N3735 0-16
AC198 0-22	BAX16 0-10	BC301 0-27	BD182 1-27	BF562 0-23	MJ520 0-86	OC241 2-16	OC230 2-70	ZTX528 0-19	2N1837 0-27	2N3736 0-16
AC198 0-22	BAX16 0-10	BC301 0-27	BD182 1-27	BF562 0-23	MJ520 0-86	OC242 2-16	OC231 2-70	ZTX529 0-19	2N1838 0-27	2N3737 0-16
AC198 0-22	BAX16 0-10	BC301 0-27	BD182 1-27	BF562 0-23	MJ520 0-86	OC243 2-16	OC232 2-70	ZTX530 0-19	2N1839 0-27	2N3738 0-16
AC198 0-22	BAX16 0-10	BC301 0-27	BD182 1-27	BF562 0-23	MJ520 0-86	OC244 2-16	OC233 2-70	ZTX531 0-19	2N1840 0-27	2N3739 0-16
AC198 0-22	BAX16 0-10	BC301 0-27	BD182 1-27	BF562 0-23	MJ520 0-86	OC245 2-16	OC234 2-70	ZTX532 0-19	2N1841 0-27	2N3740 0-16
AC198 0-22	BAX16 0-10	BC301 0-27	BD182 1-27	BF562 0-23	MJ520 0-86	OC246 2-16	OC235 2-70	ZTX533 0-19	2N1842 0-27	2N3741 0-16
AC198 0-22	BAX16 0-10	BC301 0-27	BD182 1-27	BF562 0-23	MJ520 0-86	OC247 2-16	OC236 2-70	ZTX534 0-19	2N1843 0-27	2N3742 0-16
AC198 0-22	BAX16 0-10	BC301 0-27	BD182 1-27	BF562 0-23	MJ520 0-86	OC248 2-16	OC237 2-70	ZTX535 0-19	2N1844 0-27	2N3743 0-16
AC198 0-22	BAX16 0-10	BC301 0-27	BD182 1-27	BF562 0-23	MJ520 0-86	OC249 2-16	OC238 2-70	ZTX536 0-19	2N1845 0-27	2N3744 0-16
AC198 0-22	BAX16 0-10	BC301 0-27	BD182 1-27	BF562 0-23	MJ520 0-86	OC250 2-16	OC239 2-70	ZTX537 0-19	2N1846 0-27	2N3745 0-16
AC198 0-22	BAX16 0-10	BC301 0-27	BD182 1-27	BF562 0-23	MJ520 0-86	OC251 2-16	OC240 2-70	ZTX538 0-19	2N1847 0-27	2N3746 0-16
AC198 0-22	BAX16 0-10	BC301 0-27	BD182 1-27	BF562 0-23	MJ520 0-86	OC252 2-16	OC241 2-70	ZTX539 0-19	2N1848 0-27	2N3747 0-16
AC198 0-22	BAX16 0-10	BC301 0-27	BD182 1-27	BF562 0-23	MJ520 0-86	OC253 2-16	OC242 2-70	ZTX540 0-19	2N1849 0-27	2N3748 0-16
AC198 0-22	BAX16 0-10	BC301 0-27	BD182 1-27	BF562 0-23	MJ520 0-86	OC254 2-16	OC243 2-70	ZTX541 0-19	2N1850 0-27	2N3749 0-16
AC198 0-22	BAX16 0-10	BC301 0-27	BD182 1-27	BF562 0-23	MJ520 0-86	OC255 2-16	OC244 2-70	ZTX542 0-19	2N1851 0-27	2N3750 0-16
AC198 0-22	BAX16 0-10	BC301 0-27	BD182 1-27	BF562 0-23	MJ520 0-86	OC256 2-16	OC245 2-70	ZTX543 0-19	2N1852 0-27	2N3751 0-16
AC198 0-22	BAX16 0-10	BC301 0-27	BD182 1-27	BF562 0-23	MJ520 0-86	OC257 2-16	OC246 2-70	ZTX544 0-19	2N1853 0-27	2N3752 0-16
AC198 0-22	BAX16 0-10	BC301 0-27	BD182 1-27	BF562 0-23	MJ520 0-86	OC258 2-16	OC247 2-70	ZTX545 0-19	2N1854 0-27	2N3753 0-16
AC198 0-22	BAX16 0-10	BC301 0-27	BD182 1-27	BF562 0-23	MJ520 0-86	OC259 2-16	OC248 2-70	ZTX546 0-19	2N1855 0-27	2N3754 0-16
AC198 0-22	BAX16 0-10	BC301 0-27	BD182 1-27	BF562 0-23	MJ520 0-86	OC260 2-16	OC249 2-70	ZTX547 0-19	2N1856 0-27	2N3755 0-16
AC198 0-22	BAX16 0-10	BC301 0-27	BD182 1-27	BF562 0-23	MJ520 0-86	OC261 2-16	OC250 2-70	ZTX548 0-19	2N1857 0-27	2N3756 0-16
AC198 0-22	BAX16 0-10	BC301 0-27	BD182 1-27	BF562 0-23	MJ520 0-86	OC262 2-16	OC251 2-70	ZTX549 0-19	2N1858 0-27	2N3757 0-16
AC198 0-22	BAX16 0-10	BC301 0-27	BD182 1-27	BF562 0-23	MJ520 0-86	OC263 2-16	OC252 2-70	ZTX550 0-19	2N1859 0-27	2N3758 0-16
AC198 0-22	BAX16 0-10	BC301 0-27	BD182 1-27	BF562 0-23	MJ520 0-86	OC264 2-16	OC253 2-70	ZTX551 0-19	2N1860 0-27	2N3759 0-16
AC198 0-22	BAX16 0-10	BC301 0-27	BD182 1-27	BF562 0-23	MJ520 0-86	OC265 2-16	OC254 2-70	ZTX552 0-19	2N1861 0-27	2N3760 0-16
AC198 0-22	BAX16 0-10	BC301 0-27	BD182 1-27	BF562 0-23	MJ520 0-86	OC266 2-16	OC255 2-70	ZTX553 0-19	2N1862 0-27	2N3761 0-16
AC198 0-22	BAX16 0-10	BC301 0-27	BD182 1-27	BF562 0-23	MJ520 0-86	OC267 2-16	OC256 2-70	ZTX554 0-19	2N1863 0-27	2N3762 0-16
AC198 0-22	BAX16 0-10	BC301 0-27	BD182 1-27	BF562 0-23	MJ520 0-86	OC268 2-16	OC257 2-70	ZTX555 0-19	2N1864 0-27	2N3763 0-16
AC198 0-22	BAX16 0-10	BC301 0-27	BD182 1-27	BF562 0-23	MJ520 0-86	OC269 2-16	OC258 2-70	ZTX556 0-19	2N1865 0-27	2N3764 0-16
AC198 0-22	BAX16 0-10	BC301 0-27	BD182 1-27	BF562 0-23	MJ520 0-86	OC270 2-16	OC259 2-70	ZTX557 0-19	2N1866 0-27	2N3765 0-16
AC198 0-22	BAX16 0-10	BC301 0-27	BD182 1-27	BF562 0-23	MJ520 0-86	OC271 2-16	OC260 2-70			

EDITOR

F. E. BENNETT

ASSISTANT EDITOR

B. W. TERRELL B.Sc.

PRODUCTION EDITOR

D. G. BARRINGTON

TECHNICAL SUB-EDITOR

T. J. JOHNSON G8MGS

ART EDITOR

R. F. PALMER

ASSISTANT ART EDITOR

P. A. LOATES

TECHNICAL ILLUSTRATOR

D. J. GOODING

EDITORIAL OFFICES

Kings Reach Tower,
Stamford Street,
London SE1 9LS
Phone: 01-261 6873

ADVERTISEMENT MANAGER

R. SMITH
Phone: 01-261 6671

REPRESENTATIVE

N. BELLWOOD
Phone: 01-261 6865

CLASSIFIED MANAGER

C. R. BROWN
Phone: 01-261 5762

MAKE-UP AND COPY DEPARTMENT

Phone 01-261 6618

ADVERTISEMENT OFFICES

Kings Reach Tower
Stamford Street,
London SE1 9LS

Projects... Theory ... and Popular Features ...

Loudspeaker systems have not received much attention in our pages in the past. But when we planned the *EE2020 Tuner Amplifier* it seemed sensible to offer the constructor a loudspeaker system design also, so that he would be independent of commercial enclosures if he so wished.

Our investigations into this fringe area of electronics convinced us that the possibilities are as wide and varied in range as the size of audiophile pockets—to say nothing of space considerations. This led us to the view that the differing needs of our readers could best be served producing two loudspeaker systems. The first, the *EE20* published this month, is a low cost design which seems likely to meet the needs of the greater number of constructors. We shall follow this (in September) with a three-way upmarket design to satisfy the most fastidious and affluent audio enthusiasts.

These loudspeakers have been designed with the *EE2020* in mind but they can be used with any hi fi amplifier of similar output power.

When considering loudspeakers and acoustics we move from the strictly objective field of electronics, into one where much is subjective. Measurements can be made on loudspeaker systems in laboratories and echo-free chambers but the real world where the loudspeaker has to perform is a furnished room. This itself is a delightfully ambiguous term. One man's room may be a modest 10ft by 9ft

parlour, another's a commodious 30ft by 15ft lounge. The nature of the furnishings will give the room its own peculiar acoustic properties. But over and above these concrete factors is the great imponderable—the auditory equipment of the listener. This is a very personal thing and ears cannot be equalised or otherwise modified in their response characteristics as with a piece of inanimate equipment.

So at the end of the day it is what we actually hear that counts. Hence it is a highly subjective matter and one should not make dogmatic assertions about the excellence or otherwise of particular loudspeakers. The best "measurement" one can get is a general consensus from a number of people who have listened to the equipment in the same environment.

Here we must be fair. You can't go into a showroom and hear our *EE20*. What we can tell you is that both *EE* loudspeaker systems have been specially designed for us by a well-known specialist, long experienced in this field. We believe these loudspeaker systems will be a credit to their constructor and to the amplifying equipment with which they are used.



Our August Issue will be published on Friday, July 20. See page 413 for details.

Readers' Enquiries

We cannot undertake to answer readers' letters requesting modifications, designs or information on commercial equipment or subjects not published by us. All letters requiring a personal reply should be accompanied by a stamped self-addressed envelope.

We cannot undertake to engage in discussions on the telephone.

Component Supplies

Readers should note that we do not supply electronic components for building the projects featured in **EVERYDAY ELECTRONICS**, but these requirements can be met by our advertisers.

All reasonable precautions are taken to ensure that the advice and data given to readers are reliable. We cannot however guarantee it, and we cannot accept legal responsibility for it. Prices quoted are those current as we go to press.

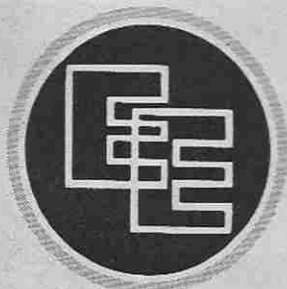

Everyday ELECTRONICS

VOL. 8 NO. 7

JULY 1979

CONSTRUCTIONAL PROJECTS

- CONFERENCE TIMER** For controlling a speaker's "floor" time by A. J. Bassett 404
MINI MODULE: 10-VOLTAGE SPLITTER Provides a three-rail supply by George Hyllton 410
SOLDERING IRON BIT SAVER Reduces power to "iron" when replaced in stand by R. A. Penfold 414
DARKROOM TIMER An l.e.d. flashing once per second by A. R. Winstanley 422
DOLLS HOUSE LIGHTS ECONOMISER Automatically disconnects battery after five minutes by H. Clough 424
EE20 LOUDSPEAKER An economy design, for amplifier outputs up to 30 watts by R. F. Stephens 427
WATER LEVEL INDICATOR Audible tone produced when moisture bridges probe by H. W. Gleaves and S. F. Gregory 442

GENERAL FEATURES

EDITORIAL

- FOR YOUR ENTERTAINMENT** Armstrong's Radio Patents by Adrian Hope 412
DOING IT DIGITALLY Part 10: Interfacing to Alarm Systems by O. N. Bishop 418
SHOP TALK Retail news, products and component buying by D. G. Barrington 426
JACK PLUG AND FAMILY Cartoon by Doug Baker 431
EVERYDAY NEWS What's happening in the world of electronics 432
RADIO WORLD A commentary by Pat Hawker 434
MICROPROCESSOR BASICS Part 5: Programming a microprocessor by R. W. Coles 436
PLEASE TAKE NOTE Electronic Dice, EE 2020 Tuner Amplifier 439
WORKSHOP MATTERS Choosing a Multimeter by Harry T. Kitchen 441
CROSSWORD NO. 17 By D. P. Newton 444
RUMMAGING AROUND Money saving ideas for the constructor by Keith Cadbury 446
SQUARE ONE Beginners Page. Guide to circuit symbols 449
PROFESSOR ERNEST EVERSURE The Extraordinary Experiments of. by Anthony J. Bassett 450
COUNTER INTELLIGENCE A retailer comments by Paul Young 453

Back Issues

Certain back issues of EVERYDAY ELECTRONICS are available worldwide price 70p inclusive of postage and packing per copy. Enquiries with remittance should be sent to Post Sales Department, IPC Magazines Ltd., Lavington House, 25 Lavington Street, London SE1 0PF. In the event of non-availability remittances will be returned.

Binders

Binders to hold one volume (12 issues) are available from the above address for £2.85 (U.K.), £3.45 (overseas) inclusive of postage and packing. Please state which Volume.

Subscriptions

Annual subscription for delivery direct to any address in the UK: £8.50, overseas: £9.50. Cheques should be made payable to IPC Magazines Ltd., and sent to Room 2613 Kings Reach Tower, Stamford Street, London SE1 9LS.

© IPC Magazines Limited 1979. Copyright in all drawings, photographs and articles published in EVERYDAY ELECTRONICS is fully protected, and reproductions or imitations in whole or in part are expressly forbidden.

See you at... ★ ★ ★
**THE GREAT BRITISH
ELECTRONIC BAZAAR
ALLY PALLY**
June 28-30 Stand 163 ★



CONFERENCE TIMER

By A. J. Bassett

THIS DEVICE is intended for the timing of speeches at conferences etc, by means of coloured light signals.

Such a device will be a boon to speakers' clubs, discussion groups, debating societies, schools and universities. It might also have applications in offices, factories, the home and for various hobby interests.

The unit contains five indicators which operate as follows:

1. A light emitting diode. This shows that the unit is ready for use.

2. A green lamp which comes

on, and stays on, at the commencement of the speech.

3. An amber lamp which comes on shortly prior to the full time allocated, as a signal to warn the performer that time is nearly up.

4. A red lamp lights signifying that the allotted time has expired.

5. A blue lamp to signal that an interruption is being made. The chairman can switch on the blue light in order to make an urgent announcement, and the timing function is suspended until the blue light is switched off again, thus the speaker does not lose time as a result of interruptions.

CIRCUIT DESCRIPTION

The circuit diagram for the Conference Timer, excluding its power supply section is shown in Fig. 1.

When switch S1 is placed in the RESET position as shown in the diagram, the timing capacitor, formed by the parallel combination of C1, C2 and C3, is rapidly discharged via R2 to bring the output voltages of IC1 and IC2 to a value of almost 12 volts.

At the same time, the positive supply voltage to the indicator lamps, LP2, LP3 and LP4 is removed, except for the light emitting diode, D1, which now receives current through R1 and lights up to indicate when the unit is connected to the supply, and switched on ready to use.

When S1 is switched over to the START position the timing commences as C1, C2 and C3 begin to charge by way of VR1 and R3, causing the voltage at pin 3, IC1 to slowly fall towards the 0V rail. At the same time, the l.e.d. extinguishes and the green lamp, LP2 comes on as it receives current by way of power transistors TR1 and TR2 which are biased on by current from the output of IC1. This bias is applied to the base of TR1 by way of resistor R7.

AMBER ON

When the voltage at pin 3 of IC1 reaches the same level as VR2 wiper, the integrated circuit IC1 responds and its output voltage falls rapidly towards the negative supply rail. This removes the bias from TR1 and TR2 and the green lamp goes out as these transistors cease to conduct. The output voltages of IC2 remains near the positive supply and a voltage thus develops across the potential divider R9 and R10 sufficient to cause TR3 to conduct. This also enables TR4 and TR5 to conduct as the collector current of TR3 passes through R13 to the base of TR4, and the amber lamp lights up.

As the voltage at pin 3 continues to fall it eventually reaches the same level as the voltage at the junction of R5 and R6. Thus we have the situation where the voltages at pin 2 and 3 of IC2 are the same, the output voltage thus falls rapidly towards the negative supply rail. This lowers the voltage across the potential divider R9 and R10 so that TR3 is no longer biased on and ceases to conduct. Tran-

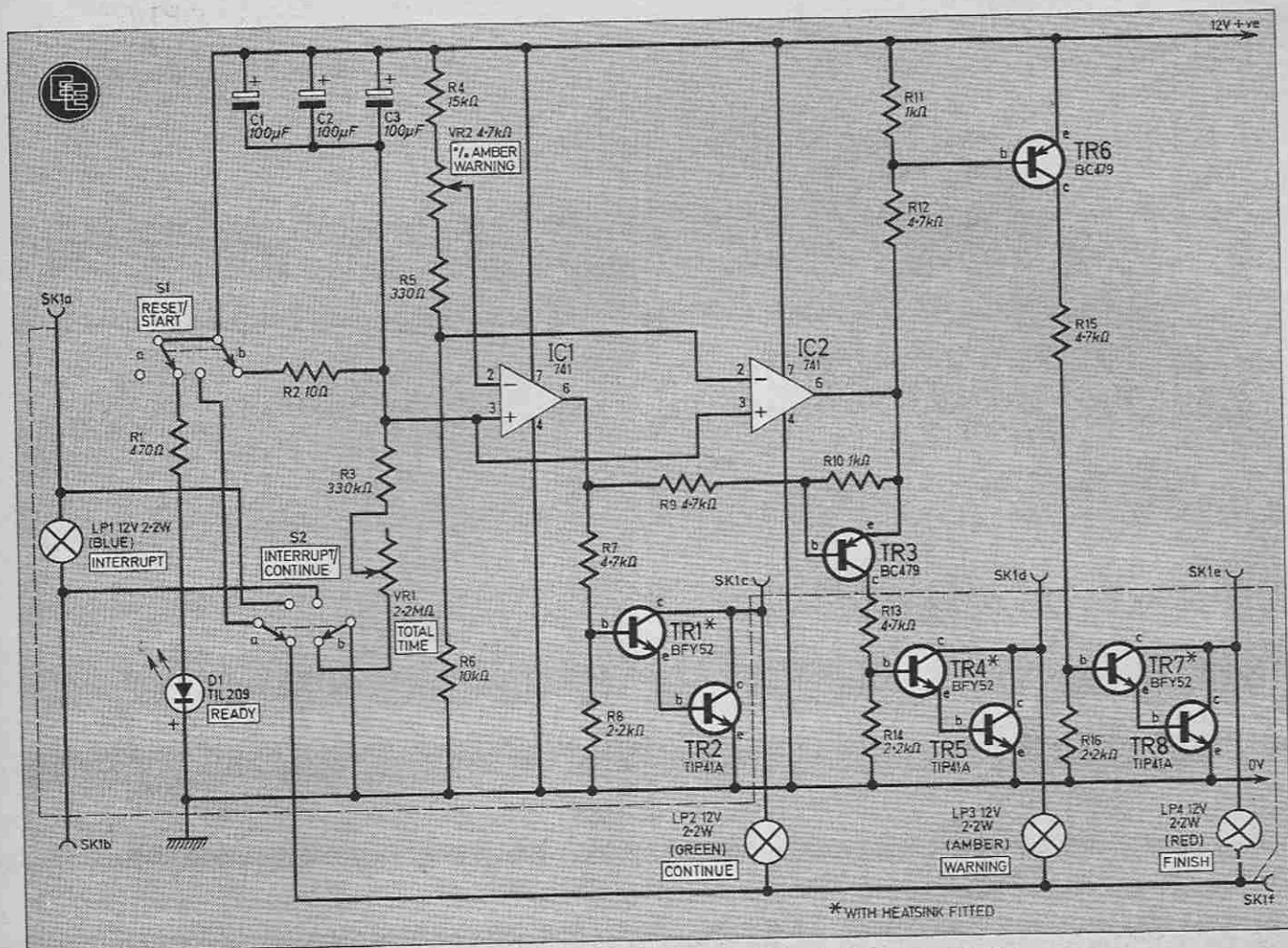

Fig. 1. The circuit diagram of the Conference Timer, (excluding power supply).

sistors, TR4 and TR5 then also stop conducting and the amber lamp goes out.

Now, because the output of IC2 is low, the voltage across potential divider R11 and R12 is sufficient to bias TR6 into conduction. Current is now supplied to the base of TR7 via R15; TR7 and TR8 begin to conduct and the red light comes on, signifying that the allotted time has come to an end.

If during the period when the amber or the green lamp is lit the chairman decides to make an interruption, he switches S2 to the INTERRUPT position. This switches on the blue lamp to signify that

an interruption is being made, and at the same time stops the charging of the timing capacitors by interrupting the flow of current through VR1 and R3.

Although in this condition the voltage on these capacitors will in fact fall, it does so very slowly and, for short-term interruptions the timing is affected very little. When the interruption is over, S2 is returned to the CONTINUE position and the timing proceeds as before.

POWER SUPPLY

The circuit of Fig. 1 requires a power supply of 12 volts; the current taken varying between 250mA and 1.5 amps according to whether the extension indicators are fitted.

Batteries or the 12 volt mains derived power unit shown in Fig. 2 may be used.

Mains voltage is stepped down by transformer T1 and the voltage appearing across T1 secondary is full-wave rectified by D2 and D3

and smoothed by C4. A 16 volt d.c. level is developed across C4.

Transistors TR11 and TR12 are arranged to form a constant current source, control voltage being derived from the output. The volt-

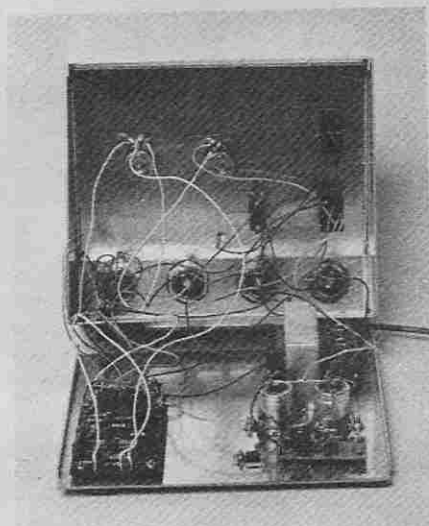

Interior view of the completed prototype unit.

COMPONENTS
approximate
cost £21 excluding
 case

age at R17/R18 is derived from the potential divider chain composed of R17/R18 and TR11 collector/emitter resistance.

For an output voltage of 12 volts, TR12 base is clamped at 1 volt which causes the voltage at R17/R18 to be about 13.2 volts. This biases on TR9 and TR10 and allows current to be drawn through TR10. A drop of 0.6 volts across each of TR9 and TR10 base emitter junctions produces 12 volts at TR10 emitter completing the loop to the output.

If there is a tendency for the output voltage to rise, TR11 and TR12 are caused to conduct more since voltage drop across R20 increases producing a larger current in the divider chain. Hence R17/R18 voltage decreases thereby reducing the output voltage to 12 volts.

Any tendency for the output voltage to decrease would cause TR11 and TR12 to conduct less resulting in the voltage at R17/R18 rising to restore the output level to 12 volts similar to above.

The output is thus stabilised at 12 volts and appears across C6.

The circuit features current limiting which is achieved by the inclusion of R21. If the voltage drop across this resistor reaches 0.6 volts, TR10 stops conducting since its base and emitter terminals will be at the same potential. This happens when the output current reaches about 2 amps.

CONSTRUCTION
starts here

CIRCUIT BOARDS

The prototype unit used two circuit boards in its construction, one for the main timing and lighting circuitry (board A) and a smaller one for the power supply section (board B).

Component layout details for board A are shown in Fig. 3 together with the breaks to be made on the underside. Veropins are used for all wiring to the board. Transistors TR1, 4, and 7 are fitted with heatsinks.

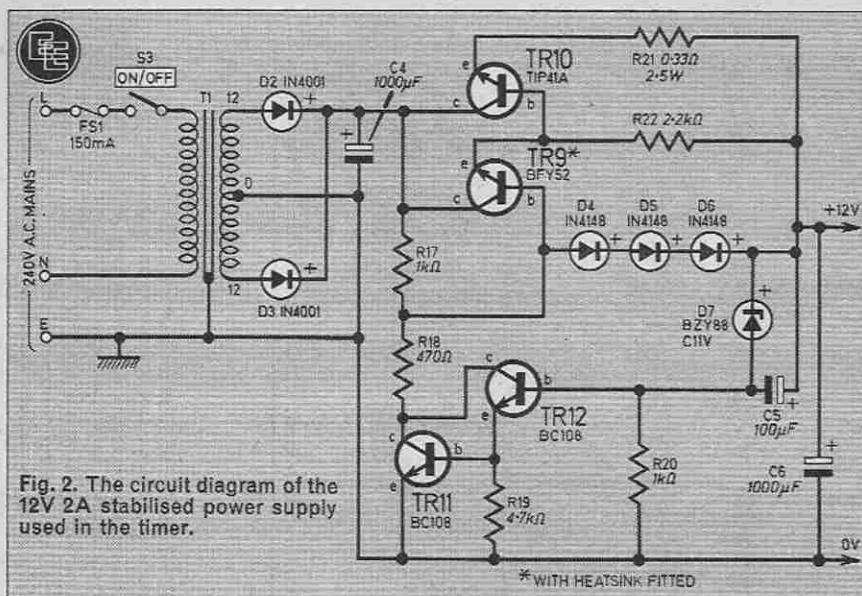

Fig. 2. The circuit diagram of the 12V 2A stabilised power supply used in the timer.

COMPONENTS

Resistors

R1 470Ω	R9 4.7kΩ	R17 1kΩ
R2 10Ω	R10 1kΩ	R18 470Ω
R3 330kΩ	R11 1kΩ	R19 4.7kΩ
R4 15kΩ	R12 4.7kΩ	R20 1kΩ
R5 330Ω	R13 4.7kΩ	R21 0.33Ω 2.5W
R6 10kΩ	R14 2.2kΩ	R22 2.2kΩ
R7 4.7kΩ	R15 4.7kΩ	All ½W carbon ±5% except R21
R8 2.2kΩ	R16 2.2kΩ	

Potentiometers

- VR1 2.2MΩ carbon lin.
- VR2 4.7kΩ carbon lin.

Capacitors

- C1, 2, 3 100µF 12V tantalum (3 off)
- C4 1000µF 25V elect.
- C5 100µF 25V elect.
- C6 1000µF 25V elect.

Semiconductors

- D1 TIL209 red light emitting diode
- D2, 3 1N4001 1A silicon rectifier (2 off)
- D4, 5, 6 1N4148 small signal silicon diode
- D7 BZY88C11V 11V 400mW Zener diode
- TR1, 4, 7, 9 BFY52 silicon npn (4 off)
- TR2, 5, 8, 10 TIP41A silicon npn (4 off)
- TR11, 12 BC108 silicon npn (2 off)
- IC1, 2 741. operational amplifier 8-pin d.i.l. (2 off)

Miscellaneous

- T1 mains primary/ 12-0-12V 2A secondary
- S1, 2 d.p.d.t. toggle
- S3 single-pole on/off mains toggle
- LP1 to 4 12V 2.2W m.e.s. bulb (4 off)
- LP5 to 8 12V 6W car sidelamp bulb (4 off)
- SK1 six-pin panel mounting socket
- PL1 plug to suit SK1
- FS1 150mA with chassis holder to suit
- Stripboard: 0.1 inch matrix 24 strips × 37 holes, 10 strips × 24 holes; insulating kits for power transistors (4 off); TO-5 heatsinks (4 off); Veropins (18 off); panel mounting m.e.s. bulb holders with domed cap (4 off); control knobs (2 off); 8-pin d.i.l. sockets; capacitor clips to suit C4 and C6; 4BA and 6BA fixings; insulated connecting wire; mains cable 3-core; 6-way tagstrip (2 off); 6-core cable; cable clips (2 off); cases (2 off).

See
**Shop
Talk**
page 426

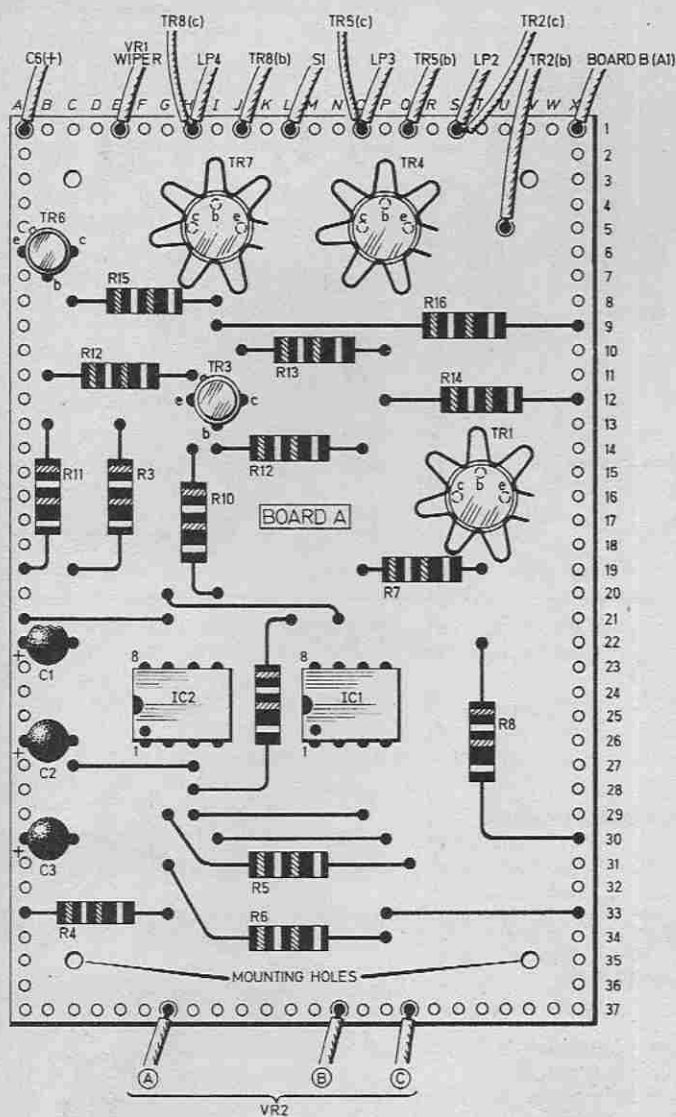

Fig. 3. The layout of the components on the topside of board A, the main circuit board and the breaks to be made along the copper strips on the underside.

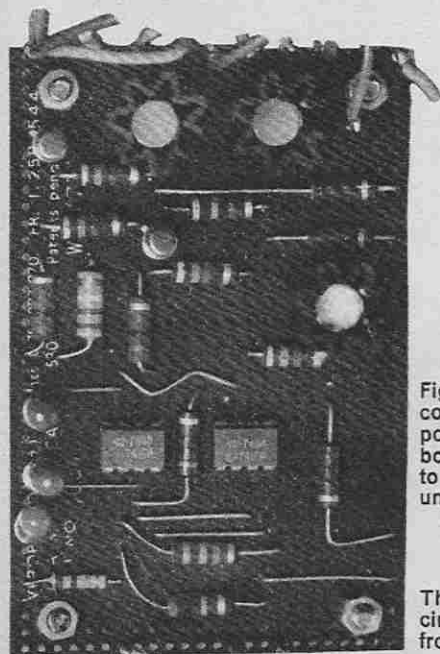
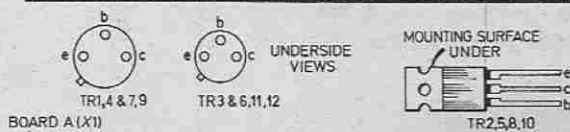
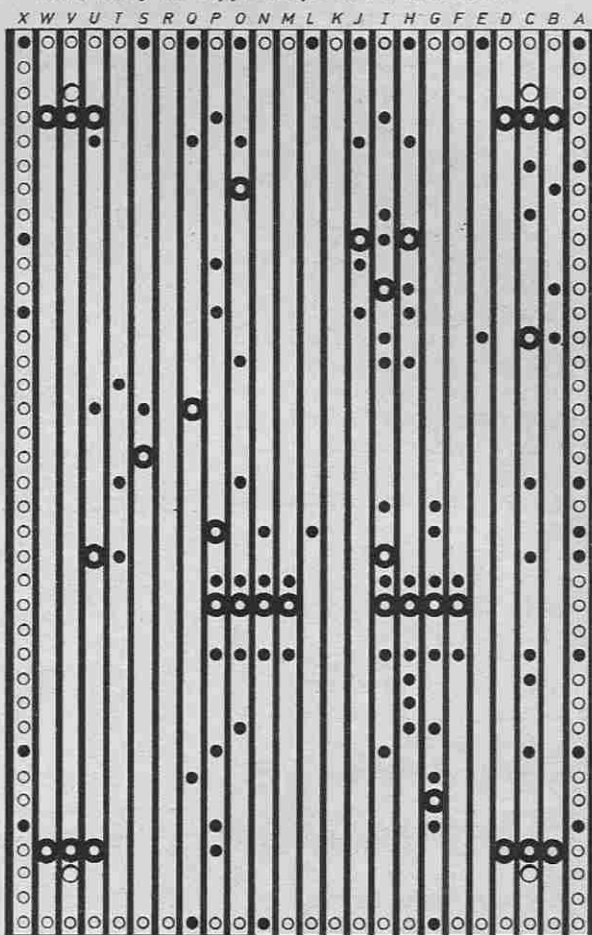
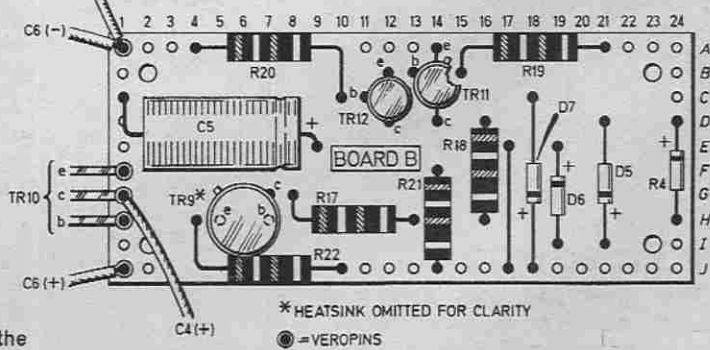

Fig. 4. The layout of the components on the power supply board, board B and the breaks to be made on the underside.

The prototype main circuit board removed from its case.



* HEATSINK OMITTED FOR CLARITY

⊙ = VEROPINS

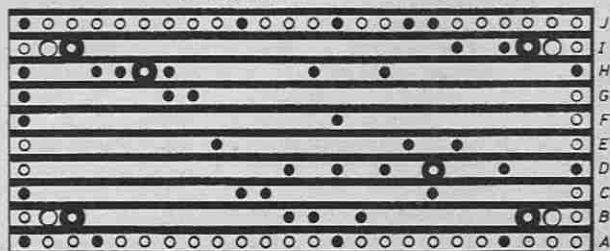
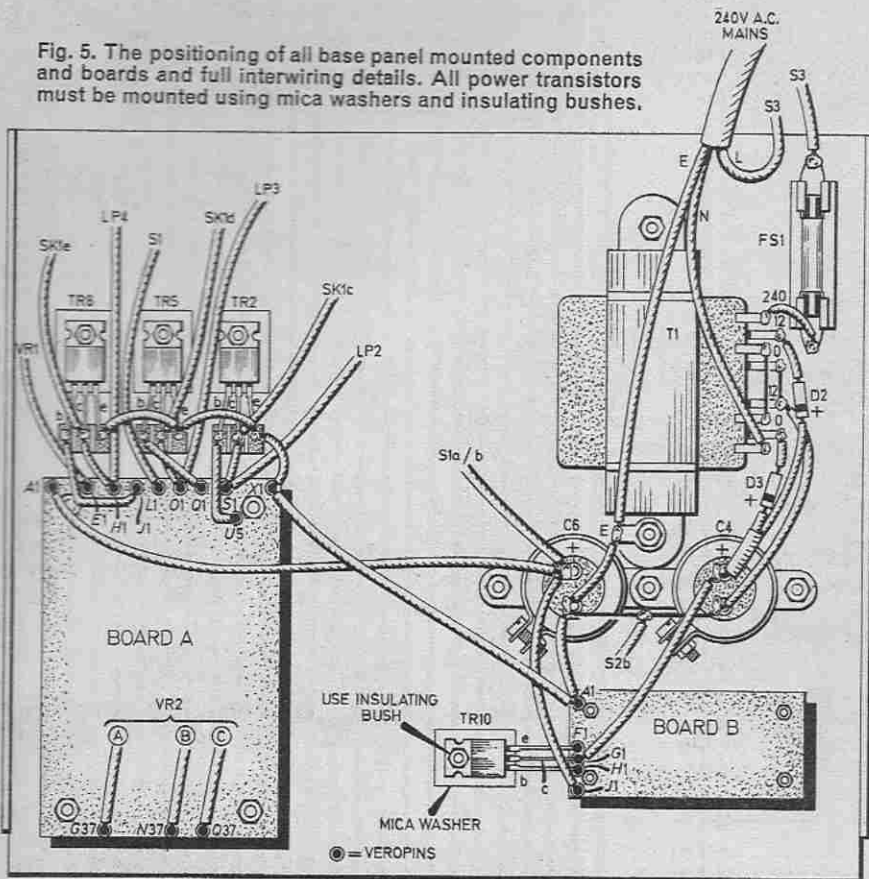
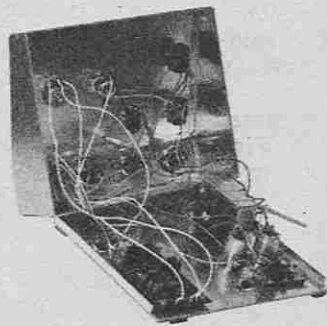

Fig. 5. The positioning of all base panel mounted components and boards and full interwiring details. All power transistors must be mounted using mica washers and insulating bushes.



CONFERENCE TIMER



The completed unit ready for final assembly.

Fig. 6. The positions of the lamps and controls mounted on the top panel showing wiring up details. Note the polarity of D1.

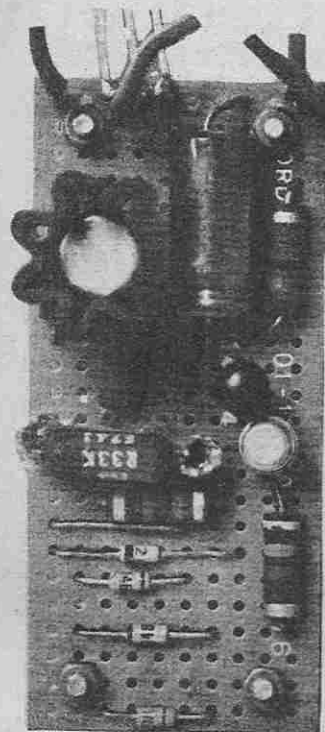
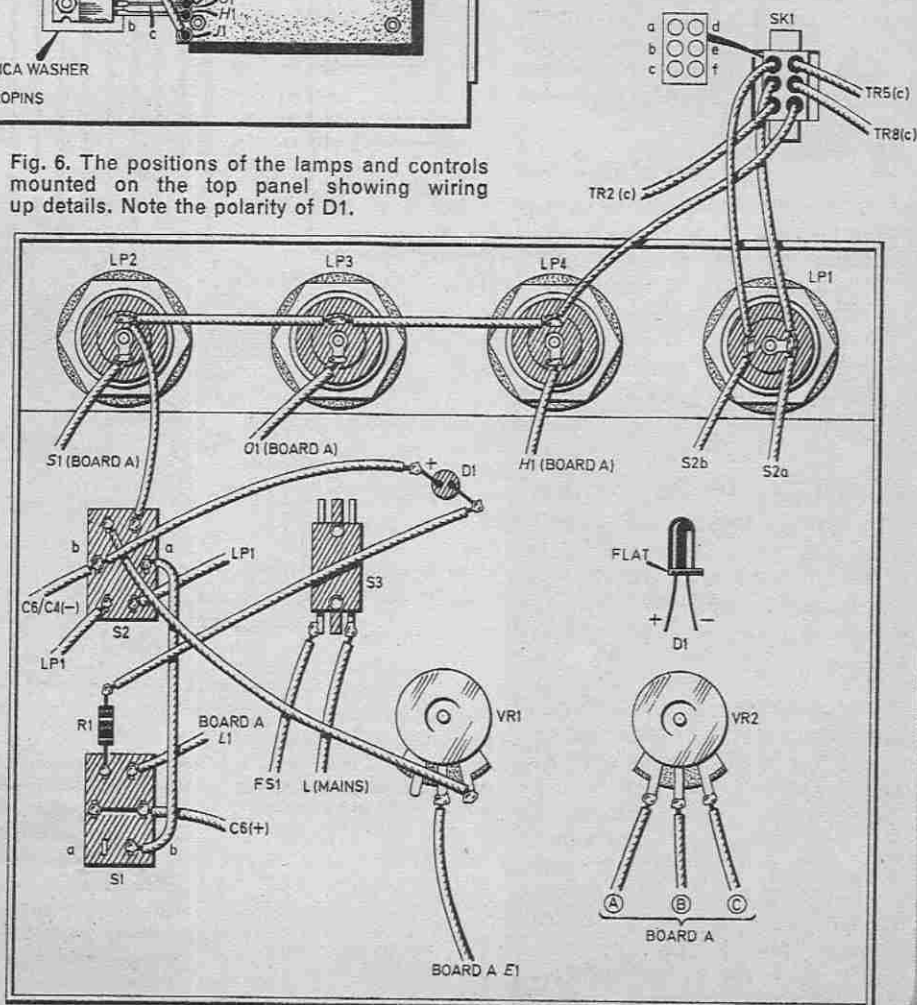

A close-up of the power supply board.

Having made the breaks and fixing holes, solder in the Veropins, link wires, resistors and capacitors paying attention to the polarity of the latter. Dual-in-line sockets for IC1 and 2 were not used in the author's model but are recommended. Finally solder in the transistors using a heatshunt on their leads to avoid thermal damage from the soldering iron. Do not attach any flying leads at this stage.

Similar details for board B are shown in Fig. 4 and should be assembled in a similar manner as board A. Note that a heatsink is required for TR9. Do not connect flying leads or TR10 just yet.

Before proceeding, inspect the boards for any solder bridges or wire whiskers between tracks. A bradawl or fine-blade screwdriver run between the tracks should dislodge such items.

The prototype used an aluminium box with a removable flat base size 227x190mm, and most of the components are mounted on this panel as shown in Fig. 5. The power supply smoothing capacitors are mounted by means of vertical type capacitor clips.

All power transistors are bolted to the case for cooling purposes but must be insulated from the base by using mica washers and insulating bushes. Silicon grease or other heatsink compound is advised for good thermal contact.

Fix all the base mounted components in position and then make all the interwiring connections as shown in Fig. 5.

EXTENSION INDICATORS

The six-way socket SK1 mounted on the rear panel is to connect the unit to four more indicator lamps in an extension indicator unit. This uses more powerful bulbs, and 6 watt car sidelamp bulbs were found to be suitable. The unit described will power up to three of these extensions, and extra six-way sockets, wired in parallel with SK1 may be fitted if required.

The circuit arrangement for such an extension indicator is shown in Fig. 7. A point to notice here is that the blue lamp receives its positive supply separate from the other three lamps.

Although there is obviously scope for imagination in the positioning and arrangement for the

Fig. 7. The circuit diagram for the extension indicators. Note that the supply for the blue interrupt lamp is separate from the rest.

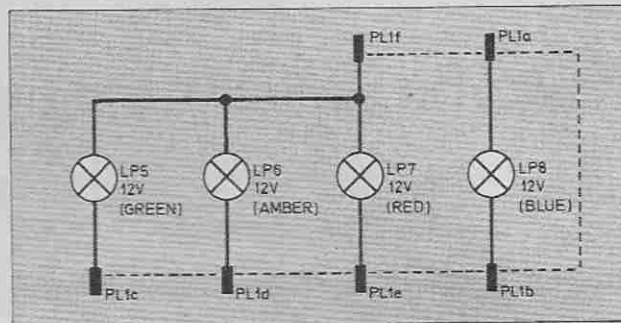

extension indicator lamps, the following suggestions may be helpful.

1. Use a box with four separate compartments. Line each compartment with reflecting metal foil and place a different coloured filter in front of each bulb. Suitable filters may be made by coating pieces of transparent glass or Perspex with an even layer of transparent coloured varnish such as Winsor and Newton Vitrina transparent glass painting colours, or transparent "lens marking colours" available at many art stores.

2. Use a box with only one compartment, and install coloured bulbs. Ordinary bulbs may be coloured using Deka transparent heat-resisting paint, available from art stores. With this method, it is a good idea to colour a few extra bulbs as spares.

The prototype used this method with a sheet of embossed Perspex fitted to disperse the light. Details for construction are given in Fig. 8.

TESTING THE TIMER

When construction has been completed and the unit checked and visually inspected, it may be switched on. The l.e.d. should light up when S1 is at RESET. Turn the timing control VR1 to give minimum time and switch S1 to the START position. The green lamp should light up, and the l.e.d. extinguish.

Check the INTERRUPT switch S2. When this is operated the blue lamp should light and the green extinguish, then back to green when S3 is set to CONTINUE.

After a timing period of just over 1 minute the green lamp

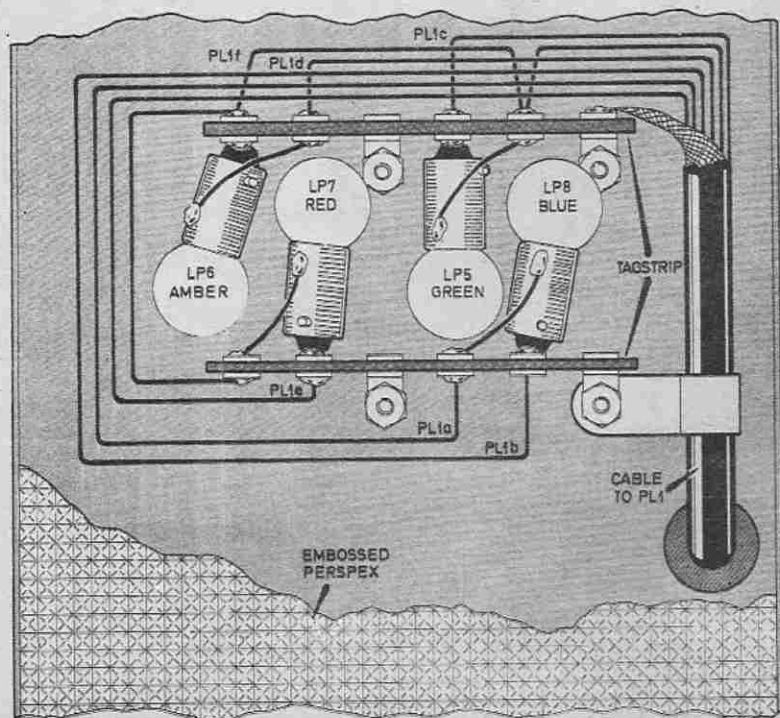

Fig. 8. The layout of the bulbs and wiring up details for the extension indicator box used in the prototype.

should extinguish and the amber lamp should light, and after about 2 minutes the amber lamp should go out and the red lamp should light. By changing the value of R3 the minimum timing period may be adjusted if necessary to suit individual requirements.

CALIBRATION

By setting VR1 to maximum resistance a time period of just over 20 minutes should be obtained. Adjust VR1 so that the total time period is 20 minutes and mark this point. Then turn it down until a time of 15 minutes is obtained.

By small adjustments of VR1, in succession, it is possible to obtain accurate positioning of the calibration marks, and the author found that timing could be made accurate to within a few seconds even for the longer periods of 20 minutes.

However, due to the time taken by these successive adjustments and tests a considerable amount of time should be allocated for the purpose and it is a good idea to settle down with a book, or some

small assembly job, which can be done adjacent to the indicator lights.

Set VR1 to give a timing period of 10 minutes and place a small calibration mark in this position.

Leaving VR1 at the 10 minute position, set VR2 fully clockwise; the amber light will then come on quite early in the timing cycle, probably after 55 per cent or 60 per cent of the time has elapsed. The time remaining will then be 45 or 40 per cent of the total, so that a 45 per cent calibration mark can be placed after 5½ minutes have elapsed, and the amber lamp just lights, then after 6 minutes a 40 per cent mark can be placed.

Prepare to make a number of calibration marks in quick succession, at intervals of 30 seconds around the VR2 control. With VR1 still set at 10 minutes switch S2 to the START position, timing this as accurately as possible. Set VR2 fully clockwise, and when the amber lamp lights, you will find that by adjusting VR2 very slightly back and forth, the green and amber lamps will light alternately.

The position at which this alter-

nation can be observed changes slowly due to the operation of the timing circuit, and calibration marks may be placed at 30 second intervals each corresponding to 5 per cent of the total time, so that marks may be placed from 40 per cent down to 5 per cent corresponding to 4 minutes remaining down to 30 seconds remaining when VR1 is set at 10 minutes.

Because the calibration of VR2 is expressed as a percentage of the total time set by VR1, VR2 cannot be calibrated in minutes for every setting of VR1; this would require a more complex circuit than the one presented in this article. This is not a major drawback as such percentages can be very readily worked out, especially so with the aid of a calculator!

The calibration points may now be labelled using Letraset or any similar method to give a presentable finish to the Conference Timer.

The user should find that functions may be timed electronically, effectively, tactfully, easily and fairly with the assistance of this device. □



MINI-MODULES

By George Hylton

Handy "Beginner" projects based on simple circuits and featuring a variety of building methods.

9

VOLTAGE SPLITTER

THIS month's Mini Module is a simple but effective circuit for turning a single-ended d.c. voltage supply into a centre-tapped supply. Such a supply is needed for powering operational amplifier circuits and other circuits which call for a three-rail supply with positive, zero-voltage and negative lines.

Normally the zero voltage rail is earthed or commoned but this is not obligatory and any one output terminal may be earthed. The circuit in the form given here (Fig. 1) can deliver enough output current for most low-power circuits. Higher outputs are

obtainable by adding a power transistor output stage.

The input voltage is, however, limited to 30V by the ratings of the 741 op-amp, which is used. This gives a maximum output of 15-0-15V.

If what is needed is not a centre-tapped supply but one divided unequally, for example, 20-0-10V, this is easily arranged by a simple change of resistances. The low-voltage limit of useful input voltage is about 6V, to give outputs of 3-0-3V.

A 741 op-amp, IC1, is used to compare the output voltage with half the

input voltage, as set by the voltage divider R1+R2. Any error is amplified and used to adjust the output voltage to the correct value. In other words the circuit acts as a negative feedback stabiliser but the reference voltage is not a fixed value but is half the input voltage, whatever that may be.

The BFY51 output transistor, TR1, is able to deliver more current than the 741 alone. It acts as an emitter-follower buffer amplifier and the maximum output current is as shown in the chart in Fig. 1.

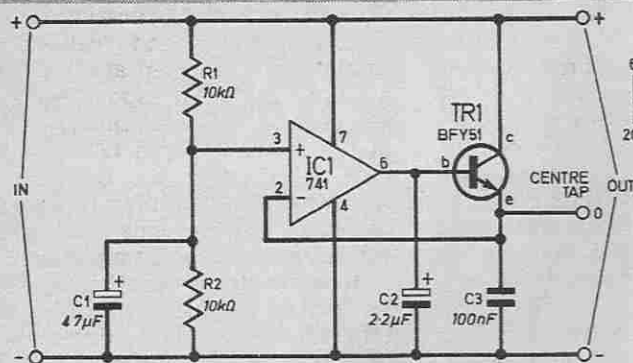

Fig. 1. Circuit diagram of the Voltage Splitter and input voltage/output current chart.

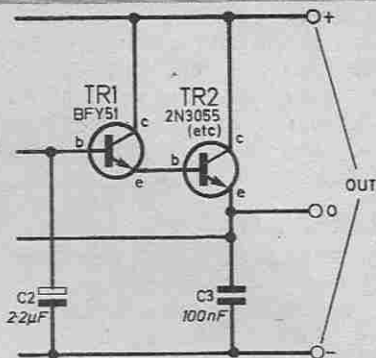
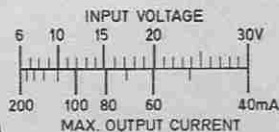

Fig. 2. The addition of a power transistor (TR2) for higher output currents.

CONSTRUCTION

A small piece of 0.1-inch matrix stripboard (such as given free with the March, 1979 issue of this magazine) forms a convenient baseboard. Four breaks in the conductor strips are required, below the 741 integrated circuit, which is in the 8-pin DIL format. Otherwise no preparation is needed.

The finished board can be mounted inside an existing power supply unit or (as here) put in a small plastics box such as the Norman Type PB1. No special mounting arrangements are required: the board can be hung on the input and output terminals by its own leads so long as these are of reasonably thick wire. (See Fig. 3.)

COMPONENTS

Resistors

- R1 10kΩ
 - R2 10kΩ
- All carbon film, 5% tol. 1/4W

Capacitors

- C1 4.7μF 25V elect.
- C2 2.2 or 3.3μF 25V elect.
- C3 0.1μF met. polyester

Semiconductors

- IC1 741 operational amplifier in 8-pin DIL package
- TR1 BFY51 npn transistor

Miscellaneous

- Stripboard (10 strips × 17 holes).
- Plastic case (Norman PB1). Five screw terminals. Five earth tags.
- Heat sink for TR1 (TO-5 cooler).

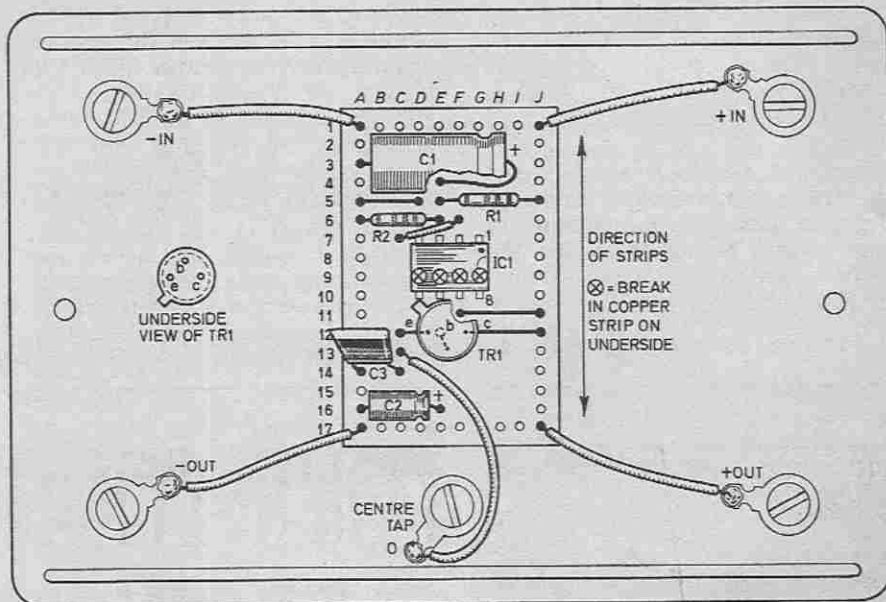

Fig. 3. The completed stripboard assembly mounted inside the plastics box.

OUTPUT OPTIONS

The maximum output current is limited by the permissible collector power dissipation of the BFY51. This is 600mW and gives the currents shown on the chart. A small increase (50 per cent) is obtainable by fitting a good cooling cap to the BFY51 (a useful thing to do anyway).

For larger currents a proper power transistor must be added, on an adequate heat sink (Fig. 2). The collector dissipation, with a centre-tapped output arrangement, is half the input voltage times the whole of the output current. Thus a 20V input arranged for 10.0-10V out at 1 ampere gives a dissipation of 10W.

The power transistor (a 2N3055 or similar TO-3 device) must then be mounted on a heat sink whose thermal resistance is low enough to prevent the transistor temperature from rising to a dangerous level when dissipating 10W. (Articles on the choice of heat

sinks appear from time to time in magazines like this one.)

Another common requirement is for a stabilised negative rail, between output terminals "0" and "-". This can be arranged by exchanging R2 for a Zener diode, D1, whose operating voltage is the required stabilised negative output voltage.

If, instead of a centre-tap, some unequal division of the input voltage is required this is easily arranged by changing the relative values of R1 and R2.

For example, if the input is 18V and an output of 12.0-6V is required, R2 should be half R1 since it will then drop one third of the input voltage. In other words the usual voltage-divider rule applies:

$$R1/R2 = (V_{in}/V_{out}) - 1$$

where V_{out} is the tap voltage.

Next month: Electronic Swanee Whistler.

OPERATION

Connect the input and outputs. Take care not to exceed the maximum output currents shown on Fig. 1. Remember that only one terminal at a time may be earthed; if for instance the centre-tap is earthed it is not permissible to earth also the negative or positive terminal.

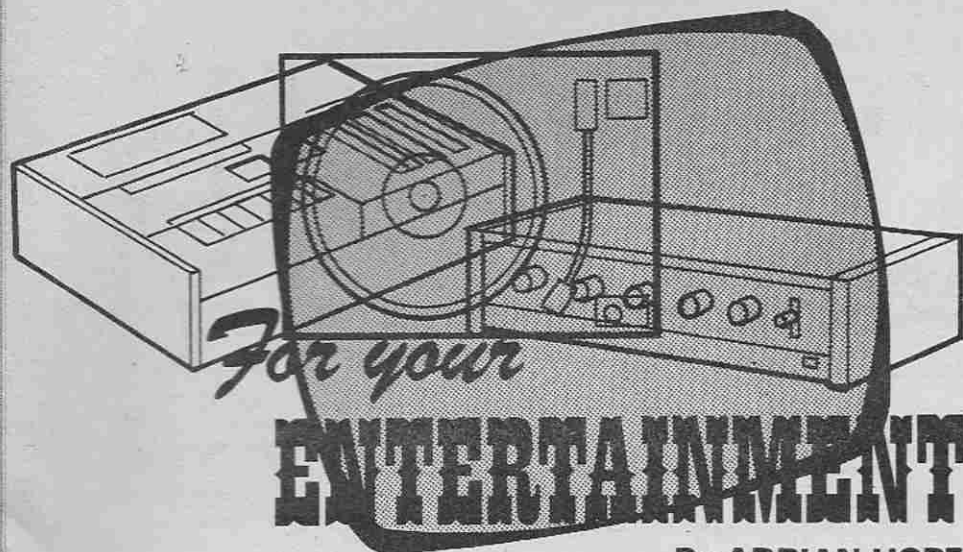

By ADRIAN HOPE

Master Inventor

I was in the USA recently researching the story of a millionaire inventor by the name of Armstrong who committed suicide twenty-five years ago. He killed himself because he could no longer face the burden of literally a score of legal actions which involved his patents.

Who?, said most people, when I told them I was visiting New York's Columbia University Library to scratch the surface of nearly a quarter of a million Armstrong documents archived there. It's a predictable query because the world of electronics owes more to Major Edwin Howard Armstrong than many people will ever realise.

It was Armstrong who in 1912, and while still a student at Columbia University, discovered how to turn the primitive triode or audion valve invented six years earlier by Lee de Forest into an amplifier and oscillator. It was Armstrong who in 1918, while serving in the Signal Corp in France, devised the super heterodyne solution to receiving radio waves of much higher frequency than had previously been feasible.

It was Armstrong in 1921 who invented a super-simple amplifying principle which made him a millionaire but has never been fully exploited and is today forgotten by all but the most avid radio enthusiast. It was Armstrong who in 1933 proved the mathematicians wrong and succeeded with the theoretically impossible by achieving static free transmission and reception using frequency rather than amplitude modulation.

Feedback

There is no doubt that it was Lee de Forest who in 1906 first came up with the idea of adding a third electrode to the diode rectifying

valve which had been invented two years earlier by John Ambrose Fleming of University College London. But there is also little doubt that de Forest saw the triode or audion simply as a glorified rectifier or detector. De Forest was also very hazy over how the audion actually worked, talking in his patents only vaguely of "molecular activity" and "hot gas detection" and admitting that "the action and theory" of the extra grid electrode was "merely hypothetical".

The young student Armstrong had the classic enquiring mind and was dissatisfied with Lee de Forest's explanations because they actually explained nothing. It was while looking for a fuller answer to why the triode grid improved detection that Armstrong hit on the idea of feeding back some of the anode output into the grid input via a tuned inductance.

Thus was the idea of feedback or regeneration born, and with it the phenomena of amplification and oscillation as we know them today.

Heterodyne

In the meantime, Armstrong had joined the army and during the First World War set his enquiring mind to the problem of detecting and amplifying high frequency radio signals with feedback valve circuits intrinsically unsuitable for the purpose.

His solution was brilliantly simple. He heterodyned or "beat" the incoming high frequency signal with a locally generated high frequency signal of fairly close frequency. This produced a difference or "intermediate frequency" signal which could easily be handled by conventional feedback amplifiers. Thus was the concept of super heterodyning and i.f. amplification conceived.

It made Armstrong even more rich and famous and nobody ever seriously disputed his rights on the idea. Virtually every radio receiver in use today relies on both the feedback and superhet ideas originally conceived by Armstrong.

Super Regeneration

In 1921 Armstrong devised a way of taming the wild oscillation of a feedback circuit so that it operated as an enormously efficient amplifier. He did this by continuously varying the relationship between the feedback and damping factors to establish a new and artificially high state of amplifying equilibrium without oscillation. It seemed as if 'super-regeneration', as Armstrong christened the system, would offer the world ridiculously cheap amplifiers and radio receivers.

Frequency Modulation

The fourth, final and most famous Armstrong invention, frequency modulation (f.m.), was made in 1933. Here he succeeded by researching the problem of static interference on radio in exactly the opposite direction to that which everyone else had taken.

With a.m. transmission it was established practice to use a receiver with a wide bandwidth tuning "window" which accepted as much wanted signal as possible to swamp unwanted a.m. static noise. But attempts at using the same technique with f.m. showed that there was f.m. static as well, albeit at a fairly low level.

As a stroke of genius Armstrong narrowed the reception tuning window, heavily modulated the f.m. carrier with the programme and used drastic a.m. limiting at the front end. The a.m. limiting eliminated static noise due to a.m. and the narrow reception window allowed in only a little f.m. static noise. This was swamped by the wanted programme on the heavily modulated f.m. carrier.

By 1934 Armstrong was transmitting static free f.m. radio on an experimental basis from the top of the Empire State Building in New York. By 1939 he had built his own f.m. station at Alpine Heights, seventeen miles from New York and this broadcast commercial-free f.m. radio, at Armstrong's expense, until his death in 1954.

He killed himself because f.m. became a commercial success after the Second World War and it galled him to see some of the largest radio manufacturers in the USA cocking a snoot at his f.m. patents while others paid royalties.

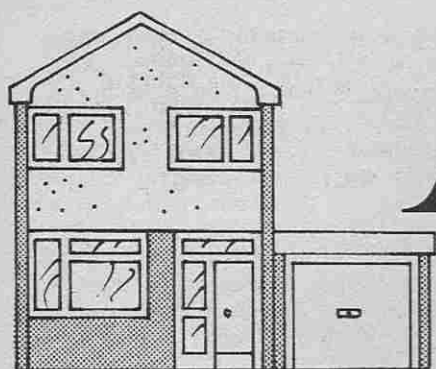

AT HOME OR AWAY

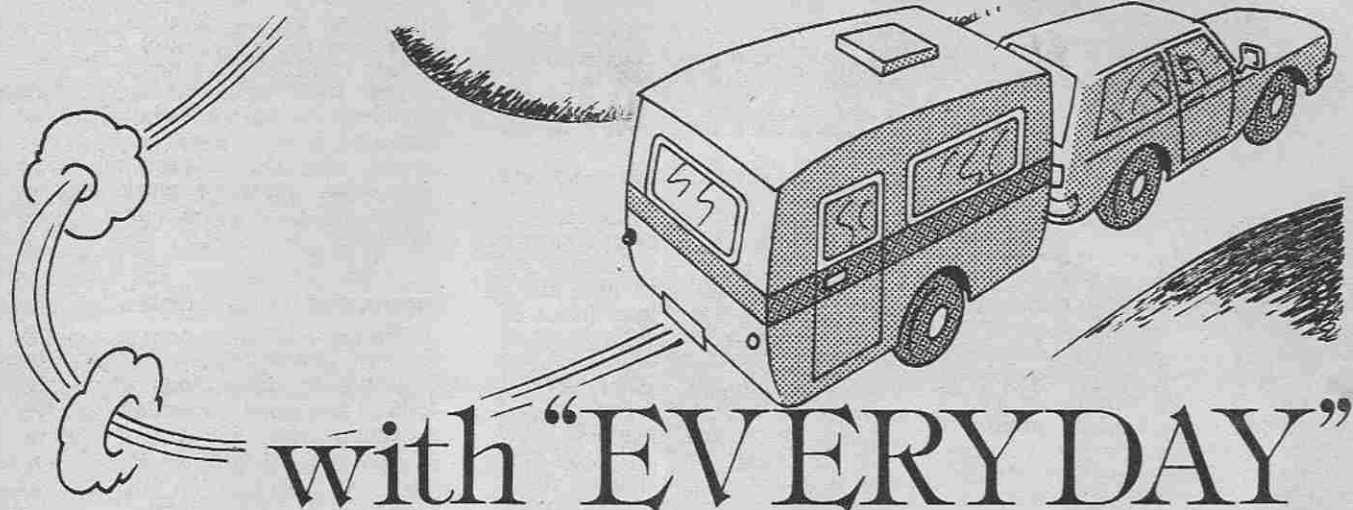

with "EVERYDAY"

TRAILER FLASHER UNIT

This simple unit drives the flasher indicator lights of a trailer or caravan and monitors their operation.

TOUCH-ON PILOT LIGHT

The touch pad is easier to locate in darkness than a conventional switch. Runs from 4.5V battery so is quite safe. An ideal project for the beginner.

ELECTRONIC TUNING FORK

For quick and accurate tuning of a guitar or other musical instrument. A l.e.d. indicator enables guitar to be tuned to within 1Hz of the reference tone.

WARBLING TIMER

Can be set for periods ranging from a few minutes, or periods as long as two or three hours. Emits a loud and distinctive tone. It is suitable for many applications in the home.

QUIZ REFEREE

This unit displays which individual is first to press their button. A pre-settable timer rejects replies after selected period. Simple and low cost to construct.

9V POWER SUPPLY

An invaluable piece of equipment for the experimenter. Also suitable to power a radio, cassette recorder, or calculator. Provides a continuously variable output from 0 to 9 volts.

Everyday ELECTRONICS

AUGUST
ISSUE ON SALE
FRIDAY, JULY 20
Price 45p

BIT SAVER

By R. A. PENFOLD

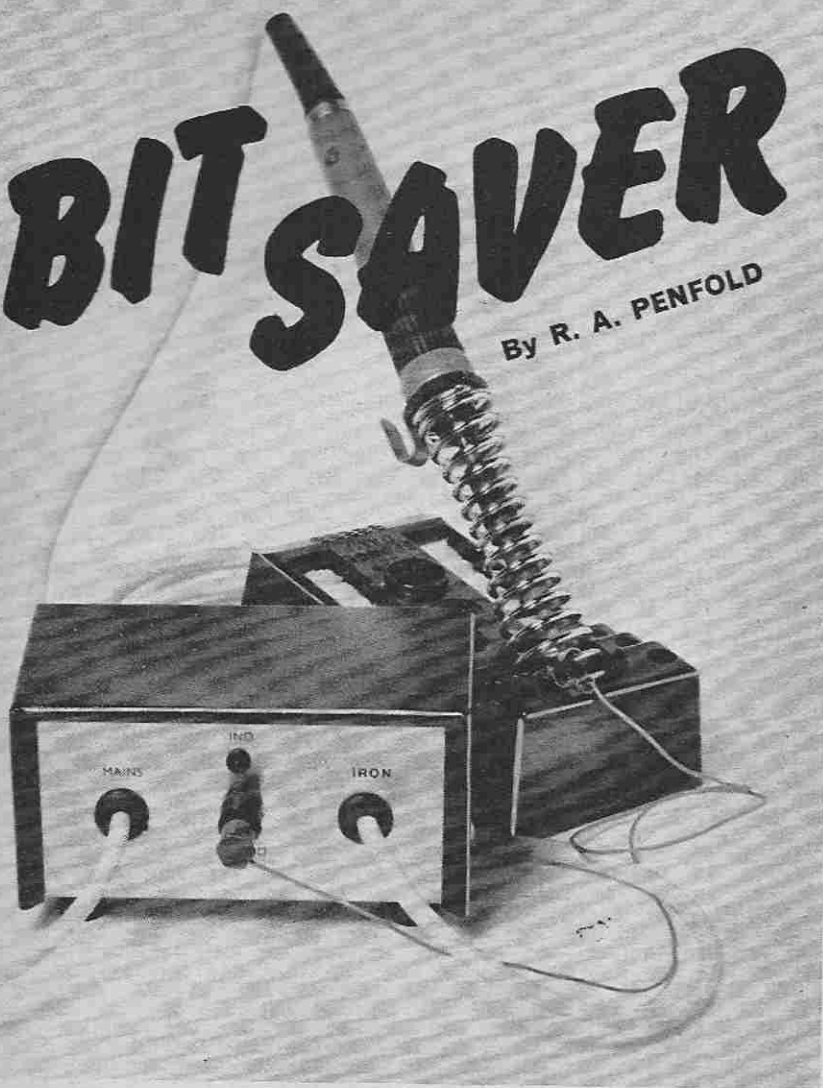

designed to have a heatsinking effect, but this is unlikely to be enough to prevent overheating.

There are probably other contributory factors, such as many irons having a nominal supply voltage of 220V, whereas the standard UK mains voltage is 240. And in many areas it is usually a little higher than this in actual fact. It is also very easy to leave a soldering iron left on after a soldering session.

REDUCED POWER

One way of overcoming this problem is to run the iron at reduced power while it is in its stand, and the usual method of achieving this is shown in Fig. 1. This merely consists of a switch and a rectifier connected in parallel with one another, and wired in series with one input lead of the iron.

Full power will obviously be applied to the iron when the switch is closed. When the switch is open, some power will still be supplied to the iron since the rectifier will conduct on one set of mains half cycles. However, the other set will be blocked, and the iron will be run at half power. This is enough to bring the bit up to soldering temperature while the iron is in its stand. When out of its stand and in use, the switch is closed and the power needed for normal useage will be available.

The switch could be operated manually, but it is more convenient to have automatic operation by either using a micro switch, or, as in this case, a simple electronic switching circuit.

CIRCUIT DESCRIPTION

The circuit diagram of the Bit Saver appears in Fig. 2.

Mains transformer T1 isolates the circuit from the mains and provides a low voltage output which is full wave rectified by D2 and D3 and smoothed to a steady d.c. voltage by C1. This produces a nominal supply voltage of about 9 volts.

Diode D5 is a panel mounted light emitting diode and is fed from the supply rails through current limiting resistor R2. This is merely a pilot light and reduces the likelihood of the soldering iron being accidentally left switched on.

A COMMON problem with soldering irons which do not have thermostatic control is that of a surprisingly short bit life. One soldering iron used by the author, admittedly for frequent and prolonged periods, has an average bit life of only about six weeks!

The main reason for this is that most soldering irons are designed to be able to carry out almost constant, heavy duty soldering jobs. They therefore have a fairly high power output as otherwise the soldering iron bit would soon drastically fall in temperature when undertaking demanding soldering jobs, with the bit tending to "freeze" to the joint in consequence.

Normal amateur requirements do not require a powerful iron, with the majority of joints being quite small and intricate, and requiring little power. The excess

power tends to cause overheating, and a reduction in bit and element life.

Another cause of overheating is that even when switched on, the soldering iron probably spends a good deal of time in its stand, particularly when troubleshooting or undertaking experimental work. Most soldering iron stands are

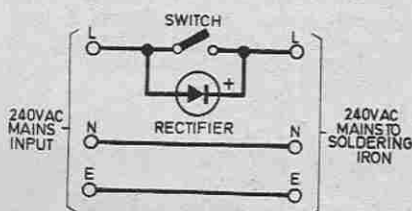

Fig.1. A simple method of enabling a soldering iron to run at reduced power is to switch in a silicon rectifier. In normal operation the rectifier is short circuited by the switch, and only comes into operation when the iron is in the stand.

Transistor TR1 is an emitter follower amplifier and it has a relay coil as its emitter load. A set of normally closed relay contacts are used and they are connected in series with the live power lead to the soldering iron. Thus, full power is applied to the soldering iron when the relay is not activated.

As the circuit stands, TR1 will receive no base current, only leakage currents will flow through its emitter circuit, and the relay will therefore be switched off. The base of TR1 is connected to the soldering iron stand via R1 and a connecting cable.

RELAY SWITCHING

It is assumed that the soldering iron is a type which has an earthed bit (any normal iron for use in electronic applications will be of this type), and so when the iron is in its stand the left hand side of R1 will be connected to earth.

As the positive supply rail of the circuit is earthed, this will result in the left hand side of R1 being connected to the positive supply rail. This results in a large base current being fed to TR1, and so an emitter current of sufficient level to switch on the relay is produced.

When the relay switches on, the two relay contacts open and power is supplied to the soldering iron through D1. This removes one set of mains half cycles and so only half power is applied to the iron. In this way the soldering iron is switched on normally when out of its stand, and is only driven at half power when in its stand.

HOW IT WORKS

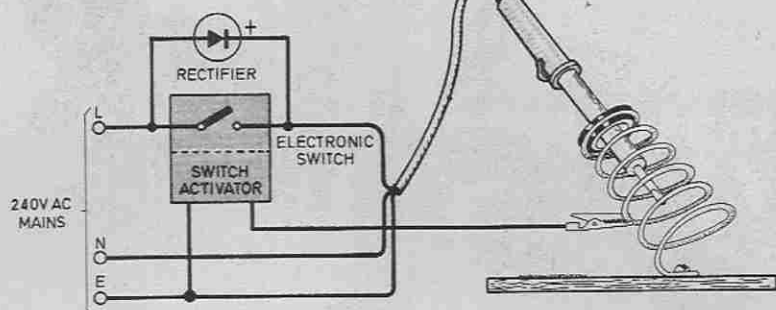

By supplying half power to the soldering iron when it is not being used, an increase in bit life is obtained. In this circuit a silicon rectifier is caused to be switched in and out by an electronic switch. When the iron is inserted in its stand, a circuit is made between the earth lead of the iron and the stand. This turns on the switch activator which then turns on the electronic switch, which opens to allow the rectifier to come into operation. Thus half power is being applied to the iron. When the iron is removed, the circuit is broken, the electronic switch closes and removes the rectifier. The iron thus quickly heats up to its normal temperature ready for use.

The iron is powered through a rectifier rather than a dropper resistor when driven at reduced power as a rectifier is cheaper, smaller, and does not generate any significant heat.

The relay is operated via an amplifier so that only a small switching current is needed, and even a fairly poor connection is good enough to produce proper operation from the equipment.

Capacitor C2 prevents rapid switching of the relay as the iron is placed in, and removed from its stand. This could otherwise result in reduced relay contact life and the radiation of radio interference.

Resistor R1 is a current limiting resistor and prevents a high surge current flowing as C2 initially charges up. This surge would

be undesirable as it could cause a small spark as the iron touched the stand, with reduced bit life occurring in consequence.

Diode D4 is a protective diode, and this suppresses the high reverse voltage that would otherwise be generated across the relay coil as it de-energised. If not suppressed, this could be of high enough amplitude to damage the semiconductor devices in the circuit.

CONSTRUCTION
starts here

Fig. 2. Complete circuit diagram of the Bit Saver.

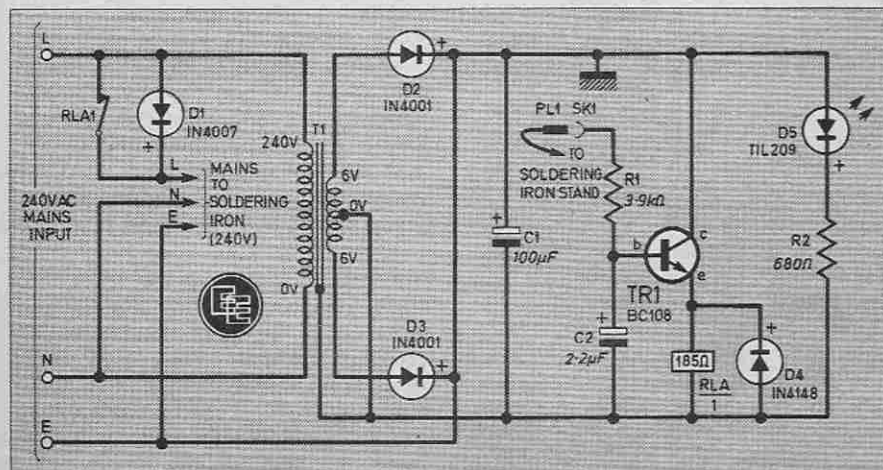

CIRCUIT BOARD

The prototype circuit was built on a piece of 0.15-inch matrix stripboard having 14 strips by 27 holes, and it is housed in a small metal instrument type case which has approximate outside dimensions of 112 x 42 x 55mm. Any similar case should also be suitable, but it is recommended that a metal case should be employed and that it should be earthed.

The component layout of the stripboard panel is shown in Fig. 3. Start by cutting the board to size and then drill the two mounting holes plus the mounting holes for T1. These are all drilled 6BA,

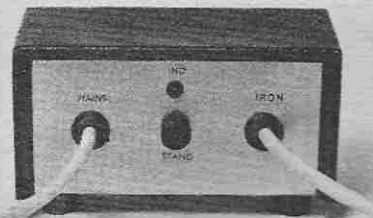

BIT SAVER

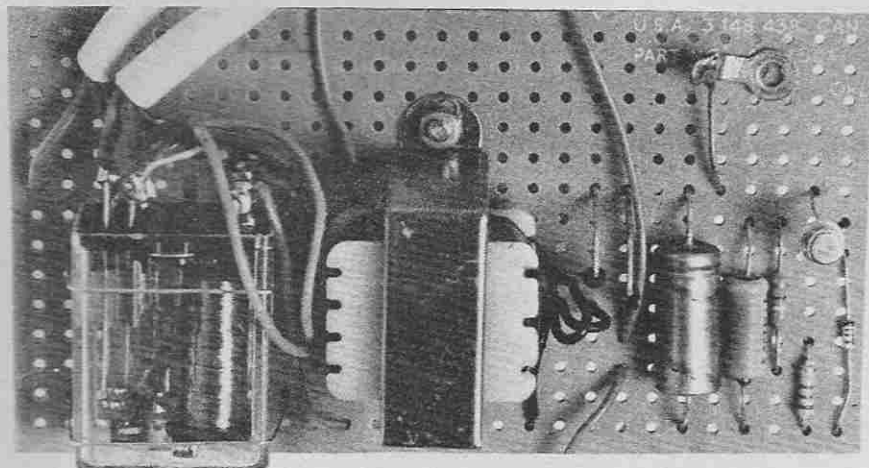

The completed circuit board for the soldering iron bit saver.

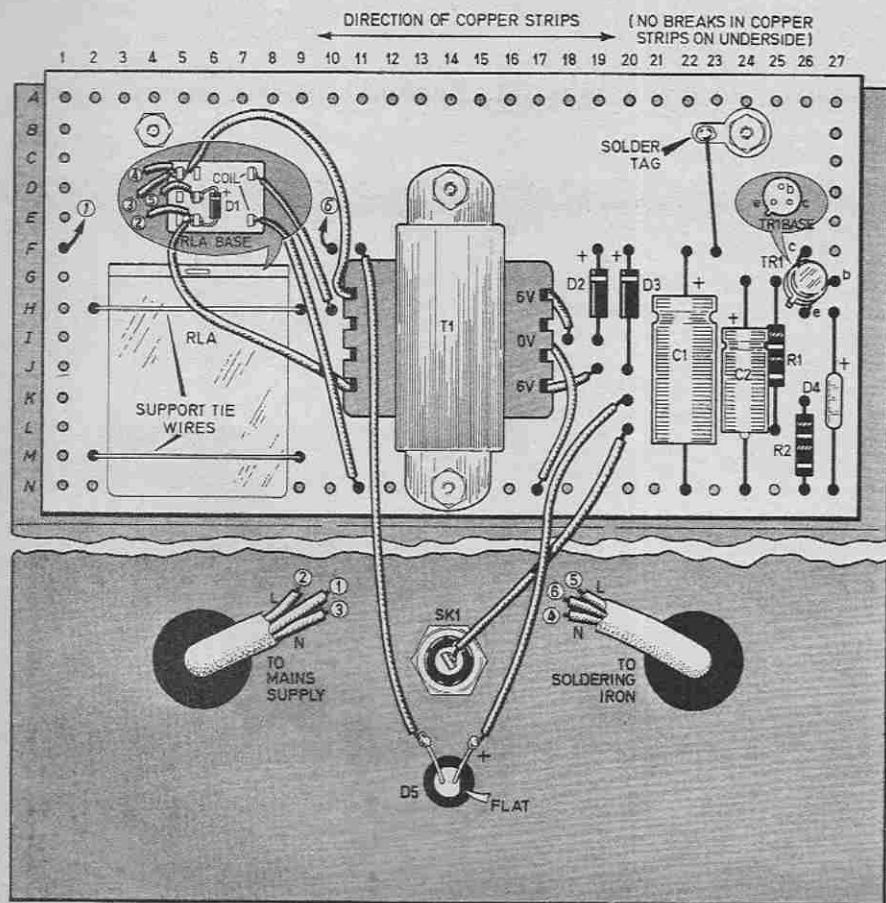

Fig. 3. Wiring details for the unit. The front and rear panels of the case have been opened out for clarity. There are no breaks to be made on the stripboard. Note that the transformer does not need to be of the same type as specified. If a different type is used then there is a possibility that it will not fit on the board, if this is the case then mounting it on the case will be the best idea.

clear, about 3.2mm in diameter. No breaks in the copper strips are required.

Next T1 is bolted into position and the relay is mounted on the board. The latter is glued into place, and a couple of single strand wire loops, about 22 s.w.g., are used to hold it firmly in position. It is not essential to use the specified relay, and any type having a nominal coil voltage of about 6 to 12V, a coil resistance of about 150 ohms or more, and at least one set of normally closed contacts capable of switching mains voltages, is electrically suitable. Other types may necessitate some alterations to the physical construction of the unit though.

COMPONENTS
 approximate
 cost **£6**
 excluding case

The various components are then soldered into the appropriate positions on the board, except D1 which is mounted on the two relay contacts that are utilized. Also connect the solder tag, this being used to provide the earth connection for the case when the component panel is bolted to the case

FRONT PANEL

A hole for SK1 is drilled in the centre of the front panel of the case and D5 is mounted just above this in a plastic panel holder. A hole for the mains input lead is drilled on the left-hand side of the front panel, and a hole for the soldering iron lead is drilled opposite this. Both these holes are fitted with grommets. The component panel will be mounted on the rear panel of the case, and suitable mounting holes must be made here.

Before mounting the component panel, wire it up to D5 and SK1 using ordinary multistrand p.v.c. covered connecting wire. Also thread the mains input lead and the soldering iron lead through the front panel holes, and then wire them to the relay and component panel. One tag of the unused set

of relay contacts is used as a suitable junction point for neutral connections of the mains lead, soldering iron lead and T1.

Do not use the spare tag of the relay contacts that are used, for this would short circuit the mains supply.

FITTING THE IRON

If a separate soldering iron is not available it will obviously not be possible to solder the lead from the iron direct into circuit. One way around this is to use a three way connector block so that the soldering iron lead can be connected into circuit using screw terminals.

Connector blocks are usually sold in twelve-way strips, and a

COMPONENTS

Resistors

R1 3.9k Ω
R2 680 Ω
Both $\frac{1}{4}$ W carbon $\pm 5\%$

Capacitors

C1 100 μ F 10V elect.
C2 2.2 μ F 10V elect.

Miscellaneous

T1 mains primary 6-0-6V at 100mA secondary
RLA 6 to 12V, coil resistance 185 Ω , with one set of normally closed contacts.

SK1 wander socket

PL1 wander plug

Stripboard, 0.15 inch matrix 14 strips by 27 holes; small metal case 112 x 55 x 42mm or similar; crocodile clip; two rubber grommets; mounting clip for D5; solder tag; standard connecting wire; length of mains cable as required.

Semiconductors

TR1 BC108 silicon npn
D1 1N4007 silicon
D2, D3 1N4001 silicon (2 off)
D4 1N4148 silicon
D5 T1L209 red light emitting diode

See
**Shop
Talk**
page 426

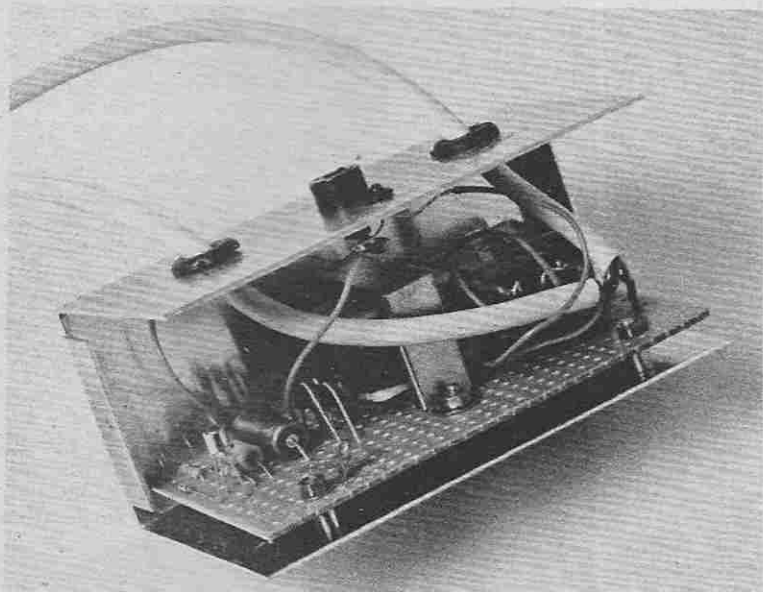

Interior view of the U-shaped chassis showing the method of mounting the circuit board on spacers. Care must be taken to ensure that SK1 solder tag does not short on the transformer.

block of the required length is simply cut off using a sharp knife.

An alternative method is to use a larger case so that a mains socket can be mounted on it. The three output leads would then connect to this socket and the soldering iron would plug into the socket. In some ways this is the best form of construction, although it would be more expensive and difficult to build.

Finally, the component panel is mounted on the rear panel of the case using countersunk 6BA screws, and spacers about 6mm or so long are used to keep the connections on the rear of the com-

ponent panel clear of the metal casing.

USING THE UNIT

A connection is made to a metal part of the soldering iron stand via an insulated lead terminated in a wander plug (which fits into SK1) at one end, and a crocodile clip which clips onto the stand at the other end.

If the crocodile clip is a type having a plastic cover, this should be removed as it is likely that the clip will become quite warm in use. The prototype equipment was tested and used with an Antex

type ST3 soldering iron stand, and as this has a spring-like metal part which actually holds the iron, there is no problem in making the connection to the stand.

When the iron is placed in its stand, the relay should be heard switching on almost immediately. When the iron is removed from the stand there will be a delay of about one second before the relay is heard switching off.

The equipment has been noticed to work properly even when the stand is quite dirty with flux, and the soldering iron bit is quite dirty and corroded. However, if either of them are excessively dirty it is likely that the electrical connection between the two will be inadequate for correct operation to occur. □



DOING IT DIGITALLY



PART 10

By O. N. Bishop

THIS MONTH we look at some digital circuits for making noises and ways of interfacing these to the outside world to produce alarm systems and others that give audible output.

TTL OSCILLATOR

The simplest form of sound generator is the circuit shown in Fig. 10.1a, ignoring the connection to CLOCK. You may recall that this is the circuit used for the Test-Bed built-in clock. The way it works was described in Part 5. The values of the capacitors C1 and C2 have been chosen to give an audible output.

The output is fed to the speaker via capacitor C3. This can have any value over the range 1 μ F to 100 μ F, but if its capacitance is smaller than about 0.47 μ F there is a reduction in the volume of sound produced by the speaker. When wiring and testing this circuit on the Test-Bed, the unused inputs of the gates may be left floating (effectively high inputs), but if you are building this circuit as a permanent device, such as a door buzzer, or Morse code practice set, the unused inputs should be joined together and

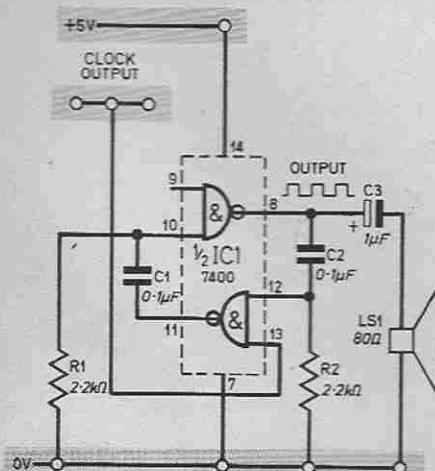

Fig. 10.1a. Circuit for an intermittently sounding audible tone generator.

connected to V_{cc} through a 1 kilohm resistor.

Since this circuit is identical to that of the Test-Bed clock, you can use the clock itself as the sound generator for most of the other circuits described this month. It should be switched to its highest frequency (450Hz), but you have the advantage of being able to run it at low frequency if you want to follow the stages of operation of a circuit.

INTERMITTENT TONES

An intermittently sounding note catches the attention much more readily than a continuously sounding note, especially in a noisy environment. We use a second oscillator, running at low frequency (say 1Hz) to achieve this. The low-frequency oscillator consists of two NAND gates connected as in Fig. 10.1a but the values of C1 and C2 are in the range 220 μ F to 1000 μ F.

The output of this oscillator is taken to one of the unused inputs of the a.f. oscillator. When the low-frequency oscillator output is high, the a.f. oscillator can operate and sound is produced. When the low-frequency oscillator output is low, the output of the gate to which it is connected is continuously high, whatever the state of the other input to that gate. The a.f. oscillator is inhibited, and no sound is produced. The result of this action is

an intermittent tone.

By varying the values of the capacitors of the low-frequency oscillator, making one, say, 250 μ F and the other 1000 μ F, you can alter the duty cycle and so vary the effect, obtaining a series of short "pips" with a relatively long time-interval between them, or a series of longer bursts with short periods of silence.

Wire up this oscillator on the Test-Bed as shown in Fig. 10.1b. As shown, the clock output (at low or medium frequency) is being used to provide the low-frequency output required for the intermittent note. Having used the clock as shown disconnect it and wire up a complete low-frequency oscillator, using the two remaining NAND gates of IC1.

As a door alarm, this circuit is based on only a single 7400 i.c. producing a cheap and effective system. As such, the wire ending A is connected through a 1 kilohm resistor to V_{cc} . The note is made to sound

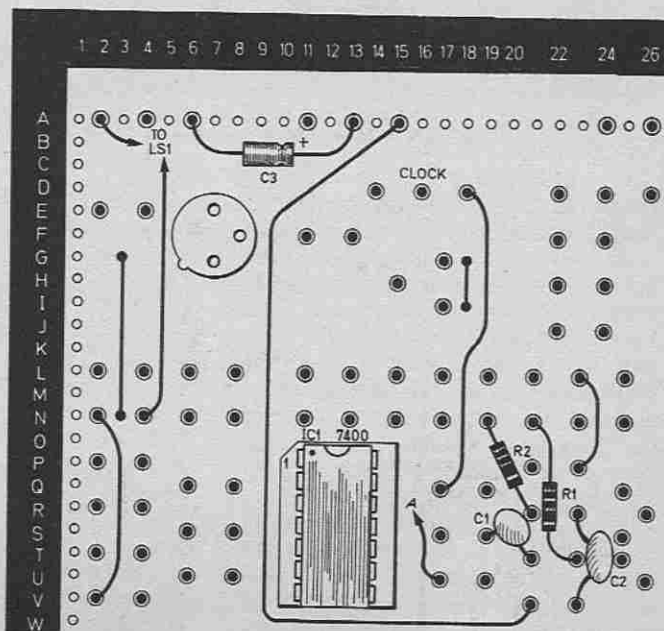

Fig. 10.1b. The circuit of Fig. 10.1a wired up on the Test-Bed

by switching on the power, for example, by pressing a bell-button.

Although we use a 5V supply on the Test Bed, a 6V dry cell with series "dropper diode" can more conveniently be used to power a door-alarm system. Please note that a door-bell transformer supplying 6V alternating current output should definitely not be used.

If you touch wire A to ground, the action of the a.f. oscillator is inhibited and no note is heard. The only sound is a series of very soft "ticks" as the low-frequency oscillator changes state. This is an indication that the system is working though not triggered to emit the intermittent sound. When A is removed from ground, the note is heard. This gives us a clue as to how the sounding of the note can be controlled by logic circuits.

If A is connected to the output of a logic gate, the alarm is silent as long as the logic gate output is low, but sounds as soon as the logic gate output goes high.

We will next investigate how various events can be made to trigger a gate to give a high output, and so sound the alarm. In other words, we are going to interface the alarm system to various kinds of happening in the outside world.

LIGHT DETECTOR

The light sensor and the high speed light sensor, described in Part 7 can both be interfaced to an alarm system. As explained in Part 7, these sensors give a high output either when light level falls or when it rises, depending on how they are constructed. Thus the output from either type of light sensor is suitable for controlling the action of the simple TTL a.f. oscillator of Fig. 10.1a, in place of clock, or the more complicated intermittent tone generator.

A light-triggered alarm system has many uses. As an intruder alarm it can be made to operate when a light beam is broken. If we use daylight, a room lamp, or a distant street lamp as the light source, the alarm sounds when the shadow of the intruder falls on the photosensitive device. The alarm can be triggered by the headlights of an arriving car, or by the light of the rising sun.

If you intend to use the latter as an early morning waker, be prepared for a late awakening on dull cloudy mornings!

If connected as described, the alarm sounds only while the light sensor is responding to changed lighting conditions. This may be suitable in many applications, but if you wish the alarm to continue to sound indefinitely after it has been triggered, connect a bistable between light sensor and alarm as shown in Fig. 10.2.

TRIGGER LEVEL

The variable resistor VR1 allows the triggering level to be set. You may find that you can dispense with this resistor altogether if your system is intended for working at fairly high light levels. The required bistable consists of one gate that is already part of the high-speed light sensor circuit, and the other unused gate of the 7413 i.c., a Schmitt trigger.

If you have already built the high speed light sensor as a separate module, it is a simple matter to amend the connections to the 7413. The whole triggered alarm circuit requires only two i.c.s and is a good illustration of the way one can design and build digital circuits from very simple units.

If you wire up this circuit on the Test-Bed, you will find that it is triggered by an increase of light falling on the phototransistor. It could be

triggered by a flash from the headlights of an approaching car, or from the torch of an intruder. It could also be used to detect fire.

If you need the opposite function, connect the input of the a.f. oscillator to point B instead of to point A. In either mode you will find that when the circuit is correctly adjusted its speed of operation is extremely high. If the beam is broken for an instant (or the briefest flash of light occurs) the alarm is triggered. You will find it difficult to "beat the system." If you do not need response to such brief events, you can use the other light sensor, based on a light-dependent resistor. This can be modified and coupled to the alarm circuit in a manner similar to that already described.

OTHER INTERFACES

The circuits for a number of other interfaces are shown in Fig. 10.3 to Fig. 10.5. The thermistor RTH1 in Fig. 10.3 is a bar, disc or bead of semiconductor material. As temperature increases the resistance of the thermistor decreases. As a result of this, the voltage at point A falls. When it has fallen to approximately 0.8V, the input to the NAND Schmitt gate reaches its lower threshold. At

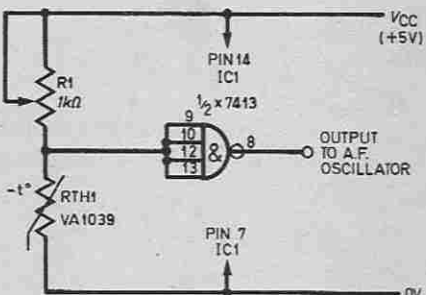

Fig. 10.3. Thermistor interface circuit; RTH1 has a resistance of 470 ohms at 25 degrees C.

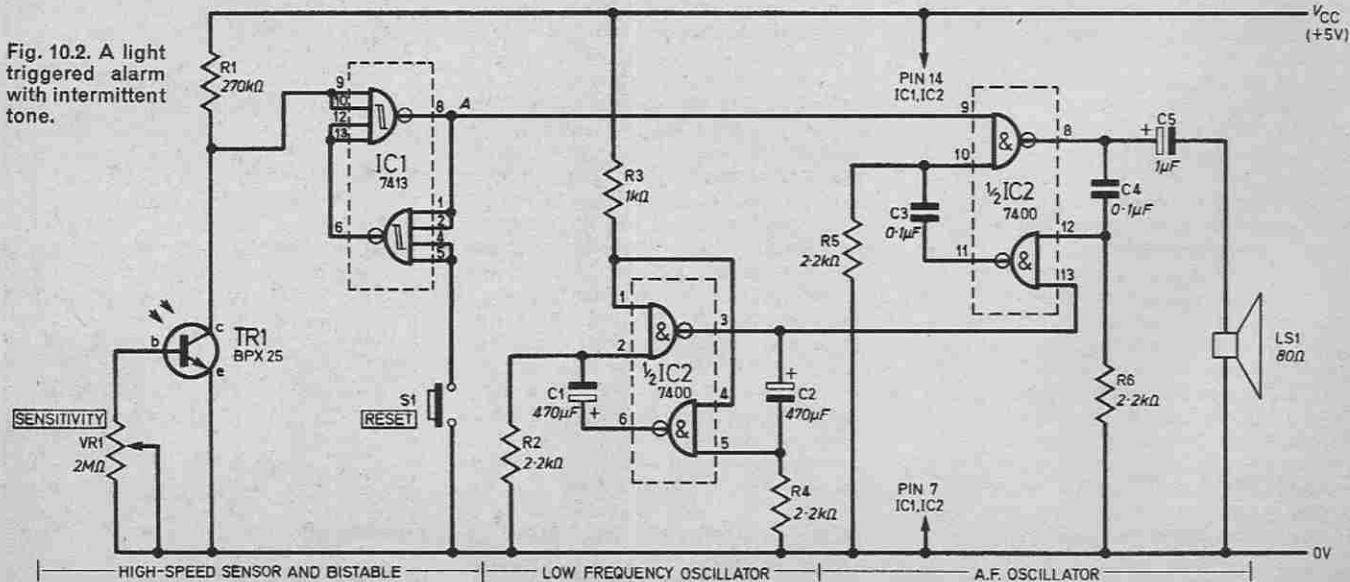

Fig. 10.2. A light triggered alarm with intermittent tone.

this stage the output of the gate changes from low to high. If connected to the alarm circuit, this high output allows the a.f. oscillator to operate and an alarm sounds. The level at which triggering occurs can be set by adjusting the variable resistor VR1.

The reverse operation, causing the warning to be sounded when temperature drops below a given level, can be obtained by interchanging the thermistor and the variable resistor. This could have applications as a frost warning device, or to indicate that the greenhouse temperature is lower than it should be.

Note that the thermistor can be connected to the remainder of the circuit by leads several metres in length, so that the thermistor can be situated outdoors and the power supply and alarm circuit to any convenient location indoors. By choosing a thermistor with an appropriate resistance value at 25 degrees Centigrade, and choosing a corresponding value for VR1, the interface can be designed to operate at any required temperature over a very wide range.

MOISTURE SENSOR

The moisture-detecting interface (Fig. 10.4) depends on the electrical conductivity of water. The probe can consist of a piece of stripboard with alternate strips wired together. Placed outdoors where it is exposed to rain, the probe becomes conductive when a raindrop bridges the gap between two adjacent strips. This allows base current to flow to TR1. When the transistor switches on, its collector potential falls, giving a low input to the NAND gate. The resulting high output from the gate is fed to the a.f. oscillator of the alarm circuit.

Another form of probe consists of two bare wires, mounted a few millimetres apart. These can be used to detect a rising water level in a tank or bath, giving warning when the water has reached a certain level. The reverse action can also be obtained by simply omitting the NAND gate and connecting the collector terminal (point A) directly to the a.f. oscillator.

This interface is able to detect water, even when it is present as a thin film, as you can demonstrate by pressing a moist finger-tip on the probe plate.

To make a soil moisture probe, two parallel wires about 3cm long and about 0.5cm apart are thrust into the soil. Conduction through the soil from one wire to the other is sufficient to supply adequate base current to TR1.

In normal use, the collector of TR1 is connected directly to the a.f. oscillator. If the soil becomes dry, conduction is reduced, TR1 switches off and its collector potential rises. This allows the alarm to sound. This inter-

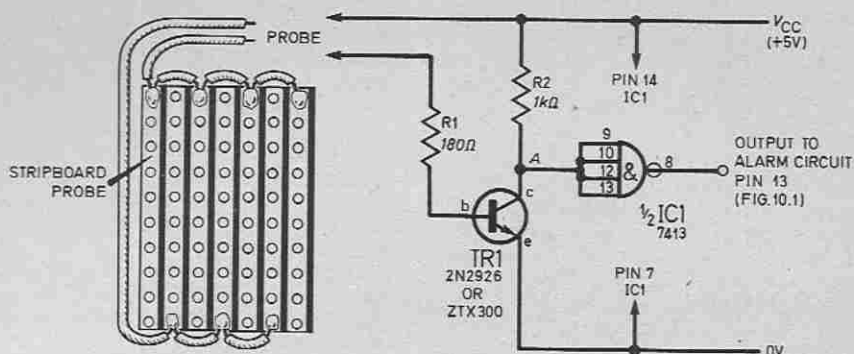

Fig. 10.4. Moisture detecting interface with probe for detecting rain.

face has several applications in the home, garden or greenhouse.

SUPER-SENSITIVE INTERFACE

The interface shown in Fig. 10.5 detects currents even smaller than those detected by the interface of Fig. 10.4. When using this interface you may find that the small current flowing between the probe wires or plates is sufficient to switch TR1 on. In these applications, VR1 may be

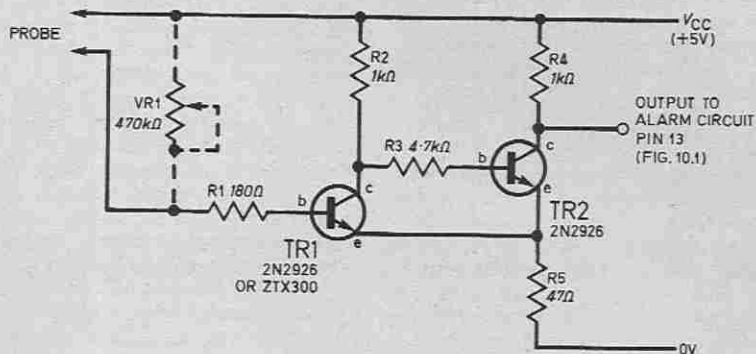

Fig. 10.5. A more sensitive conductivity interface; VR1 is optional, see text.

omitted. If the interface is required to operate under conditions of very low moisture content, VR1 is required.

After adjusting the setting of VR1 so that base current is not quite enough to turn TR1 on, we rely on the small additional current flowing between the probe wires to supply the deficiency; TR1 turns on and the output of the device is low. The alarm is silent. When conditions become drier, the flow between probe wires is reduced and that flowing through VR1 is insufficient to supply TR1 which turns off and the interface output goes high. The alarm sounds.

This interface can be connected to a touch-plate consisting of two metal strips or plates mounted on a non-conductive material, with a narrow gap between them. For this purpose you can use a small piece of stripboard, wired as in Fig. 10.4, or make a touch plate by etching a design on copper-clad board. Suitable designs are illustrated in Fig. 10.6.

When the gap is bridged by a finger-tip, conduction through the

skin is enough to operate the interface.

If this interface is connected directly to the alarm circuit, the alarm sounds for as long as the touch-plate is contacted.

This combination of circuits has applications as a door-alarm, or as a bedside alarm system for an invalid incapable of operating an ordinary push-button.

The circuit of Fig. 10.5 is not restricted to moisture detection. The

reader may like to investigate the use of this circuit with a light-dependent resistor, a phototransistor or a thermistor connected in place of the probe wires, in parallel with VR1. It should be possible to build a sensor that responds to very small changes in incident light, or in temperature.

Yet another modification of the previous circuit is shown in Fig. 10.7a. Here we use the small current generated by a crystal microphone when sound waves make it vibrate. A sound-operated interface has several applications, including detecting intruders, listening for the telephone bell, or sounding an alarm when baby

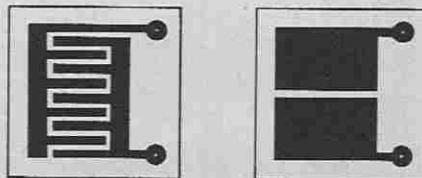

Fig. 10.6. Two simple designs for touch plates on p.c.b.

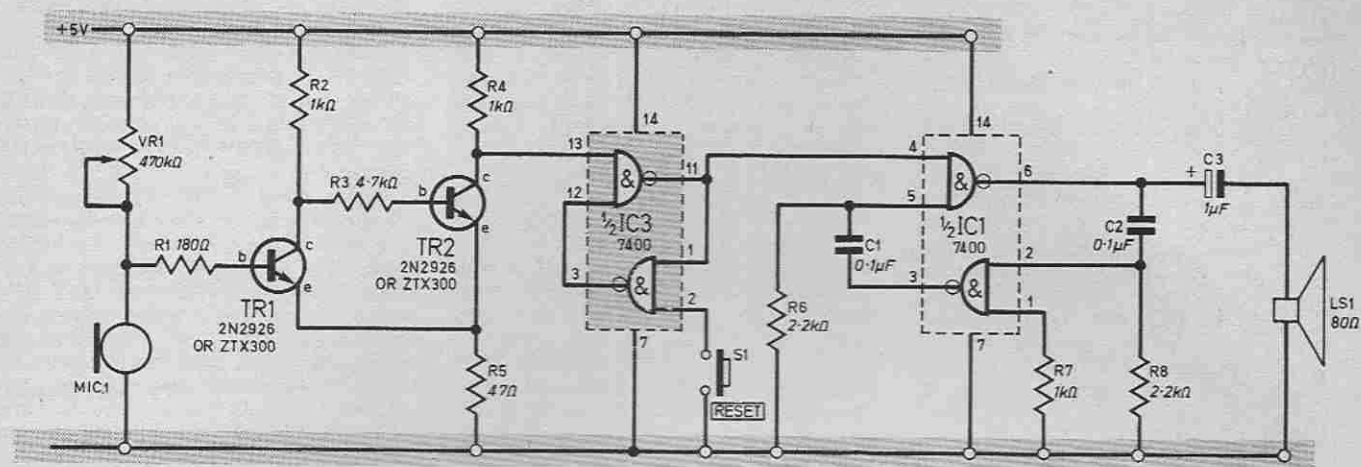

Fig. 10.7a. A sound triggered interface operating a simple audio generator and loudspeaker.

cries. The circuit incorporates a bistable, for it is assumed that we require that the noise which is of relatively short duration will trigger the alarm to sound for a longer period, until the reset button is pressed.

When sound is received by the microphone a brief, irregularly alternating current is produced. The high peaks of this current add to the steady current flowing through VR1. The current through VR1 is just insufficient to turn on TR1, but when the additional current flows, TR1 is

turned on for very brief periods of time. The first time that the interface output falls low, the bistable changes state, even though the output may be low for only a very short period. From then on, until it is reset, the bistable output is high and the alarm sounds.

SOUND OPERATED ALARM

In Fig. 10.7b we see how the sound-operated alarm system is set up on the Test-Bed. In this version the note is continuous, though an intermittent note can be obtained if the clock

output is connected to Test-Bed location P4 and the 1 kilohm resistor is omitted.

In a permanently wired unit, the low-frequency oscillator could be built around the other two gates of the 7400. The emitters of the transistors are not to be connected directly to ground so the transistor socket of the Test-Bed cannot be used. Instead the transistors are mounted on the "free" strips at the lower edge of the board. Resistors R2 and R5 cannot be connected directly to V_{cc} or ground, as their leads are not long enough;

instead, use is made of the connections between pins DD17 and DD19 and between pins EE21 and EE23, since the corresponding i.c. socket is unoccupied.

When setting up the circuit it is not necessary to use the oscillator for testing purposes; this spares neighbours a certain amount of noise. The interface circuit is first connected to two l.e.d.s (dotted lines), which indicate the state of the bistable. In a reasonably quiet environment the setting of VR1 is first adjusted to a position in which the interface is just *not* triggered. The easiest way to do this is to turn VR1 to minimum value and then repeatedly press the reset button. The bistable remains permanently set, but if VR1 is then turned *slowly* toward its maximum value, and reset is pressed repeatedly, a point is eventually reached at which resetting occurs.

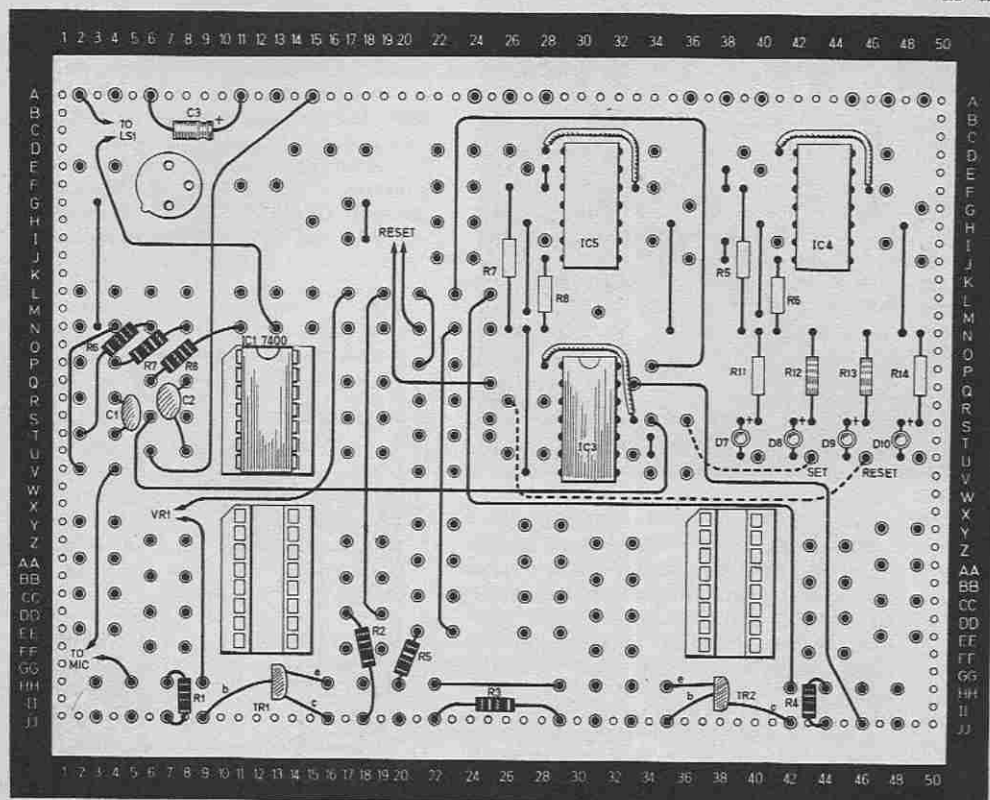

Fig. 10.7b. The circuit of Fig. 10.7a wired up on the Test-Bed.

Leave VR1 in this position. Now, when a noise is made beside the microphone, the bistable should set. Further slight adjustment of VR1 can then be made to find the most sensitive setting.

At this stage the reader may find it worthwhile to remove VR1 from the circuit without altering its setting, and use a testmeter to measure its resistance. When the circuit was under trial on the Test-Bed it was found that the effective resistance of VR1 at this stage was a little over 60 kilohms; VR1 was then replaced by a fixed carbon resistor of 56 kilohms in series with a 10 kilohm preset. This arrangement made it easier to adjust the circuit for greatest sensitivity.

When adjusting is complete, the connections to the l.e.d.s are removed and the oscillator is assembled and connected to the bistable output at S34.

Before leaving the subject of interfaces we should mention the simplest interface of all—a pair of metal contacts forcibly brought together or parted.

For burglar alarm systems a number of pairs of contacts can be positioned on windows and doors, so as to be in contact when the window or door is shut, but parted when it is opened. Parting the contacts, one of

which is connected to ground and the other to the a.f. oscillator, causes the alarm to sound.

Pressure mats are available for use beneath carpets and make contact when they are trodden on. These too can be used as interfaces to alarm circuits.

TTL VERSATILITY

This part of the series has been almost entirely concerned with alarm circuits, but many of the units described have applications in other fields. The sound-triggered interface can be used with the digital dice (April 1979) to make a novel voice-operated dice that displays a random number when a play shouts "Stop".

The temperature-sensitive interface can be connected to a timing circuit so that we can measure for how many hours of the day or night the temperature of a room (or greenhouse) exceeds a given level. We can build a circuit that switches on an electric fan when the room becomes too hot. With a little more ingenuity we can cause an electric train to stop, or start, or reverse in sequence each time a whistle is blown. By blowing the appropriate number of blasts on the whistle the motion of the train can be remotely and realistically controlled. Such a controller would need

only the sound-operated interface, a number of flip-flops, a few power switches and some relays.

Most of these have all been described in previous articles in this series, and all that needs to be done is to work out the logical way of connecting them together so as to perform the required function.

There seems to be virtually no limit to the number of ways of connecting together the relatively few basic units that we have examined so far. Whatever you want to do electronically, the great versatility of TTL makes it highly likely that you will succeed in *doing it digitally*.

To be continued

ERRATUM

An error occurred in the Keyboard construction diagram Fig. 5.5. Four 470 ohm pull-down resistors and the connection to ground were omitted. These resistors should be inserted to span 125/A25, 126/B26, 127/C27, and 128/B28. Also a Soldercon pin, Veropin or flying lead needs to be connected to location 134.

It is important that this amendment be made as the Keyboard is used a lot in Parts 11 and 12.

DARKROOM TIMER

By A. R. Winstanley

THERE MUST be many instances when a simple visual indication of elapsed time could prove to be just as effective as the most sophisticated of electronic timepieces. The unit described here is a small portable device which illuminates a light emitting diode once per second.

The circuit itself is very simple and so phenomenal accuracies cannot be expected from it. It is possible however to obtain an accuracy of about $\pm 1/60$ th of a second.

The reader will no doubt find other uses, besides its intended use as a timer in the darkroom. It should be possible to use the unit for both colour and black/white printing and enlarging, although one must be aware of its accuracy.

CIRCUIT DESCRIPTION

The circuit diagram appears in Fig. 1. The transistor arrangement illustrated will be familiar to many readers and is called an *astable multivibrator*.

Operation of this configuration is as follows.

When power is initially applied, one of the transistors must turn on before the other, this is due to inherent component tolerances. For simplicity, let us assume that TR1 will switch on first. The positive plate of C1 is therefore grounded, and this negative pulse is transmitted to TR2 base, which effectively biases TR2 off. With TR1 on and TR2 held off, C1 charges up via VR1 and R2 until the potential at

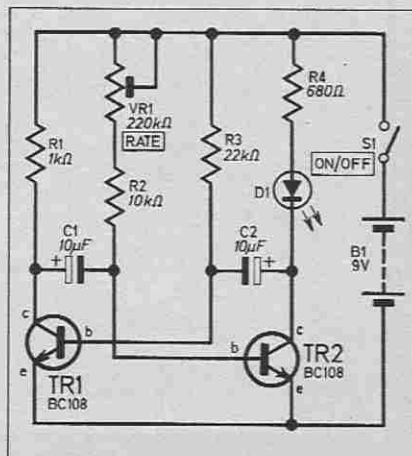

Fig. 1. Circuit diagram of the Darkroom Timer.

TR2 base equals some 600mV.

When this point is attained, TR2 is now able to switch on, as its base is now correctly biased. As TR2 switches on, D1 is able to illuminate, R4 serving to limit the current to a safe level; also, a negative pulse is transmitted via C2 and TR1 base and effectively switches TR1 off.

With TR2 on and TR1 off, C2 can charge through R3 until 600mV is present at TR1 base, this permitting TR1 to switch on again, and so causing TR2, via C1, to be forced off.

It can be seen that the whole circuit is oscillating, the charging cycles repeating themselves, and this will continue until the power supply is removed. By adjusting the timing components, VR1, R2, R3, C1 and C2 we can adjust the frequency of operation of the circuit, and in fact VR1 is included so that a near perfect one hertz frequency (one cycle per second) is achievable.

CONSTRUCTION starts here

The circuit, with the exception of the l.e.d., is built on a piece of 0.1 inch stripboard measuring 9 strips by 23 holes.

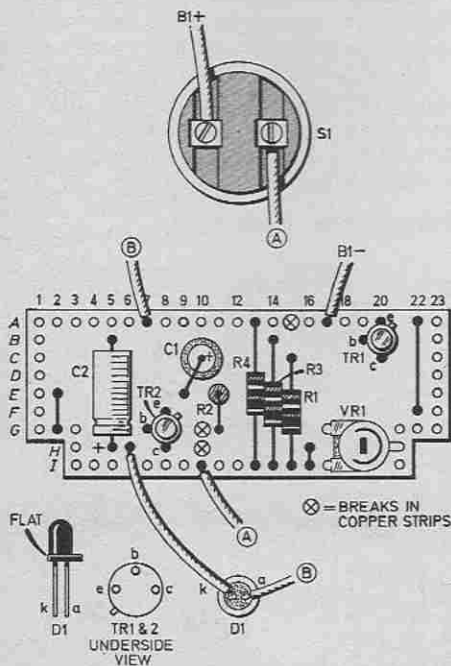
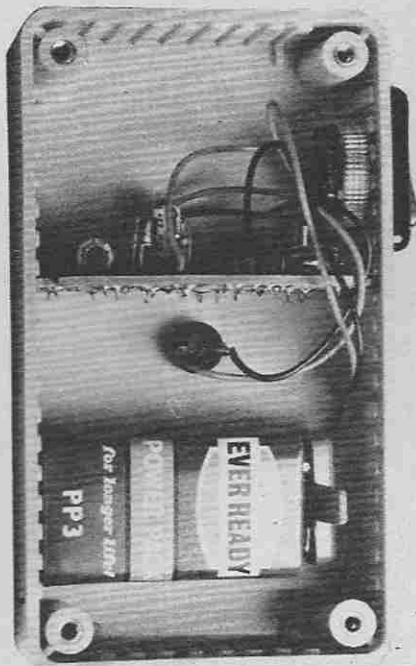
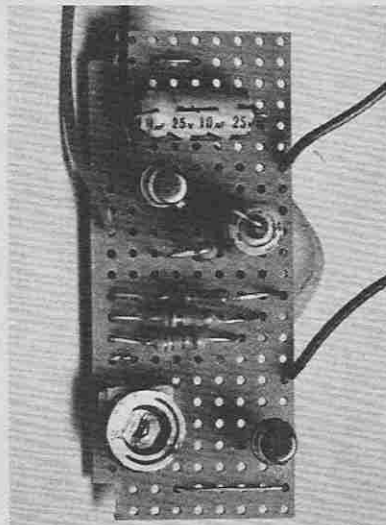

Fig. 2. Complete wiring details for the unit. Take particular care when soldering heat sensitive components, and observe polarity.



The completed prototype with base panel removed.

These dimensions permit the retention of the circuit by the p.c.b. guides moulded within the case. The plastic box used is a Bimbox type BIM2003/13 and it measures 112 x 62 x 31mm, although any similar size can be used.



The component layout on the stripboard.

Construction of the unit will be quite straightforward as seen from Fig. 2, and there should be no problems. Note that 1/4 watt resistors are used throughout; these can be quite heat sensitive (as are the transistors) so take care to use a heat-shunt during soldering. Take care to orientate the transistor leadouts correctly and similarly note the connections to the l.e.d.—the cathode is indicated by the "flat" on the case.

Drill the case to take the l.e.d. mounting clip and the switch. Letter

COMPONENTS

Resistors

- R1 1kΩ
- R2 10kΩ
- R3 22kΩ
- R4 680Ω
- All 1/4W carbon ± 5%

See
**Shop
Talk**

page 426

Potentiometer

- VR1 220kΩ miniature horizontal preset

Capacitors

- C1 10μF 10V elect.
- C2 10μF 10V elect.

Semiconductors

- TR1, 2 BC108 silicon npn (2 off)
- D1 TIL209 red light emitting diode

Miscellaneous

- B1 9V PP3 battery
- S1 s.p.s.t. "Hekla" rocker switch (Maplin)
- Stripboard: 0.1 inch matrix 23 holes x 9 strips; plastic case: Bimbox type BIM2003/13 orange or similar 112 x 62 x 31mm; battery clip to suit B1; mounting clip for D1; lettering as required; connecting wire.

Approx cost Guidance only
£1.50 excluding case

the case as required using proprietary rub-down lettering and then spray the case with a coat or two of clear aerosol lacquer to protect the lettering.

Check the wiring carefully, set VR1 to its midway position and then switch the unit on. The l.e.d. should be flashing at an arbitrary frequency. Unfortunately setting up is rather a trial and error affair, and consists of trimming VR1 until the l.e.d. is illuminating once per second at the desired accuracy.

One method of monitoring the accuracy is to count the number of flashes in 60 seconds, and divide this answer by 60 to obtain the interval between flashes.



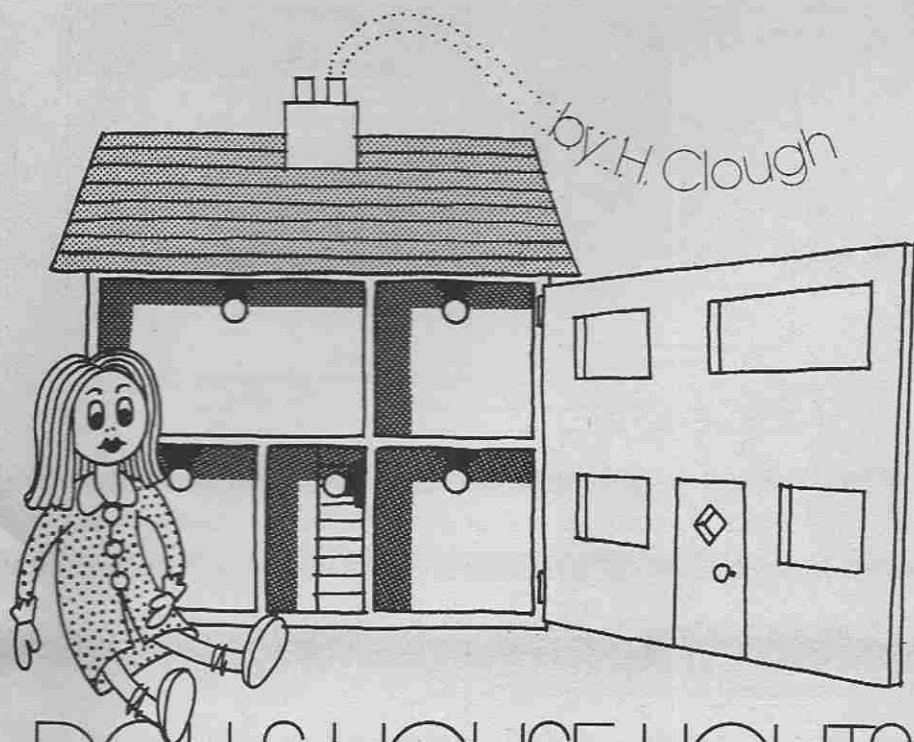

DOLLS HOUSE LIGHTS ECONOMISER

THE SIMPLE project to be described here was originally designed by the author as an automatic time switch for a dolls house lighting system, which will switch off the lights after a preset delay, thus reducing battery drain caused by forgetful children.

The circuit is very easily constructed and should be ideal for the beginner to tackle. There is wide tolerance on the components which can be used, thus the constructor can use components already to hand, thus saving cost.

The circuit can also be used for a variety of uses other than that originally intended, such as a predetermined timer, a games timer, possible uses in the photographic darkroom etc. No doubt other uses will come to mind. It should be remembered however, that the circuit can only control external devices which operate within the voltage and current capabilities of the battery used.

This problem can be overcome by using a relay with an additional set of contacts, which can then be wired into the supply of the external device.

CIRCUIT DESCRIPTION

The complete circuit for the unit appears in Fig. 1 and operates as follows.

Upon closing the on/off switch S1, capacitor C1 is discharged via S1a to earth. The second half of the switch, S1b applies power to the circuit. Current flows through R2 thus switching transistor TR2

on. As TR2 is now turned on current is able to flow thus energising the relay.

The contacts close and apply power to the lights. At the same time, the contacts also provide a hold facility. That is, when S1 is released, the relay is held on via its own contact. Because S1 is a momentary action switch, if the contact was not in circuit, the relay would just switch on and release each time the switch was pressed, and would not maintain power to the circuit. Hence the very simple hold arrangement.

SWITCHING

With the release of S1 the short circuit across the capacitor is removed, C1 thus starts to charge up via R1. When 0.6V is reached, transistor TR1 turns on, and as it does so the collector voltage falls to very nearly zero volts. The normal base bias on TR2 is cut off, and so this transistor turns off. In turning off, the collector voltage rises towards the positive supply.

This action causes the relay to de-energise, the relay contacts open, removing all power from the circuit, including the lights in the dolls house.

The entire cycle may be repeated by a further depression of S1.

The timing components, R1 and C1 have been chosen to give a delay of approximately five to seven minutes, which seems a reasonable time for this particular application. Diode D1 is included to prevent damage to the transistor from back e.m.f. due to the relay de-energising.

Fig. 1. Complete circuit diagram of the Dolls House Timer.

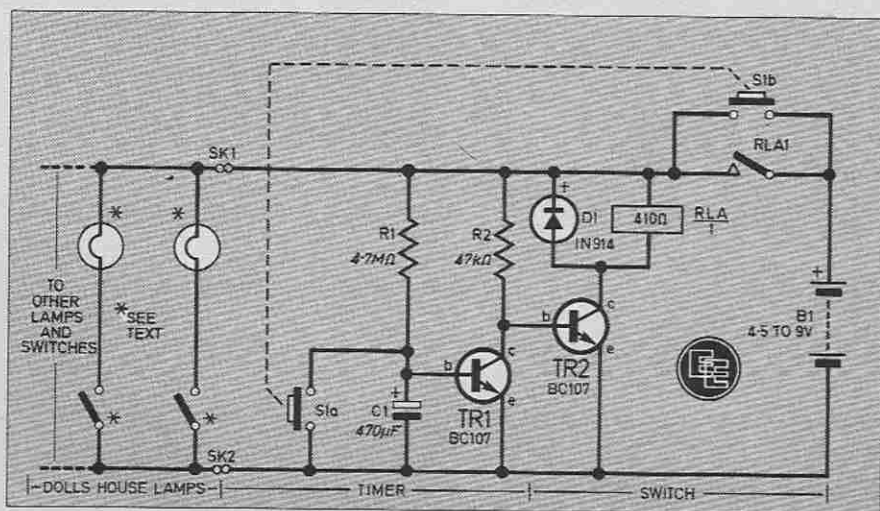

The battery B1 is the normal supply used in the dolls house, and in most instances will be 4.5V. No ratings for the lamps have been given as these should already be existing in the dolls house.

CONSTRUCTION starts here

The entire circuit excluding the switch and relay are mounted on a piece of 0.1 inch matrix stripboard, having 13 strips by 16 holes, and is shown in Fig. 2. There is nothing critical about the layout and could be altered as desired. Remember to observe polarity of the electrolytic capacitor and the correct orientation of the transistors.

The diagram also shows the remainder of the wiring to the relay, the on/off switch, and the battery. A connector block is used to wire the lights to the unit. In some cases very many wires will probably be wired, so it is best to get a large block which will accommodate them easily.

COMPONENTS

Resistors

R1 4.7M Ω

R2 47k Ω

Both $\frac{1}{4}$ W
carbon $\pm 10\%$

See
**Shop
Talk**
page 426

Capacitor

C1 470 μ F 10V elect.

Semiconductors

TR1 BC107 npn silicon

TR2 BC107 npn silicon

D1 1N914 silicon or similar

Miscellaneous

S1 push switch with two normally open contacts

RLA miniature open relay, 410 Ω coil, one make contact (RS 349 125)

B1 See text

SK1, 2 two terminal connector block

Stripboard, 0.1 inch matrix 13 strips by 16 holes; connectors to suit battery; connecting wire.

Approx cost Guidance only
£1.50 excluding case

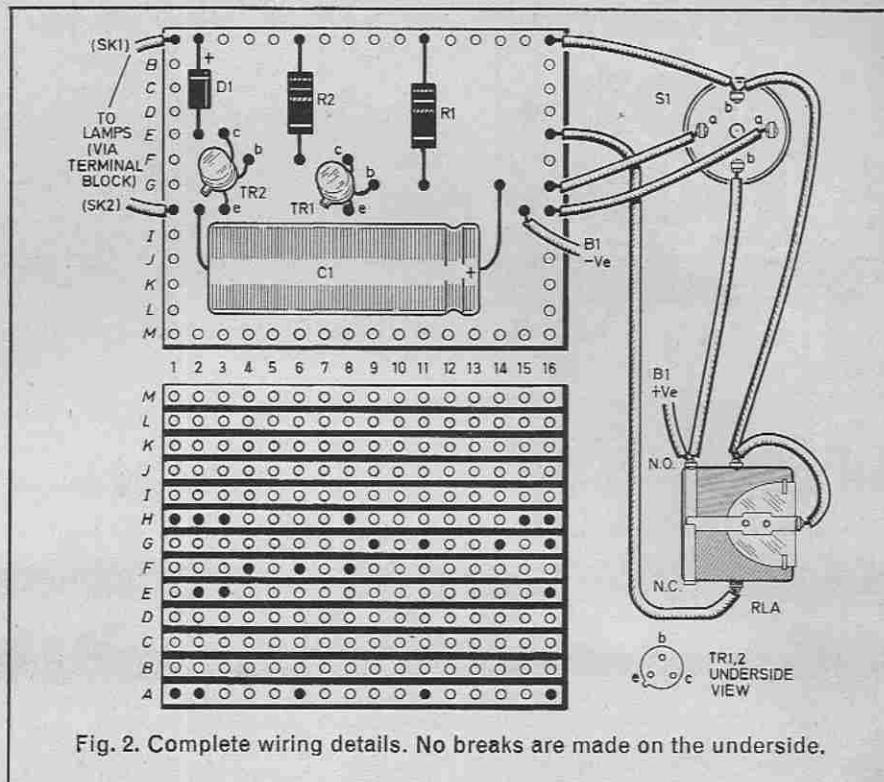

Fig. 2. Complete wiring details. No breaks are made on the underside.

MOUNTING

The overall constructional design of the dolls house will eventually decide where to mount the unit. In the author's arrangement, the unit was mounted under the stairs with the on/off switch projecting through the outer wall.

It is assumed that the dolls house will already have a suitable lighting system, if this is the case then all that is needed is to disconnect the battery and wire the unit between that and the lights. If the existing system has a master on/off switch this should be retained.

If, as might be the case, the dolls house does not have a lighting system, then this will have to be designed by the constructor. A typical system would possibly have three lights upstairs, and four downstairs, possibly with a few small wall lights here and there. Telephone cable can be used for the circuit, running it in the loft space and under carpets.

Each light should have its own on/off switch, with possibly a master controlling all the lights. No doubt the constructor will have his/her own ideas.

IN USE

With the components specified, the delay is about seven minutes.

If it is desired to alter this time then there are two ways of doing so. The first is to change both the values of C1 and R1, the higher the values the longer the delay and vice versa. The second is to use a potentiometer in series with R1. The value can be 2.2 megohms, or some other value as desired. This will then give a fairly wide range of times.

To turn on the lights, S1 is momentarily pressed, this will cause the unit to switch on and apply power to the lights. Individual lights can then be turned on as required. After the predetermined time the relay will de-energise and thus switch off all the lights. If further time is required, then once again S1 is momentarily pressed, whereupon a further time period is started.

In terms of the expense of run-down batteries this small unit will most certainly pay for itself in the course of time. □





By Dave Barrington

Mini Drill

We have been pleasantly surprised by the popularity of the *EE 2020 Tuner Amplifier* project, which, for us was an ambitious undertaking and necessitated the use of printed circuit boards to ease construction for our readers. Also, after reading the special feature on making your own printed circuit boards (January '79 issue) many readers are now attempting to make their own boards.

Due to the large size and component density of the boards the most time consuming item is the drilling of the wiring and component locating holes. To this end, we should like to recommend the miniature Bimdrill from Boss Industrial Mouldings.

The mains powered Bimdrill with collets and tommy bar.



The Bimdrill is mains powered and housed in a fully insulated bright orange ABS body. The drill weighs only 250 grams and has an off-load speed of approximately 7500 r.p.m.

The drill is fitted with 2 metres of two core mains cable terminated in a moulded 2-pin DIN plug. The on/off rocker switch is neatly recessed at the top of the body. A tommy bar and three collets are supplied which enable drill bits with shanks of 1mm, 2mm and 0.125 inch diameter to be used and is ideal for work on s.r.b.p. and Fibre-

glass p.c.b.s., as well as steel, aluminium and brass.

The Bimdrill can be obtained direct from the manufacturers, Boss Industrial Mouldings Ltd., Dept. EE, Higgins Industrial Estate, 2 Herne Hill Road, London SE24 0AU. The cost including VAT and post and packing is £10.53.

Also, the more comprehensive Bimdrill Mk2, having four collets and twenty other tools (drills, grinders, polishers, etc.), and housed in a carrying/presentation case is available for £22.14 inclusive.

New Premises

With the need to keep updating and adding to their already large range of "off-the-shelf" components and equipment, Marshall's have just moved their Bristol branch to new premises.

The new retail shop is larger than their old shop and is situated only five minutes walk from the main shopping centre of Bristol at: 108A Stoke's Croft, Bristol.

Readers presently engaged in teletext experiments may be interested to learn that Marshall's have been appointed sole distributor for the amateur market for the new Mullard series SAA 5000 teletext "chips".

Mainline Amplifiers

The entire stock of Mainline Electronics Ltd., previously of Windsor and Slough, has been acquired by Arrow Electronics.

The Mainline audio equipment spares will also be available from Arrow and it is contemplated that production of the Mainline amplifier will be continued, as it is proposed to merge this production with their existing "Leader" range of kits.

CONSTRUCTIONAL PROJECTS

Soldering Iron Bit Saver

All components for the *Soldering Iron Bit Saver* should be readily available but two components require special mention.

The first is the transformer. The type used in the prototype allowed fixing directly onto the circuit board. This is by no means an essential requirement, but if preferred, care must be exercised in choosing this component. The type used in the prototype was obtained from Maplin and specified in their catalogue as MIN TR6V, Cat. No. WB06G.

The relay is the other component. The circuit requires one with one normally closed set of contacts capable of handling mains voltages. The prototype used a type having two sets of changeover contacts and one of the spare contact tags used as an anchor point for flying leads. This anchor point could be transposed to a spare

strip on the circuit board if a single contact relay is obtained.

Darkroom Timer

No problem's should be encountered in obtaining the components for our very simple project this month the *Darkroom Timer*. An attractive low profile single nut fixing rocker switch was employed in the prototype to enhance the appearance and is available from Maplin. This can be replaced by any other switch available. The case is available from the manufacturers, Boss Industrial Mouldings, address elsewhere in this page.

Conference Timer

The *Conference Timer* has the largest component count of all the projects appearing this month and most should be readily obtainable.

Six-core cable is required for connecting to the extension indicators. This may be difficult to locate and 8-core cable may have to be used. In fact 8-core screened was used by the author. A cheaper alternative may be to use a double length of 3-core mains cable or even a triple length of twin-core bell wire.

There are many multipin plugs/sockets available from the numerous component suppliers. The types used in the prototype were from RS Components under QM multipole connectors. You cannot buy direct from them but your local electronic or T.V. service shop will be able to obtain them for you. Alternatively, screw fixing terminal blocks are suitable and will certainly be much cheaper.

OBITUARY

DAVID COHEN

David Cohen, proprietor of Radio and TV Components (Acton), died in April after a short illness, age 64.

One of the longest in the retail component trade and one of its colourful characters, David Cohen started his first business during the 'thirties when only 16 years old in a Birmingham shop, charging accumulators and supplying receiver kits and components.

During the 1939-1945 war he was employed on Government work at EMI Hayes. In 1945 he started up again on his own, dealing in the then prolific war surplus market of electronic equipment. His success, based on long experience in the radio field and an acute business flair, led to the establishment of Radio and TV Components at Acton, West London, in 1958.

The business, which includes a retail shop in Edgware Road, London, is now managed by David's son, Leslie Cohen.

We offer our condolence to Mrs. Cohen and family at their sad and unexpected loss.

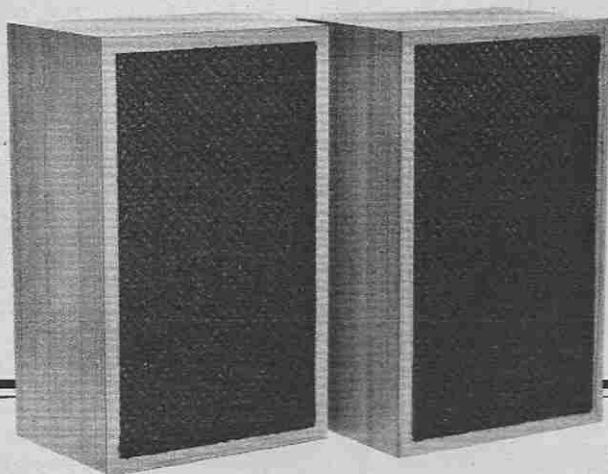

WITH THE EE2020 IN MIND—
THE FIRST OF TWO QUALITY LOUD-
SPEAKER SYSTEMS*

BY R. F. STEPHENS

ee20 loudspeaker

THIS article describes the construction of an inexpensive two-way loudspeaker system. Whilst primarily intended for use with the *Everyday Electronics* 2020 Tuner Amplifier, this speaker will give good results with any amplifier delivering an output of 15-20 watts (into 8 ohms) per channel.

Surprisingly good results can be obtained with quite inexpensive speaker drive units if sufficient care is devoted to such things as enclosure and crossover network design.

DESIGN CONSIDERATIONS

The first decisions to be made in designing a loudspeaker system are fairly obvious: power handling? price? size?

The power handling decision was already made—at least 20 watts r.m.s. to suit the 2020 Tuner Amplifier. Price?—well as this loudspeaker design puts the accent on economy, £25 or so seemed a reasonable target for the drive units and crossover components (for a stereo pair).

Size? Every loudspeaker design is the sum of many compromises. A small cabinet may be economical in its material requirements, but it does impose two restrictions (which are inter-related): poor sensitivity and restricted bass response. On the plus side, a compact cabinet has small and rigid panels which give little trouble from panel resonances and subsequent colouration.

SPECIFICATION

Infinite baffle speaker enclosure:
Dimensions: 508 × 305 × 228mm
Drive units: 8 inch bass, 3 inch tweeter
Frequency range: ±3dB 50Hz to 19kHz
Crossover frequency: 4,000Hz
Impedance: 8 ohms
Amplifier output: up to 30W

* This is strictly an "optimum-value-for-money" design. Later we shall describe an up-market three-way system in the £150 bracket.

An 8-inch bass drive unit seemed to offer the best compromise of bass response, power handling and cost, and this in turn goes a long way towards determining the compromises of cabinet size and type of cabinet loading.

Reflex loading ("vented" or "ported" enclosure) has its attractions as a means of extending the bass response from a given size of cabinet, but as it was desired to give some flexibility in the method of construction (more of that later) it seemed prudent to opt for a simple infinite baffle, that is, a completely sealed enclosure.

THE DRIVE UNIT

In practice, finding a suitable bass drive unit was easier said than done—most 8-inch bass units

seemed to fit into one of two categories: "hi-fi and expensive" on the one hand, and "low-fi and nasty" on the other.

Eventually Electro Acoustic Industries Limited agreed to make a unit specifically for this design at a very reasonable price. This, known as model 8NC367, is a paper-coned unit with a roll surround and a hefty 12,000 gauss magnet.

This bass unit matches the Elac 3-inch cone tweeter for sensitivity and whilst a dome type may have given a slight improvement in quality, the extra cost of the dome tweeter would have increased the cost of the system by some 50 per cent.

THE ENCLOSURE

The cabinet dimensions chosen were 508 × 305 × 228mm (external). The enclosure may therefore be described as large bookshelf/small floorstanding. This would give acceptable bass response with a suitable bass unit and is a domestically convenient size.

The prototype cabinets were constructed from 18mm chipboard and lined with laminated bituminous felt panels of 13mm thickness.

The object of the felt panels is to stiffen the cabinet panels so making it less likely that these resonances will be excited by the frequencies produced by the bass unit.

The home constructor who has wood offcuts lying about his workshop can use these to obtain much the same results as are achieved with the felt panels. The cabinet should be lined with the offcuts of plywood or chipboard securely glued and screwed to all the inside surfaces of the cabinet (except the baffle board). In the diagrams the dimensions given for the cabinet assume the 13mm felt panels are used to line 18mm chipboard or plywood.

The case dimensions should be adjusted accordingly if material of a different thickness is used to line the cabinets.

Conventional loudspeakers which have large cabinet panels which are undamped and unbraced can actually generate more sound from the cabinet panels (cabinet sides and back, generally) at certain frequencies than is generated by the speaker drive units themselves. This is obviously an unsatisfactory state of affairs as it adds a high level of undesirable colouration to the sound produced.

Rigid, well constructed cabinets are therefore essential for anything approaching "hi fi" results.



CABINET CONSTRUCTION

Full details of the enclosure appear in Fig. 1.

The front and back frame external dimensions correspond with internal dimensions of the case. These frames are fitted flush with edges of case and glued and pinned, or screwed, in position.

If speaker grille fabric is to be used for the frontal trim, a grille panel of 10 or 12mm plywood is necessary. The grille fabric is glued or stapled to the back of the panel (see drawing). Velcro hook-and-loop tape provides a simple method of fixing the grill panel to the cabinet.

An alternative trim is possible with "acoustically transparent" (reticulated) foam. This does not require a supporting frame and can be fixed with "single-sided"

COMPONENTS and MATERIALS

Resistors

R1 10 Ω 5W wirewound, ceramic insulated

Capacitors

C1 4 μ F }
 C2 4 μ F } reversible electrolytics, 50V ("Elcap")
 C3 10 μ F }

Inductors

L1, 2 (2 off) 0.6 μ H ferrite cored

Loudspeakers

LS1 3 inch tweeter unit Elac TW3/04
 LS2 8 inch drive unit Elac 8NC367

Miscellaneous

Stripboard or p.c.b. Two ty-raps (for L1, 2). 1 sq. yd. 10 oz Acoustilux BAF wadding. 8 "T" nuts and bolts. 8 laminated bituminous felt panels (or offcuts of plywood or chipboard). Chipboard and plywood for cabinet—see Fig. 1.

All the above items (except wood) are obtainable from Wilmslow Audio Limited, Swan Works, Bank Square, Wilmslow, Cheshire, who also offer a Kit for two enclosures, comprising:

2 Elac 8NC367, 2 Elac TW3/04, and 2 crossover kits (with p.c.b.'s). Price £26.50 inclusive of VAT, but plus £2.50 carriage.

or including the laminated bituminous felt panels, Acoustilux BAF wadding and "T" nuts and bolts for £35 plus £5 carriage.

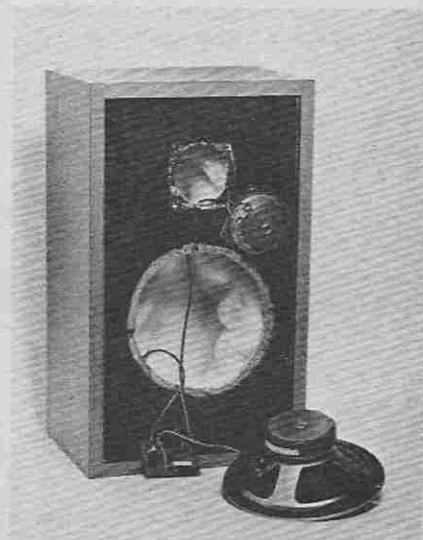
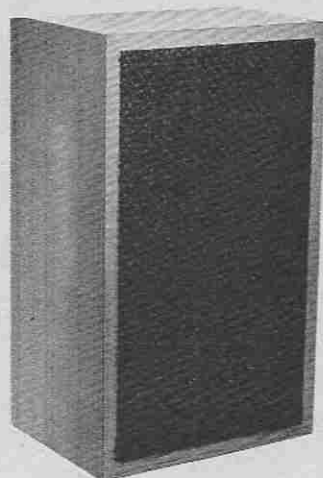

The three photographs on the right show (top) the completed EE20 Loudspeaker, (centre) before grille panel fitted and (bottom) speaker units and crossover unit wired up before being secured to enclosure; the Acoustilux wadding lining can also be seen.

Velcro. This is similar to the hook half of the familiar hook-and-loop type, but with larger hooks which fit directly into the holes in the reticulated foam.

ee20 loudspeaker enclosure

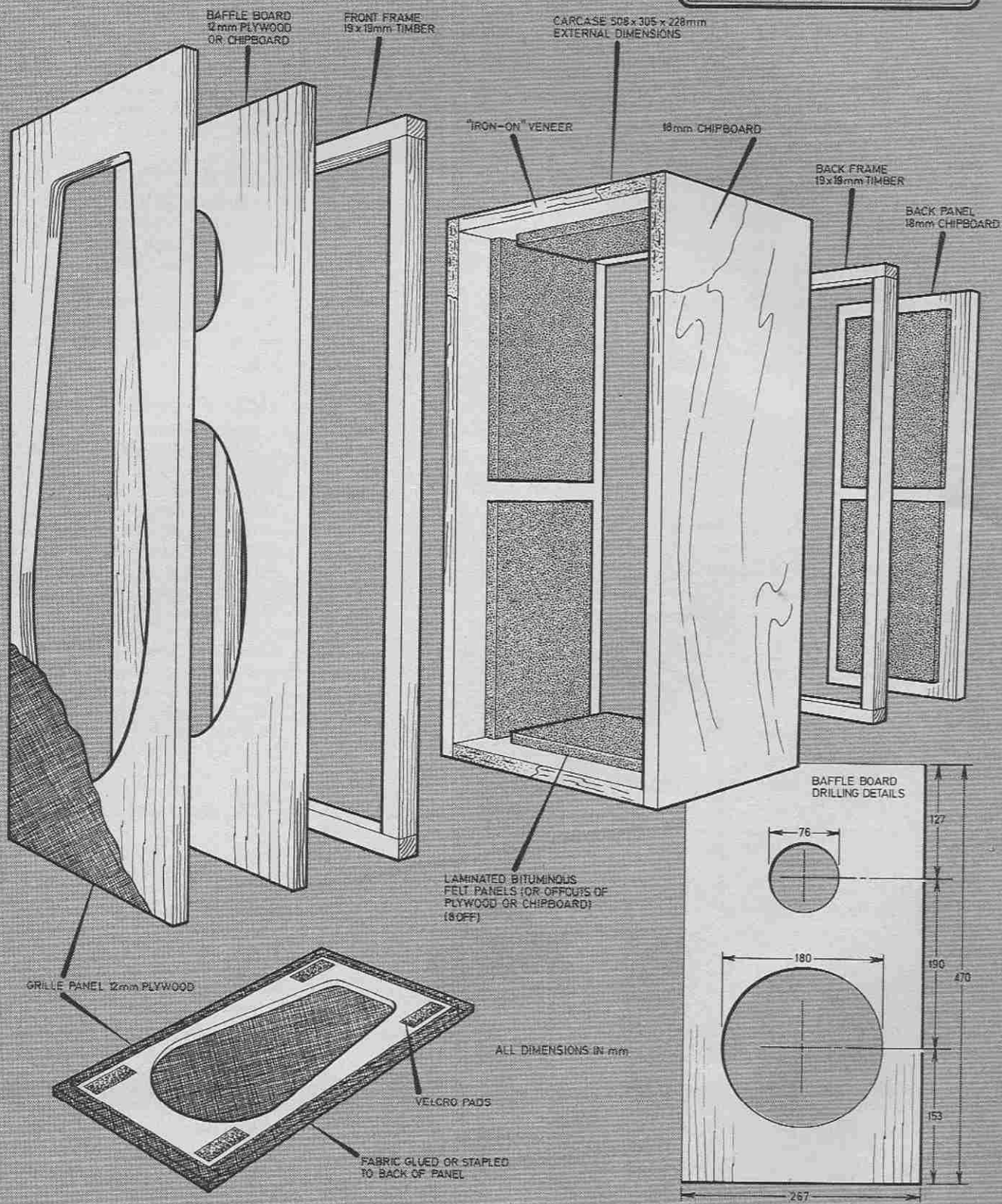

Fig. 1. Construction details of the EE20 Loudspeaker Enclosure.

Both drive units are fitted from the front of the baffle board so that both baffle board and cabinet back can be fixed permanently in place after the cabinet has been lined with the felt panels (or wood offcuts) and the crossover network fastened in the bottom of the cabinet. The cabinet is then lined

with BAF wadding which can be inserted through the bass unit aperture in the baffle board. The drive units are fixed with "T" nuts and bolts.

Sufficient glue should be used in all joints to ensure an airtight seal. Remember that no one is likely to see the surplus glue that squeezes

out inside the cabinet! The actual method of cabinet construction is dependent on the skill of the constructor and the workshop facilities available. The exploded view illustrates the simplest "butt jointed and battened" construction, but mitred corners or tongue and groove joints are possible if the necessary facilities are available.

CABINET FINISH

The kind of finish applied to the cabinet is a matter for personal preference and really outside the scope of this article. The author has obtained very good results with "iron-on" veneer, but there are many Formica, cork and hessian finishes which could be used.

THE CROSSOVER NETWORK

The crossover network, which integrates the response of the bass and treble units is a very important part of a loudspeaker system. The crossover frequency and rates of roll-off chosen should complement the response of the drive units so that the overall result is a "flat" response curve from the whole speaker system.

A nominal 4,000Hz crossover point was chosen as this is a good octave away from any irregularities in the top-end response of the bass unit and similarly an octave up from the effective "bottom-end" response of the treble unit, Fig. 5.

Standard, easily available, component values are used in the 12dB/Octave network, Fig. 2. C1 and L1 form a high-pass filter which feeds the tweeter drive unit LS1. A low-pass filter, L2, C2, feeds the bass drive unit LS2. The additional components R1 and C3 are for the purpose of reshaping the curve in the important midrange region, as will be seen from the accompanying curve, Fig. 6.

The crossover is simple enough to assemble onto a piece of strip-board (Veroboard), however, a printed circuit is provided in this article, see Fig. 4. The one important fact to remember when assembling these components is that the two inductors L1 and L2 are mounted with their axes at right angles to each other.

Secure the board to the base of the cabinet, and then wire up to the loudspeakers in accordance with Fig. 2.

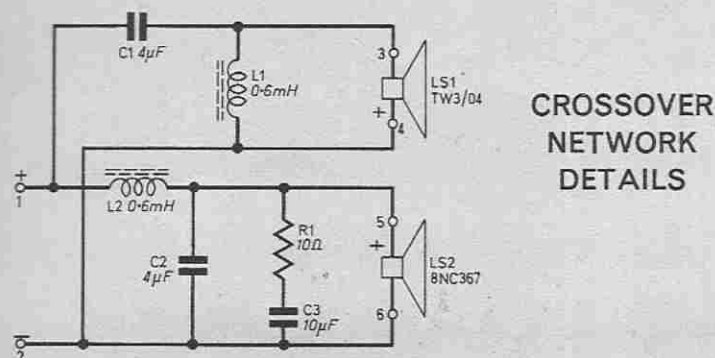

Fig. 2. Circuit of the EE20 crossover network.

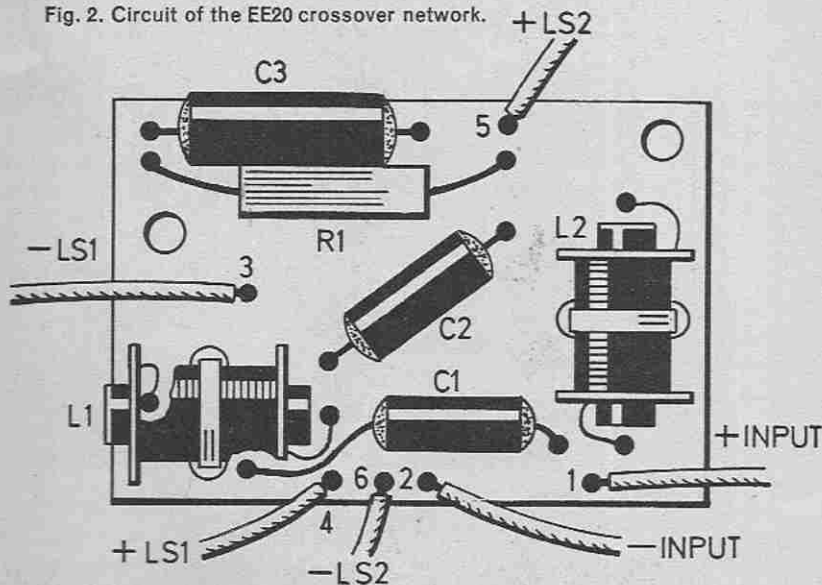

Fig. 3. Component arrangement on p.c.b.

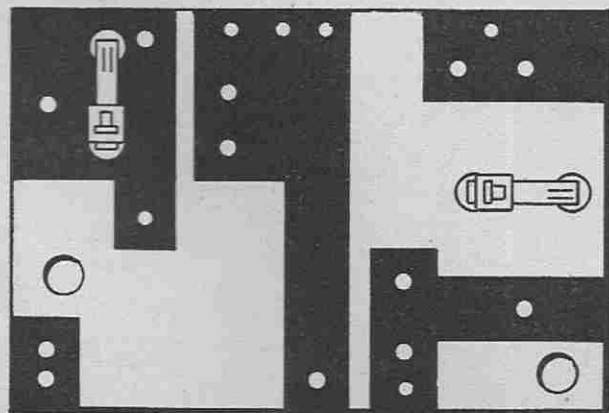

Fig. 4. Printed circuit for crossover network.

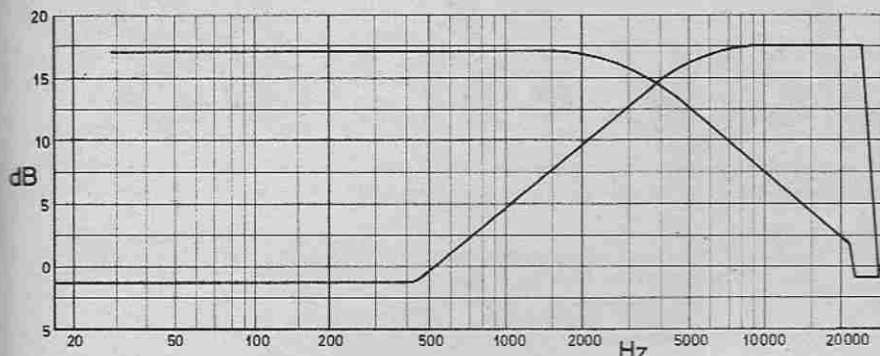

Fig. 5. Crossover network characteristics.

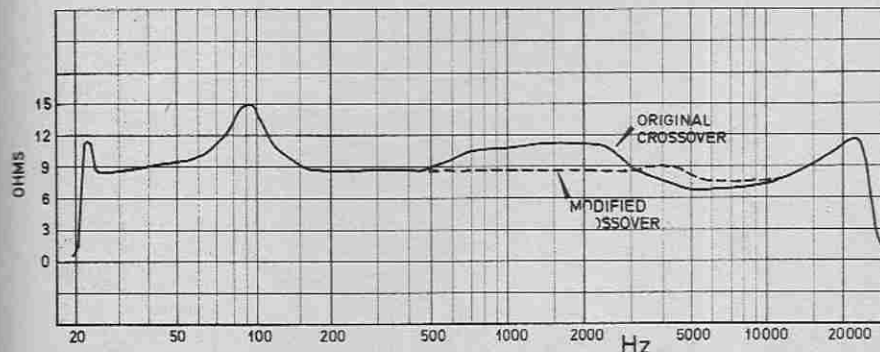

Fig. 6. Impedance/Frequency curve showing effect of equalising network.

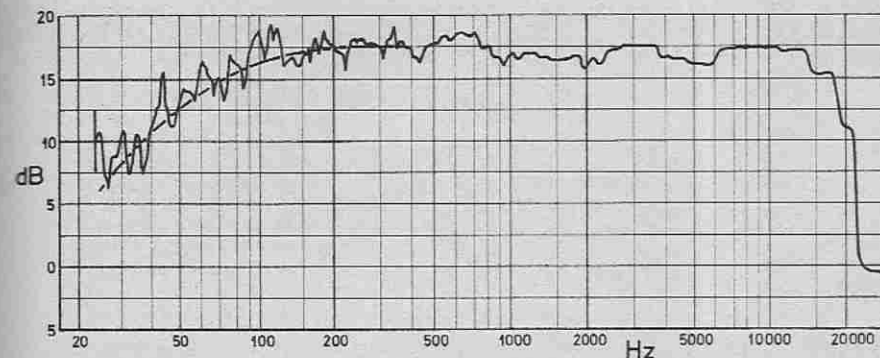

Fig. 7. Frequency response of EE20 Speaker System.

CONNECTING THE SPEAKERS

There are several types of connectors on the market suitable for use on loudspeaker cabinets. Screw terminals, recessed panels fitted with DIN or 4mm sockets, and spring-loaded connectors are three popular alternatives. Mark the terminals "+" and "-" to correspond with the connections made to the crossover unit.

The speaker leads should be of reasonable conductor size, particularly if the amplifier is sited some distance from the speakers—say 0.75 sq mm. Two-core 6A flexible mains cable, with 24/0.2mm conductors, will meet this requirement.

USING THE SPEAKERS

The EE2020 loudspeaker system produces 90dB for 1 watt at 1 metre. This means that under normal domestic conditions it will be possible to achieve whatever sound pressure level is required well within the amplifiers rated output.

Best results will be obtained, generally, with the base of the enclosures about 330 to 500mm from the ground. Using the speakers placed directly on the floor will increase the apparent bass output, as also will placing a speaker near to a side wall.

As with any stereo loudspeakers it is worthwhile spending some time and trouble in siting the pair of enclosures to give:

1. The best stereo image.
2. The best (not the boomiest!) bass response.
3. The least interference from room resonances.



Everyday News

MICROS FOR THE HANDICAPPED

ONCE AGAIN another area where microprocessors are improving the well being of today's society, without creating any redundancies, is highlighted by a new aid for speech-handicapped persons.

Combining the words "speech" and "link", "Splink" is the name of a new electronic system designed to bridge the communication gap between the speech-handicapped, the deaf and their families and friends.

Activated by a microprocessor, it consists of a keyboard alphabetically printed with 950 of our most commonly used words. The user has merely to depress the required words on a keyboard and build them into sentences which immediately appear on an ordinary domestic television screen linked to the unit by the aerial socket.



Initial letters on the keyboard make it possible to build any word or name desired and some of the keys short-circuit the process by automatically printing out such basic phrases as "I want a", "Can you tell me?" and "What did you say?".

Invented by a Woking doctor, Splink has been developed with a view to commercial production by the Queen's Award-winning firm, Medelec Ltd, of Woking, who manufacture highly specialised electronic medical equipment.

Clinical trials have proved the practical usefulness of Splink and families which have had pilot systems on loan for experimental purposes have confessed to feeling lost after returning them.

QUEEN'S AWARD

Among the winners of this year's Queen's Awards for Export Achievement and Technological Achievement is a joint award to BDH Chemicals Ltd, the Solid State Physics & Devices Dept, of the Royal Signals and Radar Establishment and the Department of Chemistry of Hull University.

The award is for outstanding work in research, development and now large scale commercial production of liquid crystals for digital displays in calculators, watches, etc. BDH Chemicals is currently exporting 98 per cent of production, almost all to Japan and the US.

Britain is now claimed to be the world leader in liquid crystal technology.

A £100,000 order for a computerised print composing system has been placed by Waterlow (Dunstable) Ltd., with Ferranti for the C570-20 system.

The system is based on an Argus 700G minicomputer and will be linked to a Linotron 404 phototypesetter.

MPU car seat

For the motorist who has nearly everything, a programmed seat-adjuster should have appeal. A system developed by National Semiconductor and Recaro allows driving seat rake, height, backrest and other parameters to be motor driven to suit the physique of the driver.

Once the best position is programmed in, it is held in a memory. Positions for two different drivers can also be stored.

STOP THIEF!

Electronic tagging of merchandise is expected to reduce the £650 million worth of goods per year lost to British retailers through shoplifting. A system developed by Parmeko of Leicester raises an alarm if the electronic tag has not been removed by the shop assistant using a special tool at the time of purchase.

All customers leave the store through concealed detection zones and a shoplifter carrying a tagged item is immediately detected. The special tags which re-radiate a signal in the detection zones are, of course, reusable.

A system to protect, say, 6,000 garments would cost the store some £7,000 but could quickly repay its initial cost.

CRIME DETECTION BREAKTHROUGH

The latest crime detection aid is searching for fingerprints undetectable by present methods by using a laser beam. The new technique, developed by Control Laser Corporation of Orlando, Florida, is said to be so sensitive that it can detect fingerprints on human skin, thus opening up the possibility of discovering a murderer in a case of strangulation or other bodily assault.

MULTI-SCOPE

A new oscilloscope from Tektronix has a built-in auto-ranging digital multimeter. The scope is dual-trace with 5MHz bandwidth and the DMM has 12 ranges of d.c., a.c. and resistance measurement. It is fully portable, battery-operated and designed for the field service engineer.

GIGA VALVES

The thermionic valve is not dead though severely maimed by its modern semiconductor successor. The Mullard Valve factory, recently celebrating its 40th anniversary, claimed that over the period of its history in Blackburn it has produced 1,000 million of them.

Export to Japan

ITT Semiconductors, Footscray, expects to sell more than £5 million worth of devices to the Far East this year with 80 per cent going to Japan. Products in demand are ITT's range of i.c.s for TV applications and 4K and 16K random access memories.

IRISH MPU

The US Mostek Corporation is setting up a manufacturing unit for i.c., memories and MPUs, at Blanchardstown, near Dublin. Eventually about 1,100 jobs will be created. It is expected that most of the output of the new plant will be exported to Europe.



ANALYSIS

WIND OF CHANGE

Once upon a time the electronic hobbyist was a true home constructor, winding his own coils and transformers and wire-wound resistors, fabricating his breadboards and panels out of plywood or ebonite, perhaps even making his own wet-cell batteries although, of course, the thermionic valve was beyond his capabilities.

In the modern world of specialisation we have all become assemblers, even buying in our matrix board and ready-made panels and enclosures. There is nothing wrong in this. Mass production has provided us with a rich supply of components better and cheaper than we could make ourselves and our home projects today have a professional touch.

The same pattern can be seen in the electronics industry. The equipment manufacturer may also be a circuit designer but basically he is still an assembler of components bought from specialist component firms. So, traditionally, there has always been a fairly well-defined demarcation between firms supplying the end-user with completed equipment and firms supplying the equipment people with components. Altogether a nice business relationship with each depending on the other to make a living.

Over the past few years there has been a wind of change, at first a gentle breeze but now approaching gale force, which is threatening to destroy the once-happy balance in the industry structure.

It all started with the integrated circuit and the wind of change has accelerated with VLSI and, most notably, the microprocessor. The equipment firm used to design the circuit and wire up all the components. Today, quite a few semiconductor manufacturers (i.e. component companies) have MPUs emerging from their factories which are as operationally powerful as some of the mid-range mini-computers built by equipment companies.

There is, of course, no law determining who sells what to whom in an open market and so it is quite logical for the MPU manufacturer to sell his systems direct to the end user rather than through an intermediate manufacturer and this is now happening.

But another important factor also comes into play and this is that the pace-setters in the technology are the semiconductor manufacturers themselves so they have the advantage of technical edge, at least for the time being. The computer manufacturers are fighting back by setting up their own semiconductor research units in an attempt to gain technical independence.

It is difficult to foresee how the new pattern of trade will evolve over the next year or two. Fortunately the data processing market is still expanding at a rate sufficient to absorb new entrants and the "war" is more a matter of reconnaissance and small-scale infiltration by the MPU makers rather than full frontal assault. **Brian G. Peck.**

A fold-away 50-inch screen and a colour picture said to be viewable in ordinary daylight by up to 100 people at a time, is the latest TV set offering from Mitsubishi. The UK selling price is to be about £3,500.

Britain's first electronic telephone exchange to be produced on a commercial scale, the TXE2, celebrated its thousandth installation in

the UK at Hagley, West Midlands. The TXE2, built by Plessey, has also enjoyed export successes.

Citizen's Band Radio is still big business. South Korea is now the world's largest manufacturer of CB sets after the USA and Japan despite the fact that CB is illegal in South Korea. This disproves the theory that a strong home market is essential for business success.

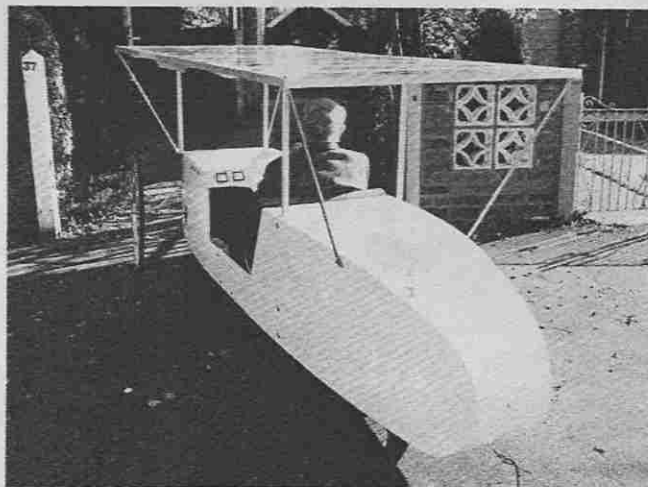

SOLAR POWER

The instrumentation for an experimental vehicle powered by solar energy is provided by the new 440 series of meters from Ernest Turner Instruments.

The car (above), capable of 15 m.p.h. was designed and built as a private research project by Mr. Alan Freeman of Rugby and is driven by a 120W permanent magnet motor with power derived from a canopy of Solar cells.

CLUB NEWS

BAEC

The next get together of the British Amateur Electronics Club will be at their 14th annual Exhibition, at the Shelter, The Esplanade, Penarth, South Glamorgan, from July 21 to 28.

On show will be members' constructional projects and all proceeds from the exhibition will be donated to the Cancer Research Campaign.

SYPCG

News this month of a computer club in South Yorkshire formed to cater for the growing interest in do-it-yourself home computing.

Known as the South Yorkshire Personal Computing Group (SYPCG), the initial programme of events is to meet on the second Wednesday in every month at The Central Engineering Lecture Theatre, Floor D, St George's Building, University of Sheffield, St George's Square, Sheffield 1.

At each meeting a person will take along and give a profile of some computing equipment; there will also be a short talk on a specialist topic followed by an open

forum/discussion, part of which will be a computing problem solving session.

Readers who would like further information on the SYPCG should write to: Mr. T. Rycroft, SYPCG Secretary, 88 Spinneyfield, Moorgate, Rotherham, S. Yorks.

COURSES

Two one-day courses on microprocessors are being held at the University of Salford this month. They are "Industry and the Microprocessor" on June 28 (cost £35) and "Fundamentals of Microprocessors" on June 29 (cost £55).

The first course is a general awareness teach-in for non-technical managers and the second is a review of the basic principles of digital systems and microprocessor architecture, including "hands-on" sessions.

The two courses together can be attended for a reduced fee of £80 and further information is obtainable from the Administrative Assistant (Short Courses), Room 110, University of Salford, Salford M5 4WT.

RADIO WORLD

By Pat Hawker, G3VA

Broadcasting and Short Waves

REGULAR listening to world-wide broadcast stations on "short waves" (h.f.) between 3 and 30MHz is something which appeals in the main (at least in the UK) to a rather special type of enthusiast whose numbers have never been large by broadcasting standards. Many of these listeners are far more interested in identifying and "logging" distant or unusual or low-power stations than in the information or entertainment content of the programmes.

One could quote a variety of reasons why this should be the case: the great difficulty on h.f. of tuning the run-of-the-mill "all-band" domestic receiver to a specific frequency; the impossibility of remembering all the many frequencies; the loss of interest among most radio amateurs due to their use of "amateur-bands-only" communications receivers; receiver-performance problems of "image" and other spurious responses, as well as oscillator drift; the need for an effective outdoor aerial to achieve good results; the deep fading and consequent distortion; above all, the complexity and difficulty of understanding the constantly changing propagation conditions and the need to change bands at different times of the day and night which the average listener finds quite baffling.

Finding and holding a programme you want on short-waves has undoubtedly always needed a degree of skill and expertise and the cultivation of "safecracker's fingers" for tuning.

On the other hand, there are of course the expatriates who are prepared to learn the tricks of h.f. in order to keep in touch with their home countries, and the many listeners in tropical countries where static ruins medium-wave reception and distances are often too great for v.h.f./f.m.

H.F. Stations

There are now thousands of h.f. broadcasting stations hopefully spraying powerful signals to all parts of the world, largely funded by governments and religious organisations and motivated by the wish to achieve national prestige, to convert listeners to particular ideologies or religions, or occasionally for commercial purposes (how many listeners recall the "commercials" on American short-wave

broadcast stations for a period before the "Voice of America"?). Some provide excellent programmes but at the same time they have helped to reduce large portions of the h.f. spectrum to a shambles, due to attracting the "jammers".

Will it always be so? There is an increasing range of general-coverage receivers now available, including a number with ingenious "triple-mix" tuning systems and some with digital frequency readout that make it easy to tune to any required frequency and provide the necessary sensitivity and selectivity, although mostly at a cost appreciably higher than what the average listener has been used to paying for a broadcast set. In effect these are virtually "communications receivers" and have already led to something approaching a boom in short-wave listening in Japan.

Clearly someone who feels there is an increasing interest in short-wave listening is Mitch Murray who has recently brought out a long-playing disc *Long Live Short Wave!* (Trans-Island Productions Ltd, P.O. Box 24, Douglas, Isle of Man). One side of this record is devoted to useful advice on short-wave listening as a hobby, including a short section by Henry Hatch, G2CBB whom many enthusiasts will know from his regular participation in the BBC's *World Radio Club* programmes (0745 G.M.T. Sundays, 1115 G.M.T. Mondays, 2100 G.M.T. Tuesdays and 2315 G.M.T. Wednesdays on BBC World Service).

The other side of this record consists of tapes explaining and helping to identify a number of the h.f. broadcast services. In my view the most useful items are those which cannot be effectively described in print, such as the identification not only of broadcast stations but of various types of communications signals such as radio teleprinter and facsimile signals, and how to tune stations using single-sideband.

But here again one feels that Mitch Murray is aiming his record at those who have already caught the bug and may only confirm to the majority of broadcast listeners that this is a hobby of undoubted fascination to the initiated but something quite apart from normal entertainment radio.

I must admit to having rather jaundiced views about the large demands which are being put forward, with an

eye to the World Administrative Radio Conference this September, for a vast increase in frequencies for h.f. broadcasting, including the use by European stations of the bands normally reserved for "tropical" use only.

As I have written elsewhere: "Broadcasters and governments must come to grips with one simple, overwhelming fact of life—much of the present mess in radio allocations is due to expanding external broadcasting, while pretending this does not affect domestic broadcasting and other services: such a policy is possible only by allotting more and more of the precious frequencies to broadcasting at the expense of other services."

The Museum Amateur Stations

For many people, the first time they ever see an "amateur radio station" is the impressive GB2SM installation at the Science Museum in Kensington, London where the number of visitors exceeds a million a year. Sometimes, I must admit, I do wonder whether the very elaborate set-up may tend to suggest to some of the visitors that amateur radio must be an excessively expensive hobby. This in fact need not be the case (my own present equipment on which I can work the world cost me well under £100). But GB2SM has undoubtedly for many years set an example for other museums to follow.

I occasionally hear, for example, NN3SI, the amateur station established a few years ago at the Smithsonian Institution's National Museum of Technology in Washington, DC, USA. When I visited this station a couple of years ago, it included a pretty full complement of the latest American and Japanese h.f. and v.h.f. equipment. The station is manned by volunteer operators from the Washington area. There are two operating consoles, one for h.f. and the other for v.h.f., with an impressive h.f. rotary beam on the roof.

The latest museum station is VK2-BQK at the Museum of Applied Arts and Sciences, Sydney, Australia. This has a number of Yaesu h.f. and v.h.f. transceivers and an FRG7 general purpose h.f. receiver donated by the Dick Smith Electronics Group. Over 300,000 people visit the museum annually and the Australian amateurs believe that the new station will help recruit more enthusiasts to the hobby as well as educating the public generally about radio communication.

THREE FOR FREE FROM CSC

ELECTRONICS BY NUMBERS
FREE PROJECTS
No 1, No 2,
& No 3.

ELECTRONICS BY NUMBERS

LED BAR GRAPH UNIVERSAL INDICATOR

Now using **EXPERIMENTOR BREADBOARDS** and following the instructions in "Electronics by numbers" ANYBODY can build electronic projects.

Look at the diagram and select R1, this is a resistor with a value between 120 to 270 ohm. Plug it into holes X20 and D20, now take LED 1 and plug it into holes E20 and F20. Do the same with the Diodes e.g. plug D7 into holes G7 and G10.

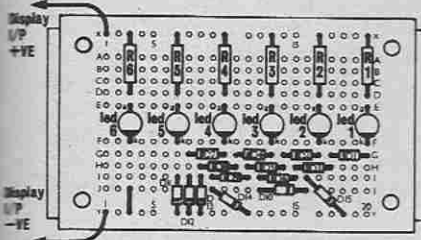

YOU WILL NEED

EXP. ANY EXPERIMENTOR BREADBOARD

D1 to D15 - Silicon Diodes (such as 1N914)
R1 to R6 - From 120-270 ohm resistors ¼ watt.

LED1 to LED6 - Light emitting diodes.

LED BAR GRAPHS are replacing analogue meters as voltage-level indicators in many instances.

This circuit uses the forward voltage drop of diodes to determine how many LEDs light up. Any type of diode can be used but you must use all the same type. For full working details of this circuit fill in the coupon.

If you have already built the Two-transistor Radio and the Fish'n'cliks projects you will find that you can reuse the components from these projects to build other projects in the series.

FILL IN THE COUPON AND WE WILL SEND YOU FREE OF CHARGE FULL COPIES OF "ELECTRONICS BY NUMBERS" PROJECTS No 1, No 2 and No 3.

PROTO-CLIP TEST CLIPS.

Brings IC leads up from crowded PC boards. Available plain or with cable with clips at one or both ends.

PC - 16 pin. £2.75.

PC - 16 pin with cable. £6.00.

PC - 16 with cable and 16 pin clips at both ends. £10.25.



CONTINENTAL SPECIALTIES CORPORATION



Europe, Africa, Mid-East: CSC UK LTD.
Dept 4T, Unit 1, Shire Hill Industrial Estate,
Saffron Walden, Essex CB11 3AQ.
Telephone: SAFFRON WALDEN 21682.
Telex: 817477.

EXPERIMENTOR BREADBOARDS.

No soldering modular breadboards, simply plug components in and out of letter number identified nickel-silver contact holes. Start small and simply snap-lock boards together to build breadboard of any size.

All EXP Breadboards have two bus-bars as an integral part of the board, if you need more than 2 buses simply snap on 4 more bus-bars with the aid of an EXP.4B.

EXP.325. The ideal breadboard for 1 chip circuits.

Accepts 8,14,16 and up to 22 pin IC's.

ONLY £1.60.

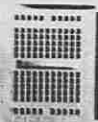

EXP.350. £3.15.

270 contact points with two 20-point bus-bars.

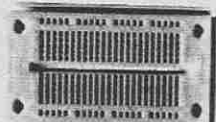

EXP. 300.

550 contacts with two 40-point bus-bars.

£5.75.

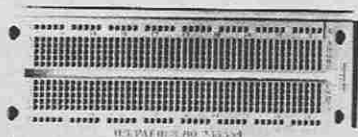

EXP. 650 for Micro-processors. **£3.60.**

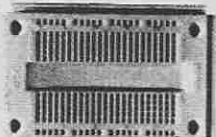

EXP 4B.

More bus-bars.

£2.30.



ALL EXP.300 Breadboards mix and match with 600 series.

PROTO-BOARDS.

THE ULTIMATE IN BREADBOARDS FOR THE MINIMUM COST. TWO EASILY ASSEMBLED KITS.

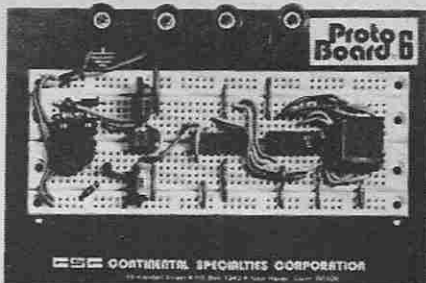

PB.6 Kit, 630 contacts, four 5-way binding posts accepts up to six 14-pin Dips.

PROTO-BOARD 6 KIT. £9.20.

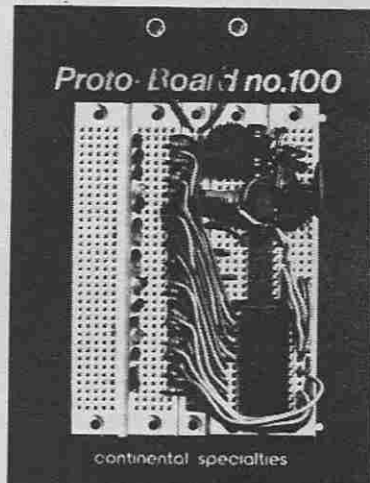

PB.100 Kit complete with 760 contacts accepts up to ten 14-pin Dips, with two binding posts and sturdy base. Large capacity with Kit economy.

PROTO-BOARD 100 KIT £11.80.

HOW TO ORDER AND RECEIVE FREE COPY OF TWO-TRANSISTOR RADIO PROJECT, FISH'N'CLIKS AND LED BAR GRAPH.

CSC UK LTD. Dept 4T, Unit 1, Shire Hill Industrial Estate, Saffron Walden, Essex CB11 3AQ.

It's easy. Give us your name and full postal address, in block capitals. Enclose cheque, postal order or credit card number and expiry date. OR telephone 0799 21682 and give us your Access, American Express or Barclaycard number and your order will be in the post that night.

EXPERIMENTOR BREADBOARDS.	CONTACT HOLES.	IC CAPACITY 14 PIN.DIP.	UNIT PRICE INCLUDING POSTAGE AND V.A.T.
EXP. 325	130	1	£ 2.53
EXP. 350	270	3	£ 4.21
EXP. 300	550	6	£ 7.29
EXP. 650	270	use with 0.6 pitch Dip's Bus-Bar Strip	£ 4.69
EXP. 4B.	Four 40 Point Bus-Bars		£ 3.29
TEST CLIPS			
PC. 16.			£ 3.78
PC.16-18.			£ 7.56
PC. 16-18 Dual Clip.			£12.15
PROTO-BOARDS.			
PB. 6.	630	6	£11.01
PB. 100.	760	10	£13.82

NAME

ADDRESS

DEPT. 4T

FILL IN COUPON & RECEIVE FREE COPY OF

MICROPROCESSOR BASICS

By R. W. Coles

5

IN PART 2 we saw how the microprocessor chip is able to FETCH instructions from memory and then EXECUTE them. In Parts 3 and 4 we examined the ROM and RAM chips in which the instructions can be stored. It is now time to consider the sort of instructions which are available to the programmer, and how these can be strung together to form a useful program.

It is the "programmability" of the microprocessor chip which gives it the power and flexibility to do almost any kind of control job which we need done.

With one program, a microprocessor system could be used to control motorway signals. With a different program, it could be carrying out scientific calculations, playing children's games, or winging its way to the outer planets on board a space probe. In each case, the same microprocessor could be used. All that changes is the program and the peripheral hardware.

MACHINE CODE

The instructions which the microprocessor needs in its ROM or RAM are called "Machine Code" instructions, because they directly modify the operation of microprocessor chip facilities such as registers and the Arithmetic & Logic Unit (ALU). These instructions are stored in binary form in the ROM or RAM chips, and binary is really the only language a micro' chip understands.

HEXADECIMAL CODE

To make life a little easier for us humans, who find binary a clumsy and difficult coding system, a useful shorthand code called "Hexadecimal" (hex) has been developed. Hexadecimal code is just another way of writing binary but it is much easier to use. It relies for its success on the fact that

microprocessor word lengths are usually multiples of four bits (such as 4, 8, 12, 16).

To convert a binary number into its hex equivalent, just chop up the binary into four-bit chunks, starting at the righthand, or least significant, end. With four bits there are 16 possible combinations (i.e. 2^4), and the next step is to replace each group of bits with a single character from the set 0-9 and A-F. In this way 0000 Bin. becomes 0 Hex, 1111 Bin. becomes F Hex, and 1010 becomes A Hex. To convert Hex to Bin you simply reverse the process, using a table like Fig. 5.1.

Eight-bit words now reduce to two hex digits and are therefore much easier to use and remember. We can't use decimal numbers in the same way of course, because there is no grouping of bits which gives us exactly ten combinations. Three bits have eight combinations and four bits have 16 and so on.

After a little practice hex code is quite easy to use, and most small hobby microprocessor systems are supplied with a *resident* program called a monitor, which allows you to enter your *own* programs in Hex rather than in binary.

DIFFICULT

Let's not kid ourselves, writing machine language programs for a microprocessor is a difficult and at first frustrating, business. Why then do people bother to do it at all? Well, I think, it's true to say that there is no better way to appreciate and learn about the exciting field of microprocessing than by learning how to make that hobby system actually *do* something useful under the control of your own machine code program. Once you have taken the plunge, it all seems to get much easier, and before you know where you are, you will be a dedicated micro'-nut!

Machine language programming is quite difficult because you have to understand the hardware of the system and what it can do before you can write a list of instructions to make it do it. You may have done some programming on a large computer which runs one of the so-called high-level languages like BASIC, and if you have, you may be thinking that "big" computers are much easier to program because they let you say things like:

```
LET X=A+B
```

in your program.

Programming a microprocessor in machine code to carry out the same task would mean keying in a string of hexadecimal characters, so obviously there's a big difference, or is there?

Well, no actually. The big computer has a primitive machine "language" just like the micro's only with a larger repertoire of instructions. To get it to accept English statements like:

```
IF X=5 THEN GO TO 20
```

someone has had to spend long hours writing a large program in machine code which then interprets the "High-level" instructions which you write in say, BASIC or FORTRAN.

Just the same thing can be done for a microprocessor, and the new microprocessor-based home computers have BASIC interpreters available which are themselves written in machine code. Trouble is, systems with these facilities are very expensive, and they may not be the best way to start out anyway.

BASIC is great for programs to solve mathematics problems and to balance business accounts, but try and cook up a program to control a model train layout or your central heating system and things can get a bit tricky. To do these jobs you really need to write your programs in machine code, and

you'll also have to put together some simple electronic interface circuits to handle your points, signals, or gas boiler controls.

If you are an electronics enthusiast, which I expect you are then this sort of thing could be just what you are looking for, and it has the big advantage of being cheap—you can buy a micro' system for machine code programming for less than £50.

So there you are, machine code programming is a real challenge, but it's well worth the effort of learning how to do it, and as an electronics enthusiast you'll appreciate the close association with hardware which machine code programming gives you.

INSTRUCTION SET

One problem with machine code programming is that each machine (microprocessor) has its own unique instruction set, and you'll have to study the internal architecture and associated instructions of the micro' you decide to buy. There are lots to choose from. Some you may have already heard of are the National SC/MP, the Intel 8080, the Motorola 6800 and perhaps the RCA 1802 COSMAC.

All have different instruction sets and are quite different in so far as the number and types of

internal registers and control bus signals are concerned.

The SC/MP has about 50 instructions available, which means that it is quite a simple microprocessor and fairly easy to use. Other microprocessors have much longer instruction sets which makes them more powerful, but in some cases a bit more confusing for the beginner.

You can take a look at the SC/MP instruction set in Fig. 5.2. Confusing, isn't it? One reason the action of some of the instructions is not immediately obvious, is because you need to appreciate the internal facilities of the SC/MP chip first (Part 2 of *Microprocessor Basics* could help here). Don't hope to understand all of the instructions at once though. Start with a few obvious ones like ADD or LOAD. The significance of the others will come slowly once you start to try out sample programs.

Notice that Fig. 5.2 describes an instruction in three ways. The *Opcode* column shows the hex code which converts directly into binary when you load it into memory. The *Mnemonic* column contains a short "name" for the instruction to make it easy to remember and quite compact when written down as a program. The *Operation* column gives a brief description of the effect of the instruction, and

this is sufficient information for only the experienced programmer.

To appreciate what "Pulse H-flag" really means, we need to refer to a more detailed description, and this can be found in the SC/MP manual.

The other thing the manual will tell us is that the entries in the *Opcode* column don't tell the whole story. As listed in Fig. 5.2, all the opcodes consist of a single byte (eight bits) but many SC/MP instructions use two bytes. The extra byte is actually data or address information which may be needed to make the instruction make sense, and this will be different every time the instruction is used.

INSTRUCTION TYPES

To make more sense of an instruction set it is useful to divide it up into various "classes" of instruction. Some manufacturers do this for you in their manuals, and they don't all agree about what classes to use. I have chosen a fairly typical selection of titles, so let's have a look at them one by one.

DATA TRANSFER GROUP

Apart from the automatic instruction-fetch operation a micro' chip performs, it also needs to

HEX	BINARY	Opcode	Mnemonic	Operation
0	00000000	00	HALT	Pulse H-flag
1	00000001	01	XAE	Exchange AC and Extension
2	00000010	02	CCL	Clear Carry/Link
3	00000011	03	SCL	Set Carry/Link
4	00000100	04	DINT	Disable Interrupts
5	00000101	05	IEN	Enable Interrupts
6	00000110	06	CSA	Copy Status to AC
7	00000111	07	CAS	Copy AC to Status
8	00001000	08	NOP	No Operation
9	00001001	09	SIO	Serial Input/Output
A	00001010	0A	SR	Shift Right
B	00001011	0B	SRL	Shift Right with CY/L
C	00001100	0C	RR	Rotate Right
D	00001101	0D	RRL	Rotate Right with CY/L
E	00001110	0E	XPAL	Exchange Pointer Low
F	00001111	0F	XPAH	Exchange Pointer High
		10	XRPC	Exchange Pointer with PC
		11	LDE	Load from Extension
		12	ANE	AND Extension
		13	ORE	OR Extension
		14	XRE	Exclusive-OR Extension
		15	DAE	Decimal Add Extension
		16	ADE	Add Extension
		17	CAE	Complement and Add Extension
		18	DLY	Delay
		19	JMP	Jump
		1A	JP	Jump if Positive
		1B	JZ	Jump if Zero
		1C	JNZ	Jump if Not Zero
		1D	ILD	Increment and Load
		1E	DLI	Decrement and Load
		1F	LDI	Load Immediate
		20	ST	Store
		21	AND	AND
		22	ANI	AND Immediate
		23	OR	OR
		24	ORI	OR Immediate
		25	XOR	Exclusive-OR
		26	XRI	Exclusive-OR Immediate
		27	DAD	Decimal Add
		28	DAI	Decimal Add Immediate
		29	ADD	Add
		2A	ADI	Add Immediate
		2B	CAD	Complement and Add
		2C	CAI	Complement and Add Immediate

Fig. 5.2. Opcode index of instructions for the National SC/MP.

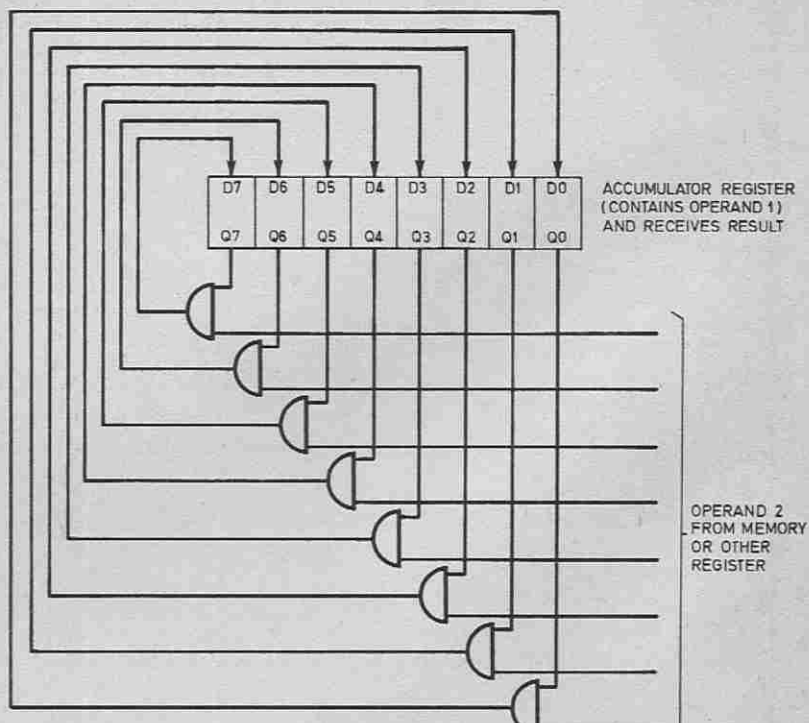

Fig. 5.3. Hardware model of the operation of a logical "AND" instruction.

MICROPROFILE: PRACTICAL PROGRAMMING

Let's assume that you have taken the plunge and bought one of the simple micro' kits now available. You have great fun wiring it up, but now comes the tricky bit—what do you do next?

READ THE MANUAL. It looks daunting at first, but it has to be done. You need a familiarity with the hardware, the instruction set of the micro-processor chip, and with the basic monitor program supplied by the manufacturers which allows you to enter your own programs.

After studying the manual you can try out some of the example programs which are usually given. You may find it difficult at first to see just how some of these programs operate, but by persevering and making sure you understand each line before moving on, the use of instructions and addressing modes should eventually become clearer.

Now what? At this point the manual can let you down, you are on your own, and you begin to realise that writing and running your own programs is very different from running the example programs in the manual!

The best way to get started is to follow some sort of method, and until you work out a better method of your own, you may like to try mine.

STEP ONE

The flow chart. I always find a flow chart a very useful program design aid because it can be drawn up very quickly, and it helps you to visualise the sequence of program steps required. You can modify flow charts easily, and you can make successive generations of them, each more detailed than the last, as you zero in on the desired program.

There's no need for lots of fancy shaped boxes, you don't even need a stencil. I use three shapes—circles for the beginnings and endings of programs, square boxes for activities, and diamonds for decision points.

The first flow chart should be very general in nature, you can write things in the boxes like "turn light on" or "set up count register." The final flow chart should take into account the actual instructions and hardware available. You can even write the mnemonics you intend to use in the program, in the boxes if it helps.

STEP TWO

The listing. With a good idea of how the program will work derived from the flow charts, you can now start to list the sequence of mnemonics which will eventually become the program proper. For this step a pad of machine code programming sheets can be useful, but these are not easy to come by, so you can make up your own as shown in Fig. 5.4.

Each line on the sheet corresponds to one location in memory, so for two-byte instructions you will have to use two lines of hex code. To start with you should list your program in mnemonic form only, multi-byte instructions should have the mnemonic on one line followed by an appropriate number of blank lines for the address or data which can be entered later.

Locations which will be destinations for jumps can be given names, and these can be listed in the label column. Instructions which are jumps can use the appropriate label in their mnemonic column.

The comment column is there for you to write in as much plain English as possible to explain the action of your own program—ignore it at your peril!

Always fill out these sheets in *pencil*. You will need to modify them at some stage, and writing it all out again is a pain.

STEP THREE

The coding. With all the mnemonics and labels now listed, the time has come to translate the listing into its equivalent hexadecimal form, ready for use.

To do this you need the opcode listings in the manual, you will also need to code any immediate data into hex, and look up the label destination addresses on your sheets before entering them in the proper place in the hex column.

STEP FOUR

Try it out. It probably won't work at first, (they hardly ever do!) but using the monitor program in conjunction with your listings you should be able to pinpoint the problems fairly quickly. Modifications, if they are required, can be difficult to implement due to the need to move whole blocks of instructions around if an extra line is needed. There are two things you can do to ease matters.

- (i) Start with *short* programs.
- (ii) Sprinkle NOP instructions around in your program. These can be replaced by the extra instructions required without a substantial rewriting job.

If you feel that there must be a better way, well, there *is* a better way. On larger, more expensive systems, a program known as an "assembler" can be used to take the difficulty out of programming in machine language. With an assembler you don't have to worry about absolute addresses or hex code, and the machine code is replaced with what is known as assembly language—but that's another story!

MACHINE CODE PROGRAMMING SHEET					
TITLE	SWITCHCHECK				
PAGE No	6	DATE	05/06/79	INITIALS	RJC
ADDRESS (HEX)	CODE (HEX)	LABEL	OPCODE/ OPERAND	COMMENTS	
01A8	BA	BACK	DLD	CHECK IF DONE	
01A9	09		COUNT		
01AA	9C		JNZ	NO IF JUMP	
01AB	ED		LOOP		
01AC	C2		LD		
01AD	0A		PUSHED	CHECK IF KEY	
01AE	98		JZ	PRESSED	
01AF			CK		
01B					

Fig. 5.4. An example of a listing of instructions, which will eventually constitute the program. Sheets like the one shown should be drawn up by the individual for his own use. Fill in entries in pencil to permit alterations.

"fetch" data from memory or "put" data to the memory under the control of the instructions themselves. This is done during the execute portion of an instruction cycle. Instructions which move data around, whether to and from memory or between internal registers, can be called "data transfer instructions."

Examples from the SC/MP instruction set include:

- XAE Exchange the contents of the accumulator register and the extension register.
- LD Load data from memory into the accumulator.
- ST Store data from the accumulator into memory.

ARITHMETIC & LOGIC GROUP

We all know that microprocessors can do sums, but it comes as a bit of a surprise to find out that they aren't very good at them! It's not that they get the wrong answers, it's just that they can only do very simple sums when

you buy them, the sort of sums you could do when you were six.

With most microprocessors arithmetic precision is limited to eight bits, and there are no multiply or divide instructions at all, so really they are pretty dumb. Their strength lies in the speed with which they operate.

By stringing together a series of eight-bit addition operations to form a program segment or "routine", it is possible to make your pet micro' carry out arithmetic to any desired precision. Similarly, by using a different "routine" it is possible to perform multiplication and division.

If you have to, it is also possible to write programs to generate SIN, COS, TAN, LOG and other functions, but notice the operative word *program*, you don't get these goodies as part of the instruction set! Examples of arithmetic instructions from the SC/MP set include:

ADE Add the contents of the extension register to accumulator.

ADD Add the contents of a memory location to the accumulator.

CAD Complement the contents of a memory location and add it to the accumulator. (Performs subtraction.)

Logical instructions work just like gates, only since the micro' works with eight bits at a time, one instruction is similar to a collection of eight gates. The logical instructions work on a pair of words at a time, so using the gate analogy they are actually two-input gates (Fig. 5.3). Examples from the SC/MP set include:

ANE Carry out a logical AND function between the contents of the accumulator and the contents of the extension register.

OR Carry out a logical OR function between the contents of a memory location and the accumulator.

XRI Carry out an EXCLUSIVE-OR function between the contents of the memory location following this instruction, and the accumulator. **To be continued**

PLEASE TAKE NOTE

ELECTRONIC DICE (May 1979)

We apologise for the following errors that occurred in this article:

Components List, page 274

R4 should read 100k Ω

IC1, 4 should read 74C193 CMOS 4-bit

... counter The p.c.b. (page 274) should be amended as shown below.

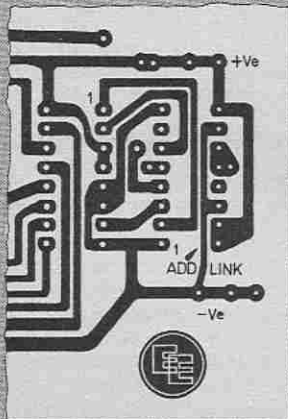

EE2020 TUNER AMPLIFIER (December 1978 to May 1979)

We apologise to readers for some errors that have occurred in the course of this 6 Part Series. They are not serious, and constructors will probably have already detected and rectified these mistakes.

Page 878 (Dec. '78)

FIXED RESISTORS

should read:

1k Ω 24

4-7k Ω 15

330k Ω 12

CAPACITORS

Polyester, Mullard type C280

add: 250V

first item should read: 0.01 μ F 2

Electrolytic, Printed Circuit type

delete the entry: 22 μ F 63V 1

Page 879 (Dec. '78)

Fig. 1.2b Circuit Diagram, Power Amplifier and Power Supply.

The lower end of R101 should be disconnected from the line to "TD3" and taken instead to the TD2a line, as correctly shown on the practical layout diagram Fig. 3.2.

(Already covered in NOTE to caption for Fig. 3.2).

Page 37 (Jan. '79)

Fig. 2.2 (lower r.h. corner)

R17 should read: R19

Page 38

Capacitors, should read:

C1 2.2 μ F 63V elect.

C19 or 470pF

Page 39

Capacitors, should read:

C65 0.047 μ F

Page 102 (Feb. '79)

Fig. 3.3 Printed Circuit Board B. Unfortunately, two holes have become obliterated during printing.

(i) Immediately above the central bus bar, about $\frac{1}{8}$ inches to right of "TB4", the large pad requires a second hole, just below existing one. This is for the wire link (see Fig. 3.4).

(ii) One hole for C38a may not be clear, this is the mid one of three on the long "vertical" pad, about 1 inch to the right of "TB3a".

Capacitors, should read: C35a,b 0.047 μ F

Page 242 (April '79)

Fig. 5.5. Pushbutton switches.

The letters "c" and "d" on switch S2 should be transposed. Connection is made to S2c, at the underside (p.c.b.) only.

S2d is not used at all. (Already covered by Erratum on page 309).

Stereo Decoder IC2

Motorola MC1310 is a pin-for-pin replacement for the type specified, and may be more readily available.

(Already covered in Part 6, page 309).

Simply ahead!

**HIGH PERFORMANCE MODULAR UNITS
BACKED BY NO-QUIBBLE 5 YEAR GUARANTEE**

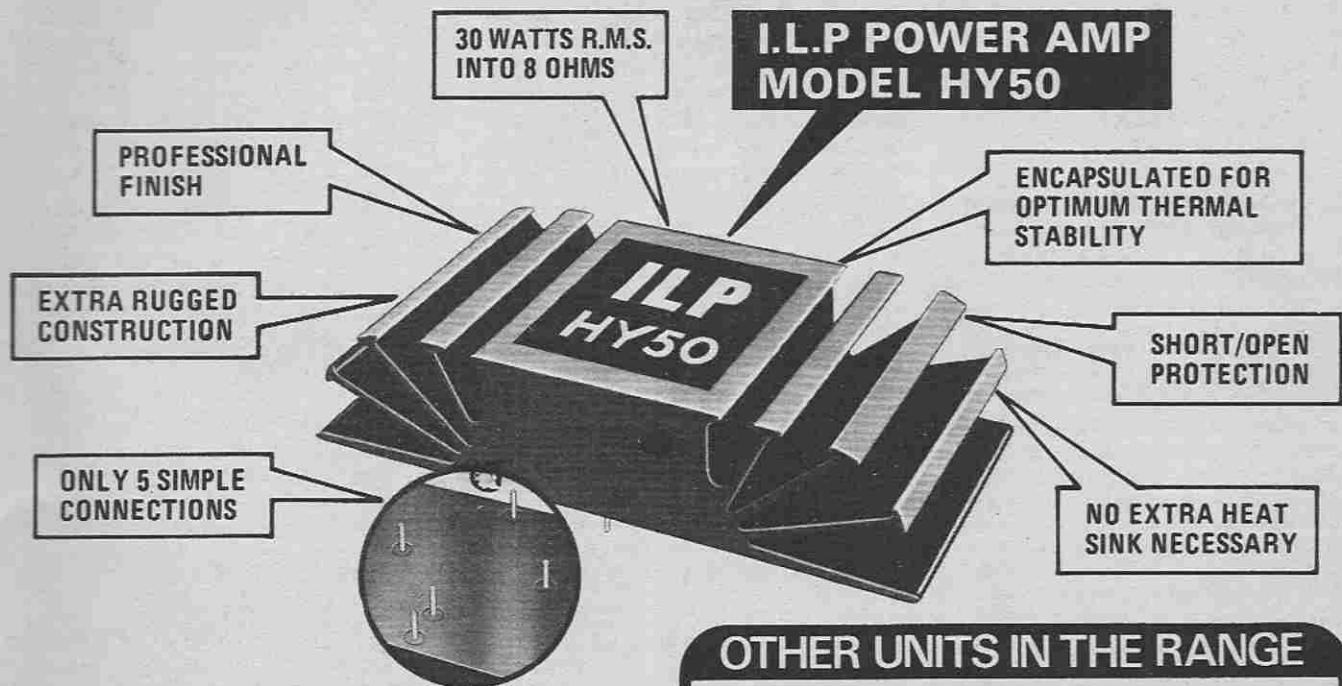

Of all the purpose-built power amplifier modules by I.L.P., the HY50 is understandably the most popular with those wanting to build or up-grade a hi-fi system, run a small high quality P.A. system, amplify a musical instrument (say for practise or small range use) or use it for lab work. Its useful 30 watts RMS output into 8ohms, its rugged construction and freedom from heatsink worries make HY50 the ideal all-purpose quality power amp—and it is unconditionally guaranteed for five years. Ten of thousands are in use throughout the world.

... and a spec that means what it says!

Encapsulated power amp with integral full-rated heatsink. Input—500mV.
Output 30 watts RMS/8Ω.
Load Impedance—4 to 16Ω.
Distortion—0.04% from 100mW to 25 watts at 1KHz/8Ω.
Supply Voltage ±25V. Size 105 × 50 × 25mm.
Inc. V.A.T. and postage in U.K. **£8.15**

Nothing has been overlooked in the design and manufacture of I.L.P. Modular Units. Heavy duty heatsinks, encapsulated circuitry, no-compromise production standards and true professional finish ensures world leadership for I.L.P. Now we have up-graded output ratings and down-graded prices to bring I.L.P. within easier reach of all who want the best.

New production techniques enable us to reduce prices by an average of 20%, making I.L.P. a better buy than ever.
USE OUR FREE POST SERVICE for sending your orders, requests for information sheets etc. Simply address envelope. No stamps required.



FREEPOST 3
Graham Bell House, Roper Close, Canterbury, Kent CT2 7EP
Phone (0227) 54778

OTHER UNITS IN THE RANGE

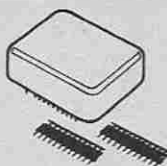

OTHER UNITS IN THE RANGE
All prices inc. V.A.T. & Postage in the U.K.

HY5 PRE-AMPLIFIER

Compatible with all I.L.P. power amps and P.S.U.'s in a single pack, needs external pots and switches. Multi-function equalization, 5 inputs. High overload margin. Active tone controls, 500mV out. Distortion at 1 KHz—0.01%. Two connect easily for stereo. **£5.22**

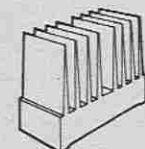

THE POWER AMPS

With heatsinks, full load line and thermal protection. Distortion typically 0.05% at 1 KHz.

HY120	60 Watts RMS/8Ω	114 × 50 × 85mm	£16.42
HY200	120 Watts RMS/8Ω	114 × 50 × 85mm	£19.92
HY400	240 Watts RMS/4Ω	114 × 100 × 85mm	£29.89

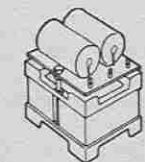

THE POWER SUPPLY UNITS

(Split line outputs to suit I.L.P. power amps and HY5)

PSU50	for 1 or 2 × HY50	£9.11
PSU70	for 1 or 2 × HY120	£14.70
PSU90	for one HY200	£14.70
PSU180	for one HY400 or 2 × HY200s	£24.80

★ NOW-PRICES DOWN BY 20%

Please supply

Total Purchase Price.....

I Enclose Cheque Postal Orders Money Order

Please debit my Access account/Barclaycard Account number.....

Name

Address

.....

Signature.....

FP3/7...
Reg. Bus No. 1032630 Eng.

WORKSHOP MATTERS

By Harry T. Kitchen

Choosing a Multimeter

For the beginner undoubtedly the biggest single cash outlay involves the purchase of a multimeter. This is essentially a moving coil meter movement with a number of resistors, rectifiers and batteries, which by suitable selection will enable you to measure d.c. and a.c. voltage, d.c. current certainly, and possibly a.c. current also, and resistance. A few instruments permit the measurement of capacitance as well.

Basic multimeters start at around £10, whilst the more comprehensive, accurate, and reliable instruments cost around £100. How do you select a suitable multimeter? There is, in my view, no simple, categorical answer; it all depends on your bank balance, ambitions and your priorities.

Draw up a list somewhat as follows: cost; d.c. and a.c. voltage; d.c. and a.c. current; resistance; possibly capacitance; d.c. and a.c. input resistances. Shuffle it around, try to arrive at a balanced compromise. Then look at brochures.

Sensitivity

Still unsure? Be of good cheer! It's not too difficult. Let us look first at input resistance, which invariably is quoted as an "OPV" figure. This stands for Ohms Per Volt, and denotes the sensitivity of the instrument, its goodness factor if you like.

The higher the OPV factor the more useful the instrument for electronics workshop use. The norm now is 20k Ω /V, though 10k Ω /V is acceptable. A few instruments offer 100k Ω /V.

This method is in my view illogical. What ought to be quoted is the meter sensitivity, the current it consumes for full-scale deflection or f.s.d. Ohm's law shows that for the above cases this will be 50 μ A, 100 μ A, and 10 μ A respectively.

These figures apply to the measurement of d.c. voltages only. Measurement of a.c. voltages requires the use of a rectifier interposed between the range resistors and the meter. Due to the characteristics of the rectifiers, the a.c. input resistance is less than the d.c. input resistance. A factor of x4 to x10 is usual; thus a 20k Ω /V meter may have an a.c. rating of between 5k Ω /V and 1k Ω /V.

The f.s.d. rating is for full-scale deflection. This can have two meanings: the current required for full-scale

deflection of the meter movement, or the voltage or current that has to be applied to the terminals for meter f.s.d. The first is the basic figure; the second takes into account series or shunt resistors. A basic 50 μ A movement could thus measure virtually any voltage or current; the limiting factor would be the series (voltage) or shunt (current) resistors.

Measurement of Resistance

Measurement of resistance is effected simply by connecting a battery in the circuit, in one of two ways; series or shunt.

In the series mode the battery, meter, and resistance to be measured are connected in series; the current to the meter being limited by the unknown resistance. Since the current is dependent on the resistance, the meter can be scaled directly in ohms. Zero ohms corresponds to maximum meter deflection, Maximum (open circuit) ohms corresponds to zero meter deflection.

In the shunt mode the unknown resistor is connected directly across the meter, and the opposite conditions apply. Generally, the series mode is used for high resistances, shunt for low. It is usual for the better class instrument to be provided with several ranges, accompanied by a change in battery voltage.

Current is measured by connecting resistors in parallel with the meter for d.c., and these shunt excess current away from the meter. For a.c. work it is usual to employ a transformer, the primary being tapped to suit the ranges required. The secondary then feeds into a rectifier as for voltage measurements.

Capacitance measurements usually invoke the use of the mains. In effect the reactance of the capacitor is measured, but the meter is scaled in terms of capacity. Since the frequency is fixed the range is small, and the facility is of very limited use.

Important Features

We agreed, earlier, that a multimeter should have as high an input resistance as possible; 10k Ω /V minimum, 20k Ω /V desirable. 100k Ω /V instruments are available, but are more fragile; incorporating a lighter movement for increased sensitivity.

The advantage of the 20k Ω /V instrument is that the majority of circuit diagrams are annotated with voltages

obtained by such an instrument. Meaningful comparisons can therefore be drawn whilst trouble shooting.

The upper voltage limit of most instruments is 1kV d.c. and a.c. Some allow voltages up to 5kV to be measured, some are limited to 500V. Apart from the mains, there will be little necessity to measure above 250 volts. Thus 500 volts f.s.d. is quite adequate. Lower down, base/emitter voltages or diode voltage drops may have to be measured; 150mV for germanium, 700mV for silicon. Thus a meter minimum f.s.d. of 1 volt is essential.

Transistor currents can be very minute, in the microamp or nano amp region. For these a 50 μ A f.s.d. scale is essential. Power amplifiers can consume several amps, so a 2.5A or 5A f.s.d. scale is essential, though 1A f.s.d. may serve at a pinch.

Resistance ranges should enable low value resistors to be accurately measured, and should enable reasonable accuracy to be obtained in the megohm region. A maximum of 10M Ω is typical for a 20k Ω /V instrument, though at this extreme, faith is required, since calibration marks are very cramped.

Scales and Accuracy

Scales should be clear and totally unambiguous. A plethora of scales may look impressive, but closely spaced, multitudinous scales, aid and abet inaccuracy. Clear, widely-spaced scales, are infinitely superior.

Limits of accuracy, more accurately inaccuracy, should be specified. Thus d.c. voltages can be $\pm 2\frac{1}{2}$ per cent, d.c. currents ± 3 per cent, resistance ± 5 per cent and so on. Note, however, that this is the f.s.d. accuracy, and as the pointer drops down-scale so accuracy is degraded accordingly. At one-tenth f.s.d. our 3 per cent accuracy is now ± 30 per cent, a not-insignificant degradation. This is why multimeters have multiple scales so that the pointer can be kept as far up the scale as possible.

Crossword No. 17—Solution

R	I	N	G	C	I	R	C	U	I	T	W
O	E	N	A	N	K	I	T	E			
C	O	N	N	E	C	T	S	B	N	A	
K	E	H	T	U	R	N	O	N	K		
R	E	V	E	R	A		E	B	R	E	
R	A	G	R	O	U	N	D	S	P	I	N
S	T	G								D	
A	M	M	E	T	E	R	A	C	K	A	G
A							V	I	E		
P	R	I	A	I	R	C	E	L	L		
T	Y	N				R	O	V	E	R	
R	A	R	I	F	S	W	A				
O	R	M	A	G	I	T	A	T	E		
A	T	O	M	A	C	O	T	E			
T			A	L	T	E	R	N	A	T	E

WATER LEVEL INDICATOR

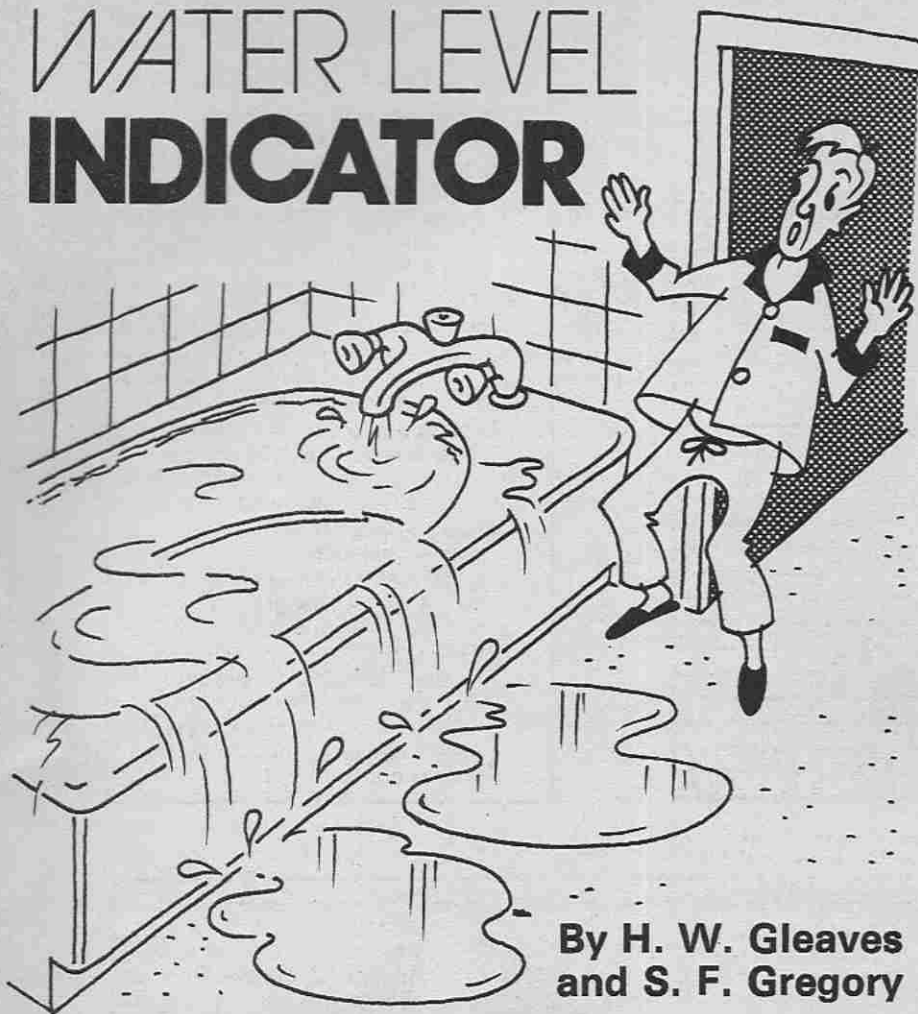

By H. W. Gleaves
and S. F. Gregory

THE PROJECT to be described here is a very simple device, which indicates when the water in a bath reaches a certain level. Although the device was designed initially for use in one of the author's bathroom it can have many other uses such as a rain or snow alarm with an appropriate probe plugged in.

CIRCUIT CONSTRUCTION

The circuit of the Water Level Indicator is shown in Fig. 1, and consists of an astable multivibrator connected in series with a Darlington pair, the input to the latter being connected to the probe.

When the probe is dry, i.e., open circuit, the base of TR1 will also be open circuit and the Darlington pair will have a very high resistance between collector and emitter. In this state the multivibrator will be inoperative as it is effectively disconnected from the negative side of the battery.

However, when the probe is bridged by water, TR1 will have a small base current flowing which will be amplified to an extent equal to the product of the individual gains of TR1 and TR3. The result is that TR3 will be turned hard on and 9 volts will appear across the multivibrator. Transistors TR2 and TR4 will now begin to turn on, but

due to component tolerances either TR2 or TR4 will begin to turn on faster than the other.

Assume that TR4 turns on the faster. As it does so the collector voltage will tend to fall in value. This negative signal is fed via C2 to the base of TR1. This has the effect of turning TR2 off, hence its collector voltage will rise. This positive signal is applied via C1 to the base of TR4 which will conduct even harder.

Eventually TR4 will saturate, thus its collector voltage will fall to near the negative supply, and the negative signal being fed back C2 via to TR2 base will cease.

Capacitor C2 will now commence to charge via R4 until about 0.6V is present on the base of TR2, whereupon TR2 will now begin to turn on. As this happens a negative signal will be applied via C1 to the base of TR4 which will now tend to turn off. The collector will now go positive and this positive signal will be applied via C2 to the base of TR2 thus turning it on even harder.

Transistor TR2 will eventually saturate whereupon C1 will begin to charge via R3 until about 0.6V is present at the base of TR4. This transistor will now commence to turn on again. This regenerative action will continue as long as the supply voltage is present.

COMPONENTS
approximate
cost **£4**

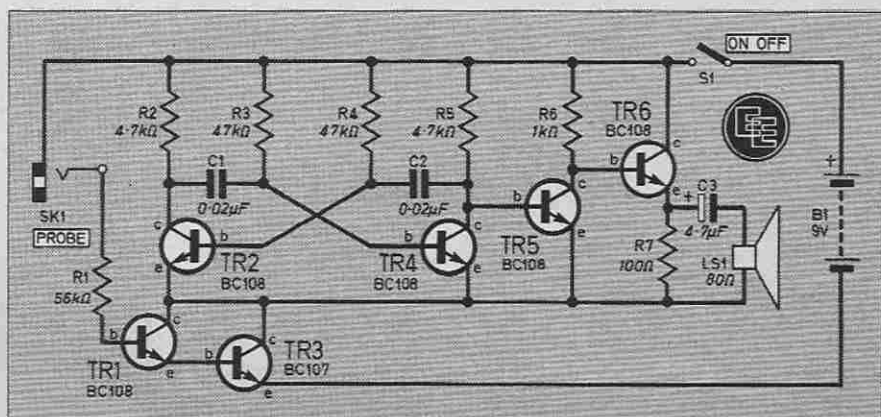
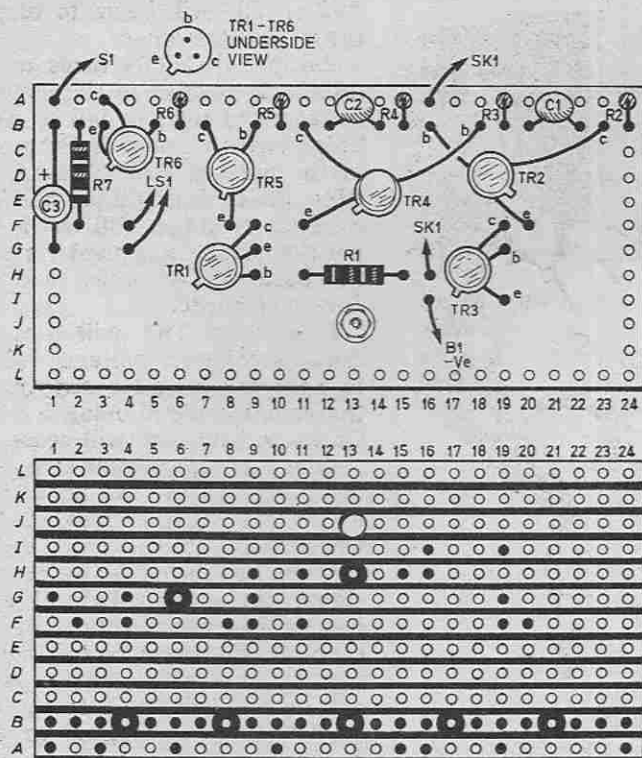

Fig. 1. Complete circuit diagram of the Water Level Indicator.



COMPONENTS

Resistors

R1	56k Ω	R5	4.7k Ω
R2	4.7k Ω	R6	1k Ω
R3	47k Ω	R7	100 Ω
R4	47k Ω		
All $\frac{1}{4}$ W $\pm 10\%$			

Capacitors

C1, 2	0.02 μ F disc ceramic (2 off)
C3	4.7 μ F 10V elect.

Semiconductors

TR1, 2, 4, 5, 6	BC108 silicon npn (5 off)
TR3	BC107 silicon npn

Miscellaneous

- SK1 3.5mm jack plug
- LS1 80 Ω 50mm loudspeaker
- S1 s.p.s.t. miniature toggle
- B1 9V PP3 battery
- Stripboard, 0.1 inch matrix 24 holes by 12 strips; plastic case, size 110 x 60 x 30mm or similar; connector to suit battery; 4BA hardware; materials for probe; connecting wire.

See
**Shop
Talk**

page 426

Fig. 2. (above) Stripboard layout showing the breaks to be made. (Below right) The remainder of the wiring is completed as shown here.

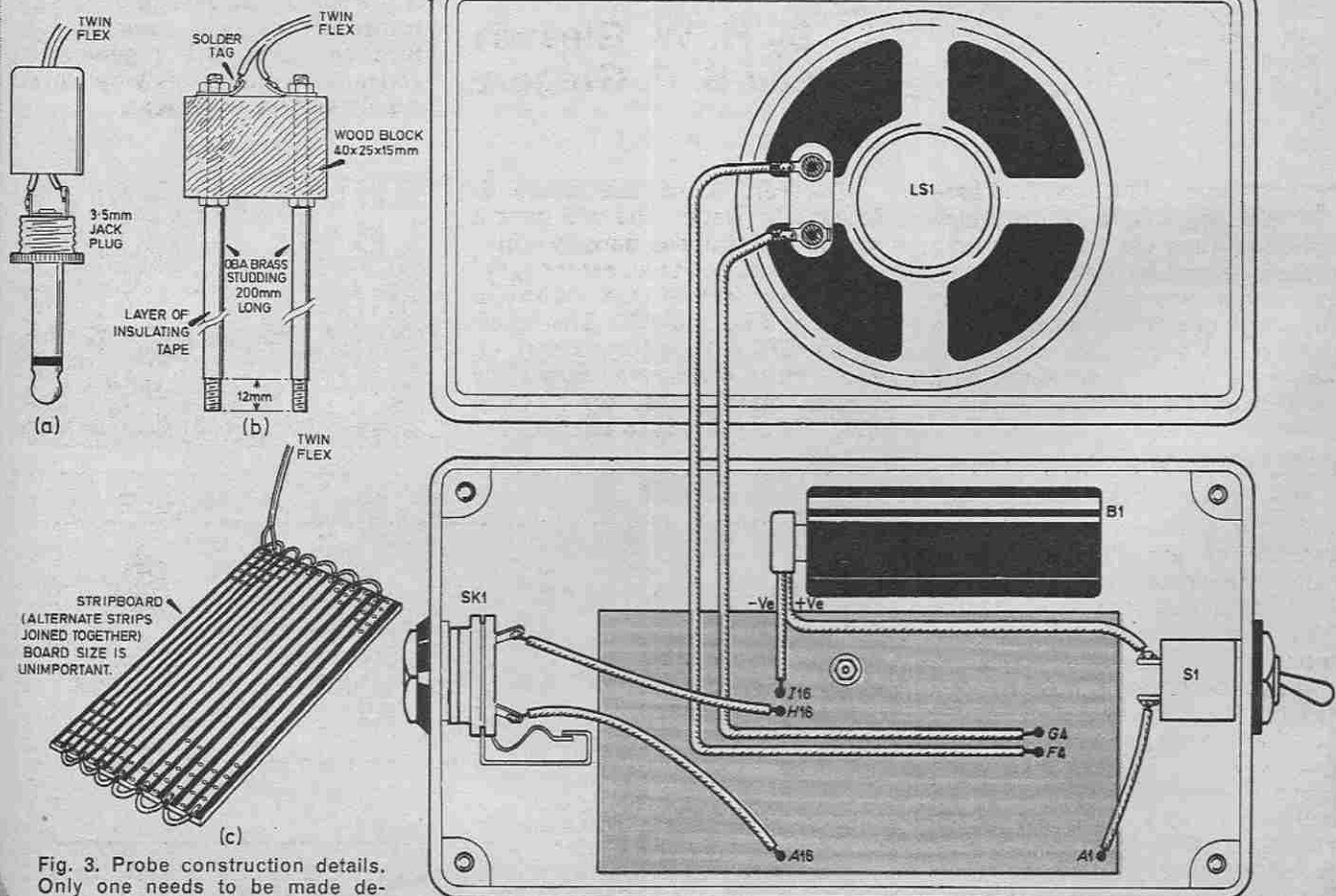

Fig. 3. Probe construction details. Only one needs to be made depending on application envisaged.

This type of multivibrator is said to have quasi-stable states, i.e., there are two states which the circuit may be in at any instant: TR2 saturated and TR4 off, or TR4 saturated and TR2 off.

The output from the multivibrator is amplified by transistors TR5 and TR6 and is heard in the loudspeaker.



Most of the components are mounted on a piece of 0.1 inch matrix stripboard, having 12 strips by 24 holes. The first step is to make the required breaks on the underside of the board. The component assembly and general wiring can now be made according to Fig. 2.

The resistors should be soldered first, followed by the capacitors, care being taken to ensure that C3, which is an electrolytic type, is inserted correctly.

Finally, the six transistors can be soldered in. It is advisable to use a heatshunt on the lead-out wires since semiconductors are

easily damaged by excess heat. The loudspeaker, battery and other flying leads can now be soldered on to the board. For neatness the wires to the loudspeaker and jack socket can be twisted together.

CASE

The case used in the prototype was made of plastic and has overall dimensions of 110 x 60 x 30mm, although any larger size case can be used. A 4BA bolt and two nuts were used in the prototype to secure the stripboard to the case, one of the nuts acting as a spacer.

Suitable holes should then be drilled for the jack socket and on/off switch.

TESTING

Before fitting the board into the case it should be thoroughly checked for dry joints etc. If all is well the battery may be connected and the unit switched on. At this stage there should be no sound from the speaker, however as soon as the probe is bridged, say, by inserting it into a liquid, a tone should be heard.

The frequency of the tone is approximately 760Hz.

PROBES

The unit as described is really very versatile in that it can be

used for a variety of purposes. For example, a rain alarm, a snow alarm, a steam alarm, etc, simply by plugging in an appropriate probe. Three probes which could be used with the unit are shown in Fig. 3.

The first (a) is the "standard" probe used for detecting the level of water in a bath, and is simply a 3.5mm jack plug. The second type of probe (b) may be used with the unit as a soil moisture monitor. The last probe (c) shown can be considered as a "universal" or all purpose probe, consisting of a piece of stripboard with alternate tracks joined together. This one can be used for detecting rain etc.

IN USE

The finished unit can be fitted to a bath in a number of ways, the exact method is left to the reader. For example, with a metal bath the unit can be attached to the side near the top by means of a small magnet.

For a non-metallic bath, fibreglass for example, providing the surface is reasonably smooth and flat, a rubber sucker could be the means of fixing the unit. Another possibility is to use a long strip of aluminium bolted to the unit and bent to suit the edge of bath used. □

EE CROSSWORD No 17

BY D. P. NEWTON

ACROSS

- 1 Loopy household wiring.
- 7 A bird that was Benjamin's aerial.
- 8 Makes contact.
- 9 Get going to switch (4, 2).
- 10 The ready battery is always there.
- 11 Concerning.
- 12 Washed high and dry in an earthy sort of way.
- 13 Rotate the pins (Anag.).
- 15 Currently a measurer.
- 16 Parcel of items, sometimes a deal.
- 19 A neat, little variable capacitor.
- 21 Battery unit having gaseous electrolyte? (3, 4).
- 23 Large electrical stress.
- 24 Call before out.
- 25 Electrical charging rate.

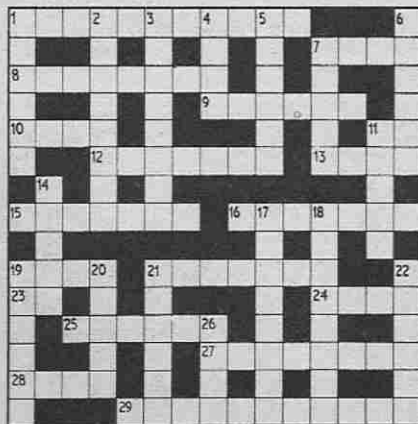

- 27 A gate ditched in the beginning makes disturbed (Anag.).
- 28 Dalton was happy with it!
- 29 Pulsing to and fro.

DOWN

- 1 A switch, to be really hep or off it.
- 2 Bringing electricity into existence.
- 3 The controller, not unlike accumulator refuelling (2, 6).
- 4 Iron of high carbon content.
- 5 If two fast-breeder reactors got together, would this be their closely related offspring?
- 6 Losing strength.
- 7 Devices for facilitating rotation of variable components.
- 11 Mountainous area from the latter part of a pick-up.
- 14 Clever or quick-witted.
- 17 Dislike another tale.
- 18 4 16A at 240V.
- 19 Mike might be at it.
- 20 I might not chance it (2, 3).
- 21 Once thought to be a kind of electricity, in a faunal way.
- 22 Wind treads about in the tropics (Anag.).
- 26 A front on an inter basis giving access.

Solution on page 441



20 x 20 WATT STEREO AMPLIFIER

Viscount IV unit in teak simulate cabinet. Silver finish rotary controls and pushbuttons with matching fascia, red rms indicator and stereo jack socket. Functions switch for mic, magnetic and crystal pickups, tape tuner and auxiliary. Rear panel features two mains outlets DIN speaker and input sockets plus fuse 20x20 watts RMS 40x40 watts peak. For use with 8 to 15 ohm speakers.

£29.90
£2.50 p&p

30x30 WATT AMPLIFIER IN KIT FORM

For the experienced constructor complete in every detail, same facilities as Viscount IV, but with 30x30 output 60x60 watts peak. For use with 4.15 ohms speakers.

£29.00 + p&p
£2.50

SPECIAL OFFER

30 x 30 WATT AMPLIFIER KIT with BSR P200 belt drive deck and Shure M75 cartridge.

£55.00
+ p&p £5.00

EMI SPEAKER BARGAIN

Stereo pair 350 kit. System consists of 12" x 8" approx. woofer with rolled surround, 2 1/2" approx. Audax tweeter, crossover components and circuit diagram. Frequency response 20 Hz to 20 KHz. Power handling 15 watts RMS. 20 watts max. 8 ohm impedance.

£14.95

Per stereo pair
+ £3.40 p&p

BSR P200

Belt drive chassis turntable unit semi automatic, cueing device.

£24.95
p&p £2.55

A.D.C. QLM 30 Mk III Magnetic Cartridge to suit.

£7.75



BSR Manual single play record deck with auto return and cueing lever. Fitted with stereo ceramic cartridge 2 speeds with 45 r.p.m. spindle adaptor ideally suited from home or disco use.

OUR PRICE £10.95 p&p £2.55

GARRARD DECK MODEL CC 10A

Record changer with cueing device fitted with stereo ceramic cartridge ready to fit into your own plinth.

£7.95 p&p £2.00 Size 12" x 8 1/2"

SANYO Nic/cad. battery, with mains charger equivalent in size and replaces 4 SP11 type batts. Size 3 1/4" x 1 1/4" x 2" approx.

£7.60 p&p £1.50p

BARGAIN FOR PERSONAL SHOPPERS ONLY
Altone UA4 Stereo System

Features 8 watt total output. Full size BSR manual turntable with cueing and auto return. Socket for tape in and out and stereo headphones.

complete with speakers. **£34.95**

Micro Cassette Recorder
Pocket size—home or office use or when travelling.

£13.95

Battery operated fluorescent camping lamp.
Runs off 8 U2 batteries.

£4.50

Mullard

AUDIO MODULES IN BARGAIN PACKS CURRENT CATALOGUE

PRICE **£25** AT OVER PER PACK

SEE OUR PRICES

1 PACK 1. 2 x LP1173 10w. RMS output power audio amp modules. + 1 LP1182/2 Stereo pre amp for ceramic and auxiliary input.

OUR PRICE **£4.95**
p+p £1.00

2 PACK 2. 2 x LP1173 10w. RMS output power audio amp modules + 1 LP1184/2 Stereo pre amp for magnetic, ceramic and auxiliary inputs.

illus. OUR PRICE **£7.45**
p+p £1.00

AVAILABLE ALSO TO PURCHASERS OF THE 10 + 10 AMPLIFIER KIT.

10 + 10 AMPLIFIER KIT

An opportunity to buy a 10 watts per channel stereo amplifier kit which is suitable for use with a ceramic cartridge. The amplifier utilises proven Mullard modules and is available at a very competitive price. The amplifier kit comes complete with instructions and includes: a Mullard LP1183 stereo preamplifier module, two LP1173 power amplifiers with integral heatsinks, a power supply, Zobel networks, front and back mounting panels, a finished fascia panel, all control potentiometers (bass, treble, volume and balance), switches, input, output and headphone sockets, wire, and an easily assembled wrap around cabinet to house the finished unit.

Size approximately 9 1/4" x 8 3/4" x 4" p&p £2.05 **£11.95**

BARGAINS FOR PERSONAL SHOPPERS

LED 5 function men's digital watch stainless steel finish

£5.95

LED 5 function men's digital watch stainless steel finish

£6.95

LCD 8 Function CHRONOGRAPH men's digital watch, stainless steel finish

£12.95

POCKET CALCULATOR. With LED display, memory and percentage key

£2.95

AM/FM DIGITAL CLOCK RADIO

Accurate 4 Digit Electronic Clock with 1/2" LED display. Buzzer and snooze timer

£11.95



125 Watt Power Amp Module

£13.95

Mains power supply for above unit.

£3.50

MULLARD Built power supply

£1.50

DECCA 20w Stereo speaker kit comprising 2 8" approx. bass units + 2 3 1/2" approx. tweeter inc crossovers

£20.00

VIDEOMASTER Super Score TV Game with pistol mains operation

£14.95

PORTABLE RADIO/CASSETTE RECORDER, AM/FM with clock. LW, MW, SW, VHF mains/battery operation.

£41.95

VIDEOMASTER COLOUR SHOT TV GAME

Choice of three games—Football, Tennis and Squash. Ready to play—one or two players. MAINS OPERATED.

OPPORTUNITY AT **£9.95** ONLY



323 EDGWARE ROAD, LONDON W2
21 A HIGH STREET, ACTON W3 6NG

ACTON: Mail Order only. No callers.

ALL PRICES INCLUDE VAT AT 12 1/2%

All items subject to availability. Price correct at 4/4/79 and subject to change without notice.

ACCESSORIES ARE ONLY AVAILABLE TO THOSE CUSTOMERS WHEN BUYING OUR BARGAIN PACKS

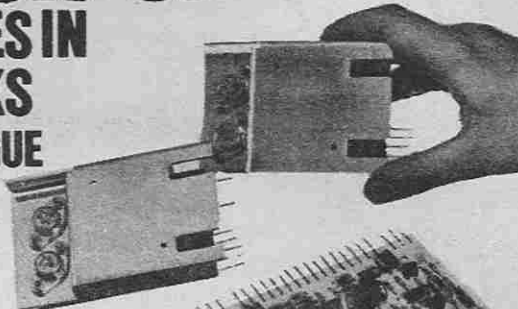

ACCESSORIES

Suitable mains power supply parts, consisting of mains transformer, bridge rectifier, smoothing capacitor and set of rotary stereo controls for treble, bass, volume and balance.

£2.90
plus £1.50 p&p

Two Way Speaker Kit

Comprising of two 8" x 5" approx. 4 ohm bass and two 3 1/2" 15 ohm mid-range tweeter with two cross-over capacitors.

£3.95
per stereo pair plus £1.50 p&p

50 WATT MONO DISCO AMP

£29.95
P&P £2.50

Size approx. 13 3/4" x 5 1/4" x 6 3/4"

50 watts rms. 100 watts peak output. Big features include two disc inputs, both for ceramic cartridges, tape input and microphone input. Level mixing controls fitted with integral push-pull switches. Independent bass and treble controls and master volume.



70 & 100 WATT MONO DISCO AMP

Size approx. 14" x 4" x 10 1/4"

Brushed aluminium fascia and rotary controls.

Five vertical slide controls, master volume, tape level, mic level, disc level, PLUS INTER DECK FADER

for perfect graduated change from record track No. 1 to No. 2, or vice versa. Pre fade level control (PFL) lets YOU hear next disc before fading it in. VU meter monitors output level.

Output 100 watts RMS 200 watts peak.



70 watt **£57**

140 watt peak p&p £4.00

100 watt **£65**

FOR PERSONAL SHOPPERS ONLY

DUO II SPEAKERS

Attractive teak finish, modern design, incorporating 2 speaker units—6" approx. woofer and 2 1/2" approx. tweeter. 45 to 1800 Hz. Impedance 8 ohms. Power 15 watts RMS. 20 watts max. Per stereo pair

£17.00

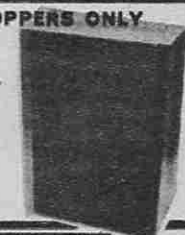

FOR PERSONAL SHOPPERS ONLY

STEREO RADIOGRAM CABINET

Finished in a natural teak veneer with opening top. Easily modified to accommodate stereo equipment of your choice.

Price **£10.95**

Size approximately 47" x 15 1/2" x 15"



RUMMAGING AROUND

with Keith Cadbury

ABOUT thirty years ago, when I was a snotty little village lad, with knee-length shorts and a side-parting, my father took it into his head to build a television set. An engineer by trade, but a confirmed do-it-yourself man (before they invented the term), he made this wondrous machine from war-surplus components.

When it was finished, the whole village would troop into our cottage living-room whenever something important happened (like Boat Race Day), to watch the eight-inch green screen. Yes, green. The colour of the cathode ray tube, taken from a wartime radar display unit.

Just one channel, and about four hours' transmission a night. Days of Gilbert Harding, and *Cafe Continental*, and the most frequently-seen image was "Normal Service will be Resumed as Soon as Possible."

I mention this childhood memory, following a conversation with an older electronics enthusiast, who wished for a return of the days of "War Surplus" yards.

WAR SURPLUS

I remember travelling on the village bus with dad, when he went to buy components. Two hours of meandering over bumpy narrow roads that connected the villages and small towns of our part of Surrey, in a rickety old 1928 single-decker, that finally arrived in Kingston-Upon-Thames.

We always went to Proops Bros, which was then just a wooden shack and about half-an-acre of mud, on which was piled thousands of racks of ex-War Department equipment. Stacked about eight feet high, and vaguely covered with tarpaulins when it rained, the racks of valve equipment (no transistors in 1948, remember) would be prodded and poked, and when his selection had been made and extricated, my dad and I would struggle back to the bus stop.

Sometimes he would have to make more than one journey, leaving me at the bus stop guarding piles of grey-panelled electric boxes that no-one

else would have dreamt of touching anyway.

(At the time I refer to, dear younger readers, Vandals were people that we had read about in our history books, who destroyed works-of-art, just as the Crusaders did, if they were not clearly "Christian". Damage to other people's property was unthinkable, just after the Second World War, and all the damage that had caused.)

There was an inevitable argument with the driver of the bus. He didn't like us taking up all the luggage-rack space, and half of the gangway with stuff that took ten minutes to load and as long to unload at the other end. Sometimes the driver refused us entry, and we would sit on the equipment and wait an hour for the next bus, hoping that it would be a driver who lived in our village. He would have heard about dad's "machine", and would be looking forward to calling on us to see it working.

When dad finally got the contraption working, we would quite often have to turn it on during the day, when there were no transmissions—just so that some visitor could see the 405-line raster, all green and blank (like me on January 1, every year).

THE GREEN-EYED MONSTER

The "Machine" took pride of place in our tiny living-room. About twelve cubic feet, it was encased in three-ply, and painted ex-War Department battleship grey, with rows and rows of black knobs of various sizes and designs. With an oil-filled glass magnifier strapped to the front of the miniscule green screen and dad mostly round the back of it, making adjustments with screwdriver and torch, it was nevertheless the first television in our village (excluding the squire's, whose splendid pre-war device, with a mirror inside the lid, had been described by a neighbour who cleaned for him).

The total cost of this (just) post-war example of ingenuity was something like eight pounds—a good week's wages in those days. And forever more there were boxes of valves, rack-handles, condensers (now called capacitors), rotary switches, etc, everywhere.

TODAY

What, in this day and age, would draw a whole "village", to wonder and admire? Perhaps, if I could afford it, I could be the first in my small town to construct a chess computer that plugs into the television receiver. There would be some callers, but only to ask where they could buy such a device (with a credit card), and can you get one that works in colour, as if chessmen have ever been anything but black and white.

The pioneering spirit has not disappeared completely, perhaps, but the days of a little man-in-the-street impressing those around him have gone, I fear. It's not what you have done, or what you can do, that impresses nowadays, but how much money you have made out of it.

GOODY BAGS

The surplus stores have gone, but there is a seventies-equivalent. Firms often seem to go into liquidation these days, and the vast amounts of stock they held are auctioned-off. Electronic components from such sources often end up in "Goody Bags" that can be bought from many electronics shops. A good source of cheap components.

A couple of weeks ago I walked down Tottenham Court Road, calling into various electronics shops. I visited Proops Bros' shop, and told the Irish manager of my childhood visits to Kingston-Upon-Thames, to which he laughed, and said it was before his time.

Although mass-production and modern marketing methods have given us (relatively-speaking) fantastic bargains, I think back, and feel that it must have been exciting to buy the complete electronic innards of a Halifax bomber for a pound (get it out yourself).

SELF SERVICE

Our local Tesco store recently got a new manager, who had ideas on shop-layout quite different from his predecessor. Whilst my wife, along with a thousand other housewives, complained bitterly at being unable to find things in their new positions, her old man was gleefully scrabbling about inside a skip at the back of the store.

Having obtained permission from the new man, I found and took away assorted sheets of white-enamelled aluminium (once used as shelves), a couple of double eight-foot fluorescent tube fittings, two eight-by-four laminated bench-tops, and an assortment of chromium-plated grills.

The grills can be used to protect loudspeaker apertures on cabinets that are lugged-about a lot, by groups or discos, for example. Sheet aluminium is always useful to electronics workers. The fluorescent tube fittings would be useful to me in my workshop, if seeing what I am doing would help me understand. (I swear that I could make half of my experimental circuits blindfolded, and my hands are guided from above, by that great Designer of infinite PCB's.) Anyway, a lot of useful stuff from just one skip of "rubbish."

SQUARE one

EVERY constructional article (and many other articles) appearing in EVERYDAY ELECTRONICS contains a circuit diagram. This shows how the components must be interconnected to achieve the required function. The components themselves are for clarity, simplicity and standardisation, represented by "circuit symbols".

This month's beginners page is devoted to the basic and most common types of circuit symbols used in EE.

SEMICONDUCTORS

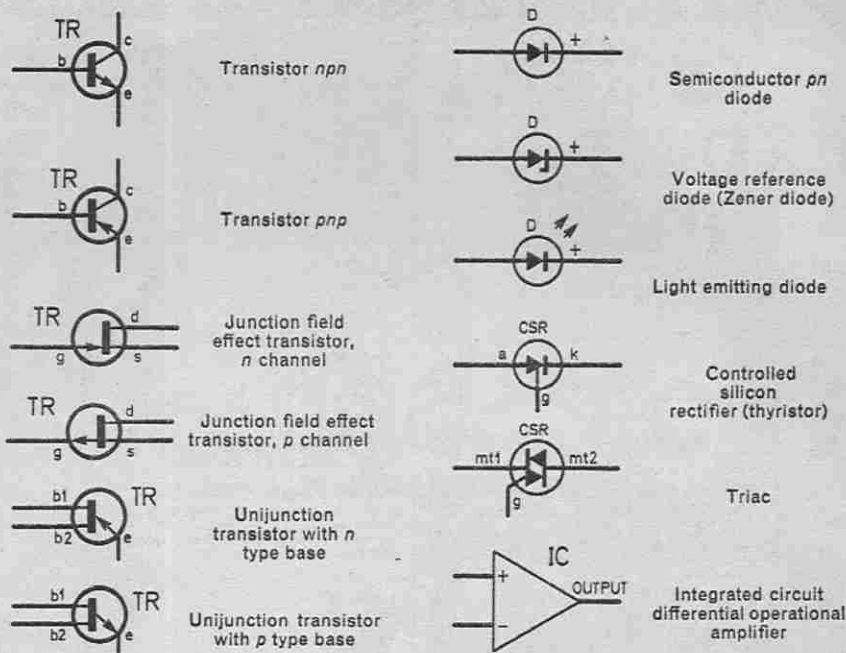

RESISTORS AND POTENTIOMETERS

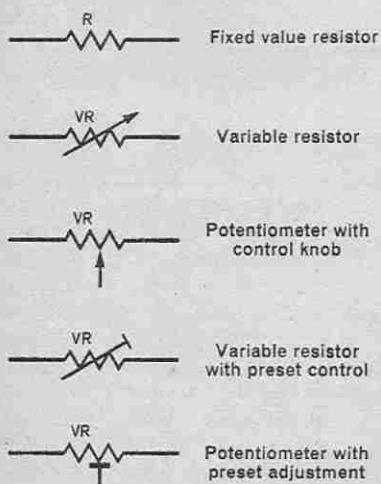

CAPACITORS

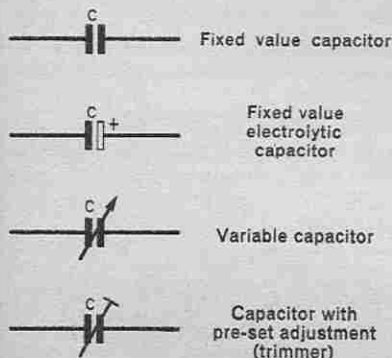

MISCELLANEOUS

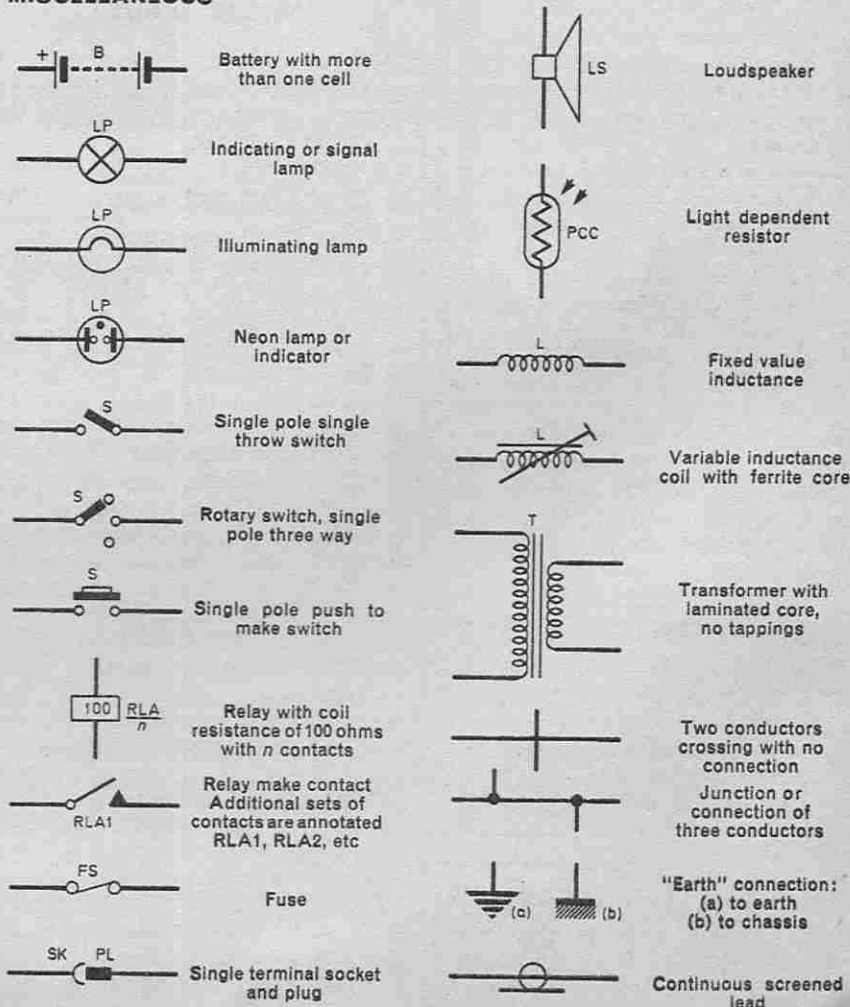

The Extraordinary Experiments of Professor Ernest Eversure

by Anthony John Bassett

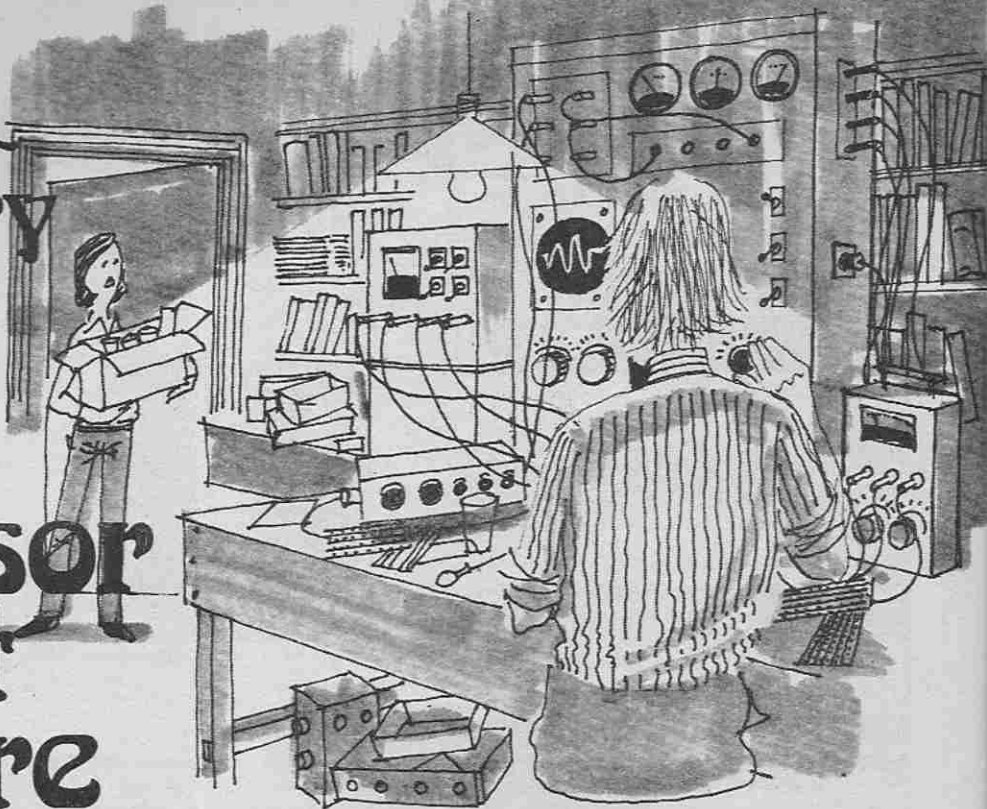

Bob has asked the Prof. to tell him more about possible uses for electronically produced beams in space. They are inside the Prof.'s giant experimental vacuum chamber where, dressed in "space suits", they can carry out experiments in a simulated space environment.

"Before you can begin to comprehend the vast range of possibilities and uses for these beams in the vacuum of space, and other environments such as may be encountered on and near the planets, asteroids, comets and clouds of gas and dust in some regions, it is best to learn something of the properties of the beams themselves, and of their sources."

ENERGY CARRYING BEAMS

"One of the fundamental properties of these beams is that they carry energy. The energy is carried in various forms according to the nature of the beam. Each type of beam emanates from a source which must have an adequate supply of energy with which to produce the beam.

Because the beam takes energy away from the source, it may be necessary to replenish the source with energy where a continuous beam is required. For instance,

where an electron-gun is used as the source of an electron beam, it must be fed with electrical energy from a power supply in order to maintain the beam."

SOURCE EFFICIENCY

"Prof., we learned a little about electron-guns at school, and some electron-guns are better than others. Early electron-guns were not very powerful, then by using a heated cathode, it was found that a more powerful electron beam could be produced. By coating the cathode with chemicals, electron emission was improved further.

But even with the most modern electron guns, some of the power is wasted and does not go into the electron beam. Some of it goes in heat lost by radiation from the hot cathode, some is wasted when electrons are absorbed by the beam-forming electrodes of the electron-gun instead of joining the main beam. There are a number of sources of inefficiency in the system which produces the electron-beam.

Prof., "what I want to know is, how important is the source efficiency of the various types of beam producing apparatus?"

"This is a very important consideration, Bob. Many types of

beam producing apparatus are inefficient and only a very small percentage of energy supplied actually goes into the beam."

LASER SURGEON

But the properties of the beam itself may be so highly important that it is worth while. An example of this may be given in the use of laser-beams in eye-surgery and many other delicate operations. Here it is obviously more important that the laser surgeon should have available a finely focused and controllable beam, and the fact that a few joules of energy are wanted in its production is a lesser consideration in this case.

HIGH POWER BEAMS

It is in the production of high-power beams that efficiency becomes a major consideration. Here even a small change in efficiency means a large loss or gain in power, and the design of high efficiency beam-producing apparatus will be more and more at a premium.

ENERGY CRISIS IN SPACE?

Also, the "wasted" energy which does not go into the beam does not simply disappear. It is

SAXON ENTERTAINMENTS

P.A. & DISCOTHEQUE EQUIPMENT AT INCOMPARABLE PRICES

STANDARD CENTAUR 100W

£249 + Carr £15 & VAT £21.12 Deposit £57.12
12 months @ £21.94 or 24 months @ £12.54

SUPER CENTAUR 200W

£299 + Carr £15 & VAT £25.12 Deposit £68.12
12 months @ £26.19 or 24 months @ £14.90

GXL 200W

With Twin 200 Watt Cabinets

£389 + Carr £15 & VAT £32.32 Deposit £87.32
12 months @ £33.64 or 24 months @ £14.90

GXL WITH PDF BINS (illus)

£417 + Carr £15 & VAT £34.56 Deposit £93.56
12 months @ £36.36 or 24 months @ £20.81

CUSTOM CENTAUR 400/600W WITH FOUR PDF 100A BINS

£699 + Carr & VAT £57.52 Deposit £155.52
12 months @ £60.54 or 24 months @ £34.66

CENTAUR STEREO DISCOS

C/W LIGHT SHOW & DISPLAY TWIN LOUDSPEAKERS & LEADS 100W-600W

20% DEPOSIT CREDIT TERMS



6XL + PDF BINS

- ★ 2 Year warranty
- ★ Full Mixing + Crossfade + Mic/Tape Inputs
- ★ Headphone & Cue Light Monitoring
- ★ Full Range Bass/Treble Controls + Mic Tone
- ★ 4 Channel Soundlight + Display

JUST PLUG IN AND GO!!
SEND TODAY FOR YOUR FREE BROCHURE

MINI DISCO 100 WATT

MONO SYSTEM WITH LOUDSPEAKERS

£179.50 + Carr £15 & VAT £15.56 Deposit £42.06
12 months @ £16.22 or 24 months @ £9.24

P.A. SYSTEMS

2 YEAR GUARANTEE

100 WATT + Carr £15 & VAT £13.99 Deposit £37.89
12 months @ £14.77 or 24 months @ £8.48

- ★ Four Mixing Inputs
- ★ Bass & Treble Controls
- ★ Twin Piezo Horn Columns

200 WATT + Carr £15 & VAT £21.12 Deposit £57.12
12 months @ £22.23 or 24 months @ £12.73

AMPLIFIER UNITS ONLY

AP100 AMPLIFIER £49.50 + Carr £1.50 & VAT £3.96

- ★ 4 Mixed Inputs
- ★ Bass/Treble Controls
- ★ Vynide Case
- ★ 100 Watts Output

AP200 AMPLIFIER £89.50 + Carr £1.50 & VAT £7.16

- ★ Six Mixed Inputs
- ★ Three Sets Bass/Treble
- ★ 200 Watts Output
- ★ Slave Socket



NEW SAXON KLAXON

UK Police Hawaii 5.0
US Police Destroyer
Four Sirens in one package £18.75 + VAT £1.50
Individual Sirens £8.50 + VAT 68p



NEW SAXON SMASH

ALIEN VOICE SIMULATOR
Add a new dimension to your disco with this press button effect unit
Insert between mic & amp £8.50 + VAT 68p



PLUTO PROJECTORS

P140 £38.50 150 WATT INC WHEEL
P250 £69.90 + VAT £5.59
250 watt Q.L. inc Cassette/Wheel (Full range of wheels - ask for list)



ELECTRECT MIC DI501 £18.50* TOP QUALITY UNIT + VAT £2.31

ECM105 LOW COST ELECTRECT CONDENSER MIC + VAT 62p £5.00*

MELOS CASSETTE ECHO-REVERB UNIT - Twin input VARIABLE SPEED & DEPTH + VAT £5.52 £69.00

AMPLIFIER MODULES

- 30Hz-20kHz
- Short/open circuit proof
- Top grade components
- Suit most mixers



SA308 8 ohms 30W 45V £10.75* + £1.34
Supply for 2 modules £11.90* + £1.49
SA604 4 ohms 50V £14.50 + £1.16
Supply for 1 or 2 modules £14.95 + £1.20
SA608 8 ohms 60W 65V £15.50 + £1.24
Supply for 1 or 2 modules £14.95 + £1.20
SA1204 4 ohms 120W 75V £17.50 + £1.40
Supply for 1 module £14.95 + £1.20
SA1208 8 ohms 120W 95V £21.00 + £1.68
Supply for 2 modules £24.75 + £1.98

DISCO MIXERS - COMPLETE OR MODULAR



MONO OR STEREO WITH AUTOFADE
Available complete and ready to plug in or as an easy to connect module with all controls except monitor switch already fitted - full instructions supplied.

FEATURES INCLUDE:
Twin Deck - Mic & Tape Inputs - Wide range bass & treble controls - Full headphone monitoring - Crossfade - Professional standard performance.

COMPLETE MIXERS (with case)
Mono mains £45.75 + £3.66
Stereo mains £63.75 + £5.10
MODULES
Mono module £27.50 + £2.20
Stereo module £37.50 + £3.00
Panel £3.95 + 32p
Kit of knobs/sockets etc £5.50 + 44p

D.I.Y. MODULES FOR P.A. SYSTEMS MONO/STEREO

Input Modules
Mono PCB only £6.50 + 52p
Stereo PCB only £10.50 + 84p
Mono C/W Front panel £9.50 + 76p
Stereo C/W Front panel £13.75 + £1.10
Mixer/Monitor Modules
Mono PCB only £6.50 + 52p
Stereo PCB only £10.50 + 84p
Mono C/W Front panel £9.50 + 76p
Stereo C/W Front panel £13.75 + £1.10
Powersupply to suit £9.50 send for full details: +VAT 76p



Make your own mixer Mono/Stereo up to 20 channels accept all inputs available as PCB only or complete on front panels

SOUND-TO-LIGHT UNITS



3 CHANNEL - 3kW £29.50
 Operates from 1W upwards +VAT £2.36
 Bass/middle/treble/master controls + £1 carr. complete
Module only £19.75 + VAT £1.58
Panel £2.95 + VAT 24p
4 CHANNEL - 4 kW SOUNDLIGHT SEQUENCER (illus) £39.50 Carr £1 + VAT £3.16
 Dimmer on each channel
 Automatic sound light level
 Logic circuitry throughout
Module only £26.75 + VAT £2.14
Panel £2.95 + VAT 24p

MOTOROLA PIEZO HORNS £4.99 YES!! + VAT 40p

FUZZ LIGHTS Red, Blue, Yellow, Green £23.90 + VAT £1.91

HEAVY DUTY SPOT BANKS - MATCHES LOUDSPEAKERS
3 way 600W £35.50 4 way 800W £39.50 Carr £2 + VAT £2.84 + VAT £3.16

100W SPOTS
Red - Blue - Amber - Green £1.50 ea. + VAT 12p

CABINET FITTINGS
ICI Vynide 50" wide £3.50m + VAT 28p
Kick-res grille 50" wide £3.50m + VAT 28p
Netlon kick proof 24" wide £3.50m + VAT 28p
Corners/feet recess plates 15p ea. + VAT 1p
Recess handle 45p + VAT 3p
Bar handles £2.50 + VAT 20p
Jack plugs/sockets 25p + VAT 2p

LOUDSPEAKER CABINETS - COMPLETE WITH LEADS

- Fitted with 100W 17,000 Gauss drivers
- Rugged cabinets with aluminium trim - black vynide etc
- Lifetime guarantee on main drive unit

Standard 100W 1 x 12 (48 x 41 x 24) £39.00 Carr £3 + VAT £3.12
Large 100W 1 x 12 (65 x 48 x 24) £49.50 Carr £3 + VAT £3.96
P.A. 1 x 12 (+ 2 Piezos) (80 x 38 x 24) £66.50 Carr £3 + VAT £5.32
P.A. 2 x 12 200W (100 x 38 x 24) £99.00 Carr £3 + VAT £7.92
Disco 2 x 12 200W (80 x 63 x 24) £85.00 Carr £3 + VAT £6.80
PDF reflex bin (80 x 40 x 41) £95.00 Carr £3 + VAT £7.60

PDF100 Reflex Bin - Twin Horns - Integrated Slave Amplifier - Accepts mono or stereo signals
 Use with all types of mixer
 Pan and volume controls
 Send for details £130 Carr £3 Deposit £28.40 + VAT £10.64

100W Chassis loudspeaker £25.75 + VAT £2.86

All prices subject to 8% VAT except where asterisked (12.1% Shop premises open Tues to Sat 9 am - 5 pm Lunch 12.30 - 1.30 pm Mail order dept open Mon to Fri 10 am - 4 pm Ring 01-684 6385

TO ORDER
By Post Send your requirements with cheque crossed P.O. or 60p COD charge to address below or just send your Access or Barclaycard Number NOT THE CARD.

By Phone You may order COD, Access or Barclaycard. Post & Packing 50p on all orders except where stated.

SAXON ENTERTAINMENTS
327 Whitehorse Road, Croydon, Surrey.
All Enquiries Large SAE Please Brochures on request

MANCHESTER DISCO CENTRE, 237 DEANS GATE, MANCHESTER
CALLERS ONLY - (061) 832 8772 - COMPLETE UNITS ONLY

AS REVIEWED IN HOBBY ELECTRONICS

The **teleplay** Colour Programagame

ENGLANDS MOST POPULAR TV GAME KIT

now back in stock at reduced prices



TELEPLAY have produced a new product of easy to assemble cartridge games, for you and all your family, that will not go out of date. Just ADD each new cartridge, as it becomes available, and your colour video centre will be up to date the Teleplay way. You will save pounds in the long run. Works OK on Black and White TV.

The Teleplay Kit consists of a Professional Finished Inject Mounted Box — Joystick Hand Controls — one cartridge which consists of 10 games — Football, Tennis, Solo Squash (1 & 2 players), Shoot etc. Mains Adaptor. All holes are pre-drilled — No Special equipment required. You'll be surprised how easy it is to assemble this professional kit! Instruction Manual supplied separately at 0.45p. TELEPLAY GIVES YOU TWICE THE FUN BUILDING AND PLAYING THE MOST PROFESSIONAL TV GAME KIT EVER OFFERED.

Electrical knowledge is not a necessity to assemble this project — just simple soldering.

Every 3 months a NEW game will become available to you and those already under production include Submarines, Space War, Wipe Out and many more. The price of these will vary from £12 to £19 depending upon the complexity of the game. All Cartridges fully assembled.

We offer all this to you for ONLY **£23.90** (KIT) + 8% VAT Fully Assembled **£32.90** + 8% VAT

All parts fully guaranteed.

EX-STOCK IMMEDIATE DELIVERY

Main Console has 3 Facility Handicapping Switches.

- STUNT CYCLE 4 games — Cartridges and Hand Controls — **£12.90**
 - WIPE OUT — 6 games — **£11.90**
 - TANK BATTLE — Cartridge and Hand Controls — **£18.90**
 - ROAD RACE — 2 games — Cartridge — Controls already with basic kit — **£10.90**
- + 8% VAT

EUROPE'S LARGEST STOCKIST OF TV GAME COMPONENTS.

COMP IS AN APPOINTED DEALER FOR COMMODORE, EXIDY, APPLE, NASCOM, OHIO, GI, ATARI, TELEPLAY & ITHACA. Please make cheques and postal orders payable to COMP, or phone your order quoting BARCLAYCARD or ACCESS number.

COMP COMPUTER COMPONENTS
VISIT OUR NEW SHOP AT 1 WALLCOT BUILDINGS, LONDON ROAD, BATH, AVON.

14 STATION ROAD, NEW BARNET, HERTFORDSHIRE TEL: 01-441 2922 (Sales) 01-449 6596
CLOSE TO NEW BARNET BR STATION — MOORGATE LINE TELEX: 298755
OPEN — 10am to 7pm — Monday to Saturday CONTINUOUS DEMONSTRATIONS
(PART OF THE COMPSHOP LTD. GROUP)

New Heathkit electronic test equipment course.

- Section 1. Analogue and digital meters.
- Section 2. Oscilloscopes.
- Section 3. Frequency generation and measurement.
- Section 4. Special measuring instruments.

New Heathkit car electrical systems course.

- Section 1. Electrical principles of the car.
- Section 2. Starting system fundamentals.
- Section 3. Car charging systems.
- Section 4. Accessories and body electrical.

Two new self-instruction courses from Heathkit. Based on step-by-step programmed instructions, they let you learn at your own pace in your own home.

Each course is complete and contains audio/visual material, text, and parts for 'hands on' experiments with the optional Heathkit experimenter trainer. So all you need is a cassette player and the will to learn.

Full details of Heathkit courses are available in the Heathkit catalogue, together with hundreds of kits you can build for yourself — computers, oscilloscopes, transceivers etc. ... Send for your copy now.

There are Heathkit Electronics Centres at 233 Tottenham Court Road, London (01-636 7349) and at Bristol Road, Gloucester (0452 29451). Registered in England, No. 606177.

Soldering Iron offer FREE

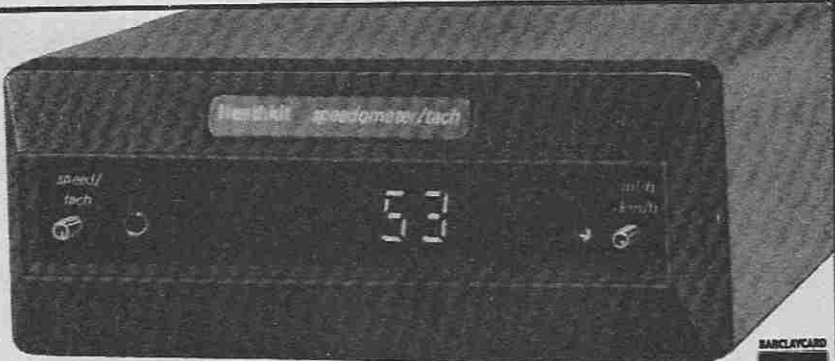

New Heathkit CI 1265 Digital Tach/Speedometer.

Push-button digital readout. Displays engine speed/rpm. Accurate to 1 mph or rpm variations of 100.

To: Heath (Gloucester) Limited, Dept. EE17/79 Bristol Road, Gloucester, GL2 6EE.
Please send a copy of the Heathkit catalogue. I enclose 20p in stamps.
Please send a copy of the Computer Brochure. I enclose 20p in stamps.

Name _____
Address _____

N.B. If you are already on the Heathkit mailing list you will automatically receive a copy of the latest Heathkit catalogue without having to use this coupon.

When you receive your catalogue you will get details of this free offer.



HEATHKIT

HEATH
Schlumberger

usually produced as heat, and consequently some part of the apparatus gets hotter. In high-power equipment some arrangement must be made to remove this surplus energy, and cooling systems are very important means of doing so.

High power lasers on Earth are often cooled by feeding in cold water from the nearest tap. Hot water comes out and goes down the drain.

In a spacecraft this would not usually be possible, as the entire water supply might be heated up. The problem then becomes: How to dissipate this surplus energy from the craft.

Suppose for example that a spacecraft carries a microwave beam generator of 95 per cent efficiency, and that the maximum beam power is limited by the ability of the heat dissipators to remove the 5 per cent of the

power used, in the form of heat waste.

If the equipment develops a fault which reduces the efficiency to 80 per cent, this would mean that the same full beam power would give a waste heat dissipation nearly five times greater than the permissible level. To keep waste heat dissipation within tolerable levels, it would be necessary to reduce beam power to less than a quarter of its normal strength at maximum. Otherwise, the spacecraft might heat up—or some components burn out.

EFFICIENCY

Changes in efficiency of such apparatus could cause a real energy crisis in space, as such a small change in efficiency as 15 per cent would result, in the example, in a need to reduce full power in a ratio quite out of pro-

portion to safe operation. Maintenance of the efficiency of apparatus in space will obviously be an important task for space-maintenance engineers!

With the expansion of the various space programmes, the design of spacecraft and equipment of higher and higher efficiency will also be an important task for design engineers here on earth."

"Prof. I find this function of beams as carriers of energy in various forms fascinating, I think I'll try to find out more about all the various forms of energy which can be carried by beams!

But do these energy beams have many other interesting properties?"

"Yes Bob, there are lots of interesting things which are really worth knowing about, for instance..."

To be continued



Casting Your Vote

As I write we have just elected a lady Prime Minister, the remarkable Mrs. Thatcher, and while anyone in business must not openly express their political persuasions, I naturally wish her every success in the formidable task ahead.

As I cast my vote on May 3rd, I could not help thinking what a cumbersome process it all is. I believe in some parts of the world, including the United States, this is already being done electronically. In other words, the voter goes into the polling booth and is confronted with the names of the candidates and alongside each one is a button. He simply presses the button, against his choice. It must save a few thousand man (sorry) person, hours, and in addition if the last vote is cast at 10 p.m., the result would be known by 10.05 p.m.

But no, cynic that I am, I can just imagine that there would be a couple of dry joints or a burnt-up chip somewhere in the machine and bingo, we would find we had elected the National Front or the Communist Party!

If you think that is far fetched, only last week a chap was drawing some

money out from one of these money dispensers; he tapped out £15 on the keys and out came £195!! I understand that the queue that formed up behind him was nearly a mile long. Needless to say, by the time I reached the offending apparatus it had been switched off!

In The Picture

The other day as I was locking up my establishment, a last minute customer rushed up and as usual I asked him what he required, because if it was something simple I would go back and get it. He said he wanted all the parts to build a colour television. I had to break it to him that not only would I not have them all, but doubted whether any supplier could.

He sighed and said "I am wanting to make this by following a series of articles in the magazine *Television*. Wouldn't it be wonderful if there was just one supplier to whom I could send £250 and he would send me all the bits needed?" I agreed with him, and then gently told him the facts of life.

I told him that due to inflation, everyone had to carry smaller and smaller stocks, and therefore tended to con-

centrate on a smaller and smaller segment of the whole electronic range. It therefore follows, that in order to obtain his requirements he would have to deal with five or six suppliers. What it boils down to is this, knowing where to find suppliers is basic to the successful pursuit of any hobby and this applies particularly to electronics.

Unwritten Law

Most of you are familiar with Ohm's law and similar laws governing electronics but do you know Murphy's law? Murphy's law states that if anything can go wrong it probably will, and the more serious the consequences, the more likely it is to happen.

I was witness to a splendid example of this when I went to watch my friends at Home Radio move, and give them moral support. The office they were moving into had a peculiar door which was only twenty inches wide. They therefore decided that the only way to get their desks into the building, was to haul them up one flight on ropes and take them through the kitchen window. After partially dismantling the window they managed to do this, only to find the desk was too wide to go up the next flight of stairs. "Ah" they said, we will have to dismantle it.

Now all their desks had specially made formica tops. In the case of this particular desk, the carpenter had screwed on the top and then stuck the formica over the screw heads! They went back to their former premises examined another desk, and found to their astonishment that it all came to bits. They had nine desks in total, out of the nine, only one would not come to pieces and that was the one they tried to move! Murphy strikes again!

Newnes

constructors projects



- ☆ More books in our series for the electronics enthusiast.
- ☆ There are now eight titles available at £2.25 each (US \$5.25)

Electronic Projects in the Workshop *R.A. Penfold*
 Electronic Projects in Music *A.J. Flind*
 Electronic Projects in Audio *R.A. Penfold*
 Electronic Projects in Hobbies *F.G. Rayer*

Electronic Projects in the Car *M. George*
 Electronic Game Projects *F.G. Rayer*
 Electronic Projects in the Home *Owen Bishop*
 Projects in Radio and Electronics *Ian R. Sinclair*

Each book contains a collection of constructional projects, giving details of how the circuit works, how it may be assembled and how setting-up and trouble-shooting problems may be solved. The skilful use of colour in the text helps to clarify circuit operation, and circuit board layouts are suggested. Shopping lists of components are included.

Write for a free colour brochure about all our hobby books to

Newnes Technical Books

Borough Green, Sevenoaks, Kent TN15 8PH



Clef Kits



Designer approved quality kits for Electronic Musical Instrument Construction.

JOANNA 72 & 88 PIANOS
 Six and 7½ Octave Electronic Pianos with unique Touch Sensitive Action, as used in the P.E. JOANNA, which electronically simulates piano key inertia—a feature not available in any other design. A new physical layout has been adopted to simplify construction.

P.E. STRING ENSEMBLE
 The only kit available to the proven A. J. Boothman Design for this versatile String Machine.

Sent S.A.E. to:

Clef Products (Dept E.E.)
 16 Mayfield Road, Bramhall, Cheshire SK7 1JU.

SINCLAIR PRODUCTS PFM200 £49-48 case £3-24, adaptor £3-24, connector kit £10-58. Microvision TV UK model £89-95, mains adaptor £6-73. PDM35 £28-95, mains adaptor £3-19, case £3-19, case £3-19. DM350 £68-95, DM450 £97-95, DM225 £49-45, rechargeable batte. £7-50, mains adaptor £3-70, case £8-45. Enterprise prog calculator with accessories £22-95. Cambridge prog calculator £12-13, prog library £4-45, mains adaptor £3-20.

CSC MAX100 freq meter £75-40.

CAI SCOPE oscilloscope send see for data or see the Calscope advert in this magazine. Super 6 £174. Super 10 £236.

COMPUTER GAMES Star chess £59. Chess challenger 7 £79. Checker challenger 4 £84. Checker challenger 2 £59. Atari Video computer £138. Cartridges £13-45.

COMPONENTS 1N4148 14p. 1N4002 2-9p. 741 15p. bc182b, bc183b, bc184b, bc212b, bc213b, bc214c 4-5p. Resistors 1W 5% E12 10R to 10M 1p, 0-8p for 50+ of one value. 16V electrolytics 5-1/2/5/10/22uf 5p. 100uf 6p, 100uf 10p. 1 1b FeC1 £1-13. Dale pen 79p. 40 sq ins pcb 80p.

TV GAMES AY-3-8500 + kit £8-95. Rifle kit £4-95. AY-3-8510 + kit £15-70. Stunt cycle chip + kit £15-70. AY-3-8503 chip £3-90.

TRANSFORMERS 6-0-6V 100ma 74p, 11a £2-35, 6-3V 121 £1-89, 9-0-9V 75ma 74p, 1a £2, 2a £2-00, 12-0-12V 100ma 90p, 1a £2-49.

IC AUDIO AMPS with pcb. JC12 6W £1-80. JCS0 10W £2-95.

BATTERY ELIMINATORS 3-way type 6/7/9V 300ma £2-95. 100ma radio type with press-studs 9V £3-35, 9V+9V £4-50. Car converter 12V input, output 4 1/2/7 1/2/9V 800ma £2-50.

BATTERY ELIMINATOR KITS 100ma radio types with press-studs 4 1/2V £1-40, 6V £1-40, 9V £1-40, 4 1/2V+4 1/2V £1-80, 6+6V £1-80, 9+9V £1-80. Stabilized 2-way types 3/4/6/7/9/12/15/18V 100ma £2-80, 1 Amp £8-40. Stabilized power kits 2-12V 100ma £2-80, 2-30V 1A £8-95, 2-30V 2A £10-95.

12V car converter 8 1/2/9V 1A £1-35.

T-DEC AND CSC BREADBOARDS s-dec £3-80, t-dec £4-02, u-deca £4-40, u-decb £8-73, exp1b £2-48, exp300 £8-21, exp350 £3-40, exp325 £1-73.

BI-PAK AUDIO MODULES 450 £23-31. AL60 £4-80, PA100 £18-95, spm80 £4-47, bm80 £5-95. Stereo 30 £23-12. AL30 £3-95. PA12 £7-60, PS12 £1-39, MA60 £35-44.

SWANLEY ELECTRONICS
 Dept. EE, 32 Goldsrl Rd., Swanley, Kent Post 30p extra. Prices include VAT. Official and overseas orders welcome. Lists 20p post free.

a digitizer adds another dimension

The Bit Pad computer digitizer converts graphic information into digital form for direct entry into a computer. By touching a pen like stylus or a cursor, to any position on a drawing, diagram, photograph, or other graphic presentation, the position co-ordinates are converted to digital equivalents.

- Bit Pad interfaces with almost any micro computer.
- Bit Pad consists of a 15" sq. digitizer tablet (11" sq. active area), a stylus, and a controller cabinet.
- Bit Pad costs only £450 (excluding VAT). Fill in the coupon and we will send you full information and details.

Terminal Display Systems Ltd., Hillside, Whitebirk Industrial Estate, Blackburn BBI 5SM, Lancs, England

Send to: Department CPED, Terminal Display Systems Ltd., Hillside, Whitebirk Industrial Estate Blackburn BBI 5SM, Lancs, England.

Name

Address



Microscope, Network Architecture
 Structural, Mechanical, Electrical
 Con... Exam Electrical
 Teaching... nional research
 Measuring... ment Military
 Menus Market re... Geographical
 Cartographic Design Geol... Town Planning
 Orthodontics Design Geol... istics Traffic
 Radiology Microscopy Art... Architecture
 Structural Civil M... Electrical
 Process Control Gra... rking
 Teaching Games... arch
 Measuring Biolog... ary
 Menus Market resea... cal
 Archeological Ad... g
 Design Geology...

MAGENTA ELECTRONICS LTD.

E.E. PROJECT KITS

Make us YOUR No. 1 SUPPLIER of KITS and COMPONENTS for E.E. Projects. We supply carefully selected sets of parts to enable you to construct E.E. projects. Appropriate hardware—nuts, screws, I.C. sockets are included. Each project kit comes complete with its own FREE COMPONENT IDENTIFICATION SHEET. We supply—You construct. PRICES INCLUDE CASES UNLESS OTHERWISE STATED. BATTERIES NOT INCLUDED. "PROJECT INSTRUCTIONS ONLY SUPPLIED AS EXTRA 39p EACH".

INTRUDER ALARM. May 79. £13.65. Less Est. Buzzer & Lamp and Loop Components.
SHORT WAVE CONVERTER. May 79. £12.99 inc. case.
THERMOSTAT. 'PHOTO' SOLUTIONS. May 79. £12.75. Less socket, tube and grease.
SHAVEN INVERTER. April 79. £10.99.
TRANSISTOR TESTER. April 79. £3.18.
TOUCH BLEEPER. April 79. £2.99.
ONE TRANSISTOR RADIO. Mar. 79. With Amplifier & Headset. Less case. £5.84.
TIME DELAY INDICATOR. Mar. 79. £4.98.
VERSATILE POWER SUPPLY. Mar. 79. £7.36.
CHOKO WARNING DEVICE. Apr. 79. £6.05 case T.T.O.
AUDIO MODULATOR. Feb. 79. £1.44 less case and pins.
LW CONVERTER. Feb. 79. £3.98, case £1.49.
THYRISTOR TESTER. Feb. 79. £2.98.
ADJUSTABLE PSU. Feb. 79. £21.54. Case (horizontal layout) £3.54 extra.
'I'M FIRST'. Jan. 79. £3.98 (less case).
LIGHTS REMINDER. Jan. 79. £4.16.
CONTINUITY TESTER. Jan. 79. £2.91 less case.
FUZZ BOX. Dec. 78. £4.98.
VEHICLE IMMOBILISER. Inc. PCB. Dec. 78. £3.77 case extra 71p.
WATER LEVEL ALERT. Nov. 78. £4.82.
'HOT LINE' GAME. Nov. 78. £4.23 less case & rod.
AUDIO EFFECTS OSCILLATOR. Nov. 78. £2.75 inc. board.
SUBSCRIBERS TELE TEL METER. Nov. 78. £15.95 case extra £3.75.
FUSE CHECKER. Oct. 78. £1.51.
C.MOS RADIO. Oct. 78. £7.79.
TREASURE HUNTER. Oct. 78. £14.44 less handle & coil former.
GUITAR TONE BOOSTER. Sept. 78. £4.13 inc. p.c.b.
SOUND TO LIGHT. Sept. 78. £5.99.
FILTER. £1.25.

SLAVE FLASH. Aug. 78. £2.66 less SK1.
LOGIC PROBE. July 78. £2.29.
IN SITU TRANSISTOR TESTER. June 78. £4.73.
VISUAL CONTINUITY CHECKER. June 78. £2.98 inc. probes.
FLASHMETER. May 78. £11.29 less calc and diffuser.
POCKET TIMER. April 78. £2.82.
WEIRD SOUND EFFECTS GENERATOR. Mar. 78. £3.64.
CHASER LIGHT DISPLAY. Feb. 78. £19.78 inc. p.c.b. case extra £3.54.
AUDIO VISUAL METRONOME. Jan. 78. £4.22.
RAPID DIODE CHECK. Jan. 78. £1.97.
AUTOMATIC PHASE BOX. Dec. 77. £9.45 inc. p.c.b.
VHF RADIO. Nov. 77. £11.48.
ULTRASONIC REMOTE CONTROL. Nov./Dec. 77. £13.75.
TREASURE LOCATOR. Oct. 77. £3.77 case extra. £2.32. Less handle, etc.
ELECTRONIC DICE. March 77. £4.20.
SOIL MOISTURE INDICATOR. June 77. £3.09 inc. probe.
PHONE DOORBELL REPEATER. July 77. £5.27.
SHORT WAVE RECEIVER. Aug. 77. £10.98 case extra £1.49.
CAR BATTERY STATE INDICATOR. Sept. 78. £1.54 less case inc. PCB.
R.F. SIGNAL GENERATOR. Sept. 78. £15.30 less case.
TRANSISTOR TESTER. Oct. 77. £5.34 case extra £3.55.
ELECTRONIC TOUCH SWITCH. Jan. 78. £1.44.
ADD-ON CAPACITANCE UNIT. Sept. 77. £4.48.
A.F. SIGNAL GENERATOR. Aug. 78. less dial. £10.99.
QUAGMIRE. July 78. £7.51 less case pins & counters.
CATCH-A-LIGHT. Mar. 78. £6.74.
CAR SYSTEM ALARM. Feb. 78. £4.74.
HEADPHONE ENHANCER. Jan. 79. £2.24.
PASSIVE MIXER. Oct. 78. £2.68.
MIC AMP. Dec. 78. £2.19.
AUDIBLE FLASHER. Dec. 78. £1.08.

LATEST KITS: S.A.E. OR 'PHONE FOR PRICES

1979 ELECTRONICS CONSTRUCTORS CATALOGUE

MAGENTA'S CATALOGUE HAS BEEN CAREFULLY DESIGNED FOR E.E. READERS. PRODUCT DATA AND ILLUSTRATIONS MAKE THE MAGENTA CATALOGUE AN INDISPENSABLE GUIDE FOR THE CONSTRUCTOR. CATALOGUE INCLUDES CIRCUIT IDEAS FOR YOU TO BUILD.

NO MINIMUM ORDER—ALL PRODUCTS ARE STOCK LINES. FIRST CLASS DELIVERY OF FIRST CLASS COMPONENTS. SEND FOR YOUR COPY AND SEE HOW EASY IT IS TO USE THE MAGENTA CATALOGUE! WRITE TODAY ENCLOSING 4 x 9p STAMPS.

MAGENTA ELECTRONICS LTD.

EG6, 98 CALAIS ROAD, BURTON-ON-TRENT, STAFFS., DE13 0UL. 0283-65435. 9-12, 2-5 MON.-FRI.

MAGENTA gives you FAST DELIVERY BY FIRST CLASS POST OF QUALITY COMPONENTS & KITS. All products are stock lines and are new & full specification. We give personal service & quality products to all our customers—HAVE YOU TRIED US?

DOING IT DIGITALLY

Complete Kit IN STOCK NOW for FAST DELIVERY by FIRST CLASS POST. All top quality components as specified by EVERYDAY ELECTRONICS. Our kit comes complete with FREE TTL AND COMPONENT IDENTIFICATION CHART. £22.95 for the TTL TEST BED. £3.75 for ADDITIONAL COMPONENTS for first 6 months.

NEXT 6 MONTHS PARTS:—BPX25, £1.29. ORP12, 69p. 555, 45p. 80 ohm Speaker £1.16. 2N2926, 11p. 0.1uF, 9p. Resistors, 11p. 100uF 10V, 8p. 7404, 27p. 7408, 27p. 7410, 26p. 7413, 48p. 7430, 26p. 7447, £1.10. 7454, 36p. 7490, 59p. 7492, 88p.

MULTIMETER TYPE 1. 1,000 o.p.v. with probes. 2" x 3 1/4" x 1". £5.99.

MULTIMETER TYPE 2. 20,000 o.p.v. with case and probes. 5" x 3 1/4" x 1 1/2". £12.95.

ANTEX X25 SOLDERING IRON 25W. Ideal for electronics. £3.98.

SOLDERING IRON STAND. Antex ST3. £1.24.

SPARE BITS. 2.3mm, 3mm, 4.7mm. 59p.

DESOLDER BRAID. 62p.

HEAT SINK TWEEZERS. 13p.

DESOLDER PUMP. Easy to use. £5.88.

F.M. INDOOR AERIAL. 49p.

TELESCOPIC AERIAL. 120 c.m. £1.89.

TELEPHONE PICK-UP COIL. 65p.

CRYSTAL MICROPHONE INSERT. 57p.

SPEAKERS MINIATURE. 8 ohm 79p. 64 ohm 89p. 80 ohm £1.16.

PILLOW SPEAKER. 8 ohm 98p.

6" ROUND SPEAKER. 8 ohm, 5W, £1.98.

CABINET SPEAKER. 8 ohm, 5W, 5" speaker. Cabinet 10" x 7" x 4". £8.75.

RE-ENTRANT HORN SPEAKER. 8 ohm S.W. Horn dia. 5 1/2". £4.79.

EARPIECES. Crystal 38p. Magnetic 15p.

STETHOSCOPE ATTACHMENT. Fits our earpieces 58p.

BUZZER. 6V 74p. 12V 77p.

MONO HEADPHONES. 2K. Padded. Superior. Sensitive. £2.98.

STEREO HEADPHONES. 8 ohm. Padded. £3.85.

INTERCOM. 2 Station. Desk. £6.45.

MICROPHONE DYNAMIC. 600 ohm. Cassette type. £1.25.

DENTISTS MIRROR. Adjustable. £2.15.

JEWELLERS EYEGLASS. 98p.

TRIPLE MAGNIFIER. £1.48.

HAND MAGNIFIER. 3" Lens. £2.98.

SPECTACLE MAGNIFIER. Clips on to spectacle frame. £3.98.

ILLUMINATED MAGNIFIERS. 1 1/2" lens 99p. 3" lens £2.75.

SIGNAL INJECTOR. £4.98.

POCKET TOOL SET. 20 piece. £3.72.

SCREWDRIVER SET. Six piece. £1.98.

O MAX PUNCH. 1" £1.94. 1 1/2" £2.17. 1 1/4" £2.27.

DRILL 12V. Hand or stand use. £10.38. Stand £5.98.

CAPACITANCE SUBSTITUTION BOX. Nine values. 100pF—0.22uF. £2.75.

QUICKTEST. Mains connector. £5.30.

PLUG IN POWER SUPPLY. 6, 7.5-9V d.c. 300mA. £3.58.

SPRINGS—SMALL. 100 Ass'd. 98p.

CROC CLIP TEST LEAD SET. 10 leads with 20 clips. 98p.

DIMMER SWITCH. 240V. 800W. £3.75.

TRADITIONAL STYLE BELL. 3-8V. 70mm chrome gong. £1.45.

UNDERMOUNT BELL. 4-10V. Smart. Dia. 70mm. £1.78.

TOWERS INTERNATIONAL TRANSISTOR SELECTOR. New edition. £5.65.

F.M. TUNER CHASSIS. 88-108MHz. gV d.c. £8.35.

MORSE KEY. High speed. £3.40.

PANEL METERS. 60 x 45mm. Modern style. 50uA, 100uA, 1mA, 1A, 25V d.c. £5.75.

NIGHT LIGHT. Plug type. 98p.

CONNECTING WIRE PACK. 5 x 5yd. coils. 50p.

VERO SPOT FACE CUTTER. 96p.

VERO PIN INSERTION TOOL. 0-1" £1.33. 0-15" £1.32.

RESISTOR COLOUR CODE CALCULATOR. 19p.

TEACH-IN-78

COMPLETE KIT £14.98

INCLUDES FREE COMPONENT IDENTIFICATION CHART. TEACH-IN REPRINTS EXTRA 39p EACH PART. ALL 12 PARTS AVAILABLE.

EVERYDAY ELECTRONICS FEB 79

G.P. POWER SUPPLY VARIABLE 0-20V 0-1A

WITH CALIBRATED VOLTMETER AND AMMETER ALL COMPONENTS AND HARDWARE £21.54. CASE (Horizontal Layout) £3.54 EXTRA.

OFFICIAL ORDERS FROM SCHOOLS, UNIVERSITIES ETC. WELCOME. MAIL ORDER ONLY.

ALL PRICES INCLUDE VAT AND FIRST CLASS POST. ADD 25p TO ORDERS UNDER £5. ENQUIRIES MUST INCLUDE S.A.E.



TOPS THE PACK!

- COMPONENTS** — Now over 1,000 types in stock!
- KITS** — See the new range of low-cost 'ELEKITS'.
- SERVICE QUALITY PRICES** — 1st Class same day despatch.
- MAGAZINE PROJECTS** — All guaranteed products.
- S.A.E. for list of EE projects** — Many reductions!
- Trouble-free!

I enclose 30p*, please send catalogue.

Name _____

Address _____

*Refundable with future orders over £5.00.



EVERYBODY'S DOING IT!

Doing what? Sending for the latest Home Radio Catalogue. It's the most comprehensive components catalogue you can get. 128 pages, about 2,500 items listed, and profusely illustrated. Now only £1.25 with a free bargain list. Send your cheque or postal order now.

HOME RADIO COMPONENTS LTD. Dept. EE, 234 London Road Mitcham, Surrey CR4 3HD

LOOK!

Here's how you master electronics.

.... the **practical** way.

This new style course will enable anyone to have a real understanding by a modern, practical and visual method. No previous knowledge is required, no maths, and an absolute minimum of theory.

You learn the practical way in easy steps mastering all the essentials of your hobby or to further your career in electronics or as a self-employed electronics engineer.

All the training can be carried out in the comfort of your own home and at your own pace. A tutor is available to whom you can write, at any time, for advice or help during your work. A Certificate is given at the end of every course.

1. Build an oscilloscope.

As the first stage of your training, you actually build your own Cathode ray oscilloscope! This is no toy, but a test instrument that you will need not only for the course's practical experiments, but also later if you decide to develop your knowledge and enter the profession. It remains your property and represents a very large saving over buying a similar piece of essential equipment.

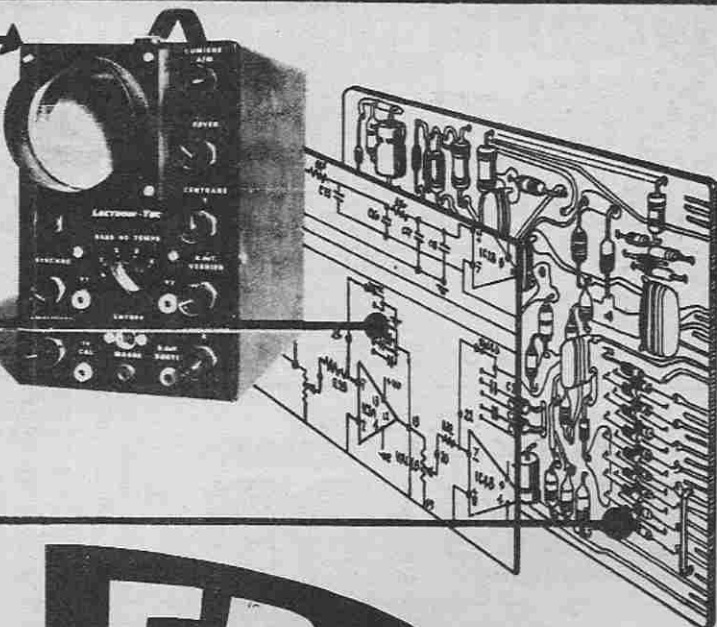

2. Read, draw and understand circuit diagrams.

In a short time you will be able to read and draw circuit diagrams, understand the very fundamentals of television, radio, computers and countless other electronic devices and their servicing procedures.

3. Carry out over 40 experiments on basic circuits.

We show you how to conduct experiments on a wide variety of different circuits and turn the information gained into a working knowledge of testing, servicing and maintaining all types of electronic equipment, radio, t.v. etc.

4. Free Gift.

All students enrolling in our courses receive a free circuit board originating from a computer and containing many different components that can be used in experiments and provide an excellent example of current electronic practice.

FREE

Post now, without obligation, to:-

BRITISH NATIONAL RADIO & ELECTRONICS SCHOOL

P.O. Box 156, Jersey, Channel Islands.

NAME _____

ADDRESS _____

EEB/7/79

Block caps please

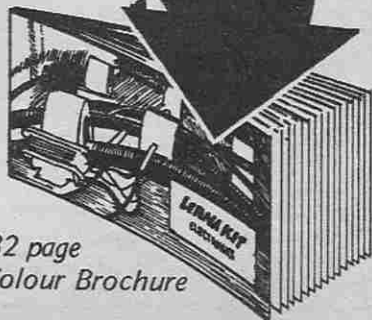

32 page
Colour Brochure

GREENWELD

443D Millbrook Road, Southampton
SO1 0HX Tel: (0703) 772501

All prices quoted include VAT. Add 25p UK/BFPO Postage. Most orders despatched on day of receipt. SAE with enquiries please. MINIMUM ORDER VALUE £1. Official orders accepted from schools, etc. (Minimum invoice charge £3). Export/Wholesale enquiries welcome. Wholesale list now available for bona-fide traders. Surplus components always wanted.

THE NEW 1978-9 GREENWELD CATALOGUE

FEATURES INCLUDE:

- 50p Discount Vouchers
 - Quantity prices for bulk buyers
 - Bargain List Supplement
 - Reply Paid Envelope
 - Priority Order Form
 - VAT inclusive prices
- PRICE 30p + 15p POST

KITS OF BITS FOR THIS MONTH'S EE PROJECTS

JUNE 1979

QUADROPHONIC SIMULATOR
TREMULO UNIT
METAL LOCATOR
ELECTRONIC CANARY

MAY 1979

ELECTRONIC DICE
S.W. CONVERTER
INTRUDER ALARM

APRIL 1979

SHAVER INVERTER
TOUCH BLEEPER
TRANSISTOR TESTER
TOUCH BLEEPER

MARCH 1979
LABCENTRE

A portable "instant" electronic workshop with tools, power supplies and test equipment for design work in logic (TTL and CMOS), audio, r.f. etc.

CAR DIRECTION
INDICATOR
ONE-TRANSISTOR
RADIO

Prices not available at time of going to press. Please send S.A.E. for full details.

E.E. 20+20 TUNER
AMPLIFIER

We can supply all parts required except the components for the RF unit for approx. £40. Send SAE for detailed list.

NOTE: A more detailed list of parts supplied in these and other kits is available on receipt of a SAE.

Most E.E. Projects back to
SEPTEMBER 1978 available.

"DOING IT DIGITALLY"

This new series which started October 1978 is bound to be a big success. We supply a complete set of parts (as we did for last year's Teach-in series) for just £19.75 + 21p post for the Electronic Test Bed, and £2.75 for additional parts required for first 6 parts.

**THE GREENWELD
Amplifier Kit**

Ideal for the beginner to make, this kit is complete right down to the last screw! Easily constructed on the PCB provided, the 4 transistor circuit will give 2W output from a crystal cartridge. Battery version £1.75, or with transformer for mains operation £3.95

PC ETCHING KIT MK III

Now contains 200 sq. ins. copper clad board, 1lb. Ferric Chloride, DALO etch-resist pen, abrasive cleaner, two miniature drill bits, etching dish and instructions. £4.50

COMPONENT CABINET IDEAL FOR THE NEWCOMER TO ELECTRONICS

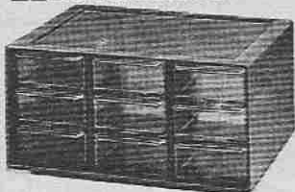

Contains hundreds of brand new resistors, capacitors, transistors diodes and I.C.'s. All useful values, carefully chosen to help the new constructor pursue his hobby without finding himself short of some vital parts!

All parts contained in clearly marked bags in a plastic storage cabinet 232 x 121 x 165mm with 9 drawers into which all parts can be neatly located.

If bought individually parts plus case would cost over £45 but we are offering this for ONLY £29.95 + £1 p & p. Simply send a cheque or P/O for £30.95 for immediate despatch.

CONTENTS:

- 200 ½ watt resistors
- 20 Wire wound resistors
- 70 Ceramic Capacitors
- 70 Mylar Capacitors
- 50 Polyester Capacitors
- 56 Electrolytic Capacitors
- 61 Transistors
- 12 I.C.'s
- 20 L.E.D.'s
- 55 Diodes and rectifiers

Altogether 614 components.

Price includes current catalogue and Greenweld pen for reordering supplies. Plus FREE surprise gift.

TRANSFORMERS

All mains primary: 12-0-12V 50mA 85p; 100mA 95p; 1A £2.50. 0-0-8V 100mA 85p; 1A £2.40. 0-0-8V 75mA 85p; 1A £2.10. Multitapped type 0-12-12-0-24-30V, 1A £3.95; 2A £3.35; 3A £3.90; 20V 2A £3.90; 25V 1A £2.25; 12V 8A £4; 24V 5A £7.50; 0-22-34-41V 4A £7.50; 20V @ 300mA twice £2.90; 12V @ 250mA twice £2.90

RELAYS

W847 Low profile PC mntg 10 x 33 x 20mm 6V coil, SPCO 3A contacts. 95p
W817 11 pin plug in relay, rated 24V ac, but works well on 6V DC. Contacts 3 pole c/o rated 10A, 95p
W848 Open construction mains relay. 3 sets 10A c/o contacts. £1.20
W877 675R 12-27V. DPCO 23 x 20 x 10mm sealed can 80p.
W890 220V a/c DPCO 10A contacts, enclosed case £1.30.
W830 200R 6-12V DPCO, 23 x 20 x 10mm, sealed can 80p.
Send SAE for our relay list—84 types listed and illustrated.

HEAT SINK OFFER

Copper T05 sink 17mm dia x 20mm. 10 for 40p; 100 for £3.1000 for £33

POLYTHENE SHEET

Size 36 x 18" 200g. Hundreds of uses around the home. 100 sheets for £1.50. Box of 1500 for £19

MAIL ORDER DEPT.

CRESCENT RADIO LTD.

1, ST. MICHAELS TERRACE, WOOD GREEN, LONDON, N22. 4SJ.
PHONE 01-888 3206



"FLIP"

Push button heads or tails. Complete kit and full instructions supplied. A pocket game. Easy to build and great to play. Kit price—£5.25 + 8% VAT. Post free.

4 OHM DOOR MOUNTING CAR LOUSPEAKERS

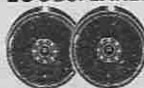

High performance, door mounting. 5½ inch units with smart front grill. 10 oz magnet, 12 watts, 4 ohms. In attractive see-through carton. £12.60 + 12½% VAT. per pair.

HEAVY DUTY XOVER 2 WAY 8 OHM

A 2 way 8 ohm H/D Xover suitable for L/S systems up to 100 watt. Fitted with screw terminals for input and a three position 'HF LEVEL' switch which selects either Flat, -3dB or -6dB. ONLY £3.00 + 8% VAT

A CRESCENT 'SUPERBUY'
Goodmans 5" 8 ohm long throw H/D loudspeaker. Mounting plate is integral with L/S chassis and has fixing holes with centres spaced at 5½" (diagonally). ONLY £5.00 + 12½% VAT



'P&P' ORDERS UP TO £5, Add 30p
ORDERS £5-£10, Add 50p
All orders over £10 post free!
Please add VAT as shown.
S.A.E. with all enquiries please



Personal callers welcome at: 21 GREEN LANES, PALMERS GREEN, N13.
ALSO. 13 SOUTH MALL, EDMONTON GREEN, EDMONTON.

LOUDSPEAKERS 90p
2½" (57mm) 8 or 75 ohm + 12½% VAT
(please state impedance req'd)



MORSE KEY CR.38

All metal, cast base, professional high speed key. Fine adjustment. Mounted on bakelite base. Dimensions: (Base) 120 x 75mm £3.90 + 8% VAT

CR 4110 DESOLDERING PUMP



ONLY £6 + 8% VAT
High suction pump with automatic ejection. Knurled, anti corrosive casing. Teflon nozzle.

3 KILOWATT PSYCHEDELIC LIGHT CONTROL UNIT

1000W lighting per channel, max. This 3 channel sound to light unit is housed in a robust metal case, with a sensitivity control for each channel i.e. Bass, middle and treble. Full instructions supplied. S.A.E. for spec. sheet. ONLY £20.00 + 8% VAT

CR LVI 12v DRILL



£12.00 + 8% VAT
BRITISH MADE "Versadrill", 12 volts DC. Compact battery operated power tool, sufficiently powerful to perform all the operations associated with 240v drills. Dimensions:— 150 x 50mm (dia.)



Wilmslow Audio

THE firm for speakers!

SEND 15P STAMP FOR THE WORLD'S
BEST CATALOGUE OF SPEAKERS,
DRIVE UNITS, KITS, CROSSOVERS
ETC. AND DISCOUNT PRICE LIST.

AUDAX ● BAKER ● BOWERS & WILKINS ● CASTLE ● CELESTION ● CHARTWELL COLES ● DALESFORD ● DECCA ● EMI ● EAGLE ● ELAC ● FANE ● GOODMAN'S ● HELME ● I.M.F. ● ISOPHON ● JR ● JORDAN WATTS ● KEF ● LEAK ● LOWTHER MCKENZIE ● MONITOR AUDIO ● PEERLESS ● RADFORD ● RAM ● RICHARD ALLAN ● SEAS ● TANNOY ● VIDEOTONE ● WHARFEDALE

WILMSLOW AUDIO (Dept. EE)

SWAN WORKS, BANK SQUARE, WILMSLOW,
CHESHIRE SK9 1HF

Discount HiFi Etc. at 5 Swan Street and 10 Swan Street
Speakers, Mail Order & Export 0625 529599 Hi-Fi 0625 526213

STEVENSON

Electronic Components

REGULATORS

78L05 30p	7805 60p	79L05 70p	7912 80p
78L12 30p	7812 60p	79L12 70p	7915 80p
78L15 30p	7815 60p	7905 80p	LM723 35p

HARDWARE

MINIATURE TRANSFORMERS

240 Volt Primary

Secondary rated at 100mA.

Available with secondaries of:

6-0-6	9-0-9	and
12-0-12	92p. each.	

LOUDSPEAKERS

56mm dia. 8 ohms	70p
64mm dia. 8 ohms	75p
64mm dia. 64 ohms	75p
70mm dia. 8 ohms	100p
70mm dia. 80 ohms	110p

TERMINALS

Rated at 10A. Accepts 4mm plug, black, blue, green, brown and red . . . 22p

SWITCHES

Subminiature toggle. Rated at 3A 250V.

SPDT 70p SPDT centre off 75p

DPDT 80p DPDT centre off 95p

Standard toggle

SPST 34p DPDT 48p

Wavechange switches:

1P12W, 2P6W, 3P4W or 4P3W all 43p ea.

Miniature switches (non-locking)

Push to make 15p Push to break 20p

Slide switches (DPDT)

Miniature 14p Standard 15p

CONTROL KNOBS

Ideal for use on mixers etc. Push on type with black base and marked position line. Cap available in red, blue, green, grey, yellow and black. 14p

TRANSISTORS

AC127 17p	BCY71 14p	ZTX109 14p	
AC128 16p	BCY72 14p	ZTX300 16p	
AC176 18p	BD131 35p	2N697 12p	
AD161 38p	BD132 35p	3N1302 38p	
AD162 38p	BD135 38p	2N2905 22p	
BC107 8p	BD139 35p	2N2807 22p	
BC108 8p	BD140 35p	2N3053 18p	
BC109 8p	BF2448 36p	2N3055 50p	
BC147 7p	BFY50 15p	2N3442 135p	
BC148 7p	BFY51 15p	2N3702 8p	
BC149 8p	BFY52 15p	2N3704 8p	
BC148 9p	MJ2955 98p	2N3705 8p	
BC177 14p	MPSA06 20p	2N3706 9p	
BC178 14p	MPSA56 20p	2N3707 9p	
BC179 14p	TIP29C 60p	2N3708 8p	
BC182 10p	TIP30C 70p	2N3819 22p	
BC182L 10p	TIP31C 65p	2N3904 8p	
BC184 10p	TIP32C 80p	2N3905 8p	
BC184L 10p	ZTX107 14p	2N3906 8p	
BC212 10p	ZTX108 14p	2N4058 12p	
BC212L 10p		2N5457 32p	
BC214 10p		2N5458 30p	
BC214L 10p		2N5459 32p	
BC477 19p		2N5777 50p	
BC478 19p			
BC479 19p			
BC548 10p			
BCY70 14p			

DIODES

1N914 3p	1N5401 13p
1N4001 4p	BZY88ser. 8p
Full spec. product.	
1N4148 £1.40/100. £11/1000	

LINEAR

CA3140 38p	NE555 21p
LM301AN 26p	NE556 50p
LM318N 85p	NE565 85p
LM324 45p	NE567 170p
LM339 45p	SN76003 200p
709 28p	LM380 75p
741 16p	LM382 120p
747 40p	LM1830 150p
748 30p	LM3900 50p
CA3046 55p	LM3909 85p
CA3080 70p	MC1496 50p
CA3130 90p	MC1458 32p
	ZN414 75p

CAPACITORS

TANTALUM BEAD each

0.1, 0.15, 0.22, 0.33, 0.47, 0.68,
1 & 2.2uF @ 35V 8p
4.7, 6.8, 10uF @ 25V 13p
22 @ 16V, 47 @ 6V, 100 @ 3V 16p

MYLAR FILM

0.001, 0.01, 0.022, 0.033, 0.047
0.068, 0.1 3p
0.068, 0.1 4p

POLYESTER

Mullard C280 series

0.01, 0.015, 0.022, 0.033, 0.047, 0.068, 0.1 5p
0.15, 0.22 7p
0.33, 0.47 10p
0.68 14p
1.0uF 17p

CERAMIC

Plate type 50V. Available in E12 series from 22pF to 1000pF and E6 series from 1500pF to 0.047uF 2p

RADIAL LEAD ELECTROLYTIC

63V	0.47	1.0	2.2	4.7	10	5p
						7p
	100					13p
		220				20p
25V	10	22	33	47		5p
						8p
		220				10p
			470			15p
				1000		23p

CONNECTORS

JACK PLUGS AND SOCKETS

	screened	unscreened	socket
2.5mm	9p	13p	7p
3.5mm	9p	14p	8p
Standard	16p	30p	15p
Stereo	23p	36p	18p

DIN PLUGS AND SOCKETS

	plug	chassis socket	line socket
2pin	7p	7p	7p
3pin	11p	9p	14p
5pin 180°	11p	10p	14p
5pin 240°	13p	10p	16p

1mm PLUGS AND SOCKETS

Suitable for low voltage circuits. Red & black. Plugs: 6p each Sockets: 7p each.

4mm PLUGS AND SOCKETS

Available in blue, black, green, brown, red, white and yellow. Plugs: 11p each Sockets: 12p each

PHONO PLUGS AND SOCKETS

Insulated plug in red or black	9p
Screened plug	13p
Single socket	7p Double socket 10p

VERO

Size in.	0.1in.	0.15in.	Veropins-
2.5 x 1	14p	13p	single sided per 100
2.5 x 3.75	42p	40p	
2.5 x 5	52p	50p	0.1in 35p
3.75 x 5	60p	60p	0.15in 40p
3.75 x 17	195p	180p	

BOXES

Aluminium boxes with lid and screws

	Length	width	height	
AL1	3	2	1	48p
AL2	4	3	1 1/2	58p
AL3	4	3	2	65p
AL4	6	4	2	70p
AL5	6	4	3	85p
AL6	8	6	2	116p

THYRISTORS

	4A	8A	12A
100V	38p	45p	62p
200V	42p	53p	68p
400V	51p	66p	86p

TRIACS

Plastic cased Triacs. Texas. All rated at 400V.

4A 70p	12A 90p	20A 185p
8A 80p	16A 95p	25A 215p

CMOS

4018 55p	4050 25p
4023 12p	4066 35p
4024 40p	4068 18p
4026 90p	4069 12p
4027 30p	4071 12p
4028 48p	4081 13p
4029 50p	4093 45p
4040 60p	4510 65p
4042 50p	4511 65p
4046 90p	4518 65p
4049 25p	4520 60p

FULL DETAILS IN CATALOGUE!

SKTS

Low profile by Texas

8 pin	8p	16 pin	11p	28 pin	22p
14 pin	10p	24 pin	18p	40 pin	32p

Soldercon pins: 100-50p, 1000-370p

OPTO

LED's	0.125in.	0.2in	each	100+
Red	TIL209	TIL220	9p	8p
Green	TIL211	TIL221	13p	12p
Yellow	TIL213	TIL223	13p	12p
Clips	3p	3p		

DISPLAYS

DL704	0.3 in CC	130p	120p
DL707	0.3 in CA	130p	120p
FND500	0.5 in CC	100p	80p

RESISTORS

Carbon film resistors. High stability. Low noise 5%. E12 series. 4.7 ohms to 10M. Any mix:

0.25W	each	100+	1000+
0.5W	1p	0.9p	0.8p
	1.5p	1.2p	1p

Special development packs consisting of 10 of each value from 4.7 ohms to 1 Meg-ohm (650 res) 0.5W £7.50. 0.25W £5.70.

METAL FILM RESISTORS

Very high stability, low noise rated at 1/2W 1%. Available from 51 ohms to 330k in E24 series. Any mix:

0.25W	each	100+	1000+
	4p	3.5p	3.2p

PLEASE WRITE FOR YOUR FREE COPY OF OUR NEW 64 PAGE CATALOGUE OF COMPONENTS. CONTAINS OVER 2500 STOCK ITEMS.



WHY NOT VISIT OUR NEW SHOP

We welcome callers at our new premises at the address below (5 mins. from High St.) We are open Mon - Sat, 9am - 6pm. Special offers available.

Express telephone order service. Orders received before 5pm. are shipped first class on that day. Contact our Sales Office now! Tel: 01-464 2951/5770.

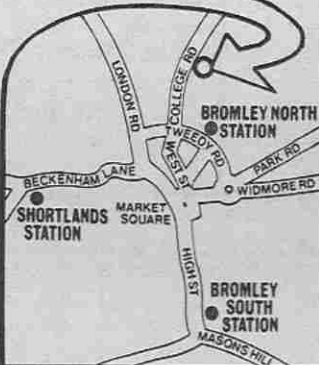

ORDERS DESPATCHED BY RETURN POST

Quantity discounts on any mix TTL, CMOS, 74LS and Linear circuits: 100+ 10%, 1000+ 15%. Prices VAT inclusive. Please add 30p for carriage. All prices valid to April 1980. Official orders welcome.

BARCLAYCARD & ACCESS WELCOME.



Mail orders to: STEVENSON (Dept EE)

The latest kit innovation!

from **Sparkrite**

Sparkrite was featured by Shaw Taylor in "DRIVE IN"

the quickest fitting
CLIP ON
capacitive discharge
electronic ignition
in KIT FORM

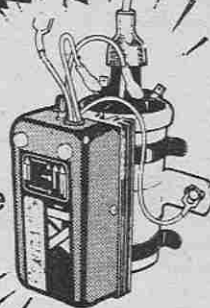

- Smoother running
- Instant all-weather starting
- Continual peak performance
- Longer coil/battery/plug life
- Improved acceleration/top speeds
- Optimum fuel consumption

Sparkrite X4 is a high performance, high quality capacitive discharge, electronic ignition system in kit form. Tried, tested, proven, reliable and complete. It can be assembled in two or three hours and fitted in 1/3 mins. Because of the superb design of the Sparkrite circuit it completely eliminates problems of the contact breaker. There is no misfire due to contact breaker bounce which is eliminated electronically by a pulse suppression circuit which prevents the unit firing if the points bounce open at high R.P.M. Contact breaker burn is eliminated by reducing the current to about 1/50th of the norm. It will perform equally well with new, old, or even badly pitted points and is not dependent upon the dwell time of the contact breakers for recharging the system. Sparkrite incorporates a short circuit protected inverter which eliminates the problems of SCR lock on and, therefore, eliminates the possibility of blowing the transistors or the SCR. (Most capacitive discharge ignitions are not completely foolproof in this respect). The circuit incorporates a voltage regulated output for greatly improved cold starting. The circuit includes built in static timing light, systems function light, and security changeover switch. All kits fit vehicles with coil/distributor ignition up to 8 cylinders.

THE KIT COMPRISES EVERYTHING NEEDED

Die pressed epoxy coated case. Ready drilled, aluminium extruded base and heat sink, coil mounting clips, and accessories. Top quality 5 year guaranteed transformer and components, cables, connectors, P.C.B., nuts, bolts and silicon grease. Full instructions to assemble kit neg. or pos. earth and fully illustrated installation instructions.

NOTE - Vehicles with current impulse tachometers (Smiths code on dial RV1) will require a tachometer pulse slave unit. Price £3.85 inc. VAT. post & packing.

Electronics Design Associates, Dept. EE 5
82 Bath Street, Walsall, WS1 3DE. Phone: (9) 614791

Electronics Design Associates, Dept. EE 7
82 Bath Street, Walsall, WS1 3DE. Phone: (9) 614791

Name _____
Address _____

Phone your order with Access or Barclaycard

Inc. V.A.T. and P.P. (U.K. only.) QUANTITY REQD. Send SAE if brochure only required.
I enclose cheque/PO's for

X4 KIT	£16.65	£
TACHO PULSE SLAVE UNIT	£3.85	

Cheque No. _____
PLEASE STATE POLARITY POS OR NEG EARTH.
Access or Barclaycard No. _____

S. & R. BREWSTER LIMITED

WHY PAY MORE?

	PRICE EACH	P & P Extra EACH
for Miniature Soldering Irons & Accessories		
18 watt Soldering Iron available in 12, 110 & 240 Volts, fitted with No. 20 bit	£3.78	+ 22p
SPARE BITS No. 19 size 1.5mm or No. 20 size 3 mm or No. 21 size 4.5 mm or No. 22 size 6 mm	44p	—
No. 78 I.C. Desoldering Bit	88p	+ 9p
No. 1920L Long Life Bit	95p	—
SAFETY STAND	£3.25	+ 65p
SOLDER Savbit 20'	52p	+ 9p
Savbit 10'	26p	+ 4p
Lowmelt 10'	65p	+ 9p

INDUSTRIAL/RETAIL ENQUIRIES WELCOME FOR THE ABOVE

We also Offer & Recommend for Mail Order & Personal Callers Only

	PRICES EACH including V.A.T. and P & P
Oryx 50 Temperature Controlled Soldering Iron	£1.10
Spare tips for above	£20.40
Isotip quick charge rechargeable Soldering Iron	£2.60
Spare tips for above	£2.25
Cable 7/0.2 11 Colours 100 meter reel	£1.90
0.1 Veroboard 3 1/2" x 11 1/2"	£4.25
0.1 Veroboard 4 1/2" x 18"	70p
Copper Clad board single sided	£4.75
Watchmakers Side Cutters	£4.25
Watchmakers Pliers	£4.25
Transformer 100VA 2 x 12V 4.1A	£10.50

OTHER ITEMS ALSO AVAILABLE ASK FOR LIST S.A.E.

MAIL ORDER DEPT.
86-88 Union Street, Plymouth
PL1 3HG Tel: (0752) 65011

Please Quote your Number when ordering



SOLDERING IRONS
THE MIGHTY MIDGETS

TRAIN AT HOME

Be an ELECTRONIC ENGINEER

Do something PRACTICAL about your future. Firms all over Britain are crying out for qualified people. With the right training, you could take your pick of these jobs.

Now, the British Institute of Engineering Technology will train you in your spare time to be an Electrical Engineer.

You risk nothing! We promise to get you through your chosen course—or refund your fee!

So, join the thousands who have built a new future through home study Engineering courses.

Courses in
C & G Elect. Technicians
C & G Elect. Installations
Telecomms. Technicians Exams
Television Servicing
Radio Maint. & Repairs (BIET)
Pract. Radio & Electronics
Plus over 60 other home study courses.

POST COUPON FOR FREE 44 PAGE GUIDE

BRITISH INSTITUTE OF ENGINEERING TECHNOLOGY

Aldermaston Court, Dept. TEE45, Reading RG7 4PF.

NAME (Block capitals please) _____

ADDRESS _____

POSTCODE _____

Other Subjects _____ AGE _____

Accredited by CACC Member of ABCC

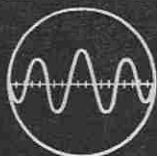

TUAC

TRANSISTOR UNIVERSAL AMPLIFICATION CO. LTD.
PHONE 01-672 3137/672 9080
MANUFACTURERS OF QUALITY AMPLIFICATION AND LIGHTING
CONTROL SYSTEMS

PRICES INCLUDE VAT. P & P FREE
correct at 1.5.79
TO ORDER BY POST

Make cheques/P.O.s payable to TUAC LTD. or quote
Access/Barclaycard No. and post to TUAC LTD. 121
Charlmont Road, London SW17 9AB. We accept phone numbers
from Access/Barclaycard Holders, Phone 01-672 9080.

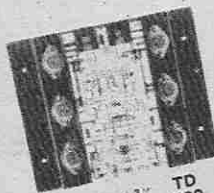

NEW FROM TUAC ULTRA QUALITY HIGH POWER New D.C. Coupled Design AMPLIFIERS

Featuring
Electronic Short Open & Thermal Overload Protection.
Brief Spec.
Input Sensitivity 0.775v. R.M.S. (O.D.B.) at 25 K Ohms
Frequency Response 20 Hz-20 KHz
Hum & Noise - 100 dB Relative full output

T.H.D. at full power 0.1%	
T.D. 500 300W into 2 Ohms	
220W into 4 Ohms	£45.00
140W into 8 Ohms	£30.00
Power supply P.S. 300	
T.D. 150 150W into 4 Ohms	£26.25
100W into 8 Ohms	£19.75
Power supply P.S. 150	
T.D. 150. 60 Version 60W into 8 Ohms	£19.75
40W into 15 Ohms.	£15.50
Power supply P.S.60	
Note P.S. 300 will drive 2 T.D. 150 amplifiers	

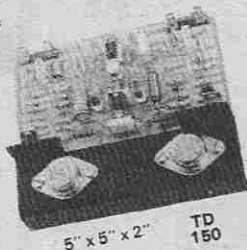

All output ratings are R.M.S. continuous sine wave output.

AMPLIFIER MODULES

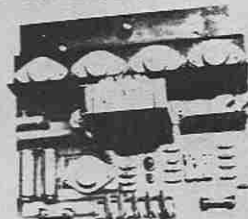

SPEC. INPUT
SENSITIVITY 60 mV
for full output
Frequency response
20 Hz-20 KHz
HUM & NOISE - 70dB

TL30 5" x 5" x 2"	
* 35 watt 10 amp output transistors	£13.25
TL60 5" x 5" x 3"	
* 60 watt R.M.S. continuous sine wave output	
* 2 R.C.A. 110 watt 15 amp output transistors	£18.50
TL100 5" x 5" x 3"	
* 100 watt R.M.S. continuous sine wave output	
* 2 R.C.A. 150 watt 15 amp output transistors	£21.50
TP125 7" x 6 1/2" x 3"	
* 125 watt R.M.S. continuous sine wave output	
* 4 R.C.A. 150 watt 15 amp output transistors	£27.50

4 CHANNEL SOUND TO LIGHT SEQUENCE CHASER - 4LSM1

- Full wave control
- RCA 8A Triacs
- 1000W per channel
- Fully suppressed and fused
- Switched master control for sound operation from 1W to 125W
- Speed control for fixed rate sequence from 8 per minute to 50 per second
- Full logic integrated circuitry with optical isolation for amplifier protection

£21.50

Model 501 500W per channel as above without sound triggering

£14.00

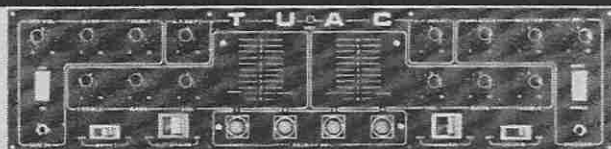

STEREO DISCO MIXER

With touch sensitive switching and auto fade

INPUTS: Four identical stereo inputs available with any equalisation. Two magnetic and two flat supplied as standard. High quality slider control on each channel. Volume, treble and bass controls for each pair of sliders. Sensitivity mag. 3mV (R.I.A.A. comp.). Flat 50mV at 1kHz. Bass controls + 18dB at 60Hz. Treble controls + 18dB at 15kHz.
OUTPUT: Up to 3 volts (+ 120dB) available. Attenuated output for TUAC Power Modules. Rotary master and balance controls. Band width 15Hz - 25kHz ± dB.
P.F.L.: Output 250mV into 8 ohms. Rotary volume control. Monitoring facility for all 4 channels. Selection via touch sensitive illuminated switches. Switched visual cue indicator.
Miscellaneous Facilities: Two illuminated deck on/off switches. Mains illuminated on/off switches. Auto fade illuminated on/off switch. Mains powered with integral screen and back cover. Complete with full instructions.
Size: 25in long x 6in high x 3in deep.

Mono Disco Mixer with autofade £52.00

£189.00

3 CHANNEL LIGHT MODULATOR SILMB

- RCA 8A Triacs
- 1000W per channel
- Each channel fully suppressed and fused
- Master control to operate from 1W to 125W
- Full wave control

£20.75

Single Channel Version 1500 Watts

£9.75

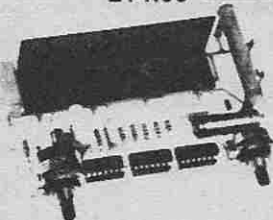

FRONT PANEL FOR LIGHTING EFFECT MODULES

(complete with switches, neons and knobs)
as illustrated



For S1LMB £7.25
Size 8" x 4 1/2"



4LSM1 £6.00
Size 6 1/2" x 4 1/2"



FUZZ LIGHTS
Red, Green, Blue,
Amber. £24.50



S1LMB £8.25
Combined with 3SDM1
Size 9" x 4 1/2"

POWER SUPPLIES

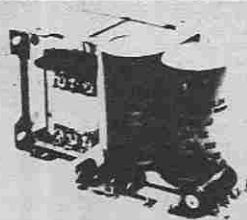

Vacuum varnish impregnated. Transformers with supply board incorporating pre-amp supply:

PS250 for supplying 2 TP125s	£30.00
PS200 for supplying 2 TL100s	£30.00
PS60/60 for supplying 2 TL60s	£30.00
PS125 ± 45 volts for TP125	£18.50
PS100 ± 43 volts for TL100	£17.00
PS60 ± 38 volts for TL60	£15.50
PS30 ± 25 volts for TL30	£11.75
PSU 2 for supplying disco mixer	£7.50

STOCKISTS CALLERS ONLY

A1 Music, 88, Oxford Street, Manchester (Tel 061-236 0340)
Geo. Mathews, 85/87, Hurst St., Birmingham (Tel 021-622 1941)
Soccodi, 9, The Friars (Tel. Canterbury 60948)
Cookies Disco Centre, 126/128, West Street (Tel Crewe 4739)
Garland Bros. Ltd., Deptford Broadway, London 01-692 4412
Luton Disco Centre, 88, Wellington Street, Luton (Tel Luton 411733)
Session Music, 163, Mitcham Road, Tooting (Tel 01-672 3413).
Mon-Sat 10am to 6pm. Closed Wed.
Electrosure Ltd., Four St., Exeter. Tel. 56687.
Salcofen Ltd., 43 Borough Rd., Cleveland, Middlesbrough.
(Tel. 242851).
Menhouse Ltd., 82, St. Mary St., Southampton. (Tel 28028)
Electra Centre, 58 Lancaster Road, Preston (Tel. Preston 58488).
TRADE & EXPORT ENQUIRIES 01-672 3137

ADD SEQUENCE CHASING + DIMMING EFFECTS FOR TUAC 3 CHANNEL LIGHT MODULATOR



- Speed Control 3 per min. to 10 per sec.
- Full logic integrated circuitry
- Dimmer control to each channel

3SDM1 £15.25

SUPPLIERS TO H.M. GOVT. DEPTS. MANUFACTURED AND ASSEMBLED IN G.T. BRITAIN FULLY TESTED AND GUARANTEED
SEND NOW FOR OUR FREE 28 PAGE ILLUSTRATED CATALOGUE. SEND STAMP PLEASE



For Sale

EVERYDAY ELECTRONICS, Number One, November 1971 to August 1977, £17. Norwich S02504.

EVERYDAY ELECTRONICS—March '72 to December '78 complete. Offers: R. Shorto, 53 Victoria Road, Warminster, Wilts.

NEW BACK ISSUES of "EVERYDAY ELECTRONICS". Available 60p each Post Free, open PO/Cheque returned if not in stock. **BELL'S TELEVISION SERVICES** 190 Kings Road, Harrogate, Yorkshire. Tel: (0423) 55885.

Books and Publications

INTRODUCTION TO MICROPROCESSORS and Computing. 50 pages of diagrams and explanation to get you started. Price £2.30 plus 45p postage. **EDUCATIONAL DATA AND TECHNICAL SERVICES**, 59 Station Road, Cogenhoe, Northampton NN7 1LU.

Complete repair information any requested T.V. £5 (with diagrams £5.50). Any requested service sheet for £1 plus SAE. SAE brings newsletter & special offers—service sheets from 50p, bargain vouchers, unique publications

AUS (EE)

76 Church St., Larkhall, Lanarkshire.

WHY NOT START YOUR OWN BUSINESS REWINDING ELECTRIC MOTORS

A genuine opportunity to success. **LARGE PROFITS**. You can't help but make money if you follow the easy, step by step, instructions in our fully illustrated Manual showing how to rewind Electric Motors, Armatures and Field coils as used in Vacuum Cleaners, Electric Drills and Power Tools. **NO PREVIOUS KNOWLEDGE IS REQUIRED**, as the Manual covers in 13 Chapters, where to obtain all the work you need; materials required, all instructions rewinding charts and how to take data, etc. A goldmine of information. How to set up your home workshop and how to cost each job to your customer. £4.00 plus 30p P. & P. U.K. CWO to:

INDUSTRIAL SUPPLIES

102 Parrswood Road, Withington, Manchester 20, Dept. EE

Service Sheets

SERVICE SHEETS for Radio, Television, Tape Recorders, Stereo, etc. With free fault-finding guide, from 50p and s.a.s. Catalogue 25p and s.a.e. Hamilton Radio, 47 Bohemia Road, St. Leonards, Sussex.

BELL'S TELEVISION SERVICE for service sheets of Radio, TV etc. £1 plus SAE. Colour TV Service Manuals on request. SAE with enquiries to **BTS**, 180 King's Road, Harrogate, N. Yorkshire. Tel: 0423 55885.

SMALL ADS

The prepaid rate for classified advertisements is 18 pence per word (minimum 12 words), box number 60p extra. Semi-display setting £4.40 per single column centimetre (minimum 2.5cm). All cheques, postal orders, etc., to be made payable to Everyday Electronics and crossed "Lloyds Bank Ltd." Treasury notes should always be sent registered post. Advertisements, together with remittance, should be sent to the Classified Advertisement Manager, Everyday Electronics, Room 2337, IPC Magazines Limited, King's Reach Tower, Stamford St., London, SE1 9LS. (Telephone 01-261 5918).

Receivers and Components

DISCOVER ELECTRONICS. Build forty easy projects including: Metal Detector; Wireless Transmitter; Breathalyser; Radios; Stethoscope; Lie Detector; Touch time-switches; Burglar Alarms, etc. Circuits, plans all for £1.29 including FREE circuit board. Mail only. **RIDLEY PHOTO/ELECTRONICS**, Box 62, 111 Rockspark Road, Uckfield, Sussex.

TIRRO's new mail order price list of electronic components now available on receipt of SAE. **TIRRO Electronics**, Grenfell Place, Maidenhead, Berks.

ELECTRONIC CAR BATTERY VOLT METER, IC, PCB, full instructions, £2.75 inc. SAE for details. **Tritech Electronics**, 190 Roding Road, Loughton, Essex.

CONSTRUCTOR PARCELS, over 200 parts, £4 lists. SAE. Sole, 37 Stanley Street, Ormskirk, Lancs L39 2DH.

ICs 7400/10p 7448/56p 7476/28p 74123/40p 74LS10/18p 74LS74/29p 7905/90p 7805/60p LM380/70p LM709/22p LM741/18p LM747/50p LM324/65p NE555/25p 4001/15p 4017/55p 4023/15p **MANY MORE!** SAE FULL LIST CP ICs 22 Oakfield Road, Croydon, Surrey.

NO LICENCE EXAMS NEEDED

To operate this miniature, solid-state Transmitter-Receiver Kit. Only £10-25 plus 25p P. & P.

'Brain-Freeze' 'em with a **MINI-STROBE** Electronics Kit, pocket-sized 'lightning flashes', vari-speed, for discos and parties. A mere £4-50 plus 25p P. & P. Experiment with a psychedelic **DREAM LAB**, or pick up faint speech/sounds with the **BIG EAR** sound-catcher; ready-made multi-function modules. £5 each plus 25p P. & P.

LOTS MORE! Send 25p for lists. Prices include VAT.

BOFFIN PROJECTS

4 CUNLIFFE ROAD, STONELEIGH EWELL, SURREY. (E.E.)

ELECTRONIC COMPONENTS and E.E. project kits 1973-now. Catalogue SAE, plus 30p **Jadebond Ltd.**, Middridge Drift Ind. Est., Middridge, Shildon, Co. Durham. Tel: Shildon (038 884) 3845.

COMPONENT LEDS. 0-2in any colour 9p. IN4148 10 for 12p; 100 for £1 IN4005 3-5p each LM723 25p. NE555 22p LM3900 40p. Resistors 1/2p each. Ceramic Disc. 27pF to 8n2 1p each any mix. 7400 6p. 4002/11/12 12p, 14PIN. Sockets. Ex equip. 6-5p each. 1lb Ferric Chloride 45p (25p P&P) 10lb. Post Free. Send for Free Catalogue. P&P 12p M.E.C.A., 14 Hopetoun Street, Bathgate, West Lothian.

SMALL AUDIO AMPLIFIERS. 3 transistors equivalent to AC128, OC72 with circuit 3 for £1. 300 small components, transistors, diodes. £1.60. Wire ended neons, 20 for £1. Panel with 40 74 series ICs, £1-50. 100 assorted C280 polyester capacitors £1-20 no Postage. List 15p refundable. Insurance add 15p. **J.W.B. RADIO**, 2 Barnfield Crescent, Sale, Cheshire M33 1NL.

CONDITIONS OF ACCEPTANCE OF CLASSIFIED ADVERTISEMENTS

- Advertisements are accepted subject to the conditions appearing on our current advertisement rate card and on the express understanding that the Advertiser warrants that the advertisement does not contravene any Act of Parliament nor is it an infringement of the British Code of Advertising Practice.
- The publishers reserve the right to refuse or withdraw any advertisement.
- Although every care is taken, the Publishers shall not be liable for clerical or printers' errors or their consequences.

Record Accessories

STYLI, CARTRIDGES FOR MUSIC CENTRES &c. FREE List No. 29. For S.A.E. includes Leads, Mikes, Phones, etc. **FELSTEAD ELECTRONICS (EE)**, LONGLEY LANE, GATLEY, CHEADLE, CHES SK8 4EE.

Miscellaneous

THE SCIENTIFIC WIRE COMPANY

PO Box 30, London E.4.
Reg. Office, 22 Coningsby Gardens.

ENAMELLED COPPER WIRE			
SWG	1 lb	8 oz	4 oz
10-19	2-65	1-45	-75
20-29	2-85	1-65	-80
30-34	3-05	1-75	-85
35-40	3-40	1-95	-94
41-43	4-55	2-55	1-85
44-46	5-05	3-05	2-15
47	8-00	5-00	3-00
48	15-00	9-00	6-00

SILVER PLATED COPPER WIRE			
	1 lb	8 oz	4 oz
14, 16, 18	4-50	2-25	1-44
20 & 22	5-00	2-85	1-74
24 & 26	5-70	3-31	2-00
28 & 30	6-67	3-86	2-35

Prices include P & P and VAT.
SAE brings list of copper & resistance Wires.
Dealer enquiries invited.

AERIAL BOOSTERS

Improves weak VHF radio & television reception.

B45-UHF TV, B11-VHF RADIO.

For next to the set fitting.

PRICE £5. S.A.E. FOR LEAFLETS.

ELECTRONIC MAILORDER LTD.
Ramsbottom, Bury, Lancs, BLO 9AG.

BUILD 25 PROJECTS with our Multi-purpose kits, details supplied. Send £19.00 to Major Oak Services, 33 Lillian Avenue, London, W3.

NO SIG. GEN.?

LOW COST 10Hz-200KHz, logic and variable sine or square waves, so useful, only £10.80.

RADIO 4 GONE? 200KHz to Medium Wave Converter, built-in antenna, 1000km range, inductive and coax (for FRG7 etc) outputs, £9.70.

PROGRAM YOUR OWN TUNES on a MUSICAL DOORBELL, new tune each day, just needs bell transformer and speaker, £19.50.

LOST THE TIME? MSF 60KHz Receiver, built-in antenna, data output, case, pcb, £13.70. Sequential year, month, date, day, hours, minutes, seconds display parts (no case or pcb, Veroboard okay) for receiver £10.70.

Giro 21-923-4000. Each easy-assembly kit includes all parts, printed, circuit, case, postage etc, money back assurance so SEND OFF NOW.

CAMBRIDGE KITS

45 (VU) Old School Lane, Milton, Cambridge

TUNBRIDGE WELLS COMPONENTS, BALLARD'S, 108 Camden Road, Tunbridge Wells, Phone 31805. No lists, enquiries S.A.E.

BUILD A SYNTHESISER!

**NO SPECIAL SKILLS
SPECIAL EQUIPMENT REQUIRED**



Using **Dewtron** (Reg'd)
PROFESSIONAL MODULES

Over 20 different electronic modules to select what YOU want to build a synthesiser; simple or complex. Start simple and add to it as you can afford. New attractive prices for the long-popular, well-tried range of Dewtron synthesiser and other effects modules.

Send 25p for Musical Miracles Catalogue NOW!

D.E.W. LTD.

254 RINGWOOD ROAD, FERNDOWN, DORSET BH22 9AR

Codespeed Electronics

PO Box 23, 34 Seafield Rd, Copnor, Portsmouth, PO3 5BJ

ELECTRONIC MAIL ORDER SPECIALISTS

New, Full Spec. Devices

MM5314 CLOCK CHIP SNIP. A bulk purchase allows us to offer these digital clock chips at the unbelievable price of only £1.99 each. With data. Cat. Number 207

4 DIGIT LIQUID CRYSTAL DISPLAY. A super, high contrast 4 digit non-multiplexed display. Digit height is 0.5" and the display is supplied with data and a special, easy to solder, edge connector. £8.95. Cat. Number 206

DIGITAL ALARM CLOCK MODULE. A digital alarm clock module, complete with 0.8" LED display. Just add mini transformer and time setting switches for fully functional clock. With data and instructions, only £6.50. Catalogue number 205

9 DIGIT DISPLAY. A 9 digit, 7 segment gas discharge display. Super, bright 0.25" high digits. With data, only 75p. Cat. Number 310

DIGITAL MULTIMETER CHIP. This MM5330 d.v.m. chip can be used to build a high accuracy d.v.m. or panel meter. Has auto polarity and over-range indication. Supplied with data and circuit. Requires some additional circuitry. Only £3.95. Cat. number 404

5 DIGIT MICRO L.E.D. DISPLAY. Built on top of a 16 pin dual in line package this 7 segment display has 5 bright 0.09" high digits. Terrific value for only 75p. Cat. number 306

10 HYBRID CIRCUITS. Now miniaturise your home produced PCB's with these 10 hybrid circuits, each containing 8 resistors and 8 capacitors. Useful values. 10 hybrids for 50p. Cat. number 801

6 DIGIT L.E.D. DISPLAY. A common cathode 6 digit 7 segment L.E.D. display from Texas Instruments. Multiplexed with built in bubble magnifiers. Digit height 0.1". £1.00. Cat. number 306

POLARISING FILTER MATERIAL. A lightly tinted polarising filter material, manufactured by 'Polaroid', in 0.006" plastic film. Any size cut, from 1 sq. inch to a maximum size of 19" by 250 feet. Our price—only 2p per square inch. Catalogue number 701

CALCULATOR KEYBOARDS. Two multifunction calculator keyboards. Excellent key action. Only £1.00 the pair. Cat. number 101

25 MINIATURE DIODES. 25 miniature IN3470 germanium diodes (600mA, 35v). All brand new. What a bargain (at just 2p each) !!! 25 diodes for 50p. Catalogue number 401

P.U.T.'s. Four MEU21 Programmable Unijunction Transistors (electrically similar to 2N6027). Lots of uses, long delay timers, oscillators, phase controllers and many more. With data and usage sheet. 4 for 50p. Cat. number 402

HIGH SPEED SWITCHING DIODES. 10 x IN4151 high speed diodes. Same as IN4148 but has higher P.I.V. 10 diodes for 35p. Cat. number 403

CALCULATOR CHIP. An MM5725 calculator chip, offered for only £1.00 (not compatible with calculator keyboards offered as cat. no. 101). Order cat. number 103.

Untested or Used Items.

DEFECTIVE CALCULATORS. A production line reject calculator with lots of accessible goodies inside. Detachable keyboard, display, case and PCB with approx. 25 transistors and calculator chip. Not much wrong with some we tested. A bargain at only £2.50. Cat. number 104

A full refund guarantee on all items.
Post and Packing please add 25p (Overseas orders add 60p)

Lots more goodies in our catalogue. Send a medium sized SAE for your free copy.

**ELECTRONICS SUPPLIERS
SHOPS, IMPORTERS,
MANUFACTURERS**

HONG KONG IS CHEAPER

Owing to the rising value of the Japanese Yen, products from Japan are becoming very expensive.

We have equivalent quality products at far better prices from Hong Kong, Taiwan and Korea.

We can supply in both large and small quantities with proven quality.

Even if you have never imported goods before, we can show you how!

86 pages, comprehensive, fully priced catalogue available: specialising in products for the electronics hobbyist.



Catalogue \$US4.00 to cover airmail postage.

DICK SMITH
ELECTRONICS (HK) LTD.
Retail Showroom & Buying Office
29-39 Ashley Rd, Kowloon, H.K.
Tel. 3-669 352 Tlx. 64398
Call in when you're next
in Hong Kong!



Why buy colour films?

When you get a Kodak colour film

FREE

for every one you send in for processing by the Everyday Electronics Colour Print Service!



Reliability at less cost

Photography can cost you a lot less these days. If you know how to go about it. Like the hundreds of thousands of magazine readers who are delighted with this reliable Colour Print Service – and the replacement films that come FREE to every customer! So why don't you give it a try? Here's what you do. Send us any make of colour print film inside the envelope enclosed in this issue. Or fill in the coupon below and send it with your film in a strong envelope to: The Everyday Electronics Colour Print Service, Freepost, Teddington, Middlesex, TW11 8BR. No stamp is required.

Send no money

But don't send any money until you see the colour of your prints. We're so confident in the reliability of the service and the quality of our prints, every one of which is checked by professionals at our laboratories.

Luxury colour prints

You'll be amazed at the crisp, sharp, high-definition sheen finish of the prints we supply . . . borderless to give you maximum picture area. And coming with the prints will be your FREE Kodak colour film, worth around £1, the same size as the one you sent us for processing.

Unbeatable value

What about prices? Ours are certainly much less than those you would pay in most shops – quite apart from the free film you get every time we develop and print for you.

Our Colour Print Service charges you only 15p for each print, plus 85p towards developing, postage and packing. The minimum charge is 85p inc. VAT (that is, if no prints can be made). The offer is limited to the UK, Eire, CI and BFPO.

More benefits to you

You benefit in two additional ways. Firstly, you enjoy a personal service with every care taken over each individual order. And secondly, you pay only for what you get – with no credit vouchers as with many other companies. An invoice comes with your prints so it's a straight business transaction.

Use this label if you haven't got an envelope, or pass it to a friend who might like to take advantage of our offer. It is used to send your prints and free film.

(Offer Exc. Minolta & Sub-miniature. Roll Film 10p surcharge 400 ASA 20p surcharge).

From: Everyday Electronics Colour Print Service, Freepost, Teddington, Middlesex TW11 8BR

Mr/Ms _____

Address _____

Postcode _____



A quality range of British made electrical accessories plus a 'How to ...' book. Do your own home electrical work with complete confidence. See cat. pages 129 to 134.



This superb organ—build the first working section for just over £100. Full specification in our catalogue.



A range of highly attractive knobs is described in our catalogue. Our prices are very attractive too!



Add-on bass pedal unit for organs. Has excellent bass guitar stop for guitarists accompaniment. Specification in our catalogue.



A pulse width train controller for smooth slow running plus inertia braking and acceleration. Full construction details in our catalogue.

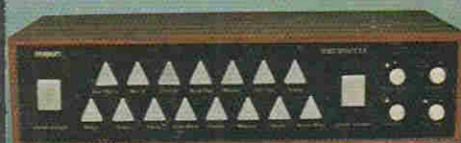

Touch operated rhythm generator, the 'Drumsette'. Construction details 25p. (Leaflet MES49). Specification in our catalogue.



Mobile amateur radio, TV and FM aeriels plus lots of accessories are described in our catalogue.



The 3800 synthesiser build it yourself at a fraction of the cost of one ready-made with this specification. Full details in our catalogue.



A wide range of disco accessories at marvellous prices. Our catalogue has all the details.

MAPLIN

ELECTRONIC SUPPLIES LTD

All mail to:—
P.O. Box 3, Rayleigh, Essex SS6 8LR.
Telephone: Southend (0702) 554155.

Shop: 284 London Road,
Westcliff-on-Sea, Essex.
(Closed on Monday).

Telephone: Southend (0702) 554155.



A superb technical bookshop in your home! All you need is our catalogue. Post the coupon now!



An attractive mains alarm clock with radio switching function and battery back up! Complete kit with case only £13.88 (incl. VAT 4 p & 13 MA1023 module only £8.42 (incl. VAT)).



A massive new catalogue from Maplin that's even bigger and better than before. If you ever buy electronic components, this is the one catalogue you must not be without. Over 280 pages come in full colour—it's a comprehensive guide to electronic components with hundreds of photographs and illustrations and page after page of invaluable data.

Our bi-monthly newsletter contains guaranteed prices, special offers and all the latest news from Maplin.



A 63-key ASCII keyboard with 625-line TV interface, 4-page memory and microprocessor interface. Details in our catalogue.

Post this coupon now for your copy of our 1979-80 catalogue price 75p.

Please send me a copy of your 280 page catalogue as soon as it is published (8th Jan. 1979). I enclose 75p but understand that if I am not completely satisfied I may return the catalogue to you within 14 days and have my 75p refunded immediately if you live outside U.K. send £1 or ten International Reply Coupons.

NAME _____

ADDRESS _____