

Easy to build projects for everyone

MARCH 79
40p

Everyday ELECTRONICS

FREE

**A VERY
SPECIAL CASE**

**THE
circuit
board**



**FOR THE
DESIGNER**



LABCENTRE



**ONE -
TRANSISTOR
RADIO**

new series **MICROPROCESSOR**
*** BASICS ***

**mini-
module** **VERSATILE POWER SUPPLY**
CAR DIRECTION INDICATOR

Iron out the little problems...



Model TCSU1 Soldering Station

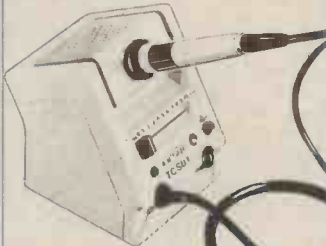

CTC 35 watt -



The TCSU1 soldering station with the XTC50 watt - 24/26 volt soldering iron or the CTC35 watt - soldering iron for pin point precision and exceptionally fast recovery time. We have put at least twice as much power into irons which are already well known for good recovery time. The temperature control stops them from over-heating; the "fail-safe" electronic circuit provides protection even if the thermocouple fails. TCSU1 soldering station £38.10 XTC and CTC irons £14.85 inclusive of VAT and P.&P.

Model SK3 Kit



Contains both the model CX230 soldering iron and the stand ST3. It makes an excellent present for the radio amateur modelmaker or hobbyist.

Model SK4 Kit



With the model X25/240 general purpose iron and the ST3 stand, this kit is a must for every toolkit in the home. Priced at £6.21 inclusive of VAT and P.&P.

Model CX 17 watts

(illustrated)

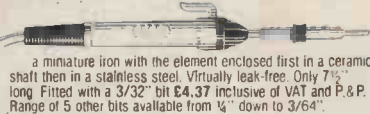

a miniature iron with the element enclosed first in a ceramic shaft then in a stainless steel. Virtually leak-free. Only 7 1/2" long. Fitted with a 3/32" bit £4.37 inclusive of VAT and P.&P. Range of 5 other bits available from 1/4" down to 3/64".

Model X25 - 25 watts



A general purpose iron also with a ceramic and steel shaft to give you toughness combined with near-perfect insulation. Fitted with 1/8" bit and priced at £4.37 inclusive of VAT and P.&P. Range of 4 other bits available.

Model MLX Kit

The soldering iron in this kit can be operated from any ordinary car battery. It is fitted with 15 feet flexible cable and battery clips. Packed in a strong plastic envelope it can be left in a car, a boat or a caravan ready for soldering in the field. Price £4.83 inclusive of VAT and P.&P.



Model SK1 Kit

This kit contains a 15 watt miniature soldering iron, complete with 2 spare bits, a coil of solder, a heat sink and a booklet, 'How to Solder'. Priced at £6.48 inclusive of VAT and P.&P.

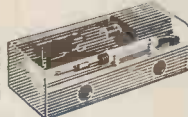

...with Antex

The ANTEX multi purpose range of soldering equipment is fast becoming a must for every home. Built with precision for long life, each iron is fully tested and guaranteed.

ANTEX soldering irons are made in England to strict local and international standards of safety.

Our name for reliability is spreading from all over Europe to U.S.A.

to Japan and to many other countries.

Stocked by many wholesalers and retailers or direct from us if you are desperate.



Mayflower House, Armada Way,
Plymouth, Devon.
Tel: 0752 67377/8
Telex: 45296

Please send me the Antex colour brochure I enclose cheque/P.O. / Giro No. 258 1000

Please send the following

Name _____ Address _____

WATFORD ELECTRONICS

35 CARDIFF ROAD, WATFORD, HERTS., ENGLAND
MAIL ORDER, CALLERS WELCOME. Tel. Watford 40588/9

ALL DEVICES BRAND NEW. FULL SPEC. AND FULLY GUARANTEED ORDERS DESPATCHED BY RETURN OF POST. TERMS OF BUSINESS: CASH/CHEQUE/P.O. OR BANKERS DRAFT WITH ORDER. GOVERNMENT AND EDUCATIONAL INSTITUTIONS' OFFICIAL ORDERS ACCEPTED. TRADE AND EXPORT INQUIRY WELCOME. P&P ADD 30p* TO ALL ORDERS UNDER £10.00. OVERSEAS ORDERS POSTAGE AT COST. AIR/SURFACE. Send 50p (plus 25p p&p) for our catalogue.

VAT Export orders no VAT. Applicable to U.K. Customers only. Unless stated otherwise, all prices are exclusive of VAT. Please add 8% to devices marked *. To the rest add 12%.

We stock many more items. It pays to visit us. We are situated behind Watford Football Ground. Nearest Underground/BR Station: Watford High Street. Open Monday to Saturday 9.00 am-8.00 pm. Ample Free Car Parking space available.

POLYESTER CAPACITORS: Axial lead type (Values are in μF)
400V: 0-001, 0-0015, 0-0022, 0-0033 7p; 0-0047, 0-0068, 0-01, 0-015, 0-018 8p; 0-022, 0-033, 10p;
0-047, 0-088 14p; 0-10 15p; 0-15, 0-22 22p; 0-33, 0-47 33p; 0-68 45p.
100V: 0-039, 0-15, 0-22, 11p; 0-33, 0-47 19p; 0-68, 1-0 22p; 1-5 23p; 2-2 32p; 4-7 48p.
DUBILIER: 1000V: 0-01, 0-015 20p; 0-022 22p; 0-047, 0-09, 0-1 38p; 0-1 38p; 0-1 38p; 0-1 38p.

POLYESTER RADIAL LEAD (Values in μF) 250V:
0-01, 0-015, 0-022, 0-027 5p; 0-033, 0-047, 0-068, 0-1 7p; 0-15 11p;
0-22, 0-33 15p; 0-47 15p; 0-68 18p; 1-0 24p; 1-5 27p; 2-2 31p.

ELECTROLYTIC CAPACITORS: Axial lead type (Values are in μF) 500V 10 40p; 47 68p;
250V: 100 65p; 83V 0-47, 1-0, 1-5, 2-2, 2-5, 3-3, 4-7, 6-8, 8, 10, 18, 22p; 47, 32, 50, 100 27p
50V: 1-0 7p; 50, 100, 220 25p; 470 50p; 1000 40V: 22, 33, 9p; 100 11p; 2200 8p; 3300 8p; 4700 8p
35V: 10, 33 7p; 330, 470 32p; 1000 48p; 25V: 1-0, 2-2, 47 6p; 80, 100, 150 8p; 220, 250 13p; 470, 540
25p; 1000 27p; 1500 30p; 2200 41p; 3300 32p; 4700 34p; 16V: 10, 40, 47, 68 7p; 100, 125 8p; 220,
330, 470 14p; 1000, 1500 20p; 2200 34p; 10V: 100 8p; 640 10p; 1000 14p.
TAG-END TYPE: 70V: 2000 88p; 4700 135p; 50V: 10,000 255p; 40V: 2500 65p; 3300, 4700 70p;
15,000 45p; 25V: 4700 68p; 2200 48p; 325V: 200+1000-50+100 190p.

TANTALUM LEAD CAPACITORS (AB OR EG EN)
35V: 0-1 μF , 0-22, 0-33, 0-47, 0-68, 1-0, 2-2 μF , 3-3, 4-7, 6-8 25V;
1-5, 10, 20V: 1-5 18V: 10 μF 13p each
47, 100 40p. 10V: 22 μF , 33, 5V: 47, 68, 100, 3V: 68, 100 μF , 20p each

MYLAR FILM CAPACITORS
100V: 0-001, 0-002, 0-005, 0-01 μF 8p
0-015, 0-02, 0-04, 0-05, 0-056 μF 7p
0-1 μF , 0-2 9p 50V: 0-47 11p

MINIATURE TYPE TRIMMERS
2-5 6pF, 3-10pF, 10-40pF 20p
5-25pF, 5-45pF, 60pF, 88pF 30p

COMPRESSION TRIMMERS
3-40pF, 10-80pF, 25-190pF 25p
100-500pF 38p

POLYSTYRENE CAPACITORS
10pF to 1nF 8p; 1.5nF to 47nF 10p.

SILVER MICA (Values in pF) 3-3, 4-7, 6-8, 10, 12, 18, 22, 33, 47, 50, 68, 82, 95, 100, 120, 150, 200 9p each
600, 820 16p each
1000, 1800, 2000, 2200 20p each

CERAMIC TRIMMER CAPACITORS
2-7pF, 4-15pF, 6-25pF, 8-30pF 20p

SOLDERCON PINS*
100 50p; 1000 395p

JACK PLUGS		SOCKETS	
2.5mm	Screened chrome body 13p	open metal	moulded break contacts
3.5mm	15p	8p	20p
MONO	25p	14p	30p
STEREO	32p	18p	24p

DIN	Plugs	Sockets	In Line
2 PIN Loudspek.	10p	6p	20p
3 & 4 Pin Audio	13p	8p	26p

CO-AXIAL	plastic	metal
10p	12p	12p
18p	18p	22p

PHONO	10p	8p single	15p double	15p 4-way
assorted colors	10p	8p	15p	20p
Metal Screened	11p	12p	15p	20p

BANANA	4mm	2mm	1mm	3mm
11p	10p	8p	8p	8p
25p	10p	8p	8p	8p

JACKSONS VARIABLE CAPACITORS	Dielectric	0.2 365pF with slow motion	140p Drive	250p Drive	500p Drive	1000p Drive
6.1 Ball Drive	500pF	0.208/176	285p	285p	285p	285p
481/DAF	115p*	" " with slow motion	325p	325p	325p	325p
Dial Drive 4103	6/316	100 50pF	10 15p	10 15p	10 15p	10 15p
Drum 54mm	30p*	100, 150pF	218p	218p	218p	218p
0.1-365pF	245p	'L' x 3 210pF	493p	493p	493p	493p
0.2 365pF	275p	0.0-3 25pF	493p	493p	493p	493p

DENCO COILS	RD2	92p
'DP' VALVE TYPE	RFC 5 chokes	91p
Range 1 to 5 Bl.,	RFC 7 (19mH)	86p
Rd., Yl. Wht. 86p	FT 13	14p
0-7 B.Y. 75p	1 FT 18/1-6	88p
1-5 Green 92p	1 FT 18/1-6	88p
'T' to 5 Bl., Yl.,	1 FT 18/1685	105p
Rd., Wht. 93p	TOC 1	85p
89A Valve Holder	MW5F	82p
25p	MW/LW 5FR	102p

VEROBOARD	0-1	0-18	0-18
	(copper clad)	(plain)	(plain)
2 x 3	48p	39p	24p
2 x 5	55p	50p	31p
3 x 3	55p	50p	31p
3 x 5	82p	87p	45p
4 x 17	181p	135p	92p
4 x 17	218p	180p	120p
4 x 17	280p	-	183p
Spot of 35 pins			30p
Pkt face cutter			85p
Pin insertion tool			120p

DIODES	AA119	18	Range 2V7 to 39V	400mV
	AA129	20	1A100V	42
	BA100	12	1A200V	47
	BY126	14	33V, 1-3W	17p each
	BY127	14	1A800V	70
	CRO33	148	1A100V	32
	OA9	75	8A300V	35
	OA47	10	8A300V	48
	OA70	12	8A300V	58
	OA79	18	8A600V	65
	OA81	18	12A300V	89
	OA85	14	12A300V	92
	OA90	7	1A100V	22
	OA91	8	1A200V	25
	OA95	8	1A400V	25
	OA202	9	1A600V	34
	IN214	4	2A/50V	35
	IN916	5	2A/100V	44
	IN4001/2	5	2A/200V	48
	IN4003	6	2A/400V	53
	IN4004/5	7	2A/800V	65
	IN4148	7	4A/100V	72
	IS44	20	4A/200V	78
	3A/100V*	15	4A/400V	105
	3A/400V*	15	4A/800V	120
	3A/600V*	24	6A/100V	78
	3A/1000V*	30	6A/200V	78
	6A/600V	60	6A/400V	85
	6A/1000V	60	6A/100V	56
	6A/600V	60	VM18 DIL	40

ZENERS	1A300V	39V	1A100V	42
	1A200V	47	1A400V	70
	1A800V	70	1A100V	32
	8A300V	48	8A300V	58
	8A600V	65	12A300V	89
	12A300V	92	12A300V	92
	1A100V	22	BT46	190
	1A200V	25	CT108	38
	1A400V	25	TIC44	25
	1A600V	34	TIC48	48

SCRs*	1A300V	39V	1A100V	42
	1A200V	47	1A400V	70
	1A800V	70	1A100V	32
	8A300V	48	8A300V	58
	8A600V	65	12A300V	89
	12A300V	92	12A300V	92
	1A100V	22	BT46	190
	1A200V	25	CT108	38
	1A400V	25	TIC44	25
	1A600V	34	TIC48	48

TRIACS*	1A300V	39V	1A100V	42
	1A200V	47	1A400V	70
	1A800V	70	1A100V	32
	8A300V	48	8A300V	58
	8A600V	65	12A300V	89
	12A300V	92	12A300V	92
	1A100V	22	BT46	190
	1A200V	25	CT108	38
	1A400V	25	TIC44	25
	1A600V	34	TIC48	48

DIACs*	1A300V	39V	1A100V	42
	1A200V	47	1A400V	70
	1A800V	70	1A100V	32
	8A300V	48	8A300V	58
	8A600V	65	12A300V	89
	12A300V	92	12A300V	92
	1A100V	22	BT46	190
	1A200V	25	CT108	38
	1A400V	25	TIC44	25
	1A600V	34	TIC48	48

TTL 74*	7494	78	74193	96	4056	134	LINEAR IC's	MC1489*	90
7400	93	7495	65	74194	96	4057	2570	702	75
7401	13	7496	57	74195	98	4059	480	709C 14 pin	35
7402	14	7497	189	74196	93	4060	115	723*	67
7403	14	74100	119	74197	80	4061	1425	730*	45
7404	14	74105	62	74198	80	4062	999	733*	45
7405	14	74107	113	74199	110	4063	11	741C-8 pin	22
7406	38	74109	54	75491	75	4066	58	747C*	78
7407	38	74110	54	75492	80	4067	38	748C*	36
7408	17	74111	68			4068	22	753	150
7409	17	74112	125			4069BE	20	810	159
7410	15	74116	198	CMOS*	15	4070	32	8038CC*	335
7411	20	74118	83	4001	15	4071	21	AY-1-0212	35
7412	17	74119	149	4002	16	4072	21	AY-1-1313	660
7413	17	74120	118	4006	92	4073	25	AY-1-1320	315
7414	51	74121	25	4007	18	4075	23	AY-1-5050	180
7415	96	74122	48	4008	82	4076	85	AY-1-5051	145
7417	30	74123	48	4009	38	4077	40	AY-1-8721/8	195
7420	18	74128	38	4011	18	4078	21	AY-3-8500A	385
7421	29	74128	57	4012	18	4081	20	AY-5-1224A	290
7423	27	74132	74	4013	45	4082	21	AY-5-1230A	450
7425	27	74136	73	4014	80	4083	21	CA3011*	82
7426	36	74141	56	4015	82	4089	150	CA3018*	68
7427	27	74142	209	4016	45	4093	85	CA3020A	80
7428	35	74143	314	4017	45	4094	190	CA3035	120
7429	37	74144	314	4018	48	4095	105	CA3043	190
7430	37	74145	65	4019	48	4096	105	CA3046	71
7433	40	74147	115	4020	99	4097	372	CA3048	200
7437	30	74148	109	4021	95	4098	110	CA3090A	398

MAGENTA ELECTRONICS LTD

EH12. 98 CALAIS ROAD, BURTON-ON-TRENT, STAFFS. DE13 0UL. PHONE 02 83 65435

E.E. PROJECT KITS

Make us YOUR No. 1 SUPPLIER of KITS and COMPONENTS for E.E. Projects. We supply carefully selected sets of parts to enable you to construct E.E. projects. Appropriate hardware—nuts, screws, I.C. sockets are included. Each project kit comes complete with its own FREE COMPONENT IDENTIFICATION SHEET. We supply—You construct.
PRICES INCLUDE CASES UNLESS OTHERWISE STATED.

CHOKE WARNING DEVICE. Feb. 79. £5.05 case 71p
AUDIO MODULATOR. Feb. 79. £1.44 less case and pins.
LW CONVERTER. Feb. 79. £3.98, case £1.25.
THYRISTOR TESTER. Feb. 79. £2.98
ADJUSTABLE PSU. Feb. 79. £18.98. Case (horizontal layout) £3.54 extra.
ROULETTE. Jan. 79. £16.99 less case.
I'M FIRST. Jan. 79. £3.06 less cases.
LIGHTS REMINDER. Jan. 79. £3.55
CONTINUITY TESTER. Jan. 79. £2.91 less case.
MIC AMP. Dec. 78. £2.19
FUZZ BOX. Dec. 78. £4.36
VEHICLE IMMOBILISER. Inc. PCB. Dec. 78. £3.77 case extra 71p.
WATER LEVEL ALERT. Nov. 78. £4.82
"HOT LINE" GAME. Nov. 78. £4.23 less case & rod.
AUDIO EFFECTS OSCILLATOR. Nov. 78. £2.75 inc. board.
SUBSCRIBERS TELE TEL METER. Nov. 78. £15.55 case extra £3.75.
FUSE CHECKER. Oct. 78. £1.40.
C.MOS RADIO. Oct. 78. £7.55.
TREASURE HUNTER. Oct. 78. £14.20 less handle & coil former.
GUITAR TONE BOOSTER. Sept. 78. £4.13 inc. p.c.b.
SOUND TO LIGHT. Sept. 78. £5.77
FILTER. £1.25.
SLAVE FLASH. Aug. 78. £2.66 less SK1.
LOGIC PROBE. July 78. £2.29 inc. case.
IN SITU TRANSISTOR TESTER. June 78. £4.49.
VISUAL CONTINUITY CHECKER. June 78. £2.96 inc. probes.
FLASHMETER. May 78. £9.98.

POCKET TIMER. April 78. £2.82
WEIRD SOUND EFFECTS GENERATOR. Mar. 78. £3.64.
CHASER LIGHT DISPLAY. Feb. 78. £19.78. Inc. p.c.b. case extra £3.54.
AUDIO VISUAL METRONOME. Jan. 78. £4.22.
RAPID DIODE CHECK. Jan. 78. £1.97
AUTOMATIC PHASE BOX. Dec. 77. £9.45 inc. p.c.b.
VHF RADIO. Nov. 77. £11.46.
ULTRASONIC REMOTE CONTROL. Nov./Dec. 77. £13.64.
TREASURE LOCATOR. Oct. 77. £8.77 case extra. £2.32. Less handle, etc.
ELECTRONIC DICE. March 77. £4.09.
SOIL MOISTURE INDICATOR. June 77. £3.09 inc. probe.
PHONE/DOORBELL REPEATER. July 77. £5.27.
SHORT WAVE RECEIVER. Aug. 77. £10.98 case extra £1.25.
CAR BATTERY STATE INDICATOR. Sept. 78. £1.54 less case inc. PCB.
MULTIMETER TYPE 1. 1,000 o.p.v. with probes 2" x 3 1/2" x 1" £5.95.
MULTIMETER TYPE 2. 20,000 o.p.v. with case and probes 5" x 3 1/2" x 1 1/2" £12.45.
ANTEX X25 SOLDERING IRON 25W. Ideal for electronics £3.95.
SOLDERING IRON STAND. ANTEX ST3 £1.55.
DESOLDER BRAID. 62p.
HEAT SINK TWEEZERS. 13p.
DESOLDER PUMP. Easy to use £5.98.
SIGNAL INJECTOR. £4.98.
DENTISTS MIRROR. Adjustable £1.70.
JEWELLERS EYEGLASS. 93p.
TRIPLE MAGNIFIER. £1.15.

ALL PRICES INCLUDE VAT AND FIRST CLASS POST. ADD 15p TO ORDERS UNDER £5. COPIES OF E.E. CONSTRUCTIONAL ARTICLES 39p.

CATALOGUE — SEND 3 x 9p STAMPS.



TEACH-IN-78 COMPLETE KIT £14.50

INCLUDES FREE COMPONENT IDENTIFICATION CHART. TEACH-IN REPRINTS EXTRA 39p. EACH PART. ALL 12 PARTS AVAILABLE.

1979 ELECTRONICS CONSTRUCTORS CATALOGUE

HAVE YOU GOT YOUR COPY YET? MAGENTA'S NEW CATALOGUE INCLUDES MANY NEW PRODUCTS — CAREFULLY CHOSEN FOR EVERYDAY ELECTRONICS READERS. PRODUCT DATA AND ILLUSTRATIONS MAKE THE MAGENTA CATALOGUE AN INDISPENSABLE GUIDE FOR CONSTRUCTORS. FULLY INCLUSIVE PRICES RIGHT NEXT TO THE PRODUCTS MAKE ORDERING EASY. NO MINIMUM ORDER — ALL PRODUCTS STOCK LINES. FIRST CLASS DELIVERY OF FIRST CLASS COMPONENTS. SEND FOR YOUR COPY AND SEE HOW EASY IT IS TO USE THE MAGENTA CATALOGUE!

WRITE TODAY ENCLONG 3 x 9p STAMPS.

BUZZER. 6V 74p. 12V 77p.
F.M. INDOOR AERIAL. 49p.
TELEPHONE PICK-UP COIL. 65p.
SPEAKERS. Miniature 8 ohm 79p. 64 ohm 89p. 80 ohm £1.15.
EARPIECES. Crystal 38p. Magnetic 15p.
STETHOSCOPE ATTACHMENT. fits our earpieces 58p.
HEADPHONES. MONO. 2K Padded Superlor Sensitive. £2.98.
HEADPHONES. STEREO. 8 ohm. £3.85.
INTERCOM. 2 STATION. £5.95.
MICROPHONE DYNAMIC 600 OHM CASSETTE TYPE with 3.5mm Jack plug and plastic desk stand. £1.25.

R.F. SIGNAL GENERATOR. Sept. 78. £15.30 less case.
TRANSISTOR TESTER. Oct. 77. £6.34 case extra £3.35.
CATCH-A-LIGHT. Mar. 78. £6.74.
HEADPHONE ENHANCER. Jan. 79. £2.24.
PASSIVE MIXER. Oct. 78. £2.68.
ELECTRONIC TOUCH SWITCH. Jan. 78. £1.44.
AUDIBLE FLASHER. Dec. 78. £1.08.
ADD-ON CAPACITANCE UNIT. Sept. 77. £4.46.
SPRINGS—SMALL 100 Asstd. 98p.
CROC CLIP TEST LEAD SET 10 leads with 20 clips 96p.

DOING IT DIGITALLY

New Series—complete kit or separate parts IN STOCK NOW for FAST DELIVERY by FIRST CLASS POST. All top quality components as specified by Everyday Electronics. Our kit comes complete with FREE TTL and COMPONENT IDENTIFICATION CHART. Follow this educational series—start today—and learn about digital electronics. SEND £22.95 for the TTL TEST BED. £3.75 for ADDITIONAL COMPONENTS (6 months).

TRAIN AT HOME

Be an ELECTRONIC ENGINEER

Do something PRACTICAL about your future. Firms all over Britain are crying out for qualified people. With the right training, you could take your pick of these jobs.

Now, the British Institute of Engineering Technology will train you in your spare time to be an Electrical Engineer.

You risk nothing! We promise to get you through your chosen course—or refund your fee!

So, join the thousands who have built a new future through home study Engineering courses.

Courses in
 C & G Elect. Technicians
 C & G Elect. Installations
 Telecomms. Technicians Exams
 Television Servicing
 Radio Maint. & Repairs (BIET)
 Pract. Radio & Electronics
 Plus over 60 other home study courses.

POST COUPON FOR FREE 44 PAGE GUIDE

BRITISH INSTITUTE OF ENGINEERING TECHNOLOGY

Aldermaston Court, Dept. TEE41 Reading RG7 4PF.

NAME (Block capitals please) _____

ADDRESS _____

POSTCODE _____

Other Subjects _____ AGE _____

Accredited by CACC

Member of ABCC

SOLVE your component buying problems with this famous Catalogue

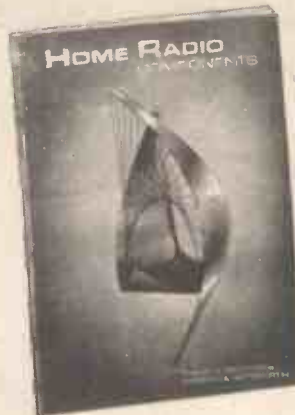

- The finest components catalogue yet published.
- Over 128 A-4-size pages.
- About 2,500 items clearly listed and indexed.
- Nearly 1,000 illustrations.
- Bargain list sent free.
- At £1.25 incl. p. & p. the catalogue is a bargain.

Send the coupon below now.

HOME RADIO (Components) LTD., Dept. EE., 234-240 London Road, Mitcham, Surrey CR4 3HD

POST THIS COUPON with cheque or P.O. for £1.25

Please write your Name and Address in block capitals

NAME _____

ADDRESS _____



HOME RADIO (Components) LTD., Dept. EE 234-240 London Road, Mitcham, Surrey CR4 3HD

(Regn. No London 912966)

Everyone knows about Veroboard

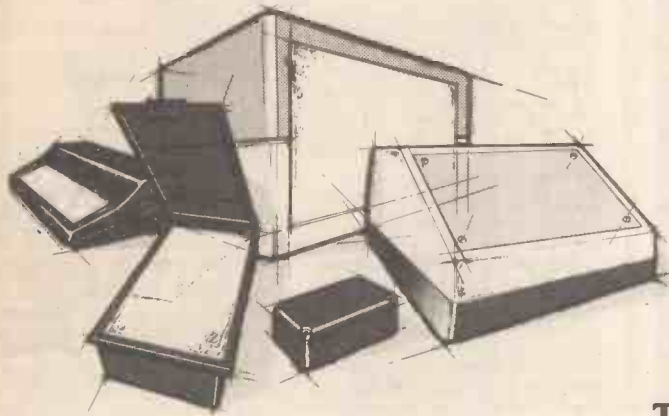

But did you know that our catalogue of Products for the Home Constructor contains hundreds more items? There's accessories to go on your board – pins, DIP sockets, etc., and a wide range of plastic boxes and metal cases to house all your projects.

There's even an easy-to-assemble frame system for module applications and they are all produced to the high standard you've a right to expect. Send 25p to cover post and packing and the catalogue's all yours.

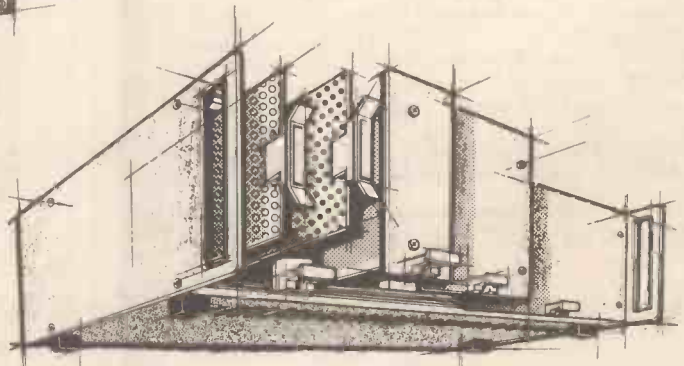
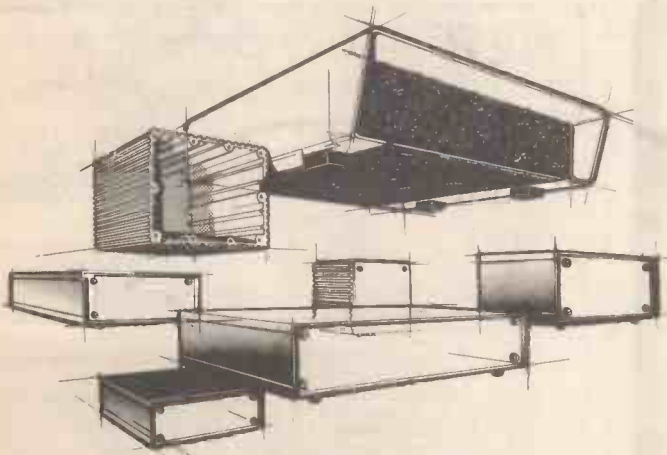

vero

VERO ELECTRONICS LTD. RETAIL DEPT.
Industrial Estate, Chandlers Ford, Hants. SO5 3ZR.
Telephone Chandlers Ford (04215) 2956

The latest kit innovation!

from **Sparkrite**

Sparkrite - was featured by Shaw Taylor in "DRIVE IN"

the quickest fitting
CLIP ON
capacitive discharge
electronic ignition
in KIT FORM

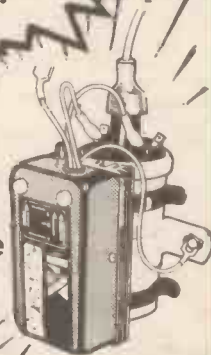

- Smoother running
- Instant all-weather starting
- Continual peak performance
- Longer coil/battery/plug life
- Improved acceleration/top speeds
- Optimum fuel consumption

Sparkrite X4 is a high performance, high quality capacitive discharge, electronic ignition system in kit form. Tried, tested, proven, reliable and complete. It can be assembled in two or three hours and fitted in 1/3 mins.

Because of the superb design of the Sparkrite circuit it completely eliminates problems of the contact breaker. There is no misfire due to contact breaker bounce which is eliminated electronically by a pulse suppression circuit which prevents the unit firing if the points bounce open at high R.P.M. Contact breaker burn is eliminated by reducing the current to about 1/50th of the norm. It will perform equally well with new, old, or even badly pitted points and is not dependent upon the dwell time of the contact breakers for recharging the system. Sparkrite incorporates a short circuit protected inverter which eliminates the problems of SCR lock on and, therefore, eliminates the possibility of blowing the transistors or the SCR. (Most capacitive discharge ignitions are not completely foolproof in this respect). The circuit incorporates a voltage regulated output for greatly improved cold starting. The circuit includes built in static timing light, systems function light, and security changeover switch. All kits fit vehicles with coil/distributor ignition up to 8 cylinders.

THE KIT COMPRISES EVERYTHING NEEDED

Die pressed epoxy coated case. Ready drilled, aluminium extruded base and heat sink, coil mounting clips, and accessories. Top quality 5 year guaranteed transformer and components, cables, connectors, P.C.B., nuts, bolts and silicon grease. Full instructions to assemble kit neg. or pos. earth and fully illustrated installation instructions.

NOTE - Vehicles with current impulse tachometers (Smiths code on dial RV1) will require a tachometer pulse slave unit. Price £3.85 inc. VAT, post & packing.

Electronics Design Associates, Dept. EE 2 (U.K. only)
82 Bath Street, Walsall, WS1 3DE. Phone: (9) 614791

Electronics Design Associates, Dept. EE 3
82 Bath Street, Walsall, WS1 3DE. Phone: (9) 614791

Name

Address

Phone your order with Access or Barclaycard

Inc. VAT, and P.P. (U.K. only.) QUANTITY REQ'D.

Send SAE if brochure only required.

I enclose cheque/PO's for

X4 KIT **£16.65**

TACHO PULSE SLAVE UNIT **£3.85**

£

Cheque No.

PLEASE STATE POLARITY POS OR NEG EARTH.
Access or Barclaycard No.

the MIGHTY MIDGETS

MINIATURE SOLDERING IRONS AND ACCESSORIES



	RETAIL PRICE each inc. v.a.t.	POSTAGE extra.
18 WATT IRON inc. No. 20 BIT	£3.78	22p
SPARE BITS	44p	—
STANDS	£3.25	65p
SOLDER: SAVBIT 20'	52p	9p
" 10'	26p	4p
LOWMELT 10'	65p	9p
I.C. DESOLDERING BIT	88p	9p

BIT SIZES: No. 19 (1.5 mm) No. 20 (3 mm)
No. 21 (4.5 mm) No. 22 (6 mm)



Please quote your
number when ordering

EEL

From your Local Dealer or Direct from Manufacturers

S & R. BREWSTER LTD.

86-88 Union St. Plymouth PL1 3HG
Tel: 0752 65011 TRADE ENQUIRIES WELCOME



ANNOUNCING A NEW SET OF BASIC ELECTRONICS

This 5 volume set contains over 500 pages.
Bound in stiff linen. Cover size 8 1/2 in x 5 in.
Price £7.50 per set (we pay the postage).

- | | |
|---------------------------------|--------------------------------------|
| Book 1. Introducing Electronics | Book 4. Meters/Voltage-dividers |
| Book 2. Resistors/Capacitors | Book 5. Transistor Project Circuitry |
| Book 3. Inductors/Diodes | |

The manuals are unquestionably the finest and most up-to-date available and represent exceptional value.

This series has been written in a fascinating, absorbing and exciting way, providing an approach to acquiring knowledge that is a very enjoyable experience. Suitable for industrial trainees, City and Guilds students, DIY enthusiasts and readers of electronic journals.

Each part explains electronics in an easy-to-follow way, and contains numerous diagrams and half tone blocks with construction details and circuit diagrams for making the following transistor projects: Lamp Flasher, Metronome, Wailer, Photographic/Monostable Timer, Metal Locator, Geiger Counter, Radio Receiver, Intercom., Intruder Alarm, Electronic Organ, Battery Eliminator, Anemometer, Sound Switch, Light and Water-operated Switches, Pressure-operated Switches, Light meter, Radio Thermometer, Ice Alarm,

Order now:
Selray Book Company
60 Hayes Hill
Bromley
BR2 7HP

OUR 100% GUARANTEE
Should you decide to return the set after 10 days examination, your money will be refunded by return of post.

Amount enclosed: £

Name:

Address:

EEL4

BIMENCLOSURES



ALL METAL BIMCASES
Red, Grey or Orange 14swg Aluminium removable top and bottom covers. 18 swg black mild steel chassis with fixing support brackets.
BIM 3000
(250x167.5x68.5mm)
£14.58



MINI DESK BIMCONSOLES
Orange, Blue, Black or Grey ABS body incorporates 1.8mm pcb guides, stand-off bosses in base with 4 BIMFEET supplied. 1mm Grey Aluminium panel sits recessed with fixing screws into integral brass bushes.
BIM 1005 (161 x 96 x 58mm) £2.18
BIM 1006 (215 x 130 x 75mm) £3.05

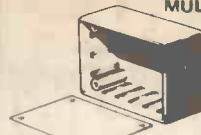

MULTI PURPOSE BIMBOXES
Orange, Blue, Black or Grey ABS with 1mm Grey Aluminium recessed front cover held by screws into integral brass bushes. 1.8mm pcb guides incorporated and 4 BIMFEET supplied.
BIM 4003 (85x56x28.5mm) £1.18
BIM 4004 (111x71x41.5mm) £1.62
BIM 4005 (161x96x52.5mm) £2.19

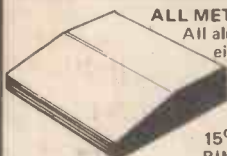

ALL METAL BIMCONSOLES

All aluminium, 2 piece desk consoles with either 15° or 30° sloping fronts, sit on 4 self-adhesive non-slip rubber feet. Ventilation slots in base and rear panel for excellent cooling. See latest catalogue for new styles and sizes

Colour Code	Top Panel	Base
A	Off White	Blue
B	Sand	Green
C	Satin Black	Gold

15° Sloping Panel		30° Sloping Panel		
BIM7151 (102x140x51[28] mm)	BIM7301 (102x140x76[28] mm)	£10.67		
BIM7152 (165x140x51[28] mm)	BIM7302 (165x140x76[28] mm)	£11.44		
BIM7153 (165x216x51[28] mm)	BIM7303 (165x183x102[28] mm)	£12.61		
BIM7154 (165x211x76[33] mm)	BIM7304 (254x140x76[28] mm)	£13.82		
BIM7155 (254x211x76[33] mm)	BIM7305 (254x183x102[28] mm)	£15.36		
BIM7156 (254x287x76[33] mm)	BIM7306 (254x259x102[28] mm)	£16.67		
BIM7157 (356x211x76[33] mm)	BIM7307 (356x183x102[28] mm)	£17.58		
BIM7158 (356x287x76[33] mm)	BIM7308 (356x259x102[28] mm)	£18.55		



LOW PROFILE BIMCONSOLES

Orange, Blue, Black or Grey ABS body has ventilation slots as well as 1.8mm pcb guides and stand-off bosses in base. Double angle recessed front panel with 4 fixing screws into integral brass bushes. 4 BIMFEET supplied.

BIM 6005 (143 x 105 x 55.5 [31.5] mm)	£2.37
BIM 6006 (143 x 170 x 55.5 [31.5] mm)	£3.08
BIM 6007 (214 x 170 x 82.0 [31.5] mm)	£4.12

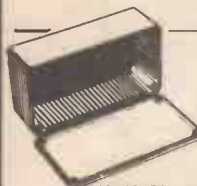

ABS & DIECAST BIMBOXES

6 sizes in ABS or Diecast Aluminium. ABS moulded in Orange, Blue, Black or Grey. Diecast Aluminium in Grey Hammetone or Natural. All boxes incorporate 1.8mm pcb guides, stand-off supports in base and have close fitting flanged lids held by screws into integral brass bushes (ABS) or tapped holes (Diecast).

	ABS	Diecast	Hammetone	Natural
(50x50x31mm)	N/A	BIM5001/11	TBA	£1.02
(100x50x25mm)	BIM2002/12	BIM5002/12	£1.46	£1.19
(112x62x31mm)	BIM2003/13	BIM5003/13	£1.78	£1.46
(120x65x40mm)	BIM2004/14	BIM5004/14	£2.24	£1.82
(150x80x50mm)	BIM2005/15	BIM5005/15	£2.84	£2.28
(190x110x60mm)	BIM2006/16	BIM5006/16	£3.94	£3.33

Also available in Grey Polystyrene with no slots and self-tapping screws
BIM 2007/17 (112x61x31mm) £1.00



EUROCARD BIMCONSOLES

Orange, Blue, Black or Grey ABS body accepts full or 1/2 size Eurocards, with bosses in the base for direct fixing. 1.8mm wide pcb guides incorporated and 4 BIMFEET supplied. 1mm Grey aluminium lid sits flush with body top and held by 4 screws into integral brass bushes.

BIM 8005 (169x127x70[45] mm)	£4.12
BIM 8007 (243x187x103[66] mm)	£6.10

BIMTOOLS + BIMACCESSORIES



MAINS BIMDRILLS

Small, powerful 240V hand drill complete with 2 metres of cable and 2 pin DIN plug. Accepts all tools with 1mm, 2mm or .125" dia. shanks. Drills brass, steel, aluminium and pcb's. Under 250g, off load speed 7500 rpm. Orange ABS, high impact, fully insulated body with integral on/off switch £10.53

Mains Accessory Kit 1 includes 1mm, 2mm, .125" twist drills, 5 burrs and 2.4mm collet £2.48

Mains Kit 2 includes Mains BIMDRILL as above, 20 assorted drills, mops, burrs, grinding wheels and mounted points, 1mm, 2mm, 2.4mm and .125" collets. Complete in transparent case measuring 230x130x58mm £22.14

BIMDAPTORS

Allows pcb's to be flat mounted sandwich fashion in BIMBOXES, BIMCONSOLES, and all other enclosures having 1.5mm wide vertical guide slots. One plastic BIMDAPTOR on each corner of pcb(s) enables assembly to be simply slid into place. 54mm long, 10 slots on 5mm spacing and can be simply snapped off to length. £1.08 per pack of 25.

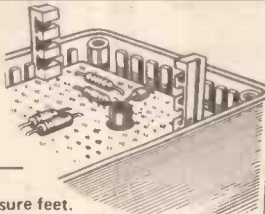

BIMFEET

11mm dia. 3mm high, grey rubber self-adhesive enclosure feet. £0.77 per pack of 24

12 VOLT BIMDRILLS

12 volt, powerful drills easily hand held or used with lathe/stand adaptor. Integral on/off switch and 1 metre cable.

Mini BIMDRILL with 3 collets up to 2.4mm dia. £ 8.10
Major BIMDRILL with 4 collets up to 3mm dia. £13.60

Accessory Kits 1 have appropriate drills and collets as above plus 20 assorted tools. Mini Kit 1 - £15.12, Major Kit 1 - £19.44. Accessory Kits 2 have appropriate drills, collets plus 40 tools and mains-12V dc adaptor. Mini Kit 2 - £34.02, Major Kit 2 - £39.42. Accessory Kits 3 as appropriate Kits 2 plus stand/lathe unit. Mini Kit 3 - £45.36, Major Kit 3 - £50.76.

BIMPUMPS

2 all metal desoldering tools provide high suction power and have easily replaceable screw in Teflon tips. Primed and released by thumb operation with in-built safety guard and anti-recoil system.

BIMPUMP Major (180mm long) £7.99
BIMPUMP Minor (150mm long) £6.80

BIMIRONS



Type 30 General Purpose
27 watt iron with long life, rapid change element, screw on tip, stainless steel shaft and clip on hook. Styled handle with neon. £4.05

Type M3 Precision 17 watt iron, quick change tip, long life element, styled handle with clip on hook. £4.43

BIMBOARDS



DIL COMPATIBLE BIMBOARDS

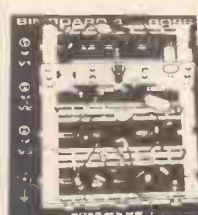

Accept all sizes (4-50 pin) of DIL IC packages as well as resistors, diodes, capacitors and LEDs. Integral Bus Strips up each side for power lines and Component Support Bracket for holding lamps, switches and fuses etc. Available as single or multiple

units, the latter mounted on 1.5mm thick black aluminium back plate which stand on non slip rubber feet and have 4 screw terminals for incoming power.

BIMBOARD 1 has 550 sockets, multiple units utilising 2, 3 and 4 BIMBOARDS incorporate 1100, 1650 and 2200 sockets, all on 2.5mm (0.1") matrix.

BIMBOARD 1	£ 8.83
BIMBOARD 2	£21.01
BIMBOARD 3	£29.84
BIMBOARD 4	£38.79

DESIGNER PROTOTYPING SYSTEM

1, 2, or 3 BIMBOARDS mounted on BIM 6007 BIMCONSOLE with Integral Power Supply (±5 to ±15Vdc @ 100mA and fixed +5Vdc @ 1A) All O/P's fully isolated. Short circuit and fast fold back protection. Power rails brought out to cable clamps that accept stripped wire or 4mm plug.

DESIGNER 1	£55.62
DESIGNER 2	£61.02
DESIGNER 3	£66.42

...FROM **BOSS**
INDUSTRIAL MOULDINGS LIMITED

All quoted prices are 1 off and include Postage, Packing and VAT. Terms are strictly cash with order unless you have authorised BOSS account. For individual data sheets or short form catalogue on all BOSS products send stamped, self addressed 4 1/2 x 8 1/2" envelope.

2 Herne Hill Road, London SE24 0AU
Telephone: 01-737 2383
Telex: 919693 Answer Back: 'LITZEN G'
Cables & Telegrams: 'LITZEN LONDON SE24'

It's W-W-WINTER S-S

74 SERIES TTL IC'S

Type	Price	Type	Price	Type	Price	Type	Price	Type	Price
7440	£0.07	7427	£0.21	7472	£0.19	74107	£0.22	74165	£0.65
7401	£0.09	7428	£0.26	7473	£0.22	74110	£0.35	74166	£0.75
7402	£0.09	7430	£0.26	7474	£0.22	74111	£0.35	74167	£2.00
7403	£0.09	7432	£0.20	7475	£0.27	74118	£0.78	74174	£0.60
7404	£0.09	7433	£0.28	7476	£0.22	74119	£1.10	74175	£0.60
7405	£0.09	7437	£0.20	7480	£0.40	74121	£0.22	74176	£0.55
7406	£0.22	7438	£0.20	7481	£0.80	74122	£0.35	74177	£0.55
7407	£0.22	7440	£0.10	7482	£0.65	74123	£0.38	74180	£0.80
7408	£0.12	7441	£0.46	7483	£0.55	74136	£0.60	74181	£1.25
7409	£0.12	7442	£0.38	7484	£0.52	74141	£0.50	74182	£0.85
7410	£0.09	7443	£0.68	7485	£0.22	74145	£0.54	74184	£1.00
7411	£0.15	7444	£0.68	7486	£0.22	74150	£0.65	74190	£0.88
7412	£0.14	7445	£0.64	7489	£1.60	74151	£0.45	74191	£0.88
7413	£0.22	7446	£0.60	7490	£0.30	74153	£0.45	74192	£0.85
7414	£0.45	7447	£0.80	7491	£0.80	74154	£0.80	74193	£0.60
7415	£0.22	7448	£0.52	7492	£0.32	74155	£0.48	74194	£0.55
7417	£0.22	7450	£0.09	7493	£0.35	74156	£0.48	74195	£0.85
7420	£0.09	7451	£0.09	7494	£0.70	74157	£0.48	74199	£0.60
7421	£0.19	7452	£0.09	7495	£0.45	74160	£0.55	74197	£0.88
7422	£0.15	7453	£0.09	7496	£0.48	74161	£0.60	74198	£1.00
7423	£0.20	7454	£0.09	74100	£0.80	74162	£0.60	74199	£1.00
7425	£0.18	7460	£0.09	74104	£0.35	74163	£0.60	74279	£1.00
7426	£0.21	7470	£0.24	74105	£0.35	74164	£0.65		

CMOS I.C.'s

Type	Price	Type	Price	Type	Price	Type	Price
CD4000	£0.12	CD4017	£0.85	CD4031	£1.60	CD4055	£1.00
CD4001	£0.13	CD4018	£0.70	CD4035	£0.90	CD4056	£1.15
CD4002	£0.13	CD4019	£0.35	CD4037	£0.78	CD4069	£0.15
CD4006	£0.80	CD4020	£0.80	CD4040	£0.78	CD4070	£0.15
CD4007	£0.14	CD4021	£0.75	CD4041	£0.68	CD4071	£0.15
CD4008	£0.80	CD4022	£0.75	CD4042	£0.72	CD4072	£0.15
CD4009	£0.40	CD4023	£0.13	CD4043	£0.78	CD4081	£0.15
CD4010	£0.42	CD4024	£0.55	CD4044	£0.78	CD4082	£0.15
CD4011	£0.13	CD4025	£0.13	CD4045	£1.15	CD4510	£0.80
CD4012	£0.14	CD4026	£1.00	CD4046	£0.95	CD4511	£0.80
CD4013	£0.35	CD4027	£0.45	CD4047	£0.75	CD4516	£0.85
CD4014	£0.70	CD4028	£0.60	CD4049	£0.35	CD4518	£0.85
CD4015	£0.70	CD4029	£0.65	CD4050	£0.35	CD4520	£0.85
CD4016	£0.35	CD4030	£0.40	CD4054	£0.95		

BOOKS BY BABANI

The following books are offered at 10% off their normal price.

		Normal Price	Sale Price
BP6	Engineers & Machinists Reference Tables	£0.40	£0.36
BP14	Second Book of Transistor Equivalents & Substitutes	£1.10	£0.99
BP22	79 Electronic Novelty Circuits	£0.75	£0.68
BP24	52 Projects Using IC741 for equivalents	£0.75	£0.68
BP26	Radio Antenna Handbook for Long Distance Reception & Transmission	£0.85	£0.77
BP27	Giant Chart of Radio Electronic Semi-conductor and Logic Symbols	£0.60	£0.54
BP32	How to Build Your Own Metal & Treasure Locators	£0.85	£0.77
BP34	Practical Repair & Renovation of Colour TVs	£0.95	£0.86
BP35	Handbook of IC Audio Preamplifier & Power amplifier construction	£0.95	£0.86
BP36	50 Circuits Using Germanium, Silicon & Zener Diodes	£0.75	£0.68
BP37	50 Projects Using Relays SCR's and Triacs	£1.10	£0.99
BP39	50 (FET) Field Effect Transistor Projects	£1.25	£1.13
BP40	Digital IC Equivalents & Pin Connections	£2.50	£2.25
BP41	Linear IC Equivalents & Pin Connections	£2.75	£2.48
BP42	50 Simple LED Circuits	£0.75	£0.68
BP43	How to make Walkie-Talkie	£1.25	£1.13
BP44	IC 555 Timer Projects	£1.45	£1.31
BP45	Projects on Opto-Electronics	£1.25	£1.13
BP46	Radio Circuits using IC's	£1.35	£1.22
BP47	Mobile Discotique Handbook	£1.35	£1.22
BP48	Electronic Projects for Beginners	£1.35	£1.22
BP49	Popular Electronic Projects	£1.45	£1.31
BP50	IC LM3900 Projects	£1.35	£1.22
BP55	Radio Stations Guide	£1.45	£1.31
BP160	Coil Design & Construction Manual	£0.75	£0.68
BP202	Handbook of Integrated Circuits (ICs) Equivalents & Substitutes	£0.75	£0.68
BP205	First Book of Hi-Fi Loudspeaker Enclosures	£0.75	£0.68
BP213	Electronic Circuits for Model Railways	£0.85	£0.77
BP215	Shortwave Circuits & Gear for Experimenters and Radio Hams	£0.85	£0.77
BP216	Electronic Gadgets & Games	£0.85	£0.77
BP217	Solid State Power Supply Handbook	£0.85	£0.77
BP221	28 Tested Transistor Projects	£0.95	£0.86
BP222	Solid State Short Wave Receivers for Beginners	£0.95	£0.86
BP223	50 Projects Using IC CA3130	£0.95	£0.86
BP224	50 CMOS IC Projects	£0.95	£0.86
BP225	A Practical Introduction to Digital ICs	£0.95	£0.86
BP226	How to Build Advanced Short Wave Receivers	£1.20	£1.08
BP227	Beginners Guide to Building Electronic Projects	£1.25	£1.13
BP228	Essential Theory for the Electronics Hobbyist	£1.25	£1.13

VPS30 Variable Regulated Stabilised Power Supply Module

Incorporating a short circuit protection and current limiting:
Voltage Regulation 2-30V
Regulated Current 0-2A
AC Input Maximum 25V
Eliminates the use of batteries and thus saves £'s-can be used time and time again ONLY £7.80 + V.A.T.

BRAND NEW	
ITT 923 Silicon Diodes 200mA 200v.	
100 off - £ 2.00	
500 off - £ 9.00	
1000 off - £ 15.00	
10,000 off - £130.00	

P.C. BOARD	
Single-Sided Fibre Glass Board 12" x 31" approx. 2 pcs	£0.80
S143	

THYRISTORS

No. THY1A/50	1 Amp	50 volt	T05	18p
No. THY1A/400	1 Amp	400 volt	T05	32p
No. THY3A/50	3 Amp	50 volt	T064	25p
No. THY3A/200	3 Amp	200 volt	T064	32p
No. THY3A/400	3 Amp	400 volt	T064	40p
No. THY5A/50	5 Amp	50 volt	T066	25p
No. THY5A/400	5 Amp	400 volt	T066	40p
No. THY5A/600	5 Amp	600 volt	T066	50p
No. C108/4	6 Amp	400 volt	T0220	42p

TRIAC

S84 8 Amp 400 volt T0220 80p

DIACS

ITT V413 equt	12p
BR100 D32 each	12p

CAPACITOR PAKS

16201	18 Electrolytics	4.7µF - 10µF
16202	18 Electrolytics	10µF - 100µF
16203	18 Electrolytics	100µF - 680µF
All 3 at SPECIAL PRICE of £1.20*		
16160	24 Ceramic Caps	22pF - 82pF
16181	24 Ceramic Caps	100pF - 390pF
16162	24 Ceramic Caps	470pF - 3300
16163	21 Ceramic Caps	4700pF - 0.047µF
All 4 at SPECIAL PRICE of £1.60*		

RESISTOR PAKS

Order No.			
16213	60½W.	100 ohm - 820 ohm	
16214	60½W.	1K - 8.2K	
16215	60½W.	10K - 82K	
16216	60½W.	100K - 820K	
All 4 at SPECIAL PRICE of £1.60*			
16217	40½W.	100 ohm - 820 ohm	
16218	40½W.	1W - 8.2K	
16219	40½W.	1K - 8.2K	
16220	40½W.	100K - 820K	
All 4 at SPECIAL PRICE of £1.60*			

VOLTAGE REGULATORS

Positive			
No. MVR7805	µA7805	T0220	55p
No. MVR7812	µA7812	T0220	55p
No. MVR7815	µA7815	T0220	55p
No. MVR7818	µA7818	T0220	55p
No. MVR7824	µA7824	T0220	55p
Negative			
No. MVR7905	µA7905	T0220	75p
No. MVR7912	µA7912	T0220	75p
No. MVR7915	µA7915	T0220	75p
No. MVR7918	µA7918	T0220	75p
No. MVR7924	µA7924	T0220	75p
µA723C T099	38p	7223 14 pin Dii	38p
	LM309K	T03	£1.20

SWITCHES

No. 16178	5 x Mains Slide Switches	40p*
No. S17	5 x Miniature Slide Switches	40p*
No. S18	4 x Standard Slide Switches	40p*
No. S19	4 x Miniature Push to Make single hole mounting	40p*
No. S20	3 x Miniature Push to Break single hole mounting	40p*
No. S21	Push button Switch Pak 4 x Assorted types multi bank and singles Latching and non-Latching	£1.00*

AUDIO LEADS

Order No.		
127	Audio lead 5 pin DIN plug to 4 phono plugs	90p*
129	Audio lead 5 pin plug to 5 pin DIN plug - Mirror Image	70p*
130	5 metre lead 2 pin DIN plug to 2 pin DIN intine socket	45p*

AUDIO PLUG AND SOCKET PAKS

Order No.		
S1	5 x 3.5 mm Plastic Jack Plugs	40p*
S2	5 x 2.5 mm Plastic Jack Plugs	40p*
S3	4 x Std. Plastic Jack Plugs	50p*
S4	2 x Stereo Jack Plugs	30p*
S5	5 x 5 Pin 180° DIN Plugs	50p*
S6	8 x 2 Pin Loudspeaker Plugs	50p*
S7	6 x Phono Plugs Plastic	50p*
S8	5 x 3.5 mm Chassis Sockets (Switched)	25p*
S9	5 x 2.5 mm Chassis Sockets (Switched)	25p*
S11	2 x Stereo Jack Sockets with instruction leaflet for Hi/Phone connection	50p*
S12	5 x 5 Pin 180° DIN Chassis Sockets	40p*
S13	8 x 2 Pin DIN Chassis Sockets	50p*
S14	6 x Single Phono Sockets	40p*

SPECIAL OFFER!

UNTESTED SEMICONDUCTOR PAKS

Code No's shown below are given as a guide to the type of device. The devices themselves are normally unmarked.

No. 16130	100 Germ. Gold bonded diodes like OA47	40p
No. 16131	150 Germ. Point contact diodes like OA70/81	40p
No. 16132	100 200mA Sil. diodes like OA200	40p
No. 16133	150 75mA Sil. Fast switching diode like IN4148	40p
No. 16134	50 750mA Sil. top hat Rects.	40p
No. 16135	20 3 amp Sil. stud Rect.	40p
No. 16136	50 400mV Zeners D.O.7 case	40p
No. 16137	30 NPN Plastic trans. like BC107/8	40p*
No. 16138	30 PNP Plastic trans. like BC177/8	40p*
No. 16139	25 NPN trans. like 2N697/2N1711 T039	40p
No. 16140	25 PNP trans. like 2N2905 T039	40p
No. 16141	30 NPN trans. like 2N706 T018	40p
No. 16143	30 NPN Plastic trans. like 2N3906 40p*	
No. 16144	30 PNP Plastic trans like 2N3905 40p*	
No. 16145	30 PNP Germ. trans like OC71	40p*
No. 16147	10 NPN to 3 Power trans like 2N3055	80p

I.C. SOCKET PAKS

No. S66	11 x 8 pin DIL Sockets	£1.00
No. S67	10 x 14 pin DIL Sockets	£1.00
No. S68	9 x 16 pin DIL Sockets	£1.00
No. S69	4 x 24 pin DIL Sockets	£1.00
No. S70	3 x 28 pin DIL Sockets	£1.00

MAMMOTH I.C. PAK

Approx. 200 pieces Assorted fall-out integrated circuits, including Logic 74 series, Linear, Audio and D.T.L. Many coded devices, but some unmarked-you to identify.
Order No. 16223 £1.00

MATCHED PAIRS OF PNP GERMANIUM MED. POWER TRANS

	VCE	VCB	HFE	750mW
NKT301	40	60	30-100	35p per pair
NKT302	40	60	50-150	35p per pair
NKT303	20	30	30-100	25p per pair
NKT304	20	30	50-150	25p per pair

From U.S.A. by

DINDY SCREW CASED LOW NOISE CASSETTES



Order No. S53 10 for £3.50*

HEAD-CLEANING CASSETTE 45p each

AUDIO AMPLIFIER

RETURN OF THE AL20A

By popular demand - this useful 5 watt RMS Power Amplifier is offered at the re-introduitory price of £2.75* - Hook-up data supplied.

ETCH RESIST PENS

Order No. 1609 50p each

UNI-JUNCTION TRANSISTORS

UT46	TIS43	20p
FET's		
2N3B19	15p	2N5458 18p

2 AMP. BRIDGE RECTIFIERS

SALE T-TIME again!

SPECIAL OFFER!

COMPONENT PAKS

Order No.	Quantity	Price
16168	5 pieces Assorted Ferrite rods	40p
16169	2 pieces Tuning gangs MW/LW	40p
16170	50 metres Single strand wire assorted wire	40p
16171	10 Reed switches	40p
16172	3 Micro switches	40p
16176	20 Assorted electrolytics Trans types	40p
16177	1 pack Assorted Hardware nuts/bolts etc.	40p
16179	20 Assorted tag strips and panels	40p
16180	15 Assorted control knobs	40p
16184	15 Assorted Fuses 100mA-5 amp	40p
16188	60 1/2W resistors mixed values	40p
16187	30 metres stranded wire / assorted colours	40p
S100	120 1/2 watt resistors, Pre-formed. 1978 Prod. Our mix	60p*
S101	120 1/2 watt resistors, Pre-formed. 1978 Prod. Mixed values	60p*
S102	250 1/2 watt resistors. Range 100 ohms - 1.8 meg.	£2.00*
S103	220 1/2 watt resistors. Range 100 ohms - 10 meg.	£2.00*
S104	60 Low ohms 1/2 watt resistors. 10 - 100 ohms	60p*
S105	40 Low ohms 1/2 watt resistors. 12 - 100 ohms	60p*
S106	25 Mixed wirewound resistors	60p*
S107	20 Tantulum bead caps 0.22 - 100mF Our mix	£1.00*
S108	High quality electrolytics 10mF-500mF voltage range 15-50v. Our mix. 40 for	£1.00*
16204	C280 Pak. Contains 50 metal foil caps	£1.00*

POTENTIOMETERS

Order No.	Description	Price
Slider 40mm TRAVEL		
16191	6 x 470 Ohm LIN Single	40p*
S24	6 x 1 K LIN Single	40p*
SA25	6 x 5 K LIN Single	40p*
16193	6 x 22 K LIN Single	40p*
16195	6 x 47 K LIN Single	40p*
16194	6 x 47 K LIN Single	40p*
S27	6 x 100 K LIN Single	40p*
S28	6 x 100 K LOG Single	40p*
S29	6 x 500 K LOG Single	40p*
S32	6 x 50 K LIN Single	40p*
Slider 60mm TRAVEL		
S30	6 x 2.5 K LOG Single	40p*
S34	4 x 5 K LOG Dual	40p*
S36	4 x 100 K LOG Dual	40p*
S37	4 x 1.3 MEG LOG Dual	40p*
S94	6 x 220 K LIN Single	40p*
S95	6 x 100 K LOG Single	40p*
S96	6 x 500 K LIN Single	40p*
S38	Mixed slider pots - various values and sizes - our mix	only £1.00* 40p*
S39	6 x Chrome slider knobs	40p*

WIREWOUND

S90	Wirewound Pots. Linear 1 Watt rating. Mixed useful values. 5 for	£1.00*
-----	--	--------

CARBON TYPES

S91	Car Radio type. Dual Switched Pot P.C. mounting. 100 K Lin switched. 2.5 K Lin	each 60p*
-----	--	-----------

DUAL POTS P.C. MOUNTING

S92	4 x 100 K Lin	£1.00*
S93	4 x 100 K Log	£1.00*
16173	15 Rotary Pot Assorted	40p*
16186	25 Pre-sets Assorted Values	40p*

ZENER PAKS

No. S55	20 mixed values 400mW Zener diodes 3-10V	£1.00
No. S56	20 mixed values 400mW Zener diodes 11-33V	£1.00
No. S57	10 mixed values 1W Zener diodes 3-10V	£1.00
No. S58	10 mixed values 1W Zener diodes 11-33V	£1.00

SILICON POWER TRANS. N.P.N.

S97	8D37 1.2 Amp 1.2w. 60Vceo Hfe 40-400, Case T092 with heat tab. 5 for	60p*
S98	2N5293 R.C.A. 36w 4 Amps 75Vceo Hfe 30-120. 5 for	£1.00*

Crystal Ear Pieces S126 Less plug	£0.20*
-----------------------------------	--------

Plugs for above No. 16106 2.5 plastic	£0.09*
No. 1697 3.5 plastic	£0.11*

Mono Crystal Cartridge S127 GP91/1SC Special Offer	£1.00*
--	--------

Nickel Cadmium Rechargeable Batteries 1.25V	£2.50
S128 3500D Cell size=U2	£0.90
S129 900C Cell size=U11	

S130 Complete kit of parts to build nickel cadmium charger	£3.50
--	-------

Super Save Pak S124 6 x 741P	£1.00
S125 5 x 855	£1.00

S138 Surplus/End of Manufacturers Line/Pre-amp. with Base, Treble, Volume Control & circuit diagram supplied. ONCE ONLY OFFER	£1.25*
---	--------

S137 20 Assorted Slider Knobs - Chrome/Black	£1.00*
--	--------

S131 2 x 12v Relays plastic case	£0.70*
----------------------------------	--------

S132 2 x 24v Relays plastic case	£0.60*
----------------------------------	--------

S133 1 switch bank 5 way Incl. silver knob	£0.75*
--	--------

S134 2 x Magnets suitable for reed switches	£0.10
---	-------

S135 .1 Veroboard pak 2 pcs 45 sq. ins. approx.	£0.80
---	-------

S136 .15 Veroboard pak 2 pcs 60 sq. ins. approx.	£1.10
--	-------

16199 .1 Veroboard pak pcs 30 sq. ins. approx.	£0.50
--	-------

16200 .15 Veroboard pak pcs 30 sq. ins. approx.	£0.50
---	-------

TOOLS

No. 2011 5" wire cutters	£1.55
No. 2012 5" long wire pleyer	£1.45

SUPER DUPER COMPONENT BOX

Min. 3lbs in weight consisting of a fantastic assortment of Electronic Components - Pots, Resistors, Condensers, Switches, Relays, Board - Semiconductors, wire, hardware, Etc., etc., etc.

This is a large box and is sent separate to your order £2.50 including p & p. S140

TRANSFORMERS SALE OFFER

S141 0235 240v primary, 0-55v at 2 amp secondary, £4.50* + £1.00 p&p.
S142 0349 240v primary, 0-20v at 2amp secondary, £3.50* + £0.85 p&p.

COMPLETE AUDIO AMPLIFIER KITS:

STA15 15 watts per channel amplifier kit	
Consists: 2 x AL60-1xPA100-1xSPM80	
1 x 2034 transformer	£37.70inc VAT
2x coupling capacitors	+ .86p p/p

STA25 25 watts per channel amplifier kit. Consists:	
2xAL60-1xPA100-1xSPM120/45	
1x2040 transformer	£41.45inc VAT
1xreservoir cap	+ £1.16p p & p

STA35 35 watts per channel amplifier kit. consists:	
2xAL60-1xPA100-1xSPM120. 1x2041 transformer	£48.45inc VAT
1 reservoir capacitor	+ £1.16p p & p

STA50 50 watts per channel amplifier kit. Consists:	
2xAL120-1xPA200-1xSPM120/65	
2x2041 transformer	£58.20inc VAT
1xreservoir capacitor	+ £1.10p p & p

STA125 125 watts per channel amplifier kit. Consists:	
2xAL250-1xPA200-2xAL120/65	
2x2041 transformers	£72.85inc VAT
1xreservoir capacitor	+ £1.25p p & p

STA125 125 watts per channel amplifier kit. Consists:	
2xAL250-1xPA200-2xAL120/65	
2x2041 transformers	£72.85inc VAT
1xreservoir capacitor	+ £1.25p p & p

STA125 125 watts per channel amplifier kit. Consists:	
2xAL250-1xPA200-2xAL120/65	
2x2041 transformers	£72.85inc VAT
1xreservoir capacitor	+ £1.25p p & p

STA125 125 watts per channel amplifier kit. Consists:	
2xAL250-1xPA200-2xAL120/65	
2x2041 transformers	£72.85inc VAT
1xreservoir capacitor	+ £1.25p p & p

ORDERING

Minimum postage and packing for Sale Orders £0.50 PLUS any further postage as stated as per this Sale Advertisement
Overseas Orders - ADD extra for Air-mail

V.A.T.

Please ADD V.A.T. as follows:
12 1/2% to items marked * 8% to unmarked items NO V.A.T. on Books

SEND FOR YOUR BI-PAK CATALOGUE 65p post free.

TRANSISTORS

BRAND NEW - FULLY GUARANTEED

Type	Price	Type	Price	Type	Price	Type	Price	Type	Price
AC107	25p	BC177	12p	BF194	*9p	TIP32A	34p	2N1613	15p
AC126	14p	BC178	14p	BF195	*9p	TIP32B	35p	2N1711	15p
AC127	16p	BC179	12p	BF196	*12p	TIP32C	36p	2N1893	28p
AC128	16p	BC182	*9p	BF197	*12p	TIP41A	34p	2N2218	15p
AC128K	24p	BC182L	*9p	BF200	25p	TIP41B	35p	2N2218A	18p
AC176	16p	BC183	*9p	BFX29	22p	TIP41C	36p	2N2219	15p
AC176K	24p	BC183L	*9p	BFX84	18p	TIP42A	35p	2N2219A	18p
AC187	16p	BC184	*9p	BFY50	12p	TIP42B	37p	2N2221	15p
AC187K	26p	BC184L	*9p	BFY51	12p	TIP42C	38p	2N2221A	16p
AC188	16p	BC212	*10p	BFY52	12p	TIP295S	65p	2N2222	15p
AC188K	26p	BC212L	*10p	MPSA05	*22p	TIP305S	42p	2N2222A	16p
AD161	80p	BC213	*10p	MPSA08	*22p	ZTX107	*6p	2N2369	10p
162MP	30p	BC213L	*10p	MPSA85	*22p	ZTX108	*6p	2N2904	14p
AF139	30p	BC214	10p	MPSA85	*22p	ZTX109	*7p	2N2904A	15p
AF239	30p	BC214L	*10p	MPSA56	*22p	ZTX300	*7p	2N2905	14p
BC107	6p	BC251	*10p	OC44	12p	ZTX301	*7p	2N2905A	15p
BC108	6p	BCY70	12p	OC46	12p	ZTX302	*8p	2N2906	12p
BC109	6p	BCY71	12p	OC71	9p	ZTX500	*10p	2N2906A	14p
BC118	*10p	BDY72	12p	OC72	12p	ZTX501	*12p	2N2907	12p
BC147	*8p	BD115	*40p	OC75	10p	ZTX502	*12p	2N2907A	13p
BC148	*8p	BD131	*35p	OC81	14p	2N695	10p	2N2926G	*8p
BC149	*8p	BD132	*37p	OC81	14p	2N697	10p	2N2926	*7p
BC154	*16p	BF115	17p	TX29A	35p	2N706	7p	2N3053	12p
BC157	*9p	BF167	19p	TIP29B	36p	2N708A	8p	2N3085	35p
BC158	*9p	BF173	20p	TIP29C	38p	2N708	8p	2N3702	*7p
BC159	*9p	BF180	25p	TIP30A	36p	2N1302	12p	2N3703	*7p
BC169C	*10p	BF181	25p	TIP30B	37p	2N1303	15p	2N3704	*6p
BC170	*10p	BF182	25p	TIP30C	38p	2N1304	15p	2N3903	*11p
BC171	*6p	BF183	25p	TIP31A	32p	2N1307	18p	2N3904	*11p
BC172	*6p	BF184	25p	TIP31B	32p	2N1308	22p	2N3905	*11p
BC173	*7p	BF185	25p	TIP31C	34p	2N1309	22p	2N3906	*11p

DIODES

Type	Price	Type	Price	Type	Price	Type	Price	Type	Price
AA119	5p	BAX16/	5p	BY216	30p	OA85	7p	IS44	3p
AA213	4p	OA202	5p	BY217	28p	OA90	6p		
BA100	6p			BY218	28p	OA91	7p	IN5400	10p
BA115	5p	BY100	15p	BY219	28p	OA95	7p	IN5401	11p
BA144	5p	BY127	*10p					IN5402	12p
BA148	10p	BY210	32p	OA47	5p	IN34	5p	IN5404	13p
BA173	10p	BY211	32p	OA70	5p	IN60	6p	IN5406	16p
BAX13/	6p	BY212	32p	OA79	7p	IN914	4p	IN5407	17p
OA200	5p	BY213	30p	OA81	7p	IN4148	4p	IN5408	19p

LINEAR I.C.'s

TBA800	£0.75*	UA711	£0.25*	UA748	£0.28*
TBA810	£0.85*	UA703	£0.20*	72558	£0.45*
TBA820	£0.65*	741P	£0.18*	MC1310P	£1.25*
LM380	£0.80*	72741	£0.20*	76115	£1.28*
LM385	£1.25*	UA71C	£0.20*	NE555	£0.22*
72709	£0.20*	72747	£0.85*	SL414A	£1.80*
UA709	£0.20*	748P	£0.28*		

ZN 414 RADIO CHIP 75*

TBA800	£0.75*	UA711	£0.25*	UA748	£0.28*
TBA810	£0.85*	UA703	£0.20*	72558	£0.45*
TBA820	£0.65*	741P	£0.18*	MC1310P	£1.25*
LM380	£0.80*	72741	£0.20*	76115	£1.28*

EDITOR

F. E. BENNETT

ASSISTANT EDITOR

B. W. TERRELL B.Sc.

PRODUCTION EDITOR

D. G. BARRINGTON

TECHNICAL SUB-EDITOR

T. J. JOHNSON G8MGS

ART EDITOR

R. F. PALMER

ASSISTANT ART EDITOR

P. A. LOATES

TECHNICAL ILLUSTRATOR

D. J. GOODING

EDITORIAL OFFICES

Kings Reach Tower,
Stamford Street,
London SE1 9LS
Phone: 01-261 6873

ADVERTISEMENT MANAGER

V. PIERI
Phone: 01-261 6727

REPRESENTATIVE

N. BELLWOOD
Phone: 01-261 6727

CLASSIFIED MANAGER

C. R. BROWN
Phone: 01-261 5782

MAKE-UP AND COPY DEPARTMENT

Phone 01-261 6618

ADVERTISEMENT OFFICES

Kings Reach Tower
Stamford Street,
London SE1 9LS

Projects... Theory...

and Popular Features ...

The constructor has gained directly from developments in components and in hardware. Neater, more professional looking projects are the order of the day. And of course the standing of the amateur is greatly enhanced by the evidence of a well organised and neatly assembled piece of equipment. The means are there, the circuit designs flow forth in abundance and variety month after month from magazines such as EVERYDAY ELECTRONICS. In short, one might say the constructor is sitting pretty.

But this hobby embraces other activities such as experimenting and designing, as well.

Experimenting, or to use a more homely expression, playing with circuits, is an absorbing exercise whatever the final outcome may be. It is, after all, the best way to learn once the basics have been mastered. It is also, perhaps more importantly in the hobby context, fun.

In comparison with the constructor, the experimenter or designer has not received quite the attention that is his due. Representing a minority section of all electronics enthusiasts, this is in a sense understandable although it is a situation that requires rectifying.

Contemporary components, hardware and assembly techniques should be applied just as diligently and effectively to aid the experimenter as the project builder. That is what we have long believed, and our thoughts

in this connection have materialised in the form of the *EE Labcentre*.

We believe that anyone with a serious interest in electronics will be proud to possess this equipment. The initial outlay in parts will be a good investment over the years. For this is no toy, it is not limited in any way to hobby activities, but will serve the practising professional equally well (a point that parents of budding engineers might note when the cost of this project is weighed).

Compact, self-sufficient and highly organised for breadboarding work with discretes and i.c.s, *EE Labcentre* will answer an urgent need.

Newcomers to electronics will find this issue of EVERYDAY ELECTRONICS especially important. First, there is the free piece of circuit board which they can use for their first project. Our helpful feature *Square One* explains just how to use this circuit board, which is the basis of many designs published in this magazine.

Everyone wants to learn more about microprocessors—and rightly so. They represent the “biggest thing” in electronics since the transistor. Our new series *Microprocessor Basics* will help you understand what they are all about.

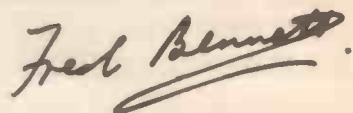

Our April issue will be published on Friday, March 16. See page 171 for details.

Readers' Enquiries

We cannot undertake to answer readers' letters requesting modifications, designs or information on commercial equipment or subjects not published by us. All letters requiring a personal reply should be accompanied by a stamped self-addressed envelope.

Telephone enquiries should be limited to those requiring only a brief reply. We cannot undertake to engage in discussions on the telephone, technical or otherwise.

Component Supplies

Readers should note that we do not supply electronic components for building the projects featured in EVERYDAY ELECTRONICS, but these requirements can be met by our advertisers.

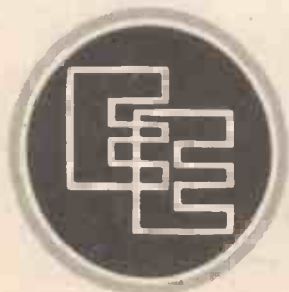

Everyday ELECTRONICS

VOL. 8 NO. 3

MARCH 1979

CONSTRUCTIONAL PROJECTS

CAR DIRECTION INDICATOR Audiovisual unit with hazard flasher option by B. Hamill	138
TIME DELAY INDICATOR Adjustable delays from 3 to 100 seconds by A. R. Winstanley	143
ONE TRANSISTOR RADIO Medium and long waves with optional audio amplifier by F. G. Rayer	146
EE LABCENTRE Part 1: Portable "instant" laboratory by R. W. Coles and B. Cullen	151
MINI MODULE: 6-VERSATILE POWER SUPPLY For the newcomer (and others) by George Hylton	157
EE2020 TUNER AMPLIFIER Part 4: Chassis construction by E. A. Rule	164

GENERAL FEATURES

EDITORIAL	136
COUNTER INTELLIGENCE A retailer comments by Paul Young	142
SHOP TALK Guidance on component buying by Dave Barrington	144
SQUARE ONE Beginner's page. Using stripboard	145
CROSSWORD NO. 13 by D. P. Newton	150
DOWN TO EARTH Sidebands and carriers by George Hylton	159
MICROPROCESSOR BASICS Part 1: Getting to grips with the "chips" revolution by R. W. Coles	160
JACK PLUG AND FAMILY Cartoon by Doug Baker	163
EVERYDAY NEWS What's happening in the world of electronics	172
EE SPECIAL REPORT Denshi-Gakken Kits	174
RADIO WORLD A commentary by Pat Hawker	177
FOR YOUR ENTERTAINMENT Unusual radio, Teletext and Prestel by Adrian Hope	178
DOING IT DIGITALLY Part 6: Digital counting and displays by O. N. Bishop	180
BOOK REVIEWS A selection of recent releases	184
COMPETITION RESULT Winners of the AVO Multimeter Competition	184

★ **FREE WITH THIS ISSUE—STRIPBOARD** (Mounted on Front Cover)

Back issues of EVERYDAY ELECTRONICS June 1977 onwards (October to December 1977, January to March 1978 NOT available) are available worldwide at a cost of 60p per copy inclusive of postage and packing. Orders and remittance should be sent to: Post Sales Department, IPC Magazines Ltd., Lavington House, 25 Lavington Street, London SE1 0PF.

Binders for Volumes 1 to 8 (state which) are available from the above address for £2.85 inclusive of postage and packing. Subscriptions (for one year)—UK: £8.50. Overseas: £9.50.

© IPC Magazines Limited 1979. Copyright in all drawings, photographs and articles published in EVERYDAY ELECTRONICS is fully protected, and reproductions or imitations in whole or in part are expressly forbidden.

All reasonable precautions are taken to ensure that the advice and data given to readers are reliable. We cannot however guarantee it, and we cannot accept legal responsibility for it. Prices quoted are those current as we go to press.

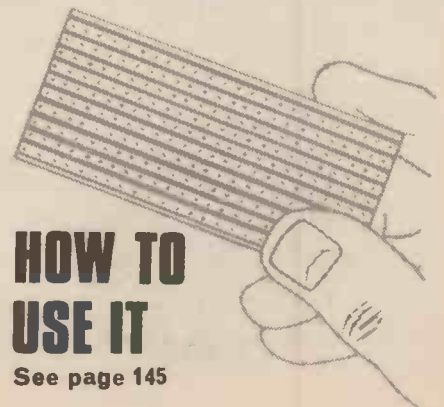



By B. Hamill

CAR DIRECTION INDICATOR



WITH HAZARD FLASHER OPTION

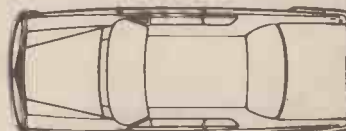

THE CONVENTIONAL electro-mechanical flasher units fitted to most vehicles have many drawbacks, principally because they rely on the expansion and contraction of a length of wire connected in series with the indicator lamps; any variation in the current drawn by the lamps, caused by low battery voltage or corrosion of the lamp connections etc, is usually sufficient to send the flashing rate well outside the legal limits of between 60 and 120 flashes per minute.

The unit described in this article is designed to replace a conventional flasher with only a few minor connections to the vehicles wiring. In addition, the device provides an audible warning tone as well as the normal dashboard warning lamp. The

main circuit is designed for negative earth vehicles but can be modified for positive earth and/or 6 or 12 volt systems.

This choice of systems thus makes the unit very versatile indeed.

CIRCUIT DESCRIPTION

The complete circuit diagram is shown in Fig. 1, and consists of IC1 connected to form two astable multivibrators running at different frequencies. One oscillator drives the relay RLA via TR1. The frequency of this oscillator is determined by C1 and R2, resistor R1 compensating for variations in supply voltage and temperature.

Although C1 is a fairly high value capacitor, a non-electrolytic type must be used, since C1 is

charged in opposite directions during each half of the cycle.

The other oscillator, whose frequency is determined by C2 and R3, generates a tone of approximately 600Hz, which is amplified by TR2 and drives the small loud-speaker LS1.

When the car's indicator switch is moved either way from the centre off position, C3 is connected through D2 and the indicator lamps to earth, and thus charges up to the supply voltage.

The base of TR3 swings negative with respect to its emitter, and since the TR3 is a *npn* device, it turns on. This switches on the supply voltage to IC1, which is stabilised by resistor R7 and the Zener diode D3.

The two oscillators then start operating, opening and closing

Fig. 1. Complete circuit diagram of the negative earth version of the Direction Indicator.

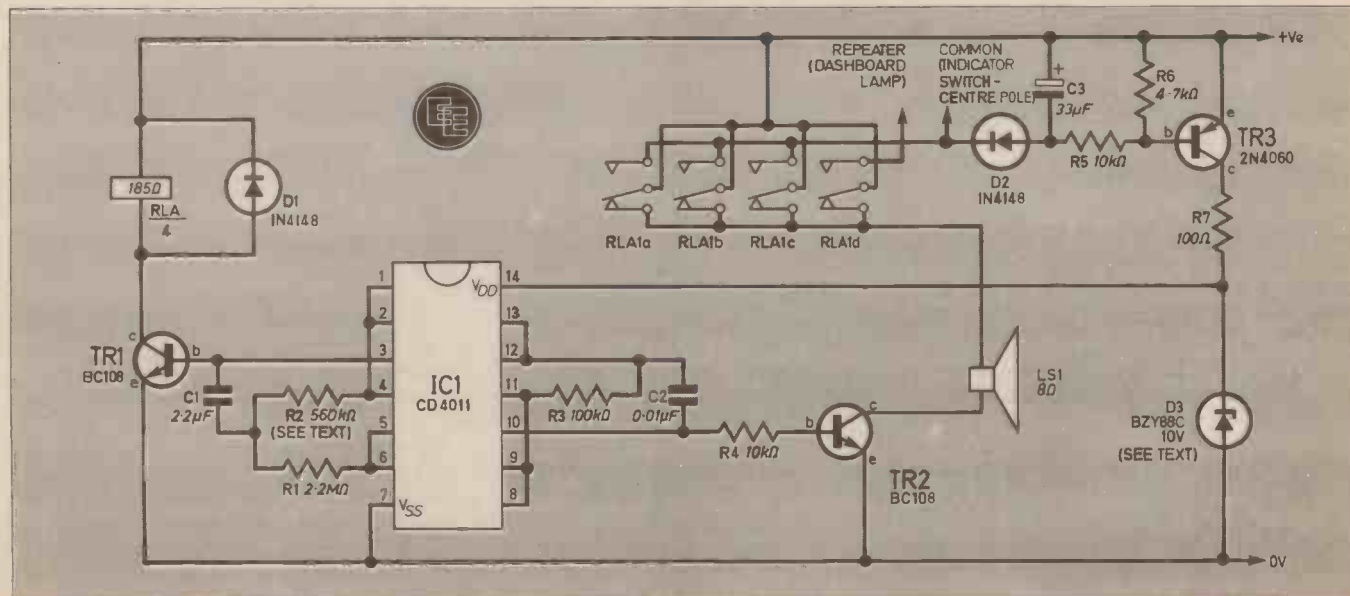

RLA which in turn switches on and off the indicator lamps. During the period in which the lamps are on, D2 is reverse biased and prevents C3 discharging. This capacitor discharges slowly through R5 and R6, holding TR3 on until the relay contacts open again, whereupon it is immediately recharged.

The speaker, LS1 is connected to the positive line through one of the relay contacts, so that the audible tone is switched on and off synchronously with the lamps. The dashboard repeater lamp is connected similarly.

By connecting the loudspeaker in this way, it serves as a constant check on the operation of the device, since the audible tone will only function if all parts of the circuit are operating normally. When the indicator switch is returned to the off position, the lamps stop flashing immediately and C3 is discharged by R5 and R6, switching off TR3; this removes the power supply from IC1, thus turning off TR1 and TR2.

CONSTRUCTION starts here

In the prototype, the circuit was built on a piece of 0.1 inch matrix stripboard having 12 strips by 36 holes, the layout of which is shown in Fig. 2.

Since the integrated circuit is a CMOS type, it should be handled with care. An i.c. socket should be used for this component, which should not be inserted until all other wiring is complete.

Begin construction by inserting the resistors, note that these must be miniature types to avoid overcrowding of components on the board, continue by inserting the capacitors, of which C3 and particularly C1 should be as small as possible, observing the polarity of C3.

The connecting wires and the relay may now be mounted on the board. The length of connecting wires required will depend on the position of the original flasher unit in the vehicle. If this is

situated in the engine compartment, the wires should be long enough to allow the new unit to be placed in the passenger compartment, preferably under the dashboard.

VEHICLE WIRING

In the prototype, the connections to the vehicle wiring were made by a plastic block connector, although "spade" terminals similar to those used on the original flasher unit may of course be used. In addition to the three original connections; POSITIVE, COMMON, and REPEATER, the unit requires a connection to the vehicle chassis.

The relay used in the prototype was a miniature type with four sets of changeover contacts. Three of these are connected in parallel to carry the lamp current, typically 3.5A or more for a 12 volt system, and the fourth is used to switch the dashboard repeater lamp and the loudspeaker. The connections required for the most common type of miniature relay, and as used on the prototype are shown in Fig. 2. The relay coil is connected to the circuit board by short lengths of wire.

Complete the construction by connecting the diodes and transistors and the loudspeaker. The

**COMPONENTS
APPROXIMATE
COST**
**£5 or £7.50
with hazard
option**

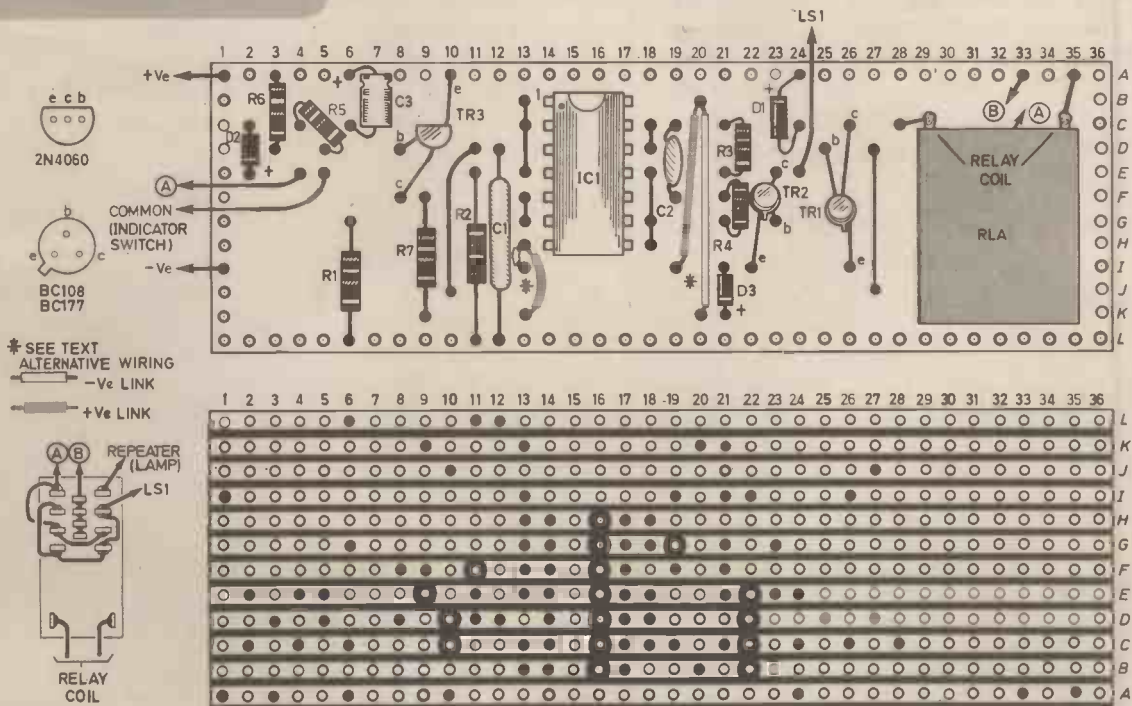

Fig. 2. Stripboard layout for the unit. This layout applies to both the negative and positive earth versions, although see text regarding variations, polarised components and different transistors, for the positive earth version. The two links shown tinted are required only for the positive earth version and should be disregarded for negative version.

integrated circuit may now be inserted, taking care to ensure that it is correctly oriented.

SIX VOLT OPERATION

The basic circuit shown in Fig. 1 is designed to operate on 12V negative earth systems. For those constructors who may have vehicles which use a six volt system, although rare, can modify the circuit to suit. There are only three changes to be made:

1. Change the value of R2 to 470kΩ.
2. Change the Zener diode D3 to a 4.7V device.
3. The relay used must be changed for one which operates on 6V.

POSITIVE EARTH

For positive earth systems several changes are required together with minor changes to the layout. The changes are as follows:

1. Connect the positive supply of the circuit to car chassis, connect the negative terminal to positive of the car electrical system.

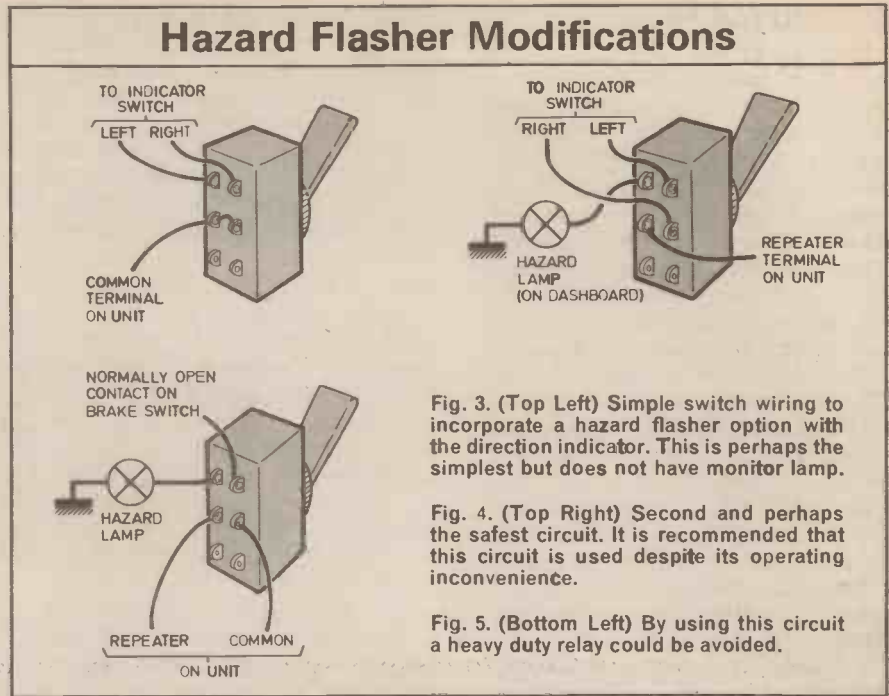

Fig. 3. (Top Left) Simple switch wiring to incorporate a hazard flasher option with the direction indicator. This is perhaps the simplest but does not have monitor lamp.

Fig. 4. (Top Right) Second and perhaps the safest circuit. It is recommended that this circuit is used despite its operating inconvenience.

Fig. 5. (Bottom Left) By using this circuit a heavy duty relay could be avoided.

2. Reverse the polarities of all diodes and the electrolytic capacitor C3.
3. Substitute BC177 pnp transistors for TR1 and TR2. Change TR3 to a BC108 npn device.
4. Connect pin 7 of the i.c. to

point K13, connect pin 14 to point I19 on the stripboard layout. These changes in links are clearly shown in the diagram of Fig. 2 as tinted wires. Remove the original wire links, shown as plain open wires.

NEGATIVE EARTH AND HAZARD WARNING WIRING

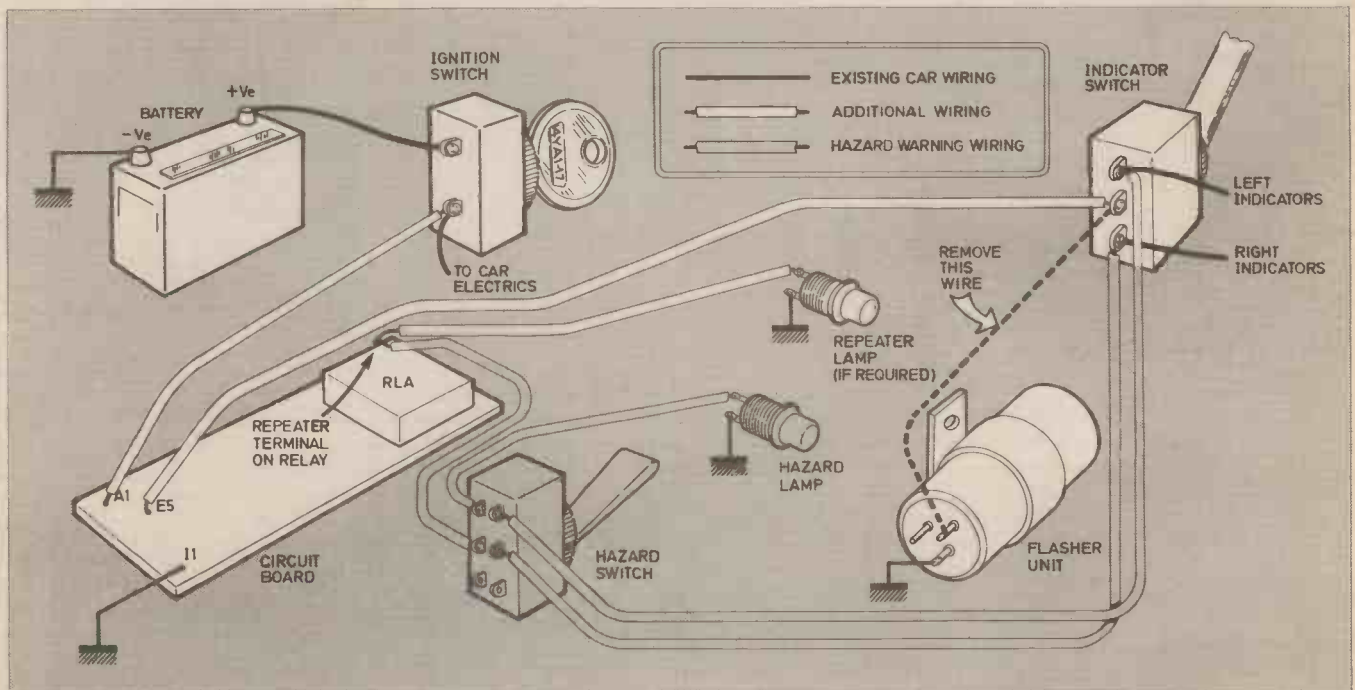

Fig. 6. Simplified wiring diagram of how to fit the unit into the car electrical system. As with all car projects it is advisable to check with the car workshop manual to find the exact wiring details. Also shown is the additional wiring required to incorporate the hazard flasher option. We have selected the circuit of Fig. 4 to show how this is done.

HAZARD FLASHER

The Direction Indicator can easily be used to operate as a hazard flasher. There are several ways of doing this, depending on whether an additional dashboard indicator lamp is required to monitor the operation of the hazard lights. All require a heavy duty double pole double throw toggle switch in addition to the original circuit, and a heavy duty relay with 7A contacts in place of RLA.

It may be necessary to increase the rating of TR1 which may be needed depending on the current flowing in the coil of the new relay. A BFY51 is suitable in the case of negative earth systems, and a BFX88 for positive earth.

Three circuits can be used—the choice is entirely up to the constructor.

The first, Fig. 3 is perhaps the simplest, in terms of operating convenience but does not use an indicator lamp to monitor operation.

The second, Fig. 4, although has an indicator lamp incorporated does have the inconvenience in that both the toggle switch and car indicator switch must be operated. Some people will however find this method safer as with the first method no indication is given that the lights are actually flashing—dangerous if you are actually driving with them on.

Whichever method is chosen it is sure to be a worthwhile addition, and will certainly give peace of mind in the unfortunate situation of a breakdown.

CONNECTION TO CAR

The diagram of Fig. 6 shows very simply how to connect the Direction Indicator into the cars

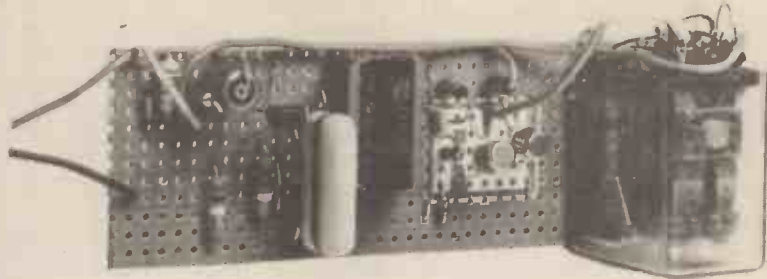

The last method, Fig. 5, does avoid the use of a heavy duty relay, which may or may not be easy to obtain, but only flashes the brake lights and gives no indication at the front of the vehicle.

electrical system. Also shown are the connections required if the hazard flasher facility is also required.

There are one or two points to remember when actually wiring, one of which would cause the unit to be destroyed if connected incorrectly. These are as follows:

COMPONENTS

NEGATIVE EARTH VERSION

Resistors

- R1 2.2M Ω
- R2 560k Ω (12V) 470k Ω (6V)
- R3 100k Ω
- R4 10k Ω
- R5 10k Ω
- R6 4.7k Ω
- R7 100 Ω
- All $\frac{1}{4}$ W carbon $\pm 5\%$

Capacitors

- C1 2.2 μ F miniature polyester
- C2 0.01 μ F polyester
- C3 33 μ F 16V elect.

Semiconductors

- TR1 BC108 silicon *nnp*
- TR2 BC108 silicon *nnp*
- TR3 2N4060 silicon *pnp*
- IC1 CD4011 Quad 2-input NAND gate
- D1 1N4148 or similar silicon diode
- D2 1N4148 or similar silicon diode
- D3 BZY88C10V 10V 400mW Zener diode (12V) or BZY88C4V7 4.7V 400mW Zener diode (6V)

Miscellaneous

- LS1 8 ohm miniature loudspeaker 75mm diameter
- RLA 6V or 12V miniature relay with four sets of change over contacts (RS type 348 942).
- Stripboard: 0.1 inch matrix 12 strips x 36 holes; 14 pin i.c. socket; small plastic case to suit; connecting wire.

POSITIVE EARTH VERSION

As above but change TR1 and TR2 to BC177 silicon *pnp*, and TR3 to BC108 silicon *nnp*.

HAZARD FLASHER MODIFICATION

Use components as above for negative or positive earth as required, and add: heavy duty d.p.d.t. toggle switch; small panel mounting lamp (voltage as required); substitute heavy duty relay (7A contacts) for RLA.

FLASHER UNIT

It is important to disconnect the flasher unit entirely from the wiring. Normally there is only one lead going to the indicator switch from the flasher unit, and this is removed. Depending where the Direction Indicator is to be mounted it may be easier to remove the lead from the flasher unit and connect it to the circuit board. Alternatively the lead can be disconnected from the switch, but should be well isolated. The lead from the circuit board can then be connected direct to the switch.

REPEATER LAMP

The lead marked REPEATER is not normally required on most of today's modern vehicles, as the normal repeat lamps are connected in parallel with the indicator lamps. Thus normal operation is still retained. However older cars may not have this facility, so it is a good idea to have some positive indication that the indicators are actually working.

To have this facility all that is needed is to connect the REPEATER

See
**Shop
Talk**
page 144

lead to a lamp mounted somewhere conspicuous on the dashboard. Note however that this does not give an indication of which side is working, merely that they are at all!

HAZARD FLASHER

The hazard flasher wiring also shown in Fig. 6, shows only one version which can be wired up. The toggle switch and lamp as already explained are extras, and can be mounted in any convenient position on the dashboard.

ADJUSTMENTS

Before installing the unit in the vehicle, it should be tested as follows; connect a 6 or 12 volt supply as appropriate, and connect a small lamp of the same voltage between the negative supply line and the COMMON (positive end of D2) connection.

The lamp should flash at a frequency of 1 to 2Hz, and the tone

should appear in the loudspeaker. If all is well, the unit may be fitted in a suitable box and mounted in the vehicle. Before doing this, it is a good idea to varnish the underside of the circuit board with quick drying paint, in order to waterproof the unit—the interior of a car can be quite moist at times!

Because of the variation in transfer voltages of the logic gates of ICI, it may be found that the flashing rate is outside the required legal limits. If this is the case, the value of R2 should be increased if the flashing rate is too high, or decreased if the flashing rate is too low. Remove ICI from its socket before modifying the circuit board.

Some constructors may prefer to select the correct value of R2 by attaching two leads to the board in place of R2, and connecting a 1 megohm potentiometer between them. When the correct setting has been found, the resistance may be

measured with an ohmmeter, and the nearest available value of resistor used for R2.

It is not advisable to use a preset in place of R2 as a permanent feature, as the value of this preset is very likely to change when subjected to the adverse operating conditions experienced inside a vehicle.

IN USE

There should be no problems in using the device, the prototype having been installed in the authors car for some time now. As the unit is so versatile, it could be readily adapted for other uses as required. It is equally suitable for motorcycles, although where to put all the extra switches etc could pose a problem! The hazard facility would certainly be welcomed by most bike owners.

No doubt other uses will come to mind. ☐



I was pleased to see an Exhibition again in London, devoted more to the amateur constructor. I refer, of course, to the Breadboard Exhibition at Seymour Hall in November. The journals represented included EVERYDAY ELECTRONICS.

I thought there was rather a pre-dominance of musical instruments and electronic games, I would like to have seen more discrete components on view and better still on sale. Some stands it is true, were selling goods but half the fun of going to an amateur Exhibition is being able to purchase goods (especially bargains). I do hope this will be an annual event, but could not a more appropriate title be found for it?

I am fairly impervious to shocks caused by inflation, but I must confess even my eyebrows went up a shade recently, when I learned that the retail cost of a small 500pF solid dielectric variable capacitor is now £4.95!! I suggest, that where such a device is incorporated in a constructional design it could in many cases be replaced by a

500pF compression trimmer fitted with a brass spindle. Cost about 50–60p.

Wrong Again!

Everywhere I see adverts telling me that there are now small computers for the home at relatively modest prices, but what I cannot fathom is, what I would do with one if I had it. I suppose I can get the news and weather twenty-four hours a day and the share index.

However, I do not want any of these things anyway, though it reminds me of something my brother told me recently. When he was Editor of an electronics trade publication which shall be nameless, he had a girl, who apart from making the tea and typing, also looked after all his records. One day he was informed his girl would be replaced by a computer. Naturally he wanted to find out what advantage this would bring about. For a start he said, my girl can produce complete data on all our advertisers and customers in thirty seconds flat. Can the computer beat that? "Oh! dear me no", they said,

it will take the computer two or three days!! "Ah! well" said my brother it will save the cost of the girl's salary, probably over two thousand five hundred a year and she is leaving to get married anyway. Wrong again! They pointed out that the computer time has to be paid for, and it will cost the company up to double the girl's salary!

My brother concluded ruefully, that by becoming computerised, the job would take ten times as long, and cost twice as much. You have got to hand it to those computer salesmen, they really could sell sand to the Bedouin.

Sounds Vintage

There seems to be a great revival of interest in vintage radio, which includes all radios or radiograms made up to the outbreak of World War II. I recently read of one gentleman who started collecting them and quickly filled up his house. Then friends started pestering him to sell them some. He now has a very profitable business, almost any old mains set fetching at least £50. Strange to think that only a few months ago they could probably have been picked up off the local rubbish dump for nothing!

Following on from this I was delighted to see my old friend Norman Stevens, one time Editor of *Practical Wireless* has now started a publication called *Sounds Vintage*. I would like to wish it every success.

Talking of publications a friend of mine sends me every month one of the most popular American Electronics Magazines. I am bound to say, it's not a patch on EVERYDAY ELECTRONICS. To borrow a phrase "You Lucky People".



By A. R. Winstanley

THE DEVICE to be described here is designed to generate an audible tone after a predetermined delay. The delay period can be adjusted between approximately three seconds and one hundred seconds, but much longer delays can be obtained by experimenting with component values.

Suggested uses include its utilisation in children's games as a "time up" buzzer, or possibly delayed action burglar alarms. The photographer will also find it most useful.

CIRCUIT DESCRIPTION

The circuit diagram is shown in Fig. 1. Transistor TR1 is a special type of transistor called a "unijunction transistor". In this circuit it is normally off, that is, there is a very high resistance between base 2 and base 1.

Capacitor C1 is a large electrolytic capacitor which charges up slowly through VR1 (a variable resistor) and R1, until the potential at the emitter of TR1 is approximately 5.5V.

At this point the unijunction transistor rapidly switches over and C1 is able to discharge through the transistor and R3 to ground. The electrolytic capacitor will then recharge and the whole process is repeated until the power supply is removed from the circuit.

Note that by adjusting C1, R1 or VR1, different time delays can be achieved.

TRIGGER PULSE

The positive discharge pulse at base 1 of TR1 is transmitted by C2 to the gate of CSR1. This device is a controlled silicon rectifier or "thyristor" and normally a very high resistance exists between anode (a) and cathode (k). Once however, a suitable pulse is received at the gate terminal (g), the thyristor will rapidly trigger and the anode to cathode resistance falls to a very low value. The circuit to WD1, a miniature audible warning device consuming only 15mA, is therefore completed and the buzzer operates.

A thyristor will remain in this conductive state once a pulse is transmitted to its gate. It can be reset by removing the power supply or reducing the anode/cathode current to a very low value. Resistor R4 is included in the anode circuit to ensure that a minimum holding current is always flowing when the c.s.r. is conductive, therefore preventing it from resetting undesirably.

The audible warning device could be replaced with a visual indicator but the load must not exceed the forward current rating of the thyristor (500mA) and due attention should be paid to the capacity of the PP3 battery from which the circuit operates.

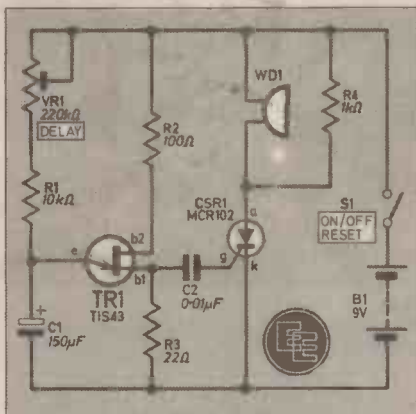

Fig. 1. Circuit diagram of the Time Delay Indicator.

CONSTRUCTION

The circuit is housed in a Bimbox, type BIM2003/13 plastic box measuring 112 x 62 x 31mm, although any similar size case can be used. The circuit itself is built onto a small piece of 0.1 inch stripboard measuring 23 holes by 9 strips as shown in Fig. 2. This is trimmed from the standard 10 strips x 24 holes stripboard and enables the circuit board to be retained in the p.c. guides moulded into the interior of the plastic case.

Construction is quite straightforward. The only points to watch are correct orientation of the transistor and thyristor leads. Also make sure you connect the electrolytic capacitor and audible warning device the right

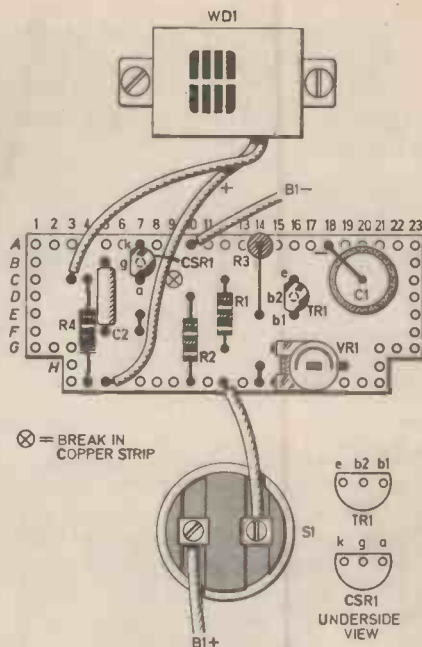

Fig. 2. Complete wiring details for the unit. Note that if you are using the Free piece of stripboard with this issue, one strip and a column of holes need to be removed. This is to allow the board to be vertically mounted within the specified case, using the fixing slots. Also note the two cut-outs and one break to be made.

COMPONENTS

Resistors

- R1 10kΩ
- R2 100Ω
- R3 22Ω
- R4 1kΩ
- All ½W carbon ± 5%

See
**Shop
Talk**
page 144

Potentiometer

- VR1 220kΩ miniature horizontal preset

Capacitors

- C1 150μF 10V elect.
- C2 0.01μF polyester

Semiconductors

- TR1 TIS43 n-channel unijunction transistor
- CSR1 MCR102 or similar thyristor (0.5A 30V)

Miscellaneous

- WD1 9V 15mA audible warning device (Maplin)
- S1 s.p.s.t. "Hekla" rocker switch (Maplin)
- B1 9V PP3 battery
- Stripboard: 0.1 inch matrix 9 strips x 23 holes; plastic case: Bimbox type BIM2003/13 blue or similar 112 x 62 x 31mm; battery clip to suit B1; lettering as required; connecting wire.

Approx cost—Guidance only
£2.50 excluding case

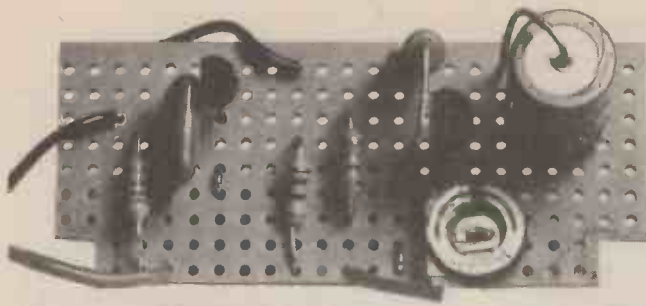

The completed circuit board showing layout of components. Note the two small link wires. If you use the specified case and the stripboard given Free with this issue you must remove one strip and a row of holes, and cut the corners as shown. This allows the lid to hold the board in place

way round. Finally do not overheat the semiconductors (TR1 and CSR1) in the soldering process. A heatshunt is advised for this process.

Drill the case as necessary to take the switch and buzzer. The latter item is mounted on the exterior of the case using two 8BA bolts. Complete the

unit and arrange the internally-retained components to conform with the overall arrangement used in the prototype unit.

The case could be lettered if desired; use rub-down lettering and then give the case a light coat or two of clear aerosol lacquer. This should all be done just after the case has been drilled.

The battery can be retained using double sided adhesive foam strips.

Once constructed, set the preset resistor to give the desired delay before the alarm sounds. The device is then complete and ready for use. ☐



By Dave Barrington

CONSTRUCTIONAL PROJECTS

Just a look at the list of this month's construction projects should send most readers rushing for their soldering irons.

Time Delay Indicator

For the *Time Delay Indicator* a thyristor type MCR102 is called for and could prove a problem. However, this should be available from Maplin. Also, any other type which requires a 0.8V at 0.2mA gate trigger signal will be suitable.

The audible warning device and switch is available from many of our advertisers. An alternative warning device is obtainable from Progressive Radio, 31 Cheapside, Liverpool, L2 2DY, price 78p (postage extra). Specify the 9V version. The Bleepitone from Home Radio or the Mini-Bleepitone from Verospeed (£3.80 plus VAT) are also suitable types.

Direction Indicator

One or two points need to be made regarding the *Direction Indicator*. The transistor type 2N4060 may be difficult to obtain, but is listed by Maplin Electronic in their catalogue. Also, the 2N4061 or 2N4062 may be used for TR3.

The relay specified does not necessarily have to have four sets of contacts, they must however be changeover types, as three sets of contacts are wired in parallel merely to be on the safe side when carrying the large currents required by the Indicators. Any other relay, provided it can handle the current requirements, with at least two sets of changeover contacts can be used.

When incorporating the "Hazard Flasher" modification, a heavy duty relay is specified. This relay replaces the existing one only if the original cannot handle the increased current.

One Transistor Radio

There should be no problems with components for the *One Transistor Radio*, but some readers may experience difficulty in locating the Dilecon 300pF variable capacitor CI. Maplin, Watford, Home Radio, Greenweld are just four of our advertisers who should be able to supply.

Versatile Power Supply

The only item that could be troublesome in the *Versatile Power Supply*, this month's *Mini Module* project, is likely to be the mains transformer. This transformer calls for a 9V-0-9V secondary and many of our advertisers should be able to supply an equivalent.

2020 Tuner Amplifier

This month we get to grips with the hardware for the *2020 Tuner Amplifier*. The cord drive assembly for the radio section is available from Maplin Electronics.

For those readers who are not too keen on doing their own metal bending a kit of undrilled metal work is available from Kitson's Sheet Metal Ltd., It may be possible that readers can

make arrangements with their local stockists who may be prepared to do the necessary bending.

Labcentre

Our major constructional article this month is the *EE Labcentre* and we are sure it will appeal to both the professional and amateur alike. Provided details are followed carefully it should not present any difficulties in construction and only a few components warrant further mention.

The "executive" type briefcase used to house the electronics and tools is, of course, arbitrary and readers may use any suitable housing of their own choice. The "test bed" or breadboarding strip used in the prototype was of American origin but there are now many alternative types available from advertisers which would be suitable.

We found that the Super Strip SS2 from Lektrokit Ltd. London Road, Reading, Berks. RG6 1AZ is identical to the original at a cost of £11.50 including postage. The SS2 is also available from Maplin, Watford and Marshalls.

Should the mains switch with built-in neon prove troublesome to obtain it can be replaced with a standard mains switch and a separate mains neon indicator.

As the *Labcentre* is going to see regular service we suggest readers use a good quality printed circuit board for this project. If readers do not feel capable of making their own board they can be purchased from C.C. Consultants, 77 St. Marks Road, Worle, Weston-Super-Mare, Avon BS22 0HN, who hold the copyright for the p.c.b. design. The cost is £4.85 including postage.

Components Sale!

We understand that in readiness for their move to new premises shortly, Home Radio are going to offer drastic price reduction on certain components. Items being offered are new stock surplus to current catalogue.

This offer is to personal shoppers only at their current address from March 24 to 31.

SQUARE one

FOR BEGINNERS

ONE of the many forms of circuit board available to the home constructor of electronic projects is stripboard. A usable piece of this is given FREE with this issue and the *Time Delay Indicator* is one example of a project to be built on this, see page 143.

As can be seen by examining this board (Fig. 1) it consists of a number of parallel strips of copper bonded to synthetic-resin-bonded-paper (usually abbreviated to s.r.b.p.) which is an insulating material. The strips are punched at intervals so as to produce a matrix of holes. The matrix pitch (the distance between holes on the same strip) can be either 0.1 inch or 0.15 inch.

Our particular board has a pitch of 0.1 inch. It has 10 strips and each strip has 24 punched holes. So a project requiring this board would specify in the components list: Stripboard, 0.1 inch matrix 10 strips x 24 holes.

If the required size for a particular project is non-standard (as is most

likely), the required piece may be cut from a larger sheet (Fig. 1). This is easily carried out with a junior hacksaw and the edges then filed smooth. The cut end should be examined for possible copper whiskers bridging adjacent tracks.

MOUNTING COMPONENTS

Components are intended to be mounted on the unclad side of the board—referred to as the topside, and their leads pushed through the punched holes. The leads are then cropped to about 2mm or so protruding beyond the copper strip—or underside, see Fig. 2. The leads should be bent in opposite directions to prevent the component falling out when the board is turned over for soldering, Fig. 3.

For components such as capacitors, resistors, diodes and wire links, the leads will need to be bent at right angles to the component body axis (Fig. 4) the bends being made at the correct points to span the allotted

holes. This is easiest achieved by use of a wire bending tool such as that given free with the May 1977 issue of E.E. Without this pliers will be needed, see Fig. 5.

COPPER STRIPS

The copper strip acts as "electrical wiring" between the components to connect them in the configuration of the circuit diagram.

The number of copper strips may effectively be increased by making "breaks" along the strip to divide them into two or more strips. This can be achieved by cutting away the copper at a particular point. A tool made for this job is a spot-face cutter but an ordinary twist drill-bit achieves the same result.

The tool or drill bit is placed in a punched hole closest to the required break point and twisted so as to cut away the copper, as shown in Fig. 6.

SOLDERING

Flying leads can be connected directly to the copper strips on the underside or from the topside through a hole. Either way, the tinned wire should be bent to be in contact with the strip. A tinned soldering iron tip is positioned to be in contact with both lead, and copper strip and solder placed on a convenient point to melt onto the strip and wire (Fig. 7)—not the iron bit! Remove the iron and solder and allow the joint to cool.

A smaller iron "bit" is required for work on 0.1 inch matrix board than on the 0.15 inch variety. The maximum size for convenience on a 0.1 inch board is 3mm to avoid solder bridges, Fig. 8.

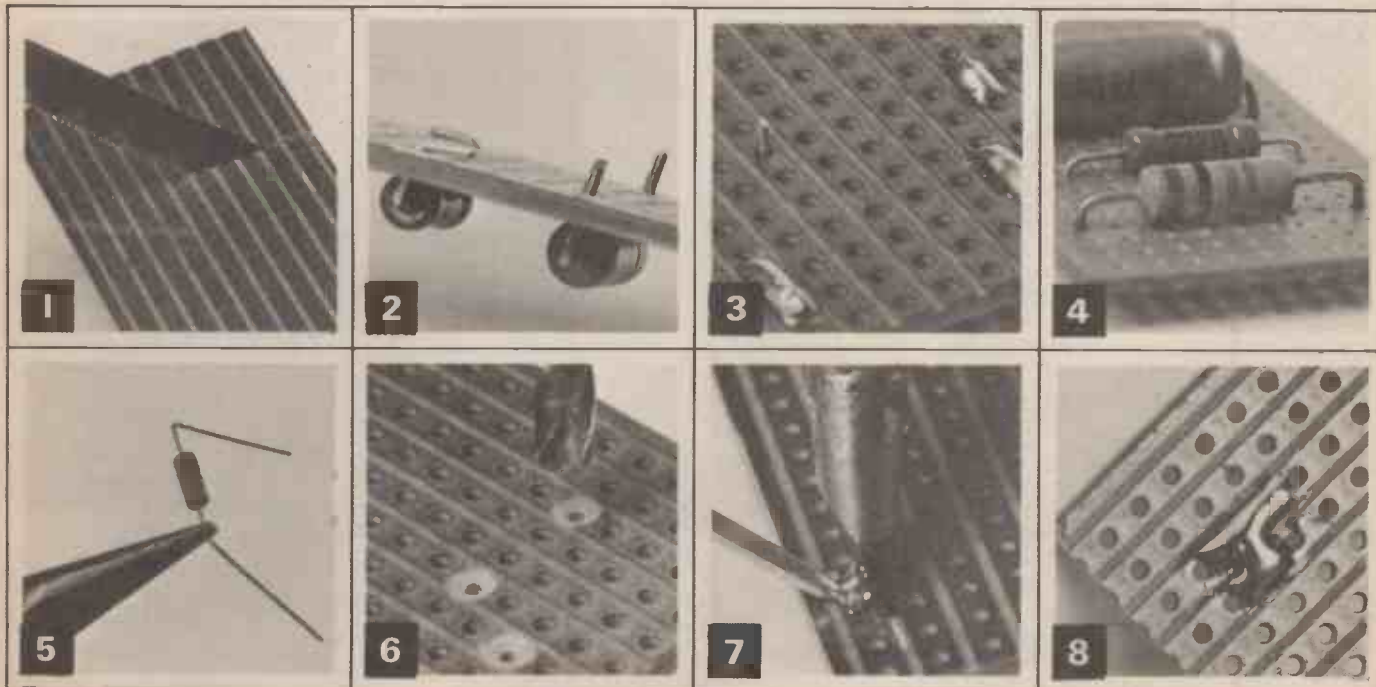



TRANSISTOR RADIO

With optional single transistor audio amplifier

By F. G. Rayer

THE ONE-TRANSISTOR radio to be described here is an easily constructed project and is intended to provide headphone reception of medium and long wave transmissions. A crystal diode receiver is often built because of its simplicity, but incorporating an amplifier provides very much better volume, and needs few extra components. Subsequently, an additional audio stage can be added, and in many areas this allows loudspeaker reception.

CIRCUIT DESCRIPTION

The circuit diagram for the radio is shown in Fig. 1. Sockets SK1 and SK2 are optional aerial connections, SK1 is best for a long aerial, and SK2 for a shorter wire. The aerial is connected to whichever socket gives best results.

For medium wave reception S1 is closed, so that only the m.w. coil L1 is in use, and is tuned by C1. Opening S1 places L2 in series with L1, for long waves.

The value for C1 can be anything from about 250pF to 500pF, solid dielectric or air spaced, so a component to hand or from an old receiver may be put to good use.

Many surplus or other types of diodes will also prove to be satisfactory for D1. It needs to be a

point-contact or detector type, not a power rectifier or silicon type. A surplus item can easily be checked in this position.

Transistor TR1 provides high gain for audio signals, and the output is developed across R2.

As resistor R2 provides collector current, a crystal earpiece can

be plugged into the output socket. A magnetic high impedance headset can also be used, and will generally give much more satisfactory listening. Such phones could have an impedance of between 2 and 4 kilohms. If such phones were always to be used, R2 could even be omitted.

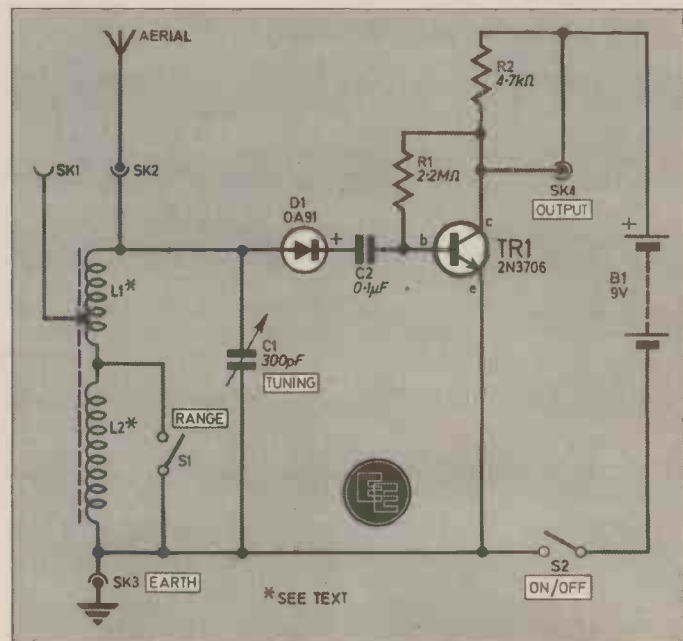

Fig. 1. Circuit diagram of the One-Transistor Radio.

CONSTRUCTION starts here

COILS

The two coils, L1 and L2, are wound on a ferrite rod about 120mm long, however, this length is not important and any size to hand can be used.

Coil L1 has 75 turns in all, and the tap is 20 turns from one end. A tube made out of postcard or similar material is wound about twice round the rod. Put a little adhesive on the card. It is best if the tube is a sliding fit on the rod, so it can be loose. The coil uses 28 s.w.g. enamelled wire, but a small change in wire gauge is unimportant. Secure the ends with cotton or dabs of adhesive. Scrape the ends and the tap for soldering.

For L2, glue two card discs about 20mm in diameter to a card tube, with a winding space of 16mm between them. Pass a length of 34 s.w.g. enamelled copper wire through a small hole, then "pile" wind 250 turns. Cement the end over, or cover the winding with adhesive tape.

The coils should be placed so that the direction of rotation of turns is the same throughout. This can be noted when winding, or L2 can be slid off the rod and turned over, if l.w. reception is found to be poor.

The rod is mounted on a block of wood about 25 x 20 x 10mm, with adhesive between rod and block, and on the base. A screw driven from below into the block will make this secure.

CIRCUIT BOARD

The circuit board is 0.15 inch stripboard having 7 strips by 25 holes, to allow space for the additional audio amplifier. The drawing of Fig. 2 shows the layout for the receiver section only.

Place the components as shown, and solder the leads to the foil. Snip off excess length of wires, and check that no shorts arise between adjacent foils. Only one foil break is needed, under C2.

Solder on leads for SK2, positive, earth and output connections. Also drill two holes for mounting.

BASE AND PANEL

The remaining and complete wiring details are shown in Fig. 3. Slots for S1 and S2 are made by drilling holes and enlarging them with a small flat file. The switches are fixed with short screws or bolts through the panel. Panel and base are secured together with screws and adhesive.

The board is then placed as in Fig. 3 and fixed with screws. Two small rubber grommets are put on the screws under the board, to give clearance. If metal nuts or washers are used, check they do not cause a short circuit between the foils.

Also shown in Fig. 3 are the modifications required to the wiring when the additional amplifier is to be used. If constructing just the receiver, these modifications shown as dotted wires can be ignored. See later for details on the amplifier.

CASE

A scale for use with C1 is drawn on card or paper as shown in Fig. 4. Any kind of 9V battery can be used, polarity must of course be correct. A PP9 or similar large battery is most suitable when the extra stage will be used.

The case shown is made from thin wood. Beading forms a 1/4 inch edge round the front, so that the receiver can be pushed in from behind, and secured with small screws from below.

The pieces need to be sawn accurately, and fitted together with wood adhesive. When this is hard, smooth the joints with glass-paper on a block. The case was covered with wood grain adhesive material as used for shelving, but could be painted. There is no back to the receiver, although one could of course be added.

Space is available on the front panel for a 65mm diameter speaker. This is optional to plugging in an external speaker. Where the internal speaker is going to be fitted, cut a hole in the panel to match its cone.

COMPONENTS



RECEIVER

Resistors

- R1 2.2M Ω
- R2 4.7k Ω
- Both 1/4W carbon \pm 5%

Capacitors

- C1 300pF (Dilecon) variable solid dielectric
- C2 0.1 μ F polyester

Semiconductors

- TR1 2N3706 silicon *npn*
- D1 OA91 or similar germanium point contact diode

Miscellaneous

- S1, 2 single-pole single-throw slide switch (2 off)
- SK1, 2, 3 4mm sockets (3 off different colours)
- B1 PP9 9V battery
- L1 75 turns 28 s.w.g. enamelled copper wire (see text)
- L2 250 turns 34 s.w.g. enamelled copper wire (see text)
- SK4 3.5mm jack socket

Stripboard: 0.15 inch matrix 7 strips x 25 holes; battery connector to suit B1; ferrite rod 120 x 10mm; one large knob; material for scale; thin card for coils; connecting wire; headphones as required; Fablon or similar material.

AMPLIFIER

Resistors

- R3 47k Ω
- R4 220 Ω
- Both 1/4W carbon \pm 5%

Capacitors

- C3 0.47 μ F polyester
- C4 640 μ F 10V elect.
- C5 100 μ F 10V elect.

Semiconductor

- TR1 2N3706 silicon *npn*

See
**Shop
Talk**
page 144

TRANSISTOR RADIO

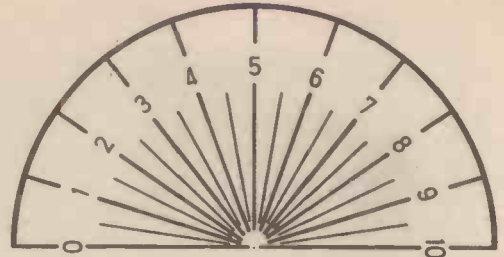

Fig. 4. Scale as used on the prototype. This is drawn full size and may be traced.

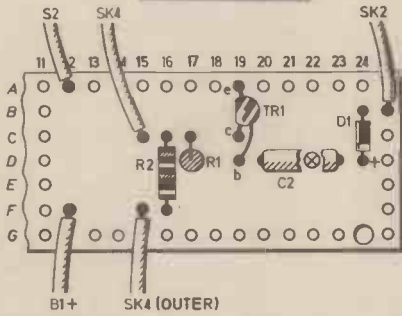

Fig. 2. Stripboard layout. There is only one break to be made and this is under C2 at location D22. A large board has been used so that the amplifier can be incorporated easily at a later date, hence the board is shown only in part.

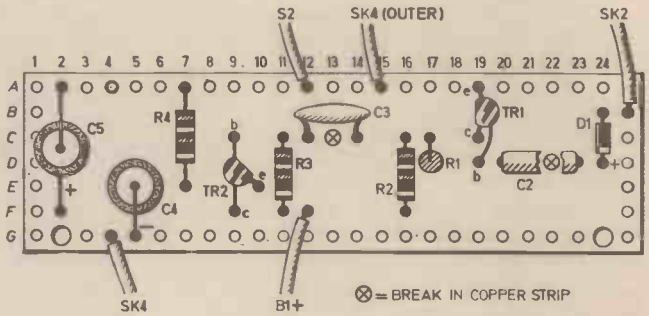

Fig. 7. Stripboard layout for the amplifier, which also includes the previous layout of Fig. 2 for clarity. One further break is required and this under C3 at location C13.

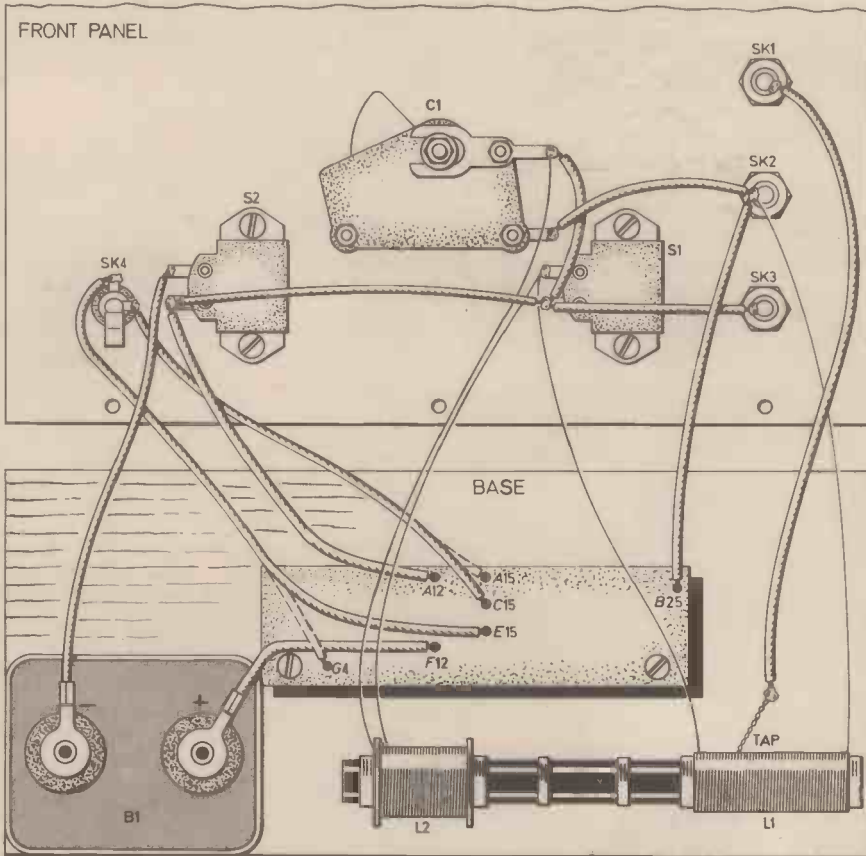

Fig. 3. Wiring diagram showing interconnections between the components on the front panel. If the amplifier stage is to be used, connect the leads from SK4 to points G4 and A15, otherwise connect them to C15 and E15 for the radio only. No other change in wiring is necessary. Dimensions for the front are not critical.



ONE-TRANSISTOR RADIO CHASSIS AND CASE CUTTING LIST

Top and Bottom	215 × 115 × 4mm (2 off)
Sides	Plywood
Sides	130 × 115 × 4mm (2 off)
Front Panel	Plywood
Front Panel	202 × 128mm (1 off) 4mm
Base	Hardboard
Base	128 × 90 × 10mm (1 off)
Edging	Softwood
Edging	Quarter-round beading, about 750 × 5mm
Covering	Fablon or similar

COMPONENTS
approximate
cost **£4.50**
excluding case

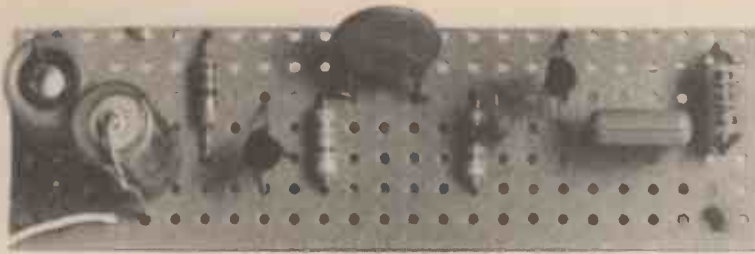

It is clear that many other cases could be used—such as plastic boxes, or one of the ready-made cases which can be purchased. A metal box is *not* recommended.

AERIAL

A receiver of this type requires an external aerial, and also an earth, if possible.

An outdoor aerial which is high and clear of earthed objects such as buildings is best of all. This can be made from some 12 to 22 metres or so of 7/26 or other aerial wire, one uncut length forming the horizontal section and down lead. The horizontal portion is supported by an insulator each end, and cords running to high anchor points—these may be found at the house, with a tree, post or other building for the distant end. Bring the wire down and into the house, probably at a window. One method is shown in Fig. 5.

Less ideal and shorter outdoor aerials can also give quite good results. These may have only one high support and may slope, or may be nearer to buildings than preferred.

Indoor aerials are satisfactory in many areas, and especially at ceiling height in a bedroom, or in a loft space. Thin bell wire can

be almost invisible. It can be stretched along two walls, *not* folded back on itself in a complete loop.

EARTH

For the earth connection, a lead clipped to a descending metal water pipe is usually good, do *not* use a gas pipe. A wire may be

It is quite easy to experiment with various aerials and earth connections.

IN USE

Band coverage should be suitable with the windings located as shown. If C1 is under 300pF, L1 and L2 can be pushed a little farther on the rod. If it is 500pF, L1 can be slid a little nearer the rod end.

The socket marked as AE2 gives best volume from any aerial. But with a long aerial selectivity may be too poor. Using AE1 helps correct this.

Selectivity can be increased by placing a capacitor in series with the aerial lead to the receiver. It will generally be put between the

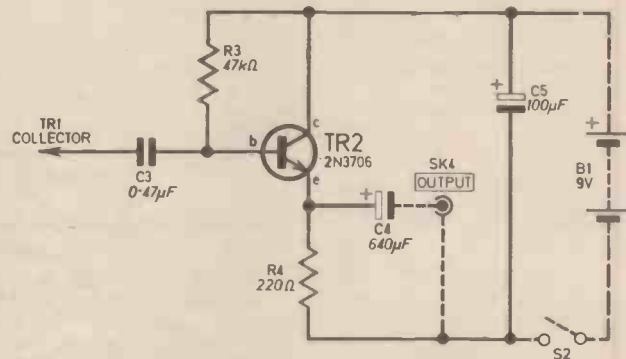

Fig. 6. Circuit diagram of the additional amplifier stage. Note that SK4, S2 and B1 are common to the receiver and are shown dotted to distinguish this point.

taken to an earth spike driven into the ground, or may be attached to a metal can buried in damp soil. In some areas reception can be adequate with no earth, but the improvement obtained when an earth is present is so great that it is worth while.

aerial and socket in use. A preset or variable capacitor with a maximum value of around 150pF will be most suitable.

It can then be adjusted for best results, and can be an important aid in receiving signals without interference. Various small value fixed capacitors could also be used instead.

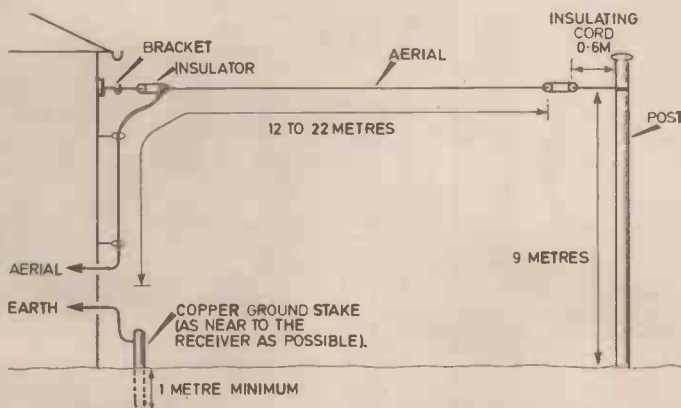

Fig. 5. One method of erecting an outdoor aerial. The post can in fact be any convenient support, a tree, another building etc. In any aerial installation it is important to keep the lead from the earth to the receiver as short as possible.

ADDITIONAL AUDIO AMPLIFIER

The circuit of the extra audio stage which can be added to the original circuit is shown in Fig. 6. It requires few components, gives a considerable degree of amplification, and will work into all sorts of output loads.

Audio signals come from the collector of TR1 to C3, which is the base coupling capacitor for TR2. Base bias is obtained via R3.

After amplification, the audio signal output is developed across

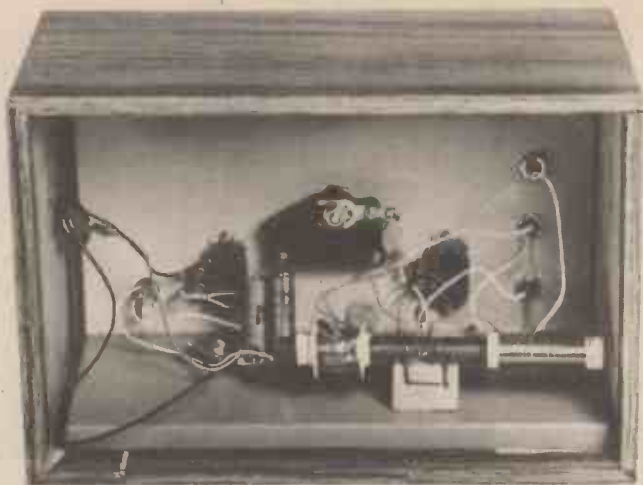

Looking from the back inside the unit. Note how the ferrite rod is mounted to the base. In this version the optional amplifier has been added.

the emitter resistor R4. Capacitor C4 couples audio signals to the output jack. As this capacitor isolates the emitter and output circuits, operation of TR2 is not upset by any other circuitry connected to the output jack.

WIRING

It is necessary to remove the board, and place the additional components as in Fig. 7. Components up to R2 will already be present of course. Take off the old output leads, which are no longer needed and rewire accordingly.

Do not overlook the foil break under C3. Also note the correct polarity of the electrolytic capacitors C4 and C5.

When the finished board is replaced, the diode and earth leads are restored as originally.

OUTPUT

An earpiece or headphones as employed originally can be used. Again, a good headset of medium impedance will give best results.

Signals should prove to be very considerably increased in volume. It will be found that adequate

loudspeaker results may be obtained where reception conditions, and the aerial and earth, gave good volume with the simpler circuit.

A loudspeaker of about 75 to 80 ohms will be most suitable. A sensitive and efficient speaker, in its own cabinet, can give quite loud reproduction.

Speakers of somewhat lower impedance can also give good results, but volume will tend to fall off considerably if the speaker is of very low impedance—2 or 3 ohm. Generally, the unit would be at least 15 ohm, or preferably at least 30 ohm. Low impedance speakers can be used with a matching transformer, if these are already to hand.

With headphones, volume is likely to be too great for comfort, so it may be necessary to bring into use aerial socket SK1, or to fit a variable capacitor in the aerial lead as described earlier. ☐



EE CROSSWORD No 13

BY D.P. NEWTON

ACROSS

- 2 Units designed for a visual display pastime (2, 5, 4).
- 7 Ray, but not of sunshine.
- 8 About 10⁻⁹ for a year.
- 9 The things that are left but essentially an electrical supply.
- 11 Bulb accused of indecent exposure?
- 12 The hoped for l.s. output.
- 15 Fill the mind completely.
- 17 Set of connected things but not necessarily electronic.
- 20 To free oneself.
- 23 Sitting on the electrical fence.
- 24 Staccato noise — sometimes from a loose wire.
- 27 Crowd expression in unison.
- 28 Almost too much from the amplifier.
- 29 Honestly, it's a device for galvanic skin response (3, 8).

DOWN

- 1 To be stripped naked, as with wire.
- 2 Hackneyed conveyance.
- 3 Overcome by the third state of matter.
- 4 Monocle.
- 5 The rude means of tuning.
- 6 Calculator with additional capabilities.
- 9 Means of remote manipulation (5, 7).
- 10 Root mean square is confused initially for a woman.
- 13 Brown unit.
- 14 Musical background of a meter.
- 16 Without deviation and neat, too.
- 18 Amps, weakened without one, gives a fool.
- 19 Hoarded, as by capacitors.
- 21 Electrical receiver.
- 22 Moose.
- 25 Partly open.
- 26 Quieten.

Solution on page 163

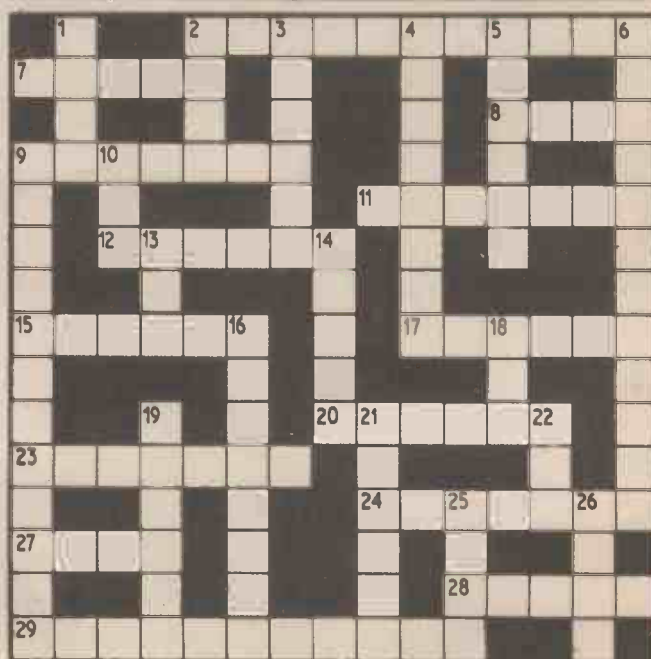

LAB CENTRE

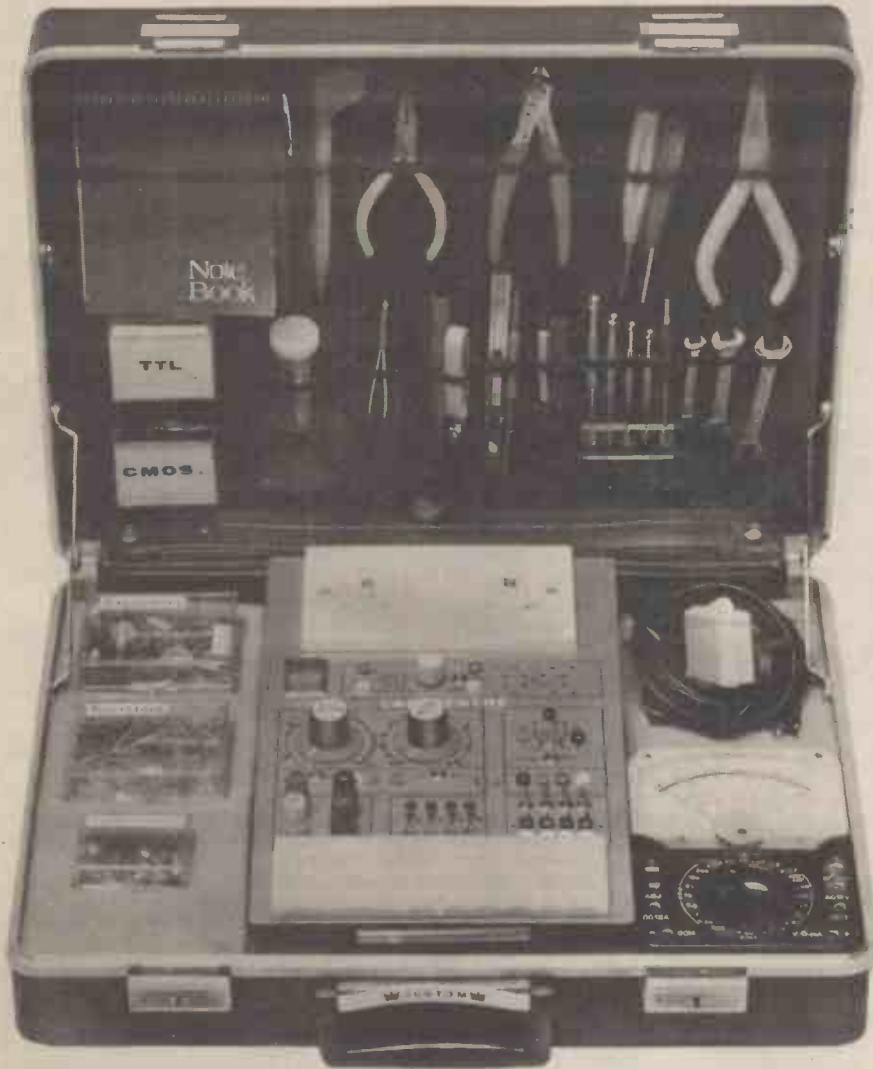

PART 1

By R. W. Coles
and B. Callen

HOW MANY readers are lucky enough to have a fully equipped workshop or room where they can practice their hobby in harmony with the rest of the household? Very few we would estimate. The trouble seems to be that most residences are not really designed for those people who have ordinary hobbies like lion-taming, boat building or the ever

popular electronics! And what about the many budding electronics enthusiasts who live in flats or bed-sitters or caravans? For them, things must be even worse.

Electronics, while perhaps a more domestically acceptable hobby than many others, can be a messy business. A bewildering array of interconnected power supplies, amplifiers, multi-

meters and other test equipment is often required, and to set the whole thing off there will be the usually less-than-beautiful new-project "birds-nest".

Even the more accommodating wives and mothers are likely to draw the line at that sort of lash-up adorning the kitchen or dining room table for more than a few hours, and what happens when dinner's ready? After all, it took hours to get the whole thing connected up in the first place.

With the plight of this unfortunate and numerous band of electronics enthusiasts firmly in mind a long look was taken at the space problem. Attention was turned to the prospect of an "instant" electronics lab, one which would require neither bulging biceps nor miles of multi-coloured wire for its ready-for-use assembly.

The result is Labcentre and now one can't help wondering why on earth it hasn't been done before!

BASIC REQUIREMENTS AND FACILITIES

The requirements for the Labcentre were an all-purpose electronic laboratory which could be rapidly put into operation on a kitchen table or any similar flat surface after being stored for a time in a cupboard for instance, or after a bus trip across town. No "toy" laboratory would do, the system had to contain all the necessary bits and pieces including tools, power, supplies, test equipment and component storage, so that not only could those all important experiments be conducted, but also the design, construction, and testing of complete projects without recourse to a soldering iron.

Tools were a must of course and the usual assortment of cutters, pliers, screwdrivers and so on were chosen, and mounted on a removable tool-board in the lid of the case. The final choice of which tools to stock will of course be a matter for the individual constructor/designer.

Power supplies are always a problem. An easy way out would have been to include a single variable power supply, but examination of a cross section of projects revealed that usually several supply rails were needed, the most popular voltages being +5 volts (for TTL logic) and ± 15 volts (for operational amplifiers and CMOS). It was therefore decided to incorporate such a multi-output supply accordingly. The 5V rail can supply currents up to 500mA, and the ± 15 V rails, 250mA.

Other voltages that may be required up to 15V (e.g. 9V, 6V, 4.5V) can easily be achieved by means of a Zener diode and series resistor connected across the +15V supply, and sited on the breadboard.

A multimeter was considered essential, but after examining the possibility of building one into the design, this

COMPONENTS approximate cost £40 excluding breadboard/case

was rejected in favour of a separate meter of conventional design. After all, most electronics enthusiasts already own one. Sufficient space is available in the final casing to accommodate most medium sized multi-meters.

SIGNAL GENERATOR

A signal generator is an essential part of any designers set-up. This and more is achieved by using a function generator i.c.

A function generator, for those who haven't come across this relatively new instrument before, is rather like a signal generator but with the added facility of being able to choose the shape of the output waveform.

Some function generators have a wide variety of possible waveshapes; the Labcentre generator has a choice of sinewaves, triangular waves and square waves.

Apart from the choice of output waveshape, the usual signal generator facilities of variable frequency and variable output voltage amplitude are available. Output frequencies of from 1Hz to 100kHz in two switched ranges are available, at continuously variable voltages from 0 to 10 volts.

A choice of sine or triangle waveforms can be selected at the flick of a switch. Square waves of the same frequency and even divisions up to eight are simultaneously available at 5V and 15V amplitudes.

The fact that square waves are rich in harmonics means that they can also be used to advantage when testing audio amplifiers or even radio receivers.

AUDIO AMPLIFIER

An audio amplifier and small loudspeaker can be very useful for checking out tuner front ends, alarm circuits, oscillators, preamplifiers etc. and so were included in the design. The amplifier can deliver up to about 350 milliwatts which incidentally is quite loud. The speaker may be disconnected by means of a switch thus allowing it to be used for other functions.

DE-BOUNCED PUSH BUTTON

Nowadays, digital logic circuitry using TTL or CMOS is becoming increasingly popular. In view of this a de-bounced push button pulser was embodied in the unit.

The push button pulser is a simple but invaluable aid for use with flip-flop and counter circuits. A depression of the button generates a logic high level at one output for as long as the button is pressed. Releasing the button causes the output to revert to logic 0.

This could have been done with only a switch, but the dreaded "switch bounce" would in fact cause a rapid oscillation during the make or break of the switch and any flip-flops or counters connected might toggle many times for each depression. The addition of this circuit prevents this happening and gives fast clean pulse edges.

A facility to allow the visual monitoring of logic levels is afforded by the inclusion of a bank of four buffered l.e.d.s with input sockets. The buffers are CMOS drivers which will turn on an l.e.d. for any input voltage between 2 and 15 volts making them suitable for TTL and CMOS logic.

SPARE SWITCHES AND SOCKETS

Close to the breadboarding area are sited a collection of four uncommitted toggle switches with sockets so that they can be wired into user circuitry on the breadboard to provide logic levels, control selection, or any one of a hundred other jobs for which a switch is needed.

At the rear of the console front panel is a simple but useful facility provided by a pair of 13A switched mains sockets. These sockets are powered via the console mains lead and are there to provide power to the soldering irons, lamps or equipment such as an oscilloscope which may be needed during a project. When, as often happens, you have only a single wall socket within easy reach, this facility makes life so much simpler!

BREADBOARD

In the past, many ingenious "breadboarding" systems have undoubtedly been used by constructors including the dreaded "birdnest" (a nest of interconnected components, soldered joints, croc-clips, etc.).

The Labcentre uses a commercially available breadboard system as the basis of interconnecting components for design and test. No sol-

dering is required whatsoever thereby being extremely economical on components allowing them to be used over and over again.

There are many different shapes and sizes of commercial breadboards currently on sale of the plug-in type used here, and any one (or more) may be used in this project.

The type used in the prototype (size approximately 165 x 55mm) has 640 plug-in tie points for circuit components plus eight distribution buses (200 tie points), and can hold up to nine 14-pin d.i.l. i.c.s. Such a board is the Letrokit Super-Strip SS-2.

Connecting wires and component leads are simply pushed into the sockets which contain nickel-silver alloy sprung contacts which accept wire thicknesses of up to 20 s.w.g. Connection between breadboard and Labcentre circuitry is made with wire terminated in a 2mm plug.

BRIEF CASE

All the electronics have been housed in a single "console" whose dimensions (31 x 19 x 8cm) have been tailored to suit a Custom executive style brief case, leaving room for component and instrument storage.

The brief case is not essential by any means. Everyone will have their own ideas about how to develop the Labcentre concept, and these could include wiring the console as an independent unit or building a "custom" case in wood or metal. If you already have a brief case of suitable dimensions, you do not have to dedicate it to Labcentre exclusively, as all the parts are instantly removable so that you can use your case for any other purpose at the drop of a soldering iron.

CIRCUIT DESCRIPTION

The complete circuit diagram of the Labcentre appears in Figs. 1.1 and 1.2, the power supply having been detached from the rest of the circuitry

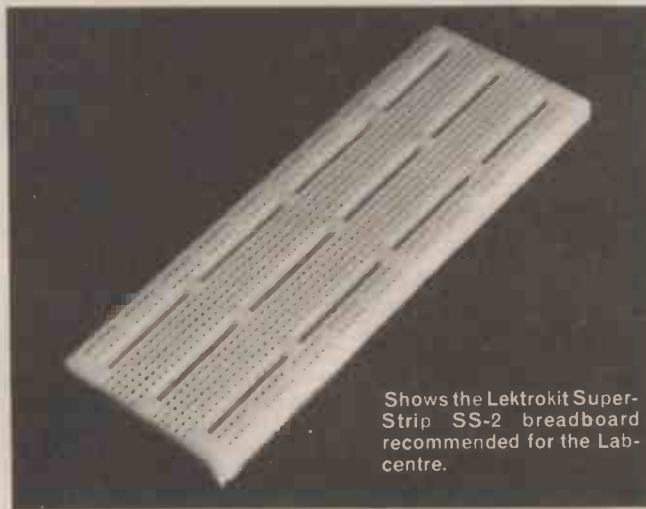

Shows the Lektrokit Super-Strip SS-2 breadboard recommended for the Labcentre.

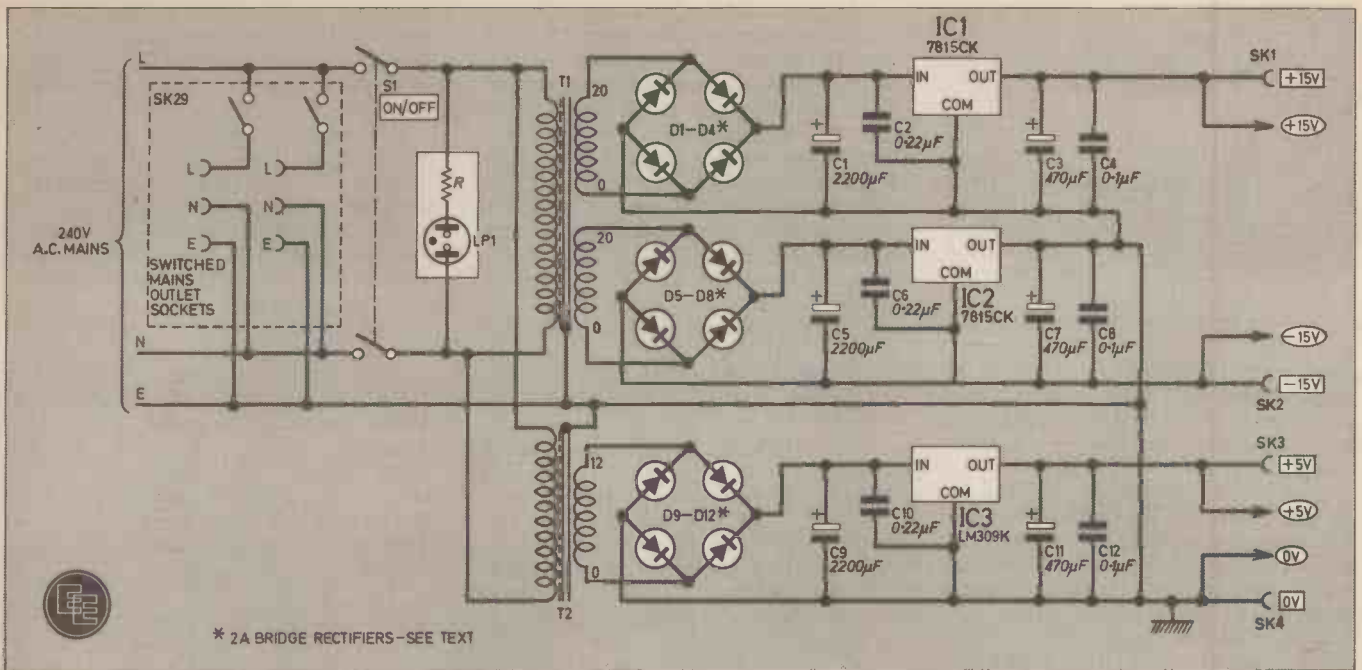

Fig. 1.1. The circuit diagram for the multioutput power supply section of the Labcentre.

for clarity. As can be seen, the overall circuit diagram appears as a number of distinct sections and each of these will be described in turn.

POWER SUPPLIES

The circuit of the power supplies is shown in Fig. 1.1.

Thanks to the very capable fixed voltage power regulators now widely available, the power supply is quite easy to build and can be readily understood. The transformers T1 and T2 reduce the 240V a.c. mains to the lower a.c. voltages required to supply the 15V and 5V regulators, IC1 to IC3. Three rectifier bridges (D1-D4, D5-D8 and D9-D12) and three smoothing capacitors (C1, C5, C9) provide the raw d.c. inputs to each of the three fixed voltage regulator i.c.s which are housed in individual TO-3 power transistor cans mounted on small heatsinks.

REGULATORS

Inside each of the regulator packages there is a complex analogue circuit which includes a Zener diode reference, several high gain amplifier stages and a power transistor which acts as the "business end" of the regulator. Also included is a protection circuit which limits the output current of the regulator under short circuit or fault conditions. A useful facility for a power supply which is used for "breadboard" purposes!

The regulators IC1 and IC2 are both 15 volt types but notice that IC2 does not have its common (COM) or case terminal connected to 0V like the other two. This is because we are

using a *positive* regulator in a circuit where the positive regulated output pin is connected to 0V, and means in practice that the IC2 heatsink must not be allowed to touch the other two.

Capacitors C2, C6 and C10 are used to ensure regulator stability at high frequencies where the inductance of the connecting wires becomes significant and circuit oscillation is a real possibility. They are mounted as close as possible to the regulators themselves. Capacitors C3, C7 and C11 help to prevent transient outputs which the regulator itself cannot eliminate, and also reduce the regulator output impedance at high frequencies. The low value capacitors C4, C8 and C12 eliminate possible high frequency oscillations on the supply lines.

FUNCTION GENERATOR

The function generator design (Fig. 1.2) utilises the now freely available Intersil 8038 integrated circuit mated with a wide bandwidth operational amplifier, the Signetics NE531. The aim was to produce an untemperamental circuit which used inexpensive components and yet which would provide the widest possible frequency range and an adjustable output voltage.

The resulting circuit uses no difficult-to-wind inductors, being tuned by means of a variable resistor and a fixed capacitor.

The 8038 is a fourteen-pin integrated circuit of monolithic construction which produces simultaneous output waveforms of square, triangle, and

Fig. 1.3. Internal block diagram of the 8038 i.c. illustrating principle of operation.

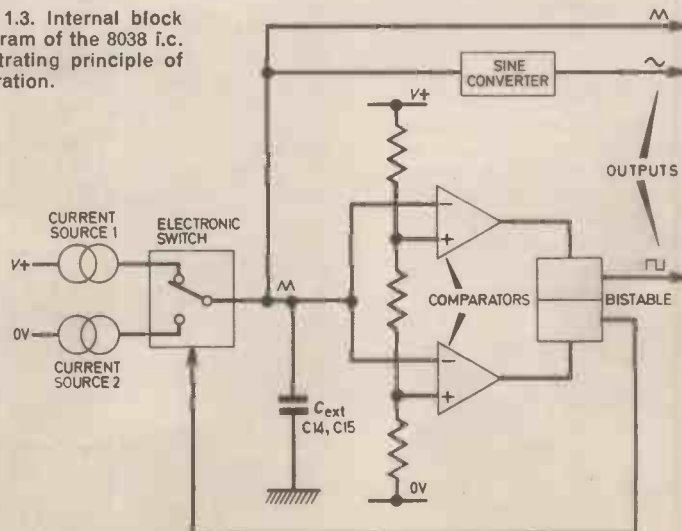

sine shape over a wide frequency range with high stability and low distortion. The basic circuit elements inside the i.c. are shown in Fig. 1.3.

RAMP VOLTAGE

The external capacitor C_{ext} is charged, via the constant current source 1, so that the voltage across it is a linearly rising ramp. This ramp voltage is applied to a pair of comparator circuits (very high gain amplifiers) which each have a reference input derived from the circuit supply voltage.

As the rising ramp reaches the threshold of the upper comparator, the comparator fires and its output changes state, resetting the bistable flip-flop which changes the position of the electronic switch so that a second constant current source is connected to the charged capacitor. This discharges the capacitor producing a linear, falling ramp voltage across the capacitor.

When this linear ramp voltage falls to the threshold level of the lower comparator circuit, it fires in its turn and changes the state of the flip-flop back to the starting condition.

The flip-flop changes the position of the electronic switch to reconnect the other current source, the ramp starts to rise once more, and the whole process repeats itself indefinitely at a rate determined by the current through the current sources and the value of the capacitor, C_{ext} .

The complete circuit of the function generator is shown in Fig. 1.2, and here C_{ext} is chosen as either C14 or C15 to provide coarse frequency control, while fine frequency setting is made possible by VR2 which varies the current source outputs via the control terminal, pin 8.

Varying the ratio of the currents from current sources 1 and 2 will alter the symmetry of the output waveforms, and VR4 is provided so that this symmetry can be properly adjusted via the individual current source control pins, 4 and 5.

With Labcentre, the aim is to adjust VR4 for a 1:1 mark-to-space ratio on the square wave output, which guarantees a symmetrical sine and triangle wave output.

It is possible to adjust VR4 to give a sawtooth output waveform instead of a triangle should this ever be needed, but this will cause the sine-wave output to become very distorted.

SINEWAVE OUTPUT

The sinewave output is derived from the triangle waveform using a circuit block inside the 8038 known as a sine-converter. The sine-converter consists of two fixed-biased transistor "trees" which are used to vary the gain of the converter stage depending on the input voltage level.

As the input voltage rises towards a maximum (or drops towards a minimum) additional transistors in the appropriate tree conduct to vary the ratio of a potential divider and hence the slope of the output waveform. The fact that each transistor turns on gradually, rather than suddenly at some precise threshold level, ensures that the changes in slope of the output waveform appear to occur quite smoothly, giving a very good approximation to a sinewave.

Two trees are required, one for the positive half-cycle and one for the

negative half cycle, and fine adjustment of the sine shape is made possible by VR5 and VR6 which adjust the current in each leg of the potential divider.

The sine and triangle wave outputs of the 8038 (pins 2 and 3) are not suitable for driving even medium impedance loads as they stand and so to give a good drive capability in the final circuit they are buffered by means of an NE531 operational amplifier (IC5).

Potentiometer VR7 acts as an output voltage control, and R1 and R2

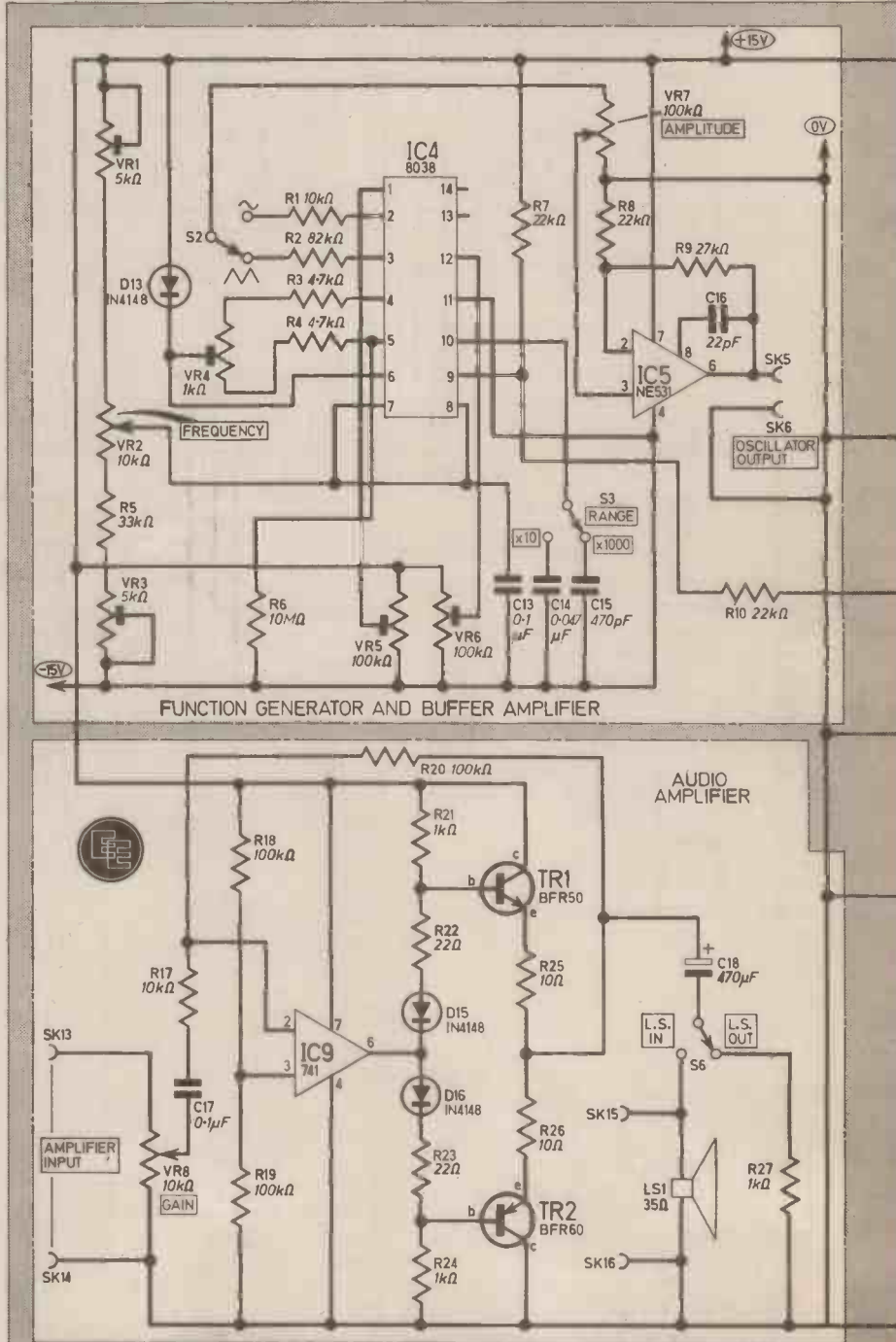

Fig. 1.2. The main circuitry of the Labcentre containing Function Generator, Level Translator/Clock Divider, De-bounced Pulser, Audio Amplifier and i.e.d. Drivers.

ensure that the sine and triangle wave outputs are of equal amplitude.

The NE531 is an operational amplifier chip with an enhanced high frequency performance which makes it ideal for our purposes, but it is pin compatible with the very common 741 device, and during initial circuit testing at l.f. (up to 200kHz) a 741 can be substituted if required.

Finally the square wave output of the 8038 (pin 9) is converted into a 15 volt logic swing suitable for driving CMOS with R7, R10, and D14. This output is used to drive the CMOS

counter, IC6, and one of the buffer stages in IC7.

LOGIC CIRCUITS

The clock pulse generator circuit is shown in more detail in Fig. 1.4. The output from the function generator is fed to pin 15 of IC6 (MC14516) which is used here as a straightforward binary counter. The MC14516 is actually a sophisticated chip with provision for parallel loading, reversible counting, and asynchronous clearing, but in this application these facilities

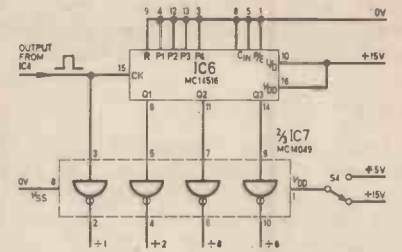

Fig. 1.4. The circuit of the Level Translator/Clock Divider in detail.

go unused, which accounts for the large number of pins which are "tied down" to 0V.

Each of the four flip-flops inside the MC14516 divides the function generator output by two, but due to lack of front panel space, only three of the divided outputs are actually utilised.

Four of the buffers of IC7 provide a high drive capability, or "fanout" which allows several standard TTL loads and an almost unlimited number of CMOS loads to be driven. They also provide a neat solution to the problem of providing two different logic swings of 0-5V and 0-15V which was a requirement of the design.

The MC14049 is not only a buffer but also a level translator designed to convert input logic swings of up to 15V to an output swing determined by the voltage applied to its V_{CC} pin. By switching the voltage to the V_{CC} pin between 5V and 15V it is therefore possible to choose either TTL or 15V CMOS compatibility for all six outputs from the one chip.

At this point it is worth pointing out that the TTL, or 5V logic swing, is of course quite suitable for driving CMOS circuitry which runs from 5V supplies. The 15 volt CMOS outputs are needed only where high speed or op-amp compatibility is required when using CMOS logic. It is also prudent to point out that the 15V setting must not be used with TTL logic, or with CMOS logic using 5V supplies!

PULSER

The operation of the push button pulser circuit is shown more fully in Fig. 1.5. It is a simple but very useful facility when breadboarding logic circuits which utilise registers or counters. The two MC14011 NAND gates of IC8 are cross-coupled to form a simple set/reset latch which can be set (i.e. the Q output at logic 1 and the \bar{Q} output at logic 0) by depression of the push button. The reset state is regained when the push button is released, and the transitions from one state to the other are "clean" with no contact bounce of the sort which would occur with the switch alone wired up to do the job.

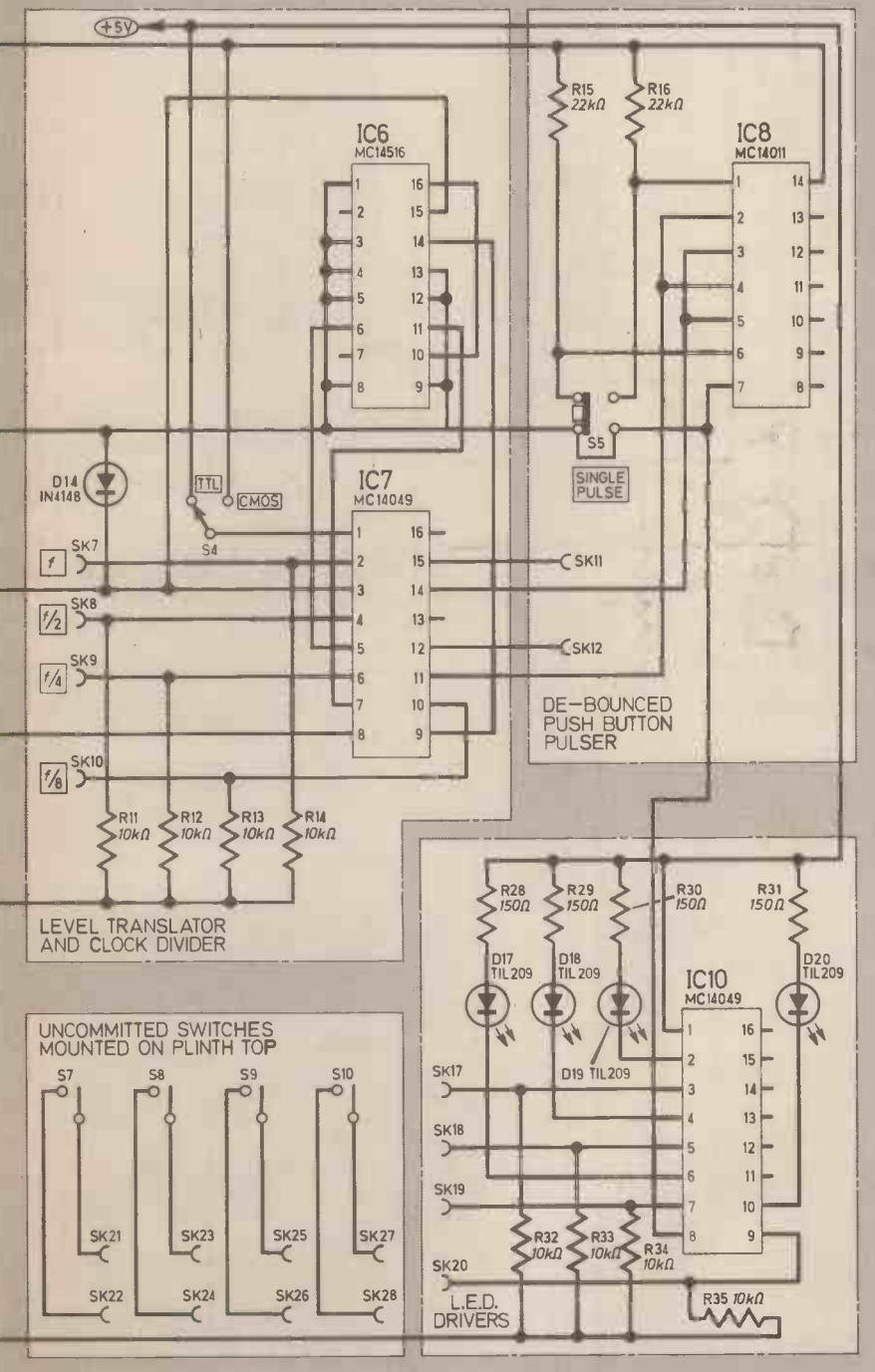

COMPONENTS

Resistors

R1 10k Ω	R12 10k Ω	R23 22 Ω
R2 82k Ω	R13 10k Ω	R24 1k Ω
R3 4.7k Ω	R14 10k Ω	R25 10 Ω
R4 4.7k Ω	R15 22k Ω	R26 10 Ω
R5 33k Ω	R16 22k Ω	R27 1k Ω
R6 10M Ω	R17 10k Ω	R28 150 Ω
R7 22k Ω	R18 100k Ω	R29 150 Ω
R8 22k Ω	R19 100k Ω	R30 150 Ω
R9 27k Ω	R20 100 Ω	R31 150 Ω
R10 22k Ω	R21 1k Ω	R32 10k Ω
R11 10k Ω	R22 22 Ω	R33 10k Ω
		R34 10k Ω
		R35 10k Ω

All $\frac{1}{4}$ W carbon film $\pm 5\%$

Capacitors

C1 2200 μ F 25V elect.	C10 0.22 μ F polyester
C2 0.22 μ F polyester	C11 470 μ F 25V elect.
C3 470 μ F 25V elect.	C12 0.1 μ F disc ceramic
C4 0.1 μ F disc ceramic	C13 0.1 μ F disc ceramic
C5 2,200 μ F 25V elect.	C14 0.047 μ F polyester (radial lead)
C6 0.22 μ F polyester	C15 470pF polystyrene
C7 470 μ F 25V elect.	C16 22pF polystyrene
C8 0.1 μ F disc ceramic	C17 0.1 μ F disc ceramic
C9 2200 μ F 25V elect.	C18 470 μ F 16V elect. (radial leads)

Potentiometers

VR1 5k Ω miniature cermet 20-turn trimpot ($\frac{3}{4}$ inch Spectrol type 43P)
VR2 10k Ω lin. wirewound
VR3 5k Ω miniature cermet 20-turn trimpot ($\frac{3}{4}$ inch Spectrol type 43P)
VR4 1k Ω miniature horizontal carbon preset
VR5 100k Ω miniature horizontal carbon preset
VR6 100k Ω miniature horizontal carbon preset
VR7 100k Ω lin. carbon
VR8 10k Ω log. carbon

Semiconductors

D1-D4 2A bridge rectifier	} type SO2 (μ -Electronics) or KBPC102 (General Instruments)
D5-D8 2A bridge rectifier	
D9-D12 2A bridge rectifier	
D13-D16 1N4148 silicon (4 off)	
D17-D20 TIL209 red light emitting diode with panel mounting bush (4 off)	
TR1 BFR50 silicon <i>npn</i>	
TR2 BFR60 silicon <i>pnp</i>	
IC1, 2 15 volt positive voltage regulator type 7815CK or LO37T1—TO-3 case style (2 off)	
IC3 5V positive voltage regulator type 7805CK, LM309k or LO5T1—TO-3 case style	
IC4 8038 function generator i.c.	
IC5 NE531 operational amplifier 8 pin d.i.l.	
IC6 MC14516 or CD4516 Binary up/down counter	
IC7 MC14049 or CD4049 Hex inverter/buffer	
IC8 MC14011 or CD4011 Quad 2-input NAND gates	
IC9 741 operation amplifier 8 pin d.i.l.	
IC10 MC14049 or CD4049 Hex inverter/buffer	

See
**Shop
Talk**
page 144

Miscellaneous

T1 Mains primary, 0-20V, 0-20V 150mA secondary
T2 Mains primary, 0-12V, 0-12V 250mA secondary (or 0-12V 500mA)
S1/LP1 Mains on/off rocker with built-in neon
S2-S4 Miniature single-pole double-throw toggle (3 off)
S5 Two-pole changeover push button
S6-S10 Miniature single-pole double-throw toggle (5 off)
SK1-SK4 Heavy duty panel mounting screw terminals/sockets (1 red, 1 black, 1 green, 1 yellow)
SK5-SK28 2mm panel mounting sockets (24 off various colours)
SK29 Individually switched double mains outlet socket
LS1 Miniature moving coil loudspeaker, 35 ohms impedance 50mm diameter

Printed circuit board (copyright held by C. C. Consultants—see Shop Talk); Letrokit Super-Strip SS-2; terminal pins (58 off); i.c. sockets: 8 pin (2 off), 14 pin (2 off), 16 pin (3 off); 4BA fixings: nuts (20 off), bolts (10 off), solder tags (1 off); 6BA fixings: nuts (8 off), bolts (4 off), washers (12 off), solder tags (2 off); heat-sinks type (3 off); heatsink compound; mains cable; connecting wire.

The outputs of the pulser latch are level translated and buffered by the remaining two MC14049 buffers in IC7, and are therefore controlled by the TTL/CMOS switch (S4) as required.

The buffered light emitting diodes D17-D20 also make use of the level translation ability of the MC14049 device, although here the V_{CC} pin and the i.e.d.s are wired permanently to 5V, and input logic swings can be from 0 to 2.5V to 0 to 15V for reliable operation of the lamps. The resistors in series with the lamps limit the i.e.d. current to a safe value and ensure uniform brilliance across the display.

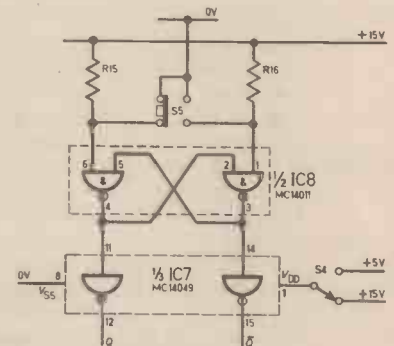

Fig. 15. Detailed circuit of the De-bounced Pulser. Only one pulse is produced for the depression of S5.

AUDIO AMPLIFIER

Monolithic audio amplifiers (power amp i.c.s) were rejected because those tried turned out to be too temperamental and the requirement was a very forgiving design! The final circuit uses a 741 op-amp and a complementary pair of silicon transistors in plastic packages.

In a nutshell, the 741 acts as a voltage amplifier and provides sufficient current to drive the output transistors. The transistors themselves act as current amplifiers in the emitter-follower configuration providing a low impedance output capable of driving the speaker.

The voltage gain of the whole amplifier is set by negative feedback via R24. Potentiometer VR8 acts as an input attenuator/volume control, and the 741 is operated across only one half of the 15-0-15V supply with the amplifier virtual-earth point set at about +7.5V by R22 and R23. When not in use, the output of the amplifier positive plate of C18 should float at a d.c. voltage of about 7.5V with no input signal. Measuring this voltage is a useful test for correct circuit operation.

With the loudspeaker switched off, a dummy load (R31) is connected across the output of the amplifier and the speaker becomes available for use as an input or output device for bread-board circuits.

To be continued

MINI-MODULES By George Hylton

Handy "Beginner" projects based on simple circuits and featuring a variety of building methods.

6 VERSATILE POWER SUPPLY



This month's Mini-Module is designed to avoid the need for batteries to power low-consumption circuits like most of those in this series. It is a mains power unit. Instead of a straightforward "battery eliminator" (also known, nowadays, as an "a.c./d.c. converter") this one has an output voltage adjustable from about 1 to 9 volts.

The output voltage is stabilised and this stabilised output is provided with an overload protection circuit which limits the current to what the unit can safely deliver.

There is also an unstabilised output, which is not protected in this way but which is useful for certain purposes.

The stabilised output can be thought of as a variable voltage tapping on the unstabilised supply and the two can be used together so long as the total current drawn is not more than the mains transformer can deliver.

THE CIRCUIT

Referring to the circuit diagram (Fig. 1), the left hand group of components T1, D1, D2 and C1 form a conventional power supply unit with push-pull rectification. (For reasons which there is no space here to give it is safest to use a transformer with a nominal current rating of at least 100mA.)

Fig. 1. Circuit diagram of the versatile power supply unit.

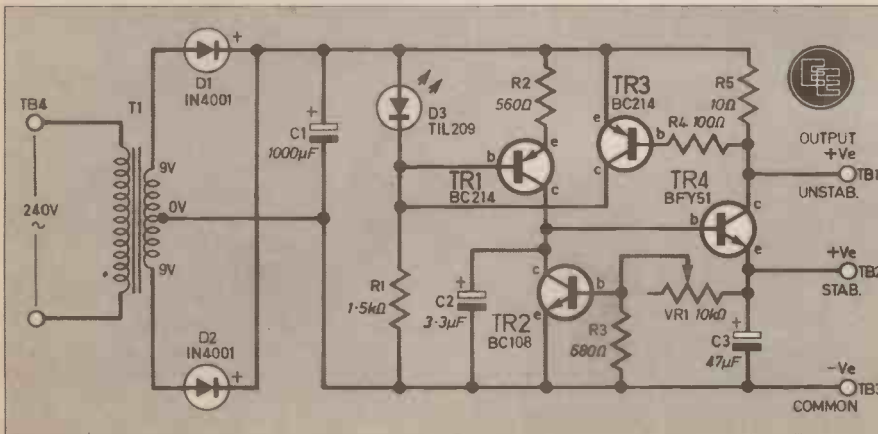

The voltage drop across the l.e.d., D3, is constant at about 1.8V. This constant voltage, applied to the base of TR1, causes a collector current to flow which is set by R2 to about 1.7mA. If TR2 is non-conducting all this current flows into the base of TR4. If TR4 had an amplification factor (h_{FE}) of 100, its collector current would then be about 170mA, and its emitter current slightly greater.

The emitter current of TR4 is the output current of the stabiliser. To effect stabilisation it is necessary to sense when enough current flows out of TR4 emitter to set up the required voltage across the load, then prevent the current from rising any higher.

This job is done by TR2. A fraction of the output voltage is applied, via VR1 and R3, to TR2 base. When this base voltage reaches about 600mV, TR2 begins to conduct. Since its collector current has to come from TR1 the result is that some of TR4 base current is now diverted through TR2. This prevents the output voltage from rising higher than the set value.

Naturally the system works just as well in reverse. If the output voltage falls, TR4 diverts less current from TR4 base and counteracts the fall.

OVERLOAD PROTECTION

To protect against overload a means is provided of limiting the current

through TR4 when the load (output) current reaches its safe maximum. To do this the collector current of TR4 (which is almost the same as the load current) is passed through a small resistance R5.

With R5 equal to 10 ohms the voltage drop is 600mV when the current is 60mA. This voltage (via R4) turns on TR3. At first nothing much happens but as the load current rises beyond 60mA a point is reached at which TR3 is turned on so hard that it saturates and short-circuits the l.e.d., D3. This robs TR1 of its base voltage and its collector current falls, restricting the output by limiting the base current available for TR4.

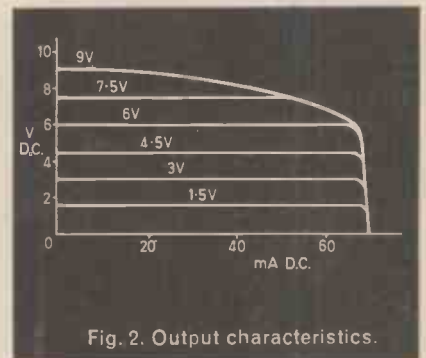

Fig. 2. Output characteristics.

OUTPUT CHARACTERISTICS

The effect of this restriction can be seen from the graph (Fig. 2) which shows how the current is limited to 70mA. (The actual limiting current varies somewhat from unit to unit because of transistor variations and resistance tolerances. If necessary it can be reduced by increasing R5.)

Fig. 2 also shows that the output at high voltages is restricted to about 20mA before it begins to fall. This is not the effect of the stabiliser but of the fall in unstabilised output from the transformer-rectifier part of the circuit. This is normal and is due to the resistance of the transformer windings.

The unstabilised output has to be some 2V greater than the stabilised output for D3 and TR1 to function properly. With no load the unstabilised

output of a rectifier driven from 9V r.m.s. is around 12V but as the load increases the voltage falls. (In the prototype the unstabilised output falls to 8V for a 70mA load, which explains why full output current is obtained for output voltages up to 6V but not for higher voltages.)

In general the high-voltage performance will be improved by substituting a larger mains transformer for the miniature one used in the prototype; but it won't fit the small plastic box used to house the prototype so a larger case would be required.

CONSTRUCTION

A plastic box is recommended. (If a metal box is used it is essential to use a three-core mains cable and to connect the metal box to the earth lead.)

The prototype was housed in a "Norman" multi-purpose plastic case type PBI. This case is on the shallow side for housing a mains transformer: the "Brazenose" (Japanese) Model 909/1 transformer used in the prototype is 25mm high and only just fits in. This presented a small constructional problem.

The solution was a double-layer base, with a piece of Formica to carry the transformer with the minimum of added thickness and a smaller hard-

board "circuit panel" cut to fit round the transformer and glued to the Formica, after circuit assembly. See Fig. 4.

For those who want to avoid the depth problem there are plastic boxes on the market which are deeper than the one used, for example the Type MB2 from Ace Mailtronix, this is 95 x 71 x 35mm and the lid fixes at the corners, which makes baseboard construction easier. (The Norman case fixtures fall in the centres of the short sides and the base has to be notched to fit round the fixing pillars; cutting off corners is simpler.)

A further point to watch in construction concerns the voltage control potentiometer VR1. This is fitted to the lid. It must not protrude so far into the box that it touches the circuit. With a shallow box this precludes the use of a potentiometer with a combined mains switch. The prototype has no mains switch and must be turned off by unplugging or switching off the power point which supplies the mains to it.

Ordinary pins are driven through the circuit panel to provide anchoring and soldering points for components and wiring.

OUTPUT TERMINALS

For good insulation the mains cable is terminated inside the case on a small piece of two-ampere plastic "choc block" terminal strip, TB4.

COMPONENTS

Resistors

- R1 1.5k Ω
 - R2 560 Ω
 - R3 680 Ω
 - R4 100 Ω
 - R5 10 Ω
- All carbon, 5% tol. $\frac{1}{4}$ W

Potentiometer

- VR1 10k Ω carbon track, log. or linear

Capacitors

- C1 1,000 μ F 25V elect.
- C2 3.3 μ F 12V elect.
- C3 47 μ F 12V elect.

Semiconductors

- D1, D2 1N4001 50V 1A rectifier (2 off)
- D3 TIL209 I.e.d., red
- TR1 BC214 *pnp* transistor
- TR2 BC108 *nnp* transistor
- TR3 BC214 *pnp* transistor
- TR4 BFY51 *nnp* transistor

Miscellaneous

- T1 Mains transformer 0-240V primary; 9-0-9V 100mA secondary. (Brazenose 909/1 or similar).

Plastic case (Norman PBI or see text). Formica, hardboard. Four 2-way terminal blocks. Pointer knob. Mains flex, twin, 2A.

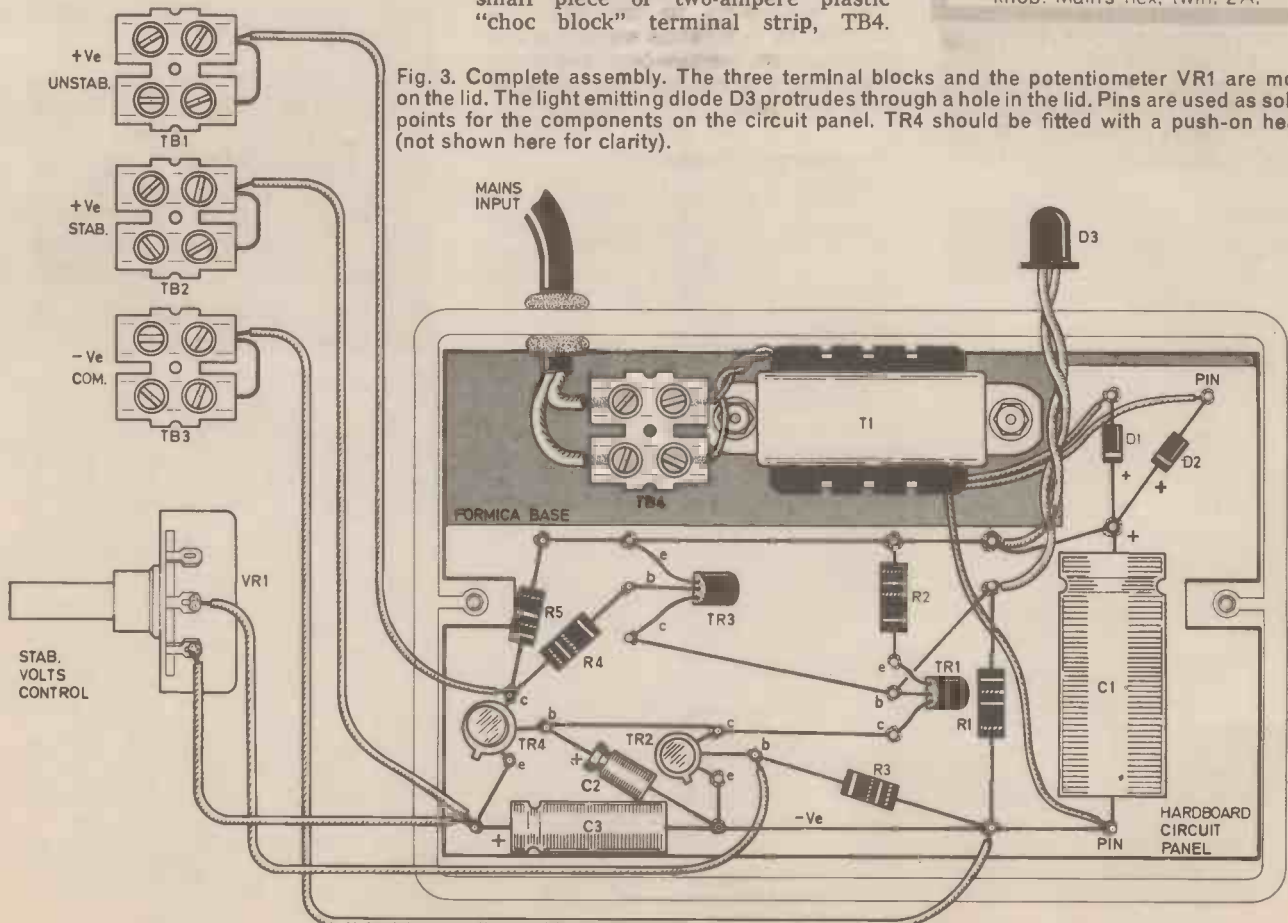

Fig. 3. Complete assembly. The three terminal blocks and the potentiometer VR1 are mounted on the lid. The light emitting diode D3 protrudes through a hole in the lid. Pins are used as soldering points for the components on the circuit panel. TR4 should be fitted with a push-on heat sink (not shown here for clarity).

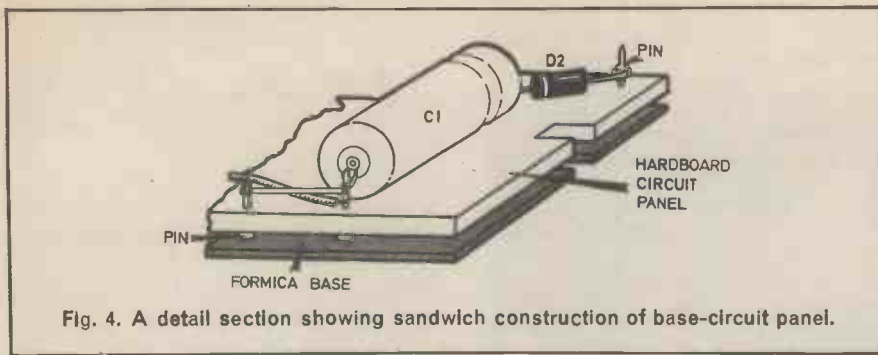

Fig. 4. A detail section showing sandwich construction of base-circuit panel.

Three other similar blocks, TB1, 2 and 3, are mounted on the lid to serve as output terminals—one for the un-stabilised output, one for the stabilised output and one for the common negative terminal. The "choc blocks" are fixed by small self-tapping screws, from below.

It would, of course, be possible to bring the three output leads to a

single terminal block with just three positions. Experience shows, however, that it is then very easy to connect to the wrong terminal, with disastrous results. So keep them apart!

The i.e.d., D3, functions not only as a voltage stabiliser for TR1 but also as a pilot light and an overload warning device. (It dims when there is an overload, including an overload of the

un-stabilised output.) For these reasons it should be mounted on the lid, where it can be seen, instead of shut up inside the case.

The BFY51 output transistor TR4 operates near the limit of its permissible dissipation under overload conditions. For this reason it is advisable to fit it with a good push-on heat sink.

VENTILATION

The mains transformer and TR4 both develop a fair amount of heat. However, a 9V 100mA transformer handles only about one watt and even under overload conditions when all the power is turned into heat inside the case there should be no cooling problem provided that the case itself is in the open and not covered up or boxed in. There is thus no need to drill ventilation holes.

Next Month: Transistor Tester



Sidebands

A READER remarks on the lack of any simple explanation of how sidebands are created when a carrier wave is modulated by an audio frequency.

The point is a good one. The reason for the absence of a clear description of how sidebands are generated in modulation, why they are of the frequencies mentioned in books for beginners, and so on, is just nobody has yet thought of a nice simple physical analogy.

The flow of current through a wire can readily be imagined from the flow of liquid through a pipe but there is no such easy analogy for the creation of sidebands.

This is a pity because on occasions the absence of any simple explanation has led engineers to waste time in a vain attempt to do the impossible. A notable example cropped up in the thirties when there appeared at a certain exhibition a radio receiver called the Stenode. It was claimed to be infinitely selective because it incorporated a filter so sharply tuned

that only the carrier got through. Since the receiver worked this proved (it was said) that there are no such things as sidebands.

This must have come as a surprise to mathematicians. Their calculations had "proved" that if a steady single frequency is varied in amplitude (strength) then new frequencies are created—sidebands, in fact. If the variation is itself a steady frequency then (according to the mathematicians) the sidebands are in the form of two steady frequencies, one higher than the original carrier frequency and one lower.

Sum and Difference

These "side frequencies" are sum and difference frequencies. If the carrier frequency is 100kHz and is varied in amplitude at a rate of 1kHz then the sideband frequencies are 101kHz, the sum and 99kHz, the difference.

But calculations are one thing and demonstrations another. What was needed to settle the argument was a convincing demonstration that sidebands really exist. Nowadays it would be easy. All you'd need do would be to feed a modulated signal into a spectrum analyser. A picture would

then appear on its cathode ray tube screen showing the carrier frequency and the sideband frequencies.

In the case of a steady modulation such as 100kHz modulated by 1kHz the picture on the screen looks like Fig. 1. For speech and music or noise it is like Fig. 2, where the sidebands are not steady but fluctuate as different side frequencies appear and disappear.

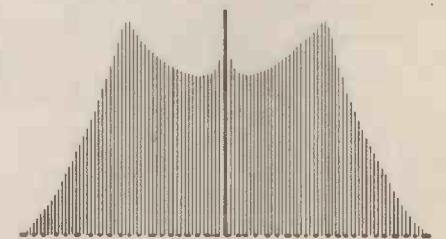

Fig. 2. A carrier being modulated by a whole range of frequencies.

Selective Receiver

Back in the thirties no such instrument was available in Britain so the National Physical Laboratory did the job another way. They constructed a very selective receiver, applied a steadily modulated signal and tuned across the spectrum, measuring the detector's d.c. output as the receiver tuned in first the lower side frequency then the carrier and finally the upper side frequency. The spectral lines were not as sharp as in Fig. 1, because the receiver tuning was not as sharp as a modern spectrum analyser's.

Sidebands exist: they are not just mathematical abstractions.

So how did the Stenode receiver work? Easy. It didn't just let the carrier through. It let some of the sideband energy through as well, though attenuated.

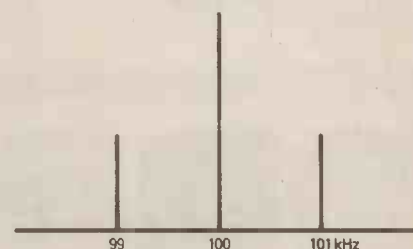

Fig. 1. Modulating a carrier with a single audio frequency.



A single-chip microprocessor (foreground) and some input/output and memory support chips (RCA).



The NASCOM I computer system for the home user.

NINETEEN SEVENTY EIGHT could easily go down in history as the year the great British public "discovered" the microprocessor.

Not that microprocessors were invented in 1978, of course. They were first produced way back in the very early '70s by a small youthful American firm called Intel. A firm which is now a world leader in microprocessors and one of that select band of semiconductor giants which dominate the electronics industry.

No, the reason why 1978 was so special was that at last the pre-

vious trickle of microprocessor based products had turned into a sufficiently fast flowing stream for the mass media to sit up and take notice!

The newspapers (well some of them!) had never even heard of the integrated circuit let alone microprocessors, and so the effect of the joint discovery was shattering. Headlines such as: "MARCH OF THE MINI-BRAIN" and "LIFE AND WAR IN CHIP VALLEY" began to appear, and countless prophets heralded the start of a new industrial revolution.

A PROPER PERSPECTIVE

We of the electronics fraternity, of course, were able to put all this into a proper perspective, whether we were actually "into" microprocessors or not. But problems remain.

Before the big discovery, if you mentioned microprocessors in polite conversation, you would be greeted with glazed expressions and retorts of "Micro-what?" But since 1978 all that has changed. Let slip that you dabble with electronics and you will be mobbed with questions like "How many transistors does the average micro' chip consist of?" and "What is a ROM?" and "Are you going to control your domestic environment with a micro?"

If you don't actually know the answers, this can seem like the technological equivalent of having sand kicked in your face, and you may find your friends (now suffering from microprocessor shell-shock) quite indifferent to the finer technical points of your muscular four transistor egg-timer or that dynamic TTL train controller.

Take heart though, because EVERYDAY ELECTRONICS has the answer! Follow the *Microprocessor Basics* series for a few months and you will be thrilled by the gasps of admiration which follow your off-hand statements like "The average micro' chip consists of more than 5,000 transistors" and "A ROM is a read-only memory which is often used to hold microprocessor programs" or even "I am currently engaged in a project to control my central heating with a microprocessor. The fuel savings will be impressive."

Seriously though, quite apart from its use as a primer in conversational microprocessor one-upmanship, this new series will provide a solid introduction to the subject, and may well lead the interested hobbyist on to greater things. After all, the newspaper headlines weren't wrong, life will never be the same now that the microprocessor has arrived in force!

MICROPROC

WHAT IS A MICROPROCESSOR?

A microprocessor is a general purpose digital computer subsystem which, thanks to the semiconductor technology of Large Scale Integration (LSI) has been shrunk to fit on to a single chip of silicon, just like the familiar calculator and clock chips which are now so freely available.

The difference between the microprocessor chip and the other LSI chips is not in manufacturing techniques but in the internal circuit design. A clock chip and a calculator chip can be used in precious little else other than clocks and calculators. They are dedicated.

The calculator chip can certainly be thought of as a computer, but it is not a general purpose computer. It adds, subtracts, multiplies and divides under the control of an internal and unalterable program, will talk to only seven-segment displays, and will listen only to a numeric keypad.

A microprocessor chip on the other hand, is a general purpose device which is programmed by the user, not by the semiconductor manufacturer. When manufactured, the microprocessor is endowed with a set of primitive instructions which it will obey, things like ADD and LOAD and SHIFT. The program which strings these primitive instructions together, so that in combination they perform some higher level task such as the control of a television game for example, can be written by the manufacturer of the TV game (usually a much smaller fish than the semiconductor manufacturer), or even you and me, if we have a small general purpose microprocessor system!

The microprocessor can move data around, do simple sums and even make logical decisions on the basis of: IF a condition is true THEN do activity (i) ELSE do activity (ii). And it can do all this in just a few millionths of a second.

Clever as the microprocessor is though, it can't do everything. It usually needs large amounts of external memory (which can also be built up from semiconductor chips) to store data and programs and because it can't communicate with humans directly, it may need bulky mechanical devices such as keyboards and printers.

Add to these needs the requirement for software (human programming effort which is usually far more expensive to produce than the electronic components or hardware of a microprocessor system) and already you can begin to hear the air escaping from that highly inflated microprocessor myth of an all powerful chip which will solve everyone's problems almost overnight. Even in the age of the microprocessor, problems are solved by people, not silicon!

APPLICATIONS

Well, having re-established the undoubted supremacy of the human race, perhaps we had better take a closer look at just why micro's are being hailed as competitors to all!

The two most impressive things about microprocessor chips are (i) their very broad area of application and (ii) their as yet almost untapped potential for solving human problems.

There is a microprocessor chip to suit every pocket. At the high end, they are in direct competition with the traditional digital computers which themselves consist of several expensive circuit cards stuffed with regiments of 16-pin TTL integrated circuits. At the low end, they are doing jobs which would either have been done by relays and transistors or would not even have been attempted without the flexible power of a microprocessor.

The high-end applications are usually referred to as "data-processing" tasks, and one important spin-off here has been the introduction of the microprocessor based

"Home Computer," a real computer at a hobby price, which can be programmed, just like its larger cousins, to play games, handle household accounts, and do all your maths homework!

The low-end applications are often called "controller" tasks, and microprocessors used in this area can sometimes be harder to spot. Simple controller systems do not need keyboards, printers, or display screens. Inputs and outputs are dedicated to simple tasks such as "start-pump", "overload", "lamp-on" and so on, and the microprocessors used do not need large amounts of memory or other peripheral circuits to perform effectively.

WIDE RANGE OF CHIPS

Despite the possibility of using a single type of microprocessor chip to handle data processing and controller tasks, in general this is not an economical proposition, and as a result the range of microprocessor chips available has become very wide.

At the high end, you can pay as much as £50 for a super-powerful 16-bit device, a bargain when you consider the room-sized computer it can help to replace. At the other end of the spectrum, manufacturers who build micro's into their washing machines or food blenders may be able to get the price of the chips they use down to a couple of pounds or less if they buy 100,00 of them at a time!

EXPERIMENTING WITH MICROPROCESSORS

Given this very broad range of prices and capabilities, many electronics hobbyists must be wondering how on earth they can enter this exciting and rather alien field, or even whether micro's should perhaps be left alone entirely because they seem too complex and too pricey.

Our advice here is "Don't despair!" If you find microprocessors

PROCESSOR BASICS 1

MICROPROCESSOR APPLICATIONS ROUND-UP

Microprocessors are being used in everything from toys to powerful computer systems, and it will soon be impossible for any of us to get through the day without running into at least one, though we may not recognise it when we meet it!

GAMES AND TOYS

At Christmas you may have noticed some new games with keyboards, displays, joysticks and other electronic appendages. Chances are, the games you saw were microprocessor based. The more sophisticated TV games centres are one example, and others are games such as Battleships, and educational "toys" such as the "Little Professor" and the Incredible "Speak and Spell".

DOMESTIC APPLIANCES

In the home, you may be lucky enough to have one of those clever doorbells which play a variety of tunes to serenade your callers, at its heart is a single-chip microprocessor (see *EE Microchime*, February 1979). In the kitchen, washing machines, food mixers and blenders, central heating controllers and even sewing machines are ideal for micro' control, and in the living room you may soon have a microprocessor in your television set to provide channel selection, time-on-screen, and Teletext or Vlewdata facilities. Your telephone may have a microprocessor call logger, your car a micro' controlled ignition system and dashboard instrumentation. You will soon be surrounded by the little blighters!

FACTORY, OFFICE AND SHOP

In industry and commerce, the microprocessor is already well established, and its low cost computing power is helping to improve industrial efficiency.

In supermarkets, micro' based tills have fewer mechanical parts to wear out, and with a light-wand attached, they can help reduce mistakes and protect the nail polish of the check-out girls, by reading bar codes directly from the goods in your trolley. Restocking of supermarket shelves and the control of stock will also be streamlined by the use of a micro' based portable terminal and light wand which can be used to carry out rapid stock checks.

Microprocessors can also be used to directly recognise small vocabularies of spoken words, so that it is now possible to reduce operator fatigue by using voice control in some industrial situations.

Microprocessors are involved in the manufacture of everything from biscuits to cars, and if you enjoy the convenience of instant money from your banks cash dispenser, it's the micro' you have to thank.

In the office, word processor systems get round the inefficiencies involved in that age old problem, the report that has to be retyped over and over again. With a word processor, the secretary can insert new paragraphs, delete old ones, and see the result instantly on a VDU screen.

DATA PROCESSING

In data processing applications, microprocessor systems are taking large chunks out of the market traditionally filled by minicomputers costing £20,000 or more, and some of the latest micro' chips are so powerful that they outperform many of the so-called "mainframe" computers of ten years ago, at a fraction of the cost.

Last but not least, the microprocessor has brought us the "Home Computer," a general purpose system which can play games, balance household accounts, remind you of birthdays, telephone numbers, and recipes, carry out scientific problem-solving, produce graphic displays for fun or data presentation, and of course teach the gentle art of computer programming.



Microprocessor-based Chess Challenger



Texas Speak and Spell learning aid



Microprocessor controlled Singer Futura sewing machine



Assembly of an Herbert & Sons electronic weighing machine which incorporates a Gould Advance microprocessor control system



The now famous Commodore PET home computer

and digital techniques fascinating, and want to get some hands-on experience, there is no reason to hesitate. Microprocessor systems have been produced with the electronics hobbyist in mind, and by following this series you should be well prepared to tackle the construction, programming, and application of your very own micro-computer.

EVALUATION CARDS

Microprocessor systems suitable for the home constructor are often called "evaluation-cards" because they were originally introduced to allow design engineers to get to grips with the particular micro-processor used. Systems of this sort usually consist of a mid-range microprocessor chip, such as the Motorola 6800 or the National SC/MP, surrounded by a clock oscillator, a small amount of software in read-only memory (ROM), a small helping of Read/Write Memory (Where you can store and run your own programs), a simple keyboard for data entry, and a seven-segment display.

As you may expect, the best way to learn about the operation of a microprocessor chip is to get some hands-on experience, and these inexpensive evaluation cards are ideally suited to provide this sort of tutoring. By contrast, the much more expensive "Home Computers" are great fun, and will certainly help to teach you computer programming, but they unfortunately will be of very little help if what you want to understand is

the electronic, or hardware, aspects of microprocessing.

NEED TO KNOW

To gain the maximum benefit from *Microprocessor Basics* there are a few things you may need to brush up on. A basic knowledge of binary notation and techniques will be useful, and if you didn't do this at school, you should be able to get to grips with it in an evening or so, when armed with a suitable library book!

Binary is important because microprocessors rely on digital rather than analogue techniques for their operation. Data are represented by patterns of "Ones" and "Zeros", and when the data represents a number, the number must be expressed in a binary format where each bit (Binary digIT) represents the presence (One) or absence (Zero) of a power of two. (That is 1, 2, 4, 8, 16, 32, 64 etc.) In binary, then, 0101 is equivalent to the decimal number 5, because the number contains one 1, no 2, one 4 and no 8.

The use of a system in which only two states exist makes good sense because a "one" can be simply represented by, say, a positive voltage of greater than 2.5 volts and a "zero" by a voltage of less than 0.5 volts. Alternatively switches, open or closed, or currents flowing or not flowing, can be used.

Microprocessors are not alone in using this sort of data representation, the computer at your bank, the calculator in your pocket, and

the digital watch you may be wearing, all do things the same way (but they don't let you see that they do!).

The "working-parts" of a micro-processor are logic gates and flip-flops, and so to understand micro's properly it is useful to have some familiarity with logic circuitry. (A good way to get this would be to study *Doing It Digitally*, EVERYDAY ELECTRONICS, October 1978 to September 1979).

Finally, if you have any knowledge of programming, either in flow chart form or in terms of programmable calculators or computers, this will help but it isn't essential.

Next month we will be taking a look at the microprocessor chips themselves, and later we will deal with microprocessor systems, programming, home computers, and using a hobby system.

To be continued

Crossword No. 13—Solution

B		T	V	G	A	M	E	S	C	H	I	S
G	A	M	M	A	A		Y	O				R
R		X	S				E		B	A	N	N
P	R	E	M	A	I	N	S		G	R		G
A	R		E				F	L	A	S	H	E
D		S	O	U	N	D	S		A	E		A
I		N					C	S				M
B	S	E	S	S		A		S	Y	S	T	E
C						T	L		A			A
O		S	R			R		S	C	A	P	E
N	E	U	T	R	A	L		O			L	L
T		O		I				C	R	A	C	K
R	O	A	R		G			K	J			U
O		E		H				E		A	M	P
P	E	I	E	D	E	T	E	C	T	O	R	L

JACK PLUG & FAMILY...

BY DOUG BAKER

SITTING ABOUT ALL THE TIME WON'T DO YOUR HEALTH ANY GOOD. WHY DON'T YOU...



... SPEND SOME TIME ON THAT ELECTRONIC JOGGING MACHINE WE BOUGHT YOU FOR CHRISTMAS?

I WOULD BUT IT MEANS GOING ALL THE WAY UPSTAIRS TO GET IT.



TUNER AMPLIFIER

HI-FI SERIES

PART 4



THIS month's article is devoted to the construction of the chassis assembly. This consists of three principal parts: the base plate or main chassis, the front panel, and the rear panel.

The remaining metal parts that have to be fabricated are a screening panel, the scale pan, and the tuning potentiometer bracket.

All these parts are made from sheet aluminium 2mm (14 s.w.g.) thick. Detailed drawings with full instructions for cutting, bending, and drilling are given in this article.

It will be seen that the base plate has turned-up edges, on all four sides, thus forming a shallow tray. This provides strength and rigidity; also means for fixing the front and rear panels.

Constructors lacking experience in metal work, or without the necessary equipment and facilities, are advised to purchase a set of ready-prepared parts. See *Materials List* for name of supplier.

It is recommended that *undrilled* parts be obtained. The average constructor should be able to perform this part of the preparation for himself, following the details given in the diagrams. This has the advantage of allowing minor adjustments to be made to the positioning of certain "critical" holes, should this prove necessary. For example, p.c.b. fixing and mains transformer fixing.

PROTECTIVE COATING

The aluminium for the front and rear panels should have a plastic or paper coating on one side. This is to protect the surface while cutting or drilling, and should be left in position until final assembly. These protective coverings can be marked out quite easily, but do not use too much pressure when scribing a line; mark only the covering, do not go right through or you will mark the metal surface underneath.

DRILLING

Always drill a small pilot hole before drilling to the required final size. If a drill of approximately 1mm outside diameter is used for the pilot

hole there is no need to centre-punch first, although of course this will ensure even greater accuracy.

Mark out the holes by measuring from the centre lines where shown. This is to ensure that the front panel control holes line up with the push-buttons when finally assembled together. Do NOT drill holes for p.c.b.s, screening panel, or mains transformer at this stage, but see below.

CHECK HOLE POSITIONS

Screw the front panel to the chassis base plate (five 8 BA c/sk screws and nuts). Place boards A and B in position with their pushbuttons located in the holes in the front panel. Carefully adjust the boards if necessary for correct alignment of all push-buttons. Then using the large holes on the p.c.b.s as templates mark the exact position for each mounting

CHASSIS MATERIALS AND PARTS

TUNING DRIVE

Drive cord drum	} Maplin type	{	RX43W
Tuning spindle			RX46A
Drive cord			BL73Q
Spacers 7mm (4 off)			FW35Q

SHEET ALUMINIUM

2mm (14 s.w.g.)	
Main chassis	500 × 270mm
Front panel	500 × 85mm
Rear panel	500 × 77mm
Scale pan	500 × 56mm
Screen	230 × 70mm
Bracket	60 × 30mm

A set of the above six items, cut and bent according to Figs 4.1 to 4.5 inclusive, but undrilled, is available from—Kitson's Sheet Metal Ltd., Roundtree Way, Norwich NR7 8SH

PERSPEX (3mm)

Rear Dial white	215 × 30mm
Front Dial clear, or tinted	200 × 24mm
Preset Cover, rear white	60 × 10mm
	front clear, or tinted 66 × 12mm

HARDWARE

Screws, nuts and washers required for assembly of the chassis are included under HARDWARE in Part 2

The following items are additional to those listed in Part 2.

Capacitor fixing clips, horizontal

35mm dia. (for C58) RS type 543-383 (1 off)

25mm dia. (for C55a, b) RS type 543-052 (2 off)

Screws 4BA C/SK 3/8 inch	(8 off)	Screws 8BA C/SK 3/8 inch	(4 off)
Nuts 4BA full	(8 off)	Nuts 8BA	(8 off)
Washers 4BA	(8 off)	Washers 8BA	(4 off)
Solder tag 4BA	(1 off)	Fibre Washers 8BA	(8 off)
Screws 6BA 1 inch	(3 off)		
Screws 6BA 1/2 inch.	(11 off)		
Nuts 6BA	(14 off)		
Washers 6BA	(11 off)		
Cable ties RS type 543-428	(25 off)		
Stick-on feet RS type 543-327	(4 off)		

See
**Shop
Talk**
page 144

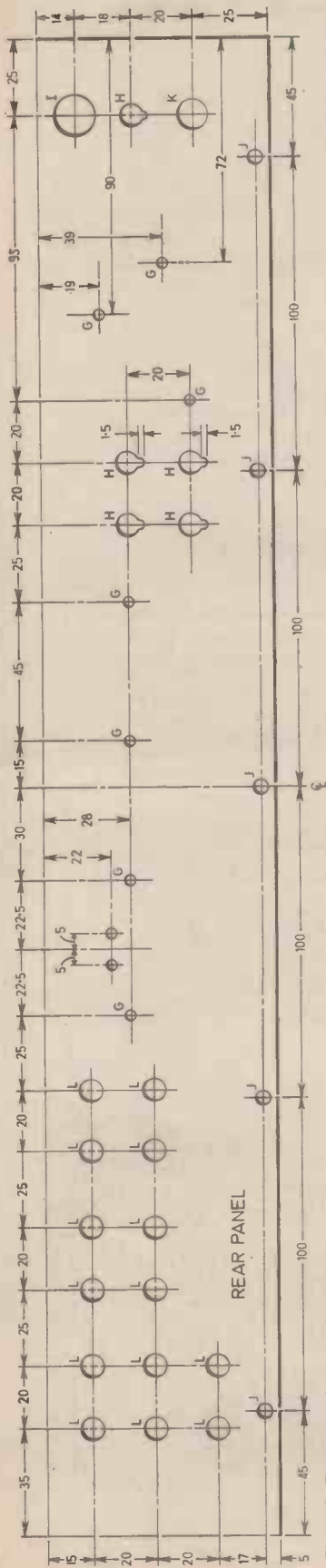

Fig. 4.3. Rear panel: drilling details.

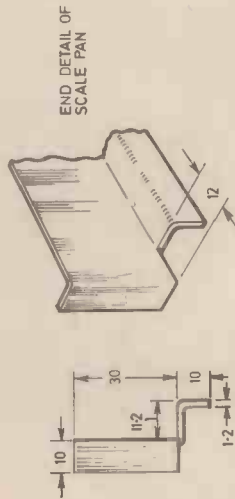

Fig. 4.5. (right) Tuning potentiometer bracket: bending and drilling details.

Fig. 4.4. (below) Scale pan: bending, cut-out and drilling details.

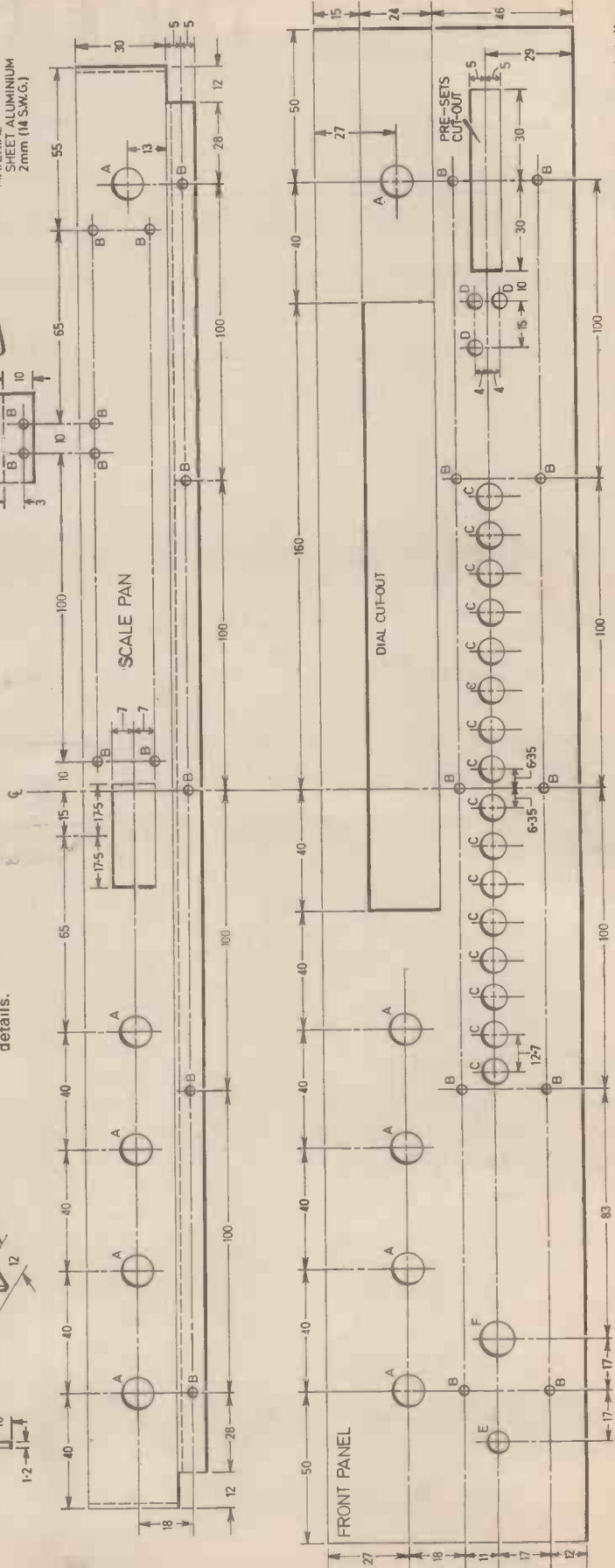

Fig. 4.6. (bottom) Front panel: drilling and cut-out details.

EE2020 TUNER AMPLIFIER

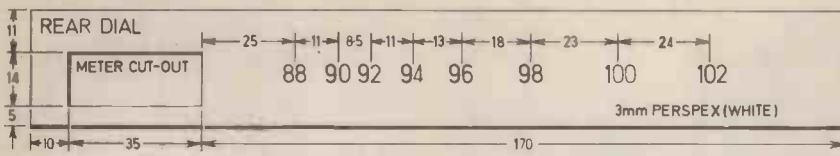

Fig. 4.7. Tuning dial.

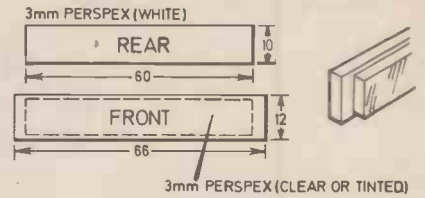

Fig. 4.8. Preset tuning cover: rear portion is glued to front in position shown.

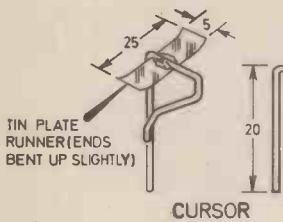

Fig. 4.10. Tuning cursor.

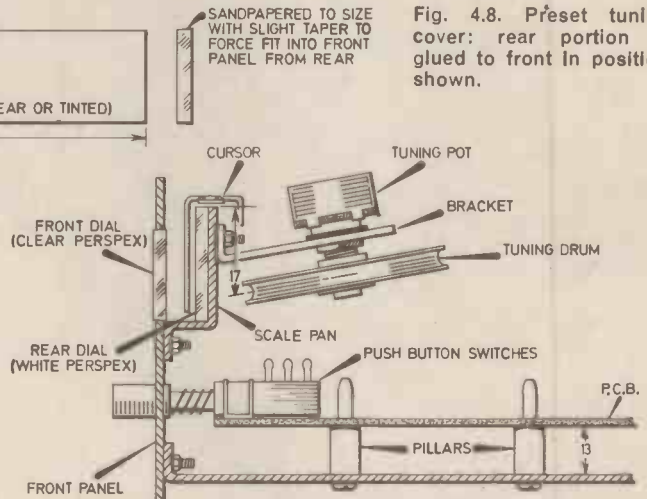

Fig. 4.11. Side section showing general assembly of scale pan, tuning drive, pushbuttons and p.c.b. fixing.

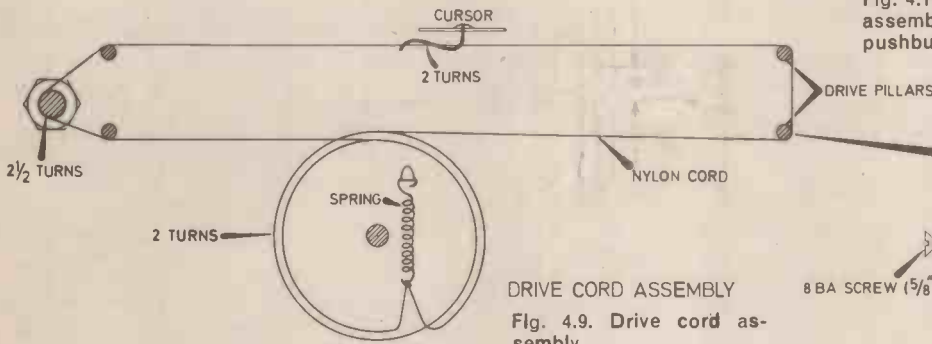
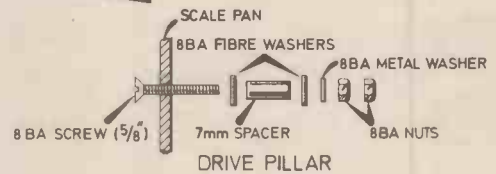

Fig. 4.9. Drive cord assembly.



ALL DIMENSIONS IN mm

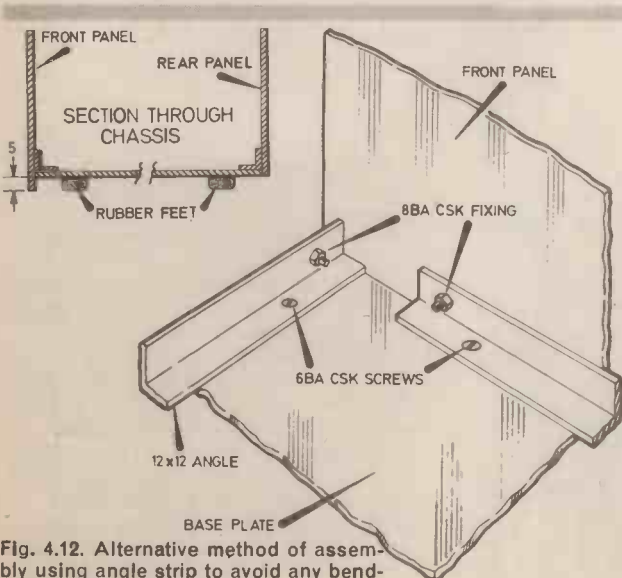
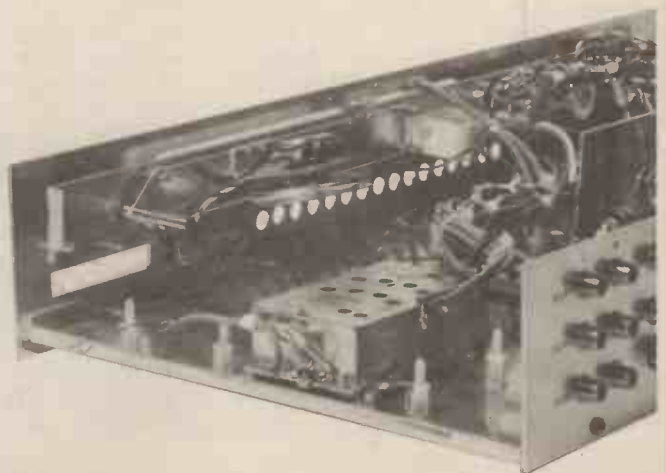

Fig. 4.12. Alternative method of assembly using angle strip to avoid any bending of chassis base plate.



EE2020



pillar on the base plate. Also mark the two securing holes for the screening panel at rear of board B. Next position the remaining p.c.b.s and mark the base plate as before.

Now remove the front panel and complete the drilling of the base plate. Likewise use the mains transformer as a template for location of fixing holes in the base plate. The mains transformer should be located centrally in the area left of board E.

CUTTING THE SLOTS

The slots in the front panel and scale pan are cut using one of the round saw blades which fit a hack saw and meant for cutting shaped holes. Cut the slots undersize and file to the

final size. Note that the Perspex in the front panel is a "force" fit, so final filing should be left until the Perspex panels are actually fitted.

ASSEMBLY OF CHASSIS

When satisfied that all holes and bends are correct, assembly of the chassis can begin. Start by refitting the front panel to the base plate (five 8 BA c/sk screws and nuts).

TUNING DRIVE AND SCALE PAN

Assemble the tuning drive upon the scale pan as follows. Secure the bracket to the scale pan (two 8 BA c/sk screws and nuts). Assemble the

four drive cord pillars to the scale pan. See Fig. 4.9 for details.

Mount the tuning potentiometer on the bracket and fit the drum to the end of the spindle. See Fig. 4.11. Fit the drive cord to drum spring and wind round periphery of drum and take round the four pillars then return to drum and secure to end of spring.

Secure the tuning dial to the scale pan with a little glue. The tuning dial is held in place by double-sided sticky tape or blue tack. Alignment of meter cut-outs will give correct positioning. Do NOT fit meter at this stage.

After fitting the tuning scale, fit the tuning cursor (see Fig. 4.10) and check that it travels smoothly along the top edge of the scale. Check that potentiometer is fully anticlockwise when cursor is at left hand end of dial. Tighten grub screw on drum. Fit the volume, balance, bass, and treble potentiometers to the scale pan and then secure the scale pan assembly to the front panel (five 8 BA c/sk screws and nuts).

The clear Perspex panel should be fixed to the front panel before the scale pan. It is held in place by being a force fit from the rear of the panel and finally secured with a small touch of glue at each end.

REAR PANEL AND BASEPLATE

Screw the rear panel to the base plate flange (five No. 6 self-tapping screws).

Mount and secure on the base plate the Radio Unit (4 BA screws, washers and nuts), the clips for electrolytic capacitors C55a, b and C58, and the solder tag (4BA screws, washers and nuts).

Secure all 20 p.c.b. pillars* to base plate with No. 6 self-tapping screws. NOTE. The boards should not be fitted at this stage, but after the front and rear panel components have been mounted—see Part 5.

* Described in Hardware list on page 39 as "P.C.B. Spacers".

D.I.Y. METALWORK

For those who wish to undertake all metalwork themselves, the following guidance is offered.

If metal bending facilities are available, place the sheet between two blocks of hardwood (or a metal angle could be used) and clamp the whole in the vice, like a sandwich.

An alternative method of construction is to use 12mm ($\frac{1}{2}$ inch) aluminium angle instead of making bends on the base plate. Strips of angle should be screwed in place along the front, rear and side edges of the (unbent) base plate. One point to watch is that allowance must be made for the extra thickness of metal when working out the holes for fixing the front and rear panels. See Fig. 4.12.

To be continued

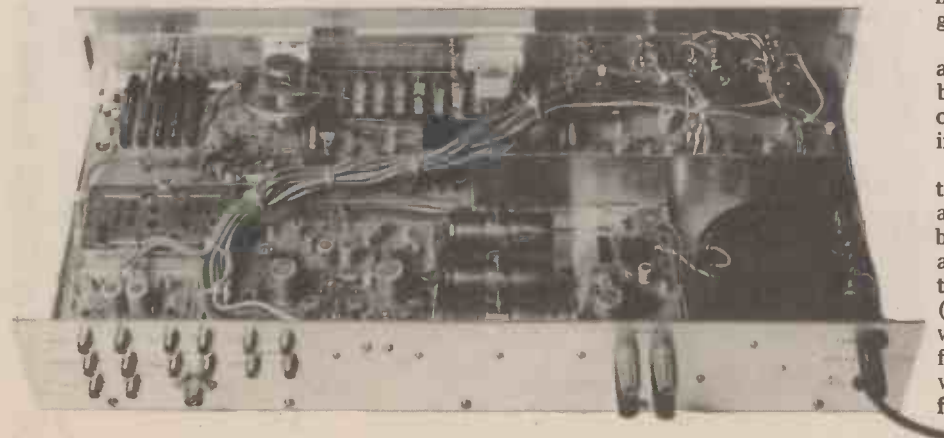

LOOK!

Here's how you master electronics.

.... the **practical** way.

This new style course will enable anyone to have a real understanding by a modern, practical and visual method. No previous knowledge is required, no maths, and an absolute minimum of theory.

You learn the practical way in easy steps mastering all the essentials of your hobby or to further your career in electronics or as a self-employed electronics engineer.

All the training can be carried out in the comfort of your own home and at your own pace. A tutor is available to whom you can write, at any time, for advice or help during your work. A Certificate is given at the end of every course.

1. Build an oscilloscope.

As the first stage of your training, you actually build your own Cathode ray oscilloscope! This is no toy, but a test instrument that you will need not only for the course's practical experiments, but also later if you decide to develop your knowledge and enter the profession. It remains your property and represents a very large saving over buying a similar piece of essential equipment.

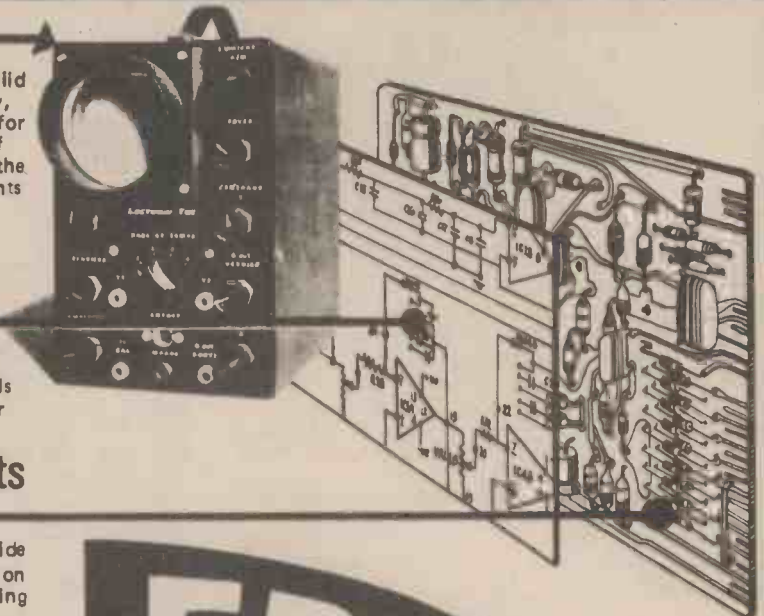

2. Read, draw and understand circuit diagrams.

In a short time you will be able to read and draw circuit diagrams, understand the very fundamentals of television, radio, computers and countless other electronic devices and their servicing procedures.

3. Carry out over 40 experiments on basic circuits.

We show you how to conduct experiments on a wide variety of different circuits and turn the information gained into a working knowledge of testing, servicing and maintaining all types of electronic equipment, radio, t.v. etc.

4. Free Gift.

All students enrolling in our courses receive a free circuit board originating from a computer and containing many different components that can be used in experiments and provide an excellent example of current electronic practice.

FREE

Post now, without obligation, to:-

BRITISH NATIONAL RADIO & ELECTRONICS SCHOOL

P.O. Box 156, Jersey, Channel Islands,

NAME _____

ADDRESS _____

EEB3/79

Block caps please

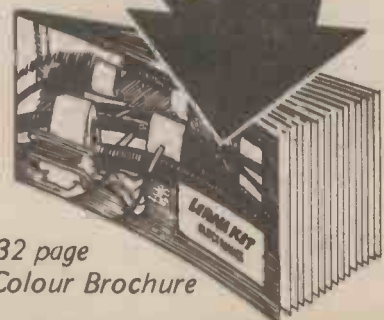

32 page
Colour Brochure

ELECTRONI-KIT

"EDUCATIONAL KITS OF EXCEPTIONAL QUALITY"

(AUDIO magazine)



THIS IS A POWERFUL RADIO RECEIVER!

The same kit is also 150 other different actual working projects e.g.:

Computer & Logic Circuits, Electronic Organ, Timer, Light Control, Agility Tester, Lie Detector, Siren, Horn, Buzzer, Bird, Metronome, Cds cell light & sound control, Photogun, Light Oscillator, Light Switch, Light and Sound Morse Code, Field Strength Meter, Hygrometer, Sphygmometer, Etc., Etc.

Radio Receiver, Transmitter, Amplifier, Audio Generator, Signal Tracer & Injector, Continuity Tester, Telegraph, Photoradio Receiver, Radio Receiver/Microphone Mixer, Illuminometer, Voltmeter, Ammeter, Sound Level Meter, Ohmmeter, Diode & Transistor Tester, Transparency Indicator Etc., Etc.

The above is just a selection of the circuits available—you can also design your own circuits with these superb new Denshi-Gakken "EX" construction kits.

No previous experience of electronics is required but you learn as you construct and have a great deal of fun too. The kits are completely safe for anyone to use.

Kits are complete with very extensive construction manuals PLUS Hamlyn's "All-Colour" 160 page book "Electronics" (free of charge whilst stocks last).

ALL KITS ARE FULLY GUARANTEED. Add-on sets (to increase the scope of each kit) are available, plus spares and accessories as required.

150 PROJECT KIT £39.75 60 PROJECT KIT £25.75
120 PROJECT KIT £33.75 30 PROJECT KIT £18.95
100 PROJECT KIT £29.25 15 PROJECT KIT £16.75

Prices include educational manuals, free book, VAT, p & p (in the U.K.). Free introduction to the British Amateur Electronic Club. Free list of low price electronic books.

Callers at 20 Bride Lane will be very welcome. Trade and Educational enquiries invited.

Cheque/P.O./Barclaycard/Access No. (or 14p for illustrated literature) to DEPT. EE.

ELECTRONI-KIT LTD.

20 BRIDE LANE, LUDGATE CIRCUS,
LONDON EC4Y 8DX (01-353 6430)

OUR RANGE OF PRODUCTS ARE NOW INDIVIDUALLY AND ATTRACTIVELY PACKAGED

vero

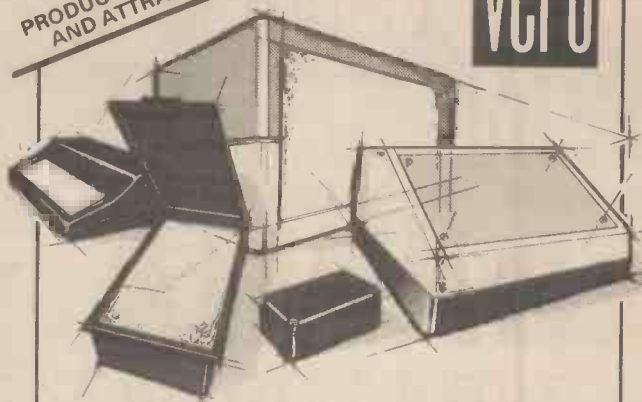

Our new catalogue lists a whole range of plastic boxes to house all your projects. And we've got circuit boards, accessories, module systems, and metal cases — everything you need to give your equipment the quality you demand. Send 25p to cover post and packing and the catalogue's yours.

VERO ELECTRONICS LTD. RETAIL DEPT.
Industrial Estate, Chandlers Ford, Hants. SO5 3ZR
Telephone Chandlers Ford (04215) 2956

MINIATURE VARIABLE CAPACITORS 25+25+25pf @ 75p.
SUB-MINIATURE TANTALUM CAPACITORS 4-7uf 10v.w. @ 6 for 25p.
TRANSISTORS BC 548 or BC 549 at 10p, 6 for 50p.
DAU TRIMMERS 2 to 9pf @ 10p, 6 to 45pf @ 10p, 0 to 125pf @ 12p, 8 to 140pf @ 15p.
POSTAGE STAMP TRIMMERS 10pf @ 10p, 30pf @ 10p, 1000pf @ 10p.
VERNITRON FM 4 10-7 MHz FILTERS @ 50p, 3 for £1.
50 AC 128 TRANSISTORS Branded but untested @ 57p.
1uf 25v.w. ELECTROLYTICS @ 6 for 25p.
10 AMP S.C.R.'s 100 PIV @ 25p, 400 PIV @ 50p, 800 PIV @ 60p.
MULLARD SOLID DIELECTRIC VARIABLE CAPACITORS 195+80pf @ 40p.
COIL FORMERS 1/4" dia. with core @ 6 for 25p.
McMURDO 8 PIN PLUGS @ 20p, 8 PIN SOCKETS @ 20p, COVERS @ 15p.
20 PHOTO TRANSISTORS AND DARLINGTONS Assorted untested @ £1.
ELECTRET MICROPHONE INSERTS WITH FET PRE-AMP @ £1-85.
10 ASSORTED PUSH BUTTON BANKS less knobs for £1-30.
200 RESISTORS Assorted 1/4, 1/2 watt for 75p.
PLASTIC TRIAC 400 PIV 6 Amp @ 60p each.
UNIJUNCTION TRANSISTORS 2N 4871 @ 22p, 2N 6028 @ 25p, 2N 6029 @ 25p, MEU 21 @ 22p, MU 4894 @ 22p, 4JDS29 @ 22p, TIS 43 Type @ 20p.
VARIABLE CAPACITORS Direct Drive 5pf @ 75p, 10pf @ 75p, 15pf @ 75p, 30pf @ 85p, 125+125pf @ 55p, 100+200pf @ 55p, 200+200+25+25pf @ 55p. With S.M. Drive. 500+500+25+25pf @ 55p, 250+250+20+20+20pf @ 75p, 365+365+365pf @ 65p.
MINIATURE ROTARY SWITCHES 2 Pole 4 way @ 20p, 1 Pole 10 way 2 Bank @ 40p, 3 Pole 3 way @ 40p.
LM 380 AUDIO I.C. with circuits @ 80p.
50 ASSORTED 2 WATT ZENER Untested @ 57p.
50 VARI-CAP DIODES LIKE BA 102 Untested @ 57p.
TANTALUM CAPACITORS 1uf 35v.w., .33uf 35v.w., 1uf 35v.w., 2-2uf 35v.w., 4-7uf 35v.w., 6-8uf 35v.w., 10uf 25v.w., 22uf 16v.w., 33uf 25v.w., 47uf 6v.w. All at 9p each.
MAINS TRANSFORMERS 240 volt Input, Type 1. 24 volt Tapped at 14 volt 1 amp @ £1-30 (P&P 25p). Type 2. 22-0-22 volt 500mA @ £1-60 (P&P 25p). Type 3. 45 volt 6 amp @ £4-50 (P&P 95p).
600 MHz FREQUENCY 8 DIGIT COUNTER @ £115.
1N 4148 SILICON DIODES 10 for 40p.
DIE-CAST ALLOY BOXES Size 6" x 3-1/2" x 2" @ £1-15.
800 MHz T PACK NPN TRANSISTORS BF 362 @ 25p each.
ELECTROLYTIC CAPACITORS Screw Terminals. 680uf 160v.w. @ 20p, 3,300uf 63v.w. @ 50p, 15,000uf 40v.w. @ 75p, 33,000uf 16v.w. @ 75p, 47,000uf 10v.w. @ 75p, Tag Ended Types, 500uf 70v.w. @ 15p, 500uf 100v.w. @ 15p, 1000uf 100v.w. @ 50p, 3000uf 25v.w. @ 50p, 4700uf 25v.w. @ 50p.
50 BC 107-8-9 TRANSISTORS Untested @ 57p.
HC 8U CRYSTALS 40MHZ, 44-3MHZ, 45-9MHZ, 46-5MHZ, 46-7MHZ, 48-3MHZ, 50-1MHZ. All at 50p each.
3 PIN PLUG AND SOCKET like R.S. European type with 2 metres of Cable @ 75p pair.
Please add 20p for post and packing on U.K. orders under £2. Overseas postage at cost.

J. BIRKETT
RADIO COMPONENT SUPPLIERS
25 The Strait, Lincoln LN2 1JF Tel. 20767

FREE ENTRY
COMPETITION
25 ANTEX



SOLDERING KITS & IRONS
MUST BE WON

**TWO SIMPLE
PROJECTS
TRANSISTOR TESTER
AND TOUCH BLEEPER**



**SHAVER
INVERTER**

A DOUBLE FOR
THE MOTORIST

**CHOKE
WARNING
DEVICE**

**Everyday
ELECTRONICS**

APRIL
ISSUE ON SALE
FRIDAY, MARCH 16

Everyday News

COMPUTING—IT'S CHILD'S PLAY

The first-ever Computer Exhibition aimed at the 8 to 14 year old was held recently in London. Organised by the British Computer Society together with the Institute of Education, the exhibits allowed youngsters to approach and communicate with the many computer systems without fear.

The TV screens asked the question: What is your name? and when a child typed his name on the keyboard contact was made, the ice was broken, the computer started its program, the game begins. Chess, Othello, battle stations, noughts and crosses, they were all there; so too were members of the British Computer Society who manned the stands



COLOUR ON THE MOTORWAY

Drivers on the M1 Motorway will soon see coloured motorway signals which show recommended speed, a sign of the hazard ahead in the conventional red triangle, and the distance ahead of the hazard.

Ten of the new signals, which use fibre-optic technology, are to be installed experimentally by Rank Optics under a scheme originated by the Road Research Laboratory.

Girl of the Year

The 1978 winner of the Girl Technician Engineer of the Year award sponsored by the Caroline Haslett Memorial Trust and the IEETE was Erzsebet Kibble. Erzsebet received her reward from the Rt. Hon. Shirley Williams, M.P., Secretary of State for Education and Science. Mrs. Kibble, of Hungarian birth, is an assistant manager in Thorn-Ericsson Telecommunications (Sales) Ltd.

Despite schemes to encourage the ladies into engineering careers the number is still depressingly low, only some 5 per cent of all engineering entrants.



voluntarily and were more than helpful in assisting everyone overcome the fear of actually operating "a computer".

The "Young Computer Exhibition and Fun Fair" was held at the Bloomsbury Centre Hotel and the BCS conference "Living with Computers" was on at the same time. The organisers had anticipated fairly quiet days on the Thursday and Friday but the message was out and the school Christmas holidays still on . . . so, it was packed out.

A portable programmable computer "in-a-briefcase" system, which, when connected to a TV set (preferably colour for clarity) enabled handicapped people to make better and easier use of electronics was shown by Ferranti. Fitted with an alphanumeric keyboard the prototype enables the user to control the home lighting, heating, fans, etc through machine codes that are visual and easy to understand, whilst also providing a basic and practical computer. Additional programs on minicassettes provide the necessary back-up for even the severely handicapped to achieve the same amount of control, even to producing typed letters using a simple two pushbutton unit remote from the equipments.

The National Police Computer showed their system of immediate investigations into the background of people. The files of CRO (Criminal Record Office) and General Information are now being held on Computer Records with instant access, and the idea of the stand seemed to be to let children know how "instant" justice will be in the future.

"What is a Computer Program?" was the title of a

film show presented in the lecture theatre at the exhibition, but if children expected to find out the answer I fear they didn't. Unfortunately, the presenter assumed too high a level of basic (computer) knowledge that left the uninitiated not only bewildered and lost, but bored. Such descriptions as: Housekeeping, Executive and even Compiler were thrown at the young audience along with basic concepts of program routines. Alas, it was beyond them.

The Institute of Education stand enabled visitors to scan through information about College courses, University placements, etc using both a computer system and a separate microfilm file. This not only gave a clear idea of the education available it also simply showed the usefulness and adaptability of the two media.

Footnote

If any school wishes to receive a visit from a local member of the British Computer Society, they are quite happy to arrange this for you. Schools interested should write to: The British Computer Society, 29 Portland Place, London, W1.

—ANALYSIS—

THROUGH THICK AND THIN

The monolithic silicon integrated circuit is unquestionably today's glamour component in electronics. It's most developed form in very large scale integration (VLSI) has captured the popular imagination under the generic four-letter word, the "chip".

So swamped are we by incessant publicity on the "chip" that we are in danger of overlooking the fact that it is not the only form of microelectronics. A parallel development during the last decade has been thick and thin film technology in which circuits are laid down on a substrate, normally of ceramic material.

Film circuits can be quite simple resistor networks or quite complicated devices incorporating not only R and C and all the inter-connections but, by the addition of discrete components, tiny capacitors, transistors, diodes, even I.C.s, become monolithic in their own right. When active components are added in this way the device is called a hybrid integrated circuit.

The early problems of crudity in thick films have now been overcome and because of the economics of manufacture thick film circuits are now the dominant type. Resistive inks are available which allow resistors to be printed within the range of 5 ohms to 50 megohms and trimmed by laser beam to 1 per cent tolerance. Conductors, again printed, can be gold or palladium silver. Add-on capacitors can be as high in value as 100 μ F using tantalum chips. The whole assembly can be encapsulated and hermetically sealed. Thick film enthusiasts never tire of telling you how flexible, how reliable, how cost-effective thick film hybrids can be.

The electronic hobbyist is unlikely to use thick film circuits. He is better off with his accustomed laminates and P.C.B.s. But how many hobbyists need true microminiaturisation and the sort of reliability that is needed for the extreme environments of missiles, avionics or space satellites?

Nonetheless, the hobbyist should be aware that there are alternative methods of achieving a desired end and it is certainly true that the professionals in electronics see thick film hybrid integrated circuits as a growing technology with a large and expanding market, not as a direct rival to the silicon I.C. but as complementary to it in many applications. A case, in fact, of horses for courses.

Brian G. Peck



London's Portman Hotel has scooped its industry by becoming the first hotel to feature Prestel viewdata, the new television/telephone linked data information system developed by the Post Office, as a permanent feature at the hotel. The set, a Baird 26 inch colour model has been specially installed in the lobby where guests can access pages of information.

—POCKET TV PRICE WAR—

The new single standard Microvision TV receiver from Sinclair Radionic's is expected to be able to compete with Japanese competition. At a recommended price of £99 plus VAT it is less than half the price of the original multi-standard Microvision aimed at the US market.

ELECTRONICS SUMMER SCHOOL

The Department of Electrical Engineering Science at the University of Essex will be holding its annual electronics summer school for teachers during the week 9 to 13 July 1979. This year, as well as courses in linear circuit design and digital circuit design, a third course in electronic systems is also available which is closely related to the A.E.B. electronics systems A-level.

A programme of laboratory work is included on each course so that the lecture material is fully supported. Further information on the Summer School may be obtained from Dr. M. J. Hawksford or Mrs. J. E. Mead at the Department of Electrical Engineering Science, University of Essex, Wivenhoe Park, Colchester CO4 3SQ.

A NEW LIGHT

The new managing director of Mullard Ltd, to succeed Jack Ackerman, is to be Ivor Cohen the divisional director of Philips UK Lighting Division.

This appointment follows the decision by Dr. J. M. Whitehead not to take up his appointment as MD of Mullards.

TESTING TIME

Almost 30 papers dealing with the latest developments in automatic testing and test and measurement systems will be presented at the "ATE/Test & Measurement Show '79", to be held at Wiesbaden, West Germany, from March 20 to 22, 1979.

Skyflash

Britain has won a £60 million order from Sweden for Skyflash air-to-air missiles. They will be used on Sweden's new Viggen JA-37 all-weather interceptor aircraft.

The semi-active radar homing head on Skyflash is made by Marconi Space and Defence Systems and the missile by the Dynamics Division of British Aerospace.



The IBM's new 64k RAM actually has over 66k bits of RAM on it, the idea being that the built-in spare bits can be used in chips that have comparatively large fault areas, thus improving yields and reducing scrap.

BUBBLE TIME

Data entry, editing and storage for commercial applications such as remote sales-order entry, computer time-sharing systems and newspaper reporting is possible with the Texas Instruments Model 765 portable bubble-memory terminal.

Because the terminal's bubble memory retains data even when power is switched off, information from a variety of sources can be stored in the terminal for as long as required, and then transmitted in a single batch over a normal telephone line using the built-in acoustic coupler. This enables batch transmission to take place during the telephone system's cheap rate times.



EX-150

EE SPECIAL



DENSHI-GAKKEN KITS

THE SUBJECT of our report this month is the new completely solderless Denshi-Gakken EX-Series of Educational kits.

We had heard such glowing reports from various sources, including readers, that we thought it was time we investigated them more closely. We are very pleased that we did and that we can add our own endorsement to the ever growing list of admirers of their products.

KIT CONTENTS

These educational kits are not cheap, but when you purchase any product that is accepted as one of the best in its field they never are. The range runs from the EX-15 (£16.75), to the EX-150 (£39.75). The figures refer to the number of building projects possible with each kit.

Wanting to experience their complete range we chose the EX-150, which enables 150 circuits ranging from basic theory and test gear to an i.c. amplifier, a radio microphone and a lie detector to be built.

The kit consists of 46 plastic cubes with components mounted in the centres, including two transistors and two diodes; an i.c. amplifier module with loudspeaker and volume control; a plastic housing with ready mounted a.m. aerial, variable capacitor, on/off switch and a light sensitive cell (CDS). Also included in the kit is a microphone, an earphone, connecting leads and test probes.

Finally, the most important item in the kit is the 158-page instruction manual. This manual is excellently illustrated, each page containing a circuit diagram and an easy to follow "building block" component layout together with any interconnecting details; i.e. microphone or test probes. The layout diagram fills half a page and a brief introduction to the circuit is also included on the page.

COMPONENTS

At first sight the kit case looks like one of those "military style" radios (see photograph) that are so popular at the moment, but in fact this robust plastic casing also forms the experimenters "test-bed".

The top section of the case near the carrying handle takes the plug-in i.c. amplifier module, the meter, tuning capacitor, light sensitive cell, and the supply on/off switch.

The lower section of the case has a rectangular well which accepts the various component cubes. The base or floor of the well is marked up into a matrix of squares and the component cubes are located in these squares, held in position by small plastic locating pillars at the corners of the squares.

The sides of the well have sprung-metal connecting lugs which mate with identical connecting strips on the sides of the component cubes. The contacts on the sides of the well are also wired to the various components mounted in the top section of the case and a.m. aerial.

The top edge connectors being clearly marked for the cadmium cell, supplies, meter and volume control. The connections to the a.m. aerial being clearly marked on the left side of the well.

The component cubes are made of preformed plastic and have sprung metal connecting strips on the sides of the cubes. These connecting contacts also bend under the cube to accept components which are pre-soldered to the contacts and housed in the centre of the cube.

Some of these connecting contacts are linked by wires instead of components and are used as interwiring links between components and various points of a circuit. The top of the cubes are clearly marked with the circuit symbol and value of the component inside.

CONSTRUCTION

Once you have familiarised yourself with the various components, the first stage in building is to select the required components according to the chosen project.

A working project is then constructed by simply slotting the component cubes and connecting leads into the "test bed" as shown in the layout diagram in the instruction manual. No soldering or wiring being required as the cubes complete the electrical connections.

Provided the circuit symbols on the cubes agreed with the layout diagram and they were double checked for good electrical contact, simply by wriggling them in their allotted locations, we found the projects usually worked first time. When they did not work this was found to be due to human error.

CONCLUSIONS

We found the kits well made and excellently set out, although we do not agree with the order the projects are presented in the instruction manual. Of course, if you do not wish to work through the manual from the first project to the last it is a simple matter to select a particular project and build a working model from that page.

We would question the education value, in terms of understanding the theory of electronics, but the kits certainly offer a very interesting variety of projects which will introduce beginners to the many possible applications of electronics.

It is possible to remove components from their cubes and insert others enabling the constructor to extend the range of circuits even further. We do NOT recommend the inexperienced constructor to attempt this.

The EX-Series of kits are available from Electroni-Kit, Dept EE, 20 Bride Lane, Ludgate Circus, London EC4 8DX. They are also supplying, free of charge, while stocks last, a 160-page Hamlyn book entitled "Electronics" with every kit purchased.

The method of mounting components inside the "building brick" and close-up view showing the circuit symbol and value of component in the centre of the cube

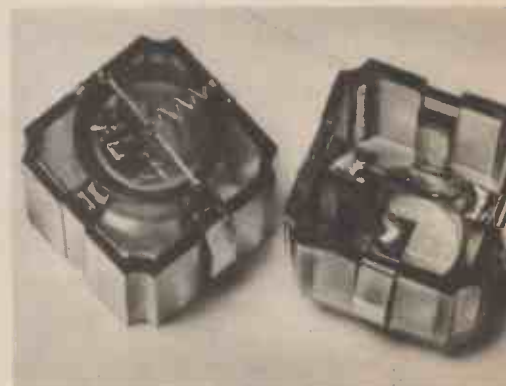

ROOM THERMOSTAT

Famous Satchwell, elegant design. Intended for wall mounting. Will switch up to 20 amps at mains voltage, covers the range 0.30 C. Special snip this month £3.75.

ROD THERMOSTAT—£3.00.

WINDSCREEN WIPER CONTROL

Vary speed of your wiper to suit conditions. All parts and instructions to make £3.75.

MICRO SWITCH BARGAINS

Rated at 5 amps 250V. Ideal to make a switch panel for a calculator and for dozens of other applications. Parcel of 10 (two types) for £1.25.

RADIO STETHOSCOPE

Easiest way to fault find, traces signal from aerial to speaker, when signal stops you've found the fault. Use it on Radio, TV, amplifier, anything. Kit comprises transistors and parts including probe tube and twin stetho-set £3.95.

MULTISPEED MOTORS

Six speeds are available 500, 800 and 1,000 r.p.m. and 7,000, 9,000 and 11,000 r.p.m. Shaft is 1/8 in. diameter and approximately 1 in. long. 230/240V. Its speed may be further controlled with the use of our Thyristor controller. Very powerful and useful motor size approx. 2 in. dia. x 5 in. long. Price £2.

12V MINIATURE RELAY

dc operated with two sets of change over contacts. The unique feature of this relay is its heavy lead out wires; these provide adequate support and therefore the relay needs no fixing; on the other hand there is a fixing bolt protruding through one side so if you wish you can fix the relay and use its very strong lead outs to secure circuit components—an expansive relay, but we are offering it for only 87p each. Don't miss this exceptional bargain!

EXTRACTOR FAN

Ex computers—made by Woods of Colchester. Ideal for fixing through panel—reasonably quiet running—very powerful 2500 rpm. Choice of two sizes 5" or 6 1/2" dia. £3, £6.

MAINS RELAYS

With triple 10 amp changeover contacts—operating coil wound for 230V a.c. Chassis mounting one screw fixing. Price £1.25

BURGLAR ALARM ITEMS

(Trigger free on application)

Trigger mats 15" x 10" £1.95

Relay 24 volt 85p

9-12 volt 95p

Alarm Bell 24 volt £7-50

9-12 volt £8-25

Reset, Switch, ordinary 45p

Secret type with key 95p

Wire—100 metres £1-50

24v Power unit mains operated £5-35

MERCURY BATTERIES

Bank of 7 Mercury cells type 625

which are approx. 1/2 in. diameter by 1/2 in. thick in plastic tube giving a total of 10-17V.

Being in a plastic tube it is very easy to break up the battery into separate cells and use these for radio control and similar equipment. Carton of 25 batteries £1-60.

PP3/PP9 REPLACEMENT

Japanese made in plastic container with leads size 2in. x 1/2in. x 1/2in., this is ideal to power a calculator or radio. It has a full wave rectifier and smoothed output of 9V suitable for loading of up to 100mA. £2-53.

SWITCH TRIGGER MATS

So thin is undetectable under carpet but will switch on with slightest pressure. For burglar alarms, shop doors, etc. 24in. x 18in. £2-50. 13in. x 10in. £1-95.

MAINS TRANSISTOR PACK

Designed to operate transistor sets and amplifiers. Adjustable output 6v., 9v., 12 volts for up to 500mA (class B working). Takes the place of any of the following batteries: PP1, PP3, PP4, PP6, PP7, PP9 and others. Kit comprises: mains transformer, rectifier, smoothing and lead resistors, condensers and instructions. Real snip at only £1-95.

CONTROL DRILL SPEEDS

DRILL CONTROLLER

Electronically changes speed from approximately 10 revs to maximum. Full power at all speeds by finger-tip control. Kit includes all parts, case, everything and full instructions. £3-45

Made up model £1-00 extra

8 POWERFUL BATTERY MOTORS

For models, Meccanos, drills, remote control planes, boats, etc. £2.

ROTARY PUMP

Self priming, portable, fits drill or electric motor, pumps up to 200 gallons per hour depending upon revs. Virtually uncorrodable, use to suck water, oil, petrol, fertiliser, chemicals, anything liquid. Hose connectors each end. £2.

SHORTWAVE CRYSTAL SET

Although this uses no battery it gives really amazing results. You will receive an amazing assortment of stations over the 10, 25, 29, 31 metre bands. Kit contains chassis from panel and all the parts £1-94—crystal earphone 55p including VAT and postage.

MULLARD UNILEX

A mains operated 4+4 stereo system. Rated one of the finest performers in the stereo field this would make a wonderful gift for almost anyone in easy-to-assemble modular form and complete with a pair of speakers this should sell at about £30—but due to a special bulk-buy and as an incentive for you to buy this month we offer the system complete at only £15 including VAT and postage.

HUMIDITY SWITCH

American made by Ranco, their type No. J11. The action of this device depends upon the dampness causing a membrane to stretch and trigger a sensitive micro-switch adjustable by a screw, quite sensitive—breathing on it for instance will switch it on. Micro 3 amp. at 250V a.c. Overall size of the device approx. 3 1/2 in. long, 1 in. wide and 1 1/2 in. deep 75p.

DELAY SWITCH

Mains operated—delay can be accurately set with pointers knob for periods of up to 2 1/2 hrs. 2 contacts suitable to switch 10 amps—second contact opens few minutes after first contact 95p.

25A ELECTRIC PROGRAMMER

Learn in your sleep. Have radio playing and kettle boiling as you wake—switch on lights to ward off intruders—have a warm house to come home to.

All these and many other things you can do if you invest in an electrical programmer. Clock by famous maker with 15 amp on/off switch. Switch-on time can be set anywhere to stay on up to 6 hours independent 80 minute memory jogger. A beautiful unit. £3-50.

MULLARD AUDIO AMPLIFIERS

All in module form, each ready built complete with heat sinks and connection tags, data supplied Model 1153 500mW.

power, output £1-69

Model 1172—10 watt power output £3-94

Model 1172 1W. power output £2-25

Model EP9004 4 watt power output £2-90

EP 9001 twin channel or stereo pre-amp £2-90

TANGENTIAL HEATER UNIT

A most efficient and quiet running blower-heater by Solatron—same type as is fitted to many famous name heaters—Comprises mains induction motor—long turbo fan—split 2 kw heating element and thermostatic safety trip—simply connect to the mains for immediate heat—mount in a simple wooden or metal case or mount direct onto base of any kitchen unit—price £4-95 post £1-50 control switch to give 2kw, 1kw, cold blow or off available 60p extra.

2 k.w. model made in metal case with control switch £12-00

THERMOSTATS

Refrigeration as illustrated with 36" capillary £1-62.

Limpet Stat must be mounted in close contact calibrated 90°-190°F 15 amp contacts £1-62.

Appliance Stat fit like a volume control—15 amp contact 30°-80°F 85p.

ditto but for high temps £1-25.

Over Stat—with Serson and capillary 85p

Wall Mounting by Satchwell £3-00

Boiler Stat. with control 20°-80°C £2-18

SOUND TO LIGHT UNIT

Add colour or white light to your amplifier. Will operate 1, 2 or 3 lamps (maximum 450W). Unit in box all ready to work. £9-95.

MINI-MULTI TESTER

Amazing, deluxe pocket size precision moving coil instrument jewelled bearings—1000 opv—mirrored scale. 11 instant ranges measure:—DC volts 10, 50, 250, 1000 AC volts 10, 50, 250, 1000 DC amps 0-1 mA and 0-100 mA Continuity and resistance 0-150K ohms. Complete with insulated probes, leads, battery, circuit diagram and instructions.

Unbelievable value only £6-50 + 50p post and insurance.

FREE Amps ranges kit enable you to read DC current from 0-10 amps, directly on the 0-10 scale. It's free if you purchase quickly but if you already own a mini tester and would like one send £1 50p.

TERMS: Cash with order—but orders under £8 must add 50p to offset packing, etc.

BULK ENQUIRIES INVITED PHONE: 01-688 1833.

ACCESS & BARCLAYCARD ACCEPTED

J. BULL (ELECTRICAL) LTD

(Dept. E.E.), 103 TAMWORTH RD., CROYDON CR9 1SG

IT'S FREE

Our monthly Advance Advertising Bargains List gives details of bargains arriving or just arrived—often bargains which sell out before our advertisement can appear—it's an interesting list and it's free—just send S.A.E. Below are a few of the Bargains still available from previous lines.

Telephone Ringing Mains Unit Rather novel unit as it not only reduces mains to 50 volts but also reduces the mains frequency to 25 Hz, this frequency gives correct ringing note for GPO bells. These units were made for the GPO so obviously are first class. Completely assembled and safe to mount on the wall or stand on a shelf. Price £3-20.

Telephone Extension Bells In bakelite wall box, these will save you missing calls when you are out in the garden or shed, etc. Price £3-16.

Variable Mains Supply A bench mounting unit which contains an isolation transformer for safety and a 2 amp variable auto-stability. With this you will be able to get continuously variable mains supply from zero to full voltage at 2 amps. A real time saving device, price only £20-75.

Answering Machines still available as last month's newsletter but supplies are going down rapidly and this may well be your last chance to acquire one of these.

A very large purchase this month enables us to offer a range of radio items. You will find the prices well below average:

Cassette Recorder/Player Japanese or Hong Kong made, these have all the normal facilities record, playback, fast rewind, etc., also sockets for stop/start, microphone, earphone and lead for mains in this case. Operate from mains or HP batteries. £12-80. **8ix Transistor Pocket Radios** Medium wave only, but with Radio 2 and Radio 4 changing places. Medium wave is all the average listener will want in the future. These little radios would make a lovely gift for a child. Modern design and in popular colours, please state preferred colour and give an alternative, price only £1-80.

AM/FM Radios There's no doubt that FM does give better reproduction in good areas so a more adult member of the family will be pleased with one of these. The ones we have are in leatherette cases and are battery/mains radios having the main unit built in and are complete with mains plug. These cover medium wave and VHF with optional AFC. Price £8-78.

3 Track Cassette Adaptor Carriers are going out of popularity, cassettes on the other hand are being made in increasing numbers and cover practically every field of sound entertainment. Cassettes can be played in 8 track if you have an adaptor. We offer these adaptors complete in carrying case and the price is only £8-90.

Soft Toy Radios Not necessarily only for the younger members of the family as these are soft and cute and have universal appeal. Dolls, poodles, elephants and rabbits each with zip compartment at the bottom where the radio fits. Medium wave only, working from PP3 batteries. When ordering please state preference and if possible give an alternative. £4-80.

5 Band Portable. A very impressive radio in black imitation crocodile case, size approx 12 in. wide, 7 in. high and 4 in. deep. This has metal embellished carrying handle and a pullout chrome plated FM aerial, covers the following bands AM 535 to 1605 kHz, FM 88 to 108 MHz weather band 162.5 MHz and it has a logging scale. This battery/mains radio has the built in mains unit also serve as a charger if you use rechargeable batteries. The mains lead has a plug tucked away in its own compartment, another feature is a dial indicator which shows state of batteries. A real snip at £10-50.

Car Battery Power Unit made for Rank Radio. This unit has been designed to operate 6V battery powered equipment from a 12V car battery, it provides a reliable source of stabilised voltage and gives protection to your equipment in case of sudden reversal of connections also against excessive car battery voltage should this occur. The unit is very robust and virtually everlasting if used sensibly. It uses a negative earth circuit but it will operate in a positive earth car providing the instrument being played is not connected to the car chassis. A real bargain at £2-20.

Extension Speaker Cabinets A new delivery of these enables us to bring down the price quite a lot. We can now supply the smaller ones (11 in. x 8 in. x 4 in. approx.) at £1-95. Post £1-00 and we have a larger one with a silver finish size approximately 12 1/2 in. x 9 in. x 5 1/2 in. Price of this is £1-69, post £1-50. If you can call and collect these cabinets you can save yourself the quite considerable postage and you only have to buy a few to get a discount as well as the quantity discount for these is a historical rate of 25% if you buy four or more. Note these cabinets are very good quality (made for Rank Audio Systems) the grill material is Dacron.

Slide Switch Bargain Double pole changeover standard size with good length of connecting wire soldered to each tag—10 for £1-38.

Six Digit Counter Mains operated, 1 pulse moves counter through one digit, not resettable but all you have to do is to make note of the numbers before the start of each count. Real bargain at 80p.

Be Prepared for possible blackouts and interruptions in electricity supply this winter! Have some emergency lighting nearby. We stock a range of emergency lighting equipment. A 12V car battery and the price is still the same £3-95 plus 50p post complete with a 21in tube.

Stereo Car Speakers usual type in neat compact enclosures for the rear shelf of the car. 8 ohms 5 Watt £5-60 per pair.

Bleppers 6/12V battery or transformer operated, ideal for using in many alarm circuits but particularly for car and motor cycle alarms. These give a loud shrill note. American made by Delta Alarms. Price £1-08 + 8p. Large quantities available.

Most Useful Timer Up to 12 on/off per 24 hours is what you can get from the Venner time switch if you fit our adaptor. The shortest on/off time is one hour but you can use any combinations of on/off to make up the 24 hours. An obvious use for this is to control immersion heaters. These are real current consumers and even though the thermostats are working properly, economies can be quite considerable if a time switch is used. Our Venners are all capable of 20 amp switching. There are of course many other applications for the time switch, which you will remember in its basic form follows the sun switching on at dusk and off at dawn. Price £3-24 plus 50p post for switch with adaptor, extra for plastic case £1-08 or metal case £2-16 + 16p.

Safe Solatank For growers who use soil heating on benches, economies can be made by using a thermostat but if mains voltage equipment is used then the thermostat must be enclosed in a waterproof and earthable container. We can now supply this price £3-78 + 28p. This container will accept the normal immersion heater type thermostat but for soil heating you want one which covers 50 deg. fahrenheit and upwards, we can supply these at £3-20.

Motorised Light Flasher We can offer two motorised units both capable of 2 000V of light. Our 1/2 second flasher changes every 1/2 second and the 2 second flasher changes every 2 seconds. Either type £6-40.

Frightening Fuel Bills could lose some of their sting if you fit double glazing but even if the fuel bill does not come down much you will have a more comfortable home, less draughts, etc. Double glazing frames, made by using a thermostat but if mains voltage equipment is used then the thermostat must be enclosed in a waterproof and earthable container. We can now supply this price £3-78 + 28p. This container will accept the normal immersion heater type thermostat but for soil heating you want one which covers 50 deg. fahrenheit and upwards, we can supply these at £3-20.

The professional scopes you've always needed.



Super 8
£162.00 plus VAT



Super 10
£219.00 plus VAT

When it comes to oscilloscopes, you'll have to go a long way to equal the reliability and performance of Calscope.

Calscope set new standards in their products, as you'll discover when you compare specification and price against the competition.

The Calscope Super 10, dual trace 10 MHz has probably the highest standard anywhere for a low cost general purpose oscilloscope. A 3% accuracy is obtained by the use of stabilised power supplies which cope with mains fluctuations.

The price £219 plus VAT.

The Super 6 is a portable 6MHz single beam model with easy to use controls and has a time base range of 1µs to 100ms/cm with 10mV sensitivity. Price £162 plus VAT.

Prices correct at time of going to Press

CALSCOPE DISTRIBUTED BY
Marshall Electronic Components,
Kingsgate House,
Kingsgate Place,
London, N.W.6.

Audio Electronics,
301 Edgware Road, London W.2.
Tel: 01-724 3564
Access and Barclay card facilities
(Personal Shoppers)

Maplin Electronics Supplies Ltd.
P.O. Box 3
Rayleigh, Essex.
Tel: 0702 715 155
Mail Order

CALSCOPE

KITS FOR SOUND EFFECTS AND OTHER PROJECTS

PHONOSONICS

MAIL ORDER SUPPLIERS OF QUALITY PRINTED CIRCUIT BOARDS, KITS AND COMPONENTS TO A WORLD-WIDE MARKET.



GUITAR EFFECTS PEDAL (P.E. July 75)
Modulates the attack, decay and filter characteristics of an audio signal not only from a guitar but from any audio source producing 8 different switchable effects that can be further modified by manual controls. Possibly the most interesting of all the low-priced sound effects units in our range. Circuit does not duplicate effects from the Guitar Overdrive Unit.
Component set with special foot operated switches £7.89
Alternative component set with panel switches £5.05
Printed circuit board £1.43

GUITAR FREQUENCY DOUBLER (P.E. Aug. 77)
A modified and extended version of the circuit published.
Component set and PCB £4.52

GUITAR OVERDRIVE UNIT (P.E. Aug. 76)
Sophisticated, versatile Fuzz unit, including variable and switchable controls affecting the fuzz quality whilst retaining the attack and decay and also providing filtering. Does not duplicate the effects from the Guitar Effects Pedal and can be used with it and with other electronic instruments.
Component set using dual rotary pot £6.89
Printed circuit board £1.82

GUITAR SUSTAIN (P.E. Oct. 77)
Maintains the natural attack whilst extending note duration.
Component set, PCB and foot switches £5.13
Component set, PCB and panel switches £3.71

WIND AND RAIN UNIT
A manually controlled unit for producing the above-named sounds.
Component set (incl. PCB) £4.26

COMPONENTS SETS include all necessary resistors, capacitors, semi-conductors, potentiometers and transformers. Hardware such as cases, sockets, knobs, keyboards, etc. are not included but most of these may be bought separately.

10% DISCOUNT VOUCHER (E893)
TERMS: Goods in current adverts & lists over £50 goods value (excl. P & P & VAT). Correctly coded. C.W.O., U.K. orders only. This voucher must accompany order. Valid until end of month on cover of E.E.

PHONOSONICS · DEPT. EE93 · 22 HIGH STREET · SIDCUP · KENT DA14 6EH

VOICE OPERATED FADER (P.E. Dec. 73)
For automatically reducing music volume during "talk-over" — particularly useful for Disco work or for home-movie shows.
Component set (incl. PCB) £3.97

PHASING UNIT (P.E. Sept. 73)
A simple but effective manually controlled unit for introducing the phasing sound into live or recorded music.
Component set (incl. PCB) £3.20

PHASING CONTROL UNIT (P.E. Oct. 74)
For use with the above Phasing Unit to automatically control the rate of phasing.
Component set (incl. PCB) £4.74

TREMOLO UNIT
Based upon P.E. Sound Design circuit
Component set (incl. PCB) £2.94

TREBLE BOOST UNIT (P.E. Apr. 76)
Gives a much shriller quality to audio signals fed through it. The depth of boost is manually adjustable.
Component set (incl. PCB) £2.81

WAH-WAH UNIT (P.E. Apr. 76)
The Wah-Wah effect produced by this unit can be controlled manually or by the integral automatic controller.
Component set (incl. PCB) £3.63

AUTOWAH UNIT (P.E. Mar. 77)
Automatically produces Wah-pedal and Swell-pedal sounds each time a new note is played.
Component set, PCB, special foot switches £7.97
Component set and PCB, with panel switches £4.83

CIRCUIT AND LAYOUT DIAGRAMS are supplied free with all PCBs unless "as published".
Fuller details of kits, PCBs and parts are shown in our lists.

ADD: POST & HANDLING
U.K. orders—Keyboards add £2.00 each plus VAT. Other goods: under £18 add 25p plus VAT, over £15 add 50p plus VAT. Recommended: optional insurance against postal mishaps, add 50p for cover up to £50, £1.00 for £100 cover, etc. pro-rata.
N.B. Eire, C.I., B.F.P.O. and other countries are subject to higher export postage rates.

FUZZ UNIT
Simple Fuzz unit based upon P.E. "Sound Design" circuit
Component set (incl. PCB) £2.05

P.E. TUNING FORK (P.E. Nov. 75)
Produces 84 switch-selected frequency-accurate tones. A LED monitor clearly displays all beat note adjustments. Ideal for tuning acoustic or electronic musical instruments.
Main component set (incl. PCB) £14.93
Power supply set (incl. PCB) £5.28

SYNTHESIZER TUNING INDICATOR (P.E. July 77)
A simple 4-octave frequency comparator for use with synthesizers and other instruments where the full versatility of the P.E. Tuning Fork is not required.
Component and PCB (but excl. sw.) £7.45

DYNAMIC RANGE LIMITER (P.E. Apr. 77)
Automatically controls sound output to within a preset level.
Component set (incl. PCB) £4.58

CONSTANT DISPLAY FREQUENCY METER (P.E. Aug. 78)
A 5-digit frequency counter for 1Hz to 99999Hz with a 1Hz sampling rate. Readout does not count visibly or flicker due to display blanking.
Component set £24.05*
Printed circuit board £3.03*

MANY MORE KITS
For Synthesizers, Rhythm Generators, Electronic Pianos and other projects, big, small, simple or complex, are available, plus a range of keyboards, separate components and accessories. Details in our lists.

PHOTOGRAPHS in this advertisement show two of our units containing some of the P.E. projects built from our kits and PCBs. The cases were built by ourselves and are not for sale, though a small selection of other cases is available.

EXPORT ORDERS ARE WELCOME but to avoid delay we advise you to see our list for postage rates. All payments must be cash-with-order, in Sterling by International Money Order or through an English Bank. To obtain list—Europe send 20p, other countries send 50p.
PRICES ARE CORRECT AT TIME OF PRESS. E.A.O.E. DELIVERY SUBJECT TO AVAILABILITY.

TERMS: C.W.O., MAIL ORDER OR COLLECTION BY APPOINTMENT (TEL: 01-302 5164)

RADIO WORLD

By Pat Hawker, G3VA

VERY few of the people I talk to seem even to have heard of the American work directed towards providing multiplex stereo broadcasts over a single amplitude-modulated (a.m.) m.f. transmitter. Some indeed do not want to know as they say it has been difficult enough trying to persuade listeners to take advantage of the v.h.f./f.m. stereo broadcasts on the BBC national networks and the IBA local stations.

Stereo on medium waves

Indeed a.m. stereo is unlikely ever to be as good as f.m. stereo owing to the restricted frequency and dynamic ranges of European medium wave broadcasts. Nevertheless it could be attractive, particularly for car radios or in places where it is virtually impossible to receive strong v.h.f. signals.

In the USA investigations have been going on for several years in an effort to pick the best system of a.m. stereo from no less than five main contenders (all of which work but each of which has its own advantages and disadvantages). The contenders are: (1) Belar "a.m./f.m." system; (2) Harris "modified quadrature" system; (3) Kahn/Hazeltine "independent sideband" system; (4) Magnavox "a.m./p.m." (phase modulation) system; and (5) Motorola "compatible quadrature" system.

One of the attractions of the Kahn system (which has been used for some years at a Mexican station directed towards Southern California) is that you can achieve some stereo effect using two conventional medium-wave receivers by carefully tuning each to the opposite sideband from the other. But for best results all systems need special decoders which are unlikely to be widely available to the public until the FCC finally chooses one system.

One wonders if more research should not be done soon in the UK since otherwise we may be forced later to use an American system chosen to suit different standards and other broadcasting practices.

URP's abound

In these days of unidentified flying objects, it is worth noting that there are still a number of unidentified radio phenomena (URP) that still await full or satisfactory explanation. Among these I would put at the top of my list "long delayed echoes" (radio echoes

with intervals of many seconds) and the sadly neglected "sweepers" and "creepers"—apparently natural radio emissions akin to atmospheric but with a finite frequency that sweeps rapidly across a given band, usually but not always in decreasing frequency and to be found most often between 20 to 30MHz (but sometimes much lower).

Sweepers were identified by American observers as long ago as 1958 and observed frequently in India during 1974 in an investigation organised by the University of Calcutta.

During the past year radio amateurs in many parts of the world including the UK, South Africa, Australia etc have all been observing these curious phenomena. Professor Martin Harrison, G3USF, of Keele University and Ted Cooke, ZS6BT of Johannesburg have been particularly active in this field, and I have recently listened to a series of excellent tape recordings made by Ted Cooke which graphically catch the curious sounds of these "unstable" signals.

Although apparently linked with the solar cycle and possibly with the conditions that give rise to Sporadic-E propagation (though this is far from proven) no entirely convincing explanation of their cause has yet emerged, although Ted Cooke has advanced a most interesting "energy loss" theory. Perhaps the biggest mystery of all is the lack of serious investigation of this apparently quite frequent phenomenon for 15 or so years after their original discovery, in comparison for example with the intensive scientific work on the very-low-frequency "whistlers" for which entirely satisfactory explanations now exist.

The rapidly chirping sweepers and the more buzz-like slow moving creepers would at least prove a more rewarding field of investigation than the puzzling long delay echoes which, though reliably and quite frequently observed in the decade 1928-38, are nowadays so rare and fleeting that many investigators have given up in despair of ever observing one themselves!

World apart

Incidentally, for those who want to listen for intelligent beings in other worlds a new "preferred frequency for interstellar communications" has been

proposed by three Japanese scientists. They advise us to tune to precisely 4829.659MHz, the spectral line of formaldehyde. At least this should be a change from 1420.406MHz, the hydrogen line, which has been the preferred frequency for a number of years.

Packet switching

Build a better mousetrap and the world will beat a path to your door, it is said—but is it true? Experience suggests that ideas may eventually be taken up by others but seldom in response to the innovator. Today, in 1979, in telecommunications the "in thing" is the concept of packet switching which divides input flow of information into small segments of data which are then sent through the line or radio network in a manner similar to the handling of mail "packets" but at immensely higher speeds.

Who first thought out the idea? In the United States Paul Baran in 1964 for the US Air Force but they took no follow up action and the report sat largely ignored for many years until packet switching was rediscovered and applied by others.

In the UK, Donald Davies of the National Physical Laboratory actually coined the term "packet switching" and, unaware of Baran's work, circulated his ideas in 1965-66 and it is generally agreed that this should have led quickly to a UK project. In fact the communications world was hard to convince and again nothing happened for several years and so the UK lost its opportunity of blazing the way into a multimode packet switching network.

Of course, it is not enough to be an innovator unless the concept can be applied universally. I was very impressed by an editorial in Marconi's "Communication and Broadcasting" a year or two back:

"If the spread of technology is to be maintained so that its benefits can be shared by greater numbers of the world's population, the skills and expertise of the specialist have to be taken to the far corners of the world. It is not enough that technology should be sent haphazardly to an unprepared world. It is no good placing a piece of advanced equipment in a remote corner of the earth and saying 'You are now the happy recipient of this wonderful scientific achievement. Press Button A and your life will be magically improved'."

There is, the editorial stressed, a responsibility to ensure that the ultimate user obtains the maximum benefit from his investment in new technology.



By ADRIAN HOPE

Radio Dentist

Last Summer a country vet (not, I should add, James Herriot) appealed to the scientific press for help over a curious medical problem he had encountered. A Siamese cat patient had started to emit a high pitched musical note from its left ear, rather like a superhet whine!

No, it wasn't a joke. And the final explanation brought together some interesting, otherwise unlinked facts, some of them red herrings, if you will pardon the metaphor.

Cats, like dogs and other domestic animals, are able to hear much higher pitched sounds than humans. This is why the remote controls for some TV sets and hi-fi systems which operate with ultrasonic soundwaves can quite literally drive domestic pets to distraction.

Siamese cats are often more highly strung than mongrel "moggies" and are often very distressed by ultrasonic sounds. But in this case feline ultrasonic perception wasn't involved. The cat was unperturbed even though its ear was generating the sound.

It has long been known that humans can sometimes hear radio transmissions without the aid of a radio receiver. What usually happens is that an adjacent pair of metal tooth fillings, or a cracked single filling serves as a semiconductor junction. This then "detects" any powerful radio transmission that is by chance tuned to resonance.

This could account for the tales of shipwrecked survivors in lifeboats who pick up the sound of radio transmissions from search parties in the area.

In the USA recently a doctor's patient complained about the sound of radio broadcasts in her head. The doctor was astonished to find that the signal being detected by the patient's teeth was so strong that the received

sound was audible not only to the patient but also to anyone else who put their ear close to the woman's mouth.

Just as the transformer of an amplifier will sometimes sing audibly in sympathy with the signals passing through it, so the woman's tooth fillings were singing in sympathy with the radio signals they were detecting in semiconductor fashion. So was the Siamese cat radiating the sound of a received radio carrier?

Almost certainly not. According to specialists in the field it is not unknown for human ears to sing a fixed pitch note in the manner of the Siamese cat. No one is quite sure exactly how it happens. But due to spontaneous vibration of muscle tissue or blood vessels near the ear, the ear drum is set in vibration and acts as a tiny loudspeaker.

The phenomenon is, of course, quite separate from that already well known, whereby we sometimes hear a singing in the ears, for instance after a gun shot or very loud noise. In this case the singing is heard only by the sufferer.

Differing Viewpoints

By now most readers will have heard of Teletext and Viewdata. But a brief re-cap might help.

Viewdata is a system which enables anyone with a telephone and a special television receiver and calculator style keyboard control to dial up a Post Office computer and ask it questions. The answers are then displayed on the TV screen.

Teletext is the broadcast system operated by the BBC and IBA whereby news flashes and the like are transmitted in digitally encoded message form buried in the analogue waveform of an ordinary television programme. Again a special receiver is needed and

a similar calculator style keyboard control is used, this time enabling the user to select which of a hundred or so pages of information is to come up on the screen.

The important point is that the Teletext system is purely *passive*. The viewer can only select and read a page of whatever information is being transmitted. The Post Office Viewdata system is *active*, in that the subscriber can interrogate the Post Office computer via his telephone, in any of the information fields covered by the system.

So far these areas are pretty limited. For instance, when I tried to interrogate the Post Office computer on train timetables I found that only main line station information was stored in the computer. But doubtless it is only a question of time before the computer has been fed the timetable for every train running throughout the country.

Both Viewdata sets and Teletext sets have a fair amount of electronic circuitry in common, including the keyboard control of course. Both types of set reproduce ordinary television programmes in conventional fashion and both have character generation circuits that reproduce digitally coded messages as numbers and figures on the screen.

The differences arise in how the coded messages arrive and are handled. With a Teletext set they arrive "off air" down the aerial lead and with Viewdata they arrive via the hard wires of domestic telephone.

The Viewdata circuitry is rather more complex than the Teletext circuitry and it looks as if Viewdata-capable sets will cost more than Teletext-capable sets. It follows that Viewdata-capable sets will probably offer Teletext as a bonus but not *vice-versa*.

Matter of Generic

Incidentally, there is an interesting story behind the word 'Viewdata'. This was the working title given to the system by the Post Office engineers and it caught on. The Post Office tried to register and thus monopolise the word Viewdata with the British Trademarks Registry, which is attached to the British Patent Office.

This attempt was doomed to failure because even when incorporated in a picture or "logo" the word Viewdata is really nothing more than a simple combination of the two well known words "view" and "data". And under British trademark law it is impossible to register, and thus monopolize, such an obviously descriptive or "generic" term.

So the Post Office have dropped the idea of monopolizing the word "Viewdata" and are instead diverting their legal energies to registering the word "Prestel" as a trademark for the Post Office system of viewdata.



TUAC

TRANSISTOR UNIVERSAL AMPLIFICATION CO. LTD.
PHONE 01-672 3137/672 9080
MANUFACTURERS OF QUALITY AMPLIFICATION AND LIGHTING
CONTROL SYSTEMS

PRICES INCLUDE VAT. P & P FREE

correct at 1.11.78
TO ORDER BY POST

Make cheques/P.O.s payable to TUAC LTD. or quote
Access/Barclaycard No. and post to TUAC LTD. 121
Charlton Road, London SW17 9AB. We accept phone numbers
from Access/Barclaycard Holders. Phone 01-672 9080.

NEW FROM TUAC ULTRA QUALITY HIGH POWER New D.C. Coupled Design AMPLIFIERS

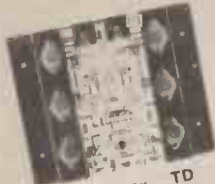

7" x 9" x 1 1/2" TD 500

T.H.D. at full power 0.1%
T.D. 500 300W into 2 Ohms
220W into 4 Ohms
140W into 8 Ohms
Power supply P.S. 300
T.D. 150 150W into 4 Ohms
100W into 8 Ohms
Power supply P.S. 150
T.D. 150. 60 Version 60W into 8 Ohms
40W into 15 Ohms.
Power supply P.S.60
Note P.S. 300 will drive 2 T.D. 150 amplifiers

£45.00
£30.00
£26.25
£18.50
£17.75
£15.50

Featuring
Electronic Short Open & Thermal Overload Protection.
Brief Spec.
Input Sensitivity 0.775v. r.m.s. (O.D.B.) at 25 K Ohms
Frequency Response 20 Hz-20 KHz
Hum & Noise - 100 dB Relative full output



5" x 5" x 2" TD 150

All output ratings are R.M.S. continuous sine wave output.

AMPLIFIER MODULES



SPEC. INPUT
SENSITIVITY 60 mV
for full output
Frequency response
20 Hz-20 KHz
HUM & NOISE - 70dB

TL30 5" x 5" x 2"
• 35 watt 10 amp output transistors **£13.25**
TL60 5" x 5" x 3"
• 60 watt R.M.S. continuous sine wave output
• 2 R.C.A. 110 watt 15 amp output transistors **£18.50**
TL100 5" x 5" x 3"
• 100 watt R.M.S. continuous sine wave output
• 2 R.C.A. 150 watt 15 amp output transistors **£21.50**
TP125 7" x 6 1/2" x 3"
• 125 watt R.M.S. continuous sine wave output
• 4 R.C.A. 150 watt 15 amp output transistors **£27.50**

4 CHANNEL SOUND TO LIGHT SEQUENCE CHASER - 4LSM1

- Full wave control
- RCA 8A Triacs
- 1000W per channel
- Fully suppressed and fused
- Switched master control for sound operation from 1W to 125W
- Speed control for fixed rate sequence from 8 per minute to 50 per second
- Full logic integrated circuitry with optical isolation for amplifier protection

£21.50

Model 501 500W per channel as above without sound triggering

£14.00

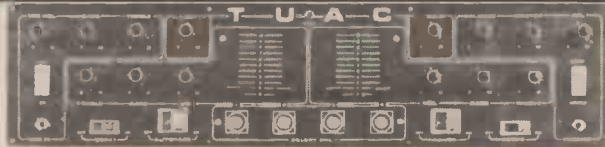

STEREO DISCO MIXER

With touch sensitive switching and auto fade

INPUTS: Four identical stereo inputs available with any equalisation. Two magnetic and two flat supplied as standard. High quality slider control on each channel. Volume, treble and bass controls for each pair of sliders. Sensitivity mag. 3mV (R.I.A.A. comp.). Flat 50mV at 1kHz. Bass controls ± 18dB at 60Hz. Treble controls ± 18dB at 15kHz.
OUTPUT: Up to 3 volts (+ 12dB) available. Attenuated output for TUAC Power Modules. Rotary master and balance controls. Band width 15Hz - 25kHz ± dB.
P.F.L.: Output 250mV into 8 ohms. Rotary volume control. Monitoring facility for all 4 channels. Selection via touch sensitive illuminated switches. Switched visual cue indicator.
Miscellaneous Facilities: Two illuminated deck on/off switches. Mains illuminated on/off switches. Auto fade illuminated on/off switch. Mains powered with integral screen and back cover. Complete with full instructions
Size: 25in long x 6in high x 3in deep.
Mono Disco Mixer with autofade **£49.00**

£149.00

3 CHANNEL LIGHT MODULATOR SILMB

- RCA 8A Triacs
- 1000W per channel
- Each channel fully suppressed and fused
- Master control to operate from 1W to 125W
- Full wave control

£20.75

Single Channel Version 1500 Watts

£9.75

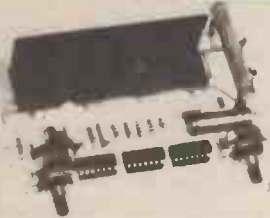

FRONT PANEL FOR LIGHTING EFFECT MODULES

(complete with switches, neons and knobs)
as illustrated



For SILMB **£7.25**
Size 8" x 4 1/2"



4LSM1 **£6.00**
Size 6 1/2" x 4 1/2"



FUZZ LIGHTS
Red, Green, Blue,
Amber. **£24.50**



SILMB **£8.25**
Combined with 3SDM1
Size 9" x 4 1/2"

POWER SUPPLIES

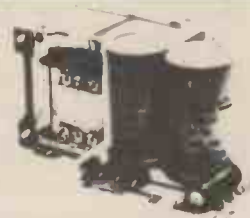

Vacuum varnish impregnated. Transformers
with supply board incorporating pre-amp supply:

PS250 for supplying 2 TP125s **£30.00**
PS200 for supplying to TL100s **£30.00**
PS60/60 for supplying 2 TL60s **£30.00**
PS125 ± 45 volts for TP125 **£18.50**
PS100 ± 43 volts for TL100 **£17.00**
PS60 ± 38 volts for TL60 **£15.50**
PS30 ± 25 volts for TL30 **£11.75**
PSU 2 for supplying disco mixer **£7.50**

STOCKISTS - CALLERS ONLY

A1 Music, 88, Oxford Street, Manchester (Tel 061 236 0340)
Geo Mathews, 85/87, Hurst Street, Birmingham (Tel 021-622 1941)
Soccod, 9, The Friars (Tel Canterbury 60948)
Cookies Disco Centre, 126/128, West Street (Tel Craws 4739)
Garland Bros. Ltd., Deptford Broadway, London 01-692 4412
Luton Disco Centre, 88, Wellington Street, Luton (Tel Luton 411733)
Session Music, 163, Mitcham Road, Tooting (Tel 01-672 3413).
Mon-Sat 10am to 6pm. Closed Wed.

Electra Centre, 58 Lancaster Road, Preston (Tel Preston 58488)

THADE & EXPORT ENQUIRIES 01-672 3137

ADD SEQUENCE CHASING + DIMMING EFFECTS FOR TUAC 3 CHANNEL LIGHT MODULATOR



- Speed Control 3 per min. to 10 per sec.
- Full logic integrated circuitry
- Dimmer control to each channel

3SDM1 **£15.25**

SUPPLIERS TO H.M. GOVT. DEPTS. MANUFACTURED AND ASSEMBLED IN GT. BRITAIN FULLY TESTED AND GUARANTEED
SEND NOW FOR OUR FREE 28 PAGE ILLUSTRATED CATALOGUE. SEND STAMP PLEASE

DOING IT DIGITALLY



PART 6

By O. N. Bishop

THIS month we shall be concerned with binary coded decimal systems, decoding and seven-segment displays.

BINARY AND BCD

Although TTL is well able to handle calculations in the binary system, there are practical reasons for retaining one feature of our decimal system. On a keyboard we enter a number as a series of single digits, representing thousands, hundreds, tens, units, and perhaps decimal fractions too. It is convenient if we design the circuit so that it handles each of these digits in order, but *separately*—just as we do when we perform an addition or a multiplication on paper.

If the answer to any column of our calculation comes to more than one digit, we *carry* the extra digit or digits over to the next column. The calculator circuit does this too. If we adopt this method of calculation, the machine needs to be able to work with only the digits 0 to 9, but in binary form. It does not need to be able to recognise larger numbers in binary.

For example, the number 4869 consists of the four digits 4, 8, 6 and 9. If we split this number into these four digits and then code each digit *separately*, we obtain a 16-digit number, see Fig. 6.1.

This system for representing a number is called *binary coded decimal*, or BCD for short. It needs far more digits than are used in the decimal system, and appreciable more than in the wholly binary system, but we gain in the simplicity of the circuits required for coding and decoding. A keyboard coder would need thousands of keys—one for each number that we would need to enter—or it would have to be backed up by complicated coding circuits.

In the same way, the final decoding is very complex for a binary number of ten or more digits. To split it into groups of four digits and then decode these to one of the ten digits 0 to 9 is far simpler. The results can be fed straight to the decimal display or the printout machine.

DECODING

A decoding circuit which has rather limited capability is shown in Fig. 6.2a but can be wired up on the Test-Bed as an example of how decoders work. It accepts only two BCD inputs, *B* and *A*, so consequently can decode only digits 0 to 3. Before going ahead with wiring up, we need to follow the logic of the type of gate used in this decoder.

This is a type we have not met before in this series. The four gates which are connected to the l.e.d.s are called NOR gates, or negative-OR. The truth tables for OR and NOR are given in Table 6.1, where it is seen that NOR is simply the inverse of OR.

Table 6.1. The OR and NOR truth tables

Input		Output		Corresponding decimal digit
B	A	OR	NOR	
L	L	L	H	0
L	H	H	L	1
H	L	H	L	2
H	H	H	L	3

OR: High when either *A* or *B* is high.
NOR: High when neither *A* nor *B* are high.

An l.e.d. connected to the output of a NOR gate will light only when both (or all, if three or more) inputs are *low*. Thus it lights for *only one* of the four possible combinations of two inputs, which means that we can arrange for an l.e.d. to light only when the two inputs are of correct level. In addition to the NOR gates, we use two NOT gates to obtain the inverses of *A* and *B*, which we refer to as *A* and *B*.

Table 6.2. Truth table for the decoder

Decimal digit	Input		Output			
	A	B	0	1	2	3
0	0	0	1	0	0	0
1	0	1	0	1	0	0
2	1	0	0	0	1	0
3	1	1	0	0	0	1

The truth table for the decoder is given in Table 6.2.

The decoder is to be made up on the Test-bed using a 7402 (quadruple 2-input NOR) according to Fig. 6.2b. One of the required NOT gates is obtained from IC3, ready-wired on the Test-Bed; the other can be easily obtained by joining the two inputs of

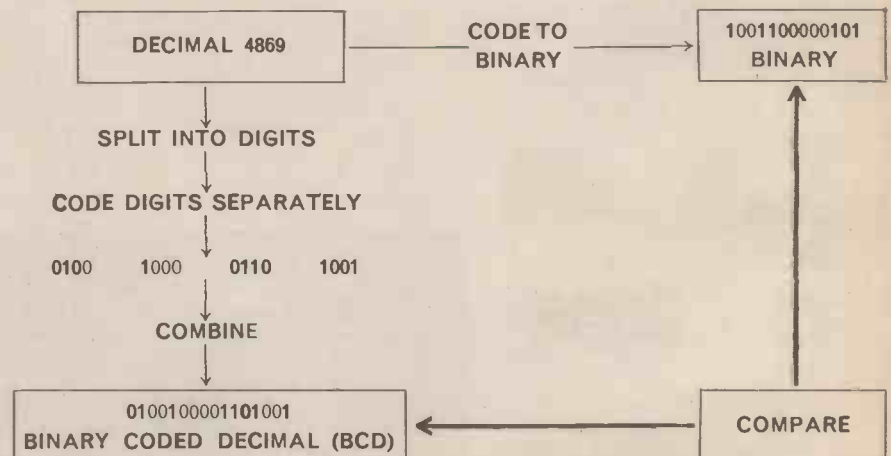

Fig. 6.1. Illustrates the difference between a number converted to binary and binary coded decimal.

the NAND gate of IC3. The pin numbers for the 7402 are given in Fig. 6.3.

Inputs A and B are provided from the keyboard, or by connecting A or B or both to ground. According to the binary input applied to the circuit, one of the l.e.d.s lights, to indicate the corresponding decimal number.

The circuit for decoding a four-digit binary input to one of the figures 0 to 9 is far too complex to be built on the Test-Bed. Such a decoder can be purchased, in integrated-circuit form, as the 74141. This accepts a four-digit binary input and has ten outputs (0 to

9), which go low when the corresponding binary input is applied.

A display controlled by this i.c. could be a row or ring of ten l.e.d.s, or a numerical display tube of the Nixie type. The latter are often used in cash-registers and shop scales.

The tube is a neon-filled discharge tube containing ten electrodes made from thin wire and arranged one behind the other. They are shaped like the ten digits 0 to 9. When a 'low' potential is applied to an electrode, the other electrode being positive, the neon gas in its vicinity glows brightly indicating the appropriate digit, the other electrodes remaining relatively invisible.

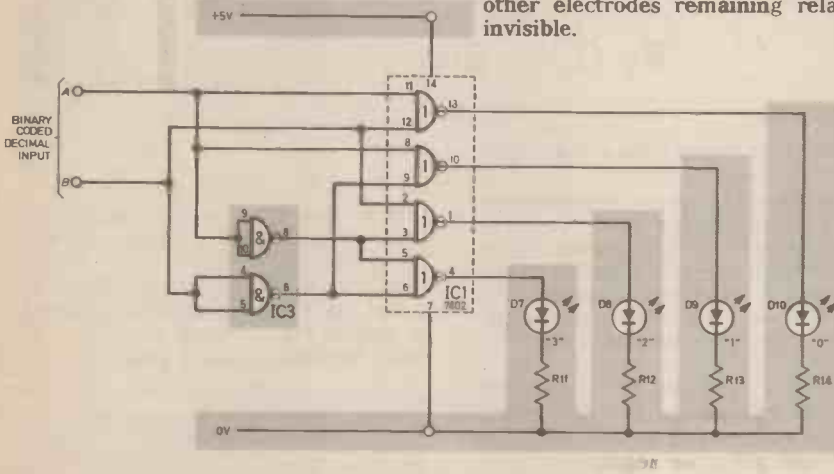

Fig. 6.2(a). A simple to binary to decimal decoding circuit for decoding numbers 0 to 3 made from discrete gates.

In our display on the Test-Bed, we use a different type of decoding i.c., the 7447 which provides the special output needed for driving the seven-segment digital l.e.d. display.

7-SEGMENT DISPLAY

The seven-segment l.e.d. display is the most commonly used type of display to be found in almost all calculators, watches, clocks and a variety of measuring instruments with digital readout.

Each display unit consists of seven bar-shaped segments, arranged as in Fig. 6.4, and denoted by the letters a to g. Most displays also incorporate a small round l.e.d., the decimal point. The type used in the Test-Bed is the common anode type of display in

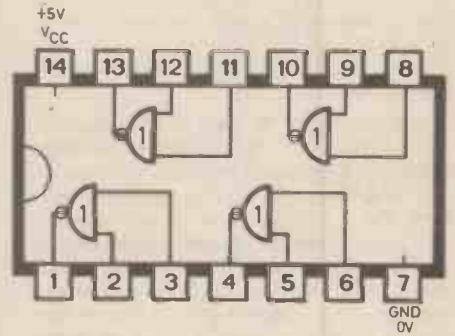

Fig. 6.3. Pinning details for the 7402 i.c.

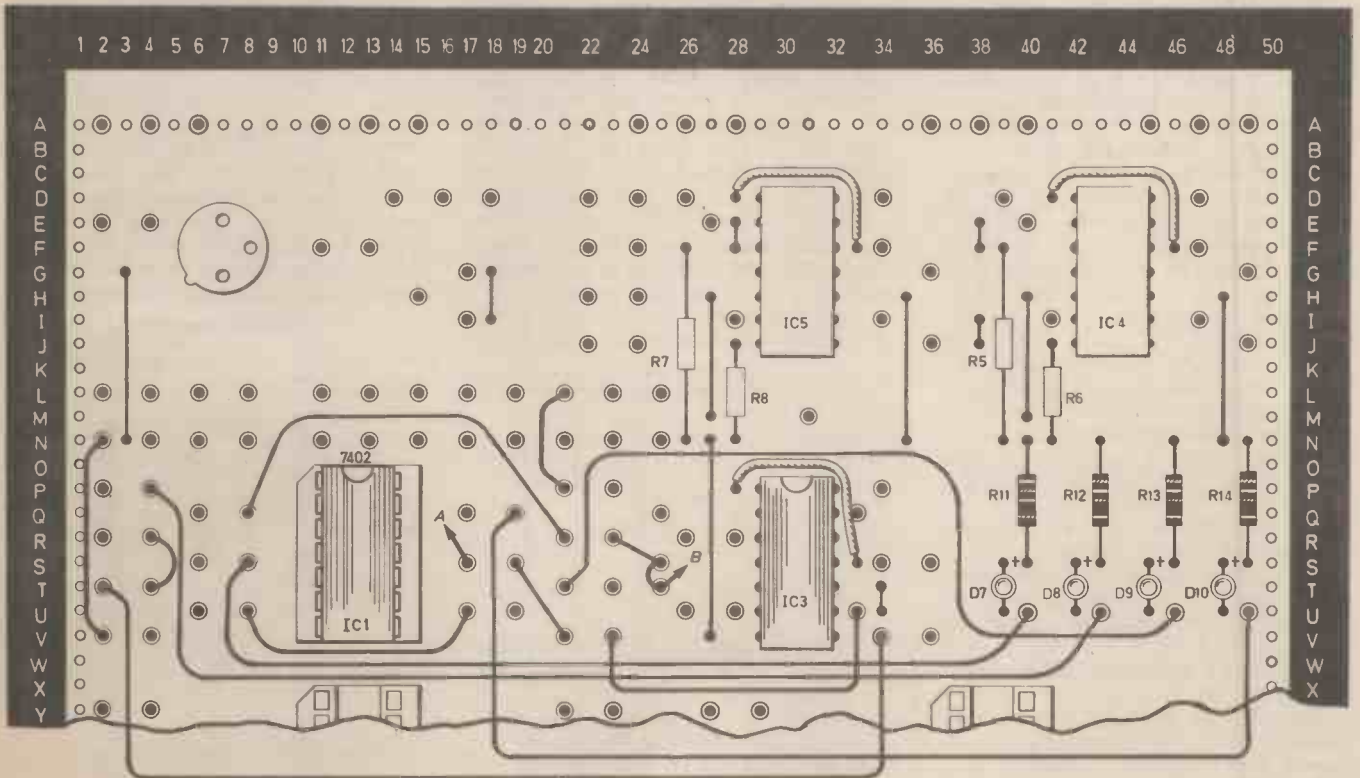

Fig. 6.2(b). Interwiring between components on the Test-Bed for the experiment of Fig. 6.2(a).

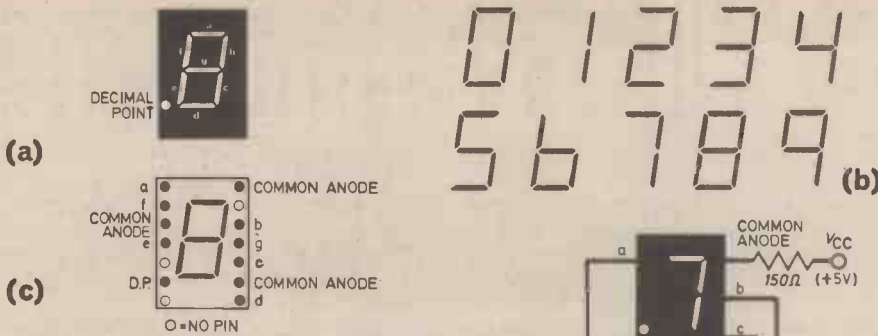

Fig. 6.4. Seven-segment I.e.d. numbered display: (a) front face showing lettered segments, (b) the way the numbers 0 to 9 are obtained, (c) pin connections for the device used in our Test-Bed viewed from above—the letters indicate connections to the cathodes, (d) how to wire the device to display decimal 7.

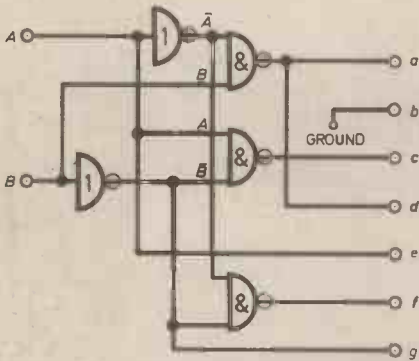

Fig. 6.5. A seven-segment decoder for digits 0 to 3.

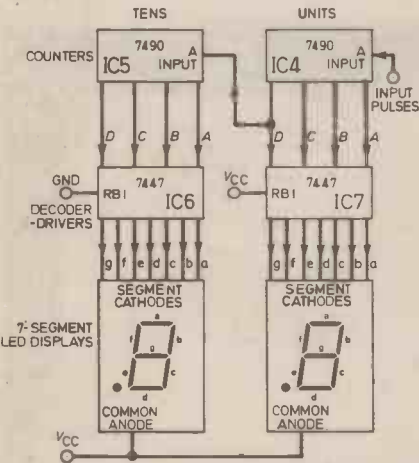
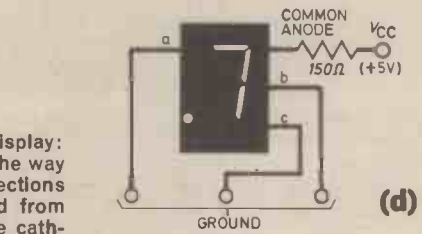
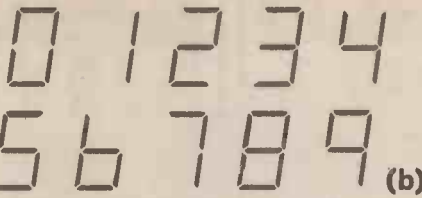

Fig. 6.6. The Test-Bed display wired up to count and display numbers from 0 to 99.

which the anodes of all segments are connected to a single pin (or all to two pins), and their cathodes are each connected to a separate pin. A resistor in series with the anode pin limits current to a reasonable level (about 20mA maximum) when V_{∞} is 5V.

To cause a segment to light its cathode must be grounded, or connected to a "low" TTL output.

If a spare display is at hand, or you care to disconnect one from the Test-Bed, try grounding the pins in



various combinations to obtain the various digits. Table 6.3 will help.

Table 6.3. Decimal to seven-segment for common anode display

Digit	a	b	c	d	e	f	g
0	L	L	L	L	L	L	.
1	.	L	L
2	.	L	L	.	L	.	L
3	L	L	L	L	.	.	L
4	.	L	L	L	.	L	L
5	L	.	L	L	.	L	L
6	L	.	L	L	L	L	L
7	L	L	L
8	L	L	L	L	L	.	L
9	L	L	L	.	.	L	L

L=grounded or to TTL "low" output.

The table also tells us what outputs are required from the 7447 decoder. Before going on to investigate the 7447, why not design and build your own seven-segment decoder on the Test-Bed? Let it accept only two BCD inputs, and provide outputs for the display of digits 0 to 3. It can be done with only three NAND gates and two NOT gates, see 6.5. To check your logic, connect your circuit to the keyboard and to a seven-segment display.

To function as a decoder the circuit must have the truth table of Table 6.4.

Table 6.4. Seven-segment decoder truth table

Inputs	Outputs							Equivalent decimal
B A	a	b	c	d	e	f	g	
L L	L	L	L	L	L	L	.	0
L H	.	L	L	1
H L	L	L	.	L	.	L	.	2
H H	L	L	L	L	.	L	.	3

Since for a, c and d we are aiming to obtain a high output for only one particular combination of A and B inputs we use NOR gates. These have high outputs only when both inputs are low. Output a can be obtained by feeding \bar{A} and B to the NAND (see Fig. 6.5); inputs are both low for only decimal "1", as required.

Similarly, output c is the NOR of A and B. Output d is the same as output a and is obtained from the same gate. Output b is to be low for all four digits, so is easily obtained by permanently grounding the b pin of the display. Output e follows A identically, so a direct connection can be made; similarly for g, which is the inverse of B (=B). Output f needs to be high for three combinations of inputs, so we chose a NAND gate to provide this logical output, and feed it with A and B, which are both high when the inputs A and B are both low (decimal zero).

If we were to build a decoder for more digits, much of the above logic would no longer apply. We would have to start from scratch and the final circuit would be far more complicated than that of Fig. 6.5.

TEST BED DISPLAY

The Test-Bed display system consists of three parts as shown in Fig. 6.6.

(1) Counting circuit to count incoming pulses and register their total number in BCD form. We use two 7490 decade counters, which can be wired in series to enable counting from 0 to 99.

(2) Decoder-driver circuit to decode the BCD output given by the counting circuit and to produce outputs for driving the 7-segment displays. Two 7447 i.c.s are used for this purpose.

(3) The 7-segment displays, of which we use two.

The action of the above, except the 7447 i.c.s, has been described in earlier parts of this series.

7447 DECODER-DRIVER

The 7447 works on the same principle as the 0 to 3 decoding circuit you built from the individual logic gates in Fig. 6.2a. As you might expect, the internal circuitry of the 7447 is a lot more complicated than

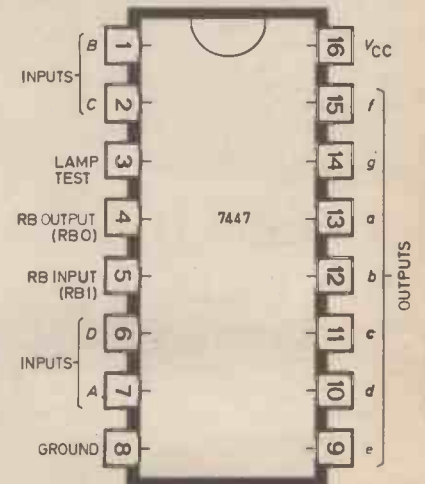

Fig. 6.7. Pinning details for the 7447 seven-segment decoder/driver i.c.

GREENWELD

443D Millbrook Road, Southampton
SO1 0HX Tel: (0703) 772501

All prices quoted include VAT. Add 25p UK/BFPO Postage. Most orders despatched on day of receipt. SAE with enquiries please. MINIMUM ORDER VALUE £1. Official orders accepted from schools, etc. (Minimum invoice charge £5). Export/Wholesale enquiries welcome. Wholesale list now available for bona-fide traders. Surplus components always wanted.

THE NEW 1978-9 GREENWELD CATALOGUE

FEATURES INCLUDE:

- 50p Discount Vouchers
- Quantity prices for bulk buyers
- Bargain List Supplement
- Reply Paid Envelope
- Priority Order Form
- VAT inclusive prices

PRICE 30p + 15p POST

KITS OF BITS FOR THIS MONTH'S EE PROJECTS

LABCENTRE

A portable "Instant" electronic workshop with tools, power supplies and test equipment for design work in logic (TTL and CMOS), audio, r.f. etc.

CAR DIRECTION INDICATOR ONE-TRANSISTOR RADIO

Prices not available at time of going to press. Please send S.A.E. for full details.

OLD FAVOURITES

Still available from previous months.

- M.W. MINI .. £2-50
- SOUND TO LIGHT UNIT .. £1-85
- HOT LINE GAME .. £2-25
- AUDIO EFFECTS OSCILLATOR .. £2-25
- AIR FRESHENER .. £7-95

JANUARY PROJECTS CONTINUITY TESTER

All parts except box .. £2-40

LIGHTS REMINDER

All parts including box .. £3-35

I'M FIRST

All parts excluding containers .. £1-55

ROULETTE

All parts as specified except materials for case and bowl for £11-95

I.C. sockets £1 extra if required.

E.E. 20+20 TUNER AMPLIFIER

We can supply all parts required except the components for the RF unit for approx. £40. Send SAE for detailed list.

NOTE: A more detailed list of parts supplied in these and other kits is available on receipt of a SAE.

"DOING IT DIGITALLY"

This new series which started October 1978 is bound to be a big success. We supply a complete set of parts (as we did for last year's Teach-in series) for just £19-75 + £1 post for the Electronic Test Bed, and £2-75 for additional parts required for first 6 parts.

The GREENWELD Amplifier Kit

Ideal for the beginner to make, this kit is complete right down to the last screw! Easily constructed on the PCB provided, the 4 transistor circuit will give 2W output from a crystal cartridge. Battery version £1-75, or with transformer for mains operation £3-95

PC ETCHING KIT MK III

Now contains 200 sq. ins. copper clad board, 1lb. Ferric Chloride, DALO etch-resistant pen, abrasive cleaner, two miniature drill bits, etching dish and instructions. £4-25

BUY A COMPLETE RANGE OF COMPONENTS AND THESE PACKS WILL HELP YOU

★ **SAVE ON TIME**—No delays in waiting for parts to come or shops to open!

★ **SAVE ON MONEY**—Bulk buying means lowest prices—just compare with others!

★ **HAVE THE RIGHT PART**—No guesswork or substitution necessary!

ALL PACKS CONTAIN FULL SPEC. BRAND NEW, MARKED DEVICES—SENT BY RETURN OF POST. VAT INCLUSIVE PRICES.

K001 50V ceramic plate capacitors, 5%, 10 of each value 22pF to 1000pF. Total 210. £3-35

K002 Extended range. 22pF to 0.1µF. 330 values £4-90

K003 Polyester capacitors, 10 each of these values: 0.01, 0.015, 0.022, 0.033, 0.047, 0.068, 0.1, 0.15, 0.22, 0.33, 0.47µF, 110 altogether for £4-75

K004 Mylar capacitors, min 100V type, 10 each all values from 1000pF to 10,000pF. Total 130 for £3-75

K005 Polystyrene capacitors, 10 each value from 10pF to 10,000pF. E12 series 5% 150V. Total 370 for £12-30

K006 Tantalum bead capacitors, 10 each of the following: 0.1, 0.15, 0.22, 0.33, 0.47, 0.68, 1, 2.2, 3.3, 4.7, 6.8, all 35V; 10/25 15/16 22/16 33/10 47/6 100/3. Total 170 tants for £34-20

K007 Electrolytic capacitors 25V working small physical size. 10 each of these popular values: 1, 2.2, 4.7, 10, 22, 47, 100µF. Total 70 for £3-50

K008 Extended range, as above, also including 220, 470 and 1000µF. Total 100 for £5-90

K021 Miniature carbon film 5% resistors, CR25 or similar, 10 of each value from 10R to 1M, E12 series. Total 610 resistors, £6-00

K022 Extended range, total 850 resistors from 1R to 10M £8-30

K041 Zener diodes, 400mW 5% BZY88, etc. 10 of each value from 2.7V to 30V. E24 series. Total 280 for £15-30

K042 As above but 5 of each value £8-70

TRANSFORMERS

All mains primary: 12-0-12V 50mA 85p; 100mA 85p; 1A £2-50, 6.0-6V 100mA 85p; 1A £2-40, 9-0-9V 75mA 85p; 1A £2-10, Multitapped type 0-12-15-20-24-30V, 1A £3-95; 2A £5-35; 3A £8-90; 20V 2A £3-90; 25V 1A £2-25; 12V 8A £4; 24V 5A £7-50; 0-22-34-41V 4A £7-50; 20V @ 300mA twice £2-50; 12V @ 250mA twice £2-00

RELAYS

W847 Low profile PC mntg 10x33x20mm 6V coil, SPCO 3A contacts, 83p
W817 11 pin plug in relay, rated 24V ac, but works well on 6V DC. Contacts 3 pole c/o rated 10A, 85p

W839 50V ac (24V DC) coil, 11 pin plug in type, 3 pole c/o 10A contacts. Only 85p

W846 Open construction mains relay, 3 sets 10A c/o contacts. £1-20

W877 675R 12-27V. DPCC 23 x 20 x 10mm sealed can 85p.

W890 230V a/c DPCC 10A contacts, enclosed case £1-30.

W830 200R 6-12V DPCC, 23 x 20 x 10mm, sealed can 85p.

Send SAE for our relay list—84 types listed and illustrated.

HEAT SINK OFFER

Copper TOS sink 17mm dia x 20mm, 10 for 40p; 100 for £3; 1000 for £25

POLYTHENE SHEET

Size 36 x 18" 200g. Hundreds of uses around the home. 100 sheets for £1-50. Box of 1500 for £19

ELECTROVALUE

FOR A GOOD DEAL BETTER THAN MOST

WE PAY POSTAGE on C.W.O. orders in U.K. over £5.00 list value.

WE GIVE DISCOUNTS on C.W.O. orders—5% on list value over £10.00; 10% on list value over £25.00.

WE GUARANTEE all goods are brand new clean and to specification—no seconds, no surplus.

WE GIVE SERVICE to all orders large or small—we use microfilm order storage, computer processing and double check personal supervision.

This month's ELECTROVALUABLES

'Electrovaluables' are our own overstocked items offered from time to time at greatly reduced prices. Orders should quote 'Electrovaluables' and description and price as advertised. PRICES ARE NET AND V.A.T. MUST BE ADDED @ 8% or 12½% where prices show

- Polycarbonate Siemens B32551 PC mounting 10mm 0-015, 0-022, 0-047, 0-068. any 100 £2.00
- Electrolytic cans by Daly. each 1000uf 50V, 200UF 25V 40p, 1000UF 100V 85p, 2200UF 100V £1-50
- Electrolytic pluggable Siemens B41316 2-2/63, 10/63, 22/35, 22/63, 220/3 any 25 for £1-50
- 100/63, each 12p
- Electrolytic axial Siemens 22/100, 47/75, 47/100, 100/3 any 20 for £1.00
- 100/100, 220/100, 2200/3, 2200/10 any 10 for £1.00
- Tantalum Siemens B45134 18/35, 10 for 50p
- Potentiometers Carbon track P20: 22K log short spindle 8 for £1, 2K2 log standard spindle 8 for £1
- P20: + switch 470K 1M log 3 for £1
- JP20 47K 1in, short spindle 3 for £1
- 2M2 1in, long spindle 3 for £1
- 100K log, 2M2 log 3 for £1
- 1M log, rev log short-spindle: 3 for £1
- PG58, slider, 1M 1in, 10K log, 47K log, 100K log, 220K log, 1M log, any 6 for £1
- PR15 presets Horiz: 220, 1K, 2K2, 47K, 470K, 4M7 any 10 for 40p
- PR140 Presets 10M horiz, 100 K vert any 10 for 80p
- Plessey MPWT moulded track 47K, 220, 47K, 220K, 1M any 3 for £1
- Magneto resistor FP30 L100E 5 for £2-50

WE ARE NATIONAL DISTRIBUTORS FOR



NASCOM MICROCOMPUTER KITS for delivery from stock from £197-50 net + V.A.T. Also full range of supporting Nascom items. Enquiries invited. Leaflet on request.

MOTOROLA D.2. MICROPROCESSOR EVALUATION KIT (for the M.680 Microcomputer—£175-87 net + V.A.T.)

CATALOGUE 9

Yours for the asking—and it's FREE

Completely revised and up-dated 120 pages semi-conductors, I.Cs, Opto-electronics, Rs, Cs, etc. etc. And you'll be delighted with our three-month stabilised price list



Two Depots to serve you—one SOUTH, one NORTH

Communications and orders by post to our Englefield Green address. Dept E4 Shop Hours 9-5-30. Sats. 1.30 p.m.

ELECTROVALUE LTD

28 ST. JUDES ROAD, ENGLEFIELD GREEN, EGHAM, SURREY TW20 0HB

Telephone Egham 3603 Telex 264475

Northern Branch-680, BURNAGE LANE, BURNAGE, MANCHESTER M19 1NA(061) 432 4945

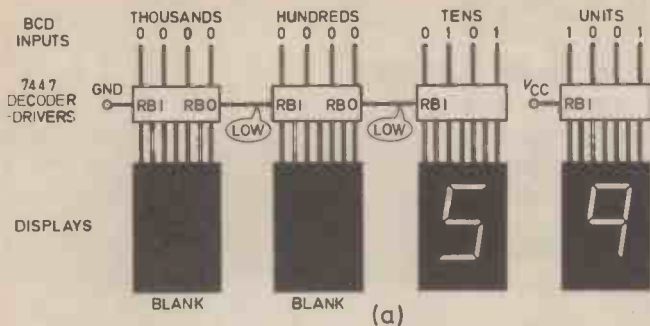

Fig. 6.8(a). Illustrating leading-edge zero blanking.

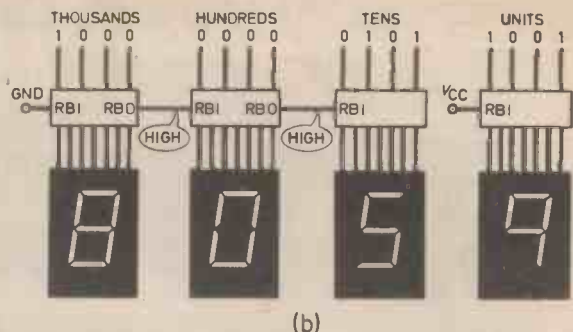

Fig. 6.8(b). Presence of a significant "thousands" digit causes zero to be displayed at the "hundreds" digit.

that of the 0 to 3 decoder. Its terminal connections are shown in Fig. 6.7. It has four terminals to receive the BCD input. There are seven output terminals (a to g) to drive the correspondingly lettered segments of the display.

The LAMP TEST input is normally held high. If it is made low, all outputs go low, making all segments of the display light up. This feature is for testing the display, but we do not use it here, so the LAMP TEST input is wired to V_{CC} (+5V).

RIPPLE-BLANKING INPUT

The action of the ripple-blanking input (RBI) is explained by reference to Fig. 6.6. Pulses arriving at the input are counted by IC4. The D output from IC4 is fed to the A input of IC5. When D goes low, as the output of IC4 changes from 1001 (=9) to 0000 (=0), IC5 registers one pulse; in other words, it counts the "tens".

The RBI of IC7 is wired to V_{CC} . The effect of this is that whenever the decoder receives a 0000 input, its outputs are such as to produce a 0 on the display. Thus, as pulses arrive at IC4, the display of units runs from

0 up to 9, back to 0 and so on. The RBI of IC6 is wired to ground (0V). The effect of this is that whenever the decoder receives a 0000 input, its outputs all go high, and the display is completely blank. Thus this display (the "tens" display) begins by being blank, then runs from 1 to 9, then goes blank, then repeats 1 to 9, and so on. By this means we obtain a sequence of two-digit numbers as we normally write them:

0, 1, 2, 3, 4, 5, 6, 7, 8, 9, 10, 11, 12, ...

If, instead of the arrangement shown, we connect the RBI pins of both decoders to V_{CC} there is no blanking, and the sequence of numbers would be:

00, 01, 02, 03, 04, 05, 06, 07, 08, 09, 10, 11, 12, ...

If you prefer the latter sequence, you can change the RBI connection of IC6 to V_{CC} within the Test-Bed.

A system such as that of Fig. 6.6 is said to have leading-edge zero-blanking.

RIPPLE-BLANKING OUTPUT

The ripple-blanking output or RBO pin is used when we have a system

with three or more digits, as in Fig. 6.8. Its operation depends on the fact that the conditions which produce a blank display (BCD inputs all low, and RBI input low) cause RBO to go low. In Fig. 6.8a, the "thousands" decoder is in this state and its RBO is providing a low input to the "hundreds" decoder. This has 0000 input, so the "hundreds" display is blank, too. Its RBO is low, but since the "tens" decoder has 0101 input, the "tens" display is 5. The "units" decoder has RBI wired to V_{CC} so it displays 0 even if all inputs to all decoders are 0000.

If the "thousands" input is suddenly changed to 1000 (Fig. 6.8b), the "thousands" display becomes 8. Its RBO goes high. Now, although the "hundreds" input is unchanged, and is still 0000, the "hundreds" display now shows 0 instead of being blank. In this way the complete number 8059 is displayed.

A similar arrangement is used if required to blank trailing-edge zeros following significant figures after a decimal point.

To be continued

BOOK REVIEWS

TELEVISION & RADIO 1979

Price £2.50

Size 230mm x 190mm

Publisher Independent Broadcasting Authority

ISBN 0 900485 32 9

THIS handbook spotlights the behind the scene activities that take place in bringing commercial television and independent local radio programmes to our homes. It contains separate chapters on each category of programmes. Full details about audience research, advertising controls, programme planning and possible future technological developments.

The "potted" histories and breakdown of programme output provided by the present 19 local radio stations made interesting reading and shows just how valuable a service they provide to local communities.

As some kind soul removed last years edition from my desk before I had a chance to turn the pages I cannot

compare the two editions, but with 224 pages and over 300 illustrations, many in colour, this year's handbook can best be summarised by one of its section titles, namely "attention to detail". The layouts, editorial writing and printing are a credit to all persons involved in the production of the 1979 edition. DGB

EVERYDAY ELECTRONICS "MULTIMETER" COMPETITION

In September last we featured a competition in which readers were asked to place eight functions of a multimeter, in order of likely usefulness to the average EVERYDAY ELECTRONICS reader.

Having considered all entries, the judges decided that the best received were a number of identical attempts listing the following selection:

1st-E; 2nd-C; 3rd-B; 4th-J;

5th-K; 6th-A; 7th-L; 8th-D.

Senders of this selection then took part in an eliminating contest to determine the five winners and from this the following entrants were chosen. Each wins an Electronic Avometer EM272:

R. Hovell, Worksop; W. Mayhew, Belfast; C. Murdoch, Sale; P. Pavlou, Coventry; V. Rinaldi, Cumbernauld.

EMI SPEAKER BARGAIN

Stereo pair 350 kit. System consists of 13" x 8" approx. woofer with rolled surround, 2 1/2" approx. Audax tweeter, crossover components and circuit diagram. Frequency response 20 Hz to 20 KHz. Power handling 15 watts RMS, 20 watts max. 8 ohm impedance.

£14.95 Per stereo pair + £3.40 p&p.

As above but complete with all woodwork in kit form, finished in simulated teak veneer, with instructions. Size approx 20" x 11" x 9 1/2" £28.00 Per stereo pair + £5.00 p&p.



BSR Manual single play record deck with auto-rewind and cueing lever, fitted with stereo ceramic cartridge 2 speeds with 45 r.p.m spindle adaptor ideally suited from home or disco use. OUR PRICE £10.95 p&p £2.95

TURNTABLE BARGAINS FOR PERSONAL SHOPPERS

GARRARD 86SB Deck £26.95 | GARRARD SP25 MKIV Deck with Shure head £25.95

Plinth and cover for BSR decks £6.00

BARGAINS FOR PERSONAL SHOPPERS

PORTABLE STEREO RADIO CASSETTE RECORDER UNREPEATABLE

MW, LW, SW and Stereo VHF. 6 watts output Battery/Mains operation. 160 15 VOLT MAINS TRANSFORMER. 2 1/2 amp.

£69.95 £2.50

Garrard Record auto deck oh plinth with stereo cartridge ready wired

LED 5 function men's digital watch stainless steel finish

LCD 5 function men's digital watch stainless steel finish

£18.95

LCD 8 Function CHRONOGRAPH men's digital watch, stainless steel finish.

£5.95

Battery/mains Cassette Recorder with built in mic.

£6.95

AM/FM DIGITAL CLOCK RADIO Accurate 4 Digit Electronic Clock with 1/2" LED display. Buzzer and snooze timer.

£11.95

125 Watt Power Amp Module

£13.95

Mains power supply for above unit.

£3.50

MUSIC CENTRE CABINET with hinged smoke acrylic top, finished in natural teak veneers, size 30 1/2" x 14 1/2" x 7 1/2" approx.

£5.95

MULLARD Built power supply

£1.50

OECCA DC 1000 Stereo Cassette P.C.B. complete with switch oscillator coils and tape-heads.

£2.95

OECCA 20w Stereo speaker kit comprising 2 8" approx. bass units + 2 3 1/2" approx. tweeter inc. crossovers

£20.00

VIDEOMASTER Super Store TV Game with pistol mains operation

£14.95

PORTABLE RADIO/CASSETTE RECORDER, AM/FM with clock.

£41.95

LW, MW, SW, VHF mains/battery operation.

£8.95

7" TAPE TRANSPORT Mechanism—a selection of models from

SANYO Nic/cad. battery, with mains charger equivalent in size and replaces 4 SP11 type batts. Size 3 1/4" x 1 1/4" x 2" approx.

£7.50 p&p £1.50p



AM/FM STEREO TUNER AMPLIFIER CHASSIS COMPLETE WITH DECODER

Ready built. Designed in a slim form for compact, modern installation. Rotary Controls Vo, On/Off, Bass, Treble, Balance. Push Buttons for Gram, Tape, VHF, MW, LW and 5 button rotary selection switch.

Power Output 5 watts per channel Sine at 2% THD into 15 Ohm 7 watts speech and music.

Tape Sensitivity Playback 400mV/30K OHM for max output Record 200mV/50K output available from 25KHz (150mV/100K) deviation

FM signal Frequency Range (Audio) 50Hz to 17KHz within ±1dB

Radio FM sensitivity for 3dB below limiting better than 10 uV

AM sensitivity for 20dB S/N MW 350 uV/Metre LW 1mV/Metre

Size approx length 16" x height 2 1/4" x depth 4 1/4" £19.95 p&p £2.55

240 Volts AC Complete with Circuit diagram

Mullard

AUDIO MODULES IN BARGAIN PACKS

CURRENT CATALOGUE PRICE & AT OVER **25** PER PACK

SEE OUR PRICES

1 PACK 1. 2 x LP1173 10w. RMS output power audio amp modules, + 1 LP1182/2 Stereo pre amp for ceramic and auxiliary input. OUR PRICE p+p £1.00 **£4.95**

2 PACK 2. 2 x LP1173 10w. RMS output power audio amp modules + 1 LP1184/2. Stereo pre amp for magnetic, ceramic and auxiliary inputs. OUR PRICE p+p £1.00 **£7.45**

ACCESSORIES

Suitable power supply parts including mains transformer, rectifier, smoothing and output capacitors. £1.00 p+p **£1.95**

Recommended set of rotary stereo controls comprising BASS, TREBLE, VOLUME and BALANCE. p+p 50p **95p**



GARRARD BARGAIN

LIST PRICE ~~£95.00~~

OUR PRICE **£39.95**

86 SB MKII. Belt drive, 2 speed turntable module with plinth and cover.



20 x 20 WATT STEREO AMPLIFIER

Viscount LV unit in teak simulate cabinet Silver/facsa with aluminium rotary controls/pushbuttons, red mains indicator and stereo jack socket. Functions switch for mic. magnetic crystal pickups, tape tuner and auxiliary. Rear panel features two mains outlets DIN speaker and input sockets plus fuse 20 - 20 watts RMS 40 - 40 watts peak. For use with 8 to 16 ohm speakers £29.90 + £2.50 p&p

SPECIAL OFFER FOR PERSONAL SHOPPERS ONLY

FREE. 4 dimensional stereo sound adaptor, when purchasing the 20x20 Viscount amplifier.

30x30 WATT AMPLIFIER IN KIT FORM

For the experienced constructor complete in every detail, same facilities as Viscount IV, but with 30x30 output, 60x60 watts peak. For use with 4-15 ohms speakers. £23.00 without cabinet. £29.00 complete with cabinet, p&p £2.50 in each case.

£23.00 + £2.50 (NOTE Cabinet not available separately.) £29.00 + p&p £2.50 complete with cabinet.

SPECIAL OFFER Complete with 30x30 WATT AMPLIFIER IN KIT WITH SPEAKERS

2 Goodman compact 12" bass woofers with cropped size 14,000 Gauss magnet. 30 watt RMS handling + 3 1/2" approx. tweeters and crossovers. £49.00 + p&p £4.00

BUILT AND READY TO PLAY 39.00

30x30 Viscount. Available fully built and tested. + p&p £2.50

50 WATT MONO DISCO AMP £29.95 P&P £2.50

Size approx 13 1/2" x 5 1/4" x 6 3/4"

50 watts rms, 100 watts peak output. Big features include two disc inputs, both for ceramic cartridges, tape input and microphone input. Level mixing controls fitted with integral push-pull switches. Independent bass and treble controls and master volume. SPECIAL OFFER. The above 50 watt amp plus 4 Goodmans Type 8P. 8" speakers. Package price £45.00 + £4.00 P&P.

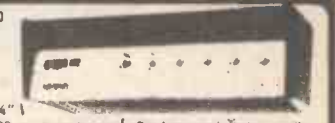

70 & 100 WATT MONO DISCO AMP

Size approx. 14" x 4" x 10 1/2"

Brushed aluminium fascia and rotary controls. Five vertical slide controls: master volume, tape level, mic level, deck level. PLUS INTER DECK FADER for perfect graduated change from record deck No. 1 to No. 2, or vice versa. Pre fade level control 70 watt peak £57 (PFL) lets YOU hear next disc before fading 140 watt peak p & p £4.00

Output 100 watts RMS 200 watts peak. 100 watt £65

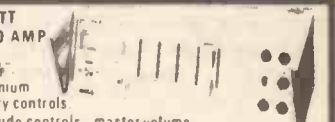

STEREO CASSETTE TAPE DECK ASSEMBLY

Consisting of ready built tape transport system/mechanism, mated to the electronics. Unit is ready built for installing into cabinet of own choice. Features include pause control, solenoid assisted auto-stop, 3 digit tape counter, belt driven balanced fly wheel by DC motor with electronic speed control, twin VU meters. Specification Power Output, more than 0.5v, m.c. -85dB 10K/Hz, DIN -47dB 100K Hz. Track-2 channel stereo record play-back, Tape speed 4.8cm/sec. Freq response 50.1200 Hz signal to noise ratio 42dB Recording system AC bias Erasing system AC erase Bias free, 57KHz. Compatible for both normal and chrome dioxide tapes. Size of mechanism only 4 1/2" x 8 1/2" x 11 1/2" approx. Included a moulded top-plate as illustrated.

13 1/2" x 9 1/2" approx. with circuit diagram. £25.00 P&P £2.50

Opt. extras: Mains transformer to suite £2.50 + £1 p & p.



323 EDGWARE ROAD, LONDON W2
21B HIGH STREET, ACTON W3 6NG

ALL PRICES INCLUDE VAT AT 12 1/2%

All items subject to availability. Price correct at 15.12.78 and subject to change without notice.

HANIMEX
Electronic
LED Alarm Clock

Same as ETI offer
Thousands sold



Feature and Specification

- ★ Hour minute display
- ★ Large LED display with p.m. and alarm on indicator
- ★ 24 Hours alarm with on-off control
- ★ Display flashing for power loss indication
- ★ Repeatable 9-minute snooze
- ★ Display bright dim modes control

Size 5.15" x 3.93" x 2.36" (131mm x 100mm x 60mm)

Weight: 1.43lbs (0.65kg)

Guaranteed same day despatch

£8.65

LADIES LCD

Only 25 x 20mm and 6mm thick. 5 function: hours, mins, secs, day, date, + back light and auto cal. Elegant metal bracelet in silver or gold. State preference.

£10.95

Guaranteed same day despatch



5 FUNCTION LCD

Hours, mins, secs, month, date, auto calendar, back-light, quality metal bracelet.

£7.65

Guaranteed same day despatch.



Very slim, only 6mm thick

THOUSANDS SOLD
11 FUNCTION
SLIM CHRONO

- 6 digit 11 functions
- Hours, mins, secs, Day, date, day of week,
- 1/100, 1/10, secs, 10x secs, mins.
- Split and lap modes.
- Back light, auto calendar.
- Only 8mm thick.

This same watch is being sold for £22.00 in newspaper and magazine special offer ads.

Metac Price
£12.65

Guaranteed same day despatch



12 MONTH'S
GUARANTEE

on all products

- ★ All prices include V.A.T.
- ★ Please add 30p p & p with all orders.
- ★ Shops open MON.-SAT. 9.30a.m.-6.00p.m.

★ **DELIVERY: ONE WEEK**
Except where same day Service is stated.

Trade Enquiries welcome.

ALARM
CHRONOGRAPH
WITH DUAL TIME
ZONE FACILITY

- ★ Constant LCD display of hours and minutes, plus optional seconds or date display, plus day of the week and am/pm indication.
- ★ Perpetual calendar, day, date, month and year.
- ★ 24 hour alarm with on/off indication.
- ★ 1/10 second chronograph measuring net lap and first and second place times.
- ★ Dual time zone facility. Night light.



£27.95

FULL MONEY BACK 10 DAY
RE-ASSURANCE

with all our products.

All watches are despatched by **FIRST-CLASS POST**

- ★ and include
- ★ **NEW BATTERIES**
- ★ **GUARANTEE**
- ★ **INSTRUCTIONS**

Battery fitting service is available at our shops for no extra charge. We stock most watch batteries and this service is available to all. Metac have been selling electronic watches probably longer than anyone else in the UK. We take care of your watch not just this year but next year and the years after that.

METAC

Electronics & Time Centre (Dept E.E.)

327 EDGEWARE ROAD,
LONDON W2
Tel: (01) 723 4753

67, HIGH STREET, DAVENTRY,
NORTHANTS.
Tel: (032 72) 78545



Telephone Special
24-hour phone service
Credit-card customers are
welcome to buy by phone
01-723-4753
credit-card number with
order please.

INTRODUCTORY 2-WAY OFFER!!

I Try the C-More BATTERY CONDITION DISPLAY with a 10 DAY MONEY BACK OFFER if not delighted

II Buy at 20% BELOW NORMAL COST if order is placed promptly (valid to 1.4.79)



NEAT
DASHBOARD
INSTALLATION
—takes only
a few minutes

The C-More mounts easily on the dash with adhesive pads (supplied), and connects to earth and an ignition wire through a quick connector (also supplied).

The battery voltage is electronically monitored immediately the ignition is switched on, and presented through a LED display using a novel split colour comparator.

The all electronic display shows both red and yellow when all is well. Red only shows low battery or charge, and yellow only shows overcharge. Full fitting and operating instructions even highlight probable cause of faults when they occur. Helps prevent those unnecessary and expensive replacements.

NOT £5.95 but £4.75 + 25p P&P

We make this offer in the confidence that drivers who read *Everyday Electronics* appreciate the need to know about the state of their battery and charging system—and that they recognise the best instrument to do the job—simply, accurately and reliably. **HARVELEC (Dept. EE), 1 Formby Ave., St. Helens, Merseyside WA10 3NW**

As supplied to: CANADA, U.S.A., GERMANY, SWEDEN, UAE, NIGERIA, HONG KONG, BARBADOS, ICELAND, TURKEY

USE THIS COUPON TO SECURE YOUR C-MORE AND TAKE ADVANTAGE OF OUR UNIQUE 2-WAY OFFER

Please send C-Mores at £5.00 ea. (inclusive) to:
(+ 25% for export please)

.....

.....Cheque/P.O. Value

I understand that the units will be despatched within 4 days of receipt of order, and that I can return it within 10 days if not fully satisfied, for a refund of the purchase price. Post to:

HARVELEC (Dept. EE), 1 FORMBY AVE., ST. HELENS MERSEYSIDE WA10 3NW. REGN. No. 212 1206

MAIL ORDER DEPT.

CRESCENT RADIO LTD.

1, ST. MICHAELS TERRACE, WOOD GREEN, LONDON, N22. 4SJ.
PHONE 01-888 3206

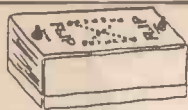

"FLIP"

Push button heads or tails.
Complete kit and full instructions supplied.

A pocket game.
Easy to build and great to play.
Kit price—£5.25 + 8% VAT. Post free.

CR 4110 DESOLDERING PUMP



ONLY £6 + 8% VAT

High suction pump with automatic ejection. Knurled, anti corrosive casing. Teflon nozzle.

HEAVY DUTY XOVER 2 WAY 8 OHM

A 2 way 8 ohm H/D Xover suitable for L/S systems up to 100 watt.

Fitted with screw terminals for input and a three position 'HF LEVEL' switch which selects either Flat, -3dB or -6dB.

ONLY £3.00 + 8% VAT

A CRESCENT 'SUPERBUY'

Goodmans 5" 8 ohm long throw H/D loudspeaker.

Mounting plate is integral with L/S chassis and has fixing holes with centres spaced at 5 1/2" (diagonally).

ONLY £5.00 + 12 1/2% VAT

TELESCOPIC AERIAL + 12 1/2% VAT

11 section telescopic aerial.

Extended length: 1 metre (39 1/4")
Fully closed: 135mm (5 1/4")

Fixing: nut and bolt fixing through recess at base of aerial.

ONLY 75p EACH!

LOUDSPEAKERS + 12 1/2% V.A.T.

- 2 1/2" (57mm) 8 or 75 ohm 90p
(please state impedance req'd)
- 2 1/2" (60mm) 8 ohm (limited stocks) 60p
- 2 1/2" (70mm) 8 ohm (limited stocks) 60p
- 5" 8 ohm Ceramic £1.50
- 8" "ELAC" 8 ohm 15W dual cone £5.00
- 8" "GOODMANS" 'Audiom 8PA' £4.95
- 8 ohm 15W £4.95
- 7" x 4" 8 ohm 4W £2.00

LOUDSPEAKERS + 8% VAT.

- 12" "McKENZIE" 8 ohm 75W Bass £23.62
- 12" "McKENZIE" 8 ohm 75W dual cone £23.62
- 12" "McKENZIE" 8 ohm 75W general purpose £18.37

3 KILOWATT PSYCHEDELIC LIGHT CONTROL UNIT

1000W lighting per channel, max. This 3 channel sound to light unit is housed in a robust metal case, with a sensitivity control for each channel i.e. Bass, middle and treble. Full instructions supplied. S.A.E. for spec. sheet. ONLY £20.00 + 8% VAT

CR LVI 12v DRILL

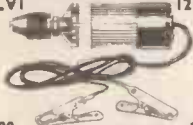

£12.00 8% VAT
BRITISH MADE "Versadrill", 12 volts DC. Compact battery operated power tool, sufficiently powerful to perform all the operations associated with 240v drills. Dimensions:— 150 x 50mm (dia.)



'P&P' ORDERS UP TO £5, Add 30p
ORDERS £5-£10, Add 50p
All orders over £10 post free!
Please add VAT as shown.
S.A.E. with all enquiries please



Personal callers welcome at: 21 GREEN LANES, PALMERS GREEN, N13.
ALSO. 13 SOUTH MALL, EDMONTON GREEN, EDMONTON.

MICRO CHIMES

FROM THE INVENTORS
OF MICROPROCESSOR
MUSICAL CHIMES

A COMPLETE KIT FOR THE EE MICRO CHIME

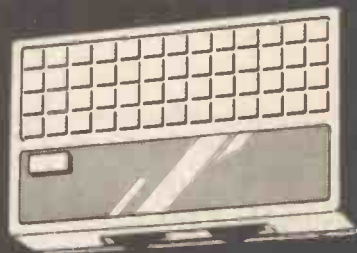

This easy to build kit includes:

- * TMS1000 Custom MPU Chip
- * Special purpose designed case
- * Fully drilled and legended PCB
- * All transistors, Resistors and Capacitors
- * Full set of mechanical parts
- * Smart fascia labels
- * IC Socket and Loudspeaker
- * Really Low Price!

only £8.95 + 55p p&p

TMS 1000N - MP0027A Micro-computer chip available separately if required. Full 24 tune spec device supplied with data sheet and fully guaranteed.

New low price only £4.95 inc. p&p

(Only present 24 tune repertoire currently available.)

New price for the original
CHROMA-CHIME 24 tune model!

Due to the fantastic success of this product right across the World we are able to offer it at

only £9.95 + 75p p&p

Comes complete with:

- * TMS1000 Micro
- * Superb cabinet
- * All R's & C's
- * Switches & pots
- * Fully detailed kit manual
- * Fully prepared PCB
- * All semiconductors
- * Loudspeaker
- * Socket & Hardware

ALL CHROMATRONICS PRODUCTS
SUPPLIED WITH MONEY BACK GUARANTEE

TO: CHROMATRONICS, RIVER WAY, HARLOW, ESSEX. UK.

NAME _____
ADDRESS _____

EE2

I enclose cheque/PO value £ _____
or debit my ACCESS/BARCLAYCARD account no. _____

Signature _____

CHROMATRONICS

TOPS THE PACK!

ACE

COMPONENTS - Now over 1,000 types in stock.
KITS - See the new range of low-cost 'ELEKITS'.
MODULES - New ready-built functions.
SERVICE - 1st Class same day despatch.
QUALITY - All guaranteed products.
PRICES - Many reductions!
MAGAZINE PROJECTS - Trouble-free!

LOOK

ACE MAILTRONIX LTD
Dept. 27 Coastal Street
Walsfield, W. Yorkshire WF1 5JR

Our 2nd edition illustrated catalogue is now available. The much increased range shows many welcome reductions.

INTRODUCING
FABULOUS

'ELEKITS'

Easy build introduction to electronics. Many hours of enjoyment.

NOW AVAILABLE!

The new range of easy build kits complete with simple to follow instructions. Battery powered (not supplied). With case.

- * BURGLAR ALARM
- * ROULETTE
- * BICYCLE SOUND FLASHER
- * WATER LEVEL ALARM
- * SIREN
- * BLINKER
- * TIME SWITCH

Many others in preparation - included in full ACE catalogue - send S.A.E. for free brochure of kit range.



Mini ORGAN

only £7.95

PRICES Inc.VAT

MORSE TRAINER

only £4.95

I enclose 30p*, please send catalogue.

Name _____
Address _____

* Refundable with future orders over £5.00.

Newnes

constructors projects



☆ This new series has been specially compiled for the electronics enthusiast.

Each book contains a collection of constructional projects, giving details of how the circuit works, how it may be assembled and how setting-up and trouble-shooting problems may be solved. The skilful use of colour in the text helps to clarify circuit operation, and circuit board layouts are suggested. Shopping lists of components are drawn up for each project.

☆ The first four titles are available now at £2.25 each (US \$5.25)

Electronic Projects in Audio *R. A. Penfold*
 Electronic Projects in Hobbies *F.G. Rayer*

Electronic Projects in the Home *Owen Bishop*
 Projects in Radio and Electronics *Ian R. Sinclair*

☆ Also available six Constructors Guides:

Electronic Diagrams £1.80 US \$4.25
 Electronic Components £1.80 US \$4.25
 Simple Circuit Building £1.90 US \$4.50

Printed Circuit Assembly £1.80 US \$4.25
 Project Planning and Building £1.90 US \$4.50
 Practical Electronic Project Building £1.90 US \$4.50

Write for a free colour brochure about all our hobby books to

Newnes Technical Books

Borough Green, Sevenoaks, Kent TN15 8PH



CHROMASONIC electronics

your soundest connection in the world of components

Dept EE2, 56 Fortis Green Road, Muswell Hill, London N10 3HN
 Telephone: 01-883 3705

Transistors

AC107	20*	BC187	30*	BF196	12	OC71	28	ZTX303	24	2N2926Y	09
AC126	20*	BC204	14	BF197	12	OC72	32*	ZTX304	27	2N3053	22*
AC127	20*	BC209	10	BF200	30*	OC75	48*	ZTX311	19	2N3054	53*
AC128	20*	BC212L	10	BF244B	19	OC76	40	ZTX312	19	2N3055	48*
AC176	20*	BC213L	11	BF272	£1 26	OC81	30	ZTX341	22	2N3442	£1 41*
AC187	21*	BC214L	11	BF288	27	OC83	52	ZTX500	15	2N3638	64*
AC187K	35*	BC327	15	BFY50	22	ORP12	£1 00*	ZTX501	16	2N3702	11
AC188	21*	BC441	34	BFY51	22	TIP29C	67	ZTX502	21	2N3703	12
AC188K	35*	BC461	34	BFY52	22	TIP30C	73	ZTX503	17	2N3704	11
AD140	77	BC477	25	BRV39	48	TIP31A	43*	ZTX504	28	2N3705	12
AD149	60	BC478	25	BS440	20	TIP31C	68*	ZTX531	28	2N3706	11
AD161	45*	BC479	25	BU205	£1 40*	TIP32A	53*	ZTX550	28	2N3707	11
AD162	45*	BC547	13	BU206	£2 05*	TIP32C	76*	2N914	34*	2N3708	11
AD161/162MP	90*	BC548	13	BU208	£2 43*	TIP33A	86*	2N1131	24*	2N3709	11
AF114	21*	BC549	13	MJ480	£1 28	TIP33C	£1 13*	2N1132	24*	2N3710	11
AF115	21*	BC557	14	MJ481	£1 62	TIP34A	91*	2N1302	54*	2N3711	11
AF116	21*	BC558	13	MJ2955	£1 11	TIP34C	£1 13*	2N1304	54*	2N3771	£3 36*
AF116	21*	BC559	15	MJ3055	90	TIP35A	£2 43*	2N1305	30*	2N3772	£1 83*
AF117	24*	BCY70	17	MJ4000	£1 72	TIP35C	£2 90*	2N1306	38*	2N3773	£3 11*
AF124	59*	BCY71	17	MJ4010	£2 30	TIP36A	£2 86*	2N1307	57*	2N3819	25*
AF139	38*	BCY72	18	MJE340	40*	TIP36C	£3 51*	2N1308	50*	2N3820	35*
AF172	35*	BD115	63*	MJE2955	56	TIP41A	68*	2N1309	54*	2N3823	70*
AF239	45*	BD131	41*	£1 10*	TIP41C	84*	2N1613	25*	2N3866	£1 01	
ASY26	43*	BD132	41*	MJE3055	86*	TIP42C	69*	2N1671B	25*	2N3903	20
BC107	10*	BD131/132MP	99*	MPF102	34	TIP42C	96*	£1 50*	2N3904	20	
BC108	10*	BD135	40*	MPF103	40	TIP125	81*	2N1711	22*	2N3905	20
BC109	10*	BD136	40*	MPF104	40	TIP126	£1 04*	2N1893	32*	2N3906	18
BC147	08	BD139/140	40*	MPF105	40	TIP141	£2 77*	2N2218	33*	2N4248	85*
BC148	08	BD239C	35	MPS106	56	TIP142	£2 77*	2N2219	22*	2N5447	16
BC149	09	BD239C	35	MPSA05	27	TIP146	£3 15*	2N2220	28*	2N5449	26
BC157	11	BF160	32*	MPSA06	27	TIP147	£3 76*	2N2221	25*	2N5457	35
BC158	12	BF167	30*	MPSA55	27	TIP2955	68*	2N2222A	21*	2N5458	35
BC168	13	BF173	27*	MPSA56	27	TIP3054	54*	2N2369	16*	2N5459	35
BC169C	11	BF177	26*	MPSU05	54	TIP3055	56*	2N2646	52*	2N5777	48*
BC171	12	BF178	27*	MPSU06	61	TIS43	40	2N2904	24*	2N6027	45
BC172	11	BF179	32*	MPSU55	59	TIS91	25	2N2905	22*	2N6076	20
BC177	17	BF180	23	MPSU56	63	ZTX107	12	2N2906	19*	2N6111	62
BC178	16	BF181	32	OC28	£1 69*	ZTX108	12	2N2907	22*	2N6288	50
BC179	16	BF184	24	OC35	36*	ZTX109	12	2N2925	11	3N1440	95
BC182L	11	BF185	24	OC36	£1 11	ZTX300	15	2N2926G	11	3N1441	99
BC183L	11	BF194	12	OC44	35	ZTX301	18	2N2926S	11	3N1533	99
BC184L	11	BF195	12	OC45	22	ZTX302	20	2N2926R	09	40673	79

μ A741

NE555

TIL209

5 for £1.00*

4 for £1.00*

10 for £1.00*

V.A.T. Inclusive prices *8% others 12.5%. Export Customers deduct V.A.T. 2/27 from *1/9 from others.

Postage and Packing 25p. Trade and Export Inquiries most welcome. Hours 9.00am-5.00pm.

Now available our ORDER-RING line, just phone your order through with your Access or Barclaycard number and providing the order is received by 3.00pm the components will be despatched the same day (min tel order £5.00).

Following the success of Breadboard '78, Trident Exhibitions announce



The second hobby electronics show

Information on exhibiting from:
 Trident International Exhibitions Limited,
 Abbey Mead House, 23a Plymouth Road,
 Tavistock, Devon, PL19 8AU.
 Telephone (0822) 4671 Telex 45412 TRITAV

December 4th - 8th Royal Horticultural Hall, Westminster, London SW1

You know it's easy with Heathkit.

Electronics Courses

New series of courses on car electrical systems.
 New series of courses on electronic equipment.
 DC electronics.
 AC electronics.
 Semi-conductors.
 Electronic circuits.
 Digital techniques.
 Microprocessors.

Heathkit self-instruction electronics courses are complete, low-cost learning systems. All you need is the will to learn and the Heathkit courses will teach you at your own pace.

It's easy because the courses are based on step-by-step programmed instructions, with audio records (or optional cassettes), self evaluation quizzes to test your understanding, and interesting experiments that encourage you to learn the easy "hands-on" way with the optional Heathkit experimenter-trainers.

Thousands of people just like you have already learnt electronics the easy Heathkit way - at home, in educational establishments and in industry throughout the world.

You'll find it easy too. Full details are in the Heathkit catalogue, together with hundreds of kits you can build yourself; for the home, car and workshop.

Send for your copy now.



New Kits

Line printer.
 Dual floppy disc.
 Dual trace 5MHz and 35MHz oscilloscopes.
 Memory expansion for digital trainer.
 2M hand-held transceiver.

To Heath (Gloucester) Limited, Dept Bristol Road, Gloucester GL2 6EE. Please send the items I have ticked.
 Heathkit catalogue (enclose 20p in stamps). 16 page computer brochure (enclose 20p in stamps).

Name _____

Address _____

HEATH
Schlumberger

EE3/79

NB. If you are already on the Heathkit mailing list then you will automatically receive a copy of the latest Heathkit catalogue without having to use this coupon. Registered in England, number 606177.

There are Heathkit Electronics Centres at 233 Tottenham Court Road, London (01-636 7349) and at Bristol Road, Gloucester. (Gloucester 29451).

Electronics. Make a job of it....



Enrol in the BNR & E School and you'll have an entertaining and fascinating hobby. Stick with it and the opportunities and the big money await you, if qualified, in every field of Electronics today. We offer the finest home study training for all subjects in radio, television, etc., especially for the CITY AND GUILDS EXAMS (Technicians' Certificates); the Grad. Brit. I.E.R. Exam; the RADIO AMATEUR'S LICENCE; P.M.G. Certificates; the R.T.E.B. Servicing Certificates; etc. Also courses in Television; Transistors; Radar; Computers; Servo-mechanisms; Mathematics and Practical Transistor Radio course with equipment. We have OVER 20 YEARS' experience in teaching radio subjects and an unbroken record of exam successes. We are the only privately run British home study College specialising in electronics subjects only. Fullest details will be gladly sent without any obligation.

Become a Radio Amateur.

Learn how to become a radio-amateur in contact with the whole world. We give skilled preparation for the G.P.O. licence.

Brochure without obligation to:

British National Radio & Electronic School

P.O. Box 156, Jersey, Channel Islands.

NAME _____

ADDRESS _____

EEL3/79

Block caps please

Free!

TIMETRON

Recommended by

TEMPUS

Until TEMPUS have re-established their business we will be pleased to supply you from the superb range of

QUALITY CASIO PRODUCTS

A well known consumer magazine has published a report on digital watches which supports our opinion that CASIO and SEIKO are probably the best watches in the world, with CASIO offering unbeatable value for money.

NEW CASIO 46CS-27B

Almost certainly the slimmest and most sophisticated alarm/chronograph watch available today. Liquid crystal display of hours, minutes, seconds, day; And with day, date, month and year perpetual calendar.

- Optional 1/2 hour clock (with am/pm indicators) or 24 hour display.
- 24 hour alarm setting.
- Optional hour chimes.
- Chronograph measures in units of 1/100 second to six hours.
- Net, lap and 1st & 2nd place times
- All stainless steel case only 7.8mm thick.
- Mineral glass face.
- Water res. to 100ft.
- ± 10 seconds/month

RRP £89.95

£74.95



CASIO CHRONOGRAPH

45CS-22B Similar functions to the above watch but without the alarm and chime. (RRP £89.95) £54.95

CASIO SPORTS WATCHES. LCD, 6 digits, 1/100 second stopwatch; net, lap and 1st & 2nd place times. Time and calendar display. P-100 Resin case, strap (£24.95) £19.95

S2QS-14B s/s encased, bracelet (£44.95) £34.95

NEW CASIO CARD WATCH

THE INCREDIBLE MQ-11

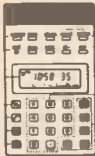

Microcomputer Quartz Sensor Touch keys LC Display of hours, minutes, seconds, am/pm, full calendar display of day, date and every Sunday. Also digital date, month, year; And day, Sundays. Three date memories. Two independent alarms with hold and display face. Countdown alarm/timer, or Time Memory (24hr), or 1/10 sec stopwatch.

Will display any monthly calendar from 1901 to 2099. Memorises and displays three optional important dates. Calculator with Sensor Touch keys, full memory, %, √, K. Battery life approx. 1 year. 7 1/2 x 2 1/2 x 3/16 ins. Leatherette wallet with window (£34.95). An Incredible

£29.95

NEW CASIO CQ-82

LCD calculating alarm clock with snooze facility



6 digit LC Display of time, with nightlight. Four alarms, one with snooze facility. Calculator with %, √, K. Long battery life, compact size (£24.95)

£19.95

CQ-81 Calculating alarm clock now only £14.95

CO-7 Alarm clock, alarm/timer, stopwatch. Now £17.95

NEW CASIO AQ-2000

Calculating alarm clock with stopwatch and calendar

ST-24 Card Time. Calculator, stopwatch, 2 alarm/timers

£19.95

NEW LCD calculator with full memory, %, √, K.

Most CASIO products in stock. Send 15p for brochures.

Prices include VAT, P&P. Send cheque, P.O. or phone your Access or B'card number to:—

Dept. E.E., Beaumont Suite, 164-167 East Road Cambridge CB1 1DB Telephone 0223 67503

Callers welcome by appointment

TIMETRON

Callers welcome by appointment

SMALL ADS

The prepaid rate for classified advertisements is 16 pence per word (minimum 12 words), box number 60p extra. Semi-display setting £4.40 per single column centimetre. All cheques, postal orders, etc., to be made payable to Everyday Electronics and crossed "Lloyds Bank Ltd." Treasury notes should always be sent registered post. Advertisements, together with remittance, should be sent to the Classified Advertisement Manager, Everyday Electronics, Room 2337, IPC Magazines Limited, King's Reach Tower, Stamford St., London, SE1 9LS. (Telephone 01-261 5918).

CONDITIONS OF ACCEPTANCE OF CLASSIFIED ADVERTISEMENTS

1. Advertisements are accepted subject to the conditions appearing on our current advertisement rate card and on the express understanding that the Advertiser warrants that the advertisement does not contravene any Act of Parliament nor is it an infringement of the British Code of Advertising Practice.
2. The publishers reserve the right to refuse or withdraw any advertisement.
3. Although every care is taken, the Publishers shall not be liable for clerical or printers' errors or their consequences.

NOTICE TO READERS

When replying to Classified Advertisements please ensure:

- (A) That you have clearly stated your requirements.
- (B) That you have enclosed the right remittance.
- (C) That your name and address is written in block capitals, and
- (D) That your letter is correctly addressed to the advertiser.

This will assist advertisers in processing and despatching orders with the minimum of delay.

Miscellaneous

AERIAL BOOSTERS improve weak VHF radio and television reception, price £5. SAE for leaflets, Electronic Mailorder Ltd., Ramsbottom, Bury, Lancashire, BL0 9AG.

TUNBRIDGE WELLS COMPONENTS, BALLARD'S, 108 Camden Road, Tunbridge Wells, Phone 31803. No lists, enquiries S.A.E.

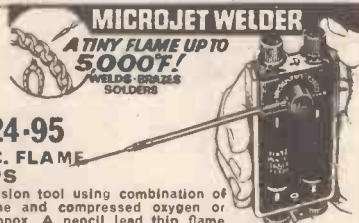

£24.95

INC. FLAME TIPS

Precision tool using combination of butane and compressed oxygen or micronox. A pencil lead thin flame size, adjustable to 5,000° F. Cuts metals, welds, brazes and solders gold, silver. Ideal electronic and computer servicing, modeling, electricians, opticians, silversmiths, jewellery, clockmakers. Up to 30 minutes use on fuel supplied. Replacement set of 2 micronox, 1 butane cylinder £2.30 + 25p p&p extra. Only £24.95 + £1.35 p&p. Access accepted.

JOHN DUDLEY & CO. LTD. (Dept. EE15), Carolyn House, Water Road, Wembley, Middx. (Wall Order). Tel. 01-435 5456 before noon.

SINGLES / HOLIDAYS / HOUSEPARTIES. Friendship introductions. Free details—Christian Friendship Fellowship, Dept. B94, Edenthorpe, Doncaster (SAE).

THE SCIENTIFIC WIRE COMPANY

PO Box 36, London E.4. Reg. Office, 22 Coningsby Gardens.

ENAMELLED COPPER WIRE

SWG	1 lb	8 oz	4 oz	2 oz
10-19	2-65	1-45	.75	.60
20-29	2-85	1-65	.90	.70
30-34	3-05	1-75	1-00	.75
35-40	3-40	1-95	1-15	.84
41-43	4-55	2-55	1-95	1-30
44-48	5-05	3-05	2-15	1-70
47	8-00	5-00	3-00	1-80
48	15-00	9-00	6-00	3-30

SILVER PLATED COPPER WIRE

	4.50	2.25	1.44	.90
14 & 16	4.50	2.25	1.44	.90
20 & 22	5.00	2.85	1.74	1.06
24 & 26	5.70	3.31	2.00	1.22
28 & 30	6.67	3.86	2.35	1.44

Prices include P & P and VAT. SAE brings list of copper & resistance Wires. Dealer enquiries invited.

AMATEUR ELECTRONIC CONSTRUCTOR, experienced, required by enthusiast short of time. Bedford 711538 weekends.

Receivers and Components

DISCOVER ELECTRONICS. Build forty easy projects including: Metal Detector; Wireless Transmitter; Breathalyser; Radios; Stethoscope; Lie Detector; Touch time-switches; Burglar Alarms, etc. Circuits, plans all for £1.29 including FREE circuit board. Mail only. RIDLEY PHOTO/ELECTRONICS, Box 62, 111 Rockspark Road, Uckfield, Sussex.

NO LICENCE EXAMS NEEDED

To operate this miniature, solid-state Transmitter-Receiver Kit. Only £9.75 plus 25p P&P. 'Brain-Freeze' 'em with a MINI STROBE Kit, pocket-sized 'lightning flashes', vari-speed, for discos and parties. A mere £4.10 plus 20p P&P. Experiment with a psychedelic DREAM LAB, or pick up faint speech/sounds with the BIG EAR sound-catcher; ready-made multi-function modules. £5.00 each plus 20p P&P. LOTS MORE! Send 20p for lists. Prices include VAT.

BOFFIN PROJECTS

4 CUNLIFFE ROAD, STONELEIGH EWELL, SURREY. (E.E.)

71b ASSORTED COMPONENTS £3-60. 3 1/2 lb £1.95. Small Audio Amplifiers, 3 Transistors equivalent to AC128, OC72, with circuit, 3 for £1. 300 small components, Transistors, Diodes £1-50. Wire ended Neon's 7p, 20 for £1. No postage. List 15p refundable. Insurance add 15p. J.W.B. RADIO, 2 Barnfield Crescent, Sale, Cheshire M33 1NL.

FULL SPEC COMPONENTS. Brand new no surplus. 9p for list. TERO, 109 Clitheroe Road, Salden, Blackburn, Lancs.

Don't ignore us, PROOVE FOR YOURSELF we're a name to remember for service, quality & value. We offer a very wide range at competitive prices, from resistors to colour TVs and test equipment; agents for R. S. Mullards, etc.

Send an SAE to

4 Auckland Court, London, SE27 9PE

... REEL SOUNDS the natural choice!

GUARANTEED ICs. 7400/10p 7447/55p 7473/24p 74121/24p 4000/15p 4011/15p 4017/15p 4027/32p 709/22p 741/22p 7805/60p NE555/25p. Many more! SAE full list CP ICs 22 Oakfield Road, Croydon, Surrey.

TIRRO's new mail order price list of electronic components now available on receipt of SAE. TIRRO Electronics, Grenfell Place, Maidenhead, Berks.

Tapes

C60 CASSETTE TAPES in library cases 32p each. POST PAID. Send your order to: A. W. & J. M. West, 56 Frankwell Drive, Coventry CV2 2FB.

Books and Publications

INTRODUCTION TO MICROPROCESSORS AND COMPUTING. Fifty pages of explanation and diagrams to get you started. Contents include: binary arithmetic, codes, microprocessor operation, machine language programming, summary of higher level languages and systems, glossary of terms. Price £2.30 plus 45p P&P. (Crossed cheques and POs.) Educational Data and Technical Services, 59 Station Road, Cogenhoe, Northampton NN7 1LU.

SIMPLIFIED TV REPAIRS. Full repair instructions individual British sets £5.00, request free circuit diagram. Stamp brings details unique TV publications. Aulse, 76 Church Street, Larkhall, Lanarkshire.

WHY NOT START YOUR OWN BUSINESS REWINDING ELECTRIC MOTORS

A genuine opportunity to success. **LARGE PROFITS.** You can't help but make money if you follow the easy, step by step, instructions in our fully illustrated Manual showing how to rewind Electric Motors, Armatures and Field coils as used in Vacuum Cleaners, Electric Drills and Power Tools. **NO PREVIOUS KNOWLEDGE IS REQUIRED,** as the Manual covers in 13 Chapters, where to obtain all the work you need, materials required, all instructions rewind charts and how to take data, etc. A goldmine of information. How to set up your home workshop and how to cost each job to your customer. £4.00 plus 30p P. & P. U.K. CWO to:

INDUSTRIAL SUPPLIES

102 Parrwood Road, Withington,
Manchester 20, Dept. EE

Record Accessories

STYLI for Hi-Fi, Music Centres, III list free for SAE. Also cartridges, leads, accessories. Details—Felstead Electronics (EE), Longley Lane, Gatley, Cheadle, Ches. SK8 4EE.

For Sale

NEW BACK ISSUES of "EVERYDAY ELECTRONICS". Available 60p each Post Free, open PO/Cheque returned if not in stock. **BELL'S TELEVISION SERVICES** 190 Kings Road, Harrogate, Yorkshire. Tel: (0423) 55885.

Service Sheets

SERVICE SHEETS for Radio, Television, Tape Recorders, Stereo, etc. With free fault-finding guide, from 50p and s.a.e. Catalogue 25p and s.a.e. **Hamilton Radio**, 47 Bohemia Road, St. Leonards, Sussex.

BELL'S TELEVISION SERVICE for service sheets of Radio, TV etc. £1 plus SAE. Colour TV Service Manuals on request. SAE with enquiries to **BTS**, 190 King's Road, Harrogate, N. Yorkshire. Tel: 0423 55885.

INDEX TO ADVERTISERS

Ace Mailtronix	187
Antex	Cov II
BI-Pak	134, 135
Birkett J.	170
B.N.R.E.S.	169, 189
Boffin Projects	190
Boss Industrial	133
Brewster S.R.	132
Bull J.	175
Calscope (Scopex)	176
Chromasonics	188
Chromatronics	187
Clef Projects	192
Collier McMillan (B.I.E.T.)	130
Crescent Radio	187
Dudley, John & Co. Ltd... ..	190
E.D.A.	132
Electroni-Kit	170
Electrovalue	183
Greenweld	183
Harveil	186
Heath-Kit	189
Home Radio	130
Industrial Supplies	191
Intertext (ICS)	191
Magenta Electronics	130
Maplin	Cov IV
Marshall A.	Cov III
Metac	186
Newnes-Butterworths	188
Phonosonics	176
Quinton Tool Supplies	192
Radio & TV Components	185
Reel Sounds	190
Scientific Wire Co.	190
Selray Book Co.	132
Swanley Electronics	191
Tamtronik	192
Timetron	190
Trident Exhibitions	188
TUAC	179
Veroboard	131
Vero Electronics	170
Watford Electronics	129

TECHNICAL TRAINING IN ELECTRONICS AND TELECOMMUNICATIONS

ICS can provide the technical knowledge that is so essential to your success: knowledge that will enable you to take advantage of the many opportunities open to you. Study in your own home, in your own time and at your own pace and if you are studying for an examination ICS guarantee coaching until you are successful.

City and Guilds Certificates:
Telecommunications Technicians
Radio, TV, Electronics Technicians
Technical Communications
Radio Servicing Theory
Radio Amateurs
Electrical Installation Work
MPT Radio Communications Certificate

Diploma Courses:
Colour TV Servicing
Electronic Engineering and Maintenance
Computer Engineering and Programming
Radio, TV, Audio Engineering and Servicing
Electrical Engineering, Installation and Contracting

POST OR PHONE TODAY FOR FREE BOOKLET

IGS To: International Correspondence Schools

Dept E268 Intertext House, London SW8 4UJ or telephone 622 9911

Subject of Interest

Name

Address

Tel:

Age:

Please mention
EVERYDAY ELECTRONICS
when replying to advertisements

SINCLAIR PRODUCTS

Microvision TV UK model £89.95. PDM35 £27.25. Mains adaptor £3.24. Case £3.25. DM350 £67.80. DM450 £96.50. DM235 £49.45. Rechargeable batts £7.50. Mains adaptor £3.70. Enterprise prog calculator £21.95. Cambridge prog calculator £13.13. Prog library £3.45. Mains adaptor £3.20.

COMPONENTS

Send SAE for full list. 1 lb FeCl £1.05. Daio pen 73p. 60 sq ins pcb 55p. Laminate cutter 75p. Small drill 20p. ZN414 £1.05. PCB and extra parts for radio £3.85. Case £1. 1N4148 1-4p. 1N4002 2-9p. 723 28p. 741 15p. NE555 23p. BC192b, bc183b, bc194b, bc212b, bc213b, bc214c 4-5p. Plastic equivs bc107, bc109 4-5p. 1W 5% E12 resistors 10R to 10M 1p. 0-8p for 50+ of one value. Electrolytics 16v. 5/12/15/10/22mf 5p. 100mf 6p. 100mf 10p. 1500 mf (PC) 3-4p. 10v 2mf 1-7p. 1000mf 5-1p. 2200mf 6p. Polyesters 250v. .015, .068, .1mf 1-4p. Ceramics 50v E5 22pf to 47n 2p. Polystyrenes 63v E12 10pf to 10in 3p. Zeners 400mW E24 2v7 to 33v 7p.

TV GAMES

Send SAE for data. AY-3-8500 + kit £8.95. Rifle kit £4.95. AY-3-8600 + kit £12.50. Stunt cycle chip + kit £10.90. Racing cars chip + kit £17.90.

TRANSFORMERS

6-0-6v 100ma 74p. 1ja £2.35. 0-3v 1ja £1.89. 9-0-9v 75ma 74p. 1a £2. 2a £2.60. 12-0-12v 100ma 80p. 1a £2.40.

IC AUDIO AMPS

With pcb. JC12 6W £1.60. JC20 10W £2.85. Send SAE for data.

BATTERY ELIMINATORS

3-way type 6/7/9v 300 ma £2.95. 100ma radio type with press-studs 9v £3.35. 9+9v £4.50. Stabilized type 3/6/7/9v 400ma £5.30. 12v car converters 3/4/6/7/9v 800ma £2.50.

BATTERY ELIMINATOR KITS

Send SAE for data. 100ma radio types with press-studs 4.5v £1.40. 6v £1.40. 9v £1.80. 4.5+4.5v £1.80. 6+6v £1.80. 9+9v £1.80. Stabilized 8-way types 3/4/6/7/9/12/15/18v 100ma £2.80. 1Amp £6.40. Stabilized power kits 2-18v 100ma £3.80. 2-30v 1A £8.95. 2-30v 2a £10.95. 12v car converter 6/7/9v 1a £1.35.

T-DEC AND CSC BREADBOARDS

S-dec £3.17. T-dec £4.02. U-dec £4.40. U-dec £6.73. 16 dil adaptor £2.14. exp300 £8.21. exp350 £3.40. exp 650 £3.30.

SWANLEY ELECTRONICS (Dept EE)
32 Gosdel Rd., Swanley, Kent.
Post 30p extra. prices include VAT.

TAMTRONIK LTD (DEPT EE)

217, Toll End Road, TIPTON, West Midlands DY4 0HW TEL: 021-557-9144

Printed Circuit Boards & KITS for EE projects

Mag Issue	PROJECT	Ref	P.C.B.	KIT	KIT CONTENTS (see key)
1978 Jan	Audio Visual Metronome	E001	+ 75	5-50	B.E.H.L.
	Touch Switch	E002	+ 84	1-80	B.E.
	Code Scrambler	E003	+ 81	5-54	B.E.J.L.
	Rapid Diode Check	E004	+ 52	2-23	B.E.H.L.
Feb	Car Alarm	E005	+ 80	5-48	B.E.G.J.L.
	Lead Tester	E006	51	4-17	B.E.H.L.
	Chaser Light Display	E007	+ 75	19-89	B.E.H.L.
	A.C. Meter Converter	E008	+ 60	5-37	B.E.H.L.
Mar	Audio Test (2 Pcb's)	E009	+1-74	14-78	B.F.G.J.
	C.R. Substitution Box	E010	—	8-45	E.H.L.
	Catch-a-Light	E011	+ 82	8-32	B.E.H.L.
	Weird Sound	E012	+ 62	5-29	B.E.H.L.
Apr	Roof Rack Alarm	E013	+ 80	—	—
	Mains Delay Switch	E014	+ 94	12-48	B.E.J.L.
	Pocket Timer	E015	+ 60	3-46	B.E.H.L.
May	Flash Meter	E016	+ 75	11-09	B.E.H.L.
	Mains Tester	E017	+ 54	1-35	B.E.H.
	Teach In—Power Amp	E018	—	1-55	E.
	Power Pack	E019	+ 70	5-71	B.E.H.L.
Jun	Tele-Bell	E020	+1-00	10-69	B.E.H.L.
	Instlu—Transistor Tester	E021	+ 65	8-10	B.E.G.H.L.
	Teach In—S.W. Receiver	E022	—	2-81	E.
	Power Slave	E023	+1-75	—	—
	Visual Continuity Tester	E024	—	4-09	E.H.L.
Jul	Auto Night Light	E025	+ 85	9-39	B.E.G.H.L.
	Short Wave Radio	E026	—	7-86	E.J.
	Quagmire	E027	+1-40	7-39	B.E.G.H.
	Logic Probe	E028	+ 50	2-76	B.E.G.H.L.
Aug	Slave Flask	E029	+ 55	2-72	B.E.
	M.W. Mini Radio	E030	50	4-78	B.E.J.L.
	Audio Freq. Signal Generator	E031	+ 85	12-41	B.E.J.L.
	CHRONOSTOP	E032	+2-50	29-20	C.E.G.K.M.P.
Sep	R.F. Signal Generator	E033	—	15-82	E.H.
	Sound to Light Unit	E034	—	5-14	E.H.L.
	Guitar Tone Booster	E035	75	4-06	B.E.H.L.
	Car Battery State Indicator	E036	85	1-62	B.E.
Oct	C.M.O.S. Radio	E037	+1-45	10-32	B.E.G.H.L.
	Fuse Checker	E038	—	1-60	E.H.L.
	Treasure Hunter	E039	+1-25	14-02	B.E.G.H.L.
	DOING-IT-DIGITALLY—TTL TEST BED	E040	—	20-85	N.
	DOING-IT-DIGITALLY—1st 6 PARTS	E041	—	3-80	N. (inc. add. comps.)
Nov	Audio Effects Oscillator	E042	—	2-40	E.H.L.
Dec	Water Level Alert	E043	+ 70	3-98	B.E.G.J.L.
Nov	SUBSCRIBERS TELE-TELE METER	E044	+2-80	19-50	C.E.G.K.M.P.
	Components to add 3rd digit to kit E044	E044A	—	2-75	E.
	Combination Lock (2 x PCB's)	E045	+2-55	19-90	B.E.H.L.
	Motline Game	E046	+ 75	4-57	B.E.H.
Oct	Mini-Module—Passive Mixer	E047	—	2-47	B.E.H.
Dec	Audible Flasher	E048	—	70	E.H.
	Fuzz Box	E049	+ 75	5-20	B.E.H.L.
	Vehicle Immobiliser	E050	+1-00	4-56	B.E.H.L.
	Mini-Module—Microphone Amp	E051	—	2-45	D.E.H.
1979 Jan	Mini Module—Continuity Tester	E052	+ 80	3-75	B.E.H.
	Lights Reminder	E053	+ 80	5-62	B.E.G.H.L.
	I'm First	E054	—	1-58	E.H.
	Roulette Inc. colour printed wheel (2 x PCB's)	E055	+3-40	7-90	B.E.H.
	Headphone Enhancer	E056	—	2-08	E.H.L.
DEC	EE 2020 Tuner Amp—Board A inc. RF unit	E057	3-65	54-44	B.E.G.H.
	EE 2020 Tuner Amp—Board B	E058	3-40	22-38	B.E.H.
	EE 2020 Tuner Amp—Board C	E059	1-45	4-30	B.E.H.
TO	EE 2020 Tuner Amp—Board D	E060	2-20	18-53	B.E.H.
	EE 2020 Tuner Amp—Board E Hardware & wire	E061	1-40	23-56	B.E.G.H.
FEB	EE 2020	E062	—	11-95	K.
		E063	10-50	123-00	B.E.G.K.

+ P.c.b.'s designed by Tamtronik to EE circuit specifications

KEY TO KIT CONTENTS

- A Vero-board(s)
- B Printed Circuit Board(s)
- C With screen printed component layout
- D Tag strip
- E ALL Resistors, potentiometers, capacitors, Semi-conductors
- F As E but with exclusions—Please ask for details
- G DIL and/or transistor sockets and/or soldercon pins
- H Hardware includes Switches, Knobs, Lamps & Holders, Fuses & Holders, Plugs & Sockets, Microphones, Transformers, Speakers, Meters, Relays, Terminal Blocks, Battery Connectors, etc. BUT excludes nuts, bolts, washers, connecting wire, Batteries and special miscellaneous items.
- J As H but with exclusions—Please ask for details
- K As H but including connecting wire
- L Suitable Case(s)
- M Suitable Case with Screen printed facia
- N Full kit to magazine specified standards
- P Kit with professional finish incorporating all prime features including screen printed PCB and case where appropriate

Doing-it-Digitally TTL ELECTRONIC TEST BED

Complete kit E040

£20-65

Components for first 6 parts E041 £3-60 (including additional components)

BOTH KITS (special price) £24-00

TELE-TEL

Nov. 78 Ref. E044

Subscribers phone call charge meter

A kit with a professional finish CASE with screen printed facia similar to magazine photograph but includes provision for 3rd digit.

An aluminium sub-facia panel is also provided with screen printed hole centres to allow access to preset potentiometers.

PCB designed to incorporate 3rd digit facility and is screen printed for ease of assembly.

Basic kit (2 digits) £19-50

(3 digits) £22-25

BARGAIN CORNER

100 x 1/2w 1k carbon resistors 30p

10 x 1w 5% 1k5 resistors 10p

10 x 1w 5% 7k5 resistors 12p

10 x 1w 5% 100R resistors 12p

10 x 6w 5% 390R wirewound 50p

10 x 47u 10v Axial Elec. Caps 25p

4 x NE55 Timer £1-00

Plug in mains PSU

3V6V/9V/12V DC

300mA suitable for calculators & T.V. Games £2-99

CHRONOSTOP

Aug. 78 Ref. E032

SPLIT 6 TAYLOR lap timing modes plus normal start/stop operation.

A kit with a professional finish including

CASE with screen printed facia

PCB with screen printed component layout

Full Assembly Instructions

PRICE INC. VAT £29-20

SOLDERING IRONS & ACCESSORIES

SRD 18 watt Iron Inc. No 20

Bit £3-78

Stand £3-25

Solder-Savbit 20 Inch 52p

Bit sizes No. 90 (1-5mm)

" " " 20 (3mm)

" " " 21 (4-5mm)

" " " 22 (6mm)

Ideal for Home Constructor

Tamtronik Ltd. reserves the right to change kit content without notice, where necessary to incorporate current modifications or to make valid substitution for temporarily unavailable components. The majority of the kits we advertise can be supplied from stock or compiled at short notice from component stocks held, but when ordering you should be prepared to allow at least ten days, and up to one month, for us to complete your order. Upon receipt of your order, acknowledgement will be made by return post within 48 hours detailing our control number for that transaction. In case of any enquiry please quote this number.

Kits can be supplied excluding P.C.B.'s and/or case. Send SAE for details naming kit and kit reference and free catalogue.

TRADE & EDUCATIONAL ENQUIRIES WELCOME

PRICES INCLUDE VAT P & P 30p

VISIT OUR SHOP AT

32 Market Place,
Great Bridge, Tipton,
West Midlands.

Telephone or Letter



PLIERS FOR ELECTRONICS

PROFESSIONAL-QUALITY TOOLS
—AT A PRICE YOU CANNOT AFFORD TO MISS!
4 1/2 inch PRECISION-MADE BOX-JOINTED PLIERS
WITH INSULATED HANDLES ONLY £3.95 EACH

No. 1 SIDE CUTTING No. 2 TOP CUTTING
No. 3 SNIPE NOSE No. 4 FLAT NOSE No. 5 ROUND NOSE
CASH WITH ORDER TO QUINTON TOOL SUPPLIES,
52 GRAYSWOOD PARK ROAD, BIRMINGHAM B32 1HE

NAME
ADDRESS

PLEASE SEND IMMEDIATELY Nos.....PLIERS
SAVE £2. SEND SET(S) Nos. 1-5 AT £17.75 per set

Clef Kits



Designer approved quality kits for Electronic Musical Instrument Construction.

JOANNA 72 & 88 PIANOS
Six and 7 1/2 Octave Electronic Pianos with unique Touch Sensitive Action, as used in the P.E. JOANNA, which electronically simulates piano key inertia—a feature not available in any other design. A new physical layout has been adopted to simplify construction.

P.E. STRING ENSEMBLE
The only kit available to the proven A. J. Boothman Design for this versatile String Machine.

Send S.A.E. to:

Clef Products (Dept E.E.)
16 Mayfield Road, Bramhall, Cheshire SK7 1JU.

Marshall's Electronics

A. Marshall (London) Ltd., Dept. PE. Head Office mail order: Kingsgate House, Kingsgate Place, NW6 4TA. Tel: 01-624 8005
Retail Sales London: 40-42 Cricklewood Broadway, NW2 3ET. Tel: 01-452 0161/2. Telex: 21492. London: 325 Edgware Road, W2. Tel: 01-723 4242.
Glasgow: 85 West Regent Street, G2 2QD. Tel: 041-332 4133. Bristol: 1 Straits Parade, Fishponds Road, B516 2LX. Tel: 0272 654201.

2N1304	0.80	2N3905	0.18	AC151	0.43	BC147C	0.13
2N1305	0.80	2N3906	0.18	AC152	0.54	BC148	0.13
2N1306	1.00	2N4036	0.72	AC153	0.59	BC148A	0.13
2N1307	1.00	2N4037	0.60	AC153K	0.59	BC149B	0.13
2N2129	0.38	2N4400	0.16	AC176K	0.70	BC148C	0.13
2N2219A	0.39	2N4401	0.20	AC176	0.54	BC149	0.13
2N2389	0.27	2N4402	0.20	AC187	0.59	BC149B	0.13
2N2395A	0.27	2N4403	0.20	AC187K	0.65	BC149C	0.13
2N2526	1.70	2N4559	0.32	AC195	0.54	BC157	0.15
2N2547	1.55	2N6027	0.84	AC188K	0.65	BC157A	0.15
2N2904	0.31	2N6121	0.41	AD136	2.75	BC157B	0.15
2N2905	0.31	2N6122	0.44	AD142	1.45	BC158	0.15
2N2906	0.25	2N6123	0.48	AD143	1.45	BC158A	0.15
2N2907	0.25	2N6124	0.45	AD149	2.85	BC158B	0.15
2N2926	0.17	2N6125	0.47	AD153	3.10	BC159	0.17
2N3053	0.25	2N6126	0.48	AD161	1.00	BC159A	0.17
2N3054	0.72	3N81	3.50	AD162	1.00	BC159B	0.17
2N3055	0.75	3N140	1.10	AF124	0.70	BC160	0.38
2N3402	0.21	3N141	0.95	AF125	0.70	BC169	0.13
2N3404	0.21	3N142	0.75	AF200	1.30	BC169B	0.13
2N3405	0.21	3N200	0.85	AF235	0.70	BC169C	0.13
2N3663	0.29	3N201	1.35	BC107	0.16	BC177	0.22
2N3702	0.14	40361	0.55	BC107A	0.16	BC177A	0.22
2N3703	0.14	40362	0.55	BC107B	0.16	BC177B	0.22
2N3704	0.14	40363	1.45	BC108	0.16	BC178	0.22
2N3705	0.14	40406	0.82	BC108B	0.16	BC178A	0.22
2N3706	0.14	40410	0.82	BC108C	0.16	BC178B	0.22
2N3708	0.12	40411	3.10	BC109	0.16	BC179A	0.22
2N3709	0.12	40412	0.68	BC109B	0.16	BC179B	0.22
2N3710	0.12	40414	4.95	BC109C	0.16	BC179C	0.22
2N3711	2.15	40594	0.87	BC140	0.30	BC182A	0.12
2N3712	2.20	40595	0.98	BC141	0.32	BC182B	0.12
2N3713	3.15	40636	1.37	BC142	0.32	BC182C	0.12
2N3819	0.36	40673	0.80	BC143	0.32	BC182L	0.12
2N3820	0.39	AC126	0.48	BC147	0.13	BC183	0.12
2N3903	0.20	AC178	0.48	BC147A	0.13	BC183A	0.12
2N3904	0.18	AC178B	0.48	BC147B	0.13	BC183B	0.12

TRANSISTORS

See catalogue for full range

BCY72	0.18	BFK68	0.30	MJ4502	4.90	TP41C	0.97
BCY77	0.70	BFK89	1.37	MJ4504	0.62	TP42A	0.86
BD121	2.20	BFV50	0.35	MJE350	0.62	TP42C	1.08
BD124	2.20	BFV51	0.35	MJE370	0.62	TP110	0.77
BD131	0.55	BFV51	0.35	MJE371	0.65	TP112	0.93
BD132	0.75	BFV90	1.35	MJE520	0.50	TP115	0.83
BD135	0.40	BR101	0.55	MJE521	0.70	TP117	0.97
BD136	0.40	BR101	0.55	MJE525	1.65	TP120	0.89
BD137	0.41	BSY54A	0.37	MJE3065	1.05	TP122	1.04
BD138	0.49	BZ008	1.80	MP8111	0.40	TP125	0.93
BD139	0.43	BU105	1.55	MP8112	0.45	TP127	1.11
BD140	0.16	BU109	0.16	MP8113	0.50	TP130	1.16
BD141	0.17	BU204	2.70	MP8114	0.50	TP132	1.33
BD142	0.40	BU206	2.00	MP8121	0.40	TP132	1.33
BD143	0.16	BU209A	0.44	MP8122	0.45	TP135	1.26
BD144	0.16	BU209B	0.59	MP8123	0.50	TP137	1.45
BD145	0.16	BU209C	0.59	MP8124	0.50	TP140	2.23
BD146	0.16	BU209D	0.59	MPF102	0.33	TP142	2.57
BD147	1.55	J310	0.64	MPF103	0.44	TP145	2.47
BD148	1.55	J310	0.64	MPF104	0.44	TP147	2.84
BD149	0.22	MPF105	0.44	TP2955	0.70		
BD150	0.22	MPF106	0.44	TP3055	0.59		
BD151	0.22	MPF107	0.44	TP3055	0.59		
BD152	0.22	MPF108	0.44	TP3055	0.59		
BD153	0.22	MPF109	0.44	TP3055	0.59		
BD154	0.22	MPF110	0.44	TP3055	0.59		
BD155	0.22	MPF111	0.44	TP3055	0.59		
BD156	0.22	MPF112	0.44	TP3055	0.59		
BD157	0.22	MPF113	0.44	TP3055	0.59		
BD158	0.22	MPF114	0.44	TP3055	0.59		
BD159	0.22	MPF115	0.44	TP3055	0.59		
BD160	0.22	MPF116	0.44	TP3055	0.59		
BD161	0.22	MPF117	0.44	TP3055	0.59		
BD162	0.22	MPF118	0.44	TP3055	0.59		
BD163	0.22	MPF119	0.44	TP3055	0.59		
BD164	0.22	MPF120	0.44	TP3055	0.59		
BD165	0.22	MPF121	0.44	TP3055	0.59		
BD166	0.22	MPF122	0.44	TP3055	0.59		
BD167	0.22	MPF123	0.44	TP3055	0.59		
BD168	0.22	MPF124	0.44	TP3055	0.59		
BD169	0.22	MPF125	0.44	TP3055	0.59		
BD170	0.22	MPF126	0.44	TP3055	0.59		
BD171	0.22	MPF127	0.44	TP3055	0.59		
BD172	0.22	MPF128	0.44	TP3055	0.59		
BD173	0.22	MPF129	0.44	TP3055	0.59		
BD174	0.22	MPF130	0.44	TP3055	0.59		
BD175	0.22	MPF131	0.44	TP3055	0.59		
BD176	0.22	MPF132	0.44	TP3055	0.59		
BD177	0.22	MPF133	0.44	TP3055	0.59		
BD178	0.22	MPF134	0.44	TP3055	0.59		
BD179	0.22	MPF135	0.44	TP3055	0.59		
BD180	0.22	MPF136	0.44	TP3055	0.59		
BD181	0.22	MPF137	0.44	TP3055	0.59		
BD182	0.22	MPF138	0.44	TP3055	0.59		
BD183	0.22	MPF139	0.44	TP3055	0.59		
BD184	0.22	MPF140	0.44	TP3055	0.59		
BD185	0.22	MPF141	0.44	TP3055	0.59		
BD186	0.22	MPF142	0.44	TP3055	0.59		
BD187	0.22	MPF143	0.44	TP3055	0.59		
BD188	0.22	MPF144	0.44	TP3055	0.59		
BD189	0.22	MPF145	0.44	TP3055	0.59		
BD190	0.22	MPF146	0.44	TP3055	0.59		
BD191	0.22	MPF147	0.44	TP3055	0.59		
BD192	0.22	MPF148	0.44	TP3055	0.59		
BD193	0.22	MPF149	0.44	TP3055	0.59		
BD194	0.22	MPF150	0.44	TP3055	0.59		
BD195	0.22	MPF151	0.44	TP3055	0.59		
BD196	0.22	MPF152	0.44	TP3055	0.59		
BD197	0.22	MPF153	0.44	TP3055	0.59		
BD198	0.22	MPF154	0.44	TP3055	0.59		
BD199	0.22	MPF155	0.44	TP3055	0.59		
BD200	0.22	MPF156	0.44	TP3055	0.59		

NEW 1979 CATALOGUE

48 page catalogue - new enlarged micro section - largest range of quality components from franchised suppliers available in the UK. All VAT inclusive prices. Over 8,500 line items plus lots more. 50p post paid or 40p to callers at any of our four branches.

MAIL ORDER

Quick service on all orders - please add 40p for P & P. Telephone orders £10 minimum.

Credit cards welcome

LINER

See catalogue for full range

CA3018	0.75	LM377N	1.80	NE558N	1.98
CA3018A	1.10	LM378N	2.40	NE560N	4.50
CA3020	2.20	LM379S	4.25	NE561N	4.50
CA3020A	2.20	LM380N-8	0.96	NE562N	4.50
CA3028A	0.90	LM380N-14	1.08	NE565CN	1.00
CA3028B	1.25	LM381N	1.69	NE567N	1.00
CA3030	1.50	LM381N	1.69	NE567N	1.00
CA3030A	2.20	LM382N	1.32	NE571N	4.95
CA3038	2.90	LM384N	1.55	SAU110	2.15
CA3038A	4.10	LM388N	0.88	SAS560	2.70
CA3045	1.55	LM387N	1.10	SAS570	2.70
CA3046	0.77	LM389N	1.00	SN76001N	1.30
CA3048	2.45	LM392N	1.00	SN76003N	3.08
CA3052	1.78	LM700C	0.81	SN76008KE	1.95
CA3080	0.85	LM700CH	0.70	SN76103N	2.04
CA3080A	2.10	LM700S-8	0.50	SN76103ND	1.72
CA3086	0.50	LM389B	1.43	SN76103E	1.80
CA3088E	1.87	LM710CH	0.67	SN76023N	2.05
CA3089E	2.90	LM710C	0.48	SN76023ND	1.72
CA3090	4.00	LM711CN	0.48	SN76033N	3.08
CA3130	1.06	LM723CH	0.62	SO41P	1.35
CA3140	1.04	LM723C-14	0.46	SO42P	1.35
LF355N	0.80	LM741C-8	0.50	TAD100	2.00
LF355N	0.80	LM741C-8	0.50	TA283	1.35
LF357N	0.80	LM741C-14	0.60	TA300	3.70
LF13201N	3.00	LM747CN	0.78	TA521	1.10
LF13311N	3.00	LM748-8	0.50	TA522	1.85
LF1341N	0.49	LM1333N	1.15	TA550	0.48
LF13741N	0.38	LM1304N	1.52	TA661B	2.30
LM3018	0.30	LM1305N	1.22	TA662A	1.50
LM307N	0.50	LM1307N	1.52	TA661A	2.65
LM308N	0.95	LM1310N	2.10	TA661B	1.45
LM309KC	1.55	LM1311N	1.30	TA700	3.50
LM317K	1.35	LM1450N	0.45	TA930N	3.00
LM317MP	1.35	LM1456N	0.97	TA930B	1.45
LM317T	2.20	LM1800N	1.94	TBA120	0.80
LM318N	2.45	LM1801N	2.25	TBA510	1.76
LM320T-5	1.86	LM1808N	2.10	TBA520	2.60
LM320T-12	1.86	LM1810N	6.20	TBA520	2.72
LM320T-15	1.86	LM1820N	1.16	TBA530	2.35

EXPAND AND GROW WITH KIM

AMERICA'S FASTEST SELLING MOST POPULAR 6502 BASED SYSTEM - EASILY EXPANDED INTO A PERSONAL HOME COMPUTER

The basic KIM 2 includes Hex keyboard and display, audio cassette interface, VDU interface, Superb documentation, 2K monitor software in ROM. Powerful instruction set. The beauty of this system is the ease of extension and versatility with all the possible future requirements catered for. Up and running in minutes. Any future benefits from Commodore's PET computer will be software compatible with their KIM system and In fact your KIM system has the design flexibility to suit any requirements.

KIM IS EXPANDABLE - Expand as you learn up to 65K

- KIM 1 - Basic board with above features assembled £108.00
- KIM 3 - 8K static RAM card plugs into motherboard £141.00
- KIM 4 - Motherboard (takes 6 x KIM 3) + power supply £75.50

The Commodore PET and KIM are both based on the 6502 micro VDU INTERFACE - VDU card - takes control £151.00

Fully assembled TTY Card - ASC II keyboard In - converts TV set to cheap computer terminal via aerial socket. Also standard RS232 connector for micro computer or modem - 16 lines x 64 characters

SEND SAE NOW FOR FULL DETAILS.

PET 2001 COMPUTER

Suitable for educational, commercial, scientific and domestic applications

Memory - 8k ram (expandable to 32k externally)

Display - 1000 characters 40col x 25 rows

Keyboard - full ASCII character set + graphics separate numeric keyboard

Other features include - reliable cassette unit, comprehensive I/O facilities, 8k resident basic interpreter

Send S.A.E. 9" x 6" for data and software list

TTL

See catalogue for full range

SN7400N	0.17	SN74123N	0.55	74C107N	1.22	74LS38N	0.32
SN7401N	0.17	SN74124N	1.20	74C150N	4.14	74LS40N	0.26
SN7402N	0.17	SN74125N	0.45	74C151N	2.47	74LS42N	0.80
SN7403N	0.17	SN74131N	0.56	74C154N	3.28	74LS47N	1.08
SN7404N	0.15	SN74145N	0.85	74C157N	2.21	74LS48N	1.00



A quality range of British made electrical accessories plus a 'How to ...' book. Do your own home electrical work with complete confidence. See cat. pages 129 to 134.



This superb organ—build the first working section for just over £100. Full specification in our catalogue.



A range of highly attractive knobs is described in our catalogue. Our prices are very attractive too!

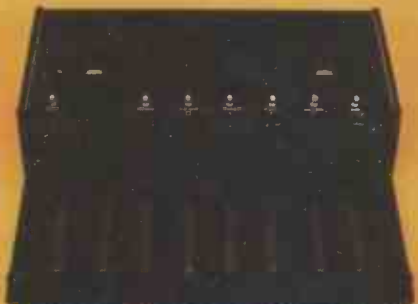

Add-on bass pedal unit for organs. Has excellent bass guitar stop for guitarists accompaniment. Specification in our catalogue.



A pulse width train controller for smooth slow running plus inertia braking and acceleration. Full construction details in our catalogue.



Touch operated rhythm generator, the 'Drumsette'. Construction details 25p. (Leaflet MES49). Specification in our catalogue.



Mobile amateur radio, TV and FM aerials plus lots of accessories are described in our catalogue.



The 3800 synthesiser build it yourself at a fraction of the cost of one ready-made with this specification. Full details in our catalogue.



A wide range of disco accessories at marvellous prices. Our catalogue has all the details.

MAPLIN

ELECTRONIC SUPPLIES LTD

All mail to:—

P.O. Box 3, Rayleigh, Essex SS6 8LR.
Telephone: Southend (0702) 554155.

Shop: 284 London Road,
Westcliff-on-Sea, Essex.
(Closed on Monday).

Telephone: Southend (0702) 554155.



A superb technical bookshop in your home! All you need is our catalogue. Post the coupon now!



An attractive mains alarm clock with radio switching function and battery back up! Complete kit with case only £11.88 (incl. VAT & p & p) MA1023 module only £2.45 (VAT)



A massive new catalogue from Maplin that's even bigger and better than before. If you ever buy electronic components, this is the one catalogue you must not be without. Over 280 pages—some in full colour—it's a comprehensive guide to electronic components with hundreds of photographs and illustrations and page after page of invaluable data.

Our bi-monthly newsletter contains guaranteed prices, special offers and all the latest news from Maplin.



A 63-key ASCII keyboard with 625-line TV interface, 4-page memory and microprocessor interface. Details in our catalogue.

Post this coupon now for your copy of our 1979-80 catalogue price 75p.

Please send me a copy of your 280 page catalogue as soon as it is published (8th Jan. 1979). I enclose 75p but understand that if I am not completely satisfied I may return the catalogue to you within 14 days and have my 75p refunded immediately. If you live outside U.K. send £1 or ten International Reply Coupons.

NAME _____

ADDRESS _____