

Easy to build projects for everyone

Everyday ELECTRONICS

NOV. 77
40p

Probe-less
CONTINUITY
TESTER

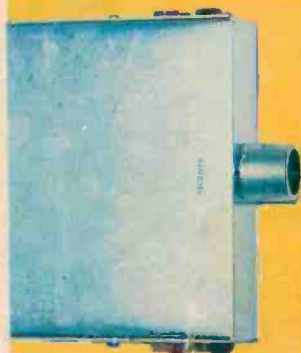

ULTRASONIC
REMOTE
CONTROL
SYSTEM

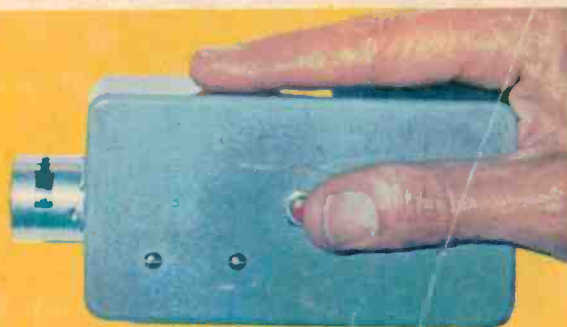

FIND
the
PAIR

SPECIAL
OFFER!



SOLDERING IRON

LOOK! Here's how you master electronics.

...the practical way.

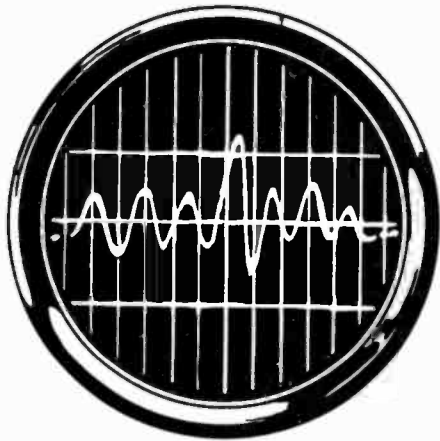

This new style course will enable anyone to have a real understanding of electronics by a modern, practical and visual method. No previous knowledge is required, no maths, and an absolute minimum of theory.

You learn the practical way in easy steps mastering all the essentials of your hobby or to further your career in electronics or as a self-employed electronics engineer.

All the training can be carried out in the comfort of your own home and at your own pace. A tutor is available to whom you can write, at any time, for advice or help during your work. A Certificate is given at the end of every course.

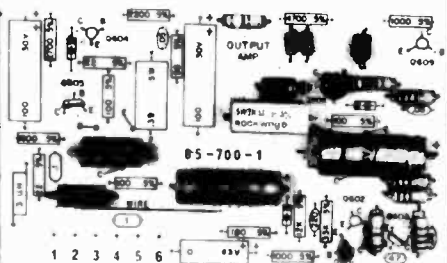
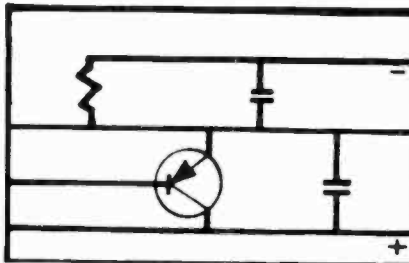
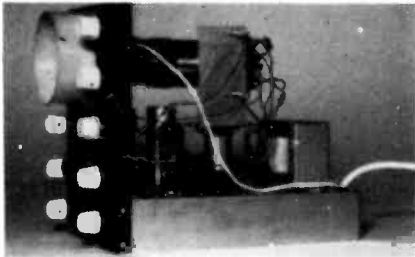

1 Build an oscilloscope.

As the first stage of your training, you actually build your own Cathode ray oscilloscope! This is no toy, but a test instrument that you will need not only for the course's practical experiments, but also later if you decide to develop your knowledge and enter the profession. It remains your property and represents a very large saving over buying a similar piece of essential equipment.

2 Read, draw and understand circuit diagrams.

In a short time you will be able to read and draw circuit diagrams, understand the very fundamentals of television, radio, computers and countless other electronic devices and their servicing procedures.

3 Carry out over 40 experiments on basic circuits.

We show you how to conduct experiments on a wide variety of different circuits and turn the information gained into a working knowledge of testing, servicing and maintaining all types of electronic equipment, radio, t.v. etc.

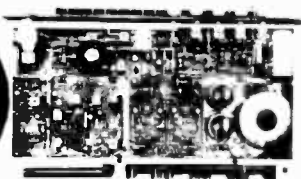

All students enrolling in our courses receive a free circuit board originating from a computer and containing many different components that can be used in experiments and provide an excellent example of current electronic practice.

Free!

To find out more about how to learn electronics in a new, exciting and absorbing way, just clip the coupon for a free colour brochure and full details of enrolment.

British National Radio & Electronic School

P.O. Box 156, Jersey, Channel Islands.

NAME _____

ADDRESS _____

EEB11 Block caps please

SOUND TO LIGHT UNIT

Add colour or white light to your amplifier. Will operate 1, 2 or 3 lamps (maximum 450W). Unit in box all ready to work. £7.95 plus 95p VAT & Postage.



MAINS OPERATED SOLENOIDS



Model TT2—small but powerful 1in. pull—approx. size 1½ × 1½ × 1½in. £1.00.
Model 4001—2in. pull. Size 2½ × 2 × 1½in. £1.50.
Model TT10—1½in. pull. Size 3 × 2½ × 2in. £4.50.
Prices include VAT & postage.

PP3/PP9 REPLACEMENT MAINS UNIT

Japanese made in plastic container with leads size 2" × 1½" × 1½". This is ideal to power a calculator or radio. It has a full wave rectified and smoothed output of 9 volts suitable for a loading of up to 100mA. £2.53.



3 NEW BOOKS BY G. C. DODDS

Practical Test Equipment describes the theory, the construction, and the operation of 7 instruments for beginners to make from readily obtainable components: Transistor Tester—Transistor checker—Square wave oscillator—AC Bridge—Signal injector and signal tracer combined in a Multi Checker—Dual range ohm metre, the final chapter deals with a range of test leads and give more detailed notes on signal injecting and signal tracing.
Published price 75p our price 50p.

Practical Electronic Projects describes the construction and uses of 9 projects for beginners, all made from easily obtainable parts describes construction and operation of:—Windscreen wiper delay—Electronic Siren—Drum beat simulator—Lamp dimmer—Light/Dark operated switch—electronic bird, emotional state indicator—telephone amplifier—Solar powered radio.
Published price 75p our price 50p.

Shortwave Receivers for Beginners after a few pages of general notes on wave bands, band spreading etc, the author gives constructional details of a one transistor radio then a two transistor and finally a multi stage receiver with band spreading and reaction.
Published price 60p our price 45p.

FREE If you purchase the other two you get the shortwave one free.

RADIO STETHOSCOPE

Easiest way to fault find, traces, signal from aerial to speaker, when signal stops you've found the fault. Use it on Radio, TV, amplifier, anything. Kit comprises transistors and parts including probe tube and twin stetho-set. £3.95 VAT and postage inc.



Breakdown Parcel—four unused, made for computer units containing most useful components, and these components unlike those from most computer panel, have wire ends of usable length. The transistors for instance have leads over 1" long—the diodes have approx. ½" leads.—17 assorted transistors—38 assorted diodes—60 assorted resistors and condensers—4 gold plated plugs in units which can serve as multipin plugs or as hook up boards for experimental or quickly changed circuits (note we can supply the socket boards which were made to receive these units). The price of this four units parcel is £1 including VAT and post (considerably less than value of the transistor or diodes alone) DON'T MISS THIS SPLENDID OFFER.



MINI-MULTI TESTER



Amazing, deluxe pocket size precision moving coil instrument—jewelled bearings—1000 opv—mirrored scale.
11 Instant ranges measure:—DC volts 10, 50, 250, 1000 AC volts 10, 50, 250, 1000 DC amps 0.1 mA and 0.100 mA Continuity and resistance 0-150K ohms.
Complete with insulated probes, leads, battery, circuit diagram and instructions.
Unbelievable value only £5.50p + 50p post and insurance.

FREE

Amps ranges kit enable you to read AC and DC current from 0-10 amps, directly on the 0-10 scale. It's free if you purchase quickly but if you already own a mini tester and would like one send £1.50p.

MULLARD UNILEX

A mains operated 4 + 4 stereo system. Rated one of the finest performers in the stereo field this would make a wonderful gift for almost any one in easy-to-assemble modular form and complete with a pair of Plessey speakers (this should sell at about £30—but due to a special bulk buy and as an incentive for you to buy this month we offer the system complete at only £14.00 including VAT and postage.



DISTRIBUTION PANELS

Just what you need for work bench or lab. 4 × 13 amp sockets in metal box to take standard 13 amp fused plugs and on/off switch with neon warning light. Supplied complete with 6 feet of flex cable. Wired up ready to work. £2.75, VAT & postage 85p.



SHORTWAVE CRYSTAL SET

Although this uses no battery it gives really amazing results. You will receive an amazing assortment of stations over the 19, 25, 29, 31 metre bands. Kit contains chassis front panel and all the parts £1.90—crystal carphone 55p including VAT and postage.



ROOM THERMOSTAT

Famous Satchwell, elegant design, intended for wall mounting. Will switch up to 20 amps at mains voltage, covers the range 0-30°C. Special snip this month £2.50, post and VAT paid.



MAINS RELAYS



With triple 10 amp changeover contacts—operating coil wound for 230 volts AC, chassis mounting, one screw fixing, ex unused equipment 60p each, 10 for £5 post and VAT paid.

TEACH IN '78

Start right away.
Order the parts for this series—send £3 deposit and £2 monthly for 5 months or £12 cash

CENTRAL HEATING HEARTS

Randal (illustrated) replacement in 3060 etc. £6.75.
HORTSMAN £6.30
SMITHS Controller 10/100 complete in wall mounting case £7.50.

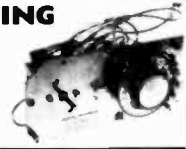

THIS MONTH'S SNIP HI FI RECORD PLAYER



Stereo 5 watts per channel. Russian made but guaranteed repairable. Travel damaged or test line rejects, in need of attention, consist of mains operated record deck—mounted in wooden plinth with super 10 watt amplifier. Controls are "on/off", "mono/stereo", "Base", "Treble", "Balance", "Volume". We are offering these at price of record deck only so are a bargain not to be missed only £6.75p, post £2.00p. Note cartridge and all spares are available at low prices.

TANGENTIAL HEATER UNIT

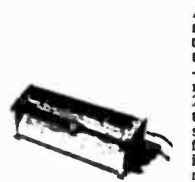

A most efficient and quiet running blower-heater by Solatron—same type as is fitted to many famous name heaters—Comprises mains induction motor—long turbo fan—split 2 kw heating element and thermostatic safety trip—simply connect to the mains for immediate heat—mounts in a simple wooden or metal case or mount direct onto base of say kitchen unit—price £4.95 post £1.50 control switch to give 2kw, 1kw, cold blow or off available 60p extra.

TERMS: Cash with order—but orders under £6 must add 50p to offset packing etc. BULK ENQUIRIES INVITED. PHONE: 01-688 1833

J. BULL (ELECTRICAL) LTD
(Dept. EE), 103 TAMWORTH RD.
CROYDON CR9 1SG

IT'S FREE

Our monthly Advance Advertising Bargains List gives details of bargains arriving or just arrived—often bargains which sell out before our advertisement can appear—it's an interesting list and it's free—just send S.A.E. Below are a few of the Bargains still available from previous lines.

Spare: for Party Times. Circuit diagrams—50p, Cartidges £2.25, Record mats 85p, Mains transformers £3.00, Amplifiers £2.50, Gram motors £3.00. Ask about any other spares you require—and when you have it working o.k. we can supply the proper Party Time speakers, £9.50 a pair. All prices include post and VAT.

250 watt Mains Transformers—40v secondary, made up of four 10v sections, all the ends of which are brought out to the tag panel, so they can be separated if required—also the 10v coils are all a very heavy gauge wire, thick enough to take 2.5 amps, so any one of these coils can be loaded up to the full 250 watts, or this wattage can be spread over two or more coils. We can recommend this transformer for heavy duty battery charging—high power amplifier—plastic sealing—soil heating—light welding and dozens of other jobs. Price, still only £4.50 + 36p. Post £1.50 + 12p.

Save Yourself A Fortune. Build your own rechargeable batteries; using our ex-Home Office nickel cadmium cells—these cells are German made, ref. NCB 22M, which we understand are ½ amp hour rating. Normally, these cells retail at about £1.00 each, but a special purchase enables us to offer them at only 30p each, or four for £1.08. Post 30p + 3p.

Free Gift: All those who purchase 12 cells, will receive, free of charge, a mains operator ni-cad charger unit. DON'T miss this offer.

Self Repairing Fuses—not exactly; but our magnetic circuit breakers do the same job and are a boon for the test bench, saving valuable time. In the event of a short, they trip almost instantly, before the fuse can blow. They are rated at 1.5 amps (enough for the average repair bench). Simply wire it in parallel with your bench switch—you would then use the circuit breaker to switch bench supply on, but keep your normal switch for loads over 1.5 amps—a real bargain at £1.00 + 8p.

9v-0-9v Mains Transformer. "C" core construction, ½ amp continuous rating. Very compact, but there is still room to add a few extra turns for an extra winding, or to change the voltage to, say, 20v. In fact, the transformer uses a separate bobbin for the secondary—its not varnished so if you want a special voltage transformer quickly, then this could be the answer. Price £1.50 + 12p. Post 20p + 2p.

6.5v-0-6.5v Mains Transformer. Continental make, but has standard 230/40v 50hz primary and is upright mounting, and is rated at 0.75A. Price £1.75 + 14p. Post 20p + 2p.

Multicore Flex Cables: 14 coloured coded cores, rated at 3 amp, with circular p.v.c. outer—suitable for module inter-connections etc. 10 meter coil £1.00 + 8p.

Sub-Minature Variable Resistor. 500 ohms, p.c.b. mounting, have had dozens of applications. 10 for £1.00 + 8p.

Vacuum Relay. American made (EIMEC), ref. no. V.S.2 This has a change over action and looks suitable for aerial switching and similar applications. Price £2.50 + 20p. Post 60p + 5p. Operation is by coil over one arm—we do not include the coil, nor do we have any in stock, but they are promised; watch future News letters for details.

Rotary Switch. Heavy duty—made for switching d.c., these will make and break really high a.c. currents. We guess these at 30 or more amp—we have type (A) cover engraved on/off. Price £1.00. (B) cover engraved "on", "high", "off", "low". Six wires can be brought to the switch and would be joined as follows: 1 to 5 and 6 to 2 and in the other position, 1 to 3 and 2 to 4. Prices: (A) £1.00 + 8p. (B) £1.50 + 12p.

Motor with Fan Blades, mains operated, nicely made motor with long bearing for quiet operation and good quality set of fan blades, made by Smiths (air moving division). It is a simple matter to make a stand out of 14 gauge (clothes line) wire, you then have a simple but efficient desk fan. Or if you fit this behind a heating element, in a box, you have a fan heater. Price of motor and fan, £2.50 + 32p. Post 50p + 6p.

Mains Driven Blowers: all have square or oblong outlets for easy fitting to cabinet or trunking. We have a small one, outlet size approximately 2" square, made by Woods. This is a centrifugal type of blower. Price £4.00 + 50p. Post 20p + 3p. We also have a larger unit, made by Smiths, outlet size 3" × 3½". Actually it is a simple matter to stand this on a shelf or counter, put a few paper streamers to the outlet, and you start feeling cooler at once. The motor and blades are out of harms way inside the casing. Price £5.75 + 46p. Post 80p + 6p.

This Month's Special Lighting Snips—camping or emergency lights, all made up ready to join to your 12v car battery. Two models.—21, 13w. Price £3.00 + 24p. Post 60p + 5p, and 12", 8w. Price £2.75 + 22p. Post 50p + 4p.

BLACK LIGHT

As used in disco's and stage effects etc.—virtually no white light appear until rays impinge on white collars and cuffs etc—we offer mains B.L. lamps, 175 watts plugs into any lamp holder requires no choke or control gear price £7.00 + 95p post and VAT or for glamorising rock specimens, looking for watermarks etc. a 9" 6 watt tube with starter, choke lamp holds, etc. all for £4.50 post and VAT paid.



ELECTRONICS

22 Newland Street, Kettering, Northants.
 Mail order, phone Kettering 83922.
 All other enquiries Kettering 520910.
 Shop open, Monday to Saturday 9.00 to 6.00.
 Early closing Thursday 1.00 p.m.
 Closed daily for lunch 1.00 to 2.00.

**PROBABLY THE LARGEST ALL
 ELECTRONICS STORE IN THE
 UK WITH 1000's OF SQUARE
 FEET DEVOTED TO THE BEST
 IN CONSTRUCTIONAL
 ELECTRONICS.**

TEACH-IN '78 COMPONENT KIT

Send for the complete set of components for the Teach-In '78 Series and we'll also send you a

FREE TEACH-IN QUERY COUPON

Send this back to us with details of any queries or problems you have about the series and our technical department will do their best to help you out.

EACH COMPONENT KIT CONTAINS

95 resistors 4 potentiometers
 37 capacitors 26 semiconductors
 plus ferrite, speaker, wires, bulb,
 batteries, cable, clips and knobs etc.

everything you're going to need, specially selected
 and all in one package.....£16.00

Plus all the back-up service you'd expect from the UK's largest electronic store.

Send sae for full list of kit contents and individual prices.

Telephone orders accepted for Barclaycard & Access

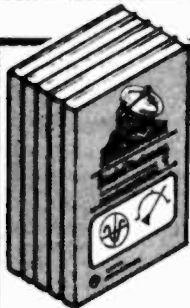
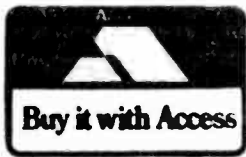

ANNOUNCING A NEW SET OF BASIC ELECTRONICS

This 5 volume set contains over 500 pages.
 Bound in stiff linen. Cover size 8 1/2 in x 5 in.
 Price £7.50 per set (we pay the postage).

- Book 1. Introducing Electronics Book 4. Meters/Voltage-dividers
 Book 2. Resistors/Capacitors Book 5. Transistor Project Circuitry
 Book 3. Inductors/Diodes

The manuals are unquestionably the finest and most up-to-date available and represent exceptional value.

This series has been written in a fascinating, absorbing and exciting way, providing an approach to acquiring knowledge that is a very enjoyable experience. Suitable for industrial trainees, City and Guilds students, DIY enthusiasts and readers of electronic journals.

Each part explains electronics in an easy-to-follow way, and contains numerous diagrams and half tone blocks with construction details and circuit diagrams for making the following transistor projects: Lamp Flasher, Metronome, Wailer, Photographic/Monostable Timer, Metal Locator, Geiger Counter, Radio Receiver, Intercom., Intruder Alarm, Electronic Organ, Battery Eliminator, Anemometer, Sound Switch, Light and Water-operated Switches, Pressure-operated Switches, Light meter, Radio Thermometer, Ice Alarm, etc., etc.

FREE. A list of components for constructing the projects.

Order now:
 Selray Book Company
 60 Hayes Hill
 Bromley
 BR2 7HP

OUR 100% GUARANTEE

Should you decide to return the set after 10 days examination, your money will be refunded by return of post.

Amount enclosed: £

Name:

Address:

ET1

PHILIPS



YOU & PHILIPS HI-FI KITS

The top sellers for home assembly in Europe – now available in the U.K.

Now – read all about the Philips range of quality kits for home assembly – mixers, amplifiers, speakers, etc, etc. Send today to

S.S.T. Distributors (Electronic Components) Ltd.,
 West Road, Tottenham, London N17 0RN

Please send me, quickly, the new colour catalogue.

E111

Name

Address

Postcode



free SEND TODAY!

S.S.T. Distributors is a member of the Philips Group of Companies.

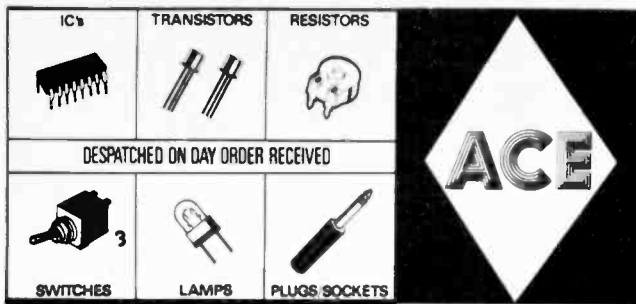

ORDERING IS EASY WITH THE UNIQUE COMBINED CATALOGUE/ORDER FORM

ACE MAILTRONIX LTD
Dept. EE Tootal Street
Wakefield, W. Yorkshire WF1 5JR

SEND STAMP ADDRESSED ENVELOPE NOW FOR THE EASY TO USE ACE ORDER FORM CONTAINING 500 TOP QUALITY POPULAR ELECTRONIC COMPONENTS AT PRICES YOU CAN AFFORD. P & P FREE ON ORDERS OVER £2, OTHERWISE 20p. ALL PRODUCTS GUARANTEED ONE YEAR IF CORRECTLY USED. SOME EXAMPLES FROM THE COMPETITIVE ACE RANGE WITH VAT INCLUSIVE PRICES ARE SHOWN BELOW

BC107/108/109 Metal	13p	1/4W Resistors CF +5%	3 for 6p
BC207/208/209 Plastic	11p	Minipresets Horiz./vert.	8p
2N3055	65p	Electrolytic 100µF 25v	10p
741 Op Amp-8 pin	30p	Polyester C280 0.1µF	8p
555 Timer	50p	LED Red 0.2"	15p
W04 1A Bridge	31p	Phono plugs	8p
7400 TTL	15p	Mintoggle SPST	80p
IN4148 Diode	4p	Wire-PVC Stranded 10m	25p
IN4001 Rec	5p	Veroboard 0.1 2.5x 3-75	50p
BZY88 Zeners	12p	S-DEC Breadboard	216p

Get an ACE up your sleeve!

CRESCENT RADIO LTD.

MAIL ORDER DEPT. 1 St Michaels Terrace, Wood Green
London N22 4SJ Phone 888-4474

MAINS INTERFERENCE SUPPRESSOR
Designed to reduce unwanted mains interference caused by fridges, boilers, etc. The unit is fitted with a 3-pin 13A mains socket and 1.5m of 3 core cable and comes housed in a black plastic box with silver front panel.
Approx size: 116 x 77 x 54mm.
Max. current loading 3A.
OUR PRICE £9.35 + 8% V.A.T.

ABS PLASTIC BOXES
Ideal for the constructor. Fitted with 1mm front panels.
1005=105 x 73 x 45mm=82p.
1006=150 x 74 x 47mm=£1.00
1007=185 x 124 x 60mm=£2.20
1022=107 x 85 x 45mm=82p.
(sloping front) plus 8% V.A.T.

MAINS 'KEYNECTOR'
This connecting block connects any electrical equipment to the mains supply in seconds. Ideal for bench, garage, demonstrations, etc. Max. load 13A fused.
A bargain at £5.85 + 8% V.A.T.



BARGAIN TRANSFORMERS
240v PRIMARY—12-0-12v 500mA SEC. Approx. size: 60 x 40 x 50mm. Fixing centres: 75mm.
PRICE: £1.80 + 8% V.A.T.
Also available MAINS TRANSFORMER with 18v 500mA SEC. Price and size same as above.

T1 MULTI-METER
Ideal tester for everybody interested in electronics. Weighing less than 100gm. and only 60 x 24 x 90mm.
RANGES: A.C. volts: 0-10v, 50v, 250v, 1,000v. D.C. volts: 0-10v, 50v, 250v, 1,000v. D.C. current: 0-1mA, 0-100mA. Resistance: 0-150Kohm.
OUR PRICE: £5.80 + 8% V.A.T.

BARGAIN PROJECT BOX
A plastic box with moulded extrusion rails for PC or Chassis panels, with metal front plate fitted with four screws (all supplied). Internal size: 81 x 51 x 28mm.
OUR PRICE: 70p + 8% V.A.T.

FERRIC CHLORIDE
Anhydrous ferric chloride in double sealed 11b poly. packs at £1.25 + 8% V.A.T. per lb.

LOW NOISE LOW PRICE CASSETTES
+ 8% V.A.T.
Good quality tape in well made screw type cassettes. Presented in single plastic cases.
C60=45p., C90=55p., C120=65p.

POWER SUPPLY UNIT TYPE 'PPI'
Switched 3, 4½, 6, 7½, 9 and 12 volts at: 500mA. With on/off switch and pilot light.
Size: 130mm x 55mm x 75mm approx.
OUR PRICE: Only £6.00 + 8% V.A.T.

10% DISCOUNT on ten or more cassettes of one type.

ACCESS AND BARCLAYCARD ACCEPTED - PHONE ORDERS WELCOMED. ALL PRICES INCLUDE POSTAGE—PLEASE ADD V.A.T. AS SHOWN—S.A.E. WITH ALL ENQUIRIES PLEASE.

Personal Callers Welcome at: 164-166 HIGH ROAD, WOOD GREEN, LONDON N22. Phone: 888-3206 and 13 SOUTH MALL, EDMONTON, N9. Phone: 803-1685.

Everyday Electronics, November 1977

Technical Training in Radio, Television and Electronics

ICS have helped thousands of ambitious people to move up into higher paid, more secure jobs in the field of electronics—now it can be your turn. Whether you are a newcomer to the field or are already working in the industry, ICS can provide you with the specialised training so essential to success.

Personal Tuition and Guaranteed Success

The expert and personal guidance by fully qualified tutors, backed by the ICS guarantee of tuition until successful is the key to our outstanding record in the technical training field. You study at the time and pace that suits you best and in your own home. In the words of one of our many successful students: "Since starting my course, my salary has trebled and I am expecting a further increase when my course is completed."

City and Guilds Certificates

Excellent job prospects await those who hold one of these recognised certificates. ICS can coach you for:
Telecommunications Technicians
Radio, TV Electronics Technicians
Technical Communications
Radio Servicing Theory
Radio Amateurs
Electrical Installation Work
Also MPT Radio Communications Certificate

Diploma Courses

Colour TV Servicing
Electronic Engineering and Maintenance
Computer Engineering and Programming
Radio, TV and Audio, Engineering and Servicing
Electrical Engineering, Installations and Contracting

Qualify for a New Career

Home study courses for leading professional examinations and diploma courses for business and technical subjects:—
G.C.E. Engineering Purchasing
60 subjects Farming Sales
at "O" & Heating Storekeeping
"A" levels Industrial Work Study
Accountancy Management
Air Mechanical
Conditioning
Building

POST OR PHONE TODAY FOR FREE BOOKLET.

ICS To: International Correspondence Schools
SINCE 1890
Dept 710L Intertext House, London
SW8 4UJ or telephone 622 9911

Subject of Interest.....
Name.....
Address.....
Telephone Number.....

B. BAMBER ELECTRONICS

Dept. E.E., STATION ROAD, LITTLEPORT, CAMBS., CB6 1QE
Telephone: ELY (0353) 860185 (2 lines) Tuesday to Saturday

PLEASE ADD 8% VAT UNLESS OTHERWISE STATED

18V DC RELAYS. 4 pole change-over (double contacts) (will work from 14-24V DC). Brand New, boxed, good quality, made by AEI 40p each.

Slider Switches. 2 pole make and break (or can be used as 1 pole change-over by linking the two centre pins). 4 for 50p.

Smart Min. Rectangular Push to Make Switches. black rectangular surround with white rectangular button. overall size 12 x 17mm. 3 for 50p.

A NEW RANGE OF QUALITY BOXES & INSTRUMENT CASES.
Aluminium Boxes with Lids

AB10	5 1/2 x 4 x 1 1/2	60p
AB13	6 x 4 x 2	80p
AB14	7 x 5 x 2 1/2	£1.00
AB15	8 x 6 x 3	£1.30
AB16	10 x 7 x 3	£1.50
AB17	10 x 4 1/2 x 3	£1.30
AB25	6 x 4 x 3	£1.00

Vinyl Coated Instrument Cases.
Light Blue tops and White lower sections. Very smart finish.

WB1	5 x 2 1/2 x 2 1/2	60p
WB2	6 x 4 1/2 x 1 1/2	£1.10
WB3	8 x 5 x 2	£1.60
WB4	9 x 5 1/2 x 2 1/2	£1.80
WB5	11 x 8 1/2 x 3	£2.00
WB6	11 x 7 1/2 x 3 1/2	£2.25
WB7	12 x 8 1/2 x 5 1/2	£2.60
WB853	8 x 5 1/2 x 3 1/2	£2.00

MAGNETIC DEVICES PROGRAMMERS. Contain 3 fully adjustable cams and 8 change over micro-switches (rated approx. 1A at 240VAC) Needs slow-motion motor to drive (not supplied). Ideal for disco lights, sequence switching, etc. ex equipment £1.50 each.

CALIBRATOR XTALS 100kHz + 1MHz in one 10-X can, £1.00 each.

MAINS TRANSFORMERS. Type 60/2. Mains Input 200-210-220-230-240-250V a.c. output 0-20-40-60V at 2A. in Metal and Plastic case, approx. 7 1/2 x 4 x 4. Fully fused (ideal for PSU) £3.00 each.

MAINS TRANSFORMERS. Type 15/300 240V input, 15V at 300mA output. £1.50 each.

MAINS TRANSFORMERS. Type 45/100, 240, 220, 110, 20, 0V input. 45V at 100mA output. £1.50 each.

RED LEDs (Min. type) 5 for 70p.

VIDICON SCAN COILS (Transistor type, but no data) complete with vidicon base £6.50 each. Brand New

FULL RANGE OF BERNARDS/BABANI ELECTRONICS BOOKS IN STOCK. S.A.E. FOR LIST.

NEW FOR THE VHF CONSTRUCTOR. A range of tuned circuits on formers with slugs and screening cans. Frequencies quoted are approximate, and range can be greatly extended by using varying capacitors in parallel.

Type S (1/2 in. square, dummy type).
Type SA 20 to 30MHz (when 33pF fitted in parallel).
Type SB 35 to 50MHz (with link-winding).
Type SC 70 to 100MHz (with link winding).
Type SD 135 to 175MHz (with link winding).
Type M (Min. 1/2 in. square types).
Type MA 19 to 28MHz (when 33pF fitted in parallel).
Type MB 22 to 32MHz (when 33pF fitted in parallel).
Type MC 20 to 35MHz (when 33pF fitted in parallel).
Type MD 38 to 50MHz (when 33pF fitted in parallel).
Type ME 45 to 60MHz (when 33pF fitted in parallel).
Type MF 100 to 200MHz (without slug) when 0 to 30pF variable fitted in parallel.

All the above coils available in packs of five only (same type) at 50p per pack of 5.

PLASTIC PROJECT BOXES with screw on lids (in black ABS) with brass inserts.
Type NB1 approx. 3in. x 2 1/2 in. x 1 1/2 in. 40p each.
Type NB2 approx. 3 1/2 in. x 2 1/2 in. x 1 1/2 in. 50p each.
Type NB3 approx. 4 1/2 in. x 3 1/2 in. x 1 1/2 in. 60p each.

MULLARD 85A2 85V STABILISER VALVES (Brand New) 70p each or 2 for £1.20.

TO3 transistor insulator sets. 10 for 50p

BSX20 (VHF Osc/Mult). 3 for 50p.
BC108 (metal can). 4 for 50p.
PBC108 (plastic BC108). 5 for 50p.
BFY51 Transistors. 4 for 60p.
BCY72 Transistors. 4 for 50p
PNP audio type TOS Transistors. 12 for 25p.
BF152 (UHF amp/mixer). 3 for 50p.
2N3619 Fet. 3 for 60p.
BC148 NPN SILICON. 4 for 50p.
BC158 PNP SILICON. 4 for 50p.
BAY31 Signal Diodes. 10 for 35p.
BA121 Varicap Diodes. 4 for 50p.

741CG op amps by RCA. 4 for £1

PERSPEX TUNER PANELS (for FM Band 2 tuner) marked 88-108MHz and Channels 9-10. clear numbers, rest blacked out, smart modern appearance, size approx. 8 1/2 in x 1 1/2 in. 2 for 35p.

PLUGS AND SOCKETS
N-Type Plugs 50 ohm. 60p each, 3 for £1.50.
PL259 Plugs (PTFE). brand new, packed with reducers. 65p each.
SO239 Sockets (PTFE). brand new (4-hole fixing type). 50p each

SOLDER SUCKERS (Plunger type). Standard Model. £5. Skirted Model £5.50. Spare Nozzles 60p each.

WELLER SOLDERING IRONS
EXPERT. Built-in-spotlight illuminates work. Pistol grip with fingertip trigger. High efficiency copper soldering tip.
EXPERT SOLDER GUN £100D £9.90.
EXPERT SOLDER GUN KIT (spare bits, case, etc.) £12.90.
Spare bits 35p pair.

NEW MARKSMAN RANGE OF SOLDERING IRONS.

S115D 15W 240V £3.80.
S125D 25W 240V £3.80.
S140D 40W 240V £4.20.
S125DK 25W 240V + bits etc. KIT £4.90.
SPECIAL 12V version S125-12 25W 12V £3.80.
BENCH STAND with spring and sponge for Marksman irons £2.38.

Spare bits MT9 (for 15W) 50p, MT5 (for 25W) 45p, MT10 (for 40W) 50p.

ALL PRICES + 8% VAT.
TC2 TEMPERATURE CONTROLLED IRON. Temperature controlled iron and PSU. £30 + VAT (£2.40).

SPARE TIPS
Type CC single flat. Type K double flat fine tip. MT10 (for 40W) 50p.
Type P, very fine tip. £1 each + VAT (6p).
MOST SPARES AVAILABLE.

MULTICORE SOLDER
Size 5 Savbit 18 s.w.g. in alloy dispenser. 32p + VAT (3p).
Size C15AV18 Savbit 18 s.w.g. 56p + VAT (4p).
Kg. (1.1lb) 60 x 40, 20 s.w.g. on plastic reel £3 + VAT (24p).

14 DIL REED RELAYS. 5 to 12V DC. 450 ohm coil. Designed to work directly from TTL Logic. Single Pole Change over. Contact ratings 28V 1A 3W. £1.75 each.

A LARGE RANGE OF CAPACITORS AVAILABLE AT BARGAIN PRICES. S.A.E. FOR LIST.

MIXED COMPONENT PACKS. containing resistors, capacitors, pots, etc. All new. Hundreds of items. £2 per pack, while stocks last.

ALU-SOL ALUMINIUM SOLDER (made by Multicore). Solders aluminium to itself or copper, brass, steel, nickel or tinplate. 16 s.w.g. with multicore flux, with instructions. Approx. 1 metre coil 40p pack. Large reel £2.75.

VARICAP TUNERS Mullard type ELC1043/05. Brand New. £4.40 + 12 1/2% VAT.

BARGAIN PACK OF LOW VOLTAGE ELECTROLYTIC CAPACITORS. Up to 50V working. Seatronic Manufacture. Approx. 100. £1.50 per pack + 12 1/2% VAT.

OSMOR REED RELAY COILS (for reed relays up to 1/2 in dia., not supplied) 12V, 500 ohm coil. 2 for 50p.

We now stock Spratlux Tools for the electronic enthusiast. Screwdrivers, Nut spanners, BA and Metric sizes, pop rivet guns, etc. S.A.E. for list.

TWIN I.F. CANS. approx. 1in. x 1/2 in. x 1in. high. around 3-5.5MHz, 2 separate transformers in 1 can. Internally screened. 5 for 50p + 12 1/2% VAT.

Duobiler Electrolytics. 50µF. 450V. 2 for 50p.
Duobiler Electrolytics. 100µF. 275V. 2 for 50p.
Plessey Electrolytics. 470µF. 63V. 3 for 50p.
TCC Electrolytics. 1000µF. 30V. 3 for 60p.
Duobiler Electrolytics. 5000µF. 35V. 50p each.
Duobiler Electrolytics. 5000µF. 50V. 60p each.
ITT Electrolytics. 6800µF. 25V. high grade. screw terminals, with mounting clips. 50p each.
PLEASE ADD 12 1/2% VAT TO ALL CAPACITORS.

TV PLUGS AND SOCKETS
TV Plugs (metal type). 4 for 50p.
TV Sockets (metal type). 4 for 50p.
TV Line Connectors (back-to-back sockets). 4 for 50p.
Please add 12 1/2% VAT.

Terms of Business: CASH WITH ORDER. MINIMUM ORDER £2. ALL PRICES INCLUDE POST & PACKING (UK ONLY). SAE with ALL ENQUIRIES Please. PLEASE ADD VAT AS SHOWN. ALL GOODS IN STOCK DESPATCHED BY RETURN. CALLERS WELCOME BY APPOINTMENT ONLY

You can work wonders with your free time.

There's immense satisfaction in making your own equipment. And you'll get excellent results with Heathkit.

Every kit is absolutely complete down to the last nut and bolt. The quality is the best. And each kit has an easy to follow instruction manual that explains exactly what to do at each step.

So you enjoy assembling your kit and you finish with first-class equipment every time.

That's why Heathkit are so successful. And that's why the range is the biggest in the world.

It's all in the new edition of the free Heathkit catalogue. Everything from the simplest to the most sophisticated. Alarms, digital clocks, testers, transceivers and lots more... even the tools are there!

See for yourself. Send the coupon now.

NEW CATALOGUE
NEW TEST INSTRUMENTS
NEW DIGITAL BATHROOM SCALES
NEW AMATEUR RADIO EQUIPMENT
NEW AUDIO SYSTEMS AND MANY OTHER NEW ITEMS



The new Heathkit catalogue. Out now FREE.
To: Heath (Gloucester) Ltd., Dept. EE-117, Gloucester, GL2 6EE. Please send me my Heathkit catalogue. I enclose an 11p stamp for postage.

HEATH
Schlumberger

Name _____
Address _____
Postcode _____

ACCESS AND BARGAIN CARD WELCOMED

Showrooms at 233 Tottenham Court Road, London (Phone 01-636 7349) and Bristol Road, Gloucester (Phone Gloucester 29451).

PAKS—PARTS—AUDIO MODULES

PANEL METERS

4" RANGE

Size 4 1/2" x 3 1/2" x 1 1/2"

Value	No.	Price
0-50U	1302	£4.50
0-100UA	1303	£4.50
0-500UA	1304	£4.50
0-1MA	1305	£6.00
0-50V	1306	£6.00

2" RANGE

Size 2 1/2" x 1 1/2" x 1 1/4"

Value	No.	Price
0-50UA	1307	£3.50
0-100UA	1308	£3.50
0-500UA	1309	£3.50
0-1MA	1310	£3.50
0-50V	1311	£3.50

MR2P TYPE

Size 42 x 42 x 30mm

Value	No.	Price
0-50UA	1313	£4.80
0-1MA	1315	£3.20

EDGEWISE

Size 3 1/2" x 1 1/2" x 2 1/4"

Value	No.	Price
0-1MA	1316	£4.05
0-500UA	1317	£4.05

MINIATURE BALANCE/TUNING METER

Size 23 x 22 x 26mm

No.	Price
1318	£1.95

BALANCE/TUNING

Size 45 x 22 x 34mm

No.	Price
1319	£2.00

MIN. LEVEL METER

Size 23 x 22 x 26mm

No.	Price
1320	£1.95

Vu METER

Size 40 x 40 x 29mm

No.	Price
1321	£2.00

MINI MULTI-METER

Size 60 x 24 x 90mm

No.	Price
1322	£5.95

P&P

Postage and Packing add 25p unless otherwise shown. Add extra for airmail. Minimum order £1.

TRANSISTORS

BRAND NEW — FULLY GUARANTEED

Type	Price	Type	Price	Type	Price	Type	Price	Type	Price	Type	Price
AC126	£0.18	BC109C	£0.08	BC550	£0.14	BFY52	£0.14	TIP3055	£0.75	2N3708A	£0.07
AC127	£0.18	BC147	£0.10	BC555	£0.14	BF19	£0.18	TIP343	£0.24	2N3709	£0.07
AC128	£0.18	BC148	£0.10	BC557	£0.13	BIP20	£0.38	TIS90	£0.22	2N3710	£0.07
AC128K	£0.26	BC149	£0.10	BC558	£0.12	BIP19	£0.14	UT46	£0.22	2N3711	£0.07
AC132	£0.20	BC157	£0.10	BC559	£0.14	20MP	£0.80	ZTX107	£0.10	2N3711	£0.07
AC134	£0.20	BC158	£0.10	BD115	£0.50	BRV39	£0.45	ZTX108	£0.10	2N3819	£0.20
AC137	£0.20	BC159	£0.10	BD116	£0.80	BU105	£1.70	ZTX109	£0.10	2N3820	£0.40
AC141	£0.22	BC167	£0.12	BD121	£0.65	BU105/02	£1.95	ZTX300	£0.12	2N3821	£0.60
AC141K	£0.30	BC168	£0.12	BD123	£0.65	BU204	£1.70	ZTX500	£0.14	2N3823	£0.60
AC142	£0.20	BC169	£0.12	BD124	£0.70	BU205	£1.70	2N1613	£0.20	2N4058	£0.12
AC176	£0.18	BC169C	£0.12	BD131	£0.38	BU208	£2.40	2N1711	£0.20	2N4059	£0.14
AC176K	£0.26	BC170	£0.10	BD132	£0.40	BU208/02	£2.95	2N1889	£0.45	2N4060	£0.14
AC178	£0.25	BC171	£0.10	BD131/	£0.40	E1222	£0.38	2N1890	£0.45	2N4061	£0.12
AC179	£0.25	BC172	£0.10	132MP	£0.85	MJE2955	£0.98	2N1893	£0.30	2N4062	£0.12
AC180	£0.28	BC173	£0.16	BD133	£0.40	MJE3055	£0.50	2N2147	£0.75	2N4284	£0.18
AC180K	£0.28	BC177	£0.16	BD135	£0.40	MJE3440	£0.52	2N2148	£0.70	2N4285	£0.18
AC181	£0.20	BC178	£0.16	BD136	£0.40	MPB113	£0.82	2N2160	£0.80	2N4286	£0.18
AC181K	£0.28	BC179	£0.16	BD137	£0.42	MPF102	£0.35	2N2192	£0.38	2N4287	£0.18
AC187	£0.18	BC180	£0.25	BD138	£0.45	MPF104	£0.38	2N2193	£0.38	2N4288	£0.18
AC187K	£0.20	BC181	£0.25	BD139	£0.54	MPF105	£0.38	2N2194	£0.38	2N4289	£0.18
AC188	£0.18	BC182L	£0.10	BD140	£0.60	MP5A05	£0.30	2N2217	£0.22	2N4290	£0.18
AC188K	£0.20	BC183	£0.10	BD139/	£0.60	MP5A06	£0.30	2N2218	£0.22	2N4291	£0.18
AD140	£0.60	BC183L	£0.10	140MP	£1.20	MP5A55	£0.28	2N2218A	£0.20	2N4292	£0.18
AD142	£0.85	BC184	£0.10	BD155	£0.80	MP5A56	£0.28	2N2219	£0.20	2N4293	£0.18
AD143	£0.75	BC184L	£0.10	BE175	£0.60	OC22	£1.50	2N2219A	£0.24	2N4293	£0.55
AD149	£0.60	BC207	£0.11	BD176	£0.60	OC23	£1.50	2N2904	£0.28	2N4292	£0.65
AD161	£0.42	BC208	£0.11	BD177	£0.68	OC24	£1.35	2N2904A	£0.21	2N5135	£0.10
AD162	£0.42	BC209	£0.12	BD179	£0.68	OC25	£0.60	2N2905	£0.18	3N5135	£0.10
AD161	£0.35	BC212	£0.11	BD179	£0.75	OC26	£0.60	2N2905A	£0.21	2N5139	£0.10
AF114	£0.21	BC212L	£0.11	BD201/	£0.70	OC27	£0.60	2N2906	£0.19	2N5142	£0.50
AF115	£0.21	BC213L	£0.11	BD203	£0.80	OC29	£0.98	2N2906A	£0.19	2N5245	£0.40
AF116	£0.21	BC214	£0.12	BD204	£0.80	OC35	£0.90	2N2907	£0.20	2N5294	£0.34
AF117	£0.21	BC214L	£0.12	BD203/	£0.80	OC36	£0.90	2N2907A	£0.22	2N5296	£0.56
AF118	£0.40	BC237	£0.16	204MP	£1.70	OC70	£0.24	2N296G	£0.09	2N5457	£0.32
AF124	£0.30	BC238	£0.16	BDY20	£0.80	OC71	£0.15	2N2926V	£0.08	2N5458	£0.32
AF125	£0.30	BC251	£0.15	BDX77	£0.90	TIC44	£0.29	2N29260	£0.08	2N5459	£0.38
AF126	£0.30	BC251A	£0.16	BF457	£0.37	TIC45	£0.35	2N2926R	£0.08	2N5551	£0.36
AF127	£0.32	BC301	£0.28	BF458	£0.37	TIP29A	£0.44	2N2926B	£0.08	2N6027	£0.39
AF139	£0.58	BC302	£0.28	BF459	£0.38	TIP29B	£0.52	2N3053	£0.16	2N6121	£0.70
AF180	£0.40	BC303	£0.28	BF594	£0.30	TIP29C	£0.62	2N3054	£0.40	2N6122	£0.70
AF181	£0.60	BC304	£0.38	BF596	£0.28	TIP30A	£0.50	2N3055	£0.40	40311	£0.38
AF196	£0.58	BC327	£0.18	BF839	£0.25	TIP30B	£0.60	2N3414	£0.16	40313	£0.95
AF239	£0.50	BC328	£0.15	BF840	£0.25	TIP30C	£0.70	2N3415	£0.16	40316	£0.95
AL102	£0.38	BC337	£0.15	BF879	£0.25	TIP31A	£0.45	2N3416	£0.29	40317	£0.40
AL103	£1.20	BC338	£0.15	BF880	£0.28	TIP31B	£0.47	2N3417	£0.29	40326	£0.40
AU104	£1.18	BC440	£0.30	BFX29	£0.25	TIP31C	£0.49	2N3614	£0.85	40327	£0.45
AU110	£1.00	BC441	£0.30	BFX30	£0.25	TIP32A	£0.49	2N3615	£0.90	40346	£0.45
AU113	£1.00	BC460	£0.38	BFX84	£0.23	TIP32B	£0.51	2N3616	£0.90	40347	£0.65
BC107A	£0.08	BC461	£0.38	BFX85	£0.24	TIP32C	£0.53	2N3646	£0.09	40348	£0.80
BC107B	£0.08	BC477	£0.20	BFX86	£0.25	TIP41A	£0.49	2N3702	£0.08	40360	£0.36
BC107C	£0.08	BC478	£0.20	BFX87	£0.22	TIP41B	£0.51	2N3703	£0.08	40361	£0.36
BC108A	£0.08	BC479	£0.20	BFX88	£0.22	TIP41C	£0.53	2N3704	£0.07	40362	£0.38
BC108B	£0.08	BC547	£0.12	BFX90	£0.55	TIP42A	£0.53	2N3705	£0.07	40406	£0.45
BC108C	£0.08	BC548	£0.12	BFY50	£0.14	TIP42B	£0.55	2N3706	£0.08	40407	£0.45
BC109B	£0.08	BC549	£0.12	BFY51	£0.14	TIP2955	£0.95	2N3707	£0.08	40408	£0.52
								2N3708	£0.07	40409	£0.75

74 SERIES TTL IC'S

BI-PAK STILL LOWEST IN PRICE.
FULL SPECIFICATION GUARANTEED ALL FAMOUS MANUFACTURERS

Type	Price	Type	Price	Type	Price	Type	Price	Type	Price	Type	Price
7400	0.14	7409	0.15	7441	0.64	7482	0.95	7493	0.40	74122	0.50
7401	0.14	7410	0.14	7442	0.64	7483	0.95	7494	0.88	74123	0.50
7402	0.15	7411	0.23	7445	0.90	7484	0.98	7495	0.75	74141	0.40
7403	0.15	7412	0.23	7446	0.90	7485	1.20	7496	0.80	74154	1.30
7404	0.15	7413	0.27	7447	0.78	7486	0.30	74100	1.00	74180	1.10
7405	0.15	7414	0.58	7448	0.80	7489	2.90	74110	0.50	74181	2.00
7406	0.30	7416	0.28	7475	0.48	7490	0.42	74118	0.90	74190	1.50
7407	0.30	7417	0.28	7480	0.50	7491	0.75	74119	1.85	74198	2.00
7408	0.15	7440	0.15	7481	0.95	7492	0.45	74121	0.30	74199	1.90

CMOS IC'S

Type	Price	Type	Price	Type	Price	Type	Price	Type	Price	Type	Price
CD4000	0.20	CD4012	0.20	CD4022	0.98	CD4031	2.20	3D4046	1.30	CD4071	0.23
CD4001	0.20	CD4013	0.52	CD4023	0.20	CD4035	1.50	3D4047	1.10	CD4072	0.23
CD4002	0.20	CD4015	0.98	CD4024	0.80	CD4037	0.95	CD4049	0.55	CD4081	0.22
CD4006	0.98	CD4016	0.52	CD4025	0.20	CD4040	0.95	CD4			

EDITOR

F. E. BENNETT

TECHNICAL EDITOR

B. W. TERRELL B.Sc.

TECHNICAL SUB-EDITOR

T. J. JOHNSON G8MGS

ART EDITOR

J. D. POUNTNEY

TECHNICAL ILLUSTRATOR

P. A. LOATES

GENERAL ARTIST

K. A. WOODRUFF

EDITORIAL OFFICES

Fleetway House
 Farringdon Street
 London EC4A 4AD
 Phone: 01-634 4452

ADVERTISEMENT MANAGER

D. W. B. TILLEARD
 Phone: 01-634 4504

REPRESENTATIVE

P. J. MEW
 Phone: 01-634 4181

CLASSIFIED MANAGER

C. R. BROWN
 Phone: 01-261 5762

MAKE-UP AND COPY DEPARTMENT

Phone 01-634 4372

ADVERTISEMENT OFFICES

Fleetway House
 Farringdon Street
 London EC4A 4AD

Projects... Theory... and Popular Features ...

We endeavour to present all our projects in such a way so that anyone with but a rudimentary knowledge of electronics will be able to build them successfully. The one special skill needed is in soldering. With today's small components a correspondingly small soldering iron is essential and therefore the whole operation demands a fair degree of finesse. Once equipped with the right kind of instrument and a few small tools, practice will make perfect.

How to solder was explained in the opening part of *Teach-In 78*, last month, and newcomers should certainly study the relevant sections of that article before tackling their first constructional project. As regards the soldering iron, we are happy to give details of a Special Offer to EVERYDAY ELECTRONICS readers—see page 124.

Ultrasonics provide a way of communicating over short distances without interconnecting leads. This technique also keeps us free of licensing regulations. Using sound pressure waves, we find that the air is literally free!

Commercial examples of this use of ultrasonics are commonplace in the form of remote control units for television sets. Other applications will no doubt occur to our readers. We only offer a few suggestions in this month's article *Ultrasonic Remote Control System*, because this is obviously an opportunity for individual ideas to be generated.

All details of the construction of the two units involved in this system will be covered in two articles. The first article describes the transmitter; next month the receiver unit will be covered. So while building the first unit, start considering exactly how you will use this system. You will then be prepared with ideas for any ancillary circuitry and electro-mechanical devices that may need devising to meet the particular need.

(An open-ended project such as the *Ultrasonic Remote Control System* is especially valuable since it encourages further involvement by the constructor other than just following a published design.)

The more immediately obvious applications will be those where electrically operated equipment is simply switched on or off remotely. No great problems here, and the specified receiver relay will cope with a load of up to 1,200 watts. But there are bound to be possible applications where the electrical signal is required to be translated into some form of mechanical action—with the aid of intermediary electric motors or such like. Electronic constructors with a mechanical bent will find something to get their teeth into in solving the electro-to-mechanical interface in such cases.



Our December issue will be published on Friday, November 18. See page 123 for details.

Readers' Enquiries

We cannot undertake to answer readers' letters requesting modifications, designs or information on commercial equipment or subjects not published by us. All letters requiring a personal reply should be accompanied by a stamped self-addressed envelope.

Telephone enquiries should be limited to those requiring only a brief reply. We cannot undertake to engage in discussions on the telephone, technical or otherwise.

Component Supplies

Readers should note that we do not supply electronic components for building the projects featured in EVERYDAY ELECTRONICS, but these requirements can be met by our advertisers.



Everyday ELECTRONICS

VOL. 7 NO. 3

NOVEMBER 1977

CONSTRUCTIONAL PROJECTS

ULTRASONIC REMOTE CONTROL SYSTEM

Part 1: The Transmitter. For remote control of electrical appliances by R. A. Penfold 104

PROBE-LESS CONTINUITY TESTER

A handy piece of equipment for the home and workshop by C. J. Mair 109

V.H.F. PORTABLE RADIO

For reception of amateur and broadcast transmissions within the range 55 to 198MHz by F. G. Rayer 125

FIND THE PAIR *An ideal fund-raiser for school and church fetes* by F. G. Saddler 131

GENERAL FEATURES

EDITORIAL 102

SHOP TALK *Component buying for constructional projects* by Brian Terrell 108

SQUARE ONE *Identifying components—resistors and capacitors* 112

FOR YOUR ENTERTAINMENT *Hi fi journalism* by Adrian Hope 113

PLEASE TAKE NOTE *Probophone, Enlarger Timer, Treasure Locator (see Shop Talk)* 113

PHYSICS IS FUN *A.c. measurement* by Derrick Daines 114

BRIGHT IDEAS *Readers' hints and tips* 115

TEACH-IN 78 *Part 2. Module construction and experiments* by George Hylton 116

SOLDERING IRON SPECIAL OFFER *A money saver for E.E. readers* 124

READERS' LETTERS *Your news and views* 130

JACK PLUG AND FAMILY *Cartoon* 130

PROFESSOR ERNEST EVERSURE *The Extraordinary Experiments of.* by Anthony J. Bassett 135

Back Number Service and Binders

Back issues of EVERYDAY ELECTRONICS (June 1977 onwards) are available worldwide at a cost of 60p per copy inclusive of postage and packing. Orders and remittance should be sent to: Post Sales Department, IPC Magazines Ltd., Lavington House, 25 Lavington Street, London SE1 0PF.

Binders for Volumes 1 to 6 (state which) are available from the above address for £2.10 inclusive of postage and packing.

© IPC Magazines Limited 1977. Copyright in all drawings, photographs and articles published in EVERYDAY ELECTRONICS is fully protected, and reproductions or imitations in whole or in part are expressly forbidden.

All reasonable precautions are taken to ensure that the advice and data given to readers are reliable. We cannot however guarantee it, and we cannot accept legal responsibility for it. Prices quoted are those current as we go to press.



ULTRASONIC REMOTE CONTROL SYSTEM

By R. A. Penfold

THE TRANSMITTER

The complete system can be used to remotely switch on and off electrical appliances rated at up to 1200 watts at mains voltage.

INTRODUCTION

THIS ultrasonic system provides a simple and inexpensive remote control link for which no Home Office licence is required. The maximum operating range of the system is not very large, being something in the region of 10 metres. However, this is sufficient to enable the unit to be employed in a number of useful applications, and this aspect will be fully dealt with later on.

GENERAL ARRANGEMENT

The block diagram which appears in Fig. 1 shows the general arrange-

ment used in the complete system.

A 40kHz oscillator forms the basis of the transmitter, and the output of this circuit is fed to an ultrasonic transducer. The transducers are sold in pairs, one being used in the transmitter and the other in the receiver. These transducers are piezoelectric devices, and can be regarded as being something like a mixture of a crystal earpiece, a crystal microphone, and a quartz crystal.

Like a crystal earpiece, the transducer at the transmitter will produce soundwaves if a suitable electrical stimulus is applied to it, but it does not work very efficiently at ordinary audio frequencies. It does operate efficiently at frequen-

cies just outside the upper limit of human hearing, or ultrasonic frequencies as they are usually termed.

The efficiency of the transducer reaches a peak at a frequency of 40kHz, and it is for this reason that the oscillator in the transmitter is given an operating frequency of 40kHz. This frequency is, in effect, the resonant frequency of the transducer, and is a similar property to that possessed by the piezoelectric quartz crystals which are used in highly stable r.f. oscillators.

A push button switch is connected in the supply line to the oscillator, and the transmitter is activated by operating this switch.

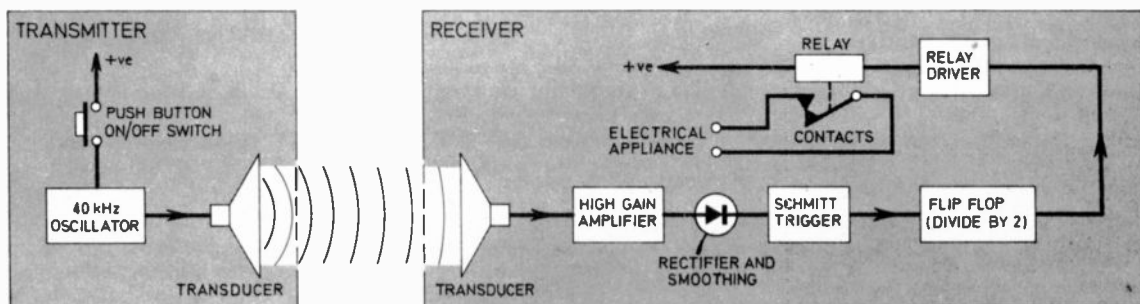

Fig. 1. The block diagram of the complete Ultrasonic Remote Control System.

RECEIVER TRANSDUCER

The second transducer is used at the input of the receiver, and this one acts as a sort of crystal microphone, but again, it is very inefficient at audio frequencies. Also as before, it works well at ultrasonic frequencies, and has a response which peaks at 40kHz. Thus a small 40kHz electrical signal will be produced by the transducer at the receiver when it picks up the ultrasonic sound from the transmitter.

This signal will have only a very low amplitude when the transmitter is at some distance from the receiver, and a considerable amount of amplification must be used if a reasonable operating range is to be attained. The necessary amplification is provided by a simple and very economic two-transistor circuit in this case.

The output of the amplifier is rectified and smoothed to a d.c. bias which is fed to the input of a Schmitt trigger circuit. The voltage at the input of the Schmitt trigger rises and falls only relatively slowly as the transmitter is switched on and off. The stage which follows the Schmitt trigger is a flip-flop divide-by-two circuit, and this must have an input signal with a fast rising waveform if it is to operate reliably. The purpose of the Schmitt trigger is merely to produce a fast rising output from the slow rising input. Provided an adequate input signal is obtained, this arrangement is highly reliable.

Operation of the flip-flop circuit is quite straightforward. This is a logic circuit and as such it can only have an output which is in one of two possible stable states. The output must either be low (logic 0 or at virtually zero volts)

or high (logic 1 or at virtually the full supply potential).

The state of the output will change state each time a positive input pulse is received. Thus if the output goes to the low state when power is initially applied to the circuit, it can be triggered to the high state by pressing the push button on the transmitter. When the push button is released there will be no effect on the flip-flop, since this causes a negative input pulse to be generated and the flip-flop will only respond to positive pulses.

If the push button is then pressed again, another positive going input pulse will be applied to the flip-flop and in consequence its output will now go low. There will be no effect on the flip-flop when the push button is released, just as before.

The output of the flip-flop is fed to a relay via a single transistor driver stage. The circuit is arranged so that the relay contacts are closed when the output of the flip-flop is high, and open when its output is low.

Thus if the relay contacts are closed, they can be made to open by briefly operating the push button on the transmitter. They can be closed again by operating the push button a second time, and in fact the relay contacts will change state with successive operations of the push button on the transmitter.

CIRCUIT DESCRIPTION

TRANSMITTER CIRCUIT

The transmitter is an extremely simple device, as will be apparent from its circuit diagram which is shown in Fig.2. It is based on an astable multivibrator which uses a simple CMOS quad 2-input NOR gate (4001) or a quad 2-input NAND gate (4011). Only three of the four gates are used, and they are not in fact used as logic circuits, but instead they have their two inputs connected in parallel so that they act as simple inverters. This is why either a 4001 or a 4011 i.c. can be used.

Components VR1, R1, R2, C1, plus the two inverters in the left hand section of the i.c. form the

multivibrator circuit, and R1 enables the frequency of oscillation to be adjusted to 40kHz. The third inverter is used as a buffer stage between the output of the astable (IC1 pin 3) and the transducer. This is necessary in order to prevent the transducer from upsetting the correct operation of the astable.

Switch S1 is a push button on/off type, and the unit has a current consumption of about 3.5mA when this switch is operated. The peak to peak output voltage swing to the transducer is virtually equal to the supply potential, and despite the simplicity of the transmitter circuit it provides quite a good operating range.

**START
HERE FOR
CONSTRUCTION**

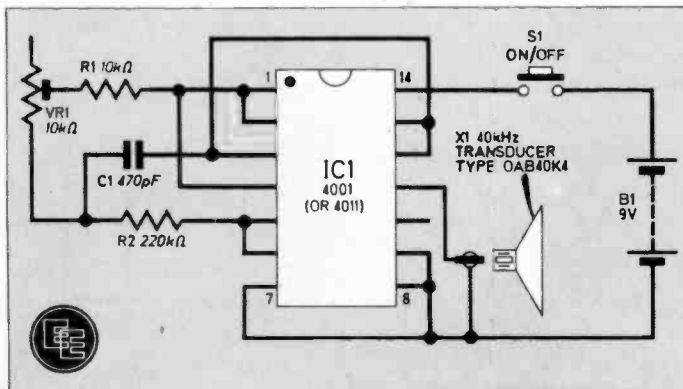

Fig. 2. The circuit diagram of the transmitter section of the Ultrasonic Remote Control System.

A plastic box having dimensions of about 120 × 65 × 40mm is used as the housing for the prototype transmitter, but any metal or plastic box of around this size should be suitable. The layout of the unit is very straightforward, as can be seen in Fig.3 and the photographs of the unit.

The transducer is fitted with a phono socket at the rear, and a 12.7mm diameter hole is drilled in the case to accommodate this. The transducer is then glued to the

ULTRASONIC REMOTE CONTROL SYSTEM

Fig. 3 (Right). The layout of the components on the strip-board and the breaks to be made on the underside.

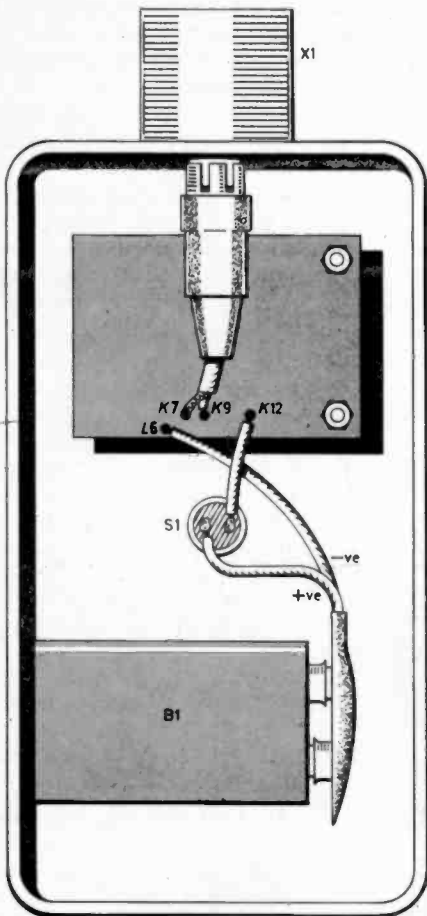
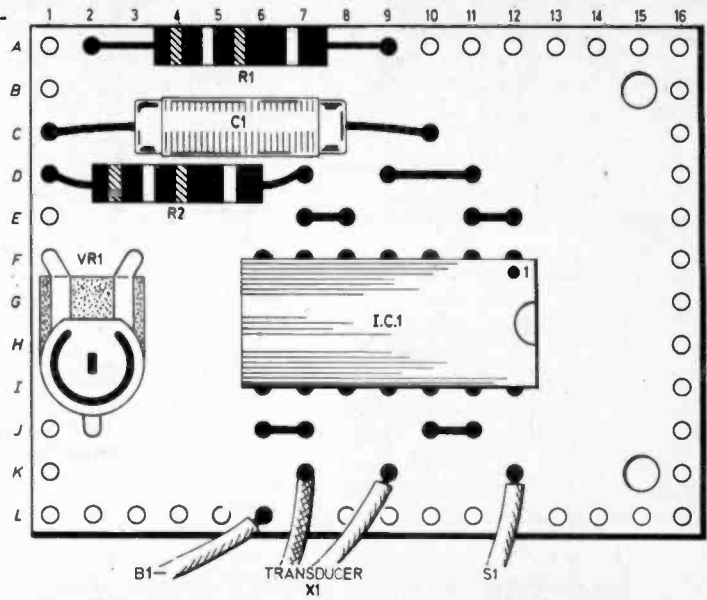
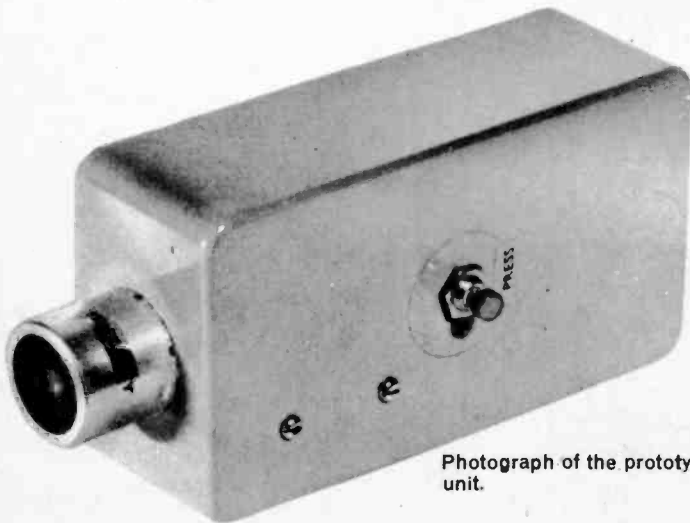
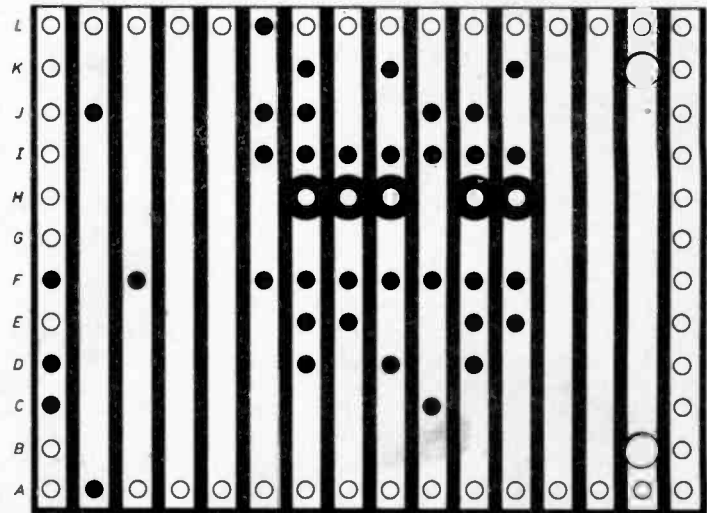

Fig. 4. (Above). The positioning of the component board and other components within the case.



Photograph of the prototype transmitter unit.

FOR GUIDANCE ONLY

ESTIMATED COST OF COMPONENTS

£7 including receiver transducer

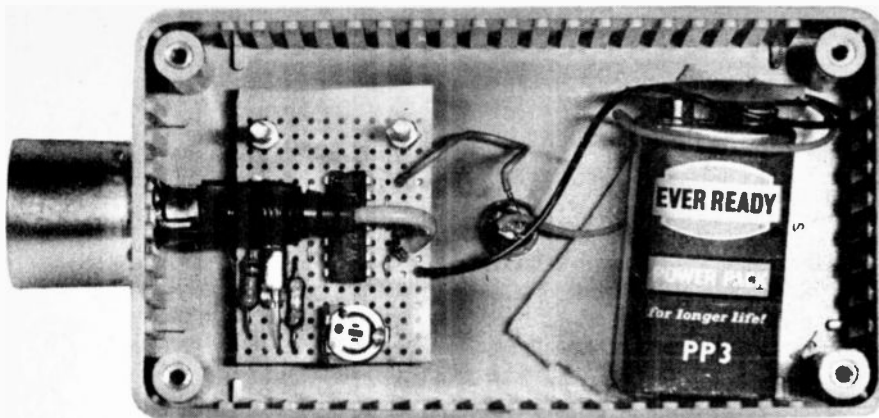

Photographs showing the transmitter with lid removed and (left) the prototype component panel.

aimed at the transducer, and VR1 is adjusted for maximum reading on the millivoltmeter.

If no suitable test gear is available, the adjustment of VR1 will have to be left until the receiver has been constructed; VR1 can then be tried at various settings in an attempt to find the one which gives the greatest range. This method is not quite as fast or accurate as the other two, but it will give excellent results provided due care is exercised.

APPLICATIONS

Perhaps the most obvious use for this equipment is in an intruder alarm. In this application the two transducers would be mounted either side of a door or corridor. Ultrasonic sound is very directional and is easily blocked by an obstruction such as a human being. Normally the transmitter would be on and would be directing a beam of sound at the receiver, which would have open relay contacts connected in series with an alarm.

If an intruder should pass down the corridor or through the door, the signal to the receiver would be cut off as they passed through the sound beam, and then restored again once they had passed. As the beam was restored the relay contacts would close and activate the alarm.

The system could probably be adapted for use in car burglar alarm circuits. Here it could be used to switch the alarm on and off from outside the car without the need for any external switches or key switches.

Other applications include the remote control of garage doors, radios, televisions, lights, etc., and there must be many other possible uses for this system.

With the relay specified in the Receiver components list (next month), mains voltages up to 5 amps can be switched i.e. electrical appliances rated up to 1200 watts. If it is required to operate equipment of larger capacity, a suitable relay will need to be found and probably a larger case than specified used to house all the circuitry in the receiver.

For d.c. appliances, the specified relay contacts can handle 150 watts (eg 5 amps at 30V, 3 amps at 50V etc.).

To be continued

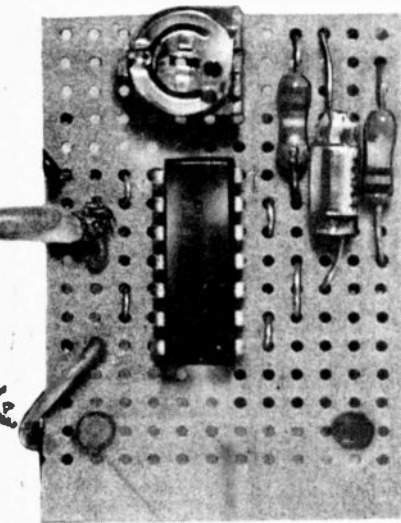

surface of the case using a good quality adhesive such as Bostik No. 1.

Most of the components are mounted on a 0.1-inch pitch stripboard which has 16 copper strips by 12 holes. Details of this panel are shown in Fig.3.

Start by cutting out a panel of the correct size using a small hacksaw, and then drill out the two 6BA clearance mounting holes (3.2mm twist drill). Then the five breaks

in the copper strips are made using either the special tool or a small drill bit held in the hand.

Next the panel is wired up to S1, the battery clip, and the transducer before it is bolted to the case. The connection to the transducer is made via a short twin cable which is terminated in a phono plug. This lead does not have to be screened.

If the PP3 battery is found to be a loose fit inside the case, some pieces of foam rubber or a similar material can be used to make it a firm fit.

ADJUSTMENT

In order to obtain maximum range from the system it is necessary to adjust VR1 to produce a frequency of oscillation which coincides with the resonant frequency of the transducers. If an a.c. millivoltmeter is available, this can have its input fed from the so far unused receiver transducer. The transmitter is then switched on and

COMPONENTS

Resistors

- R1 10k Ω
- R2 220k Ω
- Both $\frac{1}{4}$ W carbon $\pm 5\%$

Capacitor

- C1 470pF polystyrene

Integrated Circuit

- IC1 CD4001AE or CD4011 CMOS quad 2-input NOR and NAND gates respectively

Miscellaneous

- X1 OAB40K 40kHz transmitter ultrasonic transducer (see *Shop Talk*)
- B1 9V type PP3
- S1 push-to-make, release-to-break type switch
- PL1 phono plug

Stripboard: 0.1 inch matrix 16 strips x 12 holes; plastic case approximately 120 x 65 x 40mm; PP3 battery clip; 6BA nuts, bolts and washers (2 off each); wire; solder

See
**Shop
Talk**
Page 108



By Brian Terrell

New products and component buying for constructional projects.

AN ENORMOUS number of enquiries resulted from the *Treasure Locator* article published in last month's issue due mainly to a number of technical errors that appeared in the article and the difficulty encountered by many in obtaining some of the components required to complete the project. We offer our apologies for these errors and detail below the modifications to be made to the article:

1. In Fig.2, the integrated circuit IC1 is incorrectly labelled, it should read MC3360P (as was listed on this page last month).
2. In the component list under the heading of capacitors, there are two C15's. The first of these, 10nF plastic or ceramic should be deleted.
3. Add to the list of capacitors, C170-022 μ F plastic or ceramic.
4. IC1 in the component list should be amended to read MC3360P.
5. In Fig.3, the capacitor labelled C17 should be labelled C16.

Treasure Locator Component Suppliers

Components that proved difficult to obtain were C3, C4 20nF silver mica capacitors 1 or 2 per cent or polyester with 1 per cent tolerance; C2 1250pF compression trimmer; C16 50pF air spaced trimmer.

Dealing with these in order our investigations proved that 20nF silver mica capacitors are not available on the amateur market the highest value to be obtained being 10nF. Two of this value can be wired in parallel to provide the required 20nF but this will prove to be very expensive.

Closer inspection of the prototype unit revealed that polyester types were used. Tolerance was not marked. The only markings on these capacitors was Yamoto Nissei .02 on a green body. We have been unable to trace a supplier of these. However, Mylar film capacitors of the required value are available with a

tolerance of 5 per cent and this will be suitable for this project. They can be obtained from Watford Electronics, 33/35 Cardiff Road, Watford, Herts. The cost is 6 $\frac{1}{2}$ p each including VAT. There is a postage and packing charge of 25p on all orders under £10. You can also obtain the 1250pF compression trimmer and 50pF air spaced trimmer from this firm for a cost of 41p and £1.52 respectively.

Another supplier of the 1250pF compression trimmer is Home Radio, 240 London Road, Mitcham, Surrey. The cost is 60p including VAT but the postage and packing charge is rather on the high side—85p. This makes the single item very costly but is less noticeable if buying more components. Home Radio have been receiving orders for many parts of the *Treasure Locator* and are in a position to offer a complete set of electronic components for this project at an inclusive price of £14.

Also Arrow Electronics have been supplying parts for this project and are able to offer a complete set of electronic components at an inclusive price of £9.99. They also tell us that they can supply a pair of moulded plastic discs that can be fitted on either side of the coil to offer protection and produce a professional looking job. The inclusive price is £1.40p per pair.

V.H.F. Portable Radio

The *V.H.F. Portable Radio* has the highest component count amongst this month's constructional projects but most components should be readily available. Trimmer capacitors are items that often cause supply problems and this project uses two. If you experience any difficulty in obtaining these two devices, you can obtain them from Watford Electronics at a cost of £1.51 for the 10pF type 804 trimmer and 23p for the 30pF beehive trimmer. Both prices include VAT. Add 25p to cover post and packing.

The component list specifies a potentiometer/switch combination (VR2/S1) fitted with a single-pole switch. There is no reason why the more readily available d.p.d.t. type cannot be used and one half of the switch ignored.

The two field effect transistors TR1 and TR2 may have unfamiliar type numbers but are generally available as was borne out by the first three lists of semiconductors that we looked at, these being Maplin Electronic Supplies, Watford Electronics and Marshalls.

If trouble is encountered in locating a telescopic aerial, Maplin and Home Radio list these in their catalogues. The latter also hold stocks of Universal chassis.

Probe-less Continuity Tester

Not many components are required to construct the *Probe-less Continuity Tester* and none should be difficult to obtain. The battery used in the prototype PX-28 is a silver oxide type and should be available from camera shops and stores such as Boots. We contacted Dixons Photographic to find that this can be obtained from them for a cost of £1.68.

As you will notice this is a large proportion of the total cost of the project; fortunately it is not essential—it was chosen for its longer life than standard

cells and its small physical size. Any other 6 volt battery can be used but a larger case will undoubtedly be called for.

Ultrasonic Remote Control System

Only the components for the transmitter part of the *Ultrasonic Remote Control System* are listed in the component list this month but has been costed to include the receiver transducer as these are only sold in pairs.

As far as we know, the type specified is only available from Arrow Electronics Ltd., Leader House, Coptfold Road, Brentwood, Essex. The price for a pair of transducers is £5.29 which includes VAT, postage and packing. Order as RL400PP.

Arrow Electronics plan to offer a set of electronic components for the complete system—transmitter and receiver. More details of this will be available next month.

Find The Pair

No component buying problems are envisaged for the *Find The Pair* project as all are considered to be "standard" and will be available from many sources.

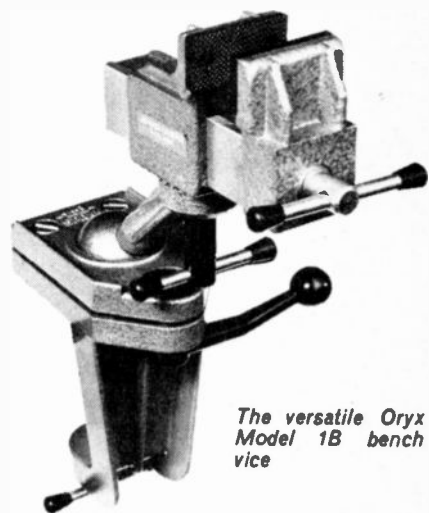

The versatile Oryx Model 1B bench vice

Adjustable Vice

A precision made bench vice which should interest both the model making and electronic constructor enthusiast is now available from Greenwood Electronics, manufacturers of professional soldering irons and equipment.

The Oryx Model 1B vice is a versatile tool with 89mm jaws and is fully adjustable to rotate through 360 degrees and can be locked in any position. The vice is equipped with nylon jaw linings giving a firm grip with no damage to the work piece. Jaw linings are replaceable.

The main components of the vice are cast in high tensile strength lightweight alloy and finished in stove enamelled green.

Cost of the Oryx 1B bench vice is £19.95 plus VAT at 8 per cent and is available from Greenwood Electronics, Dept E.E., Portman Road, Reading, Berks, RG3 1NE.

INTRODUCTION

If you have ever wondered whether a fuse is blown, the polarity of a diode, the type of a transistor, if a capacitor is holding charge, or if a wire has a break in it, and you have gone to get your multimeter and then had to juggle with the two probes, the component, and tried to watch the meter at the same time, this instrument should appeal to you.

In the time it took you in the past to dial an ohms range, with this instrument your testing will be complete. You hold the instrument, which acts as one "probe", in one hand and your other hand becomes the other "probe". So if you can hold, or touch the component, you can test it. A light emitting diode is provided which gives a quick, yes or no, indication.

FOR GUIDANCE ONLY

ESTIMATED COST OF COMPONENTS

£2.50

START
HERE FOR
CONSTRUCTION

The case is made from an aluminium tube in which one gram vitamin C tablets are sold. Firstly the paint is removed using wire wool. The cardboard in the plastic top, which retains moisture absorb-

ing chemicals, is removed and the top washed out. The plastic protrusion is then cut back to give more available space in the tube. A metal disc, preferably of copper or aluminium, and of approximately 25mm diameter is then attached to the plastic top using a 20mm 6BA bolt. Finally file a slot and drill the holes for the slide switch.

Most of the components including the battery are mounted on a small piece of 0.1 inch pitch stripboard 10 strips by 19 holes. It has to be cut oversize then filed down until the board makes a tight fit in the tube. Next break the copper strips at the points indicated in Fig. 2. The battery should be fitted first, leads are soldered on to the

HOW IT WORKS...

The component under test and the resistance due to one's body are placed in series when the component is held against the contact disc. This completes the circuit (if there is an electrical path through the component) and current flows into the amplifiers. This is only a minute current but is sufficient to cause a much larger current to flow through the light emitting diode, illuminating it to show continuity.

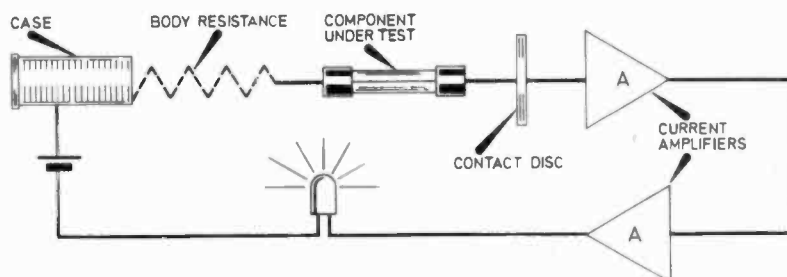

battery contacts, as the battery life should be long. The battery is held in place by two loops of wire. Next all the connecting wires should be soldered to the board, remembering to make them long enough for the top to be removed and the board withdrawn while the switch is fixed in position.

If the connecting wires used are small enough pass them through the holes on the stripboard, so they appear from the copper side of the board. When the board is inserted in the tube, these wires will

WIRE-LESS CONTINUITY TESTER

By C. J. Mair

Probe-less CONTINUITY TESTER

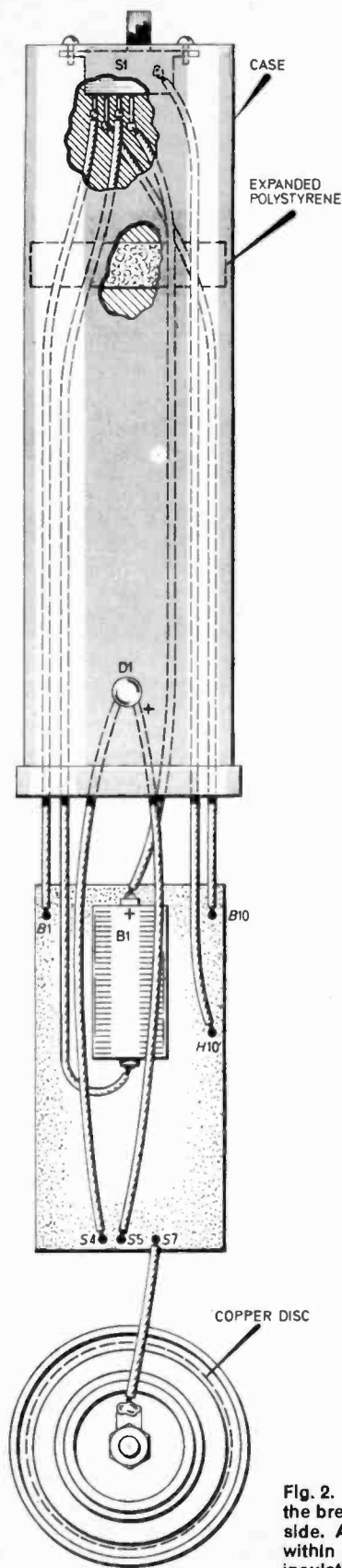

Photograph of the prototype component board.

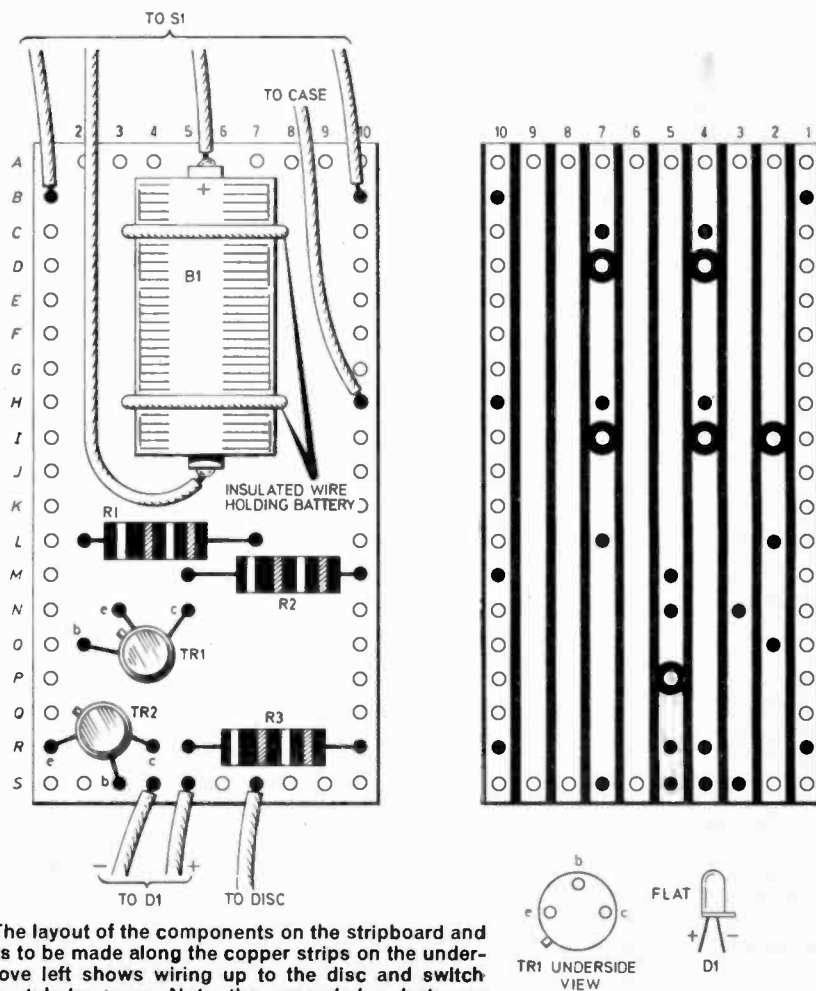
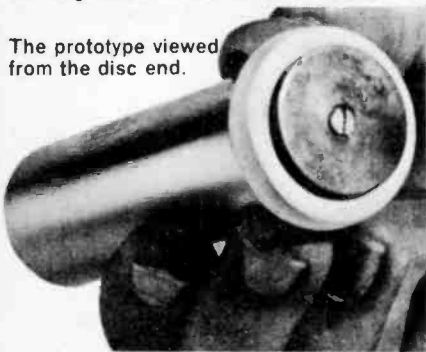

Fig. 2. The layout of the components on the stripboard and the breaks to be made along the copper strips on the underside. Above left shows wiring up to the disc and switch within the tubular case. Note the expanded polystyrene insulating washer below S1.

then curl underneath the board and not tangle up in the components. A loop of strong cotton should also be attached to the board to facilitate the removal of the board in the future. If a tag is used to connect the wire to the bolt holding the disc in place, the top can easily be replaced with a top which has a length of 6BA rod sharpened at one end to make a probe.

Solder the remaining components on the board using a heat-shunt on the leads of the transistors and l.e.d. which should now be connected to its appropriate wires. Then bolt the switch in position, ensuring it is off before doing so, place a piece of expanded polystyrene in the tube to ensure the switch and board are always separated. If the board has been made too small the polystyrene can be replaced with a circular piece

The prototype viewed from the disc end.



COMPONENTS

See
**Shop
Talk**

Resistors

R1	270k Ω	
R2	2.7k Ω	
R3	100 Ω	108
All resistors are carbon $\frac{1}{4}$ W $\pm 10\%$		

Semiconductors

TR1	BC108 silicon npn
TR2	BC108 silicon npn
D1	TIL209 light emitting diode

Miscellaneous

B1	6V silver oxide battery type PX-28
S1	d.p.d.t. miniature slide switch
Stripboard 0.1 inch matrix, 10 strips \times 19 holes; copper or aluminium disc 25mm diameter; case (see text); 6BA hardware; small length of 6BA rod; 6BA solder tag; connecting wire; plastic sleeving; solder.	

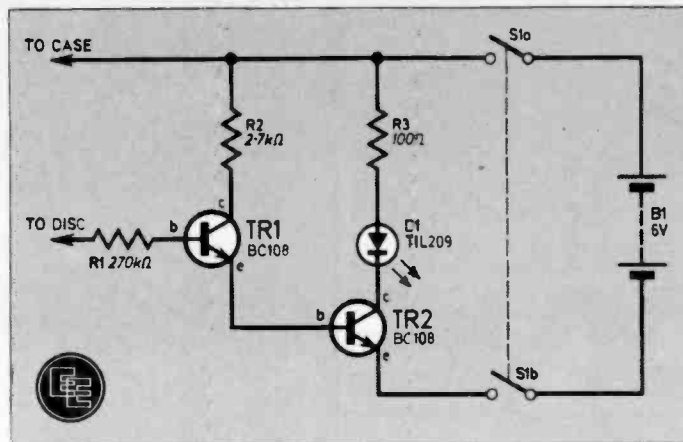

Fig. 1. The complete circuit diagram of the Probe-less Continuity Tester.

CIRCUIT DESCRIPTION

The circuit is basically a very high gain d.c. amplifier with a light emitting diode as its load. In order to achieve very high gain and a high input impedance two transistors are used in a Darlington pair configuration. The circuit diagram is shown in Fig. 1. This arrangement provides very high gain as the emitter current of TR1 becomes the base current of TR2, so the total gain is approximately equal to the product of the individual gains of TR1 and TR2.

When testing a component the case is held in one hand and the component touched against the metal disc with the other. In this way the base current for TR1 flows through you (it is limited to 17 μ A) and the component. Resistor R1 is included to ensure that the circuit cannot be damaged by accidental shorting of the case to the disc. This base current is amplified and illuminates the light emitting diode.

The input impedance of this

type of transistor configuration is very high as the input impedance of TR2 becomes the emitter load for TR1. In this way the input impedance is large compared with the resistance of the person using the instrument. This combined with the circuit being designed to put TR2 into saturation easily, makes the brightness of the l.e.d. largely independent of the resistance of the person using the instrument. So when testing fuses, diode action, transistor junctions and continuity the action is very positive. On the other hand when testing capacitors, they can actually be seen to charge up as the time constant is very large due to the high input impedance.

Although the silver oxide battery used to drive the circuit is expensive, a significant current is only taken from it during the short time the l.e.d. is on, the battery should therefore last two or three years even with frequent use.

of wood with a groove cut to support the board. Now place the board in the tube, ensuring that if the transistors have metal cases they are not touching the metal tube. It is also advisable to place plastic sleeving on the leads of the transistors, as a safeguard against short circuits. Once a hole is made for the l.e.d. it should be held in place with Araldite or similar glue. When this has set, the top can be put on and the instrument tested.

Switch on, hold the case in one hand and touch the metal disc with your other hand. The l.e.d. should light up. If it does not recheck the

wiring, the battery polarity and that of the l.e.d. If all is well the tester is then ready for use.

LIMITATIONS

Due to the necessity of making the tester's action independent of the resistance of the person using it, only a very small current, in the order of 2 or 3 μ A, needs to flow to light the l.e.d. This means that components with leakage currents of this order cannot be tested; this usually applies to germanium devices and not the more common silicon ones. \square

SQUARE

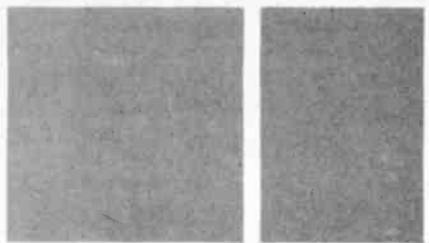

ONE

...FOR BEGINNERS

WE ARE HERE TO HELP YOU -

NO MATTER HOW NON-TECHNICAL YOU MAY BE, JUST READ ON!

IDENTIFYING COMPONENTS

Electronic components come in an enormous range of shapes, colours and sizes with their values and type numbers either printed on the body, colour coded or numerically coded. The newcomer to electronic construction may at first be bewildered when opening a package of components but in a short time should be able to instantly recognise components and readily "decipher" their values.

This month we shall deal with the most commonplace basic passive components namely resistors, and capacitors to aid identification together with circuit connection details.

RESISTORS

Resistors are generally cylindrical in shape with a connection lead emerging from each end and can be connected in circuit either way round. Some resistors are made specifically for p.c.b. construction and have short preformed leads pointing in the same direction, but these are rarely featured in these pages and are not readily available on the amateur market. You may see these in surplus stores on computer panels, etc.

The value of the resistor is either in the form of a colour code (see Data Card given free with last month's issue) or simply printed on the side. Printed values can be straight forward such as 6.8k Ω or 180 Ω or may be coded e.g. 1k2 (1.2 Kilohms) 5R6 (5.6 ohms) M47 (0.47 megohms or 470 kilohms).

CAPACITORS

Capacitors can broadly be split into two categories, *non-electrolytic* and *electrolytic* types.

The former are colour coded or have their values printed on the body. They come in a multitude of shapes, sizes and colours depending to a large extent on their composition which can be: polyester, ceramic, silver mica, paper, metallised foil, polycarbonate, plastic foil, polystyrene, mixed dielectric mylar film carbonate, to mention the common types,

see Fig. 1 for some examples.

Most non-electrolytic capacitors have their values printed directly on the body i.e. 680pF (picofarads), 0.22UF or MFD (microfarads).

You may find some capacitors marked μ F (especially high quality types) eg. 3940 μ F. This is another way of writing 3940pF. Alternatively this can be read as 3.94nF (nanofarads). Sometimes a K is printed together with the number. eg. 22K; this is 22,000pF or could be read as 22nF.

It is not uncommon nowadays to receive Russian manufactured capacitors and in particular ceramic plate types where the value on the body may read 3H3 or 10H; these are 3.3nF and 10nF respectively.

Some capacitors such as the Mullard C280 series use colour coding to indicate the value in nanofarads. See the Data Card given in last month's issue for details.

Also marked on the body is the working voltage 250V, 63V etc. The value of the voltage across the capacitor should never exceed this value, but can usually be any value below it. Non-electrolytic capacitors are not polarity conscious, that is to say they can be connected in circuit either way round.

Electrolytic capacitors are easily recognised by their physical size (quite large) and by the fact that they are enclosed in a metal case (usually covered in a plastic sleeve). One lead is connected to the metal case, this being the -ve terminal while the +ve lead is marked on the case with a "+" sign. An annular indentation at one end also marks the +ve lead.

The value is always printed on the body together with the working voltage (colour coding is never used). Connections to the capacitor are either axial wires (one from each end) or radial wires or tags (both from same end).

Electrolytic capacitors are polarity conscious and must be connected in the circuit the right way round otherwise they can be destroyed. See Fig. 2, for a selection of electrolytic capacitors.

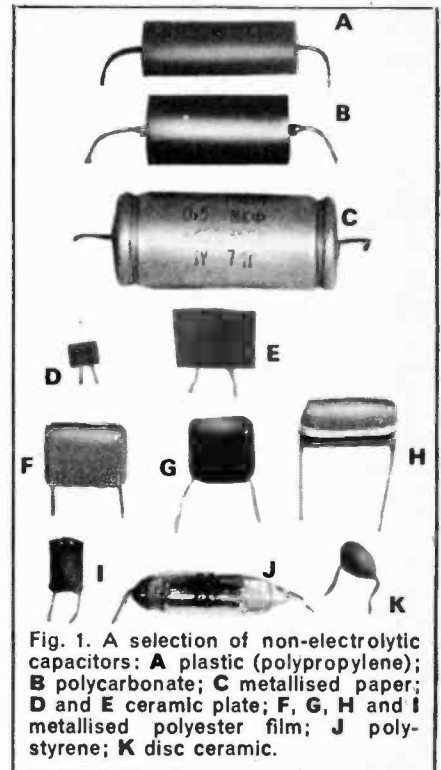
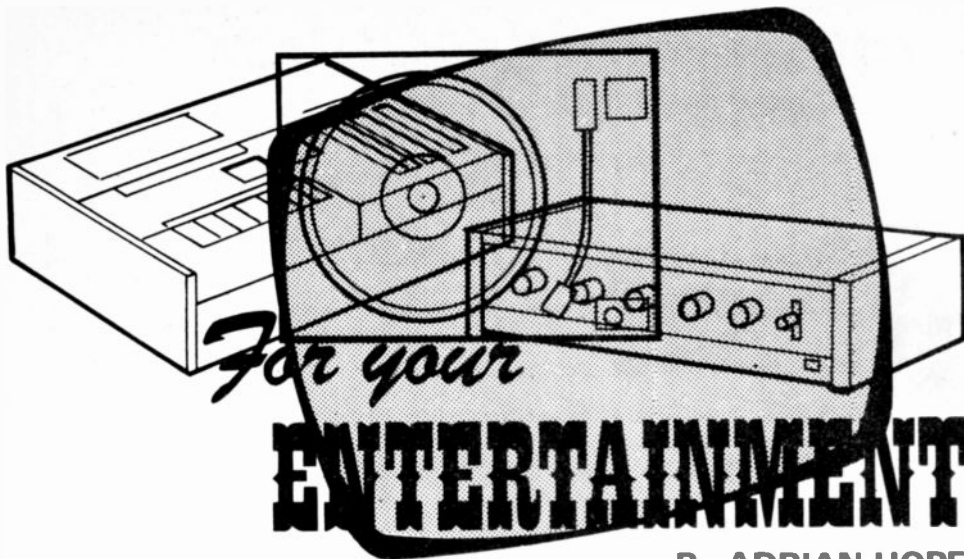

Fig. 1. A selection of non-electrolytic capacitors: A plastic (polypropylene); B polycarbonate; C metallised paper; D and E ceramic plate; F, G, H and I metallised polyester film; J polystyrene; K disc ceramic.



Fig. 2. Electrolytic capacitors: A 2000 μ F 50V; B 2200 μ F 25V; C 1000 μ F 40V; 100 μ F 40V; E 33 μ F 25V; 100 μ F 6V; 10 μ F 10V tantalum.



By ADRIAN HOPE

A CURIOUS situation has arisen in the hi fi field over recent years. What was once a semi-cottage industry, with firms turning out only a few hundred amplifiers, tuners or loudspeakers a week to meet the demands of only a relatively few devoted enthusiasts, has now become a full-scale industry with mass production. Increasing sales of equipment have created increasing interest in hi fi as a hobby in its own right and this increased interest has stimulated the growth of a whole new industry—hi fi journalism. As even a casual glance round your local bookstall will show, there is now an extremely wide range of different journals. The disease has also spread to the Continent, with almost as many French magazines and some very impressive publications from Germany and Italy.

Although it is easy for a production line to churn out more amplifiers and tuners to meet increased demand, it is far less easy for journalists to do likewise with interesting copy. So there is a continual search in the hi fi world for new authors with something interesting and accurate to say. Inevitably some mistakes have been made, and less-than-accurate statements have found their way into print.

Reviewing

In some cases, without doubt, serious damage has been done to the reputation of essentially good products, and some essentially bad products have been quite unreasonably lauded. The whole business of "amateur" reviewing of sophisticated equipment has been causing such concern, not only to reputable manufacturers but also to professional journalists and reviewers, that it was made the subject of an Audio Engineering Society meeting.

Some interesting points were brought up, that readers should bear in mind when using published technical reviews as a guide to what equipment they buy.

Quality Control

One approach to reviewing is simply to check the specification of a piece of equipment as claimed by the manufacturer in

his advertising literature. This is useful, provided the reader understands that small variations between claimed and actual specification (e.g. 99 watts output is measured instead of 100 watts claimed) is significant only in the strictly legal context of the Trade Descriptions Act. The important point to watch here is for reviewers' measurements that drastically differ from those claimed. Such differences may be as a result either of poor Quality Control on the part of the manufacturer (in which case the reviewer has taught the potential buyer something useful), or reliance by the manufacturer on outdated measuring equipment (certainly not unheard of and hardly an encouragement to buy his products).

The other main possibility is that the reviewer is an amateur working with poor or mis-used equipment. Peter Walker, of the British firm, Quad, cited the example of how the incorrect use of 3-terminal (i.e. common earth) testing equipment across the input and output of a 4-terminal amplifier (i.e. without common earth) can drastically and quite unfairly increase the distortion measurements of that amplifier.

Peter Walker also pointed to another pitfall for the inexperienced reviewer trying to compare the performance of

different loudspeakers. It has recently been proved by the BBC Research Department that if two loudspeakers are compared side by side, and one of those loudspeakers has a bad dip in its frequency response, the human ear will compensate for this dip (rather like the automatic gain control of a radio) and thus make the other loudspeaker, which has a good, flat response, sound horribly peaky!

Moratorium

Another approach to reviewing is to start with the question, "Is the product suitable for a given purpose?" But this brings personal opinion into the matter. Indeed, one AES member went so far as to propose a moratorium on all measurements. "Electronics is a technical subject, but hi fi is not," he said. "Measuring the performance characteristics of a piece of hi fi equipment is as pointless as counting the number of words used in the first act of Hamlet. In each case it is the sound that matters."

Currently there is a move afoot to form a club of accredited reviewers. But so far no one has agreed on what the basic minimum requirements should be for entry. One thing is certain, whatever the requirements, I shan't be a member. I have neither the ability nor the test gear to measure equipment, and thus never review on a technical level.

X-Rays

Columns like these can be a useful clearing house for information. A topic to be looked at in the future is the possible detrimental effect that X-rays, as used for heavy dose security checks at airports and docks, can have on electronic equipment such as transistors, i.c.s, and perhaps even liquid crystal displays. If any readers, so far unaware of this phenomenon, suddenly find two and two making five, for instance by recalling how a calculator or electronic watch went haywire after a security check at an airport, I'd be pleased to hear of them, c/o EVERYDAY ELECTRONICS.

In the meantime, just to be on the safe side it might be worth trying to have any such equipment you are carrying abroad handled like film—that is examined by hand, rather than X-rayed.

Probophone (September '77)

There is link missing between pins 2 and 6 of the i.c. in the circuit diagram of Fig. 7. This is shown correctly on the PCB and stripboard layouts. In the components list resistors R1 and R2 have been interchanged, the values are correct on the circuit diagram. In Fig. 2, the stripboard layout, the two wires to the left hand tag and wiper of VR1 should be transposed. The PCB layout is correct. On the circuit diagram of Fig. 7 the values for the presets are given as 20kΩ although in the components list they are 22kΩ. Although either value would work in the circuit, the 22kΩ presets are more readily available. On the PCB layout for the keyboard, the wire which is annotated TO PROBE should in fact go to the circuit board.

Enlarger Timer (October 1977)

In Fig. 3 on page 80, an additional break needs to be made on the underside of the stripboard at location J22 add D2 should be reversed.

Treasure Locator (October 1977). See Shop Talk

PLEASE
TAKE
NOTE

... physics is fun!

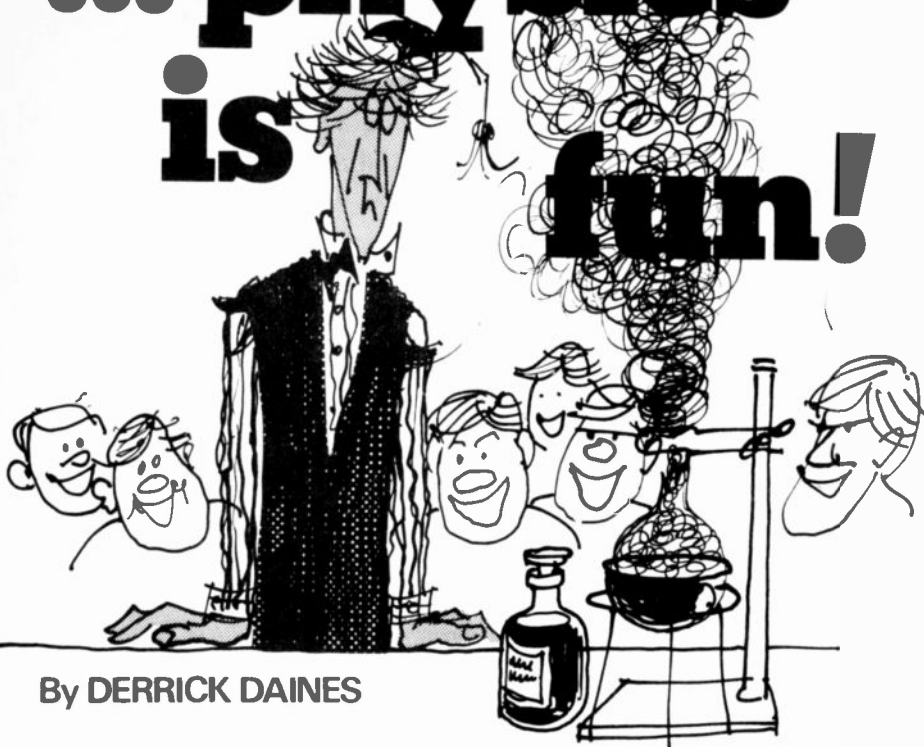

By DERRICK DAINES

ANY oscilloscope will show that an alternating current varies or alternates about zero volts. For example, the heating element (6.3 volts) of a transformer. Other less usual alternating currents may vary about a datum line that is measurably above or below zero volts, while yet others are square, triangular, spiky or any combination of these, Fig. 1. All are loosely termed alternating currents although strictly the term should be restricted to those in which the polarity changes every half-cycle—that is, those that alternate about zero volts.

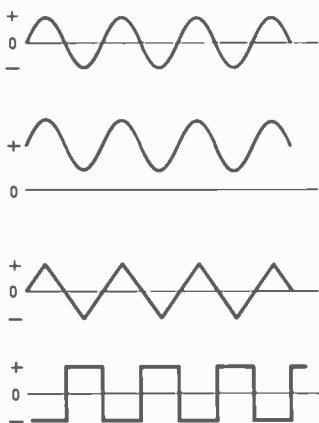

Fig. 1. Examples of different waveforms as seen on the screen of an oscilloscope.

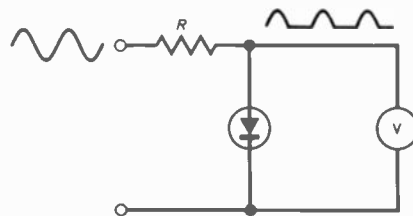

Fig. 2. Measuring a.c. voltages with this type of set-up, false readings are obtained.

A.C. measurement

If a multimeter is placed across an alternating current the needle will show no deflection if both halves of the cycle are equal because the needle does not have sufficient time to respond before the current changes. In currents derived ultimately from the house mains, for example, the 6.3 volt valve-heating tap of a transformer, the current changes at 50Hz (hertz, or cycles per second) in a smooth sinewave and this is far too fast for the needle to respond to. If one half of the cycle is cut out or earthed as in Fig. 2, the

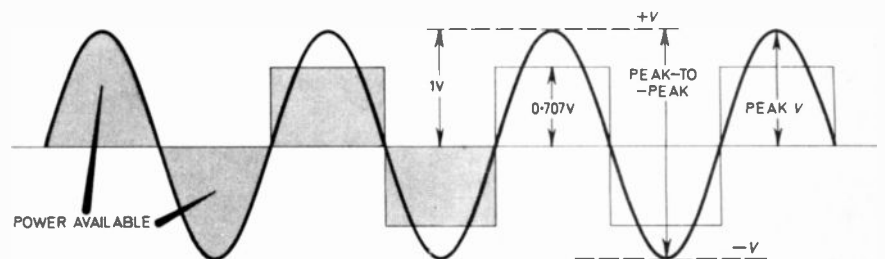

Fig. 4. The perfect sinewave. Note the different relationships. A square wave has also been drawn to compare with.

needle will indicate a figure above zero volts, but nowhere near the peak voltage of the wave.

Waveforms

Now sometimes we need to know the peak voltage; sometimes we need to know the peak-to-peak voltage, which is twice the peak; sometimes we need to know the power in the current. It all depends. With a sinewave it's all pretty easy; if we know one, we can work out the others, but with other waveforms it can get tricky.

For peak-to-peak measurements we really need a calibrated oscilloscope. If our scope is not calibrated, we can do it for ourselves with the aid of a signal generator. We set the output of the generator at (say) 4 volts peak-peak and then adjust the trace on the scope so that it traces exactly over 4 squares on the graticule, Fig. 3. Each square is thus equal to 1 volt. We make no further adjustments to the scope, but apply the unknown a.c. signal to it, thus by counting off the squares the peak-peak voltage can be measured.

This technique applies to any sort of a.c. signal, even with the datum above or below zero volts.

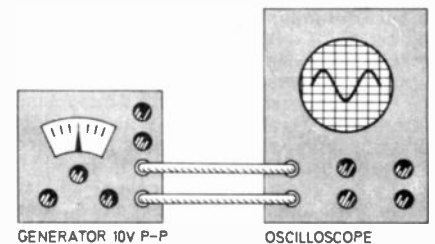

Fig. 3. Calibrating an oscilloscope with the aid of a signal generator.

Power

The power of an a.c. signal is a different matter. Power is the ability to do work and as our experiments on static electricity have shown us, we can have spikes of enormous voltage but little power. Model train enthusiasts will have come across the "pulse power" technique in which pulses of high voltage for a model train are applied continuously, but because they are "off" for as long as they are "on", the model loco creeps along the track and does not race. It is worth noting here that the power of a square wave alternating about zero volts is the same as the power in direct current of the same voltage since the polarity has nothing to do with the power available.

Mathematics has shown us that the power in a sinewave is based on the

square root of 2, which is 1.414; Fig. 4 should make the relationships clear. The power available at any instant is based on the voltage, represented by the height of the curve above or below the line. If such a sinewave is traced onto graph paper and the squares counted, it will be found that the average (or mean) is 0.707 of the height of the peak above and 0.707 of the depth below. Twice 0.707 is 1.414. In other words, the effective voltage of a sinewave is 0.707 time the peak voltage. (Note the terminology; peak voltage is half the peak-to-peak voltage.)

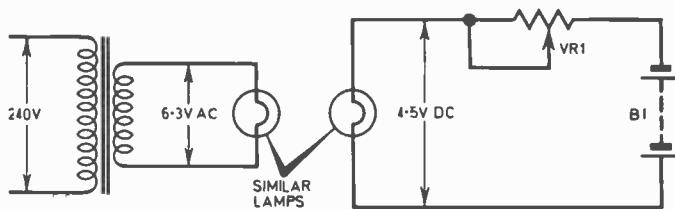

Fig. 5. Circuit arrangement to prove that the effective voltage of a sinewave is 0.707 times the peak voltage. In terms of power, 6.3V a.c. is equal to 4.45V d.c.

Heating effect

Another way of looking at the whole thing is to say that the power contained in an alternating current is based upon the effective voltage and that the power is the same as that in a direct current which will produce the same amount of heat in a given resistor as that of the a.c. current under consideration. A simple experiment

will serve to illustrate the point.

Obtain a bell transformer driven from the mains, with a 6.3V output. Connect a suitable 6.3 volt lamp to this, Fig. 5. Adjacent to it mount another 6.3 volt lamp connected to a source of variable d.c. A suitable method is a variable resistor in series with three or four cell batteries. Adjust the variable resistor until the two lamps are of a similar brilliance. Under

these conditions both are consuming the same amount of power and a measurement across the terminals of the second lamp—with the lamp removed—will reveal that the voltage here is roughly 4.5 volts, any discrepancy being due to the different resistance of the meter, plus human error.

The experiment shows that in the a.c. circuit, 6.3×0.707 equals 4.45—the effective voltage!



Readers' Bright Ideas; any idea that is published will be awarded payment according to its merit. The ideas have not been proved by us.

BUOYANCY SWITCH

After reading the article on the *Sight & Sound Fish Attractor* in the June issue of *EVERYDAY ELECTRONICS*, I came up with another method of switching the unit on and off and so replace the gravity switch. Details of my construction are shown below.

When the unit is submerged in the water, the ping-pong ball will try to float to the surface thus bending one brass strip against the other thereby "making" the switch and turning on the unit. If this method is adopted a heavier bed-weight might be needed.

David Hewitt,
Headington,
Oxford

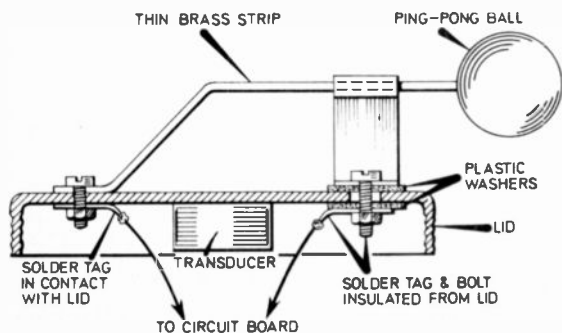

WIREBOARD

I often find that stripboard is hard to get and when I eventually do find a supplier it is very expensive. To solve this problem I have made an alternative, wireboard. Take a piece of wood the same size as the stripboard, mark on it a matrix of lines about 10mm apart, bang nails in at these points and join them with tinned copper wire. You then have a perfect piece of wireboard which, in my opinion, is equally as good as stripboard.

D. Strong,
Tiverton,
Devon

SOLDERING IRON STAND

A simple and useful soldering iron stand can be made very simply by using two crossed nails in a block of wood. The diagram shows the arrangement. In use it is a simple matter to rest the iron between the two nails.

G. Duggan,
New Ross,
Co. Wexford

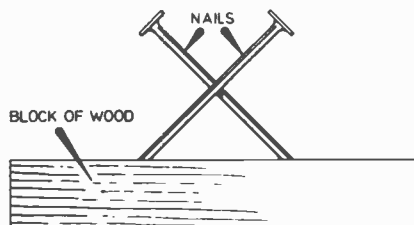

CLEANING PCB HOLES

When using copper-clad printed circuit board, it can be very difficult to clear the holes of solder when it is required to replace any component. Take a fairly large pin, which you sometimes get from a new shirt, and using the pointed end push it through the hole with the aid of a soldering iron.

The solder is then wiped away leaving a clean hole.

J. R. Hunt,
Eastbourne,
East Sussex

TEA

CH-

By
**GEORGE
HYLTON**

in

78

Part
2

CIRCUIT MODULE CONSTRUCTION

THIS month we continue by describing how to construct the first set of modules to be used in the series. These are the LED, 1000 μ F CAPACITOR PNP and NPN modules. Also described is the foundation for all our experiments; the module board. When conducting any experiments, the modules to be used are placed on the module board, interconnections are then made easily to the supply lines, etc.

CIRCUIT MODULES

In our experiments we shall need to connect the same transistors, diodes, etc. into many different circuits. These components are delicate and easily damaged by excessive heat. So to protect them against repeated handling and soldering we shall make them up into small sub-assemblies, which we shall call modules, each with its own individual soldering points and some built-in protection against overload. In this way, the delicate components need only be soldered once. Afterwards, all soldering will be done to the soldering points, which are not the same as the component lead-outs but are separated from them by lengths of wire or resistors.

LED MODULE

Our first circuit module is for a light emitting diode (l.e.d.) the circuit is shown in Fig. 2.1. This is a kind of lamp which lights up when the right amount of current is passed through it, in the right direction. If an l.e.d. is connected straight across the battery it takes too much current and is destroyed.



CARD A

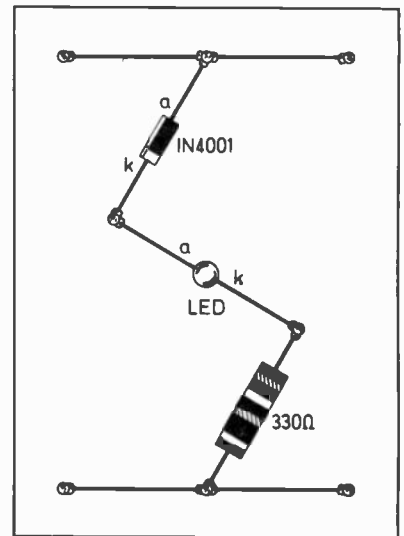

O = POSITION OF NAILS OR PINS

Fig. 2.1 (left). Circuit diagram for the LED module. Fig. 2.2 (right). Full size under card used for the module. This may be traced and used as a template.

To avoid this we shall connect a resistance of 330 ohms *permanently* in series with the l.e.d. and afterwards make all connections in such a way that this 330 ohms is in the path of the current. This limits the amount of current to a value which is quite safe for the l.e.d. specified (and for most other types too). This protective resistance alone may not be enough, however. We have said that the l.e.d. acts as a lamp if the right current is passed through it *in the right direction*.

CARD B

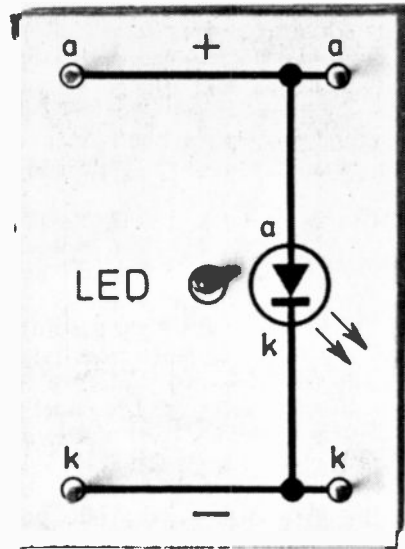
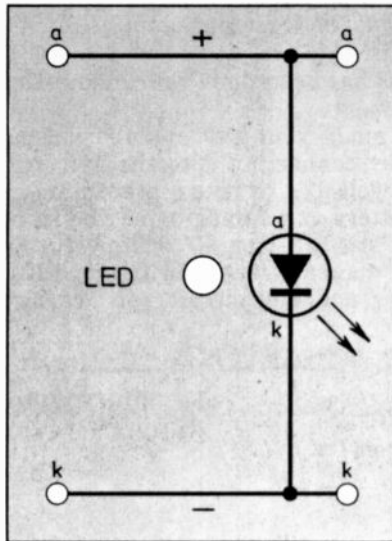

Fig. 2.3. The top card required for the LED module. Again this is drawn full size and may be used as a template. After the symbol and lettering has been finished, it can be sprayed with a colour of the constructor's choice. Shown alongside is a photograph of the completed module.

If current flows in the wrong direction the l.e.d. may again be destroyed. To avoid this, we shall include a second protective device. This will allow current to flow only in one direction. Any current in the reverse direction will be blocked. Provided that we connect this second device to the l.e.d. in the right way, it will be impossible for current to flow except in the right direction. This second protective device is a silicon junction diode of a kind designed to pass easily the sort of current needed to light the l.e.d.

CONSTRUCTION

Two methods of construction may be used by the reader, one is by using pins in hardboard, the second uses nails in plywood. Both methods will be described in detail for the LED module *only*. It is therefore up to the constructor to decide which method is best suited to his needs.

USING PINS

Refer to Fig. 2.2 this shows full size the card required to be fixed to the base and method of wiring up, the same layout is used either for the hardboard or plywood version. First, draw the layout onto stiff white card and then stick it down on the base. If you are using hardboard stick it to the rough side.

We need to hold the pins firmly in the hardboard otherwise any strain imposed on the pins will pull them out and possibly damage the components. We therefore use a simple trick. Instead of inserting the pins into the board from above we shall insert them from below, and pull the shanks through as far as they will go. The heads then prevent the pins from being pulled out.

Insert the pins through the appropriate points on the diagram, pushing or knocking them deep enough for their points to come through the back of the board. To hold the pin steady when hammering grip it with pliers near its head. Now pull the pins out,

turn the board over, and insert them through the holes they made on the back of the board. Pull them right through, as far as they will go. You are now ready to wire up the boards on the diagram side.

Bend over the pointed ends so that the points press against the shanks, out of harm's way. If you have found, from earlier soldering, that your pins take solder very easily, you can proceed to the wiring up. If not, tin the lowest parts of the shanks first. Next attach the plain connections. Use tinned copper wire except in the case of connections which cross others: use insulated wire for these. Do not stretch the wire tightly between the pins: leave it loose.

As you solder, slide the wire down the stem of the pin to press against the base, and hold it there with pliers or the tip of screwdriver until the solder hardens.

Next connect the resistor, then the diode and finally the l.e.d. It may help to tin the ends of their leads first. When doing this grip the lead you are working on firmly with the pliers, so that heat running along the lead from the iron towards the body of the component is diverted into the pliers. Use the same technique whenever you solder a component, especially a semiconductor or a plastic capacitor.

Make sure that you identify the anode and cathode of the diode and l.e.d. and connect them to the appropriate points. Similarly with any silicon diode you might substitute for the IN4001.

Most silicon diodes have a band of colour printed round their body near the cathode. Some have the cathode marked with a + sign. Light emitting diodes usually have a "flat" on the plastic casing near the cathode, also, the cathode lead may be shorter than the anode lead. Solder the l.e.d. so that its plastic body sticks up above the board. Stick some cardboard over the back of the board to insulate the pinheads. Cut off or bend over all pins except the four at each corner. Cut a piece of cardboard to fit the module and cut holes to slide over the shanks of the four long pins, also make a hole for the l.e.d. to poke through.

Mark the stiff white card on top of the components with the signs and letters shown in Fig. 2.3 and fit it,

by working the shanks of the four pins through the holes. Turn the module over and press a small blob of Blu-Tak to the plain cardboard near each corner. This anchors the module when it is placed on your base-board.

To avoid snagging yourself on the bent over points of the four long pins, fill the loops with solder.

USING NAILS

Once again draw the layout shown in Fig. 2.2 and stick this down on your piece of plywood. Hammer one inch long veneer pins through the points on the card indicated. The components are then mounted on the nails using our newly found soldering technique as shown in Fig. 2.2 only this time the short nails are cut off whereas in the previous method the pins were bent over. The same card shown in Fig. 2.3 is then placed on top of the components, only this time small pilot holes are made at the appropriate points and forced over the long nails.

The following wiring-up order, designed to minimise the risk to components, should be used for all modules and circuits.

1. Bare wires
2. Insulated wires
3. Resistors
4. Capacitors
5. Semiconductors.

MODULE BOARD

We said in *Part One* that we are going to use a "module board" as the "base" for doing our experiments. The size and materials have already been mentioned all that remains is to describe the actual

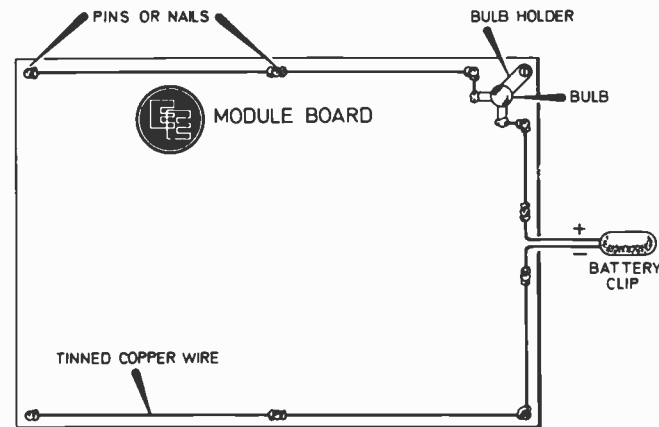

Fig. 2.4. The layout of the Module Board. This is made from a piece of 15mm fibreboard or similar material measuring 305 x 216mm. The tinned copper wire "supply lines" should be raised above the board, soldered close to the heads of the pins or nails as possible.

construction. The module board material is covered with a sheet of white card the layout is shown in Fig. 2.4. The only components to be soldered onto the board is the supply lines from the battery and the bulb holder.

Although the board was sprayed blue in our particular case there is no reason why the colour cannot be changed.

Begin by banging in nails or pins, whichever method you have chosen, and solder the tinned copper wire to the pins. Screw the bulb holder firmly to the

base. It does not matter which shape the holder is, it just depends on the type supplied with the kit of components.

Once this has been done your module board is ready for use.

Having made your LED module you can now light the l.e.d. by connecting it to the battery. However, it will be as well first to take a precaution against shorting the battery and damaging it. The safety device we shall use is a 6.3V or 8V 300mA (0.3A) bulb connected permanently between the positive terminal of the battery and any circuit you are using. Fig. 2.5.

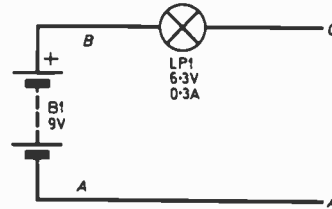

Fig. 2.5. Circuit diagram of the Module Board. Compare this with the layout of Fig. 2.4.

Therefore the "+" battery terminal (B) is not to be connected to anything but the bulb. Battery power for circuits is to be taken from point C. If A and C are shorted the bulb lights brightly (at any rate if the battery is new) and may quickly burn out if left on. The battery will quickly run down, too, so disconnect instantly if the bulb ever lights up.

The use of a bulb holder will enable you to switch the power on and off by screwing in or unscrewing the bulb. Connections to the battery terminals can be made with a battery press connector.

So far we have two modules; a series string of ten 1 kilohm resistors and an LED module with protective diode and resistor.

Used in combination these two modules give a rough and ready support to the idea that resistance tends to reduce the flow of current.

Connecting the LED module to the battery supply. Positive to positive and negative to negative will make it light up, connecting it the wrong way round won't.

Now take your chain of 1kΩ resistors and connect the negative end to the negative supply and the positive end of the LED to various points along the chain from the positive end downwards as shown in Fig. 2.6. The arrow-head and wiggly line on the diagram indicate a movable connection. The l.e.d. gets progressively dimmer as you move down the chain towards the negative end. On point 3 it scarcely lights, and it does not light at all on 2 and 1. Naturally, not on 0 either, because it is "shorted".

With the resistor chain across the battery each resistance uses up one-tenth of the battery's voltage. So for a 10V battery each resistance absorbs 1V. Tap 10 is then at 10V, being connected straight to the battery. Tap 9 is at 9V, tap 8 at 8V and so on. Tap 1 is at 1V, but more than 1V is required to light the l.e.d. Tap 2 is at 2V, but about 2.4V is needed. On Tap 3 (3V) it should light. Of course, as soon as the l.e.d. lights, the current it now passes upsets all the voltages along the resistor chain. This is because the current in the l.e.d. must flow through all the series resistances above the tap to which it is connected. This additional current further increases the voltages

absorbed by these resistances, leaving less voltage for the l.e.d. itself than would normally be found at whatever tap it is connected to.

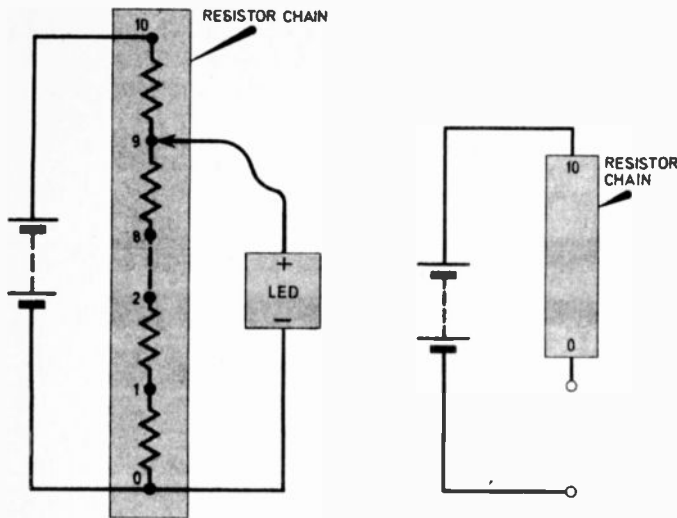

Fig. 2.6. Demonstrating the effect that any resistance tends to reduce the flow of current. Fig. 2.7. (Right). If the RESISTOR CHAIN has one end unconnected—no current flows.

With the RESISTOR CHAIN connected with its bottom end floating as in Fig. 2.7 no current flows until the LED is connected. So there is no voltage loss in the resistances and the bottom end is at the full battery voltage, say 10V. Naturally when the LED is connected to the bottom tap and current flows through the resistor chain this voltage is drastically reduced. If the bottom end of the resistor chain is not connected to the negative end of the battery, but left "floating" the full 10V must appear at point 0. However, as soon as anything is connected between 0 and negative, current flow in the resistors reduces the voltages.

If you had a perfect voltmeter, you could prove by measurement that with one end the resistor chain floating (and no LED) the full battery voltage really does appear at the floating end of the chain, despite the resistances. A perfect voltmeter should draw no

current. We do not have such an instrument, but by using a simple trick we can achieve the same result. The trick involves the use of a new circuit element. This is called capacitance and the component which embodies it is called a capacitor.

CONSTRUCTION

Make up two 1000 μ F CAPACITOR modules as shown in Fig. 2.8. Each module carries the standard circuit symbol for the component. The white plate is positive and the black plate negative. We shall use these capacitors to collect and store voltages from our RESISTOR CHAIN.

To illustrate what happens when a capacitance is charged by a battery via a resistance a water-flow analogy is helpful, Fig. 2.9. The battery is a water tank whose water level is kept constant. The level corresponds to the voltage. The capacitor is a container with an inlet at the bottom and the resistance is the pipe. You can see that, however wide or narrow, long or short the pipe may be, water flows into the container until the level is the same as in the water tank. Then stops. Using a longer or narrower pipe (that is, increasing the resistance) slows down the process. But given enough time, the container must

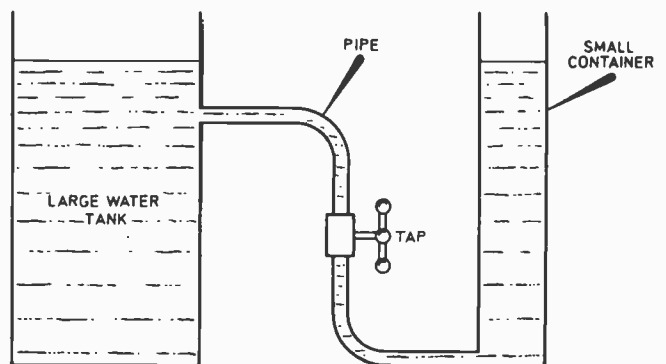

Fig. 2.9. The water-flow analogy shown here is helpful in understanding how a capacitor is charged.

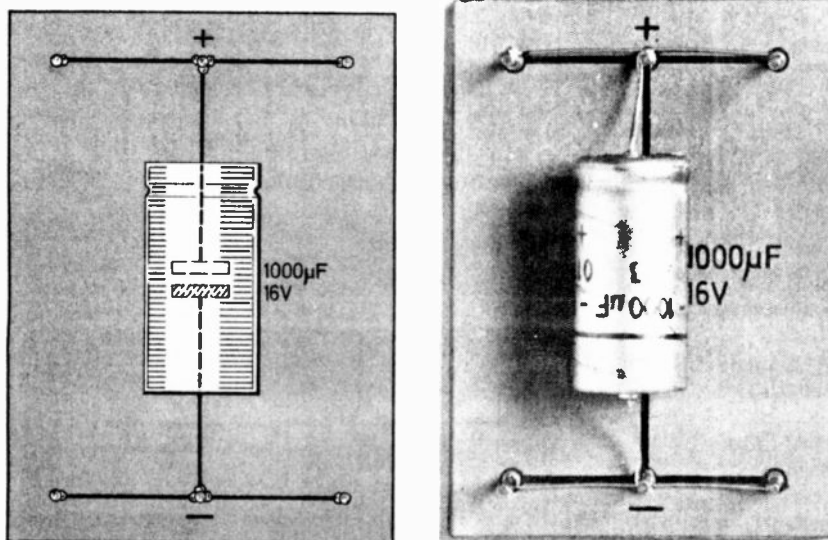

Fig. 2.8. The 1000 μ F capacitor module. Only one card is required for each module, and is shown full size.

fill to the same level, however high the resistance. If you think about it, you will see that when the tap is first opened water flows into the empty container quickly, but as the container fills the flow is slowed down. This is because the water in the container is now pressing down on the inlet, opposing the inward flow. This effective "head of water" is the difference between the level in the tank and the level in the battery. As the container fills this head of water is reduced. When the container is nearly full the flow is very small indeed. Perhaps the container never gets quite filled up to the tank level, even down to the last drop!

The equivalent electrical circuit shown in Fig. 2.10 shows the same sort of behaviour. When the switch *S* is first closed, there is no voltage on the

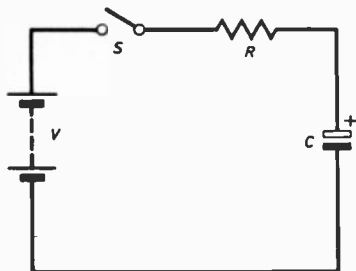

Fig. 2.10. The equivalent electrical circuit of Fig. 2.9.

capacitance. So the full battery voltage *V* drives current through *R*. But as soon as any voltage builds up in *C*, it opposes *V* and the current decreases. When the capacitor is charged to very nearly *V*, the current through *R* is very small. Perhaps *C* never quite gets charged to *V*, though obviously it can be charged to something so close to *V* that it makes no practical difference.

Anyway, it is clear that if we charge our 1000 μ F module via a resistance it will eventually charge to the battery voltage, as near as makes no difference. If the complete RESISTOR CHAIN is used, making a total of 10k Ω it takes about 30 seconds to charge almost completely to the battery voltage.

Before using newly bought electrolytics it is advisable to connect them to the battery for a few minutes, observing polarity. This reforms the oxide film if it has deteriorated in storage. A charged 1000 μ F, applied to the LED with the correct polarity produces a brief flash of light. Check that your 1000 μ F modules are holding their charge by leaving them disconnected for 5 minutes after charging and then applying them to the LED. If they fail this test discard them.

You can now connect your RESISTOR CHAIN across the battery, Fig. 2.11. Charge a 1000 μ F from various points, apply to the LED and see the flash. Equal flashes should indicate equal voltages. Your earlier experiment with the RESISTOR CHAIN connected across

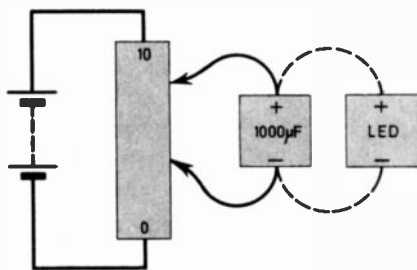

Fig. 2.11. Lighting the LED with a charged 1000 μ F module.

the battery showed that the voltage drop across the bottom three resistors is just enough to turn on the LED. In fact the drop across any three adjacent resistors just lights the LED. (Test this.) You know, however, that the voltages in the RESISTOR CHAIN are changed when the LED is connected. So you cannot be sure that this test gives a true picture of the way in which the battery voltage is shared between the series resistors.

If the capacitor is connected across any three adjacent resistors, making sure to connect the positive plate to whichever of the resistors is nearest the positive end, it will, given time, charge up to whatever voltage exists across the three resistors. After that, it will take no further current and so will not upset the voltages at all. Having charged the 1000 μ F to the true voltage you can then remove it and apply it to the LED.

Experiment with the 1000 μ F and LED, comparing voltages across equal numbers of adjacent resistors. Also, prove that when the 0 end of the chain of resistors is disconnected and the 1000 μ F is charged via the whole chain for a long enough time the flash is as great as when the 1000 μ F is charged directly from the battery. Also, get an idea of the charging time by connecting the LED as shown dotted then tapping the 1000 μ F to the same points. The LED goes out then comes on again when *C* is charged. By now you will have realised that although these "1000 μ F and LED" tests give a rough indication of circuit voltages they are not precise or convenient. In particular, the short durations of the flashes make careful comparisons difficult. The problem is that the charge in the 1000 μ F is used up too rapidly. The LED takes too much current, and quickly drains it away.

What is needed is some way of slowing down this discharge of *C*. A much larger *C* would achieve this but then it would take longer to charge, too, which

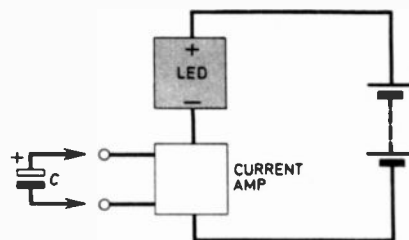

Fig. 2.12. Simple method of reducing the current taken by the LED, is by using a current amplifier.

might be tedious. A better way is not to apply the 1000 μ F to the LED directly, but via a current amplifier Fig. 2.12. If the current from the 1000 μ F is amplified 1000 times, then only a thousandth of the current needed to light the LED need be taken, and it will take 1000 times as long to discharge.

TRANSISTOR MODULES

A transistor is a current amplifier. A transistor is a device with three connections Fig. 2.13. A small input current flowing between base (b) and emitter (e) makes a much larger current flow from the battery through collector (c) and emitter (e), typically 100 times larger. This amplified current can be made to light up the LED.

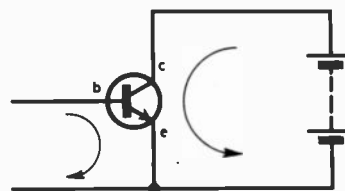

Fig. 2.13. Circuit symbol for a transistor. The current flow of each path is shown by the arrows.

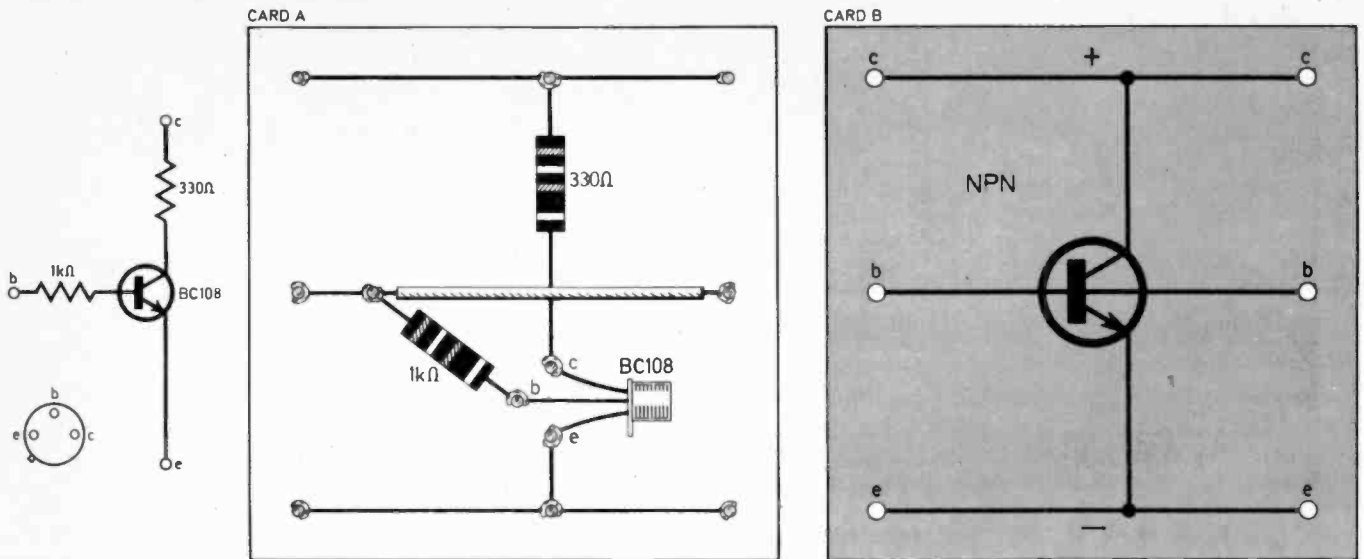

Fig. 2.14. Details of the NPN module. Construction is the same for the previous modules. Both cards are shown full size. Be extra careful when soldering the transistor.

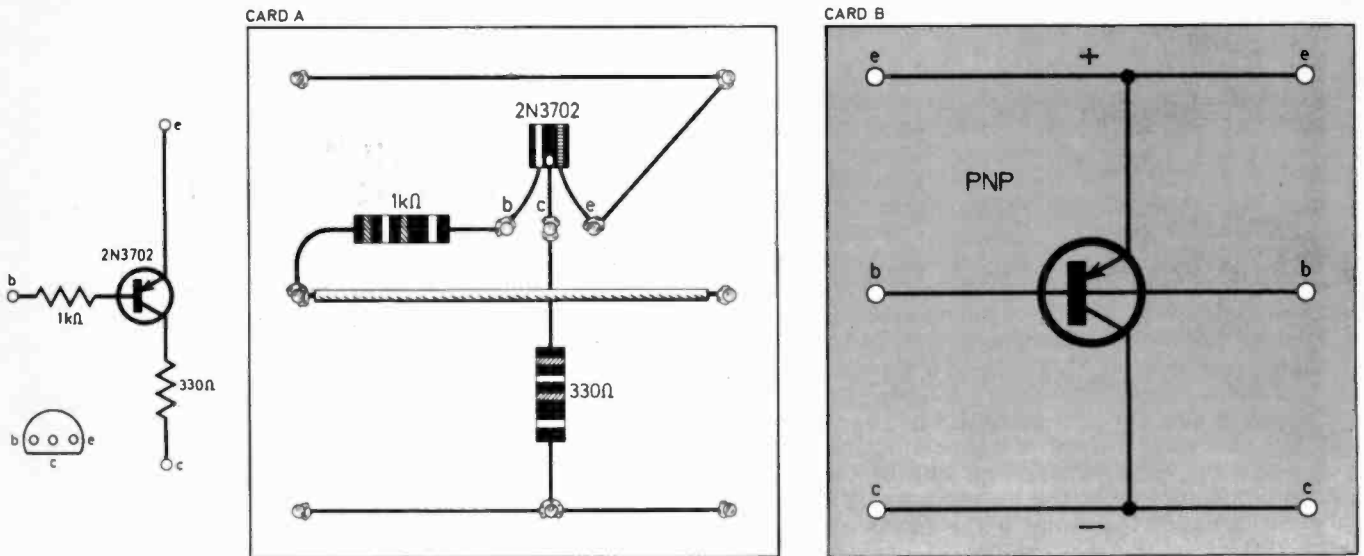
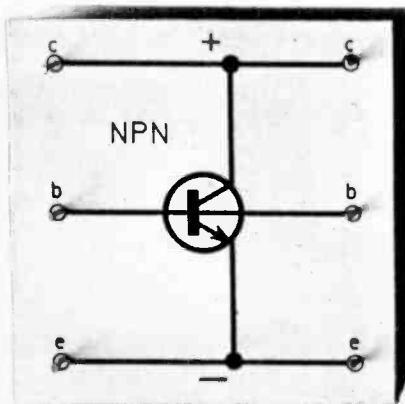
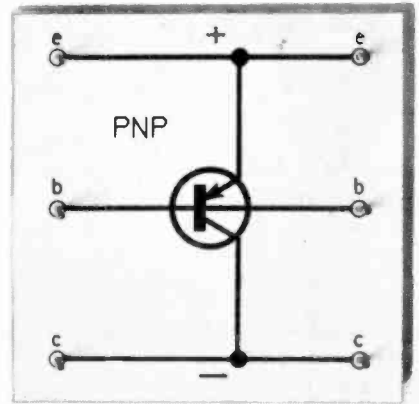

Fig. 2.15. The PNP module. This is constructed in the same manner as the NPN module. So be careful not to get them mixed up!



CIRCUIT MODULE CONSTRUCTION

Two photographs of the NPN and PNP modules. It is preferable if the two are sprayed in different colours. This then provides a further aid to identification.



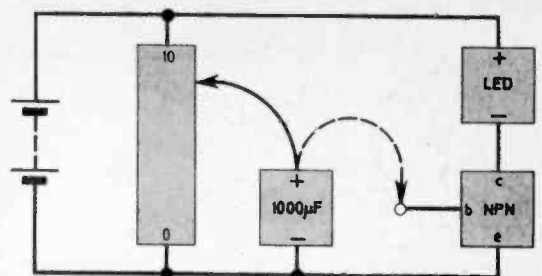
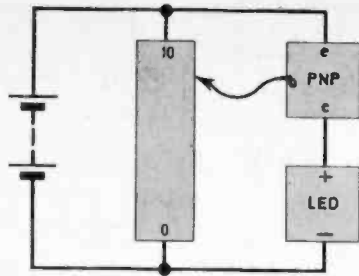
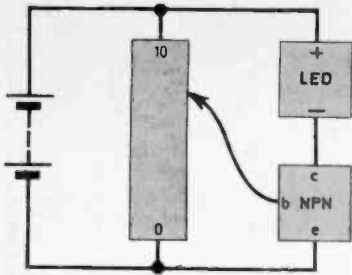

Figs. 2.16 and 17. Testing each of the NPN and PNP modules. If you do not get the correct results, re-check the wiring and in particular that of the transistors.

Fig. 2.18. An improvement on the circuit of Fig. 2.11. This time the LED stays illuminated for a longer period of time.

We now make up three transistor modules, two NPN and one PNP. Each consists of a transistor, protective resistors, and pins (or nails) for making the connections. Construction is as before; pins, plain connections, resistors, and finally the transistors. The circuit of each module and their construction are shown in Figs. 2.14 and 2.15.

Be careful to connect the transistors correctly as shown. The BC108 has a tag on its case which is a marker for the emitter lead (e). Similarly the flat on the 2N3702 serves the same purpose. Use pliers or tweezers as a heat shunt when soldering and blow on the joint as soon as it is made, to cool it. Mark the top of the modules as shown.

Now connect the LED, the resistor chain and one NPN module as shown in Fig. 2.16. You should find that the LED lights when the base (b) of the NPN module is connected to any tap on the RESISTOR CHAIN except for 0. This means that the current flowing into the base of the NPN module is enough, after amplification to light the LED, even when the voltage from the RESISTOR CHAIN is only 1 volt. We found earlier that it takes over 2 volts to turn the LED on. Evidently less than 1 volt will turn on the transistor in the NPN module.

Now test the PNP module by connecting the modules as shown in Fig. 2.17. This time you should find that the LED lights on all taps except 10.

Reconnect the NPN/LED modules as shown in Fig. 2.18. But this time instead of connecting the base (b) to the resistor chain, charge up one of the 1000µF capacitor modules from the RESISTOR CHAIN (any tapping will do) and then transfer the charged capacitor to the base (b) of the NPN module. The LED now lights for a length of time which will vary depending on the amount of charge in the capacitor.

This is a much better arrangement than just the capacitor and the LED module. The time that the LED stays illuminated now gives some indication of the voltage. Even so, it is not an entirely satisfactory way of measuring voltages. For one thing, the duration of the LED is not exactly proportional to the voltage. If it were, then it would last ten times as long for a 10 volt charge as for a 1 volt charge, but it doesn't, then again timing the LED is rather tedious.

Have you been wasting your time? Not at all.

QUESTIONS

- Most silicon diodes have a band of colour printed round the;
 - middle
 - cathode end
 - anode end
- When wiring up circuits, semiconductors should be connected;
 - last
 - first
 - after the resistors
- If a 12 volt battery is connected to a 2 kilohm and a 1 kilohm resistors in series, the voltage across the 1 kilohm resistor is;
 - 4 volts
 - 6 volts
 - 8 volts
- A capacitor is required to pass audio frequency voltages from a point at +18Vdc to a point at +5Vdc. Which of these capacitors is most likely to be suitable?
 - 10µF 10V electrolytic
 - 560pF polystyrene
 - 3.3µF 100V electrolytic
- The typical current amplification of a transistor is;
 - 100
 - 5
 - 3000
- A potential divider of 10 kilohms and 2 kilohms divides its input voltage by;
 - 3
 - 6
 - 5

Answers next month



Next month we shall return to the subject of resistance and capacitance, but in greater detail.

NEXT MONTH

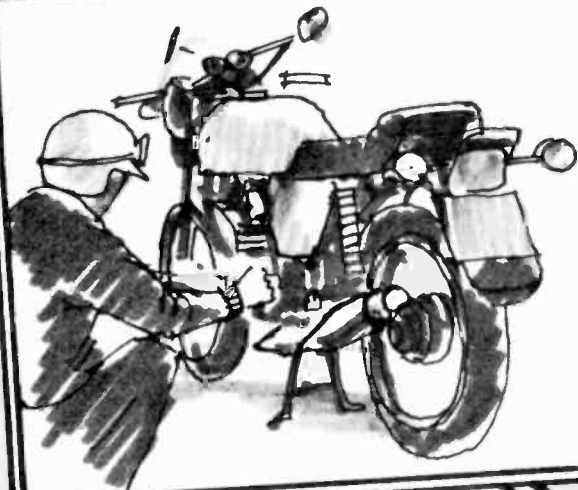

HAZARD WARNING SYSTEM...

This unit allows the existing car or motorcycle flasher unit to be used as a hazard warning system . . . all four lamps flashing simultaneously.

Automatic PHASE BOX

A unit designed for electric guitar and organ for live performances. Has a range of three octaves with a sweep rate variable from 0.2 to 5Hz.



Photoflash SLAVE UNIT

A very simple circuit that will trigger a second electronic flash when receiving the light from the main flash.



Also... ULTRASONIC REMOTE CONTROL SYSTEM - Part 2

Everyday ELECTRONICS

OUR DECEMBER ISSUE
WILL BE ON SALE
FRIDAY, NOVEMBER 18

SPECIAL OFFER

FOR READERS!

SOLDERING IRON

£2.95
Incl. Postage & Packing



The normal cost of this SRB 1 iron direct from the manufacturer is £3.70 including postage and packing.

The SRB 1 is a lightweight miniature soldering iron rated at 18 watts and comes fitted with a 3mm bit. It is mains powered (220-240V a.c.) and conforms to consumer protection regulation BS3456 2/14. The iron is fitted with approximately 2 metres of three-core mains lead and an instruction leaflet containing wiring details is included with all irons despatched to readers. The overall length of the iron is approximately 19cm with the handle incorporating a suspension hook. Each iron is guaranteed for three months.

Please complete both parts of the coupon opposite in **BLOCK CAPITALS**. Offer closes on 30th December, 1977.

Orders are normally despatched within 28 days but please allow time for carriage. You will be notified if a longer delay may be expected. Remittances must be by postal order or cheque (name and address on back of cheque, please crossed and made payable to IPC Magazines Ltd. This offer is open to readers in England, Scotland, Wales, Northern Ireland, and Channel Islands only. We regret it is not available in Eire or overseas.

To: EVERYDAY ELECTRONICS,
Dept. EE1, Rochester X, Kent, ME99 1AA

Please send me the Soldering Iron(s) as indicated below at £2.95 each including post and packing.

I enclose P.O./Cheque No. Value

No. required

Name

Address

Telephone number (Home or Work)

No. required

Name

Address

From: EVERYDAY ELECTRONICS,
Dept. EE1, Rochester X, Kent, ME99 1AA

Cut round dotted line

V.H.F. PORTABLE RADIO

By F. G. Rayer

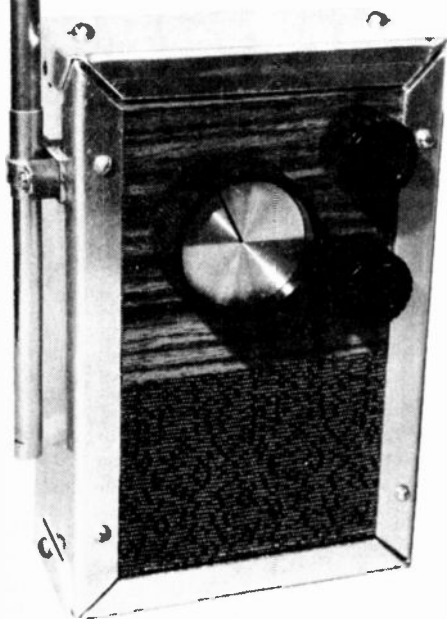

THE super-regenerative type of v.h.f. receiver is of particular interest on the grounds of simplicity (compared with a superhet) and the ease with which it can be adapted to cover a wanted range of frequencies. It has high sensitivity, is relatively inexpensive to build, and has no ganging or trimming difficulties. It lacks the selectivity of a superhet, but this does not generally prove to be too important over the range of about 55MHz to 198MHz or so which can be tuned here.

The present design has been well proven and tested, and although we make no claims about the quality of reproduction, it will give the constructor an insight to what goes on at v.h.f. frequencies. For this reason no set frequency band has been mentioned, instead a table of values for particular components has been provided together with the associated frequency range covered in each case. It should therefore be clear to the constructor that the present design can be modified to cover any frequency desired, within the frequency ranges shown and is suited to those who wish to experiment with radio reception within the v.h.f. bands.

**START
HERE FOR
CONSTRUCTION**

CASE

This needs to be prepared first, as the r.f. section is built directly onto the front panel. The box is a 150×100×50mm universal chassis, with an extra 150×100mm flat plate for the back. All the major dimensions are shown in Fig. 1. First cut a hole about 45 to 50mm in diameter for the speaker, which is near the bottom of the panel. This can be done with a large chassis punch, with an adjustable hole or tank cutter, or by drilling a ring of small holes and cutting away the excess metal. Also drill or punch holes for C5, VR1 and VR2, and for the two tagstrips, as well



as for 6BA bolts to secure the sides by their flanges, and for the audio board. Correct fitting for the latter can be obtained by drilling the board and metal panel together, in advance.

The receiver front was finished by securing fabric over the speaker opening with adhesive, bolts for the audio board having been fitted with lock nuts. These bolts are countersunk, as are those holding the tag strips, this part of the front being covered with self-adhesive material.

Bolts to secure the aerial pass through a strip of insulating material and insulating washers. This side is bolted on when wiring is finished.

RF WIRING

The layout of the r.f. section is shown in Fig. 2. Note that C1, C2 and C3 should be tubular or disc ceramics, which are convenient for their small size, this type may also be used in other positions. Connections to C1, C2, C3, C5, C6, and C8, in particular, should be as short as possible.

The trimmer C6 is soldered directly to the solder tags of C5, and a stout wire just clearing the moving plates goes to the rotor tag. Note that TR1 and TR2 have different drain, gate and source lead positions. A tag on one bolt holding the aerial is connected to TR1 gate.

Resistor R3, and the leads to VR1 wiper and C9 to VR2 should be kept close against the metal panel.

Of various transistors tried, the BF244 was found best for TR1, and an MPF102 for TR2. True, equivalents should be suitable, but similar types intended for lower

frequencies (such as the 2N5459/MPF105) ceased to regenerate at frequencies over about 100MHz so cannot be used here. There is of course no reason why different types cannot be tried.

COIL CONSTRUCTION

Coil L1 is wound with solid insulated wire, and has two turns fairly close together, with an outside diameter of about 10mm or 0.4in.

The second coil, L2 is of similar diameter, and can be 18s.w.g. or 20s.w.g. wire.

With three turns, spaced to occupy about 15mm coverage was 155 to 165MHz with C6 fully unscrewed. Screwing C6 down lowers the frequency.

A coil with four turns, 15mm long, covers approximately 130 to 155MHz with C6 fully unscrewed, this changing to 115 to 130 MHz with C6 slightly screwed down, and 85 to 115MHz with C6 nearly half closed.

Stretching or compressing L2 will also alter the frequency coverage. Amateur 2-metre signals will be found around 145MHz. Coil L1 is placed quite close to L2, but not so near that regeneration is not obtained.

HOW IT WORKS...

Signals induced into the aerial are selected by the tuned circuit. This part of the circuit consists of a coil and variable capacitor to select the required frequency. The signal is then passed via a buffer amplifier which merely isolates the aerial from the remainder of the circuit. The selected signal is then rectified by the detector which consists of a transistor which goes in and out of oscillation at the working frequency. The rate of oscillation is controlled by the regeneration control. The detected signal is then passed to the audio amplifier where it is amplified to a sufficient level to drive a loudspeaker.

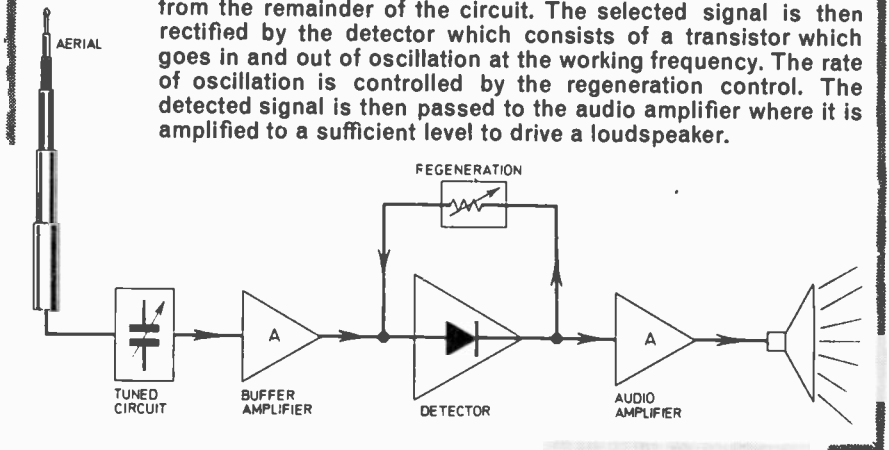

The radio frequency choke L3 consists of approximately 40 turns of 42s.w.g. enamelled copper wire, wound side by side, on a 4mm diameter insulated former. A 2.2 megohm resistor, was actually used, with the 42s.w.g. wire soldered to the resistor leads. The choke was not found to be critical, and can be wound on a small piece of insulating material. The winding should *not* be covered with

adhesive, varnish, or wax.

Although not exactly a coil, capacitor C7 needs to be constructed from wire. It consists of two insulated wires twisted tightly together for a length of 50mm. The two free ends are then soldered to the appropriate points on the wiring diagram. On no account should a single piece of wire be used, it could short out the transistor.

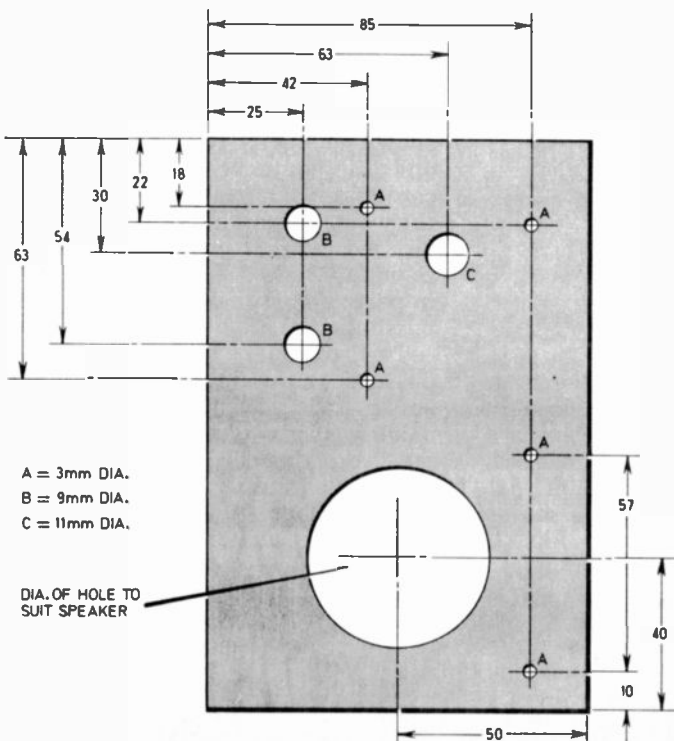
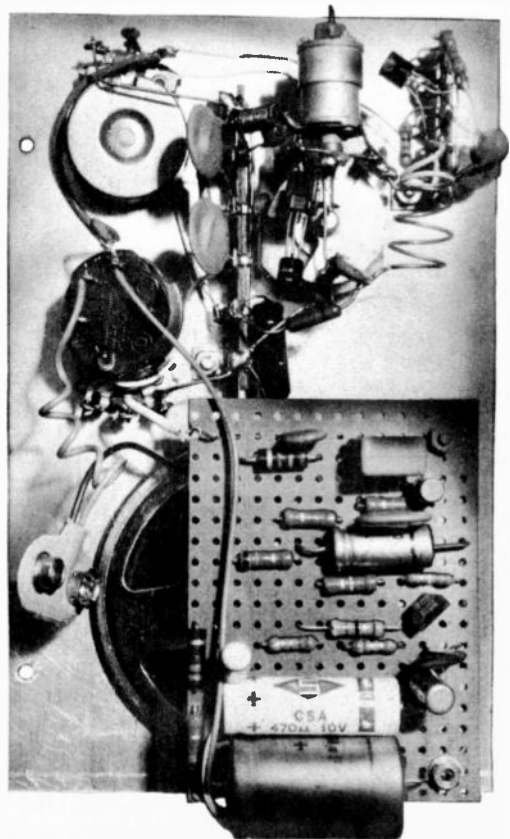

Fig. 1. The front panel with major dimensions. This is shown with the inside facing the reader. A photograph of the prototype component board and other front panel components is shown right.



V.H.F. PORTABLE RADIO

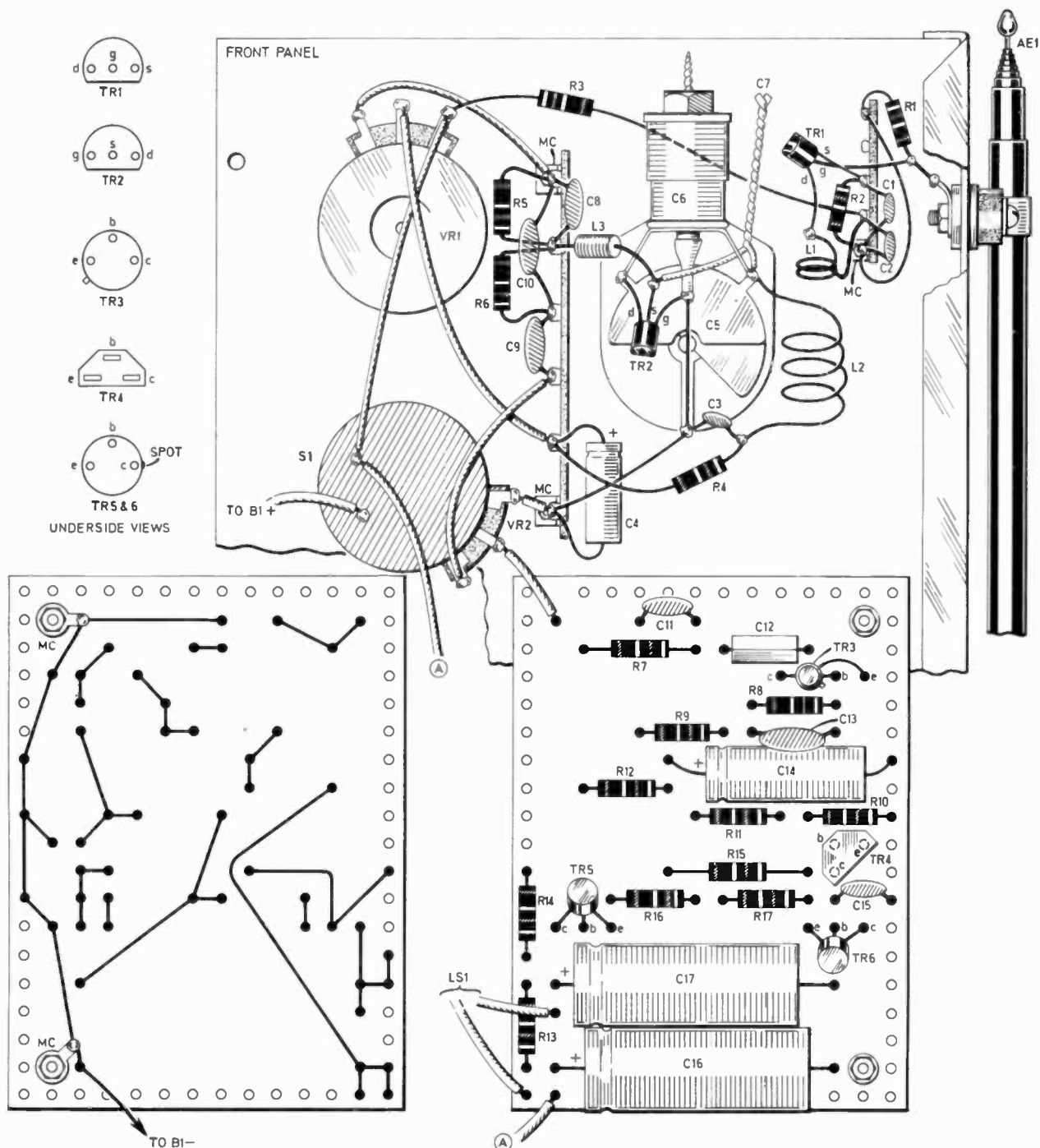

Fig. 2. Complete wiring details for the V.H.F. Portable Radio. The audio board is mounted on two long spacers arranged to clear the speaker underneath. The two insulated wires which form C7 should be arranged to point down towards the audio board. It will then be easier to adjust.

COMPONENTS

Resistors

R1 47k Ω	R10 220k Ω
R2 180 Ω	R11 270k Ω
R3 560 Ω	R12 1.5k Ω
R4 1k Ω	R13 1.5k Ω
R5 10k Ω	R14 680 Ω
R6 15k Ω	R15 47 Ω
R7 5.6k Ω	R16 2.2 Ω
R8 1.8M Ω	R17 2.2 Ω
R9 8.2k Ω	

All resistors are carbon $\frac{1}{4}$ W \pm 5%

Potentiometers

VR1 4.7k Ω lin.
VR2 100k Ω log. with single pole switch

Capacitors

C1 1nF	C9 0.1 μ F polyester
C2 1nF	C10 10nF
C3 1nF	C11 4.7nF
C4 22 μ F 10V elect.	C12 0.1 μ F polyester
C5 10pF variable (Jackson type C804)	C13 0.47 μ F polyester
C6 30pF beehive trimmer	C14 125 μ F 10V elect.
C7 1.5pF see text	C15 20nF
C8 5nF	C16 1000 μ F 10V elect.
	C17 470 μ F 6.3V elect.

All low value capacitors are tubular or disc ceramic, except where stated.

Semiconductors

TR1 BF244 <i>n</i> -channel f.e.t.	TR5 AC141 germanium <i>n</i> pn
TR2 MPF102 <i>n</i> -channel f.e.t.	TR6 AC142 germanium <i>p</i> pn
TR3 BC108 silicon <i>n</i> pn	
TR4 BC149 silicon <i>n</i> pn	

Miscellaneous

- AE1 telescopic aerial, about 90cm long
 - L1 two turns insulated wire, 10mm diameter, see text
 - L2 four turns 18 s.w.g. wire, 10mm diameter spaced to 15mm, see text
 - L3 r.f. choke, 402 turns of 42 s.w.g. wire, wound on a 2.2M Ω resistor, see text
 - B1 PP3 9V battery
 - LS1 8 ohm 55mm round loudspeaker
- Universal chassis 150 \times 100 \times 50mm; extra flat plate 150mm \times 100mm; plain stripboard 0.15 inch matrix 19 \times 14 holes; one 6-way tagstrip with two tags earthed; one 5 way tagstrip with one tag earthed; two small round knobs; one large round knob; covering for the front panel; 6BA hardware; insulating material for aerial; sleeving; connecting wire; solder.

See
**Shop
Talk**
Page 108

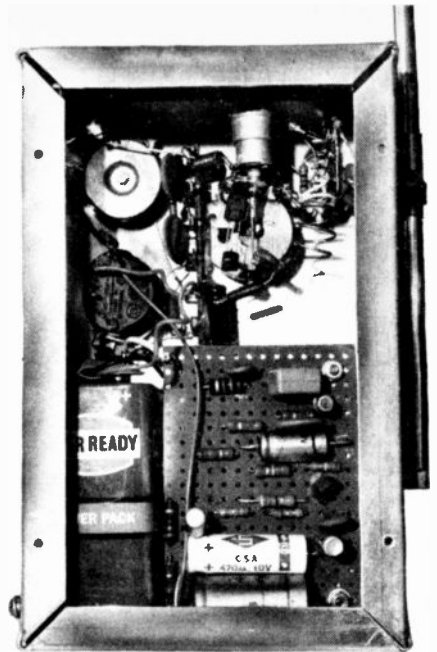

Photograph of the prototype with lid removed. Note the insulator between aerial and case.

USING THE RECEIVER

When the receiver is in use, VR1 is rotated until a loud rushing sound is obtained, which ceases when a signal is tuned in. This sound, which indicates quenching of the regeneration, may not be obtained if C6 is screwed down too far, or if TR2 cannot operate at the frequency wanted, or if L1 is too close to L2. The value of C7 also influences results, and may if wished be substituted by a small trimmer capacitor instead of the short insulated wires. Individual adjustment can then be made, if wished.

Ideally, the hiss should be obtained with VR1 rotated clockwise about one-half to two-thirds, but its setting is not very critical, except for exceptionally weak signals. With signals of ordinary strength, a type of self-limiting effect is obtained.

AUDIO BOARD

Both sides of the audio section board are shown in Fig 2, and uses plain 0.15inch matrix board. Temporarily secure two solder tags at the points marked MC. In most places the wire ends of components will reach to the necessary points and sleeving only need be added where wires might touch each other. Provide leads for the speaker and battery connections, and bring the lead from R7/C11 up through the board, so that

Table 1. Frequency coverage (MHz) for different values of L2 and C6

Setting of C6	Number of turns		
	Two	Three	Four
Fully Unscrewed	166 to 198	144 to 174	58 to 70
Slightly screwed down	114 to 170	128 to 146	55 to 98
Screwed halfway down	118 to 120	106 to 114	80 to 88

The frequencies covered in each case are only typical, variations in component tolerances will alter the final results obtained.

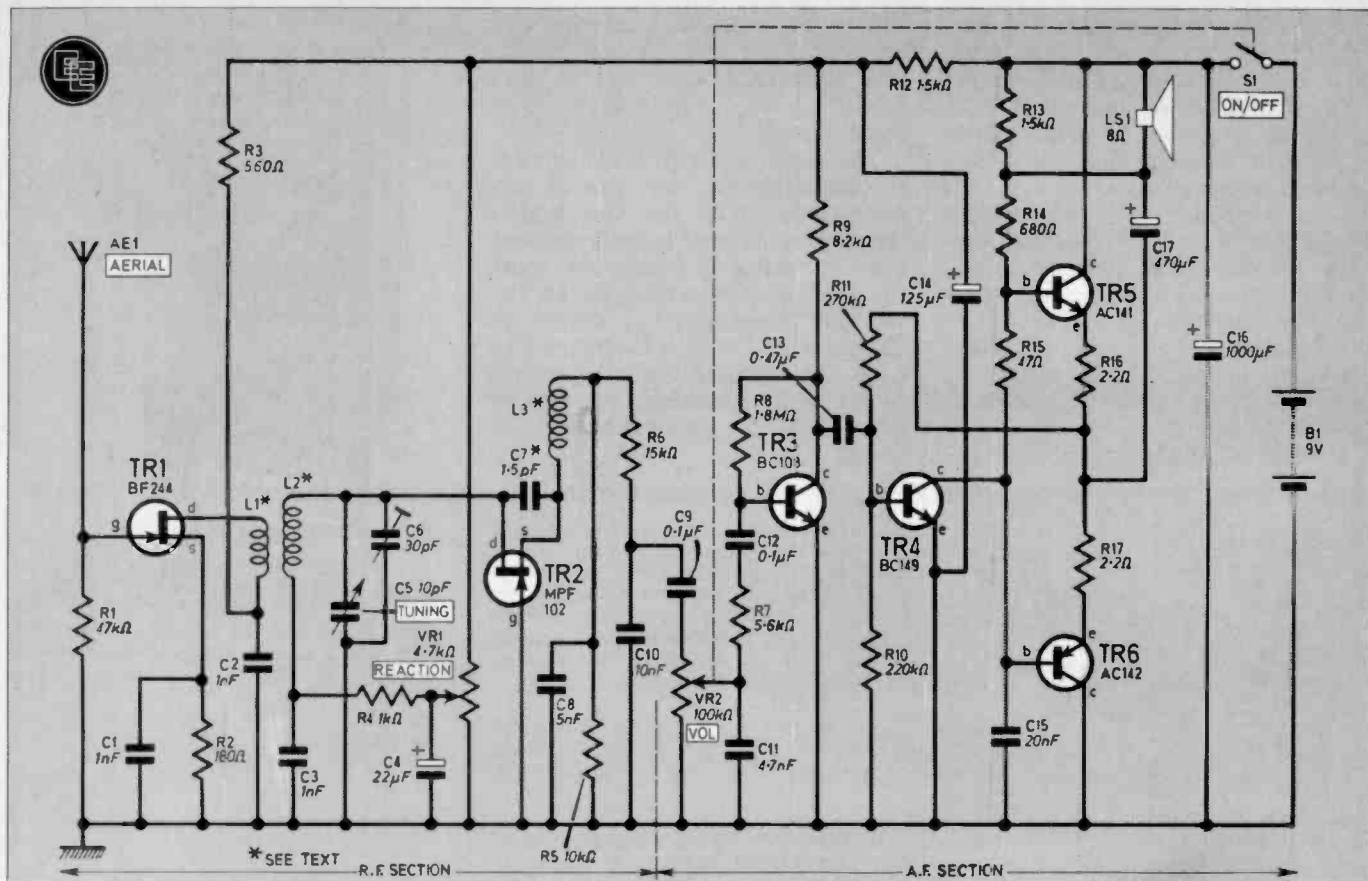

Fig. 3. Circuit diagram of the V.H.F. Portable Radio. The circuit may be logically split into two sections, the r.f. and a.f. stages.

CIRCUIT DESCRIPTION

RF SECTION

Referring to Fig. 3 this shows (to the left of the dotted line), the r.f. (radio frequency) section of the receiver, AE1 being the telescopic aerial.

Transistor TR1 is operated as a grounded source amplifier, whose main purpose is to isolate the aerial from the detector stage. Bias for the transistor is provided by resistor R1, R2 and R3. Coil L1 couples signals from the aerial to the second coil L2. This coil together with the variable capacitor C5 and trimmer C6 form a tuned circuit. The trimmer C6 provides some adjustment to the band covered by C5.

Transistor TR2 is the super-regenerative detector, with re-

generation controlled by VR1. In operation TR2 goes in and out of oscillation at a frequency determined by the values of L2, C5 and C6, this results in high sensitivity, and a slight background hiss. The latter ceases when a signal is tuned in.

Detection of the signal is arranged by TR2, the gate to source junction providing the actual rectification. The radio frequency choke, C8, C10 and R5 are provided to filter out any remaining r.f. before the audio is passed to the amplifier via R6 and C9.

Since we are using a fairly simple circuit we do not obtain the full benefits from the hi fi quality of f.m., the mode used on these sort of frequencies. Nevertheless good quality can be obtained by this method of slope-detection.

The upper limit to the frequency depends on the individual transistor used for TR2, and short wiring. For this reason a holder was used for TR2, and wiring kept as short as possible. It is therefore

recommended that the front panel layout be followed as closely as possible.

AUDIO AMPLIFIER

The circuit of this section is also shown in Fig. 3 and is to the right of the dotted line.

Should a receiver for headphone reception be wanted, TR3, with C11, C12, R7 and R8 may be assembled on a small board or tag strip, and high impedance phones may be wired in place of R9. With the full amplifier, TR3 is the first a.f. stage, followed by TR4 to drive the complementary output pair TR5 and TR6. This provides enough volume for an 8 ohm or similar speaker fitted in the case. It would be possible to use headphones by adding an output jack socket, but caution should then be taken to keep VR2 turned well back.

This part of the receiver is wired on a board, afterwards fitted behind the speaker.

it can be connected to VR2. If the layout is followed carefully, no difficulty should arise here. If wished, the amplifier can be tested by taking an audio input to R7/C11, keeping this quite low to avoid overloading.

A piece of insulating material is fixed to the back of the speaker with adhesive, as a precaution against short circuits, and the board is fixed by the long bolts previously described, and held with washers and lock nuts. Space is left for a PP3 9 volt battery at the side of the board.

Volume is controlled by VR2 in

the usual way, but generally this will not be turned to maximum, and advancing VR2 too far may easily cause overloading with some signals.

The aerial actually fitted extends to about 86cm, but this is unnecessarily long for the higher frequencies. There is little advantage in using a length of more than about $\frac{1}{8}$ wavelength at the working frequency. A dipole or similar aerial with a feeder can be used by closing the telescopic aerial and attaching the feeder conductors to receiver case and aerial. □

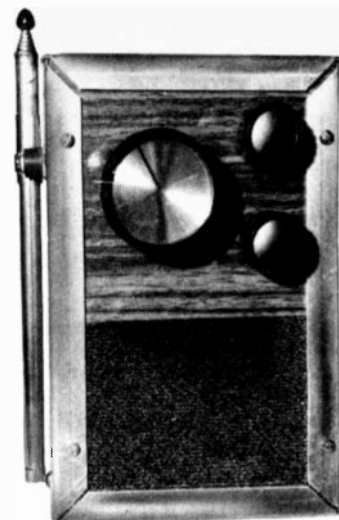

the positive supply and the positive end of C1. When the unit is switched on, current will flow through the resistor and charge up C1. After a certain time the voltage on C1 will cause TR1 to conduct and operate the alarm. In this way a player is given a certain time to complete the course. Thirty seconds is a reasonable figure.

S.D. Lang,
Stepps,
Glasgow.

The reason why

Like many readers I can only praise you on an excellent magazine, with quite an interesting and varied selection of projects. But, I feel I must say this, why oh why does some bright spark have to change the size of the magazine two thirds of the way through the year, especially as I like many others have all six binders.

D. Walker,
Nottingham

Improved steady hand

When building the *Steady Hand Tester* in the July issue, I have found the following improvements can be made:

1. A switch can be included in the circuit so that sensitivity can be selected between high and low. In practice the switch is placed across VR1 and R1.
2. A switch can be included between the collector of TR3 and TL1. This will allow the buzz to be disconnected if it causes annoyance to other people.
3. A third switch can be included to provide a "panic" facility. In use the switch connects a potentiometer between

We thank you for your improvements to the Steady Hand Tester. We are always pleased to hear from readers who find our projects interesting, and are able to improve them.

It's not all electronics!

Electrician: That's an old Volks Wagon you have there,

Car owner: Yes, but the problem is that the VW is only 6 volts,

Electrician: What! only 6VW, it must have a huge capacity.

A.W. West,
Potters Green,
Coventry.

Thank you for your recent letter, and for the fine comments you make concerning our magazine.

Regarding your criticism of the change to a larger size, we agree with you that the timing was rather unfortunate. This was a decision made elsewhere, and was governed chiefly by the paper supply situation. As you will have noted, we have started a new volume (No. 7) with the September issue, and the new binder will accommodate 16 issues. Volume 8 will commence in January 1979, and then things should be back to normal, we hope!

JACK PLUG & FAMILY...

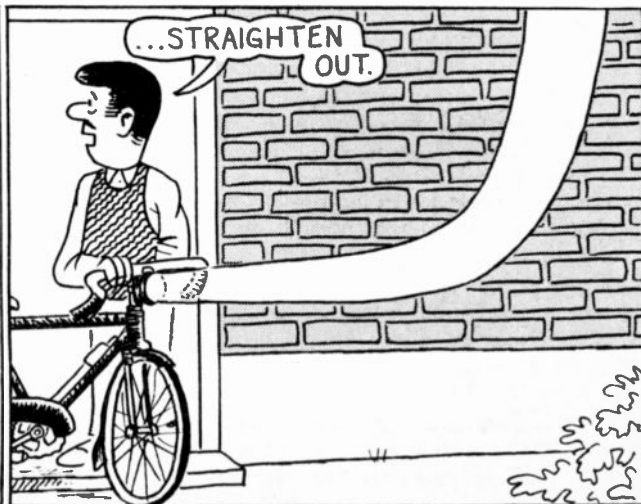

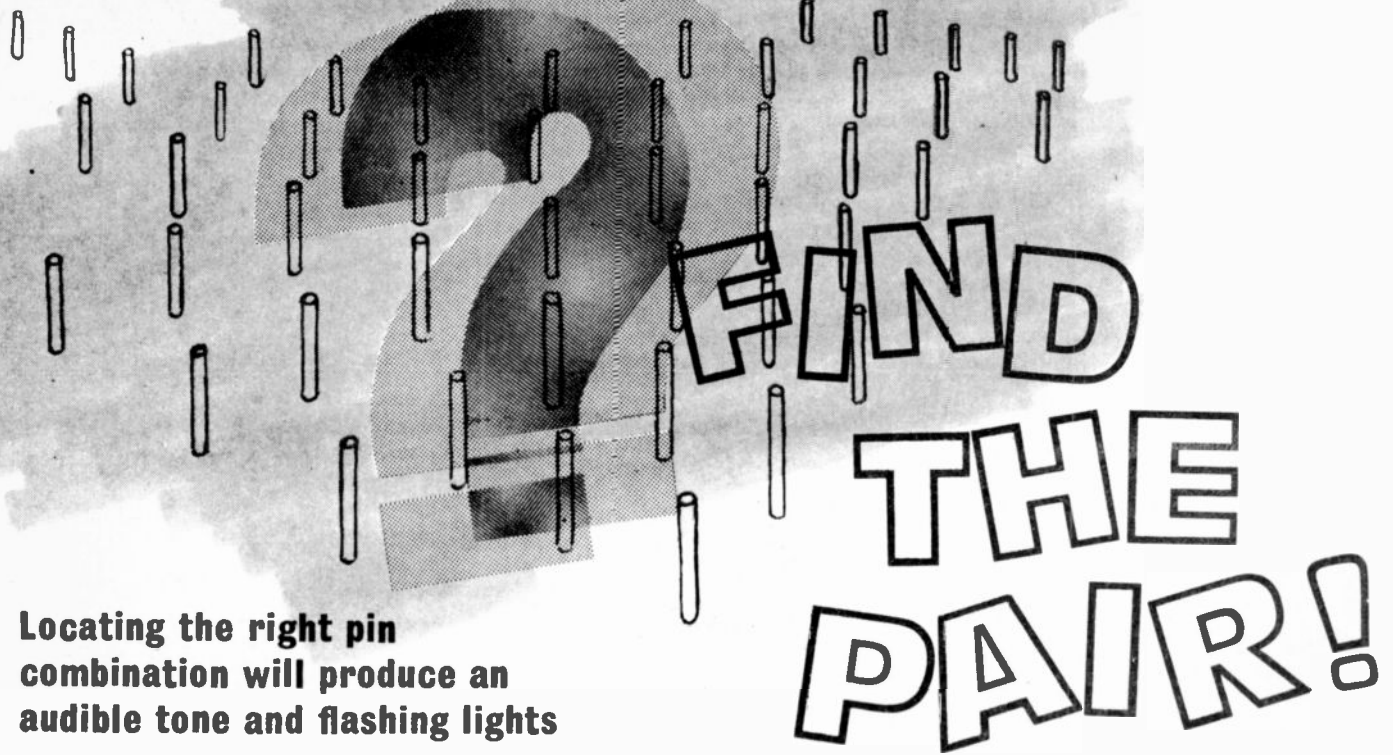

Locating the right pin combination will produce an audible tone and flashing lights

By F. G. Saddler

INTRODUCTION

THE ELECTRONIC game to be described here was originally designed to be used at school fetes as part of a fund-raising scheme. By all accounts it was very successful, a small prize being given to the person who found the pair. Use is made of two multivibrators, one operating a pair of lamps, the other operating a small loud-speaker to indicate a successful attempt. By using two multiway switches a large number of different pairs may be switched into the circuit, this of course being necessary so everyone who tries to find the pair has an equal chance, thus foiling the person with a good memory!

HOW IT WORKS...

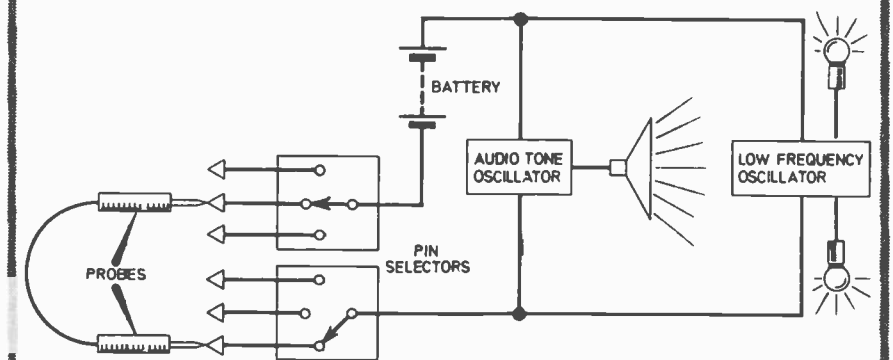

This *Find The Pair* game consists of two oscillators connected in parallel. One oscillator will produce an audible tone while the other is wired to cause two lamps to flash on and off. Normally both oscillators are off. The probes are used to complete the circuit when they are in contact with the correct pair of pins (selected by the switches) which then results in the production of a tone and flashing lights.

**START
HERE FOR
CONSTRUCTION**

Construction can begin with the case. This has a size of 255 x 115 x 75mm, and is constructed from

3mm ($\frac{1}{8}$ inch) hardboard. The case is first constructed as a four-sided box, with wood or metal angle at each of the four corners.

Two pieces of wood are then screwed to each of the longer sides thus providing a mounting for the base. One open end now forms the top. This is covered with a sheet of Formica similarly fixed by two pieces of wood as before. The layout of the top panel really depends on the choice of the constructor and the size of components. For

this reason no drilling dimensions have been given.

The matrix comprises a sheet of perforated board, 0.1 inch matrix, 16 x 33 holes. This is fixed to a small piece of wood 155 x 75 x 12mm, this being mounted on the Formica panel. A cut-out in the wood needs to be made to allow access to the pins on the board, a similar size cutout is also made in the Formica; the two panel lamps and the loudspeaker are similarly provided with holes in the Formica.

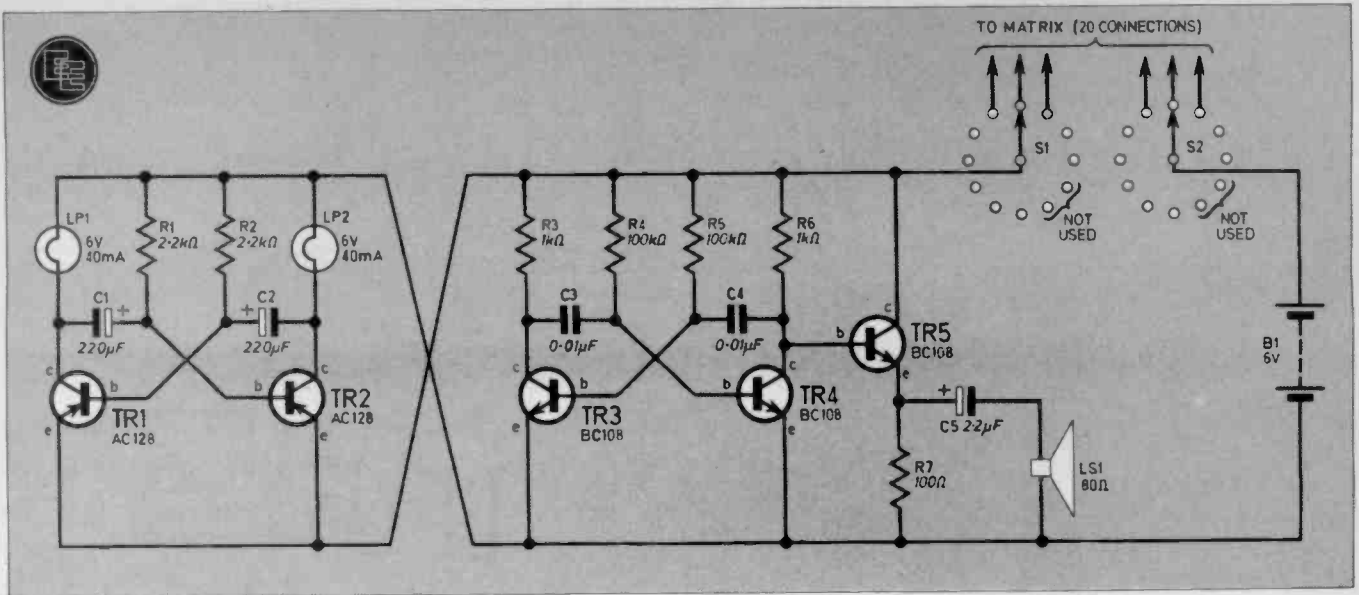

Fig. 1. The complete circuit diagram of the Find The Pair game.

CIRCUIT DESCRIPTION

The complete circuit for the game is shown in Fig. 1. It consists of two astable multivibrators, one driving a pair of lamps and the other a loudspeaker. The two separate multivibrators are similar in appearance but one uses *pnp* transistors and the other *nnp*. Since the action of each is virtually similar apart from the voltages being opposite, the *nnp* type, which is the most common, will be described. The operation of the second multivibrator will then be easily understood if the voltages are reversed.

When power is first connected to the circuit both transistors will begin to turn on, as both will be receiving base current via the

appropriate resistor. However, due to component tolerances one will begin to turn on faster than the other, for the sake of this explanation we will assume that it is TR3 that turns on the faster.

As it does so it will provide a negative signal to the base of TR4 via C3. This has the effect of turning TR4 off. TR3 thus turns hard on while TR4 is held in the off state. When the potential on the collector of TR3 has fallen to that of the negative supply voltage, obviously no further signal can be applied to the base of TR4 via C3. This capacitor therefore charges via R5 until about 0.65V is present at the base of TR4. TR4 then begins to turn on, in doing so a negative signal is applied via C4 to the base of TR3. This has the effect of turning TR3 hard off, the positive signal thus produced across R3 is fed by way of C3 to the base of TR4, turning it fully on.

Capacitor C3 then begins to charge through R4 and when about 0.65V is present at the base of TR3, TR3 begins to turn on. A regenerative action similar to that which has just occurred will now take place, except that it is TR3 which finishes hard on, and TR4 hard off.

It should now be possible to follow the action of the second multivibrator, only this time all the voltages are reversed when reading the above description.

Transistor TR5 is a simple amplifier which is used to provide enough output to drive a small loudspeaker.

The supply to each multivibrator is applied via the two switches and the matrix of pins. Each switch is able to select up to ten different pins, we thus have a total of 100 pins which means 50 pairs. A very large number indeed, even for any "memory man"!

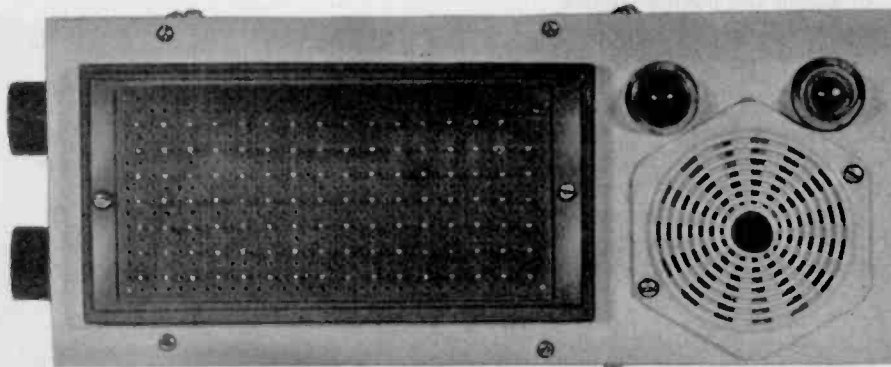

Photograph of the prototype unit showing layout of pin board, loudspeaker and lamps.



COMPONENTS

Resistors

- R1 2·2k Ω
- R2 2·2k Ω
- R3 1k Ω
- R4 100k Ω
- R5 100k Ω
- R6 1k Ω
- R7 100 Ω

All resistors are carbon $\frac{1}{4}$ W \pm 10%

Capacitors

- C1 220 μ F 10V elect.
- C2 220 μ F 10V elect.
- C3 0·01 μ F polyester
- C4 0·01 μ F polyester
- C5 2·2 μ F 10V elect.

Semiconductors

- TR1, 2 AC128 germanium *pnp*
- TR3, 4, 5 BC108 silicon *nnp*

Miscellaneous

- S1, 2 1-pole 12-way rotary switch, two tags unused (2 off)
 - B1 PP1 6V battery
 - LS1 80 ohm 70mm round loudspeaker
 - LP1, 2 6V 40mA m.e.s. bulbs complete with lampholders (2 off)
- Plain stripboard 0·1 inch matrix 16 \times 32 holes; Veropins 112 off; two large round knobs; seven-way tagboard; stripboard 0·1 inch matrix, 10 strips \times 24 holes; 1mm diameter sleeving for TR1 and TR2; material for case; hardboard, sizes as required, Formica for front panel, metal or wood brackets, four strips of softwood, block of wood 150 \times 75 \times 12mm; speaker grill (often used as airvents for cupboards); wood screws or glue as preferred for making case; connecting wire; battery clip; solder.

See
**Shop
Talk**

Page 108

vibrators are built separately, one on tag board the other on a small piece of stripboard. All the necessary wiring is shown in Fig. 2.

WIRING OF THE MATRIX

As shown in Fig. 2, only part of the matrix is shown. There is a total of 112 veropins mounted on the perforated board, in a pattern similar to that shown. There is a total of 20 connections to be made from the switches to the matrix, the exact wiring details are left to the constructor, six examples are shown. It might be a good idea to wire two or three pins together and take the connection to one tag of the switch, similarly with the other switch several pins may be wired together. This will then prove even more difficult to find the pair.

PROBES

The probes are made from discarded ball pens which have had the ink thoroughly cleaned away. A length of stranded insulated wire is then pushed down the inside of the ink container, the brass tip is temporarily removed and mounted in a vice to make soldering easier. The end of the wire is then carefully soldered to the tip. Once the soldered joint has cooled the pen can then be re-assembled. The remaining end is constructed in a similar manner.

Finally the case is painted in a colour of the constructor's choice, after which the game is then ready to infuriate those who try to find the pair! \square

knocked around too much.

The speaker may either be glued in place or as in the prototype solder tags were used, together with 6BA nuts and bolts to form clamps which hold the speaker in place without damaging it.

The two rotary switches are mounted at one end of the case, these being provided with two large knobs. The two multi-

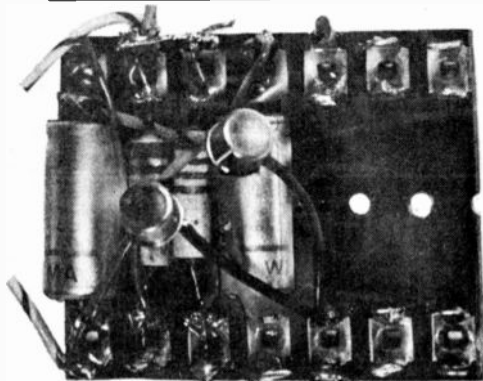
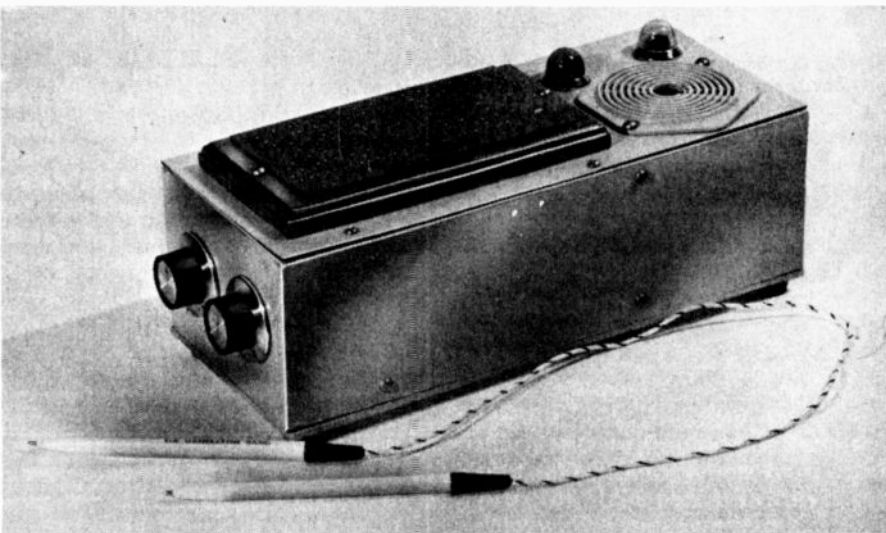

Photograph of the low frequency oscillator component board.

The general arrangement is shown in the photographs.

Sufficient space has been provided inside the case to mount the two multivibrators and a battery. The exact position of each is a matter of personal choice, the layout is not critical in any way.

As arranged in the prototype the two circuit boards are mounted by means of wood screws to the sides. A piece of wood may be mounted across the case to hold the battery in place, thus preventing it from damaging the electronics if it is

The Extraordinary Experiments of Professor Ernest Eversure

by Anthony John Bassett

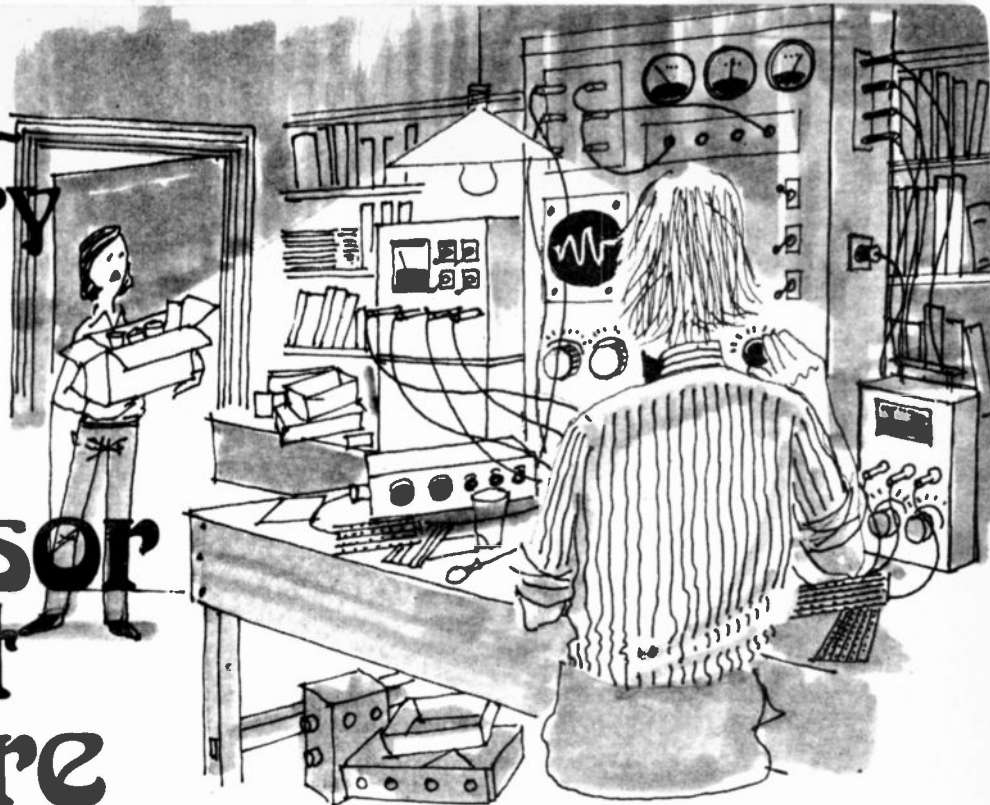

Bob and the Prof. were repairing some electret condenser microphones. Whilst the Prof. went to investigate possible replacements for an unmarked faulty transistor which appeared to carry no means of identification other than a coloured splotch on top, Bob had connected the electret unit directly through to an audio amplifier by means of a length of screened cable.

He found that the microphone still worked quite well, but did not sound so natural as one where an f.e.t. pre-amplifier is used between the electret unit and the audio amplifier.

CABLE CAPACITANCE

"This is caused by the effects of the capacitance between the screen and the inner wire of the connecting cable, whereby the higher audio frequencies tend to be shunted to the screen and partially lost. Although you can compensate for this by turning up the treble control on the amplifier, the compensation is usually not accurate, and as you have just found, Bob, the microphone will still not sound so natural as one which is fitted with an f.e.t. pre-amplifier, even though there is plenty of treble sound present."

"What is so magical, then Prof., about these f.e.t.s? I thought that

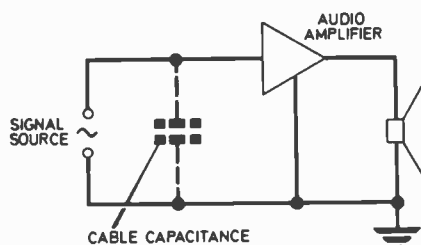

Fig. 1. A length of screened cable at the input of an amplifier acts as a capacitor (dotted) across the input.

they just amplified the signal a bit, to give more volume without having any effect, good or bad, on the tone."

"The f.e.t. pre-amplifier does not itself have much effect on the tone, Bob," the Prof. informed him, "but it does very effectively reduce the problems caused by cable capacitance. Let us first consider what these problems are, when you connect up a signal source such as this electret unit, to an amplifier, by way of a length of screened audio cable."

The Prof. drew a sketch. Fig. 1.

"The effect of the cable capacitance is so great that we may as well represent the cable, in this diagram, by way of a capacitor connected between the signal source and the amplifier. Now it is important to remember that the

electret unit is not a very energetic signal source, but a very sensitive one.

"The sensitivity of the electret unit is achieved by use of a very thin diaphragm, typically only a few thousandths of a millimetre in thickness and this is what enables it to give a good audio response over the entire audible range. In graph form this is what an ideal response (A) would look like (Fig. 2), and the output of the electret unit conforms more closely to this than do most other microphones.

RESPONSE CURVES

"However if the electret unit is connected to a capacitive cable, or a capacitor as in this diagram (Fig. 1) it has to charge and discharge the capacitor at audio frequencies. This means that the higher audio frequencies, charging and discharging the capacitor several thousand times a second. As you know, Bob, each time a capacitor is charged it absorbs energy, and stores it. At higher frequencies the rate of absorption of energy by the capacitor is higher than at the lower frequencies of the same amplitude.

"At these higher frequencies the diaphragm simply does not receive sufficient energy from the audio vibration in the air, to charge the

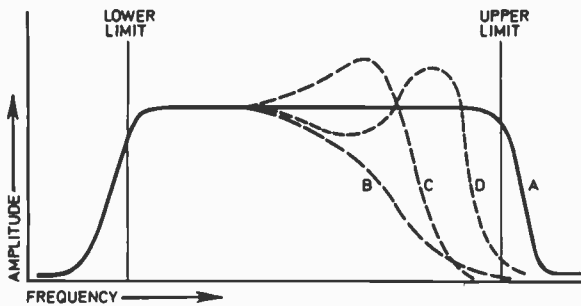

Fig. 2. Typical response curve (A) of an electret microphone. Curve (B) shows effect of capacitive loading each input lead and (C) and (D) the results of the attempts to reduce this effect by boosting the high frequencies by means of a treble boost control.

capacitor up to the voltage level represented by the ideal response curve.

"It needs an additional source of energy if this is to be achieved, and in these microphones the additional source of energy is usually a 1.5 volt cell. The release and disposal of this energy in order to achieve the desired response is controlled from the electret unit by means of the f.e.t. circuit."

The Prof. sketched out a few more response waves.

"When the electret unit is loaded by the cable capacitance, the resultant loss of high frequencies would make its response curve 'droop' at the upper end, like curve B, and when you try to compensate by turning up the treble controls, this usually improves matters. However, the action of the treble control on the amplifier is unlikely to match the action of any particular length of screened audio cable which you might happen to use, and the result will be a response curve with humps and dips in it (curves C and D), this does not sound quite so natural as the level curve. This is because the level of response signifies the least amount of interference with the sound which has been produced naturally."

IMPEDANCE

"Prof., I've quite often seen references to the use of f.e.t.s for conversion of signals from a high impedance source to a low impedance load, but here we do not seem to be doing this, as the microphone is connected to a high impedance input on the audio amplifier."

"Ah, but Bob, here, it is the connecting cable which is of low impedance at high frequencies due

to the capacitance between the screen and centre wires, although the microphone will operate well into an amplifier input of low impedance, usually as low as 600 ohms or even 200 ohms.

"The concept of impedance can be the basis of a very useful form of 'intellectual shorthand' enabling people to interconnect complex items of electronic equipment with-

out having to consider in detail, or even know, what they are really doing. This helps enormously by giving people more confidence in the handling and setting-up of electronic equipment whose technical operation they do not understand.

"It will be very interesting to relate your experiment, Bob, to the extremely useful concept of impedance. This concept of impedance is often in order to avoid description or detailed consideration of the various factors which limit the transfer of energy from one point to another. Factors such as capacitance, inductance, resistance, and mechanical factors such as friction, and inertia which are important in transducers such as the electret unit we have here.

"In these terms the electret unit is a high impedance signal source with a very limited current output. The input of the f.e.t. pre-amplifier is an almost ideal match for this, provided that it is connected with very short lengths of wire; and the 'source-follower action' at the output of the f.e.t. to match various lengths of cable, and loads of both high and low impedance with very little distortion or loss of high frequencies."

FOLLOWER CIRCUITS

"Prof. I have seen that there are quite a lot of books and magazine articles which describe this source follower action of f.e.t.s and I think I will have to study some of these a little more, as I did not know how such a simple circuit can compensate for various load impedances and conditions. This simple experiment has really given me food for thought!"

To be continued

TV GAMES IN FULL COLOUR

At last its here! The new Swanley colour generator kit £7.90. Adds different colours to the frame, ball, bats and background of the AY-3-8500 TV games. AY-3-8500 £6.95. Black and white TV games kit £11.95. Rifle kit £4.95. Send sae for our gigantic free data leaflet.

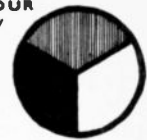

NEW COMPONENT SERVICE

Resistors 5% carbon E12 10 to 10M \pm 1% 1W 3p. Preset pots subminiature 0-1W 100 Ω to 4M7 9p. Potentiometers \pm 1W 4K7 to 2M2 log or lin. Single 30p. Dual 95p. Polystyrene capacitors E12 63V 22pf to 8200pf 3p. Ceramic capacitors 50V E6 22pf to 47000pf 3p. Polyester capacitors 250V E6 .01 to .1mf 54p. 15, 22, 33mf 7p. .47mf 11p. Electrolytics 50V .47, 1, 2mf 5p. 25V 5, 10mf 5p. 16V 22, 33, 47mf 6p. 100mf 7p. 220, 330mf 9p. 470mf 11p. 1000mf 18p. Zener diodes 400mW E24 3V3 to 33V 84p.

MAINS TRANSFORMERS

6-0-6V 100mA 94p. 9-0-9V 75mA 94p. 0/12/15/20/24/30V 1A £3.85. 12-0-12V 50mA 94p. 0/12/15/20/24/30V 2A £5.15. 6-3V 1/2A £2.30. 6-0-6V 1/2A £2.75. 9-0-9V 1A £2.39. 12-0-12V 1A £2.69. 15-0-15V 1A £2.89. 30-0-30V 1A £3.59.

PRINTED CIRCUIT KITS ETC.*

Contains etching dish, 100 sq ins of pc board, 1 lb ferric chloride, etch resist pen, drill bit and laminate cutter £3.95. 100 sq ins pc board 86p. 1 lb FeCl £1.05. Etch resist pen 45p.

S-DECS AND T-DECS*

S-DeC £1.94. T-DeC £3.61. u-DeCA £3.97. u-DeCB £6.67. IC carriers with sockets:— 16 diil £1.91. 10T05 £1.79.



SINCLAIR CALCULATORS*

Cambridge scientific programmable £13.95. Prog. library £4.95. Cambridge scientific £8.45. Oxford scientific £10.60. Mains adaptors £3.20.

BATTERY ELIMINATOR BARGAINS

TV GAMES POWER UNIT Stabilised 84V 100mA £3.20

3-WAY MODELS

With switched output. Type 1:—3/4/6V at 100mA £2.30. Type 2:—6/7/9V 300mA £2.90.

100MA RADIO MODELS

With press-stud connectors. 9V £3.45. 6V £3.45. 9V+9V £5.15. 6V+6V £5.15. 4V+4V £5.15.

CASSETTE MAINS UNIT

7 1/2V with 5 pin din plug 150mA £3.65.

FULLY STABILIZED MODEL £6.40

Switched output of 3/6/7/9V 400mA stabilized.

CAR CONVERTERS 12V INPUT

Output 9V 300mA £1.80. Output 7 1/2V 300mA £1.80.

BATTERY ELIMINATOR KITS

Send sae for free leaflet on range. 100mA radio types with press stud battery terminals. 4V £2.10. 6V £2.10. 9V £2.10. 4V+4V £2.50. 6V+6V £2.90. 9V+9V £2.90. Cassette type 7 1/2V 100mA with din plug £2.10. Transistor stabilized 8-way type for low hum. 3/4/6/7/9/12/15/18V. 100mA £3.20. 1 Amp £6.40. Heavy duty 13-way types 4/6/7/8/11/13/14/17/21/25/28/34/42V. 1 Amp, £4.85. 2 Amp £7.95. Car converter kit input 12V DC. Output 6/7/9V DC 1A transistor stabilized £1.95. Stabilized Power Kits 3-18V 100mA £3.60. 3-30V 1A £9.95. 3-60V 1A £10.95. 3-60V 2A £13.95.

BI-PAK AUDIO MODULES

S450 tuner £21.95. AL60 £4.86. PA100 £14.95. MK60 audio kit £36.45. Stereo 30 £17.95. SPM80 £3.75. BMT80 £4.25. Send sae for free data.

JC12 AND JC40 AMPLIFIERS

JC12 6V IC audio amp with free data and printed circuit £1.95. Also new JC40 20V modal with pcb £3.95. Sensational new JC20, 10W integrated circuit amp with pcb £2.95. Send sae for free leaflet on all 3 models and associated power supply and preamp kits.



FERRANTI ZN414

IC radio chip £1.44. Extra parts and pcb for radio £3.85. Case £1. Send sae for free data.

SWANLEY ELECTRONICS

DEPT. EE, PO BOX 68, 32 GOLDSSEL ROAD, SWANLEY, KENT

Post 30p. Prices include VAT. Official orders welcome. Overseas customers deduct 7% on items marked * and 11% on others.

SOC20.



The most powerful Monolithic IC amplifier in the world.

20 watts output (continuous sine wave) . . .
 Less than 0.2% total harmonic distortion at *all* powers,
all frequencies . . .
 And totally electronically indestructible!

Until recently, all monolithic IC chips suffered from two basic design weaknesses. First, thermal runaway causing heat to build up as current increased; and second, short circuiting.

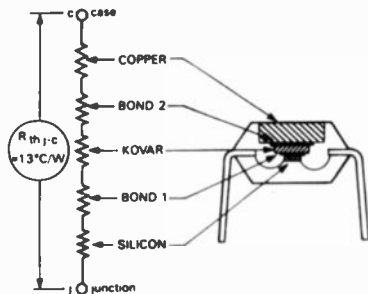

Standard plastic package with copper slug.

Until the SOC20 IC chip! This extraordinary new power amplifier chip is uniquely designed to improve thermal dissipation. It also has two separate built-in circuits, one of which measures on-chip temperature. If this should rise above 150°C the output transistors are switched off thus preventing thermal runaway.

And short circuits? The other circuit continuously monitors both current and voltage. If the product of current and voltage rises above a critical level, the

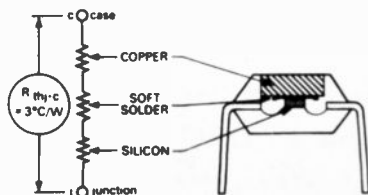

SOC20 plastic package with chip directly soft-soldered to copper slug.

drive is adjusted to bring the transistors within safe operating limits.

The amplifier can drive speakers of any impedance – maximum power will only fall outside the recommended $4\ \Omega - 8\ \Omega$ range.

And *any* pin on the chip may be shorted to *any* voltage in the system for *any* length of time . . . and *no* damage will occur!

Superb quality . . . extraordinary power

The SOC20 isn't only safe . . . it's also extraordinarily sophisticated. Total harmonic distortion is less than 0.2% at all powers and all frequencies – and in normal use is well below 0.1%.

If power is at a premium, use two SOC20 amplifiers in 'Full Bridge' to give over 40 watts continuous into $8\ \Omega$ speakers.

The SOC20 is naturally guaranteed unconditionally for one year. Although with the SOC20's unique patented design, we think you'll have little cause to make use of any guarantee!

Specification

Maximum supply voltage $\pm 22\ \text{V}$ (44 V total)

Output power 20 watts continuous $4\ \Omega$ or $8\ \Omega$

Open loop gain 100 dB

Supply voltage rejection 50 dB

Input noise voltage 4 nV

Number of transistors 18

Supplied with free printed circuit board, heat sink mounting bracket, comprehensive instructions, and suggested applications.

The SOC20 will work on any supply from 12-44 volts and therefore can be used for in-car as well as domestic applications. Apart from its obvious audio uses the fact that it is DC coupled throughout makes it ideally suited for servo systems – in radio-controlled models for example.

Incorporate the SOC20 in your equipment today!

SOC20's cost £4.95 each, or £7.95 a pair for, say, stereo applications. Only a few readily-available components are needed to build a full amplifier unit.

Of course, the SOC20 comes with a 10-day money-back guarantee.

Science of Cambridge Ltd,
 6 Kings Parade,
 Cambridge, Cambs., CB2 1SN.
 Tel: Cambridge (0223) 311488.

To: Science of Cambridge Ltd, 6 Kings Parade, Cambridge, Cambs., CB2 1SN.

Please send me _____ (qty)
 SOC20 Monolithic IC Amplifiers
 (£4.95 each or £7.95 per pair,
 inclusive of p&p and VAT at 8%).

I enclose cheque/money order/
 postal order for £ _____

Name _____

Address _____

(PLEASE PRINT).

EE/11

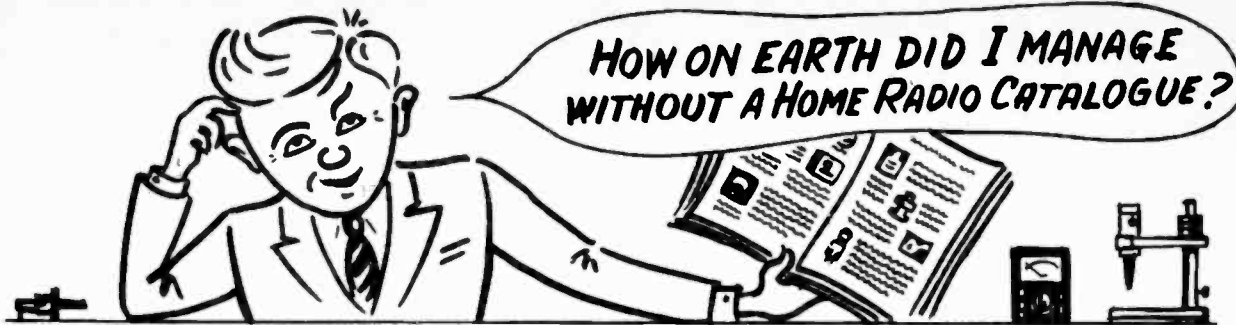

I'd been reading Home Radlo's adverts for years and kept telling myself I must send off for a copy of their famous catalogue. But being an expert procrastinator I kept putting it off. I muddled along, picking up bits here and pieces there, often calling at several shops before locating a particular component I needed.

If only I'd got a Home Radlo catalogue in the first place—what time, energy and frustration I would have saved myself! I really do wonder now how I managed—this catalogue really has solved my component buying problems. In its 200 pages I hardly ever fail to locate just the piece I need. Not surprising when you consider it lists over 5,000 items, nearly 2,000 of them illustrated. Home Radio Components Ltd do everything possible to make ordering quick and

easy, and with their simple Credit Scheme I can order by phone any time of day or night, and settle up once a month.

Don't dilly dally like I did—take the plunge now by sending the coupon below with £1.40, and in a few days you can start on a wonderful new era of simplified component buying.

**We stock all the parts
for the Teach-in Series.**

Please write your Name and Address in block capitals

NAME _____

ADDRESS _____

HOME RADIO (Components) LTD. Dept. EE
234-240 London Road, Mitcham, Surrey CR4 3HD (Regn No London 912966)



POST THIS COUPON
with cheque
or p.o. for
£1.40

HOME RADIO (Components) LTD. Dept. E.E., 234-240 London Road, Mitcham, CR4 3HD Phone 01-648 8422

GREENWELD

443 Millbrook Road Southampton
SO1 0HX Tel: (0703) 772501

TEACH-IN '78

Complete kit of parts for the New Series started last month. Everything for £13.50 including Post and VAT. Order Early!!

1977/78 CATALOGUE

Big new illustrated catalogue with 50p discount vouchers! Complete range of resistors, capacitors, semiconductors, knobs and boxes, etc., all at discount prices!! Only 30p + 15p post.

PC ETCHING KIT MK III

Now contains 200 sq. ins. copper clad board, 1lb. Ferric Chloride, DALO etch-resist pen, abrasive cleaner, two miniature drill bits, etching dish and instructions. £4.15 inc. post and VAT.

VERO OFFCUTS

Pack A, All 0.1"
Pack B, All 0.15"
Pack C, Mixed
Pack D, All 0.1" plain

Each pack contains 7 or 8 pieces with a total area of 100 sq. ins. Each pack is £1.45 inc. post and VAT.

DEVELOPMENT PACKS

Buy a complete range of components in one go and save time and money!! All packs contain full spec brand new marked devices, sent by return of post. All prices include VAT, just add 25p post for any quantity.

K001 50V ceramic plate capacitors, 5%, 10 of each value 22pF to 1000pF. Total 210, £3.35.

K002 Extended range, 22pF to 0.1µF. 330 values £4.90.

K003 Polyester capacitors, 10 each of these values: 0.01, 0.015, 0.022, 0.033, 0.047, 0.068, 0.1, 0.15, 0.22, 0.33, 0.47µF. 110 altogether for £4.75.

K004 Mylar capacitors, min 100V type. 10 each all values from 1000pF to 10,000pF. Total 130 for £4.45.

K006 Tantalum bead capacitors. 10 each of the following: 0.1, 0.15, 0.22, 0.33, 0.47, 0.68, 1, 2.2, 3.3, 4.7, 6.8, all 35V; 10/25 15/16 22/16 33/10 47/8 100/3. Total 170 tants for £14.20.

K007 Electrolytic capacitors 25V working, small physical size. 10 each of these popular values: 1, 2.2, 4.7, 10, 22, 47, 100µF. Total 70 for £3.50.

K021 Miniature carbon film 5% resistors, CR25 or similar. 10 of each value from 10R to 1M, E12 series. Total 610 resistors, £6.00.

K022 Extended range, total 850 resistors from 1R to 10M £8.30.

K041 Zener diodes, 400mW 5%, BZY88 etc. 10 of each value from 27V to 36V, E24 series. Total 280 for £15.30.

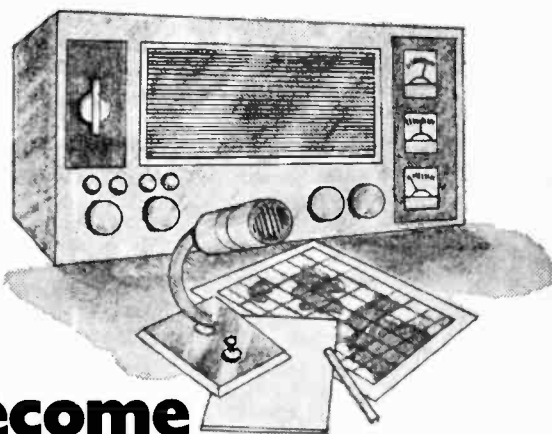

Become a radio amateur.

Learn how to become a radio-amateur in contact with the whole world. We give skilled preparation for the G.P.O. licence.

Free! Brochure, without obligation to: **BRITISH NATIONAL RADIO & ELECTRONICS SCHOOL**, P.O.Box 156, Jersey, Channel Islands.

NAME _____

ADDRESS _____ (Block caps please)

WAA
EEK11

Where to get it!
**COMPONENT
SOURCE
DIRECTORY**
**a PW pull-out
booklet**

This invaluable guide, which folds into a 24-page booklet, lists suppliers of electronic components and accessories and is just what you need when you're buying components.

**AND HERE'S YOUR
CHANCE TO USE IT**

Wide-range Voltmeter

AC-DC, reliable, 6 ranges to 1000V. Input impedance of 11M Ω plus a variety of probes for measurement at RF.

RF Resonance Indicator

indicates resonant frequency of a tuned circuit up to around 30MHz. Also selects values of capacitance and inductance for a given frequency.

Tune in to

**PRACTICAL
WIRELESS**

November issue on sale 1 October 45p

LIKE
HUNDREDS OF
NEW DORAM
KIT AND
COMPONENT
IDEAS FREE?



Doram's new catalogue is one of the great events of the electronic year, 64 pages of new ideas in construction kits, capacitors, resistors, semi-conductors, wires and cables, transformers, plugs and sockets, hardware, indicators, switches, radio equipment, tools and test equipment, audio equipment, books. All top quality and terrific value because you can depend on Doram.

DORAM

TAKE THE SHORT CUT.

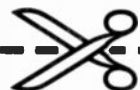

Yes, please rush my free copy of the new Doram catalogue. I enclose 20p to cover post and packing.

Name _____

Address _____

Post to: _____

Doram Electronics Ltd., PO Box TR8, E.E. NOV.
Wellington Road Estate, Wellington Bridge, Leeds LS12 2UF

**new
book**

from **NEWNES TECHNICAL BOOKS**

RADIO CIRCUITS EXPLAINED

Gordon J.
KING

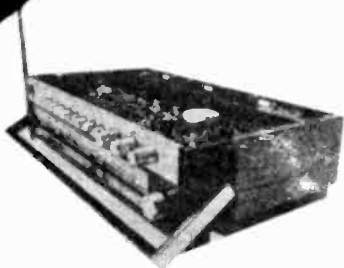

- ★ Circuits in modern radio receivers are examined — from the simple transistor set to the specialised hi-fi receiver.
- ★ Written by one of the best known authors in radio and electronics.
- ★ Invaluable to the radio and audio technician, student and enthusiast.
- ★ Richly illustrated, with a minimum use of mathematics.

CONTENTS: Block and flow diagrams — R. F. amplifier and mixer circuits — Frequency changer and r.f. oscillator circuits — Intermediate frequency circuits — Detector circuits — Audio amplifier circuits — Power amplifier circuits — Power supply circuits — Stereo coding and circuits for decoding — Index.

Available now 160 pages

£5.50

RECENT TITLES

BEGINNER'S GUIDE TO RADIO — 8th Edition

Gordon J. King

1977 240 pages £2.75

BEGINNER'S GUIDE TO INTEGRATED CIRCUITS

I. R. Sinclair

1977 192 pages £2.75



Order now from your local bookseller or from **NEWNES TECHNICAL BOOKS**, Borough Green, Sevenoaks, Kent TN15 8PH

BURGLAR ALARM

EQUIPMENT SUPPLIES (TRADE)

Bell boxes plastic coated steel	£5.25
Magnetically operated door switch surface type	£0.85
Magnetically operated door switch flush type	£0.80
Vibro sensitive switch	£2.75
Pressure pads large 29" x 15" 4 wires	£1.75
Pressure pads stair tread size 4 wires	£1.50
Aluminium window foil 100ft. self adhesive	£2.00
Take off blocks for window foil per pair	£0.40
Heavy duty 6" bell 12V	£7.75
Siren 12V	£8.00
3" bell	£2.25
Key switch single pole + chrome plate	£3.00
Battery for above large HPI	£2.50
Kojak horn	£16.00

CONTROL UNITS

Battery operated model	£14.00
Battery & mains model	£19.00
B.S. 4737 model battery + mains	£32.00
D.I.Y. battery model	£11.00
D.I.Y. battery & mains	£15.00

ALL PRICES + 12½% VAT. NO VAT EXPORTS

DISCOUNTS PER ITEM 5+ 10%, 25+ 15%, 100+ 20%. POST FREE

SAE FREE LIST FOR SPECIAL EQUIPMENT

ASTRO ALARMS

25 STOCKTON RD. SUNDERLAND. TYNE & WEAR. ENG. Tel: 0783 77825

NEW CATALOGUE TEACH-IN '78

Its bigger & better than before. NEW PRODUCTS — illustrations — data — circuit ideas. Inclusive prices right next to the products make ordering easy. No minimum order. Fast — first class delivery. All products are stock lines. Includes resistors, capacitors, transistors, ICs, cases, tools, test equipment, hardware, cable, speakers, connectors etc. **SEND NOW FOR YOUR COPY — 2 x 9p stamps.**

NEW SERIES. Send £13.95. Individual items — details — 2 x 9p stamps.

E.E. PROJECTS

- DICE — March. £4.24 inc case.
 - METRANOME — May. £3.80 inc case.
 - SOIL MOISTURE — June. £2.75 inc case & probe.
 - PHONE/DOORBELL REPEATER — July. £4.70 inc case.
 - TOUCH SWITCH — July. £8.40 inc case.
 - FUZZTONE UNIT — July. £5.75 exc case.
 - AUDIO PEAK IND — Aug. £2.00. Case extra 58p.
 - ADD ON CAPACITANCE UNIT — Sept. £4.50 inc case.
- Prices inclusive. Articles extra 25p each.

COMPONENT PACKS

RESISTORS — ½ W carbon film. IR — 10M. (280) — £4.20. C280 — mixed polyester capacitors — £2.20. ELECTROLYTIC caps. popular values up to 100µF — £2.95. CAPACITORS mixed — polystyrene, ceramic etc — £2.80. TRANSISTORS — popular types BC183, BFY51 etc — £3.50. DIODES — 1N4148, 1N4005, TIL 209 LEDs etc — £2.50. WIRE — connecting. Mixed types & colour — £1.50. All prices inclusive — top quality new components.

MAGENTA Electronics Ltd., EK10, 61 Newton Leys, Burton on Trent, Staffs. DE15 0DW

For Semi-conductors

including

- Small Signal Transistors
- Power Semi-conductors
- TTL, CMOS, I.Cs
- Linear I.Cs
- Signal and Power Diodes
- Zener Diodes
- Magneto Resistors
- Magnetic Proximity Switches
- Opto-electronic devices

Go to

ELECTROVALUE

TO MAKE THE BEST OF

For passive components

including

- Plastic Film Capacitors
- Electrolytics
- Semi-precision capacitors
- Transformers
- Pot Cores
- R.M. Cores
- Ring Cores, etc.

Go to

ELECTROVALUE

THE PROJECTS YOU BUILD

The Open Door to Quality

It's the Electrovalue Catalogue No. 8 (4th edition black and white cover) with completely up-dated prices. 144 pages, well illustrated and informative. 40p post free with 40p voucher usable on orders for £5 or more. Send for yours now and order in confidence.

GOODS SENT POST FREE IN U.K. FOR C.W.O. ORDERS. Keenly competitive prices plus **ATTRACTIVE DISCOUNTS** and only best quality goods.

ELECTROVALUE LTD

(Dept. EE.1), 28 St. Jude's Rd., Englefield Green, Egham, Surrey TW20 0HB
Phone Egham 3603. Telex 264475

North—680 Burnage Lane, Burnage, Manchester.
Phone (061) 432 5945.

Sirac Mk1 Valve Amplifier

Circuit Diagrams
Outline Drawings
Exploded Views...

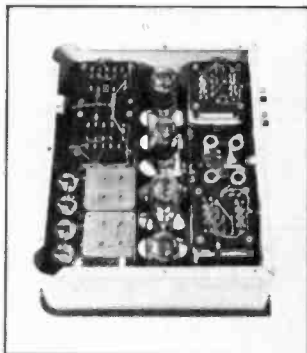

all you need to know for constructing Chris Rogers' outstanding new valve amplifier. Then compare the musicality for yourself with a transistor-type unit!

Controversial Comparison

An evaluation of the new crop of moving-coil phono cartridges and their complementary voltage step-up devices. Among those tested are the Fidelity Research FR 3, Entré I, Sony XL55, Ultimo 10A, and Nakamichi 1000, and 7 others.

Win some Aiwa Super-fi

Another big competition, with the new Autumn range of Aiwa equipment to be won.

Listening with Beyer

A special review of the Beyer infra-red headphone system.

Amplifiers Examined

This series for the more technically-minded looks this month at the 'Pulse Width Modulation' philosophy. We also test Cambridge's P80 amplifier - and the new Meridien loudspeaker/power amplifier and pre-amplifier.

PRACTICAL
HI-FI & AUDIO

November issue

out now

Sparkrite mk2 Capacitive discharge electronic ignition kit



- * Smoother running
- * Instant all-weather starting
- * Continual peak performance
- * Longer coil/battery/plug life
- * Improved acceleration/top speeds
- * Optimum fuel consumption

Sparkrite Mk. 2 is a high performance, high quality capacitive discharge, electronic ignition system in kit form. Tried, tested, proven, reliable and complete. It can be assembled in two or three hours and fitted in 15/30 mins.

Because of the superb design of the Sparkrite circuit it completely eliminates problems of the contact breaker. There is no misfire due to contact breaker bounce which is eliminated electronically by a pulse suppression circuit which prevents the unit firing if the points bounce open at high R.P.M. Contact breaker burn is eliminated by reducing the current to about 1/50th of the norm. It will perform equally well with new, old, or even badly pitted points and is not dependent upon the dwell time of the contact breakers for recharging the system. Sparkrite incorporates a short circuit protected inverter which eliminates the problems of SCR lock on and, therefore, eliminates the possibility of blowing the transistors or the SCR. (Most capacitive discharge ignitions are not completely foolproof in this respect). All kits fit vehicles with coil/distributor ignition up to 8 cylinders.

THE KIT COMPRISES EVERYTHING NEEDED

Ready drilled pressed steel case coated in matt black epoxy resin, ready drilled base and heat sink, top quality 5 year guaranteed transformer and components, cables, coil connectors, printed circuit board, nuts, bolts, silicon grease, full instructions to make the kit negative or positive earth, and 10 page installation instructions.

OPTIONAL EXTRAS

Electronic/conventional ignition switch. Gives instant changeover from "Sparkrite" ignition to conventional ignition for performance comparisons, static timing etc., and will also switch the ignition off completely as a security device, includes: switch connectors, mounting bracket and instructions. Cables excluded. Also available RPM limiting control for dashboard mounting (fitted in case on ready built unit).

CALLERS WELCOME. For Crypton tuning and fitting service - phone (0922) 33008.

PRICES INCLUDE VAT, POST AND PACKING.

IMPROVE PERFORMANCE & ECONOMY NOW

Note—Vehicles with current impulse tachometers (Smiths code on dial RV1) will require a tachometer pulse slave unit. £3.35 inc. V.A.T. p & p.
E.D.A. 82 BATH STREET, WALSALL, WS1 3DE.

POST TODAY!

Quick installation
No engine modification
required

Electronics Design Associates, Dept., EE 11
82 Bath Street, Walsall, WS1 3DE. Phone: (0922) 33652

Name
Address

Mk. 2 DIY Ass. Kit @ £11.80	QUANTITY REQD.	I enclose cheque/PO's for £
Mk. 2 Ready Built Negative Earth @ £14.97		
Mk. 2 Ready Built Positive Earth @ £14.97		Cheque No.
Ignition Changeover switches @ £4.30		
R.P.M. Limit systems in above units @ £2.42		Send SAE if brochure only required.



SMALL ADS

The prepaid rate for classified advertisements is 16 pence per word (minimum 12 words), box number 80p extra. Semi-display setting £4.00 per single column centimetre. All cheques, postal orders, etc., to be made payable to Everyday Electronics and crossed "Lloyds Bank Ltd." Treasury notes should always be sent registered post. Advertisements, together with remittance, should be sent to the Classified Advertisement Manager, Everyday Electronics, Room 2337, IPC Magazines Limited, King's Reach Tower, Stamford St., London, SE1 9LS. (Telephone 01-261 5918).

CONDITIONS OF ACCEPTANCE OF CLASSIFIED ADVERTISEMENTS

1. Advertisements are accepted subject to the conditions appearing on our current advertisement rate card and on the express understanding that the Advertiser warrants that the advertisement does not contravene any Act of Parliament nor is it an infringement of the British Code of Advertising Practice.
2. The publishers reserve the right to refuse or withdraw any advertisement.
3. Although every care is taken, the Publishers shall not be liable for clerical or printers' errors or their consequences.

Receivers and Components

SPECIAL OFFER. IN4148 4p, OA916p, BC107 10p, BC117 20p, BY94 1200V 1A diodes 11p, P & P 20p. Send S.A.E. for further lists. C. & M. ELECTRONICS, 60 Marshallstown Road, Carrickfergus BT38 9DE.

71b ASSORTED COMPONENTS £2.95. Small audio amplifiers. 3 transistors equivalent to AC128, OC72, with circuit. 3 for £1. Goods post paid. List 15p. Refunds on purchase. Insurance add 15p. J. W. B. Radio, 2 Barnfield Crescent, Sale, Cheshire M33 1NL.

TIRRO ELECTRONICS the mail order division of RITRO ELECTRONICS UK offers a wide range of components for the amateur enthusiast. Large SAE or 20p brings list. **GRENFELL PLACE, MAIDENHEAD, BERKS. SL6 1HL.**

I.C.s., TTL/C/Mos, Linear, Capacitors, Resistors (E12) SIL/Rectifiers, Diodes, LED, Thyristors, Zenors, Voltage Reg, DIL Sockets, Bridge Rectifiers, Potentiometers, Presets, Triacs, Diac, Plugs, Sockets, Cable, Vero. Carefully selected range, excellent despatch service. Same day turn round. S.A.E. List. Suppliers to A.E.R.E., U.K.A.E.A., Government Depts, Schools, Universities, Manufacturers. Accounts opened for trade and amateur. Join the professionals. Phone by 4 p.m. Goods out 1st class by 5p.m. Try us and prove it!

ORCHARD ELECTRONICS

Filnt House, High Street, Wallingford, Oxon.
Telephone 0491-35229.

DISCOVER ELECTRONICS. Build twenty easy projects including; Metal Detector; Wireless Transmitter; Breathalyser; Miniature Radios; Stethoscope; Lie Detector; Touch, time switches; Burglar Alarms; etc. Circuits, plans all for £1.29 including circuit board. Mail only. Ridley photo/electronics, Box 62, 111 Rockspark Road, Uckfield, Sussex.

NO LICENCE EXAMS NEEDED

To operate this miniature, solid-state Transmitter-Receiver Kit. Only £9.75 plus 25p P&P.

'Brain-Freeze' 'em with a MINI-STROBE Kit, pocket-sized 'lightning flashes', vari-speed, for discos and parties. A mere £4.30 plus 20p P&P. Experiment with a psychedelic DREAM LAB, or pick up faint speech/sounds with the BIG EAR sound-catcher; ready-made multi-function modules. £5.00 each plus 20p P&P.

LOTS MORE! Send 20p for lists. Prices include VAT. (Mail order U.K. only).

BOFFIN PROJECTS

4 Cunliffe Road, Stoneleigh Ewell, Surrey. (E.E.)

Miscellaneous

STYLI, CARTRIDGES & AUDIO LEADS ETC. For the best at keenest prices send SAE for free list to: **FELSTEAD ELECTRONICS (EE)**, Longley Lane, Gatley, Cheadle, Cheshire SK8 4EE.

ELECTROLYTICS 10µF-220µF £2.00/100 P&P 20p. J. Bruere, 17 Heald Close, Rochdale.

INSTRUMENT CASES, Loudspeaker cabinet kits, Teak sleeves for Amplifiers etc. Post today for free illustrated list to Curtis Furniture, Junction Road, Totton, Hants.

100 RESISTORS 75p
1W 5% c/FILM 2-2Ω-2M Ω (E12)
10 each of any value

Send stamped envelope for free sample

C60 CASSETTES 30p All Cassettes in Plastic Case with Index and Screwed Assembly.
900 CASSETTES 45p

All prices include VAT. Add Postage 10p in £1
Quantity Discounts
10 Units 5%
50 Units 7%
100 Units 10%
23 WYLE COP, SHREWSBURY, Tel. 53296

INVENTORS. "Profit from Your Invention". Sources of Finance and other assistance. Details: Large S.A.E. Delta (EV), 15 St. Mary Street, Southampton, Hants.

ENAMELLED COPPER WIRE

SWG	1 lb	8 oz	4 oz	2 oz
14-19	2.40	1.20	.69	.50
20-29	2.45	1.20	.82	.59
30-34	2.60	1.70	.89	.64
35-40	2.85	1.90	1.04	.75

Inclusive of p&p and VAT.
SAE brings Catalogue of copper and resistance wires in all coverings.

THE SCIENTIFIC WIRE COMPANY
PO Box 30, London E4 9BW
Reg. office 22, Coningsby Gardens.

Service Sheets

SERVICE SHEETS for Radio, Television, Tape Recorders, Stereo, etc. With free fault-finding guide, from 50p and s.a.e. Catalogue 25p and s.a.e. Hamilton Radio, 47 Bohemia Road, St. Leonards, Sussex.

BELL'S TELEVISION SERVICE for service sheets of Radio, TV etc. 75p plus SAE. Colour TV Service Manuals on request. SAE with enquiries to **BTS, 190 King's Road, Harrogate, N. Yorkshire.** Tel: 0423 558855.

Books and Publications

SIMPLIFIED TV REPAIRS. Full repair instructions individual British sets £4.50, request free circuit diagram. Stamp brings details unique TV publications. Ausee, 76 Church Street, Larkhall, Lanarkshire.

Wanted

SURPLUS?? Turn it into cash. Phone: 0491 35529 (Oxon).

WANTED: Issues of "Everyday Electronics" from November 1971 to September 1977. Complete set or single issues. Good price. Please write to Roar Hove, Hyllvegen 11B, 3408 Tranby, Norway.

For Sale

BARGAIN PACK of 15 miscellaneous transistors plus five diodes. Some unmarked, all tested. £1 post free. Naughton, 242 St. Mary's Road, Manchester M10 0AY.

Kits

R. W. ELECTRONICS PRESENT:

For your pleasure or profit **EASY TO BUILD** Electronic Kits.

Kit No. 01 100 Watt amplifier based on a design used by top manufacturers. Complementary symmetry circuit. 1 volt A/C input required for full output.
£4.99

Kit No. 03 Power supply kit for Kit 01. Contents: Mains transformer, bridge rectifier, capacitors, plans and instructions.
£8.99

Kit No. 04 30 watt Amplifier, one of the most advanced designs available. Uses single I.C. driving two Texas "plastic" power transistors. Simple layout using minimum of components. 500 Mv. input for 30 watts out. 35V/2A Supply required.
£3.79

Kit No. 05 Power supply kit for Kit No. 4.
£8.99

Kit No. 06 Guitar/Disco pre amp. (Suitable for use with Kits Nos. 1 & 4.) Features 2 inputs, bass, treble and volume controls. 10 Mv. input for 1 volt output.
£3.99

Kit No. 07 Advanced Guitar pre amp. Includes top boost and sustain, both essential for serious guitar work also bass, treble, pre-sense and volume controls.
£4.99

Kit No. 09 Undrilled Aluminium Chassis size 18" x 8" x 2 1/2". Suitable for any of the above kits.
£2.49

Kit No. 10 Heavy Duty aluminium finned heat sink for 30W, 100W O/P transistors. Increases reliability.

All transistors, Diodes, Triacs, integrated circuits. Circuit Boards are supplied with each kit plus plans and instructions.

Please send cash with order.

Postage and packing: 70p for power supplies and 25p for each other kit.

R. W. ELECTRONICS MARKETING
143 Lynchford Road, Farnborough, Hampshire

Educational

COURSES—RADIO AMATEURS EXAMINATION. City and Guilds. Pass this important examination and obtain your G3 licence, with an RRC home study course. For details of this, and other courses (GCE, professional examinations, etc.), write or phone: **THE RAPID RESULTS COLLEGE**, Dept. JR1, Tuition House, London SW19 4DS. Tel: 01-947 7272 (Careers Advisory Service), or phone for a prospectus only, ring 01-946 1102 (24hr recording service).

**PLEASE MENTION
EVERYDAY ELECTRONICS
when replying to advertisements**

NOTICE TO READERS

When replying to Classified Advertisements please ensure:

- (A) That you have clearly stated your requirements.
- (B) That you have enclosed the right remittance.
- (C) That your name and address is written in block capitals, and
- (D) That your letter is correctly addressed to the advertiser.

This will assist advertisers in processing and despatching orders with the minimum of delay.

IT'S EASY WHEN YOU KNOW!

To avoid missing your copy of EVERYDAY ELECTRONICS—simply complete this order form and hand it to your newsagent.

ORDER FORM

To:..... (name of newsagent)

Address

Please reserve/deliver every month one copy of EVERYDAY ELECTRONICS until further notice.

My Name

Address

DENCO (CLACTON) LIMITED

Dept. E.E.

357-8-9 OLD ROAD
CLACTON-ON-SEA
ESSEX CO15 3RH



Our components are chosen by technical authors and constructors throughout the world for their performance and reliability, every coil being inspected twice plus a final test and near spot-on alignment.

General Catalogue showing full product range 34p. Overseas Customers 70p, Air-Mail Post Paid.

**U.K. & OVERSEAS MANUFACTURERS/STOCKISTS
ENQUIRIES WELCOME**

Australian Readers Please Note—Our Complete Range of Coils are available from Watkin Wynne Pty. Ltd., 32, Falcon Street, CROWS NEST, 2065, AUSTRALIA. P.O. Box 392.

Electronics. Make a job of it....

Enrol in the BNR & E School and you'll have an entertaining and fascinating hobby. Stick with it and the opportunities and the big money await you, if qualified, in every field of Electronics today. We offer the finest home study training for all subjects in radio, television, etc., especially for the CITY AND GUILDS EXAMS (Technicians' Certificates); the Grad. Brit. I.E.R. Exam; the RADIO AMATEUR'S LICENCE; P.M.G. Certificates; the R.T.E.B. Servicing Certificates; etc. Also courses in Television; Transistors; Radar; Computers; Servo-mechanisms; Mathematics and Practical Transistor Radio course with equipment. We have OVER 20 YEARS' experience in teaching radio subjects and an unbroken record of exam successes. We are the only privately run British home study College specialising in electronics subjects only. Full details will be gladly sent without any obligation.



Become a Radio Amateur.

Learn how to become a radio-amateur in contact with the whole world. We give skilled preparation for the G.P.O. licence.

Brochure without obligation to:

British National Radio & Electronic School

P.O. Box 156, Jersey, Channel Islands.

NAME _____

ADDRESS _____

EELI! Block caps please

ELECTRONI-KIT

Proclaimed "... educational kits of exceptional quality" in extensive survey by **AUDIO** mag. Also many other first class Press reports.



The Famous DENSEI kits —now even better value

The kits are suitable both for the beginner to gain a wide practical understanding of electronics and for the more experienced to carry out many advanced experiments not available elsewhere.

Illustrated is the SR-4ADX kit—over 150 different actual working projects can be built, dismantled and rebuilt any number of times, plus any circuits of your own design.

Each component is beautifully encapsulated in transparent plastic, engraved with its electronic symbol. No soldering is involved with any kit and yet this fantastic versatility is provided. The kits are complete in every respect, including educational manuals and batteries. **NOTHING ELSE NEEDED.**

This is the most practical and effective way to learn about electronics—the kits are also first-class testing kits for laying-out and testing new circuits quickly. There is no danger whatsoever in the use of these kits.

Add-on kits and spares are available too, to increase the scope of each kit if required.

SR-1A—16 different projects—radio receivers and transmitters, signal injectors and tracers, amplifiers, morse code amplifiers and transmitters, etc., etc. **£10.75 COMPLETE**

SR-2A—30 different projects—similar to SR-2A but with more powerful circuits. **£13.45 COMPLETE**

ST-45—45 different projects—1, 2 and 3 transistor radio receivers and transmitters of various types, amplifiers, continuity testers, discontinuity warning devices, electronic birds, guns, metronomes, sirens, time buzzers, metal detectors, morse amplifiers and transmitters, burglar alarms, etc., etc. This kit features a built-in loud-speaker and amplifier unit and is ideal for educational purposes. **£18.45 COMPLETE**

PRICES INCLUDE VAT, P & P, MANUALS, BATTERIES, etc. NOTHING ELSE TO PAY—FANTASTIC VALUE for MONEY.

Educational and Trade enquiries welcomed.

Personal callers welcome.

CHEQUE/P.O. (or 11p for illustrated literature) to: Dept. EE

**ELECTRONI-KIT LTD., 20 Bride Lane,
Ludgate Circus, London, EC4Y 8DX
Tel: 353-6430.**

FOR THOSE AWKWARD JOBS!

FREE! SCREWGRIP

that holds small
screws and bolts
in position

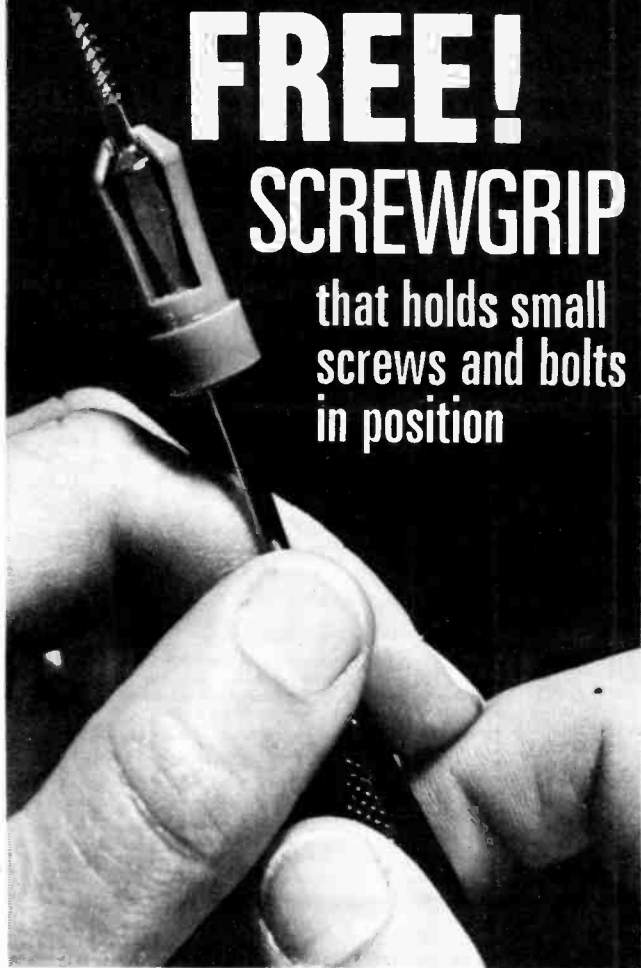

AND

FREE 48-PAGE HEATING SUPPLEMENT

Cut costs and keep cosy. That's the message for this winter. See what various heat sources are costing, ways of reducing expenditure and still staying warm—and a new gas-fired central-heating system that saves you money *automatically*. Great value!

Also home electrics info, design for a super bathroom, building a luxury kitchen and many more real money-saving projects.

FREE-ENTRY £1,000 VALUE COMPETITION

Home insulation products as prizes.

**ALL IN
PRACTICAL**

HOUSEHOLDER

NOVEMBER ISSUE OUT NOW 30p

MAPLIN

in a modern world of electronics

100W RMS STEREO DISCO

A genuine 100W RMS per channel (Both channels driven) stereo disco with auto fade on microphone, VU meters, full monitoring and cueing facilities and a very high quality light show. Complete construct or booklet MES41 price 25p. Cabinet comes complete with lid and carrying handles.

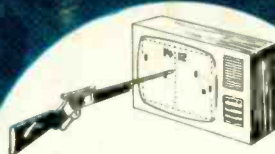
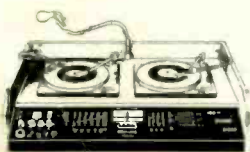

T.V. GAME

A fascinating TV game kit that plays football, tennis, squash and practice for only £21.59. Reprint of construction details 35p. Add-on rifle kit only £10.60.

WIDE RANGE OF COILS & CHOKES

Component section in our catalogue includes a wide range of coils, pct cores, ready-wound coils and chokes from microHenries to Henries, plus ranges of Denco coils and i.f. transformers etc.

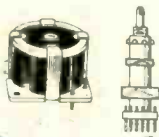

ELECTRONIC ORGAN

The only organ you can build in stages and tailor to your requirements as you go along—and at each stage you'll have a fully working instrument! We haven't got the gimmicks yet—(they're coming soon) but we have got the most beautiful sounds—you won't find them on any organ less than twice our price. So get our MES50 series leaflets now! 35p buys the three available so far.



10 CHANNEL STEREO GRAPHIC EQUALISER

A new design with no difficult coils to wind, but a specification that puts it in the top flight hi-fi class. All this for less than £70 including fully punched and printed metalwork and woodwork. Send for our component schedule now. Full construction details price 40p.



Who says the Maplin Catalogue's worth having?

- "In our 'musts' for readers-to-collect list"—P.E.
- "contains . . . just about everything the DIY electronics enthusiast requires"—P.W.
- "probably the most comprehensive catalogue we have ever come across"—E.E.
- "has been carefully prepared and is very well presented.—R.E.C.
- "make the job of ordering components an easy, accurate and enjoyable pastime"—P.W.
- "Only one word describes the publication—superb!"—E.T.J.

OVER 60,000 COPIES SOLD DON'T MISS OUT!
SEND 60p NOW

MAPLIN ELECTRONIC SUPPLIES
P.O. Box 3, RAYLEIGH, ESSEX SS6 8LR
Telephone: Southend (0702) 715155

Shop: 284 London Road,
Westcliff-on-Sea, Essex.
(Closed on Monday)
Telephone: Southend
(0702) 715157

Our bi-monthly newsletter keeps you up to date with latest guaranteed prices—our latest special offers—details of new projects and new lines. Send 30p for the next six issues (5p discount voucher with each copy).

POST THIS COUPON NOW
FOR YOUR COPY OF OUR
CATALOGUE PRICE 60p

Please rush me a copy of your 216 page catalogue. I enclose 60p, but understand that if I am not completely satisfied I may return the catalogue to you within 14 days and have my 60p refunded immediately.

NAME

ADDRESS

.....

.....

