

Inexpensive, easy to build projects

# everyday electronics

JUNE 76  
30p

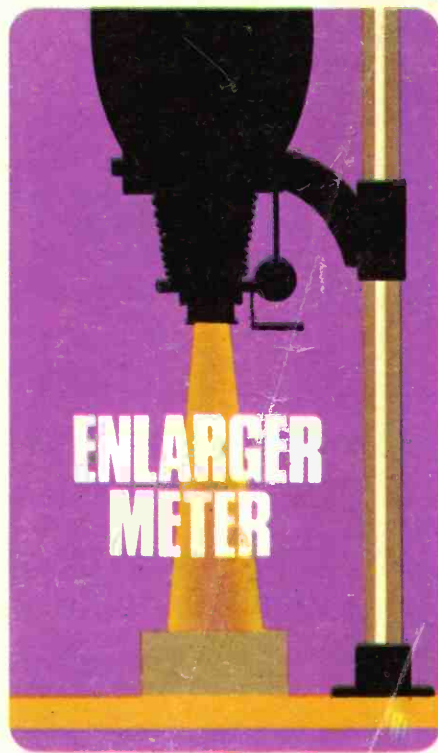
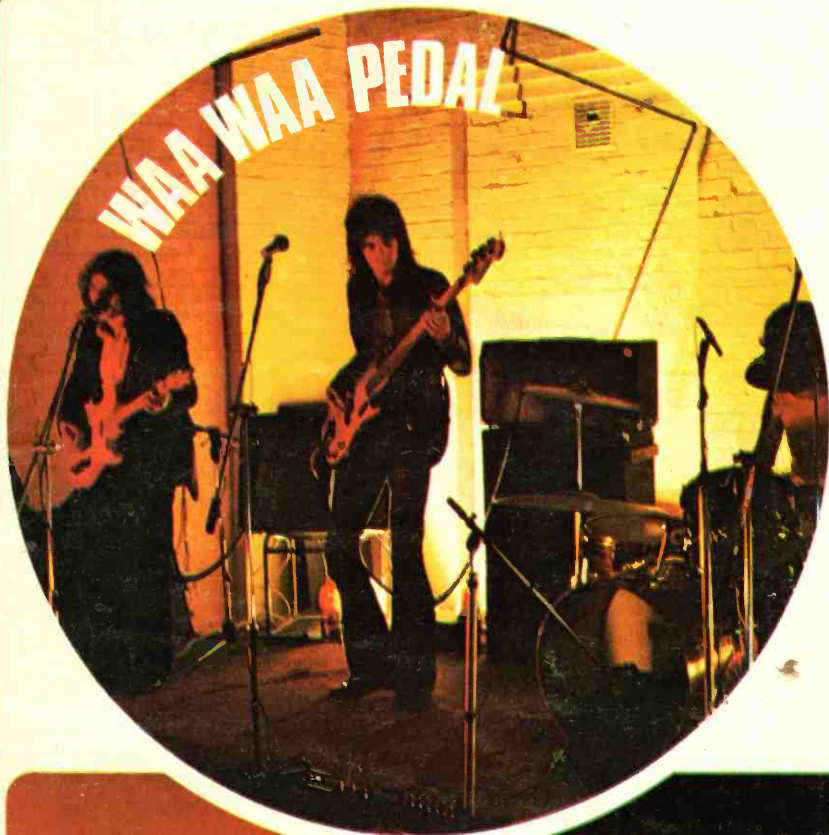

**CONTINUITY  
TESTER  
and  
PEAK LEVEL  
INDICATOR**

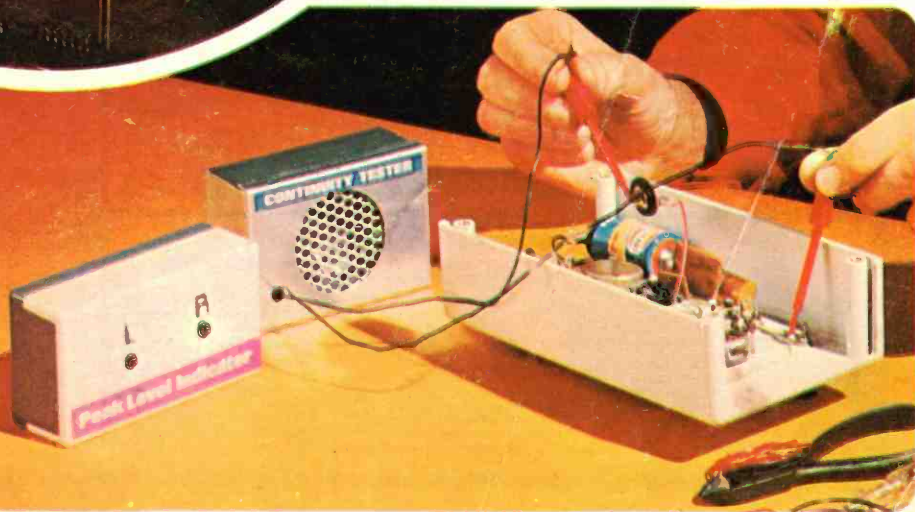

# RADIO EXCHANGE LTD.

**REDUCTIONS ON ALL KITS FOLLOWING VAT CHANGE**

## NEW EDU-KIT MAJOR

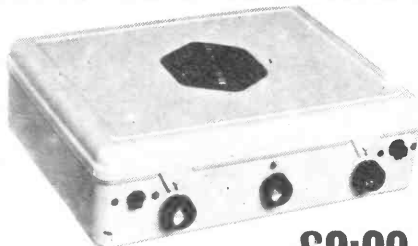

Total Building Costs

**£9-00**

PP+Ins. 65p. (Overseas Seamail P+P £3-50) INC. V.A.T.

Completely Solderless Electronic Construction Kit. Build these projects without soldering iron or solder

- ★ 4 Transistor Earpiece Radio
- ★ Signal Tracer
- ★ Signal Injector
- ★ Transistor Tester
- ★ NPN-PNP
- ★ 4 Transistor Push Pull Amplifier
- ★ 5 Transistor Push Pull Amplifier
- ★ 7 Transistor Loudspeaker Radio MW-LW
- ★ 5 Transistor Short Wave Radio
- ★ Electronic Metronome
- ★ Electronic Noise Generator
- ★ Batteryless Crystal Radio
- ★ One Transistor Radio
- ★ 2 Transistor Regenerative Radio
- ★ 3 Transistor Regenerative Radio
- ★ Audible Continuity Tester
- ★ Sensitive Pre-Amplifier

Components include: 24 Resistors ★ 21 Capacitors ★ 10 Transistors  
 ★ 3 1/2" Loudspeaker ★ Earpiece ★ Mica Baseboard ★ 3 12-way connectors  
 ★ 2 Volume controls ★ 2 Slider Switches ★ 1 Tuning Condenser ★ 3 Knobs  
 ★ Ready Wound MW/LW/SW Coils ★ Ferrite Rod ★ 6 1/2 yards of wire  
 ★ 1 Yard of sleeving, etc.  
 Complete kit of parts including construction plans

## VHF AIR CONVERTER KIT

Build this Converter Kit and receive the Aircraft Band by placing it by the side of a radio tuned to Medium Wave or the Long Wave Band and operating as shown in the instructions supplied free with all parts. Uses a retractable chrome plated telescopic aerial, Gain Control, V.H.F. Tuning Capacitor, Transistor, etc. All Parts including Case and Plans P & P and Ins. 40p.

**£3-95** INC. V.A.T.



## NEW Everyday Series

Build this exciting new series of designs.

E.V.5 5 Transistors and 2 diodes. MW/LW. Powered by 4 1/2 volt Battery. Ferrite rod aerial, tuning condenser, volume control, and now with 3" loudspeaker. Attractive case with red speaker grille. Size 9" x 5 1/2" x 2 1/2" approx. All parts including Case and Plans.

Total Building Costs **£4-30** INC. V.A.T. P & P + Ins. 50p



E.V.6 Case and looks as above. 6 Transistors and 3 diodes. Powered by 9 volt battery. Ferrite rod aerial, 3" loudspeaker, etc. MW/LW coverage. Push Pull output. All parts including case and plans.

Total Building Costs **£4-95** INC. V.A.T. P & P + Ins. 55p

E.V.7 Case and looks as above, 7 Transistors and 3 diodes. Six wavebands, MW/LW, Trawler Band SW1, SW2, SW3, powered by 9 volt battery. Push Pull output. Telescopic aerial for short waves. 3" Loudspeaker. All parts including Case and Plans.

Total Building Costs **£6-35** INC. V.A.T. P & P + Ins. 55p

## POCKET FIVE

NOW WITH 3" LOUDSPEAKER  
 3 Tunable wavebands. M.W., L.W., and Trawler Band, 7 stages, 5 transistors and 2 diodes. supersensitive ferrite rod aerial, attractive black and gold case. Size 5 1/2" x 1 1/2" x 3 1/4" approx. All Parts including Case and Plans. P&P+Ins. 50p.

Total Building Costs **£3-60** INC. V.A.T. P & P + Ins. 50p.



## ELECTRONIC CONSTRUCTION KITS

### ECK 2 Self Contained Multi-Band V.H.F. Receiver Kit. 8 Transistors and 3 Diodes. Push/Pull output. 3" Loudspeaker, Gain Control. Superb 9 section swivel ratchet and retractable chrome plated telescopic aerial. V.H.F. Tuning Capacitor, Resistors, Capacitors, Transistors, etc. Will receive T.V. Sound, Public Service Band, Aircraft, V.H.F. Local Stations, etc. Operates from a 9 Volt PP7 Battery (not supplied with kit). Complete kit of parts including construction plans P & P and Ins. 55p.

**£7-15** INC. V.A.T. P & P and Ins. 55p.

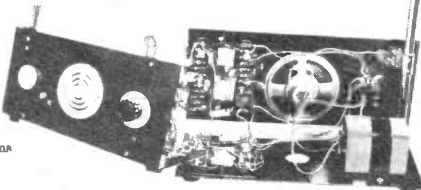

### ECK 4 7 Transistors, 6 tuneable wavebands, MW, LW, Trawler Band, 3 Short Wave Bands. Receiver Kit. With 5" x 3" Loudspeaker. Push/Pull output stage, Gain Control, and Rotary Switch. 7 Transistors and 4 Diodes. 6 section chrome-plated telescopic aerial. 8" Sensitive Ready Wound Ferrite Rod Aerial. Tuning Capacitor. Resistors, Capacitors, etc. Operates from a 9 Volt PP7 Battery (not supplied with kit). Complete kit of parts including construction plans. P & P and Ins. 55p.

**£6-55** INC. V.A.T. P & P and Ins. 55p.

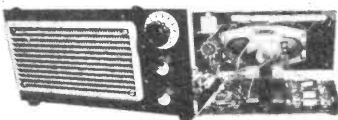

## ROAMER TEN MARK 2

WITH VHF INCLUDING AIRCRAFT

Now with free earpiece and switched socket. 10 Transistors. Latest 5" x 3" loudspeaker. 9 tuneable wavebands, MW1, MW2, LW, SW1, SW2, SW3, trawler band, VHF and local stations, also aircraft band. Built in ferrite rod aerial for MW/LW. Chrome plated. 6 section telescope aerial, can be angled and rotated for peak short wave and VHF listening. Push pull output using 600mW transistors. Car aerial socket, 10 transistors plus 3 diodes. Ganged tuning condenser with VHF section. Separate coil for aircraft band. Volume on/off. Wave change and tone controls. Attractive Case in rich chestnut shade with Gold Blocking. Size: 9" x 7" x 4". Easy to follow instructions and diagrams.

Total building costs **£10-68** INC. V.A.T. P & P + Ins. 65p

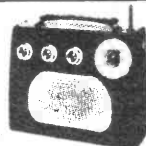

## EDU-KIT

Build Radios, Amplifiers, etc. from easy stage diagrams.

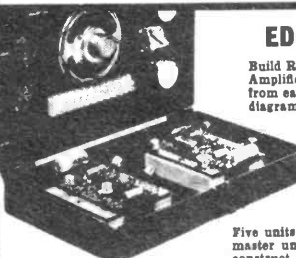

Five units including master unit to construct.

Components include: Tuning Condenser: 2 Volume Controls: 2 Slider Switches: Fine tone 3" moving coil Speaker: Terminal Strip: Ferrite Rod Aerial: Battery Clips: 4 Tag Boards: 10 Transistors: 4 Diodes: Resistors: Capacitors: Three 1" Knobs. Units once constructed are detachable from Master Unit, enabling them to be stored for future use. Ideal for Schools, Educational Authorities and all those interested in radio construction. All Parts including Case and Plans **£6-30** INC. V.A.T. P & P + Ins. 55p

## JIFFY TESTER

Easy to build and operate. Fits in the pocket A quick checker for continuity of resistors, chokes, diodes, transistors, circuit wiring (not mains) and loudspeakers. Complete with earpiece, jack plug and socket resistors, capacitors, components, etc. Complete kit of parts including construction plans. P & P + Ins. 30p.

**£2-85** INC. V.A.T.

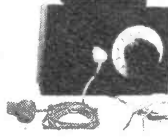

**TO RADIO EXCHANGE LTD.,**  
 61A HIGH STREET, BEDFORD MK40 1SA  
 Telephone: 0234 52367.

Reg. No. 788372

- ★ Callers side entrance "Lavelis" Shop.
- ★ Open 10-1, 2.30-4.30. Mon-Fri. 9-12 Sat.

I enclose £.....  
 for .....  
 Name .....  
 Address .....

EE676

## EDU-KIT JUNIOR

Completely Solderless Electronic Construction Kit. Build these projects without Soldering Iron or Solder.

- ★ Crystal Radio Medium Wave Coverage — No Battery necessary.
  - ★ One Transistor Radio.
  - ★ 2 Transistor Regenerative Radio.
  - ★ 3 Transistor Earpiece Radio Medium Wave Coverage.
  - ★ 4 Transistor Medium Wave Loudspeaker Radio.
  - ★ Electronic Noise Generator
  - ★ Electronic Metronome.
  - ★ 4 Transistor Push/Pull Amplifier.
- All parts including Loudspeaker, Earpiece, MW Ferrite Rod Aerial, Capacitors, Resistors, Transistors, etc. Complete kit of parts including construction plans.

**£6-55** INC. V.A.T. P & P + Ins. 55p

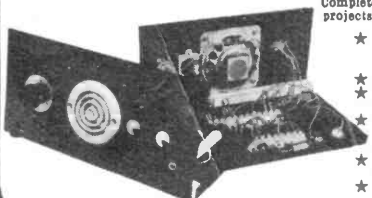

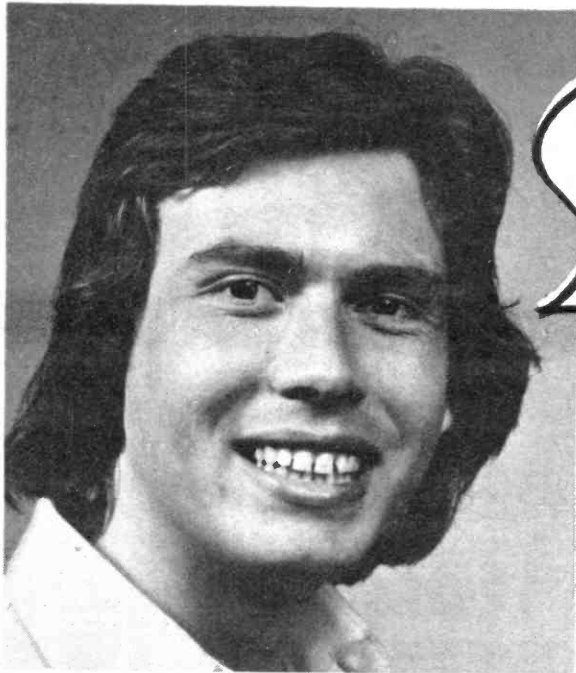

**FREE! A PIECE OF VERO BOARD... PLUS 4 PROJECTS!**

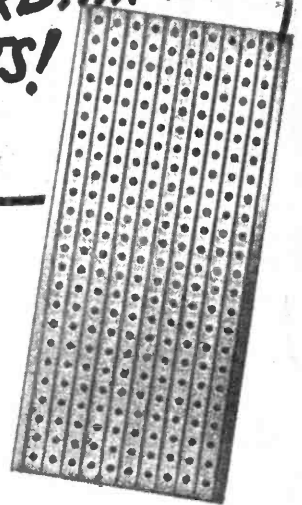
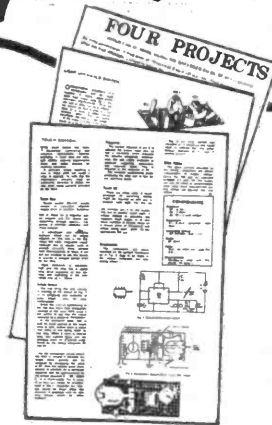

As you know, I'm fairly well in with the Managing Director of Home Radio Components Ltd. He was deep in thought when I called on him the other day. "Cooking up something new?" I said. "Yes" he replied "I'm thinking of giving a piece of Veroboard to everybody who buys one of our catalogues, but I'm wondering if the idea is a bit gimmicky." "Certainly not" I assured him "Several electronic magazines have done it before and I'm sure lots of customers appreciate it". Encouraged, he went on "I thought that if I offered 4 projects for which the board could be used it would make it even more useful and interesting". That set the ball rolling, and with the cooperation of Vero Electronics Ltd. and of Mr. Fred Bennett, Editor of 'Practical Electronics' he is now able to make this unique offer . . . to every purchaser of a Home Radio

Components Catalogue will be sent a piece of Veroboard and four projects for using it. The offer lasts for one month from the publication date of this journal. If you have not already got a current Home Radio Components Catalogue here is a wonderful opportunity to correct the omission (no constructor should be without one) and at the same time to win a useful piece of material and four interesting projects—a Touch Switch, a Thermometer, a Waa Waa Unit and a Light Operated Switch. The catalogue costs only 99p (including 34p for packing and postage) and it includes vouchers to the value of 30 pence if used as directed. This is too good to miss—send the coupon below with your cheque or P.O. for 99 pence. Why delay? Do it today!

Today's finest Components Catalogue  
**65p plus 34p POST & PACKING**

The price of 99p applies only to customers in the U.K. and to BFPO Addresses

Please write your Name and Address in block capitals

NAME .....

ADDRESS .....

.....

.....

HOME RADIO (Components) LTD., Dept. EE, (Regn. No  
 234-240 London Road, Mitcham, Surrey CR4 3HD London 912966)

**POST THIS COUPON**  
 with cheque  
 or p.o. for  
**99p**



HOME RADIO (Components) LTD Dept EE, 234-240 London Road, Mitcham, CR4 3HD. Phone 01-648 8422

# Get a great deal from Marshall's

A Marshall (London) Ltd Dept: EE  
42 Cricklewood Broadway London NW2 3ET Tel: 01-452 0161/2 Telex: 21492  
& 85 West Regent St Glasgow G2 2QD Tel: 041-332 4133  
& 1 Straits Parade Fishponds Bristol BS16 2LX Tel: 0272-654201/2  
& 27 Rue Danton Issy Les Moulineaux Paris 92 Tel: 644 2356  
Call in and see us 9-5.30 Mon-Fri 9-5.00 Sat  
Trade and export enquiries welcome  
Catalogue price 25p

## Our range covers over 7,000 items. The largest selection in Britain Top 200 IC's TTL, CMOS & Linears

CA3020A £1.80	CD4049	45p	NE556	£1.30	SN7446	84p	SN74153	68p	
CA3028A 79p	CD4050	45p	NE560	£4.48	SN7447	80p	SN74154	£1.20	
CA3035 £1.37	CD4510	£1.25	NE565	£4.48	SN7448	90p	SN74155	76p	
CA3046 70p	CD4511	£1.94	SL414	£2.35	SN7450	16p	SN74160	88p	
CA3048 £2.11	CD4516	£1.25	SL610C	£2.35	SN7451	16p	SN74161	88p	
CA3052 £1.62	CD4518	£1.87	SL611C	£2.35	SN7453	16p	SN74162	88p	
CA3089E £1.96	CD4520	£1.87	SL612C	£2.35	SN7460	16p	SN74164	£1.60	
CA3090Q £4.23	LM301A	48p	SL620C	£3.50	SN7470	29p	SN74165	£1.60	
CA3130 88p	LM308	£1.17	SL621C	£3.50	SN7472	21p	SN74167	£3.30	
CD4000 18p	LM309K	£1.88	SL623C	£5.75	SN7473	31p	SN74174	90p	
CD4001 18p	LM380	98p	SN7474	£4.00	SN7474	31p	SN74175	70p	
CD4002 18p	LM381	£2.07	SN7475	45p	SN7475	45p	SN74176	£1.14	
CD4006 99p	LM702C	75p	SN7476	30p	SN7476	30p	SN74180	£1.10	
CD4007 18p	LM709	35p	SN7477	16p	SN7477	16p	SN74181	£1.85	
CD4008 82p	T099	36p	SN7478	16p	SN7478	16p	SN74182	£1.85	
CD4009 52p	8D1L	45p	SN7479	16p	SN7479	16p	SN74191	£1.85	
CD4010 52p	14D1L	35p	SN7480	19p	SN7480	19p	SN74192	£1.15	
CD4011 18p	LM710	47p	SN7481	£1.00	SN7481	£1.00	SN74193	£1.15	
CD4012 18p	LM723C	66p	SN7482	65p	SN7482	65p	SN74199	£1.80	
CD4013 45p	LM724C	66p	SN7483	82p	SN7483	82p	SN76003N	£2.92	
CD4014 89p	8D1L	40p	SN7484	95p	SN7484	95p	SN76013N	£1.95	
CD4015 89p	14D1L	38p	SN7485	£1.00	SN7485	£1.00	SN76233N	£1.60	
CD4016 45p	LM747	£1.05	SN7486	29p	SN7486	29p	SN7633N	£2.92	
CD4017 88p	LM748	SN7411	20p	SN7490	42p	SN7490	42p	SN77199	£1.80
CD4018 88p	8D1L	44p	SN7491	75p	SN7491	75p	SN77419	£1.80	
CD4019 52p	14D1L	41p	SN7492	45p	SN7492	45p	SN774199	£1.80	
CD4020 98p	LM3900	61p	SN7493	45p	SN7493	45p	SN77603N	£1.60	
CD4021 88p	LM7805	£1.88	SN7494	75p	SN7494	75p	SN77623N	£1.60	
CD4022 85p	LM7812	£1.99	SN7495	68p	SN7495	68p	SN77633N	£2.92	
CD4023 18p	LM7815	£1.99	SN7496	68p	SN7496	68p	TAA263	£1.80	
CD4024 72p	LM7824	£1.99	SN74100	£1.10	TAA300	£1.84	TAA350A	£1.96	
CD4025 19p	MC1303L	£1.30	SN74107	30p	TAA350A	£1.96			
CD4027 43p	MC1310P	£2.50	SN74118	85p	TAA550	32p			
CD4028 83p	MC1330P	90p	SN74119	£1.75	TAA611C	£2.18			
CD4029 52p	MC1351P	80p	SN74121	32p	TAA621	£2.03			
CD4030 52p	MC14553	£4.07	SN74122	42p	TAA661B	£1.03			
CD4031 52p	MC1466L	£3.50	SN74123	65p	TAA661B	£1.23			
CD4037 88p	MC1469R	£2.75	SN74124	75p	TBA651	£1.69			
CD4041 70p	NE555V	70p	SN74141	75p	TBA800	99p			
			SN74145	72p	TBA810	98p			
			SN7441	68p	SN74150	£1.20	TBA810	98p	
			SN7442	65p	SN74151	68p	TBA820	80p	

LONDON GLASGOW PARIS AND NOW

## BRISTOL

IT'S OUR SERVICE THAT MAKES US GROW

## POPULAR SEMICONDUCTORS

2N696 22p	2N3906 19p	AF139 65p	BD139 71p	MPSA56 31p
2N697 16p	2N4058 18p	AF239 65p	BF115 29p	OC28 £1.48
2N699 55p	2N4062 15p	AF279 70p	BF117 55p	OC42 50p
2N706 14p	2N4921 83p	AF280 79p	BF154 20p	TIP229 49p
2N708 17p	2N4923 £1.00	AL102 £1.00	BF180 35p	TIP31A 62p
2N916 28p	2N5245 29p	BC107 14p	BF181 36p	TIP32A 74p
2N918 32p	2N5294 48p	BC109 15p	BF184 30p	TIP34A £1.51
2N1302 184p	2N5296 48p	BC147B 10p	BF194 12p	TIP35A £2.90
2N1306 31p	2N5458 26p	BC149B 11p	BF196 13p	TIP36A £3.70
2N1308 47p	2N5459 29p	BC157A 16p	BF197 15p	TIP41A 79p
2N1711 27p	2N6207 45p	BC158A 16p	BF198 18p	TIP42A 90p
2N2102 60p	3N128 73p	BC167B 15p	BF244 21p	TIP295S 98p
2N2148 94p	3N140 £1.00	BC168B 15p	BF258 53p	TIP305S 50p
2N2218A 47p	3N141 81p	BC169B 15p	BF259 55p	TIS43 28p
2N2219A 52p	3N200 £2.49	BC182 12p	BF259 55p	ZTX300 13p
2N2220 25p	40361 40p	BC182L 12p	BF259 55p	
2N2221 18p	40362 45p	BC183 12p	BF259 55p	
2N2222 20p	40366 44p	BC183L 12p	BF259 55p	
2N2369 20p	40407 35p	BC184 13p	BF259 55p	
2N2646 55p	40408 50p	BC184L 13p	BF259 55p	
2N2905 47p	40409 52p	BC212 16p	BF259 55p	
2N2906 33p	40410 52p	BC212L 16p	BF259 55p	
2N2927 32p	40411 £2.00	BC213L 15p	BF259 55p	
2N2926G 12p	40594 74p	BC214L 18p	BF259 55p	
2N3053 25p	40595 84p	BC237B 16p	BF259 55p	
2N3054 60p	40636 £1.10	BC239C 15p	BF259 55p	
2N3055 65p	40673 73p	BC257A 16p	BF259 55p	
2N3391 28p	AC126 20p	BC259B 17p	BF259 55p	
2N3392 15p	AC127 40p	BC261 17p	BF259 55p	
2N3490 59p	AC128 35p	BC307B 17p	BF259 55p	
2N3442 £1.40	AC152 49p	BC309C 20p	BF259 55p	
2N3638 15p	AC153 35p	BC327 23p	BF259 55p	
2N3702 12p	AC176 41p	BC328 22p	BF259 55p	
2N3703 13p	AC188K 40p	BC370 17p	BF259 55p	
2N3706 15p	AD143 68p	BC172 18p	BF259 55p	
2N3718 14p	AD161 69p	BD121 £1.00	BF259 55p	
2N3716 £1.80	AD162 69p	BD124 67p	BF259 55p	
2N3771 £2.20	AF106 40p	BD131 40p	BF259 55p	
2N3773 £2.65	AF109 40p	BD132 50p	BF259 55p	
2N3789 £2.06	AF115 35p	BD136 22p	BF259 55p	
2N3819 37p	AF116 35p	BD137 24p	BF259 55p	
2N3904 19p	AF118 35p	BD138 24p	BF259 55p	

PRICES CORRECT AT MAY 1976, BUT ALL EXCLUSIVE OF VAT. P. & P. 30p

## TECHNICAL TRAINING IN ELECTRONICS AND TELECOMMUNICATIONS

ICS can provide the technical knowledge that is so essential to your success; knowledge that will enable you to take advantage of the many opportunities open to you. Study in your own home, in your own time and at your own pace and if you are studying for an examination ICS guarantee coaching until you are successful.

City & Guilds Certificates:  
Telecommunications Technicians  
Radio, TV, Electronics Technicians  
Technical Communications  
Radio Servicing Theory  
Radio Amateurs  
Electrical Installation Work  
MPT Radio Communications Certificate

Diploma Courses:  
Colour TV Servicing  
Electronic Engineering and Maintenance  
Computer Engineering and Programming  
Radio, TV, Audio Engineering and Servicing  
Electrical Engineering, Installation  
and Contracting

POST OR PHONE TODAY FOR FREE BOOKLET.

## ICS To: International Correspondence Schools

Dept 710T Intertext House, London  
SW8 4UJ or telephone 622 9911

Subject of Interest

Name

Address

Tel:

## VALVE BARGAINS

Any 5 64p, 10 £1, 50 £4-50. Your choice from the following list:  
ECH84, ECC82, EF80, EF183, EF184, PC86, PC88, PCF80, PCF802, PCL82, PCL84, PCL85, PCL805, PFL200, PL36, PL504, PY81, PY800, PY88, EH90, 30PL14, 6F28.

Colour Valves 30p each PL508, PL 509, PY500/A.

Small Plastic Boxes (white) made out of high impact plastic with flick on lids. Ideal for most projects. All three types one price. Prices 15p each. Ten £1.30. Size (approx.): Type 1—3½ins x 2½ins x 1½in deep. Type 2—3½ins x 2½ins x 2ins deep. Type 3—3½ins x 3½ins x 1½ins deep.

Prices include V.A.T. P. & P. under £1/15p, £1 to £3/25p above £3/35p. Overseas at cost. Money back guarantee on all orders.

## ELECTRONIC MAIL ORDER

62 BRIDGE ST., RAMSBOTTOM, BURY, LANCS. Tel. Rams. 3036

## AERIAL BOOSTERS

We make three types of Aerial Boosters all for set top fitting, with Co-ax Plugs and Sockets.

B1—For Stereo and Standard VHF Radio.

B2—For the older VHF Television, please state BBC1 and ITV Channels.

B45—For mon. or colour this covers the complete UHF band.

All Boosters are complete with Battery and take only minutes to fit.

Price £3.60 each.

## CJL

CJL LTD. P.O. BOX 34, CANTERBURY, CT1 1YT

ALL PRICES INCLUDE P&P AND V.A.T.

### ANTEX SOLDERING IRONS

(with slide on & off bits)

15W 'C' miniature irons	£2.30
3/32"1/8"3/16"bits—each	£0.45
'C' Elements	£1.10
18W 'G' miniature irons	£2.50
3/32"1/8"3/16"bits—each	£0.45
'G' Elements	£1.35
15W 'CCN'Low leakage irons	£2.70
3/32"1/8"3/16" bits—each	£0.45
'CCN' Elements	£1.50
25W 'X25' Low leakage irons	£2.30
3/32"1/8"3/16"bits—each	£0.47
'X25' Elements	£1.15
'SK1'/'SK2' Soldering Kits	£3.85
ST3 Stands—for all models	£1.10
SOLDER in Bib dispenser	£0.45

### WIRE STRIPPER & CUTTER £0.85

HAND DRILLS Leytool precision, compact, 5/16" chuck	£3.99
AERIALS Extend 15-120cm	£1.50
CASSETTE 'Head Demagnetisers' Shaped pole-saves time	£3.65
EARPHONES Stethoscope	£1.25
Crystal earphone, lead & plug	£0.65
Headphone, 2,000 n	£3.20
INTERCOMS 2-station	£6.35
MICROPHONES Dynamic	£2.15
PRINTED CIRCUIT KITS -All	
Items for producing p.c.'s	£3.99
SIGNAL INJECTOR -Audio through video signals, self contained	£4.25
STEREO HEADPHONES	£4.85
SPEAKERS -75mm dia.	£1.00

# ELECTROTIME

## ELECTRONIC DIGITAL ALARM CLOCK MODEL EC 3

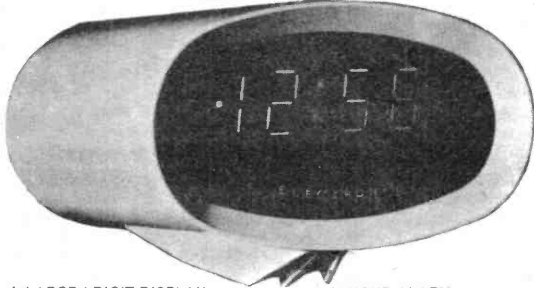

- ★ LARGE 4 DIGIT DISPLAY
- ★ AM/PM INDICATOR
- ★ FLASHING SECONDS INDICATOR
- ★ 5 MINUTE REPEATING SNOOZE ALARM
- ★ 24 HOUR ALARM
- ★ BRIGHTNESS CONTROL
- ★ ATTRACTIVE WHITE CASE

COMPLETE BUILT CLOCK PRICE **£14** inc. VAT.

## THE "MISTRAL" 1 DIGITAL CLOCK



- ★ PLEASANT GREEN DISPLAY
- ★ 12/24 HOUR READOUT
- ★ FULLY ELECTRONIC
- ★ PULSATING COLON
- ★ PUSH BUTTON SETTING
- ★ BUILDING TIME 1 HOUR

COMPLETE KIT PRICE **£11.07** inc. VAT.

BUILT CLOCK PRICE **£14.95**

## LCD MODEL TLC 4

### CONTINUOUS READOUT UTILISING LIQUID CRYSTAL DISPLAY

WITH BACKLIGHT FOR  
NIGHT READING

FEATURES—

- ★ HOURS
- ★ MINUTES
- ★ SECONDS
- ★ DATE

RHODIUM **£39.95**

GOLD **£41.50** inc. VAT.



## LED MODEL TLE 5

FEATURES—

- ★ HOURS
- ★ MINUTES
- ★ SECONDS
- ★ DATE
- ★ DAY OF WEEK

**£29.50** inc. VAT.

GOLD OR  
RHODIUM PLATED



## LED MODEL TLE 3

FEATURES—

- ★ HOURS
- ★ MINUTES
- ★ SECONDS

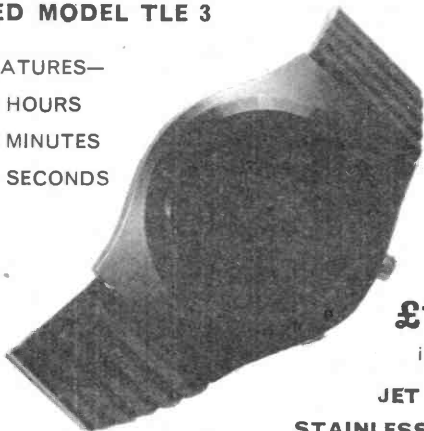

**£19.95**

inc. VAT.

JET BLACK  
STAINLESS STEEL  
CASE AND BRACELET

COME TO THE EXPERTS IN DIGITAL  
TIMEKEEPING.

\*\*\*\*\*

MONEY REFUNDED IF NOT COMPLETELY  
SATISFIED

ONE YEAR GUARANTEE WITH ALL MODELS

ELECTROTIME DEPT. 4/6,  
111, STORFORTH LANE TRADING ESTATE,  
CHESTERFIELD, DERBYSHIRE. TEL. 35804.

PLEASE SUPPLY .....  
I ENCLOSE CHEQUE/POSTAL ORDER

NAME.....

ADDRESS.....

.....

.....

# DESIGNED BY TEXAS



**30,000 ALREADY SOLD**  
**Texan Amplifier as featured by PRACTICAL WIRELESS**  
**SOLE U.K. DISTRIBUTORS - HENRY'S**

*Build it yourself for only*

**£32 KIT PRICE INC. VAT + £1.00 p&p.**  
 Built and tested £42.00 Inc. VAT + £1.00 p&p.

Build the Texan stereo amplifier, then you can be doubly proud! For a start, you'll own a superb home entertainment unit. And have had all the pleasure of doing it yourself, with the Henry's kit.

**Look at the Texan specification**

Incorporating fully integrated stereo preamp and power amp, with 6 IC's, 10 transistors, 6 rectifiers and zener diodes. Plus stabilised, protected circuitry, glass fib pcb; Gardners low-field low-line mains transformer; all facilities and controls. Slim design, chassis 14½" x 8" x 2" overall, 20 watts per channel RMS, less than 0.1% distortion at 1 kHz.

★ Can be built Stage by stage  
 Ask for leaflet 5.  
 ★ Everything necessary supplied.  
 Full after sales service and guarantees.

**TEXAN FM TUNER KIT £23.50**  
 Inc. VAT + 50p p&p

Built and tested £28.50 inc. VAT + 50p p&p.

Build the matching Texan stereo tuner! Features advanced varicap tuning, Phase lock loop decoder. Professionally designed circuit. Everything you need is in the kit. From the glass fibre pcb to the cabinet itself. Excellent spec: 2.5 uV aerial sensitivity, 500 mV output (adjustable). Tuning range 87-102 MHz. Mains powered.

**THE NATURAL FOLLOW-ON**

**Henry's latest ELECTRONICS CATALOGUE**

- \* over 5000 items - many new
- \* free 50p voucher inside every copy
- \* virtually everything needed by amateurs and professionals
- \* over 200 pages
- \* easy-to-use, complete alphabetical index
- \* section index
- \* everything at competitive prices

FREE to Educational Establishments when ordered on official headed notepaper

**VIDEO SPORT**



An up-to-the-minute game. Plugs into your own TV aerial socket. Switch on. And you're away! Choose your game - football, tennis or hole-in-the-wall. Absolutely safe. For you. Your children. And your TV. Mains powered. List Price £42.50

**HENRY'S PRICE £25.00**  
 inc. VAT + 50p p&p

★ OVER 10,000 ALREADY SOLD  
 ★ IDEAL GIFT

For this latest edition, we have made hundreds of changes and additions. Features now include:

**TRANSISTOR & VALVE DISCOUNT PRICE LIST**  
 over 2000 types  
 SEND FOR YOUR FREE COPY

**ONLY 50p**

+20p carr./pack.

**HENRY'S RADIO**

**All mail to: Henry's Radio 303 Edgware Rd, London W2**

- LONDON W2: 404/6 Edgware Road. Tel: 01-402 8381  
 LONDON W1: 231 Tottenham Ct Rd. <sup>House</sup> <sub>sales floor</sub> Tel: 01-636 6681  
 \*NOTTINGHAM: 94/96 Upper Parliament St. Tel: (0602) 40403  
 \*READING, BERKS: 130/131 Friar Street. Tel: (0734) 583230  
 \*HARROW: 190/4 Station Road. Tel: 01-863 7788  
 \*CROYDON: 110 North End. Tel: 01-681 3310

Please Note: Mail Order Customers HENRY'S WILL CREDIT ANY VAT DOWN VAT OVERPAYMENTS

**\* NEW STORES**

## EVERYDAY ELECTRONICS Easybuild DIGITAL CLOCK

We are offering kits for this attractive clock, featured in January E.E., at special prices. Anyone with a little experience of soldering should be able to build a fully working clock.

No moving parts—4 digit 0.5" green display—flashing or fixed colon—12 or 24 hour display—slim attractive white case—full instructions included.

**COMPLETE EE CLOCK KIT £15.70**

All components necessary except mains lead and plug to complete fully working clock: AY51202 clock IC, 5LT01, display, PCB, miniature transformer, resistors, capacitors, diodes, switches, verocase, green perspex panel, nuts, screws, washers, wire, grommet.

Complete kit as above, but with lead and plug **£16.20**

**EE CLOCK MODULE KIT £12.04**

This kit comprises all components as in the clock kit except verocase, perspex panel, nuts, screws, washers, wire, grommet, mains lead and plug.

AVAILABLE SEPERATELY AY51202 **£4.76**

5LT01 Transformer **£1.80** 5LT01 **£5.80**

Verocase J and green perspex **£2.94** PCB **£1.40**

"25p P & P"—ADD VAT (now 8%)  
 to ALL PRICES ABOVE

## SINTEL

53E Aston Street, Oxford. Tel. 0865 49791

# A hobby that pays big salaries.

Enrol in the BNR & E School and you'll have an entertaining and fascinating hobby. Stick with it and the opportunities and the big money await you, if qualified, in every field of Electronics today. We offer the finest home study training for all subjects in radio, television, etc., especially for the CITY AND GUILDS EXAMS (Technicians' Certificates); the Grad. Brit. I.E.R. Exam; the RADIO AMATEUR'S LICENCE; P.M.G. Certificates; the R.T.E.B. Servicing Certificates; etc. Also courses in Television; Transistors; Radar; Computers; Servo-mechanisms; Mathematics and Practical Transistor Radio course with equipment. We have OVER 20 YEARS' experience in teaching radio subjects and an unbroken record of exam successes. We are the only privately run British home study College specialising in electronics subjects only. Full-est details will be gladly sent without any obligation.

**BRITISH NATIONAL RADIO & ELECTRONICS SCHOOL, Dept EEC 66**

P.O. Box 156, Jersey, Channel Islands.

NAME \_\_\_\_\_

ADDRESS \_\_\_\_\_

(Block caps please)

# BRITAIN'S FASTEST SERVICE!



## NEW 74 SERIES TTL PRICES

	1-24	25-99	100+
7400	11p	10p	10p
7401	14p	12p	10p
7402	11p	10p	10p
7403	16p	14p	10p
7404	16p	13p	11p
7405	16p	13p	11p
7408	16p	13p	11p
7409	16p	13p	11p
7410	11p	10p	10p
7413	27p	24p	20p
7420	16p	13p	11p
7425	23p	22p	22p
7430	16p	13p	11p
7440	18p	16p	15p
7441	75p	62p	50p
7442	65p	55p	43p
7445	85p	71p	57p
7447	80p	75p	65p
7450	16p	13p	11p
7451	16p	13p	11p
7453	16p	13p	11p
7454	16p	13p	11p
7460	16p	13p	11p
7470	27p	25p	23p
7472	25p	21p	17p
7473	30p	25p	20p
7474	32p	26p	21p
7475	47p	39p	31p
7476	32p	26p	21p
7480	60p	56p	42p
7482	75p	62p	50p
7483	70p	65p	62p
7485	1-25p	1-08p	85p
7486	32p	26p	21p
7490	44p	39p	30p
7491A	65p	55p	45p
7492	57p	46p	36p
7493	45p	40p	32p
7494	73p	65p	58p
7495	70p	60p	54p
7496	70p	60p	54p
74100	1-08p	89p	78p
74107	35p	28p	22p
74121	34p	28p	22p
74141	75p	62p	52p
74150	1-05p	95p	87p
74151	65p	59p	56p
74153	62p	58p	54p
74154	1-00p	92p	85p
74155	70p	63p	58p
74156	70p	63p	58p
74174	1-00p	83p	67p
74180	1-00p	83p	67p
74181	2-31p	2-05p	1-82p
74190	1-15p	1-00p	95p
74191	1-15p	1-00p	95p
74192	1-00p	83p	67p
74193	1-05p	95p	87p
74196	1-29p	1-05p	95p
74197	1-29p	1-05p	95p

Pricing on this series is calculated on the total pieces ordered regardless of mix.

## NEW EXTENDED COSMOS RANGE

	1-24	25-99	100+
CD4000AE	19p	17p	14p
CD4001AE	19p	17p	14p
CD4002AE	19p	17p	14p
CD4006AE	1-06p	86p	70p
CD4007AE	19p	17p	14p
CD4008AE	87p	70p	58p
CD4009AE	50p	40p	34p
CD4010AE	50p	40p	34p
CD4011AE	19p	17p	14p
CD4012AE	19p	17p	14p
CD4013AE	50p	40p	34p
CD4014AE	94p	74p	61p
CD4015AE	94p	74p	61p
CD4016AE	50p	40p	34p
CD4017AE	94p	74p	61p
CD4018AE	94p	74p	61p
CD4019AE	50p	40p	34p
CD4020AE	1-06p	86p	70p
CD4021AE	94p	74p	61p
CD4022AE	87p	70p	58p
CD4023AE	19p	17p	14p
CD4024AE	72p	56p	46p
CD4025AE	19p	17p	14p
CD4026AE	1-60p	1-25p	1-03p
CD4027AE	50p	40p	34p
CD4028AE	87p	70p	58p
CD4029AE	1-06p	86p	70p
CD4030AE	50p	40p	34p
CD4035AE	1-06p	86p	70p
CD4040AE	94p	74p	61p
CD4042AE	78p	60p	50p
CD4043AE	94p	74p	61p
CD4044AE	87p	70p	58p
CD4046AE	1-24p	99p	80p
CD4049AE	50p	40p	34p
CD4050AE	50p	40p	34p
CD4052AE	87p	70p	58p
CD4056AE	1-24p	99p	80p
CD4060AE	1-24p	99p	80p
CD4066AE	87p	70p	58p
CD4068BE	20p	18p	16p
CD4069BE	20p	18p	16p
CD4070BE	20p	18p	16p
CD4071BE	20p	18p	16p
CD4073BE	20p	18p	16p
CD4077BE	20p	18p	16p
CD4081BE	20p	18p	16p
CD4082BE	20p	18p	16p
CD4085BE	65p	52p	42p
CD4086BE	65p	52p	42p
CD4093BE	75p	65p	60p
CD4099BE	1-65p	1-35p	1-10p
CD4511BE	1-65p	1-35p	1-10p
CD4528BE	1-30p	1-08p	87p

## DIL SOCKETS — NEW ULTRA LOW PROFILE

8 DIL/UP	13p
14 DIL/UP	15p
16 DIL/ULP	16p
24 DIL/ULP	26p
DIL PINS	
100 FOR	65p

## SOLDERING EQUIPMENT & TOOLS

DST Mk. 1. "Solder Sucker" a truly indispensable tool	£4-30p
CCN-15V Spare Nozzle	46p
Miniature Iron 240v	£2-95
X25-240 25 Watt Iron 240v	£2-95
X50-TC Temperature Controlled Iron	£9-25
MLX12 12volt Battery Iron	£3-50
Soldering Iron Stand	
For all models	£1-25
S167 Thermal shunt for delicate components	40p
BIT2 Spare bit Nickel clad for iron 3/32"	36p
BIT3 Spare bit Nickel clad for iron 5/32"	36p
BIT4 Spare bit Nickel clad for iron 3/16"	36p
BIT1100 Iron coated for CCN 3/32"	46p
BIT50 Spare bit for X25 and MLX12 irons—Iron coated 3/32"	46p
BIT51 Spare bit for X25 and MLX12 irons—Iron coated 1/8"	46p
BIT52 Spare bit for X25 and MLX12 irons—Iron coated 3/16"	46p

## TRANSDUCERS

40kHz Ultrasonic transducers as used in many Mag. articles complete with suggested circuits: Order type: RL400PP £4-20 pair

## IC TEST CLIP

New low price £1-95 each. clips on to 14/16 lead IC's under test. Can be used as a removal tool.

## TIMER CHIP NE555V

	1-24	25+	100+
New Low Prices:	55	49	40

## LM 380

3 watt IC  
98p

## 741 OP-AMP MINIDIP

New bulk prices and SPECIAL! YOU CAN INCLUDE YOUR 741 WITH YOUR TOTAL TTL 74 SERIES MIX to get best price:

	1-24	25+	100+
	30	25	22

## 3-2mm LEDs

Extended range plus ARROW bulk prices: All prices include free bushes.

	1-24	25+	100+
Red	14	12	10
Green	27	24	22
Amber	27	24	22

(All are TIL209 size)

## THE GREEN GIANT

Jumbo sized Green LED—jump while they last:

	1-12	13-24	25+	100+
5mm	25	22	20	18

## 3 WATT ZENERS

Axial lead, miniature plastic case full 3 Watt Disc. Following voltages only: 6-8, 8-2, 10, 11, 12, 15, 16, 18, 22, 24, 27, 32, 33, 62, 68, 91, 100.

ALL ONE PRICE 40p

## MM5314 CLOCK CHIP

With hold/advance count, output strobe, 7 Seg. output. With data £4-00\*

## 7 WATT AUDIO CHIP

TBA810S with data £1-40

## SENSATIONAL STOCK CLEARANCE

PAK: AA1 Twenty assorted transistors our choice	£1-00
PAK: AA2 Ten TAA243 Op. Amps (high gain 702)	£1-00
PAK: AA3 Ten BCW54 300mW 300mHz 64v Transistor NPN	£1-00
PAK: AA4 Three 2N3055	£1-00
PAK: AA5 Twenty Diodes & Rectifiers/Bridges	our choice £1-00
PAK: AA6 Five BD187 (pre-Tormed) Plastic Power Transistor	£1-00
PAK: AA7 Ten assorted Zeners	our choice £1-00

**SUPERPAK** Our Guaranteed Value pack of clearance lines, Semic's Resistors, Caps, Pots, etc. etc. £1-50

## GREAT TRIAC CLEARANCE

SC35A 3A 100v	50p
SC35B 3A 200v	60p
SC40B 6A 200v	65p
SC40D 6A 400v	80p
SC40E 6A 500v	85p
SC45A 10A 100v	70p
SC45B 10A 200v	75p
SC45E 10A 500v	90p
SC50D 15A 400v	£1-00p
SC50E 15A 500v	£1-10p

All stud mounted, fixing nuts supplied.

## 4-TRACK TAPE HEADS

record/pb	£3-00 ea*
Stereo heads rec/pb + erase	£1-80pr*

## SEMICONDUCTORS & IC'S

Our huge availability of transistors, diodes, Triacs SCR's, Zeners, etc., is too large to list. See previous catalogues and advertisements for price and availability or Telephone Alan Green on 0277 219435 for a quick price.

Our 1976/7 catalogue is well under way and will be bigger and better than ever.

Our Retail shop (5 mins from Brentwood mainline station) is being enlarged with many new lines. Pay us a visit!

VAT Prices are exclusive of VAT. Add VAT at 8% except for items marked \* when 12½% should be added.

POSTAGE Still no-charge.

COPTFOLD ROAD  
BRENTWOOD ESSEX

# ARROW ELECTRONICS LTD.

## RETAIL SHOP

Our shop is open six days per week—many more items stocked than we could ever list. (Thurs. early closing).

# SEMI-CONDUCTORS

## TRANSISTORS

BRAND NEW FULLY GUARANTEED

Type	Price	Type	Price	Type	Price	Type	Price	Type	Price	Type	Price	Type	Price	Type	Price
AC117K	*0.30	AF178	*0.51	BC169	0.10	BC440	*0.31	BF117	*0.46	BFY53	*0.13	OC75	*0.16	2N706	*0.08
AC126	*0.18	AF179	*0.51	BC169C	0.10	BC460	*0.37	BF118	*0.71	BSY19	*0.16	OC76	*0.16	2N706A	*0.09
AC126	*0.14	AF180	*0.51	BC170	0.09	BD115	*0.63	BF119	*0.71	BSY20	*0.16	OC77	*0.26	2N708	*0.11
AC127	*0.11	AF181	*0.51	BC171	0.09	BD116	*0.81	BF152	0.56	BSY25	*0.16	OC81	*0.16	2N714	*0.15
AC128	*0.11	AF186	*0.51	BC172	0.09	BD121	*0.61	BF153	0.46	BSY26	*0.16	OC81D	*0.16	2N718	*0.18
AC128K	*0.26	AF239	*0.38	BC173	0.09	BD123	*0.67	BF154	0.46	BSY27	*0.16	OC82	*0.16	2N718	*0.18
AC141	*0.19	AL102	*0.75	BC174	*0.15	BD124	*0.70	BF155	*0.71	BSY28	*0.16	OC82D	*0.16	2N1131	*0.18
AC141K	*0.60	AL103	*0.75	BC175	*0.22	BD131	*0.36	BF156	*0.49	BSY29	*0.16	OC83	*0.20	2N1302	*0.15
AC142	*0.19	BC107	*0.08	BC177	*0.16	BD132	*0.40	BF157	*0.56	BSY38	*0.19	OC139	*0.20	2N1303	*0.15
AC142K	*0.26	BC108	*0.08	BC178	*0.16	BD133	*0.67	BF158	0.56	BSY39	*0.19	OC140	*0.23	2N1304	*0.15
AC153K	*0.24	BC109	*0.08	BC179	0.09	BD135	*0.41	BF159	0.61	BSY40	*0.29	OC169	*0.26	2N1305	*0.18
AC176	*0.11	BC113	0.10	BC180	*0.25	BD136	*0.41	BF173	*0.15	BSY41	*0.29	OC170	*0.26	2N1306	*0.21
AC176K	*0.26	BC114	0.16	BC181	*0.25	BD137	*0.46	BF176	0.36	BSY95	*0.13	OC171	*0.26	2N1307	*0.21
AC180	*0.20	BC115	0.16	BC182	0.09	BD138	0.51	BF179	*0.31	BSY95A	*0.13	OC200	*0.26	2N1308	*0.24
AC180K	*0.30	BC116	0.16	BC182L	0.09	BD139	0.56	BF180	*0.31	BU105	*1.90	OC201	*0.29	2N1309	*0.24
AC181	*0.20	BC117	0.19	BC183	0.09	BD140	0.61	BF181	*0.31	MJE291	*0.56	OC202	*0.29	2N1613	*0.16
AC181K	*0.30	BC118	0.09	BC183L	0.09	BD155	*0.61	BF184	0.10	MJE295	*0.88	OC203	*0.26	2N1613	*0.16
AC187	*0.17	BC119	*0.31	BC184	0.09	BD175	*0.61	BF185	0.10	MJE305	*0.57	OC204	*0.26	2N1711	*0.16
AC187K	*0.23	BC120	*0.16	BC184L	0.09	BD176	*0.61	BF186	0.92	MJE3440	*0.51	OC205	*0.38	2N2148	*0.18
AC188	*0.18	BC137	*0.81	BC186	*0.29	BD177	*0.67	BF197	0.12	MPPF102	*0.28	OC211	*0.44	2N2218	*0.50
AC188K	*0.23	BC139	*0.41	BC187	*0.29	BD178	*0.67	BF198	0.12	MPPF104	*0.28	ORP12		2N2218A	*0.18
AD140	*0.49	BC140	*0.41	BC207	*0.11	BD179	*0.71	BF199	0.12	MPPF105	*0.28	NSL4931	*0.48	2N2219	*0.18
AD142	*0.35	BC141	*0.31	BC208	0.11	BD180	*0.71	BF257	*0.28	OC19	*0.36	ORP60	*0.41	2N2219A	*0.18
AD143	*0.49	BC142	*0.31	BC209	0.12	BD185	*0.67	BF258	*0.36	OC20	*0.60	ORP62	*0.41	2N2220	*0.22
AD149	*0.45	BC143	*0.31	BC212	0.10	BD186	*0.67	BF259	*0.46	OC22	*0.47	TIP27	*0.40	2N2221	*0.18
AD150	*0.65	BC145	0.46	BC212L	0.10	BD187	*0.71	BF262	0.56	OC23	*0.49	TIP30	*0.45	2N2222	*0.18
AD161	*0.36	BC147	0.09	BC213	0.10	BD188	*0.71	BF263	0.56	OC24	*0.57	TIP31A	*0.52	2N2368	*0.18
AD162	*0.36	BC148	0.09	BC213L	0.10	BD189	*0.77	BF270	*0.36	OC25	*0.39	TIP32A	*0.60	2N2369	*0.12
AD161 & AD162(MP)	*0.69	BC149	0.09	BC214	0.10	BD190	*0.77	BF271	*0.31	OC26	*0.38	TIP41A	*0.65	2N2369A	*0.12
AF114	*0.22	BC150	0.19	BC214L	0.10	BD195	*0.67	BF272	*0.65	OC28	*0.60	TI42A	*0.72		
AF115	*0.22	BC152	0.18	BC226	0.26	BD197	*0.82	BF274	0.36	OC35	*0.45	UT46	*0.20		
AF116	*0.22	BC153	0.29	BC251	0.10	BD198	*0.82	BF299	*0.25	OC36	*0.51	ZTX107	0.07		
AF117	*0.22	BC154	0.20	BC301	*0.28	BD199	*0.98	BFX84	*0.19	OC41	*0.20	ZTX108	0.07		
AF117	*0.22	BC157	0.11	BC302	*0.25	BD200	*0.98	BFX85	*0.25	OC42	*0.25	ZTX109	0.07		
AF118	*0.32	BC158	0.11	BC303	*0.31	BD205	*0.81	BFX86	*0.22	OC44	*0.16	ZTX100	0.07		
AF124	*0.28	BC160	*0.46	BC306	*0.37	BD206	*0.98	BFX87	*0.22	OC45	*0.13	ZTX500	0.09		
AF125	*0.28	BC160	*0.46	BC327	0.12	BD207	*0.98	BFX88	*0.22	OC70	*0.10	2N696	*0.10		
AF126	*0.26	BC161	*0.51	BC328	0.12	BD208	*0.98	BFY50	*0.13	OC71	*0.10	2N697	*0.11		
AF127	*0.26	BC162	0.10	BC337	0.12	BDY20	*1.02	BFY51	*0.13	OC72	*0.15	2N698	*0.20		
AF139	*0.31	BC168	0.10	BC338	0.12	BF115	*0.15	BFY52	*0.13	OC74	*0.15	2N699	*0.36		

**VAT CHAT**  
Please add 8% to prices marked \*  
Remainder add 12 1/2%. Do not add V.A.T. to prices marked †.

### SUPER UNTESTED PAKS

Pak No.	Description	Price
U 1	120 Glass Sub-min. General purpose Germ. diodes	*0.60
U 4	30 Germanium transistors like OC81, AC128	*0.60
U 5	60 200mA Sub-min. silicon diodes	*0.60
U11	20 PNP Sil. planar trans. TO-5 like 2N1132, 2N2904	*0.60
U15	20 NPN Sil. planar trans. TO-5 like 2N696, 2N697	*0.60
U19	20 Silicon NPN transistors like BC108	*0.60
U26	30 Fast switching silicon diodes like 1N914 Micro-Min.	*0.60
U29	10 1 Amp SCR's TO-5 can. up to 600 CR5/25-600	*£1.20
U32	25 Zener diodes 400mW DO-7 case 3-18 volts mixed	*0.60
U36	20 Silicon planar NPN transistors TO-5 BFY50/51/52	*0.60
U45	7 3A SCR. TO66 up to 600 PIV	*£1.20
U46	20 Unijunction transistors similar to TIS43	*0.60
U48	9 NPN Sil. Power transistors like 2N3055	*£1.20

Code No's mentioned above are given as a guide to the type of device in the Pak. The devices themselves are normally unmarked.

## DIODES

Type	Price	Type	Price	Type	Price	Type	Price
BA100	*0.10	BY100	*0.15	OA10	*0.14	OA91	*0.07
BA116	*0.21	BY100	*0.16	OA47	*0.07	OA95	*0.07
BA126	*0.22	BY126	*0.15	OA70	*0.07	OA200	*0.07
BA143	*0.15	BY127	*0.16	OA79	*0.07	OA202	*0.07
BA154	*0.12	BY128	*0.16	OA81	*0.07	1N914	*0.06
BA156	*0.14	BY164	*0.51	OA85	*0.09	1N916	*0.05
BA173	*0.15	BYX3830	*0.43	OA90	*0.07	1N4148	*0.06

## THYRISTORS

PIV	0-6A	0-8A	1A	3A	5A	5A	7A	10A	16A	30A
TO18	TO28	TO5	TO66	TO66	TO64	TO48	TO48	TO48	TO48	
10	*0.13	*0.15	—	—	—	—	—	—	—	—
20	*0.15	*0.13	—	—	—	—	—	—	—	—
30	*0.19	*0.22	—	—	—	—	—	—	—	—
50	*0.22	*0.28	*0.20	*0.25	*0.36	*0.36	*0.48	*0.51	*0.54	*1.18
100	*0.25	*0.30	*0.25	*0.25	*0.48	*0.48	*0.51	*0.57	*0.58	*1.43
150	*0.31	*0.38	—	—	—	—	—	—	—	—
200	*0.38	*0.44	*0.25	*0.30	*0.50	*0.50	*0.57	*0.62	*0.62	*1.63
400	—	—	*0.30	*0.39	*0.55	*0.57	*0.62	*0.71	*0.77	*1.79
600	—	—	*0.39	*0.48	*0.69	*0.69	*0.78	*0.89	*0.90	—
800	—	—	*0.58	*0.65	*0.81	*0.81	*0.92	*1.22	*1.39	*4.07

## SILICON RECTIFIERS

PIV	300mA (DO 7)	750mA (SO 16)	1 Amp Plastic (SO 10)	1.5 Amp (SO 10)	3 Amp (SO 10)	10 Amp (TO 48)	30 Amp (TO 48)
50	0.05	0.06	IN4001	0.05	0.07	0.14	0.56
100	0.05	0.07	IN4002	0.06	0.09	0.16	0.69
200	0.06	0.09	IN4003	0.07	0.12	0.20	0.93
400	0.07	0.14	IN4004	0.08	0.14	0.28	1.25
600	0.08	0.16	IN4005	0.09	0.18	0.33	1.76
800	0.11	0.28	IN4006	0.10	0.18	0.35	1.94
1000	0.13	0.28	—	—	0.23	0.44	2.31
1200	—	0.32	—	—	0.28	0.54	2.88

## SIL. G.P. DIODES

300mW 400 PIV (min) SUB-MIN FULLY TESTED  
Ideal for Organ builders  
30 for 50p, 100 for £1.50, 500 for £5, 1,000 for £9.

## TRIACS

2 Amp	Case TO5	100V	200V	400V
5 Amp	TO66	*0.51	*0.51	*0.71
10 Amp	TO48	*0.51	*0.61	*0.77
		*0.77	*0.91	*1.12

## GP300

115 WATT SILICON TO3 METAL CASE  
Vcbo 100V. Vceo 60V, IC 15A, Hfe, 20-100 suitable replacement for 2N3055, BDY11 or BDY20  
1-24 \*50p 100+ \*48p

## GP Switching Trans

TO18 SIM. TO 2N706/8 BSY27/28/95A  
All usable devices. No open and shorts. ALSO AVAILABLE IN PNP similar to 2N2906, BCY70, 20 for \*50p, 50 for \*£1, 100 for \*£1.80, 500 for \*£8, 1,000 for \*£14.  
When ordering please state NPN or PNP

### WORLD SCOOP!!

JUMBO SEMICONDUCTOR PAK  
Transistors-Germ. and Silicon,  
Rectifiers-Diodes, Triacs-Thyristors-I.C.'s and  
Zeners. ALL NEW AND CODED.  
Approx. 100 pieces only \*1.85p.

## ZENER DIODES

FULL RANGE IN STOCK, 2-33 Volts  
400mW 8p 1.5W 17p 10W \*30p

## HANDBOOKS

**TRANSISTOR DATA BOOK**  
DTE 1 227 Pages packed with information on European Transistors; Full specification including outlines. Price \*£2.95 each  
**TRANSISTOR EQUIVALENT BOOK**  
BPE 75 256 Pages of cross references and equivalents for European, American and Japanese Transistors. This is the most comprehensive equivalents book on the market today and has an introduction in 13 languages. Price \*£2.98 each  
**DIODE EQUIVALENT BOOK**  
DE 74 144 Pages of cross references and equivalents for European, American and Japanese diodes, Zeners, Thyristors, Triacs, Diacs and L.E.D.'s. Price \*£1.98 each  
**THE WORLD'S BROADCASTING STATIONS**  
WBS 75 An up to the minute guide for those interested in DX-ing. Contains all the world's broadcasters on SW, MW and LW, as well as European FM/TV stations. Price \*£3.58 each

**TTL DATA BOOK**  
DIC 75 Now complete Data book of 74 series TTL (7400-74132). Covering 13 main manufacturers in the U.S.A. and Europe, this book gives full data as well as equivalents. Price \*£3.74 each  
A full range of technical books available on request.



Postage and Packing add 25p unless otherwise shown.  
Add extra for airmail. £1 minimum order.

# BI-PAK

P.O. BOX 6, WARE, HERTS  
Everyday Electronics, June 1976



# SEMI-CONDUCTORS

## Linear IC's

Type	Quantities	Type	Quantities	Type	Quantities
	1 25 100+		1 25 100+		1 25 100+
72702	0-46 0-44 0-42	SL701C	0-46 0-42 0-37	76003	£1-39 £1-34 £1-30
72709	0-23 0-21 0-19	SL702C	0-46 0-42 0-37	76023	£1-39 £1-34 £1-30
72709P	0-19 0-18 0-17	TAA263	0-74 0-65 0-56	76660	0-88 0-86 0-83
72710	0-32 0-31 0-28	TAA293	0-93 0-88 0-83	LM380	0-93 0-90 0-88
72741	0-28 0-27 0-26	TAA350£1-71	£1-67 £1-57	*NE555	0-45 0-43 0-40
72741C	0-26 0-25 0-24	µA703C	0-26 0-24 0-22	*NE556	0-88 0-86 0-83
72741P	0-28 0-27 0-26	µA709C	0-19 0-18 0-17	TBA800£1-39	£1-34 £1-30
72747	0-79 0-74 0-61	µA711C	0-32 0-31 0-28	ZN414	£1-11 —
72748P	0-35 0-33 0-31	µA712C	0-32 0-31 0-28		
SL201C	0-46 0-42 0-37	µA723C	0-45 0-43 0-40		

## Untested LIN Paks

Manufacturers "Fall Outs" which include Functional and part Functional Units. These are classified as 'Out-of-spec' from the makers, very rigid specifications, but are ideal for learning about I.C.'s and experimental work.

**Untested Audio Paks**  
Comprising 5, I.C.'s:—  
76003/76023 series  
ULIC709 — 10 x 709 0-60 ONLY £1 per Pak  
ULIC710 — 7 x 710 0-60 Complete with data  
ULIC741 — 7 x 741 0-60 FM Stereo Decoder Pak  
ULIC747 — 5 x 747 0-60  
ULIC748 — 7 x 748 0-60  
Comprising 5, I.C.'s:—  
like MC1307 and SN 75110  
ONLY £1-50 per Pak  
Complete with data

## ★ 74 Series TTL IC's

BI-PAK STILL LOWEST IN PRICE. FULL SPECIFICATION GUARANTEED. ALL FAMOUS MANUFACTURERS

Type	Quantities	Type	Quantities	Type	Quantities
	1 25 100+		1 25 100+		1 25 100+
7400	0-10 0-09 0-08	7448	0-87 0-86 0-85	74122	0-52 0-51 0-50
7401	0-13 0-12 0-11	7450	0-13 0-12 0-11	74141	0-78 0-77 0-75
7402	0-12 0-12 0-11	7451	0-13 0-12 0-11	74145	0-88 0-84 0-81
7403	0-13 0-12 0-11	7453	0-13 0-12 0-11	74150	£1-37 £1-30 £1-20
7404	0-12 0-12 0-11	7454	0-13 0-12 0-11	74151	0-82 0-78 0-75
7405	0-12 0-12 0-11	7460	0-13 0-12 0-11	74153	0-82 0-78 0-75
7406	0-31 0-29 0-27	7470	0-30 0-27 0-25	74154	£1-57 £1-43 £1-48
7407	0-31 0-29 0-27	7472	0-30 0-27 0-25	74155	0-82 0-78 0-75
7408	0-17 0-15 0-13	7473	0-32 0-30 0-28	74156	0-82 0-78 0-75
7409	0-17 0-15 0-13	7474	0-34 0-31 0-29	74157	0-93 0-88 0-83
7410	0-10 0-09 0-08	7475	0-52 0-50 0-48	74160	£1-19 £1-12 £1-06
7411	0-23 0-22 0-21	7476	0-35 0-33 0-31	74161	£1-19 £1-12 £1-06
7412	0-25 0-24 0-23	7480	0-50 0-47 0-44	74162	£1-19 £1-12 £1-06
7413	0-30 0-29 0-28	7481	£1-02 0-97 0-93	74163	£1-19 £1-12 £1-06
7416	0-28 0-27 0-26	7482	0-83 0-78 0-74	74164	£1-37 £1-25 £1-19
7417	0-28 0-27 0-26	7483	£1-00 0-92 0-85	74165	£1-37 £1-25 £1-19
7420	0-12 0-12 0-11	7484	0-93 0-90 0-88	74166	£1-48 £1-37 £1-25
7422	0-28 0-27 0-26	7485	£1-25 £1-19 £1-12	74174	£1-25 £1-49 £1-12
7423	0-32 0-31 0-30	7486	0-32 0-31 0-30	74175	£1-02 0-97 0-93
7425	0-32 0-31 0-30	7489	£3-12 £2-81 £2-50	74176	£1-18 £1-11 £1-06
7426	0-32 0-31 0-30	7490	0-48 0-44 0-40	74177	£1-16 £1-11 £1-06
7427	0-32 0-31 0-30	7491	0-75 0-69 0-62	74180	£1-16 £1-11 £1-06
7428	0-42 0-39 0-37	7492	0-54 0-49 0-44	74181	£2-50 £2-38 £2-25
7430	0-13 0-12 0-11	7493	0-48 0-44 0-40	74182	£1-06 0-94 0-88
7432	0-31 0-30 0-29	7494	0-56 0-53 0-50	74184	£1-67 £1-62 £1-55
7433	0-31 0-30 0-29	7495	0-72 0-67 0-62	74190	£1-75 £1-63 £1-50
7437	0-31 0-30 0-29	7496	0-85 0-81 0-78	74191	£1-75 £1-63 £1-50
7438	0-31 0-30 0-29	74100	£1-25 £1-19 £1-13	74192	£1-37 £1-31 £1-25
7440	0-13 0-12 0-11	74104	0-38 0-34 0-31	74193	£1-37 £1-31 £1-25
7441	0-69 0-66 0-59	74105	0-38 0-34 0-31	74194	£1-20 £1-16 £1-11
7442	0-69 0-66 0-59	74107	0-38 0-34 0-31	74195	0-94 0-91 0-88
7443	£1-11 £1-06 £1-02	74109	0-56 0-51 0-46	74196	£1-11 £1-06 £1-02
7444	£1-11 £1-06 £1-02	74111	0-83 0-81 0-78	74197	£1-11 £1-06 £1-02
7445	0-94 0-89 0-85	74118	0-93 0-88 0-83	74198	£2-37 £2-31 £2-25
7446	£1-06 £1-03 £1-00	74119	£1-38 £1-30 £1-20	74199	£2-25 £2-18 £2-11
7447	0-85 0-84 0-82	74121	0-34 0-33 0-31	74123	0-69 0-68 0-65

Devices may be mixed to qualify for quantity price. (TTL 74 series only). Data is available for the above series of I.C.'s in booklet form. PRICE 35p.

## ★ DTL 930 Series

Type	Quantities	Type	Quantities	Type	Quantities
	1 25 100+		1 25 100+		1 25 100+
BP930	0-14 0-13 0-13	BP944	0-15 0-14 0-13	BP962	0-14 0-13 0-12
BP932	0-15 0-14 0-13	BP945	0-28 0-26 0-23	BP9683	0-42 0-40 0-38
BP933	0-15 0-14 0-13	BP946	0-14 0-13 0-12	74199A	0-42 0-40 0-38
BP935	0-15 0-14 0-13	BP948	0-28 0-26 0-23	BP9097	0-42 0-40 0-38
BP936	0-15 0-14 0-13	BP951	0-65 0-60 0-56	BP9099	0-42 0-40 0-38

## ★ DIL Sockets

BPSS 8 pin type (low cost)	1 25 100+
BPSS 8 pin type (low cost)	0-14 0-12 0-10
BPS14 14 pin type (low cost)	0-15 0-13 0-11
BPS16 16 pin type (low cost)	0-16 0-14 0-12
BPS24 24 pin type (low cost)	0-35 0-33 0-30

## ★ Voltage Regulators

TO-3 Plastic Encapsulation  
µA.7805/L129 5V (equiv. to MVR5V) £1-25  
µA.7812/L130 12V (equiv. to MVR12V) £1-25  
µA.7815/L131 15V (equiv. to MVR15V) £1-25  
µA.7818 18V (equiv. to MVR18V) £1-25

POW POWER!!!

R.C.A. 2N5295 NPN to 3 Plastic Power VCE 50v. VCB 60v. P 36w. Ic 4A hFE 30-120 ONLY £1-50\* for 10

## ★ Untested TTL Paks

=Pak No.	Contents	Price	Pak No.	Contents	Price
=UIC00	12 x 7400	0-60	UIC70	8 x 7470	0-60
=UIC01	12 x 7401	0-60	UIC72	8 x 7472	0-60
=UIC02	12 x 7402	0-60	UIC73	8 x 7473	0-60
=UIC03	12 x 7403	0-60	UIC74	8 x 7474	0-60
=UIC04	12 x 7407	0-60	UIC75	8 x 7475	0-60
=UIC05	12 x 7405	0-60	UIC76	8 x 7476	0-60
=UIC06	8 x 7406	0-60	UIC80	5 x 7480	0-60
=UIC07	8 x 7407	0-60	UIC81	5 x 7481	0-60
=UIC10	12 x 7410	0-60	UIC82	5 x 7482	0-60
=UIC13	8 x 7413	0-60	UIC83	5 x 7483	0-60
=UIC20	12 x 7420	0-60	UIC86	5 x 7486	0-60
=UIC30	12 x 7430	0-60	UIC90	5 x 7490	0-60
=UIC40	12 x 7440	0-60	UIC91	5 x 7491	0-60
=UIC41	5 x 7441	0-60	UIC92	5 x 7492	0-60
=UIC42	5 x 7442	0-60	UIC93	5 x 7493	0-60
=UIC43	5 x 7443	0-60	UIC94	5 x 7494	0-60
=UIC44	5 x 7444	0-60	UIC95	5 x 7495	0-60
=UIC45	5 x 7445	0-60	UIC96	5 x 7496	0-60
=UIC46	5 x 7446	0-60	UIC100	5 x 74100	0-60
=UIC47	5 x 7447	0-60	UIC121	5 x 74121	0-60
=UIC48	5 x 7448	0-60	UIC141	5 x 74141	0-60
=UIC50	12 x 7450	0-60	UIC151	5 x 74151	0-60
=UIC51	12 x 7451	0-60	UIC154	5 x 74154	0-60
=UIC53	12 x 7453	0-60	UIC193	5 x 74193	0-60
=UIC54	12 x 7454	0-60	UIC199	5 x 74199	0-60
=UIC60	12 x 7460	0-60	UIC XI 25 Assorted		

VAT  
PLEASE ADD 8% TO ITEMS MARKED ★ REMAINDER ADD 12½%

# BI-PAK

P.O. BOX 6, WARE · HERTS

# everyday electronics

PROJECTS..  
THEORY.....

## TAKE A TRAY ...

There are dreams and then there are realities. No matter how far we get carried away with the one, we have eventually to wake up and face the other. For instance, it is of course very nice to have a workshop for one's own use. A room or garden shed where one can retreat and concentrate entirely on one's hobby.

A separate workshop or workroom gives privacy and allows one to depart at any time, leaving things just as they are in the confident knowledge that they will remain so until the owner's return. And a workroom will accommodate all the equipment the average electronics constructor is ever likely to require, without crowding but laid out for maximum convenience.

But the fact is, this ideal kind of arrangement is just not possible for many people, perhaps the greater proportion of those who enjoy working with electronics in their leisure hours. Alternative arrangements have to be made in the majority of households, where the luxury of exclusive premises for one member of the family to indulge his or her favourite pastime is entirely out of the question.

Fortunately electronics is itself very accommodating. Demands for storage space can be minimal. A useful stock of components can be contained within a shoe box, while the essential tools will not fill another. Add a multimeter, and the basic stock-in-trade of a home constructor is all accounted for. As for working area, any flat surface will serve as a bench.

*Our July issue will be published on Friday, June 18*

*See page 321 for details.*

So never postpone actual construction activities until the ideal situation materialises. Find a quiet corner in any room, take a seat, place a tray (wood or plastic) on the knees and work can commence.

Newcomers should note that this informal, comfortable posture is adopted as normal procedure by quite seasoned constructors (and not infrequently by choice). All normal circuit assembly work can be performed in this homely fashion. If you prefer to sit at the table, a tray is still a good idea; apart from protecting the table top it means one can readily pick it up and carry away all bits and pieces at a moment's notice. Beating a hasty retreat is one manoeuvre the family constructor must be prepared for!

Our message is therefore this: nothing need deter the beginner from getting started. Though we can all dream about a wonderful well-equipped workshop of our own, there's no need at all to hold back until that dream materialises. Start in the modest way we have described and enjoy the fun and the practical achievements which come from being immersed in table top (or tea tray) technology.

P.S. Oh, do mind where you put that soldering iron. An oven tin will make a suitable and safe depository.



EDITOR F. E. Bennett ● ASSISTANT EDITOR M. Kenward ● TECHNICAL EDITOR B. W. Terrell B.Sc.  
ART EDITOR J. D. Pountney ● P. A. Loates ● K. A. Woodruff  
ADVERTISEMENT MANAGER D. W. B. Tilleard ● P. Mew

© IPC Magazines Limited 1976. Copyright in all drawings, photographs, and articles published in EVERYDAY ELECTRONICS is fully protected, and reproduction or imitations in whole or part are expressly forbidden.

All reasonable precautions are taken by EVERYDAY ELECTRONICS to ensure that the advice and data given to readers are reliable. We cannot, however, guarantee it, and we cannot accept legal responsibility for it. Prices quoted are those current as we go to press.

Editorial Department: Everyday Electronics, Fleetway House, Farringdon Street, London EC4 4AD. Phone 01-634 4452.

Advertisement Department: Everyday Electronics Advertisements, King's Reach Tower, Stamford Street, London SE1 9LS. Phone 01-261 5148.

**EASY TO CONSTRUCT  
SIMPLY EXPLAINED**



VOL. 5 NO. 6

JUNE 1976

## CONSTRUCTIONAL PROJECTS

<b>WAA WAA PEDAL</b> <i>Inexpensive musical effects unit</i> by B. W. Terrell	306
<b>ENLARGER METER</b> <i>For the amateur photographer</i> by A. P. Donleavy	311
<b>PEAK LEVEL INDICATOR</b> <i>Stereo instrument to show overload</i> by R. A. Shackelford	329
<b>CONTINUITY TESTER</b> <i>Simple unit with audible output</i> by R. A. Penfold	335

## GENERAL FEATURES

<b>EDITORIAL</b>	304
<b>TEACH-IN 76</b> <i>Part 9, Biasing</i> by A. P. Stephenson	314
<b>FOR YOUR ENTERTAINMENT</b> <i>Cassette Tape Production</i> by Adrian Hope	319
<b>YOUR CAREER IN ELECTRONICS</b> <i>The Electronic Instrument Industry</i> by Peter Verwig	322
<b>I.C.s EXPLAINED</b> <i>Part 2</i> by Brian Dance	325
<b>COUNTER INTELLIGENCE</b> <i>A retailer comments</i> by Paul Young	332
<b>PHYSICS IS FUN</b> <i>An inexpensive motor</i> by Derrick Davies	334
<b>PROFESSOR ERNEST EVERSURE</b> <i>The Extraordinary Experiments of.</i> By Anthony J. Bassett	338
<b>BRIGHT IDEAS</b> <i>Reader's constructional hints</i>	340
<b>PLEASE TAKE NOTE</b>	340
<b>DOWN TO EARTH</b> <i>Relaxation Oscillators</i> by George Hylton	343
<b>SHOP TALK</b> <i>Component buying</i> by Mike Kenward	344

## BACK NUMBERS, LETTERS AND BINDERS

We are unable to supply back copies of *Everyday Electronics* or reprints of articles and cannot undertake to answer readers' letters requesting designs, modifications or information on commercial equipment or subjects not published by us. An s.a.e. should be enclosed for a personal reply. Letters concerning published articles should be addressed to: The Editor, those concerning advertisements to: The Advertisement Manager, at the addresses shown opposite.

Binders for volumes 1 to 5 (state which) are available for £2-10, including postage, from Binding Department, Carlton House, Great Queen Street, London, WC2E 9PR.

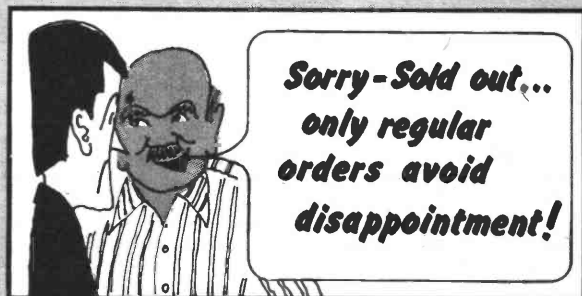

**T**HE waa waa sound effect has been around for many years, mostly on the pop music scene. Recently, its popularity has been revived and can be heard more and more in film and television film themes and scores. Although suitable for use with many electric and electronic musical instruments, it is used chiefly by the lead guitarist.

The sound produced by the waa waa pedal is very pleasant to listen to and "easy on the ear" and can be used to inject a wide variety of feeling into music, ranging from tranquillity to excitement and tension depending on the manner in which it is used.

To produce the required effect, a certain amount of skill and foot control is called for. This should be accomplished after a few hours of practice.

Although many waa waa pedals are commercially available, they are found to be quite expensive, in the order of £15 and upwards; a large part of this cost is probably attributable to the case and pedal mechanism.

This article describes how to make a complete waa waa pedal at a very low relative cost and whose performance is comparable with many commercial units.

### CIRCUIT DIAGRAM

The complete circuit diagram of the Waa Waa Pedal is shown in Fig. 1. Use is made of the versatile integrated circuit type 741. This is a differential operational amplifier and is operated in the inverting mode with frequency dependent negative feedback formed by the bridged-T

network consisting of R2, C2, C3, VR1 and R3.

For the moment ignore the T-circuit C2, C3, VR1 and R3; it can be shown that the gain of the amplifier is given by the ratio R2/R1. The effect of the T-network is to modify the "value" of the feedback resistor, R2.

It can be shown that the *effective* feedback resistor "peaks" at a frequency determined by the value of (VR1 + R3) for constant C2 and C3. Thus the frequency response curve of the amplifier is as shown in Fig. 2. By varying VR1, the peak can be moved along the frequency axis. This movement of the peak to-and-fro produces the waa waa sound effect.

The Q of the circuit (a measure of the sharpness of the peak) is a function of C1 and R1 and the values shown have been chosen to give the effect desired by the author. Readers may wish to experiment with these values to tailor the unit to their exact requirements.

A graphic consisting of two rows of the word 'WAA' in a large, bold, wavy, and textured font. The letters are filled with a halftone dot pattern, giving them a vibrating or 'waa' appearance.

# PEDAL

By **B. W. TERRELL** B.Sc.



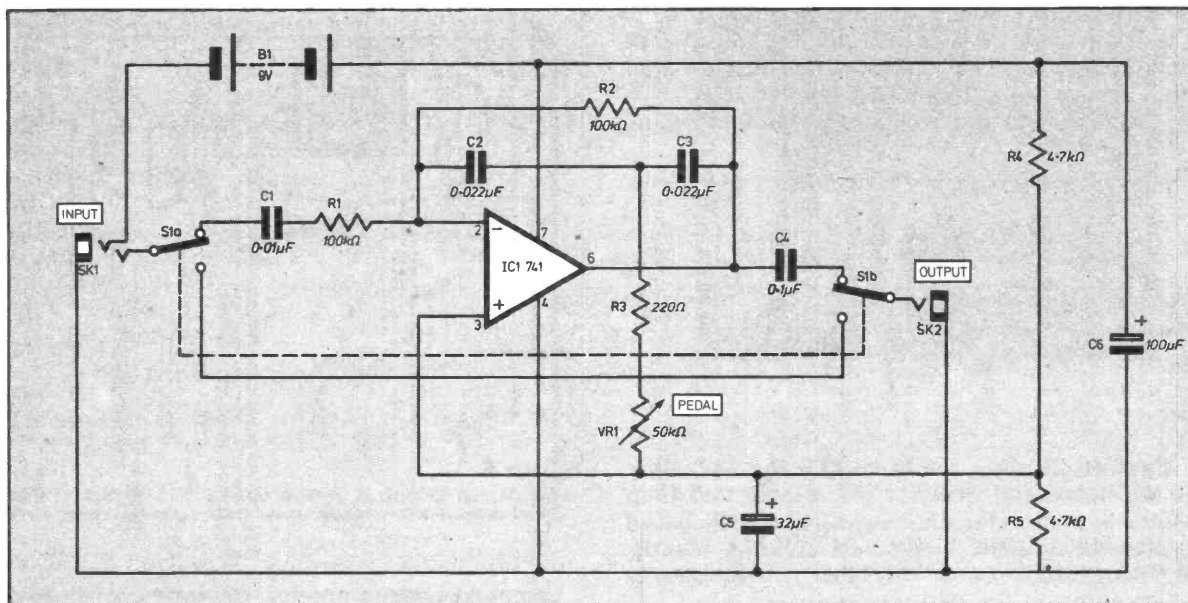

Fig. 1. The complete circuit diagram of the Waa Waa Pedal.

It has been arranged that the unit is switched on when the lead connecting the unit to the instrument is plugged into the Waa Waa Pedal. This is common practice for many guitar effects units and ensures that the unit is only switched on when in use.

As the unit will be situated on the floor, and the effect will need to be switched in and out instantly without the player removing his hands from the instrument, a push type successional action switch has been incorporated which is operated by pressing the pedal fully down. Operation of the switch causes the signal from the instrument to enter the electronic circuitry, or bypass it.

### COMPONENT BOARD

In the prototype, the circuit was constructed on a piece of 0.1 inch matrix Veroboard; the

layout is shown in Fig. 3 and is not critical and may be changed to suit components available.

It is recommended that an integrated circuit holder be used for IC1 to eliminate any thermal damage that could result from the hot soldering iron; also replacement is then an easy matter should it be necessary.

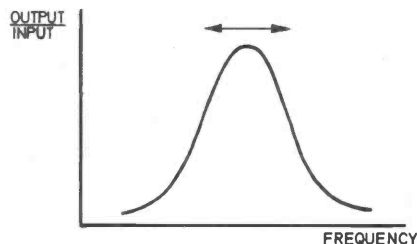
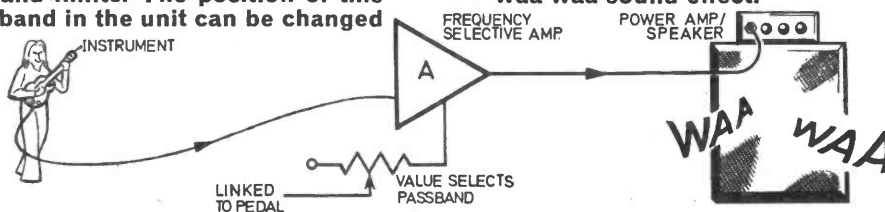

Fig. 2. Frequency response of the frequency selective amplifier. By moving the peak to and fro, the waa waa sound is produced.

### HOW IT WORKS

Basically the Waa Waa Pedal is an amplifier but it only amplifies signals with frequencies within a fairly narrow band and attenuates signals with frequencies outside this band, the amount of attenuation increasing with the distance from the band limits. The position of this frequency band in the unit can be changed

by varying a single component—the potentiometer which is mechanically linked to the pedal. Moving the pedal causes the band to sweep up and down, and when the signals from an electric guitar, for example, are injected, produces the familiar waa waa sound effect.



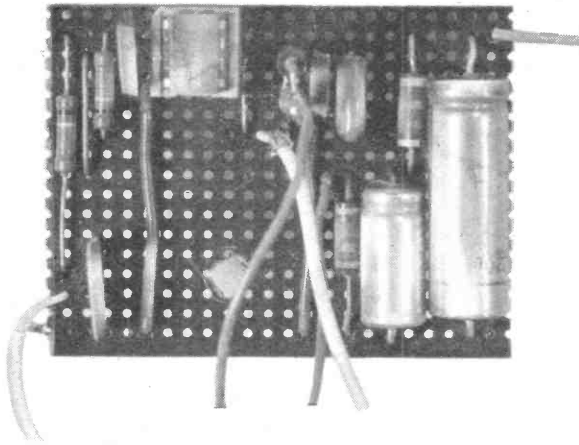

First of all make the breaks on the underside of the board and drill the fixing hole and then assemble and solder the components to the board as depicted in Fig. 3. Connect suitable lengths of flying lead to reach the other components to be mounted in the case (refer to Fig. 4).

### PEDAL, CASE AND LINKAGES

The pedal and case of the prototype were made from plywood and chipboard to the sizes shown in Fig. 4 which also shows the positioning of the board and other components within the case. The prototype case was nailed and

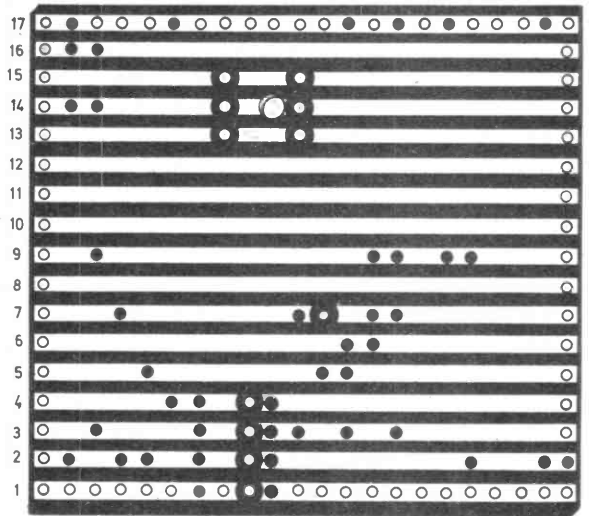
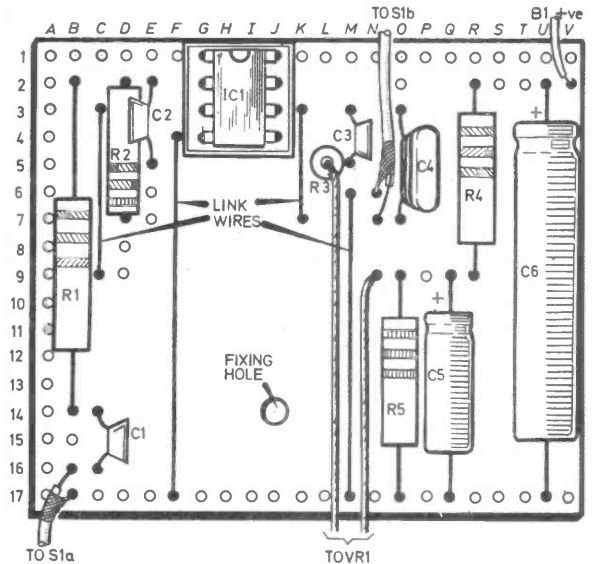

Fig. 3. The layout of the components on the topside of the Veroboard and the breaks to be made on the underside. Top left shows prototype board.

glued together using 15mm long panel pins and Evo Stik Resin W. All corners and edges were later rounded off as can be seen in the photograph.

When the case has been fabricated, the cut-outs and holes should be made in the sloping

## Components....

### Resistors

- R1 100k $\Omega$
- R2 100k $\Omega$
- R3 220 $\Omega$
- R4 4.7k $\Omega$
- R5 4.7k $\Omega$
- All  $\frac{1}{4}$  watt  $\pm 10\%$

TALK SHOP SEE

### Capacitors

- C1 0.01  $\mu$ F ceramic
- C2 0.022  $\mu$ F ceramic
- C3 0.022  $\mu$ F ceramic
- C4 0.1  $\mu$ F C280
- C5 32  $\mu$ F 6V elect.
- C6 220  $\mu$ F 10V elect.

### Integrated Circuit

- IC1 741 differential operational amplifier, 8-pin d.i.l.

### Miscellaneous

- S1 d.p.d.t. successional action footswitch type 81158
- SK1 jack socket R26/1 or stereo type to provide switch
- SK2 standard jack socket
- VR1 50k $\Omega$  lin. carbon
- B1 9V type PP3
- Veroboard: 0.1 inch matrix 17 strips x 22 holes; 8 pin d.i.l. holder for IC1;  $\frac{1}{4}$  inch brass spindle coupler; PP3 battery connector; Meccano parts and fixings.

FOR GUIDANCE ONLY

**ESTIMATED COST\***  
OF COMPONENTS  
excluding V.A.T.

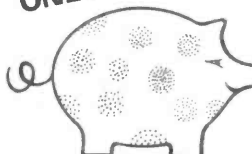

**£2.70**  
excluding case

\*Based on prices prevailing at time of going to press

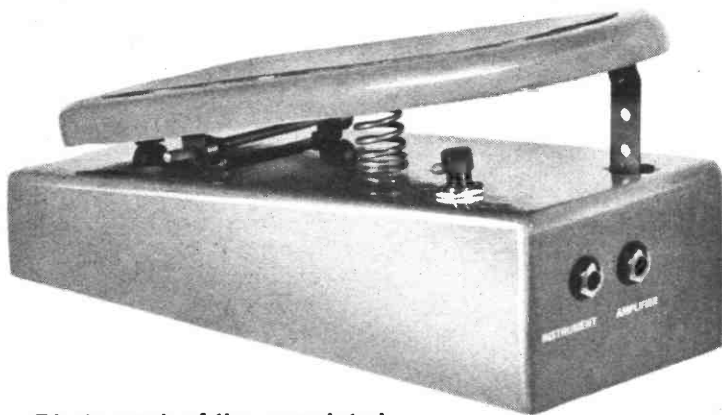

WAA  
WAA

# PEDAL

Photograph of the completed prototype unit.

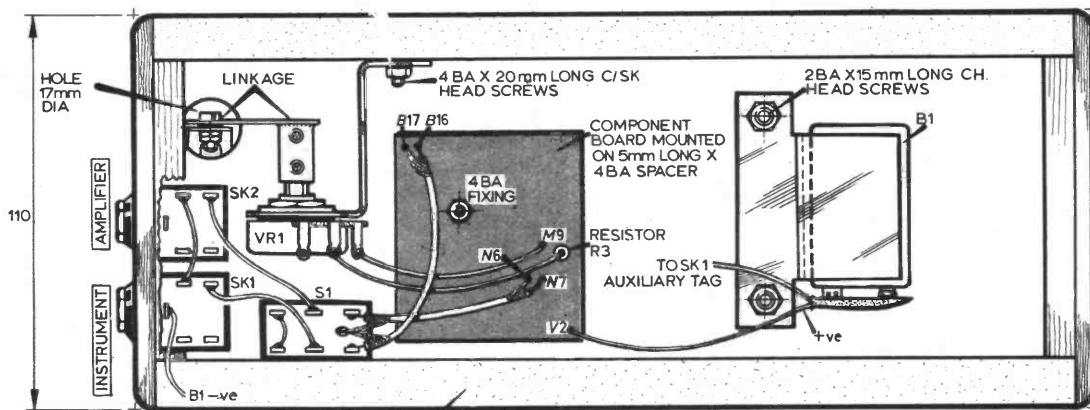
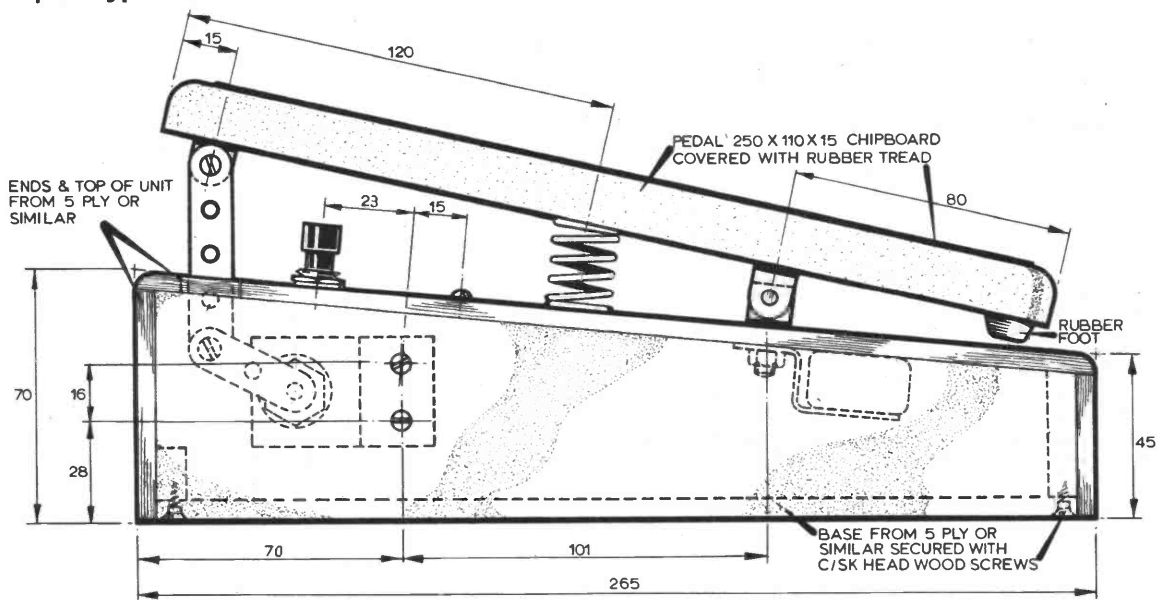

SIDES FROM 15mm CHIPBOARD

UNDERSIDE VIEW OF UNIT WITH BASE REMOVED

ALL DIMENSIONS IN mm

Fig. 4. The construction of the case and pedal, and complete wiring up details between components and component board.

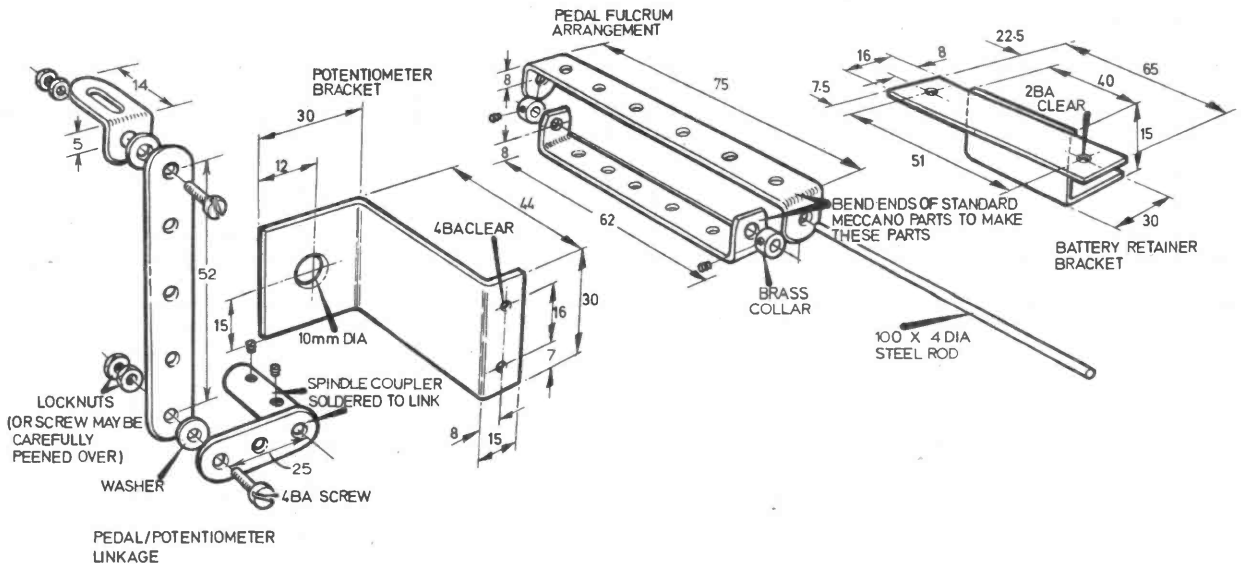

**Fig. 5. Constructional details of the pedal linkage and pivot and a suitable bracket for holding a PP3 type battery.**

panel to accommodate the pivot bracket fixings, switch S1, the linkage to VR1, and the component board fixing bolt. Next the aluminium bracket for securing VR1 should be made and fitted in position. The bolts fixing this to the side of the case should be countersunk types for a neater finish.

Meccano parts have been used to produce the linkage and pivot, and details of these are given in Fig. 5. It is not essential to use Meccano parts as steel or brass plate will do just as well. Aluminium is not recommended. For the linkage, bolt or rivet the straight sections together and solder a brass spindle coupler to the shorter length making sure that the grub screws/holes on the coupler are aligned as shown.

## ASSEMBLY

Screw the upper part of the pivot to the underside of the pedal and assemble the pivot as shown in Fig. 5. Secure the top bracket of the linkage to the underside of the pedal and the rubber foot at the heel of the pedal and then secure the pedal to the case.

Next wire the potentiometer VR1 to the component board and secure both in place. Fix the coupler to the potentiometer spindle such that the grub screw makes contact with the flat on the spindle. Next bolt the linkage to the bracket on the underside of the pedal and insert the spring in position.

Slacken off the potentiometer fixing nut and rotate the potentiometer clockwise as far as it will go and secure in this position. Finally fit the other components and wire up as shown in Fig. 4.

A bracket can be made to hold the battery, see Fig. 5, or it can be held in place with Blu-Tak or similar, as used in the prototype.

## TESTING AND FINISHING OFF

The Waa Waa Pedal should be positioned between the instrument (electric guitar or organ etc) and the amplifier, so an extra screened lead is called for.

On playing the instrument and operating the pedal simultaneously, the waa waa effect should be heard. If not, it may be because the footswitch S1 is in the bypass position. The pedal should be pressed fully down until the switch is heard to operate. Simultaneous playing and pedal movement should produce the effect.

For increased performance at the treble end of the sound, resistor R3 should be reduced in value until the required effect is produced. If the unit "hisses", resistor R3 should be increased until the hiss just disappears.

When using the pedal, do not press too hard on the down strokes otherwise the switch will be caused to operate.

To finish off, the unit should be dismantled and the wooden parts "rubbed down" and "filled in" and given a coat of undercoat paint, and when thoroughly dry, a couple of coats of gloss paint. In the prototype the Meccano parts were smoothed and given a coat of matt black spray to produce a more professional finish.

A piece of rubber matting glued to the top face of the pedal will provide a non-slip surface for the foot. Rubber feet can be screwed to the underside of the completed unit to prevent it slipping about when in use, if this should prove necessary.

It is a good idea to label the jack sockets "Instrument" and "Amplifier" as shown in the photograph. Letraset or the more easily obtainable Magic Letters are ideal. □



# ENLARGER METER

By **A. P. DONLEAVY**

**Helps you to produce perfect enlargements every time.**

**T**his Enlarger Meter is designed to eliminate the need for test strips in determining the exposure time required for making an enlargement. The instrument has a range of approximately four to 40 seconds, which should cover most needs in the amateur's darkroom.

## THE CIRCUIT

The circuit of the instrument is shown in Fig. 1. The 741 operational amplifier is connected without any feedback so it amplifies the voltage between its input terminals (pins 2 and 3) about 200,000 times. Any small voltage difference between the input terminals greater than a few millivolts will therefore cause the output to swing to either zero volts or 9 volts, i.e. the voltage limits determined by the supply voltage.

A potential divider is formed by resistor R3 and light dependent resistor PCC1. The voltage at the junction of these components depends on the resistance of PCC1 which in turn is dependent on the amount of light incident on its face.

Varying the position of the wiper of VR1 will bring the voltage at pin 3 of IC1 equal to that at pin 2. At this point the light emitting diode (D1) will go from on, to off, or vice versa. By using a calibrated scale on the potentiometer VR1, the on/off position can be used as a measure of the amount of light falling on the light dependent resistor.



The unit is powered by a 9 volt PP3 battery which should be replaced when the supply voltage drops to 6 volts.

## HOW IT WORKS

The resistance of the photocell varies with the light falling on it. Potentiometer VR1 is used to set the voltage at point A equal to that point B, the point of equality being determined using the comparator with its light emitting diode indicator. When slight adjustment of VR1 causes the l.e.d. to go on and off the balance point has been reached.

The setting of VR1 is noted and the required exposure time is read off a graph.

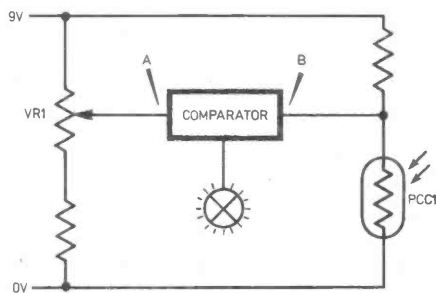

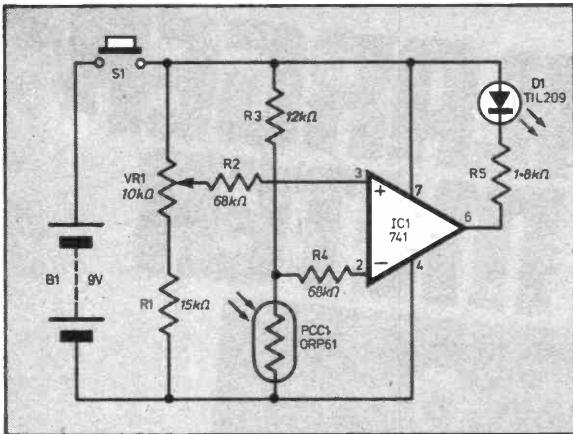

Fig. 1. The complete circuit diagram of the Enlarger Meter unit.

## COMPONENTS

The 741 operational amplifier used in the prototype came in an 8-pin dual-in-line package whose pin connections are shown in Fig. 2. Operational amplifiers type 741 are also available in 14-pin dual-in-line and 8-pin TO5 packages. Pin connections for these are also shown in Fig. 2. There is room on the board for any of these types.

If the l.d.r. specified cannot be obtained, other types may be used although some adjustment of the values of R1 and R3 may be needed.

The on/off switch is a push-to-make type and is depressed only when taking a reading. This eliminates the possibility of leaving the instrument on and wasting the battery.

## CONSTRUCTION

The unit was built in a diecast aluminium box measuring 110 x 60 x 30mm approximately. The integrated circuit and resistors were mounted on a piece of 0.1in matrix Veroboard as shown in Fig. 3. The interwiring and the layout of the components within the box are shown in Fig. 4.

The Veroboard is supported by a single bolt with a nut either side of the board to clamp it. The l.d.r. protrudes through the face of the instrument and can be secured with glue.

**FOR GUIDANCE ONLY**

**ESTIMATED COST\***  
OF COMPONENTS  
excluding V.A.T.

**£1.45**  
excluding case

\*Based on prices prevailing at time of going to press



## Components....

### Resistors

R1	15kΩ
R2	68kΩ
R3	12kΩ
R4	68kΩ
R5	1.8kΩ
All ± 5% ¼W carbon	

### Semiconductors

IC1	Type 741 integrated circuit (8-pin)
D1	TIL209 light emitting diode
PCC1	ORP61 or similar light dependent resistor

### Miscellaneous

VR1	10kΩ lin. carbon potentiometer
S1	s.p.s.t. push-to-make, release-to-break pushbutton
B1	9V PP3 battery
Veroboard 0.1in. matrix, 17 holes × 11 strips; scaled knob; connecting wire; case; PP3 battery connector	

**TOTAL  
TALK  
SHOP**  
SEE

The layout is by no means critical and can be altered to suit available boxes.

## USING THE INSTRUMENT

The most simple way to calibrate the unit is as follows. Place the Enlarger Meter on the baseboard of the enlarger and select an unexposed part of the negative, e.g. the strip between exposures, for the light to shine through on to PCC1.

Adjust VR1 until the on/off point of the light emitting diode is reached. The l.d.r. takes a couple of seconds to fully respond to the light so do not rush any reading.

Note the scale reading on the knob.

Use the usual method of test strips to determine the correct exposure time of the rest of the negative.

Repeat the procedure for several different values of light intensity, noting the scale reading of VR1 and corresponding exposure time. Construct a graph of these readings, an example of which is shown in Fig. 5.

A different exposure time/scale reading graph must be constructed for each different type of printing paper. The exposure time for any print is then obtained by using the device as described to measure the light value and then reading the correct exposure time on the graph.

Alternatively, if only one type of printing paper is used, use a pointer knob instead of a scaled knob and print the exposure times directly onto the unit.

The instrument is most useful for normally exposed negatives; under-exposed or over-exposed negatives will need some alteration to the exposure time as read from the graph.

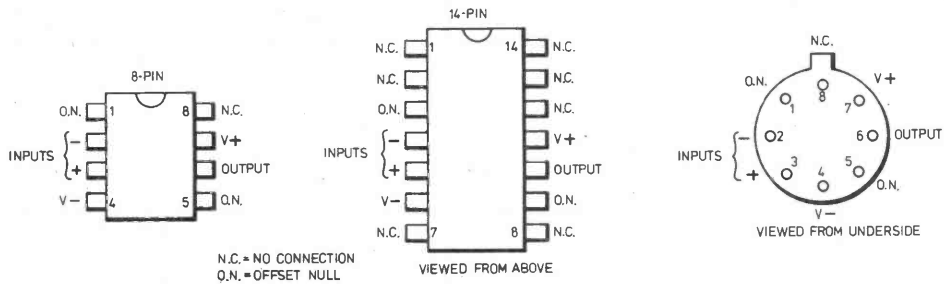

**Fig. 2. Details of the various package-types of 741 available. Shown below left is the l.e.d. type TIL 209 showing cathode lead.**

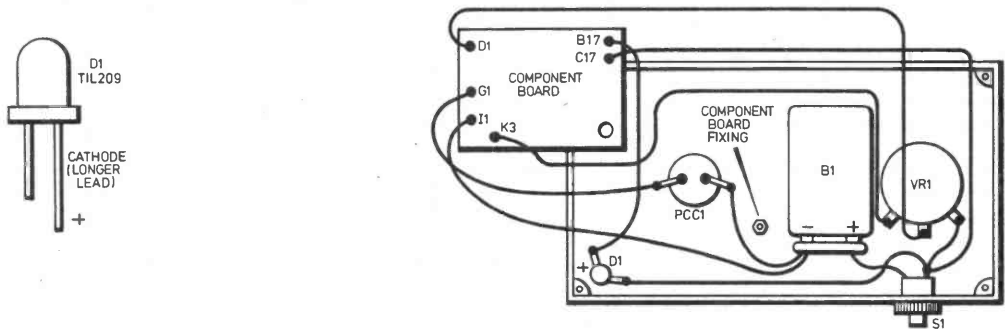

**Fig. 4. Positions of the components within the case and complete wiring up details.**

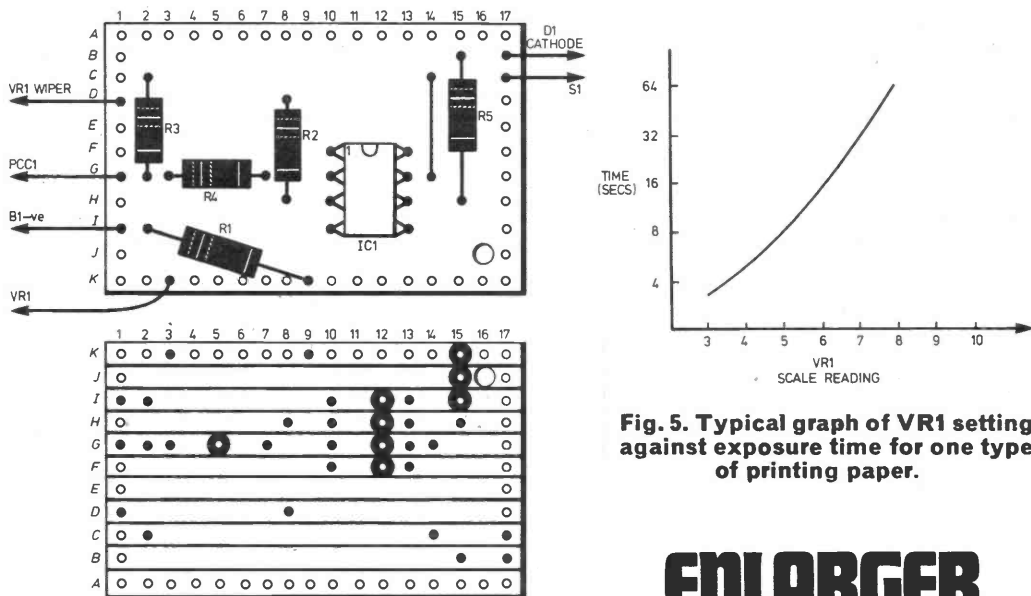

**Fig. 3. The layout of the components on the Veroboard and the breaks to be made on the underside.**

**Fig. 5. Typical graph of VR1 setting against exposure time for one type of printing paper.**

**ENLARGER  
METER**

# TEACH=IN 76

By A.P. STEPHENSON

## Part Nine

### 9.1 METHODS OF BIASING

#### Current bias with emitter stabilisation

The extra resistor  $R_e$  in Fig. 9.1a, helps to compensate for  $h_{FE}$  variations. Suppose  $h_{FE}$  happens to be higher than predicted, then  $I_c$  would tend to rise which would cause the voltage drop across  $R_e$  to rise, i.e. the emitter becomes more positive with respect to ground. But this tends to reduce the forward bias on the base and would tend to lower  $I_c$ . The tendency for  $I_c$  to rise is therefore strongly checked by  $R_e$ .

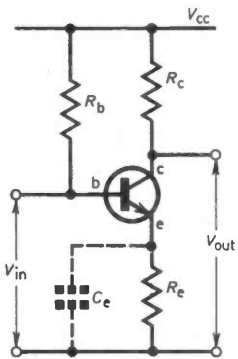

Fig. 9.1a. Current bias with emitter stabilisation.

#### Design procedure

"Waste" about 1 volt across  $R_e$  and let  $R_c$  drop half of the remaining volts. The voltage between base and ground must therefore be 1.6 volts which leaves  $(V_{cc}-1.6)$  volts across  $R_b$ .

#### Example

Again let us choose a 9 volt battery collector current ( $I_c$ ) of 1 milliamp. Then  $R_e=1$  volt/emitter current, but since the base current is negligible we may say that emitter and collector current are almost the same, so  $R_c=1$  volt/1 milliamp=1 kilohm. Similarly,  $R_c=4$  volts/1 milliamp=4 kilohms and  $R_b=7.4$  volts/ $I_b$  which if again we assume  $h_{FE}=200$ , then  $I_b=5$  microamps and  $R_b=\frac{7.4V}{5\mu A}=1.48$  megohms.

This is a much better bias method than that in



Fig. 8.5 last month but there are two snags (i) The signal gain  $A$  is less because of the compensating action of  $R_e$  which you may remember is used to reduce changes in  $I_c$ . This is called **negative feedback** and will be discussed later. A large capacitor (shown dotted) will reduce feedback and restore the gain without deterioration of bias stability (ii) The output signal swing is less because of the voltage wasted across  $R_e$ .

#### Collector to base feedback bias

Collector to base feedback bias, shown in Fig. 9.1b, is very simple and very popular and provides good bias stability. To understand this assume that  $h_{FE}$  was higher than predicted (which would cause a higher  $I_c$ ). The voltage drop across  $R_c$  however would cause the collector voltage to fall and because of the feedback via  $R_b$ , would drag the base down

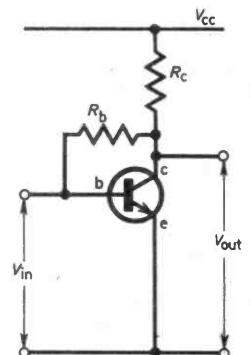

Fig. 9.1b. Simple amplifying circuit using collector to base feedback bias.

which would lower  $I_c$ . The effect of  $R_b$  is therefore beneficial, i.e. the output terminal remains at reasonably constant volts in spite of wide variations in  $h_{FE}$ . The gain  $A$  is not reduced to any great extent but the  $R_{in}$  is reduced which is not a good thing.

#### Design procedure

Assume a 9 volt supply, an  $I_c$  of 1 milliamp and an  $h_{FE}$  equal to 200. Then  $R_c = 4.5V/1mA = 4.5$  kilohms. Base current,  $I_b = 1mA/200 = 5$  microamps. The bottom end of  $R_b = 0.6$  volts to ground while the top end is 4.5 volts to ground. Therefore the voltage drop across  $R_b$  must be  $(4.5 - 0.6)V = 3.9V$ . This makes  $R_b = 3.9V/5\mu A = 0.78$  megohms or 780 kilohms.

#### Voltage divider bias

The voltage divider bias arrangement is a more complex biasing system than any of the previous circuits. It is however considered in the "trade" to be the Rolls Royce version because of its exceptional stability;  $R_e$  has the same function as described earlier. The voltage divider  $R_1$ ,  $R_2$  is calculated to tap off the required voltage to the base.

#### Design procedure

Assume again  $I_c = 1mA$ ,  $h_{FE} = 200$  and the supply is 9 volts. Waste 1 volt across  $R_e$ , which means  $R_e = 1V/1mA = 1$  kilohm. This leaves 8 volts, half of which should appear across  $R_c$  which makes  $R_c = 4V/1mA = 4$  kilohms.

The base takes  $I_c/h_{FE} = 5\mu A$  and must be 1.6

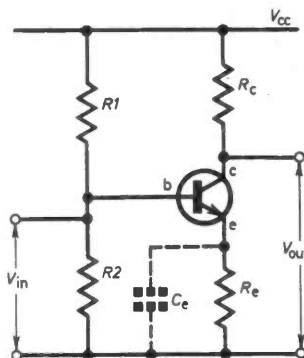

Fig. 9. 1c. Circuit using potential divide bias.

volts above ground, i.e.  $R_2$  drops 1.6 volts and by Kirchoff,  $R_1$  must drop  $(9 - 1.6)$  volts = 7.4 volts. Voltage dividers obey a simple rule—they should draw a steady current, much larger than the current delivered at the tap.

Since the base requires 5 microamps, the current down  $R_1$ ,  $R_2$  should be say 50 microamps. This would mean  $R_2 = 1.6V/50\mu A = 32$  kilohms and  $R_1 = 7.4V/55\mu A = 135$  kilohms; (the extra  $5\mu A$  is due to the base current flowing via  $R_2$ ).

The only criticism levelled against such a circuit is the effect on  $R_{in}$  which is lowered by the additional resistor  $R_2$  across the signal.

## 9.2 COUPLING BETWEEN STAGES

If the required gain or the right output resistance cannot be achieved with single transistor stage, then two or more stages can be coupled together. There are problems of course, we just can't design two separate stages and then simply connect them with a piece of wire because this may upset the bias conditions. We shall investigate three ways of coupling as shown in Figs. 9.2a b & c.

#### Capacitor coupling

A capacitor has the rather valuable property of blocking steady currents (d.c.) but allowing varying signal currents to "pass through". This means we can design the bias resistors for each stage separately and then use the capacitor to couple the output of stage 1 to the input of stage 2.

The value of the capacitor depends on two things, the value of stage 2  $R_{in}$ , and the lowest signal frequency which the system is designed to amplify.

The exact value is unimportant providing it is not less than the value given by the equation:

$$C = \frac{1}{2\pi f R_{in}}$$

where  $f$  is the lowest frequency (which may be taken as 50Hz for audio amplifiers),  $R_{in}$  is in megohms, and  $C$  is in microfarads.

This comes to over 3 microfarads if  $R_{in}$  is 1 kilohm and  $f$  is 50Hz which means an electrolytic capacitor is called for. This is an opportunity to warn that the polarity of such capacitors must be observed. The positive terminal must be on the stage 1 side if the transistors are npn.

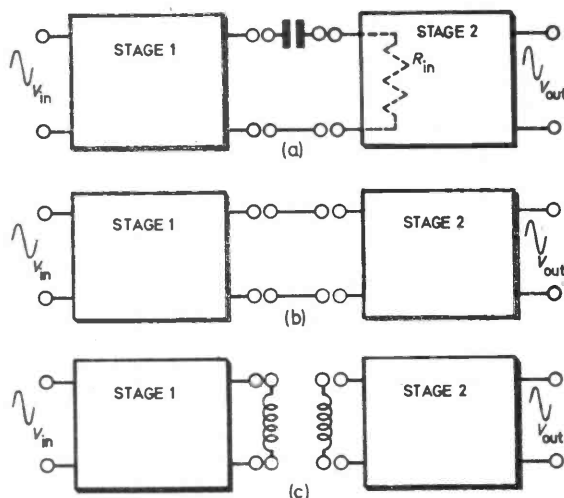

Fig. 9. 2a, b and c. The three most common means of coupling between stages.

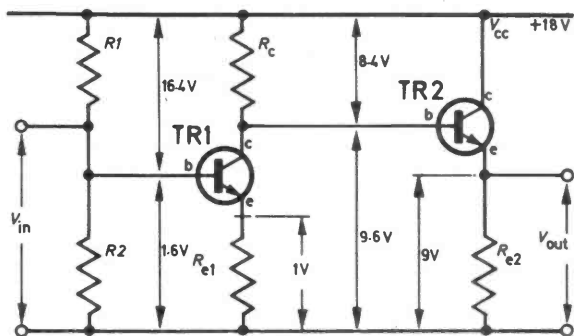

Fig. 9.2d. An example of a two-stage circuit using direct coupling between the stages.

### Direct or d.c. coupling

Direct coupling is the most efficient, but demands that stage 2 is designed first and stage 1 is designed such that a direct connection provides the correct bias to stage 2. Shown in Fig. 9.2d is a circuit of a common emitter amplifier with high gain, d.c. coupled to a common collector buffer stage which although not contributing any further gain, delivers an output with very low  $R_{out}$ , i.e. it can deliver a larger current.

### Transformer coupling

We will deal with transformer theory later in the series. It is sufficient at this point to accept that current in the left hand coil, called the *primary* induces a signal current into the right hand coil, called the *secondary*.

Since the two coils are electrically isolated the two stages can be independently biased as in capacitive coupling.

## 9.3 THE DARLINGTON PAIR

A Darlington pair is a two transistor hook up which gives a very high current gain and although widely used in many branches of electronics it is convenient to introduce it during this discussion on power amplifiers, see Fig. 9.3a.

The emitter current of TR1 is  $h_{FE}$  times the input base current and the emitter current of TR2 is yet another  $h_{FE}$  times as much as its base. The total gain of the configuration is  $h_{FE1} \times h_{FE2}$  which indicates the behaviour is that of a single transistor with a very high current gain.

For example, two BC107's in a Darlington pair would have an apparent  $h_{FE}$  of about 40,000 (if we take their separate  $h_{FE}$  as around 200).

Such a circuit would greatly improve a simple

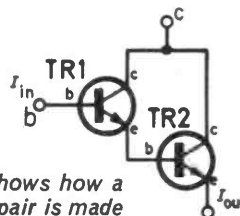

Fig. 9.3a. Shows how a Darlington pair is made up.

class A power output stage because the required signal current to drive the base would be greatly reduced; but TR2 could be a high power massive transistor but TR1 could be a more humble variety. Darlington pairs are available as single three pin devices.

## 9.4 CLASS B POWER OUTPUT STAGES

As previously described, output current flows for half of the input cycle in class B stages. To ensure recovery of the other half we can use two transistors, one of them upside down as in Fig. 9.4a.

The circuit is described as **complementary push pull**, *complementary* because a *pnp* and an *nnp* are used in series with each other and *push pull* because one of the transistors is pulling upwards towards the positive supply and the other is pushing downwards towards the negative supply.

In the absence of a signal, the two bases are dead in the middle at zero volts or earth, and because there is no bias network, both transistors are non-conducting and the power to the speaker is zero, (contrast this with the wasteful class A system).

When the signal goes upwards, past the 0.6V point, TR1 conducts via the  $+V_{cc}$  line and the speaker to earth. When the signal goes downwards, below

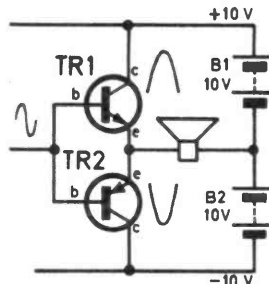

Fig. 9.4a. A class B output stage.

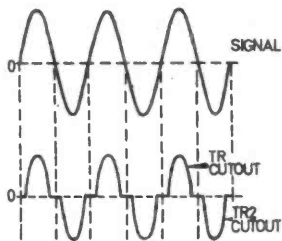

Fig. 9.4b. Input and output wave forms for the circuit of Fig. 9.4a.

the  $-0.6\text{V}$  point, TR2 conducts via the  $-V_{cc}$  line and the speaker to earth. The current waveform through the speaker is thus almost the same shape as the signal.

Why almost? Because for the first  $0.6$  volts of the signal sweep nothing happens! The distortion called **crossover distortion** which this causes is shown in Fig. 9.4b and is worse on low level signals because the  $0.6\text{V}$  is a greater fraction of the signal.

Cross-over distortion can be cured by providing a small forward bias to each transistor, just enough to bring the two transistors to the slightly conducting state in the absence of a signal. The whole of the signal sweep is then transformed to a current replica through the speaker.

For ease of description, the circuit has used two power supplies with "earth" brought out to the middle. There is no necessity for this and an equally useful circuit could be drawn with one battery (but of double the voltage) as in Fig. 9.4c. This circuit also illustrates Darlington's, a method of obtaining the slight forward bias mentioned above, and a driver stage to provide a good voltage swing.

The signal is applied to the base of TR1 which is a grounded emitter stage providing voltage amplification and operating in class A. As the collector is driven up and down it takes the bases of Darlington's with it and large signal currents flow through the speaker via the electrolytic capacitor C1.

Why is C1 necessary? Without it, a heavy d.c. current would flow through the speaker (even without a signal) which would be absolutely in contradiction to the principles of class B—and in addition would probably burn out the speech coil. A large capacitor

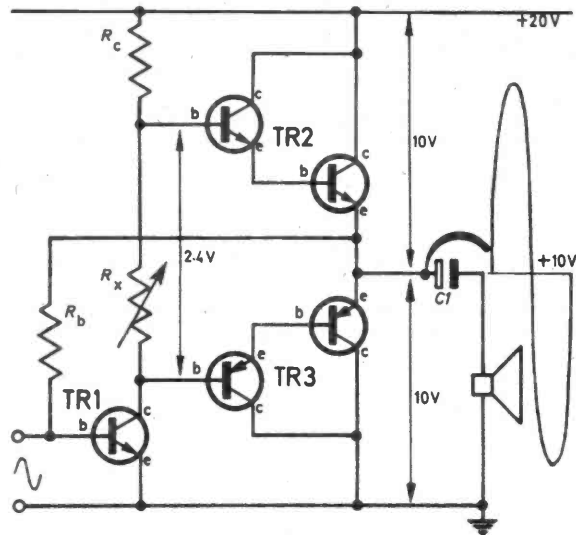

Fig. 9.4c. A class B output stage using complementary Darlington transistors. Note that crossover distortion has been eliminated.

is able to pass the varying signal currents which "ride" above and below the  $+10$  volt level but completely blocks steady d.c.

The current through TR1 (via  $R_x$  and  $R_c$ ) produces a voltage drop across  $R_x$  which is adjustable to a value of about  $2.4$  volts. This can be justified by noting that the "transistors" marked TR2 and TR3 are each Darlington's and require  $1.2$  volts each to bring them to full conduction. In practice,  $R_x$  is adjusted to allow a few milliamps in the output transistors under zero signal conditions in order to overcome cross-over distortion.

The bias resistor  $R_b$  is not (as you might expect) taken to  $V_{cc}$  because this would be simple current bias which we have already criticised. Instead it is fed from the centre point of the output transistors which is  $+10$  volts to ground.

Since TR1 causes the signal to be inverted, and the output transistors are of "common emitter" form, the amplified signal is fed back to the first stage in a direction which opposes the input signal, a system called **d.c. negative feedback**. The advantage is stability! The centre point of the output is under strong persuasion to remain at the centre.

## TEACH-IN '76 EXERCISES

### EXPERIMENT 9A

To show the very high current gain of a Darlington pair.

#### PROCEDURE

Assemble the components on the Circuit Deck as shown in Fig. 9A.1. Moisten the fingers and thumb of each hand and grasp the bare ends of the wires X, Y. The lamp should glow.

Everyday Electronics, June 1976

### CONCLUSIONS

The small current which managed to crawl through your skin (in parallel with veins, arteries and muscles etc.) was sufficient to "turn on" the Darlington pair and light the lamp.

A very rough estimate of the current gain can be made by comparing the output current through the lamp with the input current (through your body).

First estimate the input current by calculating the

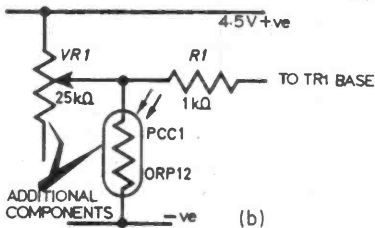
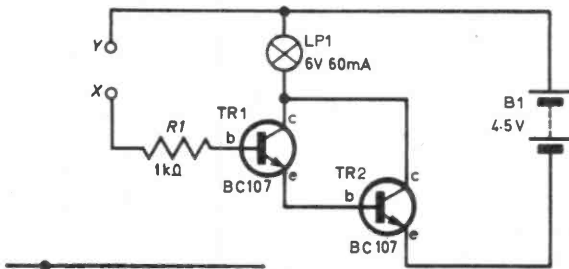
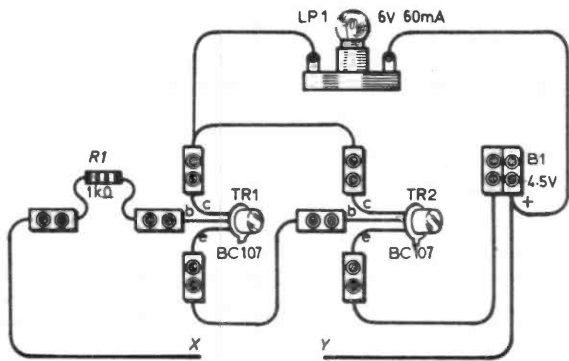

Fig. 9A.1. The layout of the components on the Circuit Deck and circuit diagram for experiment 9A. Also shown is new input circuit for part two of the experiment.

voltage across you. This will be  $(4.5 - 0.6 - 0.6)V = 3.3V$ ; it is unnecessary to calculate the volts drop across  $R_1$  because it would be negligible.

The resistance of your body will vary with emotions, how tightly you clasp the wires and how much spit you used to moisten the fingers. In the author's case a figure of around 300 kilohms was measured by a light touch across the prods of an ohmmeter. Taking this figure, the input current is  $3.3V/300K\Omega = 11$  microamps.

The output current through the lamp will not be the rated 60mA because we are only using 4.5 volts instead of 6V. Also the lamp is virtually in series with the voltage drop across TR2 which we will take as 1 volt. This allows 3.5 volts across the lamp instead of 6V so by simple proportion, the output current is  $60 \times 3.5/6 = 35mA$ .

This circuit is therefore giving a current gain of  $35mA/11\mu A$ , which in round figures is three thousand! Before dismantling the circuit perform these additional experiments.

1. Place the wire ends in a glass of tap water. In most districts, the lamp will glow, indicating the presence of conductive salts etc. (Pure water is a perfect insulator unless ionised).
2. Rearrange the input circuit as shown in Fig.9A.1

using the 25 kilohm potentiometer and the light dependent resistor ORP12.

Adjust the potentiometer until in normal room lighting the lamp is just off. Hold the hand over the ORP12 to shade it and the lamp should come on.

### Theory

The potentiometer and the ORP12 form a voltage divider feeding the base of TR1. In strong lighting the "bottom" resistor (ORP12) is a low resistance round about 1 kilohm or so which pulls the base down.

In shade, the ORP12 is very high resistance, perhaps a megohm or more so the base springs up via the potentiometer and turns on the lamp.

## EXPERIMENT 9B

To investigate common emitter stage with voltage divider bias.

### PROCEDURE

Assemble the circuit as shown in Fig. 9B.1 with VR1 initially set fully anticlockwise, i.e. slider at bottom.

Fix the voltmeter (on 10V range) to monitor  $V_{out}$  which should be reading 9 volts because there is as yet no collector current to produce a voltage drop across  $R_c$ .

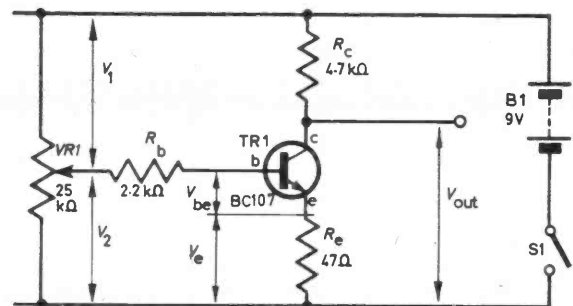
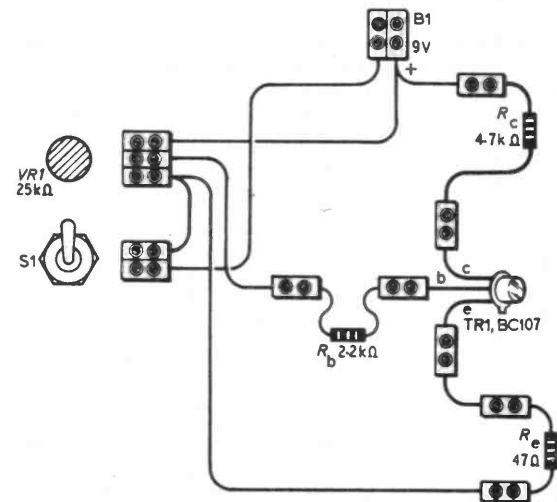

Fig 9B.2. The layout of the components on the Circuit Deck and theoretical circuit diagram for experiment 9B.



Very slowly, advance VR1 until  $V_{out}$  starts to fall, but stop when it has reached 4.5 volts. The circuit is now in its delicate class A "half way down" condition.

- (a) Calculate collector current:  $I_c = 4.5V / 4.7k\Omega = 1mA$
- (b) Measure  $V_o$  which should be  $1mA \times 47\Omega = 0.05V$
- (c) Measure  $V_{be}$  which should be the usual 0.6 to 0.7V
- (d) Measure  $V_2$  which should be  $(V_{be} + V_o) = 0.65$  to 0.75V
- (e) Measure  $V_1$  which should be  $(9 - V_{be}) = 8.35V$

Reconnect the meter to measure  $V_{out}$  again and swing the potentiometer control a small way either side. Note the output voltage swings violently, and in the opposite direction to  $V_2$  (which may be considered the input signal change).

From this we conclude the common emitter stage has high voltage gain and *inverts* the signal, i.e. 180 degrees phase shift.

Repeat this series of experiments again, and again with the following changes. Check the revised measurements and calculations. First use 220 $\Omega$  instead of 47 $\Omega$  for  $R_o$ . Secondly use 2.2k $\Omega$  for  $R_o$ .

Thirdly, repeat every step, again using an 18 volt battery supply.

From all these results, you may conclude that:

(a) The higher you make  $R_o$ , the less touchy is the bias control, but the lower is the voltage gain, i.e. the output voltage does not respond so violently to twists of the bias control.

(b) Once the output has fallen to "rock bottom" further increases of the control knob have little effect.

**Don't leave the control knob in the fully clockwise state for any length of time particularly when using 18 volts.**

Repeat the first steps again using your *pnp* transistor (BC177) but remember to reverse your battery connections so that the negative supply is at the top line in the theoretical circuit

## EXERCISES

9.1. If the coupling capacitor between two stages is a higher value than it need be, what is the effect?

9.2. Study the circuit in Fig. 9.2d in which direction would the output voltage move if, (a)  $R_{o2}$  increased in value (b)  $R_o$  increased in value (c)  $R_1$  increased in value.

(d) What is the voltage gain of TR2.

(e) Using a capacitor only, how can the overall gain of the circuit be increased?

9.3. In the circuit of Fig. 9.3a, with zero signal, calculate the voltages as follows:

- (a) Voltage across  $R_b$ .
- (b) Voltage at TR1 collector to ground.
- (c) Voltage across  $R_c$ .

## Answers

9.1. Nothing very much. 9.2 (a) Towards  $V_{oc}$  (b) Towards  $V_{oc}$  (c) A little less than 1 (d) Towards  $V_{oc}$  (e) Placing it in parallel with  $R_{o1}$ . 9.3 (a) 9.4 volts (b) 8.8 volts (c) 8.8 volts

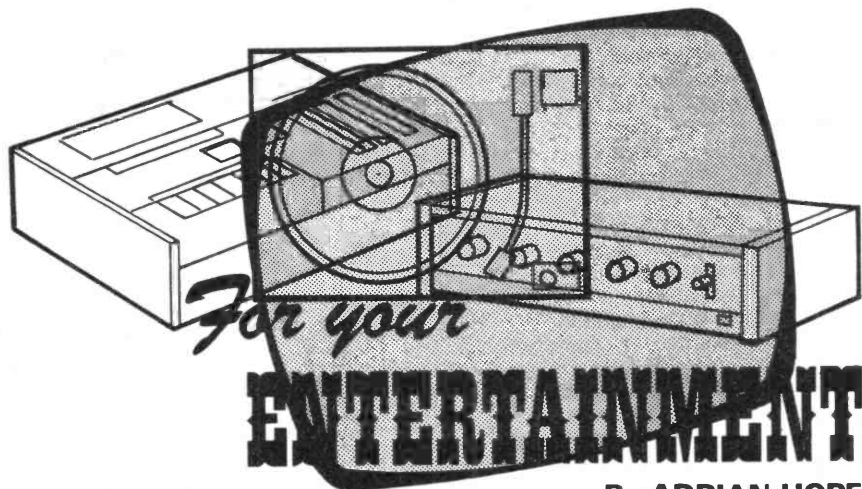

By ADRIAN HOPE

At times like these, when cash is short, it is only natural to look for economies. But in the audio and electronics field they are often false. Recently I got "caught" buying an imitation replacement stylus for a gramophone pickup; although I saved

several pounds on the normal price I ended up with a stylus which produced a sound so awful that it would have offended Walter Gabriel. It is especially easy to be caught out buying tape cassettes as some of these are now being sold at very tempting prices.

## CASSETTES

The guiding principle is, as always, that you can't get something for nothing. To understand why some cassettes can be sold much cheaper than others, you need to understand what goes into the making of a cassette, and how corners can be cut, at the expense of performance and, above all, reliability. Remember that even if a cassette behaves well to begin with, it is much worse than useless if it jams, tangles and destroys a treasured recording later on. Recently BASF took the hitherto unprecedented step of showing me round the normally secret tape testing and research areas of their manufacturing plant at Willstätt, Germany. Frankly, a great deal of what I saw and learned came as a complete surprise.

For instance, on average the whole factory has a 20 per cent wastage rate; so for every £100 worth of raw materials, only £80 worth end up as saleable finished product. The other £20 goes down

the drain, because there is no recycling possible.

All recording tape, 3.81mm (0.15 inch) cassette tape included, is made by slitting a massive role or "block" of 62cm-wide tape. The base material of this tape is plastics film, which is twelve microns thick for a C-60 cassette, eight microns thick for a C-90 and only six microns thick for a C-120. The C-120 material is so flimsy that it is impossible to roll accurately, and the original uncoated blocks look, frankly, awful, with creases clearly evident. These, however, usually disappear during subsequent stages of manufacture such as coating; but they don't always disappear and BASF reckon to throw away a great deal of finished C-120 material because it just isn't up to standard.

## COATING

Coating the tape with magnetic oxide is anything but as simple as it sounds. In theory, all you do is mix iron or chrome oxide with a binder and solvent and then spread it on the wide tape as it runs past a slit. But in practice you need to add lubricant if the finished tape is to run smoothly, and you also need to spread at ridiculously thin levels—a 4.5 micron thickness will soon be the standard for both C-60 and C-90 tape. Only a few years ago a 15 micron thickness was considered to be the minimum possible with reliability; but now a C-120 carries only three microns, and a one micron layer can be spread if necessary, in a double-layer tape.

This would all be fairly straightforward, once the basic machine and system were designed, if the raw materials could always be relied on to be exactly the same. Unfortunately they can't. The chemical nature of the binder, oxide and film all vary from batch to batch. In a perfect world anything substandard would be rejected. But that would mean closing down the production line. So instead chemical cookery is resorted to and the coating mix is altered to suit the individual batch characteristics of the raw materials available, so that the end product not only coats smoothly but, perhaps even more important, won't strip or dust off, even if the tape is stretched.

One BASF test, to check oxide shedding, involves weighing a cassette, running it for 75 hours non-

stop, and weighing it again. The total oxide loss as dust should be only 1,000th the coating weight, mostly from the edges. Another test involves stretching tape to breaking point to see whether the coating peels off.

The edges of the tape are extremely important. If the cutting knives are deformed even slightly, then the tape will be of the wrong thickness and jam in the cassette or at least cause wow on a recording. If the knives are blunt the edges will curl over or deform, with similar disastrous results. Television microscope and photocell systems are used to check the cut edges of sample lengths of tape.

## TESTING

A magnetometer linked to a computer analyses the electro-acoustic characteristics of samples taken from each batch. Batch samples are also measured for curling, cupping and straightness by standard DIN tests, and tape lengths are run through an electronic playback machine to check that the number of noticeable drop-outs in 80 milliseconds does not exceed the acceptable limit of six. Perhaps most important of all, a sample from each batch of tape manufactured is preserved, along with all the related test data, so that there can be a permanent guide to overall consistency of production over the years.

All these tests, and many more, are run *during* production and before the quality control checks on the finished article. These duplicate the previous tests along with a few others.

In essence, there is a degree of competition involved between the engineers at all stages, with the production engineers constantly trying to ensure that quality control find nothing to complain about. But inevitably they do, because although production checks are only on representative batches, QC does some tests on every single cassette. For instance, as *each* finished cassette comes off the production line it is checked mechanically on several counts on an automatic machine. Any cassette that is even minutely incorrect in size or has sticking tape is rejected.

Other QC tests are run on batches. One such test recommended by Philips but considered too drastic by some manufac-

turers, involves loading representative batches of finished cassettes into pneumatically controlled banks of cheap and cheerful recorders which are run through a fixed programme of rewind, play, stop, fast forward, and so on. The allowable failure rate is 5 per cent; but BASF aim to maintain a rate of 2 or 3 per cent.

BASF now readily acknowledge that in the early stages of cassette production they were driven to distraction trying to isolate all the different causes of faults in cassettes, especially jamming. But now they reckon that they have such a bank of experience that they can pin down more or less any fault to its cause, such as faulty coating, slitting, and so on. BASF also readily acknowledge that their cassettes, like those of any other firm taking production seriously, can't be cheap.

"Quality control is expensive and you can't compete in the low price market with high quality," I was told. I'm not saying I shall always buy BASF tape, but I shall certainly never buy cheap tape again.

One final word of warning. There is currently a Hong Kong firm offering to make cheap imitations of any household brand of tape to order, and already some of these copies have been marketed in the UK. Although the tape is atrocious, the boxes are got up to look like brand-name material. Some court injunctions have already been served, and others will doubtless follow. But such practices will always persist and in the final analysis it is the buyer who must beware.



While you were getting your tools, dear, I mended the radio with a knitting needle.

Everyday Electronics, June 1976

# Projects to build NEXT MONTH!

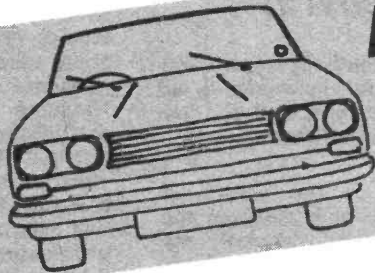

## AUTO-COOL...

Keep your car engine cool in hot weather and in traffic jams by fitting this easy to construct thermostatic unit.

## ACCENTED METRONOME...

An aid for the musician. Produces an audible "click" at preset tempo and can be set to emphasize the second, third or fourth beats in the bar.

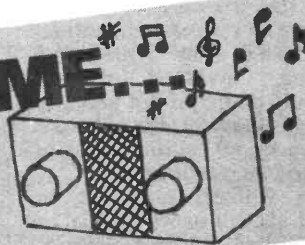

## RF/AF SIGNAL GENERATOR...

An invaluable piece of test equipment with a.f. modulated r.f. output. Extensive range from 0.3 to 30 megahertz.

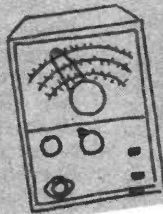

## AQUAGUARD...

A multi-purpose detector for many applications in the home laboratory, and afloat.

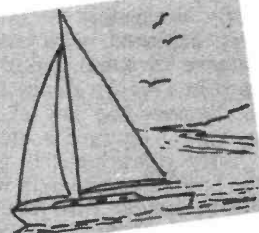

# everyday electronics

JULY ISSUE  
ON SALE FRIDAY,  
JUNE 18

IMPORTANT make  
sure of your copy,  
place an order now

# Your Career in **ELECTRONICS**

By Peter Verwig

## **THE ELECTRONIC INSTRUMENT INDUSTRY**

A career in electronics is an exciting prospect! Month by month our contributor Peter Verwig explains what working in electronics is all about, how to prepare yourself for a rewarding career, and the job opportunities available in the world's fastest growing industry.

**T**HE electronic instruments industry has its roots way back in the pre-electronics age when early experimenters, fascinated by electrical phenomena, invented devices which would detect, if not actually measure in quantity, the absence or presence of static electric charges and magnetic fields.

William Gilbert, physician to Queen Elizabeth I as well as being a distinguished natural philosopher, is generally credited as being the inventor of the first true electrical pointer instrument for electrical experiments, the electroscope, described in his famous book *De Magnete*, published in 1600.

### **MEASUREMENT**

Quantitative measurement, in which the forces between electrically charged bodies could be fairly accurately measured, was first achieved with the torsion balance invented about 1700 and used in 1771 by Henry Cavendish to discover the law of force between two charged bodies.

Fifty years later, in the 1820s, the first galvanometers were starting to appear with the great researchers of the day turning their attention to "fluid", as distinct from "static" electricity.

Precise measurement was essential to establish the laws of electricity which were still imperfectly understood. The advance of electrical knowledge was only as fast as the development of measuring apparatus enabling experimental scientists to confirm the speculations of theoreticians.

It was as late as the 1890's when, by use of a primitive form of the cathode ray tube, the great

controversy on the nature of electricity was finally resolved and it was proved beyond any reasonable doubt that the basis of all electrical phenomena was the negatively charged particle which today is called the electron.

The present century has seen an enormous explosion in the development of all forms of electrical and electronic instrumentation and a substantial industry in its own right has been built up to meet the ever-increasing demands of the general electrical, electronics and telecommunications industries.

Electronic measurement and control is also used in other industries as part of the automation process under the general heading of industrial electronics, and another great and fast-growing area is medical electronics which, itself, uses a great number of specialised electronic measurement instruments for diagnosis and patient monitoring.

We shall be discussing careers in industrial electronics and medical electronics in later articles. This month we shall confine ourselves to the field of test and measurement instruments which may be used for research and design, for production testing, and for maintenance.

### **MANY COMPANIES**

A large number of companies are involved in instrumentation and they range in size from small, often specialists, manufacturers employing perhaps only ten or a dozen people, to substantial enterprises of several hundreds, even thousands of people.

The instruments they make come in all shapes, sizes, functions

and accuracies, some being comparatively simple such as panel meters costing a few pounds to items like spectrum analysers which can cost thousands. Automatic test systems, generally incorporating a number of instrument functions and often controlled by a computer, can cost tens or even hundreds of thousands of pounds.

Some instrument companies, for example Marconi Instruments Ltd., are part of a large electronics group, in this case GEC, while others are completely independent. Some, in the United Kingdom, are branches of great multinational groups, and some are not in the mainstream of electronics at all, an example being the British Aircraft Corporation who manufacture automatic test equipment (ATE) for not only their own products like the BAC Rapier anti-aircraft missile system, but also for general use in the electronics industry.

You can still work on instruments without being in the instrument industry at all. Most large manufacturers of electronic equipment have a standards laboratory in which instruments used on production and test lines are regularly checked for accuracy and re-calibrated if necessary.

Similarly most large firms have a section or department, sometimes substantial in size, which designs and builds instruments or test systems for their own internal use. So if you have a special interest in instruments and the art of measurement you may still find an interesting career outside the instrument industry proper.

### **LOOKING BACK**

If we look back over twenty years we see how instrument design has revolutionised since the introduction of the transistor.

In the pre-transistor era the old vacuum tube (valve) technology demanded measurement in voltage ranges up to several hundred volts and current mainly in terms of milliamps. Such measurements could be made using moving coil pointer instruments with 1,000 ohms per volt sensitivity for voltage measurement without too much bother, and instruments of this type either singly or in multimeter form were regarded as industry standards.

*Everyday Electronics, June 1976*

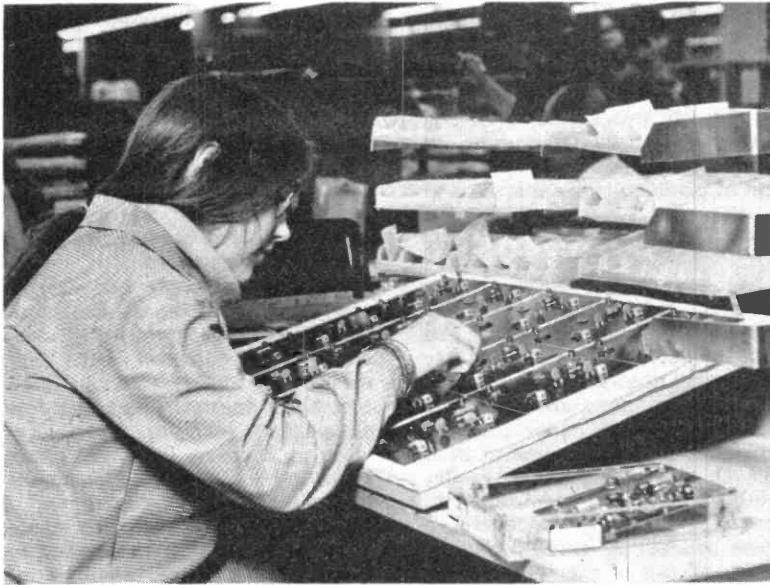

**Left. Printed circuit board assembly at Hewlett-Packard Ltd.**

**Below. The 3770A Amplitude/Delay Distortion Analyser, one of the British-designed and manufactured products from H-P.**

The transistor changed all that. What was now wanted was very high resistance to avoid loading the circuit during measurement and the ability to measure microvolts and microamps with good accuracy. One trend, therefore, has been in the direction of measuring smaller units with accuracy.

Another trend has been to move higher in frequency measurement, again with much better accuracy. Whereas years ago we used to think that a few tens of megahertz (MHz) was venturing almost into the unknown, today we measure gigahertz (GHz) with hardly a second thought. The examination of waveforms by oscilloscope has also made great advances and it is now possible to examine even very short transient waveforms in great detail.

There have been great surges forward in digital display instruments, in self-ranging instruments, in programable instruments and some of the more sophisticated instruments now coming to the market place incorporate microprocessors which give instruments the capacity to "think" and become "intelligent".

As the performance of instruments changed to meet the new challenges presented by solid-state electronics, so did the design of instruments which themselves soon switched away from vacuum tube technology to solid state. The design changes kept pace with and have frequently been in advance of general electronic developments, going through all the



stages from the use of discrete transistors to integrated circuits to LSI. Racal Instruments, for example, introduced last year a range of frequency meters based on a single LSI chip which incorporates 1,500 transistors and, as a single component, is claimed to eliminate some 5,000 discrete components which would otherwise be required.

The extensive use of solid-state components, now almost universal, has reduced instrument size and weight and has made it possible for a large number of instruments to be made fully portable, operating from internal batteries.

To be in the instrument business is to be at the frontiers of

electronic design if only because instrumentation has to be of higher accuracy and performance than the equipment to be calibrated, or otherwise tested.

## **HEWLETT-PACKARD**

We have chosen Hewlett-Packard Ltd. as our model company for describing a career in the instrument industry.

The history of H-P is a classical example of modern enterprise. The story starts in 1939 when two young and bright university graduates, Bill Hewlett and Dave Packard, decided to go-it-alone. Their first premises were the garage at Packard's home in California, their capital a borrowed

\$500 (£100 at 1939 exchange rates), their first product a new type of audio oscillator.

Today, H-P, still headed by Bill and Dave, has an annual turnover of more than \$1 billion (£500 million), over 3,400 different products, a world-wide payroll of more than 30,000 people, and manufacturing plants in the U.S.A., Brazil, France, West Germany, Japan, Malaysia, Singapore and the United Kingdom.

The historic product base of test and measuring instruments has been expanded to include medical electronics and analytical instrumentation and together these product categories represent 60 per cent of H-P's business. The remainder is mainly in electronic data products, a category which includes minicomputers and desk and pocket calculators.

H-P has always been a high technology company, concentrating on performance and quality rather than price. To keep ahead in technology, H-P employs 2,000 scientists and engineers on research and development (R and D) and last year's R and D expenditure was nearly \$90 million (£45 million).

## H-P IN THE U.K.

H-P is thus a multinational corporation producing world-class products for world-wide sale. In the United Kingdom, Hewlett-Packard Ltd. has its headquarters at Winnersh, near Wokingham, Berks., and a large manufacturing plant at South Queensferry, on the Firth of Forth, near Edinburgh. The Scottish plant currently employs some 700 people, and the administrative and marketing departments at Winnersh have 450.

In all but ultimate ownership the UK operation is British, with British management and British capital, operating profit being ploughed back into further expansion. But as well as being a British and European off-shoot of H-P Corporation, the UK H-P Ltd. is an important contributing operation both technically and economically to H-P on a world scale because it is the only design and manufacturing centre in H-P for telecommunications instrumentation.

The laboratories employ 80 engineers designing instruments for world-wide sale; this year's budget is £750,000. South Queensferry also manufactures all the home-

designed products and these account for 40 per cent of total production. The remaining production is mainly of H-P products like signal generators and frequency counters for sale in Europe. All together, some 85 per cent of production is exported.

## GETTING STARTED

As you may have already gathered, H-P Ltd. is a top-class company for top-class people. All sales engineers, for example, are university graduates who really know instrumentation and the customer's own measurement problems. The same applies to R and D staff. Technician grades joining young are encouraged to study for HNC. H-P is, in fact, a great believer in career development and one of the reasons why it is hard to get in is because very few people leave and consequently staff turnover is very low compared with most companies.

A young person joining as a technician might work his/her way up through testing to a production supervisor or, by the late twenties, be sufficiently experienced to move out to field service based on headquarters or one of the branch service centres.

How does H-P hold on to its staff? Certainly not by pay alone. H-P claim only to be competitive in salaries but there is a profit-sharing bonus which comes twice a year. The hold on staff seems to come more from job satisfaction and working conditions. There is

no distinction between people, everybody being on a monthly salary with no hourly or weekly-paid "workers".

At South Queensferry the working week is 39 hours on a Flexi-time system, people choosing their own starting time between 7.00 a.m. and 8.30 a.m. so that those who like to get home extra early can do so if they wish.

Self-motivation is encouraged and there is little of the soul-destroying repetitive work associated with conveyor belts and mass production. A skilled assembler doesn't solder in a few components and pass the instrument up the line. Far more likely to assemble the whole instrument taking up to 40 hours doing it.

Quality instruments are made in comparatively small batches so there are frequent changes of product which, itself, creates variety and interest.

Instrument manufacturers are not all like Hewlett-Packard. Many have different methods of work, different staff conditions, different product lines but nearly all have a lot in common. Except for manufacturers of the very cheapest instruments, most work on small-batch assembly principles which makes for variety. And all, to stay in business, need to strive technically for advances in performance and accuracy.

A career in instruments is a lively and fruitful occupation, is just entering a new phase of technical development so is full of interest and, in the long term, can be a career for life.

**Modern automatic test equipment (ATE) developed by GEC-Marconi Electronics for performance testing of Clansman military radio equipment. Note the programming tapes and keyboard control in the console on the right.**

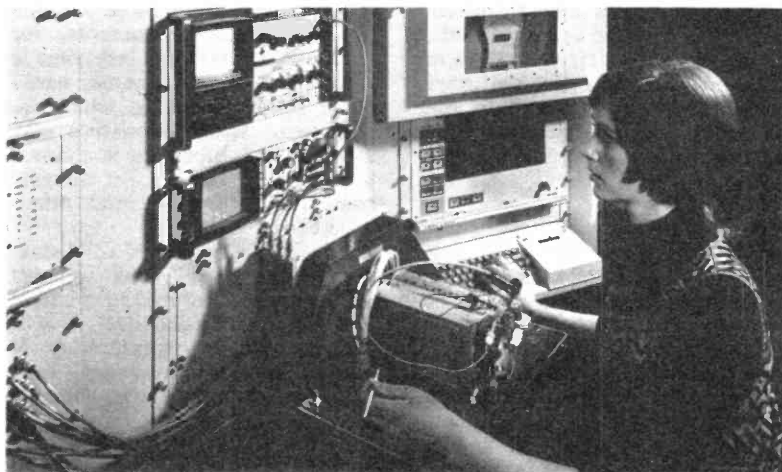

LAST month's article in this series, concluded with a section on packaging integrated circuits. We begin this second part on the same theme.

## DUAL-IN-LINE DEVICES

Circular metal can packages meet many of the requirements mentioned last month, but unfortunately they are not especially cheap and neither are they the most convenient form of package if one wishes to employ a socket.

Most of the more economical devices (such as those for consumer use) are sold in the well-known "dual-in-line" plastic packages; the connecting pins emerge from each side of the body of the device and are bent at right angles near to the body so as to form two lines of pins (see heading photo)—hence the name.

Dual-in-line devices can have any even number of pins, but 8, 14, 16, 18, 24 and 40 pin devices are some of the most common. Manufacturers generally use the minimum number of pins which is suitable for the particular application concerned.

Most dual-in-line devices have the same body width and pin spacing, but a few special types are not standard in this respect; for example, the new National Semiconductor LM379 dual power amplifier is wider than the normal dual-in-line type of device. Dual-in-line devices are sometimes known as DIP devices (dual-in-line package).

Plastic encapsulated devices are normally very reliable and develop few failures even over long periods when operated within their published characteristics. However, when the absolute optimum reliability is required over a much wider range of temperatures than those for which plastic encapsulated devices are designed, other more expensive types of encapsulation are employed.

For example, in aerospace applications the failure of a device operating at  $-50$  degrees Centigrade or above  $100$  degrees Centigrade in conditions of high humidity could result in loss of life.

Similarly, the failure of just one of the numerous integrated circuits in a computer could be extremely expensive owing to loss of computer time, repair costs, etc. Devices encapsulated in more expensive packages are therefore used for such applications.

The most reliable devices meeting military specifications include dual-in-line hermetically sealed ceramic packages with the chip enclosed in a cavity containing an inert gas. Glass to metal sealing is employed where each connection enters the cavity or alternatively the leads may be fired into the ceramic base. The lid is usually solder sealed at the top of the cavity.

In an attempt to reduce costs, the plastic cavity technique was evolved in which the chip



# I.C.'S EXPLAINED

## PART TWO

By BRIAN DANCE

is mounted on the floor of the cavity in a plastic body. Epoxy adhesives are used to seal the cavity, but may evolve some gas.

Almost all modern plastic encapsulated devices are manufactured by the solid transfer moulded system in which the chip is embedded in a suitable plastic body. No cavity is employed, but the chip is mounted on a backing plate.

### QUAD-IN-LINE

A variation of the dual-in-line package is the "quad-in-line" type which is also known as the "splayed dual-in-line" and the "staggered dual-in-line" type. This is very much like the dual-in-line package, but the tips of alternate pins on each side of the body are bent so that they are at different distances from the body. Thus one sees four lines of pins if one looks at the device from one end.

The quad-in-line package is used mainly by European manufacturers, but some types are available from manufacturers based in the U.S.A. They usually have 14, 16 or 18 pins and are normally found only in consumer products, such as power amplifiers, radio and television devices, etc.

The quad-in-line pin configuration provides a little more space than the dual-in-line when one wishes to solder the connections to the device.

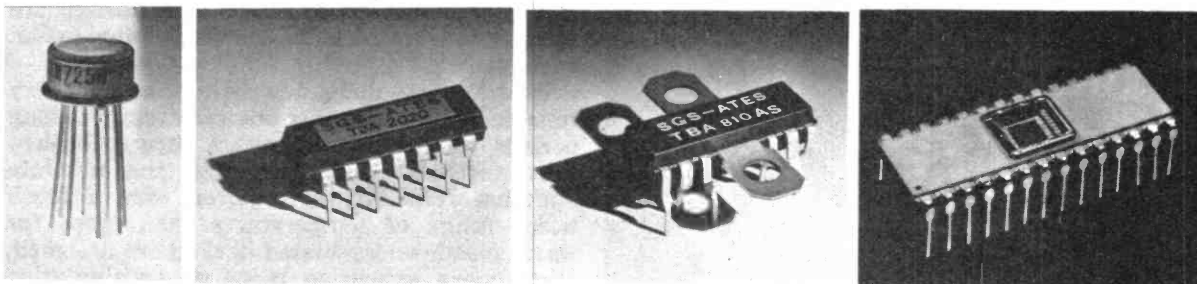

From left to right. The National Semiconductor LM725H operational amplifier in a circular metal can. The TDA2020 power amplifier which has a copper insert in its d.i.l. package for clamping to a heatsink. One of the SGS-ATES devices with cooling fins and quad-in-line configuration. A 28 pin ceramic d.i.l. package.

### FLATPACK

When a device must occupy the minimum amount of space, the "flatpack" type of encapsulation may be used. The resulting devices are very thin and are used in aerospace applications, in electronic wrist-watches, in computers, in spectacle-frame hearing aids, etc. Many flatpack devices are hermetically sealed and expensive; most amateurs therefore prefer to use other types of device.

### POWER PACKAGES

If an integrated circuit must be capable of dissipating a considerable amount of power, the standard dual-in-line encapsulation in its normal form is unsatisfactory. Some devices employ a

dual-in-line package, but have a copper inset in the back of the plastic body; the copper insert is clamped to a heat sink when the device is used. The new TDA2020 SGS-ATES 20W power amplifier employs this type of package.

Other types of power amplifier in a dual-in-line or quad-in-line package have a copper insert in the back of the plastic body, but the copper insert is permanently attached to a bracket which itself forms a heat sink, but which can be attached to a larger heat sink.

Another well-known type of device is the Sinclair "Super IC-12" which has a finned heat sink attached to the back of the plastic body; it is a 6W audio amplifier.

### FINDIP PACKAGES

Other devices have two small metal fins emerging from each side of the body of the device; a heat sink can be bolted to each fin.

The FINDIP package developed by SGS-ATES for their audio amplifiers has two fins which are each bent downwards so that they can be soldered into a suitable area of copper on a printed circuit board. The copper helps to dissipate the heat. This type of package is suitable for devices giving audio outputs of up to about 7W and is used in the TBA800 series of devices. A finned package with quad-in-line lead arrangement is shown below.

### TO-3

High power can be dissipated by fitting an integrated circuit into the well-known diamond shaped "TO-3" metal encapsulation which is much used for high power transistors. Such devices must, of course, be bolted to a suitable heat sink. This type of encapsulation is used for various types of voltage regulators.

### HIGH POWER PLASTIC

Various types of encapsulation employing a plastic body are now widely used for consumer devices where economy is most important. When there are relatively few connections, a rectangular plastic body may be fastened to a metal tab which is bolted to a suitable heat sink.



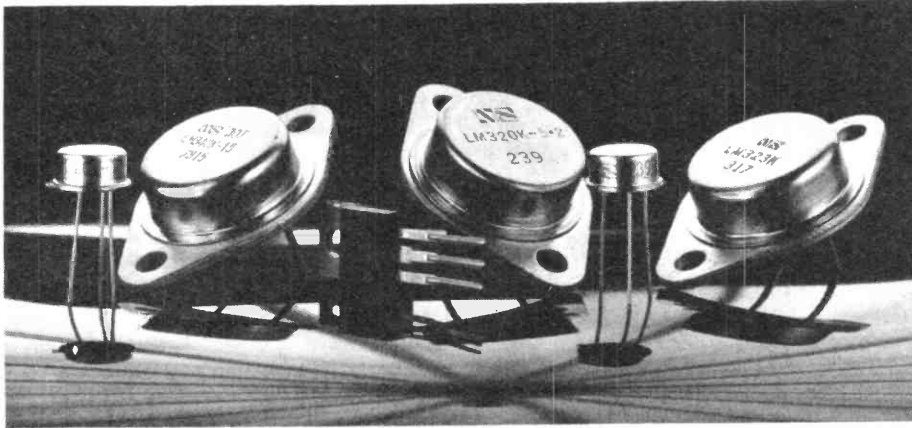

A group of National Semiconductor voltage regulators in various types of package.

The connecting leads emerge from the opposite side of the device to the metal tab. This general type of encapsulation is employed in various voltage regulators and a few power amplifiers. One type with three leads is known as the "TO-202" and another as the "TO-220", whilst a somewhat similar package with five leads (the "Pentawatt") has been developed by SGS-ATES for their high power Darlington devices.

Current trends are for the increasing use of economical plastic packages for both power and other devices.

### PACKAGE TYPE DESIGNATION

Some manufacturers put an optional suffix at the end of each device type number to show which type of package is being employed. These suffixes vary from manufacturer to manufacturer.

The National Semiconductor LM1458H, for example, is a dual operational amplifier in a circular metal can package, whilst the LM1458N is an electrically similar device in an 8 pin dual-in-line package.

In some cases a "C" is inserted *before* the package coding letter to denote that the device is specified over the "commercial" temperature range (as opposed to the more expensive devices specified over the wider "military" temperature range). For example, the LM741CN is specified from 0 to 70 degrees Centigrade, whilst the LM741N is specified from minus 55 to plus 125 degrees Centigrade.

National Semiconductor plastic encapsulated dual-in-line devices all have the suffix "N" (although this is often omitted), whereas devices from Signetics in similar packages have the suffixes "V", "A", or "B", depending on whether there are 8, 14 or 16 pins connected to the package. A typical example is the 16 pin Signetics NE560B phase locked loop.

Some manufacturers, such as RCA do not use a letter for the package coding in many cases, but in others it is shown. For example, the

CA2111AE is a 14 pin dual-in-line device, whilst the CA2111AQ is an electrically equivalent device in a 14 pin quad-in-line case. The letter "A" in these codings shows that the device is a modified version of the original one in which this letter is omitted.

The manufacturers of the packages given above are all based in the U.S.A., but European manufacturers sometimes employ a package code. For example, Mullard/Philips add a "Q" to the end of a device coding when a quad-in-line package is used, whereas ITT employ a "B" for the same purpose.

### SOCKETS

Most components such as resistors, diodes and transistors are soldered directly into a circuit,

A magnified view of the National Semiconductor LM1812 chip.

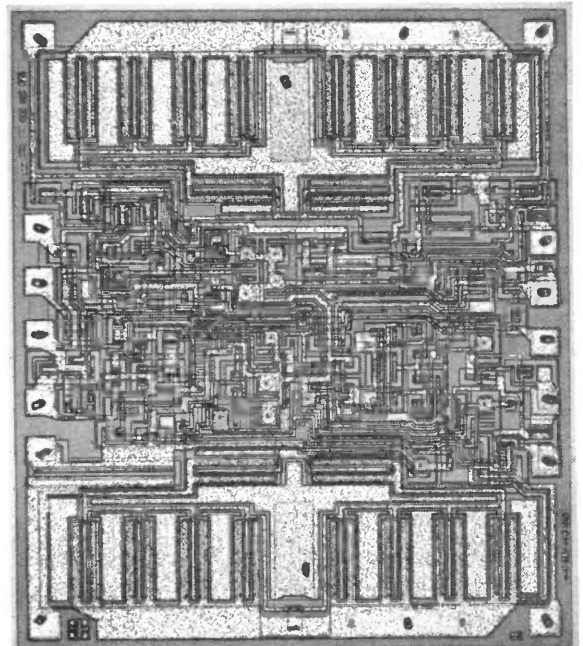

since they have only a few connections. Although transistor sockets are available, most people seldom consider using them.

Most integrated circuits employing circular metal cans or the flatpack encapsulation are also soldered directly into their circuits.

In the case of dual-in-line devices, however, one has the alternative of soldering a socket into a circuit and inserting the device into the socket.

The use of a socket has the advantage that one can quickly replace the device if one suspects it of having failed. Although one can solder a dual-in-line device into a circuit, it is not always easy to remove it—especially if it has a relatively large number of pins—since one may have to melt the solder on several of the pins simultaneously.

The use of a socket also has the advantage that one can avoid the possibility of damaging the device by overheating during soldering (although this is not likely to happen anyway) and one also avoids the possibility of damaging the device by voltage spikes on a soldering iron which is not well earthed.

On the other hand, the price of a socket is not inappreciable. Now that the price of some types of CosMOS digital devices has fallen to about 20 pence, one may well feel that the use of a socket costing as much as the device itself is rather extravagant.

If, however, one is constructing a circuit containing such economical devices and also some considerably more expensive devices, one may wish to use sockets for the more expensive ones and therefore decide to use sockets throughout.

In general the author would not recommend

**A complete MOSRAM 104 random access memory produced by National Semiconductor.**

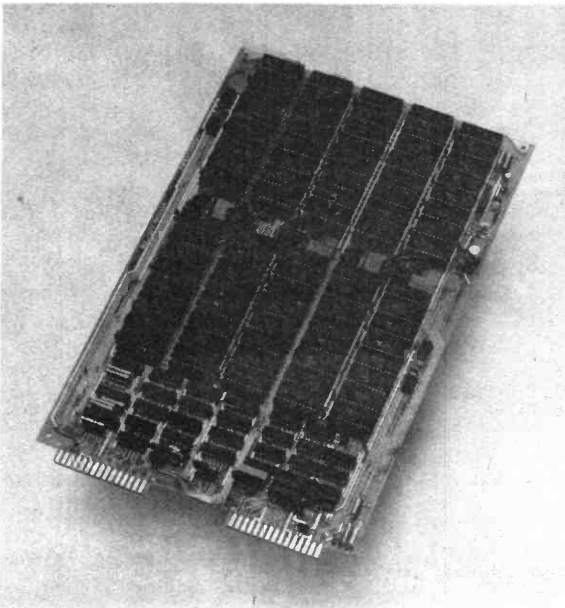

the beginner to employ sockets with audio power amplifiers or other high current devices, since the connections are thereby lengthened and with a high current flowing the circuit can be more prone to oscillation. Cooling is also much improved if no socket is employed.

Dual-in-line sockets are readily available for devices having 8, 14 or 16 connecting pins. A dual-in-line device can be fitted into a socket having the same number or any greater number of connections; indeed, two 8 pin devices are often used in one 16 pin dual-in-line socket.

Quad-in-line sockets are not commonly used, although a few manufacturers produce them. One should note that there are two types of 16 pin quad-in-line pin configurations, the difference being in the direction in which the end pins are bent relative to the body of the device. One must employ the correct socket or the pins will not be in the correct position to fit into the socket holes.

This does not arise in the case of 14 pin quad-in-line devices, since the odd number of pins along each side enables one to turn the device around so that it will fit into any 14 pin quad-in-line socket.

The pins of quad-in-line devices can, incidentally, be bent so that they will fit into a dual-in-line socket, but this is not recommended.

## SOCKET CARE

It is necessary to take considerable care when fitting dual-in-line devices into a socket; this is especially true if the socket is a new one, since it is then probable that the fit will be a tight one.

It is by no means uncommon for a "ham-fisted" individual to force a device into a socket so that it does not enter the socket symmetrically and one or more of the connecting pins are broken off or badly bent. In addition, some of the pins of the socket may be damaged.

Considerable care should also be taken when removing dual-in-line devices from sockets. If a device is gripped at each end by the fingers, it is likely to suddenly spring out of the socket and the device pins can easily be badly bent or fractured — possibly penetrating the skin in the process.

Although one can often ease an integrated circuit from a dual-in-line socket very carefully step-by-step with the fingers, it is far better to slip the thin blade of a small screwdriver under each end of the device in turn, turning the screwdriver slightly so as to lift the end of the device in the socket. The screwdriver blade can then be inserted farther beneath the device so that the latter can be lifted out.

If any pins of a device are bent, they should be straightened very carefully, first with forceps and finally with a pair of small pliers.

**Continued next month.**

# INDICATOR PEAK LEVEL

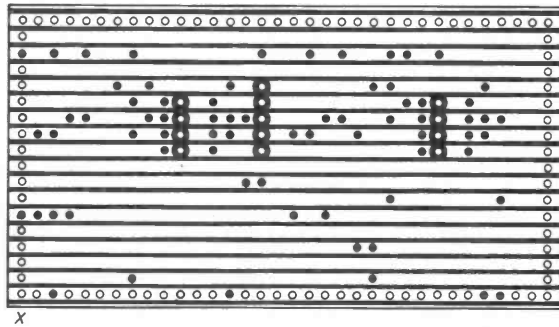
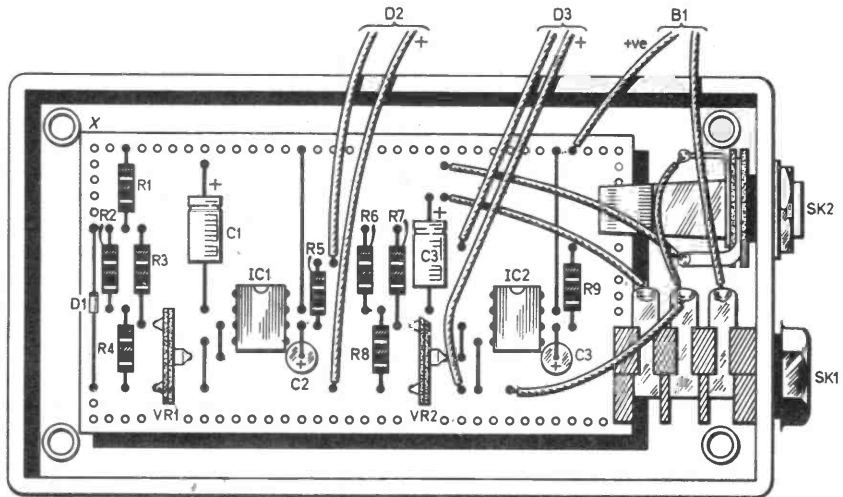
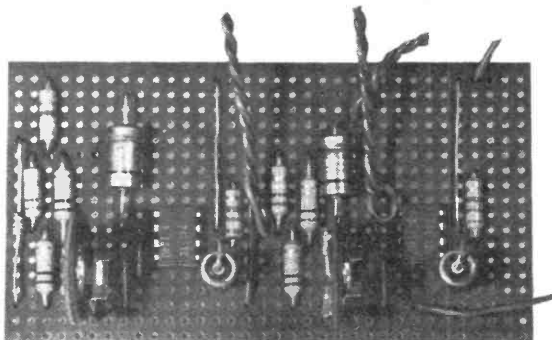

Fig. 2. Layout and wiring of the complete unit.



Photograph of the component board.

pin 3 which will cause the output to go towards 9V.

As the voltage across the capacitor cannot change instantaneously, the voltage at pin 3 rises well above the voltage at pin 2, thus keeping the output voltage high until the charge on the capacitor has decayed to the same level as the inverting input, when the output falls to its previous low level. Hence the output stays at this level until the capacitor charge has recovered at which time the circuit can be triggered again.

When the output of the operational amplifier is high the light emitting diode D2 is illuminated, resistor R5 serving to limit the current.

## CONSTRUCTION

All the components except the light emitting diodes and the jack sockets are mounted on a piece of 0.1in matrix Veroboard as shown in Fig. 2.

The two light emitting diodes are mounted on the lid of the case and the jack sockets are mounted at one end of the case base.

Standard jack sockets are used, one of which is stereo and the other mono. The reason for the stereo jack is that the body and ring contacts are used to switch on the circuit, thus obviating the need for a separate switch to conserve battery life.

Mono jack plugs are therefore used to input right and left channel signals, the inserting of one of these into the stereo socket switching the unit on.

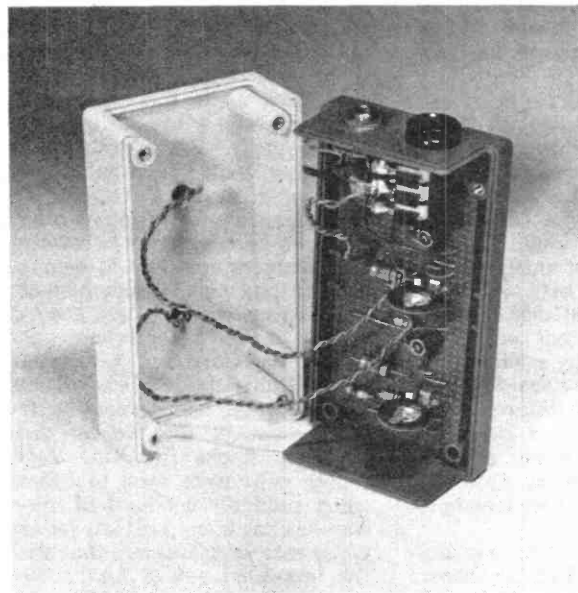

Photograph showing construction of the prototype unit.

Everyday Electronics, June 1976



The finished unit ready for use.

## Components . . . .

**RTAL  
SHOP**  
SEE

### Resistors

R1	390Ω
R2	150kΩ
R3	100kΩ
R4	100kΩ
R5	220Ω
R6	150kΩ
R7	100kΩ
R8	100kΩ
R9	220Ω
All ±5% ¼W carbon	

### Capacitors

C1-C4 4.7μF 63V elect. (4 off)

### Semiconductors

D1 BZY88 C6V2 6.2V Zener  
 D2, D3 light emitting diode (2 off)  
 IC1, IC2 741 operational amplifier 8-pin  
 d.i.l. (2 off)

### Miscellaneous

VR1, VR2 100kΩ linear vertical skeleton pre-set (2 off)  
 SK1 Stereo jack socket  
 SK2 Mono jack socket  
 B1 9V type PP3  
 0.1in matrix Veroboard 18 strips x 38 holes;  
 Verobox type 90-20-087; connector for PP3  
 battery.

FOR  
GUIDANCE  
ONLY

**ESTIMATED COST\***  
OF COMPONENTS  
excluding V.A.T.



**£2.30**

excluding case

\*Based on prices prevailing at  
time of going to press

## SETTING UP

To set up the unit it is only necessary to apply constant input signals at the desired overload levels and adjust VR1 and VR2 to illuminate the light emitting diodes strongly at the overload level.

A small standing current flows in the light emitting diodes under no signal conditions which causes them to glow at low intensity. The complete elimination of this glow was not felt desirable as it provides an indication that the unit is switched on. It is not easily mistaken for an overload signal except under the most extreme of low battery conditions.

## CONCLUSION

Whilst by no means a substitute for peak programme meters, this device enables better re-



cordings to be made by indicating the onset of distortion sooner than a VU meter and at a lower cost. □

# COUNTER INTELLIGENCE

By PAUL YOUNG

A SHORT time ago our worthy Editor asked me "How is VAT working now?" I was able to answer him quite truthfully "I am pleased to report, it is still not working beautifully!" To which the good gentleman replied, "Well the new multi-rate system has been going for about a year now, perhaps you might like to make a few comments about it?"

So there I was, all steamed up, and ready to make a few remarks, on it, that would be printable, when lo and behold I turn on my radio this morning and they are talking about going back to one rate of 10 per cent and giving their reasons for doing so!!

The Chancellor was told before he introduced it, not on any account to introduce a multi-rate of VAT and both he and his advisers must have known it would not work. What worries me is that they did not care! The idea was to soak the rich, what a laugh! Well Ted Heath managed to buy his yacht just before the 25 per cent was added to it. "Good on yer Ted!"

Apart from all this, how could anyone work a system where one manufacturer charges you 8 per cent for switches and another 25 per cent. So here is one person who is at this moment keeping his fingers crossed!

Like you, dear reader, I go through my EVERYDAY ELECTRONICS from cover to cover the minute I get it. I was fascinated by the article in the April issue on becoming a Radio Officer. In my mind's eye, I could picture myself in that smart uniform with a shiny peaked hat, strutting about the bridge. Visiting mysterious parts in the Orient and being surrounded by dusky maidens.

Hold it Young, you should know the reality is a little different, and while you might get a berth on a cruise liner, you might equally well finish up on a Grimsby trawler being chased by Icelandic gunboats.

Incidentally if you go cruising for your holiday and it's no longer the prerogative of the rich, pal up with the radio operator, the chief preferably, they are a matey

crowd on the whole. Once they know about your hobby they will usually be only too pleased to take you around, and they have some very fascinating pieces of equipment to display.

At this moment, we are revising our catalogue. This may occur at any time of the year. We have about 15,000 printed which we reckon should last a little over a year. When we get down to about six months supply, we start revising. We are about 90 per cent mail order and therefore our catalogue is vital to us.

With the vast and rapid changes in electronics today it is essential to bring it up to date at least once a year. At one time we did it every six months but it was too much for us. With the big cross section of customers, we have some that make their catalogues last five years while some change them yearly. Fortunately there are many items which go on year after year,  $\frac{1}{4}$  watt resistors for example, and Bulgin mains plugs, but even here we must be careful, as customers continue to demand smaller and smaller components.

This year sees the last page of "valve mains transformers and output transformers" taken out. We still have quite a few left, but they will be transferred to the supplement, so that we can drop them as stocks run out. Valve tuning coils were soon to follow, when suddenly a friend of mine, who designs many projects for the magazines informed me that with the increased use of f.e.t.'s they are all in demand again!!

Say what you will, it's a hard life!

# SOUND DESIGN

A PRACTICAL ELECTRONICS PUBLICATION

## THE MINISONIC MK2 SOUND SYNTHESIZER

An up-dated version of the published Mk 1, the Mk 2 has an integral keyboard, two 250 mW monitoring channels and loudspeakers, and facilities for amplitude, frequency and harmonic modulation.



Available  
Now  
**£1.20**  
POST PAID

*(Please allow at least 2 weeks for delivery)  
If you do not wish to mutilate your copy of the magazine, please send your order on a separate sheet.*

A SPECIAL  
SELECTION  
OF MUSICAL  
PROJECTS  
FROM PE

## THE JOANNA ELECTRONIC PIANO

has realistic piano effect with touch-sensitive keyboard and additional choice of harpsichord or honky-tonk voicing.

## THE ORION STEREO AMPLIFIER

A hi-fi amplifier with output of over 20+20 watts. Compact and complete in one unit, it measures only 14" x 6" x 2".

## PLUS

Some great sound effects units for guitars, keyboard instruments and general recording.

To: Practical Electronics  
IPC Magazines Ltd., Receiving Cashiers  
Dept., King's Reach Tower,  
Stamford Street, London SE1 9LS

Please send me.....copy (ies)  
of "Sound Design". I enclose a Postal  
Order/Cheque for £1.20 (post paid) or  
(state amount for more than one copy)

.....  
(£2.35 post paid for 2 copies).

PLEASE WRITE IN BLOCK LETTERS

Name .....

Address .....

.....

..... Post code .....

*Remittances with overseas orders must be sufficient to cover despatch by sea or air mail as required.*

*Company registered in England. Regd. No 53626. A subsidiary of Reed International Limited.*

# Physics is FUN!

By DERRICK DAINES



A HANDY little motor can be made very easily using nothing more complicated than a simple electromagnet. Such a motor can be used for driving a model loco turntable, for example, or display turntables of quite large dimensions. There are no brushes to wear out and little current is consumed, so the motor can be left running unattended for long periods. It sounds ideal, but it is only fair to point out that it also tends to be a little noisy.

Mount a coil with its axis horizontal and with the soft iron core projecting a little. (Fig 1). Feed low-voltage alternating current through the coil, drawn from a bell transformer suitably insulated. Now cut a strip of tinfoil about 10 mm wide and hold it by the end with a pair of pliers. Hold it near to the coil and it will be seen to vibrate. Adjust the length of the freely vibrating end until the vibration is at its greatest. The rapidity of vibration is partly dependent upon the length and there will be found to be a point at which the strip is vibrating (oscillating) at the frequency of the supply. This will occur when the strip is about 45 mm long. Mark the length carefully.

There must now be a small allowance for fastening the strip (see Fig 1a) and the end away from the fastening must be cut with a little tongue to form a connection for the operating arm. Mount the strip by screwing it to a small block of wood.

## OPERATING ARM

The operating arm should be light and stiff. Some balsa wood can be pressed into service, but piano wire is perhaps the best. The top end has a loop formed in

it, a smooth but not slack fit over the tongue, while the bottom end is pushed into the end of a type-writer eraser, or the type of ink-pencil eraser that has dual hardnesses of rubber. The softer end is arranged to rest at an angle of about 15 degrees on top of the actuating disc. (Fig 2). This can be of metal, plywood or even hardboard, smooth side up.

Dependent upon application, this disc can be mounted beneath the turntable proper or, by providing a suitable housing for the motor and arm, objects on display can be mounted directly upon it. The central spindle should be as frictionless as possible and a very good method of doing this is to use Meccano rod journalled in two blocks of nylon (curtain track holders). A single ball bearing at the bottom taking the vertical thrust.

As described, after a while the tinfoil strip will work-harden and break and those readers who may wish to use this little motor a lot are advised to make the vibrator arm as in Fig 1b, with a

piece of clockspring or phosphor bronze riveted to it.

## OPERATION

Older readers will not need the explanation that the motor works because of the alternating current fed into the coil. This has the effect of switching the magnet on and off 100 times every second, alternately attracting and releasing the vibrator arm. Because of the angle that the actuating arm and rubber makes to the surface of the disc, the rubber imparts more push than pull to it at each movement, thus slowly turning it. The disc should turn steadily and quite briskly but if results are not satisfactory, the addition of a little weight to the rubber may help.

As a demonstration the model is quite useful, but it may be worth pointing out that it is also used commercially for low-power applications and it also forms a useful conceptual link to other applications of rapidly-switched electromagnets.

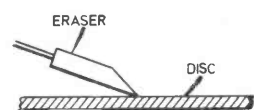
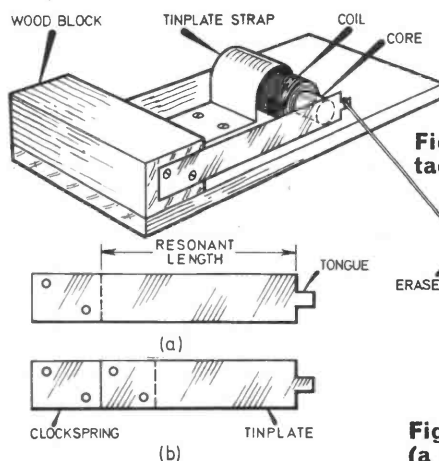

Fig. 2. Showing angle of contact of rubber.

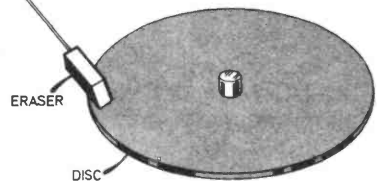

Fig. 1. The complete motor and (a and b) vibrating strip.

Everyday Electronics, June 1976

# Continuity Tester

By R.A. PENFOLD

**A useful piece of test equipment. An audible tone is heard when there is a low resistance between the probes.**

WHEN building and servicing electronic equipment, there are numerous occasions when some form of electrical continuity tester is required. It may be when tracing out the wiring around a complicated array of switches, or perhaps something more everyday such as checking for a break in a mains cable; sorting out the contacts of a wavechange switch; or checking a fuse which one suspects has blown.

A continuity tester is merely a device which gives an indication of some sort when a low resistance is present across a couple of test prods.

A multimeter switched to an ohms range is a popular form of continuity tester, but this does suffer from the disadvantage that it is necessary to look away from the test prods to look at the meter when checking for continuity. If the two test prods are awkwardly placed, as they frequently are, this can prove to be rather difficult, and also it can become rather tedious if there are a large number of tests to be made.

The very simple tester described here overcomes this difficulty by producing an audible tone to indicate continuity. The unit is very simple to construct and is also quite inexpensive as few components are used.

FOR GUIDANCE ONLY

**ESTIMATED COST\* OF COMPONENTS**  
excluding V.A.T.

**£1.20**  
excluding case

\*Based on prices prevailing at time of going to press

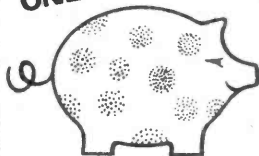

## CIRCUIT OPERATION

The circuit diagram of the Continuity Tester is shown in Fig. 1. The circuit consists of a relaxation oscillator feeding a miniature speaker.

A unijunction transistor, TR1 forms the active component in the oscillator. Unijunction transistors have little in common with ordinary bipolar transistors except that they are also three terminal devices. The terminals are named differently though, being called base 1 (b1), base 2 (b2) and emitter (e).

With no voltage present at the emitter, the base 1 and base 2 terminals have a resistance of about three to 10 kilohms across them. Therefore, when the test prods are short-circuited, a current of about a couple of milliamps will flow through the loudspeaker via the unijunction.

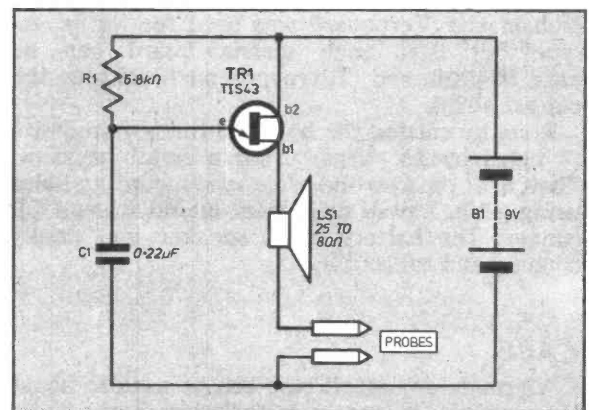

Fig. 1. The complete circuit diagram of the Continuity Tester.



This does not, of course, take into account that C1 will have charged to the supply potential within a fraction of a second of the battery being connected and so there is about 9V at the emitter of TR1.

If more than about half the supply potential is present at this terminal the emitter input impedance (which is otherwise extremely high) suddenly falls to a very low level and the base 1 to base 2 resistance of the device falls to about half its previous level.

Thus, at the instant the test prods are touched together, C1 discharges into the emitter of TR1 and a pulse of current is fed to the loudspeaker via the b1, b2 terminals of TR1.

Once C1 has largely discharged, TR1 operates as previously described until C1 is charged via R1 to the trigger voltage once again. Then C1 will again discharge and another pulse of current will be fed to the loudspeaker. This will continue in rapid succession causing a continuous tone to be emitted from the loudspeaker as long as the test prods are connected together.

If a resistance of more than a few hundred ohms is present between the two test prods, TR1 will cease to function and no audio tone will be generated.

This is an important feature, as, if the unit produced a tone even with a resistance of many kilohms across the test prods, as would be the case if the prods were connected in the positive supply for instance, misleading results could be obtained.

No on/off switch is required because, when the test prods are not connected together, the only current that flows in the circuit is the leakage current through R1 and C1 which is so minute as to be of no consequence.

## COMPONENT PANEL

A small piece of Veroboard is used as a basis for the wiring of the project. A diagram showing the layout of this panel and all the other wiring of the circuit is shown in Fig. 2. A piece of 0.1 inch matrix Veroboard was used for the prototype but 0.15 inch matrix board can be used if preferred. There are no breaks in the copper strips.

Start by cutting the board to the required size (7 holes by 15 strips) using a small hacksaw. Then drill the two 6BA clearance mounting holes using a No. 3 twist drill. Next mount R1 and C1, connect the battery clips, speaker and finally connect and solder TR1.

## CASE

Virtually any small case can be used to house the unit, the minimum suitable size being about 100×70×25mm. The author used an aluminium box type AB9 which is readily available from

several suppliers and there are several other cases about this size which can be used.

A circular cut-out 50mm diameter is made in the centre of the front panel and a piece of speaker fret is glued to the inside of the case behind this. The speaker is then carefully glued into place on the speaker fret.

A hole is drilled in the front panel near the component panel and it is fitted with a rubber or p.v.c. grommet. The leads connecting to the test prods are then threaded through this hole and are connected to the component panel before it is finally mounted.

The component panel is mounted on one side of the case by two short 6BA bolts. If a metal case is used, spacers (or a few washers) are placed over each bolt between the panel and the case so as to hold the copper strips on the panel slightly clear of the case. There is space for the battery on the other side of the case.

The plugs at the ends of commercially made test leads are usually of a type for which suitable sockets are not easily available and hence these are removed to enable a direct soldered connection to be made. With a little ingenuity, a pair of home made test prods can be constructed.

## Components . . . .

### Resistor

R1 6.8k $\Omega$   $\pm$ 10%  $\frac{1}{4}$ W carbon

### Capacitor

C1 0.22 $\mu$ F polyester type C280

### Transistor

TR1 TIS43 unijunction transistor

### Miscellaneous

LS1 25 to 80 $\Omega$  speaker up to 60mm diameter

B1 9V PP3 battery

Veroboard 0.1in matrix, 7 holes  $\times$  15 strips; aluminium box type AB9 or similar; test leads and prods; speaker fret; PP3 battery connector.

SEE  
SHOP  
TALK

## CONCLUSION

The unit is now ready for use and touching the prods together should produce an audible tone in the speaker.

When using the unit it should be borne in mind that if the circuit under test has a resistance of perhaps as much as several hundred ohms the unit will still produce an audio tone even though there is not true continuity. This is not a major drawback however as, if the resistance between the prods is more than just a few ohms, the volume of the tone drops and the type of note changes noticeably.  $\square$

# Continuity Tester

By R.A. PENFOLD

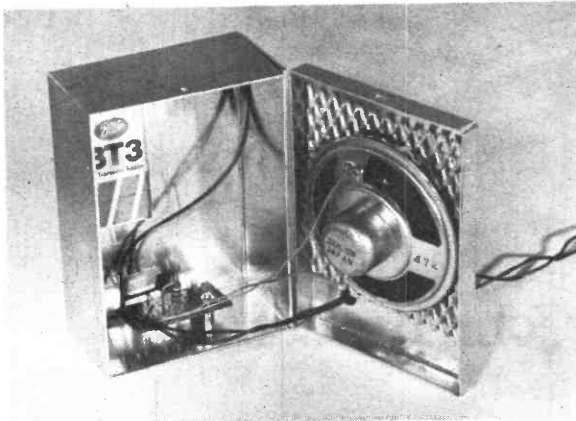

Photograph of the prototype showing fixing of components within the case.



The completed prototype with probes.

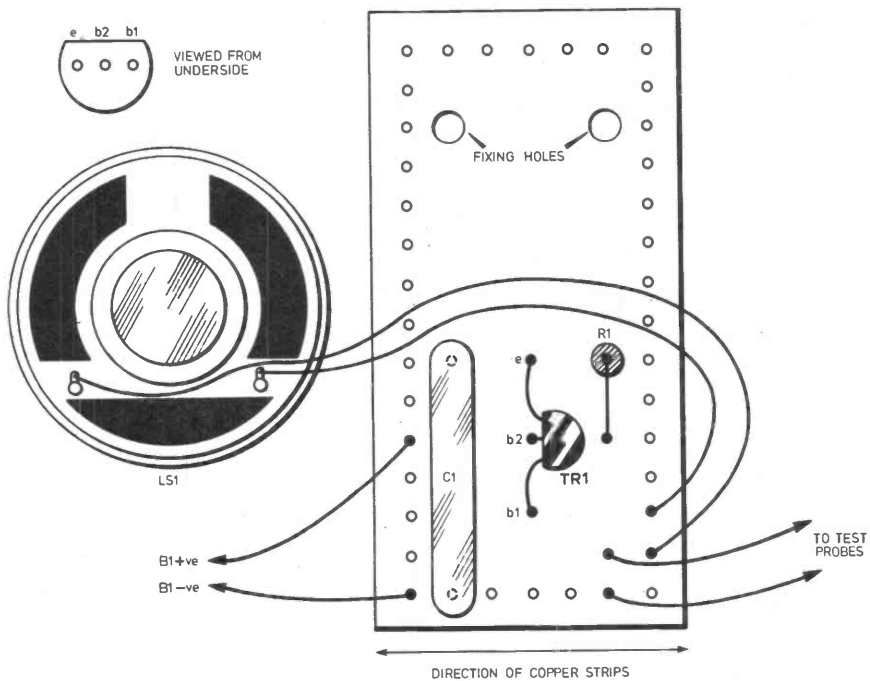
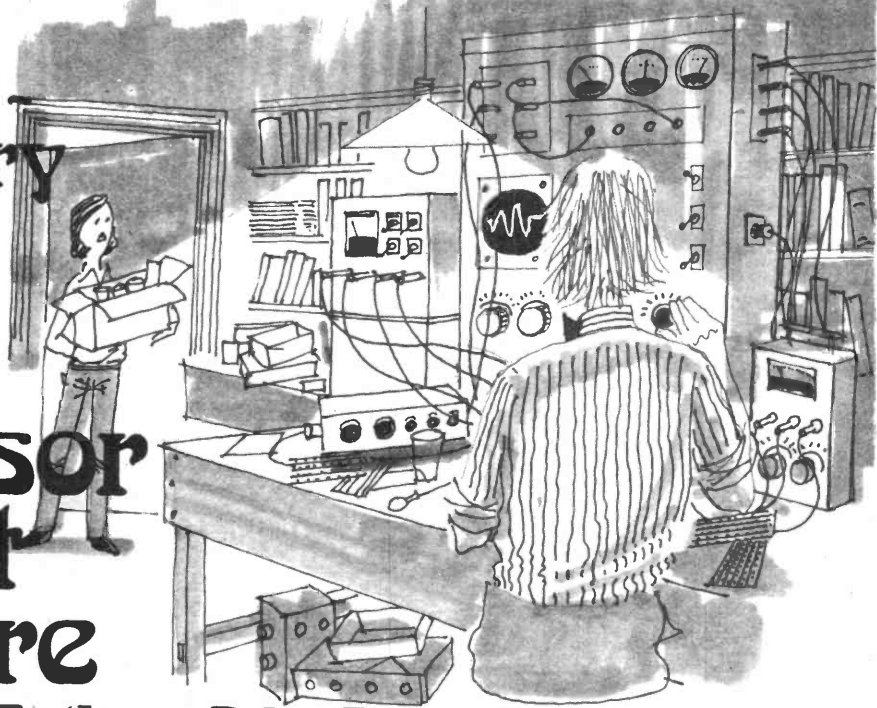

Fig. 2. The layout of the components on the Veroboard and complete wiring up details. There are no breaks to be made in the underside.

# The Extraordinary Experiments of Professor Ernest Eversure

by Anthony John Bassett



**B**OB was bursting to know what was inside the mysterious boxes, each the size of a large biscuit tin, and with two wires, one red and one black, protruding from a hole in one side. One after another the robot connected each box to the Voltage Breakdown Tester and appeared to be testing each box in turn. One or two things about this procedure were very puzzling to Bob. First, Bob was puzzled by the voltage readings the robot was obtaining from the multimeter as the voltage across each box did not rise smoothly, but appeared to rise in a series of jerky movements of the multimeter needle. What kind of component could react like this Bob wondered.

The second puzzling thing was, why did the robot repeat the test several times with each box going through all the boxes one after another, then starting with the first. Surely, Bob thought, one test should be enough, but as he saw the robot connect one of the boxes once again to the tester Bob thought in exasperation, I'm sure I've seen him test that one three or four times already. However, Bob continued with the work of constructing a Random Noise Generator in accordance with the circuit which the Prof. had drawn out; designed to take advantage

of the very efficient noise generating properties of a reverse biased light emitting diode. Soon Bob had completed the noise generator and he decided to test it.

First he connected the output of the generator to the input of an audio amplifier, and as he gradually turned up the volume a hissing sound came from the loudspeaker. As Bob adjusted the tone controls he found he could vary the sound from a low roar to a high sharp hiss.

"This is because the random output generated by this circuit contains all the frequencies in the audio range." The Prof., who had returned and was observing as Bob made these simple tests informed him, "It also contains frequencies outside the audio range both above and below the range of frequencies which we can hear.

There are a number of interesting experiments which we can perform using the random generated frequencies within the audible regions and other experiments which will demonstrate frequencies both above and below the limits of human hearing. The types of sound effects you were producing just now Bob, by adjusting controls on the amplifier, can be made even more striking by using tone filters of various

types other than the tone controls on an audio amplifier," the Prof. informed him.

The Prof. produced a number of books on the subject of electronic organs and quickly flipping through the pages soon found a number of circuits for production of various synthesised organ and instrumental tones.

"Hey Prof! Some of those circuits look really simple," remarked Bob, as he examined a few pages which were covered with small circuit diagrams.

## TONE FILTERS

Each diagram was marked with the name of a different musical instrument; organ, flute, horn, clarinet, trumpet etc.

"Yes," the Prof. agreed. "In most electronic organs the tone filter circuits are indeed simple, only a few components are needed to produce the tone of each instrument. Although the electronic organ itself may be quite a complicated piece of equipment some of the simple circuits which are used in it may be built and used separately and this is quite easy to do. It can also be very interesting, I have already built a number of these tone filter circuits and their effect is quite

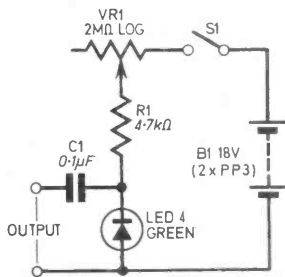

**The random noise generator designed by the Prof. last month.**

different from the effect of tone controls in an audio amplifier."

The Prof. showed Bob a number of experimental tone filters which he had built. Some of these were built in accordance with the circuits in the Prof's. reference books whilst others had been modified by the Prof. during the course of his experiments.

"Each of these tone filters has been designed for the processing of a particular waveform," the Prof. informed Bob. "Usually sawtooth, squarewave or pulse waveforms. However, they can be used to filter random noise quite successfully and most of them can be connected directly to the output of your Random Noise Generator."

Bob connected a number of the tone filters to the output of his Random Noise Generator, one at a time, connecting the output of each filter to the input of the audio amplifier and in this way he could observe the audible effects of each filter on the sound produced. The results were a remarkable series of sound effects and as Bob was about to connect one particular filter, the Prof. stopped him.

"This is a low pass filter Bob, and it will only allow the extreme bass frequencies to pass. So in order to hear the effect of this particular filter an amplifier and speaker should be used which are capable of responding well to bass frequencies and I have an amplifier here which will suit this purpose better. It is connected to a larger loudspeaker."

The Prof. connected the output of the low pass filter to the input of the bass amplifier and, as he very carefully adjusted the volume rumbling sound came from the loudspeaker. Removing the front grille from in front of the speaker he showed Bob the speaker cone which, instead of making the

regular movements associated with a steady note or frequency, appeared to be moving in an unpredictable way. On a nearby oscilloscope, which the Prof. had connected to the amplifier, the slowly moving spot on the screen appeared to mimic the movements of the speaker leaving a series of irregular humpy lines on the long persistence screen.

"If we use a low pass filter with even larger capacitors," the Prof. informed Bob, "this will cut the audible frequencies down to an imperceptible level. We would be unable to hear these frequencies if they were fed into a loudspeaker but powerful vibrations can be produced in this way and because we cannot hear them, it could be quite dangerous to health."

"The Random Noise Generator is really interesting Prof. Especially when we can hear all those sound effects through the audio filters. But this low frequency random noise which we cannot hear also seems quite interesting. But what puzzles me is whatever could it be used for?"

## ROBOT TESTER

"If the very low frequency random noise is fed to a cathode ray tube it can be made to move the spot on the screen up and down and from side to side at random. Aircraft pilots are tested on a device like this. The pilot sits at the controls of the tester and these may be arranged to resemble aircraft controls. By using these controls he can move the spot on the screen up and down and from side to side at will until the random frequency is switched on. The spot on the screen then begins to move at random. The pilot must use his controls to keep it in the middle of the screen and this can be quite a difficult test. On the screen are a number of circles like a bulls-eye target and if the pilot allows the spot to move outside one of the circles a buzzer sounds."

"Here, Bob." The Prof. led Bob to another part of the laboratory where he could see a number of experimental seats fitted with steering controls and facing each one a simulator control panel and display screen. Nearby were a variety of other test settings and partly built experimental robots.

"This part of the laboratory is being used as a robot testing

station at present and some of the equipment which I use for testing experimental robots is very similar to the equipment used for simulator testing of spacecraft pilots." Bob could see that one of the robot testers looked very much like a spacecraft atmosphere re-entry capsule with pilots and controls and a viewscreen.

"This one uses low frequency random noise generators to simulate perturbations in a trajectory and the pilot being tested must be able to correct these and maintain a correct path. Here Bob." The Prof. invited, "Get into the pilot's seat."

As Bob climbed into the pilot's seat the Prof. strapped himself into the co-pilot's seat beside him and advised Bob to fasten his seat belt as the tester could move unexpectedly under the influence of the randomly generated perturbations. These could cause it to tilt, sway, roll or turn in various ways in response to random signals, the pilot's response or a taped or computer generated test programme. As the Prof. pressed a few buttons on the control panel a number of dots appeared on the view screen. All the dots were fixed in position except one which could be moved by means of the controls. The Prof. showed Bob how the movements of this dot could be controlled from side to side by means of rudder pedals and up and down by a moveable joystick.

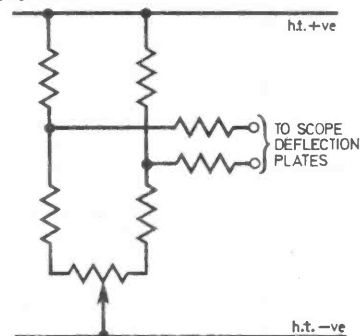

**Fig. 1. Oscilloscope vertical and horizontal position control. Values depend on voltage**

Bob could see how the remaining six dots could be joined up like a seven segment calculator display to produce any numeral and anticipated the test the Prof. was about to set him. That looks really easy he thought to himself, I know how the horizontal and vertical shift controls works on an electrostatic deflection cathode

ray tube. A picture of the basic circuit for these controls came before Bob's mind (Fig. 1). Now if the horizontal shift potentiometer is connected to the rudder pedals and the vertical shift potentiometer is fitted to the joystick it should be quite easy, thought Bob, to steer the moving dot from point to point.

Meanwhile the Prof. had made further adjustments and wherever the bluey green moving dot went it left behind it a glowing yellow trail.

"Just to familiarise yourself with these controls Bob," the Prof. suggested. "Try using the moving dot to join the six stationary dots in order to form any number you wish. I would suggest that you first try a fairly simple one, as these controls are quite tricky. To his surprise, Bob soon found that he had considerable difficulty in getting the moving spot to stop over the first dot. The reason for this being that the controls were indeed as the Prof.

warned him, somewhat tricky. Whilst the Prof. was making his adjustments to the control panel he had unknown to Bob craftily reversed the controls, by means of changeover switches, so that as Bob moved the controls the spot moved in a direction opposite to what he expected, up instead of down, left instead of right. Worse still, the controls also had a delayed action effect.

When Bob tried to steer the spot towards one of the dots it first of all went in completely the opposite direction. Then when he moved the controls the other way he found that the spot did not respond instantly. The delayed action circuit caused it to respond shortly afterwards. So that at first the spot appeared hardly to move then it gathered speed and before Bob could stop it, it had moved right past the place he was aiming for. Bob's first few attempts produced a series of wild squiggles on the viewscreen and whilst the Prof. shook and

chuckled in the co-pilot's seat. Bob, who was determined to beat the challenge, doggedly struggled with fierce concentration with the tricky controls until he had mastered them sufficiently to produce a series of numbers on the screen.

As Bob triumphantly finished off an almost perfect figure 8 on the viewscreen. The Prof. leaned across with a grin and tapped Bob's shoulder.

"Are you ready to try it with the Random Noise Generator yet Bob?" he asked.

"Yes Prof. I feel ready to try that, but first I'd really like you to explain to me how does the delayed action circuit on this gadget work. Could an attachment be easily built to enable me to do this with an ordinary oscilloscope or a TV set?"

The basic circuit for use with an oscilloscope is quite simple Bob," explained the Prof.

continued next month

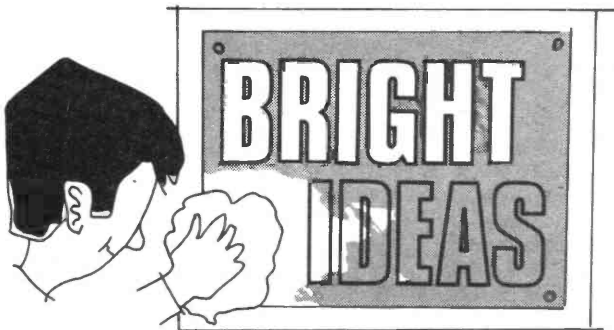

As I was making up the game of *Shoot in your sister magazine (P.E.)* using 0.1 inch pitch Veroboard, I found that it was easy to count one hole too many or too few and put a wire or component lead in the wrong track.

So instead of numbering all of the holes and tracks for just a one-off, I have made, out of metal, a right angle as shown and put a scale on it to coincide with the right holes on the component board.

Two of these right angles could be made for 0.1 and 0.15 inch pitch.

S. J. Battersby  
Lancashire

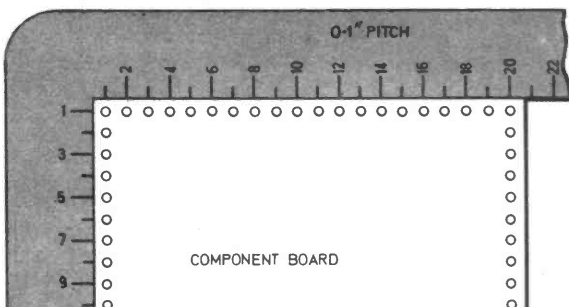

The two small items shown below have been made by myself to facilitate easy removal of i.c.'s when soldered to a circuit board. The clip is made of thin, bent steel with a 4BA bolt and compression spring. This is placed over the i.c. and squeezed so that the teeth are inserted between the i.c. pins and grip the device. The special soldering iron bit is then used to remove one row of pins at a time.

E. R. Wall  
Charlton, London

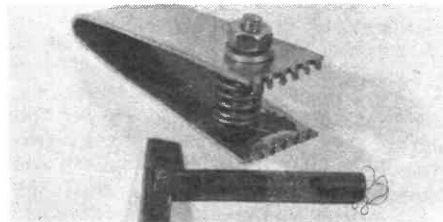

## PLEASE TAKE NOTE

In Fig. 2 of the *Touch To Talk Intercom (April '76)* the emitter and collector of TR4 are shown transposed.

The component board printed circuit layout for the *Carsafe System (Fig. 4, May '76)* is slightly different to the circuit diagram with respect to D4 and RLA coil. This will not affect operation of the unit.

## MULLARD AUDIO AMPLIFIERS

All in module form, each ready built complete with heat sinks and connection tags, data supplied.

Model 1153 500mW power output £1.10 + 40p post & VAT.  
 Model 1172 1W power output £1.35 + 45p post & VAT.  
 Model EP9000 4 watt power output £2.40 + 50p post & VAT.  
 EP 9001 twin channel or stereo pre amp. £2.50 + 40p post & VAT.

## TINY RADIO CASES

Intended to be spares for the microscopic key chain radio, size approx. 2 1/2 x 2 1/2 x 1 1/2, back removable also metal flap for battery compartment, should be about right for building your own miniature radio, transmitter or bugging device. Price 40p + 10p each.

## MICRO RADIO CONSTRUCTOR'S PARCEL

Not complete kit but consisting of eight matching components as follows:—(1) Wound ferrite aerial, (2) oscillator, (3) 4 IFTs, (4) Twin gang tuning condenser (5) volume control. These last two items being fitted with control knobs. Price 80p + 20p. Post 20p + 5p.

## MAINS TRANSISTOR PACK

Designed to operate transistor sets and amplifiers. Adjustable output 6v., 9v., 12 volts for up to 500mA (class B working). Takes the place of any of the following batteries: PP1, PF3, FF4, PF6, PF7, PF9 and others. Kit consists of a main transformer rectifier, smoothing and load resistor condensers and instructions. Real snip at only £1.50 VAT & Postage 50p.

## SOUND TO LIGHT UNIT

Add colour or white light to your amplifier. Will operate 1, 2 or 3 lamps (maximum 450w). Unit in Box all ready to work. £7.95 plus 55p VAT and postage.



## MAINS MOTOR

Precision made—as used in record decks and tape recorders—ideal also for extractor fans, blowers, heaters, etc. New and perfect. Snip at 95p + VAT & Postage 35p.  
 1" stackmotor £1.50 + VAT & postage 35p. 1 1/2" stackmotor £2 + VAT & Postage 40p.

## 6 DIGIT COUNTER

Made by famous American Company, operated by 24V D.C. or mains through resistor, 1 1/2" x 2 1/2" deep. 80p Post & VAT 20p each.

## MINIATURE WAFER SWITCHES

2 pole, 2 way—4 pole, 2 way—3 pole, 3 way—4 pole, 3 way—2 pole, 4 way—3 pole, 4 way—2 pole 6 way—1 pole, 12 way. All at 30p + 15p post & VAT each.

## MULTI-SPEED MOTOR

Six speeds are available 500, 850 and 1,100 r.p.m. and 8,000, 12,000 and 15,000 r.p.m. Shaft is 1/8 in. diameter and approximately 1 in. long. 230/240v. Its speed may be further controlled with the use of our Thyristor controller. Very powerful and useful motor size approx. 2 in. dia. x 5 in. long. Price £1.40 + 45p post & VAT.

## MERCURY BATTERIES

Each made up of 7 cells to give total of 10.7 volts, cells very easily separated for operating portable equipment. These batteries have very good shelf life. Expensive batteries normally but we are offering at an extremely low price of less than 5p per battery, namely 1p per carton of 25 batteries. VAT 8p. Post 4p + 4p.

## 25V 1/4 AMP INSTRUMENT MAINS TRANSFORMER

Extremely well made, intended for upright mounting and impregnated for quiet operation. Price £1.75 + 2p. Ditto but drop through chassis type with top cover. Price £2. + 16p. Post 15p + 2p.



## AMMETERS

Ideal for chargers etc. 2" sq. full vision 0-8 amp 95p. 1 1/2" round 0-2 amp 55p, 0-3 amp 85p, 0-4 amp 75p. Post & VAT 25p each.

## RELAY BARGAIN

Type 600 relay, 2 changeover one open and one closed contact. Twin 500 ohm coils make this suitable for closing off DC 6v, DC 12v, DC 24v or AC mains using resistor and rectifier. 40p each. Resistor or rectifier 20p extra. Post & VAT 20p.

## ONLY £1.50 FOR SEVEN ELECTRIC MOTORS

7 powerful batt. motors as used in racing cars & power models. Output & types vary for use in hundreds of different projects — Tools, toys, models, etc. All brand new reversible & for 1 1/2-2v. batts. Wiring diagram. Inc. VAT & Post 40p. FREE plan for min. power station.

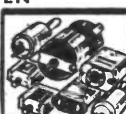

## TWIN OUTPUT POWER PACKS

These have two separately R.C. smooth outputs so can operate two battery radios on a stereo amp without cross modulation (they will of course operate one radio-tape-cassette-calculator in fact any battery appliance and will save their cost in a few months). Specs.: Full wave rectification, double insulated mains transformer—total enclosed in hard P.V.C. case—three core mains lead—terminal output. When ordering please state output voltage 4 1/2v, 6v, 7 1/2v, 9v, 12v or 24v. Price £3.95, post and VAT included.

## LIGHT PIPE

A mains operated travelling light array. 24ft. long, it uses 130 miniature bulbs which flash in sequences to make bands of light move along the tube—The tube can be draped around a particular item or set and cannot fail to attract attention—complete kit consists of—24ft. of translucent tubing—140 miniature lamps for 8 yards multicore cable—motorised switch, tape for quick connections and full wiring instruction special introductory offer £10 for the complete kit post and V.A.T. paid.



## DISTRIBUTION PANELS

Just what you need for work bench or lab. 4 x 13 amp sockets in metal box to take standard 13 amp fused plugs and on/off switch with neon warning light. Supplied complete with 6 feet of flex cable. Wired up ready to work. £2.75. VAT & postage 65p.



## ISA ELECTRICAL PROGRAMMER

Learn in your sleep: Have radio playing and kettle boiling as you awake—switch on lights to ward off intruders—have a warm house to come home to. All these and many other things you can do if you invest in an electrical programmer. Clock by famous maker with 15 amp on/off switch. Switch-on time can be set anywhere to stay on up to 6 hours. Independent 60 minute memory jogger. A beautiful unit. Price £2.95, VAT & Postage 60p, or with glass front, chrome bezel, £1.50 extra.

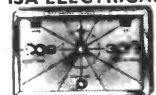

## THIS MONTH'S SNIP

### D.I.Y. BURGLAR ALARM KIT No. 1

This is simple enough for the average householder to install and maintain. It will give protection against intruders coming in through any of four windows and two doors. Intended to frighten intruders away it will start loud ringing bell which will not stop until reset by owner. Kit consists of 6 large trigger mats, 1 loud bell, 1 relay for latching, 1 secret switch, diagram and notes. Price £14 + £1.50p. Post £1.00 + 25p.

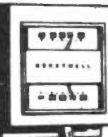

### THERMOSTAT WITH THERMOMETER

Made by Honeywell for normal air temperatures 40-80 F (-5-25 C). This is a precision instrument with a differential which can be adjusted to better than 1-5 F. A mercury switch breaks on temp. rise. Elegantly styled and encased in an ivory plastic case with clear plastic windows, thermometer above and switch setting scale below—size approx. 3-8" x 3-2" x 1-4" deep—can be mounted on conduit box or directly on wall. Price £2.25 plus 50p Post & VAT.

### SWITCH TRIGGER MATS

So thin it is undetectable under carpet but will switch on with slightest pressure. For burglar alarms, shop doors, etc. 24in x 18in £1.99. Post & VAT 60p.  
 13in x 10in £1.50. Post & VAT 50p.



### CENTRIFUGAL FAN

Mains operated, turbo blower type. Pressed steel housing contains motor and impeller. Motor is 1/10th h.p. giving considerable air flow but virtually no noise. Approx. dimensions 10 1/2" x 4 1/2" £9.50 plus Post & VAT.



### MORE CABLE BARGAINS

All prices are very much below regular wholesalers prices and with the price of copper going up, it will pay you to put some of this into stock, it's definitely better than money. Please if you intend to collect, telephoned (01-688-1833) if possible the day before in case we have to get supplies from our store.

Size	Type	Price 100 metres	Carriage n/o 200 miles
1.5mm	Single c.c.	£3.50 + 20p	90p + 6p
1.5mm	Single double insulated	£3.50 + 28p	90p + 7p.
1.5mm	Flat twin	£5.50 + 44p	£1.25 + 10p
1.5mm	Flat twin & E.	£6.50 + 52p	£1.50 + 12p
1.5mm	Flat 3 core	£8.50 + 60p	£1.75 + 14p
1.5mm	Flat 3 core & E.	£9.50 + 60p	£2.00 + 15p
4mm	Single c.c.	£7.50 + 60p	£2.00 + 15p
4mm	Single double ins.	£7.95 + 64p	£2.00 + 15p
4mm	Flat twin	£12.00 + 96p	£2.00 + 15p
4mm	Flat three core	£14.50 + £1.16	£2.50 + 20p
4mm	Flat three core & E.	£18.50 + £1.48	£2.50 + 20p
6mm	Single c.c.	£9.40 + 76p	£2.00 + 15p
6mm	Flat three core	£23.00 + £1.54	£3.00 + 24p
6mm	Twin & E.	£22.50 + £1.50	£3.00 + 24p
10mm	Twin & E.	£35.00 + £2.80	£4.00 + 32p
16mm	Twin & E.	£55.00 + £4.40	£5.00 + 40p

TERMS: Where order is under £5 please add 30p surcharge to offset packing expenses.

## J. BULL (ELECTRICAL) LTD.

(Dept. E.E.), 103 TAMWORTH ROAD, CROYDON CR0 1XX

## ITS FREE!

Our Monthly Advance Advertising Bargains List gives details of bargains arriving or just arrived—often bargains which sell out before our advertisement can appear—its an interesting list and its free—just send S.A.E. Below are a few of the Bargains still available from previous lists.

Spit motor with Carter gear box. Probably one of the best spit motors made. Originally intended to be used in very high priced cookers; however, this can be put to plenty of other uses, for instance your garden barbecue or to drive a colour disc for a dance or display or to drive a tumbler for stone polishing; in fact, there is no end to its uses. Normal mains operation. Special price during May and June £2.50 + 20p, post 30p + 2p.

Pulse transformer with circuit for sound to light unit. It is a very simple circuit and all parts are readily obtainable from us or you may already have them in your junk box. Price of the transformer with circuit 75p, post and VAT paid.

ORP 12 light cell. This device has been going for some years now but demand is still high and new applications keep being found for it. We have good stocks, price 65p + 5p.

Throat mikes. These are an ex WD item as used by air crew on their intercom, but being electromagnetic they also serve as pick-ups on musical instruments, talking to passengers on motor bike and no doubt many other use. Price 60p a pair + 15p.

1 1/2 watt speaker bargain, 8" round mid-range, made for high price hi-fi outfit, a really super speaker, £3 + 37p, post 60p + 15p.

O.C.P. photo transistor by Mullard, very popular for circuits such as Infra-red burglar alarms, smoke detectors, etc. A big buy and they sell at the very favourable price of 25p each — 2p, or 5 for £1 + 8p.

Component boards, mainly ex computer, these contain many useful parts and represent fantastic value at 5 for £1 + 8p. We guarantee the 5 would be different. You would receive ICs etc., variable controls with long leads and so are easy to remove and re-use. Post 50p — 4p.

Microswitch bargain, made by Fye, Honeywell, Burgess and similar first class makers originally for the Post Office, in fact they have been fitted to Post Office Equipment which was never put into use. They are a changeover microswitch with 10 amp contacts offered at the very low price of 20p for £1 + 8p. Post 40p + 3p.

Ferrite pot core (Vinkor) made by Mullard, maker's ref. No. LA 14107402K, circular, size approx. 1 1/2" x 3/4", a size which is the same as the one specified for the 800 ohm ignition system. Price only 60p + 4p per pair. Post 15p + 1p.

12v DC motor made by Smiths, powerful, ideal for blower; motor size 4" long x 3" diameter, 1/2" spindle, 1 1/2" long. £2. + 16p. Post 40p + 3p.

Thermostat with capillary with sensor joined by approx. 1 metre of capillary covering the temperature range 0-170°C capable of switching 16 amps at 250v. Made by the famous Ranco Company with screwed thread and spindle rather like a volume control—has dozens of applications. Offered at only 75p + 6p. Post 12p — 1p.

Aerials. For medium and long wave, wound and fitted on ferrite rod, 6" long by 1/2" diameter. Price 60p + 15p Post 10p + 5p.

Dial thermometer by Rototherm, indicates from 50F to 250F, dial size 3 1/2", chrome and glass front. 75p + 6p. Post 10p + 1p.

Instrument Mains Transformer, 6.3v at 1 amp and 150v at 100mA. This is an upright model open construction, small size (2 1/2" x 2 1/2"). Price £1.40 + postage and VAT 60p. DITTO. 6.3v at 1 amp and 150v at 200mA. This is a fully shrouded upright mounting transformer, size approx. 2 1/2" x 3" x 3". Price £1.95 + post and VAT 85p.

Instrument power supply mounted on a chassis size 9 1/2" x 2 1/2" x 4 1/2". This is suitable for instruments which use valves and has AC output of 6.3v at 1 amp and a fully smoothed DC outputs of 150v and 200v. Price £9.50 + post and VAT 74p.

FM Band amplifier. This is a 4 valve amplifier tunable to cover FM and also to stereo frequencies. Tuning is by levers in fully screened compartments and the whole is mounted on a heavy metal chassis size 9" x 2" x 2 1/2". This requires a separate power supply of 150v DC at 100 mA and 6.3v at 1 amp. Price £3.75 + post and VAT £1.58.

Instrument case, grey steel finish size 9 1/2" x 3 1/2" x 2 1/2". These cases are not secondhand but come from partly assembled equipment, so the front panel has a few holes already punched through. However, these are very suitable for toggle switches, etc. There are no really big holes, 50p each + post and VAT 36p.

6 switch disco lamp controller. This is a mains motor driving a rotating drum made up of discs with cut-outs. As the cut-outs engage on the switch levers, contact is made via 10 amp switches. A large variety of lighting effects can be obtained. A real bargain at £2.75 + post & VAT. 65p.

Clock switch for Trinity cooker, made by Smiths and probably a replacement in many other cookers. This has clock in the centre and two control switches on the right-hand side. The top control switch sets the on-off times and is infinitely adjustable over the 12 hours; the lower switch selects manual or automatic. No glass front, but you could take this off your existing clock. Price £1.75 each + post & V.A.T. 85p.

**ENGINEERS**

**FREE**

**YOURSELF FOR A**

**BETTER JOB WITH MORE PAY!**

Do you want promotion, a better job, higher pay? "New opportunities" shows you how to get them through a low-cost, Home Study Course. There are no books to buy and you can pay as you learn.



This easy to follow GUIDE TO SUCCESS should be read by every ambitious engineer. Send for this helpful 44 page free book NOW! No obligation, nobody will call on you. It could be the best thing you ever did.

**CHOOSE A BRAND NEW FUTURE HERE**

**CUT OUT THIS COUPON**

<input type="checkbox"/> <b>ELECTRICAL and ELECTRONICS</b>	<input type="checkbox"/> <b>AUTO and AERO Motor Mechanics</b>	<input type="checkbox"/> <b>MECHANICAL A.M.S.E. (Mech.)</b>
<input type="checkbox"/> Practical Radio & Electronics (with KIT)	<input type="checkbox"/> C. & G. Motor V. Mechanics	<input type="checkbox"/> General Mech. Eng.
<input type="checkbox"/> Electronic Engineering Certificate	<input type="checkbox"/> General Auto Engineering	<input type="checkbox"/> Inst. Engineers & Technicians
<input type="checkbox"/> General Elect. Eng. Certificate	<input type="checkbox"/> A.M.I.M.I.	<input type="checkbox"/> Maintenance Engineering
<input type="checkbox"/> C. & G. Elect. Installations	<input type="checkbox"/> Air Registration Board Certs.	<input type="checkbox"/> Welding
<input type="checkbox"/> Elect. Install. & Work	<input type="checkbox"/> M.A.A./I.M.I. Dip.	
<input type="checkbox"/> C. & G. Elect. Technicians	<input type="checkbox"/> <b>CONSTRUCTIONAL</b>	<input type="checkbox"/> <b>MANAGEMENT and PRODUCTION</b>
<input type="checkbox"/> <b>RADIO and TELECOMMUNICATIONS</b>	<input type="checkbox"/> Heating, Ventilating & Air Conditioning	<input type="checkbox"/> Computer Programming
<input type="checkbox"/> Colour TV Servicing	<input type="checkbox"/> Architectural Draughtsmanship & Design	<input type="checkbox"/> Inst. of Cost & Managements Accts.
<input type="checkbox"/> C. & G. Telecoms. Technician's Cert.	<input type="checkbox"/> L.I.O.B.	<input type="checkbox"/> <b>DRAUGHTSMANSHIP and DESIGN</b>
<input type="checkbox"/> C. & G. Radio, TV & Electronics Mech. Cert.	<input type="checkbox"/> Carpentry & Joinery	<input type="checkbox"/> General Draughtsmanship
<input type="checkbox"/> Radio & TV Engineering Course	<input type="checkbox"/> Plumbing Technology	<input type="checkbox"/> A.M.I.E.D.
<input type="checkbox"/> Radio, Servicing & Repairs	<input type="checkbox"/> General Building	<input type="checkbox"/> Electrical Draughtsmanship
<input type="checkbox"/> Radio Amateur's Exam.	<input type="checkbox"/> Painting & Decorating	

**POST NOW**

**G.C.E.**  
—58 'O' & 'A' Level Subjects  
—over 10,000 Group Passes!

**Aldermaston College**

Dept. TEE17 Reading RG7 4PF.

also at our London Advisory Office, 4 Fore Street Avenue, Moorgate, London EC2Y 5EJ. Tel. 01-628 2721.

NAME (Block Capitals) .....

ADDRESS .....

..... Postcode.....

Other subjects of interest..... Age.....

Accredited by C.A.C.C. Member of A.B.C.C.

**HOME OF BRITISH INSTITUTE OF ENGINEERING TECHNOLOGY**

**SPRING MADNESS BARGAIN SALE**

	NORMAL PRICE	
F.M. Tuners, 8-transistor chassis with Stereo-decoder and L.E.D. indicator	<del>£16.60</del>	£10.90
Aircraft-band receiver, just place near any radio	<del>£5.97</del>	£3.90
Echo-chamber. (Endless tape). Variable delay	<del>£32.00</del>	£34.50
Field-strength indicators, 1-250 MHz	<del>£5.00</del>	£3.30
Stereo Amplifiers complete, 3-watt, 8-ohm	<del>£4.00</del>	£2.75
10-watt Amplifiers, 12 volt D.C. 3/8/15-ohm	<del>£5.90</del>	£3.90
Cartridges, Acos GP 104. Ceramic/Diamond	<del>£2.82</del>	£1.50
Cartridges, Acos GP 101. Crystal/Sapphire/Compatible	<del>£1.00</del>	£0.50
Speakers, 2 1/2" - 8 ohm	<del>£0.50</del>	£0.35
Speakers, Car Stereo, 8-ohm, 5-watt. In cabinets	<del>£1.90</del>	£2.50
Dynamic Tape Mikes with remote-control facility	<del>£1.90</del>	£0.90
Crystal Tape Recorder Mikes	<del>£1.00</del>	£0.60
Crystal Mike Inserts with bracket	<del>£0.30</del>	£0.20
Indicators, 12-volt L.E.D. In Chrome Bezel	<del>£0.48</del>	£0.35
"Bargain Bags" 4lbs Caps/Resistors/Transistors/Diodes	<del>£5.00</del>	£4.00
Controls, Volume/Pre-set (Rotary & Slider) Assorted 100		£2.50
Transistors, 20 NPN/PNP. All new and marked		£1.00
Transistors, 100 NPN untested.		£1.00
Diodes, 100 Germanium untested		£0.50
Diodes, 100 Silicon untested		£0.50
Diodes, 100 Zener untested		£0.50
"Pack 1" 100 resistors, 100 ceramics, 100 diodes		£1.00
"Pack 2" 100 resistors, 100 ceramics, 100 polystyrene		£1.00
"Pack 3" 100 resistors, 100 S/Mica/Ceramic, 100 Polyester		£1.00
ALL ABOVE ITEMS PLUS 12 1/2% VAT		
Fluorescent 12-volt Camping Lights, 2 1/2" 13-watt	<del>£8.00</del>	£4.90
12" 8-watt	<del>£7.00</del>	£3.90
"Disco type 3-Channel flashing light units. Built-in mike. No connection needed to amp	<del>£19.95</del>	£17.50
Multimeters, AC 0-1000V. DC 0-1000V., 0-100 ma. 0-150kohm	<del>£5.50</del>	£3.50
Multimeters, AC 0-500V. (10 ranges) DC 0-500V. (12 ranges)		
DC Current 0-25ua to 0-10 amps (10 ranges)		
Resistance 0-100ohms to 0-16Mohms. (4 ranges)		
Panel Meters, 0-50ua, 2 1/2"	<del>£13.95</del>	£11.30
Soldering Irons, 15-watt, Pencil Bit.	<del>£1.50</del>	£2.50
Servisol Switch Cleaner (with Snorkel)	<del>£1.50</del>	£1.20
Copper-clad Fibre Glass Board, Single-sided, Square foot	<del>£0.65</del>	£0.50
Double-sided		£1.00
"Fotolak" Light sensitive spray for printed circuit making		£1.25
Developer for same		£1.30
Ferric Chloride for etching		£0.30
		£0.40
ALL ABOVE ITEMS PLUS 8% VAT		

G. F. MILWARD, 369 Alum Rock Road, Birmingham B8 3DR. POSTAGE: Below £10 50p Above £10 Free

**CRESCENT RADIO Ltd.**

164-166 HIGH ROAD LONDON N22 6EJ  
(also) 13 SOUTH MALL, Edmonton, N.9  
MAIL ORDER DEPT. 1 St Michaels Terrace Wood Green  
London N22 4SJ Phone 888 3206 & MAIL ORDER 888-4474

<b>POWER PACKS</b>	<b>CABLELESS SOLDERING IRON WAHL "ISO-TIP"</b>
PP1 Switched 3, 4, 6, 7 1/2, 9 and 12 volt @ 500 m/a, and 12 volt switch and pilot light. Size = 130 mm x 55 mm x 75 mm ONLY = 24.50	★ Completely Portable
PP3 Car converter, From 12v Pos. or Neg to - 6-7 1/2 volt. Easy to fit and transistor regulated. £3.90 each.	★ Solders up to 150 joints per charge
Plus 8% VAT	★ Re-charges in its own stand
	★ Fine tip for all types of soldering
	★ Only 8" long and weighs just 6 ozs.
	Our Price £9.75. Plus 8% VAT (Spare bits are available)

<b>P.C. ETCHING KIT</b>	<b>ALUMINIUM BOXES</b>																																																																						
This kit contains all that the constructor will need to etch the circuits of his own design. Contents—Plastic etching dish. Sample copper clad board. Laminate Cutter. 1 lb Ferric Chloride. Large Plastic Spoon. Etch Resist Pen. Full Etching Instructions. Complete and Big Kit Value at £3.75p + 8% VAT.	Metal Project Boxes give your work a professional finish.																																																																						
	<table border="1"> <thead> <tr> <th></th> <th>L</th> <th>W</th> <th>H</th> <th>Price</th> </tr> </thead> <tbody> <tr> <td>AB7</td> <td>2 1/2</td> <td>5 1/2</td> <td>1 1/2</td> <td>45p</td> </tr> <tr> <td>AB8</td> <td>4</td> <td>4</td> <td>1 1/2</td> <td>45p</td> </tr> <tr> <td>AB9</td> <td>4</td> <td>2 1/2</td> <td>1 1/2</td> <td>45p</td> </tr> <tr> <td>AB10</td> <td>4</td> <td>5 1/2</td> <td>1 1/2</td> <td>54p</td> </tr> <tr> <td>AB11</td> <td>4</td> <td>2 1/2</td> <td>2</td> <td>45p</td> </tr> <tr> <td>AB12</td> <td>3</td> <td>2</td> <td>1</td> <td>39p</td> </tr> <tr> <td>AB13</td> <td>6</td> <td>4</td> <td>2</td> <td>65p</td> </tr> <tr> <td>AB14</td> <td>7</td> <td>5</td> <td>2 1/2</td> <td>79p</td> </tr> <tr> <td>AB15</td> <td>8</td> <td>6</td> <td>3</td> <td>81.25p</td> </tr> <tr> <td>AB16</td> <td>10</td> <td>7</td> <td>3</td> <td>£1.35</td> </tr> <tr> <td>AB17</td> <td>10</td> <td>4 1/2</td> <td>3</td> <td>£1.02</td> </tr> <tr> <td>AB18</td> <td>12</td> <td>5</td> <td>3</td> <td>£1.20</td> </tr> <tr> <td>AB19</td> <td>12</td> <td>8</td> <td>3</td> <td>£1.50</td> </tr> </tbody> </table>		L	W	H	Price	AB7	2 1/2	5 1/2	1 1/2	45p	AB8	4	4	1 1/2	45p	AB9	4	2 1/2	1 1/2	45p	AB10	4	5 1/2	1 1/2	54p	AB11	4	2 1/2	2	45p	AB12	3	2	1	39p	AB13	6	4	2	65p	AB14	7	5	2 1/2	79p	AB15	8	6	3	81.25p	AB16	10	7	3	£1.35	AB17	10	4 1/2	3	£1.02	AB18	12	5	3	£1.20	AB19	12	8	3	£1.50
	L	W	H	Price																																																																			
AB7	2 1/2	5 1/2	1 1/2	45p																																																																			
AB8	4	4	1 1/2	45p																																																																			
AB9	4	2 1/2	1 1/2	45p																																																																			
AB10	4	5 1/2	1 1/2	54p																																																																			
AB11	4	2 1/2	2	45p																																																																			
AB12	3	2	1	39p																																																																			
AB13	6	4	2	65p																																																																			
AB14	7	5	2 1/2	79p																																																																			
AB15	8	6	3	81.25p																																																																			
AB16	10	7	3	£1.35																																																																			
AB17	10	4 1/2	3	£1.02																																																																			
AB18	12	5	3	£1.20																																																																			
AB19	12	8	3	£1.50																																																																			
	All size are approx and in inches. Plus 8% VAT																																																																						

<b>FERRIC CHLORIDE</b>	<b>2in. PANEL METERS</b>	<b>MINI LOUSPEAKERS</b>
Anhydrous ferric chloride in double sealed one pound plastic pack. OUR PRICE — 65p + PP + 8% per lb.	Size 59mm x 46mm	2 1/2" 80 ohm 60p
	0-50uA —ME5	2 1/2" 40 ohm 60p
	0-100uA —ME7	2 1/2" 8 ohm 60p
	0-500uA —ME8	+ 12 1/2%
	0-1A —ME15	
	0-1mA —ME9	
	0-5mA —ME10	
	0-10mA —ME11	
	0-50mA —ME12	
	0-100mA —ME13	
	0-500mA —ME14	
	0-1A —ME15	
	0-50V —ME16	
	0-300V a.c. —ME17	
	8 meter —ME18	
	V.U. meter —ME19	
	£3 + 8%	

**GOODMANS CROSSOVER**  
3 way 8 ohm Crossover manufactured by Goodmans. Bargain at £1 + 12 1/2%.

U.K. CARR. All prices are excluding VAT. Please add to each item the VAT rate indicated to all orders unless otherwise stated

# DOWN TO EARTH

By GEORGE HYLTON

## OSCILLATING BUCKETS

ONE of the delights of the 1951 Festival of Britain exhibition was a piece of "water sculpture" on the South Bank near the Royal Festival Hall. It was fun. A stream of water filled a bucket. The bucket was pivoted so that as it filled up it became top heavy and eventually tipped, spilling its contents. Then, being lightened, it righted itself and began to fill again.

The designer had arranged a sort of pyramid of these tilting buckets, stacked one above the other in an artistic group, with the smaller ones at the top and the big ones at the bottom. They all filled up until, at some point, one of the top buckets tilted. Its contents poured out into the buckets below, and they too tilted, and so on down the pyramid. In a few seconds what had been a static object turned into a rushing, splashing cascade. Very satisfactory.

Better still, the designer had arranged matters so that there was a pleasing element of randomness in the bucket-tipping. You could never be sure which top bucket would tilt first, or in just what sequence the buckets underneath would spill. So the cascade didn't ever seem to be the same twice, but to have a mind of its own, instead of being a mere, repetitive, mechanically monotonous thing.

It's a pity they didn't leave it there, because as I now realise, it had great educational value—as a mechanical analogue of a chain of coupled relaxation oscillators. Each tilting bucket was just such an oscillator.

The characteristics of the device are typical. First, a long, stable period during which the bucket fills, and there's no apparent action. Then a short period of violent activity as the bucket empties. Then a swing back to the original state, after which the process repeats itself ad infinitum.

## ELECTRONIC RELAXATION

In typical *electronic* relaxation oscillators, the bucket is a capacitor. The water is a current which flows into the capacitor via a resistance. The jobs of detecting when the bucket is full, that is, when the capacitor is charged, and suddenly emptying it, are done by the "active" parts of the circuit, such as transistors.

Relaxation oscillators are repetitive timing devices. They ought to be called *relaxation-time* oscillators, because it is the time taken by a capacitor to charge or discharge which governs the action. The "relaxation" bit refers to the ebbing away of a charge or the slow recovery of a charge.

## NEON TUBE

A beautifully simple relaxation oscillator is the neon-tube oscillator (see Fig.1). This works because a neon tube has the property that it doesn't "strike" (conduct and light up) until a high voltage (perhaps 100V) is applied, but then, as soon as it strikes, the voltage across it falls to a lowish value (say 80V).

When the circuit is switched on there is no voltage across the neon because the neon gets its voltage from the charge on  $C1$ . With the circuit off  $C1$  is uncharged.

Switch on, and  $C1$  charges via

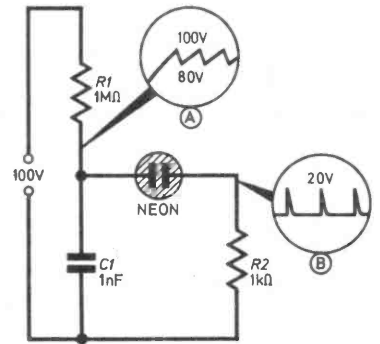

Fig. 1. The neon oscillator.

$R1$ . No current flows through the neon until  $C1$  is charged to say 100V. Then the neon strikes, and passes current, and since  $R2$  is much smaller than  $R1$  the charge on  $C1$  is rapidly drained away, until the voltage on  $C1$  falls to 80V, at which point the neon goes out and the cycle recommences.

The voltage across  $C1$ , with the circuit oscillating steadily, is shown on the diagram (at point A). What is the voltage across  $R2$ ? Since there is current in  $R2$  only when the neon conducts, and this is only during the brief periods when the voltage is falling from 100V to 80V, the voltage across  $R2$  (point B) is a series of short pulses.

## RELATIVES

The neon-tube oscillator has a close semiconductor relative in the form of the unijunction transistor oscillator, but most other transistor relaxation oscillators are much more complicated. This is because two ordinary transistors are needed for each oscillator. These two-transistor circuits can be regarded as two-stage amplifiers with a lot of positive feedback, which turns the ampli-

Fig. 2. (a) and (b) The multivibrator or astable flip flop.

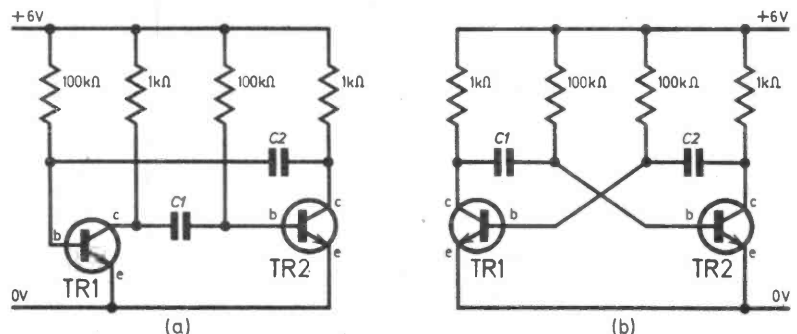



fier into an oscillator.

Oscillation is so violent that the amplifier is grossly overloaded. Consequently the transistors spend most of the time in a non-amplifying condition, either cut-off and passing no current or saturated and passing too much. The circuit of Fig. 2a is often used; it's a two-stage capacitively-coupled amplifier with the a.c. output fed back to the input via C2. It produces square waves, and is usually called a multivibrator or astable flip-flop, and drawn in the rearranged but electrically identical form as shown in Fig. 2b. Both capacitors play their part in the timing sequence: C1 controls the duration of one part of the cycle

and C2 the other. Equal C's and R's in the two stages give a square wave.

## SYNCHRONISATION

Relaxation oscillators are easily synchronised by injecting timing pulses into the circuit. On the tipping bucket analogy, it's clear that when the bucket is nearly full a tiny push will set it tipping. In the same way, when the capacitor in the neon oscillator is nearly charged to 100 volts, a small pulse is enough to make the neon strike (A negative pulse across R2 does the job.)

To synchronise with a steady train of sync. pulses the relaxation oscillator must be set to "run

slow". This is to ensure that it has not already flipped itself when the sync. pulse arrives.

It is likely that some biological timing systems (including those of human beings) are analogues of relaxation oscillators. The "circadian rhythms" in which the organism's functions go through a cycle of about 24 hours are a case in point. If a man lives for months in a deep cave, cut off from the sounds and sights of the world, and without a watch, so that he cannot know the time of day, his body's "free-running" cycle time is found to be more than 24 hours—just what you'd expect if the cycle is normally synchronised with day and night.

**New products and  
component buying  
for constructional  
projects**

# SHOP TALK

By Mike Kenward

WE must start this month with an apology, it appears that Henry's Radio are not able to supply the  $1\mu\text{F} \pm 1$  per cent capacitor required for the *Resistance Capacitance Bridge* as we stated in our April issue. However after some more searching we discovered that Electrovalue sell a "precision capacitance" which is  $1\mu\text{F}$ , 63V,  $\pm 1$  per cent and cost 90p—a very competitive price. Unfortunately they are unable to replace the item at the price and only have a limited stock (first come etc).

Whilst on the subject of the Bridge we have received a list of parts from one well known supplier and the equivalent cost to our approximate cost is £6.57. Having rechecked our figures we are prepared to stick to our £4 even if the  $1\mu\text{F}$  capacitor costs about £1.70. What we must say to readers is: If you pay much more

than our cost for your components (excluding V.A.T. and postage etc) then there is either a good reason for this (i.e. components of the highest quality and only well known makes, or exceptional service from the retailer) or you should consider looking elsewhere.

The firm in question have an excellent reputation, supply first class parts and provide a good service, however you must pay for it.

## Approximate Cost and VAT

We will continue to quote our approximate cost less V.A.T. since Mr. Healey has done nothing to sort out the ridiculous situation, even if he has brought down the cost of many components. The capacitor referred to above is available from one supplier at 8 per cent V.A.T. and another at 12.5 per cent; both are sure they are correct. The sooner we get back to one standard rate the better—it will be much more fair to the component buyer in the long run and we are quite sure it would cost the country much less in red tape.

## Cost of Projects

In the past we have had complaints from some readers about the high cost of some of our projects. After all, they say, many of our readers are still at school or college and have a very limited income. We have always tried to keep a balance when publishing an amplifier or receiver that carries a high price tag, but this month, although all the projects are excellent and useful devices, none of them costs more than £3.

When you compare this with the cost of similar commercial equipment our hobby can be shown to be very economical. For instance a comparable Waa Waa would cost you about £15 and you would not receive the satisfaction of building your own.

## Projects

Perhaps one of the main reasons this month's articles work out very cheaply is that three of them use 741 operational amplifiers and these can be purchased from most suppliers for around 25p. In fact the *Peak Level Indicator* employs two of these devices, one for each channel for stereo, together with a number of other inexpensive and readily available components. As with the other projects this month the case for this design is likely to cost as much as all the other parts.

We have not followed our usual style of writing a paragraph or two on each constructional this month simply because there is only one component specified in the four articles that requires any particular mention. Parts for the *Continuity Tester* and the *Enlarger Meter* should all be readily available. Any local difficulties should be easily overcome by ordering from one of the larger firms who advertise in our pages.

The *Waa Waa Pedal* contains the only component which warrants special mention and this, surprisingly enough, is the foot switch. We have found it difficult to buy the necessary type of switch made strong enough for foot operation. That specified in the components list is available from Express Components, 29 White Road, Stratford, London E15 4HA. The cost is £1.40 including postage etc.

*Everyday Electronics, June 1976*

# A few interesting (and not so interesting) things you could find with a Heathkit Metal Locator.

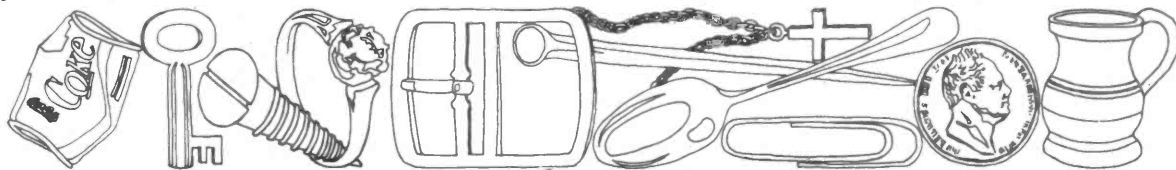

With a Heathkit Metal Locator in your hand you can find buried metal objects as small as a halfpenny.

And, unlike many other locators, the Heathkit uses a special 'induction balance' search system, which means you hear no tone at all until a metal object enters the locator's search field.

But, once a metal object is located you'll hear a signal through the loudspeaker (or optional headphones) which increases in volume the closer you get.

Two models are available: the GD-348 Deluxe Locator and the GD-48 Economy Locator.

Both models have a front-panel meter to pinpoint your find. And the Deluxe model even allows you to differentiate between ferrous and non-ferrous metals.

And of course, being Heathkits, they couldn't be easier to build. The kits come absolutely complete—with a comprehensive instruction manual that takes you step by step through the assembly.

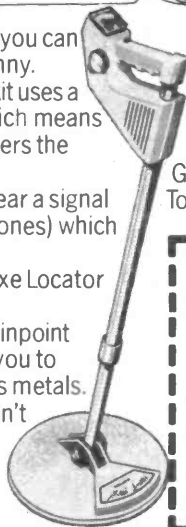

You'll find them both in the latest Heathkit catalogue. Just send us 10p for postage and we'll send you your copy.

Besides the metal locators, you'll find a lot of other interesting things in it.

Heath (Gloucester) Ltd., Bristol Road, Gloucester, GL2 6EE. Tel: (0452) 29451. Showrooms in Gloucester and Tottenham Court Road, London. **HEATHKIT**

To: Heath (Gloucester) Ltd., Dept. EE-66,  
Bristol Road, Gloucester, GL2 6EE.  
Please send me a Heathkit catalogue.  
I enclose 10p for postage.

HEATH  
Slumberger

Name .....

Address .....

Postcode .....

EASY TERMS AVAILABLE  
WITH HEATHKIT MONTHLY  
BUDGET PLAN

## ELECTRONIC DIGITAL CLOCK with alarm and snooze features

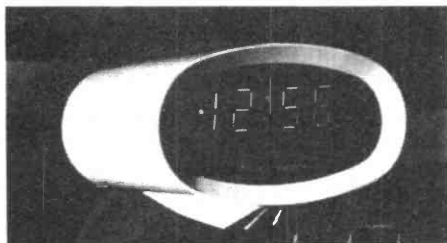

**SPECIAL OFFER**

**£12.48**

+ 99 pence VAT

**FEATURES:** ● 0.7 INCH HIGH DIGITS ● VARIABLE INTENSITY ● 24 HOUR ALARM ● 5 MINUTE REPEATING SNOOZE ALARM ● ALARM SET INDICATOR ● SNOOZE INDICATOR ● PULSING SECOND INDICATOR ● POWER INTERRUPT INDICATOR ● ALARM CANCEL FEATURES — TILT OPERATION ● ALARM TONE OUTPUT ● A.M. P.M. INDICATOR

Size: 130mm x 90mm x 95mm; Weight: 10oz; Power supply: 110 VAC ± 10% 60Hz, 230 VAC ± 10% 50Hz

Manufactured to high standards by a major American electronics corporation this superbly styled solid-state timepiece is made available to all readers fully guaranteed.

**FREE TRIAL IN YOUR HOME. TRY OUT THE CLOCK IN YOUR HOME. IF DIGITAL TIME IS NOT FOR YOU RETURN IT IN ORIGINAL CONDITION WITHIN 10 DAYS AND WE'LL REFUND YOUR MONEY WITHOUT QUESTION.**

**TIME MICROELECTRONICS**

**BRIGHTON HILL PARADE, BASINGSTOKE,  
HAMPSHIRE RG22 9EH.**

Please send  electronic clocks as illustrated

I enclose cheque  postal order  money order  £14.02 which includes 55p p & p

Name .....

Address .....

Signature .....

**SINCLAIR IC20**

IC20 10W+10W stereo IC amplifier kit with free booklet and printed circuit £4.95.  
 PZ20 Power supply kit for the above £3.95.  
 VP20 Volume, tone-control and preamp kit £7.50.  
 SP20 10W 4 ohm speaker for IC20 £2.70.  
 CS20 11 x 6 x 3in attractive case for IC20 £2.95.  
 Send sae for free leaflet.

**JC12 AMPLIFIER**

6W IC audio amp with free data and printed circuit £1.95\*

**DELUXE KIT FOR JC12**

Includes extra parts for the pcb and vol, bass and treble controls for mono version £2.06. Stereo model with balance control £4.46.

**JC12 POWER KIT**

Supplies 25V 1 Amp £3.25.

**JC12 PREAMP KITS**

Type 1 for magnetic pickups, mics and tuners. Mono £1.40. Stereo £2.80. Type 2 for ceramic or crystal pickups. Mono 78p. Stereo £1.56.

**LOUDSPEAKERS FOR JC12**

8in x 5in 8 ohms 5W £2.28.

SEND SAE FOR FREE LEAFLET ON KITS.

**FERRANTI ZN414**

IC radio chip with data £1.34. Printed circuit and extra parts for radio £3.25. Case 80p extra. Send sae for free leaflet.

**SINCLAIR PROJECT 80**

FM tuner £13.25. Q16 £10.95. PZ5 £3.95. PZ6 £8.70. PZ8 £9.10. Trans for PZ8 £5.60. Z40 £5.75. Z60 no longer available, but we stock a similar 30W equivalent amp £19.30. Stereo 80 £11.95. Project 80SQ £18.95. Quad decoder £14.95.

**PRINTED CIRCUIT KIT £3.95\***

Make your own printed circuits. Contains etching dish, 200 sq ins of copper clad board, 1lb ferric chloride, etch resist pen, small drill bit, laminate cutter and instructions.

**MAINS TRANSFORMERS**

6-0-6V 100mA 86p. 9-0-9V 100mA 86p. 18V 1A £1.65\*. 0, 12, 15, 20, 24, 30V 1A £2.95\*. 12-0-12V 1A £1.95\*. 0, 12, 15, 20, 24, 30V 2A £4.20\*. 20V 2½A £2.00. 6 and 9V trans are DC rated, others are AC volts.

**SINCLAIR BLACK WATCH**

Fully assembled with black strap £20.95\*. Bracelet £2\*.

**SINCLAIR CALCULATORS\***

Cambridge £7.95. Cambridge % £8.95. Scientific £11.95. Cambridge Scientific £14.95. Oxford 100 £6.95. Oxford 300 £16.95. Programmable Scientific £25.95. Mains adaptors:- for programmable and Oxfords £3.19; for Camb. and scientific £3.15.

**CBM CALCULATORS\***

776MD 7 digit/%memory £5.95. 796MD 8 digit/%memory £6.48. 897D 8 digit/%4 function memory £7.60. SR7919D 8 digit/memory/trig/log/pl/powers/scientific notation £13.20. SR1800 10 digit scientific £23.25. SR4148R 14 digit rechargeable scientific with charger £34.95. Mains adaptor for other machines £2.95.

**CASIO CALCULATORS\***

Personal mini 6+6 digits £5.95. Pocket 8S 8 digits/%const £6.95. Memory 8R 8 digits/%memory/const £8.95. FX20 £16.95. Mains adaptor for all models £3.95.

**NOVUS CALCULATORS\***

750 8 digit £5.45. 835 8 digit/%const/sq. root/4 function memory £7.80. 4525 10 digit programmable scientific calculator £47.95. 4510 £13.20. 4515 £39.95. 4520 £23.45. Mains adaptor £4.20.

**24 HR DIGITAL CLOCK KIT\***

Includes pcb, mains power supply, attractive case 0.5in Jumbo green display, clock chip, and all other parts. Displays hours and minutes separated by a pulsating colon. Kit £12.50. Built £13.50. Send sae for free leaflet.

**S-DECS AND T-DECS\***

S-DeC £2.24

T-DeC £4.05.

u-DeC A £4.45

u-DeC B £7.85

IC carriers:-

16 dit: plain £1.07

with socket £2.21

10T05: plain 99p.

With socket £1.95.

SST1 60p. SSU1 60p. SSN1 80p.

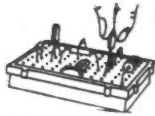
**BATTERY ELIMINATOR BARGAINS****55 WAY SUPER**

New switched model. 3 to 30V in 1V steps. Fully stabilized. 1A output. Kit £7.95. Assembled £10.95. 2 Amp model. Kit £9.95. Built £12.95.

**6 WAY SPECIAL**

Switched output of 3/4/6/7/9/12V at 500mA with 4-way multi-jack plug and free matching socket £5.20.

**6-WAY DOUBLE RADIO MODEL £6.20**

Similar to above, but with press-stud battery connectors. 3+3/4+4+6+6/7+7/9+9/12+12V at 250mA. Also gives 15/18/24V single.

**3-WAY MODEL**

Switched output of 6/7/9V at 250mA with 4-way multi-jack plug and free matching socket £2.95\*.

**RADIO MODELS**

50mA with press-stud battery connectors for radios etc. 9V £3.25. 6V £3.45. 9+9V £4.45 6+6V £4.45. 4+4+4V £4.45. Also 9V 300mA £3.95.

**CASSETTE MAINS UNITS**

7½V output to run cassette recorders from the mains. Complete with 5 pin DIN plug. 50mA model £3.48. 300mA model £3.95.

**CAR CONVERTERS**

Input 12V DC. Output 6/7/9V DC 1A regulated £3.95\*.

**BATTERY ELIMINATOR KITS**

Send sae for free leaflet on range.

100mA radio type with press stud battery terminals. 4½V £1.80. 6V £1.80. 9V £1.80.

50mA double radio type with press stud terminals. 4½V+4½V £2.50. 6V+6V £2.50. 9V+9V £2.50.

100mA cassette type with 5 pin DIN plug. 7½V £1.80. Stabilized 8-way type with voltage stabilizer to give low hum. 3/4/6/7/9/12/15/18V 50mA £2.95.

Heavy duty 12-way types 4½/6/7/8/11/13/14/17/21/28/34/42V. 1 Amp £3.95. 2 Amp £5.95.

**SWANLEY ELECTRONICS**

Dept. EE, PO BOX 68,  
 SWANLEY, KENT.

Post 30p on orders under £2, otherwise free. Prices include VAT. (Overseas customers deduct 7% on items marked\*, otherwise 11%). Official orders from schools, government labs. etc. welcome.

**QUALITY STEREO SOUND.**

ALMOST 1/2 PRICE OFFER! SOLENT AUDIO SYSTEM  
**£5.00 down**

MADE TO SELL AT DOUBLE THE PRICE IN CABINET FORM  
 OUR PRICE **£56.95**

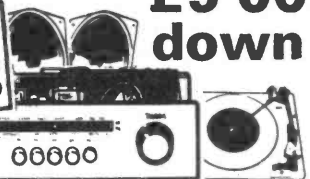

\*Stereo Tuner Amplifier chassis with AM/FM radio covering long medium short and Stereo/FM wavebands. Separate Base and Treble controls. 30 watts total power output (frequency response 25-20,000 Hz) AFC Switching Tape record and playback facilities. Dimensions 18½" x 9" x 3½". The very latest BSR automatic record deck with cue and pause control. Two matching elliptical speaker units.

Order early limited stocks available cash price £56.95. Credit Sale £5.00 deposit 9 monthly payments of £6.75 (Total Credit price £65.75). P. & P. £3.00. Send £8.00 today.

Chassis only available for cash at £45.00.

Full 12 months Guarantee.  
 CALLERS WELCOME.

Access and Barclaycard Orders Accepted by Telephone

FREE! Stereo headphones supplied with every complete order.

**LEWIS radio** 100 CHASE SIDE SOUTHGATE  
 LONDON N14 5PL Telephone: 01-882-1644

**ENGINEERS**

**FREE**

**YOURSELF FOR A BETTER JOB WITH MORE PAY!**



This 44 page FREE book shows how!

Do you want promotion, a better job, higher pay? "New Opportunities" shows you how to get them through a low-cost home study course. There are no books to buy and you can pay-as-you-learn.

This helpful guide to success should be read by every ambitious engineer. Send for this helpful 44 page FREE book now. No obligation and nobody will call on you. It could be the best thing you ever did.

**CUT OUT THIS COUPON**  
**CHOOSE A BRAND NEW FUTURE HERE!**  
 Tick or state subject of interest. Post to the address below.

<input type="checkbox"/> Electrical Engineering	<input type="checkbox"/> Colour T.V. Servicing	<input type="checkbox"/> CITY AND GUILDS Installations and Wiring
<input type="checkbox"/> Electrical Installations and Wiring	<input type="checkbox"/> C & G Radio, T.V. and Electronic Mechanics	<input type="checkbox"/> CITY AND GUILDS Electrical Technicians
<input type="checkbox"/> Electrical Draughtsmanship	<input type="checkbox"/> General Radio and TV Engineering	<input type="checkbox"/> CITY AND GUILDS Telecommunications
<input type="checkbox"/> Electrical Mathematics	<input type="checkbox"/> Radio Servicing, Maintenance and Repairs	<input type="checkbox"/> Radio Amateurs' Exam. etc. etc.
<input type="checkbox"/> Electronic Engineering	<input type="checkbox"/> Transistor Technology	
<input type="checkbox"/> Computer Program		

To: **ALDERMASTON COLLEGE**  
 DEPT. EEV 18 READING RG7 4PF  
 Also at our London Advisory Office, 4 Fore Street Avenue  
 Moorgate, London EC2Y 5EJ. Tel: 01-628 2721.  
 NAME (Block Capitals Please) \_\_\_\_\_  
 ADDRESS \_\_\_\_\_  
 POSTCODE \_\_\_\_\_  
 Other subjects \_\_\_\_\_ Age \_\_\_\_\_  
 Accredited by C.A.C.O. Member of A.B.C.C.

HOME OF BRITISH INSTITUTE OF ENGINEERING TECHNOLOGY



FROM BI-PRE-PAK

# Stirling Sound Products

NOW THE BEST POWER-AMP COSTS YOU EVEN LESS

## SS.125 NOW £5.85

including postage & VAT

### OUTPUT

25 watts R.M.S. into 8Ω using 50V

### ★ DISTORTION

LESS THAN 0.05% AT ALL POWER LEVELS (FROM 10Hz TO 10KHz)

### FREQUENCY RESPONSE

± 1dB 10Hz to 30KHz (8Ω)

### HIGH Z INPUT

100Kohms (40dB gain/100x)

### INPUT SENSITIVITY

150mV for 25W.R.M.D. out

### SIZE

(inc mounting bracket) 4½" x 3" x ½" high (120 x 76 x 22mm)

Not only is this Stirling Sound's best audio amplifier yet; it rightfully qualifies as one of the best of its kind yet made available for constructors, AND WITH VAT REDUCED BY HALF TO 12½% THE SS.125 BECOMES BEST VALUE, TOO. Intended above all for high-fidelity, the characteristics of the SS.125 are such that it can be used in many other applications where dependability is the prime consideration. The SS.125 integrates well with other SS units as well as those of other manufacturers. Incorporates new circuitry using a complementary long-tailed pair input and full complementary output circuits to give standards of performance.

Designed and made for constructors who appreciate quality and value!

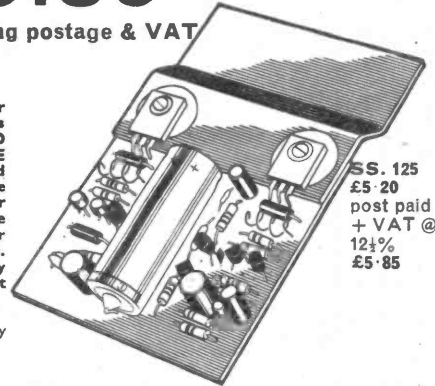

SS.125  
£5.20  
post paid  
+ VAT @  
12½%  
£5.85

## MORE STIRLING SOUND MODULES

### F.M. TUNER UNITS

SS.201/x Front End Tuner with AFC facility 108 MHz £5.00

SS.202 I.F. amp. A signal meter and/or A.F.C. can be connected (size 3" x 2") £2.65

SS.203 **STEREO DECODER** for use with Stirling Sound modules or any good mono F.M. tuner. A LED beacon indicator (Red—18p) may be incorporated (3" x 2") £3.85

SS.105 5 watt amplifier to run from 12V. (3½" x 2" x 3½") £2.25

SS.110 Similar to SS.105 but more powerful giving 10W. Into 4 ohms for 24 volt operation £2.75

SS.120 20 watt module when used with 34 volts into 4 Ω £3.25

SS.140 Delivers 40 watts R.M.S. Into 4 ohms using a 45V/2A supply such as our SS.345 the power and quality of this unit are superb. Size 4" x 3" x 2". £3.95\*

SS.100 Active tone control, stereo, ± 15dB cut and boost with suitable network £1.60

SS.101 Pre-amp for ceramic p.u., radio & tape with passive tone control details £1.60

SS.102 Stereo pre-amp with R.I.A.A. equalisation, mag., p.u. tape and radio in. £2.25

SS.300 Power Supply Stabiliser. Add this to your un-stabilised supply to obtain a steady working voltage from 12 to 50V for your pufo system, workbench etc. Money saving and very reliable £3.25\*

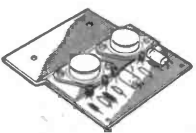
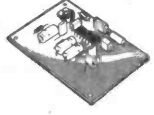

## STIRLING SOUND POWER PACKS

### WITH THE UNIQUE TAKE-OFF POINTS

Robustly designed units in each of which is a very useful stabilised take-off point to provide for tuner, pre-amp and control stages.

SS.312 12V/1A £3.75\*

SS.318 18V/1A £4.15\*

SS.324 24V/1A £4.60\*

(P/P add 50p, any model)

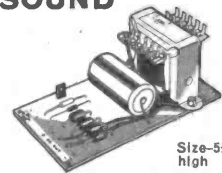

Size—5½" x 3" x 2½" high

SS.334 34V/2A £5.20\*

SS.345 45V/3A £6.25\*

### A new C.D.I. Unit for your car. Super Spark Mk 5

Even better than the original version, thousands of which are in use saving motorists appreciable time and money for petrol. Very easy to install. The Stirling Sound model incorporates switch for instant change to conventional ignition; easy adjustment for pos. of neg. earth, anti-burglar immobilising switch, pre-set control for rev. limitation and neon indicator. There are no exposed parts, the unit, on p.c.b. being housed in strong enclosed metal box. With instructions and leads. Case size 7½" x 4½" x 2½" (193 x 117 x 54mm) (P/P—add 50p). KIT £7.95\* BUILT & TESTED £10.50\*

Practical Wireless, May, say of this unit, "A very good investment indeed".

### A NEW X-HATCH GENERATOR

Operates at R.F. level Gives 4 different patterns as required. For colour and mono TV. Plugs into aerial socket of set. Operates without need for transmissions. 4 push-button operation. Runs on 4 self-contained penlite type batteries. Will fit into a large pocket. Strong plastic case. BUILT £27.50\*

### A USEFUL CATALOGUE — FREE

Send us a large S.A.E. with 10p stamp and we will send you the latest Bi-Pre-Pack catalogue free by return. Packed with useful lines, its a real money saver.

### TERMS OF BUSINESS:

VAT—12½% except items marked \* or (8%) for which the rate is 8%

VAT at the appropriate rate must be added to total value of order. No VAT on overseas orders. POST & PACKING add 30p for UK orders unless marked otherwise. Minimum mail order acceptable—£1. Overseas orders, add £1 for postage. Any difference will be credited or charged. PRICES subject to alteration without notice. AVAILABILITY All items available at time of going to press when every effort is made to ensure correctness of information.

Order your Stirling Sound products from

# BI-PRE-PAK LTD

Co Reg No 820919

222 224 WEST ROAD, WESTCLIFF-ON-SEA, ESSEX SS0 9DF.

TELEPHONE: SOUTHDEN (0702) 46344

CHEQUES/MONEY ORDERS PAYABLE TO BI-PRE-PAK LTD

Everyday Electronics, June 1976

TO STIRLING SOUND (BI-PRE-PAK LTD.) 222 WEST ROAD, WESTCLIFF-ON-SEA, ESSEX SS0 9DF

Please send .....

..... for which I enclose £ .....

inc. V.A.T.

NAME.....

ADDRESS .....

(EE 6B)



## Newnes Technical Books

Books of top quality written by popular experienced authors and designed for the beginner, student and those who just want to know more about their subject.

Here is a selection of Newnes Technical Books on electronics.

**BEGINNER'S GUIDE TO TRANSISTORS—2nd Ed.**  
I.R. Sinclair & J.A. Reddihough 160 pages £2.25

**BEGINNER'S GUIDE TO ELECTRONICS—3rd Ed.**  
T.L. Squires 240 pages £2.25

**ELECTRONICS POCKET BOOK—3rd Ed.**  
P.J. McGoldrick 350 pages £3.75

**50 PHOTOELECTRIC CIRCUITS & SYSTEMS**  
P.S. Smith 92 pages £1.80 limp £3.20 cased

**FOUNDATIONS OF WIRELESS & ELECTRONICS**  
9th Edition  
M.G. Scroggie 550 pages £3.75

**GUIDE TO BROADCASTING STATIONS—17th Ed.**  
206 pages £1.20

**QUESTIONS AND ANSWERS ON ELECTRONICS**  
Clement Brown 112 pages £1.15

**QUESTIONS AND ANSWERS ON INTEGRATED CIRCUITS**  
R.G. Hibberd 95 pages £1.00

**QUESTIONS AND ANSWERS ON TRANSISTORS**  
Clement Brown 96 pages £1.00

**RADIO VALVE & SEMICONDUCTOR DATA**  
10th Edition  
Compiled by A.M. Ball 180 pages £2.00

**TELECOMMUNICATIONS POCKET BOOK**  
T.L. Squires 152 pages £2.50

**TRANSISTOR POCKET BOOK**  
R.G. Hibberd 312 pages £3.90

## COMING JULY...

New Constructors Guides:

**SIMPLE CIRCUIT BUILDING and PROJECT PLANNING AND BUILDING** both by M.A. Colwell

**PRACTICAL ELECTRONIC PROJECT BUILDING**  
by Alan C. Ainslie and M.A. Colwell

### FREE COLOUR BROCHURE

Write to the address below for your free copy of our full colour brochure that gives details of all the Newnes Technical Books

Please order from your bookseller

**Newnes Technical Books**  
Borough Green, Sevenoaks, Kent

# ELECTROVALUE

the good components service

## COMPLETE YOUR TEACH-IN WITH E.V.

To ensure success and progress, learn above all to use components you can depend on and buy from a firm that really knows the business  
All electronic components for the E.E. Teach In  
POST PAID (UK) AND INC. VAT £14.25 NETT

## CATALOGUE 8 NOW ISSUE No. 2

With our first printing sold out, Cat. 8, No. 2 is now ready, revised and brought up to date on prices, etc. 144 pages. New items. Opto-electronics, Diagrams of Components, applications, I.C. circuits, etc. Post free 40p, including voucher for 40p for spending on order over £5 list value.

## DISCOUNTS

On all C.W.O. mail orders, except for some items marked NETT.  
5% on orders list value £10 or more 10% on orders list value £15 or more

## FREE POST & PACKING

On all C.W.O. mail orders in U.K. over £2 list value. If under, add 15p handling charge.

## PRICE STABILIZATION POLICY

Prices are held and then reviewed over minimum periods of 3 months—Next price review due July 1st.

## QUALITY GUARANTEE

On everything in our Catalogue—No manufacturer's rejects, seconds or sub-standards merchandise.

## ELECTROVALUE LTD

All communications to Dept. 63, 28 ST. JUDES ROAD, ENGLEFIELD GREEN, EGHAM, SURREY TW20 0HB. Telephone Egham 3603, Telex 284475. Shop hours 9-5.30 daily, 9-1 pm Sats.  
NORTHERN BRANCH: 680 Burnage Lane, Burnage, Manchester M19 1NA. Telephone (061) 432 4945. Shop hours Daily 9-5.30 pm; 9-1 pm Sats.

## orchard electronics

### TRANSISTORS

AC125 20p	ASY67 70p	BC147A 8p*	BC205A 15p*	BC309B 16p*
AC126 20p	BA145 15p*	BC147B 10p*	BC206A 15p*	BC317A 12p*
AC127 20p	BA154 10p	BC148 9p*	BC207A 11p*	BC319B 12p*
AC128 20p	BA155 12p	BC148B 10p*	BC208A 11p*	BC322B 15p*
AC132 35p	BAX12 10p	BC149B 11p*	BC209B 10p*	BC327 20p*
AC141 20p	BAX13 4p	BC149C 11p*	BC212A 13p*	BC328 18p*
AC142 17p	BAX16 6p	BC153 18p*	BC212L 15p*	BC337 18p*
AC151 24p	BC107 11p	BC154 15p*	BC213B 12p*	BC338 16p*
AC153 27p	BC107A 12p	BC157B 12p*	BC213L 14p*	BC461 35p
AC176 20p	BC108 10p	BC188A 12p*	BC214 15p*	BC857 8p
AC188 20p	BC108B 11p	BC189A 12p*	BC214L 17p*	BC358 9p
AD181 42p	BC109 11p	BC187A 11p*	BC237A 16p*	BC589 8p
AD192 42p	BC109B 12p	BC168B 14p*	BC238A 15p*	BCY70 15p
AF114 24p	BC109C 13p	BC171A 14p*	BC239B 15p*	BCY71 14p
AF115 24p	BC115 15p*	BC172A 15p*	BC281A 16p*	BCY72 14p
AF116 24p	BC116 15p*	BC173B 16p*	BC282A 16p	BD115 80p
AF117 24p	BC117 18p*	BC177 17p	BC286A 18p	BD121 80p
AF118 47p	BC118 10p*	BC178B 18p	BC287A 14p	BD137 90p
AF124 30p	BC119 25p	BC179B 19p	BC288B 13p	BD124 65p
AF125 30p	BC125 14p*	BC182B 10p*	BC289 13p	BD131 36p
AF126 28p	BC132 11p*	BC182L 11p*	BC287 20p	BD132 38p
AF139 34p	BC135 12p*	BC183B 10p*	BC300 27p	BD133 65p
AF186 50p	BC136 16p*	BC183L 10p*	BC301 26p	BD135 37p*
AF239 37p	BC137 16p*	BC184B 12p*	BC302 24p	BD136 39p*
AS726 30p	BC138 15p	BC184L 11p*	BC303 26p	BD137 44p*
ASY27 34p	BC139 35p	BC186 25p	BC304 27p	BD138 47p*
ASY28 30p	BC142 22p	BC187 26p	BC307A 16p*	BD139 54p*
ASY29 34p	BC143 24p	BC204A 16p*	BC308A 14p*	BD156 75p*

INTEGRATED CIRCUITS LINEAR	ZENES (400 mW)	VOLTAGE REGULATORS	DIL Sockets	INTEGRATED CIRCUITS
709 (8 pin DIL) 40p	BZX83/BZX88	(TO3)	8 pin 13p	TTL Digital
741 (8 pin DIL) 33p	3V3, 3V6, 3V9	5V 1A £1.75	14 pin 15p	7400 18p
NE555 60p	4V3, 4V7, 5V1	15V 1A £1.75	16 pin 17p	7401 20p
RESISTORS	5V6, 6V2, 6V6, 7V5, 8V2, 9V1	Diodes	IN4002 6p	7402 18p
1pp each*	10V, 12V, 13V, 1Ω-10M Ω	IN4006 10p	IN4148 5p	7403 18p
1/2 watt E12 range	All at 12p each*	IN4148 5p		7404 23p
BRIDGE RECTIFIERS	SILICON RECTIFIERS	THYRISTORS	LED	7405 23p
100V 1A 24p	100V 1A 30p	100V 1A 40p	125R RED 20p	7406 40p
200V 1A 25p	200V 1A 13p	200V 1A 40p	125A AMBER 24p	7407 40p
400V 1A 26p	100V 3A 15p	600V 1A 60p	125A RED 27p	7408 24p
200V 2A 79p	200V 3A 18p	BT106 £1.20	125Y YELLOW 27p	7409 23p
600V 2A 97p			TTL209 RED	7410 18p
				7411 24p
				7412 25p
				7413 88p

S.A.E. for full list of components  
Min. order £1. P. & F. 25p.  
VAT—Items marked \* add 12½% remainder at 8%.  
Flint House, High Street, Wallingford, Oxon OX10 0DE  
Tel.: Wallingford (0491) 35529 Telex 45PWALFRD 849349

# This hobby brings big rewards.

A soldering iron and a screwdriver. If you know how to use them, or at least know one end from the other, you know enough to enrol in our unique home electronics course.

This new style course will enable anyone to have a real understanding of electronics by a modern, practical and visual method. No previous knowledge is required, no maths, and an absolute minimum of theory.

You build, see and learn as, step by step, we take you through all the fundamentals of electronics and show you how easily the subject can be mastered and add a new dimension not only to your hobby but also to your earning capacity.

All the training can be carried out in the comfort of your own home and at your own pace. A tutor is available to whom you can write, at any time, for advice or help during your work. A Certificate is given at the end of every course.

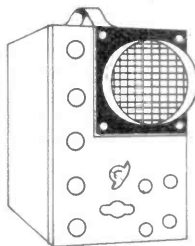
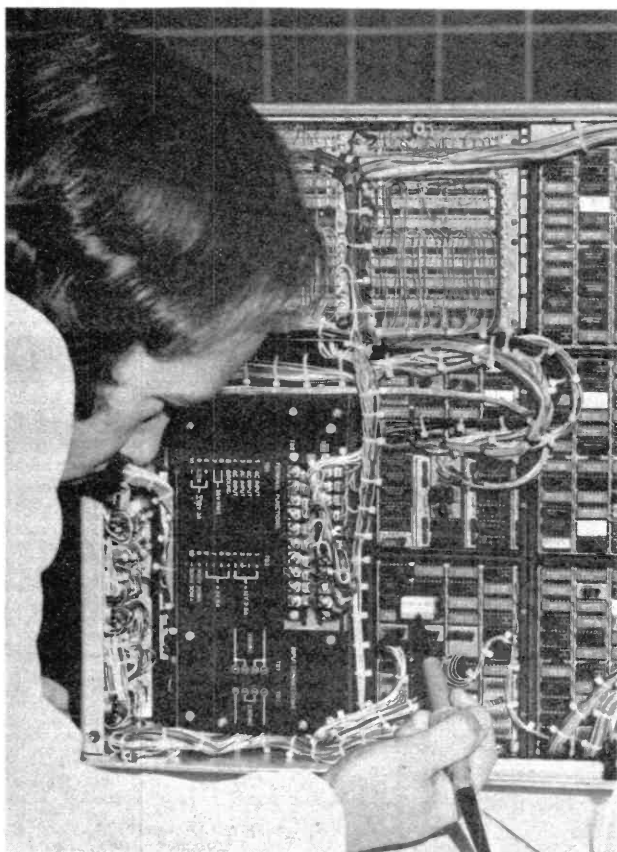

## 1 Build an oscilloscope.

As the first stage of your training, you actually build your own Cathode ray oscilloscope! This is no toy, but a test instrument that you will need not only for the course's practical experiments, but also later if you decide to develop your knowledge and enter the profession. It remains your property and represents a very large saving over buying a similar piece of essential equipment.

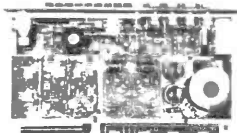

## PLUS FREE GIFT!

ALL STUDENTS ENROLLING IN OUR COURSES RECEIVE A FREE CIRCUIT BOARD ORIGINATING FROM A COMPUTER AND CONTAINING MANY DIFFERENT COMPONENTS THAT CAN BE USED IN EXPERIMENTS AND PROVIDE AN EXCELLENT EXAMPLE OF CURRENT ELECTRONIC PRACTICE

*Everyday Electronics, June 1976*

## 2

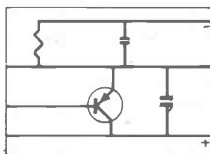

## Read, draw and understand circuit diagrams.

In a short time you will be able to read and draw circuit diagrams, understand the very fundamentals of television, radio, computers and countless other electronic devices and their servicing procedures.

To find out more about how to learn electronics in a new, exciting and absorbing way, just clip the coupon for a free colour brochure and full details of enrolment.

## 3

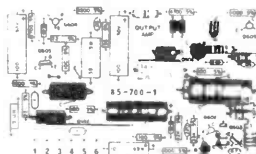

## Carry out over 40 experiments on basic circuits.

We show you how to conduct experiments on a wide variety of different circuits and turn the information gained into a working knowledge of testing, servicing and maintaining all types of electronic equipment, radio, t.v. etc.

Brochure without obligation to:  
**BRITISH NATIONAL RADIO EEL 66**  
**& ELECTRONICS SCHOOL, Dept**  
**P.O. Box 156, Jersey, Channel Islands.**

NAME \_\_\_\_\_

ADDRESS \_\_\_\_\_

(Block caps please)

# Everyday Electronics Classified Advertisements

## BOOKS AND PUBLICATIONS

### Start your own business printing pound notes

Printing pound notes? Well not quite—but "start your own business rewinding electric motors" could easily be your licence to make money in 1976.

Lavishly illustrated, this unique instruction manual shows step by step how to rewind motors working part or full time, without experience. Everything you need to know easily explained, including where to obtain materials, how to get all the work you need, etc. etc.

A goldmine of information and knowledge. Only £3.65 plus 25p P&P. From—

Magnum Publications Dept. E5, Brinksway Trading Estate, Brinksway, Stockport SK3 0BZ

## RECEIVERS and COMPONENTS

500 COMPONENTS. Resistors, Capacitors, Diodes, Transistors, Pots, Coils, etc. Identified, formed leads, fall-out, & surplus. Good value at £1.60. All inclusive. (UK postal rates only). CWO please to L. PENSENEY, E. Bankhead Farm, South Queensferry, West Lothian.

SEALED RELAYS, unused, ex-gov. 18-24V, 2 x c/o—30p, 4 x c/o—50p, Postage (any quantity) 20p. Brook, 5, Pier Street, Lee-on-Solent, PO13 9LD.

FULL SPEC. NEW DEVICES, BY RETURN			
BC107	10p	ZTX504	25p
BC108	10p	2N3055	40p
BC109	10p	2N3819	39p
BC182L	10p	1N914	4p
BC183L	10p	1N4148	4p
BC184L	10p	1N4002	4p
BC212L	14p	1N4003	4p
BC213L	14p	1N4004	5p
BC214L	14p	1N4007	9p
TIP29A	46p	3A/800V	22p
TIP30A	49p	Rec.	15p
TIP31A	51p	1A/200V	26p
TIP32A	55p	2A/600V	33p
TIP41A	72p	DIL I.C.'s	35p
TIP42A	79p	741 8 pin	25p
TIP2955	69p	555 timer	49p
TIP3055	49p	DISPLAYS	
TIS43(UJT)	35p	LED 7-SEG.	10/20p
ZTX300	15p	0-375"	£1.15
ZTX304	25p	Display Data	100/£1.50
ZTX500	15p	s.a.e. please	VAT INC. P&P 20p.

Audio-Optics, 19, Middleway, Chinnor, Oxon. Tel: 0844 52683. Catalogue now ready, 15p Inc. Data, Applications and Post.

FOUR PANELS EX F.M. STEREO AMP 14 Transistors, 3 stereo pots, 7 way push button assembly coils and IFs etc. £1.75 (45p) 20 NEONS 80p (20p) COPPER CLAD P.C. BOARDS 5 $\frac{1}{2}$ in x 5 $\frac{1}{2}$ in 6-75p 12 $\frac{1}{2}$ in x 9in 65p 8 $\frac{1}{2}$ in x 9 $\frac{1}{2}$ in 3-£1.25 all C.P. TALKING PAGE PANEL, 2 pots, 12 silicon transistors and S.C.R. plus 8 electrolytics etc. 80p (20p) 100 ASSORTED S/mica, polyester, polystyrene etc. capacitors 80p (20p) List 15p refund on purchase 7lbs assorted components £2.50 C.P. J. W. B. Radio, 2 Barnfield Crescent, Sale, Cheshire M33 1NL. Postage in Brackets. Mail Order Only.

## SERVICE SHEETS

BELL'S TELEVISION SERVICES for service sheets, manuals & books on radio/TV etc. Service sheets 50p plus SAE. Service sheet catalogue 25p. Back issues of magazines from April '74 onwards cover price plus 12p post. Free booklists on request. SAE with enquiries please to— B. T. S. 190, Kings Road, Harrogate, Yorkshire. Telephone Harrogate (Code 0423) 55885.

SERVICE SHEETS for Radio, TV, Tape Recorders, Stereo, etc., with free fault-finding guide, 50p and SAE. Hamilton Radio, 47 Bohemia Road, St. Leonards, Sussex.

## TAPES

### TAPETALK THE NATURAL WAY TO LEARN

Two C60 cassettes entitled  
INTRODUCING TRANSISTORS  
£5.44 plus 55p VAT/P. & P.  
TAPETALK, P.O. Box 99 (EE)  
Milton Keynes MK3 5BR  
Tel.: Milton Keynes (0908) 77710

## EDUCATIONAL

### TRAIN FOR SUCCESS

An ICS home study course will give you the qualifications to improve your career prospects in electronics.

### C & G Exams

Course for Certificates in Telecoms Technicians, Electrical Installations, Radio, T.V. and Electronics Technicians & Radio Amateurs.

### Practical Radio

Courses include FREE construction kits.

### Colour TV Servicing

Covers principles, practice and alignment with numerous illustrations and diagrams. Other courses for Radio & Audio Servicing.

### Technical Training

Courses include Electronic Technicians, Computer Technicians, Radio and Television Technicians and many more.

Write for full details TODAY.

ICS School of Electronics,  
Dept. 711 T, Intertech House,  
London SW8 4UJ.  
Telephone 01-622 9911 (all hours).

### TAPETALK THE CLEVER WAY TO LEARN

Two C60 Cassettes entitled  
INTRODUCING ELECTRONICS  
£5.44 plus 55p VAT/P. & P.  
TAPETALK, P.O. Box 99 (EE)  
Milton Keynes MK3 5BR  
Tel.: Milton Keynes (0908) 77710

## FOR SALE

MICROPHONES: AKG D202E1, £45.00; AKG D190C or 'E' £20.00; AKG D224, £60.00; Sennheiser MD211N, £45.00. All brand new and boxed. Please add 25% for VAT. All other AKG and Sennheiser mikes. SAE for quote to J. J. Francis (Wood Green), Ltd., Manwood House, Matching Green, Harlow, Essex. Tel: Matching 476.

E.E. NOV. '71 No. 1 to June '75 except Apr. & May '72, Sept. '74, Mar. & Apr. '75. Offers please. Williams, 37, Heol Dowlais, Efail Isaf, Pontypridd, Mid Glam.

LERNA-KIT oscilloscope and practical electronic course, 40 experiments, book etc. Phone L. Wade, Epping 75899 (Office).

## MISCELLANEOUS

NICKEL CADMIUM, fully sealed, rechargeable batteries. Equivalent dry cell sizes. Discount. S.a.e. brings full details by return.—Sandwell Plant Ltd., 1 Denholm Road, Sutton Coldfield, West Midlands B73 6PP. 021-354 9764.

STYLI & CARTRIDGES. For the best at keenest prices send SAE for free illus. list to FELSTEAD ELECTRONICS (EE), Longley Lane, Gatley, Ches. SK8 4EE.

## MINI ACCUMULATORS



2 volt MULTI-USE Sealed Lead Acid Rechargeable Cells.  
Size LA50—1.4" x 1.1" x 0.44". 3 for £2.15 inc. P. & P.  
Size GA2—1.7" x 1.3" x 0.5". 3 for £2.65 inc. P. & P.  
Suits Fi-Cord

GARFIELDS, 295 Rye Lane, London SE15

SUPERB INSTRUMENT CASES by Bazelli, manufactured from heavy duty PVC faced steel. Hundreds of people and industrial users are choosing the cases they require from our vast range, competitive prices start at a low 75p. Over 400 Models to choose from, Prompt despatch, Free literature, (stamp would be appreciated). Bazelli, Department No. 24, St. Wilfreds, Foundry Lane, Halton, Lancaster LA2 6LT.

## ENAMELLED COPPER WIRE

SWG	1lb	4oz	2oz
14-19	2.40	.80	.50
20-29	2.45	.82	.50
30-34	2.60	.89	.64
35-40	2.85	1.04	.75

Inclusive of P. & P. and VAT

S.A.E. brings Catalogue of copper and resistance wires in all coverings.

THE SCIENTIFIC WIRE COMPANY  
P.O. Box 30 London E.4. 9BW.

LOWEST COST IC SOCKETS. Use Soldercon IC socket pins for 8 to 40 pin DIL's. 50p for strip of 100 pins, £1.50 for 3 strips of 100, £4 for 1000. 10p p&p for orders under £2. Add 8% VAT. Instructions supplied—send SAE for sample. SINTEL, 55e Aston Street, Oxford. Tel: 0865 43203.

BUILD THE



## TREASURE TRACER MK III Metal Locator

- Varicap tuning
  - Britain's best selling metal locator kit; 4,000 sold
  - Weighs only 22oz. Fitted with Faraday shield
  - Speaker and earphone operation
  - Knocks down to only 17in
  - Prebuilt search coil assembly
  - Thoroughly professional finish
  - As seen on BBC1 and BBC2 TV
  - You only need soldering iron, screwdriver, pliers and snips
  - Five transistor circuit
- Send stamped addressed envelope for leaflet

Complete Kit £12.50 Built & tested £17.50  
Post 85p—£1.00 VAT (8%) Post 85p—£1.90 VAT (8%)  
MINIKITS ELECTRONICS  
6b CLEVELAND ROAD,  
LONDON, E16 2AN (Mail order only)

## LOUDSPEAKERS



Speakers, kits and cabinets for D.I.Y., Hi Fi, P.A., Disco, etc. by EMI, Fane, Godmans, Baker, Kef, Elac, Richard Allan, Wharfedale, etc. Send stamp for free booklet "Choosing a speaker"

### WILMSLOW AUDIO

Dept. EE, Swan Works, Bank Square, Wilmslow, Cheshire SK9 1HF  
Tel. Wilmslow 29599

### HOME SCIENTISTS

Get the key to a FANTASTIC WORLD of previously UNHEARD-OF-PROJECTS. The NEW Boffin catalogue lists LOTS of HIGHLY UNUSUAL, LOW-COST BARGAINS, READY-BUILT MODULES. Here are just a few examples, there are stacks more!

Dazzling MINI-STROBE (pocket size) £3-50  
PEOPLE DETECTOR £4-20  
Big-Ear SOUND-CATCHER £4-20  
Mini DREAM LABORATORY £4-20

Don't take our word for it thought GET A COPY & SEE!  
SEND ONLY 20p, and we'll RUSH YOU A COPY (YOU'LL GET THE GOODIES' JUST AS QUICKLY TOO!)

**BOFFIN PROJECTS**  
4 Cunliffe Road, Stoneleigh,  
Ewell, Surrey  
(Mail Order U.K. Only)

### DIGITAL CLOCK KIT

Using National Semiconductor Module to give 5 1/2" LED display.  
12/24 HR CLOCK .. £14-70  
12/24 HR ALARM .. £15-70

**INTERCOMS**—For Office or the home, wall mounting or desk.  
4-Way, Master and 3 slaves .. £16-55  
3-Way, Master and 2 slaves .. £13-35  
2-Way, Master and 1 slave .. £7-15

**BURGLAR ALARM**—With key and magnetic switch .. £14-05

**FIRE DETECTOR ALARM**—Buzzer activates at 50°C .. £6-05

**BABY ALARM** .. £9-10

**PRINTED CIRCUIT KIT** £2-95 (inc. P & P)

**555 TIMERS** .. 38p Each

C.W.O. VAT INCLUDED. 20p P. & P. Send 20p for Catalogue and lists.

### CLEVELAND SUPPLIES (EE)

P.O. BOX 20, REDCAR, CLEVELAND.

**PLEASE MENTION  
EVERYDAY ELECTRONICS  
WHEN REPLYING  
TO ADVERTISEMENTS**

## DENCO (CLACTON) LIMITED

Dept. E.E.

357-8-9 OLD RD.,  
CLACTON-ON-SEA  
ESSEX CO15 3RH

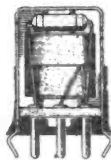

Our components are chosen by technical authors and constructors throughout the world for their performance and reliability, every coil being inspected twice plus a final test and near spot-on alignment.

General Catalogue showing full product range 32p. Overseas Customers 70p, Air-Mail Post Paid.

### U.K. & OVERSEAS MANUFACTURERS/STOCKISTS ENQUIRIES WELCOME

Australian Readers Please Note—Our Complete Range of Coils are available from Hobipak, Box 224, South Carlton, 3053, Victoria, Australia.

## 4-STATION INTERCOM



£17-25

Solve your communication problems with this 4-Station Transistor Intercom system (1 master and 3 Subs), in robust plastic cabinets for desk or wall mounting. Call/talk/listen from Master to Subs and Subs to Master. Ideally suitable for Business, Surgery, Schools, Hospitals and Office. Operates on one 9V battery. On/Off switch. Volume control Complete with 3 connecting wires each 66ft. and other accessories. P. & P. 75p.

**MAINS INTERCOM NEW MODEL**  
No batteries—no wires. Just plug in the mains for instant two-way, loud and clear communication. On off switch and volume control. Price £28-11 per pair P. & P. 75p.

### NEW! AMERICAN TYPE CRADLE TELEPHONE AMPLIFIER



ONLY  
£12-95  
+ VAT £1-04

Latest transistorised Telephone Amplifier with detached plug-in speaker. Placing the receiver on to the cradle activates a switch for immediate two-way conversation without holding the handset. Many people can listen at a time. Increase efficiency in office, shop, workshop. Perfect for "conference" calls: leaves the user's hands free to make notes, consult files. No long waiting, saves time with long-distance calls. On/Off switch, volume. Direct tape recording model at £13-95 + VAT £1-12 P. & P. 70p, 10-day price refund guarantee.

WEST LONDON DIRECT SUPPLIES E.E. 4  
189 KENSINGTON HIGH STREET, LONDON, W8



GIRO NO. 331 7056. Access and Barclaycard accepted. C.W.O. only. Terms of business as in our catalogue. Export Order enquiries welcome (£5 min.)

Official Orders accepted from Educational & Government Departments

**ALL PRICES INCLUDE VAT AS APPROPRIATE AT 8% and 12 1/2%**  
E. & O.E. AND P & P  
SHOP HOURS—9-12.30, 1.30-5 pm 5 DAYS  
CLOSED WEDNESDAY

66 Pages—3000 Items Fully illustrated

★20p Credit Vouchers★All New Stock

1976 Issue ★Satisfaction Guarantee  
★Discounts  
★New Price

Electronic Components Catalogue 5  
20p plus 10p postage  
Resistors - Capacitors - Semiconductors - Boxes - Cases - Kits - PC materials - Tools - Test Meters - Books - Pots - Coils - Hardware - Audio Accessories - Connectors - Veroboard Transformers - Screws - Knobs - Calculators - Audio - Modules - Audio Leads - Batteries - Heatinks - 5 Dec Storage Units etc. etc.

**SPECIAL RESISTOR KITS (CARBON FILM 5%)** (Prices include post & packing)  
10E12 ±W or ±W KIT: 10 of each E12 value, 22 ohms—1M, a total of 570 E3-94 net  
25E12 ±W or ±W KIT: 25 of each E12 value, 22 ohms—1M, a total of 1425 E11-70 net

**SPECIAL CAPACITOR KITS**  
C280 Kit—PC Mounting polyester 250V 5 or each value: 0-01, 0-022, 0-047, 0-1, 0-22µF, 2 of 0-47, 1µF £1-81 net  
C296 Kit—Tubular polyester, 400V 5 of each value: 0-01, 0-022, 0-047, 0-1, 0-22µF, 2 of 0-47µF £2-43 net  
Ceramic Kit—square plaque 50V 5 of each value: 22, 33, 47, 100, 220, 330, 470, 1000pF, 2200, 4700pF, 0-1µF £1-71 net  
250V Paper Kit—Tubular metal case 3 of each value: 0-05, 0-1, 0-25, 0-5, 1µF £1-29 net  
500V Paper Kit—Tubular metal case 3 of each value: 0-025, 0-05, 0-1, 0-025, 0-5µF £1-29 net  
1000V Paper Kit—Tubular metal case 3 of each value: 0-01, 0-025, 0-05, 0-1µF £1-50 net

### B. H. COMPONENT FACTORS LTD.

**MULTIMETER U4323**  
22 Ranges plus AF/IF Oscillator  
20,000 Ω/Volt.  
Vdc—0-5-3000V in 7 ranges.  
Vac—2-5-1000V in 5 ranges.  
Iac—0-05-500mA in 5 ranges.  
Resistance—5Ω-1M Ω in 4 ranges.

Accuracy—5% of F.S.D.  
OSCILLATOR—1 KHz and 465KHz (A. M.) at approx. 1 Volt  
Size—160 x 97 x 40mm.  
Supplied complete with carrying case, test leads and battery.  
PRICE £10-70 net



U4323

**MULTIMETER U4324**  
34 Ranges. High Sensitivity.  
20,000 Ω/Volt.  
Vdc—0-5-1200V in 9 ranges.  
Vac—3-900V in 8 ranges.  
Iac—0-06-3A in 6 ranges.  
Iac—0-3-3A in 5 ranges.  
Resistance—25Ω-5M Ω in 5 ranges.  
Accuracy—dc and R—2 1/2% of F.S.D. ac and db—4% of F.S.D.

Size—167 x 98 x 63mm.  
Supplied complete with storage case, test leads, spare diode and battery.  
PRICE £12-47 net



U4324

**TEACH-IN SERIES COMPONENT KIT**  
KIT No. 712  
ALL COMPONENTS AS SPECIFIED BY E.E. FULLY GUARANTEED AND NEW STOCK (INCLUDES BATTERIES) £16-10 NET

**WOOD KIT**  
Includes all wood as specified by E.E., cut to size, ready to assemble and includes adhesive and screws. (Not drilled)  
£3-75 NET

FULL LIST AVAILABLE. S.A.E. PLEASE OR FREE WITH CATALOGUE

(E. E.) LEIGHTON ELECTRONICS CENTRE  
59 NORTH STREET, LEIGHTON BUZZARD,  
LU7 7EG. Tel: Leighton Buzzard 2316 (Std. Code 05253).



# Do Something Useful for a Change!

Do it in your spare time. And enjoy it. And, perhaps, you'll save yourself some money. The secret is to be practical about the way you spend your spare time.

These practical magazines show you how.

Every month these six popular titles are packed with fascinating and constructive projects – full instructions for making your own furniture and fittings for the home as well as electronic gadgets for home, car or hobby.

See which 'practical' can widen your range of interests, whether in home-improvement, hi-fi or electronics – and on jobs you really could call useful.

## everyday electronics

June issue : a waa waa pedal, an enlarger meter, a peak-level indicator and a continuity tester.

OUT MAY 21

30p

## PRACTICAL WIRELESS

June issue : a digital frequency meter, talking transistors and a fault-finding guide.

OUT MAY 7

35p

## PRACTICAL ELECTRONICS

June issue : a proportional radio-controlled system, an audio millivoltmeter and a rally milometer.

OUT MAY 14 35p

## PRACTICAL HI-FI & AUDIO

June issue : 15 top pick-up cartridges compared, 12 pages of in-car entertainment and how an innocent fares on her first hi-fi shopping spree.

OUT MAY 14 30p

## Television

June issue : a Decca 10/30 chassis service, a Pye 173 chassis service, a simple grey-scale generator and video-tape copying.

OUT MAY 17

40p

## PRACTICAL WOOD WORKING

June issue : a pull-out booklet on hinges and fittings, a model traveller's van, a traditional-style spinster's chair and an ironing table.

OUT MAY 21 40p

## Be Practical...Get a 'Practical' Today!

If you are unable to obtain a copy of any of the above titles from your newsagent, please contact :  
Sales Manager, IPC Magazines Ltd., 66 Great Queen Street, London, WC2B 5DD

# Sparkrite Mk2

## Capacitive discharge electronic ignition

**VOTED BEST OF 8 SYSTEMS TESTED BY 'POPULAR MOTORING' MAGAZINE**



- \* Smoother running
- \* Instant all-weather starting
- \* Continual peak performance
- \* Longer coil/battery/plug life
- \* Improved acceleration/top speeds
- \* Up to 20% better fuel consumption

Sparkrite Mk. 2 is a high performance, high quality capacitive discharge, electronic ignition system in kit form. Tried, tested, proven, reliable and complete. It can be assembled in two or three hours and fitted in 15/30 mins.

Because of the superb design of the Sparkrite circuit it completely eliminates problems of the contact breaker. There is no misfire due to contact breaker bounce which is eliminated electronically by a pulse suppression circuit which prevents the unit firing if the points bounce open at high R.P.M. Contact breaker burn is eliminated by reducing the current to about 1/50th of the norm. It will perform equally well with new, old, or even badly pitted points and is not dependent upon the dwell time of the contact breakers for recharging the system. Sparkrite incorporates a short circuit protected inverter which eliminates the problems of SCR lock on and, therefore, eliminates the possibility of blowing the transistors or the SCR. (Most capacitive discharge ignitions are not completely foolproof in this respect). All kits fit vehicles with coil/distributor ignition up to 8 cylinders.

### THE KIT COMPRISES EVERYTHING NEEDED

Ready drilled pressed steel case coated in matt black epoxy resin, ready drilled base and heat-sink, top quality 5 year guaranteed transformer and components, cables, coil connectors, printed circuit board, nuts, bolts, silicon grease, full instructions to make the kit negative or positive earth, and 10 page installation instructions.

### OPTIONAL EXTRAS

Electronic/conventional ignition switch. Gives instant changeover from "Sparkrite" ignition to conventional ignition for performance comparisons, static timing etc., and will also switch the ignition off completely as a security device, includes switch connectors, mounting bracket and instructions. Cables excluded. Also available RPM limiting control for dashboard mounting (fitted in case on ready built unit).

**CALLERS WELCOME.** For Crypton tuning and fitting service — phone (0922) 33008.

**PRICES INCLUDE VAT, POST AND PACKING.**

**Improve performance & economy NOW**

**POST TODAY!**

**Quick installation  
No engine modification  
required**

Electronics Design Associates, DEPT E6  
82 Bath Street, Walsall, WS1 3DE. Phone: (0922) 33652

Name .....

Address .....

Mk. 2 DIY Ass. Kit @ £11.80

QUANTITY REQUIRED

Mk. 2 Ready Built Negative Earth @ £14.97

Mk. 2 Ready Built Positive Earth @ £14.97

Ignition Changeover switches @ £4.30

R.P.M. Limit systems in above units @ £2.42

I enclose cheque/PO's for £

Cheque No. ....

Send SAE if brochure only required.



## "I MADE IT MYSELF"

*Imagine the thrill you'll feel! Imagine how impressed people will be when they're hearing a programme on a modern radio you made yourself.*

## Now! Learn the secrets of radio and electronics by building your own modern transistor radio!

Practical lessons teach you sooner than you would dream possible.

What a wonderful way to learn—and pave the way to a new, better-paid career! No dreary ploughing through page after page of dull facts and figures. With this fascinating Technatron Course, you learn by building!

You build a modern Transistor Radio . . . a Burglar Alarm. You learn Radio and Electronics by doing actual projects you enjoy—making things with your own hands that you'll be proud to own!

No wonder it's so fast and easy to learn this way. Because learning becomes a hobby! And what a profitable hobby. Because opportunities in the field of Radio and Electronics are growing faster than they can find people to fill the jobs!

### No soldering — yet you learn faster than you ever dreamed possible.

Yes! Faster than you can imagine, you pick up the technical know how you need. Specially prepared step-by-step lessons show you how to read circuits—assemble components — build things — experiment. You enjoy every minute of it! You get everything you need! Tools. Components. Even a versatile Multimeter that we teach you how to use. All included in the course. AT NO EXTRA CHARGE! And this is a course anyone can afford. (You can even pay for it by easy instalments).

### So fast, so easy, this personalised course will teach you even if you don't know a thing today!

No matter how little you know now, no matter what your background or education, we'll teach you. Step by step, in simple easy-to-understand language, you pick up the secrets of radio and electronics.

You become somebody who makes things, not just another of the millions, who don't understand. And you could pave the way to a great new career, to add to the thrill and pride you receive when you look at what you have achieved. Within weeks you could hold in your hand your own transistor radio. And after the course you can go on to acquire high-powered technical qualifications, because our famous courses go right up to City & Guilds levels.

### Send now for FREE 44 pagebook — see how easy it is — read what others say!

Find out more now! This is the gateway to a thrilling new career, or a wonderful hobby you'll enjoy for years. Send the coupon now. There's no obligation.

**POST TODAY FOR FREE BOOK**

To: **ALDERMASTON COLLEGE DEPT. CEE 18 READING RG7 4PF**

Also at our London Advisory Office, 4 Fore Street Avenue, Moorgate, London EC2Y 5EJ. Tel: 01-628 2721. Yes, I'd like to know more about your course. Please send me free details—plus your big, 44 page book that tells about all your courses.

NAME .....

ADDRESS .....

POSTCODE .....



**BIET**

**HOME OF BRITISH INSTITUTE OF ENGINEERING TECHNOLOGY**

# FANTASTIC VALUE! ONLY 40p

132 PAGES INCLUDING PROJECTS FOR YOU TO BUILD. PLUS HUNDREDS OF ILLUSTRATIONS OF COMPONENTS.

PRICES GUARANTEED FOR TWO MONTH PERIODS

FULL DETAILS AND PICTURES OF A WIDE RANGE OF COMPONENTS

SAME-DAY MAILING SERVICE!

PAGES OF TRANSISTOR AND I.C. DATA

THOUSANDS OF COMPONENTS

A BEAUTIFULLY PRODUCED BOOK!

VALUABLE DISCOUNT VOUCHERS

## MAPLIN ELECTRONIC SUPPLIES

GET THIS! BOOK NOW

FROM: MAPLIN ELECTRONIC SUPPLIES  
P.O. Box 3, Rayleigh, Essex.  
SS6 8LR

**\*SPECIAL! SPECIAL! SPECIAL! £8.60 INC. V.A.T. & P/P\***

READY MADE \*

### ALARM CLOCK MODULE

This is a fully constructed and tested electronic clock module as illustrated. Data sheet supplied with module shows how simple it is to connect an audible alarm, and your battery will be available shortly. Data sheet available separately. Please send s.a.e.

- BRIGHT 4 DIGIT 0.5 INCH DISPLAY
- FLASHING COLON (1Hz)
- SWITCH FOR DISPLAY SECONDS
- AUTOMATIC DISPLAY BRIGHTNESS (NEEDS CdS CELL)
- TIME CAN BE SET ACCURATELY TO WITHIN ONE SECOND
- LEADING ZERO BLANKING



- ALARM SET INDICATOR
- P.M. INDICATOR
- POWER FAILURE INDICATION
- SLEEP TIMER
- SNOOZE TIMER

Simple clock kit £9.38 Alarm clock kit £10.99 Alarm clock-radio switching kit £11.51 Case £1.99  
All prices include VAT and P & P Please note details not in our catalogue.

# PEAK LEVEL

# INDICATOR

An overload indicator with a fast response.

By R.A. SHACKLEFORD

**T**HE Peak Level Indicator described here is suitable for use as a fast responding overload indicator in amplifiers and tape recorders where it will give a visual indication of fast transients normally missed by the slower responding VU meters.

## CIRCUIT OPERATION

The circuit of the complete stereo Peak Level Indicator is shown in Fig. 1. Resistor R1 and Zener diode D1 produce a stabilised 6.2 volts at their junction which is used to feed both circuits. Apart from these components the rest of the unit consists of two identical circuits, one for the left channel and one for the right channel.

Resistors R2 and R4 form a potential divider which set a fixed bias voltage at the inverting (-) input of the operational amplifier IC1.

Resistor R3 and potentiometer VR1 form another potential divider which enables a variable voltage to be applied to the non-inverting (+) input.

Under no-input conditions the inverting input will be at a higher voltage than the non-inverting input. The amplifying action of the operational amplifier will cause the output (pin 6) to drop to almost zero volts. Since the capacitor C2 is connected to the junction of the potential divider and the output of the amplifier, there will be a voltage across it of a couple of volts. This will be in such a sense as to have the non-inverting end at a higher potential than the output end.

If a signal is now applied to the input the voltage at the inverting input will vary in sympathy. Positive voltage swings will not affect the output, simply tending to drive the output nearer zero volts. Negative swings however will cause the voltage at pin 2 to fall below that at

Fig. 1. Circuit diagram of the Peak Level Indicator.

