



ELECTRONICS
TODAY INTERNATIONAL

AN ARGUS SPECIALIST PUBLICATION

LASER DIODES
Coherence from
solid-state

**THE
CONSORT**
Active
Loudspeaker
project

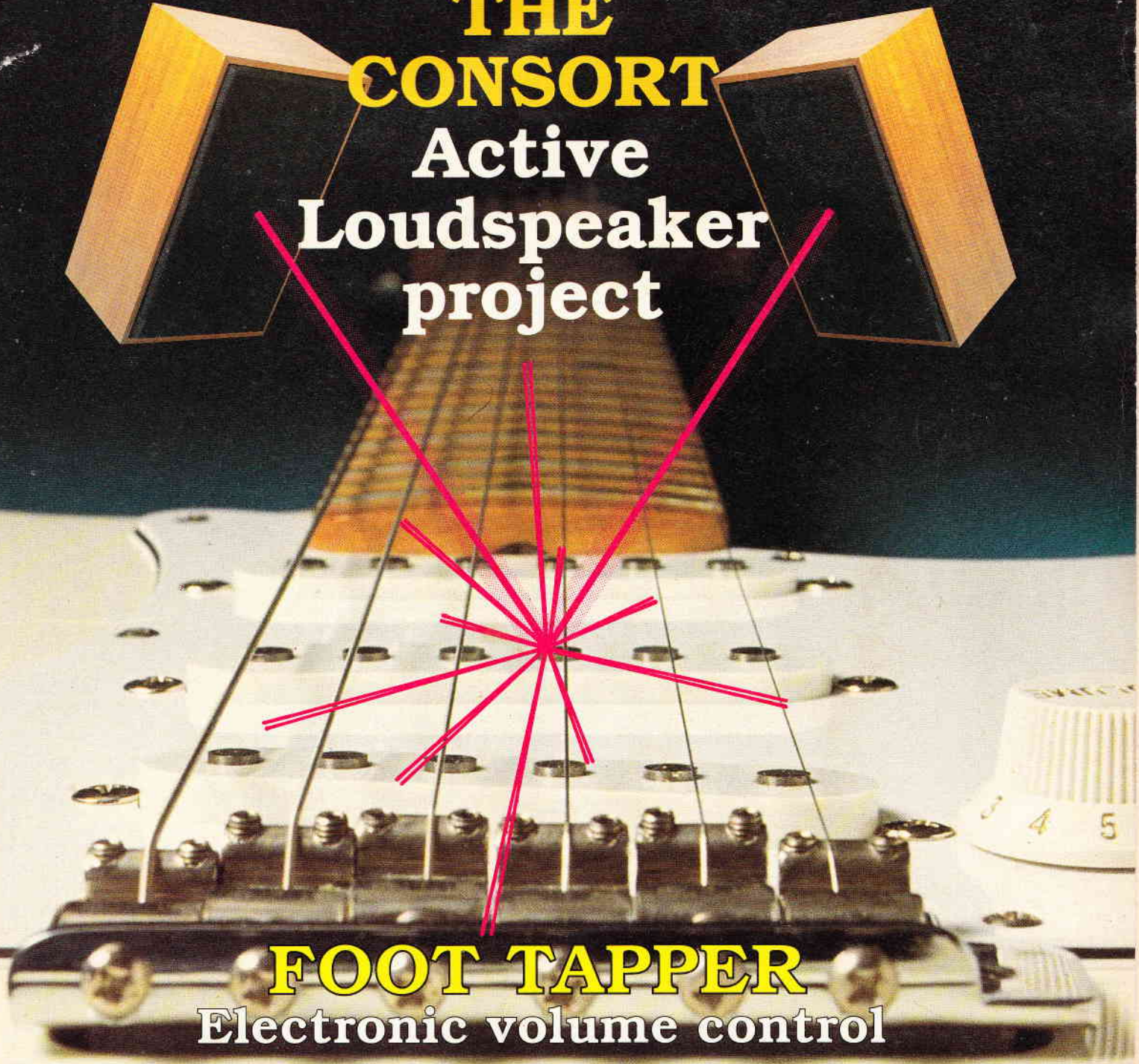

FOOT TAPPER
Electronic volume control

**MICROWAVES
FOR THE AMATEUR**



DMP POWER AMPLIFIER MODULES-TURNTABLES-DIMMERS-LOUDSPEAKERS-19 INCH STEREO RACK AMPLIFIERS

OMP POWER AMPLIFIER MODULES

Supplied ready built and tested.

OMP POWER AMPLIFIER MODULES Now enjoy a world-wide reputation for quality, reliability and performance at a realistic price. Four models available to suit the needs of the professional and hobby market, i.e., Industry, Leisure, Instrumental and Hi-Fi etc. When comparing prices, NOTE all models include Toroidal power supply, Integral heat sink, Glass fibre P.C.B., and Drive circuits to power compatible Vu meter. Open and short circuit proof.

THOUSANDS OF MODULES PURCHASED BY PROFESSIONAL USERS



OMP100 Mk 11 Bi-Polar Output power 110 watts R.M.S. into 4 ohms, Frequency Response 15Hz - 30KHz - 3dB, T.H.D. 0.01%, S.N.R. -118dB, Sens. for Max. output 500mV at 10K, Size 355 x 115x65mm. **PRICE £33.99 + £3.00 P&P.**

NEW SERIES II MOS-FET MODULES



OMP/MF 100 Mos-Fet Output power 110 watts R.M.S. into 4 ohms, Frequency Response 1Hz - 100KHz - 3dB, Damping Factor, >300, Slew Rate 45V/uS, T.H.D. Typical 0.002%, Input Sensitivity 500mV, S.N.R. -125dB, Size 300 x 123 x 60mm. **PRICE £39.99 + £3.00 P&P.**



OMP/MF200 Mos-Fet Output power 200 watts R.M.S. into 4 ohms, Frequency Response 1Hz - 100KHz - 3dB, Damping Factor >300, Slew Rate 50V/uS, T.H.D. Typical 0.001%, Input Sensitivity 500mV, S.N.R. -130dB, Size 300 x 155 x 100mm. **PRICE £62.99 + £3.50 P&P.**

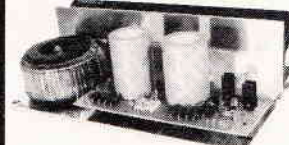

OMP/MF300 Mos-Fet Output power 300 watts R.M.S. into 4 ohms, Frequency Response 1Hz - 100KHz - 3dB, Damping Factor >300, Slew Rate 60V/uS, T.H.D. Typical 0.0008%, Input Sensitivity 500mV, S.N.R. -130dB, Size 330 x 175 x 100mm. **PRICE £79.99 + £4.50 P&P.**

NOTE:— MOS-FET MODULES ARE AVAILABLE IN TWO VERSIONS, STANDARD— INPUT SENS. 500mV BAND WIDTH 100KHz, PEC (PROFESSIONAL EQUIPMENT COMPATIBLE)— INPUT SENS. 775mV, BAND WIDTH 50KHz, ORDER STANDARD OR PEC



Vu METER Compatible with our four amplifiers detailed above. A very accurate visual display employing 11 L.E.D. diodes (7 green, 4 red) plus an additional on/off indicator. Sophisticated logic control circuits for very fast rise and decay times. Tough moulded plastic case, with tinted acrylic front. Size 84 x 27 x 45mm. **PRICE £8.50 + 50p P&P.**

LOUDSPEAKERS



LARGE SELECTION OF SPECIALIST LOUDSPEAKERS AVAILABLE, INCLUDING CABINET FITTINGS, SPEAKER GRILLES, CROSS-OVERS AND HIGH POWER, HIGH-FREQUENCY BULLETS AND HORNS, LARGE S.A.E. (30p STAMPED) FOR COMPLETE LIST.

McKENZIE:— INSTRUMENTS, P.A., DISCO, ETC.

ALL MCKENZIE UNITS 8 OHMS IMPEDANCE

- 8" 100 WATT C8100GPM GEN. PURPOSE, LEAD GUITAR, EXCELLENT MID, DISCO. RES. FREQ. 80Hz, FREQ. RESP. TO 14KHz, SENS. 99dB. **PRICE £29.30 + £2.00 P&P**
- 10" 100 WATT C10100GP GUITAR, VOICE, ORGAN, KEYBOARD, DISCO, EXCELLENT MID. RES. FREQ. 70Hz, FREQ. RESP. TO 6KHz, SENS. 100dB. **PRICE £35.58 + £2.50 P&P**
- 10" 200 WATT C10200GP GUITAR, KEYBOARD, DISCO, EXCELLENT HIGH POWER MID. RES. FREQ. 45Hz, FREQ. RESP. TO 7KHz, SENS. 103dB. **PRICE £48.67 + £2.50 P&P**
- 12" 100 WATT C12100GP HIGH POWER GEN. PURPOSE, LEAD GUITAR, DISCO. RES. FREQ. 45Hz, FREQ. RESP. TO 7KHz, SENS. 98dB. **PRICE £37.59 + £3.50 P&P**
- 12" 100 WATT C12100TC TWIN CONE) HIGH POWER WIDE RESPONSE, P.A., VOICE, DISCO. RES. FREQ. 45Hz, FREQ. RESP. TO 14KHz, SENS. 100dB. **PRICE £38.58 + £3.50 P&P**
- 12" 200 WATT C12200B HIGH POWER BASS, KEYBOARDS, DISCO, P.A. RES. FREQ. 40Hz, FREQ. RESP. TO 7KHz, SENS. 100dB. **PRICE £65.79 + £3.50 P&P**
- 12" 300 WATT C12300GP HIGH POWER BASS LEAD GUITAR, KEYBOARDS, DISCO, ETC. RES. FREQ. 45Hz, FREQ. RESP. TO 5KHz, SENS. 100dB. **PRICE £87.51 + £3.50 P&P**
- 15" 100 WATT C15100BS BASS GUITAR, LOW FREQUENCY, P.A., DISCO. RES. FREQ. 40Hz, FREQ. RESP. TO 5KHz, SENS. 98dB. **PRICE £55.05 + £4.00 P&P**
- 15" 200 WATT C15200BS VERY HIGH POWER BASS. RES. FREQ. 40Hz, FREQ. RESP. TO 4KHz, SENS. 99dB. **PRICE £75.10 + £4.00 P&P**
- 15" 250 WATT C15250BS VERY HIGH POWER BASS. RES. FREQ. 40Hz, FREQ. RESP. TO 4KHz, SENS. 99dB. **PRICE £82.54 + £4.50 P&P**
- 15" 400 WATT C15400BS VERY HIGH POWER, LOW FREQUENCY BASS. RES. FREQ. 40Hz, FREQ. RESP. TO 4KHz, SENS. 102dB. **PRICE £96.47 + £4.50 P&P**
- 18" 400 WATT C18404BS EXTREMELY HIGH POWER, LOW FREQUENCY BASS. RES. FREQ. 27Hz, FREQ. RESP. TO 3KHz, SENS. 99dB. **PRICE £172.06 + £5.00 P&P**

EARBENDERS:— HI-FI, STUDIO, IN-CAR, ETC.

- ALL EARBENDER UNITS 8 OHMS** (Except EB8-50 & EB10-50 which are dual impedance tapped @ 4 & 8 ohm.)
- BASS, SINGLE CONE, HIGH COMPLIANCE, ROLLED FOAM SURROUND**
- 8" 50 WATT EB8-50 DUAL IMPEDANCE, TAPPED 4/8 OHM BASS, HI-FI, IN-CAR. RES. FREQ. 40Hz, FREQ. RESP. TO 7KHz, SENS. 97dB. **PRICE £8.90 + £2.00 P&P**
- 10" 50 WATT EB10-50 DUAL IMPEDANCE, TAPPED 4/8 OHM BASS, HI-FI, IN-CAR. RES. FREQ. 40Hz, FREQ. RESP. TO 5KHz, SENS. 99dB. **PRICE £12.00 + £2.50 P&P**
- 10" 100 WATT EB10-100 BASS, HI-FI, STUDIO. RES. FREQ. 35Hz, FREQ. RESP. TO 3KHz, SENS. 96dB. **PRICE £27.76 + £3.50 P&P**
- 8" 60 WATT EB12-60 BASS, HI-FI, STUDIO. RES. FREQ. 28Hz, FREQ. RESP. TO 3KHz, SENS. 92dB. **PRICE £21.00 + £3.00 P&P**
- 12" 100 WATT EB12-100 BASS, STUDIO, HI-FI, EXCELLENT DISCO. RES. FREQ. 28Hz, FREQ. RESP. TO 3KHz, SENS. 99dB. **PRICE £38.75 + £3.50 P&P**
- FULL RANGE TWIN CONE, HIGH COMPLIANCE, ROLLED SURROUND**
- 5 1/2" 60 WATT EB5-60TC (TWIN CONE) HI-FI, MULTI-ARRAY DISCO ETC. RES. FREQ. 63Hz, FREQ. RESP. TO 20KHz, SENS. 92dB. **PRICE £9.99 + £1.50 P&P**
- 6 1/2" 60 WATT EB6-60TC (TWIN CONE) HI-FI, MULTI-ARRAY DISCO ETC. RES. FREQ. 38Hz, FREQ. RESP. TO 20KHz, SENS. 94dB. **PRICE £10.99 + £1.50 P&P**
- 8" 60 WATT EB8-60TC (TWIN CONE) HI-FI, MULTI-ARRAY DISCO ETC. RES. FREQ. 40Hz, FREQ. RESP. TO 18KHz, SENS. 89dB. **PRICE £12.99 + £1.50 P&P**
- 10" 60 WATT EB10-60TC (TWIN CONE) HI-FI, MULTI-ARRAY DISCO ETC. RES. FREQ. 35Hz, FREQ. RESP. TO 12KHz, SENS. 86dB. **PRICE £16.49 + £2.00 P&P**

TRANSMITTER HOBBY KITS

PROVEN TRANSMITTER DESIGNS INCLUDING GLASS FIBRE PRINTED CIRCUIT BOARD AND HIGH QUALITY COMPONENTS COMPLETE WITH CIRCUIT AND INSTRUCTIONS

3W FM TRANSMITTER 80-108MHz, VARIACAP CONTROLLED PROFESSIONAL PERFORMANCE, RANGE UP TO 3 MILES, SIZE 38 x 123mm, SUPPLY 12V @ 0.5AMP. **PRICE £14.49 + £1.00 P&P**

FM MICRO TRANSMITTER (BUG) 100-108MHz, VARIACAP TUNED COMPLETE WITH VERY SENS FET MIC, RANGE 100-300m, SIZE 56 x 46mm, SUPPLY 9V BATT, PRICE **£8.62 + £1.00 P&P**



3 watt FM Transmitter



POSTAL CHARGES PER ORDER £1.00 MINIMUM OFFICIAL ORDERS WELCOME FROM SCHOOLS, COLLEGES, GOVT. BODIES, ETC. PRICES INCLUSIVE OF V.A.T. SALES COUNTER, VISA ACCESS ACCEPTED BY POST, PHONE OR FAX.



* PRICES INCLUDE V.A.T. * PROMPT DELIVERIES * FRIENDLY SERVICE * LARGE S.A.E., 30p STAMPED FOR CURRENT LIST.

OMP VARISPEED TURNTABLE CHASSIS:



* MANUAL ARM * STEEL CHASSIS * ELECTRONIC SPEED CONTROL 33 & 45 * VARIABLE CONTROL * HIGH TORQUE SERVO DRIVEN DC MOTOR * TRANSISTOR STROBE * 10" DIE CAST PLATTER * NEON STROBE * CALIBRATED BAL WEIGHT * REMOVABLE HEAD SHELL * 1/2" CARTRIDGE FININGS * CUE LEVER * POWER 220-240V 50/60Hz * 390 x 305mm * SUPPLIED WITH MOUNTING CUT-OUT TEMPLATE. **PRICE £59.99 + £3.50 P&P.**

OPTIONAL MAGNETIC CARTRIDGES

STANTON AL500
PRICE £16.99 + 50p P&P

GOLDRING G650
PRICE £6.99 + 50p P&P

OMP MOS-FET POWER AMPLIFIERS, HIGH POWER, TWO CHANNEL 19 INCH RACK

THOUSANDS PURCHASED BY PROFESSIONAL USERS

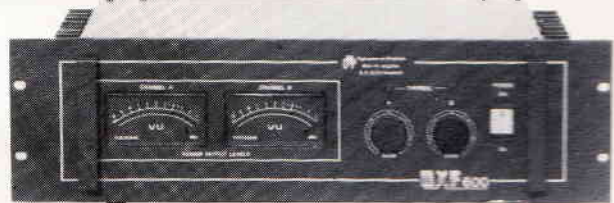

NEW MXF SERIES OF POWER AMPLIFIERS

THREE MODELS:— **MXF200** (100w + 100w) **MXF400** (200w + 200w) **MXF600** (300w + 300w)

All power ratings R.M.S. into 4 ohms

FEATURES: * Independent power supplies with two Toroidal Transformers * Twin L.E.D. Vu meters * Rotary indexed level controls * Illuminated on/off switch * XLR connectors * Standard 775mV inputs * Open and short circuit proof * Latest Mos-Fets for stress free power delivery into virtually any load * High slew rate * Very low distortion * Aluminium cases * MXF600 Fan Cooled with D.C. Loudspeaker and Thermal Protection.

USED THE WORLD OVER IN CLUBS, PUBS, CINEMAS, DISCOS ETC

SIZES:— MXF 200 W19"xH3 1/2" (2U)x D11
MXF 400 W19"xH5 1/4" (3U)x D12
MXF 600 W19"xH5 1/4" (3U)x D13

MXF200 £171.35

PRICES: MXF400 £228.85

MXF600 £322.00

SECURICOR DELIVERY £12.00 EACH



OMP LINNET LOUDSPEAKERS

THE VERY BEST IN QUALITY AND VALUE



MADE ESPECIALLY TO SUIT TODAY'S NEED FOR COMPACTNESS WITH HIGH OUTPUT SOUND LEVELS. FINISHED IN HARDWEARING BLACK VINYL WITH PROTECTIVE CORNERS, GRILLE AND CARRYING HANDLE INCORPORATES 12" DRIVER PLUS HIGH FREQ. HORN FOR FULL FREQ. RANGE. 45Hz-20KHz BOTH MODELS 8 OHM. SIZE H18" x W13" x D12".

CHOICE OF TWO MODELS

POWER RATINGS QUOTED IN WATTS RMS FOR EACH CABINET

OMP 12-100 (100W 100dB) PRICE £159.99 PER PAIR

OMP 12-200 (200W 102dB) PRICE £209.99 PER PAIR

SECURICOR DEL.— £12.00 PER PAIR

IN CAR STEREO BOOSTER AMPLIFIER



TWO SUPERB HIGH POWER CAR STEREO BOOSTER AMPLIFIERS

150 WATTS (75+75) INTO 4 OHMS
300 WATTS (150+150) INTO 4 OHMS
FEATURES:
* HIGH & LOW INPUT IMPEDANCES
* HIGH & LOW INPUT SENSITIVITIES
* VARIABLE INPUT GAIN CONTROL
* SHORT CIRCUIT OUTPUT PROTECTION
* POWER REQUIREMENT 12V. D.C.
PRICES: 150 WATT £43.00
300 WATT £95.00 + £3.00 P&P EACH

PIEZO ELECTRIC TWEETERS-MOTOROLA

PIEZO ELECTRIC TWEETERS — MOTOROLA

Join the Piezo revolution. The low dynamic mass (no voice coil) of a Piezo tweeter produces an improved transient response with a lower distortion level than ordinary dynamic tweeters. As a crossover is **not** required these units can be added to existing speaker systems of up to 100 watts (more if 2 put in series). **FREE EXPLANATORY LEAFLETS SUPPLIED WITH EACH TWEETER.**

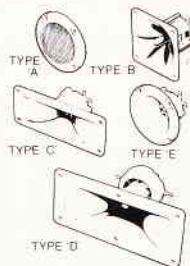

TYPE 'A' (KSN2036A) 3" round with protective wire mesh, ideal for bookshelf and medium sized Hi-Fi speakers. **Price £4.90 each + 50p P&P.**

TYPE 'B' (KSN1005A) 3 1/2" super horn. For general purpose speakers, disco and P.A. systems etc. **Price £5.99 each + 50p P&P.**

TYPE 'C' (KSN6016A) 2"x5" wide dispersion horn. For quality Hi-Fi systems and quality discos etc. **Price £6.99 each + 50p P&P.**

TYPE 'D' (KSN1025A) 2"x6" wide dispersion horn. Upper frequency response retained extending down to mid range (2KHz). Suitable for high quality Hi-Fi systems and quality discos. **Price £9.99 each + 50p P&P.**

TYPE 'E' (KSN1038A) 3 3/4" horn tweeter with attractive silver finish trim. Suitable for Hi-Fi monitor systems etc. **Price £5.99 each + 50p P&P.**

LEVEL CONTROL Combines on a recessed mounting plate, level control and cabinet input jack socket. 85x85mm. **Price £3.99 + 50p P&P.**

STEREO DISCO MIXER

STEREO DISCO MIXER with 2 x 5 band L & R graphic equalisers and twin 10 segment L.E.D. Vu Meters. **Many outstanding features** 5 inputs with individual faders providing a useful combination of the following:—
3 Turntables (Mag), 3 Mics, 4 Line including CD plus Mic with talk over switch Headphone Monitor, Pan Pot L & R, Master Output controls, Output 775mV. Size 360x280x90mm. Supply 220-240V. **Price £134.99 — £4.00 P&P**

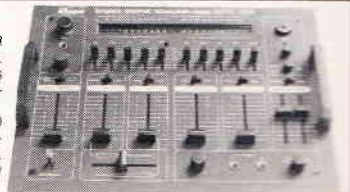

B. K. ELECTRONICS

Dept EE

UNIT 5, COMET WAY, SOUTHEND-ON-SEA, ESSEX. SS2 6TR
TEL: 0702-527572 FAX: 0702-420243

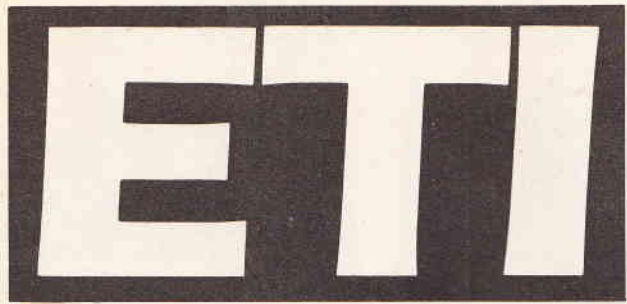

**ELECTRONICS
TODAY INTERNATIONAL**



**WHY
NOT**

— subscribe to the
best electronics
magazine in town

WHEN

— what about **NOW!**

HOW

— just complete the coupon below and you will receive
absolutely **FREE** this **WIRE STRIPPER** worth **£4.95**

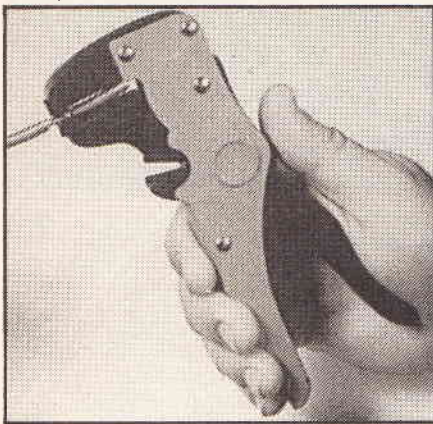

The wire strippers shown here will grip and remove the insulation cleanly from a variety of wire gauges in one easy action. No more gripping and guessing the depth of cut as with other makes, this handy service tool will do the job quickly and efficiently. Any regular electronics project builder would not do without one.

SUBSCRIPTION RATES

U.K. £19.20 EUROPE £24.10 MIDDLE EAST £24.40
FAR EAST £26.80 REST OF WORLD £25.85 USA \$48.00

This offer closes 31st July 1991 — so don't miss out just complete the coupon and send it with your remittance to the Subscription Manager, Argus House, Boundary Way, Hemel Hempstead, Herts. HP2 7ST.

This offer is open to existing subscribers who wish to extend or renew their subscriptions.

SUBSCRIPTION HOTLINE
0442 66551 ex 210
(office hours only)
please quote ETI/12

Please commence my subscription to **E.T.I.** with the _____ issue and send me my free **WIRE STRIPPER**. I enclose my cheque/money order for £ _____ payable to ASP or please debit my Access/Visa

Valid from _____ to _____

Name _____ Signature _____

Address _____

_____ Postcode _____

Please allow 28 days delivery for free gift. ETI/12

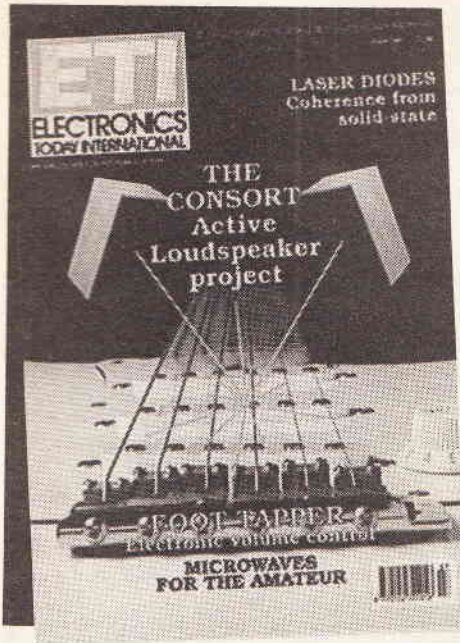

Contents

JULY '91

VOLUME 20 No 7

Regulars

Open Channel	6
Read/Write	8
News	9
News Stateside	13
Photocopy Service	26
PCB Foils	60
Classified Ads	62
PCB Service	65

Features & Projects

Tech Tips	15
More from our reader circuit file for you to experiment with.	
Back To Basics 6	17
Inductive Reactance in AC circuits is the subject of our beginners course by Paul Coxwell.	
Laser Diodes	22
Douglas Clarkson looks at the theory and application of semiconductor Lasers.	
The Consort Loudspeaker	29
Another active loudspeaker project for you to experiment with by Peter Roberts	
Four Track Cassette Update	36
Tom Scarffe presents an update to his Four-track Cassette Recorder Project.	
Amateur Microwave Equipment	38
Communicating at Microwave frequencies can be intriguing to experiment with and surprisingly simple to construct. Geoffrey Heys introduces the subject.	
Versatile Temperature Controller	42
AJP Williams continues with the constructional aspects of the controller and provides some possible uses.	
The Foot-tapper	47
A project for the guitarist to control the volume in foot-tapping stages by Paul Stephenson.	
HDTV 7b	52
James Archer finalises his review of American proposals for HDTV	
Fire Detection Systems	58
The second in our series deals with the operations of typical fire sensing mechanisms by Vivian Capel.	

Editorial

Firstly, I would like to thank you all for returning our reader survey. They will be a great help for future planning of the magazine. However, there is still time to get the last of them in and you could still win one of the fifty prizes on offer. As we have stated before, ETI is a test bed for ideas and experimentation. A large proportion of the projects we present throughout these pages are prototypes and are open to development. Construction and modification of our projects is encouraged and we of course will publish improvements and updates if the need arises.

Popularity

One of the prime objectives of the magazine is to present a gadget, gizmo or project, call it what you will, that is not currently commercially available. The appeal is enormous. Apart from the tremendous satisfaction of creating something new, the psychological aspect also has the 'Jones effect' to answer for. With gleaming pride, you demonstrate the wonder machine to others who can only gawk at in puzzled amazement when invited around for coffee.

All too often, the back-room boffins have built a prototype on the kitchen table years ago but have only regarded the beast as another experiment in the scheme of things that slowly gathers dust in the corner and continues to suffer increasing abuse from those that clean the household as to what it should be doing there. The notion that it might be appealing to others does not generally enter the mind of the creator let alone the possibility of industrial adoption to become a successful consumer product. That is where a magazine like ETI can be the springboard for bringing your wonder-box to the attention of all those who read it, including those in industry and education in the UK and overseas.

Paul Freeman.

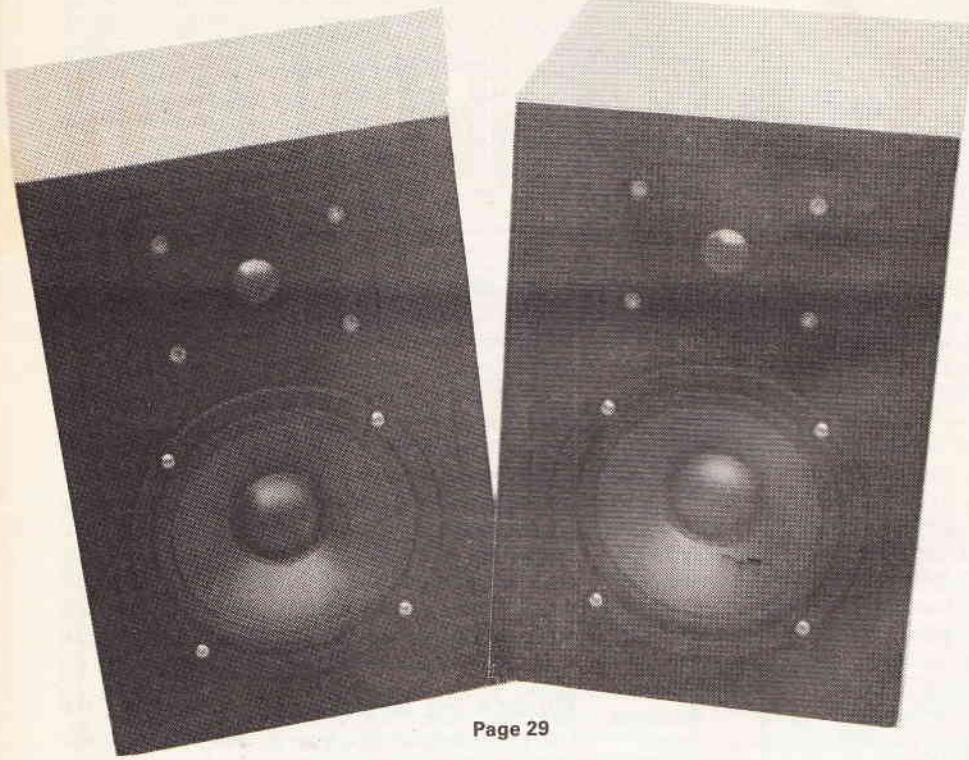

Page 29

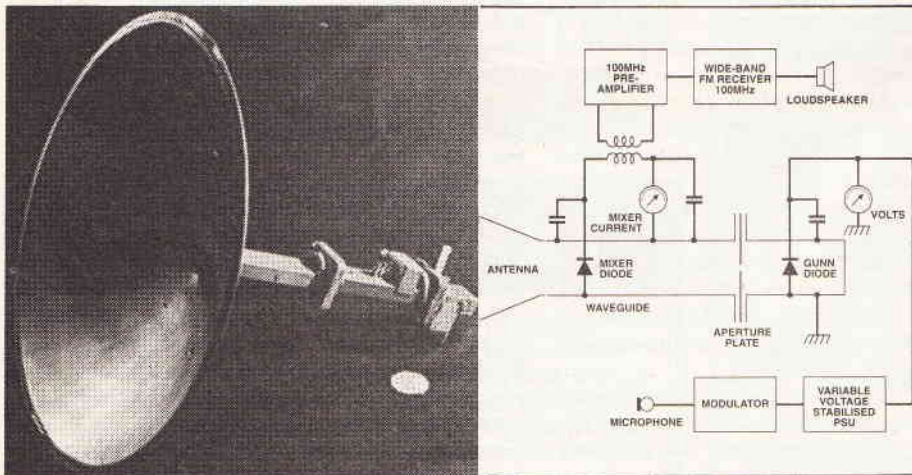

Page 36

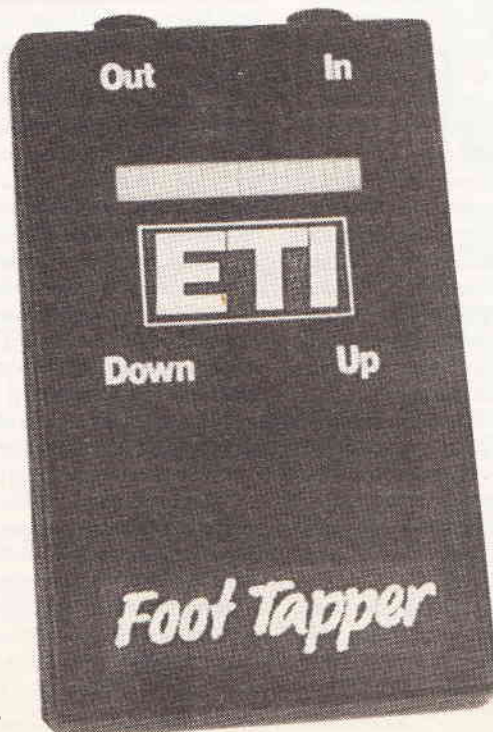

Page 47

OPEN CHANNEL

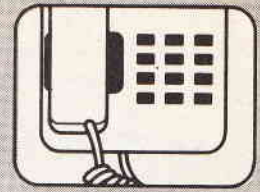

It's not often I focus my attention on computers and computing, but I'm going to this month. There's a number of reasons for this; all of them tied in with recent happenings in the field. I even reported on one of these happening last month — the current definition of Unicode, which is a 16-bit computer and communications code to replace ASCII.

Unicode, in itself, is no big deal. Its been accepted long enough by computer manufacturers and users that 8-bit ASCII isn't really good enough for modern day computers. Computers have to effectively look at each 8-bit word sequentially. Eight bits limit the numbers of different characters to a maximum of just 256, too. These factors have been barriers against large scale procedural developments in computing for a while. Unicode though, jumps through both barriers simultaneously, and consequently lays the way open for great changes in the ways computers function.

Currently, IBM dominates the computer marketplace with its personal computers with around 60% of total sales. Its interpretation of Microsoft's MS-DOS disk operating system (IBM calls its version PC-DOS) has been both a help and a hindrance to other manufacturers. With only one exception to the rule (I'll talk about the exception soon), computers generally have to be IBM-compatible for users to even consider buying. This is a pity because, while MS-DOS (and its derivatives) was a good operating system in its day, it now only holds back computers in its largely archaic manner and style. MS-DOS effectively limits a computer's performance in its dogged approach to file handling. There have been changes and upgrades but nothing to write home about.

However, computer procedural developments will be speeded up and enhanced over the next few years with first, reduced instruction set computer (RISC) architectures and second, transporter architectures. A group of companies has been formed recently to define a new range of computers using RISC microprocessors. The group's aim is to challenge IBM head on, with a completely new style of computer.

This has been attempted a few times before of course, with only one successful computer (the exception to the IBM-compatibility rule I mentioned earlier) — the Apple Macintosh. The Mac uses a totally different idea of operation known as the graphical user interface, in which users move around files and discs by pointing to on-screen icons. Its ease and efficiency of operation is reflected in the fact Apple has the second largest stake in the computer marketplace — some 10% of business sales, although much less than this in other areas such as home and education.

This stake is still small fish when compared with IBM's. It's probably true that IBM has more-or-less defined its own market share simply by allowing other manufacturers to produce IBM-compatible clones. The more clones there are, the more acceptable IBM-compatibility appears to users, so the more IBM computers are sold.

Apple has consistently chosen to shun this route; never in the machine's seven year history have Mac-clones been made. This has cost Apple a greater market share (and denied 95% of computer users a decent user interface for seven years). Apple computers have

traditionally been quite expensive, too.

Microsoft (the originator of the MS-DOS operating system) has recently developed Windows 3, a partially successful attempt to emulate a graphical user interface on IBM and compatible computers. Windows 3 is currently the fastest selling software of all time, so it doesn't take a genius to realise that Apple's original decision not to allow Mac-clones was a mistake. Users want the Mac's type of user interface.

Interestingly, rumours abound that Apple has realised this and is about to licence its technology to other manufacturers, hence allowing clones to be made. Recently introduced low-cost Macs support these rumours, and will inevitably push up Apple's share in education, home areas and business.

What's on the Box?

Use of satellites to broadcast programmes direct-to-home via dishes and receivers opens up a vexed question regarding programme quality. Before Sky started transmitting its channels from the Astra satellite a couple of years ago there were only the four terrestrial channels to worry about. All sports events, films and general entertainment programmes were shared between them in a largely haphazard way.

Satellite television broadcasters are keen to develop their programme quality and content to compete and in many cases, beat the terrestrials channels. This is easily seen in the various sports channels (there are now three broadcast in English from Astra) and the variety of sports they now cover. Where traditionally cricket test matches, golf championships, boxing fights, tennis (specifically Wimbledon) and so on were all covered by terrestrial channels for just the price of the television licence, they can be seen one by one being bought up by the satellite channels. Sports fans need to ask themselves whether terrestrial television is supplying a valuable service at all.

Sky's two film channels show all new movies only a year or so after cinema release. Compare this with the terrestrial channels' wait of over five years or so, and any film buff has a valid reason to ditch terrestrial television. Sky News transmits 24 hours a day. While terrestrial news coverage is equal to content and quality, Sky News has the advantage in availability.

Where satellite television currently loses out to terrestrial, is in general entertainment. There are arguably too many transmissions of old American serials and too few home-generated quality drama and documentary programmes, but that will change as more revenue is recouped giving a kitty from which new programmes can be financed.

Satellite television is off to a fair start and is arguably the equal of terrestrial television. As more and more viewers realise programmes they want to watch are being snapped up by satellite channels and no longer available on the ground, sales of satellite television receivers and dishes could take off in a big way.

Terrestrial broadcasters need now to sit down and consider their options. If they are to provide a continuing service which people want, they must decide what their strengths are and consolidate them accordingly. If this job is left too late, few viewers will want what remains on offer.

Keith Brindley

electronize CAR ELECTRONICS KITS

MICRO-PRESSURE CAR ALARM

This new type of alarm is triggered by a unique pressure sensing system. As any vehicle door is opened air is drawn out, causing a minute drop in air pressure. A sensor detects this sudden pressure change and sets off the alarm. A sophisticated arrangement of electronic filters and timers provide features to match more expensive ultra-sonic systems.

- ★ 1 Micro-pressure intruder detection.
- ★ 2 Operates on all doors and tailgate - no switches needed.
- ★ 3 Automatically armed 1 minute after leaving vehicle.
- ★ 4 10 second entry delay with audible warning.
- ★ 5 Sounds horn or siren intermittently for 1 minute - then re-arms.
- ★ 6 Easy fitting - only 3 wires to connect - no holes to drill.
- ★ 7 Compact design can be hidden below dashboard.
- ★ 8 All solid state Power MOSFET output - no relays.
- ★ 9 Adjustable sensitivity.

MICRO-PRESSURE ALARM DIY parts kit £15.95 Assembled £22.35
120dB PIEZO SIREN (optional for Micro-pressure & Volt Drop Alarms) £13.35

MICRO-PRESSURE TRIGGER

This module adds MICRO-PRESSURE sensing to any volt drop operated alarm simply by connecting two wires across the vehicle's 12v supply. Use it to upgrade an existing alarm or combine the benefits of both systems.

MICRO-PRESSURE TRIGGER DIY parts kit £10.95 Assembled £14.95
VOLT DROP CAR ALARM DIY parts kit £14.90 Assembled £20.95

TOTAL ENERGY DISCHARGE IGNITION

Our unbeatable Extended C.D.I. system retains the contacts for easy fitting. The contacts operate at low current whilst the 12v supply is converted to 370v for a super power spark with improved starting, performance and economy. Includes contact bounce filter, voltage regulator (full output at only 6 volts), timing L.E.D. and standard/electronic change over switch.

TOTAL ENERGY DISCHARGE IGNITION DIY parts kit £22.75 Assembled £28.45

All the above include cable, connectors and clear, easy to follow instructions. All kits include case, PCB, everything down to the last washer, even solder.

All prices now include post, packing and VAT on U.K. orders. Same prices apply to all European countries. For delivery outside Europe please add £3.

Telephone orders accepted with VISA or ACCESS payment.
 Order direct (please quote ref. T17) or send for more details from :-

ELECTRONIZE DESIGN Tel. 021 308 5877

2 Hillside Road, Four Oaks, Sutton Coldfield, B74 4DQ

MICRO BASS

The latest sub bass kit from Wilmslow Audio. Micro Bass measures only 305 x 284 x 382 mm and can be positioned almost anywhere in the confines of the listening room without affecting the stereo image. It can be connected directly into existing systems and requires no extra amplifier. Designed as the perfect partner for most small loudspeakers with a sensitivity of 86 to 89 db.

The Wilmslow Audio Micro Bass kit contains 2 x 8" Bass units, flat pack cabinet kit machined from smooth M.D.F for easy assembly, xover kits and reflex port etc.

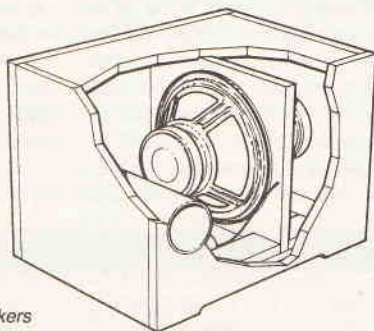

Other subwoofers available to match most types of speakers

Impedance:
8 ohms
AMP Suitability:
20-100w

£110.00 inc VAT
 carriage/ins. £10.00

Wilmslow Audio

Wellington Close,
 Parkgate Trading Estate
 Knutsford, Cheshire
 WA16 8DX
 Tel: (0565) 650605
 Fax: (0565) 650080

DIY Speaker catalogue £1.50
 post free (export £3.50)



Telephone credit card
 orders welcome



Open Tuesday to Saturday, 4 demonstration rooms available.



AUTONA LTD

UK's leading module manufacturer since 1972

FULLY BUILT AND TESTED

MODULES

ALL UNITS SUPPLIED WITH
 COMPREHENSIVE INSTRUCTIONS

★ ★ AUDIO ★ ★

AL 12580-125W AMPLIFIER

A rugged high powered module that is ideal for use in discos & P.A. Systems where powers of up to 125W, 4 ohms are required. The heavy duty output transistors ensure stable and reliable performance. It is currently supplied to a large number of equipment manufacturers where reliability and performance are the main considerations, whilst for others its low price is the major factor. Operating from a supply voltage of 40-80V into loads from 4-16 ohms.



£18.95
 + VAT

AL 2550-COMPACT LOW-COST 25W AMPLIFIER

One of our most popular audio modules with tens of thousands installed. Ideal for domestic applications where low distortion and compact size are the prime requirements. Used with supply rails of 20V-50V into loads of 8-16 ohms.

£6.55
 + VAT



MM 100-BUDGET 3-INPUT MIXER

With a host of features including 3 individual level controls, a master volume and separate bass and treble control, it provides for inputs for microphone, magnetic pick-up and tape, or second pick-up (selectable), and yet costs considerably less than competitive units. This module is ideal for discos and public address units and operates from 45V-70V.

£17.49
 + VAT



MM100G

As MM100 with two guitar + 1 microphone input intended for guitar amplifier applications.

£17.49
 + VAT

★ ★ SECURITY ★ ★

MINIATURE PASSIVE INFRA-RED SENSOR-RP33



Switchable Dual range, detects intruders up to 6 or 12 metres
 Quantity discounts start at 3 units.

New only
 £19.95
 + VAT

Size 80x60x40mm

This advanced sensor operates by detecting the body heat of an intruder moving within the detection field. Slow ambient changes such as radiators, etc. are ignored. Easily installed in a room or hallway. Providing reliable operation from a 12V supply, it is ideal for use with the CA 1382 or equivalent high quality control unit. Supplied with full instructions.

DIGITAL ULTRASONIC DETECTOR-US 5063



Crystal controlled movement detection module operating at 50kHz with an effective range up to 20ft. Suitable for operation in household or vehicle security systems. 12V operation and built-in timing makes it suitable for a wide range of applications.

£14.93
 + VAT

Easily Installed

ADVANCED CONTROL UNIT-CA 1382



Automatic Loop Test & Switch On ★ Automatic Siren Re-Set ★ Audible Entry/Exit Warning Buzzer ★ Two Separate Loop Inputs + 24-hr Circuits ★ Easily Installed. Full Instructions Supplied.

£44.95
 + VAT

This advanced control panel provides effective and reliable control for all security installations, yet its operation is sheer simplicity for all members of the family, and is supplied with two keys. Housed in a steel case with an attractive moulded front panel, it compares with units costing twice the price.

LOW COST CONTROL UNIT-CA 1250



This tried and tested control unit provides the finest value for money in control systems, with many thousands protecting houses all over the country. A suitable steel enclosure is available separately.

£21.35
 + VAT

50FT INFRA-RED BEAM-IR 1470

The IR1470 consists of a separate transmitter and receiver providing a beam of up to 50ft which, when interrupted, operates a relay in the receiver which in turn may be used to control external equipment. The system requires only 65mA from a 12V supply. Size: (each unit) 82 x 52 x 57mm

£25.61
 + VAT

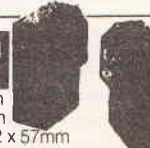

FULL RANGE OF SECURITY ACCESSORIES STOCKED PROVIDING EVERYTHING YOU NEED TO PROTECT YOUR HOME

ATTRACTIVE DISCOUNTS
 AVAILABLE FOR QUANTITY USERS

DEPT ETI 7
 51 POPPY ROAD
 PRINCES RISBOROUGH
 BUCKS HP17 9DB

TEL: (084 44) 6326 FAX: (084 44) 7102

Add VAT + £1.50 on all orders. Export add 10%



Callers by
 appointment
 only

READ \ WRITE



RIAA Track Record

Regarding M. Silvester's article on the RIAA curve, it was not clear (at least to me) why the curve was needed. The article implies that it is used to compensate for the characteristics of the listener's magnetic cartridge. Its primary purpose, however, is to compensate for the equalization used in making a record.

Perhaps, some additional explanation will help clarify the situation. When a record is made, there is a reference point called the turn-over frequency. During the cutting process, the method used to record frequencies above and below this point is different.

Below the turn-over frequency, records are made in a mode called constant amplitude. In this case, the amplitude refers to the movement of the cutting stylus. If the recording system was not equalized, then the amplitude of the cutter head would increase as the frequency decreases. At very low frequencies, the grooves would use up a large portion of the disk.

Records, of course, are made by having a specific number of grooves per inch of space. This restriction limits the amplitude that the cutting stylus can move. To restrict the cutters amplitude, the electrical input must decrease as the frequency is decreased. The rate of change is 6dB/octave, and at 20Hz the amplitude will be -20dB.

As shown in Figure 2b of Mr. Silvester's article, when the mechanical motion of the cutter is held constant, the played back signal from a magnetic cartridge will be frequency dependent. As the frequency changes, its output will also change by 6dB per octave.

For sound reproduction, the audio system must have a flat frequency response. This is obtained with the RIAA curve. Below the turn-over frequency it has a characteristic that is opposite to the one used in making the record. As shown in the article (Figure 4), at low frequencies the curve provides an amplitude

increase of 20dB. As the frequency of the input signal increases toward the turn-over point (1kHz) the amplitude decreases.

When the recorded frequencies are greater than the turn-over point, the method is changed to a technique called constant velocity. In a recording system that has not been equalized, the amplitude decreases with increasing frequency. During play back, this characteristic will also cause the output from a magnetic cartridge to decrease. At 20kHz, for instance, the output of this cartridge may be equal to or less than the record noise.

To overcome this problem, the frequencies above the turn-over point are increased in amplitude by 6dB/octave. Again as indicated in Figure 4, the RIAA compensates for this condition. At 20kHz, the amplitude is decreased by 20dB.

The RIAA curve is opposite to the one used during the recording process, and the result is a system

with flat frequency response.

The above conditions are ideal. While recording companies adhere to their curve, there is no guarantee that equipment manufacturers do the same. Not only should a listener's sound system be checked to determine if it follows the RIAA curve, but also to find out if the left and right channel are matched. Any differences will alter the stereo effect.

While an oscillator and an audio voltmeter can be used for this purpose, this technique is very time consuming. A better method is to use a simulator that duplicates the recording method. When this device is connected to the phono input of a stereo system, the user can monitor the preamps output. Any deviation from flat response is due to a problem with the circuit that provides the RIAA curve.

Ronald Wagner, Fremont, California.

Laser Transformers

With reference to Kevin Kirks article on Lasers in the May issue. I have considerable recent experience in designing switching power supplies for lasers both for use with 12V supplies and also direct from mains supplies, in the range from 1/2mW to 5mW tubes.

There does not seem to be any

gapping of the transformer cores in the design given. I have found that with flyback switchers from the 12V supply that some gap is advisable to avoid core saturation. Whilst one may get away without gap for the mW tube, it was necessary for 1-5mW and therefore I used a standard gap for all sizes. This also results in more

constant primary inductance. Also convention dictates that start-finish symbols be used on the transformer diagram. Whilst it may not matter in some circuits depending on the drive, it does help the coil winders to get it right every time. If any readers have problems with the transformer, I can offer limited quantity produc-

tion together with professional impregnation, and the care necessary to locate secondary start and finish lead to avoid arcing. I trust the above comments are acceptable.

Norman E Peart, Oldham.
Anybody interested in the service should send requests via ETI Editorial.

Radio Controlled Falcons

I shall be much obliged if it is possible, easily, to let me know if you have given a project in ETI of a tracking set up, for example, a transmitter on the tail of a falcon as an instance to locate it — or the creature so equipped — with a direction finding receiver, if it has strayed from sight.

Alternatively you may be able to suggest some other course of enquiry I can follow.

S Head, Bury St Edmunds.

An interesting one this. ETI does not have a great track record on

transmitter projects for the simple reason that although we might publish a design, it has been illegal to operate it without a licence. As you see, some might ask: Why publish a project that cannot be used?

However, even though ETI has recently presented some transmitter designs connected with the world of surveillance they might still be too cumbersome for a poor bird to carry around all the time. The main shortcomings of many constructions are of weight and operating life. What is

required is a surface mount design which produces minimal size and low power consumption with a clever antenna system using, say, the wings as a dipole. A very sensitive base receiver could be used for tracking. Better still, if a passive system similar to ground-based RADAR for detecting flying objects could be adopted at the bird end, then you can happily say good-bye to power supply problems. Other alternatives are Falcon wing powered generators to run the transmitter so the bird does all the work.

Interestingly enough, with a moving transmitter one could possibly detect speed and direction using the Doppler effect and with two base stations one could obtain positional information.

Well there we are dear readers, the seed has been sown, the quaglet has been thrown down, the balloon is up, the bird has flown and its over to you for an ETI Innovation of the year award. — Ed

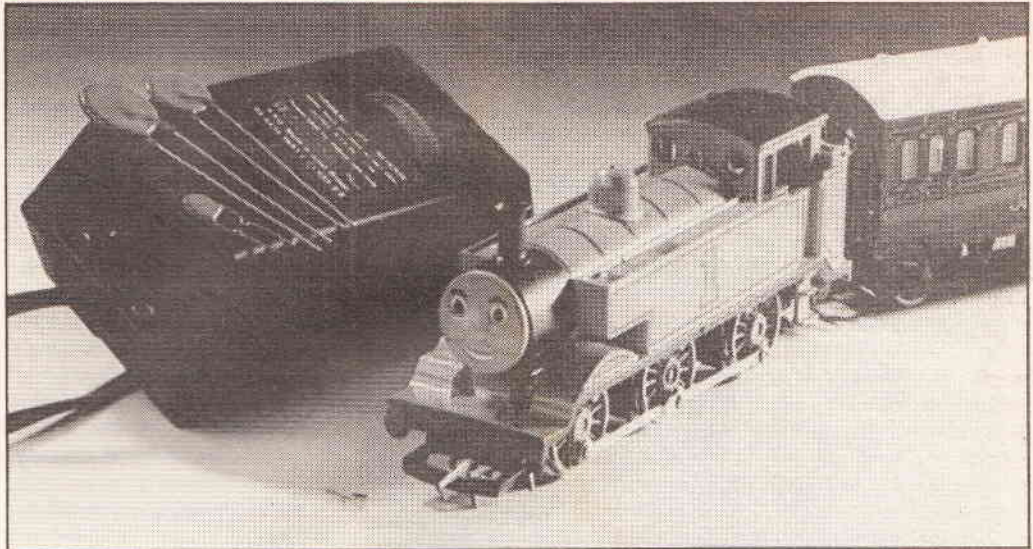

Raychem's Polyswitch circuit protectors are being used in transformers accompanying Hornby train sets and Scalextric sets.

The PTC (positive temperature coefficient) devices have been installed in all train set transformers by Margate-based Hornby Hobbies Ltd. for almost two years. Recently, they have also been incorporated into Scalextric transformers.

Hornby deputy engineering manager Mike Walters said the company had always used a variety of circuit protection devices in its units, but they changed over to PTC devices because of their minimal heat

generation and compact nature.

These self-resettable devices are the fastest PTC thermistors available today. They undergo a large, abrupt change in resistance when an overcurrent or high temperature heat them above a specific point.

When tripped, the devices limit the current to a very low value thereby protecting the equipment against any damaging overheating.

The key to the design of the Polyswitch range is the lack of moving parts, which removes the

possibility of malfunction through physical factors. The devices can be used in a variety of locations besides transformers, including battery-operated toys, personal computers, fax machines, electric motors, telephones and audio speakers.

ROYAL INSTITUTION HOST FUEL CELL SYMPOSIUM

International interest in fuel cell technology will be boosted again this September.

The Second Grove Fuel Cell Symposium is to be held at the Royal Institution, London during 24-27 September 1991. Its theme, on the commercial application of fuel cells, has already attracted worldwide interest.

In addition to researchers already engaged in fuel cell technology the Symposium will be of particular importance to those involved with advanced energy systems and energy and environmental policy making. Progress

will be reviewed in the development and commercialisation of fuel cell systems and their applications, including power generation through transport and to speciality markets.

The first Sir William Grove Memorial Medal (made from platinum) will be presented to Dr Francis Bacon for his pioneering work in modern fuel cell technology.

Said Gary Acres, Chairman of the Symposium Steering Committee, 'With energy costs now going through the roof the fuel cell is coming into its own,

especially as it is suitable for both power generation and vehicles with the added benefit of being virtually pollution free.'

William Grove invented the concept of the fuel cell in 1839 but it was the work of Francis 'Tom' Bacon, the Oxford graduate engineer who conceived the first hydrogen powered fuel cell. Fuel cells of the type designed by Bacon are still in use today, providing the power on board the space shuttle.

Fuel cells, involving direct chemical conversion of their fuel to electrical energy are more

efficient and are the perfect power source for vehicles, being clean, silent and compact.

Although the fuel cell was conceived in the UK, nearly all the development work has been made within the US, with the greatest strides towards commercial exploitation occurring in Japan. It is projected that fuel cells will hold a substantial share of energy markets within the next two decades, replacing some of the existing major power stations.

OPEN DAY AT MARTLESHAM

Demonstrations of global networking, videophones and satellite telephony along with optical fibres to carry more than 50 million calls are among a host of items in a display of leading edge technology unveiled by BT this week.

Developments such as intelligent networks, which will present customers with a mix of services and detect faults before they affect calls, are among 65 BT projects

to be demonstrated at the company's 'Innovation 91' exhibition at the BT laboratories at Martlesham Heath near Ipswich.

Timed to coincide with the launch of the new BT, the exhibition was designed to give customers a taste of the range of BT's technology and resources.

The projects demonstrated are among more than 1200 currently underway in BT's Development and Procurement division.

The displays are organised around five themes:

- total mobility and freedom: new ways of keeping in touch on the move
- living in the 21st century: technology to make life easier
- doing business in tomorrow's world
- connecting the future: the network infrastructure that will support worldwide communications into the next century

exercising the power of IT, through the computing systems that enable BT to provide new levels of customer service.

BT spends about 2% of its revenue on research and development. The direction of expenditure is moving away from components and materials to concentrate on systems, with software engineering now making up 50% of BT's activities.

FERGUSON TO LAUNCH UK'S FIRST WIDE-SCREEN TELEVISION

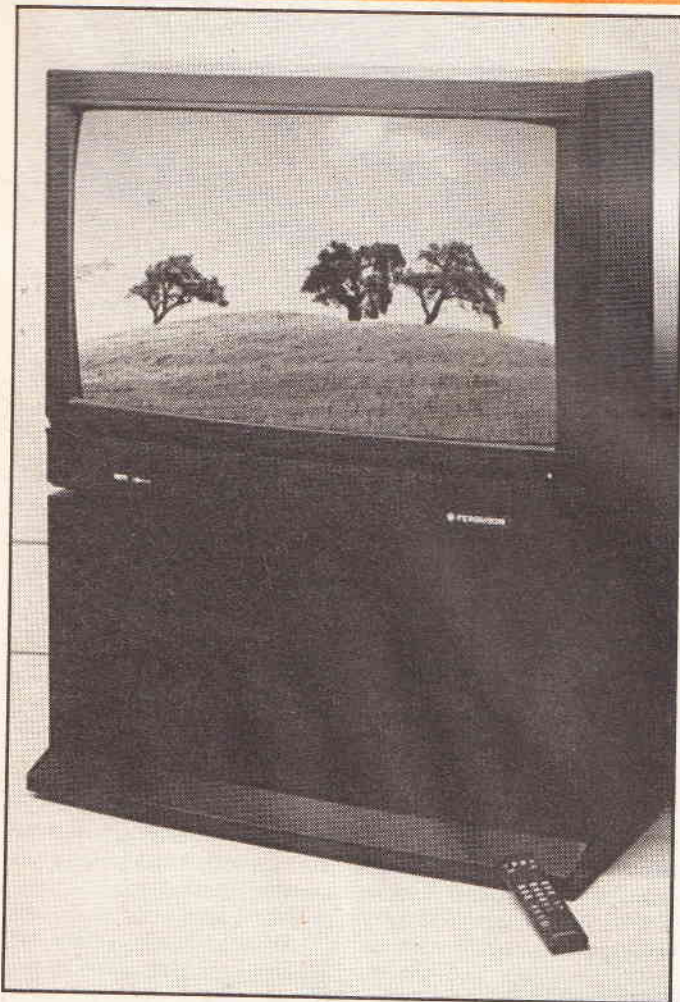

Ferguson, the manufacturer of TVs and video recorders to the UK market, is launching the country's first widescreen consumer television, capable of displaying programmes in 16:9 format (16:9 width to height aspect ratio, as opposed to the 4:3 aspect ratio of current televisions). The new set (A86W), also represents a milestone in TV technology as it features a high-scan (1250 line High Definition Television compatible) chassis that gives improved picture and sound performance. Whilst the new television is compatible with existing TV broadcasting it has been designed for the future and has the latest developments towards High Definition TV.

When receiving a signal in 16:9 format the new set automatically recognises the nature of the signal and displays the full picture. However the A86W also brings new dimensions to a 4:3 signal. Viewers will no longer have to watch widescreen films with either the sides cut off (when editing big screen films for broadcast to fit 4:3 screen ratio TV's, the side edges of the picture are often lost) or with a black band at the top and bottom of the picture. Widescreen films are viewed full picture, full screen, and the set also allows the viewer to 'zoom up' 4:3 images to occupy the entire width of the screen. Alternatively, the A86W allows the viewer to display a 4:3 signal fully in the centre of the screen between two lateral black bands, or place the image to the

left of the screen, with the vertical strip on the right being used to display three pictures from other channels — referred to as POP (Picture Outside Picture). Another feature also enables viewers to create PIP (Picture In Picture) images on the screen, when monitoring other channels. PIP and POP pictures can be used to display any source material, whether it be from the built-in satellite tuner channels or input from a VCR.

The A86W is a NICAM set with 2 x 70 watts audio and surround sound capability, Fastext, built-in satellite receiver, and remote control.

According to Ferguson Director and General Manager, Alan McWalter the new model, which will retail at around £3500, is the first of a range of 16:9 products to be marketed by Ferguson and will be available in smaller sizes. "The A86W's price is only about 30% higher than existing top-of-the-range conventional 4:3 giant screen (80cm diagonal) televisions offered by certain competitors," stressed Mr McWalter.

Mr McWalter also predicted the 16:9 format will grow dramatically in the future, replacing the existing 4:3 format, and by the year 2000, more than half the TVs sold in the world will be 16:9 format products.

The 16:9 aspect ratio, which is that of most 35mm films, has been accepted by the CCIR as an international standard and decreed the 'TV format of the future'.

TELEPHONE LINKS TO KUWAIT

BT has become the first company worldwide to restore international direct dialled telephone links to and from Kuwait since the invasion in August, 1990.

BT has erected an earth station in Kuwait City that offers

Kuwait a limited telephone service with the rest of the world, via the UK.

Mike Read, BT's Director of International Networks said: "We are delighted to be the first company to reconnect Kuwait with the rest of the world.

A BT spokesman said: "This is the only generally available international service to Kuwait and it is in high demand. If customers experience difficulty they should contact the international operator on 155."

SURFACE-MOUNT RELAYS

The 800 Series low profile DIL reed relay from Astralux Dynamics has been specifically designed for use with surface mounting assembly techniques.

Approximately one third the weight of conventional DIL reed relays, 800 Series relays are moulded in high grade epoxy resin to withstand high temperatures.

Available in 5V and 12V nominal coil voltage versions, the relays have a maximum initial contact resistance of 150milliohms.

Contact: Astralux Dynamics Ltd, Tel: 0206-302571/5.



REDUCING ENERGY COSTS FOR BRITISH COMPANIES

A London based company claims to cut typically 25% from their energy bills by using a software package to monitor energy efficiency in their buildings. The package has been developed by energy consultants, EnTech, for commercial and public-sector premises. Savings are said to have been made by large organizations including Marks and Spencer, Royal Mail, British Rail, Shell, and the Severn Trent Water Limited are all using it to keep energy costs under control. EnTech has now produced a smaller version of the package – called S/STEM – which could bring corresponding benefits to medium-sized companies, with annual energy bills totalling less than £20,000 per site. Users of the service can either run the IBM-compatible software themselves, or supply meter readings and invoices to EnTech, who process the readings and make recom-

mendations for energy saving.

S/STEM is used to monitor how much energy individual buildings use over the year, and compares this to how much they should be using. By giving early warning of equipment faults and changes in energy use, the package can pay for itself within 12 months, the company says.

Entech also offer a complete energy targeting service. The starting point is an energy survey of the individual buildings, including infra-red thermographic surveys which help uncover precise heat losses. Besides suggesting initial energy saving measures and they claim that £5,000 per year savings are common for bills of £20,000, with a maximum two-year pay-back time, EnTech feeds the information into S/STEM. The package then builds up a detailed model of the building's energy characteristics, and calculates its energy equation (energy

input = useful energy + energy wasted). Building characteristics like building fabric, heating system, lighting, and equipment installed, passive heat received through windows, weather 'exposure factor' and even the body heat of the occupants are included. The software will calculate the corresponding energy costs from electricity, gas, oil and solid fuel tariff rates.

Each week or month, the user enters meter readings and/or invoices into S/STEM. The package runs on PC compatible computers and is 'menu driven'. Normally, readings are entered in batches; after each batch, S/STEM automatically highlights errors or unlikely values for correction by the operator. The software calculates the actual costs for each building using weather and tariff data which is regularly updated by EnTech for a yearly undisclosed maintenance

fee. It compares these actual costs against target costs which were calculated from the energy characteristics of the buildings.

The software will produce management reports with graphs and charts to show up variations in energy usage by region, type of building, and deviation from energy target. It can compare year on year expenditure and print a ranking table of present and past months' performances. Future energy targets are calculated using '20-year average' weather data, and the operator can ask 'What If?' questions about energy consumption, for instance to discover the effects of replacing an oil-fired boiler by a gas-fired one, or the payback times of different types of insulation. A regular System Integrity Check helps ensure that data files are correct, complete, and free from viruses.

Contact: EnTech Energy Consultants Ltd, Tel: 071-833 3353.

S600 SUPERCOMPUTER EUROPE'S FASTEST SYSTEM

Siemens Nixdorf Information Systems Limited has announced the S600 supercomputer, Europe's fastest monoprocessor system. In independent tests, the 5600 attained a real-time peak performance of 4.009 billion floating point operations per second (Gflops).

The S600 achieved its 4.009 Gflops performance in the 1991 LINPACK 1000 x 1000 bench test. The test compared the performance of various supercompu-

ters in solving a system of linear equations, and placed the 5600 ahead of systems manufactured by CRAY, NEC and Hitachi.

The S600 is the top model in the Siemens Nixdorf S-Series supercomputer range. The range is designed to handle complex applications in all fields of science and engineering, including the simulation of costly research trials in fields such as automotive design, plasma physics, oil exploration and chemical analysis.

The S600 has a rated theoretical peak vector performance of five Gflops and is available with one or two scalar processors, each of which delivers a sustained performance of 37.5 million floating point operations per second.

The motherboard is constructed from glass ceramics, giving a highly concentrated multi-layer structure that increases overall processing speed. The scalar and vector processing units are both housed on the 61 layer

board, accommodating 144 chips.

All logic circuits in the scalar and vector units are ultra high-speed, high density, LSI chips. The processor logic uses chips with 15,000 gates and a signal propagation delay of 80 pico-seconds. Vector registers, control registers and buffers use MOS-RAM chips with a 64kbit memory capacity, giving the S600 a cycle time of 6.4ns.

Contact: Nixdorf Information Systems Ltd, Tel: 0344 862222

ADAPTIVE OPTICS

Among a new range of tilting mirrors available from Lambda Photometrics is the S380 This high-dynamic unit has a tilt angle range of 800 microradians in two axes, an angle resolution of 1 microradian and a response time of one thousandth of a second. The 100mm diameter mirror is 15mm thick and has a surface flatness to within one eighth of the wavelength of light measured at 632.28nm.

The unit is an adaptive optic system using a closed-loop piezoelectric actuator. The response time, resolution and accuracy of the mirror allows it to perform in many optical applications, such

as accurately compensating for atmospherically induced image jitters in astronomical telescopes.

In operation, two integrated piezo transducers correct image distortion in real time by tilting the mirror in two axes simultaneously over an 800x800 microradian range. A closed loop servo system, comprising four high-resolution capacitance sensors, monitors and positions the degrees of tilt in the relevant axis to preserve a 1 microradian accuracy at all times.

Technology for the unit originates from an image stabilizer designed and built by Physik Instrumente for the European Southern

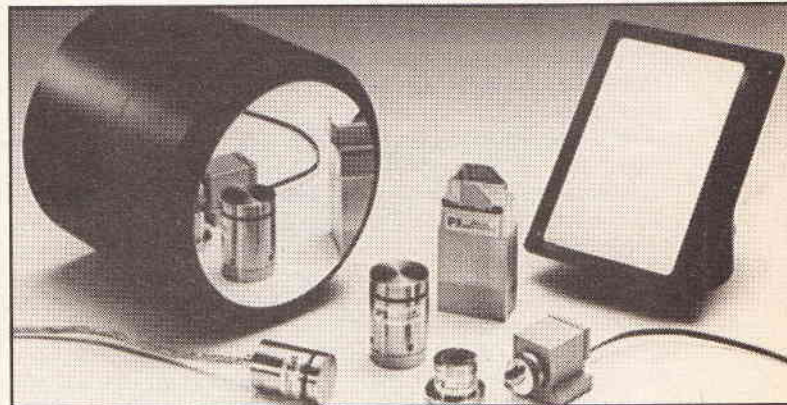

Observatory's 2.2 metre telescope.

Further information contact:

Lambda Photometrics Limited,
Tel: 05827 64334

DUCHESS OF YORK PRESENTS YOUNG ELECTRONIC DESIGNER AWARDS

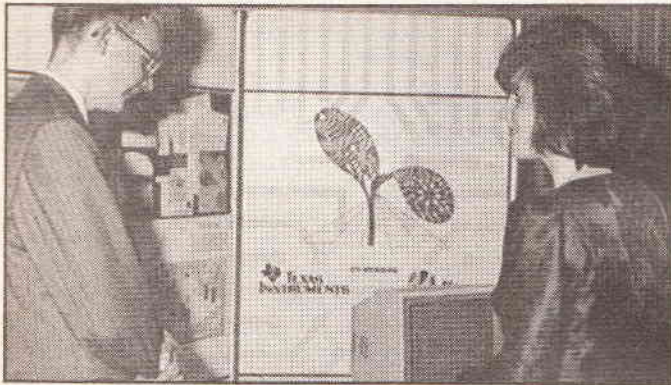

HHRH The Duchess of York presented the 1991 Young Electronic Designer Awards at the Science Museum. The Duchess praised the work of all 21 finalists,

saying how much she admired their ingenuity and their understanding of the science of electronics.

The 21 young designers,

whose ages ranged from 12 to 24, came from 15 different educational establishments in all parts of the UK. The Texas Instruments' Prize of £2,500 for the most commercially viable project was awarded to Pollyanna Robinson (Junior); The Godolphin School, Salisbury. The Mercury Communications 'Planet Award' (also worth £2,500) for the most environmentally and socially aware technology went to Jonathan Saville (Intermédiaire), Queen Elizabeth Grammar School, Wakefield. The three category awards were won by Stephen Brown (Senior), Royal Naval Engineering College, Plymouth; Jonathan Saville (In-

termediate); and Pollyanna Robinson (Junior).

The Duchess commended the young designers for their breadth of vision and scientific skills. She said: "Schemes like YEDA are dependent on sponsorship from commercial organisations which aim to put something back into the community, provide incentives for tomorrow's workforce, play a positive role in reducing skills shortages and increase their corporate profile in educational circles".

The annual scheme is organised by the YEDA Trust (a registered charity) and is open to students between the ages of 11 and 25, at secondary schools, polytechnics and universities in the UK. There are three category prizes (under 15, 16-17 and 18-25) as well as the two special sponsors' awards.

EMPLOYMENT PROSPECTS IN ELECTRONICS

Employment prospects in electronics remain positive, making it one of only a few sectors in the country not showing a decline, according to the latest Quarterly Survey of Employment Prospects published by Manpower.

The Survey questioned over 1,500 companies throughout the

country, across all industry sectors and the overall findings are yet another indication of deepening recession in the UK.

Although employers in the electronics sector anticipate more increases over decreases in employment prospects, a balance of + 16, the equivalent period in 1990 was + 20, suggesting that

employers' optimism is fading. However, electronics is still well above the national average, which shows a balance of -2.

The majority of companies in electronics predict no change in employment prospects, with 72% of employers asked, anticipating levels remaining static during the second quarter.

Employers expecting increases in employment prospects over the next quarter have fallen, from 28% in 1990 to 22% for the coming three months.

Among those employers anticipating decreases in job prospects, the figure has marginally dropped, from 8% in 1990 to 6% for the coming quarter.

DUAL DISPLAY

The latest multitester from Alpha Electronics features a true combined analogue and digital display. In the centre of the large moving pointer analogue section is a 3½ digit liquid crystal display. These combine to show both varying and instant measurements.

The TMK 600 measures AC RMS voltage to 750V in 5 ranges with an analogue sensitivity of 1M Ohm/V DC voltage is to 1000V also in 5 ranges. Direct and Alter-

nating current uses 7 ranges to measure up to 10A. Resistance together with an audible continuity feature use 6 ranges to cover 20M Ohms. Additional tests include diode and dBs.

It is battery operated and housed in a yellow ABS case. Designed to comply with the latest safety standards, it is fitted with an NBC ceramic fuse.

Contact: Quiswood Ltd on (0756) 799737.

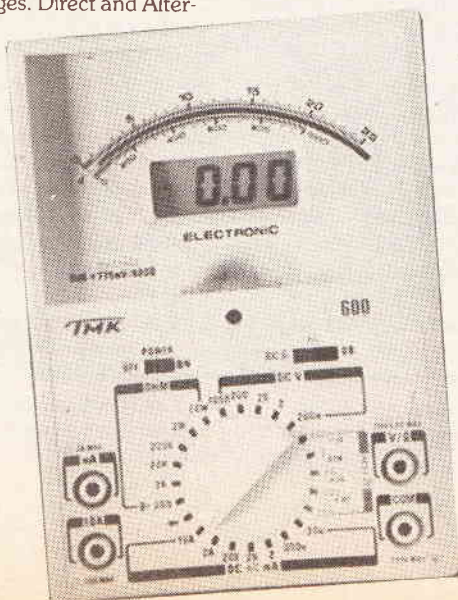

A WEATHER EYE

Even during the recent high winds and severe cold weather, the motorway crossing the Severn Bridge remained open. This was partially due to the monitoring system of chart recorders supplied by The Instrument Centre (TIC) at Newport. Eight chart recorders are in the Severn Bridge headquarters and also at Avon police Department's Almondsbury base, from where traffic flow is controlled.

The system currently monitors the speed and direction of winds affecting the Severn and Wye spans together with making humidity and temperature checks. Wind speed and direction are recorded from voltage transducers while temperature and humidity are derived from current

transducers. Each recorder operates up to four sensing channels.

One simple application is routine painting. The Forth Bridge principal of starting at one end and finishing at the other before starting all over again is a myth. In reality, each area requires different treatment at different times. Painting wet steel is a waste of time and money, so steel temperature and humidity readings will help determine the dewpoint. Having established that the steel condition is correct, a wind speed could help determine whether the working conditions are favourable and safe.

Further information contact Quiswood Ltd on (0756) 799737.



stateside

Channel selectable video op amp

The KA-2444, integrates four video op amps on a single die and offers a wideband multiplexer and a high-impedance buffer on-chip.

It is designed to replace four cross-points and digital control logic in video board applications,

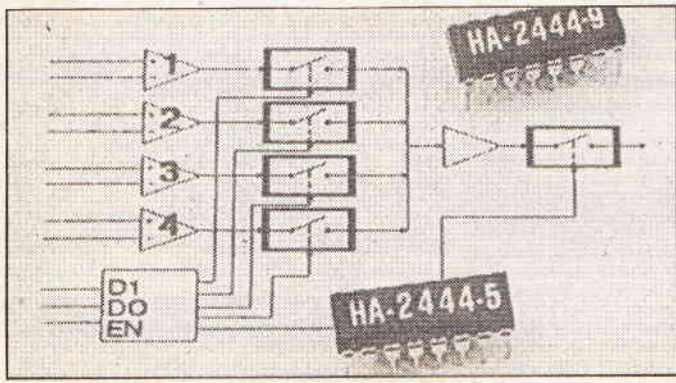

New class of conducting polymers

Chemical research being carried out at the California Institute of Technology may pave the way for a new class of conducting polymers to be used in practical applications, particularly in photovoltaic cells. However, the difficulty is to cast the complex polymers into thin films or wires. The long chain molecules tend to get tangled up with themselves, producing insoluble compounds that are very difficult to work with.

These complex molecules are being untangled by a method called Ring Opening Metathesis Polymerization, which is a catalytic process that unwinds complicated polymer structures. It transforms polyacetylene-based conductive polymers into a form that dissolves in organic solvents. The resulting solutions can be spin-coated on silicon substrates, yielding uniform conducting films.

and can help minimize board space and cost in video systems.

Functionally, the HA-2444 is a channel-selectable video op-amp comprising of four differential inputs, a single ended output, and digital control. Also, the selectable quad op amp has been optimized to offer fast selection and low crosstalk. For instance, typical channel selection time is 60ns, with crosstalk rejection of 60dB at 5MHz.

Other key features of HA-2444 include unity gain bandwidth of 45MHz, gain flatness (to 10MHz) at 0.12dB, and low differential phase and gain of 0.03 degrees and 0.03%.

Commercial and industrial versions of the HA-2444 come in 16-pin plastic small-outline IC (SOIC) and dual-in-line packages (DIPs), while the 883-compliant units will be offered in 16-pin cerdips and flat packs.

Manufacturer is the Harris Corp. of Melbourne, California.

The process results in no discernible variations of the films down to a resolution of 200nm.

The use of conducting polymers would eliminate the chemical reactions that plague metal and semi-conductor junctions. Active chemical effects degrade current flows across metal silicon contacts by trapping electrons.

Use of conducting polymers is especially promising for photovoltaic cells. Photocells based on metal and semiconductor junctions perform well below their theoretical maximum efficiency because of chemical reactions that take place in the junctions.

The chemically neutral polymer junctions are tested by coating an n-doped silicon substrate. Called polySi-COT which has been treated with the COMP Catalytic process. This is a conductive polymer with silicon side groups attached to every eighth carbon atom in a polyacetylene chain. Tests indicate that the electron flow across the polymer-silicon interface is at the ideal value.

Developing more efficient solar electric panels

A three-year subcontract has been awarded by the Solar Energy Research Institute Solarex Corp., to develop large area, high-efficiency, multijunction thin film solar electric generating modules that convert sunlight directly into electrical energy.

Under the contract terms, Solarex and SERI will share the \$6.5 million cost of developing advanced modules demonstrating a stable conversion efficiency of 12%. The contract also targets

development of a small area (1cm²) device with a 14% conversion efficiency.

Unlike typical single-junction solar cells, multi-junction solar electric devices are constructed of several solar cells 'stacked' on top of one another, each being designed to capture a different portion of the solar spectrum. The multi-junction architecture optimizes the device's ability to turn sunlight into electricity.

Multi-junction structures have already demonstrated impressive gains in stability over earlier single-junction devices. The Solarex-SERI contract will work with structures that utilize amorphous silicon-germanium and silicon carbon alloys.

Enquiries: Solarex Corp., Rockville, Maryland.

Compressed air conditioning system uses electronic timer

Supersaturated, hot, dirty air leaving a compressor must be cooled, cleaned, and dried. A compressed-air conditioning system consists of four components, an aftercooler, separator, dryer, and filter. In the past, companies have had to assemble systems from multiple suppliers and evaluate each component separately.

The aftercooler uses air, not water, to cool incoming air to within 5° of the ambient temperature. The separator uses a

rotational force to lower the humidity in the air to below 100%, so the dryer functions more efficiently. The velocity with which the supersaturated air hits the side of the vessel causes excess water to drop out.

A coalescing filter removes compressor oils by trapping 5µm particles, eventually forming a droplet is absorbed onto the filter media.

Dessiccant tablets absorb eight times their weight in water. New tablets are added periodically. A programmable electronic timer signals a gear-reduced motor to open a ball valve in the drain and discharge the condensate. Capacities vary from 35scfm at 75psig to 5,500scfm at 125psig operating pressure. Portable conditioners are also available.

Enquiries: Van Air Systems Inc., Lake City, Pennsylvania.

Faster CVD Process

A new chemical vapour deposition process has been developed which can be used to coat fibres, tapes and flat substrates with a thin film of superconducting material. It is 50 to 200 times faster than conventional deposition. The technique yields a coating 40-200µm thick per hour of deposition, depending on conditions, versus only 1.2µm/h for existing CVD technology.

A standard metal-organic CVD process, which evaporates materials and uses a carrier gas to transport them through a furnace, was modified to eliminate the complicated metal-source

vapourizers. Since the flowrate, temperature and pressure must be controlled for each vapourizer, the process was delicate and time-consuming. To eliminate the need for complex controls, the Georgia scientists replaced the vapourizers with a powder feeder. A combination of finely ground yttrium, barium and copper metal-organic powders are mixed with argon, then flow into the horizontal reactor, where deposition takes place.

The material has a critical temperature of 87K and can carry up to 40,000 A/cm² with no loss of superconductivity. Additional tests are being conducted to assess the material's electromagnetic properties.

Georgia Institute of Technology, 225 N. Avenue N.W., Atlanta, Georgia 30332.

THE ORIGINAL SURPLUS WONDERLAND!

MONITORS

MONOCHROME MONITORS

THIS MONTH'S SPECIAL!



There has never been a deal like this one! Brand spanking new & boxed monitors from NEC, normally selling at about £140! These are over-engineered for ultra reliability. 9" green screen composite input with etched non-glare screen plus switchable high/low impedance input and output for daisy-chaining. 3 front controls and 6 at rear. Standard BNC sockets. Beautiful high contrast screen and attractive case with carrying ledge. Perfect as a main or backup monitor and for quantity users! **£39.95 each (D) or 5 for £185 (G)**

CALL FOR DISCOUNTS ON HIGHER QUANTITIES!

COLOUR MONITORS

Decca 16" 80 budget range colour monitor. Features a PIL tube, beautiful teak style case and guaranteed 80 column resolution, features usually seen only on colour monitors costing 3 times our price! Ready to connect to most computers or video outputs. 75Ω composite input with integral audio amp & speaker. Fully tested surplus, sold in little or hardly used condition with 90 day full RTB guarantee. Ideal for use with video recorder or our Telebox ST, and other audio visual uses. **£99 (E) 3/£275 (G)**

20", 22" and 26" AV SPECIALS

Superbly made UK manufacture. PIL all solid state colour monitors, complete with composite video & sound inputs. Attractive teak style case. Perfect for Schools, Shops, Disco, Clubs. In EXCELLENT little used condition with full 90 day guarantee. **20".....£135 22".....£155 26".....£185 (F)**

HI-DEFINITION COLOUR MONITORS

Brand new 12" multiline high definition colour monitors by Microtek. Nice tight 0.31" dot pitch for superb clarity and modern metal black box styling. Operates from any 15.625 khz sync RGB video source, with either individual H & V syncs such as CGA IBM PC's or RGB analog with composite sync such as Atari, Commodore Amiga, Acom Archimedes & BBC. Measures only 14" x 12" square. Free data sheet including connection information. Will also function as quality TV with our RGB Telebox.



Only **£145 (E)**

Brand new Centronic 14" monitor for IBM PC and compatibles at a lower than ever priced Completely CGA equivalent. Hi-res Mitsubishi 0.42 dot pitch giving 669 x 507 pixels. Big 28 Mhz bandwidth. A super monitor in attractive style moulded case. Full 90 day guarantee.

Only **£129 (E)**

NEC CGA IBM-PC compatible. High quality ex-equipment fully tested with a 90 day guarantee. In an attractive two tone ribbed grey plastic case measuring 15" x 13" x 12". A terrific purchase enables us to pass these on at only.... **£79 (E)**

SCOOP! 14" Colour Multisync/Multifunction

Never before has such a deal been struck to bring you this quality Japanese manufactured multisync, multifunction professional grade monitor at an unheard of low price! The Electrohome ECM1311 with its host of inputs will connect to most computer systems including: IBM PC/XT/AT/PS2 (CGA, EGA, VGA modes) Atari, Archimedes (up to SVGA), Commodore, BBC and many more. Many other features include: RGB analog & TTL inputs, separate horizontal, vertical, composite and sync on green inputs; auto 15 to 36khz operation; 0.31mm tube dot pitch; tinted non glare etched screen & 30 mhz bandwidth makes this item an absolute snip! **Current makers list price over £900!** Each supplied with connection data, fully tested in used good condition, some may have screen blemishes. Complete with full 90 day RTB guarantee. Full Technical Manual £15.

Only **£149 (E)**

No Break Uninterruptable PSU's

Brand new and boxed 230 volts uninterruptable power supplies from Densel. Model MUK 0565-AUAF is 0.5 kva and MUD 1085-AHBH is 1 kva. Both have sealed lead acid batteries. MUK are internal, MUD has them in a matching case. Times from interrupt are 5 and 15 minutes respectively. Complete with full operation manuals.....**MUK.....£249 (F) MUD.....£495 (G)**

V22 1200 BAUD MODEMS

Master Systems 2/12 microprocessor controlled V22 full duplex 1200 baud modem. Fully BT approved unit, provides standard V22 high speed data comm, which at 120 cps, can save your phone bill and connect time by a staggering 75%! Ultra slim 45 mm high. Full featured with LED status indicators and remote error diagnostics. Sync or Async use; speech or data switching; built in 240v mains supply and 2 wire connection to BT. Units are in used but good condition. Fully tested prior despatch, with data and a full 90 day guarantee. What more can you ask for - and at this price!

ONLY **£69 (D)**

IBM KEYBOARD DEALS

A replacement or backup keyboard, switchable for IBM PC, PC-XT or PC-AT. LED's for Caps, Scroll & Num Locks. Standard 84 keyboard layout. Made by NCR for the English & US markets. Absolutely standard. Brand new & boxed with manual and key template for user slogans on the function keys. Attractive beige, grey and cream finish, with the usual retractable legs underneath. A generous length of curly cord, terminating in the standard 5 pin DIN plug. A beautiful clean piece of manufacturer's surplus. What a deal! **£39 (B) 5/£175 (D)**

Brand new and boxed 84 key PC/XT type keyboards in standard IBM grey with very attractive mottled finish and "clicky" solid feel keys. 10 function keys on side. Integral layout and E sign. Green LEDs for Caps, Scroll & Num locks. **£29.95 (B) 5/£135 (D)**

CALL FOR DISCOUNTS ON HIGHER QUANTITIES!

FLOPPY DISK DRIVES BARGAINS GALORE!

NEW 5 1/4 inch from £29.95!

Massive purchases of standard 5 1/4" drives enables us to present prime product at industry beating low prices! All units (unless stated) are removed from often brand new equipment and are fully tested, aligned and shipped to you with a 90 day guarantee and operate from +5 & +12vdc, are of standard size and accept the standard 34 way connector.

TANDON TM100-2A IBM compatible DS £39.95 (C)
CANON, TEC etc. DS half height. State 40 or 80T £79.00 (C)
TEAC FD-55-F. 40-80 DS half height. BRAND NEW £79.00 (C)

Specials!

TEAC FD-55 half height series in your choice of 40 track double sided 360k or 80 track double sided 720k. Ex-equipment fully tested in excellent condition with 90 day warranty. Order TE-36 for 360k **£29.95 (C)** or TE-72 for 720k **£39.95 (C)**

CHOOSE YOUR 8 INCH!

Shugart 800/801 SS refurbished & tested **£150.00 (E)**
Shugart 851 double sided refurbished & tested **£225.00 (E)**
Mitsubishi M2894-63 double sided switchable hard or soft sectors. BRAND NEW **£250.00 (E)**

SPECIAL OFFERS!!

Dual 8" drives with 2 megabyte capacity housed in a smart case with built in power supply! Ideal as exterior drives! **Only £499.00 (F)**

End of line purchase scoop! Brand new NEC D2246 8" 85 megabyte of hard disk storage! Full CPU control and industry standard SMD interface. Ultra hi speed transfer and access time leaves the good old ST506 interface standing. In mint condition and comes complete with manual. Only.....**£399 (E)**

MAINS SUPPRESSORS & FILTERS

Roxburgh SDC 021 2 amp mains RFI filter. Has an extra wide frequency range of 150 khz to 30 mhz. Can type, solder lug connection. Quality manufactured to BS 613 standards. Dims 1-1/2"D x 1-3/4"H..... **£3.95 or 3 for £10 (A) 10 for £28 (B)**
Roxburgh SDA 013/25. Similar to above rated at 1-1/2 amps. Dims 1-1/2"D x 1-3/4"H..... **£3.25 or 3 for £8.50 (A) 10 for £25 (B)**
Suppression Devices SD5 A10. Extra compact general purpose suppressor. Plastic moulded case with single bolt fixing and snap connectors. Rated at 230 vac 5 amps. Dims 1-3/4"L x 1-1/8"W x 5/8"H..... **£3.95 or 3 for £10 (A) 10 for £28 (B)**
Belling-Lee type L2127 3 amp mains RFI filters. Has a built in mains cable (English coding), and a three pin miniature non-reversible socket and a mating plug, to go to the equipment. Ideal for those who are bugged by RF interference. Very compact. Dims 3-1/8" x 2.5" x 1.5"..... **£3.95 each or 3 for £10 (A)**

RECHARGEABLE BATTERIES

LEAD ACID

Maintenance free sealed long life. Type A300.
12 volts 12 volts 3 amp/hours **£13.95 (A)**
6 volts 6 volts 3 amp/hours **£ 9.95 (A)**
12 volts Centre tapped 1.8 amp hours. RFE. **£ 5.95 (A)**
12 volts 12 volts 3 amp hours. 7-1/2"L x 6"S. RFE **£35.00 (B)**

EXTRA HI-CAPACITY NICKEL CADMIUM

Super high capacity Chloride Alcad 12 volts rechargeable type XL1.5. Electrolyte is readily available Potassium Hydroxide. In banks of 10 cells per 8"H x 2 1/4" x 5 1/2" wooden case. Each cell measures 8"H x 1.75" x 4"D. Can be easily separated. Ideal for all standby power applications. Ex MoD, like new...**£49.95 (E)**

SPECIAL INTEREST

Tektronix 1751 Waveform/Vector monitor **£2750**
Trio 0-18 vdc bench PSU. 30 amps. New **£ 470**
DEC VAX11/750 Inc. 2 Meg Ram DZ and full documentation, in brand new condition
Fujitsu M3041 600 LPM band printer
DEC LS/02 CPU board
Calcomp 1096 large drum 3 pen plotter
Thurby LA 1608 logic analyser
1.5kw 115v 60hz power source
Tektronix R140 NTSC TV test signal standard.
Sony KTX 1000 Videotex system - brand new
ADDS 2020 VDU terminals - brand new
Sekonic SD 150H 18 channel Hybrid recorder
Trend 1-9-1 Data transmission test set
Kenwood DA-3501 CD tester, laser pickup simulator **£ 350**

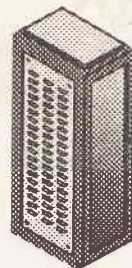

Superb Quality 6 foot 40u

19" Rack Cabinets

Massive Reductions

Virtually New, Ultra Smart!

Less Than Half Price!

Top quality 19" rack cabinets made in UK by Optima Enclosures Ltd. Units feature designer, smoked acrylic lockable front door, full height lockable half louvered back door and removable side panels. Fully adjustable internal fixing struts, ready punched for any configuration of equipment mounting plus ready mounted integral 12 way 13 amp socket switched mains distribution strip make these racks some of the most versatile we have ever sold. Racks may be stacked side by side and therefore require only two side panels or stand singly. Overall dimensions are 77-1/2"H x 32-1/2"D x 22"W. Order as:

Rack 1 Complete with removable side panels.....**£275.00 (G)**
Rack 2 Less side panels.....**£145.00 (G)**

POWER SUPPLIES

Power One SPL200-5200P 200 watt (250 w peak). Semi open frame giving +5v 35a, -5v 1.5a, +12v 4a (8a peak), -12v 1.5a, +24v 4a (6a peak). All outputs fully regulated with over voltage protection on the +5v output. AC input selectable for 110/240 vac. Dims 13" x 5" x 2.5". Fully guaranteed RFE. **£85.00 (B)**

Power One SPL130. 130 watts. Selectable for 12v (4A) or 24v (2A). 5v @ 20A ± 12v @ 1.5A. Switch mode. New. **£59.95 (B)**
Astec AC-8151 40 watts. Switch mode. +5v @ 2.5a, +12v @ 2a, -12v @ 0.1a. 6-1/4" x 4" x 1-3/4". New **£19.95 (B)**
Greendale 19AB0E 60 watts switch mode. +5v @ 6a, +12v @ 1a, +15v @ 1a. RFE and fully tested. 11 x 20 x 5.5cms. **£24.95 (C)**
Conver AC130. 130 watt hi-grade VDE spec. Switch mode. +5v @ 15a, -5v @ 1a, +12v @ 6a. 27 x 12.5 x 6.5cms. New. **£49.95 (C)**

Boshert 13090. Switch mode. Ideal for drives & system. +5v @ 6a, +12v @ 2.5a, -12v @ 0.5a, -5v @ 0.5a. **£29.95 (B)**
Farnell G6/40A. Switch mode. 5v @ 40a. Encased **£95.00 (C)**

COOLING FANS

Please specify 110 or 240 volts for AC fans.

3 inch AC 112" thick **£ 8.50 (B)**
3 1/2 inch AC ETRI slimline. Only 1" thick. **£ 9.95 (B)**
3 1/2 inch AC 230 v 8 watts. Only 3/4" thick **£12.95 (A)**
4 inch AC 110/240v 1 1/2" thick. **£10.95 (B)**
10 inch AC round. 3 1/2" thick. Rotron 110v **£10.95 (B)**
10 inch As above but 230 volts **£24.95 (B)**
60 mm DC 1" thick. No. 810 for 6/12v. 814 24v. **£15.95 (A)**
80 mm DC 5 v. Papst 8105G 4w. 38mm. RFE. **£19.95 (A)**
92 mm DC 12v. 18 mm thick. **£14.95 (A)**
4 inch DC 12v. 12w 1 1/2" thick **£12.50 (B)**
4 inch DC 24v 8w. 1" thick. **£14.50 (B)**

THE AMAZING TELEBOX!

Converts your colour monitor into a QUALITY COLOUR TV!!



TV SOUND & VIDEO TUNER!

Brand new high quality, fully cased, 7 channel UHF PAL TV tuner system. Unit simply connects to your TV aerial socket and colour video monitor turning same into a fabulous colour TV. Dont worry if your monitor does not have sound, the TELEBOX even has an integral audio amp for driving a speaker plus an auxiliary output for headphones or Hi Fi system etc. Many other features: LED Status Indicator, Smart moulded case, Mains powered, Built to BS safety specs. Many other uses for TV sound or video etc. Supplied BRAND NEW with full 1 year guarantee.
Telebox ST for composite video input monitors.....**£29.95 (B)**
Telebox STL as ST but with integral speaker.....**£34.95 (B)**
Telebox RGB for analogue RGB monitors.....**£65.95 (B)**
RGB Telebox also suitable for IBM multisync monitors with RGB analog and composite sync. Overseas versions VHF & UHF call. SECAM / NTSC not available.

BRAND NEW PRINTERS

TEC Starwriter Model FP1500-25 daisywheel printer renowned for its reliability. Diablo type print mechanism gives superb registration and quality. On board microprocessor gives full Diablo/Queme command capability. Serial RS-232C with full handshake. Bidirectional 25 cps, switchable 10 or 12 pitch, 136 cpl in Pica, 163 in Elite. Friction or tractor feed. Full ASCII including E sign. Font and ribbon Diablo compatible.....**£199 (E)**
DED DPG21 miniature ball point pen printer plotter mechanism with full 40 characters per line. Complete with data sheet which includes circuit diagrams for simple driver electronics.....**£49 (B)**
£ 150 Centronics 150 series. Always known for their reliability in continuous use - real workhorses in any environment. Fast 150 cps with 4 fonts and choice of interfaces at a fantastic price!
£ 875 150-4 Serial up to 9.5" paper, fan fold tractor.....**£ 99.00 (E)**
£ 650 150-4 Serial up to 9.5" paper, tractor, roll or s/sheet.....**£129.00 (E)**
£ 225 152-2 parallel up to 14.5" paper, tractor or s/sheet.....**£149.00 (E)**

CALL FOR THE MANY OTHERS IN STOCK.

VISIT OUR SHOP FOR BARGAINS

LARGE QUANTITIES OF OSCILLOSCOPES AND TEST GEAR ALWAYS AVAILABLE - CALL NOW!

DISPLAY

MAIL ORDER & OFFICES
Open Mon-Fri 9.00-5.30
Dept ET, 32 Biggin Way,
Upper Norwood,
London SE19 3XF.

LONDON SHOP
100's of bargains!
Open Mon-Sat 9.5-5.30
215 Whitehorse Lane,
South Norwood,
London, SE25.

DISTEL © The Original
Free dial-up database!
1000's of items+info On Line
V21, V22 & V22 bis
081-679-1888

ALL ENQUIRIES
081-679-4414
Fax- 081-679-1927
Telex- 894502



-ELECTRONICS-

All prices for UK Mainland. UK customers add 17.5% VAT to TOTAL order amount. Minimum order £10. PO orders from Government, Universities, Schools & Local Authorities welcome-minimum account order £25. Carriage charges (A)=£2.00. (B)=£4.50. (C)=£8.50. (D)=£11.50. (E)=£14.00 (F)=£18.00 (G)=Call. All goods supplied subject to our standard Conditions of Sale and unless otherwise stated guaranteed for 90 days. All guarantees on a return to base basis. We reserve the right to change prices & specifications without prior notice. Orders accepted subject to stock. Quotations willingly given for higher quantities than those stated. Bulk surplus always required for cash.

Tech Tips

Precision 10V voltage reference

This simple circuit was originally put together for use with the 'meter tester' described in the January 1991 issue. As it stood the circuit was invaluable but it suffered from the disadvantage that the meter under test had to be known to be accurate on at least one range or that a second calibrated meter was available. This is not always the case.

By using a low cost voltage reference device this circuit overcomes this drawback. The reference device produces 10V, accurate to 1% which matches the accuracy of the rest of the circuit. A separate power supply of more than 12V is required for IC1 and Q1, whilst the 10V reference is connected to the top of the reference resistor chain.

If an accurately calibrated meter is available (or can be borrowed) then the 10k preset shown dotted may be included, and used to trim the output to exactly 10V. This preset should be a highly stable, preferably multi-turn cermet type to ensure the unit remains calibrated.

When used in conjunction with the meter tester, outputs of 10, 5, 2, 1, 0.5, 0.2, and 0.1 volts are obtained along with currents of 30, 15, 10, 6, 5, 3, 2, 1.5, 1, 0.6, 0.5, 0.3, 0.2, and 0.1mA.

To increase the usefulness of the unit as a stand alone voltage reference, a voltage divider was included to give a 5V output. Instead of using two resistors of the

same value, an SIL eight resistor array was used. One end of each resistor is commoned allowing them to be connected as shown. Using this arrangement ensures a more accurate divide by two than discrete resistors. This is because the resistors are all fabricated on one substrate and so although their resistance may not be exactly that specified, all the resistors will be of a new identical value.

This 5V output must only be used for driving high resistance loads otherwise loading effects will affect its accuracy. It is therefore not suitable for feeding the voltage divider chain in the meter tester.

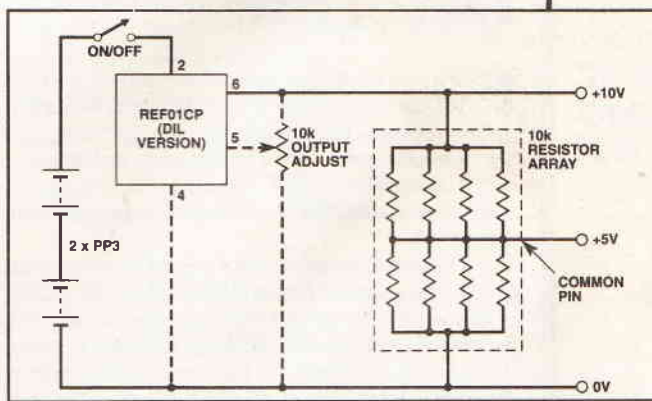

A selection of circuits from you the reader

Single Chip Amp

This single IC based audio amplifier delivers an output of about 10 watts into a 4R speaker load. The circuit gives low distortion figures and low hum levels, a clear sound reproduction with no stray inductions or picked up noises.

The circuit as shown uses a single channel amplifier IC type TA7205, which comes in a single 'in line' package. The input signal is fed to the amplifier from a pre-amplifier or any other suitable source, with adequate amplitude to drive the circuit through C1. The output signal is fed to the loudspeaker through the output coupling capacitor C2. C3 and R1 form a zobel network to help in increasing the overall stabil-

ity of the circuit. The remaining components set the frequency response characteristics of the amplifier.

No other controls other than volume controls have been used. Tone controls if required, can be connected between the centre tap of RV1 and the amplifier input ie between the points A and B. The amplifier chip needs no electrical isolation from the heat sink. The circuit can give about the expected output at a supply voltage of between 12 and 16 volts.

The amplifier must have a good heatsink without which the output quality will deviate otherwise the amplifier will shut itself off after it gets too hot.

Amrit Bir Tiwana, India

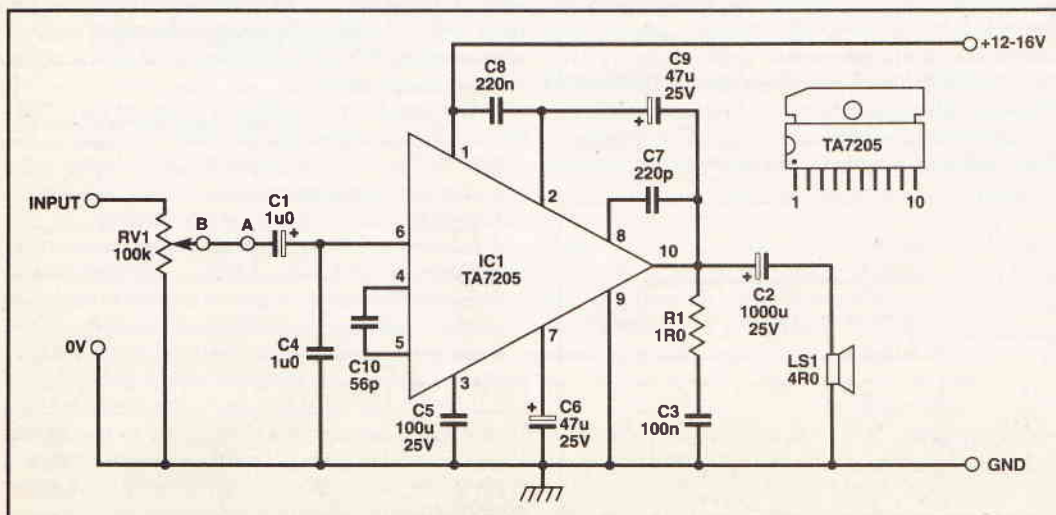

TECH TIPS

Car Lights Warning

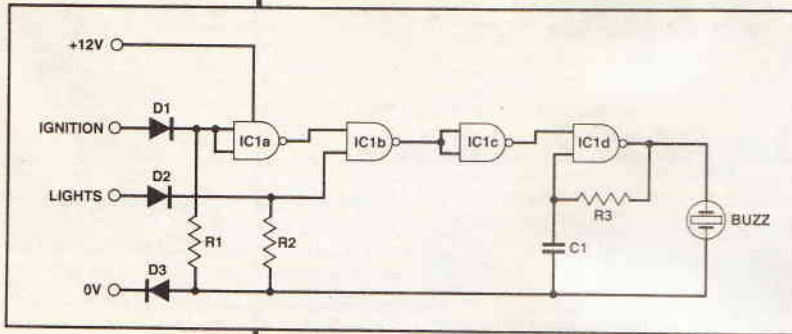

Here is a circuit of a car 'lights-on' warning device that I have recently designed and built. It was inspired by an occasion when the headlights were left on all day and jump leads were required in the evening. Not too bad, except it was dark, cold and raining!

Circuit operation is quite simple. Gates a, b, and c detect the state of lights on and ignition off. When the output of gate c is high, the oscillator formed by gate d, R3, and C1 is enabled. The output is adequate to act as a warning. R1 and R2 are included to provide static protection and D1-3 provide protection against inadvertent reverse battery polarity.

D. J. Withers, Wilmslow, Cheshire

Mains Detector

Faced with needing to detect the presence of mains in a power circuit, with a logic output isolated from mains potentials, optical isolation seemed the obvious solution (you could use a transformer, isolating the circuit magnetically and reducing the voltage to manageable levels, but it would be bulky and relatively expensive).

The problem with traditional opto-isolators is the need to push about 10mA at 2V through the input LED – how exactly do you do that from raw mains? The dropper resistor would need to be a couple of watts!

I hit on the idea of a DIY opto-isolator, with a neon indicator shining on a Light Dependent Resistor. The arrangement is shown in the drawing, with the neon, its limiter resistor, and the LDR cemented into an opaque, insulating tube (it must be light-tight, as the LDR is quite sensitive). The logic output gives a nice, clean, high output when mains is connected across the

input (if you want the inverse output, swap the positions of R2 and the LDR in the circuit).

Ken Wood, Newport, Gwent

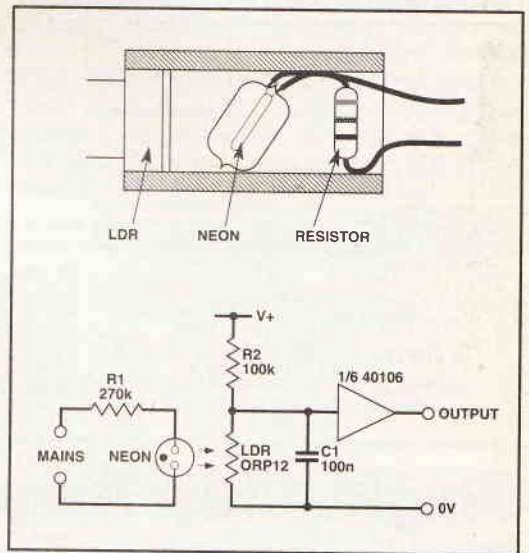

Simple Neon Tester

Upon purchasing a bulk package of untested neon indicators, I was faced with the problem of testing each one to see if it was operational. Since the ratings were varied, from 110V up to 440V, trying to test them from the mains proved impossible. Therefore this simple neon tester was designed to solve this problem.

The main component of this device is the mains transformer, used to step-up the battery volts to several hundred volts AC. The transistor switches the current flowing through one half of the secondary. The other half of the secondary provides a signal that is 180° out of phase with the driven half and via C2 and D2, feeds this signal back to the base of the transistor. Diode D2 stops any high reverse voltage from the

windings damaging Q1 and helping to provide a reasonably clean waveform.

A small mains transformer is used for T1, typically 3VA rating. This low rating limits the maximum current the transformer can deliver, enough to light a neon bulb but not enough to give a lethal shock should one's fingers accidentally touch the high voltage contacts! If desired, a transformer with two secondaries can be used, with a small loudspeaker and limiting resistor connected to this other secondary to give audible warning of operation.

The supply to the circuit is provided by a PP3 battery. This is connected to the circuit by a push switch SW1, and smoothed by C1. Capacitor C3 prevents any arcing on the contacts of SW1, helping to reduce wear and external noise interference.

In operation, the neon would be connected to the test probes and SW1 pressed. If the neon lights then it must be OK, if not then it can be thrown in the bin.

When building this device, most of the components can be obtained from the junk box, since most medium sized power transistor would do and the actual transformer used does not matter too much, as long as the usual secondary voltage is in the range 5-0-5 up to 12-0-12, but it must be a centre tapped winding.

Neil Johnson, Rye.

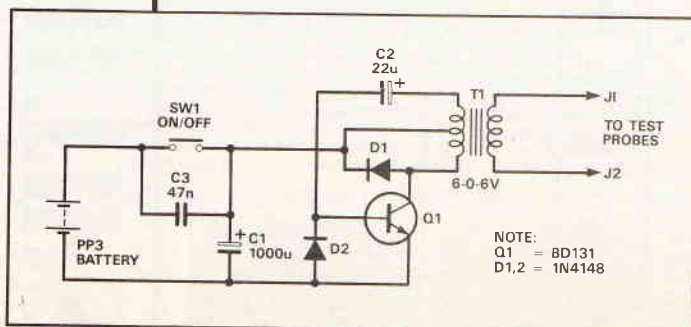

Back to Basics

6

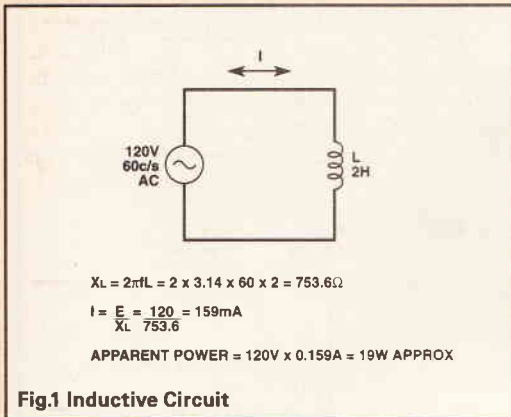

Fig.1 Inductive Circuit

Last month's installment left us examining simple inductive circuits. We have seen how to calculate the inductive reactance of a coil and how Ohm's Law can be used to work out the current that flows for any given applied voltage. Figure 1 shows the circuit under consideration.

We saw that power in a resistive AC or DC circuit is directly proportional to both voltage and current, and can be calculated by finding the product of these two values. From the way in which an inductor stores and releases energy in the form of a magnetic field, we also saw that no power is consumed by a purely inductive circuit. This however, contradicted a calculation of

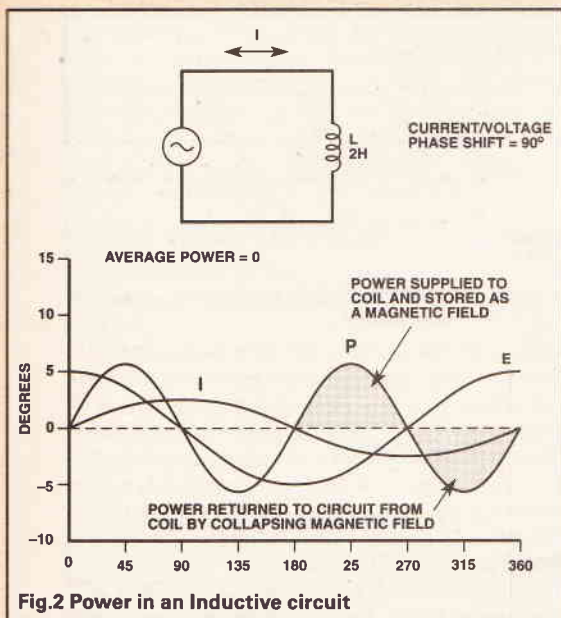

Fig.2 Power in an Inductive circuit

apparent power in the circuit.

The phase relationship between current, voltage, and power in an inductive circuit is shown in Figure 2. The shaded positive half-cycle of the power curve represents the amount of energy stored by the inductor as a magnetic field. The shaded negative half-cycle represents the energy returned to the circuit when the magnetic field collapses. Notice that the shaded areas are equal in size; the power taken and the power returned are equal, so the circuit consumes no power. Current is still flowing in the circuit, however, and an ammeter inserted in series would register this current. The current is sometimes referred to as "watt-less power," and to distinguish it from normal power that is dissipated it

is measured in different units. The unit of power is the watt (w) and the unit used for measurement in an inductive circuit is the volt-ampere (VA). The VA measurement is called reactive power, but it should always be remembered that no power is actually consumed in theory.

In the circuit shown, the apparent power obtained by multiplying the voltage applied by the current measured would be 0.159 VA. The true power is zero, because no energy is actually used up by the circuit. It is important to realize the difference between true power and apparent power: True power represents the energy that is actually consumed by the circuit; apparent power is the value obtained by way of the usual power calculation with voltage and current. In a purely resistive circuit the true power and apparent power are equal, so true power can be determined by multiplication of voltage and current values.

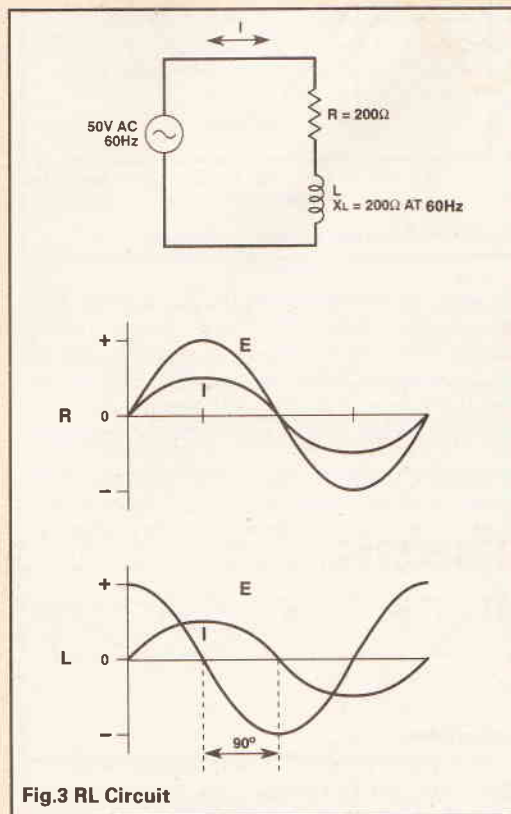

Fig.3 RL Circuit

Resistive-Inductive Circuits

Figure 3 shows a series circuit comprised of both resistance and inductance. The two graphs indicate the current and voltage phase relationships in each part of the circuit. A resistor has no way in which to store or release energy, and the voltage dropped across it will always be in direct proportion to the current flowing. The voltage across the resistor therefore, is in phase with the current flowing. The inductive part of the circuit, introduces a phase shift, because the inductor causes current to lag voltage by 90° . The voltage across the inductor is out of phase with the current.

In a series circuit, the same current flows through each part of the circuit, so the current through the resistor and the current through the inductor must be in phase implying there is a 90° phase shift between the resistor and the inductor voltage.

Inductive Reactance is the subject of this month's course in basics by Paul Coxwell.

Vector Diagrams

In dealing with resistive circuits we saw that the total voltage applied to the circuit is equal to the sum of the individual voltage drops across each component in that circuit. Simple addition and subtraction works so long as the voltages are all in phase, which is the case for a purely resistive circuit.

Out-of-phase voltages cannot be combined so easily. Figure 4 shows two individual voltages, E_1 and E_2 . To obtain the total voltage curve, E_T , it is necessary to take many points along the cycle and add the instantaneous values of E_1 and E_2 together. At zero degrees,

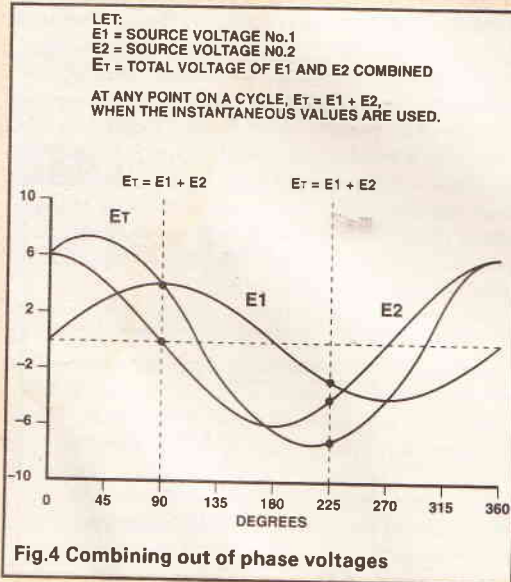

E_1 is zero, so E_T is equal to E_2 . At 225 degrees, E_1 is approximately -3 and E_2 is around -4, giving a total voltage at that point in the cycle of approximately -7 volts. Look closely at the peak values of each voltage curve. E_1 peaks at 4V and E_2 at 6V. Normal addition of these values would give the total voltage an amplitude

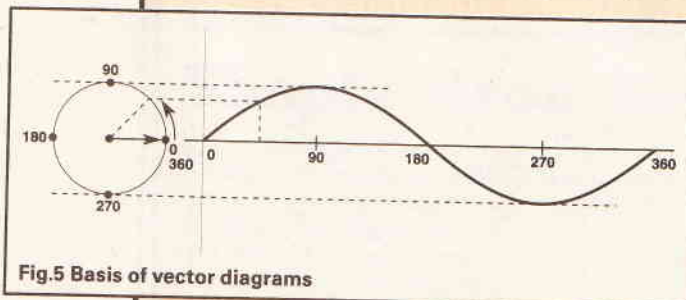

of 10V peak, but E_T actually peaks at around 7.5V. When two out-of-phase voltages are combined, the total voltage is always less than that obtained by direct addition.

Fortunately, there is a much simpler way to represent out-of-phase waveforms than by plotting them in full. Figure 5 shows the basis from which vector diagrams are derived. Imagine that the line drawn in the circle is pivoted at the centre so that it can turn through 360°. Zero degrees is to the right and the arm turns in a counter-clockwise direction. In the position shown, the end of the arm is at the zero line on the sinewave. As the arm starts to move upward, the end of it rises gradually, until at 90° it has reached a maximum positive value. As the arm passes 90°, the end of it starts to fall back toward the zero line, reaching it at 180°. The second half-turn of the arm gives a similar process for the negative half of the sinewave.

A continuous sinewave can be represented by the rotating vector. Assume that the vector is at 90° (point-

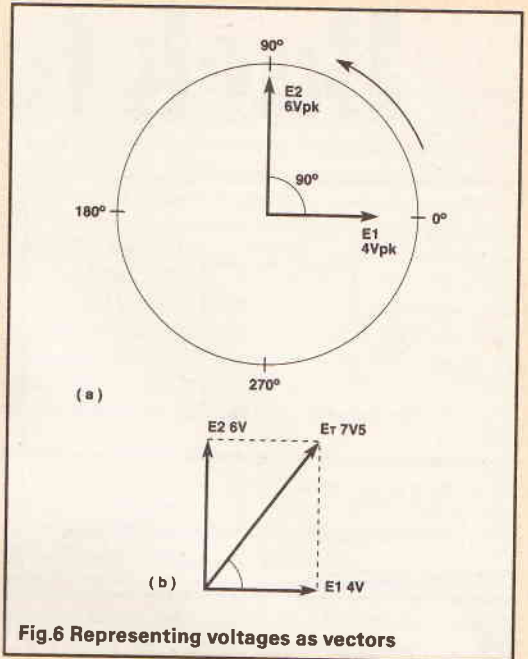

ing upward). If the length of the vector were to be increased, it would represent a sinewave of greater amplitude. A vector thus represents two quantities: phase angle and amplitude.

The two voltages E_1 and E_2 from Figure 4 are shown as vectors in Figure 6. E_1 is assumed to be at zero degrees, because on the original graph the cycle started at the zero degree point. E_2 was leading E_1 by 90°, so it is drawn upright to the 90° point. Remember that the vectors are assumed to be rotating counter-clockwise, so if any point on the circumference of the

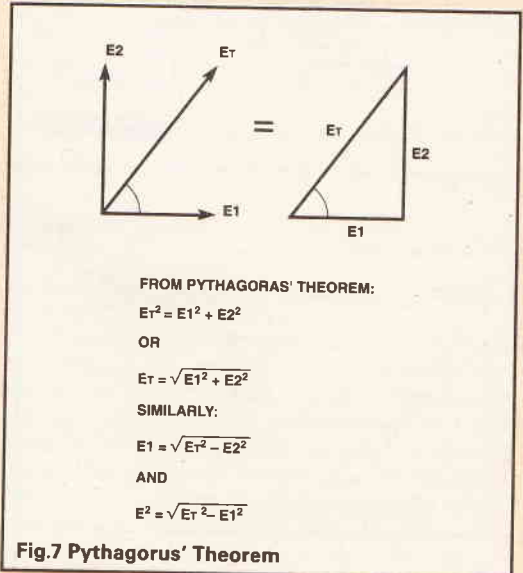

circle is taken, E_1 will always pass a quarter of turn after E_2 . It can be said that E_1 lags E_2 or that E_2 leads E_1 ; the descriptions are equivalent.

Vector diagrams are usually drawn without the outer circle, and our example is extended to the second part of Figure 6. Notice how two dotted lines have been drawn, each parallel to one of the existing vectors. The point at which these lines meet represents the angle and amplitude of the sum of the two out-of-phase voltages, so a third vector can be drawn from the centre to that point.

So long as the diagram was drawn accurately to scale, the length of the third vector E_T can be measured to obtain the correct voltage. In addition, the angle between the zero line and the vector E_T can be

measured with a protractor to give the amount of phase shift between E_1 and E_T . Phase angle is represented by the Greek letter theta as shown, and in this example the phase angle is approximately 56° .

The vector diagram has a noticeable resemblance to a right triangle (see Figure 7). All that is necessary is to move vector E_2 across to the right, and the

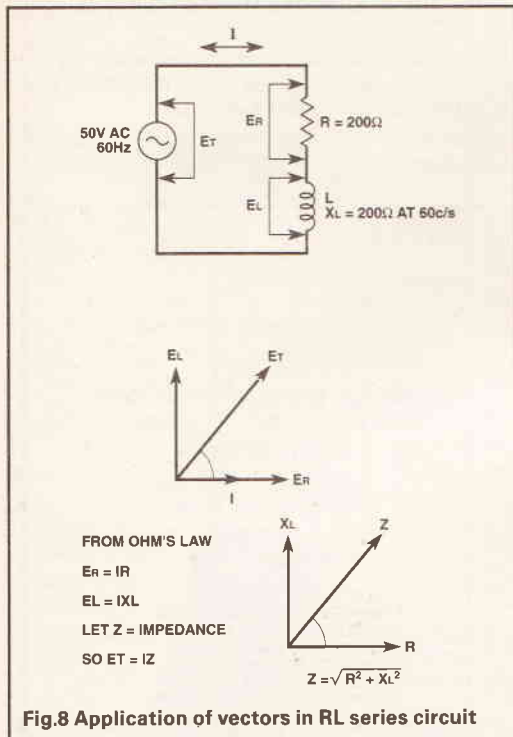

Fig.8 Application of vectors in RL series circuit

three vectors do then form a right triangle. Pythagoras' Theorem states the relationship between the sides of such a triangle: The square on the hypotenuse is equal to the sum of the squares of the other two sides. The hypotenuse of the triangle is simply its longest side, which will always be opposite the 90° angle. Using the formulae shown any value can be calculated if the other two are known. This application of Pythagoras' Theorem is important to much electrical work.

Application Of Vector Diagrams

It is now possible to develop a vector diagram for the RL series circuit we examined earlier. This is shown in Figure 8.

Current in a series circuit is the same wherever it is measured, so the current waveform is used as a reference and drawn at zero degrees. The voltage drop across a resistor is always in phase with the current through the resistor, so E_R is in phase with I and drawn along the same zero-degree line.

The voltage across an inductor leads the current by 90° as we have seen, so the vector representing E_L is drawn at the 90° point on the diagram. The applied voltage E_T is then added by extending the vectors to form a rectangle. The diagram shown gives an overall representation of the current and voltage waveforms in the circuit, without the need to plot out individual sine waves.

$$Z = \sqrt{R^2 + X_L^2} = \sqrt{200^2 + 200^2} = 283\Omega$$

$$\text{TOTAL CURRENT, } I = E_T/Z = 50V/283\Omega = 177\text{mA}$$

TO CALCULATE THE RESISTOR VOLTAGE:

$$E_R = IR = 0.177 \times 200 = 35.4V$$

TO CALCULATE THE COIL VOLTAGE:

$$E_L = IXL = 0.177 \times 200 = 35.4V$$

Fig.9 Solution for circuit

Ohm's Law can be successfully applied to each part of the series circuit or the circuit as a whole. The resistor voltage can be calculated from the current and the value of resistance; the inductor voltage can be calculated from the current and the inductive reactance of the coil at the specified frequency.

Impedance

So far, we have seen two different properties that restrict the flow of current: resistance and inductive reactance. In a circuit comprised of both resistance and inductance both will affect the current, and the combined restriction is called impedance (represented as z).

As with out-of-phase voltages, it is not possible to simply add the resistance and inductive reactance together in order to calculate the total impedance of the circuit. Refer to the formulae in Figure 8 once again. The common factor to all three equations is I ,

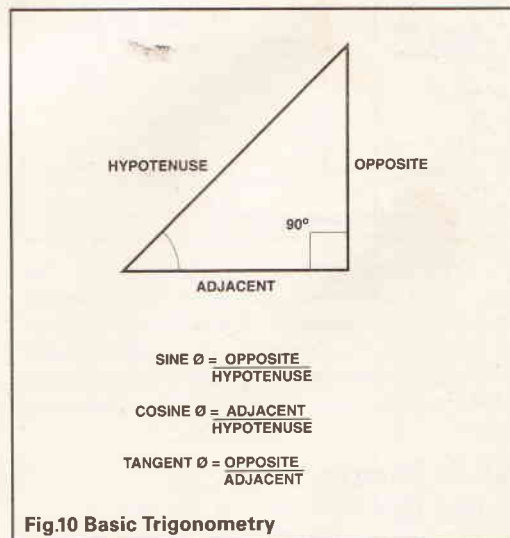

Fig.10 Basic Trigonometry

because the current is the same in each case. This implies the ratio of one voltage to another will be in the same proportion as the ratio of resistance to reactance, or impedance. The voltage vectors can be redrawn to represent resistance, reactance, and impedance, as

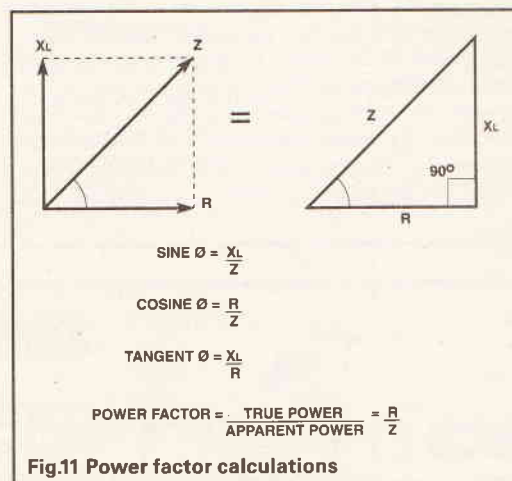

Fig.11 Power factor calculations

shown. Applying Pythagoras' Theorem once more gives the method for calculating impedance when the resistance and reactance are both known.

The vector diagram for a series RL circuit can, therefore, be used to represent either voltages or impedance. The values of resistance and reactance are known in the example circuit, so the impedance can easily be calculated (Figure 9). Once the total impedance is known, circuit current can be determined by

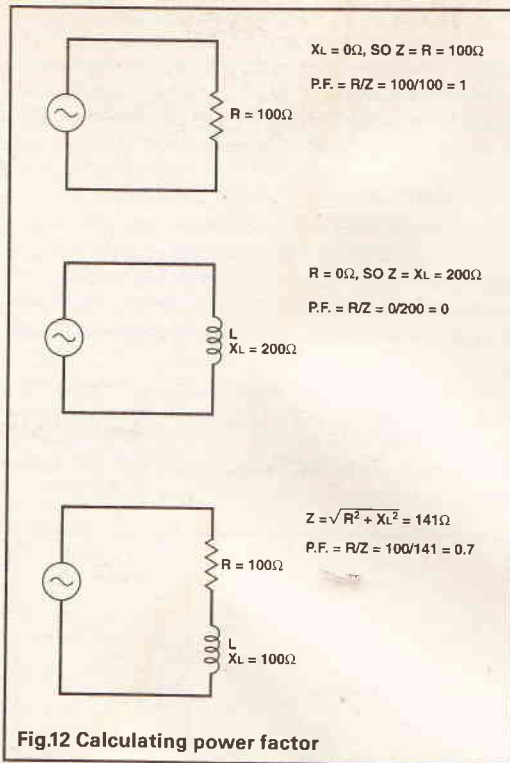

Fig.12 Calculating power factor

using Ohm's Law with the total applied voltage. The voltage drop across each individual component can then be calculated by applying Ohm's Law to each section. Notice how the direct sum of E_R and E_L is greater than the applied voltage. Always remember that vector addition must be used when dealing with out-of-phase voltages.

Power Factors

The three basic trigonometrical functions are also used extensively with electrical calculations, and they are summarized in Figure 10.

When two out of three values are known, whether for voltage or impedance, the appropriate formula can be selected in order to calculate the phase angle. If the values of resistance and inductive reactance, R and X_L , are known, the phase angle can be calculated by using the tangent function. If all three values are known, any one of the formulae may be used to give the same result. Some of the current flowing in a series circuit containing inductance does not consume power. It is the ratio of consumed power to apparent power that determines the power factor of a circuit. If all the current is used to dissipate power, the power factor is one, as true and apparent power are equal. Circuits that

contain only inductance gives a power factor of zero, because no power is used up — it is only apparent, or reactive power. In a combination circuit the power factor will be somewhere between zero and one (Figure 12).

Power is only consumed by the resistive portion of the circuit, so the value given as the power factor specifies how much of the apparent power really is used.

To finish, Figure 13 shows another series RL circuit. Try to calculate the values for the items listed and then check your answers in Figure 14.

Next month we continue our look at inductive-resistive circuits and examine parallel combinations.

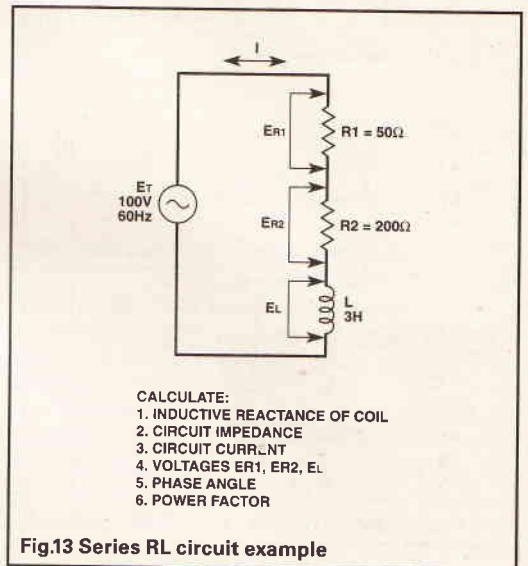

- CALCULATE:
1. INDUCTIVE REACTANCE OF COIL
 2. CIRCUIT IMPEDANCE
 3. CIRCUIT CURRENT
 4. VOLTAGES E_{R1} , E_{R2} , E_L
 5. PHASE ANGLE
 6. POWER FACTOR

Fig.13 Series RL circuit example

1. $X_L = 2\pi fL = 2 \times 3.14 \times 60 \times 3 = 1,130.4\Omega$
2. $Z = \sqrt{R^2 + X_L^2} = \sqrt{(200 + 50)^2 + 1,130.4^2} = 1,158\Omega$
3. $I = E_T/Z = 100/1,158 = 0.086A$
4. $E_{R1} = IR_1 = 0.086 \times 50 = 4.3V$
 $E_{R2} = IR_2 = 0.086 \times 200 = 17.2V$
5. $E_L = I X_L = 0.086 \times 1,130.4 = 97.2V$
6. $\cos \theta = R/Z = 250/1,158 = 0.216$

$\therefore \theta = 77.5^\circ$

(COULD USE $\sin \theta = X_L/Z$ OR $\tan \theta = X_L/R$ INSTEAD)

6. POWER FACTOR = $R/Z = 0.216$

NOTE THE RELATIONSHIP BETWEEN P.F. AND PHASE ANGLE

P.F. = $\cos \theta$

Fig.14 Solution to problem



BLUE ROSE ELECTRONICS
NEW 1991 CATALOGUE
OUT NOW!

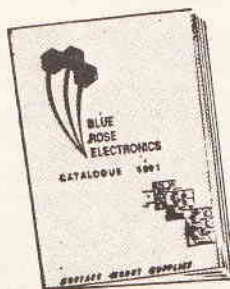

SURFACE MOUNT SUPPLIES

CONTAINS NEW RANGE OF SM KITS
FULL RANGE OF COMPONENTS
& SM HARDWARE

SEND £1.50 (inc P&P) FOR
CATALOGUE & KIT LIST



Mail Order Address: 538 Liverpool Rd, Great Sankey, Warrington, Cheshire WA5 3LU
Telephone: 0925 72 7848 (Callers by Appointment)

RTVC HAVE DONE IT AGAIN!

We have secured all stocks of nearly new factory refurbished units with manufacturer approval, at unrepeatable prices. We also offer a 6 month guarantee with all units (this only applies to products marked ★ on this page.)



Alba digital auto reverse push button AM/FM / LW car stereo with separate bass/treble control APPSS on tape. 25 watts per channel output, with line output for car components use.

★£79.40 + £2.30 pp



Sparkomatic Phoenix Digital auto reverse AM/FM/LW car stereo, with tape volume and balance control. 9 watts output per channel

★£52.40 + £2.80 pp

AUSTIN ROVER SHELF SPEAKERS

15 watt speaker. Moulded in black plastic housing for vertical or horizontal use, contains 4 1/2" Goodmans drive unit with a good size magnet

SPECIAL OFFER £4.95 pair + £2 pp

FILOFAX.

PERSONAL ORGANISER
RADIO/CALCULATOR

Solar Powered
Calculator

Eight Digit
Display

Imperial,
Metric
Conversion
Tables



Battery
Powered
AM Radio
High/Low
Volume Control

Earphone provided

Punched with 6 holes to fit into all personal organisers

Listed price £19.95 **OUR PRICE £8.95 plus 75p p&p**

Genuine **FILOFAX.** complete

with 91 calendar, A to Z index and address section. **£5.95 plus 75p p&p**

MULTIBAND RADIO

VHF 54-176MHz + AM CB BANDS 1-80
Listen to: AIR TRAFFIC CONTROL,
AIRCRAFT, RADAR,
PUBLIC UTILITIES,
MANY MANY MORE
SQUELCH CONTROL
"RUBBER DUCK AERIAL"

£17.95
POSTAGE £2.85



ROSS PUSH BUTTON RADIO

Mains and battery operated.
High quality VHF/FM,
Medium and Long Wave reception,
6 push button selected
preset stations.
Fully retractable telescopic
aerial.
Headphone/earphone
jack socket.
Size 230H x 150W x 65D
Ref. RE-5500
Brand new.
Listed price over £30.00
OFFER £13.50
+ £2.80 pp

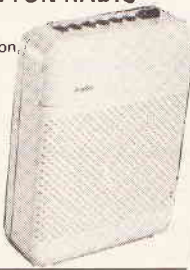

30 + 30 WATT AMPLIFIER KIT



An easy to build amplifier with a good specification. All the components are mounted on the single PCB which is already punched and back-printed.

- 30W x 2 (DIN 4 ohm)
- CD/Aux, tape I, tape II, tuner and phono inputs.
- Separate treble and bass.
- Headphone jack.
- Size (H.W.D.) 74 x 400 x 195mm.
- Kit enclosed: case, PCB, all components, scale and knobs **£36.80 + £3.50 pp.**
- (Featured project in *Everyday Electronics*, April 1989 issue). Reprint Free with kit.

MAIL ORDER £1 BARGAIN PACKS BUY 20 GET 1 FREE

Please state pack(s) required

No	Qty. per pack	Description
BP015B	1	30W dome tweeter Size 90x66mm JAPAN made
BP017	3	33000µF 16V d.c. electrolytic high quality computer grade UK made
BP019	20	20 ceramic trimmers
BP020	4	Tuning capacitors, 2 gang dielectric a.m. type
BP021	10	3 position, 8 tag slide switch 3 amp rated 125V a.c. made in USA
BP022	5	Push-button switches, push on push off, 2 pole changeover. PC mount JAPAN made
BP023	6	2 pole 2 way rotary switch
BP024	2	2 Right angle, PCB mounting rotary switch, 4 pole, 3 way rotary switch UK made by LORLIN
BP025	4	3 pole, 3 way miniature rotary switch with one extra position off (open frame YAXLEY type)
BP026	4	4 pole, 2 way rotary switch UK made by LORLIN
BP027	30	Mixed control knobs
BP029	6	Stereo rotary potentiometers
BP030	2	10k wire wound double precision potentiometers UK made
BP032	4	UHF varicap tuner heads, unboxed and untested UK made by PHILIPS
BP033	2	FM stereo decoder modules with diagram UK made by PHILIPS
BP033A	3	6"x6" High grade Ferrite rod, UK made
BP034	2	AM IF modules with diagram PHILIPS UK MADE
BP034A	1	AM-FM tuner head modules. UK made by Mullard
BP034B	6	Hi-Fi stereo pre-amp module inputs for CD, tuner, tape, magnetic cartridge with diagram. UK made by MULLARD
BP035	6	All metal co-axial aerial plugs
BP036	20	Fuse holders, panel mounting 20mm type
BP038	6	5 pin din, 180° chassis socket
BP039	3	Double phono sockets, Paxolin mounted
BP041	2	2.8m lengths of 3 core 5 amp mains flex
BP042	2	Large VU meters JAPAN made
BP043	30	4V miniature bulbs, wire ended, new untested
BP044	2	Sonotone stereo crystal cartridge with 78 and LP styli JAPAN made
BP045A	2	Mono Cassette Record and play heads
BP046A	2	606 Mains transformers, PCB mounting. Size 42x33x35
BP047A	1	25V DC 150mA mains adaptor in black plastic case with flying input and output leads new units made for famous sound mixer manufacturer. Size 80x55x47
BP049	10	OC44 transistors. Remove paint from top and it becomes a photo-electric cell (ORP 12) UK made by MULLARD
BP050	30	Low signal transistors n.p.n., p.n.p. types
BP051	6	14 watt output transistors. 3 complimentary pairs in TO66 case. (Ideal replacement for AD161 and 162s)
BP052A	1	Tape deck pre-amp IC with record/replay switching No LM1818 with diagram
BP053	5	5 watt audio ICs. No TBA800 (ATEZ)
BP054	10	Motor speed control ICs, as used with most cassette and record player motors
BP055	1	Digital DVM meter IC. made by PLESSEY as used by THANDAR with diagram
BP056	4	7 segment 0.3 LED display (red)
BP057	8	Bridge rectifiers, 1 amp, 24V
BP058	200	Assorted carbon resistors
BP059	1	Power supply PCB with 30V 4V/A transformer MC7818CT IC & bridge rectifier. Size 4" x 2 3/4"
BP061	5	6.35mm Mono jack plugs
BP063	5	6.35mm stereo switched jack sockets
BP064	12	Coax chassis mount sockets
BP065	1	3mtr Euro-mains lead with chassis socket

Postage £3 per order

28.0.28V 4 AMP MAINS TRANSFORMER

With a 5.5V at 0.5A mains input 110-240. Size 90 x 105 x 75 fitted with copper screening band; made for famous HiFi Co. £6.50 each. Postage £2.80. It's weight is 2.7Kg! Brand new and unused condition.

2 for £14 POST PAID

KOSS STEREO HEADPHONES

High quality lightweight stereo headphones fitted 3.5mm jack with adaptor to 6.4mm jack. Ideal use HiFi or personal stereos. Made to sell for nine pounds. Our price for this unit £4.25 postage 60p.

Hi-Fi stereo cassette deck transport mechanism, complete with 3 digit rev counter and tape heads. 12V d.c. operation. Unused manufacturers surplus JAPAN made. **£6.20 + 2.50 P&P 2 for £10.00 + 3.50 P&P**

BSR STEREO RECORD PLAYER DECK

Manual auto operation, 3 speed (78, 45, 33"), 240V operation. Unused but store soiled. **£10.50 ea + £3.75 P&P 2 for £18.00 + £3.75 P&P**

RADIO AND TV COMPONENTS ACTON LTD

21 HIGH STREET, ACTON, LONDON W3 6NG

MAIL ORDER TERMS: POSTAL ORDERS and/or CHEQUES with orders. Net monthly accounts to Schools, Colleges and P.L.C. only. ACCESS: VISA. Phone orders between 9.30-12pm please. Overseas readers write for quote on delivery.

Phone 071 723 8432 or 081 992 8430

Callers: 323 Edgware Road, London W2, Closed Sun
21 High St, Acton, London W3, closed Sun, Mon, Tues & Wed.

AMPHONIC 125+125 POWER AMPLIFIER



125 watt per channel stereo power amplifier with independent volume controls, professional 19" rack mount and silent running cooling fan for extra reliability

Output power.....125W RMS max per channel
Output impedance.....4 to 16 ohms
(max power into 4 ohms)

Sensitivity.....450V at 22K ohms
Protection.....Electronic short-circuit and fuses
Power.....220-240V a.c. 50Hz
Chassis dim.....435 x 125 x 280mm

£142 + £7.00 pp

SPECIAL OFFER

DTMF TONE DIALLER

Suitable for remote control of telephone answering machines, videos, appliances etc. requiring DTMF signals over telephone lines.

£8.95

Please add 75p p&p when ordering



VIDEO SENDER

With this handy unit you can transmit the output of your home video, video camera or satellite equipment over-the-air to a receiving television within a range of 100ft. Simply connect the video and audio output of your equipment into this unit and a 10-13.8V dc power supply extra **£3.75** size 122 x 70 x 21mm

SALE OFFER £11.50 + £2 pp

VHF RADIO TRANSMITTERS

100mW mini bug. Built on a neat little fibre glass pcb with condenser mic. Fully tuneable over the FM band. 9V DC **£5.75 + £0.90 pp**
2 Watt transmitter kit, supplied with fibre glass pcb, all components, diagrams, ready for you to build. 12-24V DC. **£7.50 + £0.70 pp**
25 Watt Transmitter kit. Fully tuneable over the FM band. Kit comprises double sided pcb diagrams and all components, including heat sink. Supply voltage 12-18V DC. **£67 + £1 pp**
Transmitters listed on this page are not licensable in the UK.

HIFI WOOFERS

10" round 100 watt Goodmans Hifi woofer 2" coil, paper cone, foam rubber surround 4 1/2" magnet, frame size 10 1/2" imp 8Ω **£17.50 - £2.80 pp**
8" round 100 watt Audax Hifi woofer, 1" coil with fitted phaseplug, Hiteck TPX polimar core with rubber surround 4 1/2" magnet, dia cast chassis, size 9 1/2" 8Ω imp **£34.90 + £4 pp**
8" square 80 watt Audax Hifi woofer, 1 1/2" coil, polypropylene cone, rubber surround, 3 1/2" magnet, chassis size 8 3/4" square 8Ω imp **£19.70 - £2.50 pp**
8" round 70 watt Peerless Hifi woofer 1" coil, treated paper cone, foam rubber surround, 3 1/2" magnet, 8Ω imp **£12.50 + £2.50 pp**
5 1/2" 35 watt Goodmans Hifi woofer, 1 1/2" coil, treated paper cone, rubber surround, 3 1/2" magnet, 8Ω imp **£7.20 + £2.50 pp**
4 1/2" square 35 watt Audax Hifi woofer, 1in coil, paper cone, rolled surround, 2 1/2" magnet, 8Ω imp **£7.50 + £2.50 pp**

HIFI TWEETER AND MID RANGE

4 3/4" square 100 watt Goodmans sealed back mid range, 1" coil, treated paper cone, 2 1/2" magnet, 8Ω imp **£5.50 + £2.50 pp**
4" square 75 watt Audax sealed back mid range 3/4" coil treated paper cone, Ferrofluid cooled coil, chassis size 3 1/2" 8Ω imp **£7.95 - £1 pp**
4" round 130 watt Peerless 1" metal dome Hifi tweeter, 1" coil, 2 1/2" magnet, rec. crossover freq 3KHz **£15.90 + £1.60 pp**
4 1/2" x 2 1/2" 75 watt 3/4" direct drive dome tweeter, Ferrofluid cooled 3/4" voice coil rec crossover, freq 4.5KHz as above but with 3 3/4" face plate **£6.90 + £1.30 pp**
10 1/2" x 4 1/2" 120W Jamo horn tweeter 8Ω imp crossover freq 7KHz **£9.95 + £2 pp**

MOTOROLA PIZO CERAMIC TWEETERS

Convert electrical energy into sound without the use of voice coils and magnet assemblies. No moving mass, hence excellent transient response and low distortion with high efficiency levels as they cannot reproduce bass sounds. No crossovers are required
3 1/2" square, 50 watt Pizo super horn tweeter **SALE OFFER £3.95 + 75 pp**
3 3/4" round, 50 watt Pizo horn tweeter **£5.75 + 75 pp**
2" x 6" wide dispersion 400 watt Pizo horn tweeter **£11.95 + £1 pp**

Laser Diodes

Douglas Clarkson reports on the construction and the latest uses of semiconductor lasers

It has taken nearly 30 years for the laser diode to become today's important means of creating laser radiation. Whether in bar code readers, CD music players or optical fibre communications links, diode lasers are playing a lead role in harnessing the benefits of new technology.

The general enthusiasm felt about laser diodes in the world of electro-optics arises from the rapidly

laser diode. This common element is the generation of optical radiation as a result of the passage of current through a semiconductor device.

Figure 1 outlines the energy levels considered to be present in a p-n semiconductor junction. The n-type material provides a source of relatively mobile electrons while the p-type material provides a source of 'holes' or gaps into which the electrons can migrate. When an electron at a higher energy level combines with a hole in the narrow junction layer, the electron is left in an excited state and can release its energy as a photon of light. The greater the energy of the transition, the 'harder' the wavelength of the radiation. Before the lasing action can take place, there is the requirement for 'population inversion' to occur in which the action of the current flowing across the junction creates larger than normal number of electrons in an excited state.

For a given energy transition E , the frequency of

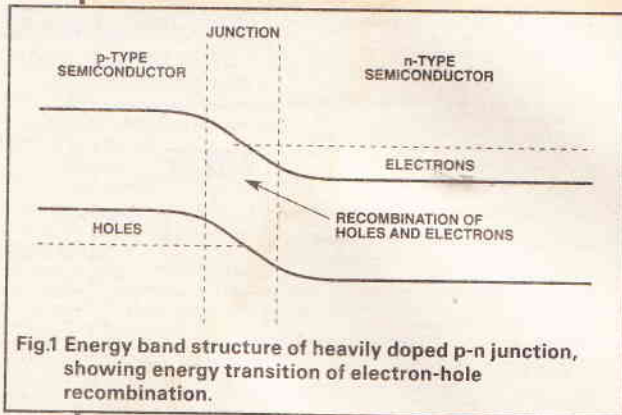

increasing range of applications. While the telecommunication market primarily at wavelengths of 1330nm and 1550nm is a significant one, the volume production market is dominated by devices in the shorter range of wavelengths (670 to 850nm) which are used for example for optical storage systems and bar code scanners. The present most popular wavelength optical is 670nm (1nm = 1 millionth of a millimetre), though industry analysts expect 630nm (very close to the HeNe laser output) to become increasingly important.

A range of so called 'lead salt' lasers emit wavelengths in the range 2.7 to 30 microns. These specialist lasers have applications primarily in spectroscopy where they are used to sample the chemical composition of substances.

While it may appear that laser diodes are just as

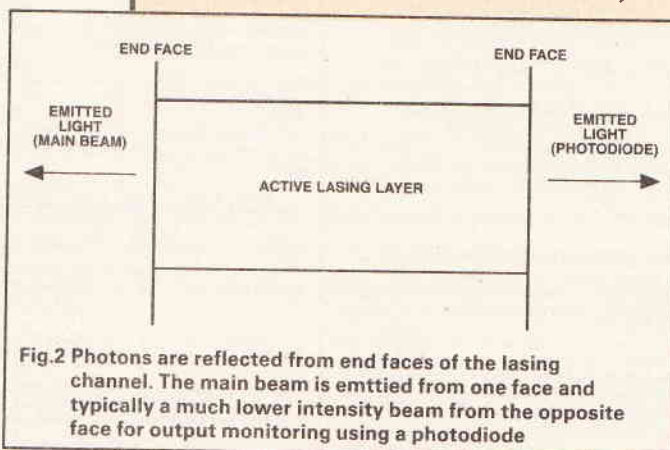

easy to drive as conventional LEDs, there remain, various points of difficulty in a 'do it yourself' approach to designing and building drive circuitry. While these difficulties may in time be overcome, they should certainly be recognised by the electronics enthusiast.

The Theory of Diode Lasers

In harnessing the function of laser diodes, it is useful to introduce some theory. There is certainly a strong similarity between the function of an LED and that of a

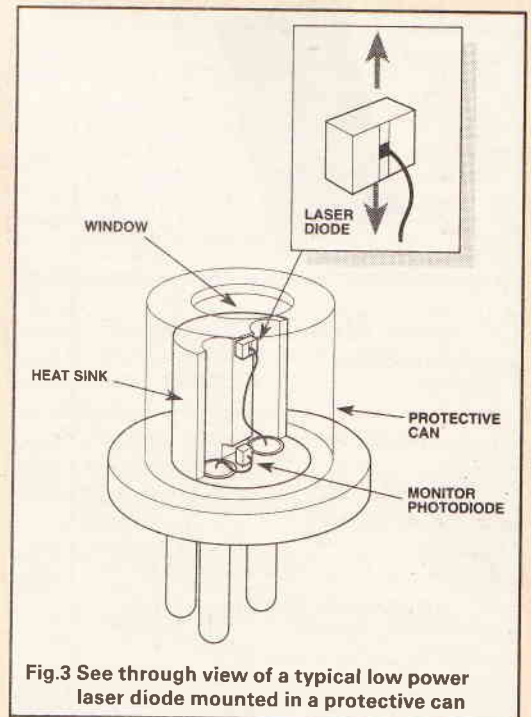

the radiation, f , is given by:

$$f = \frac{E}{h}$$

where h is Planck's constant.

When the electron/hole recombination takes place, there is created an intermediate excited state in the atomic structure which decays within a typical relaxation time. Where a photon is released in this way it is called spontaneous emission. The photon has random phase and direction in space. It is possible for a photon of light to trigger this emission process. This mechanism is termed stimulated emission. The induced photon will have identical properties to the triggering photon as regards direction of travel, polarisation and phase. The act of stimulated emission can be considered to be one of 'exact' amplification.

Even within a conventional LED there will be a number of photons released by stimulated emission, but the paths of photons within the junction will still tend to be haphazard and noncoherent.

When the area of the junction is contained within parallel optical reflectors, then it is possible for a build-up of radiation to take place as shown in Figure 2. The end faces of the diode naturally undertake this mirror function. If a photon is initiated which is propagated initially in a path parallel to the reflecting faces, and it stimulates emission of photons in a similar direction, then the radiation will sweep backwards and forwards through the lasing region gathering additional photons until equilibrium is reached.

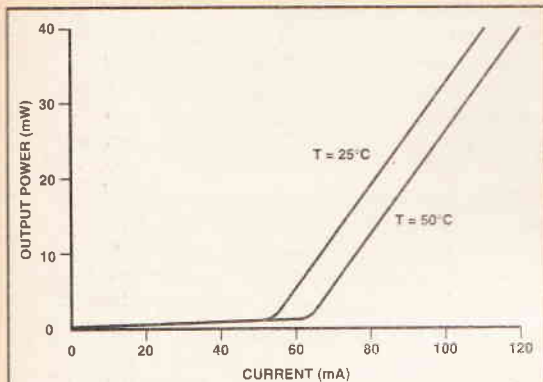

Fig.4 Typical output power of GaAlAs laser diode as a function of current at 25°C and 50°C

The radiation across the junction is coherent, ie it will be of similar phase. This is in contrast to non-laser light where the phase of individual photons is non-coherent.

It is necessary to allow the light to escape from the region where laser radiation is being stimulated. This is undertaken at the output face of the diode by normal transmission out of the device at the air/semiconductor junction. The opposite end of the lasing channel is made more poorly transmitting in order typically to drive a sensing photodiode for feedback/control applications.

Figure 3 shows a typical design of a laser diode. It shows a monitor photodiode to assist in drive electronics. The heat sink is important in stabilising the operating temperature of the laser diode when in operation.

The efficiency of GaAlAs lasers delivering 10-70mW of power is around 10%.

The human eye's response to colour peaks at about 550nm and falls off relatively sharply at longer wavelengths (towards the red) and shorter wavelengths (towards the blue). The conventional red He-Ne ion tube laser emits a wavelength of 633nm. While this is not in the most sensitive region of the eye, its radiation will appear some 14 times as bright as a laser diode of similar output power but emitting radiation at 680nm. At 650nm the ratio falls to a value of around 2.

In these laser diode applications where perception of output levels is relevant, there is a natural tendency to shorten the wavelength of the laser diode output in order to improve its 'eye efficiency'. In applications in telecommunications there is no requirement to shift down the output wavelengths towards the visible region. To do so would probably increase sharply the attenuation losses in optical fibres.

Provided diodes are protected from damaging electrical transients and operated within specified temperature limits, operation lifetimes can effectively be 'for ever'. The criteria for determining device lifetimes vary between manufacturers. NEC, for example, use the condition of determining the time within which a device will require an increased drive current of 20, while maintaining a 3 mW output at 50°C. This equates to a MTF (mean time to failure) of 36000 hours. Even better performance is predicted at lower temperatures (750,000 hours at 25°C or 85 years of

continuous operation). Use is made of the Arrhenius equation in predicting the elapsed time before failure at a given activation energy and reference temperature.

The level of heat dissipation is therefore an important consideration for laser diode devices.

Single homojunction laser diodes can only be driven in pulsed mode due to reduced power handling ability. Double heterojunction lasers can be driven in both continuous and pulsed mode. Rise times vary between 1ns and 0.1ns and so called 'relaxation' oscillations are a feature of the initial rise edge of the light output. One Giga bit per second data streams have been demonstrated on commercial fibre optic systems driven using laser diode devices.

Laser diodes are primarily operated as current driven devices rather than voltage driven devices. Figure 4 indicates how the output optical power varies with drive current and Figure 5 how the output current varies with diode voltage. Control of output optical power is more readily undertaken by directly controlling the diode current rather than the diode voltage. This is on account of the steepness of the I-V characteristic of the laser diode. The temperature of the device and the operating current can affect the wavelength of the emitted radiation. The variation of wavelength with drive current is typically 0.025nm/mA for GaAlAs devices. The effect of temperature is more significant and is typically 0.3nm/mA. It will therefore be necessary in some applications to introduce some element temperature stabilisation, eg using a thermoelectric cooling unit.

The frequency stability of a laser diode can be complicated by so called 'mode hops' where through, for example, gradual wavelength drift due to temperature change, the device can hop to a mode at a slightly different frequency. In communication systems, this is highly undesirable since it can change the signal losses along fibre links.

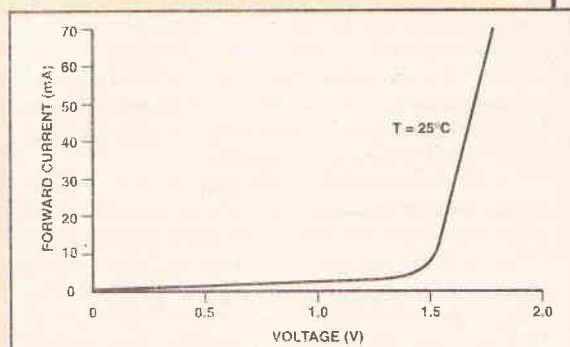

Fig.5 Typical I-V characteristic curve for GaAlAs laser diode

The output beam from the emitting strip of a laser diode is elliptical in output and emerges typically at an angle to the central axis of around 40°. The value of this angle is often referenced in term of the value of 'numerical aperture' where this value is the SIN trigonometric function of the emergent angle. If the output is plotted as a function of contour radius, the typical Gaussian TEM⁰⁰ mode profile is observed. The effective beam radius is taken as the point at which the output intensity has fallen to 1/e² of the central value. This corresponds to 13.5% of central axis power.

The light from the diode is normally polarised with the electric vector parallel to the laser junction diode. The ratio of the degree of parallel to perpendicular component is usually around 500:1 at normal levels of drive current. Close to the lasing threshold this value is smaller, due to the higher proportion of light from spontaneous emission which is not polarised.

Frequency Doubling Systems

There has been significant interest in producing blue-green coherent laser radiation using laser diodes. A fundamental problem, however, in that semiconductor materials have not been identified which will directly produce a photon of blue-green energy. Instead, ways have been found to trigger the release of two quanta of relaxation energy to produce a photon of 'doubled' energy.

One method of undertaking this process is called self frequency doubling (SFD). A new material, NYAB, for example, will deliver about 3% at wavelength 531nm from laser diode excitation radiation a 1062nm. High power blue-green laser diode devices are some way off at present and even the present low power devices are expensive.

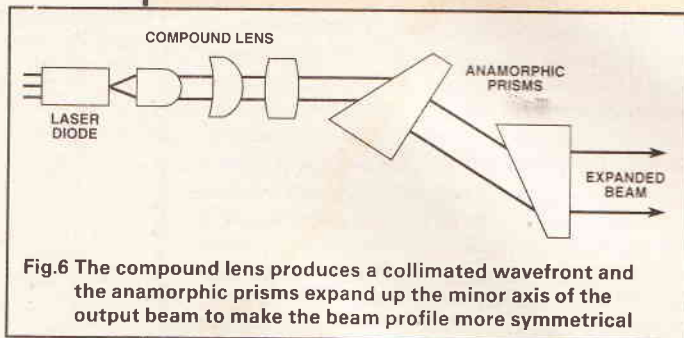

Fig.6 The compound lens produces a collimated wavefront and the anamorphic prisms expand up the minor axis of the output beam to make the beam profile more symmetrical

Beam Collimation

Optical interfaces are required to transfer the highly divergent output beam into a collimated symmetric beam of light. The nature of the application will determine the quality of the option required.

Figure 6 shows the design of a professional system, where an initial compound lens manufactured from elements of glass of different refractive indices minimises lens aberration. The collimated wavefront can be expanded in one plane by a pair of anamorphic prisms. This is to expand the 'short' axis of the elliptical cross section of light, emitted from the rectangular aperture of the diode surface. Values of magnification of 2, 4 and 6 are typically available.

For low cost applications, spheres can be used to collimate light from laser diodes as shown in Figure 7. With the output aperture of the diode located at the focal point of the sphere, a collimated beam will be produced, though of poorer optical quality than a compound lens system. Typical sphere diameters are 2, 3 and 5 mm. Anti reflection films typically of MgF are available for specific wavelengths of 633, 830, 1300 and 1550nm. Such spheres are often used for specific fibre to fibre coupling, where the beam cross section is significantly increased.

Power Supply Design

The theory of driving laser diodes is straightforward in as much as they are essentially current driven devices, with typically operating currents of around a few tens or hundreds of mA. It is the extreme sensitivity of the device to static and voltage spikes which certainly makes them difficult to interface using conventional design and construction techniques.

Due to the remaining high cost of laser diodes (typically around £50 but falling), while a circuit can be designed using low cost components, a hobbyist approach to construction can lead to a high cost of blown diodes. Even research establishments with considerable expertise in electronics may blow several devices before perfecting the design of their own circuits.

Initially the functioning of typical drive circuits is described. Figure 8 outlines the main features of a drive circuit. The current flowing is given by:

$$\frac{V_{\text{fixed}} - V_{\text{var}}}{R}$$

where V_{fixed} is a reference voltage and V_{var} is a voltage set by independent current adjustment and modulation signals. The clamp circuit prevents the voltage falling below a specific threshold value, hence limiting the output current. Normally circuits include a feedback control mechanism utilising an integral photodiode element in the laser diode unit.

Special precautions have to be taken to prevent turn on and turn off spikes which are a feature of normal power supply designs. Special filters are required to undertake this function. These cannot be allowed to interfere with the current modulation facilities of the device.

There are a range of approaches to implementing digital modulation of the diode current. One method is to establish high level and low level current limits for the high and low level logic signals (usually TTL). The modulation signal controls a fast cross over switch for switching between the current sources.

Circuits require, in addition, features to improve diode longevity such as automatic smooth current ramps during power on and power off. Specialist laser diode 'bench' power supplies. Once set parameters have been specified and checked, the diode can be switched in.

Working with Diode Lasers

When handling diode lasers, strict antistatic precautions should be observed. Earthed wristbands should, for example, be worn. Also, soldering irons should be earthed. A silicon diode can be used as the dummy load during set up/ proving of circuits. Laser diodes will have typical specification for soldering at a tem-

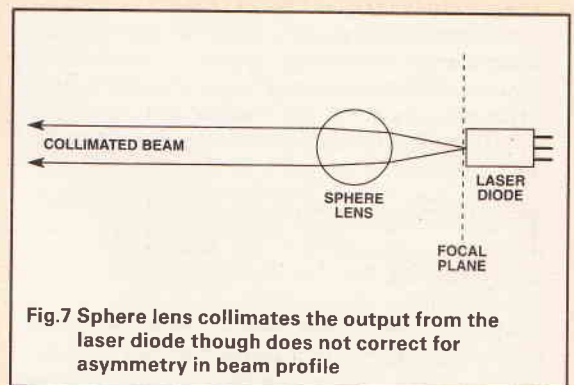

Fig.7 Sphere lens collimates the output from the laser diode though does not correct for asymmetry in beam profile

perature of 260°C for no more than 10 seconds at 2 mm from the laser body.

Figure 9 shows a simple circuit used with an NEC NDL 3200 diode while Figure 10 shows a circuit for optical mean power control for STC laser diodes. In Figure 10 the 3140 amplifier IC1 compares the set value of laser current (I_s) input to pin 2 with the feedback value registered on pin 3. The output of IC1 is fed to the inverting input of IC2 via a pair of 1N4148 diodes. The current signal from the integral photodiode is fed back to the input of IC2. This controls the maximum value of IF and provides an optical power control of the laser diode. Modulation current can be AC coupled into the laser diode cathode. Where a 50R impedance driver is used, a 47R terminating resistor should be series mounted as close to the laser pin as possible. A highly stable, transient free power supply should be employed.

'Off the Shelf' Modules

At present laser diodes are expensive for the hobbyist to purchase in small quantities. What can be more attractive, is to purchase the laser diode module as an integral package with case, lens system and power supply. Since a volume manufacturer can purchase laser diodes at large discount, they can be incorporated into a 'ready to run package for the equivalent purchase price of a single laser diode or less.

In the UK, the Applied Laser Systems laser diode, which is a Class 3a laser with output at a wavelength of 670nm, is available from Spiers Robertson of Bedford for £125 + VAT. The ALS module runs from a 5-10V DC power supply and can deliver between 1 mW and 5mW of output of deep red light using a single lens element. The beam diameter is 4mm by 0.6mm and it expands typically to a 120mm diameter circle at 15 metres range.

The device is small and compact, approximately 2.85mm diameter and 14.7mm long with a current consumption typically of 55mA which can be supplied by a battery. As an off the shelf ready to run option there is a lot to recommend it. The He-Ne laser, however, with its more eye sensitive response, can be run at lower power levels for the same apparent level of illumination.

Spiers Robertson can be contacted at:
 Moliver House,
 Oakley Road,
 Broxham,
 Bedford
 Tel: 02302 3410

Safety Considerations

The use of lasers is strictly controlled by national and international standards. In the UK the appropriate standard is BS7192. This provides definitions on the various classes of laser ranging from Class 1, Class 2, Class 3, Class 3a and Class 4. Typically low power diode lasers will either be Class 1 or Class 2 though the exact classification will depend on power output, whether pulsed or continuous and wavelength of radiation. The standard allows determination of what Class is applicable to a particular mode of laser radiation.

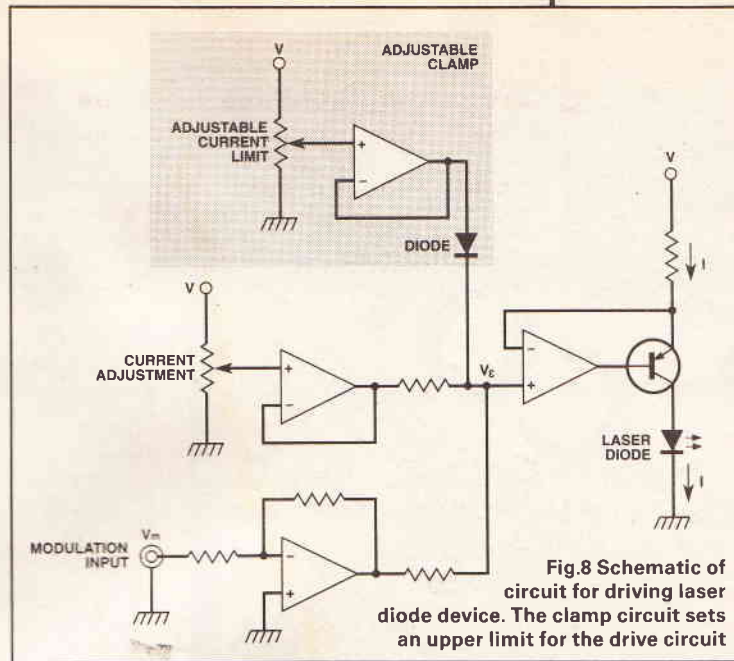

Fig.8 Schematic of circuit for driving laser diode device. The clamp circuit sets an upper limit for the drive circuit

Looking Ahead

Laser diodes have already found a broad range of applications in the fields of telecommunications, medicine, and optical data storage. There is every indication, however, that as their cost is reduced still further, wholly new applications will come to light. It is a challenging prospect.

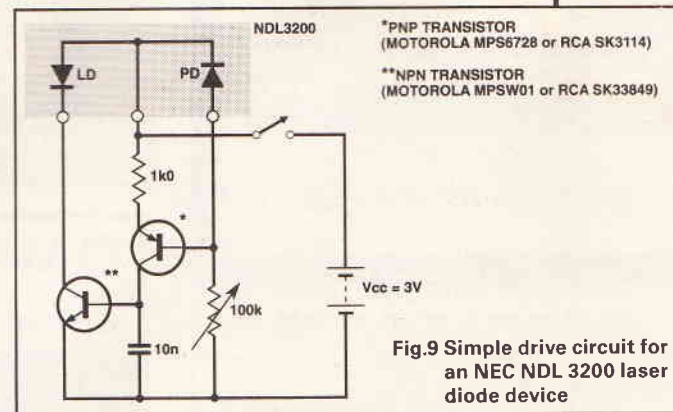

Fig.9 Simple drive circuit for an NEC NDL 3200 laser diode device

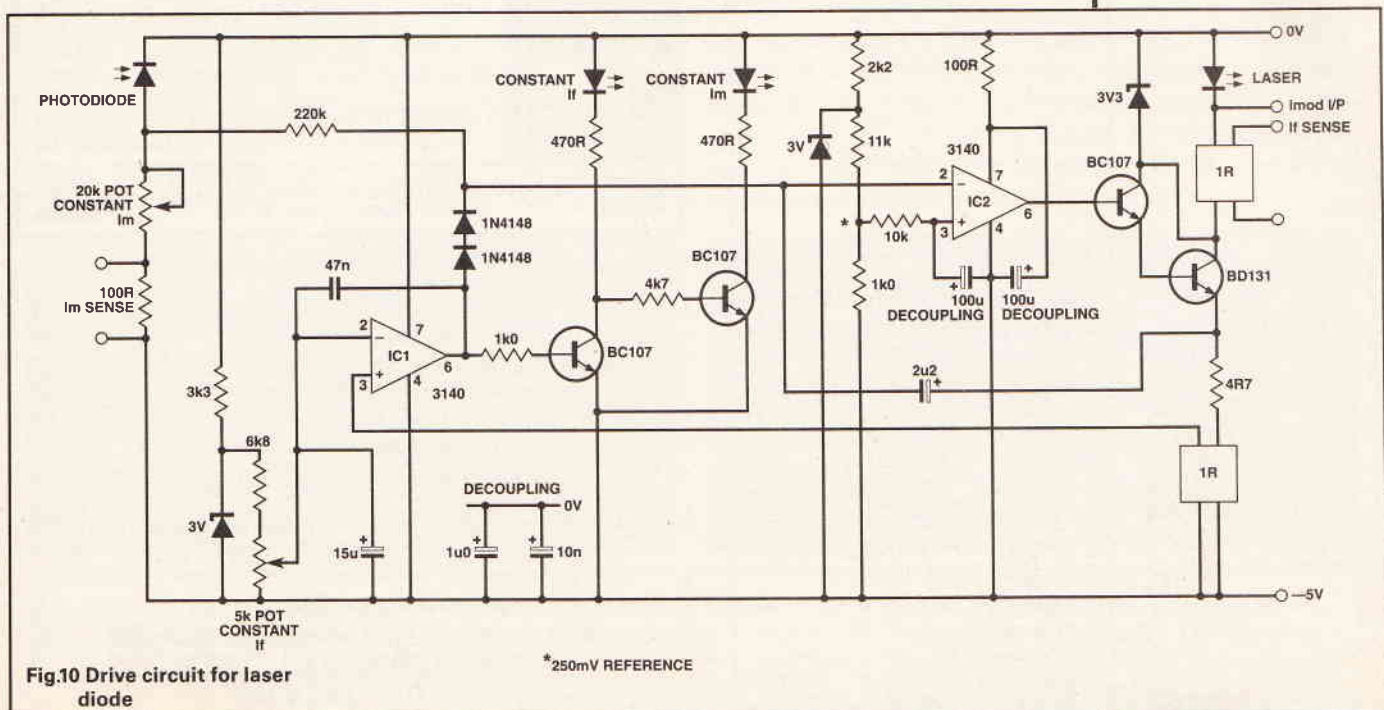

Fig.10 Drive circuit for laser diode

PHOTO-COPIES

ETI has been published for over 19 years and in this time a great many interesting and valuable projects and features have graced its pages. Although backnumbers are available for only the past 12 months issues we can supply photocopies of any individual article ever published in ETI.

Photocopies cost £1.50 per article regardless of their length. Please note that projects published over several issues must be ordered as a series of individual articles, each for £1.50.

PCB foil patterns (where published) and any errata are included with all photocopies as applicable.

Please supply photocopies of the following articles from ETI (complete in block capitals):

Month Year Page (if known)

Title

Month Year Page (if known)

Title

Month Year Page (if known)

Title

I enclose a cheque/postal order made out to ASP Ltd. to the value of £1.50 per photocopy ordered.

Total remittance £ Date

Name

Address

..... Postcode

Send the completed form and your remittance to:

ETI Photocopy Service
Argus House
Boundary Way
Hemel Hempstead
Herts HP2 7ST



HALCYON ELECTRONICS

SUPERB COLOUR FST MONITORS

Microvitec 15" HL series, with dot pitch of 0.39mm giving super colour image quality. Multi-input SCART connector for analogue TTL RGB, composite video and sound. Supplied with free SCART connector. Suitable for BBC-B, Amiga and many other computers with 15.625kHz scan rate. Also has integral touch screen facility. These monitors are engineered to high professional standard, have modern-style plastic cabinets, and are little used from new. Manufacturer's price £1000

OUR PRICE, ONLY £139

SPECIAL OFFERS

FARNELL E350 VARIABLE STABILISED PSU'S 0-350V 100MA. V.A METERS. 5.3V 2A C.T. 0-2.5-5-6.3V 3A	£49
LINSTEAD M29 MILLIVOLT METERS. BATT. OP. RANGES 1.2MV-400V AC. 120MV-400V DC	£19
TEKTRONIX 7L12 SPECTRUM ANAL. PL-IN	£1950
TEKTRONIX 7A03N. DFI 7D01 LOGIC ANAL	POA
THURLBY LA160A LOGIC ANAL PODS GRABBERS	£195
FLUKE 931B RMS DIFFERENTIAL V METER	£195
FLUKE 6160A FREQ SYNTH 1HZ-30MHZ	POA
FLUKE 7220A F.COUNTER 9 DIGIT 1.3GHZ	£285
WESTON STANDARD TWIN CELL TINSLEY	£75
REDPOINT 6E-1 HEATSINKS 1.5" CW BRAND NEW	£1.50
BBC-B COMPUTERS	£139 & £179
NELSON ROSS SPECTRUM ANALYSER 0-20KHZ	£295
CT491 CABLE TEST SET, 700YDS. CRT DISPLAY	£59
TEKSCAN 3650 TRACKING SWEEP ANALYSER	£695
RACAL DANA 9341 DIGITAL LCR BRIDGE	£295
AVO G2 457.5 COMPONENT COMPARATOR	£195
MARCONI TF2000 FM-AM MODULATION METER	£195
TEKTRONIX 535A. 545B. 585 SCOPES FROM	£65
WANDEL & GOLTERMAN TFPW-43 & TFP5-42 EA	£55
OLIVETTI 32MB EXT. HDRIIVE HDU2432	£149
UV 200W SHUTTER OP. TIMER. 240V	£89
B&K 1019 AUTO VIB EXCITER CONT-HEAD	£85
T-SWITCHES INMAC 1363 RS232 2-WAY	£40
LEAKSEEKER 46 PORTABLE GAS DETECTOR	£95
TEKTRONIX 834 PROG DATACOMMS TESTER	£495
AVO B5 M42. 5 & 6 From	£35
VARIABLE OUTPUT PSU'S From	£35
TEKTRONIX 520 PAL GR INTSC VECTORSCOPIES	£475
METROM V8 500V ELECTRONIC MEGGERS	£29
OTHER MEGGERS MEGGER BRIDGES From	£10
STAG PP41 EPROM PROGRAMMER	£2495
BENDIX 634N 150W 3GHZ DUMMY LOAD	£95
MARCONI TF2300 WAVE ANALYSER	£150
COHU 301 0-500V DC VOLTAGE STD. INT. REF.	£125
MICROWA ANALYTICAL BALANCE	£69
SARTORIUS 2432 ANALYTICAL BALANCE 200G	£285
PYE-UNICAM SP1800 UV SPECTROPHOTOMETER	POA
SULLIVAN & G STD DEC AIR CAP 0-1100PF	£495
HP 3426A SAMPLING BROADBAND V.METER	POA
ROHDE & SCHWARZ DPU ATTENUATORS	£95
NEOTRONICS OTOX91 OXYGEN ANAL. PRTABLE	POA
LYONS WGT16 16MHZ WORD GENERATOR	£245
EPSON PX4 3 TF150 TWIN FLOPPY	£175
WAVETEK 2001 SWEEP/SIG GEN TO 1.4GHZ	£1500
B&T LAB DVENS 12x13x14 INTERNAL 210°C	£195
MARCH DPL300S ELECTRONIC LOAD 60A 40V	£175
PASCALL BALL MILL. VARIABLE SPEED	£95
TEKTRONIX 5682 PLOTTERS. GPIB & RS232	£179
HP COMPUTER 9825B. 15263A. 98002A OPT. 066	£95
MICROWAVE BY H.P. KELTEC. VARIAN. ETC	POA
HITACHI CM2073A 301 20" RGB 64KHz. CAD-DTP	£495
TECMAR Q10-60H TAPE STREAMER	£95
LEADER LGG 396 NTSC PATT. GENERATOR	£395
CONRAC 7211 HIRES RGB MONITOR	£395
OSCILLOSCOPES DUAL TRACE From	£75
12" GREEN SCREEN MONITORS From	£39
LEADER LBO-9C ALIGNMENT SCOPE	£249
SIGNAL GENERATORS. AF. TO 12.5GHz From	£20

SEND FOR LIST £1, REFUNDED ON PURCHASE. BUT 1000'S OF UNLISTED BARGAINS FOR CALLERS. QUALITY ELECTRONIC EQUIPMENT BOUGHT. ALL PRICES EXC. OF P&P AND VAT

423, KINGSTON ROAD, LONDON SW20 8JR
SHOP HOURS 9-5.30 MON-SAT. TEL 081-542 6383

OMNI ELECTRONICS

174 Dalkeith Road, Edinburgh EH16 5DX · 031 667 2611

New catalogue available NOW

A COMPREHENSIVE RANGE WITH SERVICE SECOND TO NONE
OUR MUCH EXPANDED, BETTER ILLUSTRATED CATALOGUE WILL COST £1.50 - TO INCLUDE VOUCHERS TO USE AGAINST FUTURE PURCHASES. TO RECEIVE A COPY, PLEASE SEND YOUR REMITTANCE WITH YOUR NAME, ADDRESS AND TELEPHONE NUMBER REQUESTING A COPY OF THE 1990/91 OMNI CATALOGUE.



Open: Monday-Friday 9.00-6.00
Saturday 9.00-5.00



Millions of quality components at lowest ever prices.
Plus Tools, Watches, Fancy Goods, Toys.
Mail order only. UK only.

All inclusive prices
NO post, or VAT etc to add on.

Write or phone for catalogue/clearance list.
At least 2,100 offers to amaze you.

Brian J Reed Electrical
6 Queensmead Avenue, East Ewell
Epsom, Surrey KT17 3EQ
Tel: 081-393 9055

PSST...

Powerful Software Saves Time!

LABCENTER PUTS YOUR PC TO WORK

Why spend hours of your valuable time designing PCBs by hand or with a non-integrated CAD package when your PC can do it for you?

ISIS provides the easiest of ways to enter a circuit diagram into your computer and ARES has all the features needed to convert it into an elegant PCB layout. Both packages share the same Graphical User Interface, and the way that they integrate guarantees that your PCB will always match the original circuit.

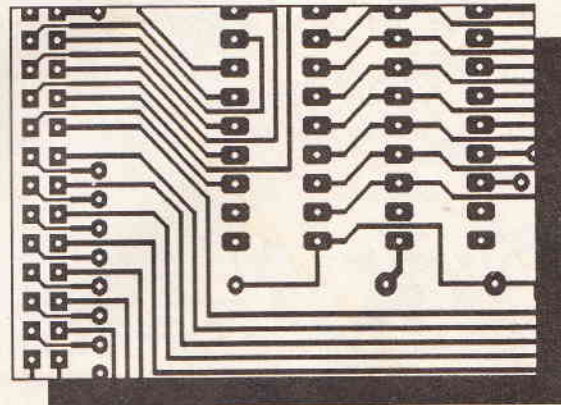
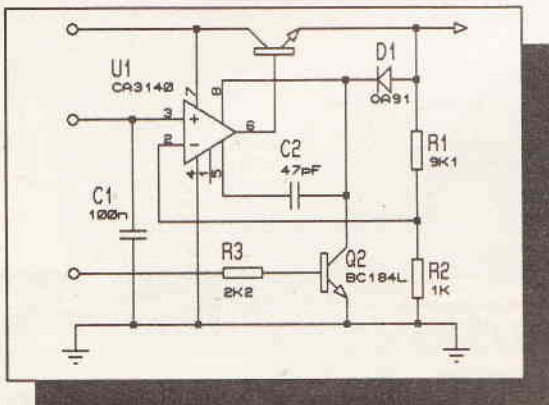

ISIS - Intelligent Schematics

ISIS DESIGNER..... £275

An easy to use schematic capture package for anyone needing to enter designs prior to further processing with ARES or other EDA software. It features our modern Graphical User Interface and an Intelligent Diagram Editor.

ISIS DESIGNER+ £475

A sophisticated design management tool - features such as an automatic annotator/packager, two systems for hierarchical design and ASCII Data Import make DESIGNER+ one of the most powerful schematics packages currently available for the PC.

- Auto wire routing.
- Auto dot placement.
- Auto name generator.
- Powerful editing facilities.
- Object oriented 2D drawing with symbol library.
- Comprehensive device libraries available.
- Output to dot matrix, pen plotters, lasers, POSTSCRIPT.
- Export to DTP packages in IMG, BMP, DXF or EPS formats.
- Multi-sheet and hierarchical designs handles in single file.
- Netlist output to most popular EDA software.
- Bill of Materials and Electrical Rules Check reports.

ARES - Advanced Routing

ARES £275

A netlist based, multi-layer PCB design package that can integrate with ISIS or other schematics software. Includes connectivity checker, design rule checker, power plane generator and automatic back-annotator.

ARES AUTOROUTE..... £475

Our new autorouter uses an advanced, multi-strategy algorithm to achieve very high completion rates, yet when driven from ISIS, there is remarkably little setting up to do - Package, Router-Strategy and DRC data can all be read from the netlist. As we said at the beginning, Powerful Software Saves Time.

- Topological Route Editor (another Labcenter innovation)
- Unlimited user configurable pad, track and via styles.
- Full surface mount and metric support.
- 10 copper + 2 silk layers.
- 1 thou resolution.
- 30x30 inch max board size.
- Up to 5000 pins, 50000 trace segments using EMS RAM.
- Object oriented 2D drawing for silk screen graphics.
- Drivers for dot matrix, pen plotters, lasers, POSTSCRIPT, Photoplot (Gerber), NC drill (Excellon).
- Graphics export in IMG, BMP or EPS formats.

labcenter
Electronics

COMBINATION PRICES

ISIS DESIGNER & ARES £495
ISIS DESIGNER & ARES AR £675
ISIS DESIGNER+ & ARES £675
ISIS DESIGNER+ & ARES AR £850
Prices inc UK delivery, exc VAT.

Call for demo packs
Tel: 0274 542868
Fax: 0274 481078

See us at
Leetronex 91
Stand No 1

14 Marriner's Drive, Bradford, BD9 4JT

OUT NOW!

SUMMER 1991 CATALOGUE

- 192 pages
- £££'s discount vouchers
- 100s new products
- New range kits
- Over 3000 lines
- Fast same day despatch

Available from most large newsagents or directly from **Cirkit**



£1.70
plus 30p
postage

Cirkit

CIRKIT DISTRIBUTION LTD

Park Lane · Broxbourne · Hertfordshire · EN10 7NQ
Telephone (0992) 444111 · Fax (0992) 464457



HART AUDIO KITS — YOUR VALUE FOR MONEY ROUTE TO ULTIMATE

HART kits give you the opportunity to build the very best engineered hi-fi equipment there is, designed by the leaders in their field, using the best components that are available.

With a HART kit you not only get more performance for your money but also the added free bonus of your own hands-on experience of modern electronic assembly. The HART combination of innovative circuit techniques, sound engineering design and professional grade components is your recipe for success in the quest for affordable ultimate audio fidelity.

Telephone or write for your FREE LISTS giving full details of all our kits, components and special offers. Featured this month is the —

AUDIO DESIGN 80 WATT AMPLIFIER



This fantastic John Linsley Hood designed amplifier is the flagship of our range, and the ideal powerhouse for your ultimate hi-fi system. This is your way to get EK performance at bargain basement prices. Unique design features such as fully FET stabilised power supplies give this amplifier World Class performance with startling clarity and transparency of sound, allied to the famous HART quality of components and ease of construction.

Useful options are a stereo LED power meter and a versatile passive front end giving switched inputs, with ALPS precision, low-noise volume and balance controls.

Construction is very simple and enjoyable with all the difficult work done for you, even the wiring is pre-terminated, ready for instant use! Complete details of the different versions are in our free lists.

RLH10 Reprints of latest 'Audio Design Amplifier' articles £2.70
K1100CM HART Construction Manual with full price lists £5.50

Why not buy the reprints and construction manual to see how easy it is to build your own equipment the HART way. The FULL cost can be credited against your subsequent kit purchase.

ALPS PRECISION LOW-NOISE STEREO POTS



To fulfil the need for higher quality controls we are now importing an exciting new range of precision audio pots in values to cover

most quality amplifier applications. All in 2-gang stereo format, with 20mm long 6mm dia. steel shafts. Now you can throw out those noisy ill-matched carbon pots and replace with the real hi-fi components only used selectively in the very top flight of World class amplifiers. The improvements in track accuracy and matching really is incredible giving better tonal balance between channels and rock solid image stability.

Values available are 10K and 100K Log, 100K lin and 10K Special Balance. (Zero loss in centre position).

Also now added to the range are two values in MOTORISED versions. These are 20K Log and 10K Special Balance with 5v DC drive motor.

2-Gang 100K Lin	£8.86
2-Gang 10K or 100K Log	£9.60
2-Gang 10K Special Balance, zero crosstalk and zero centre loss	£10.71
2-Gang 20K Log (Volume Control) MOTORISED	£19.28
2-Gang 10K Special Balance, MOTORISED, zero crosstalk and <10% centre loss	£19.98

LINSLEY HOOD 'SHUNT FEEDBACK' R.I.A.A. MOVING COIL & MOVING MAGNET PICKUP PREAMPLIFIER



Modern, ultimate sound systems are evolving towards a built-in preamplifier within the turntable unit. This keeps noise pickup to a minimum.

This new circuit by John Linsley Hood uses latest generation integrated circuits in the serially preferred shunt feedback configuration to give an accurate and musical sound, with the ability to use moving magnet and moving coil cartridges. Power comes from two 9v PP3 size batteries or a mains power supply. (Not supplied).

The HART kit for this unit is exceptionally easy to build with all the specially selected components fitting directly on to the roller tinned fibreglass printed circuit board. Even the gold plated phono sockets mount directly on the board.

Kit complete with fully machined case and a 1 metre length of miniature power supply cable is HART ref K1500. £69.23.

HIGH QUALITY REPLACEMENT CASSETTE HEADS



Do your tapes lack treble? A worn head could be the problem, for top performance cassette recorder heads should be replaced every 1,500 hours.

Fitting one of our high quality replacement heads could restore performance to better than new! Standard inductances and mountings make fitting easy on nearly all machines (Sony are special - see below) and our TC1 Test Cassette helps you set the azimuth spot-on. As we are the actual importers you get prime parts at lower prices, compare our prices with other suppliers and see! All our heads are suitable for use with any Dolby system and are normally available ex stock. We also stock a wider range of special heads for home construction and industrial users.

HM120 Standard Mono R/P Head	£3.51
HC18 Standard Quality Stereo R/P Head	£2.49
HC06 High Quality Stereo R/P Head, Hard Permalloy Construction with hyperbolic Face for improved tape to head contact	£7.98
HS16 Sensus Alloy Stereo Head. High quality head with good frequency response and hyperbolic face for good tape to head contact	£16.85
HC60S SONY Special Stereo R/P Head. This head has the unusual Sony mounting bracket and is suitable for mains powered domestic hi-fi recorders	£21.38
HQ551 4-Track RECORD & Play Permalloy Head for auto-reverse car players or quadraphonic recording	£14.90
H524 Standard Erase Head	£1.90
H561 Hi Field Erase Head for METAL Tapes	£3.49
HRP 373 Downstream Monitor Stereo Combination Head	£47.50

Many other SPECIAL cassette heads in stock, see our LIST.

REEL TO REEL HEADS

999R 2/4 Record/Play 110mH. Suits Stuart Tape Circuits	£13.64
998E 2/4 Erase Head 1mH. Universal Mount. Suits Stuart	£11.98

TAPE RECORDER CARE PRODUCTS

HART TC1 TEST CASSETTE. Our famous triple purpose test cassette. Sets tape azimuth, VU level and tape speed	£5.36
DEM1 Mains Powered Tape Head Demagnetizer, prevents noise on playback due to residual head magnetisation	£4.48
DEM115 Electronic, Cassette Type, demagnetizer	£8.81

Our new SPRING '91 List is FREE in UK. Send for your copy now. Overseas customers welcome, but please send 2 IRCs if you want a list, to cover surface post, or 5 for Airmail

QUALITY AUDIO KITS

24hr SALES LINE
(0691) 652894

ALL PRICES INCLUDE VAT
AT 17.5%



Consort Speaker



PROJECT

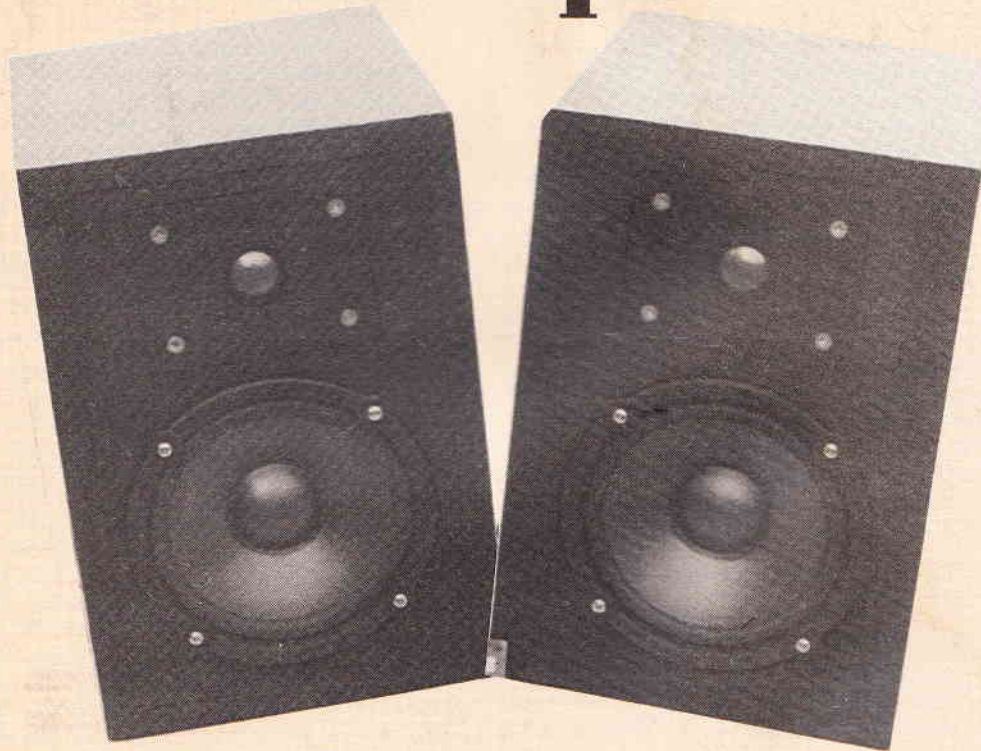

Here is a Loudspeaker project with a difference. The Consort is an active design with a negative output resistance amplifier, which increases the damping and lowers the bass distortion. It was inspired by the ETI speaker articles (July 89) and the Flatmate project (May 90) of Jeff Macauley, also the work of Thiele. Thiele published his loudspeaker design work 30 years ago this year. Happily the advent of operational amplifiers makes it much easier now than it was then to implement Thiele's ideas. The writer absolutely agrees with Mike Fox's comments in the K2 loudspeaker (ETI Feb 91) that the loudspeaker has not been given the importance it deserves by the specialist media. This design uses different techniques to achieve the same ends as the K2.

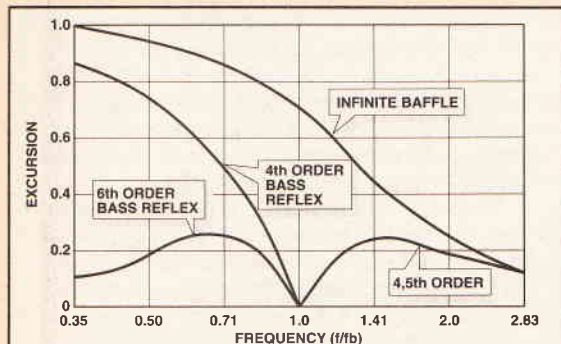

Fig.1 Cone excursion against frequency for different designs (Cabinet, drive unit and cut-off frequencies identical)

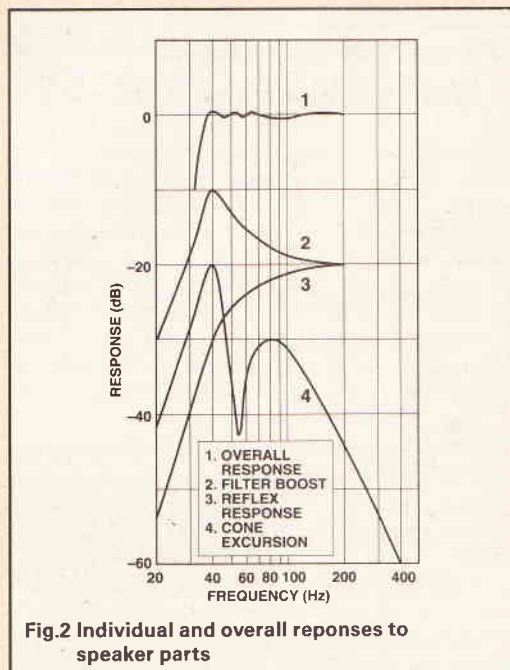

Fig.2 Individual and overall responses to speaker parts

would have you believe. The unit uses a 165mm polypropylene coned woofer and a British made Acoustic Engineering Ltd metal dome tweeter.

Like the Flatmate it is a sixth order bass reflex design. To see why this is used, look at Figure 1 which shows the cone excursion with frequency for various designs. Note how much lower the cone excursions are for the bass reflex than the infinite baffle design. The extra filter in the sixth order design lowers the excursion below f_{box} compared with the standard 4th order bass reflex design. The curves also show predicted zero-excitation at the box tuning frequency (determined by the port) This is where all the sound is

Influenced by ETI projects, Peter Roberts has produced another active loudspeaker design

Design

The aim of the Consort is to give an extended bass response (-3dB at 38Hz) in a small cabinet size (12.7 litres). Also to give a high quality sound, whilst being cost effective, these are compatible, despite what some

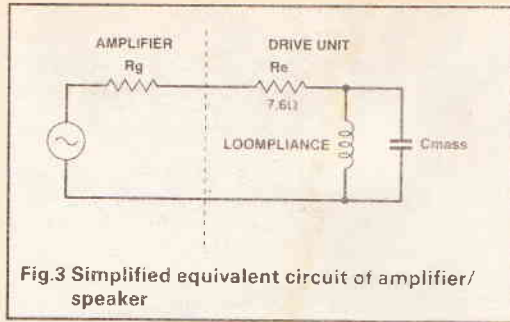

Fig.3 Simplified equivalent circuit of amplifier/speaker

theoretically coming out of the port. In practice losses will mean that the cone movement is not zero but it will be low.

The sixth order design presents 3 main possibilities. Either a higher acoustic output for the same cone movement or lower distortion for a given sound level, alternatively the useful response can be pushed lower in frequency for the same cone excursion that the infinite baffle would give. This latter option is used in The Consort. To observe this, Figure 2 shows the bass boosted signal applied from the extra filter. This

pliance by a factor (1.31 for this design). Now most woofers are designed for infinite baffle use, which demands a high compliance of typically 60 litres or more. This would give a box size 60/1.31 about 45 litres, which is a big box. It is difficult to find low compliance drive units. The writer found one with a compliance of 14 litres which gives a box size of 14/1.31 i.e 10.7 litres. In practice 2 litres are taken up with the port tube, drive unit volume and electronics volume so the final internal size is 12.7 litres.

Unfortunately the drive unit has a Qts of 0.79 which is too high for this design, which requires 0.38. Thiele's work suggested using a negative output resistance amplifier to lower the woofer Q (another way of saying increasing the damping) and it has the added benefit of lowering the distortion. The woofer specified has to be used; any other unit will not work properly.

Negative Resistance

A simplified equivalent circuit for an amplifier/speaker combination is shown in Fig.3 The inductor and capacitor represent the suspension compliance and cone and coil mass respectively. They form a tuned circuit which gives the free-air resonant frequency. Unfortu-

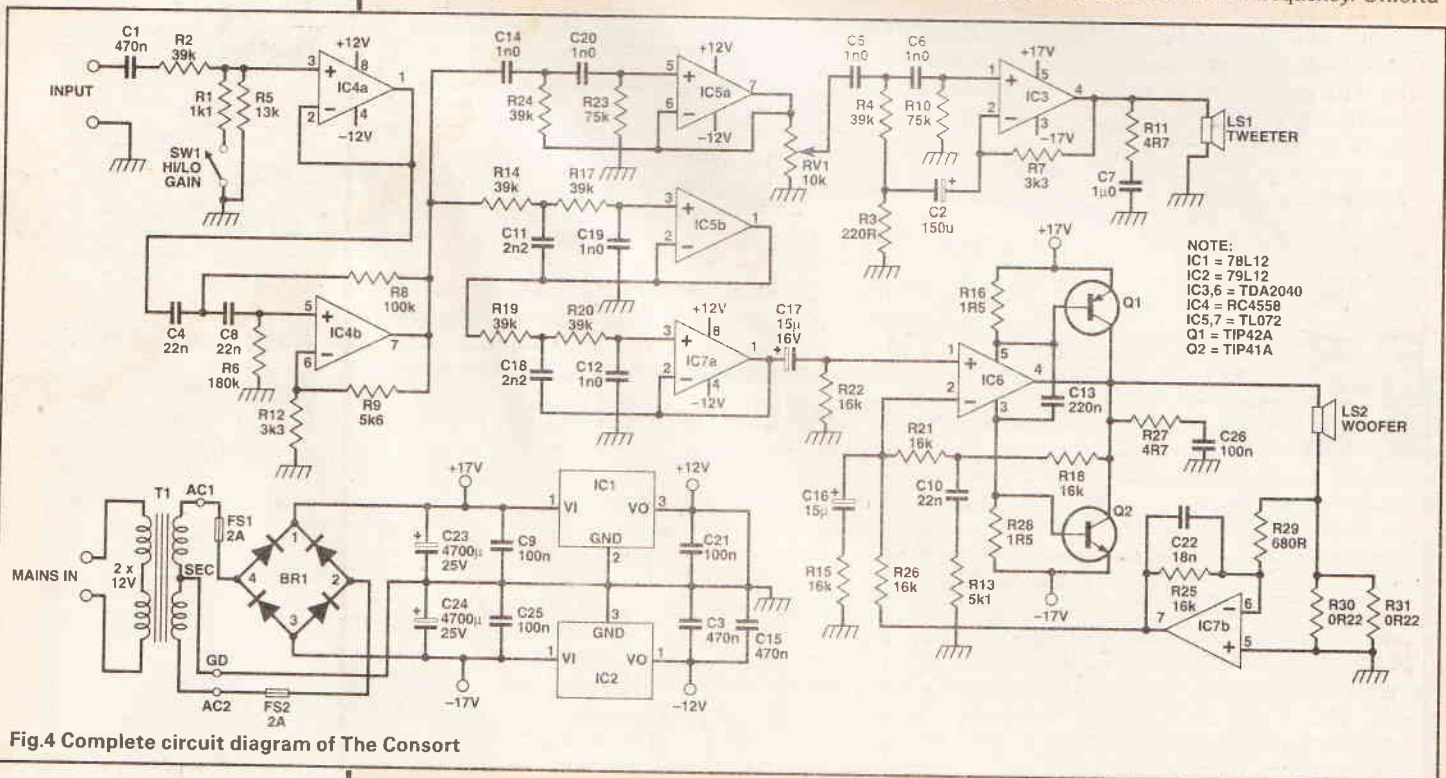

Fig.4 Complete circuit diagram of The Consort

equalises the speaker response giving an overall flat characteristic. The overall response is a correctly aligned Chebychev high pass filter with in this case 0.1dB of ripple.

For this design the port is tuned to 90% of the drive unit resonant frequency and the extra filter to 67% of the resonance giving a -3dB point at 66% of the driver resonance (58Hz), thus giving the -3dB level at 38Hz.

As Jeffs article pointed out there are 3 drive unit parameters one must know for designing a bass reflex speaker. These are the resonant frequency, the Qts and the volume equivalent of compliance, this last being a measure of the stiffness of the cone and coil surrounds. For any design there will only be one combination of parameters which is correct. It is difficult to achieve this combination, which is why the bass reflex speaker is tricky to design.

The first aspect of the design is the proposed box size. The air in the box acts as an acoustic spring. This compliance has to be matched to the drive unit com-

pliance by a factor (1.31 for this design). Now most woofers are designed for infinite baffle use, which demands a high compliance of typically 60 litres or more. This would give a box size 60/1.31 about 45 litres, which is a big box. It is difficult to find low compliance drive units. The writer found one with a compliance of 14 litres which gives a box size of 14/1.31 i.e 10.7 litres. In practice 2 litres are taken up with the port tube, drive unit volume and electronics volume so the final internal size is 12.7 litres.

Unfortunately the drive unit has a Qts of 0.79 which is too high for this design, which requires 0.38. Thiele's work suggested using a negative output resistance amplifier to lower the woofer Q (another way of saying increasing the damping) and it has the added benefit of lowering the distortion. The woofer specified has to be used; any other unit will not work properly.

The formula for the reduction in Q is:
 $Q(\text{required}) = 1/Q_m + 1/Q_e (1/(1 + R_g/R_e))$
 where Q_m and Q_e are the drive unit mechanical and electrical Q's respectively. For this design Q_m is 3.1, Q_e is 1.06, Q required is 0.38 and R_e (coil resistance) is 7.6R. Giving a value of R_g of -4.5R. In practice, to

PROJECT

compensate for voice coil heating and the consequent increase in resistance, a value of $-5R$ is used.

Circuit Design

Integrated circuit power amplifiers are used to implement the amplifier design. This simplifies the design of the negative resistance circuit. The positive feedback is rolled off at higher frequencies. This stops the rising drive unit impedance (caused by the inductance of the voice coil) lowering the output. At high frequencies the negative resistance does not acoustically damp the speaker, anyway. The negative feedback is reduced at the same time giving a flat response into the speaker load. The ICs have a distortion of 0.03% so are genuine hi-fi components. Transistor power assistance is used on the woofer amplifier to lower the distortion at the low frequency extreme. Since the maximum voltage these amplifiers will take is 40V, the transformer secondaries should be no greater than 12V.

PCB Construction

The building of the electronics is simplified because all components bar the transformer are PCB mounted. The Veropins for the connections should be fitted to the PCB first as they may need some force applied. A tap with a light hammer with the PCB supported on a wooden block is easiest. The electrolytics, bridge rectifier and ICs only go one way round. A link is required between holes B and C on the PCB. The power transistors and power ICs should be fixed on the heatsink before soldering. See Figure 5. The kits have pre-drilled and tapped heatsinks. Using a multimeter check for insulation between the device mounting screw and the device metal case. Once all the components have been soldered in and the fuses clipped in, a test can be done by connecting the transformer (careful with the mains here!) and switching on. Check that the supplies are about 17v and the supplies to the 8 pin

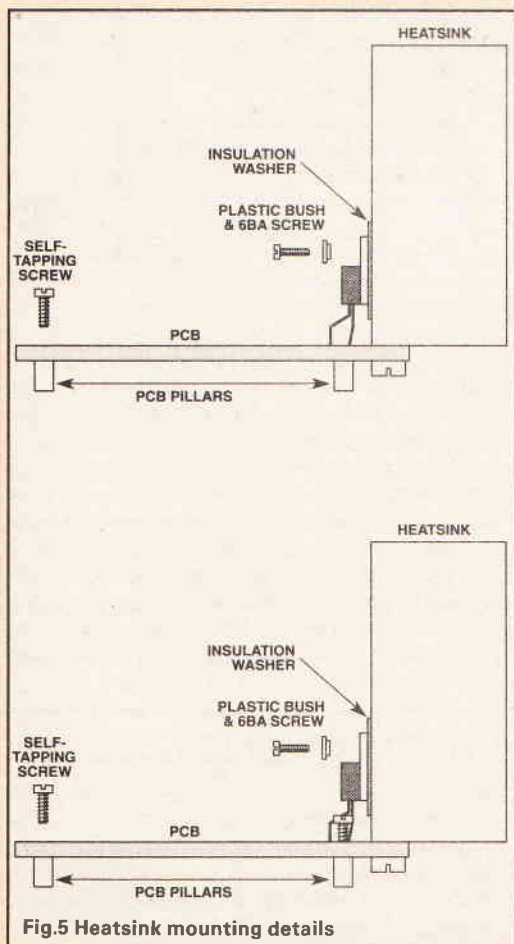

Fig.5 Heatsink mounting details

ICs pins 4 and 8 are -12 and $+12V$ respectively. The output DC voltages should be zero. If the voltages are zero speakers may be connected up (after switching off). Touching the input pin should now produce a hum.

Cabinet Construction

15mm chipboard or MDF board is used for the construction of the cabinet (except for the baffle) and may be plain, melamine or laminate faced. The writer used laminate faced material for the prototype. This produces slightly stiffer panels which give better panel damping. It would be easiest to buy the panels cut to

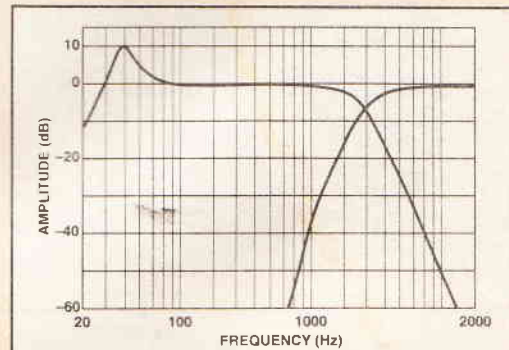

Fig.6 Actual response of woofer and tweeter outputs

size. The prototype baffles were made by glueing together a 12mm plywood sheet with a 4mm plywood sheet. The 12mm plywood being cut with a jigsaw to accept the speakers apertures and the 4mm plywood cut to match the speaker face. When the two are glued together the recess or rebate for the speakers is formed. The edge of the woofer inner hole should be bevelled slightly. The tweeter terminal cutouts are marked out by drawing around the gasket, then enlarging to 12mm sq. The drive units can now be offered up and the blind mounting holes marked and drilled with a 2.5mm drill.

If you have a router then you can use chipboard/MDF for the baffle and cut the recesses with the router. A jigsaw was used to cut the recess plate cut-out and port tube apertures in the back panel. A Flapwheel is useful here for smoothing out irregularities. The port tube is a 152 mm length of 50mm plastic tubing which is glued into the back panel with epoxy adhesive. 12mm square battens should be pinned and glued to the sides, top and bottom panels 16mm in from their front edge for the baffle to seat against (leave clearance for the corners). The sides, top and bottom are now screwed and glued together. If plain chipboard is used wood glue can be used, but for faced material epoxy resin or similar is better. The faced surface (where glued) should be keyed with wet and dry paper. At this point check for leaks and seal with epoxy resin or polyfilla. To work properly the cabinet must be leak-proof!

Panel damping material may now be applied. Wickes flashing strip being self adhesive and apparently made from pure bitumen is ideal for this. A 100mm wide strip is applied in a continuous length around 4 sides of the cabinet (except where the PCB is to be). Obtain a 3m roll and use it up on a pair of boxes, if necessary applying a double layer. If unfaced board is used the surface should be sealed before sticking the self adhesive strip (do not use the supplied primer for this unless you want to wait a week for it to stop out-gassing vapours).

The strip should be well smoothed down when sticking it. The pilot holes for fixing the transformer and PCB can now be drilled. The transformer can be mounted on the panel damping material to stop the



PROJECT

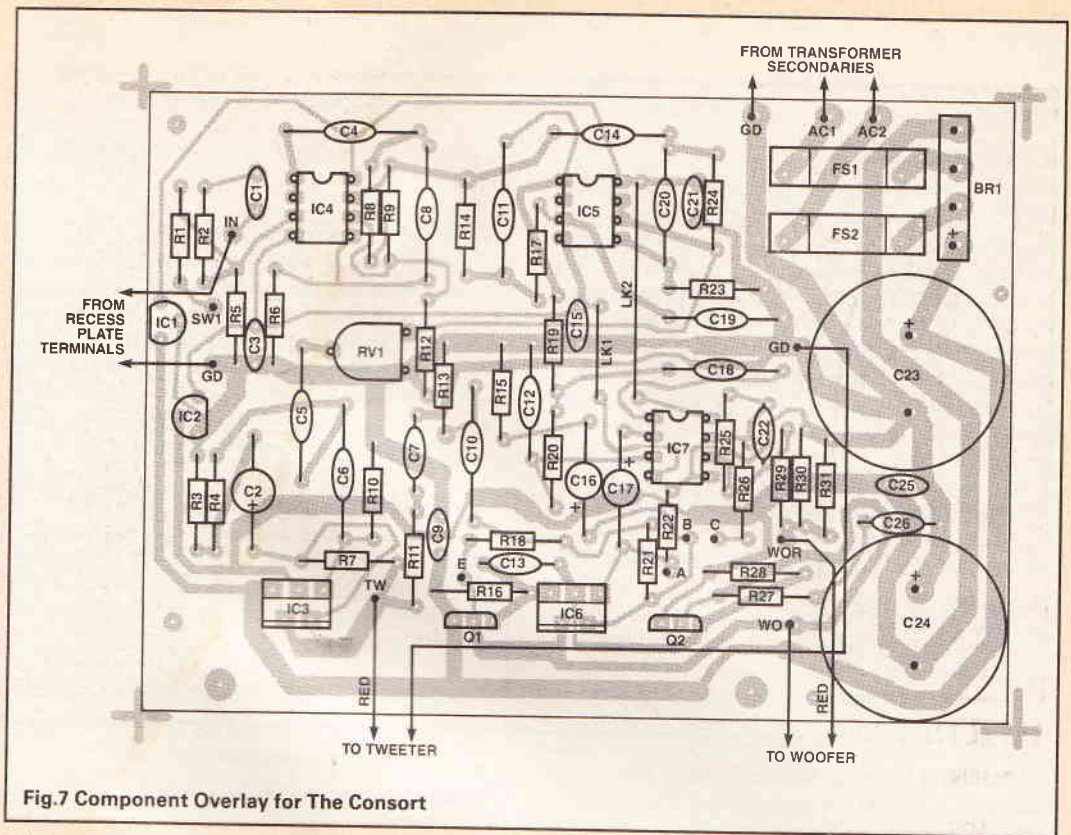

Fig.7 Component Overlay for The Consort

cabinet acting as as sounding board for any transformer mechanical noise. The back panel can now be screwed and glued in. Check for leaks again.

Assembly

Solder some twisted pair leads to the PCB for the inputs, outputs and supply. Set the pot RV1 to half-way in its travel. Fit the transformer and PCB to the cabinet. The mains cable gland can now be fitted to the recess plate, which has built-in terminals. Solder the input wires to the terminals and run the mains lead through the gland. Temporarily fit the recess plate to the back panel. Connect the transformer and loudspeakers up, so that you can check everything works at this stage. It is best to set the tweeter level up now. Put the woofer temporarily in its baffle and the baffle temporarily in the cabinet. Apply a music signal and set the pot RV1 to give the correct treble balance when compared with another hi-fi speaker. When the tweeter level has been set and you are happy that everything is OK, switch off, disconnect the speakers, and clamp the leads to the cabinet, so they will not rattle.

The front baffle may be glued and screwed in. After connecting the speakers up, the woofer is sealed to the baffle by applying a continuous bead of silicone sealant to the recess. Use the supplied gasket to seal the tweeter. The drive units are then screwed to the baffle, the woofer with 3/4" No.8 self tapping screws and the tweeter with CSK 3/8" No. 10 screws. The woofer fixing is improved by using a 19mm dia. washer under the screw. The recess plate has a gasket to seal it.

In Use

The ideal position for the speakers, would be on stands, about 0.5 metres away from the rear wall. Put on your favourite record/CD and lie back and enjoy it. Used for television sound and especially digital stereo these speakers immeasurably enhance the experience of watching a film or TV prog. with decent sound (which most of them have). The deep bass gives an ambience similar to being in a cinema. The Consort could be used as a 'minimalist' system by feeding a CD player output directly into the loudspeaker inputs, or as an upgrade to a MIDI system.

Finally, most passive speaker designs have opti-

mum damping and bass response when driven from the near zero output impedance of modern amplifiers. Indiscriminate use of the negative resistance technique on a passive design, could actually reduce the bass output, by overdamping the bass drive unit.

HOW IT WORKS

See circuit diagram Figure 4. C1 is a DC blocking capacitor to remove any DC offsets the user might apply from his signal source. This is followed by a switchable potential divider to make the overall gain of the system either unity (one) or ten. SW1 (optional) is closed or the SW1 terminal is linked to ground to give a gain of one. The switch could be fitted to the rear recess plate.

Unity gain is provided so that existing amplifiers and their settings can be used, also A-B comparisons made with passive speakers. If more gain is required the switch (or link) is opened giving a gain of ten times. Amplifier IC4a is used as a voltage follower, a low noise IC is specified here.

The extra filter, which gives the sixth order, is built around IC4b. It has a Q of 3.3 giving a gain of 10.4dB at 40 Hz. The Q is given by $1/(3-a)$ where a is $(R10+R13)/R13$ and the turn over frequency by $1/(2\pi R7C5)$ for $C5=C9$ and $R7=R9$. This is followed by the cross over filters which are cascaded 2nd order types giving a cross-over frequency of 2.9kHz. The 2nd high pass filter for the tweeter is built around the power amplifier potentiometer RV1 controls the tweeter output. The pot could be replaced with a rear recess plate mounted one.

Positive current feedback is applied to power amplifier IC6 by amplifier IC7b. The positive feedback is rolled off at high frequencies by C23. To compensate for the loss in gain at high frequencies, the negative feedback around IC6 ie. R19 and R22, is shunted by C11 and R14 giving less feedback and hence more gain at high frequency. An overall flat response is obtained. The negative resistance is given by: $-(R31/2) R26/(R22+R19)/R27R30$. See Figure 6 for the actual response measured across the woofer and tweeter outputs, the woofer output being loaded by a 76R resistor.

BUYLINES

A designer approved kit for constructing a pair of loudspeakers is £188 inc. VAT and carriage. A PCB kit is £55 a pair inc. and a drive unit kit also containing the speaker fixings, port tubes, the transformers, mains leads, glands and recess plates is £94 a pair inc. A flat-pack type cabinet kit is available in black ash finish for £39 a pair inc. All from Memex Electronics Ltd, 1 Icknield close, Ickleford, Hitchin, Herts SG5 3TD



PROJECT

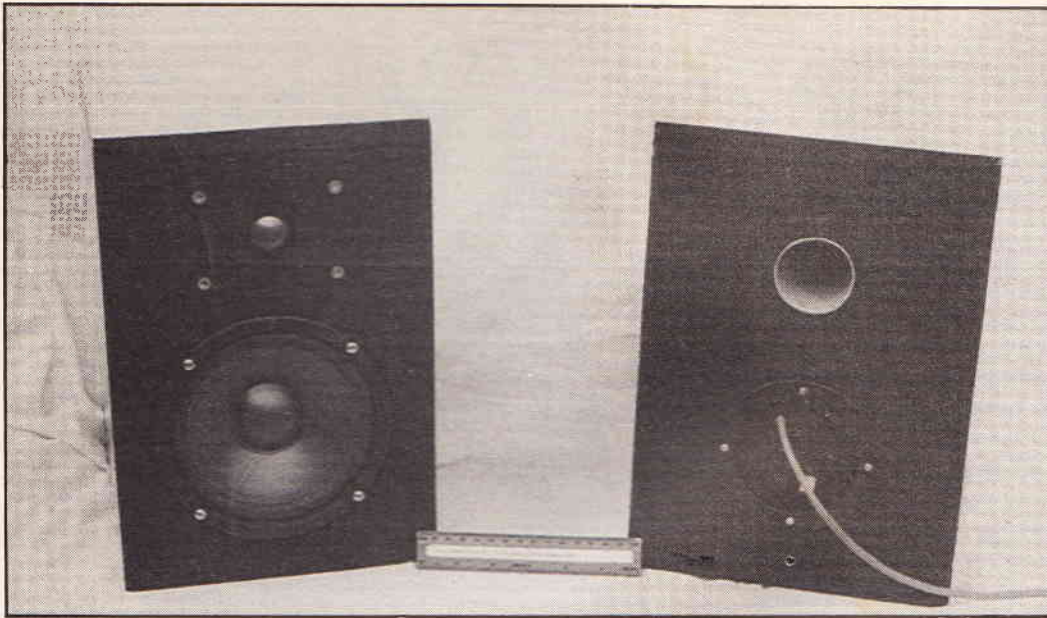

PARTS LIST

RESISTORS (all 1% metal film except R30,31 10%)

R1	1k1
R2,4,14,17,19,20,24	9k
R3	220R
R5	13k
R6,8	180k
R7,12	3k3
R9	5k6
R10,23	75k
R11,27	4R7
R13	5k1
R15,18,21,22,25,26	16k
R16,28	1R5
R29	680R
R30,31	0R22
RV1	10k preset

CAPACITORS

C1	470n poly
C2	150µ 6V3
C3,15	470n 25V Ceramic
C4,8,10	22n 1% polypropylene
C5,6,12,14,19,20	1n0 2.5% polystyrene
C7,26	100n 100V poly
C9,21,25	100n 25V Ceramic
C11,18	2n2 2.5% poly
C13	220n 100V poly
C16,17	15µ 16V
C22	18n 5% poly
C23,24	4700µ 25V

SEMICONDUCTORS

IC1	78L12
IC2	79L12
IC3,6	TDA2040
IC4	RC4558
IC5,7	TL072

MISCELLANEOUS

BR 1	BRIDGE RECTIFIER 4A 200V
Q1	TIP42A
Q2	TIP41A
T1	2x12V 2A Secondaries
FS 1	2 Fuses 2A 20mm
Fuse Clips	
Heatsink	
PCB	
TO220 Mounting Kit (4)	
Terminal Pins	
Mounting Bushes	

SPEAKER COMPONENT LIST

- 165mm Polypropylene cone woofer
- AEL metal dome tweeter
- Recess Plate
- Port Tube
- Gland for mains lead
- 2 Core Mains lead
- Fixing screws and washers
- REMEMBER to double quantities for a pair

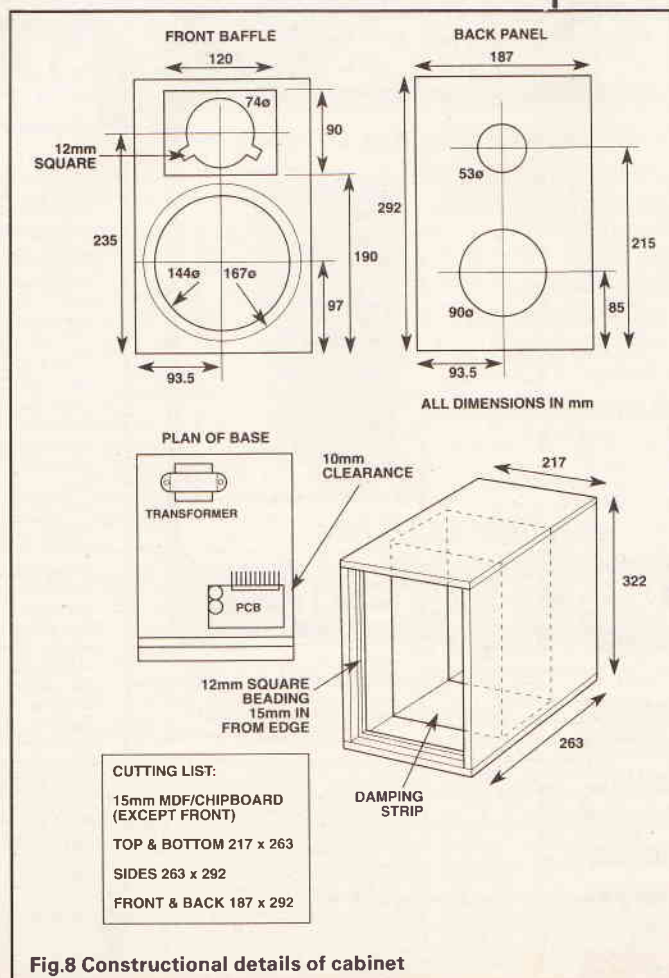

HIGH POWER AMPLIFIER For your car, it has 150 watts output. Frequency response 20HZ to 20 KHZ and a signal to noise ratio better than 60db. Has built in short circuit protection and adjustable input level to suit your existing car stereo, so needs no pre-amp. Works into speakers ref 30P7 described below. A real bargain at only £57.00 Order ref 57P1.

HIGH POWER CAR SPEAKERS. Stereo pair output 100w each. 4ohm impedance and consisting of 6 1/2" woofer 2" mid range and 1" tweeter. Ideal to work with the amplifier described above. Price per pair £30.00 Order ref 30P7.

PERSONAL STEREOS Customer returns but complete with a pair of stereo headphones very good value at £3.00 ref 3P83.

2KV 500 WATT TRANSFORMERS Suitable for high voltage experiments or as a spare for a microwave oven etc. 250v AC input. £10.00 ref 10P93.

MICROWAVE CONTROL PANEL. Mains operated, with touch switches. Complete with 4 digit display, digital clock, and 2 relay outputs one for power and one for pulsed power (programmable). Ideal for all sorts of precision timer applications etc. £6.00 ref 6P18.

FIBRE OPTIC CABLE. Stranded optical fibres sheathed in black PVC. Five metre length £7.00 ref 7P29.

12V SOLAR CELL. 200mA output ideal for trickle charging etc. 300 mm square. Our price £15.00 ref 15P42.

PASSIVE INFRA-RED MOTION SENSOR.

Complete with daylight sensor, adjustable lights on timer (8 secs -15 mins), 50' range with a 90 deg coverage. Manual override facility. Complete with wall brackets, bulb holders etc. Brand new and guaranteed. £25.00 ref 25P24. Pack of two PAR36 bulbs for above unit £12.00 ref 12P43.

VIDEO SENDER UNIT Transmits both audio and video signals from either a video camera, video recorder or computer to any standard TV set within a 100' range (tune TV to a spare channel). 12V DC op. £15.00 ref 15P39. Suitable mains adaptor £5.00 ref 5P191.

FM TRANSMITTER housed in a standard working 13A adapter (bug is mains driven) £26.00 ref 26P2.

MINIATURE RADIO TRANSCIEVERS A pair of walkie talkies with a range of up to 2 kilometres. Units measure 22x52x155mm. Complete with cases. £30.00 ref 30P12.

FM CORDLESS MICROPHONE. Small hand held unit with a 500' range! 2 transmit power levels reg PP3 battery. Tuneable to any FM receiver. Our price £15 ref 15P42A.

10 BAND COMMUNICATIONS RECEIVER. 7 short bands, FM, AM and LW DX/local switch, tuning 'eye' mains or battery. Complete with shoulder strap and mains lead. NOW ONLY £19.00! REF 19P14.

WHISPER 2000 LISTENING AID. Enables you to hear sounds that would otherwise be inaudible! Complete with headphones. Cased. £5.00 ref 5P179.

CAR STEREO AND FM RADIO. Low cost stereo system giving 5 watts per channel. Signal to noise ratio better than 45db, wow and flutter less than 35%. Neg earth. £25.00 ref 25P21.

LOW COST WALKIE TALKIES. Pair of battery operated units with a range of about 150'. Our price £8.00 a pair ref 8P50.

7 CHANNEL GRAPHIC EQUALIZER plus a 60 watt power amp! 20-21KHZ 4-8R 12-14v DC negative earth. Cased. £25 ref 25P14.

NICAD BATTERIES. Brand new top quality. 4 x AA's £4.00 ref 4P44. 2 x C's £4.00 ref 4P73, 4 x D's £9.00 ref 9P12, 1 x PP3 £6.00 ref 6P35.

TOWERS INTERNATIONAL TRANSISTOR SELECTOR GUIDE. The ultimate equivalents book. Latest edition £20.00 ref 20P32.

CABLE TIES. 142mm x 3.2mm white nylon pack of 100 £3.00 ref 3P104. Bumper pack of 1,000 ties £14.00.

WHISPER 2000 LISTENING AID. Enables you to hear sounds that would otherwise be inaudible! Complete with headphones. Cased. £5.00 ref 5P179.

CAR STEREO AND FM RADIO. Low cost stereo system giving 5 watts per channel. Signal to noise ratio better than 45db, wow and flutter less than 35%. Neg earth. £25.00 ref 25P21.

LOW COST WALKIE TALKIES. Pair of battery operated units with a range of about 150'. Our price £8.00 a pair ref 8P50.

7 CHANNEL GRAPHIC EQUALIZER plus a 60 watt power amp! 20-21KHZ 4-8R 12-14v DC negative earth. Cased. £25 ref 25P14.

NICAD BATTERIES. Brand new top quality. 4 x AA's £4.00 ref 4P44. 2 x C's £4.00 ref 4P73, 4 x D's £9.00 ref 9P12, 1 x PP3 £6.00 ref 6P35.

TOWERS INTERNATIONAL TRANSISTOR SELECTOR GUIDE. The ultimate equivalents book. Latest edition £20.00 ref 20P32.

CABLE TIES. 142mm x 3.2mm white nylon pack of 100 £3.00 ref 3P104. Bumper pack of 1,000 ties £14.00.

WHISPER 2000 LISTENING AID. Enables you to hear sounds that would otherwise be inaudible! Complete with headphones. Cased. £5.00 ref 5P179.

CAR STEREO AND FM RADIO. Low cost stereo system giving 5 watts per channel. Signal to noise ratio better than 45db, wow and flutter less than 35%. Neg earth. £25.00 ref 25P21.

LOW COST WALKIE TALKIES. Pair of battery operated units with a range of about 150'. Our price £8.00 a pair ref 8P50.

7 CHANNEL GRAPHIC EQUALIZER plus a 60 watt power amp! 20-21KHZ 4-8R 12-14v DC negative earth. Cased. £25 ref 25P14.

NICAD BATTERIES. Brand new top quality. 4 x AA's £4.00 ref 4P44. 2 x C's £4.00 ref 4P73, 4 x D's £9.00 ref 9P12, 1 x PP3 £6.00 ref 6P35.

TOWERS INTERNATIONAL TRANSISTOR SELECTOR GUIDE. The ultimate equivalents book. Latest edition £20.00 ref 20P32.

CABLE TIES. 142mm x 3.2mm white nylon pack of 100 £3.00 ref 3P104. Bumper pack of 1,000 ties £14.00.

WHISPER 2000 LISTENING AID. Enables you to hear sounds that would otherwise be inaudible! Complete with headphones. Cased. £5.00 ref 5P179.

CAR STEREO AND FM RADIO. Low cost stereo system giving 5 watts per channel. Signal to noise ratio better than 45db, wow and flutter less than 35%. Neg earth. £25.00 ref 25P21.

LOW COST WALKIE TALKIES. Pair of battery operated units with a range of about 150'. Our price £8.00 a pair ref 8P50.

7 CHANNEL GRAPHIC EQUALIZER plus a 60 watt power amp! 20-21KHZ 4-8R 12-14v DC negative earth. Cased. £25 ref 25P14.

NICAD BATTERIES. Brand new top quality. 4 x AA's £4.00 ref 4P44. 2 x C's £4.00 ref 4P73, 4 x D's £9.00 ref 9P12, 1 x PP3 £6.00 ref 6P35.

TOWERS INTERNATIONAL TRANSISTOR SELECTOR GUIDE. The ultimate equivalents book. Latest edition £20.00 ref 20P32.

CABLE TIES. 142mm x 3.2mm white nylon pack of 100 £3.00 ref 3P104. Bumper pack of 1,000 ties £14.00.

WHISPER 2000 LISTENING AID. Enables you to hear sounds that would otherwise be inaudible! Complete with headphones. Cased. £5.00 ref 5P179.

CAR STEREO AND FM RADIO. Low cost stereo system giving 5 watts per channel. Signal to noise ratio better than 45db, wow and flutter less than 35%. Neg earth. £25.00 ref 25P21.

LOW COST WALKIE TALKIES. Pair of battery operated units with a range of about 150'. Our price £8.00 a pair ref 8P50.

7 CHANNEL GRAPHIC EQUALIZER plus a 60 watt power amp! 20-21KHZ 4-8R 12-14v DC negative earth. Cased. £25 ref 25P14.

NICAD BATTERIES. Brand new top quality. 4 x AA's £4.00 ref 4P44. 2 x C's £4.00 ref 4P73, 4 x D's £9.00 ref 9P12, 1 x PP3 £6.00 ref 6P35.

TOWERS INTERNATIONAL TRANSISTOR SELECTOR GUIDE. The ultimate equivalents book. Latest edition £20.00 ref 20P32.

CABLE TIES. 142mm x 3.2mm white nylon pack of 100 £3.00 ref 3P104. Bumper pack of 1,000 ties £14.00.

WHISPER 2000 LISTENING AID. Enables you to hear sounds that would otherwise be inaudible! Complete with headphones. Cased. £5.00 ref 5P179.

CAR STEREO AND FM RADIO. Low cost stereo system giving 5 watts per channel. Signal to noise ratio better than 45db, wow and flutter less than 35%. Neg earth. £25.00 ref 25P21.

LOW COST WALKIE TALKIES. Pair of battery operated units with a range of about 150'. Our price £8.00 a pair ref 8P50.

7 CHANNEL GRAPHIC EQUALIZER plus a 60 watt power amp! 20-21KHZ 4-8R 12-14v DC negative earth. Cased. £25 ref 25P14.

NICAD BATTERIES. Brand new top quality. 4 x AA's £4.00 ref 4P44. 2 x C's £4.00 ref 4P73, 4 x D's £9.00 ref 9P12, 1 x PP3 £6.00 ref 6P35.

TOWERS INTERNATIONAL TRANSISTOR SELECTOR GUIDE. The ultimate equivalents book. Latest edition £20.00 ref 20P32.

CABLE TIES. 142mm x 3.2mm white nylon pack of 100 £3.00 ref 3P104. Bumper pack of 1,000 ties £14.00.

WHISPER 2000 LISTENING AID. Enables you to hear sounds that would otherwise be inaudible! Complete with headphones. Cased. £5.00 ref 5P179.

CAR STEREO AND FM RADIO. Low cost stereo system giving 5 watts per channel. Signal to noise ratio better than 45db, wow and flutter less than 35%. Neg earth. £25.00 ref 25P21.

LOW COST WALKIE TALKIES. Pair of battery operated units with a range of about 150'. Our price £8.00 a pair ref 8P50.

7 CHANNEL GRAPHIC EQUALIZER plus a 60 watt power amp! 20-21KHZ 4-8R 12-14v DC negative earth. Cased. £25 ref 25P14.

NICAD BATTERIES. Brand new top quality. 4 x AA's £4.00 ref 4P44. 2 x C's £4.00 ref 4P73, 4 x D's £9.00 ref 9P12, 1 x PP3 £6.00 ref 6P35.

TOWERS INTERNATIONAL TRANSISTOR SELECTOR GUIDE. The ultimate equivalents book. Latest edition £20.00 ref 20P32.

CABLE TIES. 142mm x 3.2mm white nylon pack of 100 £3.00 ref 3P104. Bumper pack of 1,000 ties £14.00.

WHISPER 2000 LISTENING AID. Enables you to hear sounds that would otherwise be inaudible! Complete with headphones. Cased. £5.00 ref 5P179.

CAR STEREO AND FM RADIO. Low cost stereo system giving 5 watts per channel. Signal to noise ratio better than 45db, wow and flutter less than 35%. Neg earth. £25.00 ref 25P21.

LOW COST WALKIE TALKIES. Pair of battery operated units with a range of about 150'. Our price £8.00 a pair ref 8P50.

7 CHANNEL GRAPHIC EQUALIZER plus a 60 watt power amp! 20-21KHZ 4-8R 12-14v DC negative earth. Cased. £25 ref 25P14.

SOLAR POWERED NICAD CHARGER. Charges 4 AA nicads in 8 hours. Brand new and cased £6.00 ref 6P3.

MOSFETS FOR POWER AMPLIFIERS ETC. 100 watt mosfet pair 2SJ99 and 2SK343 £4.00 a pair with pin out into ref 4P51. Also available is a 2SK413 and a 2SJ118 at £4.00 ref 4P42.

10 MEMORY PUSH BUTTON TELEPHONES. These are 'customer returns' so they may need slight attention. BT approved. £6.00 each ref 6P16 or 2 for £10.00 ref 10P77.

12 VOLT BRUSHLESS FAN. 1/2" square brand new ideal for boat, car, caravan etc. £5.00 ref 5P206.

ACORN DATA RECORDER ALF503. Made for BBC computer but suitable for others. Includes mains adapter, leads and book. £15.00 ref 15P43.

VIDEO TAPES. Three hour superior quality tapes made under licence from the famous JVC company. Pack of 10 tapes £20.00 ref 20P20.

ELECTRONIC SPACESHIP. Sound and impact controlled, responds to claps and shouts and reverses when it hits anything. Kit with complete assembly instructions £10.00 ref 10P81.

PHILIPS LASER 2MW HELIUM NEON LASER TUBE. BRAND NEW FULL SPEC £40.00 REF 40P10. MAINS POWER SUPPLY KIT £20.00 REF 20P33 READY BUILT AND TESTED LASER IN ONE CASE £75.00 REF 75P4.

SOLDER 22SWG. resin cored solder on a 1/2kg reel. Top quality. £4.00 a reel ref 4P70.

600 WATT HEATERS. Ideal for air or liquid, will not corrode, lasts for years. coil type construction 3"x2" mounted on a 4" dia metal plate for easy fixing. £3.00 ea ref 3P78 or 4 for £10.00 ref 10P76.

TIME AND TEMPERATURE MODULE A. clock, digital thermometer (Celsius and Fahrenheit (0-160 deg F) programmable too hot and too cold alarms. Runs for at least a year on one AA battery. £9.00 ref 9P5.

Remote temperature probe for above unit £3.00 ref 3P60.

GEARBOX KITS. Ideal for models etc. Contains 18 gears (2 of each size) 4x50mm axles and a powerful 9-12v motor. All the gears etc are push fit. £3.00 for complete kit 3P93.

ELECTRONIC TICKET MACHINES. These units contain a magnetic card reader, two matrix printers, motors, sensors and loads of electronic components etc. (12"x12"x7") Good value at £12.00 ref 12P28.

JOYSTICKS. Brand new with 2 fire buttons and suction feet these units can be modified for most computers by changing the connector etc. Price is 2 for £5.00 ref 5P174.

GAS POWERED SOLDERING IRON AND BLOW TORCH. Top quality tool with interchangeable heads and metal body. Fully adjustable, runs on lighter gas. £10.00 ref 10P130.

SMOKE ALARMS. Ionization type 5 year warranty complete with battery only £5.00 ref 5P206.

ANSWER MACHINES. BT approved remote message playback, integral push button phone, power supply and tape. Exceptional value at £45.00 ref 45P2.

CAR IONIZER KIT. Improve the air in your car! clears smoke and helps to reduce fatigue. Case required. £12.00 ref 12P8.

6V 10AH LEAD ACID. sealed battery by yuasa ex equipment but in excellent condition now only 2 for £10.00 ref 10P95.

12 TO 220V INVERTER KITs. supplied it will handle up to about 15 w at 220v but with a larger transformer it will handle 80 watts. Basic kit £12.00 ref 12P17. Larger transformer £12.00 ref 12P41.

VERO EASI WIRE PROTOTYPING SYSTEM. Ideal for designing projects on etc. Complete with tools, wire and reusable board. Our price £6.00 ref 6P33.

MICROWAVE TURNABLE MOTORS. Ideal for window displays etc. £5.00 ref 5P165.

STC SWITCHED MODE POWER SUPPLY. 220v or 110v input giving 5v at 2A, +24v at 0.25A, +12v at 0.15A and +90v at 0.4A £6.00 ref 6P59.

TELEPHONE AUTODIALLERS. These units, when triggered will automatically dial any telephone number. Originally made for alarm panels. BT approved. £12.00 ref 12P23 (please state telephone no req'd).

25 WATT STEREO AMPLIFIER. STK043. With the addition of a handful of components you can build a 25 watt amplifier. £4.00 ref 4P69 (Circuit dia included).

LINEAR POWER SUPPLY. Brand new 220v input +5 at 3A, +12 at 1A, -12 at 1A. Short circuit protected. £12.00 ref 12P21.

MAINS FANS. Snail type construction. Approx 4"x5" mounted on a metal plate for easy fixing. New £5.00 5P166.

POWERFUL IONIZER KIT. Generates 10 times more ions than commercial units! Complete kit including case £18.00 ref 18P2.

MINI RADIO MODULE. Only 2" square with ferrite aerial and tuner. Superhet. Req's PP3 battery. £1.00 ref 8D716.

HIGH RESOLUTION MONITOR. 9" black and white Philips tube in chassis made for OPD computer but may be suitable for others. £20.00 ref 20P26.

BARGAIN NICADS AAA SIZE 200MAH 1.2V PACK OF 10. £4.00 REF 4P92, PACK OF 100 £30.00 REF 30P16

CB CONVERTORS. Converts a car radio into an AM CB receiver. Cased with circuit diagram. £4.00 ref 4P48.

FLOPPY DISCS. Pack of 15 3 1/2" DSDD £10.00 ref 10P88. Pack of 10 5 1/4" DSDD £5.00 ref 5P168.

SONIC CONTROLLED MOTOR. One click to start, two click to reverse direction, 3 click to stop! £3.00 each ref 3P137.

FRESNEL MAGNIFYING LENS. 83 x 52mm £1.00 ref 8D827.

BARGAIN NICADS AAA SIZE 200MAH 1.2V PACK OF 10. £4.00 REF 4P92, PACK OF 100 £30.00 REF 30P16

CB CONVERTORS. Converts a car radio into an AM CB receiver. Cased with circuit diagram. £4.00 ref 4P48.

FLOPPY DISCS. Pack of 15 3 1/2" DSDD £10.00 ref 10P88. Pack of 10 5 1/4" DSDD £5.00 ref 5P168.

SONIC CONTROLLED MOTOR. One click to start, two click to reverse direction, 3 click to stop! £3.00 each ref 3P137.

FRESNEL MAGNIFYING LENS. 83 x 52mm £1.00 ref 8D827.

BARGAIN NICADS AAA SIZE 200MAH 1.2V PACK OF 10. £4.00 REF 4P92, PACK OF 100 £30.00 REF 30P16

CB CONVERTORS. Converts a car radio into an AM CB receiver. Cased with circuit diagram. £4.00 ref 4P48.

FLOPPY DISCS. Pack of 15 3 1/2" DSDD £10.00 ref 10P88. Pack of 10 5 1/4" DSDD £5.00 ref 5P168.

SONIC CONTROLLED MOTOR. One click to start, two click to reverse direction, 3 click to stop! £3.00 each ref 3P137.

FRESNEL MAGNIFYING LENS. 83 x 52mm £1.00 ref 8D827.

BARGAIN NICADS AAA SIZE 200MAH 1.2V PACK OF 10. £4.00 REF 4P92, PACK OF 100 £30.00 REF 30P16

CB CONVERTORS. Converts a car radio into an AM CB receiver. Cased with circuit diagram. £4.00 ref 4P48.

FLOPPY DISCS. Pack of 15 3 1/2" DSDD £10.00 ref 10P88. Pack of 10 5 1/4" DSDD £5.00 ref 5P168.

SONIC CONTROLLED MOTOR. One click to start, two click to reverse direction, 3 click to stop! £3.00 each ref 3P137.

FRESNEL MAGNIFYING LENS. 83 x 52mm £1.00 ref 8D827.

BARGAIN NICADS AAA SIZE 200MAH 1.2V PACK OF 10. £4.00 REF 4P92, PACK OF 100 £30.00 REF 30P16

CB CONVERTORS. Converts a car radio into an AM CB receiver. Cased with circuit diagram. £4.00 ref 4P48.

FLOPPY DISCS. Pack of 15 3 1/2" DSDD £10.00 ref 10P88. Pack of 10 5 1/4" DSDD £5.00 ref 5P168.

SONIC CONTROLLED MOTOR. One click to start, two click to reverse direction, 3 click to stop! £3.00 each ref 3P137.

FRESNEL MAGNIFYING LENS. 83 x 52mm £1.00 ref 8D827.

BARGAIN NICADS AAA SIZE 200MAH 1.2V PACK OF 10. £4.00 REF 4P92, PACK OF 100 £30.00 REF 30P16

CB CONVERTORS. Converts a car radio into an AM CB receiver. Cased with circuit diagram. £4.00 ref 4P48.

FLOPPY DISCS. Pack of 15 3 1/2" DSDD £10.00 ref 10P88. Pack of 10 5 1/4" DSDD £5.00 ref 5P168.

SONIC CONTROLLED MOTOR. One click to start, two click to reverse direction, 3 click to stop! £3.00 each ref 3P137.

FRESNEL MAGNIFYING LENS. 83 x 52mm £1.00 ref 8D827.

BARGAIN NICADS AAA SIZE 200MAH 1.2V PACK OF 10. £4.00 REF 4P92, PACK OF 100 £30.00 REF 30P16

CB CONVERTORS. Converts a car radio into an AM CB receiver. Cased with circuit diagram. £4.00 ref 4P48.

FLOPPY DISCS. Pack of 15 3 1/2" DSDD £10.00 ref 10P88. Pack of 10 5 1/4" DSDD £5.00 ref 5P168.

SONIC CONTROLLED MOTOR. One click to start, two click to reverse direction, 3 click to stop! £3.00 each ref 3P137.

FRESNEL MAGNIFYING LENS. 83 x 52mm £1.00 ref 8D827.

BARGAIN NICADS AAA SIZE 200MAH 1.2V PACK OF 10. £4.00 REF 4P92, PACK OF 100 £30.00 REF 30P16

CB CONVERTORS. Converts a car radio into an AM CB receiver. Cased with circuit diagram. £4.00 ref 4P48.

FLOPPY DISCS. Pack of 15 3 1/2" DSDD £10.00 ref 10P88. Pack of 10 5 1/4" DSDD £5.00 ref 5P168.

SONIC CONTROLLED MOTOR. One click to start, two click to reverse direction, 3 click to stop! £3.00 each ref 3P137.

FRESNEL MAGNIFYING LENS. 83 x 52mm £1.00 ref 8D827.

BARGAIN NICADS AAA SIZE 200MAH 1.2V PACK OF 10. £4.00 REF 4P92, PACK OF 100 £30.00 REF 30P16

CB CONVERTORS. Converts a car radio into an AM CB receiver. Cased with circuit diagram. £4.00 ref 4P48.

FLOPPY DISCS. Pack of 15 3 1/2" DSDD £10.00 ref 10P88.

Four Track Recorder Update

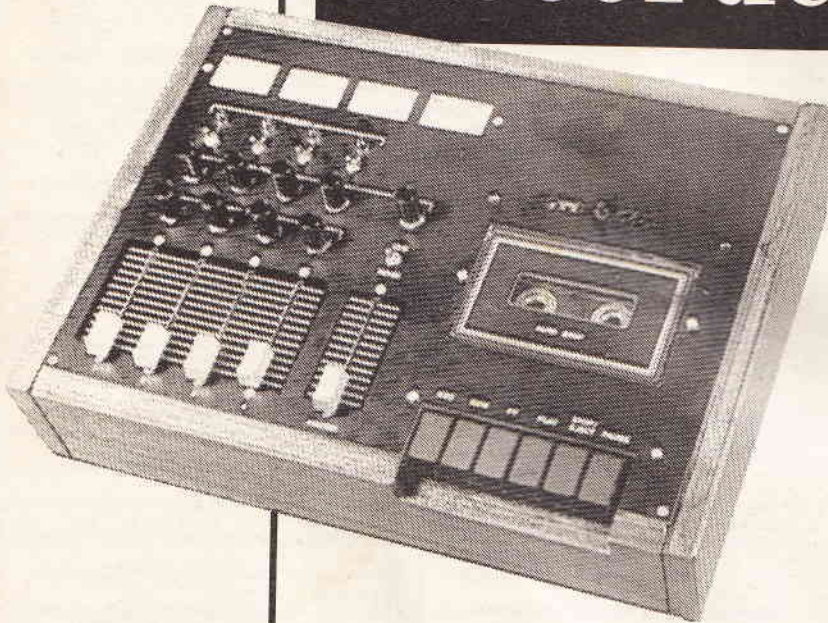

Tom Scarff provides some modifications to the Bias/Erase oscillator.

In the original design of the four-track cassette recorder (ETI Nov'90) the Bias/Erase Oscillator specified was the Toko 724 BOR 1078N, however it appears this unit is no longer available from any source.

Unfortunately Toko do not manufacture a physically similar unit, so a replacement will involve some modification to the original PCB design.

One design that could be used is shown in Figure 1 which utilises the erase heads as part of the feedback network of a Clapp Oscillator. The wiring modifications require that the earth returns from the erase heads and the erase dummy loads are connected back

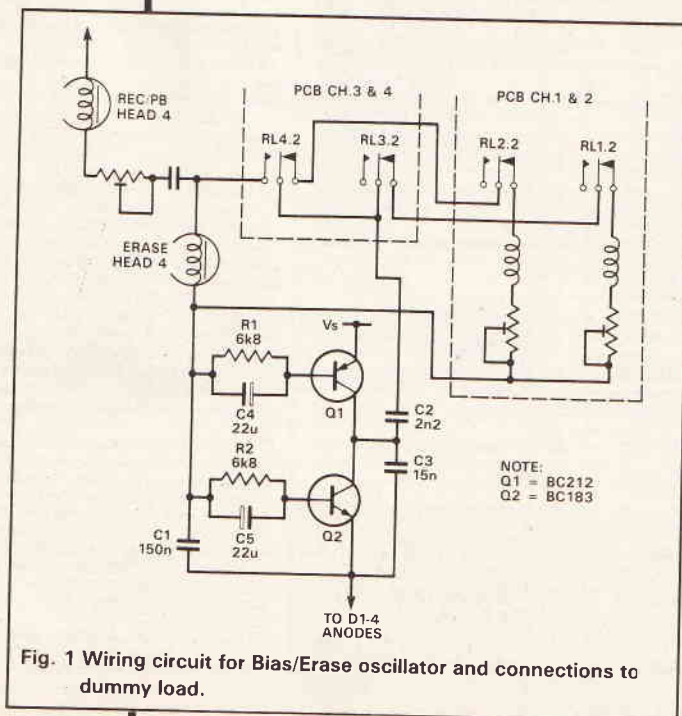

Fig. 1 Wiring circuit for Bias/Erase oscillator and connections to dummy load.

to the oscillator. This means the variable resistor of the erase dummy load should not be connected to the ground line on the PCB.

With the components specified the circuit operates at the original Bias/Erase frequency, however it should be noted that it depends on the four-track erase head being used.

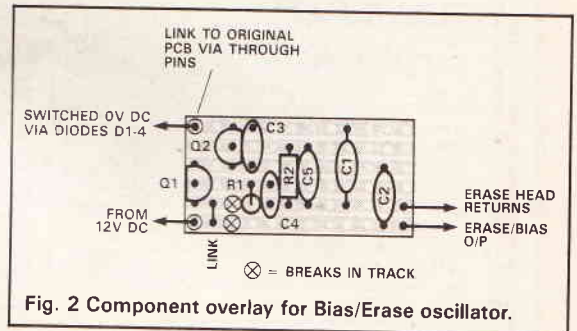

Fig. 2 Component overlay for Bias/Erase oscillator.

If necessary the component values can be changed to suit other heads. The capacitor C2 can be varied to change the frequency and the output

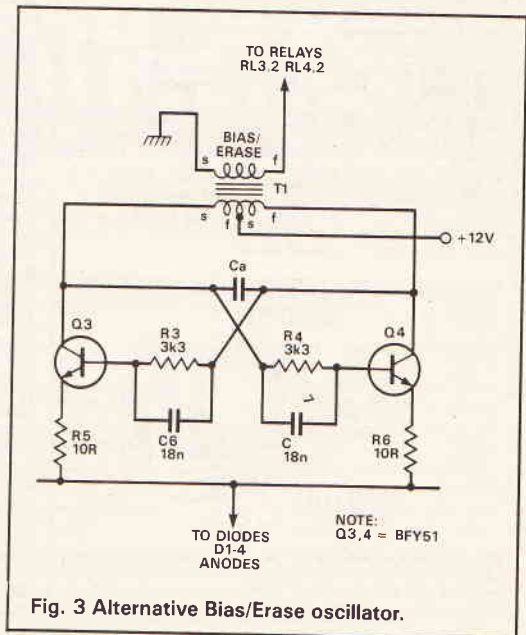

Fig. 3 Alternative Bias/Erase oscillator.

voltage can be increased by increasing the value of C3 and reducing the value of R1 and R2. However experimentation may be required as some variations of components will cause oscillation to cease.

If the required output voltage cannot be obtained the loading on the oscillator can be reduced by including bias traps, a parallel tuned L-C network, in series with the output amplifiers.

The components for the oscillator can be mounted on a piece of 0.1" matrix Veroboard as shown in Figure 2 with two Vero through-pins providing the connections and mounting to the original PCB.

While the above circuit is suitable for the minimum number of changes to the original circuit it is very component dependable and a better overall

solution may be to use a separate current-switching oscillator as shown in Figure 3, but this will require the winding of a suitable transformer.

PARTS LIST

RESISTORS (all 1/4W 5%)		Ca	sets frequency 0.1 μ approx
R1,2	6k8	SEMICONDUCTORS	
R3,4	3k3	Q1	BC212
R5,6	10R	Q2	BC183
CAPACITORS		Q3,4	BFY 51
C1	150n	MISCELLANEOUS	
C2	2n2	T1	Primary, 5+5 turns 26SWG
C3	15n		Enamel wire, Secondary, 100 turns 34SWG
C4,5	22 μ		Pot core 26mm Type LA2332 or equivalent
C6,7	18n		

PUT YOUR AGENT ON THE TRAIL

You need the facts, just the facts mam. You need a steady source to feed you information. Don't settle for a second-rate squealer. You need ETI and you need it good. Put your newsagent on the trail — clip the coupon and hand it to your neighbourhood shop.

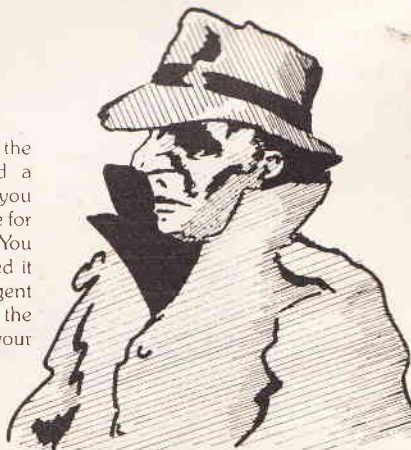

Dear Mr Newsagent
Please order me a copy of ETI
and reserve/deliver me a copy
every month.



Note this magazine is available to your wholesaler through:
SM Distribution, 6 Leigham Court Road, Streatham, London
SW16 2PG. Tel: 01-677 8111.

Name _____

Address _____

HAM RADIO TODAY

HAM RADIO TODAY caters for both the experienced user and newcomer to amateur radio. With generally informative features, the latest news and practical projects this magazine covers all aspects of this growing field; an invaluable complement for any licenced radio amateur worldwide.

Cover Price £1.60

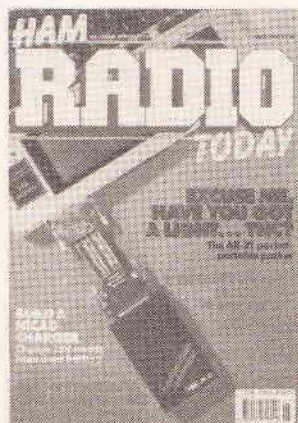

Published: 1st Friday of each month

**Order
your copy
NOW!**

Why not subscribe?
Telephone **0442 66551**
Ext 357
for further information



ARGUS BOOKS PUBLISHING FOR THE SPECIALIST

THE FULL RANGE OF ARGUS BOOKS

are available from
all good book
and hobby
shops or con-
tact Argus
Books direct
for a 1991
catalogue.

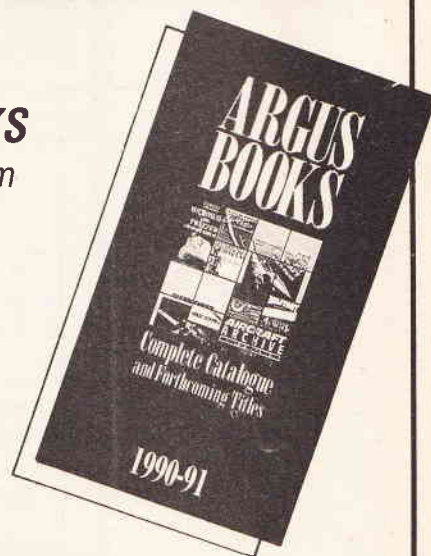

CATALOGUE OFFER, Argus Books,
Argus House, Boundary Way,
Hemel Hempstead, Herts.

OR PHONE 0442 66551 EXT. 204

Amateur Microwave Equipment

Geoffrey Heys G4GEB reports on some amateur equipment used at SHF

In this article we will have a look at some items of equipment designed and built by the radio amateur and examine some theoretical aspects concerning this equipment.

Radio Amateurs are allowed to operate on a range of microwave frequencies shown in Table 1.

**Table 1
AMATEUR MICROWAVE ALLOCATIONS**

Abbreviated frequency allocations in MHz.
1240-1325.
2310-2450.
3400-3475.
5650-5680.
5755-5765.
5820-5850.
10000-10500.
24000-24250.
47000-47200.
75500-76000.
142000-144000.
248000-250000.

Of the frequencies seen here, probably the most popular band is the 10,000MHz or 10GHz band. This corresponds to a wavelength of 3cm and falls within what is known as X-band. The reason for its popularity is because it has been easy to construct free running oscillators working on this frequency, using either klystrons or Gunn effect devices. In recent years there has been increasing use of the lower frequency bands with equipment that converts from , 70cm, using either narrow band FM or SSB.

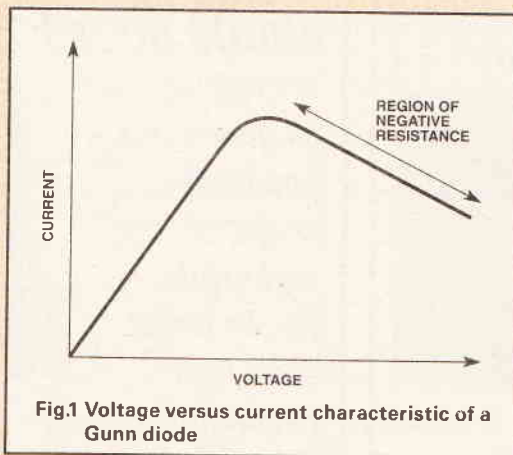

Methods Of Propagating Microwaves

Coaxial cable can be used to propagate microwave frequencies. It has the advantage that the used frequency is almost unlimited, but somewhat lossy. These losses consist of two parts, series losses in the copper conductor and shunt losses in the dielectric. The copper

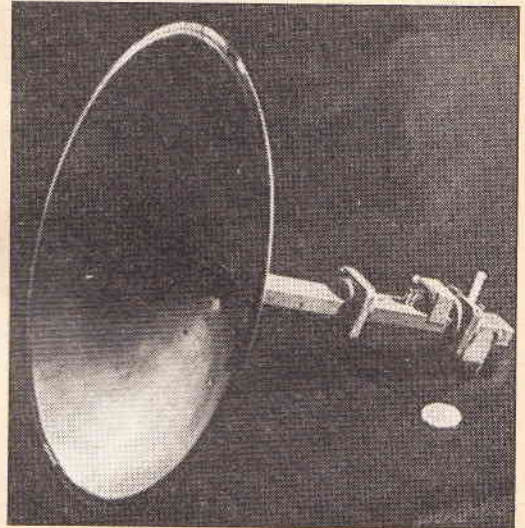

1GHz Transceiver of in-line mixer type

losses depend on the cable size and vary directly with the square root of the frequency, the dielectric losses are independent of cable size and vary directly with the frequency. Dielectric losses become increasingly important in the microwave region. The use of braid as the outer conductor produces severe attenuation at frequencies like 10MHz compared to solid conductors.

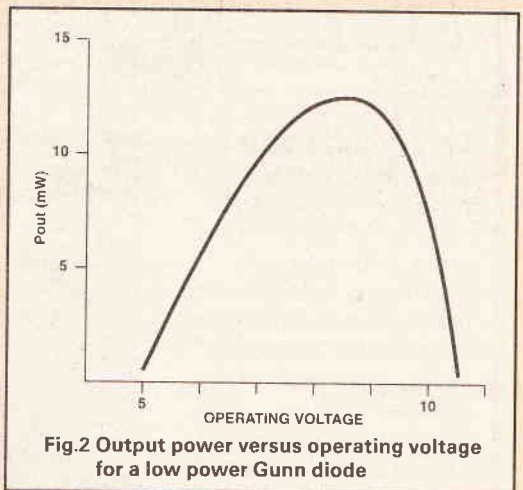

Sometimes 'lossy' coaxial cable is deliberately used as an isolating device, usually in test equipment. Coaxial cable is not used professionally for carrying high radio-frequency power since it suffers from voltage and thermal breakdown.

An alternative to coaxial cable is the use of waveguide. This is a hollow tube of metal through which electromagnetic energy can be transmitted. Waveguide may be circular or rectangular in cross section. The way in which the energy is sent out can be explained by considering how electric and their associated magnetic fields behave when confined by the waveguide. Circular waveguide is rarely used in ama-

SHF

teur equipment so we will deal with rectangular type. It can be shown that electromagnetic radiation can be propagated in a given guide in an infinite number of wave types or modes. In general there are two types of mode, these are 'transverse electric' (TE) waves because their electric fields are transverse to the axis of the guide and 'transverse magnetic' (TM) waves because their magnetic fields are transverse to the guide axis. (Electro-magnetic waves consist of an electric component and a magnetic component, one being perpendicular to the other.)

Each mode has a lower critical frequency below which it will not go down the guide. This is known as the cut-off frequency for that mode. In a given size of waveguide the mode with the lowest cut-off frequency is known as the lowest mode for that guide and will be the only one propagated if the frequency is greater than its cut-off frequency and less than the cut-off frequency for the second lowest mode. So the lowest mode cut-off frequency is comparable to the size of the guide. In general the lowest mode is used in waveguide, this being called the TE_{1,0} mode. The cross sectional dimensions of the guide are selected according to the frequency in use, which in practical terms means that waveguide 16 is used for operation at 10GHz.; another similar waveguide size is known as 'Old English'.

Waveguide has comparatively low transmission loss when compared with coaxial cables. Its disadvantage is that a certain size of guide cannot be used below a critical frequency and it is seldom used above twice this frequency. Another point in favour of waveguide is that components may be built inside and around it, enabling a complete, waveguide based RF system to be assembled. It is also more resistant to breakdown at high power than coaxial cable.

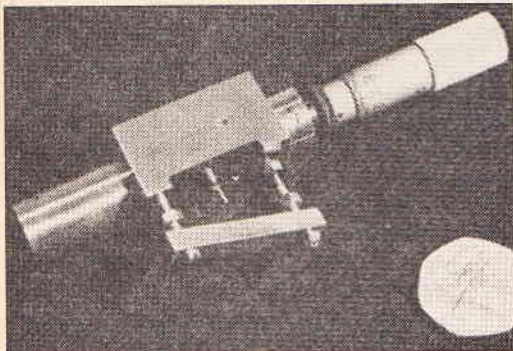

Absorption Wavemeter for X-Band

Waveguide may be straight, bent or twisted to a variety of shapes, it may also take the form of flexible waveguide. It is joined by using flanges and sometimes these flanges have RF chokes machined into them.

Wavemeters

In order to comply with the licencing conditions it is highly desirable to be able to measure the frequency of operation of equipment. (This is particularly so when using free running oscillators compared with crystal controlled equipment). Nowadays it is possible to obtain digital frequency meters that operate up to many Gigahertz. Needless to say, these are expensive. An alternative approach is to use an absorption wavemeter. There are several designs for these which give various Q values, but all operate on a similar principle. They are self calibrating, which means it is not necessary to refer to a frequency standard. The wavemeter shown in the photograph is one of these for operation at 10GHz. It consists of a rod, actually the shaft of a micrometer which is set coaxially in a cavity. The cavity is loosely coupled into waveguide via a small pick-up wire. Power is absorbed from the RF sys-

tem when the rod resonates, which is when the rod is electrically either one quarter or three quarters of a wavelength long. A calibration graph can be prepared relating micrometer setting to frequency. The difference between the readings is half a wavelength, frequency is obtained from:

$$f \text{ (MHz)} = \frac{C}{2(R1-R2)}$$

where R1 and R2 are in millimetres and C = 299,600. for air at 25°C and 30% humidity.

Absorption of power can be conveniently detected by a reduction in the mixer current of the receiver.

Antennas

Antennas for the lower frequency microwave band are commonly multi-element directional arrays, the Yagi

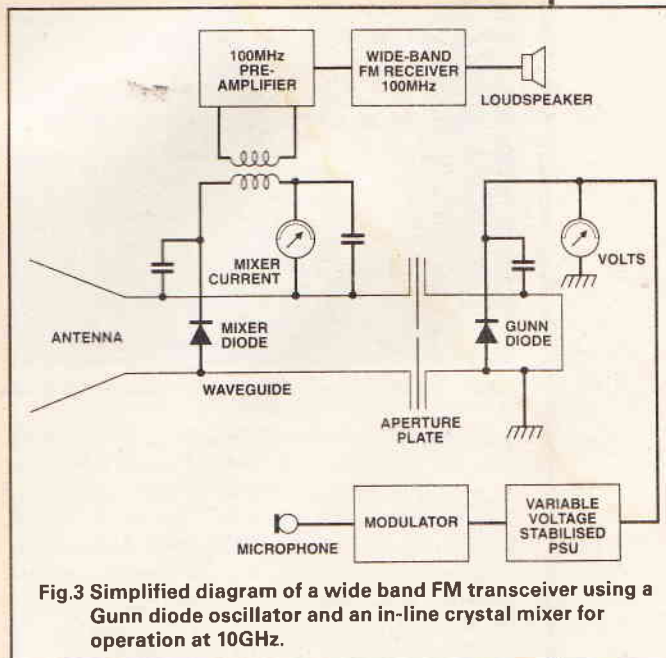

Fig.3 Simplified diagram of a wide band FM transceiver using a Gunn diode oscillator and an in-line crystal mixer for operation at 10GHz.

for example. For the higher frequency Bands other forms such as the parabolic dish and the horn are usually used. The parabolic dish is characterised by having high gain and narrow beamwidth, the larger the dish area the higher the gain and the more narrow the beamwidth, both these qualities are dependent on the frequency used. Dishes are invariably fed using waveguide and there are many ways of doing this.

Horns are interesting, they are easier to make than a parabolic reflector, although it is possible to buy dishes and make the feed arrangement. They can be made to provide a defined gain of say 20dB which is useful in measurement work with equipment. As with the dish, the gain and beamwidth characteristics are frequency dependent. Horns provide a good match for the waveguide used. Also they do not need any adjustment. These characteristics are useful when using free-running, waveguide based oscillators which are often sensitive to mismatch.

Microwave Oscillators

The use of the Gunn effect device or Gunn diode is nowadays a preferred method of generating RF at low power directly in waveguide, these are suitable for use in wide band FM equipment, usually in the 10GHz band. They are gallium arsenide two electrode oscillators which exhibit the intriguing characteristic of negative resistance. This can best be shown by looking at Figure 1.

The diode is placed in parallel with the electric plane in the centre of a waveguide cavity, that is, a

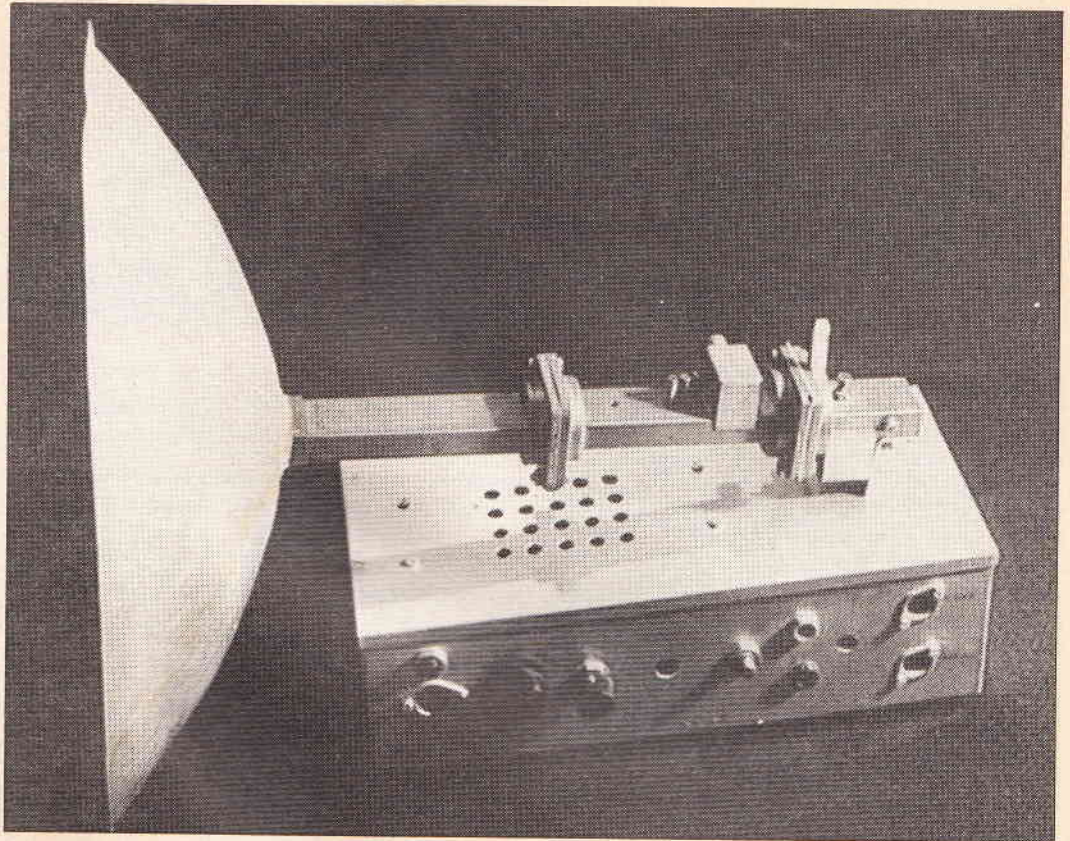

10GHz Transceiver of in-line mixer type showing assorted electronics

small section of waveguide which has an opening at one end only. The diode and the cavity, the dimensions of which are adjustable to achieve tuning, form a resonant circuit generating RF. The cavity may be tuned using an adjustable short at the closed end, or by the insertion of a screw of suitable dielectric material such as PTFE. Approximately 7 volts is applied across the diode. This voltage is usually made variable, the $P_{out}/voltage$ characteristics of the diode are shown in Figure 2. Power out is typically in the region of 5-15mW for the low power types, for example the Philips CXY 11.

These oscillators can be tuned slightly by varying the applied voltage and is a way of modulating the equipment when a Gunn diode is used as a transmitter. Audio modulation is applied to the power supply which produces wide band frequency modulation. Gunn oscillators are normally incorporated as a local oscillator for the receiver mixer. Some designs of transceiver such as the 'in-line mixer' use the same oscillator cavity as transmitter and receiver local oscillator.

Klystron oscillators are valve devices which are also used to generate RF directly in to waveguide. They are also easily modulated to provide wide band FM. Probably the simplest design for a micro-wave transceiver was known as the 'Polarplexer transceiver'. This operated on 10MHz. and used a klystron which simply fed into a metal pipe shorted at one end. Positioned in the pipe was a mixer diode and a tuning screw. With two of these units you could be on the air on 10GHz in no time.

Receiver Mixers

Microwave receivers adopt the superheterodyne principle. Mixing takes place in a crystal diode placed in parallel with the electric field in a waveguide cavity, which receives both signal frequency and signal injection from a local oscillator. A crystal rectifier is very efficient as first mixer at X-band frequencies (10GHz). At low RF power levels crystals, act as square law detectors, which means the rectified crystal current is pro-

portional to the RF power. The crystal current is usually monitored and the level of local oscillator injection set to give a current of about 2mA for optimum performance. Types used for 10GHz are the 1N23 or the coaxial CV2154.

The recovered intermediate frequency is the sum or difference between the signal frequency and the local oscillator frequency and is commonly set to 100MHz for wide band FM operation. This allows a conventional WBFM receiver circuit to be used. In practice almost any frequency could be selected as an intermediate frequency.

The impedance of the crystal is usually matched to the waveguide by means of matching screws set in

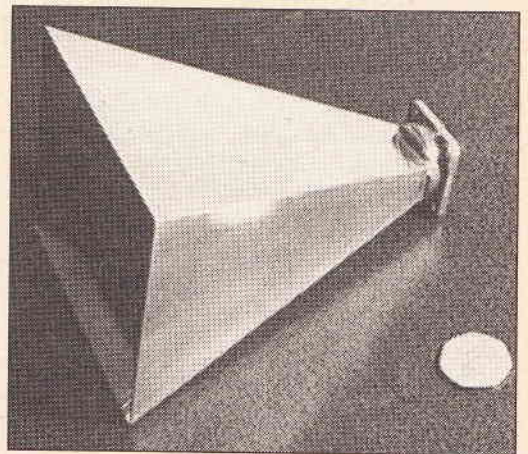

20dB Horn aerial for 10GHz

the middle of the broad face of the waveguide. This is a common method of achieving matching between waveguide components in mixer cavities, oscillators and antennas.

Some Transceiver Principles

An example of a simple transceiver for 10GHz is the 'in-line' crystal mixer design. A simplified diagram for

this type of equipment is given in Figure 3. This is a waveguide design in which a Gunn diode oscillator with an aperture plate at the front of the cavity is fed directly into a section of waveguide containing a crystal mixer. The aperture reduces the RF fed into the crystal mixer to suitable levels for mixing, producing a mixer current of 1-2mA. It also increases the Q of the Gunn oscillator which results in increased stability. In receive operation the crystal mixes the signal from the antenna with the oscillator. If these are separated by 100MHz, this produces an intermediate frequency of 100MHz. This can be fed into a 100MHz. wide band FM receiver.

Since the Gunn oscillator also 'sees' the antenna, the design will work as a transmitter if the voltage supply to the Gunn diode is modulated either from a microphone or a tone generator.

With this design of transceiver the mode of operation is duplex, in other words it is possible to transmit and receive at the same time. An alternative arrangement is to feed the output from a Gunn oscillator into the mixer cavity using a directional coupler which diverts one tenth of the RF power into the mixer and feeds the rest into the antenna for transmit purposes. In this case duplex operation is possible with the use of two antennas, alternatively a waveguide switch has to be used and the operation is simplex. Another method is to use a device known as a circulator. This does what its name implies, its operation is based on the properties of a ferrite material placed in waveguide and it circulates RF in one direction only.

With equipment such as just described it is possible to obtain contacts over distances of 100km or so using a line of sight path.



2.0-2.6GHz Signal source using microstrip PCB circuit board

Planar Transmission Lines

In the professional environment, planar microwave designs are beginning to dominate low power applications for both commercial and military uses. This is because of their performance, ease of fabrication and resulting low cost. Recently there have been amateur developments using a form of planar transmission line known as microstrip. (This is probably a result of the increasing availability on the surplus market of transistors that are able to operate at microwave frequencies. signal sources for 10GHz and the lower frequency microwave bands can be constructed using microstrip provided you have access to the required test equipment.

Let us consider some aspects concerning microstrip. Microstrip is a development of stripline, which is essentially flattened coaxial transmission line. Microstrip is configured with the conductor parallel to a ground plane, the material between them forming a substrate. As there is more electromagnetic field in the air than in the microstrip, there is rather poor isolation between circuits mounted on the same substrate. Adjacent circuits are therefore mounted in channelized compartments with absorber material on some walls. Another technique is to make the channel width small enough to prevent propagation, similar to a cut-off waveguide. The circuitry is photolithographically etched on one side of the substrate and it is easy to mount devices requiring connection between surface conductors. Substrates used include ceramics, sapphire and quartz, semiconductors and the softer, cer-

amic and glass filled Teflon (PTFE).

There are three main contributing factors to loss in microstrip, these are: Resistive losses in the strip, dielectric losses due to heating effects in the substrate and radiation losses due to the antenna action of the microstrip.

The photograph shows the circuit side of an item of microstrip equipment designed by an amateur. It is a signal source for the frequency range 2.0-2.6GHz. and

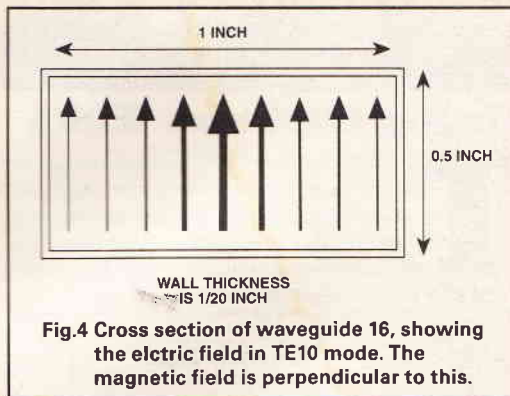

consists essentially of a crystal controlled oscillator followed by a frequency multiplier chain. Provided the component specification is followed exactly the design gives reproducible results. Anyone considering constructing such designs will however, require access to some sophisticated test equipment for alignment purposes.

I wish to thank Sam Jewell, G4DDK, for allowing me to include a photograph of his 2GMz source. I would also like to thank Dr Mike Dixon, G3PFR, for sending me a comprehensive list of suppliers.

List Of Suppliers.

- | | |
|--|--|
| J. BIRKITT.
25, The Strait, Lincoln. LN2 1JF.
Tel. 0522 20767. | Various surplus RF transistors
Gunn diodes, mixer diodes, components.
Send for list. |
| ELECTROMAIL
PO Box 33, Corby, Northants.
NN17 9EL.
Tel. 0536 204555. | Mail order. Catalogue same as RS Components.
General components inc. chip resistors & capacitors. |
| RSGB Microwave Committee Components Service.
Lambda House, Cranborne Road, Potters Bar, Herts. EN6 3JE. | Mixer/multiplier diodes.
GaAsfets. PTFE PCB material.
Selected PCB's & critical components for them.
24GHz modules & waveguide. |
| J Edmondson, G6KKA.
Wigg Farm, Blackshaw Road, Hebden Bridge, W Yorks.
HX7 7JA | Spun dishes to about 36in.
Enquire first. |
| METSPIN Ltd.
94b, New Brighton Road, Emsworth, Hants. PO10 7QS.
Tel. 0243 373712. | Spun dishes to 84in.
Enquire first, ask for Mr Cousins. |
| P G Sergeant G4ONF
6 Gurney Close, Costessey, Norwich, Norfolk. NR5 0NB
Tel: 0603 747782 | Absorption wavemeters for 10 & 24GHz.
Enquire first |
| Microwave Society
c/o Glen Ross, C8MWR
81, Ringwood Highway, Coventry.
Tel. 023 616941. | WG16 flanges. Dishes to 23in.
Gunn diodes, 24GHz. modules.
10GHz. WB TX/RX PCBs
Enquire first. |

SHR

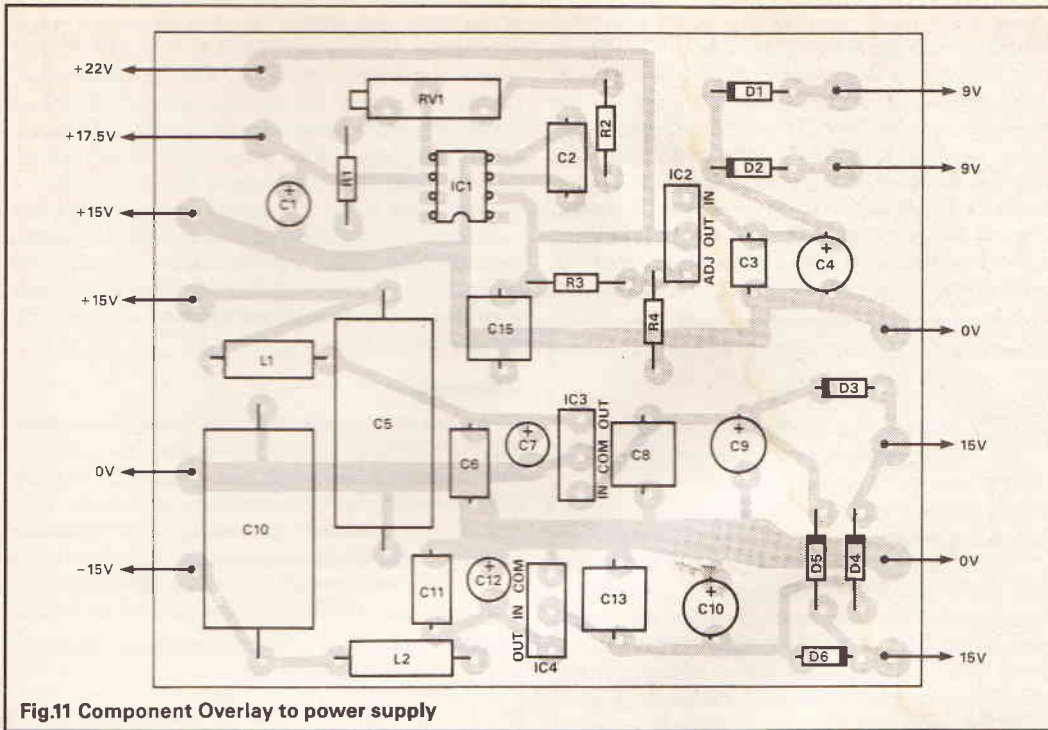

Fig.11 Component Overlay to power supply

channels was adjusted so that the reference temperature was about 0.1° Celcius above the pipe temperature. The hot clamp was heated on a gas stove then transferred to the pipe in the position shown in Figure 13.

When the heated water reaches the first sensor the timing begins (using logic output 0) and when it reaches the second sensor the timing ends. The distance between the sensors-the time taken for the water to flow between the sensors and the bore of the pipe are all known therefore the flow rate can be calculated. Using this method and comparing it with the flow rate determined by measuring the filling of a measuring jar gave the following results.

Flow rates from 3mL per second to 40ml per second within ±45%

By restricting the flow rate to rates above 10ml per second the results all had a negative error therefore in this range the estimation could be improved by adding on say 20% to the measured results. My water head was insufficient to try flow rates above 40ml per second.

The reason why the percentage error starts to go positive at low rates of flow is that the heat starts to be transferred quicker through the copper pipe than through the moving fluid.

It would appear that this method of measurement could be considerably improved by mounting a thin insulated wire element within the tube and perhaps discharging a capacitor through the element to produce the thermal step required in the fluid. The sensors could also be mounted inside the tube with their thin edge facing the flow direction to prevent the flow being unnecessarily disturbed.

Measuring the Capacitance value of Large Electrolytic Capacitors

The external circuit used is shown in Figure 14.

Connect the output of Figure 14 to the signal output of channel 1 with channel 1 probe removed. Adjust R11 to 1° Celcius, this sets the reference voltage to 0.1V.

If the electrolytic capacitor has not been used recently reform it by applying a suitable voltage until the charging current becomes very low and constant.

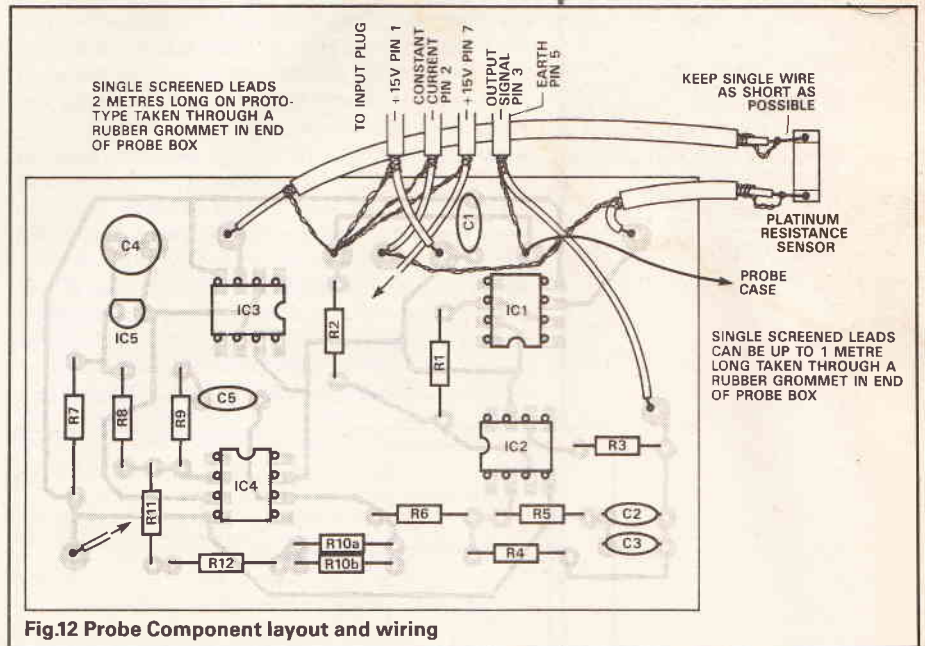

Fig.12 Probe Component layout and wiring

Put the capacitor into the position shown in Figure 14 with the switch SW1 left closed for 1 minute. Open SW1 and record the time taken for the capacitor voltage to rise from 0.1V to 0.2V ie by timing the pulse from Logic Output (A) in Figure 4. Note the average voltage across R during this timing period is 10V. The capacitance value can be read directly in terms of time as indicated below.

	Value of R	Time
10000μ to 1000μ	100k	10s to 1s
1000μ to 100μ	1M	10s to 1s
100μ to 10μ	10M	10s to 1s

Additional Apparatus Measuring The Low Temperature Emission Coefficient

The dimensions of the test apparatus shown in Figure 14 are not critical, the main requirement is that the large aluminium plate must be much larger than the two test plates. Make a small aluminum plate just large enough in width so that it can be drilled to take a

temperature sensor mounted in a TO92 case, and about 2cm in length. Attach the small aluminium plate to the centre of the large aluminium plate on the upper surface with superglue, so that the longer length of the small plate runs parallel to the long side of the large plate. The aluminium plate is coated with matt black paint on its lower surface and any paint that is electrically insulating on its upper surface. A heating element of 28 gauge enameled copper wire is fastened to the upper surface of the plate with the aid of masking tape. Start by sticking the first length of wire

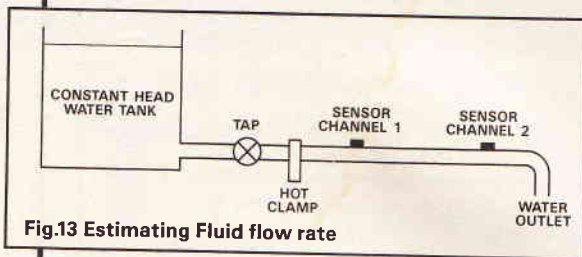

Fig.13 Estimating Fluid flow rate

along the length of the plate about 0.5 cm from the edge. Turn the wire back on itself so that the second length lies parallel to the first length and 0.5cm away from it. Stick this wire down with masking tape and then repeat the procedure until the whole plate is covered. A small strip of wood can be fastened to the inner side of each of the wood ends (Fig 14 to support the aluminum plate. The top of this plate should be 25mm from the top of the wood ends, so that when the sheet of expanded polystyrene is in position the top of this sheet is flush with the top of the wood ends. The cover sheet of hardboard can be screwed with wood-screws to the wood ends to hold everything below in position. At the rear of the apparatus a strip of plywood 130mm wide and long enough to reach from one wood end to the opposite wood end is screwed to the wood ends so that the lower end of the plywood is just above the bottom of the wood ends. A similar strip of plywood 60mm wide is screwed between the two wood ends at the front, but in this case it is mounted so that the top edge of the strip is flush with the top edge of the wood ends. These strips make the whole structure firm

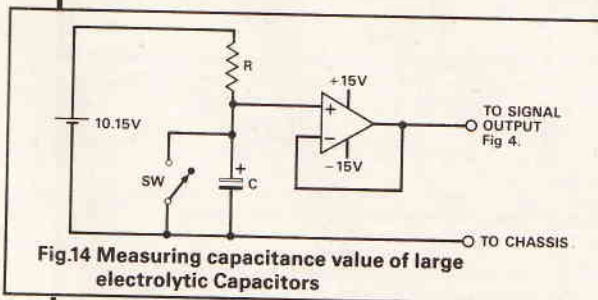

Fig.14 Measuring capacitance value of large electrolytic Capacitors

while leaving gaps so that hot air from the warmed plate can convect upwards. Eventually the apparatus will be pulled over the test plates and because the convected heat can easily escape upwards there is negligible heat transfer by convection from the hot plate to the test plates.

The test plates are copper plates 300mm × 167mm × 1mm. The one plate is coated with lamp black that has a low temperature emission coefficient of 0.95. The other test plate is coated with a surface that is under test.

The Temperature Control Circuit

The control circuit is shown in Figure 12. The LM35DZ temperature sensor has an output of 10mV per degree Celcius. This sensor is mounted in the small block on top of the large aluminium plate shown in Figure 19. IC1 is a 1.2V voltage reference, R2 and R3 form a potential divider that reduces the 1.2V to 480mV.

When the temperature of the aluminum plate approaches 48° Celcius. The output of the LM35DZ sensor approaches 480mV so that the input to IC2 becomes very small hence the temperature stabilises at 48°. This temperature is not critical but I felt it best to always work at the same temperature to ensure consistent results. The temperature is also typical of a working solar panel. The power supply voltage was determined by two heavy duty power supplies already available. The 2N3055 Power transistor is mounted on a plain aluminum sheet 250mm × 90mm which was then long enough to be able to be screwed to one of the wood sides in Figure 19.

Theory

All bodies whose temperature is above zero degrees Kelvin (-273° Celcius) emit electromagnetic radiation. The magnitude bandwidth and wavelength is determined primarily by the temperature of the body. With regard to efficient use of solar energy we are predominantly concerned with radiation from the sun, which is a body at a temperature of about 6000° Kelvin and radiation from collector surfaces warmed by the sun

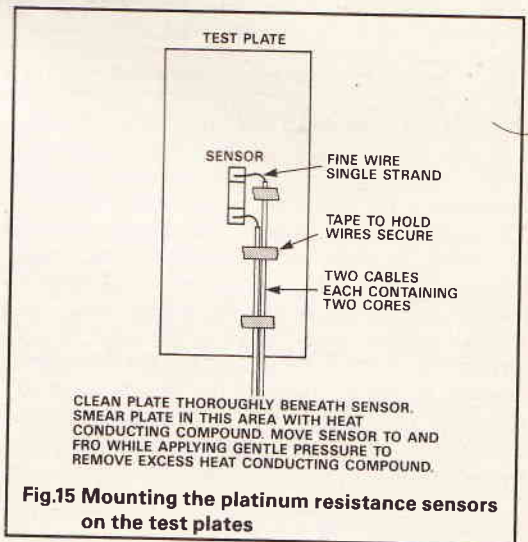

Fig.15 Mounting the platinum resistance sensors on the test plates

which can have temperatures ranging from the ambient temperature to 100°C or more. Most of the radiation from the sun is in the range of 0.3 microns to 3 microns, while the radiation from a collector at 100° Celcius, ranges from about 3-50 microns. Using these values an ideal collector surface would have an absorption coefficient of 1.0 from 0.3 microns to 3 microns and a zero emission coefficient from 3-50 microns. In the real world this is impossible.

Over the same wavelength range the absorption coefficient has the same value as the emission coefficient and in our case it is easier to measure the absorption coefficient. In practice if we can obtain a surface with an absorption coefficient of 0.95 from 0.3-2 microns and then changing to an absorption coefficient of 0.1 when the wavelength is below 4 microns then we shall have a good selective surface. Obviously there are many other factors to consider such as the variation of the surface characteristics with time, temperature and humidity.

The emission coefficient (e) can be defined as:

$$e = \frac{\text{(Power emitted by body under test)}}{\text{(Power emitted by a similar black body)}} \quad \text{Eqn 1}$$

As we will be doing each range of tests at the same temperature we can say that:

$$e = \frac{\text{(Power absorbed by body under test)}}{\text{(Power absorbed by a similar black body)}} \quad \text{Eqn 2}$$

The Power absorbed by a body (in watts) can be expressed as:

$$\text{Mass of body} \times \text{Specific Heat of body} \times 4.2 \times \text{Rate}$$

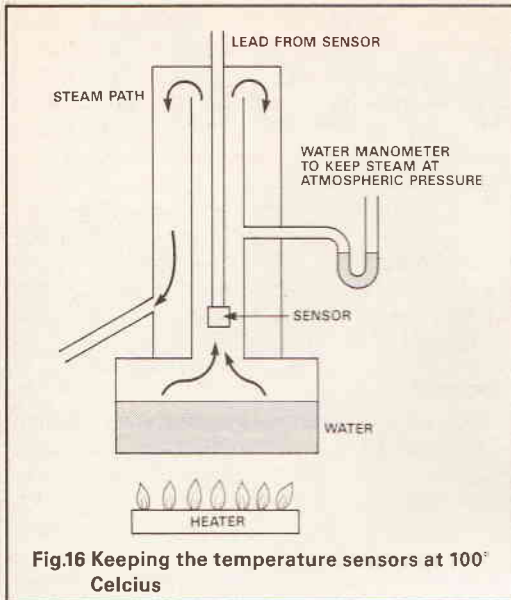

Fig.16 Keeping the temperature sensors at 100° Celcius

through 1° Celcius.

ie rate of rise of temperature=(1 degree)/(Time taken to move through 1 degree)

Substituting this expression into Equation 4:

$$e = \frac{\text{Time taken for black body to move through 1 degree C}}{\text{Time taken for plate under test to move through 1 degree C}} \quad \text{Eqn 5}$$

The theoretical 'black body plate' will move through 1 degree faster than the plate under test because a black body is the best possible absorber of radiation. This implies that the value of 'e' will always be less than unity.

Using equation 5 we can (in the mind) find the emission coefficient of a reference plate. This reference plate is one which other plates can be compared against.

$$e_{REF} = \frac{\text{Time taken for black body to move through 1 degree C}}{\text{Time taken for reference plate to move through 1 degree C}} \quad \text{Eqn 6}$$

If we now use a particular surface for the reference plate whose value of 'e' is known from previously published work, then re-arranging equation 6 we get

$$\text{Time taken for black body plate to move through 1 deg C} = (e_{REF}) \times (\text{Time taken for ref plate to move through 1 deg C})$$

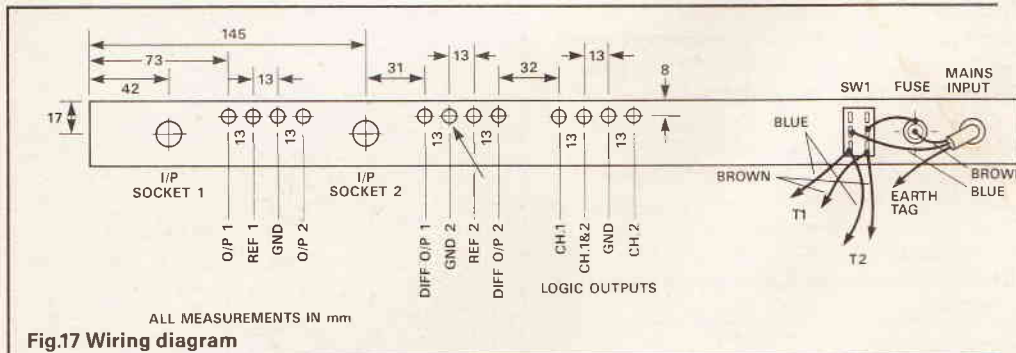

Fig.17 Wiring diagram

of Rise of temperature of body

This means that equation 2 can be written as:

$$e = \frac{\text{Mass of body} \times \text{Specific Heat of body} \times 4.2 \times \text{Rate of rise of temp}}{\text{Mass of black body} \times \text{Specific Heat of black body} \times 4.2 \times \text{Rate of rise of temp}} \quad \text{Eqn 3}$$

In our case the bodies we are considering are copper plates, all of which have the same mass and specific heat, so these quantities will cancel in equation 3 together with the (4.2) which is the conversion from calories to Joules.

Now

$$e = \frac{\text{Rate of rise of temperature of plate under test}}{\text{Rate of rise of temp of black body plate}} \quad \text{Eqn 4}$$

We will be measuring the rate of rise of temperature by measuring the time taken to move

We can use this expression back into equation 5 to give:

$$e = \frac{e_{REF} \times (\text{Time taken for reference plate to move through 1 degree C})}{\text{Time for plate under test to move through 1 degree C}} \quad \text{Eqn 7}$$

In practice we will now use equation 7 as this eliminates the need for a theoretical black body plate. Lampblack which is thicker than 0.003inch can be used as a reference with

$e_{REF}=0.95$ when checking low temperature emission coefficients and

$e_{REF}=0.96$ when checking solar absorption coefficients.

Less fragile surfaces can be used as references by checking them against the lampblack surface.

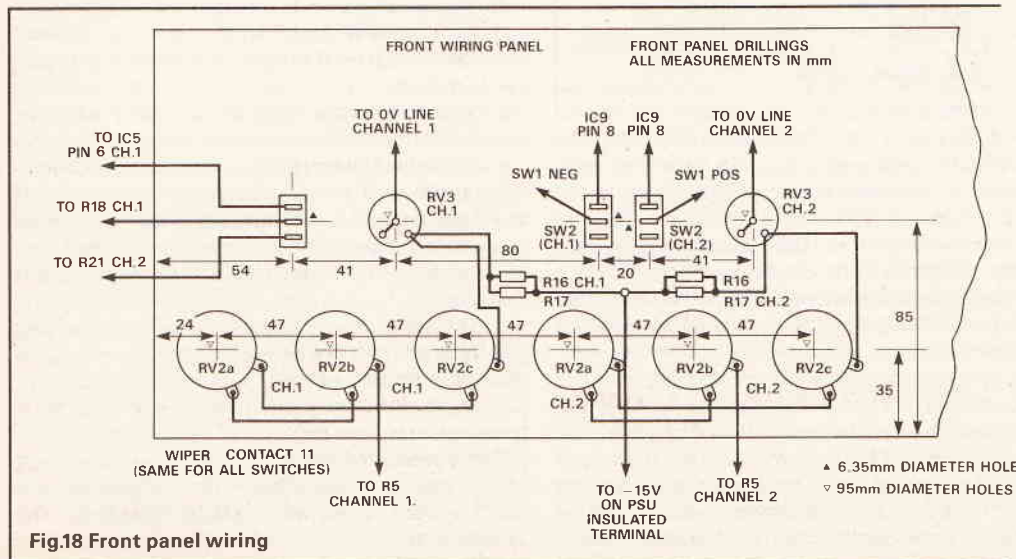

Fig.18 Front panel wiring

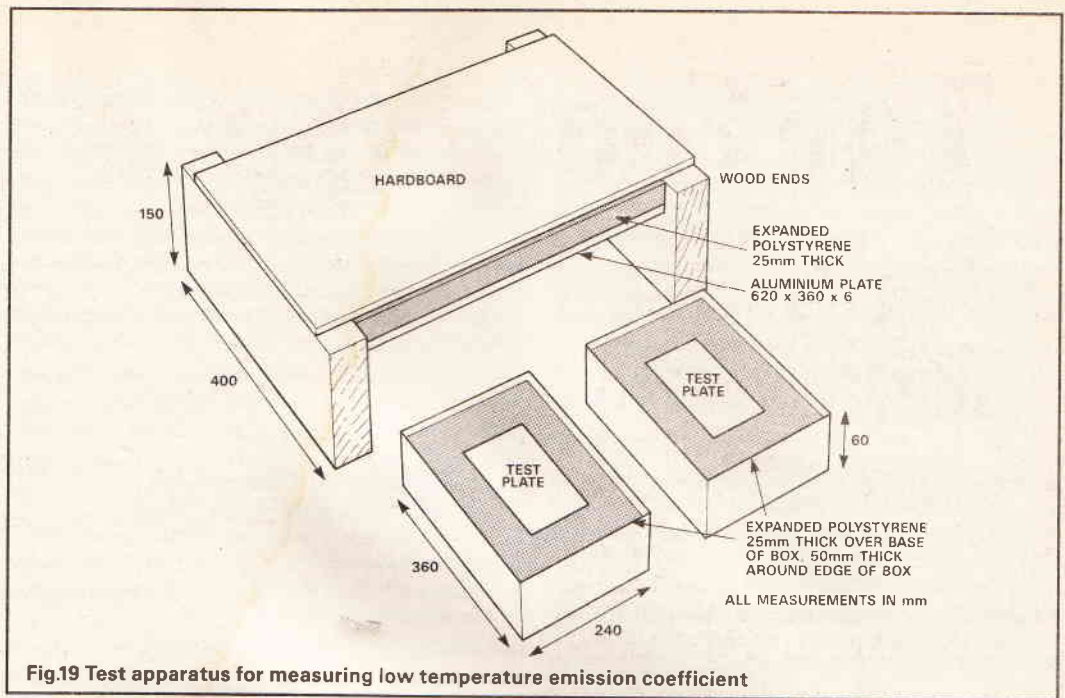

Fig.19 Test apparatus for measuring low temperature emission coefficient

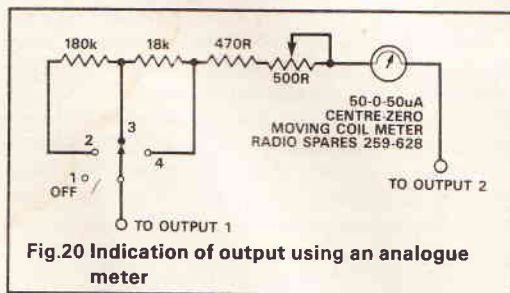

Fig.20 Indication of output using an analogue meter

APPENDIX 1 Keeping the temperature sensors at 0° Celcius

Make some ice cubes by putting purified water into a clean ice cube tray in a freezer. The ice cubes can be

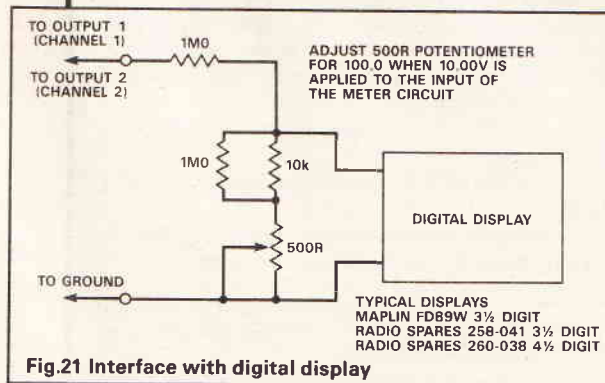

Fig.21 Interface with digital display

then put into a thick plastic bag so that they can be crushed without being contaminated and then pour the crushed ice into a clean thermos flask. The semiconductor sensors need to be put inside a small metal tube that is sealed at its lower end and just sufficient space to take the sensors. I used the top off a fountain pen that was made from one piece of metal and as a result was completely water-proof. You will need some thermal conducting compound in the bottom of the tube to ensure good thermal contact with the tube. Where the wires from the sensor come out of the tube, bind PVC tape around the wires and around the tube so that a waterproof seal is formed to prevent the possibility of water entering the tube. Push the tube into the ice so that the top of the tube is still out of the crushed ice. Where the wires come out of the flask plug the remaining space with a wad of cotton wool to minimise heat flow into the flask.

Record the temperature at intervals of time even though the recorded temperature may well be in error at this stage. From these readings you will note that the temperature will very slowly rise as heat from the surroundings seeps into the flask. When the temperature reaches zero degrees Celcius it will remain constant for a long time as the change of state from ice to water occurs. It is advisable to shake the flask occasionally by gently tapping it on a firm surface to keep the ice and water mixed. Obviously the constant temperature period will depend on how good the thermal insulation of your flask is, but you should be sure of at least a couple of hours to recognise that you are in the stable region and another couple of hours to make any adjustment to the equipment.

The freezing point reduces by 0.0075°C for an increase of atmospheric pressure of 1013 millibars (one atmosphere). The worst case change in atmospheric pressure from the average value is about ±50 millibars. This will give a change in the freezing point of 0.00037° Celcius which means that atmospheric pressure changes can be ignored regarding the zero reference point.

The double-walled vessel in the apparatus shown above reduces any reduction in temperature in the region of the sensor. The air pressure must be monitored by means of a barometer and the following correction made:-

Change in temperature from the 100° Celcius point = $273 \times 10^{-4} (760 - P)$

Where P is the Atmospheric pressure in millimetres of mercury.

If no atmospheric pressure correction is made the worst case error will be a little over 1 degree.

The method of calibration shown above is probably only suitable for the sheathed type of sensor. As my platinum resistance sensors were the unsheathed type (to give the smallest time constant possible) and since setting up the apparatus for the 100° point is rather tedious, I took the easy way out and did the calibration against an accurate resistor as described earlier. Since many of the measurements are comparative this method gives sufficient accuracy for most purposes. *Alternative method* Calibrate the 2 platinum resistance sensors using the resistance method. Replace one of the platinum resistance sensors with a semiconductor sensor. Mount the two sensors on a metal plate. By cooling and heating the plate adjust the semiconductor sensor so that it indicates the same as the Platinum resistance sensor at 0 & 100°.

The Foot-tapper



PROJECT

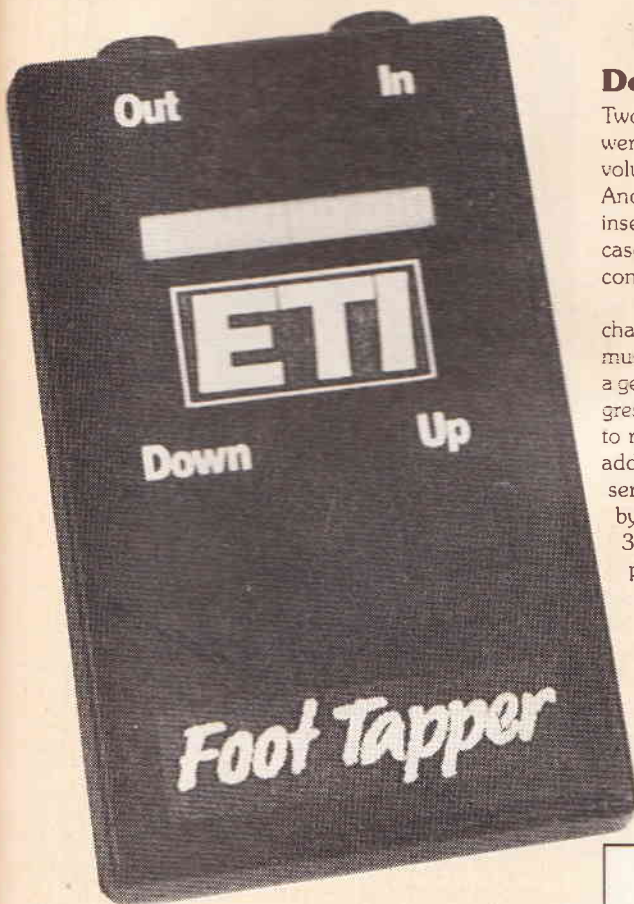

Design Approach

Two basic approaches to the volume control problem were considered. The first possibility is to use a linear volume control IC or FET circuit to set the overall gain. Another method is to select one of a set of resistors and insert it into the feedback loop of an op-amp. In both cases some simple digital circuitry would be required to control the system.

In both cases it is important to remember that the change of gain with each step is not linear. Each step must be 1.5dB. This is represented mathematically by a geometric progression rather than an arithmetic progression. For those too far removed from school maths to remember, an arithmetic progression proceeds by adding a constant number each time resulting say in a series, 3 5 7 9 11. A geometric progression proceeds by multiplying by a constant number each time, eg 3 6 12 24 48. The reason for this need of a geometric progression is associated simply with the way our ears work so we are stuck with it!

For this design it was decided to go with the switched resistors approach since it was felt to be easier to implement and had a better chance of working first time, which it did!

Since the unit must be battery powered all the devices must be low power. All the logic devices were selected from the CMOS 4000 series since they may also operate at 3 to

There are quite a number of effect and control pedals available for the electric guitarist including Chorus, Echo, Distortion and Overdrive to name but a few. One device that seems to be missing from the commercial ranges is a simple volume control pedal. The problem is that a guitar player needs both hands to play his instrument. If he is singing as well he may not even be able to leave the microphone to reach the amplifier.

The level control on the guitar can be used but, depending on the effects in use, more than just the overall volume may be changed. For instance, if there is an overdrive in the chain, the drive level will alter and thus the amount of distortion.

What is required is a foot operated volume control as the last device in the effects chain. A number of 'SWELL' pedals are available but these can require quite a level of expertise to master. They are particularly prone to moving as you lift your foot off the pedal.

The idea for this project is to provide a foot operated unit with one button to raise the volume and one to lower it. When no buttons are being pressed the unit will hold a set level. A display is provided so that the user can see immediately at what level the unit is set.

The unit provides for a boost or cut of 12dB in 1.5dB steps. Each press of a button causes the level to change by one step. There is an auto-repeat feature on the buttons so that if a button is held down the level will continue to step until an end-stop is reached.

The unit is in use by the author and has been found to provide just the 'Hands-Free' operation that is required.

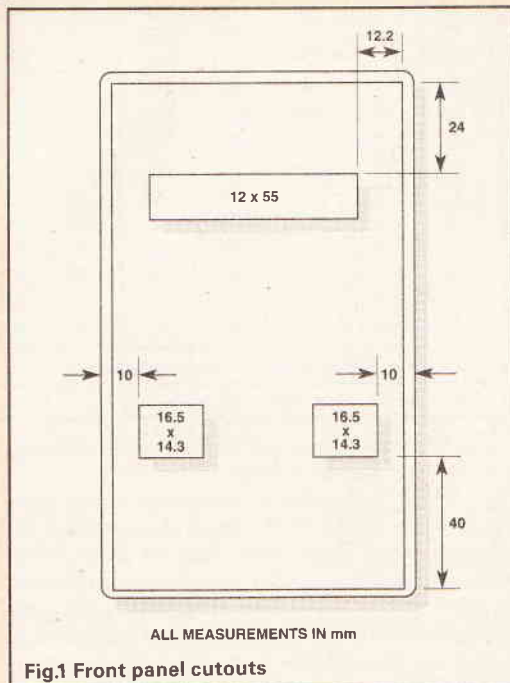

Fig.1 Front panel cutouts

15V. This enables the use of the popular PP3 type battery with no need for a regulator circuit to generate a separate 5V logic supply.

Choice of case is always a difficult decision for this type of project. It is important that the finished product looks tough and professional yet the resources for a specially cast case are obviously not available for a one off. Also special bezels around displays can be difficult to find at a justifiable price. The selected case is a plastic box designed for hand-held use. Actually it is a touch on the light side for a foot operated unit but does

Paul Stephenson presents an electronic footpedal for guitarists.



have the advantage of a battery compartment for the PP3 battery. The solution to the problem of making the display 'pretty' is Lexan.

Lexan is a material used for the little indicator lamps in the dashboard of your car. Small squares of it are printed with little logos for left-turn, ignition etc. and mounted with small bulbs behind them. This project uses a sheet of the material to cover the whole front panel. It is screen printed from behind with the lettering and a little window is left for the display to show through. The whole effect is very professional.

PCB Assembly.

The first job is to assemble the circuit board. If you are not using a PTH (plated through hole) board it will be necessary to install 24 through pins. The board has been designed with the use of such through pins in mind. There is only one connection to a component on the top-side of the board, to R25. If you do have to install through pins, the variety that come on a strip and break off after insertion are a great deal easier to use. You should next insert the terminal pins for the switch and battery connections. Terminal pins are also used for the jack sockets. This is because the PC-mount type of jack socket can be difficult to find, so the board is laid out for the more common solder lug types.

Next, insert the resistors. Here is a chance to learn your resistor colour code if you do not know it already! Some of the resistors come from the E24 series. The E24 series has 24 values in each decade rather than the usual 6 or 12. As a result there are some less famil-

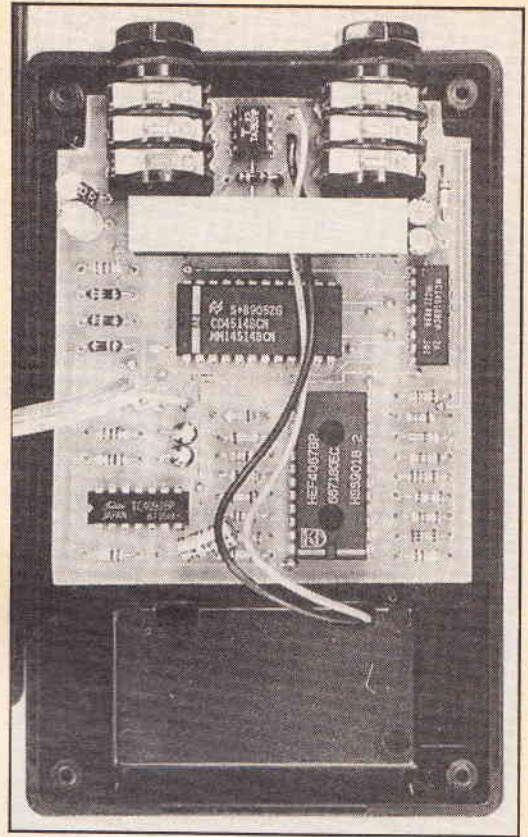

Rx	dB	Gain	Value	E24	dB	Gain	Value	E24	dB	Gain	Value	E24
7	-8	.40	251.2	270k	-16	.16	631.0	620k	-24	.06	1,584.9	1.5M
8	-7	.45	223.9	220k	-14	.20	501.2	510k	-21	.09	1,122.0	1.2M
9	-6	.50	199.5	200k	-12	.25	398.1	390k	-18	.13	794.3	750k
10	-5	.56	177.8	180k	-10	.32	316.2	330k	-15	.18	562.3	560k
11	-4	.63	158.5	160k	-8	.40	251.2	270k	-12	.25	398.1	390k
12	-3	.71	141.3	150k	-6	.50	199.5	200k	-9	.35	281.8	270k
13	-2	.79	125.9	130k	-4	.63	158.5	160k	-6	.50	199.5	200k
14	-1	.89	112.2	110k	-2	.79	125.9	130k	-3	.71	141.3	150k
15	0	1.00	100.0	100k	0	1.00	100.0	100k	0	1.00	100.0	100k
16	1	1.12	89.1	91k	2	1.26	79.4	75k	3	1.41	70.8	68k
17	2	1.26	79.4	82k	4	1.58	63.1	62k	6	2.00	50.1	51k
18	3	1.41	70.8	68k	6	2.00	50.1	51k	9	2.82	35.5	36k
19	4	1.58	63.1	62k	8	2.51	39.8	39k	12	3.98	25.1	24k
20	5	1.78	56.2	56k	10	3.16	31.6	33k	15	5.62	17.8	18k
21	6	2.00	50.1	50k	12	3.98	25.1	24k	18	7.94	12.6	13k
22	7	2.24	44.7	43k	14	5.01	20.0	20k	21	11.22	8.9	9.1k

Resistor R25 - 100k. All resistances in kilohms unless indicated

Table 1. Alternate resistor values for different step sizes.

iar resistor values. Capacitors are next, taking care with the polarity of the electrolytics.

You will not be able to use sockets for the integrated circuits because of the depth of the switches on the front panel. These may foul the 4067/4093 devices if a socket is used. You could use sockets for the other devices if you wish, though they are both fairly robust and with only battery power available it is unlikely that you will have to change them. Assuming you get them in right way round of course! You must remember that CMOS devices are prone to static damage and the usual precautions must be observed.

An extended socket is required for the Bar LED modules to raise them into position behind the front panel window. To get to just the right height requires one ordinary socket and one extended socket.

Mounting the jack sockets requires a little dexterity. First of all the solder lugs should be cut off flush with the plastic body of the sockets. Each socket may then be carefully pressed into position between the six terminal pins and solder applied to the joints. Care

should be taken not to melt the plastic of the socket too much or else the spring contacts will tend to lift out of the plastic body of the socket.

The Case

Figure 1 shows the locations for the cut-outs on the

Gain in dB	Linear Gain	R25 Value	E24 Value
-3	.7	70.8	68k
0	1.0	100.0	100k
3	1.4	141.3	150k
6	2.0	199.5	200k
9	2.8	281.8	270k
12	4.0	398.1	390k
15	5.6	562.3	560k
18	7.9	794.3	750k
21	11.2	1,122.0	1M
24	15.8	1,584.9	1.5M

All Resistor values in kilohms unless shown.

Table 2. Alternate R25 values for Different Centre Gains



HOW IT WORKS

The schematic diagram shows the full circuit diagram for the Volume Control Unit. The circuit is basically an inverting amplifier based around the op-amp IC4. The JFET input TL071 is used because of its low noise characteristic and ability to cope with the full audio frequency range.

Since the op-amp is basically a bi-polar device, ie. it needs a positive and a negative rail, the battery supply is split into two by the potential divider R1 and R2. All the analogue signals are referenced to the centre rail which takes the place of the 'ground' in a truly bi-polar circuit.

The input resistor for the op-amp is one of the sixteen R7 to R22. The selection is performed by the 4067, 'one of sixteen analogue demultiplexer'. This device works like a one-pole 16-way switch to small analogue signals. The common connection is at the Z input. The 'wiper' of the switched is moved by the binary signals placed on its SEL inputs.

The binary signals are also de-coded by IC3, a 4514 a 'one-of-sixteen digital decoder'. This device performs the same job as the 4067 but provides digital outputs and as a result is cheaper. Each output is used to light one LED, or in the case of the end groups, three LEDs. In the end

groups the LEDs are placed in series so that no more current is drawn from the battery.

The only remaining job is to generate the binary signals. IC5 is a pre-settable UP/DOWN counter. The pulses on the CLK input cause the device to count and the signal on the U/D input sets the direction. IC1 is a quad 2-input schmidt NAND gate. The Schmidt bit in this case just means it is very easy to make an oscillator from one gate, IC1b. The oscillator is gated so that it runs only when a button is pressed.

The oscillator runs when an input to IC1a goes low. The switches are connected to the drives for the end LEDs so that the counter does not 'wrap-around' and cause an unwanted, large shift in the output level.

R26 and C5 perform a reset function. When the circuit is first powered up, C5 will take a second or so to charge up through R26. During this time the Clock Disable and the Parallel Load pins on the 4516 are held high. This causes the levels present on the data input pins to be loaded into the device thus selecting R15 and setting the display to its middle position.

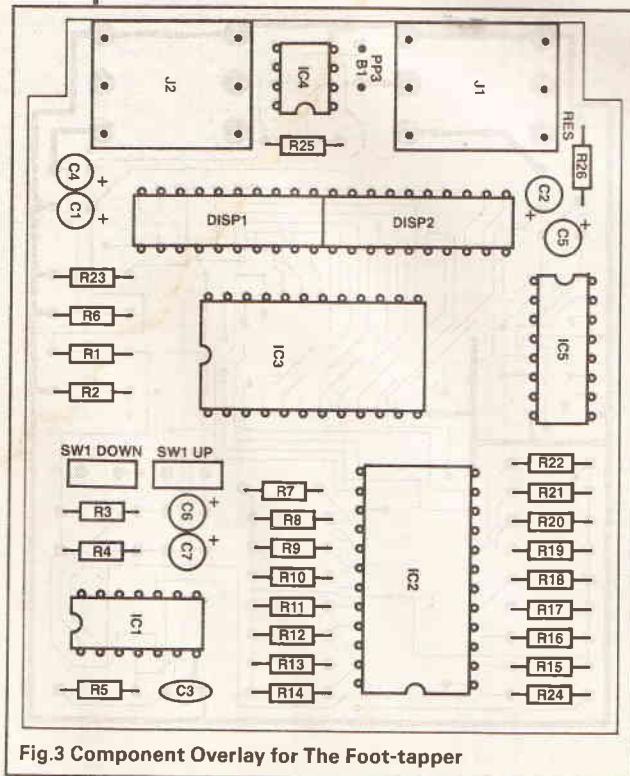

Fig.3 Component Overlay for The Foot-tapper

ing wire is required for each connection.

Remember to thread the battery connector through the hole in the battery compartment before soldering the wires to the PCB, observing polarity.

The PCB sits in the case by loosening the nuts on the jack sockets and sitting the board in the case with the nuts on the outside. The nuts should not be tightened down until the case has been assembled. This should be left until all testing has been done since the screws which hold the two halves together tend to damage the plastic pillars into which they are screwed if the operation is done repeatedly.

Give the board a careful visual final check before you connect a battery. Ensure that there are no blobs of solder between tracks and that all leads have been successfully soldered. If all is well connect a battery. The unit is switched on by inserting a jack plug into the input socket. The centre LED in the display should light up. If it doesn't then something is wrong, perhaps you have put the bar LED's in wrong way around. Check the power on the integrated circuits, it will probably be something simple like this. If the display lights correctly press the up button and verify that the display

PARTS LIST

RESISTORS(all 1/4w)

R1,R2,R6	10k
R3,R4,R23	1k
R5,R24	100k
R7	390k
R8	330k
R9	270k
R10	240k
R11	200k
R12	160k
R13	130k
R14	120k
R15,R25	100k
R16	82k
R17	68k
R18	62k
R19	51k
R20	43k
R21	36k
R22	30k
R26	1M

CAPACITORS

C1	100µ/10V
C2,C6,C7	1µ/100V
C3,C4,C5	10µ/16V

SEMICONDUCTORS

IC1	CMOS 4093
IC2	CMOS 4067
IC3	CMOS 4514
IC4	TL071 op amp
IC5	CMOS 4516
LED1,2	10 Segment Bar LED

MISCELLANEOUS

BAT1	PP3 Battery and Connector
J1, J2	Stereo JACK Socket
SW1, SW2	Push Button Switch
Terminal Pins	
Through Pins	
Connecting Wire	
Box	

BUYLINES

All of the components are available from either RS Components or Farnells (Tel 0532-636311) with the exception of the Lexan escutcheon and the PCB.

The Push-switches are by MORS, part No. 150-216 from Farnells.

steps one to the right and that holding the button down causes the display to continue stepping until it reaches the end. At each end the display will light up three segments to show that it has reached the end of its travel. The down button should behave similarly.

If the system looks as if it works correctly then now is the time to see if it sounds alright. Connect up a sound source and an amplifier and see if the volume level rises and falls as required

The Step Size.

The values shown in the schematic diagram for the gain setting resistors are chosen to give 1.5dB steps. Since there are 16 possible values of resistor this gives a boost of up to 12dB and a cut of up to -10.5dB. The choice of 1.5 dB steps gives a fairly subtle change in level for each step, it was selected because 1dB is the smallest audible step and also because ± 12 dB is sufficient for most applications. You may decide that a different step size is more appropriate for your application.

Using the two tables you may be able to devise a variety of uses for the basic circuit given and we would be interested to hear of any you find.

Since the gain of the circuit is set by the input resistor in an inverting op-amp configuration, the input impedance of the system will vary with the gain. As long as the input impedance is higher than the output impedance of the driving device all will be well. If you do experience problems with this then try connecting the unit to the send and return loop on the amplifier rather than directly in the effects chain.

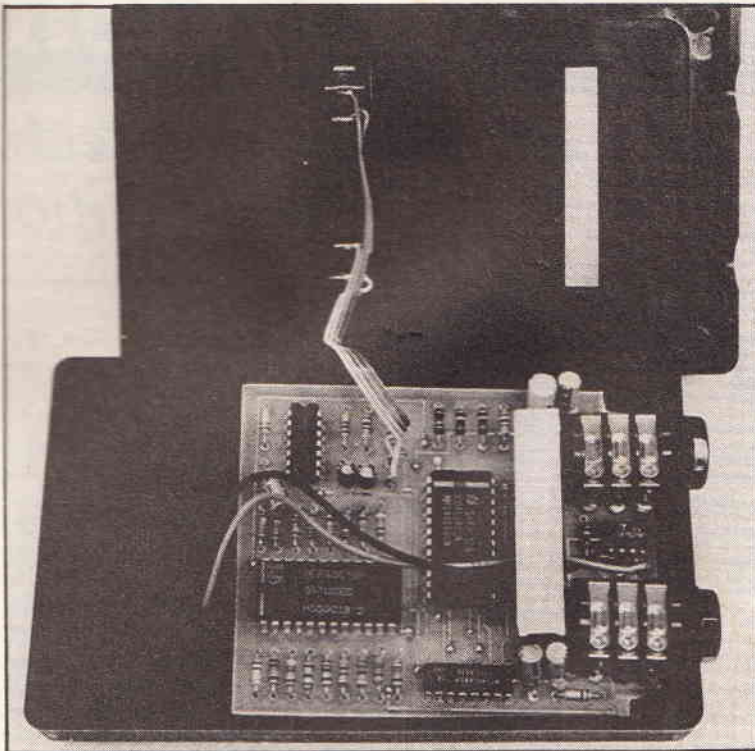

PROJECT



ETI NEEDS YOU

This is your chance to be recognised as a creative technologist worldwide. Why not see your circuit designs in print and be the envy of your friends. We particularly require new ideas and designs in the following fields:

Audio design and music effects, applied electronics for use in the home and computing hardware.

No matter what the science or technology, just send us a brief description about the project you have built or are developing and we will give your ideas serious consideration. You never know who might be reading ETI when it appears, it may be developed on a commercial basis.

Send in your synopsis to ETI, Argus House, Boundary Way, Hemel Hempstead, Herts HP2 7ST.

High Definition Television

The Broadcasting Technology Association Proposal

7b

James Archer looks at the final batch of American proposals for HDTV

Another proposal to ACATS that has since been virtually ignored in the technical press, possibly because many of the desirable features are only offered as future developments, is from the Broadcasting Technology Association (BTA). The system as submitted is really an improved NTSC system rather than a full HDTV proposal. Signals from what could be an HDTV source are first converted to a 525 line interlaced 4:3 format, and the signal processing in the studio consists of adaptive pre-emphasis to improve the detail that can be seen in dark areas of the picture, and quasi constant luminance processing. With appropriate receiver circuitry, a reference timing signal is inserted into the video signal to cancel ghosting which occurs over the transmission path. It is assumed that line doubling circuitry would be used in the receiver

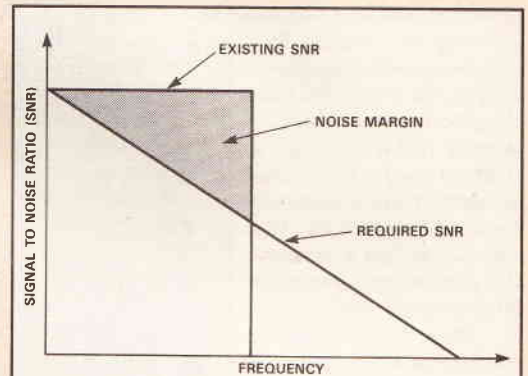

Fig.11 Basic explanation of how noise margin can be used to provide additional information in a compatible way.

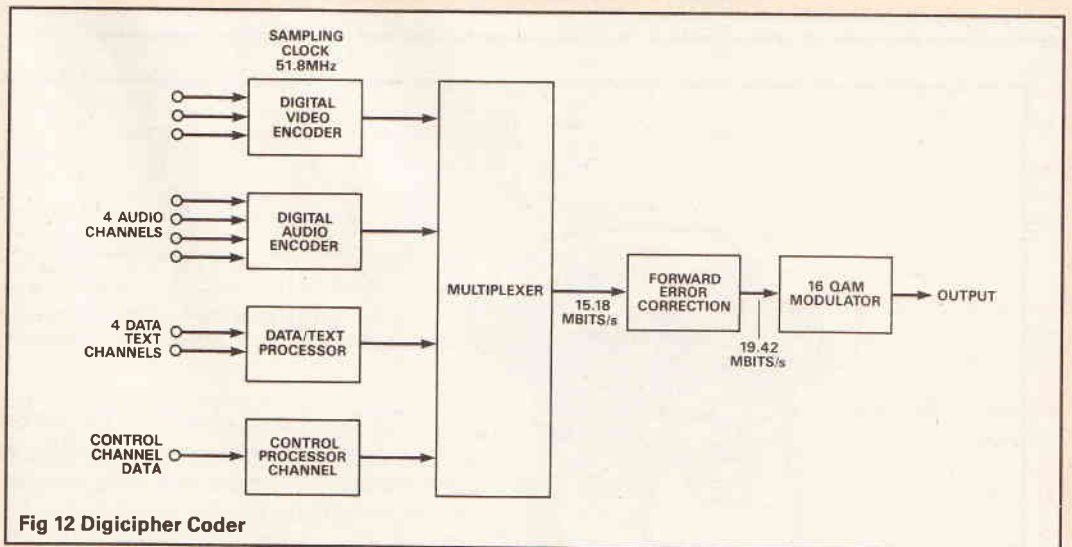

Fig 12 Digicipher Coder

converting incoming picture signals to progressive scan. The receiver would also use complex three dimensional filtering to separate the luminance and chrominance signals.

The Noise Margin Method of hiding Enhancement Information

A group of researchers from the MIT and from Bell Laboratories have put forward details of their experimental work on an ATV system which uses a novel method of hiding the augmentation information within the normal NTSC signal. The result is a signal which can be carried over a standard 6MHz channel and gives perfectly acceptable results on standard NTSC receivers, whilst offering enhanced resolution

and wider aspect ratio pictures to viewers with an ATV receiver.

The idea is that when an NTSC picture is transmitted over the air and received on a standard NTSC set providing a picture with a satisfactory signal to noise ratio (SNR), some parts of the picture signal spectrum actually have a higher signal to noise ratio than would be strictly necessary to provide an acceptable picture. The difference between the actual signal to noise ratio in these parts of the spectrum and that absolutely necessary to provide good pictures is called the 'noise margin', and this area can be used to carry extra information to back up the standard NTSC picture. This extra information can be extra picture detail and extra information for widescreen pictures, but if it is to remain compatible with ordinary NTSC sets, it

HDTV

must have the appearance of a noise signal as far as the receiver is concerned. For a standard NTSC TV the only effect of this extra information will be a slight worsening of the signal to noise ratio in some picture areas. The system has been carefully designed so that this high frequency noise is virtually invisible under most viewing conditions. Nevertheless, the 'sine qua non' of the noise margin method of hiding enhancement information is that the original NTSC pictures must have a signal to noise ratio sufficiently good to provide noise free pictures.

Figure 11 provides a simplified explanation of how the 'noise margin' occurs, and how the extra enhancement information can be squeezed in.

The human eye has the characteristic of apparently not seeing a reduction in picture quality (SNR) as the frequency of the picture detail becomes higher. The diagonal line in Figure 11 is therefore representing this characteristic, and is labelled 'required SNR' - note this SNR becomes lower as the frequency rises. The rectangle represents the signal to noise ratio of the actual received picture, with all spectral components having the same SNR, as has been found in practice for good quality NTSC pictures, and is therefore labelled 'existing SNR'. The top triangle then represents the area of the signal capable of carrying enhancement information to construct a higher definition widescreen picture. The way to obtain a wider aspect ratio has not yet been finalised, but the authors favoured the technique of vertically cropping the picture, adopted in other systems.

As with other techniques described earlier, this system uses other tricks to squeeze in even more information. Together with the noise margin idea, extra sound information is added to the signal by taking advantage of the human eye having a lower temporal bandwidth for colour than for luminance, so a 15Hz chrominance flicker is not easily noticed. The temporal rate of the chrominance signals is therefore reduced by half, to 15 fps by making each successive pair of chrominance frames identical. The digital audio signals are then added to the chrominance signals using opposite polarities on successive picture frames. Subtracting the two frames will then provide the audio information, whilst adding them will cancel out the audio and produce the colour information.

The noise margin method of enhancement can provide an EDTV system with pictures that have twice the normal NTSC resolution in the stationary areas, and as a bonus, digital audio can be added to the chrominance signals.

Liberty Television/Weaver proposal

Although it has not yet been officially submitted to ACATS, yet another ATV system was proposed at the NATPE programming conference at the end of 1989, and if it does nothing else it illustrates that the situation regarding ATV standards in the USA is still very fluid. Jon Weaver of Liberty Television, a New York production house, suggested that if an 1800 line 72Hz fps system were introduced, it would allow for simple transcoding between 1250/50, 1050/59.94, and 1125/60 standards. No firm technical details have yet been revealed, but it seems that an 1800 line 72Hz system would be likely to stretch the present state of the art as far as cameras, recorders, and video processing equipment are concerned, so it seems that this is an unlikely contender for the ATV honours.

The Digicipher HDTV system.

Although many people were beginning to think that an ATV system based upon some combination of several of the previously systems could eventually win through

in the American market, it became plain that new developments are still forthcoming in the ATV field when General Instruments announced yet another proposed system in June 1990. Its Digicipher system has resulted in a great deal of discussion amongst engineers, some of whom are extremely sceptical about whether the fascinating proposal can ever be turned into a working system.

Digicipher is an all-digital HDTV system that, it is claimed, can be transmitted over a standard 6MHz wide television channel, in either the VHF or UHF bands. Additional advantages claimed are that the decoder complexity is low, and that low transmitting power can be used, allowing the transmissions to make use of otherwise 'taboo' channels. Compatibility is achieved by simulcasting the Digi-Cipher information with a standard NTSC signal on another channel.

In order to achieve the miracle of squeezing a digital television signal through a 6MHz channel a 'highly efficient unique compression algorithm' is used to vastly reduce the data rate that is required. In common with many other researchers in this field, GI have decided to adopt a coding system based on motion compensated discrete cosine transform (DCT) coding to achieve this. Such a system can only work because successive television images nearly always contain a large amount of similar information, so that by cutting

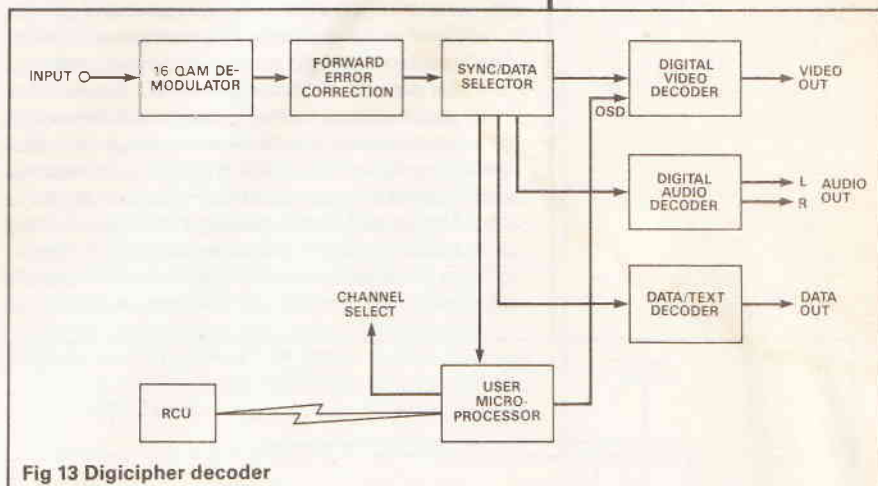

Fig 13 Digicipher decoder

out the redundant information, (the information is repeated from one image to the next), only essential data, giving the details of the changes which have taken place from one field to the next, need be sent. The Digicipher system compresses the signal by first predicting how the next frame will appear, and then sending the difference between the prediction and the actual image. The simplest way to predict what the next image will be is to use the previous field. Since some parts of the picture contain less redundancy than others, the result is a variable data rate which can sometimes be difficult to handle. This differential pulse code modulation (DPCM) idea works well if there is little movement present or if there is little spatial detail, but can collapse completely under some conditions.

As with many of the other systems using temporal compression, motion estimation and compensation techniques are used with the coding process. The Digicipher system uses large blocks of pixels, called 'superblocks', and provides a motion vector to give information about each of these blocks.

Using as its source a 1050 line/59.94 fps interlaced picture, the Digicipher digital video encoder takes the Y,U,V signals and samples them at 51.80MHz, implements the compression algorithm, and generates a video data stream. Four channels of digital audio plus four 9600 baud data channels and the necessary control and synchronising data are then

multiplexed together with the video data, to provide a 15.8Mbit/s data stream. Forward error correction data is then added, bringing the data rate up to 19.42 Mbit/s, and this data is then fed to a 16-state Quadrature Amplitude Modulator (16-QAM), in which the amplitude and the phase of the transmitted signal are varied. With 16-QAM four amplitudes and four phases are usually used, and QAM was probably chosen in preference to PSK because it has better noise tolerance and therefore better resistance to errors. The multi-level, multi-phase 16-QAM signal can then carry the complete audio and video data stream within a bandwidth of only 4.86MHz.

In the Digicipher decoder the 16-QAM demodulator receives the incoming signal from the tuner, demodulates it and provides a 19.42 Mbit/s data stream. The demodulator circuitry contains an adaptive equaliser which can compensate for distortions to the off-air signal caused by multi-path reception. The data then passes to the forward error correction circuitry, to correct random and burst errors and should provide errorfree data to the sync/data selector. The selector maintains overall synchronisation and demultiplexes the data stream to provide separate streams for video, audio, and data.

Digital Transmission

For transmission, the use of digital modulation permits a much lower transmitter power, perhaps as much as 30dB less, to achieve the same signal to noise ratio and coverage area as for analogue NTSC signals. This helps enormously in limiting potential interference to existing transmissions, and allows the system to make use of the 'taboo' channels. Since it is claimed the digital signals take up only a 6MHz bandwidth, there should be no problems in passing them along existing cable networks, allowing them to carry HDTV signals with the minimum of modifications, and the signals should also be suitable for use over Multichannel

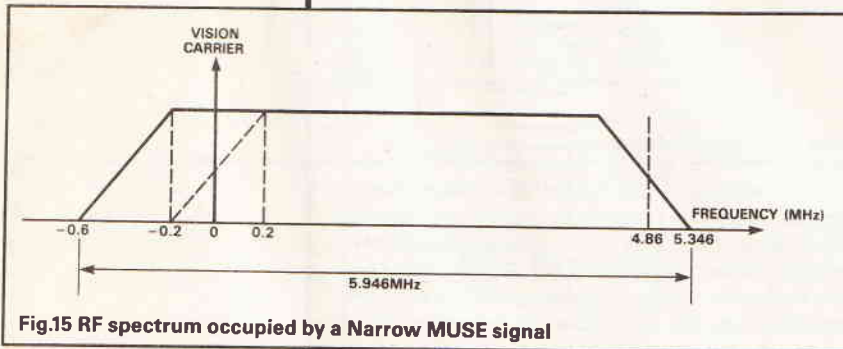

Fig.15 RF spectrum occupied by a Narrow MUSE signal

Microwave Video Distribution Systems (MVDS) and over satellite links. GI even claims that 'all-digital recording and playback of its HDTV signals is within the reach of current technology for consumer use, since the total data rate is less than 20Mbit/s. With Digicipher claiming so many different advantages, it is no wonder that the sceptics are shaking their heads!

MUSE for the USA - A Japanese Hierarchy of Systems

The systems proposed by NHK for the American market have deliberately been left until the last part of this article, mainly because we have already considered the detailed operation of the MUSE system. The variants of the MUSE system that have been proposed all work using some of the same basic principles as the system described earlier, but they have been extensively modified so the signals can be squeezed into the bandwidths the FCC has said will be made available.

The original MUSE system was designed pri-

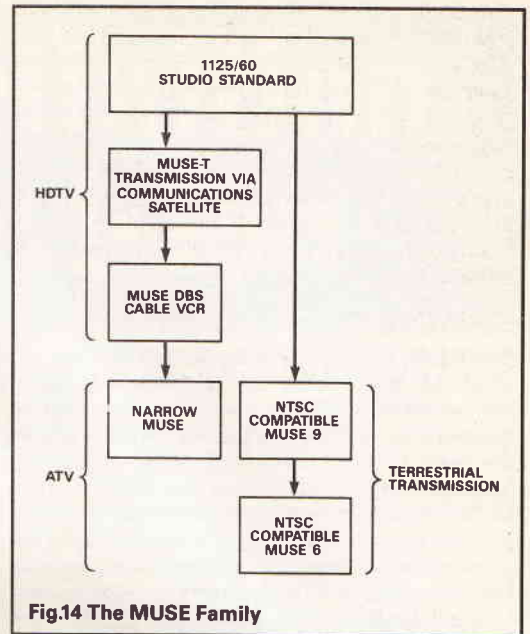

Fig.14 The MUSE Family

marily for satellite broadcasting, and uses an 8.1MHz wide baseband channel to carry a 16:9 1125 line picture with 1440 horizontal picture elements. Such a signal will not fit into a standard NTSC channel, and so three major variations of MUSE have been developed to try to find a system that would be acceptable for the North American terrestrial transmission system. Since the basic MUSE system is totally different from NTSC there is no way in which it could truly be called compatible, since the MAC-like nature of the signals means that a decoder box would be necessary to provide NTSC viewers with a picture; the only way in which compatibility could really be claimed under the rules of the FCC 'game' would be if the modified MUSE signals could be fitted into a 6MHz channel which parallels a standard NTSC channel carrying the same programme material, the so-called 'simulcast' technique. The three suggested ATV versions of MUSE are called 'Narrow MUSE', which uses the 'simulcast' technique, and 'MUSE 9', and 'MUSE 6' which are completely redesigned versions of MUSE that can also provide pictures on NTSC receivers. Figure 14 shows how they fit into the hierarchy of MUSE systems for all purposes, from wideband satellite transmissions to narrowband terrestrial ones.

Narrow MUSE

The essential features of Narrow MUSE are that it is an ATV system with four channels of digital audio that can be carried in a 6MHz wide radio frequency channel, so that it can be 'simulcast' with an NTSC signal on another channel. To reduce the bandwidth from that of the normal MUSE signal the number of scanning lines is reduced from 1125 to 750, but this should be sufficient to provide an HDTV display if appropriate upconversion is carried out in the receiver. Even this reduction in lines is not sufficient to let the signal pass through a 6MHz channel, so multiple sub-sampling is used, to provide a further reduction in bandwidth. Stationary parts of the image are sub-sampled with a combination of field offset and frame offset sampling, whereas moving parts are processed using line offset sampling, which means that moving areas will have lower resolution; as we have seen before, this will be acceptable to the eye. Essentially then, the Narrow MUSE system uses line reduction and multiple sub-sampling to reduce the spectrum required to just over half of that needed for standard MUSE, giving a baseband video signal with a bandwidth of 4.86MHz which can then be transmitted using vestigial sideband

Amplitude Modulation within the confines of a 6MHz wide radio frequency channel, as shown in Figure 15. The digital audio is transmitted during the vertical intervals, and there are two options available, giving four channels at moderate quality or two channels at high quality.

The picture quality which Narrow MUSE can provide is better than that available from the MUSE-6 and MUSE-9 systems which will be described next, primarily because the Narrow MUSE system is not constrained by NTSC compatibility.

MUSE 6

The MUSE-6 system provides pictures with twice the static resolution of NTSC, a 16:9 aspect ratio, obtained by cropping the picture vertically, and improved chrominance resolution, and yet it fits comfortably within the limits of a 6MHz wide NTSC channel and

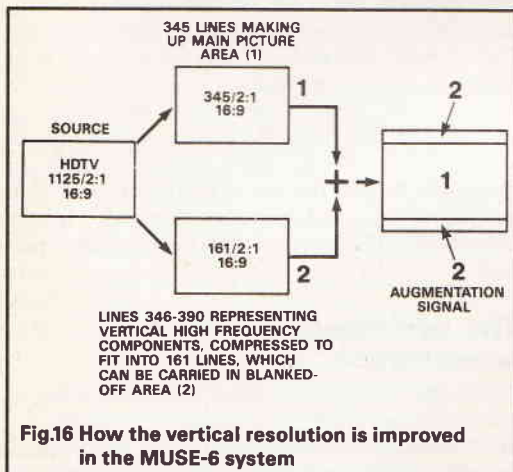

Fig.16 How the vertical resolution is improved in the MUSE-6 system

provides acceptable pictures on NTSC receivers. The improvement in horizontal resolution is obtained by frequency multiplexing different parts of the picture information. The parts of the frequency spectrum above 3.9MHz are divided into two, one extending from 3.9-5.8MHz and the other from 5.8-7.7MHz. These two components are interleaved into an NTSC

transmitted normally, but the vertical high frequency components, corresponding to lines from 346-690, are time multiplexed during the extended vertical blanking periods, ie, they are carried in the masked off portions of the picture area above and below the visible image. There are some 160 lines in the extended vertical blanking period, so to carry the lines from 346-690 it is necessary to compress the information from two lines so that it fits into one of the lines in the masked off area. In order to permit this, the horizontal resolution of the extra lines, (ie the vertical high frequency components of the picture), must be reduced by a half.

In a similar manner the chrominance signals can be given enhanced resolution by frequency multiplexing the high frequency parts of the chrominance signals into the high frequency luminance signals that are carried in the masked off parts of the picture.

Figure 17 shows the basic method of operation of the MUSE-6 NTSC compatible system.

The source, as with all MUSE systems, is an 1125 line 60Hz 2:1 interlace picture with a 16:9 aspect ratio. The source is sampled at 31.9MHz for luminance and 15.4MHz for each of the colour difference signals, and these sampled signals are then fed into a noise reducer and applied to a motion detector, which examines adjacent fields and determines the difference between them. The prior noise reduction is necessary because the difference signals from the adjacent fields will contain noise, which could lead to the motion detection circuitry becoming confused. The main signal is then converted from 1125 lines to 750 lines, interpolations between fields being used on static parts of the picture and just the current field information for moving parts of the image. It is then necessary to convert the field rate from the 60Hz of the source to the 59.94Hz which is required to ensure compatibility with NTSC; the conversion is done by reading the information into field stores at the 60Hz source rate and then reading it out at the slower 59.94Hz rate. The signals are then passed to a matrix and a non-linear processor to provide signals of an appropriate gamma for the NTSC system, and they then enter the circuitry

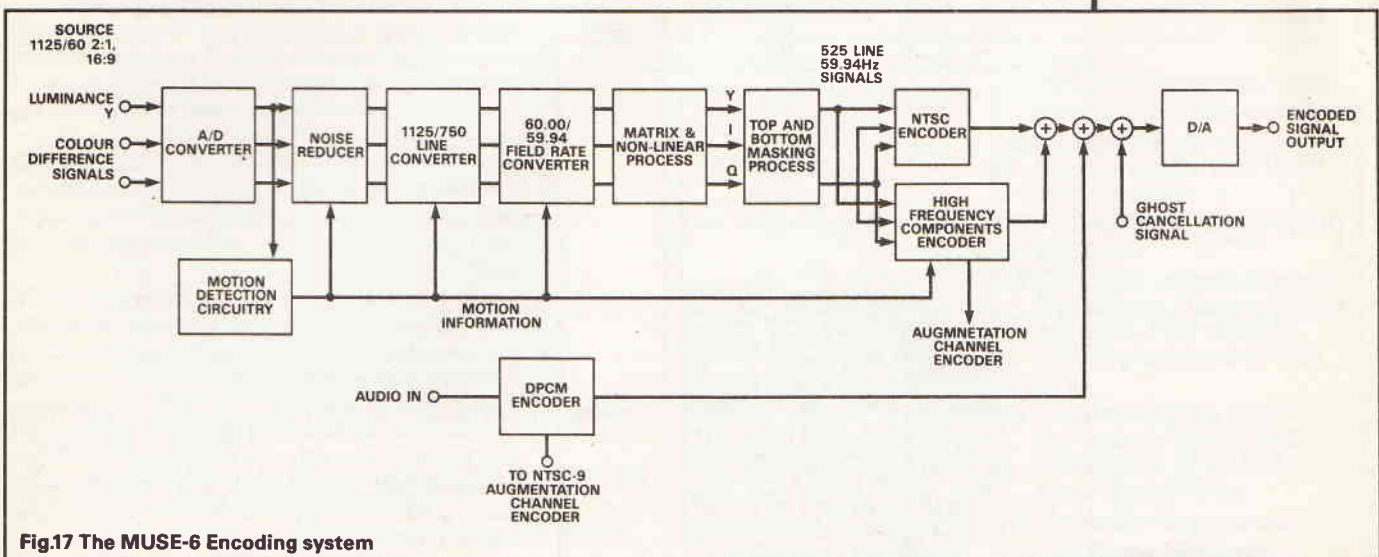

Fig.17 The MUSE-6 Encoding system

signal by using two frame-offset subcarriers. The multiplexing of the high frequency components is only carried out on static areas of the picture.

The 16:9 aspect ratio picture has only 345 basic scanning lines, which would give a vertical resolution around half that required for an ATV picture. Once again, multiplexing is used to improve things, as is shown in Figure 16.

The first 345 lines of the cropped picture are

which carries out the arrangements for ensuring that the masked off parts of the picture carry the enhancement information.

As shown earlier, the Y I and Q signals from the matrix form a 750 line signal which is divided vertically into two separate components representing the high frequency and low frequency parts. The low frequency part provides the information for the central part of the picture, whereas the high frequency part, after hori-

zonal band-limiting, is compressed, and this information provides the top and bottom parts of the masked-off picture. The Y, I, and Q signals are then pushed into an NTSC encoder, and the high frequency component signals are separately encoded. Digital audio and ghost cancellation signals are added to the vision signals before transmission. The resulting MUSE-6 signal can be carried in a standard 6MHz wide NTSC radio frequency channel, and will provide a standard NTSC receiver with an NTSC picture. ATV receivers will be able to make use of the extra information that the MUSE-6 signals contain in order to provide an 1125 line widescreen picture with better resolution.

MUSE-9

The MUSE-9 system uses a main channel which is identical to MUSE-6, but in addition it makes use of another 3MHz wide channel to carry further augmentation information. MUSE-9 is therefore compatible with existing NTSC receivers in the same way as MUSE-6. The augmentation channel, which occupies 2.1MHz of the baseband channel, provides extra information which can be used to increase the resolution of the moving parts of the picture, and to provide extra digital sound channels and an improvement in the quality of the original digital audio signals. The augmentation channel signal is transmitted as a 525 line signal in which the extra movement information about the high frequency parts of the picture is time division multiplexed with the digital audio signals. Using vestigial sideband modulation the augmentation information can be carried within a 3MHz radio frequency channel, and the main and augmentation channels can either be transmitted by one transmitter in a 9MHz wide contiguous band, or by two separate transmitters, as shown in Figure 18.

posed for American ATV use an 1125 line 60Hz source. Narrow MUSE provides the highest quality pictures and is closest to the original MUSE system in that it does not produce a signal which can be used by NTSC receivers, although it does fit into a single additional 6MHz channel, so that 'simulcasting' can provide 'compatibility'.

MUSE 6 provides NTSC receivers with a fully compatible signal, can produce widescreen pictures and two channels of digital audio on an ATV receiver. By the addition of an extra 3MHz wide augmentation channel MUSE-6 is transformed into MUSE-9, an NTSC compatible ATV system which has better resolution of the moving parts of the image than MUSE-6 and provides improved audio.

The US ATV proposals – thoughts and conclusions

We have looked at many potential ATV systems for the United States, and since many of the improved techniques in one system could just as well be used to improve some of the other systems, the number of possible permutations is enormous. Not all the proposals will be submitted for testing; at the time of writing it seems that towards the end of 1990 only about eight companies will provide complete systems for testing, although there is, of course, still time for others to join them.

The problems of critical assessment

The author is very much aware that in this series of articles the multiplicity of proposed ATV systems has been described fairly uncritically. It is a major disadvantage of having to rely on manufacturers' descriptions of what their systems can achieve whilst not yet being able to judge them in practice. Until side by side tests and demonstrations of the various systems have been carried out it will not be possible to reach sensible conclusions on which systems are best. It is important to remember that a system which performs perfectly in the laboratory may turn out to have severe problems when transmitted over air. Practical transmission systems may have to pass the signal through cable and microwave links and then through several transmitters in tandem before it finally reaches the home by means of a less than perfect antenna assembly. Received signals are likely to suffer from noise, ghosting, and selective frequency distortions which could play havoc with an ATV signal, especially if it has had its complete frequency spectrum packed full of the extra information that is necessary to provide enhanced pictures and sound.

In general the techniques used for proposed ATV, use some combination of an increased bandwidth, reduced diagonal resolution, and reduced temporal resolution to provide increased vertical and horizontal resolutions when compared with NTSC. It is possible to make some predictions of the likely problems with each type of system, although at this stage it is only fair to manufacturers to say that each would probably claim to have ways of minimising or avoiding the defects. From a normal understanding of engineering principles and the author's in-built conviction that 'you don't get something for nothing' it seems reasonable to assume that those systems with the largest bandwidth should give the best performance, provided the bandwidth has been used optimally. Also, the ATV systems have generally been designed to provide some degree of NTSC compatibility, in accordance with the FCC requirements, and this factor may act as an important constraint on what would otherwise be the optimum usage of the available spectrum. Most of the

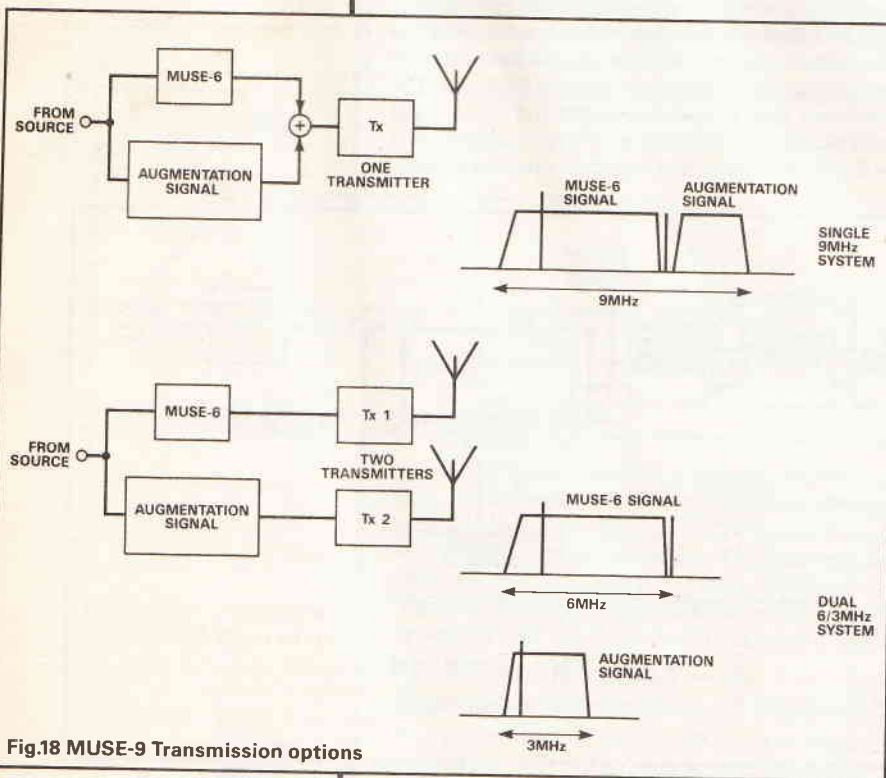

Fig.18 MUSE-9 Transmission options

It is felt that where possible the single 9MHz channel option would be preferable, since this is likely to avoid possible problems with amplitude and phase differences between the main signal and the augmentation signal.

MUSE for ATV

All of the three MUSE systems that have been pro-

techniques used in the various ATV systems actually trade off one parameter for another, as we have seen, and it is usually a case of removing information that the human visual system is not too aware of in order to include extra information giving more detail to the picture that the eye and brain find important.

So the systems which provide improved resolution, whether vertically or horizontally, generally provide reduced performance in one way or another when motion is present in the pictures. Reduced temporal resolution is the inevitable result of some of these systems; the MUSE and North American Philips proposals need more than one frame to update a picture, using 15 frames per second, whilst the Del Rey system sends only 10 fps and the Glenn VISTA system has a 7.5 fps update rate. The system proposals from Bell (SLSC), Scientific Atlanta HDB-MAC, and CBS should all provide full temporal resolution, whilst the David Sarnoff / NBC ACTV proposal is likely to suffer some loss of temporal resolution because of inter-frame averaging techniques.

The systems which include the separate transmission of side panels for wider aspect ratio pictures could suffer from problems; as an example, if the side panel signal to noise ratio is not as good as the main picture, as it often will not be, then under certain reception conditions it may well be possible to see the joins between the main picture and the edges. The systems which use a 16:9 or 5:3 picture as the basic system picture will not suffer from this problem, but may cause compatibility problems with NTSC sets displaying blank strips at the top and bottom of the picture, as we have seen.

The various sub sampling processes work extremely well for much of the time but can cause patterned artefacts and irritating motion effects to some pictures. Even the display improvements which may be

obtained from receivers providing continuously scanned pictures from incoming interlaced signals are not always without technical cost — upconverting to higher line numbers can produce visible artefacts. In the same way that the colour subcarrier of an NTSC signal can break through, to provide luminance patterning on a picture, systems that use extra subcarriers, such as the David Sarnoff / NBC ACTV system could result in further interfering patterns if the relative signal levels are not carefully controlled, as can happen when signals are sent over a difficult transmission path. Opponents of the Genesys system find it difficult to believe that all the extra information needed can be squeezed into a standard NTSC channel without the extra information causing some sort of degradation; only time and stringent testing will show who is right.

Disadvantages apart, several systems will result in the ordinary NTSC viewer actually receiving better quality pictures than before; as just one example it seems that the preprocessing of picture signals in the Faroudja SuperNTSC proposal should mean NTSC pictures will suffer much less from cross-colour and moire patterning.

Predictions are always very difficult in the television game, and it will be even more difficult than usual to predict the outcome of this particular race. Although it is tempting for engineers to believe that the 'best' technical system will win, a far more probable outcome will be that a consortium of manufacturers and broadcasters will decide to adopt the system that can most quickly be brought to market, and which can most quickly be made to pay!

Part eight of this series, in next month's issue of ETI, will look at progress towards a world standard, and will do some crystalball gazing as to what the 1990s hold for the television viewer.

HDTV

DIGITAL SIMULATION

PULSAR

£195

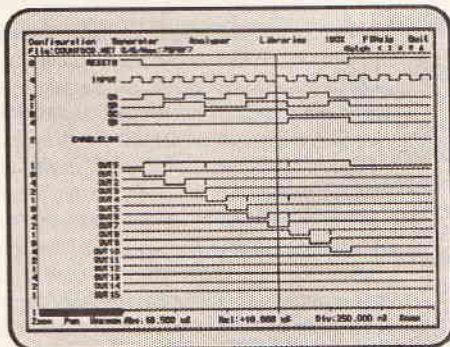

- At last! A full featured Digital Circuit Simulator for less than £1000!
- Pulsar allows you to test your designs without the need for expensive test equipment.
- Catch glitches down to a pico second per week!
- Superbly easy to learn and use.
- Runs on PC/XT/AT/286/386/486 with EGA or VGA.
- Not Copy protected.

PCB and SCHEMATIC C.A.D.

EASY-PC

£98

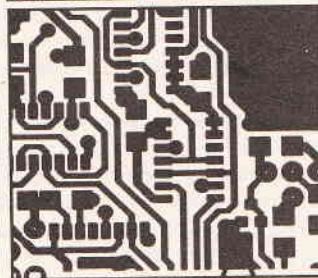
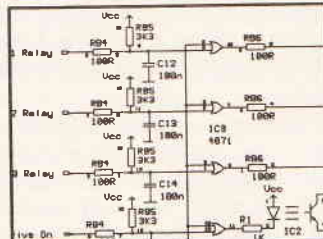

- Runs on PC/XT/AT/286/386 with Herc, CGA, EGA or VGA.
- Design Single sided, Double sided and Multi-layer boards.
- Provides Surface Mount support.
- Standard output includes Dot Matrix / Laser / Inkjet printers, Pen Plotters, Photo-plotters and NC Drill.
- Award winning EASY-PC is in use in over 8000 installations in 50 Countries World-Wide.
- Superbly Easy to use.
- Not Copy Protected.

Options - 1000 piece symbol library - £38.00
Gerber Import facility £98.00

For full info' Phone, Fax or Write to:

Number One Systems Ltd.

REF: ETI, HARDING WAY, SOMERSHAM ROAD, ST. IVES, HUNTINGDON, CAMBS, PE17 4WR, ENGLAND.

Telephone: 0480 61778 (7 lines) Fax: 0480 494042

International: +44-480-61778 Fax: +44-480-494042

The CAD Specialists

ACCESS, AMEX, MASTERCARD, VISA Welcome.

In this second part, Vivian Capel examines the electrical circuits for fire alarms

Fire Detection Systems

Circuits

If we first consider intruder alarm circuits, which may be more familiar, we can appreciate how the fire detection circuit works. The main intruder alarm detection circuit consists of a loop having sensors with normally-closed contacts connected in series. When actuated, a sensor goes open-circuit thereby interrupting a constantly circulating current which triggers an alarm condition in the control box. The reason for this arrangement is that the circuit is thereby constantly monitored when active, and any breakage or disconnection produces an alarm signal. An auxiliary normally-open circuit is also used for pressure mats which go short-circuit when stepped on.

However, some degree of sophistication is required for protection from tampering when not in use, and supply of power to active sensors such as infra red and ultrasonic detectors. For the first of these, an extra loop is provided which carries current 24 hours a day and thereby gives an indication of a fault in the wiring even when the system is switched off. Power supply for sensors requires yet another pair of wires in the cable.

In the case of the fire detection circuit, it can be either a straight-forward normally-open or a closed loop if only mechanical heat detectors and manual call points are used. Electronic detectors need a DC power supply which would normally require an extra pair of wires. Some form of monitoring is required to ensure the circuit is always on guard and that any faults are indicated. This too would seem to require extra conductors.

However, the amount of cable needed to give adequate fire protection to even medium-sized premises is considerable, far greater than that required for an intruder alarm system. A four or six-wire circuit would entail a lot of work in connecting each detector, and be very costly. The circuit commonly used for modern fire detector systems ingeniously accomplishes all these requirements with only two wires. Here's how it works.

The circuit is normally open, and the detectors are connected in a chain in parallel across the circuit. Each one has a pair of input terminals for the incoming wires and an output pair which are linked internally to them, for the outgoing ones to the next detector.

If a single pair of terminals were used with both incoming and outgoing wires twisted together and wrapped around them, a loose terminal could incapacitate that detector but would not break the connection to the next. So there would be no indication of a fault. This arrangement ensures that any loose or disconnected terminal breaks the chain and so registers a fault. The chain continuity is completed by a high impedance termination across the last detector which can conveniently be connected across its output terminals.

DC Supply

A DC supply of 24V is applied across the circuit, so the detectors are polarized with positive and negative markings which must be observed. The detector has a semi-conductor output stage across the line, along with a comparator and other circuitry. These take a small current, nominally 0.1mA in the quiescent state, but when actuated, the output stage goes low resistance and a large current of at least a hundred times that amount flows. The increased current is sensed by the control box which sounds the alarm.

As all detectors take a quiescent current it follows that there is a limit to the number that can be connected to any single circuit. The maximum current is usually specified on the control box. Commonly 4mA, this allows 40 detectors to be connected. However, the 0.1mA rating is nominal and the actual current is frequently smaller, so a few detectors over the calculated maximum can usually be accommodated if required.

Manual call points take no current so any number can be connected to a circuit. They can be mixed with other detectors in any order, but they must be of the normally-open variety for this type of circuit.

Monitoring

To monitor the condition of the circuit, a small AC voltage is superimposed on the 24VDC. The resulting current flows along the circuit and through the end-of-line termination, which consists of a capacitor and diode. This of course blocks the DC supply. Thus the circuit is open to DC but closed to AC and thereby is able to provide detection, DC supply, and monitoring functions using only two wires. As long as the AC current flows, the circuit must be continuous, but any cessation of the current produces a fault indication at the control box.

Additional security against faults can be obtained by a ring circuit. This is a chain that has both ends returned to the control box in the manner of a ring main electrical circuit. The end-of-line termination is connected to a point about half-way around. If a break occurs at any point, all detectors are still connected to the system. Further safeguards are isolators placed around the circuit to limit the effect of any short circuit, to those detectors between two isolators.

The BS 5939 specifies that any open circuit in a ring detector circuit should be indicated and identified within 60 minutes. Although the circuit is fully operative with such a break, there is now no back-up path, and a second break would take out all sensors between the two breaks. A short circuit should be indicated as a fault within 100 seconds.

Spurs

All circuits should consist of either a single chain or a ring. No spurs should be connected in at any point, nor can two chains be run from a common start. The reason being that monitoring would be defeated. If an

end-of-line termination was omitted from the spur, it would be unmonitored. If one was fitted to it as well as the main chain, monitoring current would flow through both. So if there was a fault on either the spur or the main chain from the spur connection onward, monitoring current would still flow through the other termination, and the fault would not be indicated.

Zoning

All detection circuits should be divided up into zones and connected to a separate zone input on the control panel. Each of these has an indicator so that when triggered it shows immediately which is affected. In addition, each zone has a fault indicator which is actuated if the monitoring current ceases.

The rule for zoning is that one zone should serve only one fire compartment. A fire compartment is an area which could contain a fire for a period without spreading to adjacent compartments. If out of control of course, such a spread would eventually be inevitable. Usually a fire compartment is defined as an area enclosed by walls, ceiling and floor. Each storey is a separate compartment unless the total floor area of the whole building is less than 3230ft² (300 m²), in which case the whole building is a single fire compartment and can be served by a single zone.

The floor area of a single zone even if on the same storey must not exceed 21,500ft² (2,000 m²). Storeys having a larger area than this must be divided into separate zones. Stairwells, lightwells, liftshafts and the like are single fire compartments even though they extend through several storeys. Each shaft should thus be on a separate zone.

In some cases there may be split levels and dividing walls which may make it difficult to define a compartment. In such situations the search distance necessary to visually locate a fire should not be greater than 100 ft (30 m).

So the rules for defining fire compartments are such that it enables not only the location of a fire, but its extent and confines to be quickly determined from the control panel. This information is invaluable to the fire services so that they can most effectively deploy their resources.

Detector cables

Some control panel manufacturers specify maximum resistance values for detector circuit cables. A high series resistance could reduce the detector current when actuated, and as this also produces a voltage drop to the detector output device, the current would be reduced further. Uncertain operation would result.

The specified maximum resistances are usually far greater than would be obtained with any but the largest installation. A typical value is 150R, but flat 16/02 mm cable has a resistance of 7.2R per 100m in both conductors. It would therefore require a run of 2,100m or 7,000ft to exceed the resistance. Even 7/02 mm cable, which has a resistance of 16.4R, could run for 900m or 3,000 ft before reaching 150R. The picture would be changed if any other resistance such as circuit isolators was introduced.

A maximum cable capacitance is also usually quoted. If excessive, this capacitance could shunt the monitoring current and thereby bypass the end-of-line termination. So a fault would not be indicated. Here again though, the maximum capacitance quoted are far greater than are likely to be encountered with actual cables. A typical value is 0.5u, but with a capacitance of some 27p per ft, or 90p per metre, it would need 5,500m or 19,500ft of 16/02mm to reach that value. Thinner cable has even lower capacitance.

Bell monitoring

It would be pointless to ensure fault-free operation of the detector circuit if an unreported fault could appear

in the bell circuit. This too must therefore be monitored continually and any break, signalled.

The method of monitoring the detectors would not work with the bells because they have a much lower resistance than the detectors and would bypass the AC monitoring current. So, a different system is used.

A resistor is connected across the end of the line, and each bell has a diode in series with it. When the system is on guard, a reverse current is passed around the circuit. This is blocked by the diodes from flowing through any bell, but passes through the terminating resistor. As long as this current is flowing, the bell circuit must be complete, so if it ceases, a fault is indicated on the control panel. Any short-circuit increases the current above normal, and this too produces an indication on the panel.

When an alarm is triggered, the polarity of the circuit is switched back to normal, and thus the applied power flows through the diodes to actuate the bells. The terminating resistor is of relatively high value, so its shunting effect is negligible across the circuit.

Bells intended for fire alarm systems often have a diode built-in. The diode reduces the applied voltage by about 0.5V, but with 24V operation, this is a small proportion and so has little effect. It is worth noting that some of these bells are rated 12-24V, and so can be used for intruder alarms. At 12V, the diode does have an effect on volume, so should be removed or shorted out when so used.

Bell wiring

It is desirable that the system keeps sounding for as long as possible after a fire has broken out to ensure that all including anyone who may have been asleep, are roused and aware of the emergency. Wiring to the detectors is not important at this stage, they have done their job in triggering the control box. It is the cable to the bells that needs to be protected. The BS 5939 specifies that preferably, heat-resistant cable should be used for these circuits, or if other types are used they should be protected against direct heat in some way.

Silicon rubber insulation can withstand temperatures up to 390 F (200 C), but is expensive PVC electrical installation cable or elastomer insulated textile braided cable can be used if protected by conduit.

Cable resistance for bell circuits is more significant than that of the detectors because the higher current could lead to an appreciable voltage drop, especially when there are many bells on the circuit. Using 24V as standard instead of 12V for alarm systems helps because the current is only half what it would be for 12V bells, so the voltage drop is halved too. Whatever voltage drop does occur, its proportion to 24V is only half what it is to 12V. So, the total effect of cable resistance is a quarter of what it would be at 12V.

If of solid wire, the BS 5839 further stipulates that cable should be not less than 1.0mm² in diameter, or 0.5mm² for stranded wire. Anything less than 1.0mm² should not be drawn into a conduit unless it is twin twisted which has greater strength, in which case conductors down to 0.5mm² can be drawn.

The Standard also states that fire alarm system cables should be segregated from all others. This can be done by running them in conduit, ducting, trunking, or if exposed, by running them with a separation of at least 300mm from any other. If none of these is practically possible, special easily identifiable cable should be run, or it should be labelled at intervals of not more than 2 metres.

All connections other than those to the detectors should be made in junction boxes labelled 'Fire Alarm'.

In the next article we will discuss what factors govern the location of detectors and bells.

PCB Foils

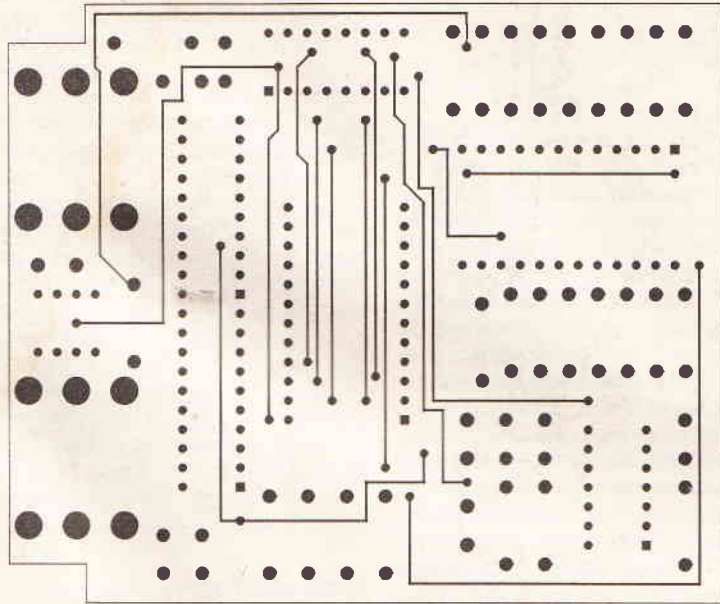

The Foot Tapper — top side

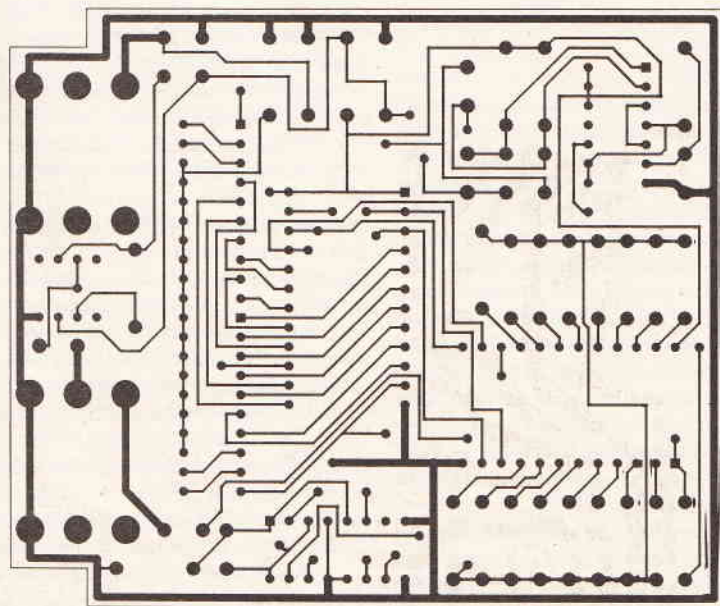

The Foot Tapper — copper side

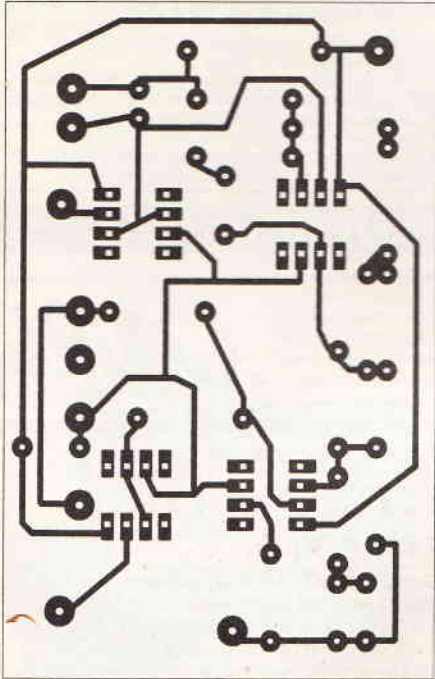

Temperature Controller — Probe PCB

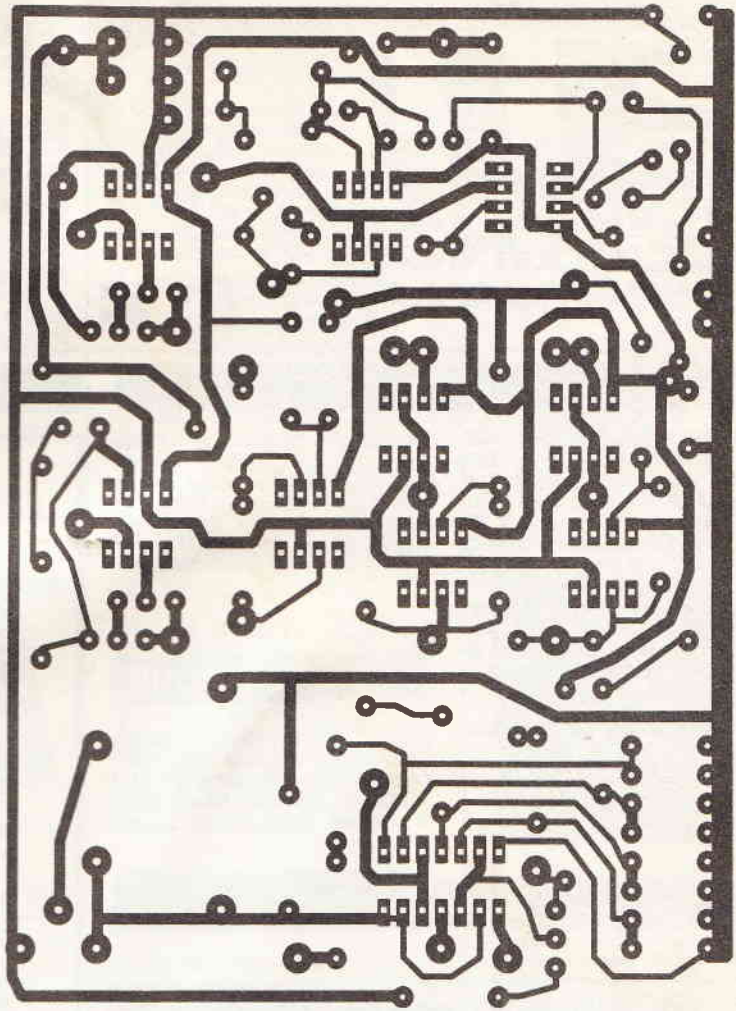

Temperature Controller — Main Board

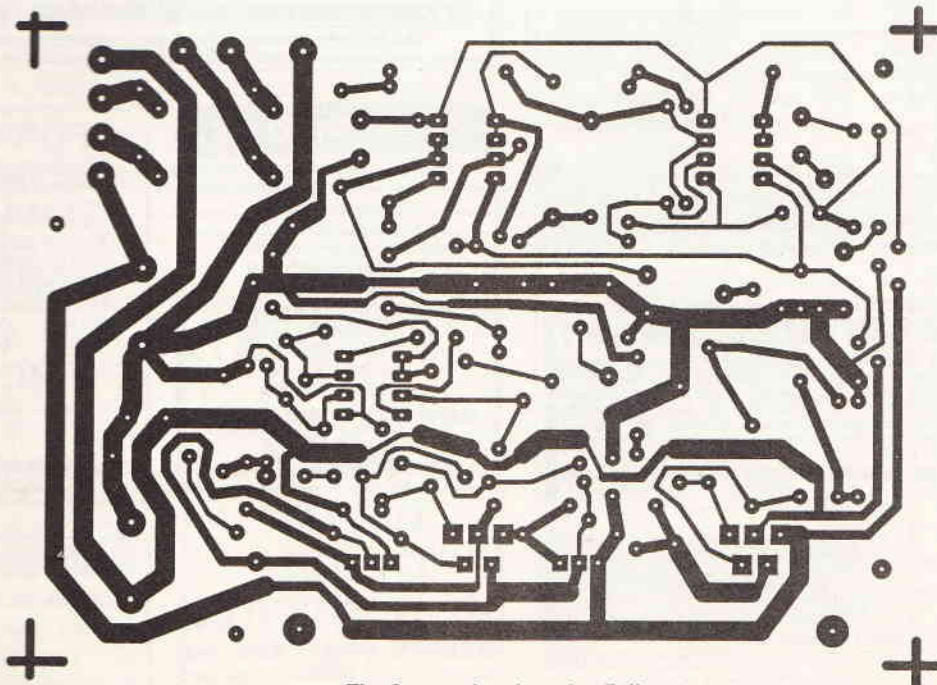

The Consort Loudspeaker Foil

ETI

ELECTRONICS TODAY INTERNATIONAL



CLASSIFIED

James Trott
0442 66551 Ext 250

Send your requirements to:
ETI Classified Department, ASP, Argus House,
Boundary Way, Hemel Hempstead, HP2 7ST.

Lineage: 55p per word (+ VAT) (minimum 15 words)
Semi Display: (minimum 2 cms)
£14.00 per single column centimetre (+ VAT) per
Electromart £22.00 per insertion (+ VAT) per insertion

Ring for information on series bookings/discounts.
All advertisements in this section must be prepaid.
Advertisements are accepted subject to the terms and conditions
printed on the advertisement rate card (available on request).

KITS

NEW VHF MICROTRANSMITTER KIT tuneable 80-135MHz, 500 metre range, sensitive electret microphone, high quality PCB, SPECIAL OFFER complete kit ONLY £5.95, assembled and ready to use £9.95 post free. Access/Visa order telephone 021-411 1821. Cheques/POs to: Quantek Electronics Ltd, Kits Dept (ETI), 45A Station Road, Northfield, Birmingham B31 3TE. S.A.E. for details of this and other kits.

CONSORT SPEAKER KIT as July '91 E.T.I. £188 inclusive. All parts available separately. Memex Electronics Ltd. 1 Icknield Close, Ickleford, Hitchin, Herts SG5 3TD.

MISCELLANEOUS

KITS, plans, etc, for surveillance, protection (sonic and HV), "007" gear. Send 2 x 22p stamps. For list ACE(TI), 53 Woodland Way, Burntwood, Staffs.

CALL
0442 66551
TO ADVERTISE

COURSES

Start training now for the following courses. Send for our brochure — without obligation or Telephone us on 0626 779398

Ref: ETI/07/91

Name _____	<input type="checkbox"/> Telecomms Tech C&G 271
_____	<input type="checkbox"/> Radio Amateur Licence C&G
_____	<input type="checkbox"/> Micro-processor
_____	<input type="checkbox"/> Introduction to Television

Radio & Telecommunications Correspondence School
12 Moor View Drive, Teignmouth, Devon TQ14 9UN

MAKE YOUR INTERESTS PAY!

Over the past 100 years more than 9 million students throughout the world have found it worth their while! An ICS home-study course can help you get a better job, make more money and have more fun out of life! ICS has over 90 years experience in home-study courses and is the largest correspondence school in the world. You learn at your own pace, when and where you want under the guidance of expert personal tutors. Find out how we can help YOU. Post or phone today for your FREE INFORMATION PACK on the course of your choice. (Tick one box only!)

Electronics <input type="checkbox"/>	TV, Video & Hi-Fi Servicing <input type="checkbox"/>
Basic Electronic Engineering (City & Guilds) <input type="checkbox"/>	Refrigeration & Air Conditioning <input type="checkbox"/>
Electrical Engineering <input type="checkbox"/>	Car Mechanics <input type="checkbox"/>
Electrical Contracting/Installation <input type="checkbox"/>	Computer Programming <input type="checkbox"/>
GCSE/GCE/SCE over 40 examination subjects to choose from <input type="checkbox"/>	

Name _____ Address _____

ICS

International Correspondence Schools, Dept. EB551 12/314 High Street, Sutton, Surrey SM1 1PR.
Telephone: 081-643 9568 or 041-221 2926 (24 hours) Dept EBS71

SITUATIONS VACANT

City Poly
City of London Polytechnic

SENIOR LECTURER IN MUSIC TECHNOLOGY

£19,608 – £23,979 p.a.

The successful applicant will join a team of electronics and acoustics specialists teaching 'electronics for the music industry' specialisms on a variety of further and higher education courses.

Applicants should have a degree or equivalent and possibly a higher degree in electronics or a related specialism and previous teaching experience.

Industrial experience in the general field of electronics will be an advantage particularly if related to the audio industry.

Candidates with experience in one or more of the following will have an advantage: sound systems and recording and studio systems; electro-acoustic systems; analogue and digital audio electronic systems; microprocessor and DSP systems; computer applications to music and sound; sound and vibration analysis; CAD systems for electronic circuit analysis and design.

For further details and an application form please write to
The Personnel Department, City of London Polytechnic,
31 Jewry Street, London EC3N 2EY,
quoting reference number. 91/42.

Closing date for receipt of applications is: 28th June 1991.

The Polytechnic is committed to a policy of equal opportunities for all.

WANTED

Turn your surplus transistors, ICs etc. into cash. Immediate settlement. We also welcome the opportunity to quote for complete factory clearance.

Contact:
COLES HARDING & CO.
103 South Brink
Wisbech, Cambs.

NOW ESTABLISHED OVER 15 YEARS

Tel: 0945 584188
Fax Number: 0945 588844

FOR MORE
DETAILS OF
ETI MAGAZINE
CALL
JAMES TROTT
ON
0442 66551

SERVICE MANUALS

SERVICE MANUALS

Available for most equipment

TV's, Video's, Test, Audio etc

Write or phone for quote
MAURITRON (HRT),
8 CHERRY TREE ROAD,
CHINNOR, OXON OX9 4QY
TEL (0844) 51694 FAX (0844) 52554

WANTED FOR CASH test equipment, communications equipment, computer hardware, unused valves, transistors, I.C's etc. Phone 051 523 4464 Fax 051 258 1106

FOR SALE

CAMBRIDGE COMPUTER SCIENCE LIMITED

3.5" 720K Diskette Drives	£38.00 each	280 298 353 365 373 390 399 670	
10MB 5 1/4" Winchester, used, 3 months Why	£42.00 each	2728 EPROMS (Ex equipment)	£120 each or £5.00 /5
5.25" Disk Drives, 80 TK, DSDO	£34.00	2728 EPROMS	£2.50 each
5.25" Disk Drives, 80 TK, DSDO Used, No Why	£15.00	27C26-25 EPROMS	£3.50 each
(The £15.00 drives are sold on a sticky 'as is' basis)		256K Byte DRAM Modules, removed from equipment	£6.00 each
5.25" Disks, DSDO, 48Kb boxes of 10	£3.00 box	616 2K Byte SRAM	£1.10 each
40W PSU 5V 3.75A, 12V 1.5A-12V 0.4A, cased with on/off switch	£18.00 each	6264-12 8K Byte SRAM	£3.00 each
Apricot Disk drive PSU	£18.00 each	62256-10 32K Byte SRAM	£5.00 each
Bare switch mode PSU 5V 2.5A, 12V 2A-12V 0.1 A	£7.00 each	65256 32K Byte RAMs	£4.00 each
5V at 8A PSU	£4.00 each	8K Byte NV ram chips	£3.00 each, £10.00 four
5V at 10A PSU	£5.40 each	20 pin di low profile IC sockets	£0.50/10, £4.00/100
Disk Drive Data lead BBC Micro to Disk Drives		24 pin di low profile IC sockets	£0.55/10, £4.00/100
Single £2.00, Dual £4.00 each		40 pin di low profile IC sockets	£0.60/10, £5.00/100
Disk Drive Power lead BBC Micro to Disk Drives		Carzul tester, finds faults in TTL & CMOS logic circuits, inc leads	£9.00 ea
Single £2.00, Dual £4.00 each		Keyboard, 100 keys on board LCD & macro V/I	£8.00 each
68000 CPUs (The first orders get 10MHz chips)	£3.50 each	Metal project boxes drilled & painted but unused 28x32.5x5cm	£5.00 each
68086 CPU chips	£2.00 each	Toroidal mains transformer, 12V 4A & 0.4A, 12-0-12, 1A & 2A, 9-0-9 2A	£4.00/1, £6.00/2, £8.00/3
280A CPL, CTC, P/O £1.20 each; DMA £2.00	£4.50 all 4	Smoke detectors, small size	£7.00 each
74LS TTL, pick and mix, buy 10 or more for	£0.22 each	Smoke detectors, large with escape light & pause feature	£13.00 each
Types available: 10 12 14 16 18 11 12 13 15 20 21 26 27 30 32			
33 37 38 42 74 83 85 86 96 107 109 122 132 136 158 138 145			
151 153 157 158 160 162 163 164 165 176 181 183 240 253 257			

Prices include postage. Add 50p (plus VAT) to orders below £5.00. All items new unless stated. Add 17.5% VAT to all prices. Send an SAE for our latest list or for more info.
Dept ETI, 374 MILTON ROAD, CAMBRIDGE, CB4 1SU
Tel: 0223 424602 or 0831 430496 (Please note mail order only)

PARTRIDGE ELECTRONICS

- ◆ Two Mic. Inputs + Line Input ◆
- ◆ Auto — Manual Control ◆
- ◆ D.T.M.F. or L.D. /Dialing ◆



OUTSIDE BROADCAST UNIT
EASY TO CARRY
FLIGHT CASE
BROADCAST OVER
STANDARD PHONE NETWORK

REPORTER Model T26



UNIT D
318 HIGH ROAD
BENFLEET
ESSEX SS7 5HB
TELEPHONE: 0268 793381

LYS ELECTRONIC COMPONENTS

555 TIMER	5 for £1.00	741 op.amp	5 for .50
7805+VREG	.40	7905-VREG	.35
7812+VREG	.40	7912-VREG	.35
LM317 ADJ REG	.50	LM337 ADJ REG	.50
ZENER DIODES 400mW ALL AT			.05 EACH
HORIZ/VERT CARBON PRESETS			.12 EACH
1/4W 5% CARBON RESISTORS	0.1 each	(100) .60	(1000) £5.50 any mix
1/4W 5% CARBON RESISTORS	0.2 each	(100) .90	(1000) £7.50 any mix
5mm RED LED .08	GREEN .08	YELLOW .08	
DIL SOCKETS L/PROFILE 8 pin .03	14 pin .05	16 pin .06	18 pin .07
20 pin .08			
DIL SWITCHES 2 way .40	4 way .60	10 way .90	
LM3914 BARGRAPH DRIVER £3.40			
R.F.COAX (ANTI MICROPHONIC) 75 OHM RANGE OUTER SHEATH			
(normally £3.00 mtr) ONLY .90 MTR	100 MTR	£60.00	

DIGITAL FREQUENCY METER KIT 2 RANGES 0-30MHZ/25-100MHZ
COMPLETE INC 3 PCB'S (EXC. METALWORK) £83.60

ANALOG PROBE KIT (EXC. CASE) £9.80

We have one of the largest ranges of used test equipment inc: Scopes, Analysers, Multimeters, Signal Generators, AF Bridges etc. All by leading manufacturers. eg. Philips PM3217 50 MHz Scope £300

For details of any of the above contact:

LYS Electronic Components, 10 Westbrook Road, Porchester, Hants PO16 9NS
Tel: (0705) 386550 Tel/Fax: (0705) 388303 (24 hrs)

SPECIAL OFFERS

CATALOGUE £1 + 25p P&P

Resistor pack, 85 different, E12 values + zero ohm link, total content 1000 resistors	£9.95
LEDs 3mm or 5mm red or green	5p each yellow, 11p each
Cable ties	1p each, £3.95 per 1000, £49.50 per 10,000
Stepping motor, 4 phase, 12V 7.5 step 50 ohms	8.95
SA1102 stepping motor drive chip	£3.95
FM Transmitter kit, good quality sound	£8.60
High quality photo resist copper clad epoxy glass boards	
Dimensions	single sided
3x4in	£0.95
4x6in	£2.40
6x12in	£3.7
12x12in	£10.66
Special offers	
Computer grade capacitors with screw terminals 38,000uf 20v	£2.50
87,000uf 10v, £1.95; 68,000uf 15v, £2.95; 10,000uf 16v, £1.50	
7 segment common anode led display 12mm	£0.45
LM2931A15.0 low drop out 5v regulator, 10,220 package	£0.85
B6250 P channel mosfet £0.45; BC559 transistor £3.95 per 100;	
741,805 hex inverter £10.00 per 100, used B48 Microcontroller	£3.50
Stereo LWMWFM tuner/preamp Assy with volume/controls & tuning scale. Brand new in makers carton £6.95, faulty £3.50, circuit etc for above £3.50	
Hour counter used 7 digit 240v ac 50Hz	£1.45
LCD display 16 digit 7x5 dots, dot matrix	£2.50
QWERTY keyboard, 59 key, good quality switches, new	£3.00
QWERTY keyboard with serial output, no data	£3.00
Wide range of CMOS TTL 74HC 74F Linear Transistors kits, capacitors tools etc always in stock. Please add 95p towards P&P. VAT included.	

JPG ELECTRONICS

276-278 Chatsworth Road, Chesterfield S40 2BH

Access/Visa Orders (0246) 211202 Callers welcome

RING
JAMES TROTT
ON
0442 66551
IF YOU
WOULD
LIKE TO
ADVERTISE IN
ETI
MAGAZINE

N. R. BARDWELL (ETI)

200 Signal Diodes IN4148	£1.00
50 Rectifier Diodes IN4007	£1.00
75 Rectifier Diodes IN4003	£1.00
75 Rectifier Diodes IN4001	£1.00
25 Asstd High Brightness LEDs	£1.00
12 Asstd 7 Segment Displays	£1.00
75 Electrolytics 47UF 50v	£1.00
50 Electrolytics 47UF 50v	£1.00

Prices include VAT, Postage £1.00. Stamps for lists

288 ABBEYSIDE ROAD
SHEFFIELD S7 1FL
TEL 0742 552886
FAX 0742 500689

ETI DIGITAL TACHOMETER KIT with dual LED display and PCB only 4x2 inches. Send £16.90 to H. Deogan, 59 Croxteth Road, Liverpool. L8 35F

SOLAR PANELS 100mm x 60mm 2.5V 0.2Wp £1.40. 6 for £8. 12" x 6" 12V or 6V 1.4Wp £8.50. 12"x 12" 12V 3Wp £15.00. 36" x 12" 12V 5-6Wp £23.50. Prices include U.K. P&P. Larger / mounted panels available. Orders to Bob Keyes GW4 IED. 4 Glanmor Crescent, Newport, Gwent. NP9 8AX.

PLANS

ELECTRONIC PLANS, laser designs, solar and wind generators, high voltage teslas, surveillance devices, pyrotechnics and computer graphics tablet. 150 projects. For catalogue. SAE to Plancentre Publications, Unit 7, Old Wharf Industrial Estate, Dymock Road, Ledbury, Herefordshire, HR8 2HS.

BUILD your own plotter / CNC machine / three axis robot. Full mechanical drawings, electronic circuits, basic programming. £19.95 inc. postage. Burlington Design, (Dept ETI), PO Box 134, Northampton. NN5 5AD.

PROTOTYPE DESIGNER

SPECIAL DISCOUNT TO SCHOOLS AND COLLEGES NOW AVAILABLE



PROTOTYPE DESIGNER
 Grey case, blue sloping top, panel incorporating +5 Volts at 500mA and + - 5 to + - 15 Volts At 1A independently adjusted to improve regulation. All supplies are short circuit protected.
PRICE £85 +£4.50 P&P. Schools and Colleges £78 + £4.50 P&P (photocopy of student union card required as proof) Please allow 28 days delivery

WRITE TO Audio, Video, Design Services, 26 Levislaw Close, Buxton, Norwich. NR10 5HQ

EPROM PROGRAMMING

EPROM PROGRAMMING from £11.50 for 2716. Write or call for details. Paul Coxwell, 30 Alford Road, Sutton on Sea, Lincolnshire. (0507)442160

SURVEILLANCE

YOUR PERSONAL EAVESDROPPER!

Amazingly powerful micro-transmitter
 Performance upgrades possible
 (Instructions in English)



Special price
 £29
 (including postage)

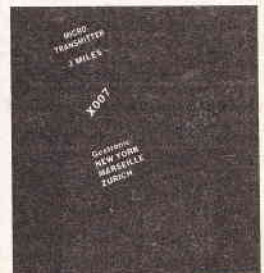

- **EASY TO USE:** Utilize any FM set (car radio, stereo, etc) for reception. Just adjust transmitter frequency to unoccupied area on your existing FM radio.
- **UNOBTAINABLE:** No wires, no connections, no external aerial, fits in anywhere.
- **PRACTICAL:** Compact, light, with up to 250 hours continuous operation on a standard 9 volt battery (not supplied).
- **HANDY AND EFFECTIVE:** For surveillance of children, businesses, garages, suspect or hostile individuals, lawbreakers, etc.
- **Your own D.I.Y. broadcasting station.**

Don't wait to try out this model (Best value for money in the range). Over 30,000 sold to date. Supplied for professionals, detectives, guard services, etc.

ORDER FORM

Satisfied or money back within 10 days
 Send to: GESTRONIC - B.P.99 (ETI)
 13442 Marseille Cantini Cedex France

QUICK AND PERSONAL DELIVERY IN PLAIN WRAPPER

- Please mail me in plain wrapper (tick choice)
- Micro-Transmitter X007, Indicate quantity (unit price £ 29)
 [1] [2] [3] [4] [5]
- I enclose a cheque or postal order (add £ 2 for postage and packing)
- COD (add £ 5 for postage and packing)

NAME _____
 CHRISTIAN NAME _____
 ADDRESS _____

 TOWN _____

E.T.I.

Powerful Miniature **VACUUM CLEANER**

Reader Offer

— use it everywhere ... for a clean sweep.

Ideal for removing dust from all those small modelling jobs, computer keyboards as well as many other uses.

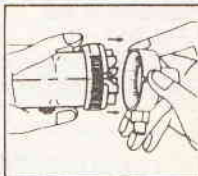
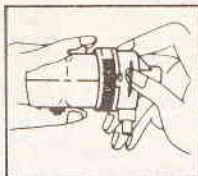

The blower can be opened for cleaning. To do this, detach the interlocking joints as shown.

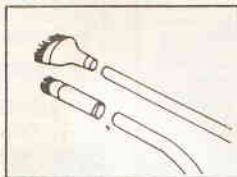

BRUSHES
Two special designed brushes, made of soft pony hair, are included for easy vacuuming.

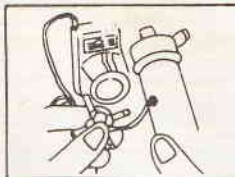

OPERATED BY AC/DC POWER
The unit can be used with common 3 volts adaptor (300mA) which can be plugged into the jack outlet.

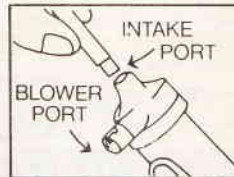

VACUUM & BLOWER ASSEMBLY
For vacuuming, insert end of tube into the intake port. For blowing, face the blower port directly to the target.

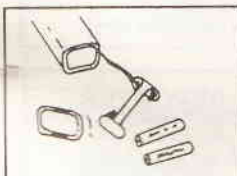

OPERATED BY BATTERY
Slide out the end cap and insert two AA size (UM3) batteries into the battery holder.

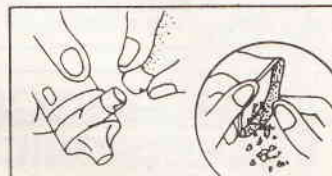

EASY-TO-EMPTY BAG
Join the bag to the blower port in the proper interlocking position. To clean dusts inside the bag, just separate the self-adhesive stripes located at the bottom of the bag.

Please supply ROET/18 @ £5.45 + £1.00 p&p.
I enclose my cheque/P.O. for £ made payable to ASP
or please debit my Access/Visa

Signature Expiry

Name

Address

Postcode

Please allow 28 days for delivery U.K. only (overseas upon request). Please send coupon to ASP Reader Offer, Argus House, Boundary Way, Hemel Hempstead, Herts HP2 7ST.
Please note the above information may be used for marketing purposes.

Telephone orders — call us Now on
0442 66551 (24 hrs)

ASP Reader Offer, Argus House,
Boundary Way, Hemel Hempstead,
Herts HP2 7ST

**Powerful Miniature
VACUUM CLEANER
only £5.45
+£1.00 p&p**

E L E C T R O M A R T

LIVERPOOL

PROGRESSIVE RADIO

87/93 Dale Street Tel: 051 236 0154

47 Whitechapel Tel: 051 236 5489

Liverpool 2

'THE ELECTRONICS SPECIALISTS'

Open: Tues-Sat 9.30-5.30

LONDON

DIRECT ELECTRONICS

ELECTRONICS COMPONENT SPECIALISTS

627 ROMFORD RD,

MANOR PARK

LONDON E12 5AD

Tel: 081-553 1174

Mon-Sat 10-6 pm/Thurs 10-1pm

We stock a large range of TV & Video spares

SOUTH COAST

ELECTRONIC COMPONENTS
are best seen at

FRASER ELECTRONICS

42 ELM GROVE ★ SOUTHSEA ★ HANTS

Telephone (0705) 815584

Barclaycard

Access

COME AND BROWSE BEFORE YOU BUY



Rates: 55p per word (+ VAT) min 15 words. Semi Display £14.00 per insertion per single column cm. Electromart £22.00 + VAT per insertion. Send to ETI Advertising Dept, ASP, Argus House, Boundary Way, Hemel Hempstead, Herts HP2 7ST.

FOR SALE

KITS

PLANS

COURSES

OTHER (PLEASE STATE)

ALL CLASSIFIED ADVERTISEMENTS MUST BE PRE-PAID.
THERE ARE NO REIMBURSEMENTS FOR CANCELLATIONS.

I enclose my Cheque/Postal Order for £ for
insertions, made payable to Argus Specialist Publications.

(*Delete as necessary) or
PLEASE DEBIT MY ACCESS/BARCLAYCARD NO.

.....

£ for insertions

Name

Address

..... Post code

Daytime Tel. No

Signature Date

EXPIRY
DATE





PCB SERVICE

July

TELEPHONE
ORDERS
may be made on
**(0442)
66551**
ACCESS or VISA

- E9107-1 Temperature Controller – Main Board K
- E9107-2 Temperature Controller – Probe PCB F
- E9107-3 The Foot Tapper – Volume Control (double sided) J
- E9107-4 The Consort Loudspeaker H

PCBs for the remaining projects are available from the companies listed in Buylines.

Use the form or a photocopy for your order. Please fill out all parts of the form. Make sure you use the board reference numbers. This not only identifies the board but also tells you when the project was published. The first two numbers are the year, the next two are the month.

Terms are strictly payment with order. We cannot accept official orders but we can supply a proforma invoice if required. Such orders will not be processed until payment is received.

Price code	Price (inc. VAT)
C	£1.80
D	£2.50
E	£3.25
F	£4.00
G	£4.75
H	£5.50
J	£6.62
K	£7.20
L	£8.80
M	£10.60
N	£13.10
O	£15.80
P	£17.90
Q	£21.80
R	£23.90
S	£25.90
T	£29.00
U	£32.20
V	£35.80
W	£37.90
X	£40.70

- | | |
|--|---|
| E9004-2 Bass Amplifier Graphic Equaliser L | E9104-1 Testmeter Volts E |
| E9004-3 Bass Amplifier Micro N | E9104-2 Active Direct Injection Box F |
| E9004-4 Quad Power Supply O | E9104-3 EPROM Eraser F |
| E9005-1 Business Display O | E9104-4 Digital Tachometer F |
| E9005-2 Phone Lock and Logger F | E9104-5 Radio Calibrator F |
| E9006-1 Dark Room Timer G | E9105-1 Modulator Laser (2 boards) H |
| E9006-2 Telephone Extension Bell C | E9105-2 Thyristor Tester F |
| E9006-3 Telephone External Bell D | E9105-3 Frequency Plotter K |
| E9006-4 Fecko Box G | E9106-1 Laser Receiver F |
| E9006-5 Bug Spotter E | E9106-2 Temperature Controller – Power Supply G |
| E9007-1 Guitar Practice Amp G | |
| E9007-2 Digital Frequency Meter M | |
| E9007-3 Footstep Alarm E | |
| E9007-4 Transistor Tester C | |
| E9007-5 Decision Maker J | |
| E9008-1 AC Millivoltmeter K | |
| E9008-2 Temperature Controller N | |
| E9008-3 FM Generator L | |
| E9009-2 Slide Projector Controller E | |
| E9009-2 Ultimate Diode Tester D | |
| E9009-3 The Entertainer G | |
| E9010-1 Component Tester F | |
| E9010-2 Active Contact Pickup E | |
| E9010-3 R4X Longwave Receiver C | |
| E9011-1 The Autocue (2 boards, 1 double sided) ... N | |
| E9011-2 Infra-lock transmitter (2 boards) K | |
| E9011-3 Infra-lock receiver H | |
| E9011-4 Four-track cassette recorder (record/playback one channel) F | |
| E9011-5 Four-track cassette recorder (Bias/erase oscillator board) K | |
| E9012-1 Infra Switch F | |
| E9101-1 Remote Control – Main Board J | |
| E9101-2 Remote Control – Display Board H | |
| E9101-3 Remote Control Timeswitch – Transmit board E | |
| E9101-4 SBC Micro-Controller Board F | |
| E9101-5 SBC Practice Interface Board F | |
| E9101-6 5 in 1 Remote Sensing Switch E | |
| E9102-1 Remote Control Timeswitch – receiver board F | |
| E9102-2 Anti Theft Alarm (2 bds) H | |
| E9103-1 Ariennes Lights L | |
| E9103-2 64K EPROM Emulator N | |
| E9103-3 SSB Radio Receiver G | |
| E9103-4 Active Loudspeaker board H | |

**TO: ETI PCB SERVICE, READERS' SERVICES,
ARGUS HOUSE, BOUNDARY WAY,
HEMEL HEMPSTEAD HP2 7ST**

Please supply:

Quantity	Ref. no.	Price Code	Price	Total Price
----------	----------	------------	-------	-------------

Post and packing £0.75

Total enclosed £

Please send my PCBs to: (BLOCK CAPITALS PLEASE)

Name

Address

Postcode

CHEQUES SHOULD BE MADE PAYABLE TO ASP Ltd.

ETI

ELECTRONICS TODAY INTERNATIONAL

EDITORIAL

Editor Paul Freeman

CREATIVE

Art Editor Peter Kirby

Designer Iain Houston

Technical Illustration Jerry Fowler

Photography Manny Cefai

ADVERTISEMENT SALES

Advertisement Manager

Mark Linacre

Advertisement Sales

Michele Donovan

Advertisement Copy Control

Marie Quilter

MANAGEMENT

Managing Director

Terry Patisson

Circulation & Promotions Manager

Debra Stuppel

Production Manager

Tony Dowdeswell

Group Editor

Mark Webb

ISSN
0142-7229

ABC

Member of the
Audit Bureau
of Circulation

ETI is normally published on the first Friday in the month preceding the cover date. The contents of this publication including all articles, designs, plans, drawings and programs and all copyright and other intellectual property rights therein belong to Argus Specialist Publications. All rights conferred by the Law of Copyright and other intellectual property rights and by virtue of international copyright conventions are specifically reserved to Argus Specialist Publications and any reproduction requires the prior written consent of the Company © 1990 Argus Specialist Publications. All reasonable care is taken in the preparation of the magazine contents, but the publishers cannot be held legally responsible for errors. Where mistakes do occur, a correction will normally be published as soon as possible afterwards. All prices and data contained in advertisements are accepted by us in good faith as correct at the time of going to press. Neither the advertisers nor the publishers can be held responsible, however, for any variations affecting price or availability which may occur after the publication has closed for press.

● Subscription rates — UK: £19.20. Europe: £24.10. Middle East: £24.40. Far East: £26.80. Rest: £25.85 or US\$48.00.

Published by Argus Specialist Publications, Argus House, Boundary Way, Hemel Hempstead HP2 7ST. Tel: (0442) 66551. UK newstrade distribution by SM Distribution Ltd., 6 Leigham Court Road, London SW16 2PG. Tel: 081-677 8111. Overseas and non-newstrade sales by Magazine Sales Department, Argus House, Boundary Way, Hemel Hempstead, HP2 7ST. Tel: (0442) 66551. Subscriptions by Select Subscriptions Ltd., 5 River Park Estate, Berkhamsted, Herts HP4 1HL. Tel: (0442) 876661. US subscriptions by Wise Owl Worldwide Publications, 4314 West 238th Street, Torrance, CA90505 USA. Tel: (213) 3756258. Typesetting and origination by Project 3 Filmsetters, Whitstable. Printed by Acorn Web Offset Ltd, Bradford, W Yorks.



Argus House, Boundary Way,
Hemel Hempstead HP2 7ST
Tel: (0442) 66551 Fax: (0442) 66998

NEXT MONTH

As time flies rapidly into the heat of the summer once again ETI has a mixed bag of items for you to read on the beach, in the hotel or in the tent.

We finalise our series on laser topics with a look at how the medical profession use these invaluable tools to cut, repair or destroy unwanted material.

In the light of TV manufacturers producing the first wide screen, higher definition TV sets, James Archer looks at a possible world standard for the next generation sets.

Back to basics examines capacitive and inductive reactance and we start a two part article on Fault finding to give you ideas on what to do with that heap of scrap in the corner that is crying out to be mended

If you are at home, the option is there to turn to more practical matters. ETI presents two model railway controllers for you to decide which most suits your needs for motor control or try constructing The Hemisyc. With the long awaited return to biofeedback techniques, here is a machine to help you relax and be creative.

All this and more at your newsagent on 5th July.

The above articles are in preparation but circumstances may prevent publication

LAST MONTH

The June issue included:

Fire Detection systems Part 1
Local Operating Networks
Piezo-Film Technology
Temperature Controller Part 1
Laser receiver
Temperature Sensor ICs
Supercomponents-Component quality

Back issues are available from Select Subscriptions
(Address on this page).

ADVERTISERS' INDEX

BK ELECTRONICS	IFC	MAPLIN ELECTRONICS	OBC
BLUE ROSE ELECTRONICS	20	NUMBER ONE SYSTEMS	57
CIRKIT ELECTRONICS	28	OMNI ELECTRONICS	26
DISPLAY ELECTRONICS	14	REED ELECTRONICS	26
ELECTRONIZE	7	R&TV COMPONENTS	21
HALCYON ELECTRONICS	26	SUMA ELECTRONICS	34
HART ELECTRONICS	28	WIMSLow AUDIO	7
J&N BULL	Insert, 35		

Take the Sensible Route!

BoardMaker is a powerful software tool which provides a convenient and fast method of designing printed circuit boards. Engineers worldwide have discovered that it provides an unparalleled price performance advantage over other PC-based and dedicated design systems by integrating sophisticated graphical editors and CAM outputs at an affordable price.

NEW VERSION

In the new version V2.23, full consideration has been given to allowing designers to continue using their existing schematic capture packages as a front end to BoardMaker. Even powerful facilities such as Top Down Modification, Component renumber and Back Annotation have been accommodated to provide overall design integrity within the links between your schematic package and BoardMaker.

Equally, powerful features are included to ensure that users who do not have schematic capture software can take full advantage BoardMaker.

£295

V2.23 of BoardMaker is still a remarkable £295.00 and includes 3 months free software updates.

NEW AUTOROUTER

BoardRouter is a new integrated gridless autoroute module which overcomes the limitations normally associated with autorouting. **YOU** specify the track width, via size and design rules for individual nets, BoardRouter then routes the board based on these settings in the same way you might route it yourself manually.

This ability allows you to autoroute mixed technology designs (SMD, analogue, digital, power switching etc) in **ONE PASS** while respecting **ALL** design rules.

GRIDLESS ROUTING

No worrying about whether tracks will fit between pins. If the tracks widths and clearances allow, BoardRouter will automatically place 1, 2 or even 3 tracks between pins.

FULLY RE-ENTRANT

You can freely pre-route any tracks manually using BoardMaker prior to autorouting. Whilst autorouting you can pan and zoom to inspect the routes placed, interrupt it, manually modify the layout and resume autorouting.

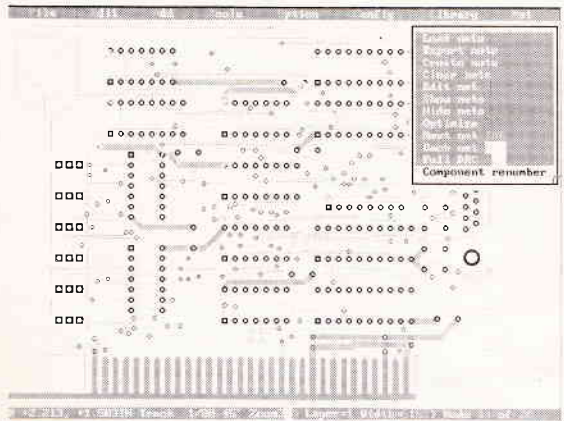

Full analogue, digital and SM support - ground and power planes - 45 degree, arced and any angle tracks with full net-based Design Rule

HIGHLIGHTS

- Net list input from OrCAD, Schema, etc
- Top down modification
- Forward and back annotation
- Component renumber
- Simultaneously routes up to eight layers
- Fully re-entrant gridless autorouting
- Powerful component placement tools
- Extensive Design Rule Checking
- Full complement of CAM outputs
- Full support and update service
- Reports generator
- PostScript output
- SMD support
- Effortless manual routing

£495

BoardMaker and BoardRouter are priced at £295.00 each. As a special introductory offer, they can be bought together for only £495.00 which puts sophisticated PCB CAD software within the reach of all engineers. This price includes 3 months free software updates and full telephone technical support.

Don't just take our word for it. Call us today for a FREE Evaluation Pack and judge it for yourself.

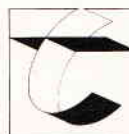

tsien

Tsien (UK) Limited
Cambridge Research Laboratories
181A Huntingdon Road
Cambridge CB3 0DJ
Tel 0223 277777
Fax 0223 277747



NICAM!

...set your sights on a better sound!

Experience a new sensation. An experience that opens up a whole new spectrum of sound.

Put yourself on stage at the Albert Hall, surrounded by a great orchestra. Imagine the sound you will hear, every nuance, every note; or travel up the Nile with an intrepid explorer, a journey not only full of breathtaking beauty and colour, but rich in the sounds of another continent; or capture the hidden gasps of 100,000 hardened fans at Wembley for the F.A. Cup Final, when the ball skims the crossbar with the last kick of the match; follow with your ears as well as your eyes, dodging the bullets, as your favourite hero battles out of yet another tight corner, it's just like being in a cinema!

Nicam hi-fi stereo will turn your living-room into a living room of

sound! You don't settle for second best with television picture quality, why settle for second best in television sound quality? Nicam sound is the new high quality digital stereo sound system, pioneered by BBC, ITV and TV/video manufacturers. In fact so good is Nicam it is comparable to the superb sound reproduction of the compact disc, when played through your existing hi-fi arrangement. If your television hasn't got a built-in Nicam decoder, you will need the Maplin Nicam Tuner System. Ultimately almost all of your favourite programmes will be broadcast in superb hi-fi quality stereo-sound. Without a Maplin Nicam Tuner you won't be able to capture every sound to its full.

Nicam hi-fi stereo. Catch your breath, open your eyes, and pin back your ears! It's what your hi-fi system was made for... It's what your ears are made for!

DIGITAL STEREO TV SOUND FROM YOUR HI-FI

The complete kit contains all the components required to build the unit. However you will also need: a power supply, 12V at 600mA regulated e.g. YZ21X at £9.95; a co-ax Y adaptor e.g. FS23A at £1.20; a co-ax lead to connect to your TV or video, RW36P 2m long at £1.36, JW39N 5m long at £1.98, or JW40T 10m long at £2.95; a phono lead to connect to your hi-fi e.g. RW50E at £1.06 or a SCART/Peritel lead JW36P at £5.95. An infra-red remote control kit is also available LP20W at £29.95.

Complete kit LP19V only £149.95 incl. VAT + £1 mail-order handling charge.



Maplin ELECTRONICS
CREDIT CARD HOTLINE
0702 554161

For a friendly welcome and the very best of service why not visit our shops in Birmingham, Brighton, Bristol, Leeds, London (Edgware and Hammersmith), Manchester, Newcastle-upon-Tyne, Nottingham, Reading, Southampton and Southend-on-Sea.
 Subject to availability. Prices subject to change.

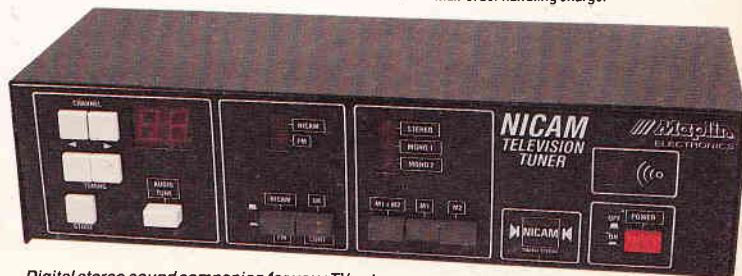

Digital stereo sound companion for your TV set.