

JULY 1974

# electronics

today

INTERNATIONAL

20p

**2**  
**GREAT ETI**  
**READER**  
**OFFERS**  
**INSIDE**

HOW CLOSE ARE WE TO  
THE DEATH-RAY-LASER?....

PLUS:  
DIGITAL FAULT FINDING  
BURGLAR-PROOF YOUR HOME  
SINCLAIR 4000 AMPLIFIER TESTED

**HI-FI**

... CONSTRUCTION ... COMMUNICATIONS ... DEVELOPMENTS

CHRIS PEAN



# AMTRON kits for the audio enthusiast



UK 190

## HI-FI AMPLIFIER 50W

Specifications  
Output power (with 5% distortion): 50 W  
Output power (with 1% distortion): 40 W  
Frequency range: 10-10,000 Hz  $\pm$  2 dB  
Output impedance: 4  $\Omega$   
Input impedance: 1 k $\Omega$   
Sensitivity: 1 V

£34.66



UK 270

Specifications  
Power supply: 15 V DC, max.  
Load resistance: 8  $\Omega$   
Output power: 6 W, peak  
No. 1 input sensitivity at 1000 Hz: 200 mV  
No. 2 input sensitivity at 1000 Hz: 230 mV  
Frequency response: 50-15,000 Hz  
No. 1 input impedance at 1000 Hz: 150 k $\Omega$   
No. 2 input impedance at 1000 Hz: 220 k $\Omega$   
TAA611/C

£9.86



UK 120

## HI-FI AMP. 12W

Specifications  
Output power: 12 W, peak  
Frequency response: 20-20,000 Hz  
Sensitivity: 2 mV  
Impedance: 8  $\Omega$   
Power supply: 24 V DC

£5.20



UK 275

## MIKE PRE-AMPLIFIER

Specifications  
Power supply: 9 V DC  
Current drain: 5 mA  
Gain (at 1000 Hz): 30 dB  
Input impedance: 10 k $\Omega$   
Output impedance: 1.5 k $\Omega$

£7.68



UK 460

## F.M. SIGNAL GENERATOR

Specification  
Power source: 9 V battery, or in connection to a Power Supply  
Fixed centre frequency signal: 10.7 MHz  
Variable frequency signal: 80 to 109 MHz, continuously adjustable  
FM frequency deviation: continuously adjustable from 0 to 75 kHz  
AM depth: 30%  
Modulation frequency  
AM: 1000 Hz; FM: 400 Hz

£19.96

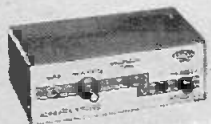

UK 760

## ACCOUSTIC SWITCH

Specifications  
Current drain: 3 to 30 mA  
Bulb current drain: 80 mA  
Mike input sensitivity: 3  $\mu$ V at 1000 Hz  
Input impedance: 300  $\Omega$   
Excitation time constant range: 2 to 10 secs.

£13.83

UK 230

## AM/FM ANTENNA AMPLIFIER

Specifications  
Power supply: 9 to 15 V DC  
Supply current: 5 to 10 mA  
Amplification (up to 20 MHz): 20 dB  
Amplification (up to 100 MHz): 8 dB  
Amplification (up to 210 MHz): 3 dB  
Input impedance: 50 to 300  $\Omega$   
Output impedance: 50 to 75  $\Omega$   
Transistor: (1) BF125

£3.62



UK 195

## MINIATURE AMPLIFIER 2W

Specifications  
Output power (at 12 V DC): 2 W  
Input sensitivity: 100 mV  
Input impedance: 200 k $\Omega$   
Output impedance: 4  $\Omega$

£4.03

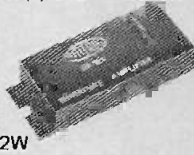

UK 127

## NOISE REDUCTION UNIT

Specification  
Power supply: 12 V DC, through the output connector  
Amplifier gain: 1  
Input impedance: higher than 10 k $\Omega$   
Output impedance: lower than or equal to 10 k $\Omega$   
Max. permissible input signal: 2 V  
Min. input signal: 50 mV  
Turn-over frequency: 2 kHz  
Attenuation characteristics:  
Frequency: 1 kHz 2 kHz 4 kHz 8 kHz  
10 kHz 20 kHz  
Attenuation: 0 dB 3 dB 6 dB 12 dB 14 dB 20 dB

£10.51

UK 142  
TONE CONTROL UNIT

Specification  
Gain at the centre frequency of 1000 Hz: 0 dB  
Maximum attenuation for bass and treble frequencies: 20 dB  
Maximum boost for bass and treble frequencies: 20 dB  
Maximum amplitude of input signal: 30 mV rms  
Maximum amplitude of output signal: 300 mV rms

£7.68



UK 550/S

## L.F. FREQUENCY METER

0 Hz to 100 kHz

£25.38



UK 570/S

## LOW FREQUENCY SIG. GEN'R. 10Hz to 1 MHz.

Specification  
Frequency range  
10 Hz to 800 kHz, as follows:  
x 1 = 10 to 100 Hz  
x 10 = 100 to 1000 Hz  
x 100 = 1 to 10 kHz  
x 1k = 10 to 100 kHz  
x 10k = 100 kHz to 800 kHz

£23.58

### KITS ALSO AVAILABLE BUT NOT ILLUSTRATED

UK 165

R.I.A.A. EQUALIZED STEREO PRE-AMPLIFIER  
£5.83

UK 167 STEREO PRE-AMP. TO R.I.A.A. or C.C.I.R. STAND.  
£7.68

UK 175 HI-FI STEREO PRE-AMP. WITH TONE CONT'S  
£35.28

UK 160 I.C. AMPLIFIER 8W  
£12.71

UK 115 HI-FI AMPLIFIER 8W  
£4.95

UK 125 STEREO CONTROL UNIT.  
£7.27

UK 110/A STEREO AMP 5+5W  
£12.71

UK 192 HI-FI STEREO AMP 50+50W  
£52.62  
UK 765 MULTIPLE STEREO CON'R. £3.64

ALL PRICES INCLUDE V.A.T.  
Trade Enquiries Invited



AMTRON UK · 4 & 7 CASTLE STREET · HASTINGS · SUSSEX · TELEPHONE HASTINGS (0424) 437875.  
All Educational Enquiries to Phillip Harris Ltd., Ludgate Hill, Birmingham. Tel: 021-236 4041.



# electronics today international

JULY 1974

Vol.3 No.7.

## main features

LASERS AT WORK . . . . .	10
<i>Is the death-ray laser a possibility?</i>	
TECHNIQUES OF DIGITAL FAULT-FINDING . . . . .	18
<i>Totally new techniques and servicing equipment are required.</i>	
DIGITAL SERVICING TOOLS . . . . .	24
<i>Fault-finding is quick and simple - if the right tools are used.</i>	
DIGITAL FAULT-FINDING METHODS . . . . .	26
<i>Logical test procedure speeds digital fault-finding routine.</i>	
EARLY RADIO PATENTS—PART TWO . . . . .	44
<i>A history of radio up until 1914.</i>	
ELECTRONICS—IT'S EASY . . . . .	56
<i>A new approach to basic electronics.</i>	

## projects

BURGLAR-PROOF YOUR HOME . . . . .	30
<i>Various straightforward circuits are described.</i>	
ETI MUSIC SYNTHESISER . . . . .	52
<i>The output circuits, control buffers and exponential converter.</i>	
TRANSISTOR TESTER . . . . .	68
<i>Measure parameters and test your transistors with this simple project.</i>	

## product tests

TEAC-A360 CASSETTE RECORDER . . . . .	38
<i>Latest and improved version of the successful A-350.</i>	
SINCLAIR SYSTEM 4000 AMPLIFIER . . . . .	40
<i>A moderately priced unit with good performance.</i>	
EMI 1515 AMPLIFIER . . . . .	42
<i>Amplifier of EMI's new system is tested.</i>	

## news & information

NEWS DIGEST . . . . .	6
PREVIEW OF AUGUST'S ETI . . . . .	36
ELECTRONICS TOMORROW . . . . .	64
TECH-TIPS . . . . .	66
DX MONITOR . . . . .	69

**TWO GREAT READER OFFERS** . . . . . **35**  
*Ten power transistors for £1 and Amtron Stereo Amplifier kit at 30% discount.*

Cover: ETI-Man is right out of popular Science-Fiction with his Laser gun, but is it a real possibility? See laser at work on page 10.

EDITORIAL & ADVERTISEMENT OFFICE  
36, Ebury Street, London SW1W 0LW,  
Tel. 01-730 2139.

HALVOR MOORSHEAD

*Editor*

ROBERT EVANS

*Advertisement Manager*

JEAN BELL

*Production Assistant*

HELEN GIMPLE

*Editorial Assistant*

KARRON MOORE

*Secretarial*

International Editions

COLLYN RIVERS

*Editorial Director*

Australia

BRIAN CHAPMAN

*Technical Editor*

ANDREW POZNIAK

*Assistant Editor*

BARRY WILKINSON

*Engineering Manager*

France

DENIS JACOB

*Editor-in-chief*

CHRISTIAN DARTEVELLE

*Editor*

Published by: Modern Magazines (Holdings) Ltd  
36, Ebury Street, London SW1W  
0LW.

Electronics Today International is published on  
the third Friday in the month prior to the cover  
date.

Distributed by: Argus Press Ltd.

Printed by: Alabaster Passmore & Sons Ltd.  
London and Maidstone.

International Associates:

Australia: Modern Magazines (Holdings) Ltd,  
Ryrie House, 15 Boundary Street, Ruchcutters  
Bay 2011, Sydney, Australia.

France: Electroniques Pour Vous International,  
17 Rue de Buci, Paris, France.

USA: ACP, Room 401, 1501 Broadway, New  
York, USA.

European News Bureau: H. Dvoretzky, Manager,  
107 Fleet Street, London EC4.

**CORRESPONDENCE:** Readers queries can only  
be answered if they relate to recent articles  
published in the magazine and must be accompanied  
by a stamped, self-addressed envelope. We are  
rarely able to provide information in addition  
to that published. Answers may be subject to  
delays at certain times due to the production  
schedule of the magazine.

**BACK NUMBERS:** Back numbers of most issues  
are available at 25p each plus 7p postage.

**SUBSCRIPTIONS:** Great Britain, £3.60 per year,  
Overseas, £4.00 per year.

**COPYRIGHT:** All material is subject to World-  
wide Copyright protection. All reasonable care  
is taken in the preparation of the magazine to  
ensure accuracy but ETI cannot be held responsible  
for it legally. Where errors do occur, a correction  
will be printed as soon as possible afterwards in the  
magazine.



# The largest selection

## BRAND NEW FULLY GUARANTEED DEVICES

AC107 0.22	AD140 0.55	RC153 0.31	BD136 0.44	BF188 0.44	MPF105 0.41	3N171B 0.13	2N2222 0.22	2N3937 0.16	2N4061 0.13
AC113 0.20	AD141 0.27	BC154 0.33	DD137 0.50	BF194 0.13	OC110 0.39	2G118 0.19	2N2368 0.19	2N3939 0.16	2N4062 0.13
AC115 0.22	AF115 0.27	BC157 0.27	DD138 0.55	BF195 0.13	OC122 0.52	2G374 0.19	2N2369 0.16	2N3940 0.16	2N4064 0.13
AC117K 0.32	AF116 0.27	BC158 0.13	DD139 0.61	BF196 0.16	OC132 0.54	2G377 0.33	2N2369A 0.16	2N3945 0.19	2N4285 0.19
AC122 0.13	AF117 0.27	BC159 0.13	DD140 0.66	BF197 0.16	OC135 0.54	2G378 0.18	2N2411 0.27	2N4040 0.23	2N4286 0.19
AC125 0.19	AF118 0.19	BC160 0.50	DD141 0.66	BF200 0.50	OC136 0.52	2G381 0.18	2N2412 0.27	2N4045 0.23	2N4287 0.19
AC126 0.19	AF119 0.27	BC161 0.55	DD142 0.66	BF202 0.55	OC137 0.52	2G382 0.16	2N2416 0.32	2N4046 0.23	2N4288 0.19
AC127 0.20	AF120 0.33	BC162 0.55	DD143 0.66	BF205 0.55	OC138 0.52	2G383 0.16	2N2417 0.33	2N4046 0.23	2N4289 0.19
AC128 0.20	AF121 0.33	BC163 0.13	DD144 0.66	BF207 0.55	OC139 0.52	2G414 0.33	2N2418 0.33	2N4047 0.17	2N4290 0.19
AC132 0.16	AF122 0.33	BC164 0.13	DD145 0.66	BF208 0.55	OC140 0.52	2G417 0.28	2N2419 0.33	2N4048 0.17	2N4291 0.19
AC134 0.16	AF123 0.33	BC165 0.13	DD146 0.66	BF209 0.55	OC141 0.52	2G418 0.28	2N2420 0.33	2N4049 0.17	2N4292 0.19
AC137 0.16	AF124 0.33	BC166 0.13	DD147 0.66	BF210 0.55	OC142 0.52	2G419 0.28	2N2421 0.33	2N4050 0.17	2N4293 0.19
AC141 0.20	AF125 0.33	BC167 0.13	DD148 0.66	BF211 0.55	OC143 0.52	2G420 0.28	2N2422 0.33	2N4051 0.17	2N4294 0.19
AC141K 0.32	AF126 0.33	BC168 0.13	DD149 0.66	BF212 0.55	OC144 0.52	2G421 0.28	2N2423 0.33	2N4052 0.17	2N4295 0.19
AC142 0.20	AF127 0.33	BC169 0.13	DD150 0.66	BF213 0.55	OC145 0.52	2G422 0.28	2N2424 0.33	2N4053 0.17	2N4296 0.19
AC142K 0.28	AF128 0.33	BC170 0.13	DD151 0.66	BF214 0.55	OC146 0.52	2G423 0.28	2N2425 0.33	2N4054 0.17	2N4297 0.19
AC151 0.17	AF129 0.41	BC171 0.16	DD152 0.66	BF215 0.55	OC147 0.52	2G424 0.28	2N2426 0.33	2N4055 0.17	2N4298 0.19
AC154 0.22	AF130 0.33	BC172 0.16	DD153 0.66	BF216 0.55	OC148 0.52	2G425 0.28	2N2427 0.33	2N4056 0.17	2N4299 0.19
AC155 0.22	AF131 0.33	BC173 0.16	DD154 0.66	BF217 0.55	OC149 0.52	2G426 0.28	2N2428 0.33	2N4057 0.17	2N4300 0.19
AC156 0.22	AF132 0.33	BC174 0.16	DD155 0.66	BF218 0.55	OC150 0.52	2G427 0.28	2N2429 0.33	2N4058 0.17	2N4301 0.19
AC157 0.27	AF133 0.33	BC175 0.24	DD156 0.66	BF219 0.55	OC151 0.52	2G428 0.28	2N2430 0.33	2N4059 0.17	2N4302 0.19
AC165 0.22	AF134 0.33	BC176 0.24	DD157 0.66	BF220 0.55	OC152 0.52	2G429 0.28	2N2431 0.33	2N4060 0.17	2N4303 0.19
AC167 0.22	AF135 0.33	BC177 0.24	DD158 0.66	BF221 0.55	OC153 0.52	2G430 0.28	2N2432 0.33	2N4061 0.17	2N4304 0.19
AC168 0.27	AF136 0.33	BC178 0.24	DD159 0.66	BF222 0.55	OC154 0.52	2G431 0.28	2N2433 0.33	2N4062 0.17	2N4305 0.19
AC169 0.16	AF137 0.33	BC179 0.24	DD160 0.66	BF223 0.55	OC155 0.52	2G432 0.28	2N2434 0.33	2N4063 0.17	2N4306 0.19
AC176 0.22	AF138 0.33	BC180 0.27	DD161 0.66	BF224 0.55	OC156 0.52	2G433 0.28	2N2435 0.33	2N4064 0.17	2N4307 0.19
AC177 0.27	AF139 0.33	BC181 0.27	DD162 0.66	BF225 0.55	OC157 0.52	2G434 0.28	2N2436 0.33	2N4065 0.17	2N4308 0.19
AC178 0.24	AF140 0.33	BC182 0.11	DD163 0.66	BF226 0.55	OC158 0.52	2G435 0.28	2N2437 0.33	2N4066 0.17	2N4309 0.19
AC179 0.31	AF141 0.33	BC183 0.11	DD164 0.66	BF227 0.55	OC159 0.52	2G436 0.28	2N2438 0.33	2N4067 0.17	2N4310 0.19
AC180 0.22	AF142 0.33	BC184 0.11	DD165 0.66	BF228 0.55	OC160 0.52	2G437 0.28	2N2439 0.33	2N4068 0.17	2N4311 0.19
AC180K 0.32	AF143 0.33	BC185 0.11	DD166 0.66	BF229 0.55	OC161 0.52	2G438 0.28	2N2440 0.33	2N4069 0.17	2N4312 0.19
AC181 0.22	AF144 0.33	BC186 0.11	DD167 0.66	BF230 0.55	OC162 0.52	2G439 0.28	2N2441 0.33	2N4070 0.17	2N4313 0.19
AC181K 0.32	AF145 0.33	BC187 0.11	DD168 0.66	BF231 0.55	OC163 0.52	2G440 0.28	2N2442 0.33	2N4071 0.17	2N4314 0.19
AC182 0.24	AF146 0.33	BC188 0.11	DD169 0.66	BF232 0.55	OC164 0.52	2G441 0.28	2N2443 0.33	2N4072 0.17	2N4315 0.19
AC182K 0.24	AF147 0.33	BC189 0.11	DD170 0.66	BF233 0.55	OC165 0.52	2G442 0.28	2N2444 0.33	2N4073 0.17	2N4316 0.19
AC183 0.24	AF148 0.33	BC190 0.11	DD171 0.66	BF234 0.55	OC166 0.52	2G443 0.28	2N2445 0.33	2N4074 0.17	2N4317 0.19
AC183K 0.24	AF149 0.33	BC191 0.11	DD172 0.66	BF235 0.55	OC167 0.52	2G444 0.28	2N2446 0.33	2N4075 0.17	2N4318 0.19
AC184 0.24	AF150 0.33	BC192 0.11	DD173 0.66	BF236 0.55	OC168 0.52	2G445 0.28	2N2447 0.33	2N4076 0.17	2N4319 0.19
AC184K 0.24	AF151 0.33	BC193 0.11	DD174 0.66	BF237 0.55	OC169 0.52	2G446 0.28	2N2448 0.33	2N4077 0.17	2N4320 0.19
AC185 0.22	AF152 0.33	BC194 0.11	DD175 0.66	BF238 0.55	OC170 0.52	2G447 0.28	2N2449 0.33	2N4078 0.17	2N4321 0.19
AC185K 0.22	AF153 0.33	BC195 0.11	DD176 0.66	BF239 0.55	OC171 0.52	2G448 0.28	2N2450 0.33	2N4079 0.17	2N4322 0.19
AC186 0.22	AF154 0.33	BC196 0.11	DD177 0.66	BF240 0.55	OC172 0.52	2G449 0.28	2N2451 0.33	2N4080 0.17	2N4323 0.19
AC186K 0.22	AF155 0.33	BC197 0.11	DD178 0.66	BF241 0.55	OC173 0.52	2G450 0.28	2N2452 0.33	2N4081 0.17	2N4324 0.19
AC187 0.22	AF156 0.33	BC198 0.11	DD179 0.66	BF242 0.55	OC174 0.52	2G451 0.28	2N2453 0.33	2N4082 0.17	2N4325 0.19
AC187K 0.22	AF157 0.33	BC199 0.11	DD180 0.66	BF243 0.55	OC175 0.52	2G452 0.28	2N2454 0.33	2N4083 0.17	2N4326 0.19
AC188 0.24	AF158 0.33	BC200 0.11	DD181 0.66	BF244 0.55	OC176 0.52	2G453 0.28	2N2455 0.33	2N4084 0.17	2N4327 0.19
AC188K 0.24	AF159 0.33	BC201 0.11	DD182 0.66	BF245 0.55	OC177 0.52	2G454 0.28	2N2456 0.33	2N4085 0.17	2N4328 0.19
AC189 0.24	AF160 0.33	BC202 0.11	DD183 0.66	BF246 0.55	OC178 0.52	2G455 0.28	2N2457 0.33	2N4086 0.17	2N4329 0.19
AC189K 0.24	AF161 0.33	BC203 0.11	DD184 0.66	BF247 0.55	OC179 0.52	2G456 0.28	2N2458 0.33	2N4087 0.17	2N4330 0.19
AC190 0.22	AF162 0.33	BC204 0.11	DD185 0.66	BF248 0.55	OC180 0.52	2G457 0.28	2N2459 0.33	2N4088 0.17	2N4331 0.19
AC190K 0.22	AF163 0.33	BC205 0.11	DD186 0.66	BF249 0.55	OC181 0.52	2G458 0.28	2N2460 0.33	2N4089 0.17	2N4332 0.19
AC191 0.22	AF164 0.33	BC206 0.11	DD187 0.66	BF250 0.55	OC182 0.52	2G459 0.28	2N2461 0.33	2N4090 0.17	2N4333 0.19
AC191K 0.22	AF165 0.33	BC207 0.11	DD188 0.66	BF251 0.55	OC183 0.52	2G460 0.28	2N2462 0.33	2N4091 0.17	2N4334 0.19
AC192 0.22	AF166 0.33	BC208 0.11	DD189 0.66	BF252 0.55	OC184 0.52	2G461 0.28	2N2463 0.33	2N4092 0.17	2N4335 0.19
AC192K 0.22	AF167 0.33	BC209 0.11	DD190 0.66	BF253 0.55	OC185 0.52	2G462 0.28	2N2464 0.33	2N4093 0.17	2N4336 0.19
AC193 0.22	AF168 0.33	BC210 0.11	DD191 0.66	BF254 0.55	OC186 0.52	2G463 0.28	2N2465 0.33	2N4094 0.17	2N4337 0.19
AC193K 0.22	AF169 0.33	BC211 0.11	DD192 0.66	BF255 0.55	OC187 0.52	2G464 0.28	2N2466 0.33	2N4095 0.17	2N4338 0.19
AC194 0.22	AF170 0.33	BC212 0.11	DD193 0.66	BF256 0.55	OC188 0.52	2G465 0.28	2N2467 0.33	2N4096 0.17	2N4339 0.19
AC194K 0.22	AF171 0.33	BC213 0.11	DD194 0.66	BF257 0.55	OC189 0.52	2G466 0.28	2N2468 0.33	2N4097 0.17	2N4340 0.19
AC195 0.22	AF172 0.33	BC214 0.11	DD195 0.66	BF258 0.55	OC190 0.52	2G467 0.28	2N2469 0.33	2N4098 0.17	2N4341 0.19
AC195K 0.22	AF173 0.33	BC215 0.11	DD196 0.66	BF259 0.55	OC191 0.52	2G468 0.28	2N2470 0.33	2N4099 0.17	2N4342 0.19
AC196 0.22	AF174 0.33	BC216 0.11	DD197 0.66	BF260 0.55	OC192 0.52	2G469 0.28	2N2471 0.33	2N4100 0.17	2N4343 0.19
AC196K 0.22	AF175 0.33	BC217 0.11	DD198 0.66	BF261 0.55	OC193 0.52	2G470 0.28	2N2472 0.33	2N4101 0.17	2N4344 0.19
AC197 0.22	AF176 0.33	BC218 0.11	DD199 0.66	BF262 0.55	OC194 0.52	2G471 0.28	2N2473 0.33	2N4102 0.17	2N4345 0.19
AC197K 0.22	AF177 0.33	BC219 0.11	DD200 0.66	BF263 0.55	OC195 0.52	2G472 0.28	2N2474 0.33	2N4103 0.17	2N4346 0.19
AC198 0.22	AF178 0.33	BC220 0.11	DD201 0.66	BF264 0.55	OC196 0.52	2G473 0.28	2N2475 0.33	2N4104 0.17	2N4347 0.19
AC198K 0.22	AF179 0.33	BC221 0.11	DD202 0.66	BF265 0.55	OC197 0.52	2G474 0.28	2N2476 0.33	2N4105 0.17	2N4348 0.19
AC199 0.22	AF180 0.33	BC222 0.11	DD203 0.66	BF266 0.55	OC198 0.52	2G475 0.28	2N2477 0.33	2N4106 0.17	2N4349 0.19
AC199K 0.22	AF181 0.33	BC223 0.11	DD204 0.66	BF267 0.55	OC199 0.52	2G476 0.28	2N2478 0.33	2N4107 0.17	2N4350 0.19
AC200 0.22	AF182 0.33	BC224 0.11	DD205 0.66	BF268 0.55	OC200 0.52	2G477 0.28	2N2479 0.33	2N4108 0.17	2N4351 0.19
AC200K 0.22	AF183 0.33	BC225 0.11	DD206 0.66	BF269 0.55	OC201 0.52	2G478 0.28	2N2480 0.33	2N4109 0.17	2N4352 0.19
AC201 0.22	AF184 0.33	BC226 0.11	DD207 0.66	BF270 0.55	OC202 0.52	2G479 0.28	2N2481 0.33	2N4110 0.17	2N4353 0.19
AC201K 0.22	AF185 0.33	BC227 0.11	DD208 0.66	BF271 0.55	OC203 0.52	2G480 0.28	2N2482 0.33	2N4111 0.17	2N4354 0.19
AC202 0.22	AF186 0.33	BC228 0.11	DD209 0.66	BF272 0.55	OC204 0.52	2G481 0.28	2N2483 0.33	2N4112 0.17	2N4355 0.19
AC202K 0.22	AF187 0.33	BC229 0.11	DD210 0.66	BF273 0.55	OC205 0.52				



# - the lowest prices!

## 74 Series T.T.L. I.C.'S

BI-PAK STILL LOWEST IN PRICE FULL SPECIFICATION GUARANTEED. ALL FAMOUS MANUFACTURERS

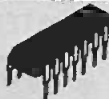

7400	1	25	100+	7448	1	25	100+	74122	1	25	100+
7401	0-18	0-17	0-16	7450	£1-10	£1-07	£1-05	74123	£1-50	£1-45	£1-40
7402	0-18	0-17	0-16	7451	0-18	0-17	0-16	74141	0-85	0-82	0-79
7403	0-18	0-17	0-16	7453	0-18	0-17	0-16	74145	£1-65	£1-55	£1-45
7404	0-18	0-17	0-16	7454	0-18	0-17	0-16	74150	£2-90	£2-80	£2-70
7405	0-18	0-17	0-16	7460	0-18	0-17	0-16	74151	£1-10	£1-05	£1-00
7406	0-39	0-34	0-31	7470	0-32	0-29	0-27	74153	£1-30	£1-20	£1-10
7407	0-39	0-34	0-31	7472	0-32	0-29	0-27	74154	£1-98	£1-90	£1-75
7408	0-20	0-19	0-18	7473	0-41	0-39	0-35	74155	£1-50	£1-45	£1-35
7409	0-20	0-19	0-18	7474	0-41	0-39	0-35	74156	£1-50	£1-45	£1-35
7410	0-18	0-17	0-16	7475	0-50	0-48	0-46	74157	£2-00	£1-90	£1-80
7411	0-28	0-27	0-26	7476	0-44	0-43	0-42	74160	£2-10	£2-00	£1-90
7412	0-39	0-34	0-31	7480	0-74	0-71	0-64	74161	£2-10	£2-00	£1-90
7413	0-32	0-31	0-30	7481	£1-30	£1-25	£1-20	74162	£4-40	£4-15	£3-85
7416	0-48	0-44	0-42	7482	0-96	0-95	0-94	74163	£4-40	£4-15	£3-85
7417	0-48	0-44	0-42	7483	£1-30	£1-15	£1-05	74164	£2-20	£2-10	£2-00
7420	0-18	0-17	0-16	7484	£1-10	£1-05	£1-00	74165	£2-30	£2-10	£2-00
7422	0-55	0-53	0-50	7485	£3-50	£3-40	£3-30	74166	£3-20	£3-10	£3-00
7423	0-55	0-53	0-50	7486	0-35	0-34	0-33	74174	£2-50	£2-40	£2-30
7425	0-55	0-53	0-50	7489	£4-00	£3-75	£3-50	74175	£1-75	£1-65	£1-55
7426	0-50	0-46	0-44	7490	0-74	0-71	0-64	74176	£1-85	£1-75	£1-65
7427	0-50	0-46	0-44	7491	£1-10	£1-05	£1-00	74177	£1-85	£1-75	£1-65
7428	0-55	0-53	0-50	7492	0-74	0-71	0-64	74180	£1-50	£1-40	£1-30
7430	0-18	0-17	0-16	7493	0-74	0-71	0-64	74181	£5-00	£4-50	£4-00
7432	0-50	0-46	0-44	7494	0-85	0-82	0-75	74182	£2-00	£1-90	£1-75
7433	0-75	0-73	0-70	7495	0-85	0-82	0-75	74184	£3-20	£3-10	£3-00
7437	0-70	0-68	0-65	7496	0-96	0-93	0-86	74190	£2-15	£2-10	£2-00
7438	0-70	0-68	0-65	74100	£1-50	£1-45	£1-40	74191	£2-15	£2-10	£2-00
7440	0-18	0-17	0-16	74104	£1-07	£1-04	£1-00	74192	£2-15	£2-10	£2-00
7441	0-74	0-71	0-64	74105	£1-07	£1-04	£1-00	74193	£2-15	£2-10	£2-00
7442	0-74	0-71	0-64	74107	0-44	0-42	0-40	74194	£2-98	£2-86	£2-75
7443	£1-20	£1-15	£1-10	74110	0-60	0-55	0-50	74195	£2-00	£1-95	£1-90
7444	£1-20	£1-15	£1-10	74111	£1-38	£1-27	£1-21	74196	£1-95	£1-90	£1-85
7445	£1-98	£1-95	£1-90	74118	£1-10	£1-05	£1-00	74197	£1-95	£1-90	£1-85
7446	£1-20	£1-15	£1-10	74119	£1-50	£1-40	£1-30	74198	£5-00	£4-75	£4-50
7447	£1-10	£1-07	£1-05	74121	0-50	0-48	0-45	74199	£5-00	£4-75	£4-50

DEVICES MAY BE MIXED TO QUALIFY FOR QUANTITY PRICE & (TTL 74 SERIES ONLY) DATA IS AVAILABLE FOR THE ABOVE SERIES OF I.C.'S IN BOOK FORM. PRICE 35p.

NOW WE GIVE YOU 50W PEAK (25W R.M.S.) PLUS THERMAL PROTECTION!

The NEW AL60 Hi-Fi Audio Amplifier

FOR ONLY £3.95

- Max Heat Sink temp 90°
- Thermal Feedback
- Frequency Response 20Hz to 100KHz
- Latest Design Improvements
- 0.1% Distortion
- Load - 3, 4, 8 or 16 ohms
- Distortion better than 1% at 1KHz
- Signal to noise ratio 80dB
- Supply voltage 10-35 volts
- Overall size 63mm x 105mm x 13mm

Especially designed to a strict specification. Only the finest components have been used and the latest solid state circuitry incorporated in this powerful little amplifier which should satisfy the most critical A.F. enthusiast.

FULLY BUILT - TESTED and GUARANTEED



## STABILISED POWER

MODULE SPM80

£3-25



AP80 is especially designed to power 2 of the AL50 Amplifiers, up to 15 watt (r.m.s.) per channel simultaneously. This module embodies the latest components and circuit techniques incorporating complete short circuit protection. With the addition of the Mains Transformer MT80, the unit will provide outputs of up to 1.5 amps at 25 volts. Size: 63 mm x 105 mm x 20 mm. These units enable you to build Audio Systems of the highest quality at a hitherto unobtainable price. Also ideal for many other applications including: Disco Systems, Public Address, Intercom Units, etc. Handbook available, 10p.

TRANSFORMER BMT80 £2-15 p. & p. 25p

### INTEGRATED CIRCUIT PAKS

Manufacturers "Full Out" which include Functional and Part-Functional Units. These are classed as 'out-of-spec' from the maker's very rigid specifications, but are ideal for learning about I.C.'s and experimental work.

Pak No.	Contents	Price	Pak No.	Contents	Price	Pak No.	Contents	Price
UIC00	- 12 x 7400	0-85	UIC48	- 5 x 7448	0-85	UIC90	- 3 x 7400	0-85
UIC01	- 12 x 7401	0-85	UIC49	- 5 x 7449	0-85	UIC91	- 3 x 7401	0-85
UIC02	- 12 x 7402	0-85	UIC50	- 12 x 7450	0-85	UIC92	- 5 x 7492	0-85
UIC03	- 12 x 7403	0-85	UIC81	- 12 x 7451	0-85	UIC93	- 5 x 7493	0-85
UIC04	- 12 x 7404	0-85	UIC82	- 12 x 7452	0-85	UIC94	- 5 x 7494	0-85
UIC05	- 12 x 7405	0-85	UIC83	- 12 x 7453	0-85	UIC95	- 5 x 7495	0-85
UIC06	- 5 x 7406	0-85	UIC84	- 12 x 7454	0-85	UIC96	- 5 x 7496	0-85
UIC07	- 5 x 7407	0-85	UIC85	- 12 x 7455	0-85	UIC97	- 5 x 7497	0-85
UIC10	- 12 x 7410	0-85	UIC86	- 5 x 7480	0-85	UIC98	- 5 x 74100	0-85
UIC12	- 12 x 7420	0-85	UIC87	- 5 x 7481	0-85	UIC99	- 5 x 74101	0-85
UIC13	- 12 x 7430	0-85	UIC88	- 5 x 7482	0-85	UIC101	- 5 x 74102	0-85
UIC14	- 12 x 7440	0-85	UIC89	- 5 x 7483	0-85	UIC102	- 5 x 74103	0-85
UIC15	- 5 x 7441	0-85	UIC90	- 5 x 7484	0-85	UIC103	- 5 x 74104	0-85
UIC16	- 5 x 7442	0-85	UIC91	- 5 x 7485	0-85	UIC104	- 5 x 74105	0-85
UIC17	- 5 x 7443	0-85	UIC92	- 5 x 7486	0-85	UIC105	- 5 x 74106	0-85
UIC18	- 5 x 7444	0-85	UIC93	- 5 x 7487	0-85	UIC106	- 5 x 74107	0-85
UIC19	- 5 x 7445	0-85	UIC94	- 5 x 7488	0-85	UIC107	- 5 x 74108	0-85
UIC45	- 5 x 7445	0-85	UIC95	- 5 x 7489	0-85	UIC108	- 5 x 74109	0-85
UIC46	- 5 x 7446	0-85				UIC109	- 5 x 74110	0-85
UIC47	- 5 x 7447	0-85				UIC110	- 25 Assorted 74's	1-55

Packs cannot be split, but 25 assorted pieces (our mix) is available as PAK UIC X1.

## STEREO PRE-AMPLIFIER TYPE PA100

Built to a specification and NOT a price, and yet still the greatest value on the market, the PA100 stereo pre-amplifier has been conceived from the latest circuit techniques. Designed for use with the AL50 power amplifier system, this quality made unit incorporates no less than eight silicon planar transistors, two of these are specially selected low noise NPN devices for use in the input stages.

- Three switched stereo inputs, and rumble and scratch filters are features of the PA100, which also has a STEREO/MONO switch, volume, balance and continuously variable bass and treble controls.
- SPECIFICATION:**
- Frequency response 20Hz-20KHz ±1dB
  - Harmonic distortion better than 0.1%
  - Input 1: Tape head 1-20mV into 50KΩ
  - Input 2: Radio, Tuner 5mV into 50KΩ
  - Input 3: Magnetic P.U. 1.5mV into 50KΩ
  - All input voltages are for an output of 250mV.
  - Tape and P.U. inputs equalised to RIAA curve within ±1dB from 20Hz to 20KHz.
  - Bass control ±15dB at 20Hz
  - Treble control ±15dB at 20KHz
  - Filters: Rumble (high pass) 100 Hz
  - Scratch (low pass) 8KHz
  - Signal/noise ratio better than +85dB
  - Input overload +26dB
  - Supply +35 volts at 20mA
  - Dimensions 292 x 89 x 35 mm

SPECIAL COMPLETE KIT MK50 COMPRISING 2 AL50's, 1 SPM80, 1BMT80 & 1 PA100 ONLY £25.30 FREE p.&p. only £13.15

### LINEAR I.C.'S - FULL SPEC.

Type No.	Case	1	25	100+
7202	DIL 14	0.30	0.48	0.45
7209	DIL 14	0.25	0.30	0.30
7210	DIL 14	0.45	0.45	0.40
7241	DIL 14	0.40	0.38	0.35
7241C	TU-5	0.45	0.43	0.40
7241D	DIL	0.38	0.38	0.34
7248P	DIL	0.58	0.58	0.54
SL201E	TU-5	0.50	0.45	0.40
SL201C	TU-3	0.58	0.45	0.40
SL202	TU-5	0.50	0.45	0.40
TA323	TU-7	0.90	0.70	0.60
TA324	TU-7	1.10	0.85	0.80
TA335A	TU-5	1.10	0.85	0.80
TA335B	TU-5	0.78	0.58	0.54
TA370C	TU-5	0.35	0.35	0.30
TA370D	TU-5	0.35	0.35	0.30
TA371	TU-8	0.45	0.45	0.40
ZM414	TU-18	1.30		

### DTL 930 SERIES LOGIC I.C.'S

Type	1	25	100+
HL930	0.15	0.14	0.13
HL932	0.18	0.15	0.14
HL933	0.18	0.15	0.14
HL934	0.18	0.15	0.14
HL935	0.18	0.15	0.14
HL936	0.18	0.15	0.14
HL937	0.18	0.15	0.14
HL938	0.18	0.15	0.14
HL939	0.18	0.15	0.14
HL940	0.18	0.15	0.14
HL941	0.18	0.15	0.14
HL942	0.18	0.15	0.14
HL943	0.18	0.15	0.14
HL944	0.18	0.15	0.14
HL945	0.18	0.15	0.14
HL946	0.18	0.15	0.14
HL947	0.18	0.15	0.14
HL948	0.18	0.15	0.14
HL949	0.18	0.15	0.14
HL950	0.18	0.15	0.14
HL951	0.18	0.15	0.14
HL952	0.18	0.15	0.14
HL953	0.18	0.15	0.14
HL954	0.18	0.15	0.14
HL955	0.18	0.15	0.14
HL956	0.18	0.15	0.14
HL957	0.18	0.15	0.14
HL958	0.18	0.15	0.14
HL959	0.18	0.15	0.14
HL960	0.18	0.15	0.14
HL961	0.18	0.15	0.14
HL962	0.18	0.15	0.14
HL963	0.18	0.15	0.14
HL964	0.18	0.15	0.14
HL965	0.18	0.15	0.14
HL966	0.18	0.15	0.14
HL967	0.18	0.15	0.14
HL968	0.18	0.15	0.14
HL969	0.18	0.15	0.14
HL970	0.18	0.15	0.14

### DUAL-IN-LINE SOCKETS.

14 & 16 Lead Sockets for use with DUAL-IN-LINE I.C.'S TWO RANGES PROFESSIONAL & NEW LOW COST.

PROF. TYPE No. 1-24 25-99 100up.

TSO 14 pin type 35p 30p 27p

TSO 16 pin type 38p 35p 32p

TO 24 75p 70p 68p

LOW COST No.

BPS 8 pin type 13p 13p 11p

BPS 14 pin type 16p 14p 12p

BPS 16 pin type 17p 15p 13p

### NUMERICAL INDICATOR TUBES

Type	Description	Price
3115E	Indicator	£1.50
MAX 3M	L.E.D. 7 Segment Display	£1.96
CD 66	6.127 High Characters Side Viewing 'Nixie' Type Tube 16 pin	£1.87
GR 118	6.127 High Characters Side Viewing 'Nixie' Type Tube 16 pin	£1.70

### 3 TERMINAL POSITIVE VOLTAGE REGULATORS

Type	Case	1	25	100+
TA78L	TO-18	0.30		



# news digest

## US BECOMES SECOND COUNTRY WITH OWN NATIONAL SATELLITE



The United States followed Canada with its own national communications satellite when Western Union's "Westar" was launched in mid-April. Both Anik (the Canadian one) and Westar were designed and built by Hughes Aircraft Company of El Segundo, California.

The Westar satellite was launched into a 22,300-mile-high synchronous orbit with a Thor Delta rocket by NASA technicians, under a contract from Western Union.

Westar can relay voice, TV, private message and data communications to the continental United States as well as Alaska, Hawaii and Puerto Rico.

Similar national satellite systems are currently being considered by countries such as Brazil, Iran, Australia, Indonesia, the Arab states and others.

Westar has an average capacity of 6,000 voice channels or 12 simultaneous colour TV channels. It is capable of transmitting combinations of voice,

TV and data traffic. Each satellite is 11ft. high and 6ft. in diameter and weighs 1,265 pounds at liftoff. They were purchased under a \$24.9 million contract signed in 1972.

## FIBRE-OPTICS COMMUNICATIONS

Fibre-optic communication systems may be closer than you think.

A telephone system using this new technique has been developed by the US Navy's Naval Electronics Laboratory (San Diego) and installed aboard the US flagship USS Little Rock.

Full details are of course not available but the system is known to consist of six telephone stations and a central switching exchange.

Voice signals are converted by an LED into frequency modulated digital light pulses which are then carried by bundles of fibre-optic materials via the central exchange.

## CALCULATOR PRICE CUTS

Price reductions on two of its pocket-sized scientific calculators have been announced by Hewlett-Packard. The HP-35 has been reduced from £152.00 to £115.00; the HP-45 from £204.00 to £177.00.

Since the introduction of its first pocket-sized calculator, the HP-35, in January 1972, Hewlett-Packard has now sold more than 300,000 units.

## NEW HELIUM-NEON LASER TUBE EXPECTED TO OPEN NEW MARKETS

RCA is developing a new low-cost laser that will make possible simpler electro-optic equipment for consumer and industrial information processing applications.

The new laser, which eliminates many expensive precision parts and handmade glass operations now required in laser manufacture, will reduce the production quantity cost of the unit more than 50 per cent below that of comparable lasers.

*"The new RCA development is expected to find volume use in the information processing market including such applications as point-of-sale, facsimile equipment, video playback units, copy machines, credit validation devices, optical card readers and many other types of equipment,"* according to Philip H. Vokrot, Manager, Market Planning Lasers for the RCA Industrial Tube Division who was speaking at a recent demonstration of an operating helium-neon laser utilizing the new simplified design.

The new design is approximately 1in. in diameter by 11in. long and eliminates many expensive precision parts and hand-glass work now used in laser manufacture. Its simple design also permits snap-in mounting similar to replacing a fluorescent tube. It is well adapted to automated quantity production manufacturing techniques which will further reduce production costs.

*"In production volume, pricing of a 1 to 2mW laser is expected to be less than half that of equivalent performing units now on the market,"* Mr. Vokrot said. *"Product availability is expected to coincide with the rapid increase in laser use forecast for early 1975."*

The new laser will be available in both continuous and modulatable versions and is expected to gain rapid acceptance in the construction market as well as the information processing market. The operating voltage is also reduced and should lead to lower power supply costs.



## REMEMBER!



*What a long way Henry's Radio of Edgware Road have come in recent times! Until a few years ago they were confined to what was, quite frankly, a dingy shop. Since then the components shop has moved twice, expanding both times and Hi-Fi discount shops have been springing up everywhere.*

*The most recent addition is at Harrow where Peter Sellers and the Wombles were enlisted to open the new store.*

## NOISE MONITORING SYSTEM AT HEATHROW AIRPORT

A computerised monitoring system, designed to analyse and record aircraft noise, is being installed at Heathrow Airport, London. The system, from Hewlett-Packard, cost £90,000 and is one of the largest of its kind in the world.

In operation, 13 noise terminals feed information to a central computer, using Post Office lines. Each terminal has a boom-mounted microphone, which while temperature stable and having a high degree of weather protection, retains excellent audio and electronic characteristics. A bandwidth of 20kHz is monitored. A calibration tone is built in and re-calibrates the apparatus automatically every hour.

The system will be operated under the aegis of the British Airports Authority mainly in connection with the statutory limits to aircraft noise. The system will not only produce information on infringement of these limits but provide a monthly analysis of noise characteristics by aircraft type.

Other potential uses of this sound monitoring system include the planning of aircraft movements and the zoning of new building in the vicinities of airports.

## CEEFAX AND ORACLE SYSTEMS COMBINED

The BBC and IBA, together with BREMA and the Broadcasting Department of the Home Office have agreed on a unified system of data broadcasting.

Until now the BBC have been working on CEEFAX, the IBA on ORACLE. Both systems allow a TV viewer to select at will from a number of different 'pages' of information and put these onto his screen. Suggested services are time checks, news flashes, weather forecasts, programme news etc. Both services convey the information in the unused time intervals in the picture signal. Sets will require modification to store and display the various services.

Until now the BBC and IBA have been in strong competition and experiments and test broadcasts have been extensive. Both systems became fairly similar and now the best points of each have been amalgamated to produce what has the unexciting name of the 'Unified System'. The Broadcasting organisations will retain the names CEEFAX and ORACLE but for the proposed service, not the system.

The Unified system uses lines 17 and 18 to provide up to 99 different 'pages', each having 40 characters per row and 24 rows per page. The pages are broadcast in sequence taking 30

seconds to complete a cycle. Each 'page' will include a 'header' which provides a digital clock giving time to the nearest second.

The IBA expect to start test transmissions on the new system in the autumn. No date has yet been set for the introduction of the service.

Estimates of the additional receiver costs vary greatly but £30 has been suggested for a system built in during manufacture.

## HP-970A COMPETITION RESULTS

Nearly 2,000 entries were received for the HP-970A, Hewlett Packard handheld digital multimeter competition held in the April 1974 issue.

The answers were:

1. Max: 55V, Min: 45V.
2. Max: 39.789V, Min: 27.100V.
3. i) 10 ohms, ii) 6.25 ohms.

A surprisingly large number of readers gave a wrong answer for question 2. In this readers were asked for the maximum and minimum readings using a 1000 ohms per volt meter on the 100V range with an accuracy of plus or minus 3%.

This 3% is of course of the 100V and not the reading shown. This was not intended as a trick question and readers who got this one wrong can take heart from the fact that one of the judges made the same mistake at first when asked to derive the answers.

Congratulations go to Mr. Khoury of Bodmin Cornwall who was drawn as the first correct answer.

## WARNING DEVICE FOR LOW SUPPLY VOLTAGE

A new solid state device that provides a piercing audible warning in the event of low mains voltage has been introduced by N. J. Fromet and Company Limited.

Applications for the device cover all voltage sensitive equipment such as computers, magnetic storage accounting machines, automatic letter writers, etc., in the office, or for numerically controlled pre-programmed machine tools in the factory.

A pre-conditioning circuit increases sensitivity on reduced frequency which occurs prior to certain power cuts, and built in memory maintains the signal after voltage has been returned to normal, so warning the operator to check his equipment if the low voltage has occurred during his absence.

*N. J. Fromet and Company Limited,  
Cliffe Road, Easton, Stamford, Lincs.*



## JOVIAN FINDINGS

Preliminary data retrieved from Pioneer 10 during its recent Jupiter fly-past is currently being evaluated by the Bendix Field Corporation at NASA's Ames Research Centre.

Over 3.5 thousand million bits of data have been stored.

One of the most significant findings has been the discovery of helium in the planet's atmosphere. Helium glow was measured at approximately 10 Rayleighs — hydrogen glow at about 100 Rayleighs.

Other discoveries include — proof that Jupiter's radiation belts are between 10,000 and one million times stronger than Earth's — a discovery that the planet emits more energy than it receives from the Sun (at least 2½ times as much) and has an atmosphere that is in effect a vast heat reservoir — and measurements that show that Jupiter has a strong and complex magnetic field.

## LIFE — AN ELECTRICAL PHENOMENON?

Evidence that life itself may be an electrical phenomenon was presented recently at the New York Academy of Science International Conference.

Discussions at the conference focussed on the evolution, development, and application of the effects of electric currents on biological systems.

Explanation of hitherto unexplained life phenomena may be attributed to the presence of small d.c. currents, the delegates were told. Epithelial cells, for example, were found to regenerate faster when d.c. currents were applied to open wounds. In fact an adult frog limb was caused to regenerate in this way (these do not normally regenerate under any circumstances).

Cartilages in dogs were also found to regenerate in a similar fashion if d.c. potentials were applied.

Tumour growth was found to be altered and even retarded when placed in an electrical field.

In humans, nerves were found to heal and function faster in electric fields.

It may be well then, that stimulation, retardation, and control of all growth mechanisms may be related to electrical phenomena which in turn may be major factors in the entire life span of all living organisms.

The conference issued a warning however that caution should be exercised in early uncontrolled clinical applications of such techniques.

## 98in. TELESCOPE USES IMAGE INTENSIFIERS

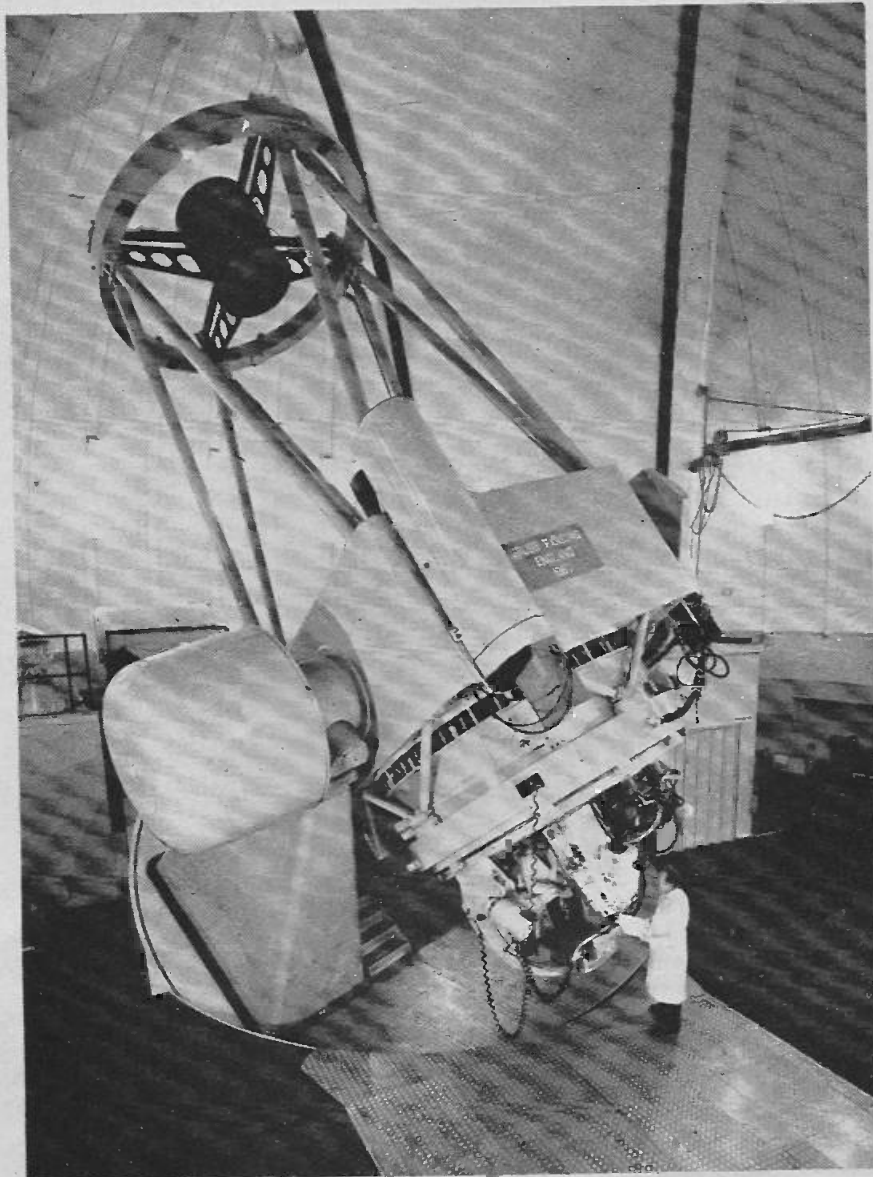

To aid the recording of images from distant stars and galaxies the Royal Greenwich Observatory based at Herstmonceux, Sussex is now using a 3-stage image intensifier supplied by EMI.

The Isaac Newton Reflector, the largest in Western Europe, reaches

further into space but distant images are so faint that they cannot be recorded. The image intensifier is capable of a gain of one million while offering a high speed photographic capability with good resolution and acceptable background noise.

## RCA OPT FOR SUN POWER

A new addition to the RCA building in New York is to be fitted with solar heat collector panels on the direction of the company Chairman, Robert W. Sarnoff. These are believed to be flat-plate collectors as described in the 'Solar Solution' (ETI, September 1973).

The sun's energy will provide 20% of heating during the winter and 15% of the air conditioning in hot weather.

## DYING BREATH

'Old valves never die, they just fade away! This epithet is applicable to the GRD7 guard ring diode, widely used for teaching purposes. This was declared 'dead' by Ferranti last December but the demand has been such that a final production run will soon be made. Anyone requiring this valve should contact Ferranti in Oldham, Lancs. before July 12th.

Continued on page 71

# WELLBERRY CASES

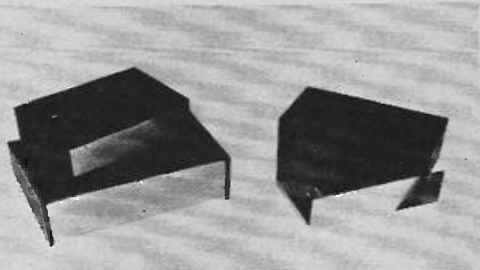

INSTRUMENT CASES FOR THE HOME CONSTRUCTOR BLACK LEATHERGRAIN FINISHED VYNIL ON STEEL COVER 20 s.w.g. ALUMINIUM BASE FRONT AND BACK UNIT.

6" x 4½" x 1¼"	18g Base	95p
8" x 5" x 2"	18g Base	£1.10p
9" x 5" x 2½"	18g Base	£1.22p
11" x 6" x 3"	18g Base	£1.44p
11" x 7½" x 3½"	16g Base	£2.15p
19" x 9" x 3½"	14g Base	£6.60p

Add 15p post and packing per order.

Wellberry Limited, (Mail Order Division),  
24, The Sycamores, Baldock, Hertfordshire.  
TRADE ENQUIRIES WELCOME

# TOP QUALITY 'PE' HI-FI KITS FROM ELECTRO SPARES



## FM VARICAP STEREOD TUNER

Featured in the May 1973 issue of 'Practical Electronics', this superb Hi-Fi tuner is available as a kit for the incredibly low price of £28.50 including VAT and postage. Electro Spares supply everything from the slim-line cabinet down to the last nut and bolt, and you can assemble it in just one evening! It's that simple. Incorporating five pre-set stations you choose yourself, with no difficult drive cord and pulley systems - spot on station selection every time. Construction time has been reduced to a minimum through the use of new pre-set Mullard modules for R.F. and I.F. circuits. Positively no alignment needed - just a simple d.c. voltmeter adjustment. Motorola I.C. Phase Lock Loop Decoder gives perfect stereo reception. Guaranteed first time results - or send it back, and we'll return it in perfect order (for a nominal handling charge).

100's  
ALREADY SOLD  
TO SATISFIED  
CUSTOMERS

**£28.50** inc. VAT and p & p.

Please send SAE (preferably 9 x 4 minimum) for full details.

Full constructional details only 10p post free.

All parts sold separately.

Only "design approved" kit available.

# DART electro services

24 South Town, Dartmouth, Devon,  
Telephone: Dartmouth 2967

### SICK OF WAITING FOR COMPONENTS?

Try our express service (normally return-of-post)

RESISTORS (E24 Series)		SCREWS, NUTS AND WASHERS	
½W 5%	Carbon Film	1p	
½W 2%	Metal Oxide	3½p	0BA 18sets 40p
2½W 5%	Wire-wound	9p	2BA " 15p
5W 5%	Wire-wound	10p	4BA " 10p
¼W 5%	Carbon Film	1½p	6BA " 13p

### SEMICONDUCTORS

BC107/8/9	11p	2N3054	54p	1N4006/7	12p
2N1302/3	18p	2N3055	57p	2N3773	£2.95
2N1304/5	21p	2N3702	13p	2N3819	34p
2N1306/7	22p	1N4001/2/3	7p	2N3703/4/5/6/7	
2N3053	24p	1N4004/5	9p		13p

Full Range of 7400 Series I.C.'s available

CAPACITORS			SILVER-MICA CAPACITORS	
µF	Volts	Price	2.2pF to 820pF	7p
1	100	6p	1000pF to 1800pF	10p
2.2	63	6p	I.C. HOLDERS	
4.7	35	6p	8-way DIL	16p
10	16	6p	14-way DIL	24p
10	63	7p	16-way DIL	27p
22	35	7p	CROC CLIPS	
100	10	7p	Std. 42mm: 4p, Mln.27mm 3p	
100	50	11p	VERO range of boards - PIN	
220	50	17p	Insertions tool 78p. Spot	
470	35	21p	cutter 50p. 0.1 pins/50 20p	
1000	25	24p	0.15/50-20p.	

ADD 10p for p&p PLUS 10% VAT

Send 20p for our illustrated catalogue containing competitive prices and descriptions of hundreds of components, accessories etc.

## 'GEMINI' STEREOD AMPLIFIER

Guaranteed  
30 watts RMS  
per channel

Make this superior quality Hi-Fi unit at home, using simple step-by-step instructions. With a specification equal to many commercial amplifiers costing far more, the "Gemini" built from our kit has a guaranteed output of 30 watts RMS per channel into 8 ohms. Full power THD is a mere 0.02%, and frequency response of -3 dB from 20 Hz to 100 kHz into 8 or 15 ohms. Regulated power supply, 2A, 55 v continuous, 6A instantaneous. Electro Spares have already sold 100s and 100s of these kits - and no wonder - they give you a fabulous amplifier which is virtually the ultimate in Hi-Fi reproduction. In fact, we've never heard it so good! We supply everything except the case - and give you various choices of some components. That's why the total cost, inc. case, can vary from £55 to £60 inc. VAT and p & p. All components as specified by original authors, and sold separately if you wish. Full constructional data book with specification graphs, fault finding guides etc. 55p plus 4p postage. Price list only. Please send S.A.E. (preferably 9 x 4 minimum) for full details.

Get it all together from

# ELECTRO SPARES

The Component Centre of the North



288 ECCLESALL ROAD  
SHEFFIELD, S11 8PEA  
Tel: Sheffield (0742) 668888.

VISITORS WELCOME

EASY PARKING



# LASERS AT WORK

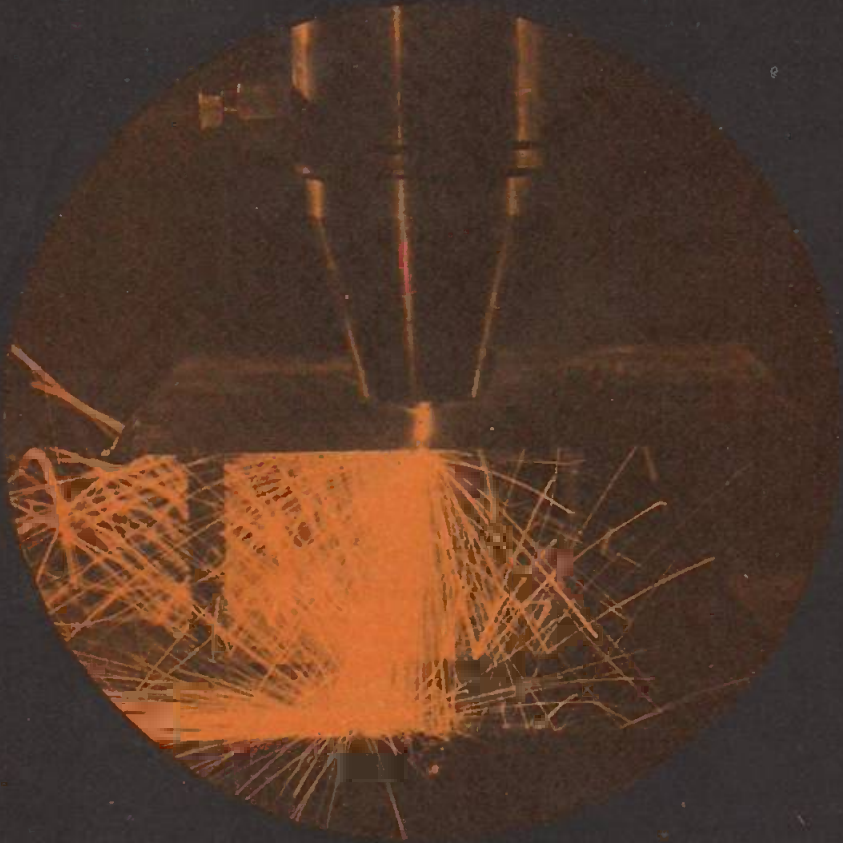

*Close-up of Laser cutting machine.*

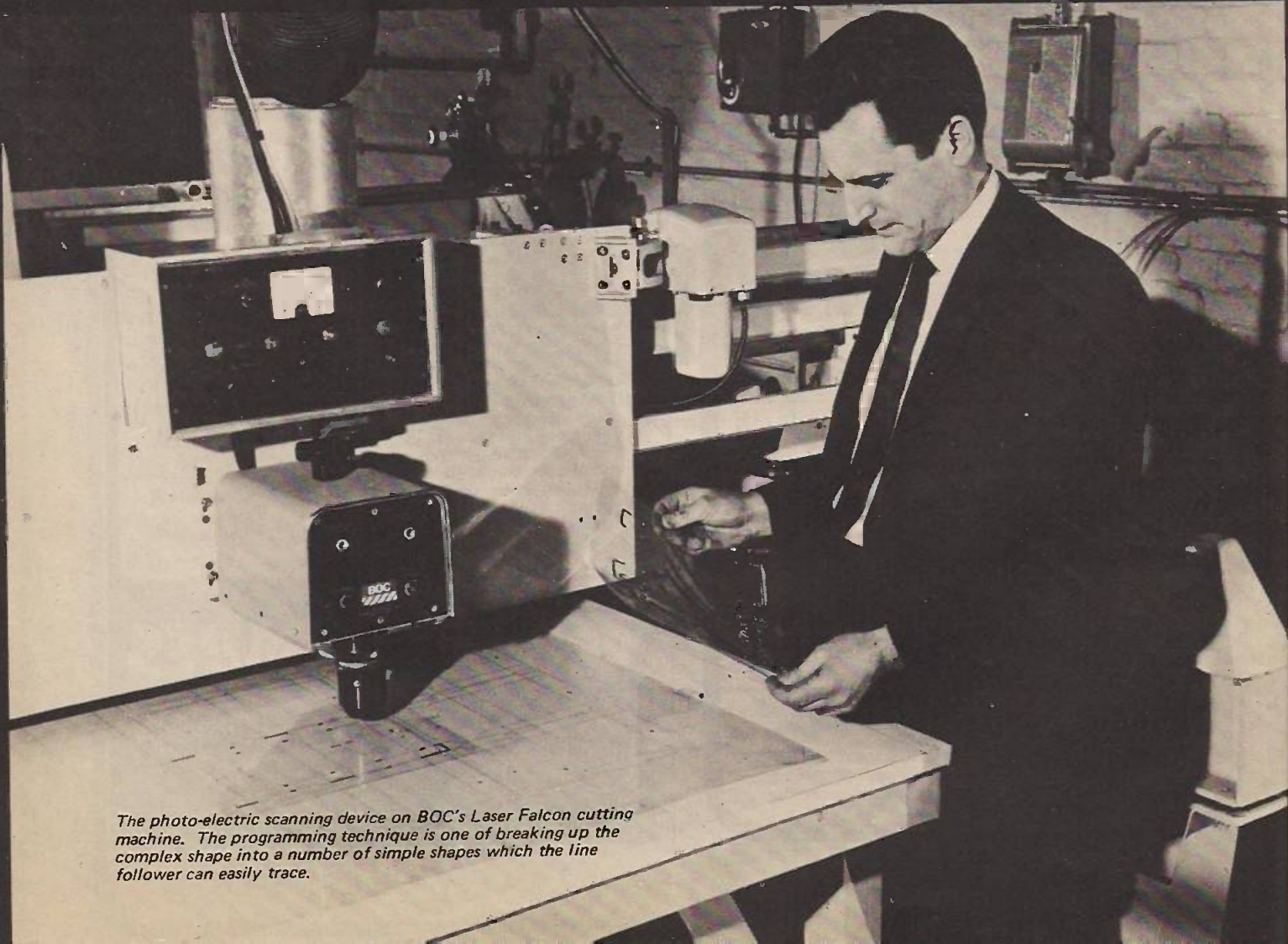

*The photo-electric scanning device on BOC's Laser Falcon cutting machine. The programming technique is one of breaking up the complex shape into a number of simple shapes which the line follower can easily trace.*



Is the laser death-ray a reality? Here, Dr. Sydenham discusses this, and innumerable other possible uses of laser engineering — ranging from communications to fusion research.

IN a previous article we covered the many applications where the availability of the laser radiation source has enabled new and improved methods to be devised for *measuring* many variables. In those applications few needed to make use of the full power capability available from the various laser designs. This time we will be considering uses that are not concerned with measurement. We start with a discussion of applications using the heating power provided by focussed laser radiation to cut, weld, or vaporize materials.

### CUTTING AND WELDING WITH LASER RADIATION

The first essential requirement needed of a thermal cutting process is that the energy density within the cut reaches limits high enough to melt or vaporize the material. Power available, even from the comparatively smaller laser unit, is sufficient to melt most materials provided the power is well-focussed (see the discussion on laser safety!). For example, a 200 W peak-power pulse (from a He-Ne pulsed laser of 180 cm length) of 500 ns duration when focussed down to 10  $\mu\text{m}$  diameter has a peak incident power density of about  $10^8 \text{ Wcm}^2$ .

This is sufficient to melt small volumes of tungsten — which has the high melting point of 3370°C. Figure 1 shows an experimental arrangement that does this.

A second important requirement for thermal cutting is that the wavelength of the source is such that the material to be cut or heated absorbs the radiation. If it is too transparent the energy passes through, producing little temperature rise. Similarly, the surface must not be excessively reflective at the wavelength involved. A useful property of the focussed beam is that the power density is raised mainly in the region of the focal point. Heating occurs in a localised spot enabling cuts to be made to specific depths, not necessarily passing right through the material.

In the high-power applications (continuous ratings of kilowatts of output) it is advantageous to force oxygen or air into the cut to clear it and to enhance the cutting speed.

A third factor to be considered is the thermal conductivity of the material. It is vital that the heat sinking rate is less than the heat input rate if the localised temperature is to be raised to a vaporizing point. This means that highly conductive materials of high melting point (such as metals) cannot

be cut to the same depths as poor thermal conductors having low melting or vaporizing points. To cut thick stainless steel or titanium requires the largest continuous power that can be practically devised.

The advantages offered by laser cutting are firstly, that the cut can be made extremely finely with good definition — down to as little as 10  $\mu\text{m}$  wide in thin-film substrate work or to 400  $\mu\text{m}$  wide when cutting 50 mm thick softwood. Secondly, the power is instantly available — the job can be set ready and power applied at the flick of a switch. Automatically controlled cutters can provide a stitched cut as easily as they can contour. A third advantage over alternative methods is that the cutting point is quite remote from the lens focussing the radiation. This enables the cutting spot to be used inside crevices and even through the transparent covers of components. Resistors and valves have been trimmed and welded internally in this way.

As there are no larger cutting forces the task of guiding the head with precision is simplified — light controlled guidance arrangements can be used.

Another valuable feature is that the actual cut can be viewed — usually by inserting a 45° mirror into the path of the beam — so that it can be seen directly. This is shown in Fig. 1.

Laser cutting and welding can be used in virtually any environment — in air, vacuum or controlled gas — that is,

Fig. 1. Micromachining with a pulsed He-Ne laser.

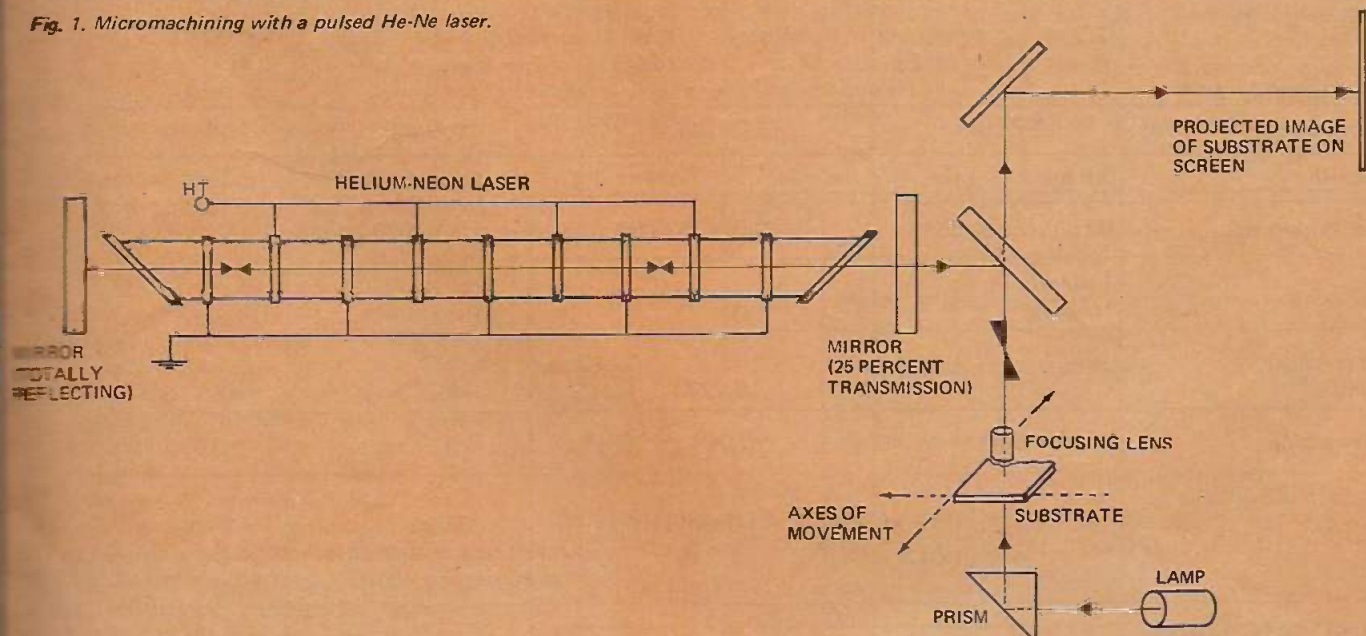



# LASERS AT WORK

of course, unless the process uses auxiliary gas.

All these advantages give the impression that laser methods are the answer to all cutting and welding problems. So why do we not see them used more often?

The answer is simple. At this stage of our technology such methods are more expensive than the traditional means. Further, in heavy applications, the power source is excessively large — a CO<sub>2</sub> unit delivering around a kilowatt of continuous power is still about desk size. There are, however, many applications where only the laser has been able to fulfil the need and the steady development being maintained at present will no doubt decrease the cost and size to a point where the laser becomes increasingly more competitive.

Cutting, welding and vaporizing applications now run to an extensive list. They include welding the edges of relay cans and the ends of miniature thermocouples; cutting around the insulation on cables prior to stripping; drilling holes in ceramics, hard steel and babies' teats; cutting contoured slots in plywood ready for the insertion of knife dies; cutting cloth in the tailoring trade; cutting carpet; trimming titanium heat-shield cones and marking paper in a laser writing head.

In the medical world the laser provides a self-cauterizing scalpel, a means to reattach retinas by stitch welding, and a way to burn away tissue defects on a selective basis.

Other recent interests include research into its use to shear sheep (the lanoline in wool is highly selective at certain wavelengths), and, believe it or not, a sincere report talks about the severing of the closure muscle in oysters — called oyster-shucking in the U.S.A. From Italy come reports of a grant providing for a laser that will be used to burn away the black dirt from marble statues that need cleaning.

Let us now look at four areas from the list of heating uses, namely, the trimming of resistors, industrial cutting, the military death-ray and fusion research.

## TRIMMING RESISTORS

A number of industrial applications call for the removal of small amounts of material in controlled quantities; one case being the trimming of thick-film resistors.

Thick-film hybrid methods are used in circuits where silicon integrated devices cannot provide high power, high operating frequency or tightly toleranced components. They consist of (as shown in Fig. 2), a suitable film laid onto a ceramic substrate by screen

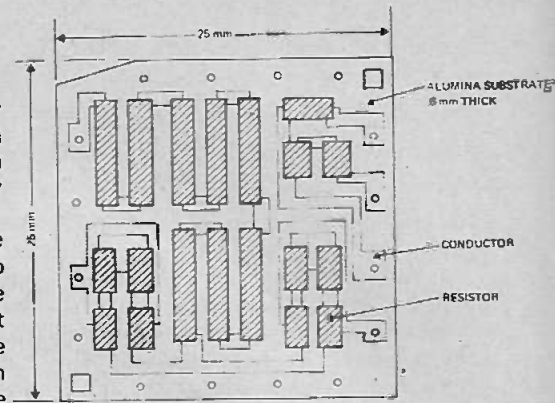

Fig. 2. Thick-film resistor layout.

printing. The normal run of production tolerance provided by these screen printed and fired resistors is not adequate and adjustment is subsequently needed to the resistance value.

The conventional method of trimming uses an air abrasive jet to steadily increase the resistance value as material is removed. This method has some short-comings, not the least being the incompatible presence of abrasive in the clean-room. It is also liable to damage discrete components already formed on the chip.

Laser trimming has become the accepted method for performing this task. It has greater precision and is a cleaner process.

The complete trimming system comprises a laser source, an optical system, a controlled movement x-y

Fig. 3. Comparison of various cutting sources.

Property	Ruby or similar solid-state laser		Yttrium-aluminium-garnet laser		Carbon-dioxide laser		Pulsed He-Ne laser
	Normal	Pulsed Q switched	Continuous	Q switched	Continuous	Q switched	Pulsed
Mode of operation	Normal	Pulsed Q switched	Continuous	Q switched	Continuous	Q switched	Pulsed
Power or mean power irradiance	20kW	1 MW (8 cm x 1 cm rod)	1W (7 cm x 1 cm rod)	1kW	50W (per metre of tube)	1kW	200W (2 m x 2.5 cm tube)
Output wavelength	0.7 μm		1.06 μm		10.6 μm		1.15 μm
Pulse length	0.5 ms	1 μs	—	200 ns	—	1 μs	1 μs
Pulse repetition rate	50 pulse/s, elaborate cooling 1 pulse/min, no cooling		—	400 pulse/s	—	1000 pulse/s	1000 pulse/s
Energy-conversion efficiency	<1%		10-22%		10-20%		1%
Beam divergence	~0.2%		~0.04°		~0.2°		~0.01°
Focal length of suitable lens (n.a. ~ 1)	1-2 cm		1-2 cm		5 cm (must be transparent at 10 μm, e.g. Ge)		5 cm
Focal-spot size with above lens	50-100 μm		5-10 μm		50-200 μm		10 μm
Peak power density in focus	10MW/cm <sup>2</sup>	1GW/cm <sup>2</sup>	—	10GW/cm <sup>2</sup>	1MW/cm	20MW/cm <sup>2</sup>	1GW/cm <sup>2</sup>

co-ordinate table to hold the substrate, a resistance-monitoring unit, and a visual display unit.

The trimmer uses a solid-state neodymium-doped YAG pulsed source providing radiation at  $1.06 \mu\text{m}$  wavelength. Various optical elements focus the beam onto the substrate and provide a viewing channel displaying the substrate on a television monitor as an enlarged image. The optimum trimming conditions occur with 20 nS pulses of 10 MJ-energy being used at 50 per second. The table moves the resistor at  $250 \mu\text{m.s}^{-1}$ . The focussed power density is  $5000 \text{ MW.cm}^2$ .

In use, the resistor is measured to ascertain its actual value. Trimming then commences by producing a cut across the width of the material to rapidly increase the value. This is then followed by a longer cut along the rectangular shape that provides the final value in a more controlled manner.

The same type of apparatus can be used to scribe (that is, cut a groove) across ceramics and semiconductor materials in readiness for a fracture break. Holes can also be provided. The above instrument drills  $200 \mu\text{m}$  diameter holes in a 1.5 mm thick ceramics in 120 seconds. It is, in fact, a micromachining tool.

A number of laser sources can be used for such applications. The table given in Fig. 3 lists typical properties of seven alternatives. The list is not extensive — many more exist with the list growing larger each day. We will now look at the use of the  $\text{CO}_2$  laser in more detail in its role of industrial cutting.

### HIGH POWER INDUSTRIAL CUTTING

To date, the highest continuous power output of any laser source is obtained with the  $\text{CO}_2$  laser which provides radiation at a wavelength of  $10.6 \mu\text{m}$  (in the infrared region).

As output power increases with length — at roughly 50 W per metre of cavity — large powers are produced at the expense of compactness. Early models used a long straight tube with lengths often reaching hundreds of metres. Obviously this arrangement has limited use in industry and new designs typically consist of folded paths and zig-zag arrangements that reduce the packaged length down to around 3 m. For example, the Coherent Radiation unit shown in Fig. 4 has two 2.5 m lengths folded once; it provides 250 W of continuous output. A recently released Ferranti unit of 450 W has a number of tubes arranged in a zig-zag manner around a cylindrical centreline. State-of-the-art commercial units can provide 1 kW for a volume of around  $2 \text{ m}^3$ , thereby

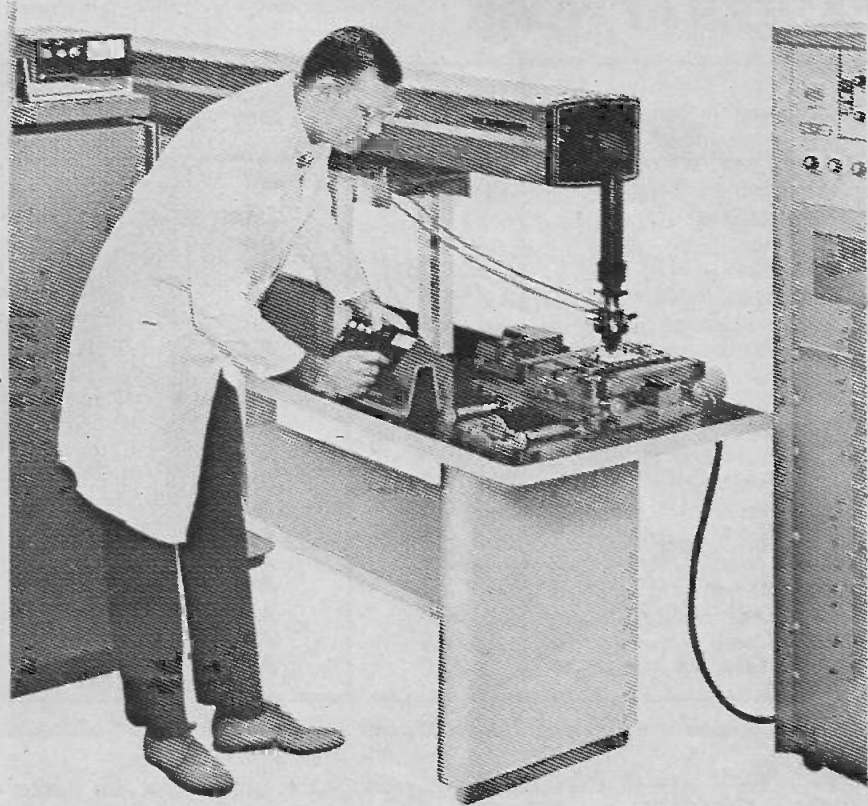

Fig. 4. 250W  $\text{CO}_2$  laser cutting unit.

providing some measure of portability.

The British Oxygen Company (BOC) in conjunction with Murex have been developing laser cutting systems for several years now and have published many useful tables. Figure 5 lists the potential uses. They have also investigated the use of a gas jet (to clear the vapour and protect the lens from sputtering) with the  $\text{CO}_2$  radiation. The jet provides a cleaner start to the cut edge. Figure 6 lists the characteristics of the cutting of material ranging from steel to wood. Slicing of confectionery and other similarly sticky pliable compounds is also suggested.

Cutting rate varies with thickness and type of material. Figure 7 shows that a 350W unit can cut 20 mm thick plywood at  $450 \text{ mm.min}^{-1}$  or 2 mm thick stainless-steel sheet. As BOC point out, laser methods are not yet able to cut slabs of steel but they can produce intricate shapes in glass plate!

In the BOC-Murex Falcon cutting machine (shown in Fig. 8) the laser is run continuously, the energy being dumped into a calorimeter (used to monitor the power) when not needed by reflecting it with a  $45^\circ$  mirror. Gold coated optics are used to reflect  $\text{CO}_2$  radiation —  $10.6 \mu\text{m}$  radiation is not absorbed or transmitted in gold films.

Application	Material
Line and Profile Cutting	Metals, plastics, glass, ceramics, textiles, composites wood
Welding	Metals, plastics, composites
Scribing	Ceramics
Perforating	Metals, ceramics, plastics
Melting	Refractory materials, metals, non-metals
Machining operations	Metals, plastics
Drying	Metals, plastics
Surface finishing	Metals, plastics

Fig. 5. Actual and potential thermal uses of lasers.



# LASERS AT WORK

Material	Thickness mm	Gas	Speed mm/min.
Mild Steel	0.5	Air	635
Stainless Steel	0.5	Oxygen	2600
Titanium	0.6	Air	200
Zirconium	0.25	Air	915
Carborundum (Sintered)	1.6	Air	760
Asbestos Cement	6.3	Air	25
Glass (Soda-Lime-Silica)	4.0	Air	100
	1.6	Air	380
	0.2	Air	5000
Perspex	25.0	Air	100
	10.0	Air	200
	4.6	Air	635
Nylon	0.8	Air	5000
P.T.F.E.	0.8	Air	6100
G.R.P.	2.4	Air	635
Leather	3.2	Air	635
Wood-Deal	50.0	Air	100
Oak	18.0	Air	200
Teak	25.0	Air	75

Fig. 6. Characteristics of cutting using a gas-jet CO<sub>2</sub> laser of 200W output.

The Falcon system development began in 1968 when a carton manufacturer in Scotland requested BOC to explore ways and means to cut deep narrow slots in plywood. Cartons are made by cutting the flattened shape out with thin steel strips set into plywood. Some of these knives cut, others compress the board, forming a crease. A finished steel rule die, as it is called, is a plywood sheet having shapes projecting as knives. The die is pressed into the cardboard. Gaskets and upholstery materials are cut in the same way.

A photo-electric line-following unit traces over the art work causing the underside mounted cutting head to

produce the same profile slot through the wood. Shaped knives are then pressed into the 0.7 mm wide grooves. The Falcon unit uses a 4 m long 400 W Co<sub>2</sub> laser.

The economics of the system are worth quoting. Traditional methods involved many man-hours of tedious fret-sawing — a multiple die for small boxes could well have 500 identical shapes on the die, each with intricate curves and cuts. It takes about 30 hours of skilled labour to prepare a

35 mm film-box die board: with the Falcon unit only five hours of unskilled labour is needed. Half of this latter time is devoted to preparing the mask. If a repeat job is needed the laser method needs only two more hours — the conventional method needs the full 30 hours again. The running cost per hour is about a third of the unskilled labour rate, so the machine soon repays its capital expenditure.

## LASER WEAPONS

In the previous part we spoke of laser guided or 'smart' bombs, that used the guidance properties of a laser beam. Laser lethal weapons are another field to themselves.

As far back as 1959 such potential was recognised — even before a laser was built. In 1961 the U.S.A. started the ball rolling with a \$2 x 10<sup>6</sup> fund. By 1968, gas dynamic lasers, such as the CO<sub>2</sub> system, enabled the concept to be advanced more effectively. In 1971 the Kirkland testing laboratories were completed including a weapons firing test range. Reports somehow gleaned by 'New Scientist' reporters suggested 60 kW continuous, ultra narrow beams were igniting wooden targets at 4 km distances — this unit was designated XLD-1. Spending on high energy lasers now runs to \$90 x 10<sup>6</sup> p.a. in the USA. It is anyone's guess how much Russia spends on the same line of research.

What is not heard about is the immense size of the units and the problems of providing the input power. Even at efficiencies of 30% there is a need for short period capability of several megawatts! Rocket motors have been suggested as the source. Missile and satellite melting systems are also being researched. It is virtually impossible to sort fact from fiction — one certainly cannot call any idea an impossibility.

Reports released in 1972 were very promising but recent releases indicate the death ray concept is not quite what it seems, for the high power beam (New Scientist, 26th July, 1973) can be greatly nullified by a number of atmospheric mechanisms. Firstly, the target surface will vaporize producing a dispersing action. Secondly, the air path becomes heated forming a defocusing gas lens — called thermal blooming. Finally, the air may break down into plasma along the path. Already ways are being devised to reduce the effect of such weapons — dumping the exhaust gases along with an additive could well protect the rear aspect of a plane or missile.

Although not military in application

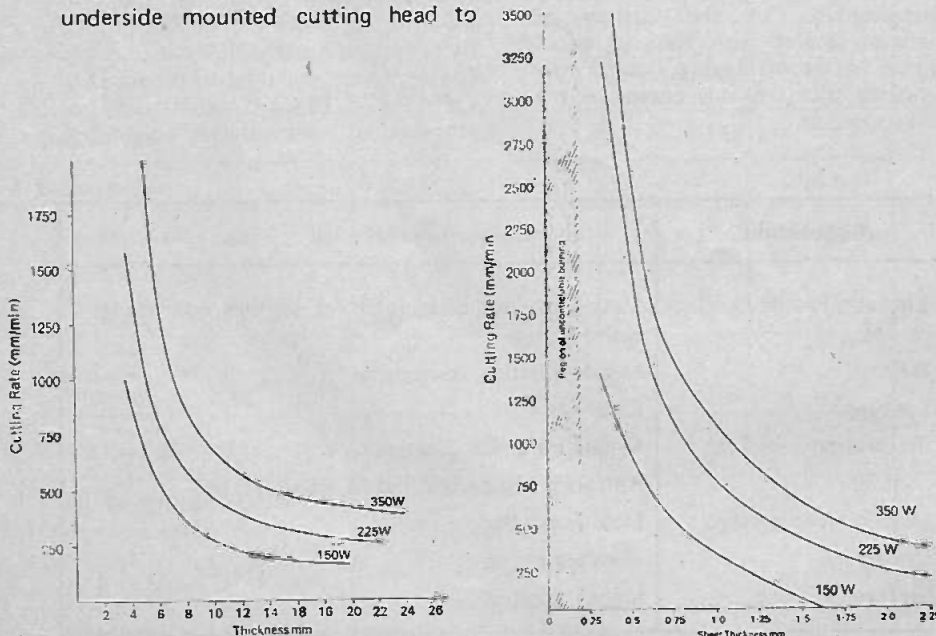

Fig. 7. Cutting rate versus thickness curves for wood and stainless-steel.

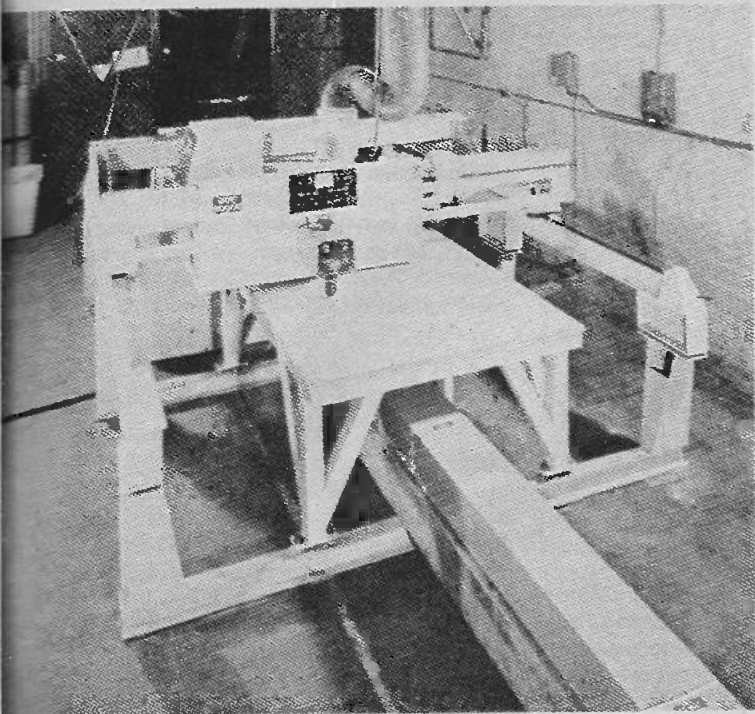

Fig. 8. The BOC Falcon cutting machine.

there is already a call for a 'death ray' in peaceful use. Fire protection authorities in Tasmania are investigating ways to start fires in controlled burn off situations. Speed is the essence, for the whole area should ideally be ignited simultaneously. Hopes are that an aircraft or ground vehicle can start the fires as fast as the vehicle travels.

Closely allied to the 'death ray' is the rule of research aimed at producing atomic reactions using extreme laser powers.

## FUSION RESEARCH

Atomic fusion results when the nuclei of light atoms combine to form less nuclei of a heavier atom: the process releases energy. Fusion is the basis of the generation of the energy contained in stars. For example, four hydrogen atoms can be made to combine to form an atom of helium releasing energy corresponding to the lost mass. Fission is the opposite to fusion: a heavy atom is split to provide lighter nuclei. In the hydrogen bomb both reactions take place, fusion being the result of the enormous temperatures generated in the process.

Due to the immense charge fields the nuclei of matter cannot normally be placed close enough together to cause fusion. If energy provided as heat makes the atoms travel faster it enhances the chance of fusion. Calculations suggest temperatures of  $10^8$  degrees C are needed to cause fusion by this method. Initial research concentrated on the use of plasmas (charged particles of matter that can have immense temperatures) for these

can be contained (without vessels that would melt) by using magnetic field "bottles".

The recent trend has been to explore the use of giant laser powers as a means to raise the temperature of a minute volume of the "fuel" to a point where fusion could take place. So far, no one has succeeded but the method holds great hope as a way to provide highly-controlled fusion reactions on a small and useful scale.

There we will have to leave power applications — a class of useage of laser radiation that will undoubtedly be on the increase as time proceeds.

Development of a device is usually prompted by a need for reduction in the price of a commodity. The laser was no exception, for it seems, looking back into the literature of the 1960s, that the promise of extensive bandwidth in communication channels had a lot to do with initial interest in lasers. It is often the way in technological advancement that the initial impetus falls by the wayside with other uses coming to the fore as time proceeds. The laser is an example of this phenomenon, for communication uses are now one of the less publicised fields of application.

## COMMUNICATIONS

It was not surprising to see that scientists and engineers of the 1960's saw laser light as a communication tool. The laser grew out of the earlier built microwave (Maser) version. The previous article included a snippet from A. L. Schawlow's Bell Laboratories Record report where he

told of the first uses of the Maiman laser as a communication link. Schawlow then saw the laser as a source of extremely high-frequency and coherent radiation capable of extending radio techniques.

The potential of a coherent visible radiation beam that is tightly controlled in its beam spread is that it offers a basic frequency range of virtually dc to  $10^{14}$  Hz. Microwave by contrast has a bandwidth 10 000 times narrower. Furthermore, the laser beam can potentially be spatially multiplexed, stacking channels as modulation, in many different directions across the beam cross-section. A single laser beam might be able to transmit  $10^9$  voice channels or  $10^6$  TV channels.

Initial research difficulties were concerned with finding ways to modulate the information onto the laser carrier. Then came the realisation that transmission losses were an even larger factor to overcome if the potential were to be realised.

To date, laser communications research is idling along — the effort is still being expanded, but research has long reached a state of diminishing returns.

In its simplest form, the laser communication path could be used directly through the air. However, water vapour and other gases in the atmosphere selectively absorb radiation. Windows, where certain wavelengths can pass, do exist in a clear atmosphere, (see Fig. 9) but fog and other particles can cause significant loss of signal — bad fog can attenuate the beam at  $200 \text{ dB.km}^{-1}$ .

A large part of the various groups' efforts has been devoted to the transmission of laser beams in a controlled environment. Pipes with refocusing lenses, bending mirrors and even reflective insides have been studied as a means to overcome the loss problems. Better results were obtained —  $57 \text{ dB.km}^{-1}$  for a 2 cm diameter aluminium, internally coated, pipe. Refocusing and guidance using gas lenses (gas flowing in the pipe is heated to form a varying density profile that forms a quick optical lens) achieved slightly less loss but nowhere near enough improvement could be obtained to make the system economic.

Next came fibre-optic principles — solid glass fibres coated with a material of different refractive index or fibre quartz tubing filled with tetrachloroethylene. Losses in fibres are as low as  $2.4 \text{ dB.km}^{-1}$ , provided the radiation wavelength matches the transmission characteristics of the fibre system



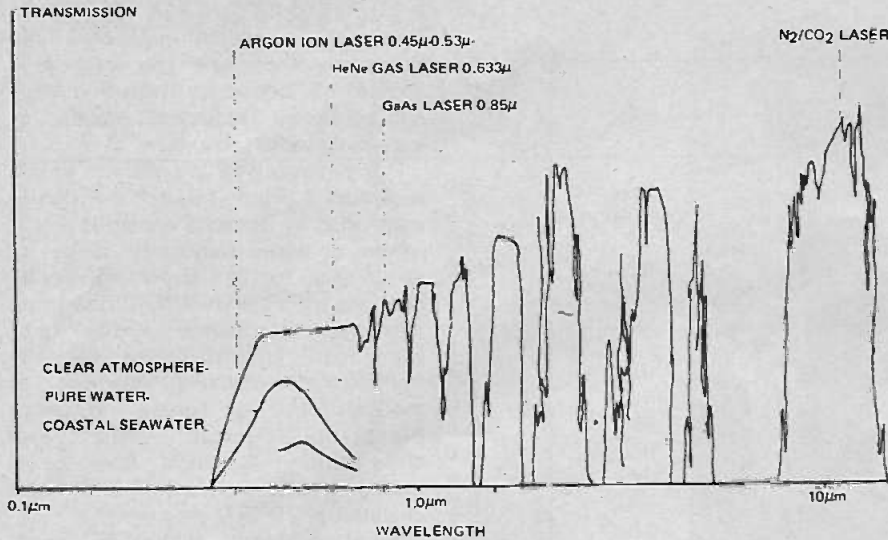

Fig. 9 Transmission of EM radiation.

Having largely overcome the transmission problem the next move is to engineer methods of coupling typical sources to the fibres. Work in progress at the Australian Post Office research laboratories is concerned with the use of GaAs solid-state lamps and detectors.

To obtain the best from GaAs sources and detectors, early units needed cooling to liquid nitrogen temperatures. Today we have efficient

room-temperature devices instead.

Clearly then it will still be a while before cables containing fibre optic channels will be installed across the world — maybe never, for who knows what new method could be discovered.

Many laser data links have been built. Police in the USA have a short distance handheld telephone link, television pictures have been transmitted over distances of miles. Gemini 7 used (in 1966) a GaAs

voice-channel to send signals back to earth. Satellite communications and improved bandwidth microwave systems have, however, increased the capability of conventional methods. The incentive to push optical communication research has undoubtedly been heavily dampened by these improvements, and by the slow path to success of almost every aspect of development of the basic laser into an economical communication system.

To conclude this review we will look at the advances that have already or soon might be seen in computing, in teaching and entertainment.

COMPUTING

It seems no matter how much storage is provided in a computer system it never quite satisfies the need. There is an eternal quest for higher capacity, faster access methods. A present law of data storage is that capacity goes down if the speed goes up. For example, core storage can provide megabit storage with access times of 1 μs; tape, on the other hand, can provide a thousand times more capacity but with access time measured in minutes. Optical methods could give the best of both worlds at a realistically low cost. A comparison is given in Fig. 10.

The optical method to be used should eventually be holography (see the previous article for a description of this). There are a number of reasons for this — readout can be made without precision imaging systems; dust and other 'noise' only alters the amplitude not the existence of a data

Fig. 10 Comparison of computer memory alternatives.

MEMORY TAPE	TAPE	DISK	DRUM	CORE	SEMI-CONDUCTOR	OPTICAL
CAPACITY	10 <sup>10</sup> bits	10 <sup>8</sup> bits	10 <sup>7</sup> -10 <sup>6</sup> bits	10 <sup>6</sup> bits	10 <sup>6</sup> bits	10 <sup>9</sup> -10 <sup>12</sup> bits
ACCESS TIME	100 sec	300 msec	10 msec	1 μsec	100 nsec	1 μsec
COST	10 <sup>6</sup> ε/bit	5 x 10 <sup>-2</sup> ε/bit	10 <sup>-2</sup> ε/bit	2 ε/bit	20 ε/bit	10 <sup>-3</sup> -10 <sup>-6</sup> ε/bit

"DO NOT LOOK INTO THE LASER"

It would be unforgivable to present a review of laser applications without a discussion of the safety aspects of their use.

Lasers are potentially dangerous, especially when large powers are involved, because the radiation intensity is much greater than that provided by conventional radiation sources.

As time passes, the safety criteria vary, but it is generally agreed that all but the smallest sources could cause eye damage by burning the retina. A normal cheap C.W. laser will produce around 3 mW. Figure 11 shows the calculated intensity that this puny source will provide on the retina — it is not so small, by any standards! Note how small the permissible level for continuous exposure is. It is not until the beam is viewed directly from at least a 20 m distance that damage will not occur.

Where possible, lasers should either be enclosed or provided with a beam broadening telescope to reduce the power density. The safest practice is never to look into a laser beam emanating from the laser — no matter how small the power is.

Care must be taken to avoid specular reflections — they reflect beams equally as intense as the source.

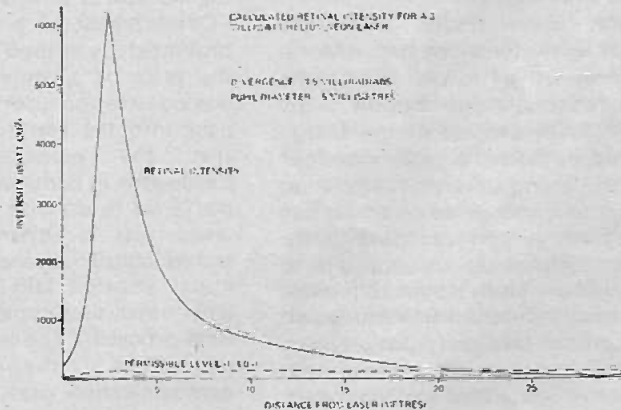

Where lasers are in use, notices should be displayed to this effect. Be sure to instruct those who could come in contact with the devices that they can be dangerous.

Especially secure precautions are needed where high power systems are used — the slightest flash of an invisible CO<sub>2</sub> laser will burn a hole in the retina.

Like all tools, the laser must be treated with respect.

bit in the hologram; no moving parts are needed; the storage density is considerably greater than with any other media; access time is around a microsecond and 3-D information and colour can also be stored. Bell Laboratories can, to date, store  $4 \times 10^6$  bits with access in  $6 \mu s$ . Future hopes are  $10^8$  bits with access in  $1 \mu s$ .

The basic procedure makes use of a volume of individual holograms. The 1 mm diameter holograms used by Bell Laboratories can store  $10^4$  bits each. There are 1024 of these minute photographic films. Illumination from a laser projects a reconstructed image of each hologram onto an array of 64 IC chips which each contain 64 photodetectors. Hitachi have also reported a similar development.

## TEACHING

The laws of diffraction and interference have been known for centuries and many experiments have been devised to demonstrate them as part of educational programmes.

Until the advent of laser sources these experiments used either white light (in special ways) or coherent light produced from discharge lamps. Interferometry and diffraction effects are much more clearly demonstrated using laser radiation. Diffraction around a fine wire or through a grating can be demonstrated in daylight to an audience of hundreds. Anyone who has had to align an interferometer using a discharge lamp source and a laser will know which is the easiest to do. The laser wins every time.

Lasers have improved the efficiency of the teaching of optical laws, enabling students to progress to a higher level of understanding in the same amount of time.

## ENTERTAINMENT

Manufacturers are always on the lookout for consumer products, for the large turnover can mean big profits, nevertheless for all the use of lasers, no company, as yet, has marketed one in a successful consumer product.

It seems the first use of lasers in the home could well be in entertainment. As far back as 1969, RCA released details of prerecorded holographic 'tapes' in which colour programme material is stored. These are read out with a laser that reconstructs the image onto a cheap television camera whose output is displayed on the home television set — and all this was to sell for £250. More recently Philips released details of a laser-read video disc. We await a definite release of such products.

Holographic television that replaces our current flat pictures is also a strong starter for the future. So far its

use is limited by the need to transmit about 20 000 times more data — the hologram, after all, represents 3D information, a film only two. This development will only come as part of normal transmission when data links wider bandwidth become available.

It seems that cineholography is also not going to be a starter (that is, seeing 3D films in the theatre) for there appears to be no way to reconstruct images of adequate size without holograms of comparable size. Films would have to be many metres across to do this — it would certainly beat Todd AO and other wide films, but the cost does not justify research at our present state-of-the-art.

In 1970 a Siemens-built stage laser was used to produce a twisting, twirling effect. Since the early 1960s, Zenith Radio have been working on acoustic-optical systems using laser to produce Son et Lumiere effects.

It is clear the laser is here to stay. One can predict that in the years to come we, or generations following, will be using laser knives in the kitchen, have holographic videophones, take amateur holographic photos, use laser headlights on cars — at different wavelengths for each direction of travel to overcome glare — you can add your own to the list. Nothing is far-fetched; it is merely a matter of economics and social pressures that decide the commodities we obtain.

## FURTHER READING

Laser technology is moving so fast that early reviews must be used with caution. The literature contains thousands of articles, so the task of presenting an adequate list is difficult — our own two articles condense over two hundred papers! The following should prove useful.

"Lasers and the Mechanical Engineer" Symposium by Inst. Mech. Engrs. London, November, 1968. (Provides breadth but now is dated.)

"Laser Focus" — all issues of this journal are devoted to lasers.

"Review of Laser Microwelding and Micromachining" — K.G. Nichols, Proc. IEE, 116, 12 December, 1969.

"BOC Laser Systems: CO<sub>2</sub> Laser Applications — TC1025" — available BOC.

"CO<sub>2</sub> Applications" — available Coherent Radiation, Palo Alto, U.S.A. ●

### BACK NUMBERS

Back numbers are available for 25p each plus 7p postage on one, 10p on two. We are unable to supply the following:

April, May 1972

February, November 1973

There are very limited supplies of January, March and April, 1974.

Orders should be sent to:

BACK NUMBERS DEPT, ET1, 36 Ebury Street, London SW1W 0LW.

## WILMSLOW AUDIO

The firm  
for  
speakers!



Baker Group 25, 3,8 or 15 ohm	£ 7.75
Baker Group 35, 3,8 or 15 ohm	£ 8.50
Baker Deluxe 8 or 15 ohm	£10.75
Baker Major 3,8 or 15 ohm	£ 8.50
Baker Regent 8 or 15 ohm	£ 7.75
Baker Superb 8 or 15 ohm	£14.50
Celestion PST8 (for Unilux)	£ 2.25
Celestion MH1000 horn 8 or 15 ohm	£10.45
EMI 13 x 8, 3,8 or 15 ohm	£ 2.15
EMI 13 x 8, 150 d/c 3,8 or 15 ohm	£ 2.35
EMI 13 x 8, 450 t/tw 3,8 or 15 ohm	£ 3.60
EMI 13 x 8, 350 8 or 15 ohm	£ 8.25
EMI 13 x 8 20 watt bass	£ 6.60
EMI 2 1/4" tweeter 8 ohm	£ .65
EMI 8 x 5, 10 watt, d/c, roll/s 8 ohm	£ 2.50
Elac 59RM109 15 ohm	£ 2.65
59RM114 8 ohm	£ 3.35
Elac 6 1/4" d/cone, roll/s 8 ohm	£ 1.21
Elac TW4 4" tweeter	£ 4.40
Fane Pop 15 watt 12"	£ 6.40
Fane Pop 25/2 25 watt 12"	£ 8.50
Fane Pop 40 40 watt 10"	£11.00
Fane Pop 50 watt 12"	£12.50
Fane Pop 55 60 watt 12"	£13.00
Fane Pop 60 watt 15"	£22.50
Fane Pop 100 watt 18"	£29.00
Fane Crescendo 12A or B, 8 or 15 ohm	£36.00
Fane Crescendo 15, 8 or 15 ohm	£47.50
Fane 807T 8" d/c, roll/s 8 or 15 ohm	£ 3.85
Fane 801T 8" d/c, roll/s 8 ohm	£ 7.00
Goodmans 8P 8 or 15 ohm	£ 4.49
Goodmans 10P 8 or 15 ohm	£ 4.70
Goodmans 12P 8 or 15 ohm	£11.65
Goodmans 12P-D, 8 or 15 ohm	£15.25
Goodmans 12P-G, 8 or 15 ohm	£14.50
Goodmans Audiom 100, 8 or 15 ohm	£ 9.50
Goodmans Axent 100, 8 ohm	£ 6.60
Goodmans Axlom 401, 8 or 15 ohm	£15.10
Goodmans Twinaxiom 8" 8 or 15 ohm	£ 6.79
Goodmans Twinaxiom 10" 8 or 15 ohm	£ 7.61
Kef T27	£ 4.75
Kef T15	£ 5.75
Kef B110	£ 6.75
Kef B200	£ 7.50
Kef B139	£11.75
Kef DN8	£ 1.92
Kef DN12	£ 4.12
Kef DN13	£ 2.75
Richard Allan CG8T 8" d/c roll/s	£ 6.35
STC4001G super tweeter	£ 6.19
Wharfedale Super 10RS/DD 8 ohm	£ 9.80
Fane 701 twin ribbon horn	£23.00
Baker Major Module	each £10.75
Fane Mode One	each £ 9.90
Goodmans DIN 20 4 ohm	each £ 8.75
Helme XLK25	pair £18.17
Helme XLK30	pair £14.95
Helme XLK50	pair £17.18
Kefkit 2	each £23.50
Kefkit 3	each £34.00
Peerless 3-25 (3 sp. system)	each £15.00
Richard Allan Twinkit	each £ 8.25
Richard Allan Triple 8	each £13.00
Richard Allan Triple	each £18.50
Richard Allan Super Triple	each £21.50
Wharfedale Linton 2 kit	pair £19.25
Wharfedale Glendale 3 kit	pair £34.50
Wharfedale Dovedale 3 kit	pair £52.50

### PRICES INCLUDE VAT.

Cabinets for Hi-Fi and PA., wadding, vynair etc. Send for free booklet—"Choosing a Speaker".

FREE with orders over £7-HiFi Loud-speaker enclosures book.

All units guaranteed new and perfect.

Prompt despatch

Carriage and insurance: Speakers 35p each, Kits 75p each (£1.50 pair) Tweeters and crossovers 20p each.

## WILMSLOW AUDIO

Dept ET1

Swan Works, Bank Square, Wilmslow,

Cheshire SK9 1HF.

Tel. Wilmslow 29599

(Discount Hi-Fi, PA and Radio at 10, Swan Street, Wilmslow).



---

---

---

# TECHNIQUES OF DIGITAL FAULT - FINDING

Digital circuitry is being used more and more. Its benefits are enormous, but they are accompanied by major problems in servicing and repair. Totally new techniques and servicing equipment are required.

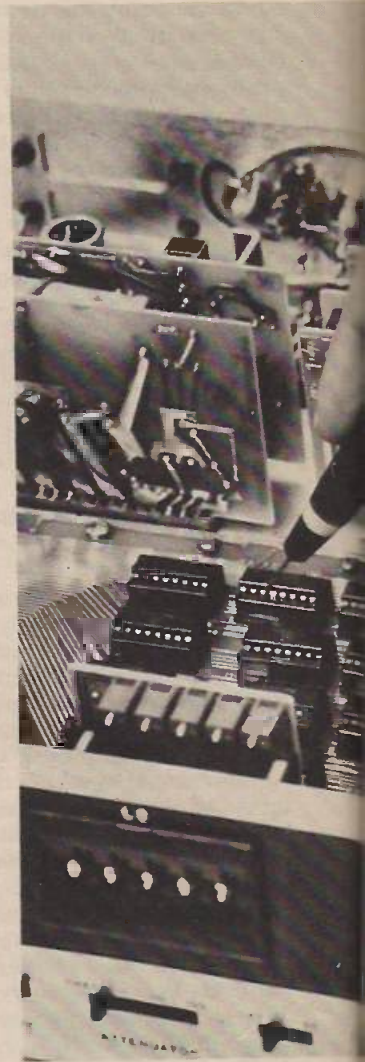

DIGITAL integrated circuits have revolutionized the electronics industry. Areas such as pocket calculators, digital computers, and all phases of a heretofore analogue world are exploding with more complex, compact, and powerful products than ever before. But this advance in electronics has not come without a price. The digital integrated circuit has also brought a major headache in maintaining and repairing these products. Fundamental differences between analogue and digital circuits and the resulting need for new instrumentation and troubleshooting techniques are responsible for these problems.

## 1. ANALOGUE TECHNIQUES AND DIGITAL TROUBLESHOOTING

When fault-finding circuits built from discrete components, the task is one of verifying relatively simple characteristics such as resistance, capacitance, or turn-on voltages of components with two or at most three nodes. And while the function of the total circuit may be quite complex, each component in that circuit

performs a relatively simple task and proper operation is easily verified.

In Figure 1, each diode, resistor, capacitor and transistor can be tested using a signal generator and a voltmeter, ohmmeter, diode checker, or oscilloscope — the traditional servicing tools. But when this circuit is built in integrated circuit form, these components are no longer accessible. It now becomes necessary to test the operation of the complete circuit function.

Thus an important difference between discrete circuitry and today's circuits built from digital IC's is in the complexity of the functions performed by these new "components". Unlike the resistor, capacitor, diode or transistor, which must be interconnected to form a circuit function, today's digital IC performs complete, complex functions. Instead of observing simple characteristics, it is now necessary to observe complex digital signals and decide if these signals are correct according to the function the IC is meant to perform.

Verifying proper component

operation now requires stimulating and observing many inputs (in Fig. 1 there are 10 inputs) while simultaneously observing several outputs (often two or three and at times as many as eight). Thus another fundamental difference between circuitry built from discrete components and digital IC's is the number of inputs and outputs associated with each component, and the need to stimulate and observe these simultaneously.

In addition to the problems of simultaneity of signals and complexity of functions at the component level, the digital IC has introduced a new degree of complexity at the circuit level. Circuits which perplex all but their designer are commonplace. Given enough time, these circuits can be studied and their operation understood, but this is not an affordable luxury for those involved in troubleshooting electronic circuits. Without understanding a circuit's intricate operation, it becomes necessary to have a technique of quickly testing each component rather than attempting to isolate a failure to



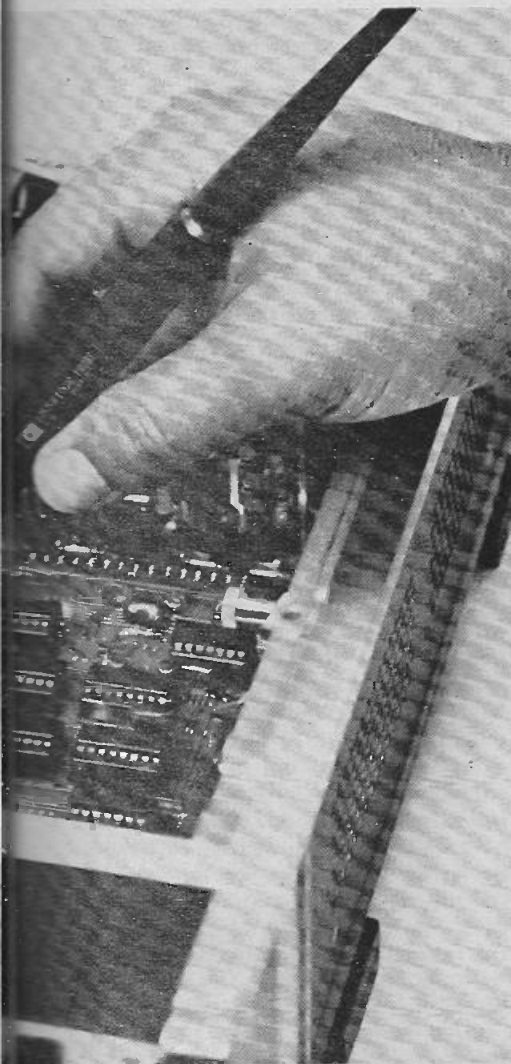

a particular circuit segment by testing for expected signals.

In order to solve these problems and to make fault-finding of digital circuits more efficient, it is necessary to take advantage of the digital nature of the signals involved. Tools and techniques designed to service analogue circuits do not take advantage of this digital nature and thus are less efficient when used to troubleshoot digital circuits.

Figure 2 shows a typical TTL (Transistor-Transistor-Logic) signal. This might as well be any analogue signal when viewed on an oscilloscope. The oscilloscope displays absolute voltage with respect to time, but in the digital world absolute values are unimportant.

A digital signal exists in one of two or three states — high, low, and undefined or in-between level — each determined by a threshold voltage. It is the relative value of the signal voltage with respect to these thresholds that determines the state of the digital signal and this digital state determines the operation of the IC, not absolute levels. In Figure 2, if the

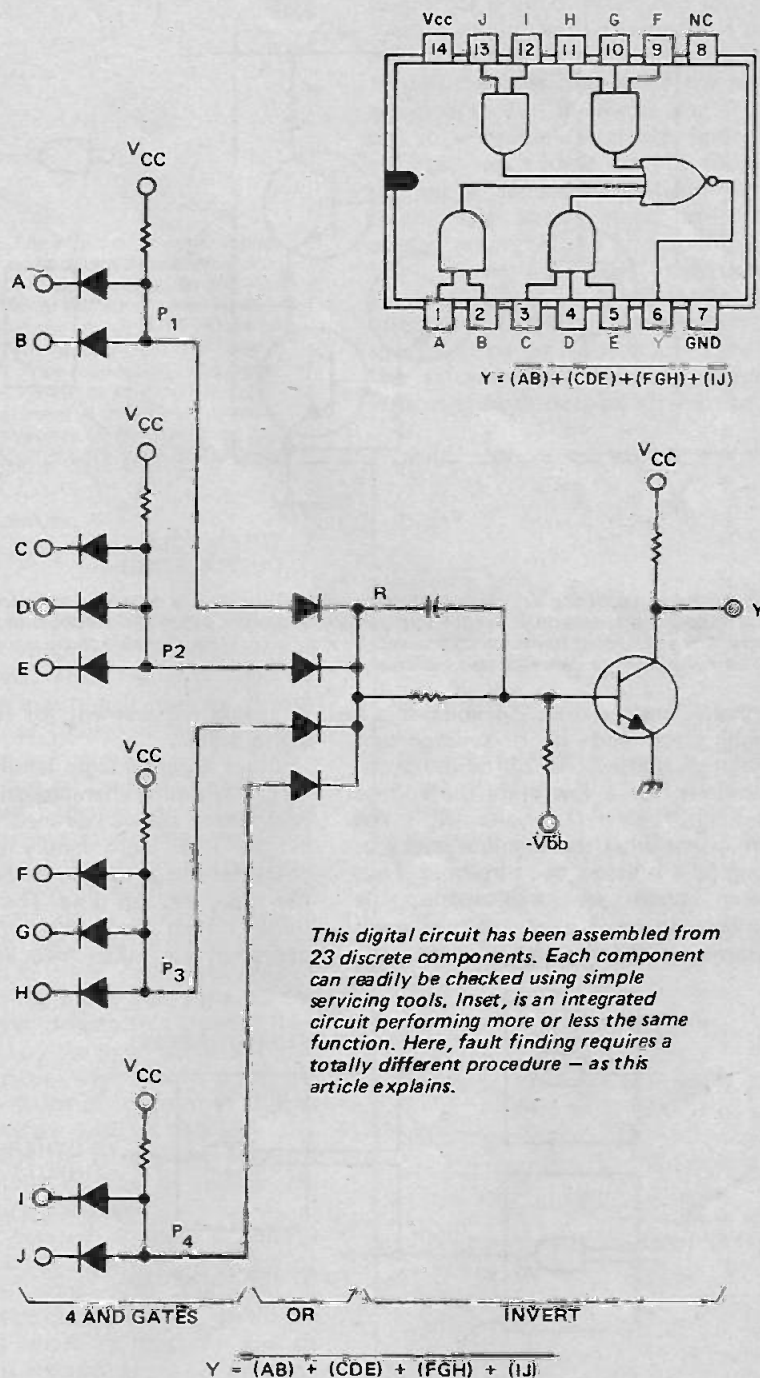

*This digital circuit has been assembled from 23 discrete components. Each component can readily be checked using simple servicing tools. Inset, is an integrated circuit performing more or less the same function. Here, fault finding requires a totally different procedure — as this article explains.*

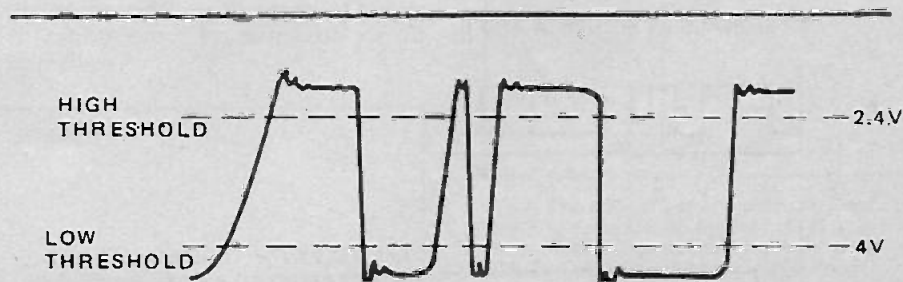

*Fig.2. TTL signal. In the digital world, the relative value of a signal voltage with respect to the threshold voltages determines the operation of the circuit. A signal above the high threshold is in the high state and whether it is 2.8 V or 3.0 V is unimportant to the operation of the circuit.*



# TECHNIQUES OF DIGITAL FAULT-FINDING

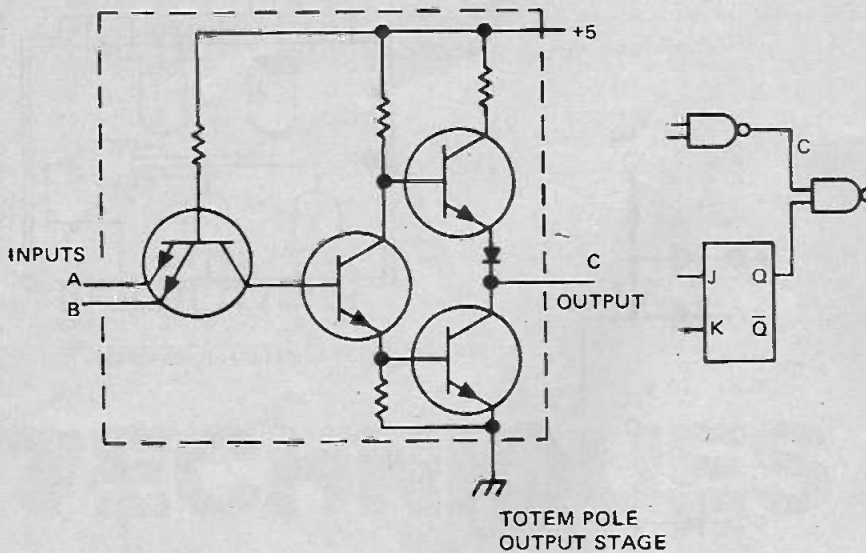
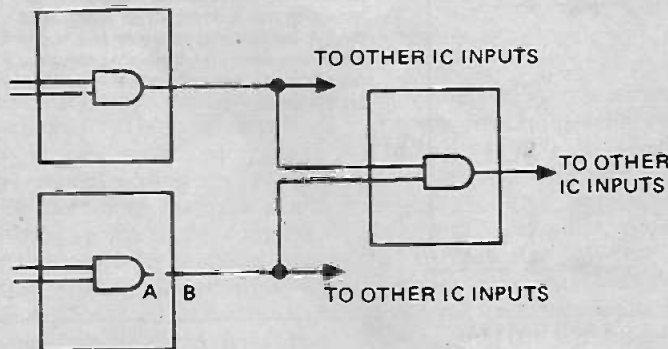

Fig.3. When stimulating a node in a circuit, such as C above, it is necessary to over-ride the low impedance 'totem pole' output stage driving that node. When the output is in the low state, it is a saturated transistor to ground. Most signal sources available today are not powerful enough to over-ride this low state.

signal is greater than 2.4 volts, it is a high state and it is unimportant whether the level is 2.8 or 3.0 volts. Similarly for a low state the voltage must be below 0.4 volts. It is not important what the absolute level is as long as it is below this threshold. Thus when using an oscilloscope, the serviceman must over and over again determine if the signal meets the

threshold requirement for the desired digital state.

Within a digital logic family, such as TTL, the timing characteristics of each component are well defined. Each gate in the TTL logic family displays a characteristic propagation delay time, rise time, and fall time. The effects of these timing parameters on circuit operation are taken into account by



SIGNALS AT POINTS A AND B:

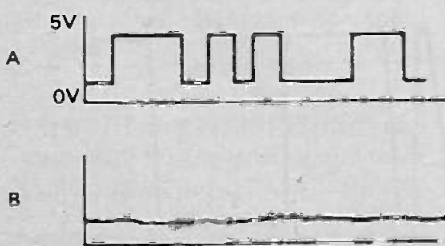

1.4V TO 1.5V = "BAD LEVEL" AND IS INTERPRETED BY TTL AND DTL INPUTS AS A HIGH STATE

Fig.4. The effect of an open output bond upon circuit operation. An open output bond allows all inputs driven by that output to float to a "bad level". This level is usually interpreted as a logic high state by the inputs. Thus the inputs driven by an open output bond will respond as though a static logic high signal was applied.

the designer. Once a design has been developed beyond breadboard or prototype stage and is into production, problems due to design have (hopefully) been corrected.

An important characteristic of digital IC's is that when they fail, they fail catastrophically. This means that timing parameters rarely degrade or become marginal. Thus observing on an oscilloscope and making repeated decisions on the validity of timing parameters is time consuming and contributes very little to the fault-finding process. Once problems due to design are corrected, the fact that pulse activity exists is usually enough indication of proper IC operation without further observation of pulse width, repetition rate, rise time or fall time.

Figure 3 shows a problem created by the TTL logic family. The output stage of a TTL device is a transistor totem pole. In either the high or low state, it is a low impedance. In the low state it is a saturated transistor to ground. It thus appears as 5-10 ohms to ground. This presents a problem to in-circuit stimulation. A signal source used to inject a pulse at a node which is driven by a TTL output must have sufficient power to override the low impedance output state. Most sources presently used for fault-finding do not provide this capability. It has been necessary for the serviceman to either cut printed circuit traces or pull out IC leads in order to stimulate the circuit being tested. Both of these practices are time consuming and lead to unreliable repairs.

Thus the use of the traditional oscilloscope and the traditional signal sources is inefficient. Since the diodes and transistors are packaged in the IC, use of diode checkers is also marginal. These tools are general purpose tools that can be applied to any situation if the serviceman has enough time. But with the quantity and complexity of today's electronic circuits, it makes sense to find the most efficient solution to the problem at hand. This suggests using the oscilloscope, diode checkers and voltmeter on analogue circuits where they really shine, and using instruments that take advantage of the digital nature of signals on the digital circuitry to be repaired.

In order to repair digital equipment efficiently, it is important to understand the type of failures found in digital circuits. These can be categorized into two main classes — those caused by a failure internal to an IC and those caused by a failure in the circuit external to the IC.

Four types of failures can occur internally to an IC. These are (1) an open bond on either an input or output, (2) a short between an input





# TECHNIQUES OF DIGITAL FAULT-FINDING

high simultaneously, or to go low simultaneously, the shorted pins will respond properly. But whenever one output attempts to go low the short will be constrained to be low.

The fourth failure internal to an IC is a failure of the internal (steering circuitry of the IC (Fig. 8). This has the effect of permanently turning on either the upper transistor of the

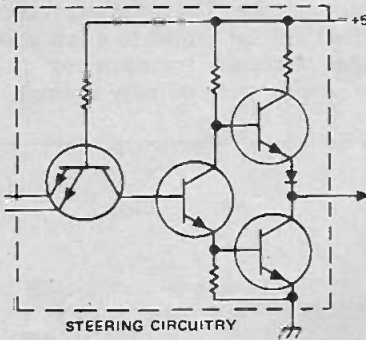

Fig.8. The effect of a failure of the internal circuitry of the IC upon circuit operation. A failure of the steering circuitry of an IC will either cause the output to be in a static high state or a static low state.

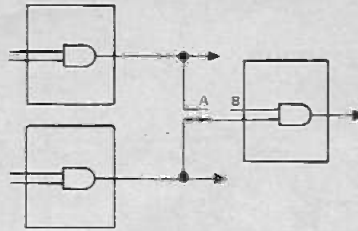

Fig.9. The effect of an open in the circuit external to an IC. All inputs attached to the node at point A will be driven properly. All inputs to the right of the open (point B) will be left to float to a "bad level" and will therefore look like a static high state.

output totem pole, thus locking the output in the high state, or turning on the lower transistor of the totem pole thus locking the output in the low state. Thus this failure blocks the signal flow and has a catastrophic effect upon circuit operation.

A short between a node and Vcc or ground external to the IC is indistinguishable from a short internal to the IC. Both will cause the signal lines connected to the node to be either always high (for shorts to Vcc) or always low (for shorts to ground).

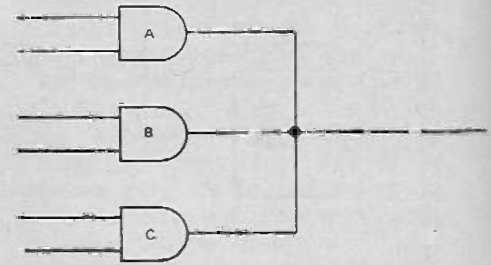

Fig.10. The "open collector" problem. When gates are connected in the "wired-OR" arrangement, the output of one IC can constrain the outputs of the other IC's to be in a state other than that defined by the gates truth table and input states.

When this type of failure is encountered only a very close physical examination of the circuit will reveal if the failure is external to the IC.

An open signal path in the circuit has a similar effect as an open output bond driving the node (Fig. 9). All inputs to the right of the open will be allowed to float to a bad level and will thus appear as a static high level in circuit operation. Those inputs to the left of the open will be unaffected by the open and will thus respond as expected.

**NEW - LOW PRICED 12" DISPLAY UNITS.** From £48.50. All units completely cased, transistorised EHT, Standard mains operation. SAE for all details.

**£1 WORTH OF UFS.** Six Brand New capacitors all between 15V and 100V. Total capacitance not less than 7,000mfd. P. & P. 45p.

**CAPACITOR PACK 50** Brand new components only 56p. P. & P. 17p.

**POTS 10** different values. Brand new. 56p. P. & P. 17p.

**COMPONENT PACK** consisting of 5 pots various values, 250 resistors 1/2 and 1 watt etc., many high stabs. All Brand new. Fine value at 60p per pack. P. & P. 27p.

**DELIVERED TO YOUR DOOR** 1 cwt. of Electronic Scrap chassis, boards, etc. No Rubbish. FOR ONLY £3.50. N. Ireland £2 extra.

**P.C.B. PACK S & D.** Quantity 2 sq. ft.—no tiny pieces. 56p plus P. & P. 20p.

**FIBRE GLASS** as above £1 plus P. & P. 20p.

**5 CRYSTALS** 70 to 90kHz. Our choice. 25p. P. & P. 15p.

**TRIMMER PACK.** 2 Twin 50/200 pf ceramic; 2 Twin 10/100 pf ceramic; 2 min strips with 4 preset 5/20 pf on each; 3 air spaced preset 30/100 pf on ceramic base. ALL BRAND NEW 25p the LOT. P. & P. 10p.

**ROTARY SWITCH PACK—8** Brand New switches (1 ceramic; 1-4 pole 2 way etc.). 56p. P. & P. 20p.

### POTENTIOMETERS

**COLVERN 3 watt.** Brand new, 25; 50k all at 13p ea.

**MORGANITE Special Brand new,** 2.5; 10; 100; 250; 500K; 1 in. sealed. 17p ea.

**BERCO 2 1/2 Watt.** Brand new, 5; 10; 50; 250; ohms; 1; 2.5; 10; 25; 50K at 15p ea.

**STANDARD 2 meg. log pots.** Current type 15p ea.

**INSTRUMENT 3 in.** Colvern 5 ohm 35p ea.; 50k and 100K 56p ea.

**BOURNS TRIMPOT POTENTIOMETERS:** 20; 50; 100; 200; 500 ohms; 1; 2; 2.5; 5; 10; 25K at 35p ea. ALL BRAND NEW.

**RELIANCE P.C.B. mounting:** 270; 470; 500 ohms; 10K at 35p ea. ALL BRAND NEW.

**ALMA** precision resistors 200K; 400K; 497K; 998K; 1 meg—0.1% 27p ea.; 3 25k, 5 6k, 13k—0.1% 29p ea.

Vast quantity of good quality components —NO PASSING TRADE—so we offer **3 LBS. of ELECTRONIC GOODIES** for £1.50 post paid.

**PHOTOCELL** equivalent OCP 71; 13p ea. **MULLARD OCP70** 16p each.

**BECKMAN 10 TURN DIALS ONLY.** Brand new. £2.25 ea. P & P 10p.

**METERS BY SIFAM** type M42, 25-0-25 microamp Scaled 25-0-25 green; 250-0-250 red, linear. As new. £3.50 ea. P & P 37p.

**METERS.** Ernest Turner. Model 402, 100 microamps. Brand new. Lovely shape, lousy scale - hence £2.25 ea. P & P 25p.

**ELECTROSTATIC VOLTMETERS** from 0-300 Volts to 0-10KV. S.A.E. with your requirements.

**MODERN TELEPHONES** type 706. Two-tone grey or black, £3.75 ea. Type 7006 two-tone green £3.75 ea. P & P 25p ea.

**IDEAL EXTENSION TELEPHONES** with standard GPO type dial, bell and lead type coding. £1.75 ea. P & P 25p ea.

**12" LONG PERSISTANCE TUBES**  
Ideal for SSTV; educational purposes. Type 12DP7A. Connections, voltages etc. Brand New Boxed £7.50 each including carriage and VAT.

**REPLACEMENT TUBES** for Cossor 1035 Mk 1 & 2 and Cossor 1049 Mk 1, 2, 3 & 4. Tested and guaranteed. £3.00 ea. P & P 37p.

**FIBRE GLASS PRINTED CIRCUIT BOARD.** Brand new. Single and double sided. Any size 1p per sq. in. P & P 10p per order.

**6 VOLT 1/2 AMP LOGIC (I.C.'s) POWER SUPPLY**  
Standard Mains Input. £2.75 each. P & P. 25p.

**MAKE YOUR SINGLE BEAM SCOPE INTO A DOUBLE WITH OUR NEW LOW PRICED SOLID STATE SWITCH.**  
2Hz to 8 MHz. Hook up a 9 volt battery and connect to your scope and have two traces for ONLY £5.50. P & P. 25p. STILL AVAILABLE our 20MHz version at £9.25 P & P. 25p.

**20HZ to 200KHZ SINE AND SQUARE WAVE GENERATOR**  
In four ranges. When bridge oscillator thermistor stabilised. Separate independent sine and square wave amplitude controls. 3V max sine. 6V max square outputs. Completely assembled P.C. Board, ready to use. 9 to 12V supply required. £7.85 each. P & P 25p. Sine Wave only £5.85 each. P & P 25p.

**TRANSISTOR INVERTER**  
12V to 1.5 KV 2 MA. Size 1 1/2 x 2 1/2 x 4 in. Multi tapped secondary and output level control makes possible large range of voltage and current output combinations without modification. Very flexible unit at £2.95 each P & P. 25p.

**NEW WIDE RANGE WOBBLATOR**  
5 MHz to 150 MHz (Useful harmonics up to 1.5 GMZ) up to 15 MHz sweep width. Only 3 controls, preset RF level, sweep width and frequency. Ideal for 10.7 or TV IF alignment, filters, receivers. Can be used with any general purpose scope. Full instructions supplied. Connect 6.3V AC and use within minutes of receiving. All this for only £5.75 P & P 25p.

Always available range of:- Oscilloscopes; signal generators; valve voltmeters; EHT Power units; EHT capacitors; EHT transformers; etc. etc.

Unless stated—please add £1.50 carriage to all units.  
**VALUE ADDED TAX not included in prices—please add 10%**  
Official Orders Welcomed, Gov./Educational Depts., Authorities, etc., otherwise Cash with Order  
Open 9 am to 6.30 pm any day (later by arrangement.)

**CHILTMHEAD LTD**  
7/9 ARTHUR ROAD, READING, BERKS. (rear Tech. College, Kings Road) Tel.: Reading 582605/65916



**I.L.P.** (Electronics) Ltd

# SHEER SIMPLICITY!

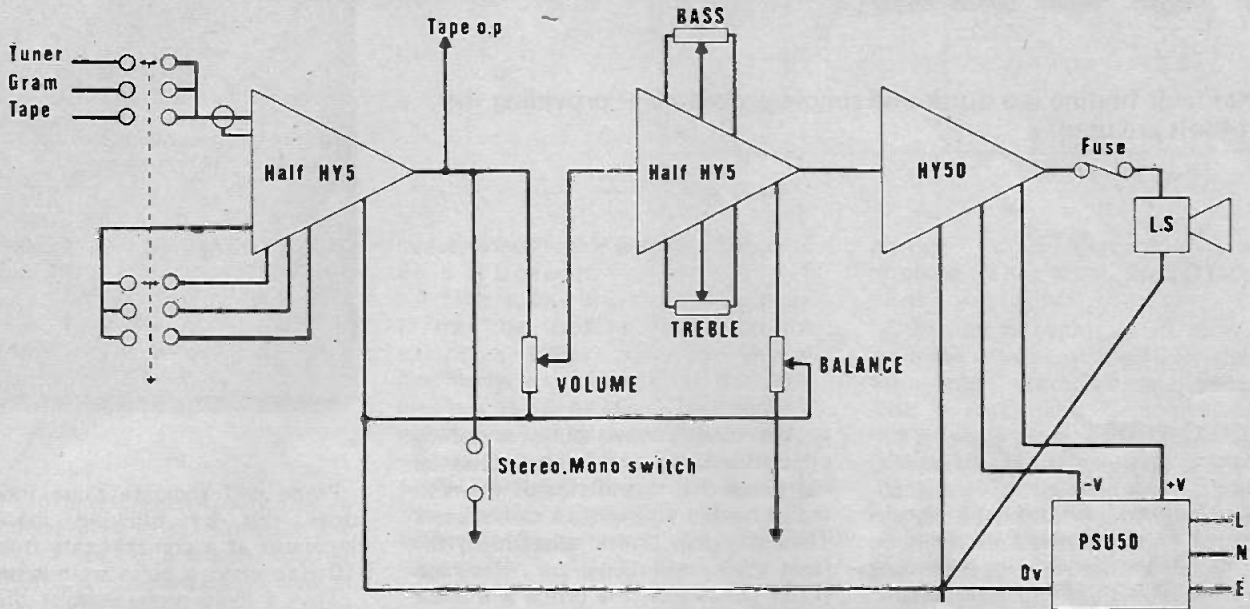

*Mono electrical circuit diagram with interconnections for stereo shown*

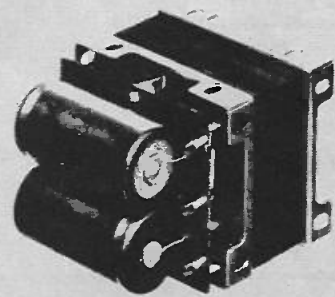
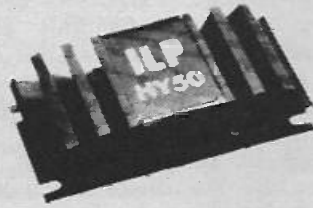
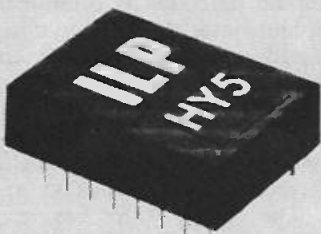

The HY5 is a complete mono hybrid preamplifier, ideally suited for both mono and stereo applications. Internally the device consists of two high quality amplifiers, the first contains frequency equalisation and gain correction, while the second caters for tone control and balance.

**TECHNICAL SPECIFICATION**

**Inputs**

Magnetic Pick-up 3mV RIAA  
 Ceramic Pick-up 30mV  
 Microphone 10mV  
 Tuner 100mV  
 Auxiliary 3-100mV  
 Input impedance 47Ω at 1kHz.

**Outputs**

Tape 100mV  
 Main output Odb (0.775 volts RMS)

**Active Tone Controls:**

Treble ±12db at 10kHz  
 Bass ±12db at 100Hz

Distortion 0.05% at 1kHz

Signal/Noise Ratio 68db

Overload Capability 40db on most sensitive input

Supply Voltage ±16-25 volts.

PRICE £4.50 + 0.45 V.A.T. P & P free.

The HY50 is a complete solid state hybrid Hi-Fi amplifier incorporating its own high conductivity heatsink hermetically sealed in black epoxy resin. Only five connections are provided: Input, output, power lines and earth.

**TECHNICAL SPECIFICATION**

Output Power 25 watts RMS into 8Ω

Load Impedance 4-16Ω

Input Sensitivity 0db (0.775 volts RMS)

Input Impedance 47Ω

Distortion Less than 0.1% at 25 watts typically 0.05%

Signal/Noise Ratio Better than 75db

Frequency Response 10Hz-50kHz ±3db

Supply Voltage ±25 volts

Size 105 x 50 x 25 mm.

PRICE £5.98 + 0.59 V.A.T. P & P free.

The PSU50 can be used for either mono or stereo systems.

**TECHNICAL SPECIFICATIONS**

Output voltage 25 volts

Input voltage 210-240 volts

Size L.70, D.90, H.60 mm.

PRICE £5.00 x 0.50 V.A.T. P & P free.

**TWO YEARS GUARANTEE ON ALL OUR PRODUCTS**

CROSSLAND HOUSE · NACKINGTON · CANTERBURY · KENT

CANTERBURY (0227) 63218



# DIGITAL SERVICING TOOLS

Digital fault finding is a quick and simple procedure — providing the right tools are used.

A LOGIC PROBE is a digital state indicator. It provides, at the user's finger tips, an indication of a high level, a low level, or bad level signal. Internal threshold indicators determine if the signal being probed is above the high threshold level, below the low threshold level, or somewhere between the two. Signal indication is given by a lamp that glows brightly for a high level, goes off for a low level, and glows dimly for a signal that is between the two thresholds. (Other types indicate signal state by different coloured lamps).

Since it is necessary to observe dynamic signal activity, as well as the static levels described above, logic

probes usually have pulse stretching circuitry that can detect pulses as narrow as 10 ns and stretch them so that a readily visible blink can be seen. Thus if a low signal pulses high, the logic probe will blink 'on'. If a high signal pulses low, the probe will blink 'off'.

With some logic probes, such as Hewlett-Packard's 10525T, a pulse memory may be (in this case optionally) provided. This enables the probe to monitor a signal line for single shot or low frequency pulses over extended periods of time.

If a pulse occurs, this will be indicated by the device which will remain 'on' until reset by the user.

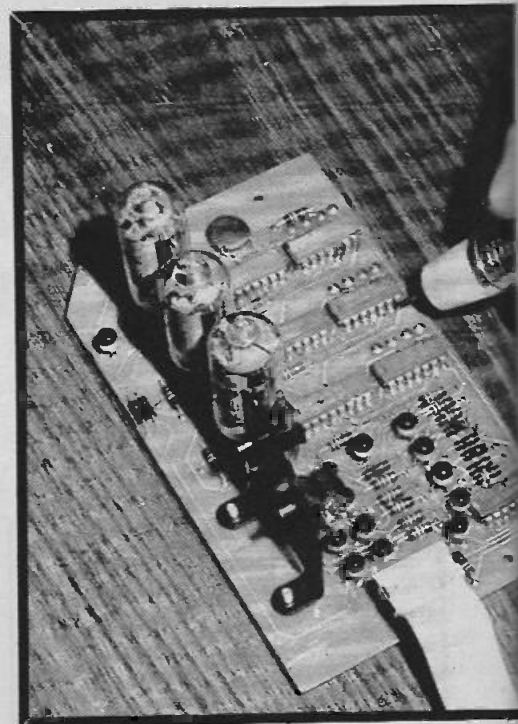

Probe will indicate pulse trains. It does this by blinking the lamp indicator at a constant rate (typically 10 Hz) when a pulse train is present.

Thus a logic probe enables the user to view static signals, single shot pulses, and pulse trains. Automatic threshold detection is often included. This eliminates the need to determine repeatedly whether a signal is above or below the threshold.

Hewlett Packard's Logic Clip is another form of digital state indicator. It enables up to 16 signals to be observed simultaneously on a single IC. The Logic Clip has a single threshold level. If a signal on a given IC pin is above this threshold level an LED indicator light is turned on corresponding to that pin. If the signal is below this level the LED is turned off.

The Logic Clip differs from a logic probe in two important ways. First it has a single threshold as opposed to the two threshold levels in most logic probes. Because of this it will not indicate a bad level. Rather it will respond to a bad level signal in the same way a TTL or DTL gate will — as a high logic state. Apart from this, the HP Logic Clip does not have pulse stretching circuitry and therefore cannot be used to view high frequency or single shot narrow pulses.

The advantage of the Logic Clip is that it has internal 'power seeking' circuitry. It cannot be attached improperly — regardless of how it is clipped onto the IC it will display the desired signal!

The ability to view signal activity on

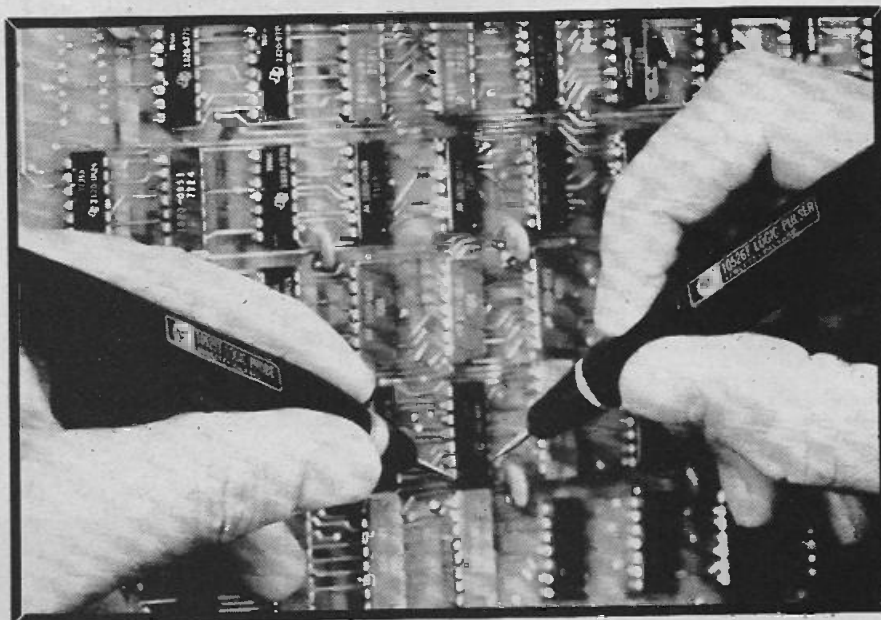

Here, a Hewlett-Packard logic probe is being used in conjunction with a logic pulsar.

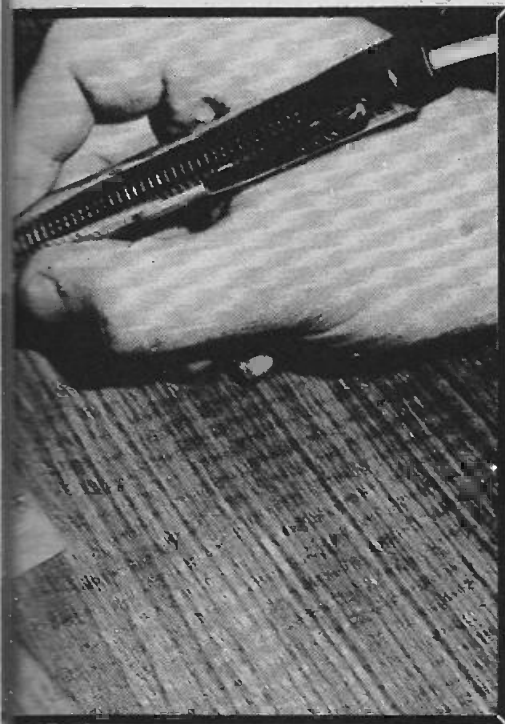

◀ This ETI-designed logic probe was described as a constructional project in our September 1972 issue.

Circuit of the ETI probe. The IC is a 7400 (Prefix depends on makers).

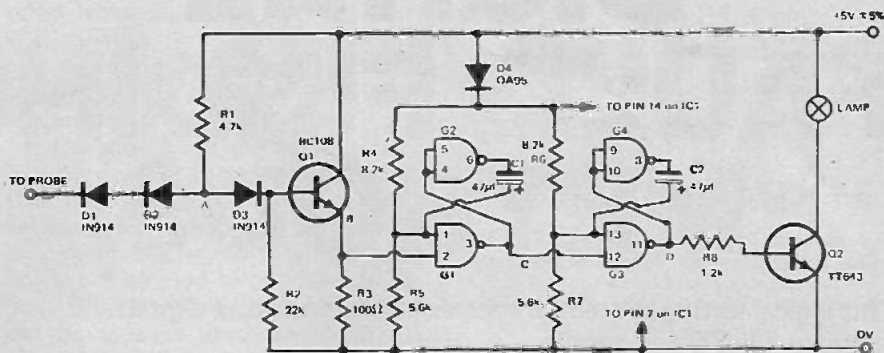

out previously this is very difficult to do in TTL circuits.

A logic pulser provides the solution. It may be used to inject into the circuit a single pulse of proper amplitude and polarity. If the node was low, it will be pulsed high and if it was high it will be pulsed low.

Thus it now becomes possible to jump rapidly from point to point in the circuit, applying pulses and observing the responses. Together the logic pulser, logic probe and logic clip

provide total in-circuit stimulus response testing for all TTL, DTL, and other 5 volt logic.

Other more sophisticated tools are available which test the IC, in-circuit, for correct operation in accordance with its truth table. Such a device is the Hewlett Packard 10529A Logic Comparator.

However, the three devices mentioned previously, offer a method of stimulus-response testing which is the mainstay of digital servicing. ●

several pins simultaneously is a tremendous time saver. Consider the problem of testing a decade counter (e.g. 7490). It is necessary to view at least one input and four outputs simultaneously to determine if this device is operating properly. With a Logic Clip this is no problem.

A Logic probe or HP Logic Clip provides a response mode of operation that is optimized to digital signals. But the mainstay of all troubleshooting is stimulus-response testing. It is necessary to apply a signal and observe the response to determine if the device is operating properly. As was pointed

*This ingenious and versatile IC tester, recently released by Fluke, combines the functions of a logic probe, logic clip, and comparator in one single unit.*

*It functionally tests ICs while in circuit. A known-to-be-good IC of the type to be tested is inserted into a conventional socket. This is then plugged into the tester, which in turn, is snapped onto the IC to be tested. Internal circuitry 'sniffs out' Vcc and ground automatically powering the tester's internal circuitry.*

*The tester, known as the Trendar 200 IC Testclip, then displays — on an illuminated indicator — any difference between the reference IC and the IC under test.*

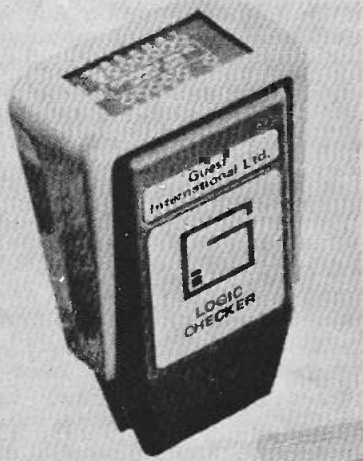
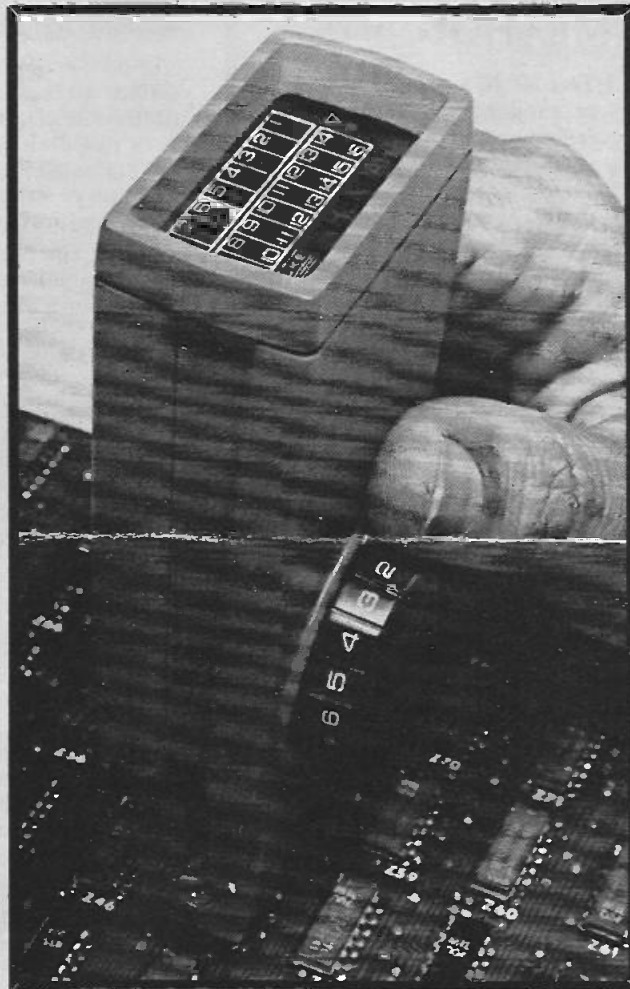

Logic checker from Guest International. This is designed to indicate the function of digital IC's (TTL, DTL) during operation. Built in circuitry and LED lamps instantly check logic levels. A DIY logic chip circuit costing about £10 is shown in Bywood's catalogue.



# DIGITAL FAULT-FINDING METHODS

This logical testing procedure enables you to fault-find digital circuitry quickly and simply.

THE FIRST STEP in any troubleshooting process is to narrow the malfunctioning area as much as possible by examining the observable characteristics of the failure. From the front panel operation (or rather mis-operation) the failure should be localised to as few circuits as possible. At this point it is necessary to narrow further the failure to one suspected

## DIGITAL FAULT-FINDING METHOD

- 1 Test all IC's using a logic probe or similar instrument. Note the failing nodes.
- 2 Check for an open output bond, driving the failing node using a logic probe. If an open bond is indicated, replace the IC driving the failing node.
- 3 Now test for a short to Vcc or GND using a logic pulser or probe. By simultaneously probing and pulsing the bad node, a short to Vcc or GND can be detected since the pulser is unable to inject a pulse into such a short.
- 4 Test for a short between two nodes using a logic probe and pulser — or an ohmmeter.
- 5 If the failure is not found in steps 2-4, then the failure, is either an open input bond or a failure of the internal circuitry of the IC driving the failing node. In either case the IC driving the failing node should be replaced.

Repeat steps 2-5 for each failing node observed in Test 1.

circuit by looking for improper key signals between circuits. The logic probe can be every effective here.

In many cases, a signal will completely disappear. By rapidly probing the inter-connecting signal paths, a missing signal can be readily detected. Another important failure is the occurrence of a signal on a line that should not have had a signal. Logic probes have a pulse memory which allows such signal lines to be monitored for single shot pulses or pulse activity over extended periods of time. The occurrence of a signal will be stored and indicated by an LED.

Dependence upon a well-written service manual is the key to this phase of troubleshooting. Isolating a failure to a single circuit requires knowledge of the instrument or system and its operating characteristics. A well written manual will indicate key signals to be observed. The logic probe will provide a rapid means of observing the presence of these signals.

Once a failure has been isolated to a single circuit, the devices described above can be used to observe the effect of the failure on circuit operation and to locate the failure to its cause (either an IC or a fault in the circuit external to the IC).

The logic probe can be used to observe the signal activity on inputs and to view the resulting output signals. From this information, a decision can be made as to the proper operation of the IC. For example, if a clock signal is occurring on a decade counter and the enabling inputs (usually reset lines) are in the enabled state then the output should be counting. A logic probe will allow the clock and enabling inputs to be observed, and, if pulse activity is indicated on the outputs, then the IC can be assumed to be operating properly. As stated before, usually it is not necessary to see the actual timing of the output signals since IC's fail



catastrophically. The occurrence of pulse activity is often enough indication of proper operation.

When more detailed study is desired or when input signal activity is missing, the logic pulser can be used to inject input signals and the Logic Clip or probe used to monitor the response. This technique is especially good when testing digital gates and other combinatorial devices. A logic pulser can be used to cause the inputs to go to a state which will cause a change in the output state. For example, a three-input NAND gate which has high, low, low inputs will have a high output. By pulsing the two low inputs high using a logic pulser the output will pulse low and can be detected by a logic probe. This then indicates that the IC is operating properly. A logic pulser is also valuable for replacing the clock in a digital circuit thus allowing the circuit to be single-stepped while the logic probe is used to observe the changes in the circuit's state.

The first step might be called the "mapping" step since the effect is to map out the problem areas for further investigation. It is important to do a complete "mapping" of the circuit before proceeding to analyse each of the indicated failures. Prematurely studying a fault can result in overlooking faults which cause multiple failures such as shorts between two nodes. This then often leads to the needless replacement of a good IC and much wasted time. With a complete trouble-area "map" we can begin to determine the type and cause of the failures. We do this by systematically eliminating the possible



failures of digital circuits discussed above.

The first failure to test for is an open bond in the IC driving the failed node. A logic probe provides a quick and accurate test for this failure. If the output bond is open, then the node will float to a bad level. By probing the node, the logic probe will quickly indicate a bad level. If a bad level is indicated then the IC driving the node should be replaced and retested.

If the node is not a bad level then a test for a short to Vcc or ground should be made next. This can be done easily using a logic pulser and probe. While a logic pulser is powerful enough to over-ride even a low impedance TTL output it is not powerful enough to effect a change in state or a Vcc or ground bus. Thus if a logic pulser is used to inject a pulse while the logic probe is used simultaneously on the same node to observe the pulse, a short to Vcc or ground can be detected. The occurrence of a pulse indicates that the node is not shorted, and the absence of a pulse indicates the node is shorted to Vcc (if it is a high) or ground (if it is a low).

If the node is shorted to Vcc or ground there are two possible causes. The first is a short in the circuit external to the IC's and the other is a short internal to one of the IC's attached to the node. The external short should be detected by an examination of the circuit. If no external short is found then the cause is equally likely to be any one of the IC's attached to the node. The only suggestion that can be made (based upon experience) is to first replace the

◀ Simple digital fault-finding can be undertaken using a simple multimeter but it is a long tedious process.

IC driving the node and if that does not solve the problem try each of the other IC's individually until the short is eliminated. (It might be noted that on occasion analogue components such as resistors or capacitors attached to the node have shorted).

If the node is not shorted to Vcc or ground, nor is it an open output bond, then we should look for a short between two nodes. This can be done in one of two ways. First the logic pulser can be used to pulse the failing node being studied and the logic probe can be used to observe each of the remaining failing nodes. If a short exists between the node being studied and one of the other failing nodes, then the pulser will cause the node being probed to change state (i.e. the probe will detect a pulse). To ensure that a short exists, the probe and pulser should be reversed and the test made again. As a further test or as another way of testing for a short between two nodes, the circuit can be removed from the instrument or system and an ohmmeter can be used to measure the impedance between the two failing nodes. A short between them will be easily detected.

If the failure is a short then there are two possible causes. The most likely is a problem in the circuit external to the IC's. This can be detected by physically examining the circuit and repairing any solder bridges or loose wire shorts found. Only if the two nodes which are shorted are common to one IC can the failure be internal to that IC. If after examining the circuit no short can be found external to the IC then the IC should be replaced.

If the failure is not a short between two nodes then there are only two possibilities left. They are that the

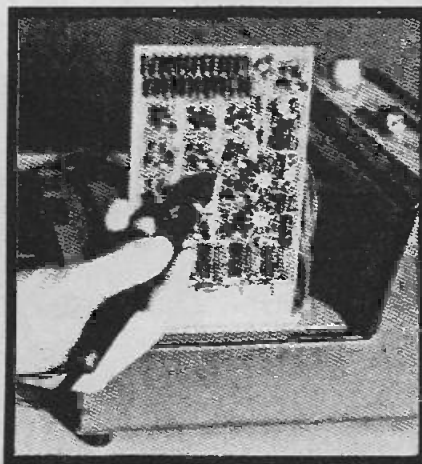

*This logic test unit from Siemens allows PC boards to be tested by applying a programmed input bit pattern to the board and displaying corresponding board outputs. A separate logic probe is used to trace faults to specific IC's on the board.*

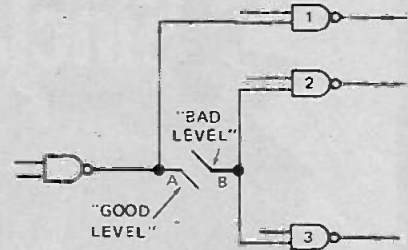

*Fig. 11. The effect of an open signal path external to the IC's. The open causes point B to float to a bad level while point A is driven by proper TTL or DTL signal levels. Starting at the input of gate 3 or 4 and proceeding back toward gate 1, the exact location of the open can be determined using a logic probe.*

failure is an open input bond or a failure of the internal circuitry of the IC. In either case, this IC should now be replaced. Thus, by systematically eliminating the IC failures, the cause can be located.

An important step at any point where an IC is replaced is the retesting of the circuit. If the testing again indicates a failure, then more study of the problem must be made with the knowledge that the failure is not in the IC that has just been replaced.

There is one type of failure that was not discussed, and that is an open signal path in the circuit external to the IC (Fig. 11).

The logic probe provides a rapid means of not only detecting but also physically locating the open. Since an open signal path allows the input to the "right" of the open to float to a bad level, the logic probe can be used to test the input of each IC for a bad level. Once an input floating at a bad level is detected, the logic probe can be used to follow the circuit back from the input looking for the open. This can be done because the circuit to the "left" of the open will be a good logic level (either high, low, or pulsing) while the circuit to the right will be a bad level. Thus probing back along the signal path will indicate a bad level until the open is passed. Thus the probe can be used to locate precisely the open. The open can then be repaired and the circuit tested.

This systematic elimination of possible failures in digital circuits by the use of such special tools will ensure a rapid and accurate repair. Because these instruments provide a digital solution to the digital problem, improvements in servicing time of at least 4:1 are easily achieved. ●

We would like to thank the Marcom Division of Hewlett Packard, for their help in the preparation of this article.



# Sinclair Cambridge kit. Was £27.45.

## Now only £14.95!

(INC VAT)

## You save £12.50!

### An advanced 4-function calculator in kit form

The Cambridge kit is the world's largest-selling calculator kit.

It's not surprising – no other calculator matches the Sinclair Cambridge in functional value for money; and buying in kit form, you make a substantial saving.

Now, simplified manufacture and continuing demand mean we can reduce even the kit price by a handsome £12.50. For under £15 you get the power to handle complex calculations in a compact, reliable package – plus the interest and entertainment of building it yourself!

### Truly pocket-sized

With all its calculating capability, the Cambridge still measures just  $4\frac{1}{3}'' \times 2'' \times \frac{11}{16}''$ . That means you can carry the Cambridge wherever you go without inconvenience – it fits in your pocket with barely a bulge. It runs on ordinary U16-type batteries which give weeks of normal use before replacement.

### Easy to assemble

All parts are supplied – all you need provide is a soldering iron and a pair of cutters. Complete step-by-step instructions are provided, and our service department will back you throughout if you've any queries or problems.

### Total cost? Just £14.95!

The Sinclair Cambridge kit is supplied to you direct from the manufacturer. Ready assembled, it costs £21.95 – so you're saving £7! Of course we'll be happy to supply you with one ready-assembled if you prefer – it's still far and away the best calculator value on the market.



### Features of the Sinclair Cambridge

- \* Uniquely handy package.  $4\frac{1}{3}'' \times 2'' \times \frac{11}{16}''$ , weight  $3\frac{1}{2}$  oz.
- \* Standard keyboard. All you need for complex calculations.
- \* Clear-last-entry feature.
- \* Fully-floating decimal point.
- \* Algebraic logic.
- \* Four operators (+, -, x, ÷), with constant on all four.
- \* Constant acts as last entry in a calculation.
- \* Constant and algebraic logic combine to act as a limited memory, allowing complex calculations on a calculator costing less than £15.
- \* Calculates to 8 significant digits.
- \* Clear, bright 8-digit display.
- \* Operates for weeks on four U16-type batteries

# A complete kit!

The kit comes to you packaged in a heavy-duty polystyrene container. It contains all you need to assemble your Sinclair Cambridge. Assembly time is about 3 hours.

**Contents:**

1. Coil.
2. Large-scale integrated circuit.
3. Interface chip.
4. Thick-film resistor pack.
5. Case mouldings, with buttons, window and light-up display in position.
6. Printed circuit board.
7. Keyboard panel.
8. Electronic components pack (diodes, resistors, capacitors, transistor).
9. Battery clips and on/off switch.
10. Soft wallet.

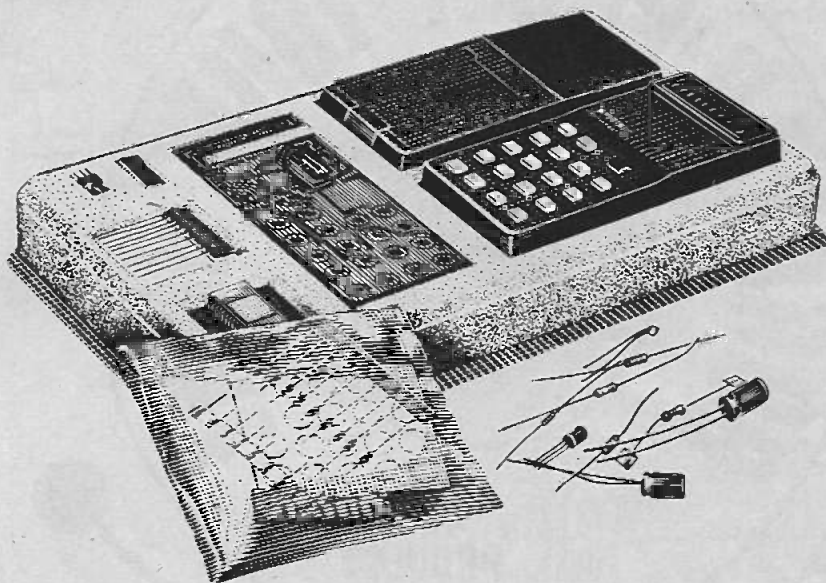

**This valuable book – free!**

If you just use your Sinclair Cambridge for routine arithmetic – for shopping, conversions, percentages, accounting, tallying, and so on – then you'll get more than your money's worth.

But if you want to get even more out of it, you can go one step further and learn how to unlock the full potential of this piece of electronic technology.



How? It's all explained in this unique booklet, written by a leading calculator design consultant. In its fact-packed 32 pages it explains, step by step, how you can use the Sinclair Cambridge to carry out complex calculations.

# sinclair

Sinclair Radionics Ltd, London Road,  
St Ives, Huntingdonshire  
Reg. no : 699483 England  
VAT Reg. no : 213 8170 88

**Why only Sinclair can make you this offer**

The reason's simple: only Sinclair – Europe's largest electronic calculator manufacturer – have the necessary combination of skills and scale.

Sinclair Radionics are the makers of the Executive – the smallest electronic calculator in the world. In spite of being one of the more expensive of the small calculators, it was a runaway best-seller. The experience gained on the Executive has enabled us to design and produce the Cambridge at this remarkably low price.

But that in itself wouldn't be enough. Sinclair also have a very long experience of producing and marketing electronic kits. You may have used one, and you've almost certainly heard of them – the Sinclair Project 80 stereo modules.

It seemed only logical to combine the knowledge of do-it-yourself kits with the knowledge of small calculator technology.

And *you* benefit!

**Take advantage of this money-back, no-risks offer today**

The Sinclair Cambridge is fully guaranteed. Return your kit within 10 days, and we'll refund your money without question. All parts are tested and checked before despatch – and we guarantee a correctly-assembled calculator for one year.

Simply fill in the preferential order form below and slip it in the post today.

**Price in kit form: £13.59 + £1.36 VAT. (Total: £14.95)**

**Price fully built: £19.95 + £2.00 VAT. (Total: £21.95)**

To: Sinclair Radionics Ltd, London Road,  
St Ives, Huntingdonshire, PE17 4HJ

Please send me

a Sinclair Cambridge Calculator kit at  
£13.59 + £1.36 VAT (Total: £14.95)

a Sinclair Cambridge calculator ready  
built at £19.95 + £2.00 VAT  
(Total: £21.95)

\*I enclose cheque for £\_\_\_\_\_, made  
out to Sinclair Radionics Ltd, and  
crossed.

\*Please debit my \*Barclaycard/Access  
account. Account number \_\_\_\_\_

\*Delete as required.

Name \_\_\_\_\_

Address \_\_\_\_\_

PLEASE PRINT



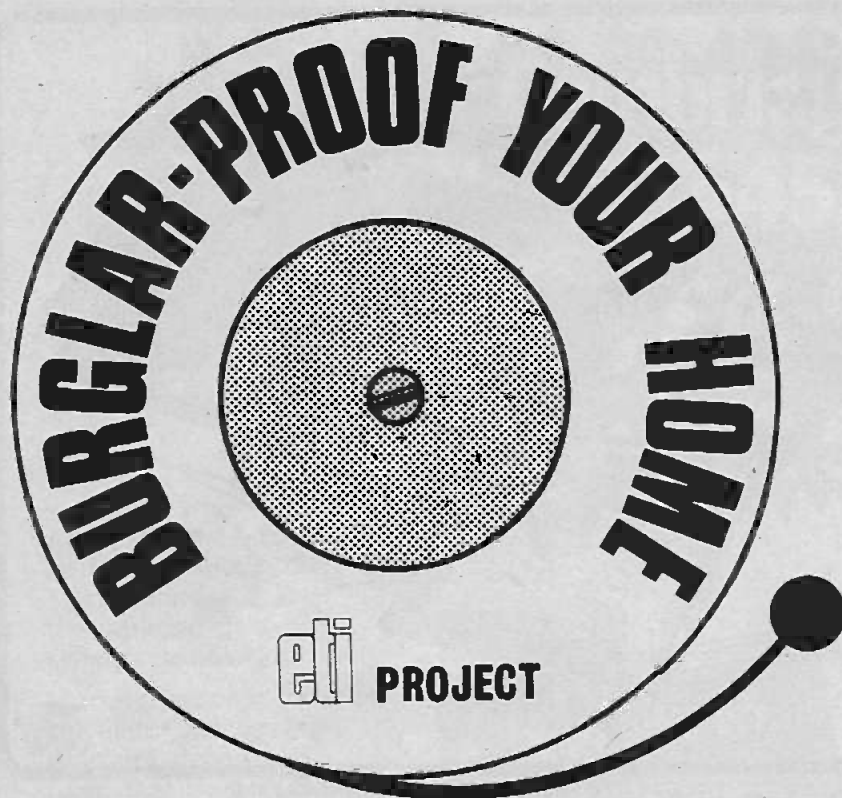

THE UNLAWFUL ENTRY of domestic premises is usually considered to be largely fortuitous, advantage being taken of the complete lack of any kind of security device. In these circumstances entry is possible while the family is asleep, or even occupied in another room. These circumstances are very different from those where a definite plan is made to enter a building known to have valuables, and thus relatively simple intruder alarm systems can assist the householder.

If some typical alarm circuits are considered in detail, it will be seen how an installation can be built up.

### PRESSURE OPERATED BELL

The circuit in Fig. 1 is of the simplest type. The transformer T1 provides a low voltage for the bell, which rings when switch contacts SW1 close. The contact may be placed under a mat or elsewhere, or may be a pressure mat of the type described later. This circuit is appropriate for a shop where a person entering operates SW1, but could be used with a mat in a corridor or passage, or possibly on the stairs.

As current is only drawn briefly, operation could be from a dry battery.

### TRANSFORMER

All the circuits operate at low voltage and, where current is drawn continuously, and to avoid battery replacements, operation is from a transformer. The primary should be for the 200/250V mains. The secondary de-

livers a much reduced voltage; with a typical bell transformer, a tapped secondary allows 3V, 5V or 8V to be selected.

The transformer should be of the approved "double insulated" type; or the core and one secondary tapping may be earthed. These precautions are to prevent any possibility of the full mains voltage arising in the low voltage secondary circuit if a fault should develop.

Transformers of other than miniature types will have integral holders with fuses, which avoid overheating if a fault should arise in the secondary wiring.

### LOCK-ON CIRCUIT

Alarm circuits are generally required to lock on, so that the bell continues to sound even after the connection to SW1 has been broken. This can be arranged by including a relay as in Fig. 2.

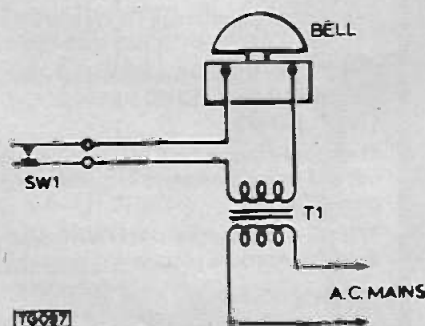

When SW1 is closed, current flows through the operating winding of the relay RL1. This causes relay contacts X-X to close. The circuit is now completed through these contacts, so that if SW1 is opened, the relay continues to be energised. Contacts Y-Y close at the same time, completing the circuit to the bell.

With this circuit, even a momentary closing of SW1 will switch the circuit on and it will remain so until the manual switch SW2 situated near the relay, is opened. This circuit, with contacts Y-Y replacing SW1 in Fig. 1, can thus make quite an effective alarm.

### RELAY SUPPLY

Relays to operate from a.c. derived from a transformer, can be obtained. However, if inexpensive surplus and similar relays which operate satisfactorily from d.c. are to be used, a rectified and smoothed supply is necessary. This may employ a bell type transformer, 2A or similar silicon rectifier D1 and capacitor C1, as in Fig. 3. If C1 is 1000 $\mu$ F 25V this will be adequate for most purposes.

### CLOSED CIRCUIT SYSTEM

This is often employed. Warning is provided when a circuit is interrupted. This interruption can be by means of door or window switches, and also arises if the lead to the switches is cut.

Figure 4 shows the method of working. SW1 is a test switch near the relay. SW2, SW3 and SW4 are door or window switches. Any number of switches can be used, the circuit passing through each in turn. SW5 is used only to set the circuit and is then normally open.

When SW5 is closed, current flows through the relay coil RL1, and contacts X-X are closed, while contacts Y-Y are opened. When SW5 is opened, the circuit is retained through X-X. If any switch SW1 to SW4 is opened, even momentarily, the relay releases, opening X-X. Closure of the affected switch will thus not re-energise the relay, X-X remaining open. In this position, Y-Y are closed, ringing the alarm.

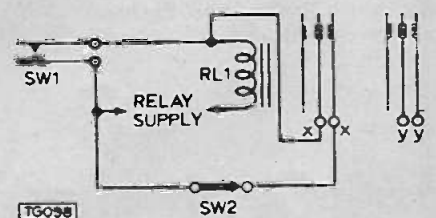

Fig.1. (left) Ultra-simple pressure operated alarm.

Fig.2. (above) How to wire the relay for a lock-on facility.



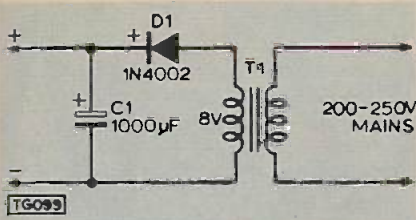

Fig. 3. (above) DC power supply.

Fig. 4. (right) Closed circuit system.

Small push-switches inset in the door frame at the hinged side may be used, and will be held open only so long as the door is closed. Similar switches may be obtained or improvised for windows.

### PRESSURE MATS

These can be obtained in various sizes, and are very thin, to place under a doormat or elsewhere. Their construction results in the circuit being completed when pressure is applied almost anywhere over the mat area.

In addition, the mats may have a closed circuit lead, so that if a wire is cut, a warning is operated by the means shown in Fig. 4.

Figure 5 shows a combined pressure mat and closed circuit system. RL1 operates as in Fig. 4, the mat closed circuit lead being included. Opening this, or any switch SW1 to SW4, results in relay contacts Y-Y of RL1 closing, ringing the bell.

RL2 operates on the mat contacts SW5, with contacts X-X holding the circuit on so that ringing can only be stopped by opening SW6. Other mats may of course be included in the circuit.

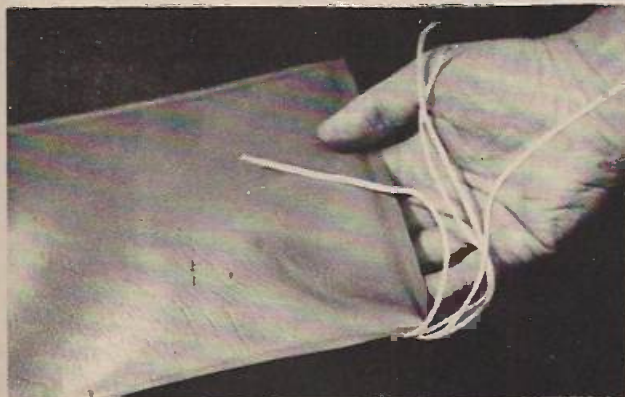

Typical pressure mat.

### ASSEMBLY

Any of these circuits can be assembled in a single case, which houses the relay, transformer and other components. Any wanted re-setting switch or test switch is included on the front of the case.

Such circuits have the advantage of

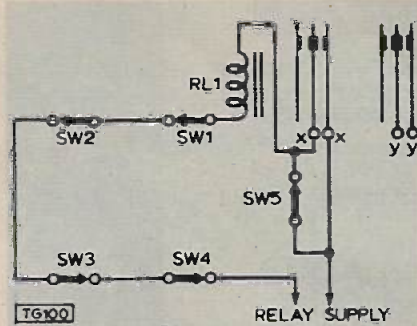

TG100

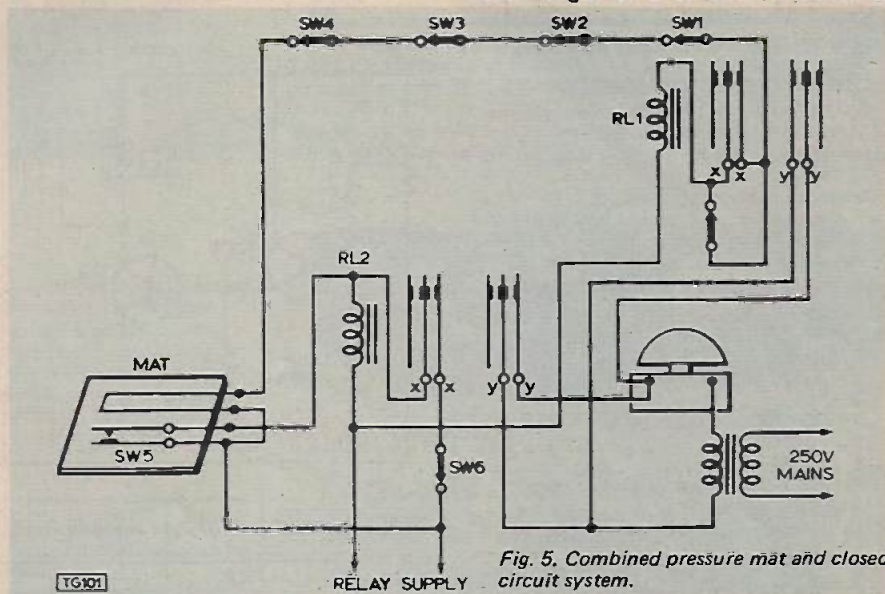

TG101

shown in Fig. 6. Here, the base is a 4 x 5 x 2in universal chassis box, with an extra 4 x 5in plate for the top. The transformer may be one with a 6.3V 500mA secondary, for a 6.3V 0.5A bulb, or 12V (or 12.6V) secondary for a 12V 6W bulb.

A canister with the bottom cut away can be used for the lamp housing. Fit a holder for the bulb as in Fig. 6. The lens need only be a simple condenser type, double convex or plano-convex (magnifying) with a focal length of 2 or 3in. A sleeve is

being straightforward and reliable and they can readily be extended by placing any number of door or other switches in circuit.

### PHOTO-ELECTRIC ALARM

With photo-electric devices, the interruption of a light beam triggers the alarm. A moving person may interrupt

made from strong card, and rings glued in hold the lens. If needed for a lens which is slightly undersize, the sleeve can be several layers of card. When the apparatus is first set up, slide the lens assembly in or out, as required to give a sharp spot from the bulb, projected on some surface at the necessary distance.

The hood is made from card, paint-

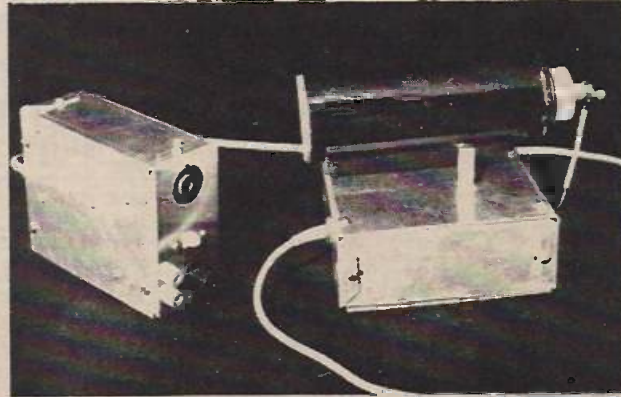

Light beam transmitter and receiver.

the beam, but the projector and receiver units may alternatively be situated so that opening a door does this. In some cases the beam can be deflected by a mirror, so that the same equipment guards two or more doorways, or a door and window.

The construction of a light beam projector for the receiver described is

ed matt black and is intended to reduce the stray light. The front disc of the hood has a small hole, centrally placed. Lamps, lens, and this aperture should be lined up to avoid unnecessary loss of illumination at the distant point. Brackets hinged together allow the lamphouse to be tilted as necessary.



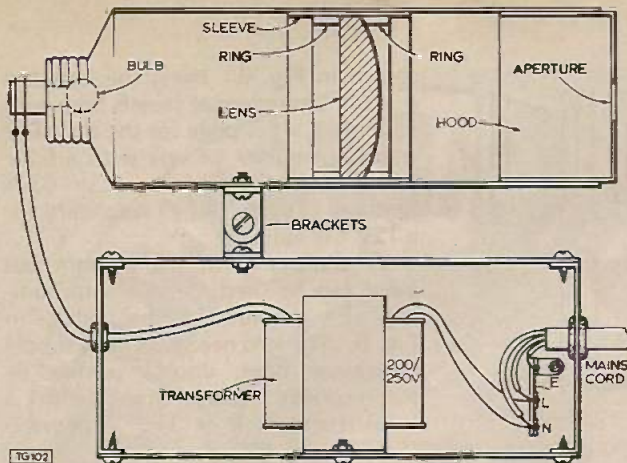

Fig. 6. Construction of beam projector.

### BEAM PROJECTOR COMPONENTS

200/250V 12V or 12.6V 0.5A transformer.  
12V 6W MES bulb and holder.  
Lens approx 1½in. to 1¾in. in dia., 2in. to 3in. focus.  
Materials for lamphouse etc.  
5 x 4 x 2in. universal chassis box with extra 4 x 5in. flat plate (Home Radio, Mitcham).  
Tag strip, grommets, mains cord etc.

### BEAM RECEIVER COMPONENTS

R1 470k ¼W  
R2 1k ¼W  
R3 100 ohm ¼W  
RV1 small 100k linear pot. Knob.  
LDR: ORP60  
Q1 BC108  
Q2 BFY51  
100 ohm 2-pole 2-way or similar relay.  
SW1 Slide switch.  
D1 Rectifier rated 8V r.m.s. 0.5A or larger.  
T1 200/250V 3/5/8V bell transformer.  
C1 1000µF 25V or similar.  
Case: 5 x 4 x 2in. universal chassis box and extra 4 x 5in. flat plate (Home Radio, Mitcham).  
Tag strips, sockets, etc.

## RECEIVER

The circuit in Fig. 7 was found to operate readily at up to 20ft from the projector. Light normally falls upon the light dependent resistor LDR. When this illumination is interrupted, the LDR resistance increases. Q1 base moves positive, conducting, so that Q1 emitter and Q2 base also move positive, and Q2 collector current rises, energising the relay. Contacts X-X close, locking on the circuit, release only being possible by opening SW1. Contacts Y-Y close so that leads to the extension circuit EX ring the warning bell. T1 provides current, and RV1 is a means of adjusting the sensitivity.

Figure 8 shows the assembly of this unit, again in a 5 x 4 x 2in universal chassis box, with extra 5 x 4 plate. Wiring is most easily carried out before fitting the remaining sides as shown.

The LDR is an end type, and is fitted in a card tube to screen it from stray illumination. This is arranged by rolling glued card round the LDR. The tube is blacked inside, and is fixed by a bracket so that its angle can be changed. The tube is behind an aperture in the case. The leads are extend-

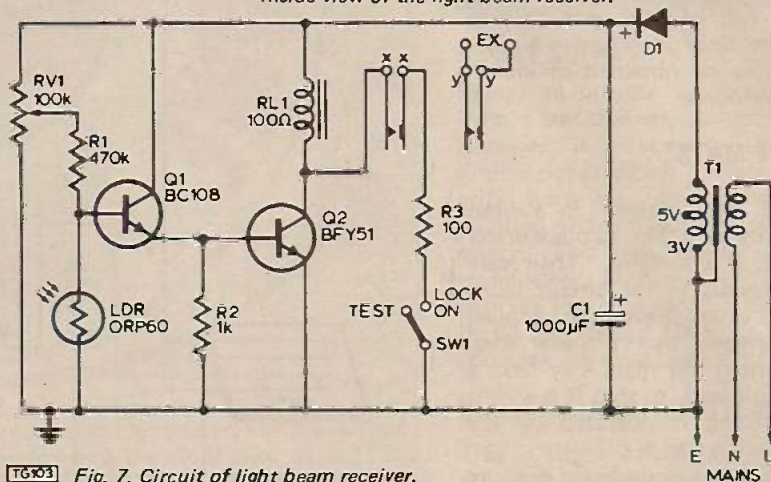

Fig. 7. Circuit of light beam receiver.

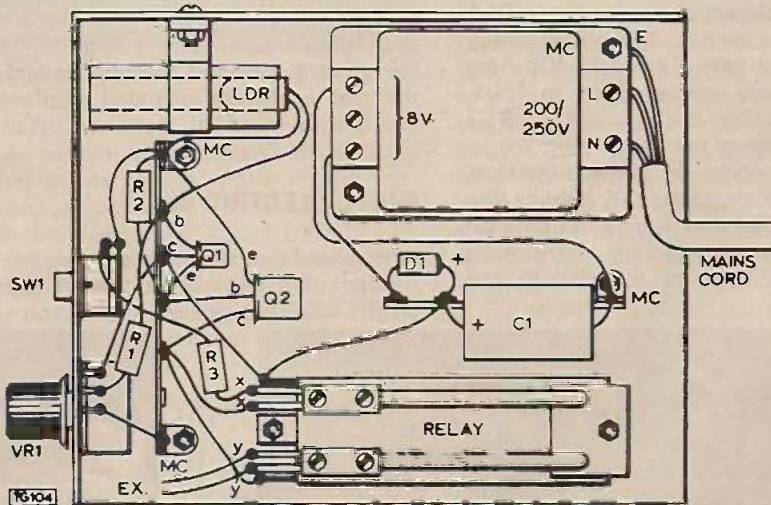

Fig. 8. Wiring of the light beam receiver.

ed with thin flex.

Other items can be assembled as in Fig. 8, noting that the case of Q2 must not touch the metal box. The working voltage across C1 will be about 10V to 11V.

With the LDR fitted in a small blackened tube as described, it is very directive, and reasonable illumination for other directions will not have much effect. Initially, direct the LDR towards some moderate source of light, and adjust VR1 so that the relay operates when a hand is placed across the aperture.

The two units should preferably be screwed to the wall, or set up so that

they will not be disturbed. Focus and locate the projector beam on the LDR tube opening, and adjust this tube in line with the beam. SW1 is placed in the open position while testing the working of the units, but is then closed to give the lock on described.

The beam is less likely to be seen when the projector is in an inconspicuous position and all its light passes into the receiver case. The LDR will operate with infra-red or dark red light, but this considerably reduces the sensitivity. For such illumination, a red or infra-red photographic filter can be included in the projector lamphouse.



# NEW CHIPS, NEW PRICES

New clock chips, new calculator chips, Sperry displays, new prices, new prices on most displays and on the CT7001 clock chips. We also now stock the CMOS digital clock/watch chip, the CT6002, in a 40 pin pack or as a complete watch module ready for casting at £96.80.

We have sold out of our initial batch of our new MHI-5314/C kits, but we should have supplies by the time this ad appears. It only goes to prove that - more than ever before -

BYWOOD HAS TIME FOR YOU!

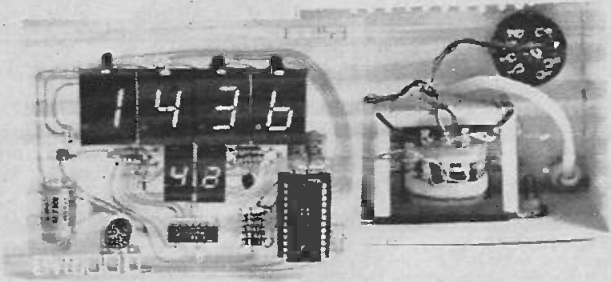

## 5316 - LC EVALUATION KIT

The MM5316 is a 40-pin LSI chip containing all the logic necessary for a four digit alarm clock. The chip also has sleep and snooze features with alternative display of minutes and seconds, and reset to zero facilities. The TA8055 is a four digit liquid crystal display unit with 0.6" digits. The MM5316 chip has the necessary a.c. drive for the LC display and thus probably the cheapest way of running any LC demonstration unit. We supply MM5316, socket, TA8055 and connector.

KIT PRICE: £30.00

## DIGITAL DISPLAYS

DISPLAY CODE	DISPLAY TYPE	DIGIT SIZE	DIGITS PER PACK	PRICE
DL701	C.ANODE LED	0.3"	1 (±1)	1.70
DL707	C.ANODE LED	0.3"	1	1.70
DL704	C.CATH LED	0.3"	1	1.70
DL747	C.ANODE LED	0.6"	1	2.45
DL34	C.CATH LED	0.1"	4	10.00
DG12H	PHOSPHOR DIODE	0.5"	1	1.50
SP151	SPERRY	0.6"	3½	7.20
SP352	SPERRY	0.6"	2	4.00
TA8055	LIQ. CRYSTAL	0.6"	4	11.00

## 5314 - JUMBO EVALUATION KIT

Our most popular kit so far is our 5314 - JUMBO Evaluation Kit, due to the large orders that we have received from amateurs and from industrial users we are able to offer this kit at a new price of £22.80.

The MM5314 is a 24-pin LSI chip containing all the logic necessary for a 12/24 hour, 4/6 digit, 50/60Hz digital clock. The new 0.6" LED display from Litronix (the Jumbo) is readable from distances of over 25ft. We supply MM5314, socket, 4 Jumbo's, 2 DL707 0.3" digits, CA3081 driver and a 5" x 4" fibreglass PCB. You supply 16 resistors, 3 capacitors, 2 diodes, 6 transistors, transformer and switch.

KIT PRICE: £22.80

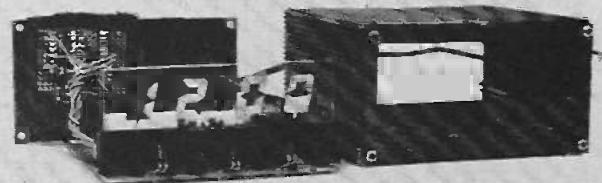

## CALCULATOR CHIPS

CT5001 - 12 digit, four function chip, similar to that used in RAPIDMAN 800 calculator. £4.80.

CT5031 - 8 digit chip with autoconstant on all four functions, also AVERAGE and EXTERNAL READY signal. Can be used as a seconds timer. £14.55.

CT5037 - Similar to CT5031 but with MEMORY in place of READY and timer functions. £15.49.

## NEW CLOCK KIT

MHI-5314/C is our new low cost kit using the MM5314 with either four or six digits of either DL707 or DL747 displays. Kits contain clock PCBm display PCB, MM5314, CA3081 driver, displays.

MHI-5314/C	+ MHI-D707/4 (four digits)	£16.00
"	+ MHI-D707/6 (six digits)	£19.80
"	+ MHI-D747/4 (four digits)	£18.50
"	+ MHI-D747/6 (six digits)	£23.75

## DIGITAL CLOCK CHIPS

CHIP NUMBER	12/24 HR	4/6 Digit	BCD OUT	7 Seg OUT	ALARM	DATE	SLEEP	SNOOZE	RESET TO '0'	STOPWATCH FACILITIES	PIN COUNT	COMMENTS	PRICE
MM5309	/	/	/	/					/		28	NEW PRODUCT	T.B.A
MM5311	/	/	/	/							28		9.00
MM5314	/	/	/	/							24		7.20
MM5316	/	4	/	/		/	/	/	/		40	WILL DRIVE LIQ. XTAL	15.00
MK5017AA	/	/	/	/		/	/	/	/		24		14.00
MK50250	/	/	/	/		/	/	/	/		28	NEW PRODUCT	7.60
CT6002	12	3½	/	/		/	/	/	/		40	CMOS-DRIVES LIQ. XTAL	28.10
CT7001	/	/	/	/	/	/	/	/	/		28	NEW PRICE	16.50
CT7002	/	/	/	/	/	/	/	/	/		28	NEW PRICE	16.50
TMS3952	/	/	/	/	/	/	/	/	/	/	28	NEW PRODUCT	20.00

CLOCK DATA SHEETS - SAE. ADVICE - PHONE 0442-62757

POST & PACKING - 10p. OVERSEAS (AIRMAIL) 50p. VAT - ALL PRICES EXCLUDE VAT.

PAYMENT C.W.O. or ACCOUNT. ACCESS. ORDERS & PAYMENT BY PHONE ACCEPTED.

QUANTITY DISCOUNTS ON MOST ITEMS - STATE REQUIREMENTS FOR QUOTATION.

# BYWOOD

BYWOOD ELECTRONICS  
181 EBBERNS ROAD  
HEMEL HEMPSTEAD  
HP3 9RDC. TEL. 0442-62757.  
24 HOUR ANSAPHONE ON-LINE.



**CF** GIRO NO. 331 7056  
 C.W.O. only. P. & P. 10p on orders below £5  
 Discount: £10-10%, £20-15% (except net items)  
 Export Order enquiries welcome (VAT free)  
 Official Orders accepted from  
 Educational & Government Departments  
**ALL PRICES INCLUDE VAT**

**SPECIAL RESISTOR KITS** (Prices include post & packing)  
 10E12 ½ W KIT: 10 of each E12 value, 22 ohms—1M, a total of 570 (CARBON FILM 5%). £3.65 net  
 10E12 ¼ W KIT: 10 of each E12 value, 22 ohms—1M, a total of 570 (CARBON FILM 5%). £3.85 net  
 25E12 ½ W KIT: 25 of each E12 value, 22 ohms—1M, a total of 1425 (CARBON FILM 5%). £8.35 net  
 25E12 ¼ W KIT: 25 of each E12 value, 22 ohms—1M, a total of 1425 (CARBON FILM 5%). £8.45 net  
 20E12 ½ W KIT: 20 of each E12 value, 22 ohms—2M2, a total of 1220 (METAL FILM 5%). £11.05 net  
**ALL QUANTITIES SPECIFIED ABOVE ARE APPROXIMATE.**

**MULLARD POLYESTER CAPACITORS C280 SERIES**  
 250V P.C. Mounting: 0.01µF, 0.015µF, 0.022µF, 0.033µF, 0.047µF, 0.068µF, 0.1µF, 0.15µF, 0.22µF, 0.33µF, 0.47µF, 0.68µF, 1.2µF, 1.5µF, 1.5µF, 2.2µF, 2.2µF, 2.2µF, 2.2µF.  
**MULLARD POLYESTER CAPACITORS C296 SERIES**  
 400V: 0.001µF, 0.0015µF, 0.0022µF, 0.0033µF, 0.0047µF, 0.0068µF, 0.01µF, 0.015µF, 0.022µF, 0.033µF, 0.047µF, 0.068µF, 0.1µF, 0.15µF, 0.22µF, 0.33µF, 0.47µF, 0.68µF, 1.2µF, 1.5µF, 1.5µF, 2.2µF, 2.2µF, 2.2µF, 2.2µF.  
 160V: 0.01µF, 0.015µF, 0.022µF, 0.033µF, 0.047µF, 0.068µF, 0.1µF, 0.15µF, 0.22µF, 0.33µF, 0.47µF, 0.68µF, 1.2µF, 1.5µF, 1.5µF, 2.2µF, 2.2µF, 2.2µF, 2.2µF.  
**MINIATURE CERAMIC PLATE CAPACITORS**  
 50V: (pF) 22, 27, 33, 39, 47, 56, 68, 82, 100, 120, 150, 180, 220, 270, 330, 390, 470, 560, 680, 820, 1K, 1K5, 2K2, 3K3, 4K7, 6K8, (µF) 0.01, 0.015, 0.022, 0.033, 0.047, 0.068, 0.1, 0.15, 0.22, 0.33, 0.47, 0.68, 1.0, 1.5, 2.2, 3.3, 4.7, 6.8, 10.0, 15.0, 22.0, 33.0, 47.0, 68.0, 100.0, 150.0, 220.0, 330.0, 470.0, 680.0, 1000.0, 1500.0, 2200.0, 3300.0, 4700.0, 6800.0, 10000.0, 4µp.  
**POLYSTYRENE CAPACITORS 160V 5%**  
 (pF) 10, 15, 22, 33, 47, 68, 100, 150, 220, 330, 470, 680, 1000, 1500, 2200, 3300, 4700, 6800, 10000, 4µp.

**RESISTORS**  
 CF—High Stab Carbon Film, 5% MF—High Stab Metal Film, 5%  
 W. Type Range 1-99 100-499 500-999 1000 Size mm  
 ½ CF 22-1M 1 0.75 0.60 0.55 2.4 x 7.5  
 ¼ CF 22-2M2 1 0.75 0.60 0.55 3.9 x 10.5  
 ¼ CF 22-1M 1 0.75 0.60 0.55 5.5 x 16  
 ½ MF 10-2M7 2 1.54 1.32 1.1 3x7  
 ¼ MF 10-2M2 2 1.43 1.21 0.99 4.2 x 10.8  
 ¼ MF 10-10M 3 1.98 1.81 1.65 6.6 x 13  
 2 MF 10-10M 4 5 3.52 3.08 2.75 8 x 17.5  
 For value mixing prices, please refer to our catalogue. (price in pence each)  
**VALUES AVAILABLE—E12 Series only.** (Net prices above 100)

**PRESET SKELETON POTENTIOMETERS**  
 MINIATURE 0.25W Vertical or horizontal 6p each 1K, 2K2, 4K7, 10K, etc. up to 1M Ω  
 SUB-MIN 0.05W Vertical, 100 Ω to 220K Ω 5p each

**B. H. COMPONENT FACTORS LTD.** (ETI) 61 CHEDDINGTON ROAD, PITSTONE, NR. LEIGHTON BUZZARD, BEDS, LU7 9AQ  
 Tel. Cheddington 668446 (Std. Code 0296)  
**PLEASE WRITE FOR FREE CATALOGUE**

**Miniature Mullard Electrolytics**  
 1 0µF 63V 6p  
 1 5µF 63V 6p  
 2 2µF 63V 6p  
 3 3µF 63V 6p  
 4 0µF 40V 6p  
 4 7µF 63V 6p  
 8 0µF 63V 6p  
 8 0µF 40V 6p  
 10µF 16V 6p  
 10µF 25V 6p  
 10µF 63V 6p  
 15µF 16V 6p  
 15µF 63V 6p  
 16µF 40V 6p  
 22µF 25V 6p  
 22µF 63V 6p  
 32µF 10V 6p  
 33µF 16V 6p  
 33µF 40V 6p  
 32µF 63V 6p  
 47µF 10V 6p  
 47µF 25V 6p  
 47µF 63V 8p

**VEROBOARD 0.1 0-15**  
 2½ x 5" 28p 28p  
 2½ x 3½" 26p 19p  
 3½ x 5" 32p 33p  
 3½ x 3½" 28p 28p  
 2½ x 1½" 7p 7p  
 2½ x 5" (Plain) 14p  
 2½ x 3½" (Plain) 12p  
 5 x 3½" (Plain) 22p  
 Insertion tool 59p 59p  
 Track Cutter 44p 44p  
 Pins. Pkt. 25 10p 10p  
**TRANSISTORS**  
 AC127 16p BC212L 12p  
 AC128 22p BC213L 12p  
 BC107 11p BC214L 17p  
 BC108 12p OC44 18p  
 BC109 13p OC71 13p  
 BC148 12p OC81 16p  
 BC149 12p OC170 23p  
 BC182L 12p TIS43 33p  
 BC183L 12p 2N2926 11p  
 BC184L 13p 2N3702 11p

**POTENTIOMETERS**  
 Carbon Track 5K Ω to 2M Ω, log of lin. Single, 16p Dual Gang 46p. Log Single with switch 26p  
 Slider Pats. 10K, 100K, 500K, 30mm, 34p, 45mm, 47p, 60mm, 55p. (Semi-log)  
**DIODES**  
 IN4001 6p  
 IN4002 7p  
 IN4003 9p  
 IN4004 9p  
 IN4005 12p  
 IN4006 14p  
 IN914 7p  
 IN916 7p  
 BA100 10p  
 OA5 42p  
 OA47 9p  
 OA81 11p  
 OA200 8p  
**PLUGS**  
 DIN 2 Pin 12p  
 3 Pin 13p  
 5 Pin 180° 15p  
 Std. Jack 14p  
 2.5mm Jack 11p  
 Phono 5p  
**SOCKETS**  
 DIN 2 Pin 10p  
 3 Pin 10p  
 5 Pin 180° 12p  
 Std. Jack 14p  
 2.5mm Jack 11p  
 Phono 5p  
**ELECTROLYTIC CAPACITORS. Tubular & Large Cans**  
 (µF/V): 1/25, 2/25, 4/25, 4.7/10, 5/25, 8/25, 10/10, 10/50, 16/25, 22/63, 25/25, 25/50, 32/25, 50/25, 100/10, 100/25, 6p, 50/50, 8p, 100/50, 200/25, 11p, 250/50, 18p, 500/10, 11p, 500/25, 15p, 500/50, 18p, 1000/10, 15p, 1000/25, 22p, 1000/50, 40p, 2000/10, 20p, 1000/100, 90p, 2000/25, 30p, 2000/100, 95p, 2500/25, 38p, 2500/50, 62p, 3000/50, 80p, 5000/25, 66p, 5000/50, £1.10  
**HI-VOLT:** 4/450, 14p, 8/350, 19p, 8/450, 20p, 16/350, 22p, 16/450, 23p, 32/350, 33p, 50/250, 20p, 100/500, 88p.  
**METALLISED PAPER CAPACITORS**  
 250V 0.05µF, 0.1µF, 6p, 0.25, 6p, 0.5µF, 7p, 1µF, 9p, 500V, 0.025, 0.05, 6p, 0.1, 6p, 0.25, 7p, 0.5, 9p, 1000V, 0.01, 11p, 0.022, 13p, 0.047, 0.1, 15p, 0.22, 23p, 0.47, 28p.  
**Integrated Circuits**  
 µA709C 50p  
 µA741C 55p  
 µA723C £1  
 ZN414 £1.32p  
**Screened Wire, Metre** 8p  
 Twin Screened Wire, Metre 12p  
 Stereo Screened Wire, Metre 12p  
 Connecting Wire, All colours, Metre 2p  
 Neon Bulb, 90V Wire Ended 5 for 24p  
 Panel Neon, 240V Red, Amber, Clear 20p

**NEW KIT SET2 ½ W METAL FILM 5% ULTRA LOW NOISE NEW RESISTORS WITH FULL COLOUR CODING 5 EACH E12 VALUE 100-1M. TOTAL 305 £2.75**

**WORLD SHORTAGES?**

Recent copies of ETI have joined the list of world shortages — they are in short supply. Unlike some of our competitors, we do run a back numbers service but we cannot help with some recent issues. There are two ways to ensure yourself of a copy: place a regular order with your newsagent or take out a subscription which will cost you a bit more due to postage but will guarantee you your copy.



Cut

To: **SUBSCRIPTION DEPARTMENT**  
**ELECTRONICS TODAY INTERNATIONAL**  
**36 EBURY STREET,**  
**LONDON SW1W 0LW.**

Please find enclosed £3.60 which includes postage (£4.00 overseas) for my annual subscription to ETI starting with the next available issue.

Name .....

Address .....

July 1974 .



# TEN 40W TRANSISTORS: £1.00

LIMITED TO THE FIRST 2500 ORDERS

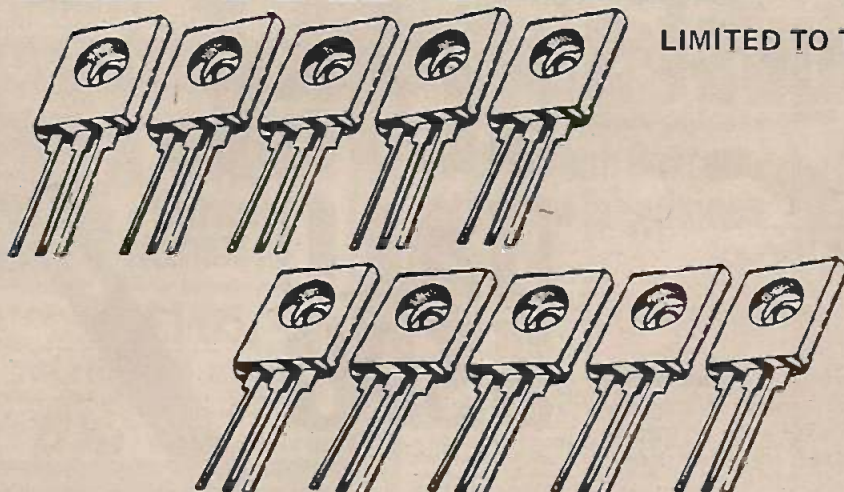

Another great ETI offer which is being run in conjunction with Bi-Pre-Pak Ltd of West Road, Westcliff-on-Sea.

This special 'pak' has been put together for ETI readers and comprises five PNP and five NPN 40W power transistors. Today's selling price for these transistors from Bi-Pre-Pak is £2.20 and even that is rightly

claimed by the company to be by far the lowest price for such devices. ETI readers however can purchase all ten transistors for £1 inclusive of VAT.

The transistors are fully tested, plastic devices with a guaranteed minimum VCE of 15V and HCE of 15. These devices are ideal for low voltage amplifiers, power supplies etc. etc.

Cut

To: ETI/Bi-Pre-Pak Transistor Offer  
Bi-Pre-Pak Limited,  
222 West Road,  
Westcliff-on-Sea, Essex SS0 9DF.

Please find enclosed my cheque/P.O. for £1 for your offer of Ten, 40W Power Transistors. I also enclose a self-addressed, stamped envelope for the return of these goods or money should the offer be oversubscribed.

Name .....

Address .....

Offer closes 31st July, 1974.

This offer is limited strictly to one pack of 10 transistors per coupon. Readers may order additional packs but a separate coupon must be enclosed for each.

## 2 GREAT ETI READER OFFERS!



# STEREO AMPLIFIER KIT

CURRENT RETAIL PRICE: £12.71

ETI READER PRICE: £8.85

LIMITED TO THE FIRST 300 ORDERS

The Amtron range of kits were only launched in Britain 18 months ago but they have already established themselves firmly in the market.

As an introduction to their extensive range of kits, we have made arrangements with Amtron for ETI readers to purchase the UK 110/A Stereo Amplifier Kit at more than 30% off.

The kit comes complete with a brushed aluminium face plate and will operate from any 12-15V power supply at 1A (Amtron can supply a suitable power supply).

The output power is 5W per channel peak into a 4Ω load. Input sensitivity is 400mV. The circuit has 8 transistors and has the advantage of using a low voltage power supply making it ideal for use in cars and boats.



Cut

To: ETI Stereo Amplifier Kit offer  
Amtron U.K.,  
4 & 7 Castle Street,  
Hastings,  
Sussex.

Please find enclosed my cheque/P.O. for £8.85 for your Stereo Amplifier Kit. I enclose a self-addressed, stamped envelope for the return of my money should the offer be oversubscribed.

Name .....

Address .....

Offer closes 31st July, 1974

This offer is limited strictly to one Stereo Amplifier Kit per coupon.



# What to look for in August's



ETI  
READER  
OFFER

## CALCULATOR CHIP: £3.

We continue to arrange the best offers going — Next month's is a full spec calculator chip. This is not a full constructional feature but circuits and other details will be given.

ETI  
MAJOR  
PROJECT

## 50W STEREO AMP

A real window-pane shaker! 50W r.m.s. per channel with excellent performance all round. This project uses discrete components throughout.

ETI  
SPECIAL  
SURVEY

## POCKET CALCULATOR REVIEW

About 18 months ago you had a choice of about five pocket calculators starting at £70. Today there are scores of them at a fraction of this price. ETI tells you how to choose and gives up-to-date details of the models available.

ETI  
FEATURE

## MAGNETIC RIVER

Professor Laithwaite's discovery and development of the 'electromagnetic river' effect has been applauded as a dramatic breakthrough. In the next issue Professor Laithwaite explains the sequence of events leading to this discovery.

**PLUS: HI-FI REVIEWS, DIY TEMPERATURE METER, ETI MUSIC SYNTHSIZER ETC.**

**AUGUST ISSUE ON SALE JULY 19TH.**

The features mentioned here are in an advanced state of preparation but circumstances may result in changes to the above.

# P.C. BORED?

— not with the

## DECON-DALO 33PC

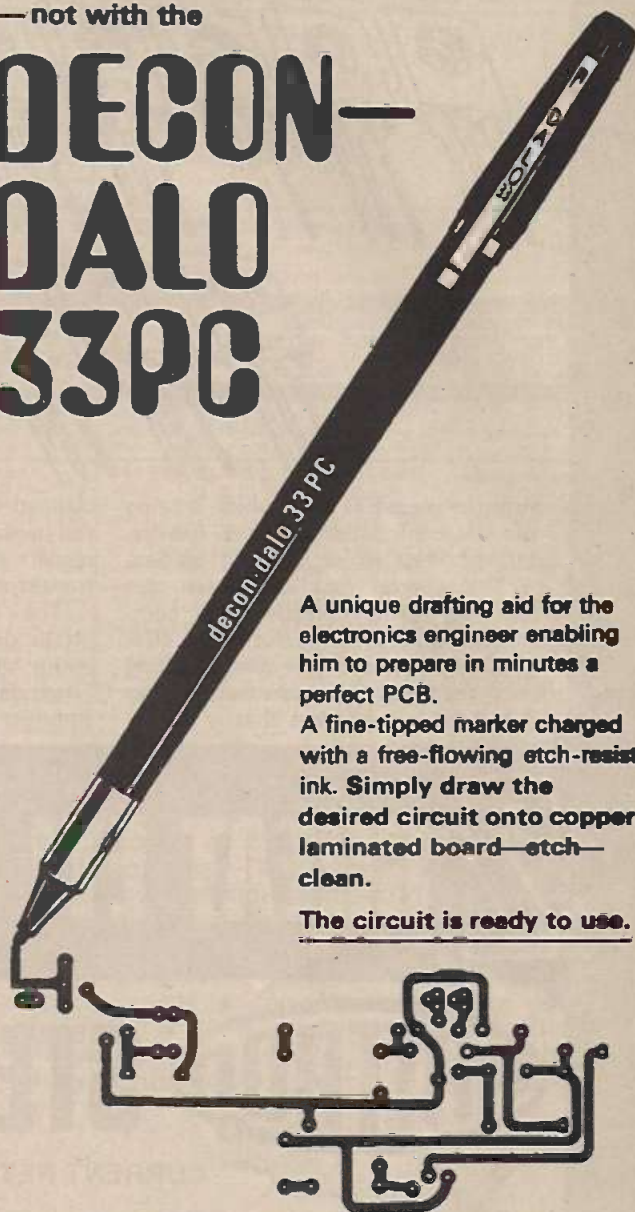

A unique drafting aid for the electronics engineer enabling him to prepare in minutes a perfect PCB.

A fine-tipped marker charged with a free-flowing etch-resist ink. Simply draw the desired circuit onto copper laminated board—etch—clean.

The circuit is ready to use.

## NO MESS — NO MASKING

£1.10 for one off £4.40 for six £8.80 for twelve VAT and post included. Available now in every country in EUROPE!

*The Decon-Dalo 33 PC marker is now available in France, Germany, Italy, Switzerland, Austria and all Scandinavian countries. Send for details of local supplier.*

Please send me further details on the 33PC:

Name \_\_\_\_\_

Address \_\_\_\_\_

Post to: **DECON LABORATORIES LTD.**

**FREEPOST**

**PORTSLADE, BRIGHTON, ENGLAND**

(No Stamp Needed) Phone 0273 414371



# BI-PRE-PAK

SUPPLIERS OF SEMI-CONDUCTORS TO THE WORLD



## Telephone Corner

COMPLETE TELEPHONES

Normal Household Type

EX. G.P.O. Only **£1-05p** P & P 45p each

## TELEPHONE DIALS

Standard Post Office type. Guaranteed in working order

Only **27 1/2p** POST & PACKING 15p

## Tested and Guaranteed Paks



- |     |     |  |     |
|-----|-----|--|-----|
| B79 | 4   | IN4007 Sil. Rec. diodes. 1,000 PIV lamp plastic            | 55p |
| B81 | 10  | Reed Switches, 1" long, 1" dia. High Speed P.O. type       | 55p |
| H35 | 100 | Mixed Diodes, Germ. Gold bonded, etc. Marked and Unmarked. | 55p |
| H38 | 30  | Short lead Transistors, NPN Silicon Planar types           | 55p |
| H39 | 6   | Integrated Circuits, 4 Gates BMC 962, 2 Flip Flops BMC 945 | 55p |
| H41 | 2   | Sil Power transistors comp pair BD131/132                  | 55p |
| H64 | 4   | 3819 N Channel FETs 2N3819 in plastic case                 | 55p |
| H65 | 4   | 40361 Type NPN Sil transistors                             | 55p |
| H66 | 4   | TO-5 can comp to H66 40362 Type PNP Sil transistors        | 55p |
|     |     | TO-5 can comp to H65                                       |     |



## Unmarked Untested Paks

- |     |     |   |     |
|-----|-----|---|-----|
| B1  | 50  | Germanium Transistors PNP, AF and RF                      | 55p |
| B66 | 150 | Germanium Diodes Min. glass type                          | 55p |
| B83 | 200 | Transistors, manufacturers' rejects, AF, RF, Sil and Germ | 55p |
| B84 | 100 | Silicon Diodes DO-7 glass equiv. to OA200, OA 202         | 55p |
| B86 | 100 | Sil. Diodes sub. min. IN914 and IN916 types               | 55p |
| H34 | 15  | Power Transistors, PNP, Germ. NPN Silicon TO-3 Can.       | 55p |
| H67 | 10  | 3819N Channel FETs plastic cage type                      | 55p |

## Make a rev counter for your car

The 'TACHO BLOCK'. This encapsulated block will turn any 0-1mA meter into a linear and accurate rev. counter for any car with normal coil ignition system.

**£1-10p each**

## Ex GPO Push Button Intercom Telephones

Exactly as internal telephone systems still in everyday use where automatic internal exchanges have not taken over. Available in 5, 10 or 15 ways. Complete with circuits and instructions. Necessary 24 pair cable 22p per yard. Price of each instrument is independent of the number of ways.

**£2.75 p.p. 38 1/2p**

Cable can be sent by parcel post. Postage and packing per 50 yards: 73 1/2p.

EXTENSION TELEPHONES: 71 1/2p each, postage and packing 27 1/2p. £1.37 1/2 for 2. P&P 55p.

## ELECTRONIC TRANSISTOR IGNITION

**£6.60p** Complete kit inc. VAT p&p 11p

Ready built & tested unit £9.90 inc. VAT. Now in kit form, we offer this "up to the minute" electronic ignition system. Simple to make, full instructions supplied with these outstanding features:— Transistor and conventional switchability, burglar proof lock up and automatic alarm, negative and positive compatibility.

## New X Hatch

Our new, vastly improved Mark Two Cross Hatch Generator is now available. Essential for alignment of colour guns on all colour T.V. receivers.

Featuring plug in I.C.'s and a more sensitive sync. pick-up circuit. The case is virtually unbreakable — ideal for the engineer's tool box — and only measures 3"x5 1/4"x3". We have already received a large order from a major TV rental company.

Ready built unit **£10-92** Complete kit **£8-72** (Includes VAT and p&p but no batteries)

## Over 1,000,000 Transistors in stock

We hold a very large range of fully marked, tested and guaranteed transistors, power transistors, diodes and rectifiers at very competitive prices. Please send for free catalogue.

## Our very popular 4p Transistors

TYPE "A" PNP Silicon alloy, TO-5 can  
TYPE "B" PNP Silicon, plastic encapsulation  
TYPE "E" PNP Germanium AF or RF  
TYPE "F" NPN Silicon plastic encapsulation  
TYPE "G" NPN silicon similar ZTX 300 range  
TYPE "H" PNP silicon similar ZTX 500 range

**8 RELAYS FOR £1-10p**

## High Speed Magnetic Counter

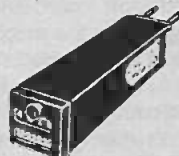

4-Digit (non-reset) 24V or 48V (state which) 4 x 1 x 1in. 33p. P&P 5p.

## Plastic Power Transistors

NOW IN TWO RANGES

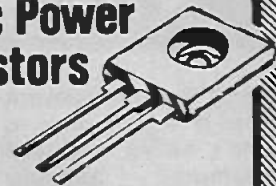

These are 40W and 90W Silicon Plastic Power Transistors of the very latest design, available in NPN or PNP at the most shatteringly low prices of all time. We have been selling these successfully in quantity to all parts of the world and we are proud to offer them under our Tested and Guaranteed terms.

Range 1. VCE. Min 15. HFE Min 15.

40 Watt	1-12	13-25	26-50
	22p	20p	18p
90 Watt	26p	24p	22p

Range 2. VCE. Min. 40. HFE Min 40.

40 Watt	1-12	13-25	26-50
	33p	31p	29p
90 Watt	38p	36p	33p

Complementary pairs matched for gain at 3 amps. 11p extra per pair. Please state NPN or PNP on order.

## LM380 AUDIO I.C.

As featured in Practical Wireless Dec. issue. Complete with application data £1-10p.

## INTEGRATED CIRCUITS

We stock a large range of I.C.s at very competitive prices (from 11p each). These are all listed in our FREE Catalogue, see coupon below.

## METRICATION CHARTS now available

This fantastically detailed conversion calculator carries thousands of classified references between metric and British (and U.S.A.) measurements of length, area, volume, liquid measure, weights etc.

Pocket Size 15p Wall Chart 18p

## LOW COST DUAL IN LINE I.C. SOCKETS

14 pin type at 16p each } Now new low profile  
16 pin type at 18p each } type

## BOOKS

We have a large selection of Reference and Technical Books in stock.

Send for lists of publications

## Our famous P1 Pak is still leading in value

Full of Short Lead Semiconductors & Electronic Components, approx. 170. We guarantee at least 30 really high quality factory marked Transistors PNP & NPN, and a host of Diodes & Rectifiers mounted on Printed Circuit Panels. Identification Chart supplied to give some information on the Transistors.

11p P & P on this Pak.

**Please ask for Pak P.1. only 55p**

Please send me the FREE Bi-Pre-Pak Catalogue.

NAME .....

ADDRESS .....

ALL PRICES INCLUDE 10% VAT

MINIMUM ORDER 50p. CASH WITH ORDER PLEASE. Add 11p post and packing per order OVERSEAS ADD EXTRA FOR POSTAGE

**BUY THESE GOODS WITH CARESS**

**BI-PRE-PAK LTD**

Co Re: No 820219

Dept. U 222-224 WEST ROAD, WESTCLIFF-ON-SEA, ESSEX.

TELEPHONE: SOUTHCEND (0702) 46344.



# ei product test

# TEAC A-360 CASSETTE RECORDER

JAPAN'S Teac Corporation have earned a worthy place as one of the world's leading manufacturers of hi-fi equipment — particularly cassette recorders.

The company's Teac A-350 has deservedly been one of the best selling machines.

But as, with any good product, improvement is generally possible, and we were not surprised to see an improved version of the Teac A-350 released as the Teac A-360.

One of the major problems that have plagued many cassette recorder manufacturers has been excessive wow and flutter. The Teac A-360 is an exception. It is one of the few machines on the market which has a wow and flutter performance comparable with a good reel to reel recorder.

The Teac A-360 has many similarities in appearance to the A-350, the most significant difference, being the relocation of the tape counter and the tape run indicator light, and a very much improved piano lever key control system. This is now colour coded to simplify identification of major functions.

The designers have also incorporated separate bias and equalisation switches as well as an MPX filter to remove the residual carrier when an FM stereo broadcast is being recorded.

Whilst the top panel of the A-350 contained more plastic than metal escutcheons, the A-360 looks more solid even though it contains just as much plastic! This has been achieved through the extensive use of a brushed satin aluminium overlay which is divided into two areas around the cassette well and over the secondary controls mounted in front of the two VU meters.

At the front of the cassette deck is a three-digit counter with a reset button and a tape run light. Beside this is a memory on-off switch. The major use of this facility is that where you desire to cue back to a previously noted position, it is only necessary to depress the counter to zero and on the fast-rewind the memory switch will deactivate the drive system as soon as the counter reaches zero.

## INTERNAL CONSTRUCTION

The internal construction is particularly interesting. A number of unusual features are apparent. The first of these is a very large capstan wheel the diameter of which is approximately 9 cms. Secondly, there is a large external rotor motor, which in conjunction with the large capstan wheel results very low wow and flutter figures. The third is the use of very large quantities of miniature shielded wire. These are formed into large wiring harnesses.

The machine contains three printed circuits. These are respectively, the power supply card, the large main amplifier card, and the Dolby B processor card.

The main amplifier card and the Dolby B processor card are held on one edge by a plastic support system which after the removal of the screws on the other side, allows the cards to be hinged back for servicing and component replacement. The large wiring harnesses which we previously mentioned, are jammed against one side of the Dolby B processor card and cause component displacement. Fortunately these components have plastic coating on their pigtails which prevents electrical shorts.

Another interesting feature which will interest the technically minded is the use of a C-core mains transformer.

The circuit designers, in keeping with the latest European and Japanese trends, have saved some wiring by locating two of the main switches on the main amplifier card with mechanical actuation from the front panel.

A well produced twenty-two page handbook is supplied with the machine. It was good to see that this handbook contained a full circuit diagram of the machine.

As with the Teac A-350, the performance of the A-360 is particularly good. Its major advantages are primarily operational rather than any significant improvement in frequency response or wow and flutter.

Nevertheless, there *have* been positive improvements in the circuitry of the A-360, and definite

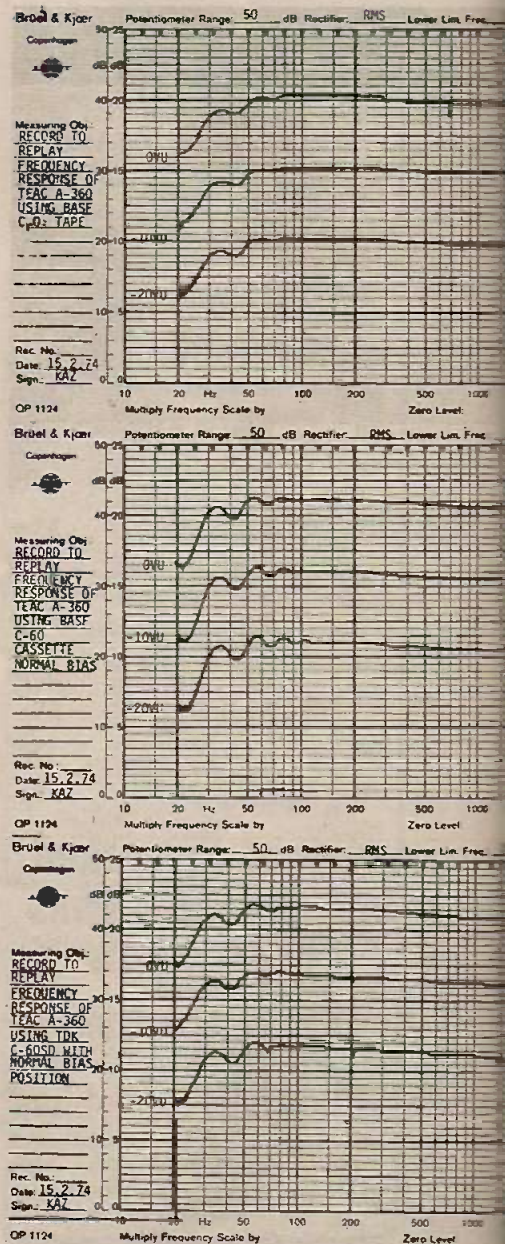

improvements in the mechanical drive system which is clearly better than that provided in the A-350.

## MEASURED PERFORMANCE

The frequency response at -10 VU is 27 Hz to 13 kHz with chromium oxide. At -20 VU it is 28 Hz to 16 kHz. This is one order of performance better than that provided by the A-350 and it should be noted that the



**SUMMARY:** The A-360 is a further improvement in the field of cassette recorders. It is one of the few machines which has a wow and flutter performance comparable to a good reel-to-reel recorder. It should satisfy most Hi-Fi enthusiasts' requirements.



### TEAC A-360 CASSETTE RECORDER

#### Record to Replay Frequency Response:

(with BASF CrO <sub>2</sub> tape) at:	0 VU	30Hz-9kHz	±3dB
	-10 VU	28Hz-13kHz	±3dB
	-20 VU	28Hz-16kHz	±3dB
(with TDK C60 tape) at:	0 VU	28Hz-5.5kHz	±3dB
	-10 VU	28Hz-8kHz	±3dB
	-20 VU	28Hz-10kHz	±3dB

Total Harmonic Distortion at 1kHz at:	100Hz	1kHz	6.3kHz
	0 VU	1.2%	1%
	-10 VU	0.5%	0.6%

Intermodulation Distortion (at 1kHz and 960Hz):	0 VU	0.8%
	-10 VU	0.5%

Signal-to-Noise Ratio (at 0 VU re 1kHz):	with Dolby	without Dolby
	-38dB (Lin)	-37dB (Lin)
	-55dB (A)	-47dB (A)

Erase Ratio (for 1kHz signal prerecorded at 0 VU):	-63dB
--	-------

Cross Talk at 0 VU:	100Hz	-45dB
	1kHz	-50dB

Wow and Flutter % - weighted 0.1% at beginning 0.05% in middle  
 Line Input Sensitivity for 0 VU: 90mV. Microphone Input Sensitivity for 0 VU: 0.25mV.  
 Line Output Sensitivity for 0 VU: 0.45mV. Dimensions 438 x 254 x 124mm. Weight 8kg.  
 Recommended Retail Price: £214.50 inc. VAT.

overall linearity of the frequency response is better at the high frequency end of the spectrum and substantially flatter at the low frequency end as well.

With TDK Super Dynamic tape, performance at -10 VU is 28 Hz to 8 kHz, and at -20 VU it is 28 Hz to 10 kHz. We found that the record-to-replay performance was better with the bias and equaliser set

to normal rather than in the high position. From a comparison with the performance on standard and super dynamic tapes chromium dioxide tape may well be a must with these machines. It certainly was with the machine supplied to us for review.

Total harmonic distortion is reasonable, being 1% at 1 kHz at 0 VU, and 0.6% at 1 kHz at -10 VU.

Intermodulation distortion is also

acceptable, at 0.8% at 0 VU, and 0.5% at -10 VU.

Wow and flutter is not quite as good as the manufacturer's claim, being 0.1% at the beginning of a cassette and 0.05% in the middle.

Signal-to-noise ratio (at 1 kHz) is -55 dB(A) with Dolby on, and -47 dB(A) without the Dolby.

Erase ratio is very good, being -63 dB.



# ei product test

# SINCLAIR SYSTEM 4000 AMPLIFIER

THE LATEST UNIT from Sinclair Radionics is the system 4000 stereo amplifier; in appearance, much the same as the system 3000 but it has been completely redesigned inside. A glance inside reveals a very neat layout all the switches (except the mains switch) mounted on the single PCB along with the controls. Plugs and sockets are also mounted on this, in fact I only managed to count a dozen wires all told. To complete the workman-like impression that the 4000 gives, the case, rather than being constructed out of bent tin and wood, is engineered out of extruded light alloy finished in matt black.

The test sample was from the first production batch and there were a couple of minor faults to correct before it could be tested. These faults can no doubt be attributed to the newness of the model (the serial of the test sample was 000102).

When the tests were made no manufacturer's specification was available so the amplifier was tested against absolute limits. The rated output power was taken as the point at which the first trace of limiting could be detected on a 1kHz triangle wave, this gave 20W per channel and a sine wave distortion of 0.03% into an 8 $\Omega$  load. Similar distortion figures with 4 $\Omega$  and 16 $\Omega$  loads produced 25W and 18W (all these figures were obtained with both channels being driven).

All the distortion figures obtained with the system 4000 were very good and approached the point at which test accuracy begins to fall off due to the residual distortion present in even the best test oscillators and distortion measuring equipment.

The frequency response to the 3dB points extended from 20Hz to 60kHz and was free of any troughs or hills except for a minor rise in the response over 1.5kHz. The action of the tone controls gave a maximum slope of about 3dB per octave to a maximum of 12dB. The filter can be used to cut the top on noisy signals and, attenuates at slightly more than 12dB per octave with a 3dB point at 9kHz.



*The Sinclair 4000 Tuner and Amplifier. We shall be publishing a review of the Tuner next month.*

this is at variance with the printed instruction sheet packed with the amplifier which suggests a turnover frequency of 7kHz. In any case, it proved effective in removing a great deal of objectionable Hiss produced from a distant FM radio station.

The system 4000 is provided with DIN input and output sockets. The

amplifier is equipped with a front panel headphone socket.

The input sensitivities of the system 4000 amplifier are rather higher than those to be found on many amplifiers which can only be counted as a point in favour; you can always turn down the volume! The PU input sensitivity at 2.2mV at 1kHz for full



*The interior is neat and clean with only a dozen wires.*



**SUMMARY:** The latest amplifier from Sinclair is a worthy successor to the 3000. The performance certainly meets Hi-Fi standards at a reasonable price.

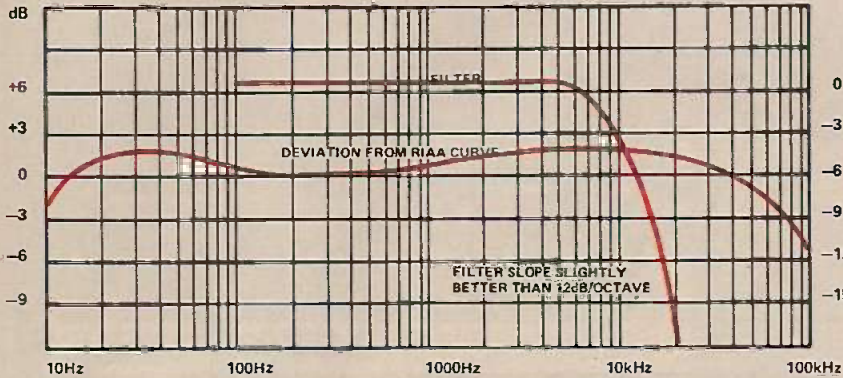

Frequency response flat and with tone control at maximum.

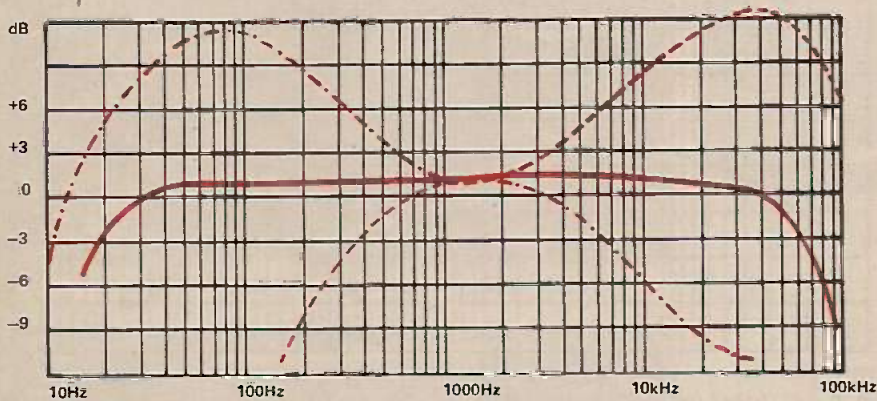

Deviation from RIAA curve and the effect of the top-cut filter.

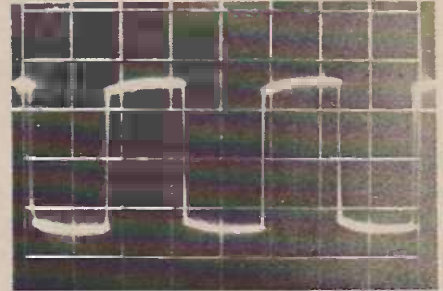

1kHz square-wave into 8Ω

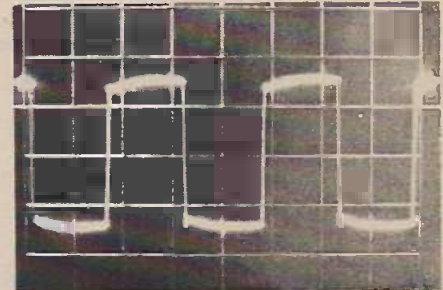

1kHz square-wave into 8Ω + 2μF.

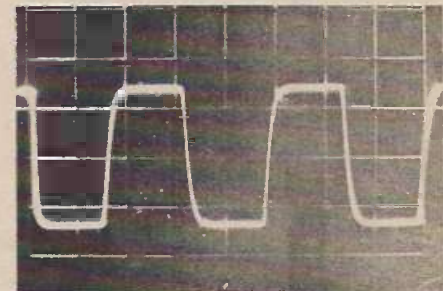

10kHz square-wave into 8Ω.

### Measured Performance of the Sinclair System 4000 Amplifier

Power Output: 20W r.m.s. per channel into 8Ω, both channel driven.

Frequency Response: 20Hz–50kHz ±1dB

Total Harmonic Distortion:

	40Hz	1kHz	10kHz
At 20W	0.3%	0.03%	0.04%
At 10W	0.25%	0.02%	0.02%
At 1W	0.02%	0.03%	0.05%

Signal to Noise Ratio: Pickup –58dB unweighted, –66dB weighted  
Other –66dB unweighted, –70dB weighted

Crosstalk: –23dB

Inputs: Mag. P.U. 2.2mV  
Aux 85mV  
Tape 80mV  
Tuner 80mV

Damping Factor: 19 for 8 ohms at 40Hz.

Recommended Retail Price: £72.05 including VAT.

output should make the system 4000 able to handle even the most insensitive of modern pick-up cartridges.

In conclusion, the System 4000 is a worthy successor to the Systems 2000 and 3000, and is good value for money, even though the power output at 20W is slightly less than would be needed to drive a very inefficient loudspeaker in a large room.

Now after the boquettes comes a few brick bats to throw at Sinclair Radionics: Why, Oh Why, with only twelve wires to connect was one earth wire not connected at all and why were the left and right hand speaker wires transposed between the head-phone socket and the loudspeaker sockets? A score of only 75% on wiring against nearly 100% on design ●



# EM product test

# EMISOUND 1515 AMPLIFIER



THIS AMPLIFIER is one unit of the recently marketed Emisound 'Audio for Home Entertainment' range which include a radio tuner (AM/FM), a record playing deck, loudspeakers and quadraphonic decoder. The latter makes it possible to convert to quadraphonic reproduction from SQ encoded discs and tapes by using two Emisound 1515 amplifiers and an extra pair of loudspeakers. To give an example, if you already have an Emisound 1501 record player, a 1515 amplifier and a pair of their LE2 loudspeakers, then conversion requires the SQ1500 decoder, another 1515 amplifier and two more LE2 loudspeakers.

The model 1515 stereo amplifier is rated for 15W r.m.s. per channel with both driven and operating into 8 ohm speakers. It has inputs for both magnetic or ceramic cartridges, tape recorder, radio tuner and microphone. There is a socket for on or off-tape monitoring and which can also be used for connection of the SQ decoder, the signals being taken from the preamplifier stage through the decoder and back to the main amplifier.

All input and output sockets are DIN types mounted on the rear panel which also carries a pair of mains sockets for ancillary equipment and a circuit protection fuse. Aside from the usual stereo controls such as bass and treble, volume and balance etc., there is one other extra, namely an HF or scratch filter. The amplifier is housed in a teak veneered case and the control panel is of brushed aluminium, a finish that is used for all the Emisound audio products.

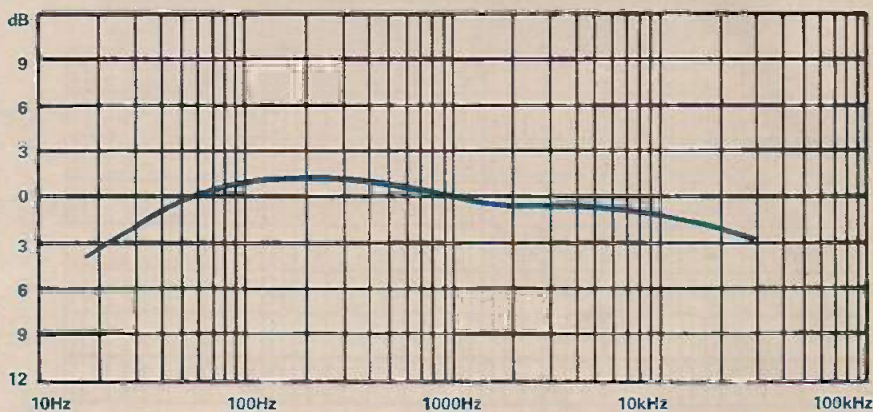

Fig. 1. (A) Overall frequency response. (BL-BC) Response of bass control; (TL-TC) Response of treble control. (F) Response of scratch filter.

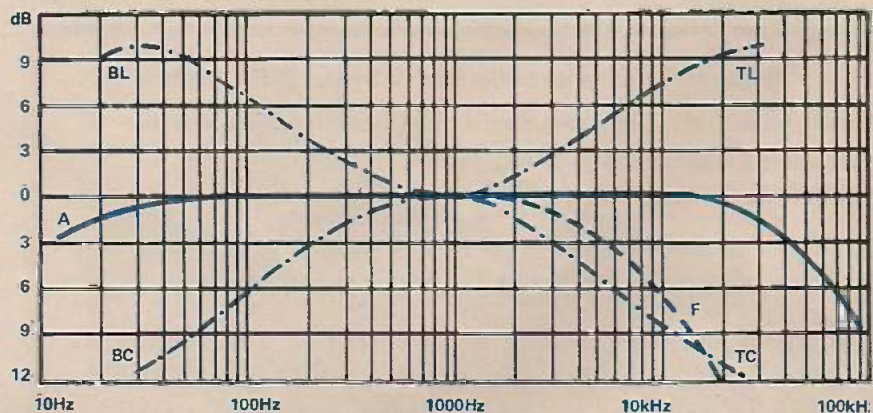

Fig. 2. Response from magnetic pickup input obtained with equalised (RIAA recording characteristic) input signal. Some deviation from true RIAA replay response is evident but not critical.

## TESTED PERFORMANCE

The table gives the test result figures but there is little that warrants comment or criticism. Power for an 8 ohm load was well up to specification with 15.5W per channel, with both

driven and the power bandwidth a very acceptable -2dB at 30Hz, then flat from 40 to 20,000Hz and falling to -3dB at 30,000Hz (relative 0dB 15W 1000Hz).

Obtained frequency responses are shown in the graphs and supported by



**SUMMARY:** Considering the relatively low price of £49.50, including VAT, the Emisound 1515 is very good value for money and meets the requirements for Hi-Fi reproduction. If the remainder of the Emisound audio equipment is to the same standard, then a complete system of the appropriate units would be well worth considering.

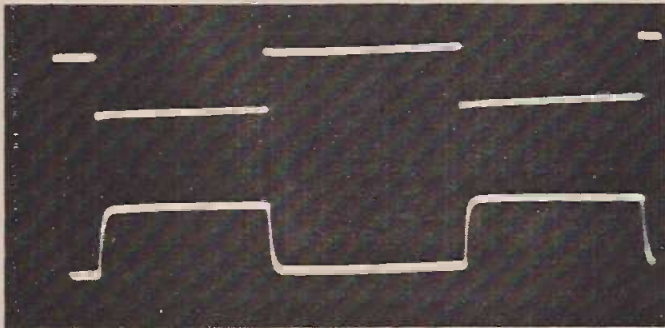

Fig. 3. Square-wave test at 1000Hz. At the top is the input signal, at the bottom the output from amplifier.

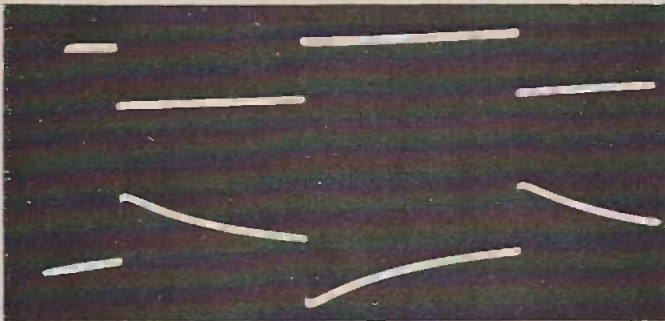

Fig. 4. Square-wave test at 100Hz. Input signal, top, output from amplifier, bottom.

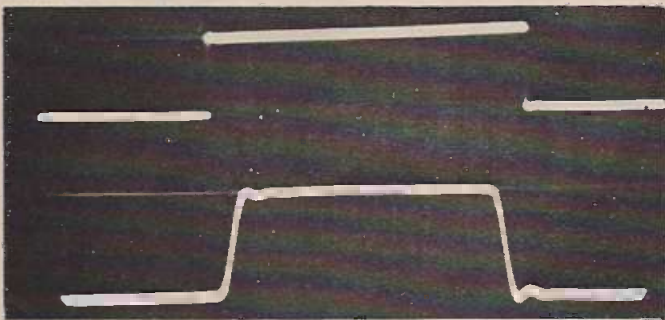

Fig. 5. Square-wave test for ringing with 2µF capacitor across 8 ohm load. Input signal, top, output from amplifier, bottom. Ringing virtually nil.

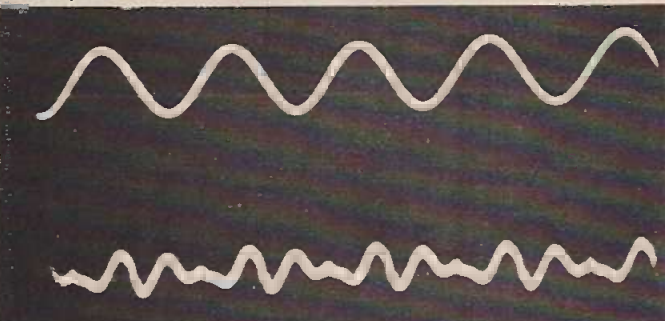

Fig. 6. Top curve shows 1000Hz sine-wave output from amplifier at 15W power output. Lower curve shows residual distortion at 0.15% (greatly amplified).

### EMISOUND 1515 AMPLIFIER

#### Measured Performance

**Power Output:** One channel only driven 20W. Both channels driven 15.5W per channel (rms) into 8 ohm load.

**Frequency Response:** As specified. See graphs.

**Power Bandwidth:** -2dB 30Hz, then flat 40 to 20,000Hz, then to -3dB 30,000Hz.

Harmonic Distortion:	100Hz	1000Hz	10kHz
	0.9%	15W 0.15%	0.4%
—	10W 0.1%	—	
—	5W 0.1%	—	
—	1W 0.14%	—	

**Signal-to-Noise:** Magnetic pickup -59dB  
Tuner/Aux/Tape -65dB  
Microphone -63dB

**Crosstalk:** -58dB 1000Hz

**Pickup input over-load margin:** 30dB

**Retail Price:** £49.50 including VAT.

the square-wave test oscillograms. Although the overall response rolls away above 20,000Hz, it is only -3dB at 30,000Hz and, therefore still very good. Many amplifiers these days have a frequency response almost flat to 100kHz but this is not really necessary. The response of the scratch filter is adequate but should ideally be steeper and with the roll-off beginning higher up the scale e.g., at about 8kHz.

Total harmonic distortion for various power levels and frequencies is shown in the table and is within specification for rated power output at 1000Hz. At 100Hz and 10,000Hz respectively the distortion factor rises but this is not unusual and in this case acceptable considering the relatively low cost of the amplifier.

Signal-to-noise performance was better than specified and with a very good figure, namely -59dB, for the magnetic pickup input. Crosstalk is not quoted in the specification but the obtained figure of 58dB (relative 15W 1000Hz) is also very good. Input sensitivities and signal outputs for tape recording and headphones were as specified.



BEFORE 1896, the wireless experimenters had one thing in common, they were interested mainly from an academic point of view.

# EARLY RADIO

## MARCONI

At least one person, however, had seen the practical implications and in 1896 British Patent No. 12039 was granted to Guglielmo Marconi for "Improvements in transmitting electrical impulses and signals".

In the Patent there is described the basic concept of using a transmitter comprising an induction coil having in its primary circuit a telegraph key and a battery, and a spark gap in its secondary circuit, and a receiver comprising a coherer in series with a telegraph receiver. From this starting point the specification goes on to discuss the use of an aerial and earth and to describe modifications to the coherer all directed towards *not* the academic study of the properties of 'Hertzian' waves *but* the realisation of a practical long distance wireless telegraphy system.

Marconi definitely led the field in the Patent stakes: he was the first to seek Patent protection for a system of wireless telegraphy using Hertzian waves.

The runner up was not far behind. Six months after Marconi applied for his Patent, in December 1896; A.C. Brown and G.R. Neilson applied for Patent No. 28955 for a wireless system "It has been known for some years past" they openly admitted in their Patent specification "that Hertzian waves are capable of being radiated or projected so as to act on other circuits placed at a distance and produce certain effects therein, such as sparking between disconnected conductors, and the alteration in resistance of 'coherers' etc. It has been known too that these effects are manifested through considerable distances in space and through various media which are in some cases opaque to ordinary light."

Having thus acknowledged the state-of-the-art, Brown and Neilson went on to describe their invention which was essentially concerned with an improvement to the construction of the oil-immersed spark gap of a Righi-type oscillator. They also however discussed the major problems which, in 1896, stood in the way of the development of practical wireless telegraphy and telephony systems.

## PROBLEMS

One such problem, consequent upon the use of a spark gap transmitter and

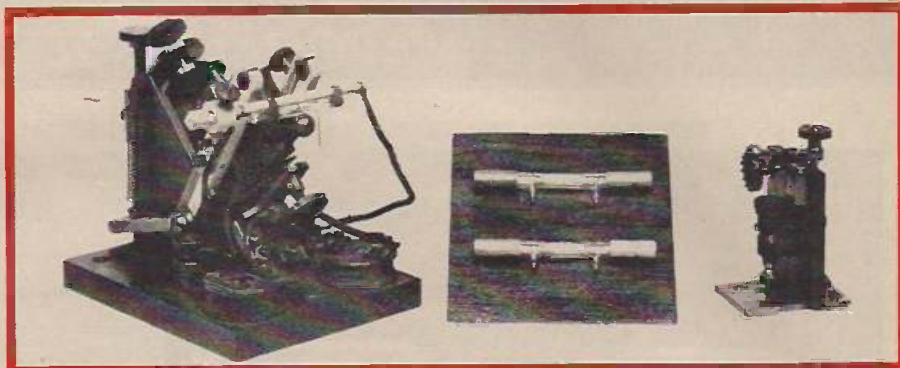

A group of early coherers.

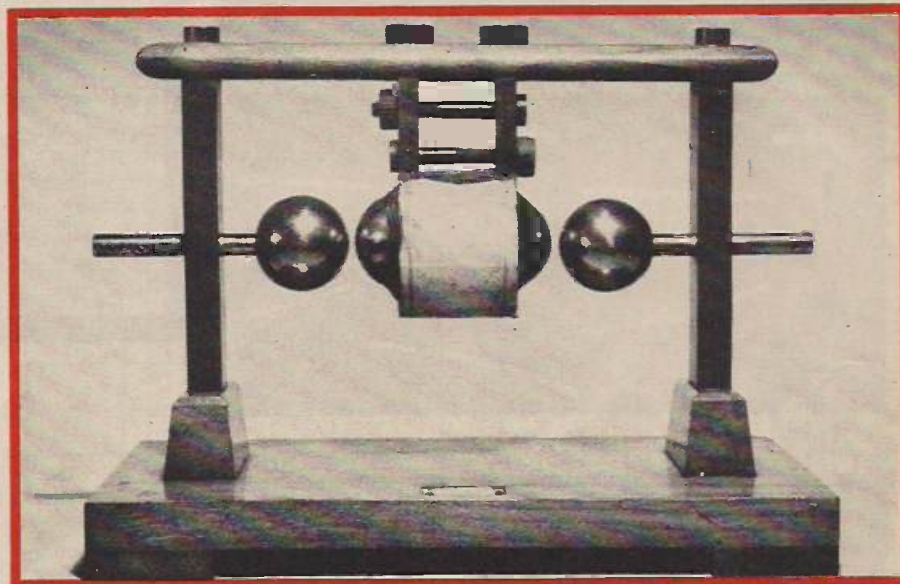

Spark gap used by Marconi.

vertical aerial, was that the signals were transmitted in all directions and over a wide range of frequencies. This was obviously inefficient and gave rise to the serious problem of interference in the case where different transmitters were operated simultaneously close to each other. Brown and Neilson referred to this problem and suggested enclosing the transmitter in a metal box, generated waves being allowed to escape in a narrow beam through a hole in one side of the box. They also suggested tuning "by inductive paths".

The nature of the transmissions produced by a spark gap oscillator also raised problems in connection with telephony. In order to be able to carry audio frequency signals, a carrier wave quite unlike the intermittent damped oscillations obtained from the spark gap is required, in other words - a continuous wave. As Brown and

Neilson put it: "it is desirable for the vibrating make and break in the primary circuit of the generating induction coil to be of high rate and the transmitting oscillating circuit designed to give a considerable number of oscillations for each break." They suggested connecting across the spark gap a loop of wire of 'some length' whereby the oscillations might be "less damped although less powerful".

A further problem was that of devising a suitable means of detection of the radio waves. The metal filings coherer used by Marconi and also Brown and Neilson was unsuitable for use in the detection of telephonic transmissions since it had to be reset after receiving a signal by mechanical agitation, for example by tapping, and was therefore incapable of responding to rapidly varying signals. Brown and Neilson tried alternative forms of de-



# PATENTS

## PART 2

tectors, in particular a detector employing a triangle of platinum or aluminium wire resting lightly across two conductors in an evacuated vessel, but in the end they recommended a variation on the conventional coherer, using carbon granules instead of metal filings, which they said did not need resetting and was therefore particularly suitable for telephony.

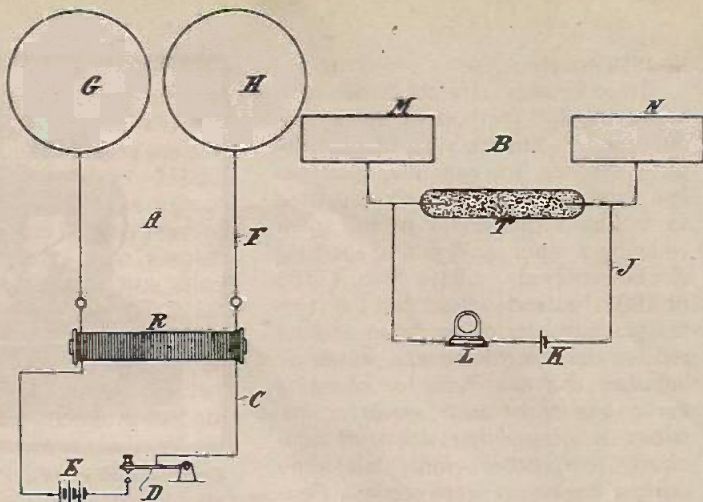

British Patent 12039 of 1896. Marconi's original wireless telegraphy Patent. The transmitter has an induction coil and spark gap and the receiver a coherer (T).

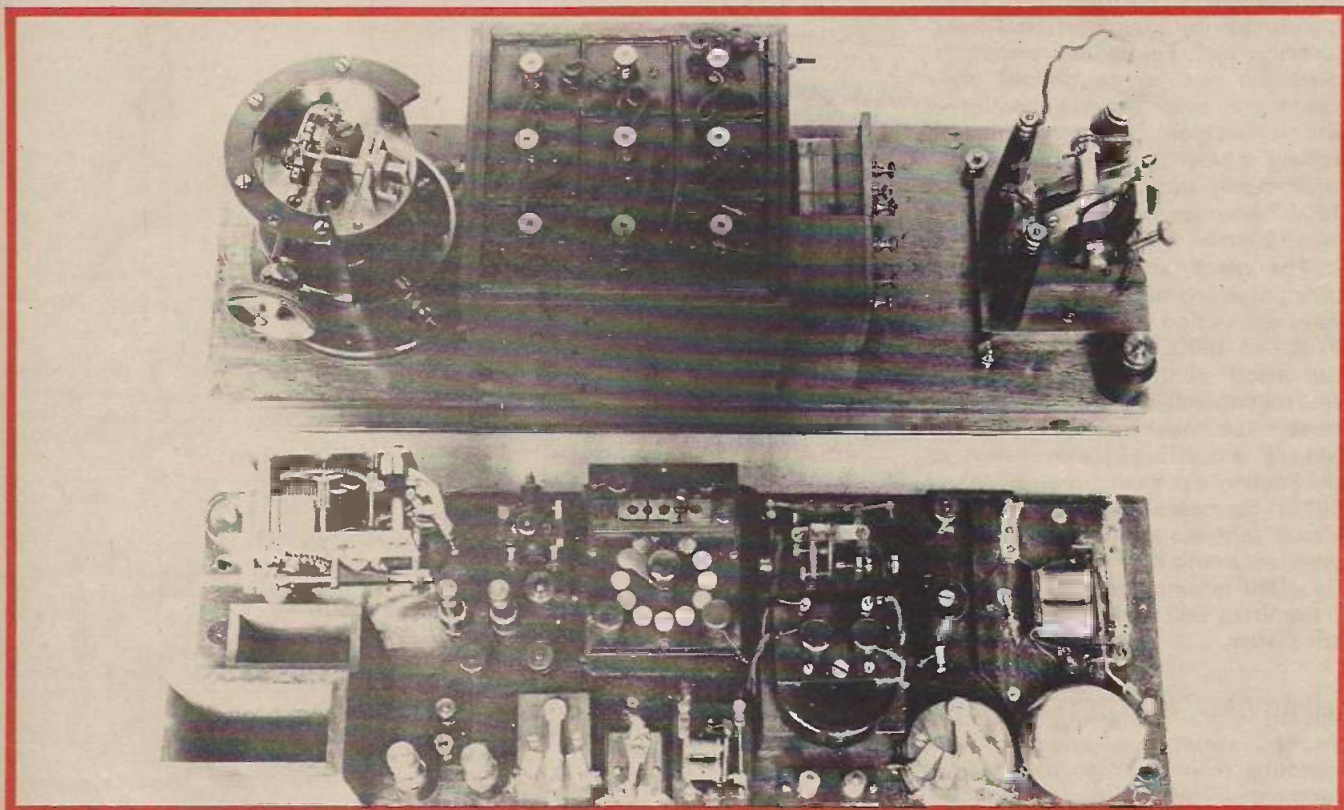

Marconi and Lodge-Muirhead early receivers.

In the years that followed, many inventors directed their efforts towards finding satisfactory solutions to these three problems considered by Brown and Neilson.

Leading the field, in 1897, was Lodge with Patent No. 11575 for a means of avoiding interference between nearby transmitters. His idea involved the use of inductance and capacitance to 'syntonise' the transmitter and the receiver, that is, to tune them to the same unique frequency. The use of inductive and capacitive elements in the transmitter circuitry also acted to reduce the damping of the oscillations and thereby to reduce the range of frequencies generated. At this stage, of course,

the future for wireless systems using Hertzian waves was by no means clear cut and Lodge, for one, was certainly hedging his bets. Thus, in Patent No. 29505 of 1897 he described the use of syntonising circuitry and coherers in an inductive telegraph system.

Marconi was following close on the heels of Lodge and in for example Patent Nos. 5387 of 1900 and 7777 of 1900 he described syntononic circuitry employing aerial coils. J.S. Stone, an immensely prolific patentee also did much work in this field as is demonstrated for example by Patent No. 27253 of 1902 which describes the use of a closed resonant circuit coupled to the aerial for producing in the

aerial forced oscillations of a single desired frequency.

The efforts of these inventors produced significant improvements but by no means totally solved the problem because quite simply it is difficult to eliminate completely unwanted frequencies from the oscillations of a spark gap transmitter.

Tesla's Patent No. 14579 of 1901 was one ingenious attempt to obtain absolute selectivity. The transmitter produced signals on two different frequencies and the receiver had two reception circuits tuned respectively to the two frequencies and coupled to a common relay. The idea was that the relay would only be actuated when both reception circuits were receiving



simultaneously.

Other Patents were concerned with improving the method of spark production. Patent No. 29142 of 1904 (J. S. Stone), for example, describes one kind of multiple spark gap used to facilitate 'quenching' of the spark whereby a more rapid rate of sparking can be achieved. In Patent No. 17706 of 1902, Fessenden described a system for "continuous transmission and reception of electromagnetic waves or impulses and modifying or changing the character of such waves or impulses without interruption of continuity", in other words telephony using a continuous wave carrier. Fessenden produced his 'continuous' wave by replacing the usual induction coil and 'trembler' of the transmitter with a high frequency alternator and a transformer. With Fessenden's system indeed the goal of continuous wave production was closely approached and it therefore became possible to achieve sharper tuning and to transmit satisfactorily telephonic messages. By 1907 Fessenden was able to broadcast over 100 miles with his system.

The key to an alternative method of approaching the goal of continuous wave production was given Patent No. 21629 of 1900. In this Patent, Duddell described the use of an electric arc to convert d.c. into a.c.. This came to be known as the 'musical' or 'singing' arc. This idea was taken up by Poulsen (in Patent No. 15599 of 1903) for use in generating radio waves and was soon competing for popularity with the Fessenden system. By 1910 telephonic signals had been transmitted 500 miles using the Poulsen system.

### IMPROVING THE DETECTORS

At the same time, inventors were directing their attention to the development of improved detection devices and in particular to the development of detection devices suitable for receiving telephonic transmissions.

Popov was an early contender. In his Patent No. 1797 of 1900 he described an improvement on the Branly coherer. In 1902 in Patent No. 10245 Marconi described his famous magnetic detector which worked on quite different principles from the coherer. In one form of the magnetic detector, an endless iron band is moved through two adjacent coils in a magnetic field. One of the coils is connected to an aerial and earth and the other is connected to a telephone receiver. Received signals act to vary the magnetic coupling of the coils and thereby produce a current flow in the telephone receiver.

Patent No. 12119 of 1903 describes the use of an electrolytic cell com-

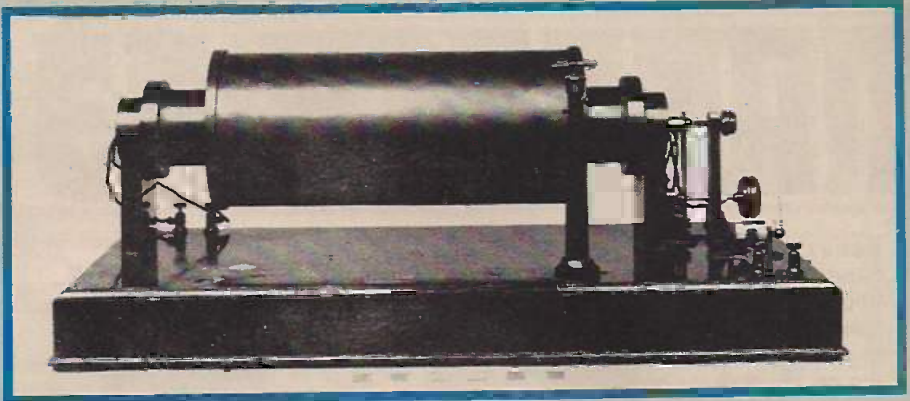

Eighteen inch spark coil used in Marconi's early wireless stations.

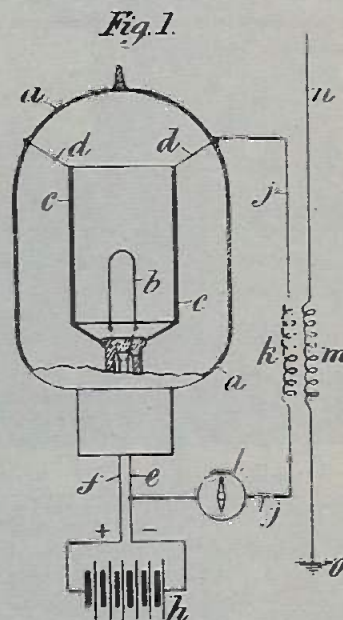

British Patent 24850 of 1904. Fleming's Patent for the thermionic diode detector.

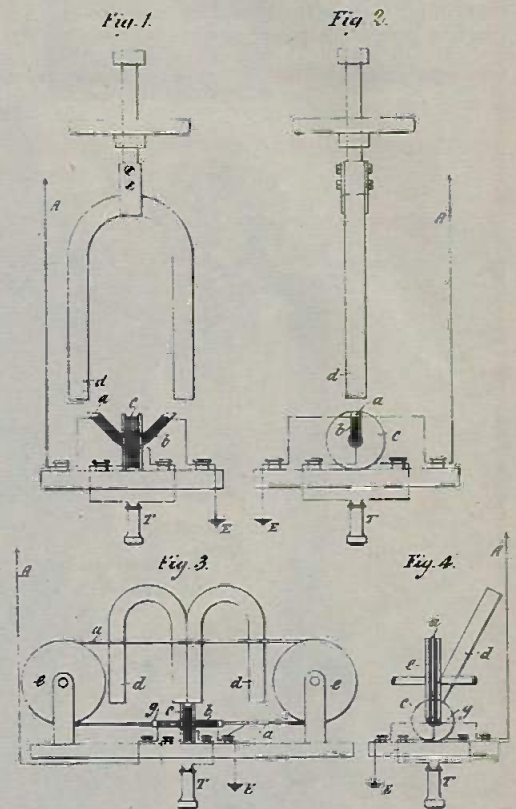

British Patent 10245 of 1902. Marconi's magnetic detector.

prising for example platinum wires immersed in sulphuric acid. Received signals disturb the cell equilibrium and vary the resistance of the cell. This idea also appeared in Fessenden's Patent No. 28291 of 1903 and Fessenden's device, known as a liquid barreter, became widely used. The electrolytic detector was important because of its great sensitivity.

Patent No. 17396 of 1902 relates to an arrangement of steel rods with oxidised tips resting on a steel plate. Patent No. 8659 of 1906 describes a crystal type detector using a natural manganese compound such as psilimelan. Patent No. 5332 of 1907 is concerned with a carborundum detector, Patent No. 18842 with silicon, Patent No. 21408 of 1907 with copper

oxide, Patent No. 10772 of 1909 with iron pyrites and Patent No. 22164 of 1910 with lead ore. The list is virtually endless, these are but a few examples.

In Patent No. 29143 of 1904, J.S. Stone describe the use of a bolometer and Patent No. 25645 of 1904 is concerned with the use of a thermocouple as a detector.

In Patent No. 6203 of 1907, far before its time, Fessenden described a heterodyne detector in which locally generated oscillations beat with the incoming signal to produce an audible tone. Fessenden had to wait another six years for the thermionic valve as a generator of oscillations to be developed before this became a practical proposition.



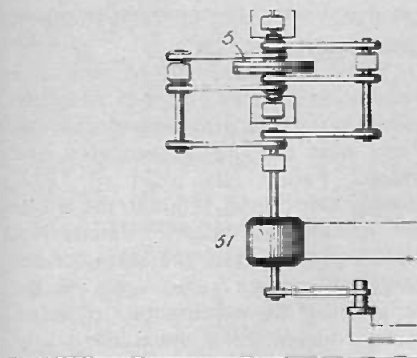
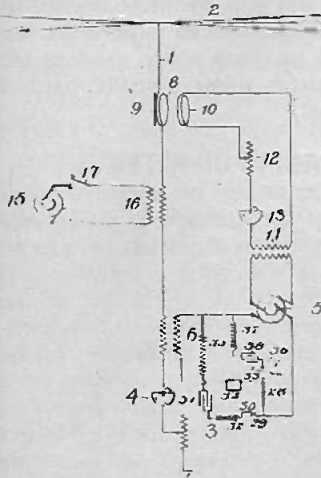

FIG. 2.



British Patent 6203 of 1907. Fessenden's heterodyne detector, using, in its original form, an alternator (5) to generate the local oscillations.

## VALVES

In 1904 vacuum tube devices were being investigated as a means of detection. Patent No. 27887 of 1904

describes the use of a mercury arc lamp, received signals being used to trigger the arc, and Patent No. 13736A of the same year relates to the use of a neon lamp. In Patent No. 24850, following the discovery of the 'Edison Effect' some 20 years earlier, Fleming described the use of a high vacuum thermionic diode, the first true valve. Two years later, in Patent No. 5258, de Forest described a circuit employing a diode type 'ionized gas' detector, and subsequently, in 1908 he described in Patent No. 1427 a circuit using not a diode but a modified form of the diode having an additional grid-like electrode between the anode and cathode.

The triode was born.

The triode was critical to the development of radio communications: it provided a convenient and effective means of generating oscillations and of amplifying weak signals. These possibilities were however by no means immediately recognised. The triode was originally devised as an improved means of detecting signals and it was some years later before its amplifying and generating properties were realised.

Insofar as amplification is concerned, this was a much considered problem and several proposals were made, before the triode was used as an amplifier, to achieve amplification by causing small electrical variations in one circuit to give rise to large electrical variations in a separate circuit.

In Patent No. 4715 of 1907, for example, Fessenden proposed an amplification system using telephone re-

Fig. 1

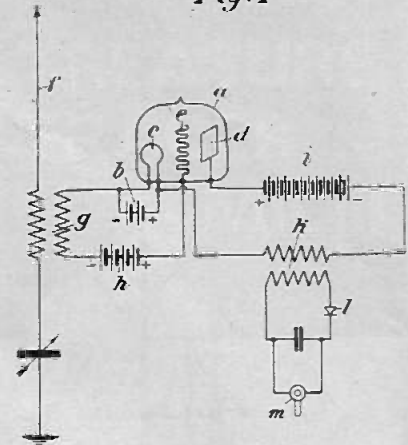

British Patent 8821 of 1913. The triode used as an amplifier.

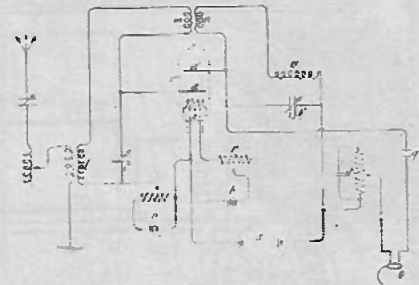

British Patent 13636 of 1913. The triode used in a feedback circuit.

ceivers, received oscillations "producing mechanical motion and said mechanical motion being caused to vary the resistance of contact of normally conducting contact surfaces." In Patent No. 300 of 1911 an amplification system using a discharge tube is described, the discharge being influenced

British Patent 23728 of 1913, Airborne radio.

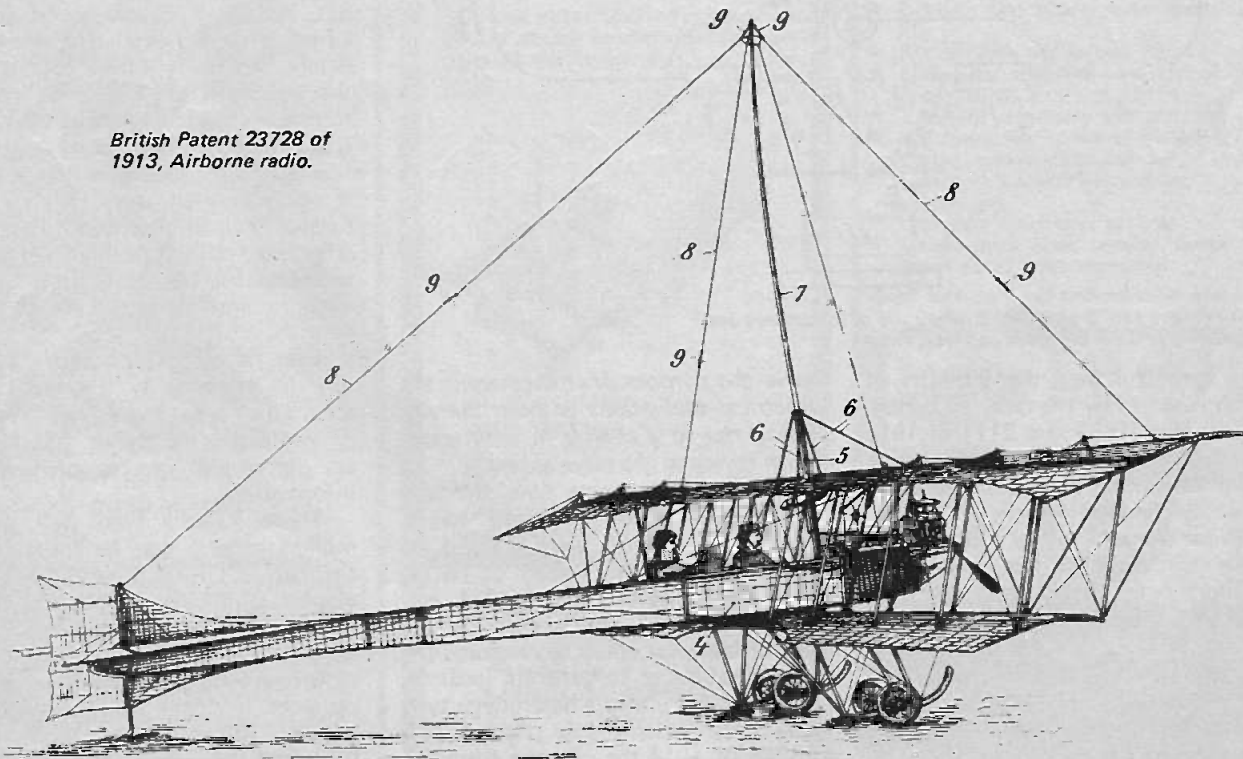



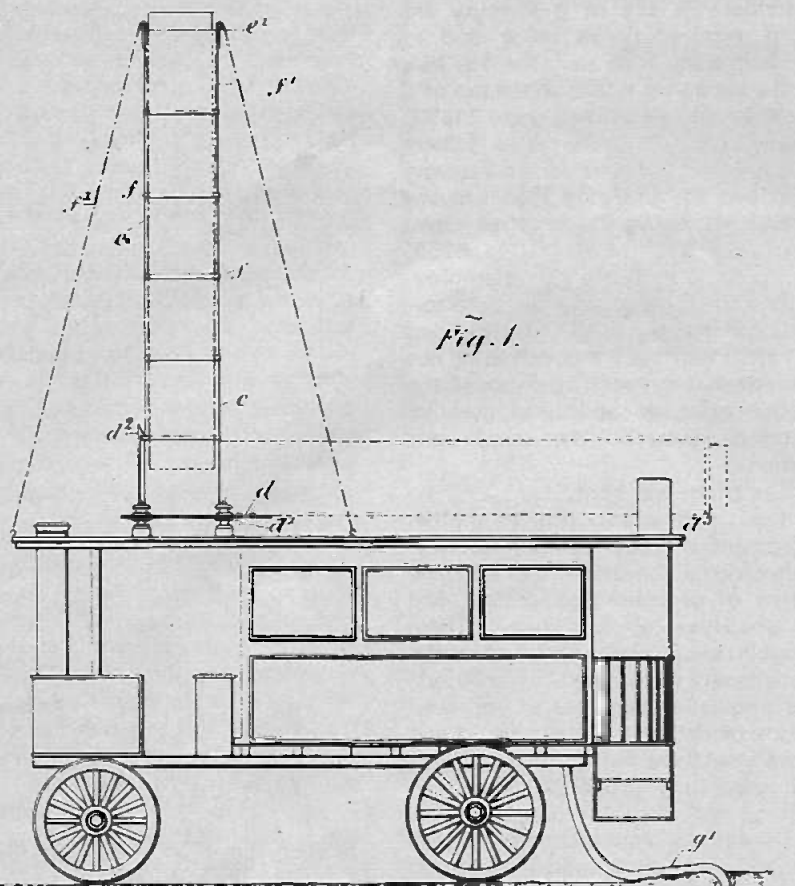

British Patent 23163 of 1900. Car radio.

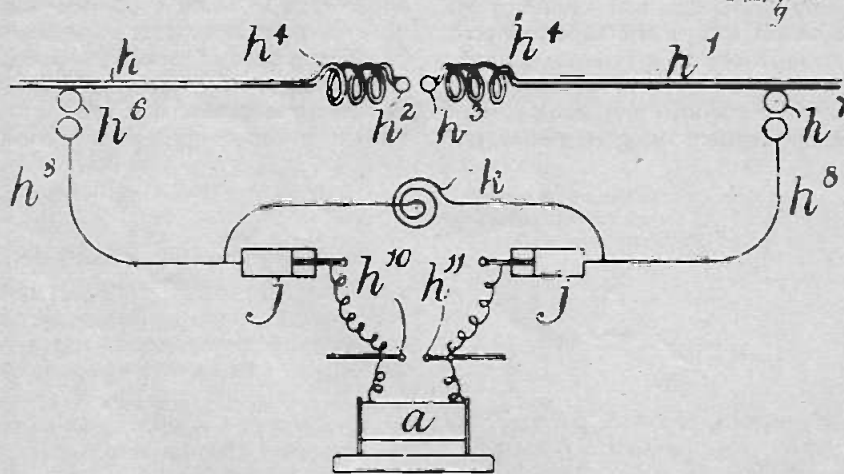

British Patent 11575 of 1897. Lodge's use of inductance and capacitance to tune the spark gap transmitter.

by a magnetic field the intensity of which is varied by the received signals. Patents Nos. 1482 and 2111 of 1911 relate to the use of a cathode ray tube for amplification purposes, the electron flow being influenced by the received signals. The use of the triode for amplification purposes is mentioned in Patent No. 8821 of 1913 which was granted to Gesellschaft für Drahtlose Telegraphie mbH.

"The object of the present invention", asserted the Patentee, "is to provide an arrangement whereby vacuum tubes having glowing cathodes

serve the purpose of strengthening the electrical oscillations without thereby giving rise to a change in their waveform owing to the valve action".

At about the same time, the idea of feedback was conceived and a number of Patents were granted, as for example Nos. 13636 of 1913, 28413 of 1913, 252 of 1914 and 24231 of 1914 which describe the use of feedback either to reinforce the amplification or to generate local oscillations for use in a heterodyne type detection system. In Patent No. 13248 of 1914 the use of a triode to

generate transmitting oscillations is describe.

The valves used up to this time were quite different from those which eventually came into widespread use. They were not highly evacuated, and indeed, Patent No. 8821 of 1913, already mentioned, refers to the triode an "ionized gas relay". Patent No. 15788 of 1914 sets the stage for the birth of modern radio with its description of the manufacture of 'hard' vacuum valves using the Gaede pump which was specially suited to the purpose and also chemical absorbants such as magnesium to remove the last traces of gas (and which produce the characteristic shiny metallic patches on valves).

### THE MEANING OF PATENTS

The inventorship of virtually every important development in the history of telecommunications has been hotly disputed at one time or another and it must be borne in mind that the above mentioned Patents do not necessarily constitute 'firsts' in their respective fields. Many inventions were not Patented by their original inventors but were Patented subsequently (often innocently) by runners-up, and some inventions were confusingly Patented several times, often in a short space of time by several inventors each thinking himself to be the first. The Patent system is of course only concerned with granting protection for ideas which are not already known or Patented but it was not until quite late that an official examination with a view to excluding 'invalid' Patents was introduced and even now it is possible for a Patent to be granted which is closely similar to an existing Patent or already known idea, it being the policy of the Patent Office only to refuse to grant a Patent were there is clearly no element of novelty whatsoever. In the case of a Patent which is not absolutely identical to a prior Patent or a known idea, the Patent is granted and it is then up to the interested parties to fight it out between themselves in the courts if they so wish.

Even if all of the above Patents do not necessarily represent milestones they are certainly representative of contemporary trends and as such are important sources of historical information.

These Patents (and well over a million others) can be inspected at the Patent Office library (25 Southampton Buildings, off Chancery Lane, London WC2A 1AY) and also at certain major provincial libraries. Copies of British Patent specifications can be obtained from the Sale Branch of the Patent Office at Orpington, Kent, BR5 3RD (25p per copy post free). ●



## AMBIT INTERNATIONAL

Microcircuit  
specialists

Did you know we supply Signetics PLL, National linear and digital, ECL from Fairchild etc. ? Devices like the 95H90 - a decade counter at 220 megs. £9.05. Or the AF amplifier LM380, by National for only £1.00. See our new A4 size data-logue for details of our full range of devices, modules, and our unique datacopying service.

AMBIT is the UK distributor for coils and filters by TOKO inc. eg:

Ceramic filters for AM:

CFT455B 455kHz-8kHz 45p

CFT455C 455kHz-6kHz 45p

Mechanical filters for

Top quality AM/SSB:

MFH71T 455kHz-7kHz 135p

MFH41T 455kHz-4kHz 135p

Ceramic filters for FM:

CFS10.7 10.7MHz 45p

(Sim. to Murata & Variantron filters.)

Plus coils/chokes etc. for radio and tv.

FM TUNER EQUIPMENT:

7251 tunerset by Larsholt - a combination of M0SPET and varicap tunerhead, and the CA3053/ca3089E 1F amplifier. Includes MUTE, AFC, METER DRIVE.

Outstanding performance and quality. The essence of any HI-FI FM Tuner.

£17.00 built and tested.

Stereo decoders:

MCL310P full kit with socket, LED etc. £5.10

CA3090Q built: £6.60

The AMBIT catalogue is full of data - get your copy now !

### TERMS

P&P 17p. VAT +10% please  
Send to: AMBIT int.,  
37 High Street-Brentwood  
ESSEX. CM14 4RH (216029).  
TRADE ENQUIRIES WELCOME.

# MODERN Component Storage?

A TREMENDOUS OFFER OF  
QUALITY STEEL UNITS AT  
BARGAIN PRICE.

### F26-06

A 6 drawer metal cabinet with polystyrene drawers, each drawer front filled with twin label holders for indexing and easy identification. This flexible filing system accepts a 9 section insert for component storage giving 54 compartments measuring 75 x 103 x 26mm.

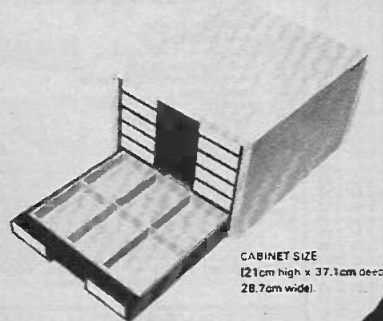

CABINET SIZE  
(21cm high x 37.1cm deep  
28.7cm wide).

PRICE OF CABINET  
(excluding insert trays)  
9 compartment inserts are 56p  
each incl. p and p and VAT.

Incl.  
VAT.  
£9.35.

F26-06 and F55-03 Insert trays  
can be purchased separately minimum  
quantity of 6 each.

### F55-03

This unit offers facility for 45 component storage compartments measuring 72 x 57 x 55mm.

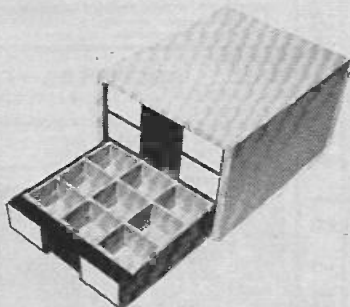

PRICE OF CABINET  
(excluding insert trays)  
15 compartment inserts are  
80p each incl. p and p and  
VAT.

DELIVERY: Please allow  
approximately 14 days.

Incl.  
VAT.  
£8.48.

## PLANETRON SYSTEMS

Dept. 24  
76 CASTLE STREET,  
FARNHAM, SURREY.  
(MAIL ORDER ONLY)

# BUILD THE TREASURE TRACER MK III

METAL  
LOCATOR



AS SEEN  
ON BBC-1  
& BBC-2  
TV

- Genuine 5-silicon transistor circuit, does not need a transistor radio to operate.
- Incorporates unique varicap tuning for extra stability.
- Search head fitted with Faraday screen to eliminate capacitive effects.
- Loudspeaker or earphone operation (both supplied).
- Britain's best selling metal locator kit.
- Kit can be built in two hours using only soldering iron, screw-driver, pliers and side-cutters.
- Excellent sensitivity and stability.
- Kit absolutely complete including drilled, tinned, fibreglass p.c. board with components siting printed on.
- Complete after sales service.
- Weighs only 22oz; handle knocks down to 17" for transport.

Send stamped, self-addressed envelope for literature.

Complete kit  
with pre-built  
search coil

£9.80  
Plus 35p Post  
(inc. VAT)

Built, tested  
and  
Guaranteed

£13.75  
Plus 35p Post  
(inc. VAT)

MINIKITS ELECTRONICS,  
35d Langley Drive, Wanstead,  
LONDON E11 2LN  
(Mail order only)

# Henry's U.K.'s LARGEST RANGE OF BRANDED AND GUARANTEED DEVICES. (Quantity Discounts 10% 12+, 15% 25+, 20% 100+) (Any one type except where quantity discounts show) Min. Order £1.00 please. Post 10p.

## INTEGRATED CIRCUITS

VERY IMPORTANT. ONLY branded I.C.'s are to the FULL manufacturers specifications. ALL others are not. Henry's sell only branded Integrated Circuits. From TEXAS, FAIRCHILD, SIGNETICS. So why buy alternatives or under spec. devices when you can purchase the genuine article from us—ex stock... need we say more!

Type	1/11 12/29 30/99	Type	1/11 12/29 30/99	Type	1/11 12/29 30/99
	£ p £ p £ p		£ p £ p £ p		£ p £ p £ p
SN7400N	0.20 0.18 0.16	SN7448N	1.50 1.27 1.13	SN74141N	1.00 0.90 0.80
SN7401N	0.20 0.18 0.16	SN7450N	0.20 0.18 0.16	SN74142N	2.00 2.00 2.52
SN7401AN	1.30 0.98 0.33	SN7451N	0.20 0.18 0.16	SN74145N	1.44 1.44 1.26
SN7402N	0.20 0.18 0.16	SN7453N	0.20 0.18 0.16	SN74147N	2.30 2.30 1.83
SN7403N	0.20 0.18 0.16	SN7454N	0.20 0.18 0.16	SN74148N	2.01 2.01 1.63
SN7403AN	0.38 0.38 0.33	SN7460N	0.20 0.18 0.16	SN74150N	2.30 2.30 2.01
SN7404N	0.24 0.21 0.18	SN7470N	0.33 0.30 0.27	SN74151N	1.15 1.15 1.00
SN7405N	0.24 0.18 0.16	SN7472N	0.38 0.38 0.34	SN74153N	1.09 1.09 0.95
SN7405AN	0.44 0.44 0.38	SN7473N	1.44 0.41 0.37	SN74155N	2.30 2.30 2.01
SN7406N	0.40 0.38 0.35	SN7474N	0.48 0.48 0.42	SN74156N	1.15 1.15 1.00
SN7407N	0.40 0.38 0.35	SN7475N	0.58 0.55 0.51	SN74157N	1.09 1.09 1.00
SN7408N	0.25 0.22 0.19	SN7476N	0.45 0.38 0.32	SN74159N	2.44 2.44 2.14
SN7409N	0.33 0.33 0.28	SN7480N	0.80 0.70 0.50	SN74160N	1.58 1.58 1.38
SN7409AN	0.44 0.44 0.38	SN7481N	1.23 1.10 0.95	SN74161N	1.58 1.58 1.38
SN7410N	0.20 0.18 0.16	SN7482N	0.87 0.80 0.72	SN74162N	1.58 1.58 1.38
SN7411N	0.25 0.23 0.21	SN7483N	1.20 1.10 1.00	SN74163N	1.58 1.58 1.38
SN7412N	0.28 0.28 0.25	SN7485N	1.87 1.87 1.63	SN74164N	2.01 2.01 1.78
SN7412AN	0.38 0.38 0.33	SN7486N	0.50 0.50 0.44	SN74165N	2.01 2.01 1.78
SN7413N	0.30 0.27 0.25	SN7489N	4.32 4.32 3.78	SN74166N	2.16 2.16 1.89
SN7414N	0.72 0.72 0.63	SN7490N	0.75 0.70 0.63	SN74167N	4.10 4.10 3.59
SN7416N	0.30 0.27 0.25	SN7491AN	1.18 1.00 0.90	SN74170N	2.88 2.88 2.52
SN7417N	0.30 0.27 0.25	SN7492N	0.75 0.70 0.63	SN74172N	5.78 5.78 5.04
SN7420N	0.20 0.18 0.16	SN7493N	0.85 0.80 0.75	SN74173N	1.00 1.00 1.45
SN7422N	0.28 0.28 0.25	SN7494N	0.85 0.80 0.75	SN74174N	1.40 1.40 1.37
SN7422AN	0.38 0.38 0.33	SN7495N	1.00 0.90 0.83	SN74175N	1.28 1.28 1.13
SN7423N	0.37 0.34 0.32	SN7496N	0.80 0.80 0.83	SN74176N	1.44 1.44 1.26
SN7425N	0.37 0.37 0.32	SN74100N	0.60 0.53 0.45	SN74177N	1.44 1.44 1.26
SN7427N	0.43 0.43 0.37	SN74101N	0.60 0.53 0.45	SN74180N	1.44 1.44 1.26
SN7428N	0.43 0.43 0.37	SN74105N	0.60 0.53 0.45	SN74181N	5.18 5.18 4.53
SN7430N	0.20 0.18 0.16	SN74107N	0.51 0.51 0.45	SN74182N	1.44 1.44 1.26
SN7432N	0.37 0.37 0.32	SN74110N	0.85 0.85 0.75	SN74184N	2.16 2.16 1.89
SN7433AN	0.43 0.43 0.38	SN74111N	0.85 0.85 0.75	SN74185AN	2.16 2.16 1.89
SN7433AN	0.57 0.57 0.50	SN74115N	1.00 0.90 0.83	SN74188N	6.48 6.48 5.67
SN7437N	0.43 0.43 0.37	SN74118N	1.92 1.92 1.68	SN74190N	2.30 2.30 2.01
SN7438N	0.43 0.43 0.37	SN74119N	1.05 1.05 0.92	SN74191N	2.30 2.30 2.01
SN7438AN	0.57 0.57 0.50	SN74120N	1.05 1.05 0.92	SN74192N	2.30 2.30 2.01
SN7440N	0.20 0.18 0.16	SN74121N	0.57 0.57 0.50	SN74193N	2.30 2.30 2.01
SN7441AN	0.85 0.79 0.73	SN74122N	0.80 0.80 0.70	SN74194N	1.72 1.72 1.51
SN7443N	1.50 1.37 1.13	SN74123N	1.44 1.44 1.26	SN74195N	1.44 1.44 1.26
SN7444N	1.50 1.27 1.13	SN74125N	0.69 0.69 0.60	SN74196N	1.58 1.58 1.38
SN7445AN	2.16 2.16 1.89	SN74126N	0.69 0.69 0.60	SN74197N	1.58 1.58 1.38
SN7446N	2.16 2.16 1.89	SN74132N	0.72 0.72 0.63	SN74198N	3.18 3.18 2.77
SN7447AN	1.80 1.80 1.57	SN74133N	0.63 0.63 0.55	SN74199N	2.88 2.88 2.52

LARGER QUANTITY AND O.E.M. PRICES PHONE (01) 723 3646. PRICING OF SN7400 SERIES IS CALCULATED ON THE TOTAL NUMBER ORDERED REGARDLESS OF MIX. SN74... HIGH POWER... SN74... LOW POWER SERIES IN STOCK... SEND FOR LIST 36, FREE ON REQUEST. LOW POWER SOCKETS 14 PIN... 15p. 16 PIN... 17p. 8 PIN... 14p.

## TRANSISTORS

A SELECTION FOR FULL LIST SEND FOR BOOKLET 36 TODAY.

AA213 10p	BC182 12p	BY213 35p	OC36 85p	ZTX108 10p	2N3714 1.60
AC107 35p	BCY32 85p	CI06D 55p	OC44 18p	ZTX300 14p	2N3771 1.75
AC128 20p	BCY39 1.00	GET111 55p	OC45 18p	ZTX302 18p	2N3773 2.25
AC187 20p	BCY55 2.50	GET115 75p	OC71 15p	ZTX500 15p	2N3780 2.50
AC417 35p	BCY71 15p	GE120 55p	OC72 25p	ZG301 40p	2N3919 3.50
AC439 65p	BCY71 15p	LM309K	OC77 55p	2N697 15p	2N3866 75p
AD149 50p	BCY72 13p	MAT121	OC81 28p	2N705 10p	2N3903 15p
AD161 39p	BD124 80p		OC83 25p	2N930 20p	2N4002 14p
AD192 39p	BD131 45p		OC140 85p	2N987 45p	2N4128 15p
AF117 20p	BF115 22p	MJE340 50p	OC170 25p	2N1132 25p	2N4871 35p
AF118 50p	BF180 35p	MJE585 65p	OC200 50p	2N1304 22p	2N4547 30p
AF139 30p	BF194 13p	MJE3055	OC202 90p	2N1613 20p	2N5001 3.00
AF188 40p	BFX13 25p		OC271 1.00	2N1671 1.00	2N5026 8.90
AF239 44p	BFX34 55p	MPP105 46p	ORP12 55p	2N2147 75p	2N5303 70p
AS272 30p	BFX28 22p	NK1217 45p	ORP90 45p	2N2160 80p	4025A 45p
BA115 10p	BFY50 20p	NKT404 60p	P345A 20p	2N2926 10p	40351 45p
BAX13 5p	BFY51 20p	OAS 60p	TIL209 25p	2N3053 29p	40362 40p
BC107 10p	BFY64 5p	DAR 1.00	TIP29A 49p	2N3054 45p	40408 50p
BC108 15p	BFY90 75p	DA200 8p	TIP30A 58p	2N3055 45p	40486 75p
BC109 15p	BLY36 6.25	OA202 10p	TIP31A 61p	2N3440 50p	40636 1.00
BC109C 14p	BSX20 15p	OC16 85p	TIP41A 74p	2N3442 1.10	40430 85p
BC113 16p	BU105 2.20	OC20 1.25	TIP42A 80p	2N3528 80p	
BC137 12p	BU100 15p	OC28 85p	TIP43A 20p	2N3814 59p	
BC169C 14p	BY127 15p	OC35 55p	V405A 25p	2N3702 11p	

## TRIACS

Type	P.I.V.	Price Each	15 AMP RANGE
SC35A	100v	40p	SC50A 100v £1.45
SC25B	200v	85p	SC50B 200v £1.85
SC35D	400v	90p	SC50D 400v £1.95
SC35E	500v	£1.20	SC50E 500v £2.25

6 AMP RANGE  
 SC40A 100v 40p  
 SC40B 200v 85p  
 SC40D 400v £1.20  
 SC40E 500v £1.50

10 AMP RANGE  
 SC45A 100v £1.05

3 AMP T048  
 15 Amp T048

## SILICON CONTROLLED RECTIFIERS

Type	P.I.V.	Price
ONE AMP (T05) P.I.V.		
CRS 1/05A	50v	30p
CRS 1/10AF	100v	30p
CRS 1/20AF	200v	35p
CRS 1/40AF	400v	45p
CRS 1/80AF	800v	55p

THREE AMP (T04)  
 CRS 3/05AF 50v 40p  
 CRS 3/10AF 100v 40p  
 CRS 3/20AF 200v 55p  
 CRS 3/40AF 400v 65p  
 CRS 3/80AF 800v 85p

FIVE AMP  
 CRS 5/400 400v 80p

SEVEN AMP (T044)  
 CRS 7/100 100v 80p  
 CRS 7/200 200v 87p  
 CRS 7/400 400v 85p  
 CRS 7/800 800v 95p

SIXTEEN AMP (T043)  
 CRS 16/100 100v 70p  
 CRS 16/200 200v 75p  
 CRS 16/400 400v 85p  
 CRS 16/800 800v £1.10

## EASY TO BUILD KITS BY AMTRON

— Everything supplied

Model No.		
310	Radio control receiver	3.29
300	4-channel R/C transmitter	6.61
345	Super set R/C receiver	6.61
65	Simple transistor tester	1.66
115	8 watt Amplifier	4.50
120	12 watt amplifier	4.73
125	Stereo control unit	6.01
130	Mono control unit	4.16
605	Power supply for 115	5.31
610	Power supply for 120	6.64
615	Power supply for 2 x 120	3.29
230	AM/FM aerial amplifier	6.80
240	Auto packing light	9.88
275	Mic. preamplifier	21.48
570	LF generator 10Hz-1mHz	19.77
575	Sq. wave generator 20Hz-20KHz	9.47
590	SWR meter	9.24
630	STAB Power supply 6-12v 0.25-0.1A	3.31
690	DC motor speed Gov.	7.00
700	Electronic Chaffinch	12.57
780	Acoustic switch	10.81
790	Metal Detector (electronics only)	7.92
790	Capacitive Burglar alarm	4.99
835	Guitar preamp.	6.99
840	Delay car alarm	
875	C.A.P. Discharge ignition for car engine	13.99
-80	Scope Calibrator	2.65
255	Level Indicator	6.98
525	120-160mHz VHF timer	11.31
715	Photo cell switch	8.87
795	Electronic continuity tester	4.97
680	Photo timer	15.81
235	Acoustic Alarm for driver	8.61
465	Quartz XTAL checker	9.90

MULLARD FM MODULES  
 LP1186 Tuning Heat Module Price £9.00 pair  
 LP1195 IF Module complete with P.I.V. FM TUNER MODULE Price £9.00 pair  
 FM 5231 12V FM Tuner £7.95  
 SD1912 Stereo Decoder £7.95  
 SF62H 6V Stereo FM Tuner £14.95

ALL KITS OFFERED SUBJECT TO STOCK AVAILABILITY  
 Prices correct at time of preparation. Subject to change without notice.

## EXCLUSIVE SPECIAL OFFERS

MW/LW CAR RADIO	£1.90
TRUCK CAR STEREO	£2.25
PORTABLE BATTERY CASSETTE TAPE	£7.25
CAR LOOPER PLUS AND ADAPTOR	£1.95
NOTE STEREOPHONES	£4.14
RH430	£0.80
RH430	£10.25
HOTEL RA310	£34.52
AKAI EX40	£69.85
W/1150	£12.75
HANIMAX SC808 POCKET CALCULATOR WITH KEY	£28.95
HANIMAX BC111M	£33.75
HANIMAX H101 STEREO COMPACT RECORD PLAYER	£38.95

## NEW RANGES BRIDGE RECTIFIERS

250mA QUARTER AMP		
BO25/05 50 PIV 18p	2 AMPS P.I.V.	
BO25/10 100 PIV 18p	B2/10 100v 40p	
BO25/20 200 PIV 25p	B2/20 200v 45p	
BO25/50 500 PIV 55p	B2/50 500v 50p	
BO25/100 1000 PIV 55p	B2/100 1000v 55p	
1 AMP P.I.V.		
B1/05 50v 25p	4 AMPS P.I.V.	
B1/10 100v 25p	B4/100 100v 55p	
B1/20 200v 25p	B4/200 200v 59p	
B1/50 500v 30p	B4/400 400v 75p	
B1/100 1000v 30p	B4/600 600v 75p	
B1/200 2000v 30p	B4/800 800v 75p	
1 AMP P.I.V.		
W01 50v 25p	6 AMPS P.I.V.	
W02 100v 30p	B6/100 100v 70p	
W05 500v 35p	B6/200 200v 80p	
W05 1000v 35p	B6/400 400v 90p	
W05 2000v 35p	B6/600 600v £1.90	

All prices correct at time of press. 10% VAT to be added to all orders (UK only) Export & UK Manufacturers Colleges supplied. E. & E.

## FREE BOOKLET

All types of Transistors—Bridges Rectifiers—Bridges SCR's—Triacs Integrated Circuits F.E.T.—Light Devices OVER 1500 DIFFERENT DEVICES ENTIRELY NEW 1973 EDITION More Devices ★ New Prices ★ New Ranges ★ This is a must for all Semi-conductor Users. (Ask for booklet No. 36.) SEND FOR YOUR FREE COPY TODAY

TBA805 WATT P.I.C.	£1.90
STROBE TUBE	£2.50
ZFT 4	£3.50
ZFT 8	£4.00
ULTRASONIC TRANSDUCERS	£5.90
SINCLAIR IC12	£2.00
ZN414 IC	£1.70
TIL209 LED	£2.20

WORLD YOURSELF A POCKET CALCULATOR

A complete kit, packaged in a poly-styrene container and taking about 3 hours to assemble—this is the Sinclair Cambridge pocket calculator from Henry's. Some of the many features include Interface chip, ink-film resistor pack, printed circuit board, electronic components pack. Size 4 1/2" long x 2" wide x 3/8" deep. Free of charge with the kit for the more advanced technologist is a 32-page booklet explaining how to calculate Logs, Tangents, Sines etc. SPECIAL OFFER £19.95 + VAT. Also available assembled ready to use £19.9



# Henry's

**DON'T RELY ON YOUR MEMORY  
BUY NOW AT BARGAIN PRICES**  
Hi Fi and Transistors - Up to date  
Brochures on request

**HENRY'S  
CATALOGUE**  
Due to rapid price changes,  
shortages of paper and raw  
materials, all prices in the  
existing catalogues no longer  
apply. Call or phone for latest  
prices. A new catalogue will  
be available for Aug/Sept. 1974.



Now built and used by thousands of satisfied customers. Features slim design overall size in cabinet 151x21x51/2 6 IC's, 10 transistors, stabilisers, Gardners low field transformer, Fibre Glass PC Panel, complete chassis work. Now available built and tested as well as in kit form, HIGH QUALITY AND STABILITY ARE PRE-DOMINANT FEATURES - DEVELOPED BY TEXAS ENGINEERS FOR PERFORMANCE, RELIABILITY AND EASE OF CONSTRUCTION. FACILITIES:

On/off switch Indicator, headphones socket, separate treble, bass, volume and balance controls, scratch and rumble filters, mono/stereo switch, Input selector; Mag. P.U. Radio Tuner, Aux. Can be altered for Mic, Tape, Tape-head, etc. Constructional details Ref. No. 21 30p. Distributed by Henry's throughout UK.

FREE—Teak cabinet with complete kit.  
**KIT PRICE £28.50**  
(+VAT+50p carr/packing) or built and tested £35.00 (+VAT+50p carr/packing) as illustrated.

## BUILD THE TEXAN

**20 + 20 WATT IC  
STEREO AMPLIFIER**  
As featured by Practical Wireless 1972

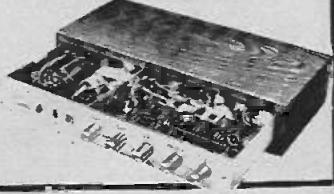

## BUILD THE NEW HENELEC STEREO FM TUNER

A completely new high stability stereo FM tuner. Features variable capacity diode tuning, stabiliser power supply, IC Decoder, high gain low noise, IF stages, LED indicators, Tuning meter, AFC, easy to construct and use. Mains operated. Slim modern design with fibre glass PC, teak cabinet etc. Available as a kit to build or ready built. Overall size 8" x 2 1/2" x 6 1/2". Produced to give high performance with a realistic price. (Parts list and constructional details Ref. No. 5 30p). Henry's are sole distributors UK and Europe.

Kit price  
**£21.00 (+ VAT)**  
OR BUILT AND TESTED £24.95 (+ VAT)

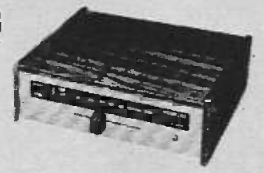

### EARN YOURSELF EASY MONEY, WITH PORTABLE DISCO EQUIPMENT

- DISCO MINI A complete portable disco, fitted mixer/preamp, 2 decks all facilities **£98.50**
- As above but with Slider Controls **£118.50**
- 100 watt amplifier for above **£49.50**
- SOLS 100 100 watt mixer/amplifier with slider controls **£89.00**
- R50 50 watt mixer/amplifier **£69.00**
- R100 100 watt mixer/amplifier **£67.50**
- DISCO AMP 100 watt mixer/amplifier chassis unit **£73.00**
- NORTHCOURT
- Disco Amp: 100 watt mixer/amplifier **£73.00**
- 400 40 watt mixer/amplifier **£37.50**
- 800 80 watt mixer/amplifier **£45.00**
- DISCO MIXER/PREAMPLIFIERS (OP for up to 6-100 watt amplifiers)
- SDII (rotary controls) **£49.50**
- SDIII (slider controls) **£58.50**
- DISCO VOX (slider controls) the complete disco preamp **£72.00**
- DJ100 100 watt power amplifier for above **£49.50**
- DJ30L 3 channel 3kw sound to light Carlsbro reverberation unit **£41.25**
- Disco anti-feedback microphone **£44.00**
- Coil 150 watt liquid wheel projector **£11.95**
- 150 watt QI liquid wheel projector **£25.50**
- 150 watt QI cassette wheel projector **£50.00**
- Spare Effects and liquid cassettes large range of patterns **£6.00**

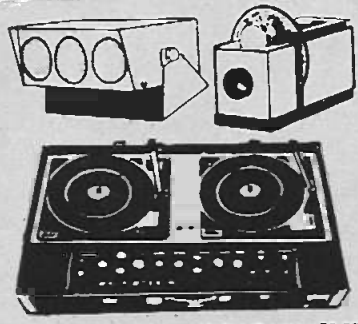

6" Liquid wheels **£5.50** Various Cassettes **£6.00**  
Mini spot bank fitted 3 lamps **£12.95**  
Auto Filire (mini with flashers) **£17.00**  
Bubblemaster with 1 call, Liquid **£22.50**  
Mixer/Misc/Speakers/Lighting UK's largest range.  
FREE stock list ref. No. 18 on request.  
AKG/Realo/DJ/Carlsbro/Eagle Mics, Stands, Mixers, Cabinets Chassis & complete speaker systems, megaphones, turntables, Public Address Components.

### EXCLUSIVE DECCA KELLY SPEAKERS

12 watt speaker Tweeter systems, 8" Bass/Midrobe and Melinex Domed HF radiator plus cross-over **£12.50** per pair of systems (carr/packg 40p) or built into veneered cabinets, size 18x12x6 1/2" **£19.50** pair (carr £1).

### HI-FI TAPE EQUIPMENT

UK's largest range with discounts and demonstrations for callers. Latest stock lists on request (Ref No. 17). Phone 01-402 4736 for Barclay/Access Card. Direct orders and latest prices.

### ELECTRONIC SUPPLIES

UK's largest range for every application. Small quantity discounts. Also Trade, Export and Industrial enquiries invited. Latest stock list (ref No. 36). Including valves on request.

### TRANSISTORS/ SEMICONDUCTORS

Specialists in electronics for more than 30 years. Trade and industry supplies - every type of component and equipment.

### MINIATURE AMPLIFIERS

- AMPLIFIERS (carr. etc. 20p).
- 4.300, 0.3 watt 9 volt **£1.75**
- 104, 1 watt 9 volt **£3.10**
- 304, 3 watt 9 volt **£3.95**
- 555, 3 watt 12 volt **£4.10**
- E1208, 5 watt 12 volt **£5.10**
- 608, 10 watt 24 volt **£4.10**
- 410, 10 watt 28 volt **£4.95**
- E1206, 30 watt 45 volt **£8.95**
- E1210, 2 1/2 + 2 1/2 watts 12 volt **£8.25**
- RE500, 5 watt IC mains operated amplifier with controls **£6.30**
- SAC14, 7.4 + 7 watt Stereo with controls **£11.75**
- SAC15, 15 + 15 watt Stereo with controls **£14.95**
- SP40-5 2Z40/Stereo 80/PZ5 **£25.00**
- SP40-6 2Z40/Stereo 80/PZ6 **£27.75**
- SP60 2Z60/Stereo 80/PZB **£30.45**
- Transformer PZB **£3.95**

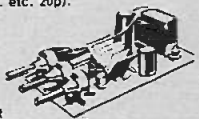

### POWER SUPPLIES FOR EVERY PURPOSE

- (All cased unless stated chassis)
- 470C 67/1/9 volt 300 MA (includes Tape Recorders, etc.) **£12.25** post 20p
  - Car Lighter Voltage Adaptors 300mA (State voltage 6v, 7 1/2v, 9v) **£1.95** ea. post 25p
  - SC202 3/67/1/9 volt 400mA **£4.25** carr. 30p
  - HC244R Stabilised version **£5.50** carr. 30p
  - P500 9 volt 500mA **£3.20** post 20p
  - P11 24 volt 500mA (chassis) **£2.90** post 20p
  - P15 26/28 volt 1 amp (chassis) **£2.90** post 20p
  - P1080 12v 1 amp (chassis) **£4.70** post 20p
  - P1081 45v 0.9 amp (chassis) **£7.80** post 20p
  - P12 4 1/2-12 volt 0.4-1 amp **£7.15** post 30p
  - SE101A 3/67/1/2 volt 1 amp (Stab.) **£12.75** post 25p
  - RP164 6/7/1/9/12 1 amp (Stab.) **£13.45** post 30p

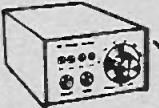

### LOW COST HI-FI SPEAKERS

- SPECIAL OFFERS**  
EMI 13" x 8" - full range speakers (post 20p each or 30p pair)  
\*150TC - 8 ohms Twin Cone 10 watt **£2.20** each or **£4.00** pair.  
\*450 10 watt C/O Twin Tweeters 3, 8 or 15 ohms **£3.85**.  
EW 15 watt 8 ohms C/O Tweeter **£5.25** each or **£7.40** pair.  
350 20 watt C/O Tweeters 8 or 15 ohms **£7.80**.  
\*Polished wood cabinet **£4.80** post 35p.
- SPEAKER KITS (carr. etc. 35p)**
- 20-2 8" 30 watt **£24.50** pair
  - 20-3 8" 40 watt **£35.95** pair
  - LINTON 2 20 watt **£18.30** pair
  - GLENDALE 3 30 watt **£32.95** pair
  - DOVEDALE 3 50 watt **£51.80** pair
  - KEF KK2 **£55.00** pair
  - KEF KK3 **£76.00** pair



### NEW SINCLAIR PROJECT 80

- Stereo PreAmplifier **£11.95**
- Audio Filter Unit **£8.95**
- Z40 15 Watt amplifier **£6.45**
- Z60 Watt Amplifier **£6.95**
- PZ5 Mod. for 1 or 2 Z40 **£4.98**
- PZ6 Mod. (S Tab) 1 or 2 Z40 **£7.98**
- PZ8 Mod. (S Tab) 1 or 2 Z60 **£7.98**
- TRANSFORMER FOR PZ8 **£3.95**
- NEW FM TUNER **£11.95**
- STEREO DECODER **£7.45**

All items post paid.

### GARRARD BATTERY TAPE DECK

GARRARD 2 speed 9 volt tape decks. Fitted record/play and oscillator/Erase heads. Wind and rewind controls. Takes up to 4" spools. Brand new complete with head circuits. **£9.50** carr. 30p.



### SPECIAL PURCHASES

#### UHF TV TUNERS CHANNELS 21 to 64

Brand new transistorised geared tuners for 625 Line Receiver 1F output. **£2.50** Post 20p



All types offered subject to availability. Prices correct at time of proof. Subject to change without notice. E & O. E. 10% VAT to be added to all orders. Export supplied.

### FIBRE OPTICS

0.01 Diam. Mono Filament **£5.50** per 100 metre reel  
0.13 Diam. 64 Fibres Sheathed **£1.00** per metre  
SPRAYS 15mm Diam. Mares Talls **£10.50**

### TOP QUALITY SLIDER CONTROLS

60mm size high quality controls complete with knobs (post, etc. 15p any quantity).  
Single Leg and Lin. 5k, 10k, 22k, 50k, 100k, 250k, 500k, 1 Meg, 48p each.  
Camped Leg and Lin 10k, 22k, 50k, 100k, 250k, 68p each.  
(Quantity discounts available. Complete with knobs.)

### MARRIOTT TAPES HEADS

4 TRACK MONO or 2 TRACK STEREO. 17 High Impedance **£2.80**. 18 Medium Impedance **£3.80**. 38 Medium Impedance **£8.00**. R730/E73 2 track mono Record/Erase low Imp. 75p pair.  
Erase Heads for 17" and 18" and 18" **£1.00**. 63 2 track mono. Hi Imp. **£1.75**. 43 Erase Head for 63" 75p. (Post, etc. 15p any quantity).

### TEST EQUIPMENT MULTIMETERS (carr. etc. 30p)

- M210 20K/Volt Slimline **£5.95**.
- M210 (Case £1.26) 20K/Volt Slimline **£6.75**. TLH33D 2K/Volt Robust **£7.80**. AF105 (Case £1.90) 50K/Volt **£12.50**. U4313 20K/Volt AC current. Steel case **£10.50**. U4341 Plus Built in transistor tester **£10.50**. Model 500 30K/Volt **£11.75**.



### OTHER EQUIPMENT

- SE 250B Pocket Signal Injector **£2.25** carr. 15p.
- TE15 Grid Dip meter 40kHz-280MHz **£16.50** carr. 30p.
- TE40 AC Millivoltmeter 1-2mHz **£19.75** carr. 35p.
- TE65 28 Range valve voltmeter **£22.50** carr. 40p.
- TE20D 120kHz 500mHz RF Generator **£18.95** carr. 40p.
- TE22D 20Hz-200kHz Audio Generator **£19.95** carr. 40p.
- SE350A Deluxe Signal Tracer **£12.95** carr. 20p.
- SE400 Volt/ohms/R-C sub/RF field/RF gen. **£15.50** carr. 20p.

### SUPER TESTER 680R - The complete testing system

Volts AC - 11 ranges from 2V to 2500V  
Volts DC - 13 ranges from 100mV to 2KV  
Amp DC - 12 ranges from 500A to 10A  
Amp AC - 10 ranges from 200A to 5A  
Ohms - 6 ranges from one tenth of Ohm to 100M  
Resistance - 1 range from 0 to 10M  
Capacity - 6 ranges from 0 to 500pF and from 0 to 0.5uF and from 0 to 50.000pF  
Frequency - 2 ranges from 0 to 500Hz and from 0 to 500KHz  
Output Voltage - 9 ranges 10V to 2500V  
Oscilloscope - 10 ranges from -24 to 70dB



price  
**£18.50**

### Accessories

- Transistor tester **£11.00**
- Electronic voltmeter **£18.00**
- Amplifier **£11.95**
- Temperature probe **£11.95**
- Guage meter **£11.95**
- Signal injector **£3.95**
- Phase Sequence **£5.95**
- EMT Probe **£6.95**
- Shunts **£4.50** each
- 25/50/100A

# Henry's RADIO LIMITED

EDGWARE ROAD, LONDON W2

404-406 Electronic Components and Equipment 01-402 8381  
309 PA - Disco Lighting High Power Sound 01-723 6963  
303 Bargains Store (Callers only)  
Home and Car Entertainment Centres London and branches now open  
120 Shaftesbury Avenue, London W1 01-437 9692  
144 Burnt Oak Broadway, Burnt Oak, Edgware 01-952 7402  
190-194 Station Road, Harrow, Middlesex 01-663 7788/9  
354-356 Edgware Road, London W2 01-402 5854/4736

All mail to  
303 Edgware Road,  
London W2 1BW  
All stores open 9 am to  
6 pm six days a week  
Hi-Fi - Tape Equipment  
Discount Stock List  
Free at all stores

# MUSIC

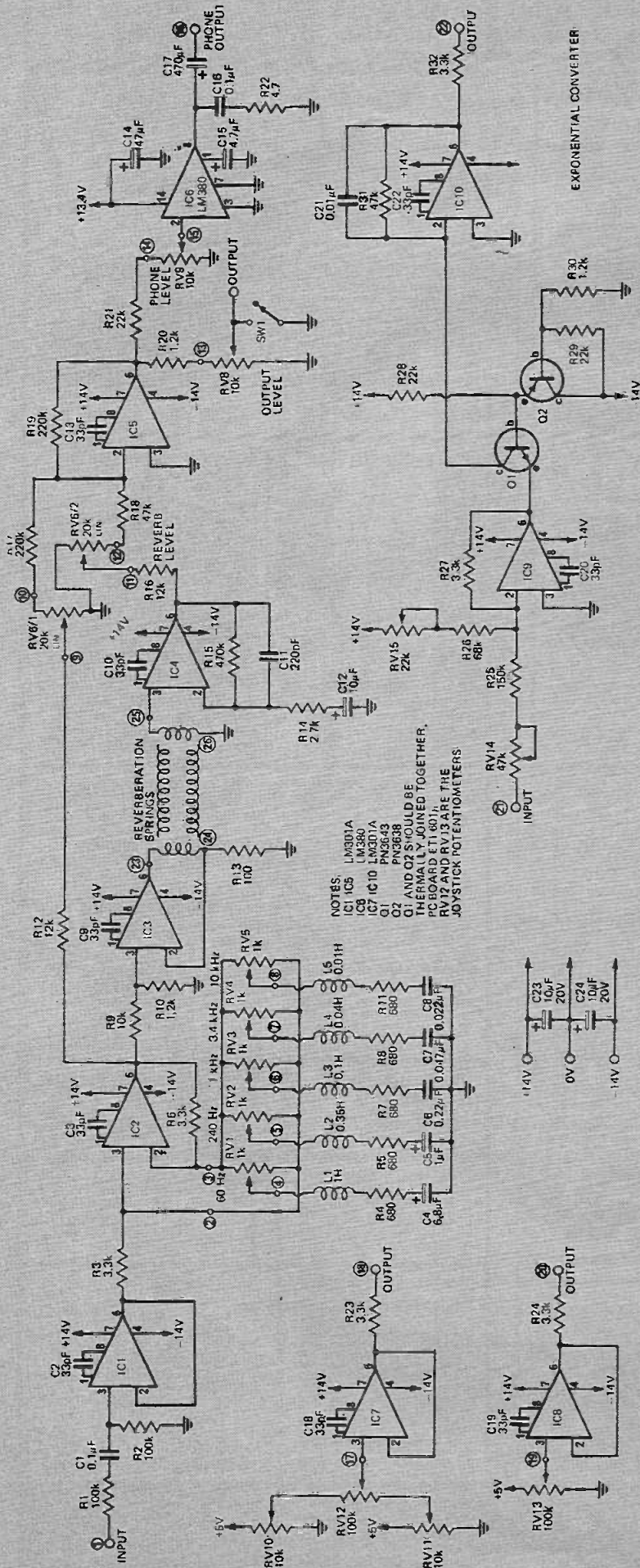

Fig. 1. Circuit diagram of the complete output stage, equalizer and exponential converter etc.

IN THIS issue we describe the output module which contains the equalizer, reverberation and output amplifiers as well as the joystick control buffers and an exponential converter.

## CONSTRUCTION

The same procedure should be followed as previously described for other modules. Assemble the printed circuit board in accordance with the component overlay, Fig. 2., taking care with the orientation of polarized components. Wire the potentiometers and switches in accordance with Fig. 3.

## CALIBRATION

The exponential converter is the only section of the circuitry that requires calibration. This should be carried out by applying 0V to the input and adjusting RV15 to obtain 0.156V, and then by applying 5 volts to the input and adjusting RV14 to obtain 5 volts output. The 0V input should then be rechecked and the input/output relationship detailed in Table 1 should then exist. This characteristic ensures that a 1 volt change in input voltage will produce an output that, when applied to an oscillator or filter, will change its frequency by one octave. Thus a 5 volt input range provides a five octave frequency range.

The control range may be extended by reducing the 0.15V output at 0 volt input (R26 may need to be increased to obtain required range) however the 1 volt/octave relationship will no longer apply.

## HOW IT WORKS

### OUTPUT MODULE

This section can be broken into sections as follows.

- INPUT BUFFER
- EQUALIZER
- REVERBERATION
- OUTPUT AMPLIFIER
- HEAD PHONE AMPLIFIER
- JOYSTICK BUFFERS
- EXPONENTIAL CONVERTER

The input buffer (IC1) has a 200 kΩ input impedance and gives an attenuation of 6 dB (1/2). The attenuation is required to prevent clipping in the equalizer output stage.

The output from the buffer is directly coupled to the input of the equalizer stage. This stage is a little unusual, since the equalizing networks are arranged to vary the negative feedback. If we consider one



# INTERNATIONAL SYNTHESIZER

section with the others disconnected, at the resonant frequency of the series LCR combination the impedance of the entire network will be equal to 680 ohms. Either side of resonance the impedance of the network will increase (with a slope dependent on the Q of the network), due to uncancelled inductive reactance above resonance and uncancelled capacitive reactance below resonance. We can therefore represent the equalizer stage with equivalent circuits as reproduced below. These circuits consider only one network is in circuit, the input signal frequency is the resonant frequency of the network, and the resistance of the inductor is negligible.

With the slider of the potentiometer at the top end (Fig. A) we have 680 ohms to the zero volt line from pin 2 of IC2, and a 1 k ohm between pin 3 and pin 2. The IC will act due to the feedback to keep the potential between pins 2 and 3 virtually zero, thus there is zero current through RV1. The voltage on pin 3 (IC2) is therefore equal to the output of the mixer since there is virtually no current through and no voltage drop across R3.

The output of IC2 in this case is approximately the input signal times  $(R6 + 680)/680$  ohms, indicating a gain of about 15 dB. If the slider is at the other end of the potentiometer (Fig. B) the signal appearing at pin 3 and thus also at pin 2 is about 0.2 of the output of the previous stage due to the voltage division of R3 and the 680Ω. There is still zero current through RV1 and also zero current through R6 since there is no path. The output voltage is therefore the same as that at pin 2, which happens to be about 0.2 times the output of the previous stage. The gain is therefore 0.2 - or -13 dB.

With all networks in circuit, the maximum boost and cut will be reduced, but a range of ±10 dB is still available. With the wiper of the potentiometers set midway - Fig. C, the gain will be unity regardless of frequency, due to the symmetry of the entire network.

The equalizer output is attenuated by about 20 dB (0.1) and fed into the reverb driver IC3. The reverb is connected in the feedback of the IC in such a way that the drive is a constant current and not a constant voltage. This drive method provides a more uniform frequency response. Note that both sides of the input drive coil must be isolated from

earth. This is achieved by removing the existing RCA socket and replacing it with an insulated socket making sure that it is completely isolated from the frame.

The output of the reverb unit is a very low amplitude signal which is amplified by IC4. The output of IC4 and the output of the equalizer (IC2) both go to RV6 which selects the percentage of each required.

The final amplifier, IC5, amplifies the output of RV6 and applies it to RV8 which adjusts the output level to the main amplifier. The output of IC5 also goes to the headphone amplifier IC6 (LM380). This IC will supply up to 1.5 watts into either headphones or a small loudspeaker.

The joystick simply supplies two voltages which vary between 0 and +5 V. The horizontal axis has both ends of the control potentiometer adjustable between 0 V and +5 V so that the range can be reduced or even reversed. Buffer amplifiers IC7 and IC8 prevent loading of the control potentiometers.

The exponential converter consists of IC9, Q1, Q2 and IC10. The input signal is inverted and attenuated by IC9. Potentiometer RV14 adjusts the gain and RV15 provides the required offset. The exponential relationship between the base-emitter voltage and collector current of a transistor (Q1) is used to provide the required law. Transistor Q2 provides temperature compensation. Note that Q1 and Q2 must be glued together to provide intimate thermal contact (see photograph). The collector current of Q1 is converted into a proportional voltage thus providing the input/output relationship detailed in Table 1.

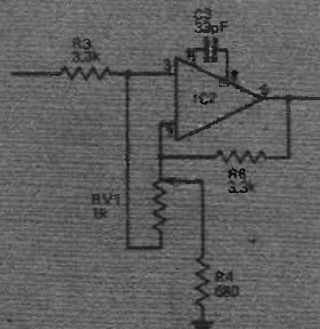

Fig. A. Equivalent circuit of the equalizer with potentiometer set for maximum boost at the resonant frequency of the network.

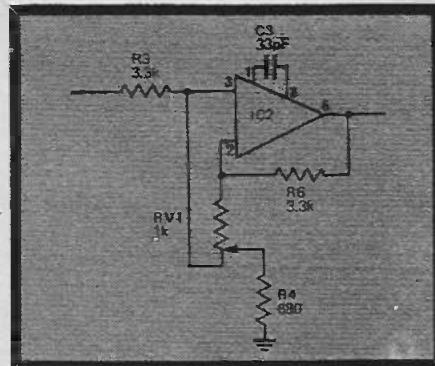

Fig. B. Equivalent circuit of the equalizer with the potentiometer set for maximum cut at the resonant frequency of the network.

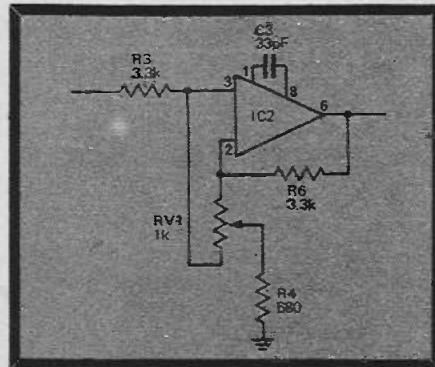
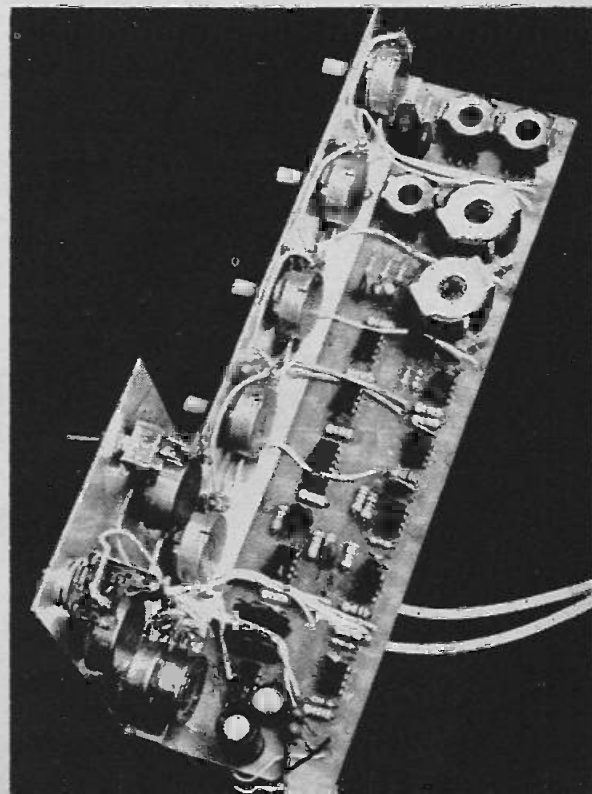

Fig. C. Equivalent circuit of the equalizer with the potentiometer set for unity gain regardless of frequency.

The output module.



# INTERNATIONAL MUSIC SYNTHESIZER

## PARTS LIST OUTPUT STAGE

R22,	Resistor	4.7k	1/4W	5%
R13	"	100k	"	"
R4,5,7,8,11	"	680Ω	"	"
R10,20,30	"	1.2k	"	"
R14	"	2.7k	"	"
R3,6,23	"	3.3k	"	"
R24,27,32	"	3.3k	"	"
R9	"	10k	"	"
R12,16	"	12k	"	"
R21,28,29	"	22k	"	"
R18,31	"	47k	"	"
R26	"	68k	"	"
R1,2	"	100k	"	"
R25	"	150k	"	"
R17,19	"	220k	"	"
R15	"	470k	"	"
RV1-5	Potentiometer	1k	lin rotary	
RV6	"	20k	dual lin rotary	
RV8,9	"	10k	log rotary	
RV10,11	"	10k	lin rotary	
RV12,13	"	special 100k	joystick	
RV14	"	47k	trim	
RV15	"	22k	trim	
C2,3,9	Capacitor	33F	Ceramic	
C10,13,18	"	33F	"	
C19,20,22	"	33F	"	
C11	"	220pF	"	
C21	"	0.01μF	Polyester	
C8	"	0.022μF	"	
C7	"	0.047μF	"	
C1,16	"	0.1μF	"	
C6	"	0.22μF	"	
C5	"	1μF	35V PC electrolytic	
C15	"	4.7μF	25V	"
C4	"	6.8μF	20V	"
C12,23,24	"	10μF	20V	"
C14	"	47μF	20V	"
C17	"	470μF	10V	"
IC1-5	Integrated circuit	LM301A	miniclip	
IC7-10	"	LM301A	"	
IC6	"	LM380	14 pin DIL	
Q1	Transistor	PN3643		
Q2	"	PN3638		
L1	Choke	1H		
L2	"	0.35H		
L3	"	100mH		
L4	"	40mH		
L5	"	10mH		

Reverb spring unit — see note on next page.  
Metal bracket to Fig  
SW1 toggle switch SPST  
6.5 mm phone socket.

## TABLE 1. CALIBRATION EXPONENTIAL CONVERTER

INPUT	OUTPUT
0V	0.15625V *
1V	0.3125V
2V	0.625V
3V	1.25V
4V	2.5V
5V	5V **
6V	10V

\* adjust RV15 with 0V input to obtain 0.156V output.

\*\* adjust RV14 with 5V input to obtain 5V output

(note that these adjustments must be done in the above sequence).

## TABLE 2. WINDING DATA EQUALIZER CHOKES

L1 1000 turns, 38 s.w.g.	Ferrite Core	Mullard	LA4543
	Former	Mullard	DT2534
	Clip (2 required)	Mullard	DT2406

L2 585 turns, 36 s.w.g.  
Core, former and clips as L1

L3 460 turns, 38 s.w.g.	Ferrite Core	Mullard	LA4345
	Former	Mullard	DT2470
	Clip (2 required)	Mullard	DT2396

L4 300 turns, 38 s.w.g.  
Core, former and clips as L3

L5 150 turns, 36 s.w.g.  
Core, former and clips.

The Mullard cores, formers and clips mentioned above are all available from Maplin Supplies.

## ERRATA

Music Synthesizer. June 1974. Parts List — Voltage Controlled Filter. 7th line should read R12, 13, 16 not R7, 8, 14 as shown.

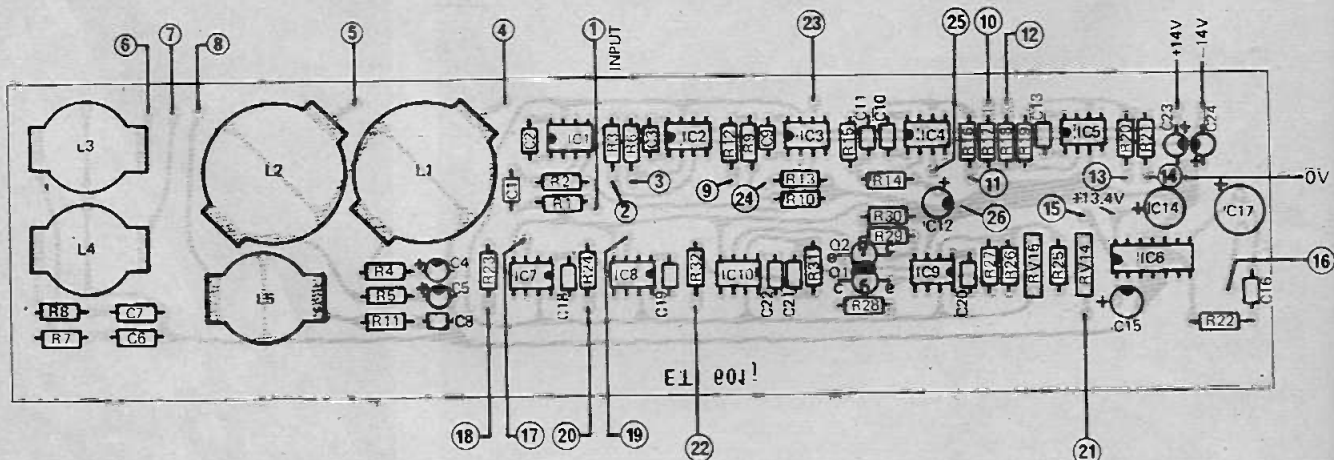
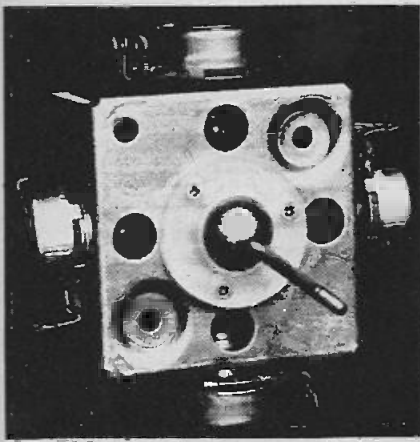

Fig.2. Component overlay for the output module.





The Joystick potentiometer. There are currently problems in the supply of the component used in the prototype. A suitable alternative will shortly be available from Maplin Supplies.

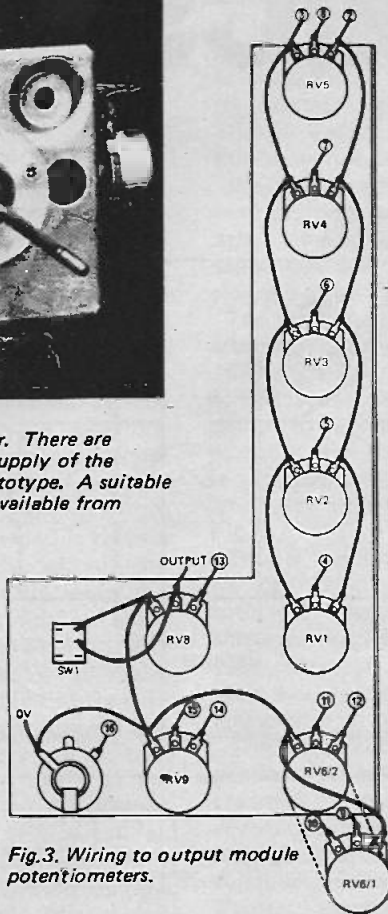

Fig.3. Wiring to output module potentiometers.

ALL DIMENSIONS ARE IN MILLIMETRES

MATERIAL 18 GAUGE ALUMINIUM OR STEEL

- 9 HOLES 9.6 mm DIA.
- 1 HOLE 6.4 mm DIA.
- ⊙ 2 HOLES 4 mm DIA.

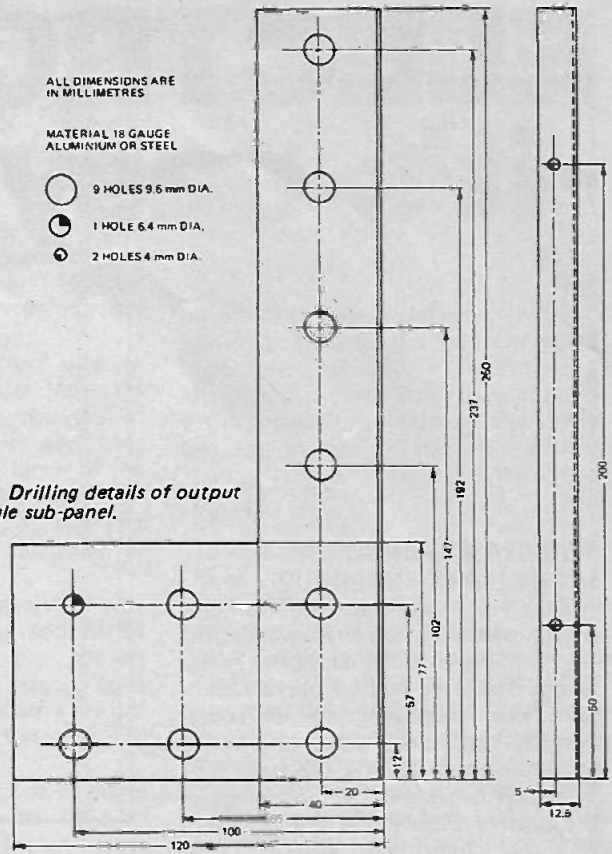
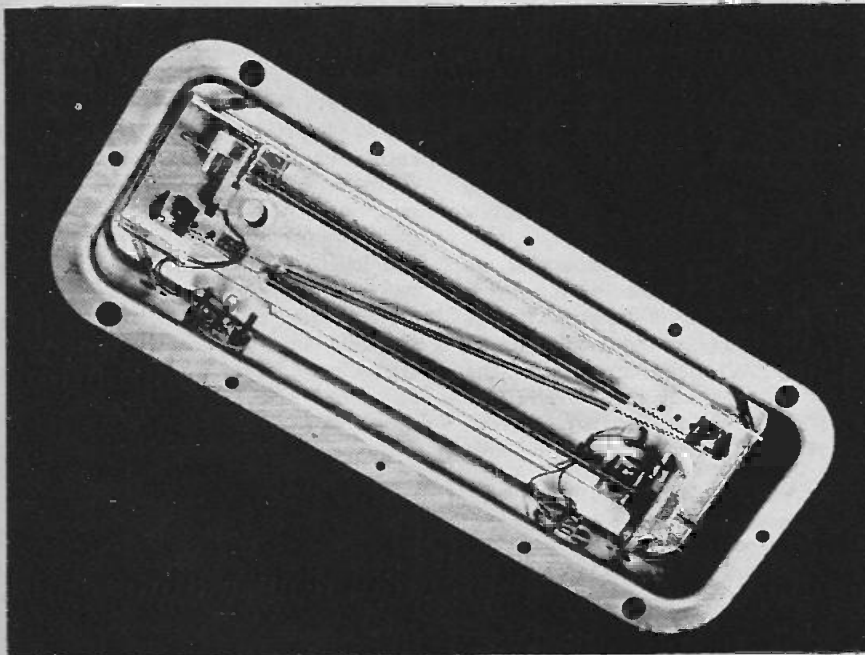

Fig.4. Drilling details of output module sub-panel.

Next month we plan to publish a complete set of full-sized p.c. board patterns for those who wish to make their own boards.

These patterns will vary slightly from those being supplied by Maplin who have modified the boards to suit the specific components that they supply.



Interior of a typical spring line reverb unit. If one with an input impedance of over  $200\Omega$  is used, no circuit mods are necessary. However the more common, low impedance types which Maplin are supplying require a preamplifier to drive the unit. This company is supplying a modification circuit which is allowed for on the PCRs that they supply.

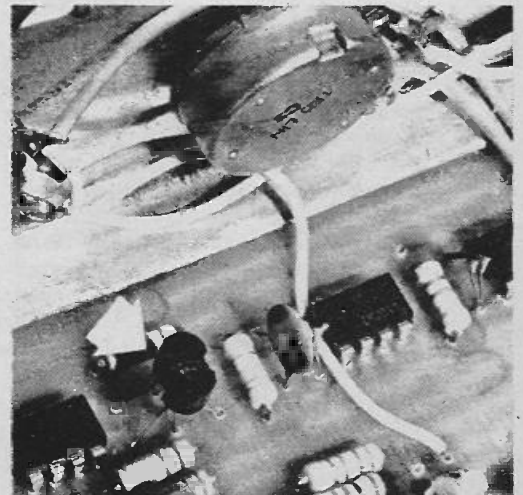

The exponential converter transistors Q1 and Q2 (arrowed) are glued together to ensure thermal balance.

# ELECTRONICS -it's easy!

We will now take a look at the forms of signals that can be used to convey information — leaving the actual circuits used until late in the course when we have developed some mastery of the workings of components and sub-systems.

## TWO CLASSES OF SIGNAL — DIGITAL AND ANALOGUE

Take a look at Fig. 1. The person operating the key-switch at the transmitting end can cause the device at the receiving end to operate, thus conveying something to the other person. What he has done, in effect, is to set a current flowing, the magnitude of which is decided by the voltage of the battery supply and the resistance of the indicating device. (The resistance of the cable is assumed to be negligible here, but in practice it must be considered, especially when distances run to many kilometres).

But as shown in Fig. 1, no matter how the switch is closed, it can only provide an ON or OFF action. If the sender repetitively opened and closed the key the current amplitude/time graph would look like that shown in Fig. 2. Note there can be no currents in the circuit between the on and off values.

As this kind of signal has only certain *discrete* values we call it a DIGITAL signal, this word originating from the Latin word for 'finger'. The type of electronic circuit that generates these signals is known as a SWITCHING circuit.

It is convenient here to point out why apparently wasteful resistance is actually so useful in electronics. In the example of Fig. 1, the resistance of the bell or light converts the flowing energy into a useful signalling effect.

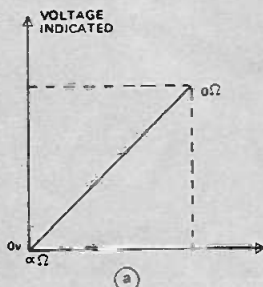
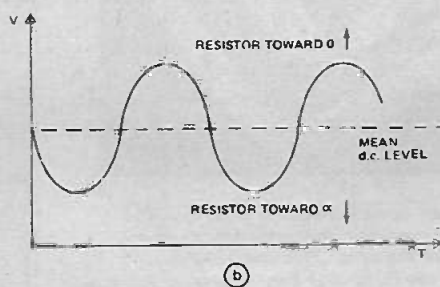

Fig. 4. Circuits with continuously varying current levels are called analogue circuits. (a) A linear ramp



(b) A sine wave.

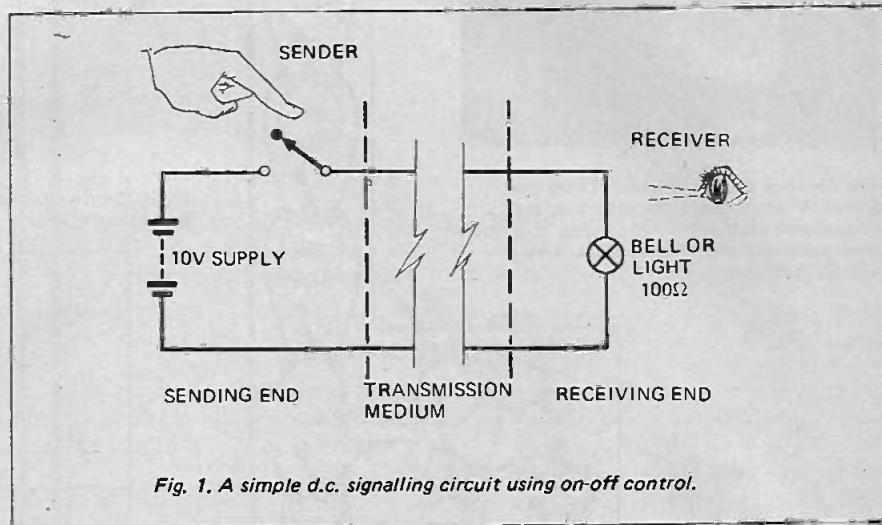

Fig. 1. A simple d.c. signalling circuit using on-off control.

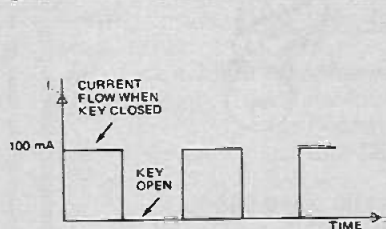

Fig. 2. Amplitude-time graph of current in a switching circuit.

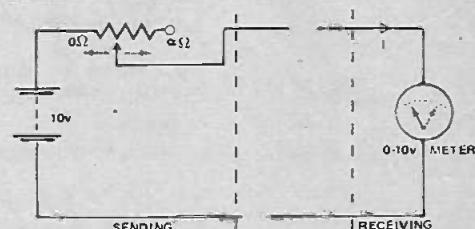

Fig. 3. A simple d.c. signalling circuit using variable current control.

Without resistance there could be no signal generated at the receiving end. Too little resistance in the device would lead to an enormous current flowing uniformly in the wires; too high a resistance in the device would not provide enough energy to produce the desired indication.

Consider now what happens if we remove the key, replacing it with a variable resistor, as is shown in Fig. 3. Further, at the receiving end we put an indicating volt-meter instead of the bell or light. As the sender varies the *resistance* in the circuit, the current also varies in accordance with Ohm's

Law. When the variable resistor is set maximum value, (infinity in our example), no current flows, and so the meter registers zero volts. As the resistance is reduced by the sender the current increases, and the meter reading increases accordingly. Finally, at minimum resistance, current reaches the level at which the meter pointer reads full-scale.

Thus the signal varies *smoothly*, without any evidence of the rapid transitions that we saw in the switching circuit (unless the sender produces them by very fast changes of the resistance). This form of signal is

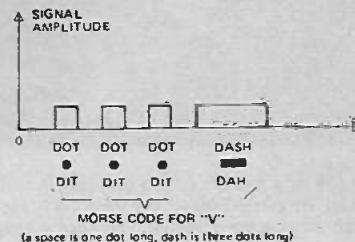

Fig. 5. Amplitude-time graph of Morse code letter V as produced by keying a d.c. circuit.



called an ANALOGUE signal.

It is not possible to uniquely define how this signal would look as time varies (as we did for the switching case), for this depends entirely on the sender. If, for example, the resistor is varied uniformly from maximum to zero a ramp signal is produced as shown in Fig. 4a. It can also be seen that a sine wave can be generated (Fig. 4b) if the resistor is first set to give half-voltage and is then moved back and forth with the appropriate time-resistance relationship. The analogue circuit can be used to produce switching action by very rapid movement, but a digital circuit cannot be used to obtain analogue behaviour (at least not without additional additional circuits — as we will see later in the course.)

The resistance of the circuit plays a vital part in the production of the analogue signals, especially when the value can be made to vary by some means or other. We will see later that the well-known transistor is really little more than a variable resistor — in which the current passing through it is controlled by another current fed to it in another terminal — much in the same fashion as a policeman controlling traffic flow at an intersection in a one-way street.

The next point to consider is how the two forms of signal (digital and analogue) convey information.

## INFORMATION IN DIGITAL SIGNALS

Digital signals can only exist at discrete set levels ... a desk calendar for instance is essentially a digital device. It either is Feb 17th — or it isn't. It shows no intermediate stages, such as Feb 17.75th!

By contrast, a conventional watch or clock is an analogue device, in that the passage of time is indicated as a smooth progression of the hands around a dial.

The most basic electronic device for generating a digital signal is a switch. It is either ON or OFF, there are two, and *only* two, possible states.

There are many other devices and circuits (described later) which have only two unique states, and these are known collectively as Binary (meaning two state) devices.

These binary devices form the basis of digital electronics, the digital computer being the most outstanding example, where many thousands or even millions of binary devices are used in combination to perform amazing tasks.

Let us examine how information may be transmitted with a keyed (switched) system such as shown in Fig. 1. Here the light is either ON or

OFF. This means that the sender can only signal one piece (we call it a bit) of information at a time ... Come when the light goes on, etc., the only information that is actually transmitted is that the key is closed. That is, we must *assign a meaning* to this bit of information.

We can however, send the same signal two or more times in sequence and assign meanings to the individual sequences. We can also make our key closures of varying duration.

The first man to construct such an arbitrary code was Samuel Morse in 1837. His code was constructed of agreed sequences of short and long dashes to represent each letter of the alphabet. For example the letter V is represented by dot, dot, dot, dash; its amplitude time graph is illustrated in Fig. 5.

Thus by sending series of such groups we can build up words and hence complete messages in any spoken language. (In computing jargon, each such *group* of bits is called a 'word' even though it may not correspond to any spoken word.)

The Morse code is only one of many possible codes that can be used to transmit information. Many other communication codes are in use, each having unique characteristics most suitable to a particular purpose. Typical examples are the Baudot, ASCII, Selectric and Hollerith codes — to quote just a few in general use.

These codes differ from Morse in that they use groups of pulses (all having the same length) and are based on variations of a fundamental counting system known as the Binary code which we shall now examine.

We normally do all our mathematics (adding, multiplying etc) in a system based on the number 10. For example the number 1285 equals:—

$$\begin{array}{r} 1 \times 10^3 = 1000 \\ + 2 \times 10^2 = 200 \\ + 8 \times 10^1 = 80 \\ + 5 \times 10^0 = 5 \\ \hline = 1285 \end{array}$$

We don't have to count by tens, we can count by two's, eight's, twelve's or any other base number we wish.

Let us now consider how a system with base 2, (a binary system) works.

If we have one switch it has only two possible states — but what happens if we have a second switch? If we let '0' equal switch position OFF, and '1' as switch position ON we can construct a table of the possible combinations as in Table 1.

From this we can see that adding a second switch gives us four possible combinations ( $2^2$ ). Taking this still further, three switches gives us  $2^3 = 8$  combinations, four switches  $2^4 =$

TABLE 1.

	4	3	2	1	
SW1				0	0
only				1	1
SW1 +			1	0	2
SW2			1	1	3
SW1 + SW2		1	0	0	4
+SW3		1	0	1	5
		1	1	0	6
		1	1	1	7
SW1 + SW2	1	0	0	0	8
+ SW3 +SW4	1	0	0	1	9
	1	0	1	0	10
	1	0	1	1	11
	1	1	0	0	12
	1	1	0	1	13
	1	1	1	0	14
	1	1	1	1	15

16 combinations etc. Thus if we were to use six switches a total of  $2^6 = 128$  combinations would be possible. We can thus use a group of six bits in a binary code sequence to represent the numbers 0 to 9, all the letters of the alphabet (in both capitals and lower case) plus a number of punctuation marks and other symbols or commands we may wish to transmit.

The length of the code word is thus fixed and the sequential groups of bits (words) are separated by a longer than normal space.

The main differences between the various codes are merely the number of bits in the 'word' and the way in which meanings are assigned to the word.

At first sight these binary codes seem to be a dreadfully slow way to transmit information. But remember electronic switches can open and close millions of times a second, so, in practice, we can send information enormously faster using serial binary codes than can a morse code operator.

Further since all the binary bits are the same length and there is the same number in each we can send each word in parallel.

For example, referring to our table, the figure 8 could be sent on four lines by putting a 'one' on line 4 and 'zeroes' on lines 1, 2 and 3. Thus in this case the transmission rate would be four times faster again. However the use of parallel transmission is impractical (due to the number of lines required) except over short distances, eg, within a computer.

## INFORMATION IN ANALOGUE SYSTEMS

Unlike digital signals, that can exist only at discrete levels, the analogue signals can exist at any level between zero and the maximum available.

In theory every minutely different level can be used to represent a specific bit of information, thereby giving us unlimited code capacity at

each instant of time. Practice, however, limits the separation between levels that we can reliably detect because Noise (the name given to unwanted disturbing signals) can add or subtract from the signal at each defined level leading us to wrongly interpret the true intended meaning.

In reality then, there is a limited signalling capability in any analogue signal and the capability depends on the level of unwanted signal entering the system. The noisy signal obtained from a temperature measuring thermometer (Fig. 7), illustrates this.

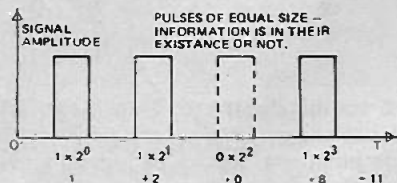

Fig. 6. Sending the number 11 in binary code (digital form of signal).

It tells us how the temperature varied with time but only to a precision limited by the width of the noise superimposed on the record. Within the width of this noise band we cannot say with certainty what the temperature was doing. It may have varied along the mean centre line, it may have varied from the upper to the lower limit or any other way you care to propose. We have no way of knowing what happens when noise swamps the signal.

## MODULATION

We saw in Figs. 3 and 4 how the current in the circuit was varied in accordance with the wishes of the operator: (The wiper contact of the resistor was moved with time to accomplish this.) In the parlance of electronics this process is called modulation; the direct current was modulated to produce ac waveforms. The Morse and the binary code are transmitted by modulating a basic dc current.

Looking at the temperature record in Fig. 7 it can be seen that the original signal is modulated by the noise to produce frequencies that probably did not exist in the true temperature signal. Although detrimental in that instance, this process of adding frequencies to others can be used gainfully to transmit information.

If we start with a continuously generated ac signal (instead of the dc case mentioned above) we can modulate the ac waveform in a similar manner by varying its amplitude or its frequency. Let us look at these modulation methods in a little more detail.

**Amplitude modulation**... this is the name given to the process in which the instantaneous amplitude of a constant frequency wavetrain is varied usually in order to convey information. This is shown in Fig. 8.

The original signal is called the **CARRIER** for it carries the signal

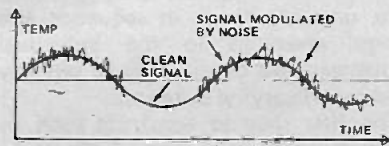

Fig. 7. Resolution of the signal in an analogue circuit is limited by the unwanted noise present with the signal.

information. Amplitude modulation is used extensively in radio transmission, especially the normal broadcasts we are now so familiar with. It is a simple matter to send Morse code over a carrier — the carrier is simply switched on and off to produce short bursts several cycles long. The principle is, however, not confined to radio but finds uses in many other fields of electronics. It is often abbreviated to 'AM'.

**Frequency modulation**... in this type of modulation the amplitude is held constant, and the instantaneous frequency varied instead. The carrier is the same as that for AM to begin with, but after modulation the combined signal has the appearance shown in Fig. 9. (This modulating form is usually known as FM). It is less prone to noise problems than AM but is more expensive to implement, so its use is more restricted than AM systems. No doubt you have heard of FM radio... the broadcasting system that uses frequency modulation to transmit the sound signals.

## WHY MODULATE AN AC CARRIER?

By now you could well be wondering why we go to all this trouble to modulate an ac signal — it needs a special generator to produce the carrier in the first place and special circuits to recover the signal when received.

Why not use a simple battery-powered dc signal and just vary it with a switch or variable resistor?

To answer this question let us consider the problem of transmitting speech over long distances. As we speak we create pressure waves in the air which another person, reasonably close to us, can detect by means of his pressure sensitive ears — but the distance over which this acoustic communication can take place is strictly limited. How can we transmit a

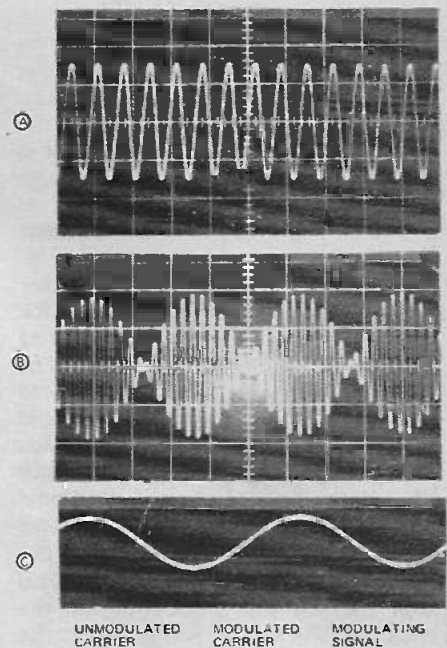

Fig. 8. In amplitude modulation, the amplitude of the a.c. carrier signal is varied, the frequency remaining the same.

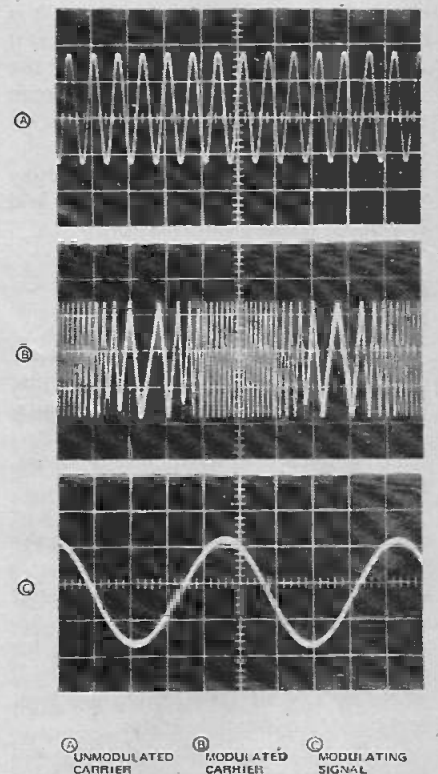

Fig. 9. In frequency modulation, the amplitude of the carrier is held constant, the information signal being used to vary the instantaneous frequency.

spoken message halfway round the world — or even to the moon?

Of course you know that the means is radio; in a radio transmission we modulate a carrier frequency by the amplitude and frequency of the voice. But how does this technique increase transmission distance? The answer lies in the nature of electromagnetic waves.



## ELECTROMAGNETIC WAVES

In a preceding section we told you that when a current flows through a wire there is also an associated magnetic field. In addition where we have two conditions, or charged bodies, insulated from each other and at different potentials, there is an electric field between them.

Thus we can have a magnetic field without an associated electric field and correspondingly an electric field without a magnetic field. However if the fields are *changing it is impossible for either type to exist separately.*

A changing electric-field will produce a magnetic field, and a changing magnetic field will produce an electric field.

This electro-magnetic disturbance, in a similar manner to the ripples caused by a stone thrown into a pond, propagates in all directions.

The remarkable thing about an electromagnetic disturbance is that it propagates at the speed of light and it does not require air, or any other medium, for its propagation.

Hence its ability to travel through the vacuum of free space.

As no-one wants to listen to everything that is broadcast, different carrier frequencies are used for different transmission applications.

The carrier frequencies used depend on the specific application, eg, radio, television, amateur radio, radar etc. All use frequencies, appropriate to the type of modulation, in bands allocated by international agreement. Thus AM radio commercial stations use carriers within the range 550 kHz to 1.5 MHz whilst radar may use frequencies in the 1 to 10 GHz region.

In fact communication systems have used electromagnetic radiation with frequencies from 10 kHz for VLF (very low frequency communications with submarines) to light wave frequencies (by using lasers) in the 100 Terahertz region.

Do not confuse low frequency electromagnetic radiation (eg 20 kHz) with audio at the same frequency. They are entirely different phenomena. Audio needs a medium such as air and propagates in air at around 334 metres per second. Also note that the speed varies, with the medium. By contrast electromagnetic radiation at 20 kHz propagates at  $300 \times 10^6$  metres per second and does not require a transmission medium.

At the receiving end, special circuitry is used to then recover the modulation impressed upon it.

## MULTIPLEXING

Assume that we wished to send four telephone communications over a wire

## ELECTRONICS-it's easy!

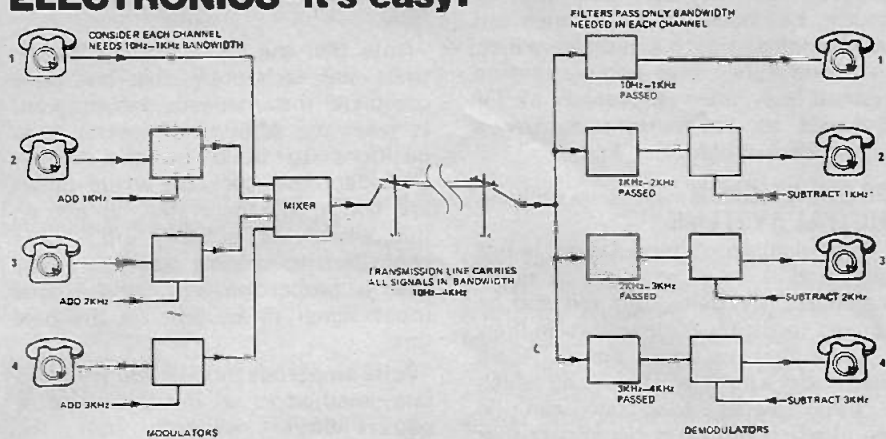

Fig. 10. Frequency multiplexing enables communication channels to be stacked up across the frequency spectrum without interaction between each.

at the same time. The first channel, as shown in Fig. 10, could be sent direct. If we attempted to add the others to the same line the result would be like a party line... if they all spoke together it could become unintelligible and certainly not private. This is overcome by adding the second voice signal to a carrier frequency just higher than any frequency in the first voice channel. This is done by modulation. The other lines are also modified this way placing each voice channel up at a higher frequency than the channel below. Hence the jargon, stacking the channels, for they are being placed across the frequency spectrum, side by side or on top of each other — however you like to visualize it.

For reasonable intelligibility it is necessary to transmit the frequency components of human speech lying, approximately, between 300 Hz and 3300 Hz, i.e. a range of 3000 Hz. This is known as the required BANDWIDTH.

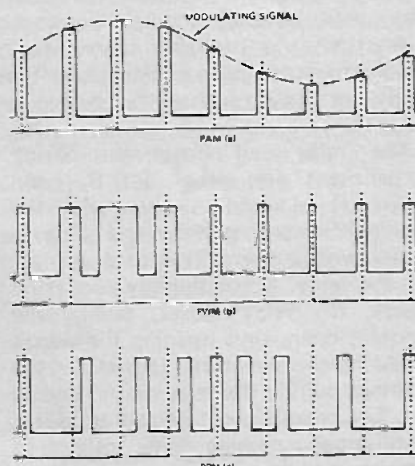

Fig. 11. Modulation of pulse carriers. (a) Pulse amplitude modulation PAM. (b) Pulse width modulation PWM. (c) Pulse position or pulse time modulation PPM or PTM.

Thus the signal in the interconnecting telephone lines may contain frequencies ranging from the lowest in the first (unmodulated) channel, to the highest in the (modulated) fourth channel. Each channel — as we have seen — requires a bandwidth of approximately 3000 Hz, (and it is desirable to separate channels to some extent to prevent overlapping) so that four voice channels will require a total bandwidth of 12 000 Hz (plus channel separation).

In normal telephone line systems however, the number of channels which can be so multiplexed is strictly limited as the total bandwidth that can be handled by a conventional telephone line is seldom much more than about 12 kHz. (Special cables however can handle thousands of channels multiplexed this way).

Having so multiplexed our separate conversations onto one line, it is obviously necessary to separate them at the other end. That is to demultiplex them. This is done by using the special electronic circuits known as filters to select the narrow band of frequencies that constituted each individual carrier. Each channel must then have the modulation recovered from the carrier. This process of demodulation is done for each channel and the recovered audio then fed to the individual telephone subscribers.

Frequency multiplexing is certainly a complicated process for sending information. But it is far less expensive to transmit many information channels this way than it is to keep adding new lines to a global communications system, especially if the lines convey television, or if they run under the sea.

As the electromagnetic frequency spectrum is usable up to at least  $10^{14}$  Hz it will be appreciated that an enormous number of communication channels may be used.

The total frequency spectrum cannot

be crammed into any one line of course, but hundreds of channels can be multiplexed onto a microwave link. In the future, laser communication systems may allow thousands of TV channels to be transmitted over a single beam of light.

## MODULATION IN DIGITAL SYSTEMS

The principle of modulation is not restricted to analogue signal transmission systems, but can also be applied to digital communication links — those that use on-off signals. Again there exist a number of ways by which a basic digital wave-train can be modified to represent signal data that comes in original analogue form.

In our discussion of the transmission of digital codes we saw how a train of pulses could be used to represent all the characters needed for the transmission of messages. In that case, see Fig. 6, the presence, or not, of pulses at certain times indicates the meaning assigned to each data word. It can be seen that the continuously transmitted signal would look like a square-wave train that has pulses missing now and then. This is in fact how signals are sent around inside a digital computer... a square-wave train is generated continuously with a generator (called the clock) and the instruction circuits (called logic) decide which pulses are to be there and which are not, depending upon the code value to be sent.

As said before this method of coding may be used for wire or radio communications and in general is

known as Pulse Code Modulation — PCM.

Note that the pulses are not always there and each pulse does not carry complete instantaneous information: It takes the addition of several pulse positions to build up the 'word'. Consider now, the case where pulses are continually generated, as before, but where we actually alter some characteristic of each pulse, in a way that is proportional to the analogue input signal to be sent on the data link.

Pulse amplitude modulation (PAM) is one method... in this case a square-wave signal has its instantaneous amplitude (of each pulse) varied in accordance with the amplitude of the analogue input signal, as is shown in Fig. 11a.

Pulse width modulation (PWM) is another method... the width of each pulse is varied, the height being held constant and the frequency remaining the same, as is illustrated in Fig. 11b.

Pulse position modulation (PPM)... also called pulse time modulation (PTM)... the remaining available variable is modulated in this. Pulses are identical in height and width but their position is varied within each carrier pulse period. The frequency remains the same, as is shown in Fig. 11c.

The advantage of using pulses to modulate the carrier is mainly that the pulses can be restored (with digital circuits) to their original form as the communication link progresses (in what are called repeaters) thus retaining the quality of the original

signal throughout the transmission. This means less errors are sent for in electronic hardware it is possible to maintain timing accuracy far more easily than amplitude accuracy.

Digital modulation methods are used extensively for data transmission in scientific experiments and equipment. Digital modulation may also be used in normal voice communications by converting the analogue voice and signals into digital form.

Cost, and the extent to which external unwanted noise is able to upset the system usually decides which method is to be preferred for both analogue and digital systems can convey information. Another factor that may influence the decision is the form of the data when derived, or the form needed on receipt. If already in digital form direct transmission of binary code probably would be preferred to converting it to an analogue equivalent and then back again at the receiving end. (Systems sending data derived from sensors are generally called TELEMETRY systems).

This has been a systems introduction to the transmission of data. To understand the design of the black boxes we will need to study many circuits before the operation of the many methods is to be fully comprehended. It has, however, added another significant chapter to the understanding of electronics at the systems level. The principles and terms encountered here are constantly used in electronics. ●

# ELECTRONICS -in practice

THEORY in this issue has been concerned with information transmission — so here are two quite different exercises that will illustrate the concepts.

The first is for those who wish to use the Morse Code, perhaps because they ultimately wish to become one of the world-wide group of radio amateurs, who spend their leisure time building and using radio transmitters and receivers for communication across the globe. A working knowledge of the code also enables you to listen in to the many signals sent in the shortwave band of the radio set.

The first thing that must be done is to learn the dot-dash code sequences used to represent each letter of the alphabet. They are given in Fig. 12. Also given are the accepted codes for punctuation and procedure. When you feel you know the code try yourself out by listening to the signals found as you scan the dial of a good short-wave

radio set. Don't be too discouraged at first. It requires much practice to reach the speeds used by trained operators.

Another, and probably better way, to learn morse is to build yourself a code practice rig such as that shown in Fig. 14.

The relay coil (from the earlier experiment on the L.D.R. and resistors) is wired in series with the operator's sending key and also in series with a normally closed contact of the relay. When the key contact is made, the relay closes, pulling the contact open, thus opening the circuit releasing the armature. This closes the contact pulling the relay on... and so on. The process continuously produces oscillations causing the relay to become a buzzer.

When the relay oscillates in this manner its electrical coil generates a high ac voltage with each swing of the armature. This voltage is sufficient to produce a loud noise in an earpiece.

The 0.005 $\mu$ F capacitor smooths away the harmful peaks of this generated voltage, safeguarding the earpiece. Components in the filter section can be varied as you please to obtain the sort of sound you desire.

The resistor placed in series with the relay coil is provided to reduce the supply voltage to a safe working level. In this mode of use the relay can be provided with a little more than its normal voltage, for the coil is not energised all of the time. Select the resistor that gives the sound you like.

This circuit gives the ardent enthusiast the chance to practice without disturbing the peace of those around (as would be the case if a normal buzzer were used). If necessary the relay can be put into a sound-proof enclosure

## MODULATION

With a working knowledge of dc and ac circuits, signal waveforms, circuit construction, a few basic components



Fig. 12. Sound equivalents of the Morse Code for letters, numbers, punctuation and procedure signals.

A di-dah	S di-di-dit
B dah-di-di-dit	T dah
C dah-di-dah-dit	U di-di-dah
D dah-di-dit	V di-di-di-dah
E dit	W di-dah-dah
F di-di-dah-dit	X dah-di-di-dah
G dah-dah-dit	Y dah-di-dah-dah
H di-di-di-dit	Z dah-dah-di-dit
I di-dit	1 di-dah-dah-dah-dah
J di-dah-dah-dah	2 di-di-dah-dah-dah
K dah-di-dah	3 di-di-di-dah-dah
L di-dah-di-dit	4 di-di-di-di-dah
M dah-dah	5 di-di-di-di-dit
N dah-dit	6 dah-di-di-di-dit
O dah-dah-dah	7 dah-dah-di-di-dit
P di-dah-dah-dit	8 dah-dah-dah-di-dit
Q dah-dah-di-dah	9 dah-dah-dah-dah-dit
R di-dah-dit	0 dah-dah-dah-dah-dah

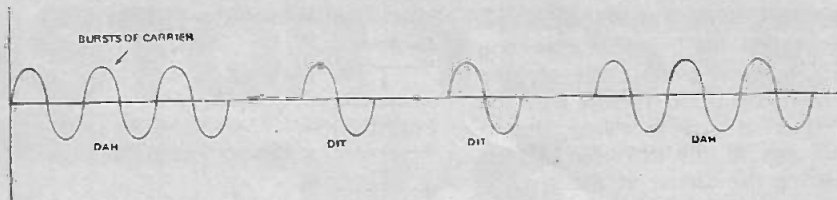

Fig. 13. Morse code sent by radio, travels as bursts of carrier signal. Here is the amplitude-time graph of the letter X.

This particular project will be in several stages adding more on each month.

### SYSTEMS USING AM AND FM TRANSMISSION

To send multiple channels of analogue signal information (that is,

the carrier). The amplitude of the carrier is modulated, the basic frequency remaining the same, before being fed to the transmission line. This set of input equipment is repeated for each channel to be sent but with each carrier different from the others. Only one input is shown in detail. Upon

## ELECTRONICS-in practice

**Punctuation**

*Frequently employed in Amateur Radio*

Question Mark	di-di-dah-dah-di-dit
Full Stop	di-dah-di-dah-di-dah
Comma*	dah-dah-di-di-dah-dah

\*Often used to indicate exclamation mark.

**Procedure Signals**

Stroke	dah-di-di-dah-dit
Break sign (=)	dah-di-di-di-dah
End of Message (+ or AR)	di-dah-di-dah-dit
End of Work (SK)	di-di-di-dah-di-dah
Wait (AS)	di-dah-di-di-dit
Preliminary call (CT)	dah-di-dah-di-dah
Error	di-di-di-di-di-dit
Invitation to transmit (K)	dah-di-dah
KN	dah-di-dah-dah-dit

\* \* \*

One dah should be equal to three di's (dit's).  
 The space between parts of the same letter should be equal to one di (dit).  
 The space between two letters should be equal to three di (dit's).  
 The space between two words should be equal to from five to seven di's (dit's).

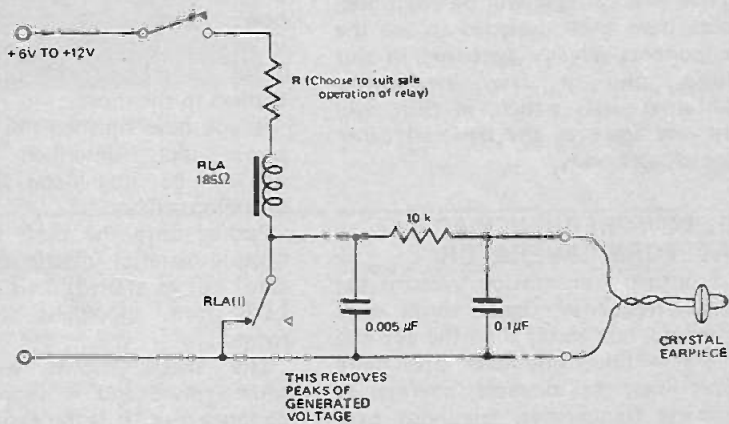

Fig. 14. A simple code practice circuit. The relay acts as a buzzer providing high-voltage a.c. signals in the earpiece.

and proper use of the multimeter, it is now quite realistic for us to tackle a more ambitious experiment. This time, then, the aim is to build an entire system for sending signals by amplitude modulation and, with a few changes, by frequency modulation. In building this system you will develop expertise in mechanical construction, use some new components, and at the same time gain direct practical experience with dc and ac signals.

To some, the project may appear formidable but, remember, even the most complicated systems break down into familiar sub-system black-boxes which are each made up of basic components in basic circuits.

the continuously varying kind which can have all values between certain limits) over a common line we have seen that we need to generate an ac carrier signal and then modulate this in some way adding the original signal frequencies to the carrier. The combined signal is then fed into the common transmission line and sent to the receiving terminal where the modulated signal is demodulated in order to recover the original data.

The system diagram, given in Fig. 15, portrays this procedure for AM working. A power supply provides dc energy to a 'box' that uses this power to produce a steady dc signal having constant amplitude and frequency:

receipt at the receiving end the varying amplitude of the carrier is used to produce a dc voltage that is proportional to the amplitude of the input signal at the sending end.

The FM system looks somewhat similar — see Fig. 16. The differences are that the modulating input is now derived by altering the frequency of the carrier, leaving its amplitude constant. Demodulation, in this case, (methods vary considerably) is achieved by deriving pulses of uniform amplitude and width (constant energy, therefore) and with one being generated for each cycle of carrier signal. These are smoothed by an averaging circuit. The more pulses

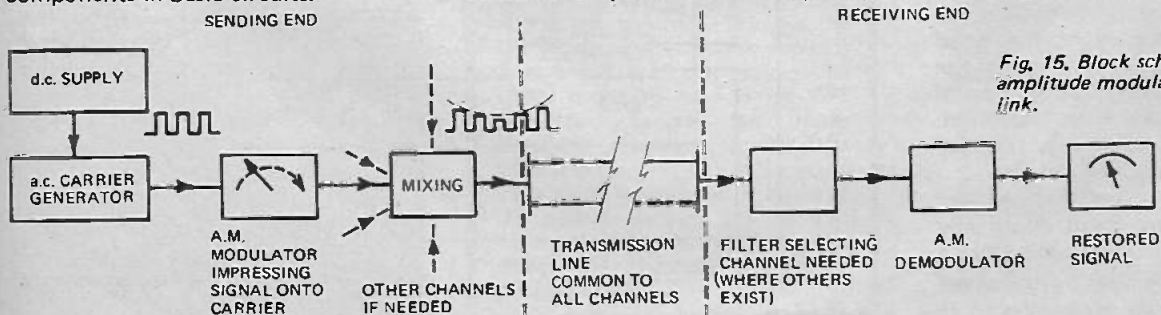

Fig. 15. Block schematic of pulse amplitude modulated communication link.

received in a given time the higher the average signal level, hence a varying frequency signal produces a varying demodulated output. In this way the dc output at the receiving end is proportional to the dc input that is modulating the carrier at the sending end.

When we get to building the complete FM stage (in the next part) we will also add a dc channel to the transmission wire to demonstrate how both the light circuit (shown in Fig. 16) and the data circuit will operate over the same line at the same time without interfering with each other. Thus we will clearly demonstrate the concept of frequency multiplexing wherein signal channels are 'stacked'.

This month we detail how to build the generator and modulating devices. In the next article in this series the rest of the two systems will be described. These have been designed to use the components already specified in this course plus a few inexpensive additional parts which, in turn, will find use again as the basis of other circuits later on.

### THE LOW-FREQUENCY AC WAVEFORM GENERATOR

In normal transmission systems the carrier frequency signal varies with time at a rate faster than the eye can follow — telephony over open wire trunk lines, for example, operates at kilohertz frequencies; telephony over microwave links is at hundreds of megahertz. Consequently if we attempted to build even the first type of system little could be learnt unless you had an oscilloscope at your disposal to look at the waveforms at various places in the system. To overcome this problem the exercise project described here has been designed to operate with a carrier frequency of around 1 Hz or less, enabling most of the waveforms to be studied by observing the movements of the pointer on a multimeter. The real system works in a similar manner — but at a far faster rate.

The generator is not made entirely from electronic components but uses mechanical motion cyclically to vary the light intensity falling on a light-dependant-resistor (LDR). The schematic diagram is given in Fig. 17.

This method gives us a good opportunity to build a composite device in which mechanical, optical and electronic parts are involved. Many sophisticated instruments use all three disciplines together like this.

The 6 Vdc motor (see Fig. 18) is of the type found in cheap electrically driven toys or in model trains. Using a rubber band as a belt and a large wheel, the output shaft speed is reduced to

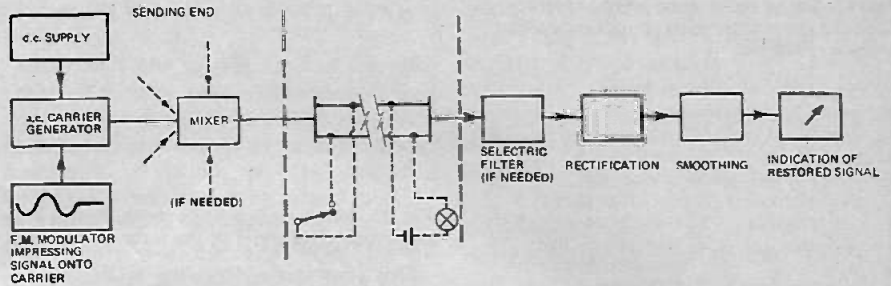

Fig. 16: Block schematic of a pulse frequency modulated link.

rotate at around 10 revs. per second maximum.

Very little precision is needed in the construction — it consists of bent pieces of aluminium or brass strip, tag strips and a suitable wheel. We made the prototype in less than three hours using only elementary hand-tools.

Almost any dc motor will do provided its operating voltage suits the power supply. A resistor can be added in series with smaller voltage motors in order to drop the maximum value applied to the motor.

If you have finished the unregulated power-supply described last month this can be used along with a series dropping resistor.

Pushed onto the shaft is a disk of opaque material (plastic sheet or thick card) cut as shown. This shutters the LDR from the light source as it rotates.

The shape shown will produce square-waves and is usually called a chopper disk. It is the easiest to make. We leave it to you to design other shapes for producing, say, sinewaves, sawtooths, or pulses of higher frequency than the rotational speed of the shaft. (If you drill about 50 holes around the disk and run it at say 10 rps it will generate a 600 Hz signal — this will easily power a loudspeaker, producing a constant tone). The circuits given are designed for use with square-waves.

The speed of the motor, and hence the frequency of the signal, is varied by varying the voltage to the motor.

Note how the variable resistor is used here as a "potentiometer" giving an output voltage between the wiper and one end which varies smoothly from 0 — 6 V.

The LDR has a 150 Ω resistor in series with it; this enables a voltage swing to be obtained as the light intensity changes — a practical example of how resistors enable voltages to be produced as needed.

By redrawing the LDR and resistor circuit you will see that they form a kind of potentiometer with the mid-point acting as the wiper connection. Ohms law explains why the voltage varies as the LDR changes resistance.

The output of this low-frequency generator is taken from the leads of the LDR and this, in turn, feeds a second potentiometer. By varying the potentiometer the amplitude of the carrier is altered from zero to the maximum available (approximately) 5V. Hence position of its shaft decides the level of the AM carrier — it is, therefore, our AM modulating signal input. (Although we use a mechanical potentiometer here, the unit could be replaced with, say an LDR and resistor which would enable us to modulate the carrier with the varying intensity of a light input). This potentiometer forms the AM modulating block shown in Fig. 15.

If we leave the AM control set to maximum, variations in motor speed will produce frequency modulation of

Continued on page 70

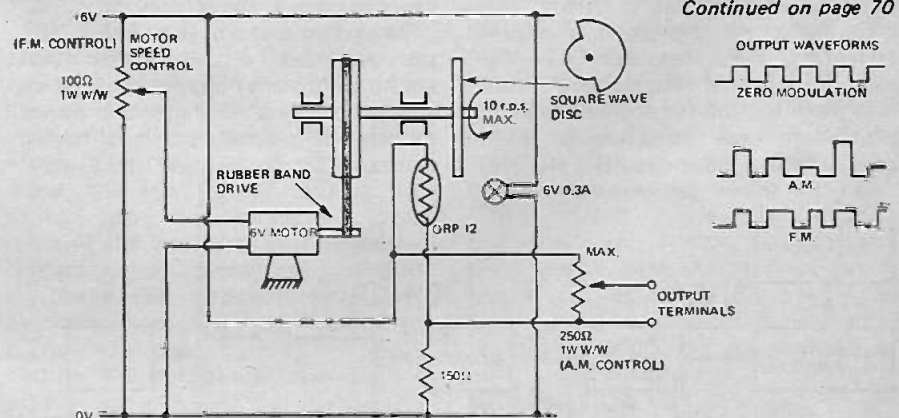
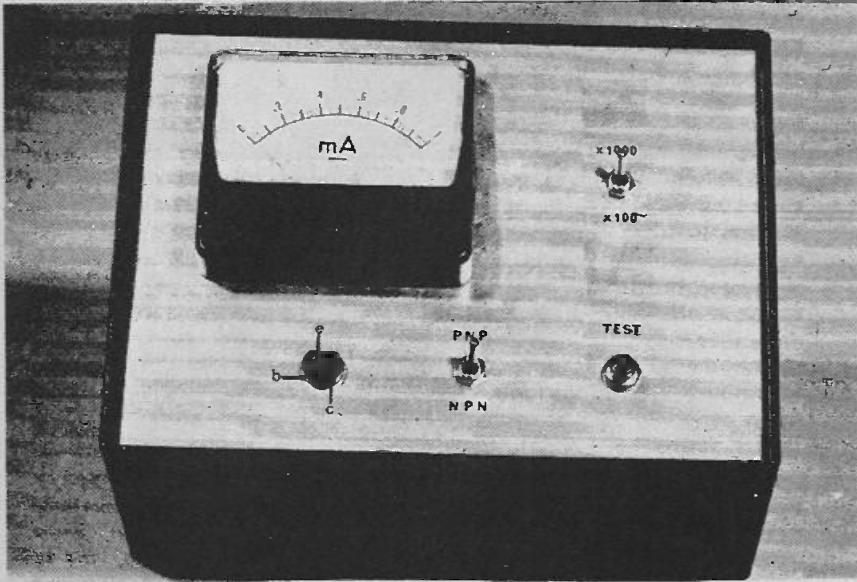

Fig. 17. Schematic layout of the mechanical low-frequency waveform generator used in the telemetry systems discussed.



# TRANSISTOR TESTER



## PROJECT 222

Measure and test your transistors with this easily built device.

EXPERIMENTERS will frequently use the same transistors in a whole sequence of experimental circuits, for recovering and re-using such components saves considerable outlay.

But semiconductors are easily damaged — by incorrect operating conditions — or by excessive application of heat when soldering.

Only too often a malfunctioning experimental circuit will be checked and rechecked before one realises that a transistor is dead.

A transistor tester will save hours of such frustrating and unproductive effort.

Transistors can often be bought cheaply in bulk — usually in unmarked and untested lots — or recovered from old computer boards. Here again a transistor tester will prove invaluable in eliminating the faulty bits.

The simple transistor tester described in this project not only sorts out the good from the bad but indicates also the approximate gain ( $\beta$ ) of the transistor. This is a most useful feature for those circuits where transistors need to be matched. Two ranges of gain (beta) are provided, 0-100, and 0-1000. The tester may also be used to check transistor polarity.

The transistor tester mounted in a metal case.

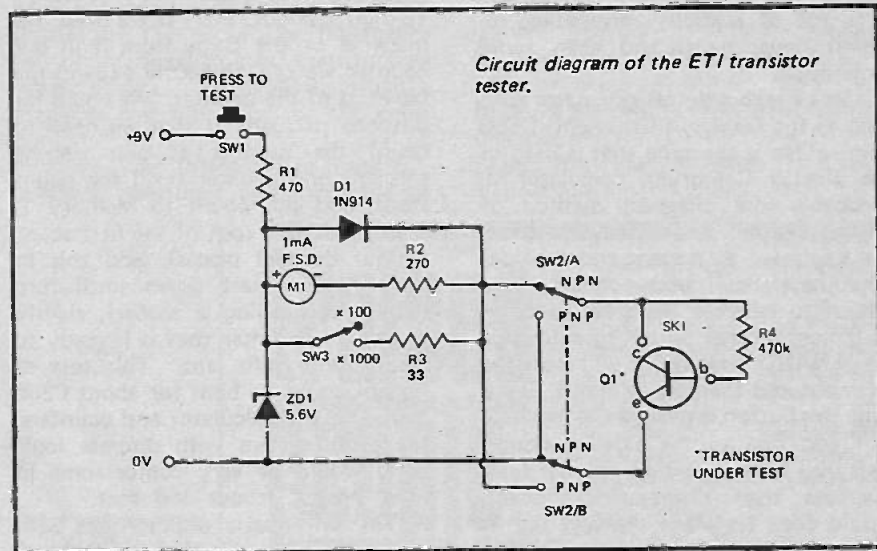

Circuit diagram of the ETI transistor tester.

### HOW IT WORKS

Operation of the tester is very simple. The meter, M1, monitors the collector current of the transistor under test whilst R4 supplies a current of about  $10 \mu\text{A}$  into the base of the test transistor. Thus, on the 100 $\beta$  range, the maximum collector current will be 1 mA and, on the 1000 $\beta$  range, 10 mA. Switch SW3 therefore changes the meter sensitivity according to the beta range selected.

The meter is protected by means of D1 against damage due to test transistors being shorted. The zener diode ZD1 stabilizes the battery voltage to 5.6V.

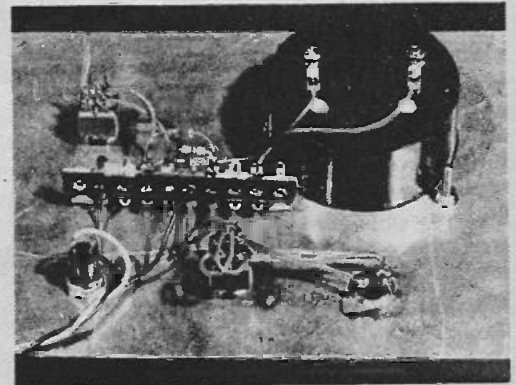

The construction method may readily be seen from this photograph of the back of the front panel.

PARTS LIST — Transistor Tester — ETI 222	
R1	Resistor 470 1/2 watt 5%
R2	Resistor 270 1/2 watt 5%
R3	Resistor 470 1/2 watt 5%
R4	Resistor 470k 1/2 watt 5%
D1	Diode 1N914
ZD1	Zener Diode BZY88C5V6
SW1	Push button plain to make
SW2	Switch toggle DPST
SW3	Switch toggle DPST
B	9V battery
M1	1mA 100 $\mu\text{A}$ movement
Q1	Transistor 2N3904 transistor type
	Metal case or equivalent

# Electronics by John Miller-Hirkpatrick Tomorrow

SEVERAL TIMES RECENTLY I have been asked about mini-computer type processing chips, are they available, how easy are they to work with, how much are they? The answers to these questions are basically that these chips *are* available but are usually sold complete with the control logic for a mini-computer on one PCB. If you understand computers then these units are reasonably easy to work with, but they are expensive in one-off quantities. For most applications where a mini-computer controlled system is required these units may well be over complicated with too many input and output options and a complex control language. An alternative to this approach is cheaper, more easily customised, and is well within the budget of a lot of schools, universities, research departments and even some individuals.

Let us take a simple calculator chip such as the General Instruments C550 chip. This is the type that is used in the Sinclair Cambridge calculator kit (probably the cheapest method of buying the chip and displays). Ignore the keyboard at present and consider what happens if you connect up a switch to activate the clear function and then another switch to activate a set of NAND gates which will close the '1' input and then the '+' input. Every time this button is pushed the machine will add one to the existing count, thus you have an 8-digit counter for a lot less than discrete components would cost, let alone the fact that it can be built in about one hour rather than a whole weekend. By adding a few other switches you can end up with an up-down counter capable of counting up at one or more increments and down at the same or different increments.

If you use a chip that has an automatic constant on all four functions (such as the National Semiconductors MM5736) then the add switch can be simplified as the increment is locked in as the constant and added each time the '+' switch is closed. A circuit showing the MM5736 as an up-down counter is shown as Fig. 1. The CLEAR switch clears the machine and resets the digits to all zero. The LOAD switch loads digit '1' into the constant, numbers other than one could be loaded by different switching arrangements. The COUNT-UP or COUNT-

DOWN switches activate the '+' or '-' inputs causing the machine to count up or down. The switches could be replaced by logic gates by using the MM74C00 as mentioned last month, the digit drive is one input, the count input is the other input, the output is inverted by another gate and led back to the K3 input. Additionally the keyboard can be left in parallel to the switches which means that a count can be keyed in and the machine will count down until zero is reached or until the negative indicator comes on. So now we have a programmable, multi-increments, six digit up-down counter at a cost of about £30.

Some of you may know the Advance 88 calculator with two memories, square root, automatic constant, 16-digit readout, etc. If we used this machine or the chips from it in our counter we can obviously expand the facilities of the counter. We could for instance persuade it that we need to count the number of pills passing through one counter until the count stops, add this count to Memory 1, take the square root of the first count (to no decimal places), add this to Memory 2, count down until zero (whilst controlling a loader), signify to the pill counter that it is ready to count more pills, etc. This sort of system could be built for about £200 including the calculator and counters, the same system with discrete logic units would be very cumbersome in time, power, labour and cost.

The only basic disadvantage with the above system is that it is a hard-wired unit and is thus reasonably difficult to modify for different but similar routines. One method would be to lead all the control wires to a patchboard and modify this patchboard whenever a change is required. If there are several standard routines then a wired plugboard could be made for each routine and this plugged into the patchboard socket. If one routine is much more complicated than the others then the patchboard or plugboard could be almost as complex as the original system would have been to build from discrete in the first place.

An alternative approach is to use LSI memory chips and to program instructions into these memories to control the system. Three types of LSI memories are available, the Random Access Memory (RAM), the Read

Only Memory (ROM) and the Programmable Read Only Memory (PROM). The disadvantage of the first is that it is cleared at power-off time and thus has to be reprogrammed each time the system is switched on. The ROM does not suffer from this problem as the memory is held in a type line or no-link system which is programmed into the chip at manufacturing time, the disadvantages are that it can not be reprogrammed and that it is very expensive for a one-off unit. The PROM is a unit which can be programmed by the customer thus saving on the manufacturers charges for this service. This type can be purchased from a few dealers in standard TTL as the 74188 fusible link PROM. The reprogrammable PROM is a new development in this line and gives the customer the option of clearing the memory by various means and then reprogramming it with new data. This is the type which is probably best for use in our system and is typified by the National Semiconductors MM5203 electrically programmable PROM.

It is available as a normal PROM and also is available with a quartz window over the chip which causes the memory to be cleared when exposed to UV light. The one-off cost of this unit is a bit high at £37.50, but the price drops quickly in small quantities. When compared to the costs involved in wiring a plug board the price per chip is not so high. The MM5203 is organised as either 512 4-bit words or 256 8-bit words, this option is selected by grounding a pin.

If we use this chip in the 8-bit word mode we can come up with a reasonably complex programmable max-calculator or mini-computer. Let each word of eight bits be equal to a key depression, we can decode the outputs from the chip to give a set of control lines, one for each different type of keyboard input. If we list all of the keyboards inputs we have and give each one a code we get Table 1. It can be seen that we run out of functions long before we run out of codes. If we use a very complex calculator as a basis such as one of the Hewlett-Packard machines we still have many more possible instructions not used.

With an 8-bit word we have the possibility of 256 different bit com-



binations and thus 256 instruction or data words. An IBM 370 computer uses an 8-bit word and even here there are a lot of words not used for data or instructions. We also have a memory of 256 words for programming, it would be possible to use a larger PROM or more than one MM5203 in series if 256 words is not long enough.

With the instruction format above the four right most bits can define an instruction or data and the left most four bits define a group. Thus group one (0000) defines the numbers 0-9. These can be decoded for keyboard switch inputs by using a BCD to decimal decoder. The other keyboard codes can be similarly decoded to decimal or hexadecimal by using additional chips, each chip being selected by a decoder driven from the group bits. To make the unit easier to program then instructions of the type STOP, GOTO, COMPARE, etc are needed. As the memory is driven by an oscillator/counter system running from 0 to 255, the STOP instruction simply inhibits the oscillator until an outside source resets the condition causing the oscillator to release and the clock to address the next word. The GOTO instruction takes the next word as an address rather than as an instruction and loads this word into the counter instead of its present data. The counter now points to a different word in the PROM and this is the next instruction used. The address following the GOTO instruction must always point to a valid instruction. To COMPARE can be executed by loading the displayed into M1, subtract the number to be compared and then test for zero, not zero or negative to give an equals, greater than or less than comparison. Having done the comparison the original number can be recalled from M1.

TABLE 1

KEYBOARD	INSTRUCTION	CODE
'0' --	Number '0' to	00000000
-- '9'	Number '9'	00001001
ADD	Add	00010000
SUB	Subtract	00010001
MLT	Multiply	00010010
DIV	Divide	00010011
RES	Equals Key	00010100
PRC	Percentage	00010101
RT	Square Root	00010110
EXC	Exchange Operands	00010111
EM1	Enter Memory 1	00011000
EM2	Enter Memory 2	00011001
AM1	Add to M1	00011010
AM2	Add to M2	00011011
RM1	Recall M1	00011100
RM2	Recall M2	00011101
SDP	Set Decimal Point	00011110
AUE	Add to M1 at RES	00011111
AUP	Add to M2 at PRC	00100000
CLR	Clear Input	00100001

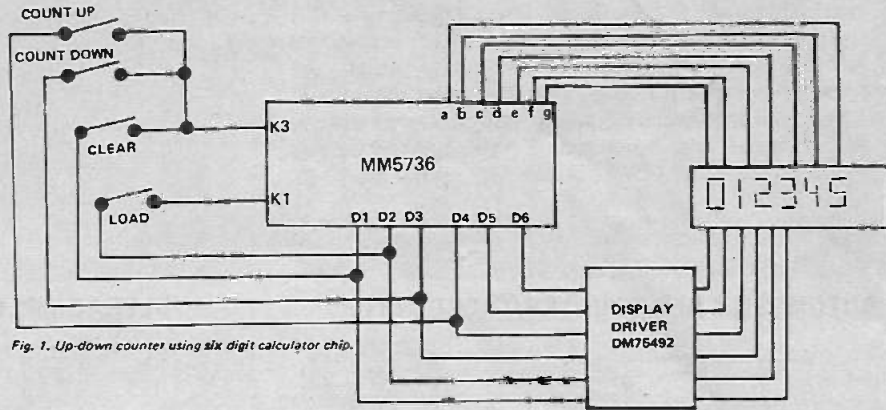

Fig. 1. Up-down counter using six digit calculator chip.

The unit we have now can be used as a programmable calculator for complex scientific or engineering calculations or can be used as the central unit in a production control system, the cost could be typically £200-£300 - a vast saving on other methods.

I hope that this month's meander into tomorrow's electronics is not too complicated for you to get the basic grasp of the idea involved. A constructional article of such a system is what is needed to explain it in greater detail but this would be financially out of the reach of most constructors unless a local firm could use such a machine and will pay for the components.

If you are interested in using calculators, memories and other digital

equipment in applications other than those for which they were designed then the following list might help.

- Calculators:**  
 Advance Electronics Ltd, Raynham Road, Bishops Stortford, Herts.  
 Hewlett-Packard Ltd, Bath Road, Slough, Bucks.  
 Sinclair Radionics, London Road, St. Ives, Hunts.
- Calculator Chips.**  
 Bywood Electronics, 181 Ebberris Road, Hemel Hempstead, Herts.  
 General Instruments Microelectronics, 57 Mortimer Street, London W1N 7TD.  
 National Semiconductors, The Precinct Broxbourne, Herts.
- ROMs, RAMs and PROMs:**  
 National Semiconductors.

# trained people succeed

Professionals or hobbyists, either way the best trained people go fastest to the top. ICS Home Study Courses make learning easy, put success in your grasp. Find out FREE what ICS can do for you. Complete and return coupon today!

Make sure you succeed with an ICS home study course for C and G Electrical Installations, Telecommunications Technicians and Radio Amateurs.

Over 5 million colour licences now. Learn the techniques of servicing Colour and Mono TV sets through new home study courses, approved by leading manufacturers. Also radio and audio courses.

Get the qualifications you need to succeed. Home study

courses in Electronics and Electrical Engineering, Maintenance, Radio, TV, Audio, Computer Engineering and Programming. Also self-build radio kits.

Succeed - your way:- Whatever your career ICS are the Professional teachers for professional success. And if you need G.C.E. passes we can help there, too. Just ask for details.



I want to succeed at: .....

NAME.....

ADDRESS .....

International Correspondence Schools, Dept. 255p, Intertext House, London SW8 4UJ, or Tel: 01-622-9911.  
 (Accredited by CACC, and Member of ABCC.)



# Tech-Tips

## AUTOMOBILE REV COUNTER/TACHOMETER

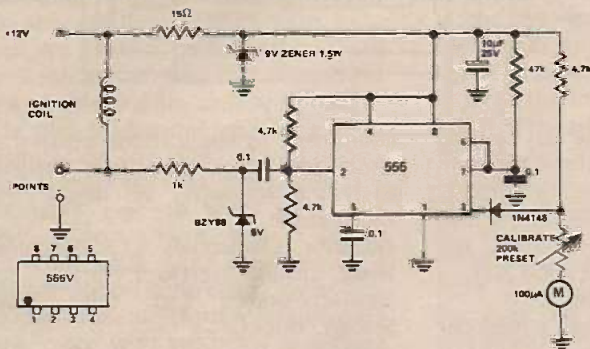

The Signetics NE555V Timër/Monostable Multivibrator is probably the most important standard IC to appear since the 741 op amp. Its versatility is obvious, but it can also perform a variety of tasks, with a 4½ to 18V supply and its ability to sink 200mA.

The Tachometer is an obvious high volume application and many working variations are possible on the above circuit.

Pulses from the points are fed to the 1k resistor and 5V zener for clamping and then trigger pin 2, which causes the output to go high on pin 3 for a duration set by the R/C ratio on pins 6 and 7. During this time the 1N4148 on pin 3 is reversed biased, and the 4.7k resistor and the preset supply a constant current to the meter, which is calibrated in Rev/Min. The meter is giving an analogue representation. When the time duration elapses pin 3 goes low, shunting all current around the meter. The ratio of current flow to the time it is shunted gives a representation of RPM which is integrated, (or smoothed) by the meters mechanical movement to give a very accurate indication, when calibrated, of the RPM. Accuracy is nominally to 2%. The 9V zener, 15 ohm resistor and 10µF capacitor are to stabilize the current supplied to the meter.

Calibration can be made using 50Hz 12V pulses derived from the domestic mains if it is remembered the points operate at 2 times the engine RPM on a 4-cylinder engine, i.e. 50Hz = 3000 cycles/min equivalent to 1500 Rev/Min for a 4-cylinder 4-stroke. On an 8-cylinder engine it would equal 750 RPM. On a 6-cylinder 50Hz equals 1125 Rev/Min.

The circuit can easily be built using 0.1 pitch vero board. The 555 IC gives temperature stability and solid state reliability.

## BATTERY CHECKING

Never check a battery off-load simply by using a voltmeter — the readings can be meaningless. Measuring on voltage on-load is o.k. but if this is not practical ensure that you connect a resistor across the meter probes so that a reasonable current is drawn. For a 9V battery a 180 ohm resistor will draw about 5mA.

## ULTRA-SIMPLE LIGHT FLASHER

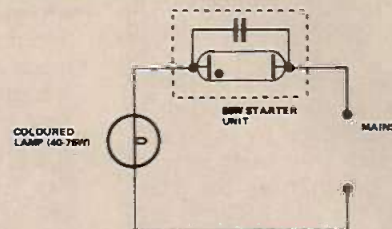

A cheap but effective way of flickering mains lamps suitable for discos etc.

It comprises a fluorescent lamp starter in series with a mains light bulb. The effect is improved with two or more units operating coloured lights. No problem is experienced with radio or TV interference and no suppression is needed since the starter has a capacitor in it.

Providing the units are not left on for long lengths of time, the starters will last quite a while.

## FUSE FAILURE INDICATOR

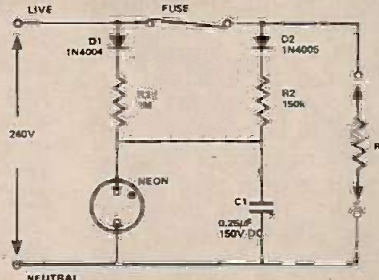

The circuit is built around the neon indicator which is normally used to show that power is being supplied to mains-driven equipment. When the fuse is intact, the neon is lit steadily as normal. However, should the fuse blow or be removed, the indicator flashes at a suitable rate, drawing the attention of the operator.

Effectively, the circuit is a simple modification to a neon relaxation oscillator. Under normal conditions, the time-constant of the RC network is such that the flash-rate of the neon is not detectable by the eye. The removal of the link between the anodes of D1 and D2, however, increases the time-constant and the neon flashes can be clearly seen. The specified component values give a frequency of approximately 2Hz.

An advantage of the circuit is that it will operate regardless of load impedance. Points to note: component values are not critical, but because the capacitor charges up to the striking voltage of the neon, diode D2 must have a PIV rating greater than peak mains plus this voltage. D1 can be rated at peak mains or greater. The types specified are suitable easily-obtained devices. Also, built-in resistors in certain types of neon indicator supplied for use at common supply voltages must either be removed or 'shorted'. The resistors should be ½W.



ETI is prepared to consider circuits or ideas submitted by readers for this page. All items used will be paid for. Drawings should be as clear as possible and the text should preferably be typed. Circuits must not be subject to copyright. Items for consideration should be sent to the Editor, Electronics Today International 36 Ebury Street, London SW1W 0LW.

## SPEEDING UP DARLINGTONS

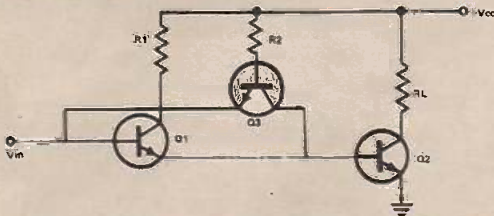

The useful properties of Darlington pairs are somewhat nullified when you need to get any speed out of them. The main drawback of the conventional Darlington in this respect is the long turn-off time, which results from the stored charge at the base of the output transistor.

However, by borrowing a trick from the designers of TTL this situation may be greatly improved, by the familiar looking addition of transistor and resistor R2 to the conventional circuit.

Q3, operating in common - base, draws a relatively steady base current. In consequence, when switching, the base charge of Q3 remains reasonably static, with only the distribution gradients varying. Since the time needed for this redistribution of charge is very small, base drive for the output transistor becomes available within several nanoseconds of positive drive at the input.

At turn-off, Q3 provides a TTL style path for the removal of base excess charges from the output stage resulting in faster turn-off time.

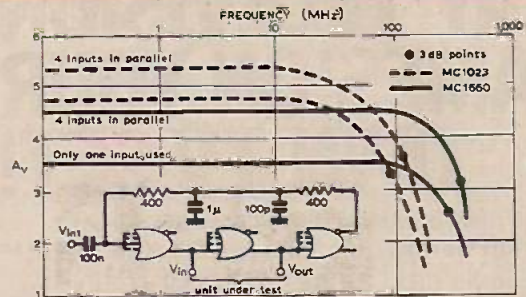

Figure 1.

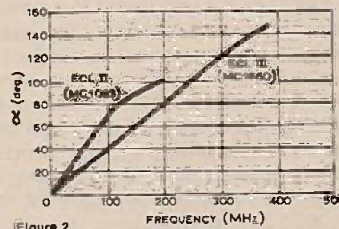

Figure 2

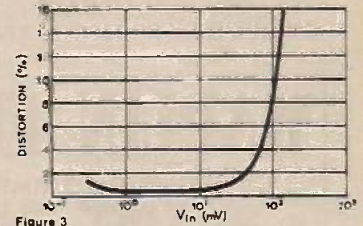

Figure 3

several inputs together to increase gains. The offset voltage between input and output increases with the number of inputs that are paralleled. It therefore depends on the individual application, if a slightly higher offset voltage can be tolerated then a higher gain can be achieved.

Fig. 2 shows the phase shift curves for the two gates and Fig. 3. is a plot of distortion against input voltage.

## WIDEBAND AMPLIFIERS

IT IS not commonly known that some digital ICs can be used in the linear mode to obtain performance equal, or superior, to some more conventional components.

A typical example is the use of a MECL logic gate as a wideband amplifier. Such an amplifier based on the Motorola MC 1023 of the MECL 2 family provides a gain of 5.2 over a frequency range from zero to 125 MHz (at the 3 dB points). A still wider bandwidth of zero to 350 MHz may be obtained by using the MC 1660 from the MECL 3 family.

The method used to bias MECL gates for linear operation is shown in the inset of Fig. 1. The NOR output is connected back to the input. This can be done over one, or over several, gates. The external 'self-biasing' network feeds back only the dc component of the output signal. Therefore the dc input current is furnished by the output of the same gate. Assuming that the voltage drop across the biasing resistors is small, the input and output voltages are identical. This is only possible in the centre of the gates' transition region. The main advantage of this very simple biasing method is that the circuit automatically compensates for all offset and bias voltage variations. In addition, the method is very economical, especially when a cascade arrangement of gates is needed.

The response depends on how many inputs are connected in parallel, there is a disadvantage however in connecting

## ZN 414 POWER SUPPLY

The Ferranti ZN 414 radio IC requires 1.1-1.8V at up to 1mA. A light-emitting diode can serve a dual purpose as a low-voltage zener diode and an "on" indicator, as shown. A suitable type is the Texas TIL 209 which gives a reasonable light output at 2-3mA consumption, so that the idea is suitable for mains or battery-powered radios. The resistor value should be

$$\frac{V_s - 1.5}{3}$$

$\Omega$  approximately where  $V_s$  is the supply voltage.

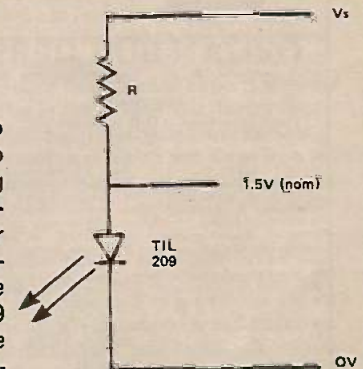



# EXCLUSIVE SCOOP

## PLAY 'TELEVISION GAMES' ON YOUR OWN TV SET!

Play the new exciting P.W. Tele-Tennis, or Television Games on your own 625-line TV set.

In this month's PRACTICAL WIRELESS a new series gives you explicit instructions for building the equipment to play Tele-Tennis... all you need is a basic knowledge of electronics and practical skills. Then just plug the equipment into your aerial socket.

If you have more advanced television knowledge, 'Television' magazine will show you how to build a more intricate device for playing either 'tennis', 'football' or 'golf'! And, if you have a colour set, you will be able to play the 'Television' games in spectacular colour!

PRACTICAL WIRELESS AND TELEVISION MAGAZINES ARE THE VERY FIRST MAGAZINES TO BRING YOU THESE UNIQUE D-I-Y PROJECTS. START BUILDING THEM TODAY

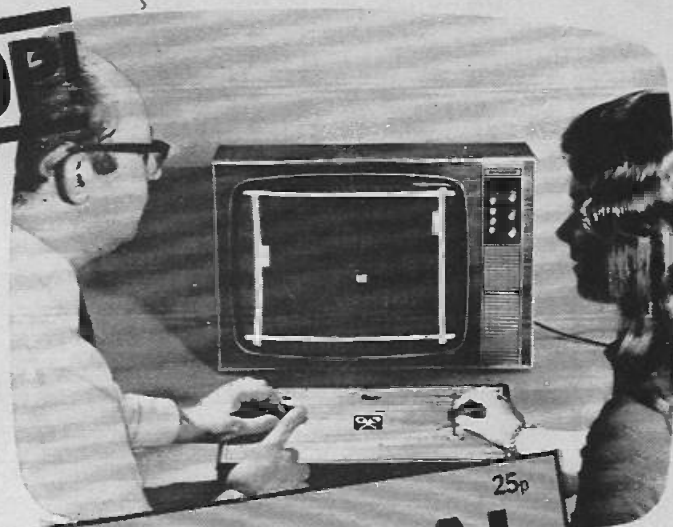

25p  
**PRACTICAL WIRELESS**

ON SALE 7th JUNE\*

25p  
**TELEVISION**

ON SALE 24th JUNE\*

\*subject to the current situation at the time of going to press.

## MAPLIN ELECTRONIC SUPPLIES

★ SAME DAY SERVICE

P. O. Box 3, Rayleigh, Essex. Tel: Southend-on Sea (0702) 44101  
**VAT** Please add 10% to the final total. Post and Packing FREE in U.K. (10p handling charge on orders under 50p)



# SYNTHESISER

We shall be stocking all the parts for this sensational new E.T.I. design. Send s.a.e. now for our detailed price list. (One available each month as the parts are published.)

YOU SIMPLY MUST SEE OUR PRICES!

### ORGAN BUILDERS

MES announce the very latest development in organ circuitry.

#### THE DMOZ

13 Master-Frequencies on ONE tiny circuit board. LOOK AT THESE AMAZING ADVANTAGES  
 ★ 13 frequencies from C8 to C9. ★ Each frequency digitally derived from a SINGLE h.f. master oscillator.  
 ★ Initial tuning for the WHOLE ORGAN; ONE SIMPLE ADJUSTMENT. ★ Relative tuning NEVER DRIFTS! ★ External control allows instant tune-up to other musicians. ★ Outputs will directly drive most types of dividers including the SAJ110. ★ And each output can also be used as a direct tone source. ★ Variable DEPTH AND RATE tremulant optional extra. ★ Gold-plated plug-in edge connexion. ★ Complete fibre glass board (including tremulant if required) ONLY 3-7in. x 4-5in. ★ Very low power consumption.

★ EXTREMELY ECONOMICAL PRICE. ★ Ready built, tested and fully guaranteed.  
 DMOZT (with tremulant) ONLY £14.25.  
 DMOZ (without tremulant) £12.25.

★ S.a.e. please for full technical details.  
 Trade enquiries welcome.

SAJ110 7-stage frequency divider in one 14 pin DIL package. Sine or square wave input allows operation from almost any type of master oscillator including the DMOZ (when 97 notes are available). Square wave outputs may be modified to saw-tooth by the addition of a few components. SAJ110: £2.63 each OR special price for pack of 12: £25.00. S.a.e. please for data sheet.

### WE KNOW YOU NEED

IT!



The MES 1974 Catalogue has over 75 pages and is STACKED with dozens of tempting new lines. BRIMMING OVER with clear illustrations and detailed data.

**WE'RE WAITING TO RUSH YOU A COPY.**

You'll be IMPRESSED with our POST FREE ordering system. EXCITED by our BIG VALUE discount vouchers. STAGGERED by our UNBEATABLE speed of service. Take the first step towards real service NOW! Send ONLY 25p for our beautifully produced catalogue and leave the rest to us!

### QUALITY ICs AT LOWEST POSSIBLE PRICES

CA3046	14-pin DIL	Transistor Array	69p*
LH0042C	TO5	FET I/P Op.Amp	£4.25*
LM301A	8-pin DIL	Op. Amp	50p*
NE555V	8-pin DIL	Timer	79p*
NE561B	14-pin DIL	Phase Locked Loop	£4.45*
SG1495D	14-pin DIL	Four Quadrant Multiplier	£2.70*
SG3402N	14-pin DIL	Wideband Amp/Multiplier	£1.69*
µA723C	14-pin DIL	2-37V Voltage Regulator	80p*
µA741C	8-pin DIL	Op. Amp	36p*
ZN414	TO5	A.M. Radio TRF	£1.20
MC1303L		Stereo Preamp	£1.39
MC1310P		FM Stereo Decoder	£3.15
MFC8010		1W Power Amp	£1.20

\*Full data in our catalogue. Price 25p



# DX MONITOR

Compiled by Alan Thompson

No photograph again this month you'll notice! The "DX MONITOR" shack is currently in the throes of being moved from a ground-floor location to an attic which has been ear-marked for that purpose for a very long time, and as this is being written any picture would be of long lengths of cable intermingled with bits of wood, lengths of aluminium channelling and the assortment of plugs, sockets, neons, switches and other gear, which Allah being kind, will eventually emerge as the new and, hopefully, improved location in which the DX will be netted in the months ahead. The chance is being taken to incorporate all sorts of improvements which have been firing my imagination for many months and, all being well, next month should see a new picture at the head of this article showing a few new pieces of equipment which might be of interest to our more-dedicated DXers. Meanwhile, a snow-storm of discarded plans emerges at regular intervals from the attic window onto the heads of innocent passers-by and an interesting meteorological phenomena is the blueness of the air in the region of 16, Ena Avenue, Neath, a phenomena which increases in intensity as I try to cram a 19in. wide receiver into a space of 18½in! Does anyone know the origin of 19in. as the standard size of width for professional radio equipment? Anyway, all being well, next month will see a picture of the new shack gracing the top of this page.

Now and again, it's a very good thing to get back to basics and a few letters have suggested that it might not be out of place to devote this issue of "DX MONITOR" to starting at the grass-roots of what this feature is all about - so here goes! Where "DX" originates for the hobby of long-distance radio is lost in the mists of the last century. The usual suggestion is that the old-time radio operators abbreviated some of the more common words by adding "x" to their initial letter as an aid to reducing the amount of key-bashing that was required. So, these days, we have in general use "Rx" for receiver, "Tx" for transmitter, "Wx" for weather and so on. On this theory, which I very much doubt, "Dx" or "DX" simply meant "distance". Its current meaning has been expanded quite a bit to denote the chasing of stations which are (a) very far away or (b) which are not so far away but which present certain problems in hearing them, since, for example, they are sharing a channel with a station of greater power and it is necessary to use the maximum of ingenuity to log them - perhaps when the powerful station is off the air: when the powerful station is not being received for some reason or other, and the weaker one can thus be heard, or just when luck is with you! There are, of course, just as many varieties of DX as you like to conjure up: some DXers devote themselves to DXing the amateur radio bands; others spend the wee small hours of the night chasing, when conditions are right, the trans-Atlantic stations which may be tracked down on the MW band; yet another branch of the fraternity is forever seeking those elusive 'openings' of the VHF band which allow reception at distances much greater than the normal service areas of the stations. This feature is devoted to SWBC (short-wave broadcast) DX and with, currently, some 180 sovereign states using that medium to put their messages across to radio listeners it provides a wide enough canvas on which to paint some sort of reasonable picture of what the hobby is all about, so ... "where's the action?"

The International Broadcasting Bands span the following frequencies, although it might be as well to say at this point that quite a few broadcasters make some or all of their transmissions, outside those ranges. Why they do this is a subject which would allow of a full feature but as we are, this time, dealing with basics, let's set out the various bands:-

49 metre band:	5950 - 6200 kHz
41 metre band:	7100 - 7300 kHz
31 metre band:	9500 - 9775 kHz
25 metre band:	11700 - 11975 kHz
19 metre band:	15100 - 15450 kHz
16 metre band:	17700 - 17900 kHz
13 metre band:	21450 - 21750 kHz
11 metre band:	25600 - 26100 kHz

The figures given are the extreme edges of the BC bands and there are some minor variations within various regions of the world. Within those bands stations operate at 5kHz intervals and, inevitably, this means that there is a great deal of interference between one station and another and very often one may hear two stations, supposedly directed to different areas of the world, operating at the same time. This, unfortunately, is a penalty that one has to pay for the popularity

of SW broadcasting - there just are not enough channels available to meet the needs of all the broadcasters, especially as the 11-metre band can, effectively, be discounted at this stage of the sunspot cycle. Additionally, there are the so-called "tropical bands" designed for local broadcasting in the near-equatorial areas of the world and for these it is more in accord with fact to quote the frequency ranges which are used rather than those which are allocated under international agreements. They are:-

120 metre band:	2200 - 2500 kHz
90 metre band:	3200 - 3400 kHz
75 metre band:	3900 - 4000 kHz
60 metre band:	4750 - 5075 kHz

The average short-wave receiver will span some, or all, of those bands, although it is less likely to cover the "tropical bands" which are the happy hunting ground of the more experienced DXer.

Many would-be DXers are put off the hobby by the fact that they see the picture of somebody's shack and observe a mass of equipment which would look at home in a professional Monitoring Station. If you were starting out in any other hobby you wouldn't expect to reach the standards of Kevin Keagan, Alan Knott, Rod Laver or Harvey Smith right at the beginning, nor would you expect to use the professional-type equipment that they use. So, with DXing, there is not the least reason why you should not start your sallies into this hobby with just about any receiver which happens to come your way. You are DXing just as soon as you switch your "trannie" to a SW-range and listen to, say, the Voice of the Andes, "Radio Station HCJB broadcasting from the roof of the world in Quito, Ecuador". It is surprising just how many stations you may hear on the very simplest of equipment with an aerial which is nothing more than a random length of wire slung from the chimney of the house to the garden shed! One of the world's greatest DXers, Arthur Cushen of New Zealand, once told me that he managed to hear 100 countries on a simple domestic radio before he took the plunge and bought his first specialised Communication receiver. Listen to them, take note of what you hear, answer their request for reports on the quality of reception and the content of their programmes and very soon you will start to amass a collection of colourful QSL cards, pennants, requests for more reports and all the other bits and pieces which make up the DXers life. In other words, you are "in" DXing and just how deeply you plunge is a matter of your taste and the depth of your pocket!

If you get well and truly bitten, you may be sure that there will come a day when you start to seek some means of knowing, *precisely*, the frequency to which you are tuned and you will be looking for a receiver which has just that bit more sensitivity and selectivity than the one which you used at the start of your activity. You may, too, get interested in the more technical side of the hobby and will start to enquire why it is that you can hear Radio Japan in the morning but not in its evening broadcast to Europe: how can you get the best out of your bit of wire - would an Aerial Matching Unit help? Would a pre-selector give just that bit more 'bite' to the signals you hear? And so on! When you reach that stage then you are certainly a real Dyer and the sky is the limit so far as the sophistication of your equipment is concerned and the fields of knowledge you will probe in your quest for more and more knowledge about the many fields into which DXing can lead you. If your interests lie in the world of languages then there is a limitless field for you to explore: if you seek the definitive answers to the theories of radio propagation you will find that there are many questions to which the experts still seek an answer: should your interests lie in the field of electronics then there are mysteries galore to be explored, investigated and tried in your quest for the (elusive) perfect receiver which will do all you require of it! The range is limitless and when you step into the DX world you are standing on the edge of an arena which has a place for everyone whatever their interest may be!

I hope I've shown you that there is nothing mysterious about DXing - it's just listening to foreign radio stations: nothing more and nothing less. How immersed you get in the hobby is a matter for you and you alone, but why not give it a try? Certainly, it will improve your knowledge of geography, current affairs, languages, radio-physics, electronics and many other disciplines so, forsake the passivity of being a "box-watcher" and come and join the many thousands around the world who get a kick out of hearing the news from where it happens. I think you won't regret it and I'm sure you'll find that DXing isn't anything like the mystery you may have believed it to be until now. Why not make a start NOW?

# SINTEL

NO P&P CHARGE for UK orders. Data supplied with orders. Send 20p, stamps if you like, for full data on all devices below (which includes circuits for using both clock IC's with Beckman displays) or send sae for information on products we distribute. SINTEL, 53a Aston St. Oxford.

## MK5025N

A very good value alarm clock IC.

28 pin



- ◆ Alarm
- ◆ Snooze
- ◆ Multiplex 6/4 digit output
- ◆ Interfaces with LED's and Beckman displays
- ◆ On-chip alarm time generator

ONLY £7.60 + VAT = £8.36

## CT7001

### DIGITAL TIMEPIECE

The most sophisticated clock/calendar IC on the market.

28 pin



- ◆ 28/30/31 day calendar
- ◆ 6 digit display
- ◆ 12/24hr alarm
- ◆ 24hr alarm
- ◆ Snooze alarm
- ◆ Radio alarm - Timed switch on and switch off
- ◆ Easy interface with Beckman displays and more - see data sheet.

£16.50 + VAT = £18.15

## LARGE \* ATTRACTIVE

(used by Britains's largest manufacturers of digital clocks) Continuous 7 segment planar gas discharge displays. Attractive orange, legible to 40 feet.

SP352

SP352

SP352



## BECKMAN DIGITAL DISPLAYS

SP151



- SP151 3½ digit (.50") clock module + am/pm £7.20 + VAT = £7.92
- SP152 1½ digit (.55") clock module + am/pm £4.00 + VAT = £4.40
- SP352 2 digits (.55") clock module + am/pm £4.00 + VAT = £4.40
- SP332 2 digits (.33") clock module + am/pm £4.00 + VAT = £4.40

## ELECTRONICS IN PRACTICE

Continued from page 62.

the carrier. The motor speed potentiometer is, therefore, a kind of FM modulator - the FM modulator box shown is Fig. 16. As we are using square waves the two cases are more correctly called pulse amplitude modulation (PAM) and pulse frequency modulation (PFM). The working concept remains the same if the chopper disk is cut to produce sine waves.

### TESTING THE SYSTEM

Little can go wrong with the generator, the only problem arising might be overheating. If in doubt use your multimeter to check currents, voltages and resistances and from these calculate the watts dissipated ( $W = I^2 R = EI = E^2/R$ ). The LDR must not be made to dissipate more than 150 mW. The motors and potentiometers are robust in the sense that they will heat slowly with little risk of rapid burnout. All components in this experiment are robust so there is little chance of failure. Later when we reach a level of using transistors and the like, things are very different. Try to develop a careful approach - "think first - connect the power last" when you are completely satisfied that the design is within safe limits. Once you

have the unit running connect the multimeter (set to dc volts) to the output terminals. If the generator is turning at about 1-2 seconds per revolution the meter movement will follow the waveform closely. Next, study the effect on the output of variations in the AM and the FM modulation controls. Note particularly that when the frequency is varied the amplitude remains constant and vice versa.

Most meter units are damped to respond to a full-scale swing in about 1-2 seconds. Consequently waveform frequencies higher than 1 Hz will tend to be averaged - the meter acts as a smoothing energy store. The degree of smoothing increases as the frequency rises.

It will be seen that the ac waveform

switches between 0V and +V and is, therefore, not a true ac signal. It 'sits' on a dc level of 0V.

It is possible to observe the frequency changes by listening to the pull-in "clicks" of a relay placed across the output terminals. A lamp circuit can be wired across the relay contacts to enable you to see the varying frequency more clearly than with the multimeter. (The relay specified for previous exercises is satisfactory).

In the next part we will assume the generator is working. We will then add on a dummy transmission line and demodulation circuits for each case. It would be wise to build the generator on one end of a board leaving as much room again for the remainder of the exercise.

TO BE CONTINUED.

## A SPARK OF GENIUS



### THE SPARKRITE MK2 ELECTRONIC IGNITION KIT

WHEN COMPLETE THE SYSTEM CAN BE FITTED IN ONLY 15 MINUTES TO GIVE:-

Instant all weather starting up to 20% fuel saving, longer battery life, higher top speed, faster acceleration, spark plugs last about five times longer, misfire due to contact breaker bounce electronically eliminated, purer exhaust emission resulting in less air pollution, contact breaker burn eliminated (suitable for petrol engined cars up to 8 cylinders).



### THE ABOVE KIT COMPRISES:-

Ready drilled case and metalwork, cables, coil connectors, silicon grease, printed circuit board, All 5 year guaranteed components, and full instructions to make this fascinating, very efficient capacitive discharge system in either positive earth or negative earth forms.

Order now from or send sae for brochure or call for demonstration between 9-5.30 weekdays, or 10-4 Saturdays. Trade enquiries welcome.

### ELECTRONICS DESIGN ASSOCIATES

Dept. ET17, 82 Bath Street, Walsall WS1 3DE. Tel: Wai.33652

### PRICE ONLY

£11.62

Ready built £14.85 (state + or - earth).

We can supply a Sparkrite ignition (ready built) to fit all petrol engined vehicles (boats, motorcycles etc.) with coil and contact breaker ignition prices on application.

PRICES INCLUDE VAT AND P AND P.

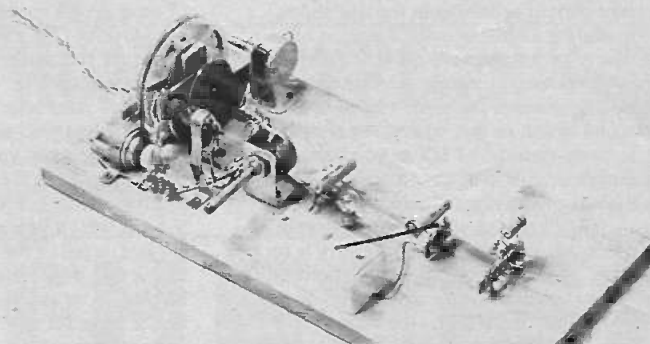
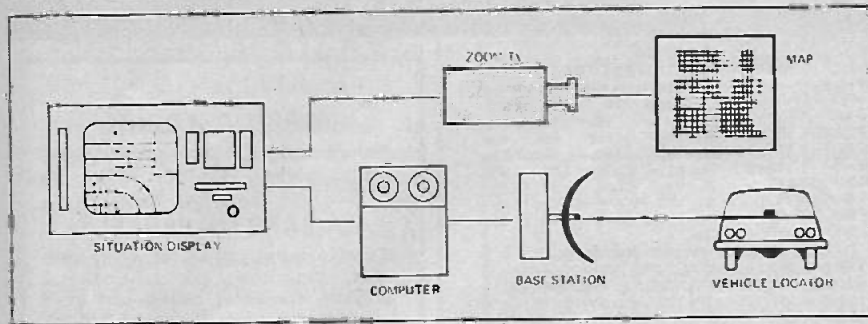

Fig. 18. The generator is simple to build and uses commonly available components.



## VEHICLE LOCATION



A vehicle location system using inertial navigation principles has recently been developed by Boeing (Wichita, Kansas, USA).

Initially planned for police vehicle use, the system can provide the location of up to 1500 vehicles to an accuracy of better than 20 metres.

Surprisingly simple in concept, the system transmits positional information derived from the vehicle's distance recorder and a magnetic heading sensor (compass) to obtain a dead-reckoning indicator.

The transmitted data is received

into a centrally located mini-computer (Varian 73) which displays the position of all vehicles on a Sony colour TV receiver. The display is up-dated every two seconds.

The system, known as 'Flair' has been tested over an 18 month period by police forces in Wichita also in St. Louis.

Boeing believe that fire, ambulance and taxi fleets may also use the system. Projecting into the future the company suggests that interstate trucks could also be plotted — using UHF via a satellite link.

## PORTABLE DIGITAL PHOTOMETER RADIOMETER

A new low cost Photometer/Radiometer manufactured by United Detector Technology (UDT) is now available in the UK from Techmation Ltd.

UDT has designed the 80X Opto-Meter for both field and laboratory applications, operating from either its own internal, rechargeable batteries or the mains. It can be used to measure radiant power, radiant energy (integrated power), illuminance, and integrated illuminance of many light sources; typically, flashtubes, lasers, light emitting diodes and indoor lighting.

The 80X has a 3½ digit LED display, plus analogue and BCD outputs. Input densities up to 15mW per cm<sup>2</sup> can be measured directly with optional attenuators for up to 15W per cm<sup>2</sup>. The standard model includes filters for a flat spectral response between 450 and 950 nanometers, and CIE response.

Accessories include a number of special-application detector heads for telephotometry, microphotometry, spectroradiometry or LED measurements. UDT can develop many other detector heads for specific customer requirements.

*Techmation Ltd, 58 Edgware Way, Edgware, Middlesex.*

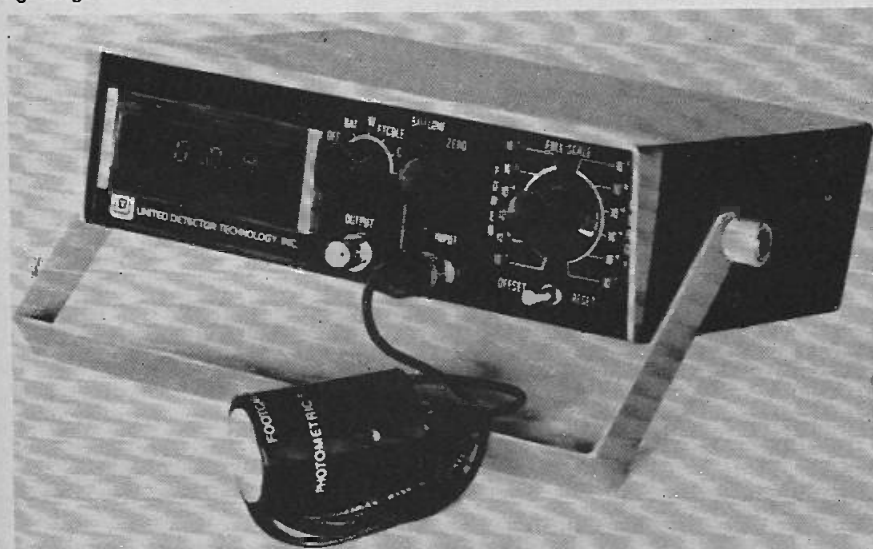

## SPACE LATEST

A joint US-European space venture has recently been proposed by officials of the US space agency NASA and its European counterparts.

Projects under discussion include a joint mission to Jupiter and a possible flight in 1980, to the comet Eake.

Both proposals involve the use of the now redundant back-up spacecraft for NASA's two Jupiter Pioneer missions.

Two alternatives are under discussion for a Jupiter venture. The first involves launching in 1978 — encountering Jupiter in 1980 — on a trajectory towards the Sun.

The second proposal is for a less-costly Jupiter orbital flight.

Further space news is of a possible (unmanned) mission to Mars (probably in 1979 or 1981) in which a Mars Rover vehicle would be used.

The basic design of the Mars Rover is a 100kg vehicle carrying a payload of 40kg. Capable of travelling up to 45 km the vehicle would also be used in unloading operations.

The Mars mission is predicted on the use of spare parts left over from the planned 1975 Viking mission to Mars.

The 1975 missions involve two landers and two orbiters. A third lander is being built as a back-up — it is this unit which, if all goes well, will be used in 1979.

## NEW HIGH-BRIGHTNESS CRT PHOSPHOR

A new cadmium sulphide phosphor, PX 78, developed at the Westinghouse Research Laboratories and now available in CRT's from the electronic tube division, is capable of much brighter displays than the standard phosphor (P31) now in use. The new phosphor is ideal for CRT applications where ambient light levels are high, such as airplane cockpits and shipboard radar and sonar displays.

The key to the new phosphor's performance is its ability to withstand the high-current loadings required for increased brightness without saturation. The phosphor's characteristic sharp, wide peak allows more total radiant power to be used when recording on film. Its resistance to shifts in peak when under heavy load ensures the absence of colour variations despite changes in load.

In addition to the new PX 78, a phosphor of a larger particle size, designated PX 58, is also available (at a slightly lower price) for conventionally settled CRT screens where ultra-high resolution is not required.

# MINI-ADS

FOR FURTHER INFORMATION  
PHONE: BOB EVANS  
01-730-2139

## HARDWARE

Screws, nuts washers etc.  
Sheet aluminium cut to size or in standard packs, plain or punched/drilled to spec.  
Printed circuit boards for published designs or individual requirements, one-off or small runs.  
Fascia panels, dials, nameplates etc in etched aluminium. 6p for details.

**Ramar Constructor Services,**  
29 Shelbourne Road,  
Stratford on Avon, Warwick.

## ETI "International 420"

### 4 Channel Amplifier Parts Kits.

As specified in Electronics Today International April 1974.

Pre-Amplifier Kit £7.00+70p VAT of parts with switch.

†Decoder Kit of £7.00+70p VAT parts with switch.

Power Supply Kit. £6.00+60p VAT

Power Amp Boards £4.40 pair + 44p Kit. \*Less S1.1010Y modules.

Steel Chassis plus £4.25+42p VAT Switch Plate.

Aluminium Facia .95+ 9p VAT (Printed)

Teak Veneer £4.20+42p VAT Cabinet

Accessories (DINs, £2.50+25p VAT PHONO etc.)  
Prices include postage and packing

\* Sanken S1.1010Y Modules available only from PHOTAIN LTD of Leatherhead see article. Alternative module available from us modified to suit project s.a.e. for details.

† Kit for discrete module decoder to be available when published.

**M. C. PRODUCTS**

62A Brewery Road, London N.1.

## AERIAL BOOSTERS £3.30.

Can produce remarkable improvements on the picture and the sound in fringe or difficult areas.

B11—For the VHF radio band.

B12—For the VHF television band.

Please state band 1 and 3 channels

B45—Tunable over the complete UHF television range.

All boosters are complete with battery for next to the set fitting.

## PLUGS AND SOCKETS

CO-AX, Plug-6p, Surface Socket-7p. DIN PLUGS, 2 Pin-15p, 3 Pin-15p, 5 Pin-15p. JACK PLUGS, Standard-15p, 3.5mm-10p, 2.5mm-10p. TOGGLE SWITCH S.P.S.T. with on/off Plate-10p. P and P 10p.

**ELECTRONIC MAILORDER LTD.**

62, Bridge Street, Ramsbottom, Bury, Lancs.

## PRECISION POLYCARBONATE CAPACITORS

440V AC (±10%)		63V		Range ±1%		±2%		-5%	
0.1µF (1 1/8" x 1/4")	50p	0.47µF	56p	46p	36p				
0.22µF (1 3/8" x 5/8")	59p	1.0µF	66p	56p	46p				
0.25µF (1 3/8" x 5/8")	62p	2.2µF	80p	65p	55p				
0.47µF (1 3/8" x 1/2")	71p	4.7µF	£1.30	£1.05	85p				
0.5µF (1 3/8" x 1/2")	75p	6.8µF	£1.64	£1.29	£1.09				
0.68µF (2" x 1/2")	80p	10.0µF	£2.00	£1.60	£1.40				
1.0µF (2" x 1/2")	91p	15.0µF	£2.75	£2.15	£1.90				
2.0µF (2" x 1")	£1.22p								

All high stability-extremely low leakage.

**TANTALUM BEAD CAPACITORS**—Values available:  
0.1, 0.22, 0.47, 1.0, 2.2, 4.7, 6.8µF at 15V/25V or 35V;  
10.0µF at 16V/20V or 25V; 22.0µF at 6V/10V or 16V;  
33.0µF at 6V or 10V; 47.0µF at 3V or 6V; 100.0µF at 3V. All at 10p each; 10 for 95p; 50 for £4.00.

**TRANSISTORS:**  
BC107/8/9 9p BC212/212L 14p BFY50 20p  
BC147/8/9 10p BC547 12p BFY51 20p  
BC157/8 12p BC558A 12p BFY52 20p  
BC182/182L 11p BF194 12p OC71 12p  
BC183/183L 11p BF197 13p 2N3055 50p  
BC184/184L 12p AF178 30p

**POPULAR DIODES:** All brand new and marked:  
1N914 5p; 8 for 45p; 18 for 90p; 1N916 8p; 6 for 45p;  
14 for 90p, 1S44 5p; 11 for 50p; 24 for £1.00, 1N4148  
5p; 6 for 27p; 12 for 48p. **LOW PRICE ZENER DIODES**  
400mW. Tol. ±5% at 5mA. Values available: 3V; 3.6V;  
4.7V; 5.1V; 5.6V; 6.2V; 6.8V; 7.5V; 8.2V; 9.1V; 10V;  
11V; 12V; 13V; 13.5V; 15V; 16V; 18V; 20V; 22V; 24V;  
27V; 30V. All at 7p each; 6 for 39p; 14 for 84p. **Special Offer:** 100 Zeners for £5.50. **RESISTORS:** High stability, low noise carbon film 5%, 1/4W at 400°C; 1/3W at 700°C. E12 series only - from 2.2Ω to 2.2MΩ. All at 1p each; 8p for 10 of any one value; 70p for 100 of any one value.

**Special Pack:** 10 of each value 2.2Ω to 2.2MΩ (730 resistors) £5.00. **SILICON PLASTIC RECTIFIERS:** 1.5A - Brand new wire ended DO27: 100 P.I.V. -7p (4/26p)  
400 P.I.V. -8p (4/30p) 800 P.I.V. -11p (4/42p) **BRIDGE RECTIFIERS:** 2x4 200V -40p 350V -45p 600V -55p. **SUBMINIATURE VERTICAL PRESETS:** 0.1W only: All at 3p each: 100Ω, 220Ω, 470Ω, 680Ω, 1k, 2.2k, 4.7k, 6.8k, 10k, 15k, 22k, 47k, 100k, 1M.

Please add 10p Post and Packing on all orders below £5.00. All export orders add cost of Sea/Airmail. **PLEASE ADD 10% VAT TO ORDERS**  
Please add 10% VAT to orders. Send S.A.E. for lists of additional ex-stock items. Wholesale price lists available to bona fide companies.

## MARCO TRADING

Dept. T6, The Maltings, Station Road, WEM, Shropshire.  
Tel: NANTWICH (Cheshire) 63291 (STD 0270)  
(Props: Minicost Trading Ltd.)

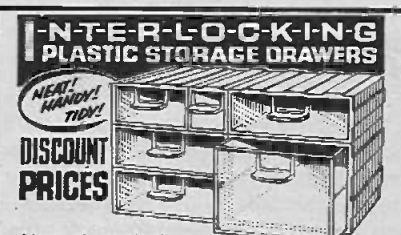

Newest, neatest system ever devised for storing small parts and components: resistors, capacitors, diodes, transistors, etc. Rigid plastic units interlock together in vertical and horizontal combinations. Transparent plastic drawers have label slots, 1D and 2D have space dividers. Build up any size cabinet for wall, bench or table top.

## BUY AT TRADE PRICES!

**SINGLE UNITS (1D)** (5In x 2 1/4Ins x 2 1/4Ins). £1.75 DOZEN.

**DOUBLE UNITS (2D)** (5Ins x 4 1/2Ins x 2 1/4Ins). £3. DOZEN.

**DOUBLE TREBLE 2 Drawers**, in one outer case (6DR) £4.25 for 8, **EXTRA LARGE SIZE (6D1)** £3.90 for 8.

**PLUS QUANTITY DISCOUNT!**  
Orders £15 and over Deduct 5% in £  
Orders £30 and over Deduct 7 1/2% in £  
Orders £50 and over Deduct 10% in £

**PACKING/POSTAGE/CARRIAGE:**  
Add 35p to all orders under £10.  
Orders £10 and over, packing/postage /carriage free.

Quotations for larger quantities.  
Please add 10% VAT to total remittance.

**FLAIDLINE SUPPLIES**

(Dept ET7) 124 Cricklewood Broadway, London, NW2.  
Tel. 01-450 4844.

## FERRIC CHLORIDE

Anhydrous to Mil-spec in double-sealed packs. 1lb 55p (22p) 3lb £1.32 (30p) 10lb £3.85 (60p).

## 7lb BARGAIN PARCELS

Contain hundreds of resistors, switches, capacitors, pot (all new) + crystals, transistor panels and loads of odds and ends. Only £1.82 (40p).

## VERSATILE POWER UNIT

Contains double insulated mains transformer, 2 amp thermal cut-out and bridge rectifier. Will give 1.7V-10.5V output with two extra capacitors (provided). Ideal for Nickel-Cad charger, 5V TTL supply, cassettes, radios, etc. Supplied complete with information 95p (20p). Also available as model garage woth lamp, switch, jack plug, etc. £1.35 (30p).

## 3W TAPE AMPLIFIERS

Polished wood cabinet 14 x 13 x 9" containing a sensitive (20µV) 4 valve amplifier with tone and volume controls, 3 watts output to the 7 x 4" 3 speaker. Also included is a non-standard tape deck. Supplied in good working condition with circuit Mains operated. £3.30 (£1.25). Amplifier chassis complete and tested (2xECC83, EL84, E280) and speaker £2.20 (45p).

## COMPUTER PANELS

3lbs assorted panels £1.10 (30p) 7lbs £2.20 (40p). Pack containing at least 500 components including at least 50 transistors 66p (20p). 12 high quality panels with power transistors, trim pots, IC's, etc. £2.20 (30p) 100 for £13.00 (£1.00). Trade supplied.

**ALL PRICES INCLUDE VAT;** Carriage in brackets, SAE list, enquiries.

**GREENWELD (ET2), 51 Shirley Park Road, Southampton, New Retail/Wholesale/Mail Order Premises. Tel. 0703 772501. Also Retail shop at 38 Lower Addiscombe Road, Croydon.**

**PLEASE MENTION ETI WHEN REPLYING TO ADVERTISEMENTS**

## LABORATORY CLEARANCE

Oscilloscopes, AF/RF Oscillators, Audio and General Test Equipment, Tape Heads, Decks, Millivoltmeters, Bridges, Sweep Generators, Etc. Etc. Tel. Lower Beeding 236.



## DO YOU WANT PROFESSIONAL STATUS?

C.E.I Part III Course

This course leads to Council of Engineering Institutions Examinations. Successful candidates

achieve the academic requirements for membership of I.E.E. or I.E.R.E.

Details of entrance requirements grants etc. for this and other courses apply:

Medway & Maidstone College of Technology, Chatham, Kent.

BUILDING and PURCHASING an AUDIO MIXER pre-amp, autofade, V.U. or audio monitor, V.E. mixer, driver or power supply etc. First consult

PARTRIDGE ELECTRONICS  
ref. ETI. 21-25, Hart Road, Banfleet,  
Essex. established 23 years.

## ZN414 IC's FOR SALE

Full spec devices, properly coded.  
£7.50 for 10, £60 for 100. Prices  
inclusive of VAT. No single orders.

For details write to:

Box No. 31, Electronics Today  
International, 36 Ebury Street,  
London SW1W 0LW

## LOW TTL PRICES

	1-30	30+
7400	20p	18p
7404	22p	20p
7410	20p	18p
7413	31p	29p
7420	20p	18p
7473	44p	42p
7486	48p	44p
7490	78p	74p
7493	75p	70p
BC183	11p	10p

All devices full spec. by leading manufacturers. 30+ prices apply to mixture of TTL types. Prices include VAT. Minimum order value £2.00 + 10p p&p. Cash with order.

**CHILTERN ENGINEERING,  
KINGWOOD,  
HENLEY-ON-THAMES,  
OXON., RG9 5NB.**

The Proprietors of British Patent No. 970174, for "Current lead-in for Discharge Chambers", desire to enter into negotiations for the sale of the patent, or for the grant of licences thereunder. Further particulars may be obtained from Marks and Clerk, 57-60 Lincoln's Inn Fields, London WC2A 3LS.

The Proprietors of British Patent No. 1021367, for "Method and apparatus for fabrication and in situ testing of Wire Harness Structures", desire to enter into negotiations for the sale of the patent, or for the grant of licences thereunder. Further particulars may be obtained from Marks and Clerk, 57-60 Lincoln's Inn Fields, London WC2A 3LS

The Proprietors of British Patent No. 1021368, for "Improved Wire Harness Test Hold", desire to enter into negotiations for the sale of the patent, or for the grant of licences thereunder. Further particulars may be obtained from Marks and Clerk, 57-60 Lincoln's Inn Fields, London WC2A 3LS.

# FIELD ENGINEERING ON E.D.P. SYSTEMS

We require additional Electronic and Electro-Mechanical Engineers, to be involved in the servicing of Main Frame Computers on customers premises in the London Area.

Training programmes will be arranged for successful applicants, 21 years of age and over, who have a good technical background to ONC/HNC level, City and Guilds or Radio/Radar

experience in the Forces.

After training, and in appropriate circumstances, shift and lunch allowances will enhance the competitive basis salary, as will our twice yearly bonus. A contributory pension plan includes generous life insurance. Please write for an application form to E. J. Young, N.C.R. 1000, North Circular Road, London NW2 7TL.

Assure your future with

**NCR**

# secureye

+ dimmer

Secureye helps to guard your home from the night prowler or thief by switching on a light in a room when you are out of the house during the hours of darkness. It is designed to switch on the light as darkness approaches and switch it off again when dawn breaks.

The 'Secureye' is very easily installed, directly replacing flush or surface switches of similar pattern. No additional wiring is involved. Just remove the old switch and replace with Secureye. Fitting instructions included.

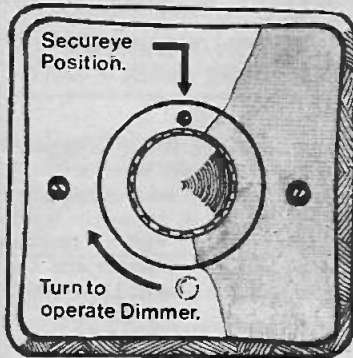

£5.60

Rec. Retail Price + VAT



WOODSTOCK PHOTOSOUND LIMITED,  
300 High Street, Sutton, Surrey 01-643 7277

## BUILDING YOUR OWN HI-FI AMPLIFIER?

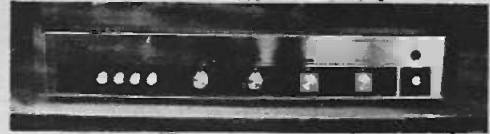

### WHY NOT USE A PROFESSIONAL CASE?

We have a limited number of high quality case assemblies valued at over £15.00 which must be sold.

#### LOOK AT THESE FEATURES:

- \* Ready punched steel chassis
- \* 3 piece, teak veneered case
- \* Screen printed front and rear plates
- \* Full compliment of hardware.

#### FRONT PANEL

Function switch for P.U./TAPE selection, MONO/STEREO and SCRATCH FILTER switches. Bass, treble, volume and balance. On/off and neon indicator.

#### BACK PANEL

P.U. input socket. Tuner input socket. Tape in/out socket. MAGNETIC (CERAMIC switch. Speaker output sockets. Headphone output socket. A.C. outlet socket. Fuse holder and mains lead.

#### HARDWARE COMPLIMENTS includes

Push button switch rails, potentiometers, sockets, knobs, plastic feet, slide switch, neon indicator, screws, nuts etc. COMPLETE KIT OF PARTS ONLY £8.80 POST FREE.

#### ALSO AVAILABLE

Stereo pre-amplifier p.c. board and circuit diagram to suit £2.75 post free. Teak plinth to match amplifier (out to accept B.S.R. MP60, C123 etc.) £3.30 post free. Smoked dust covers £2.20 post free. B.S.R. C123 deck (less cartridge) £8.25 post free. B.S.R. MP60 deck (less cartridge) £12.10 post free. S.A.E. for full list.

### SOUND ELECTRONICS (NEWCASTLE) LIMITED.

43, Heaton Grove, Newcastle-upon-Tyne, NE6 5NP.

Tel: 650 108.

## RICHARDS ELECTRICS ex-stock components

FULL DATA ON ALL DEVICES - SAE OR PHONE US

GUARANTEED SEMICONDUCTORS - FULL SPEC.

BC107	13p	BFY51	18p	2N3702	12p	2S303	25p
BC108	12p	BSY95A	9p	2N3704	12p	OA91	9p
BC109	13p	C444	13p	2N3819	34p	1N914	6p
BC182LB	12p	OCP71	15p	2N3866	25p	1N4004	7p
BC212LB	13p	2N1711	30p	2N4058	14p	1N4007	11p

4087 1/2 - RCA 100V COMP. POWER IN FLAT PACK 75p ea

TIC44 - TEXAS 60 PIV .6A SCR IN TO-18 PACKAGE 37p

4O486 - RCA 400 PIV 4A TRIAC IN TO-5 PACKAGE 60p

**Bridges** { N6002 100 PIV 2.2A 49p  
N7012 100 PIV 4A 65p

**Clock Chip CT7001** with data £15.

We strongly advise use of our 28 pin dil socket-chip is MOS. CT7001 + 4x3" LITRONIX DISPLAYS £18; +6" DISPLAYS £20

Automatic 28-30-31 day calendar; noise & radio alarm; snooze facility; battery standby; 12 or 24hr; 4 or 6 digit interface for led display; this must be the most versatile digiclock chip available. SAE or phone for further data.

LITRONIX 3" 7seg. Display £1.35; TIL209 125" LED 26p (Red)

DIL I.C. SOCKETS 8pin 18p; 14pin 20p; 16pin 22p; 28pin £1.25

MIN. TOGGLES 12mm dolly SPST-35p; SPDT-38p; DPDT-42p

50W RMS Power Module - superb spec. £9.25 or SAE 4 data.

**all prices include VAT**

ALL ORDERS INCLUDING 11p POST & PACKING TO  
16 FRIAR STREET, WORCESTER WR1 2LZ tel 0905-28550  
CALLERS WELCOME AT OUR SHOP

## INDEX TO ADVERTISERS

Ambit . . . . .	49
Amtron . . . . .	2
B.H. Component Factors . . . . .	34
B.I.E.T. . . . .	75
Bi-Pak . . . . .	4
Bi-Pre-Pak . . . . .	37
Bywood . . . . .	33
Chiltmead . . . . .	22
Dart . . . . .	9
Decon . . . . .	36
Electrosparcs . . . . .	9
Flairline Supplies . . . . .	72
Greenweld Electronics . . . . .	72
Henry's Radio . . . . .	50
I.C.E. Electronics . . . . .	70
I.C.S. Intertext . . . . .	65
L.L.P. Electronics . . . . .	23
I.P.C. . . . .	68
Maplin . . . . .	68
Marco Trading . . . . .	72
Minikits Electronics . . . . .	49
N.C.R. . . . .	73
Planetron . . . . .	49
Richards . . . . .	74
Sinclair Calculators . . . . .	28
Sinclair . . . . .	76
Sintel . . . . .	70
Sound Electronics . . . . .	74
Wellberry Products . . . . .	9
Wilmslow . . . . .	17
Woodstock Photosound . . . . .	74



# FREE!

## Over 150 ways to engineer a better future

**HIGHER PAY**      **A BETTER JOB**  
**SECURITY**

### find out how in just 2 minutes

That's how long it will take you to fill in the coupon. Mail it to B.I.E.T. and we'll send you full details and a free book. B.I.E.T. has successfully trained *thousands* of men at home - equipped them for higher pay and better, more interesting jobs. We can do as much for YOU. A low-cost B.I.E.T. home study course gets results fast - makes learning easier and something to look forward to. There are no books to buy and you can pay-as-you-learn.

Why not do the thing that really interests you? Without losing a day's pay, you could quietly turn yourself into something of an expert. Complete the coupon (or write if you prefer not to cut the page). No obligation and nobody will call on you ... but it could be the best thing you ever did.

#### Others have done it, so can you

"Yesterday I received a letter from the Institution informing that my application for Associate Membership had been approved. I can honestly say that this has been the best value for money I have ever obtained - a view echoed by two colleagues who recently commenced the course".—Student D.I.B., Yorks.

"Completing your course, meant going from a job I detested to a job that I love, with unlimited prospects".—Student J.A.O. Dublin.

"My training with B.I.E.T. quickly changed my earning capacity and, in the next few years, my earnings increased fourfold".—Student C.C.P., Bucks.

#### FIND OUT FOR YOURSELF

These letters - and there are many more on file at Aldermaston Court - speak of the rewards that come to the man who has given himself the specialised know-how employers seek. There's no surer way of getting ahead or of opening up new opportunities for yourself. It will cost you a stamp to find out how we can help you. Write to B.I.E.T. Dept. BE101 Aldermaston Court, Reading RG7 4PF.

Practical Radio & Electronics Certificate course includes a learn while you build **3 transistor radio kit.**

Everything you need to know about **Radio & Electronics** maintenance and repairs for a **spare time income** and a **career** for a better future.



**CUT OUT THIS COUPON**  
 Tick or state subject of interest. Post to address below.

<b>MECHANICAL</b>	<input type="checkbox"/> Man. Prod.—cont.	<input type="checkbox"/> <b>Constructional-cont.</b>
A.M.S.E. (Mech.)	<input type="checkbox"/> Quality Control	<input type="checkbox"/> Building
Boiler Inspect. & Operation	<input type="checkbox"/> Salesmanship	<input type="checkbox"/> Building Drawing
C & G Eng. Crafts	<input type="checkbox"/> Storekeeping	<input type="checkbox"/> Build. Foreman
C & G Fabricat.	<input type="checkbox"/> Work Study	<input type="checkbox"/> Carpentry & Join.
Diesel Eng.	<input type="checkbox"/> Works	<input type="checkbox"/> Civil & Municipal
Eng. Inspection	<input type="checkbox"/> Management	<input type="checkbox"/> Engineering
Eng. Metallurgy	<input type="checkbox"/> <b>DRAUGHTSMANSHIP</b>	<input type="checkbox"/> Constructional
Inst. Eng. & Tech.	A.M.I.E.D.	<input type="checkbox"/> Engineering
Inst. Motor Ind.	Design of Elec. Machines	<input type="checkbox"/> Construction
Mainten. Eng.	Die & Press Tool Design	<input type="checkbox"/> Surveyors
Mechanical Eng.	Electrical Draughtsmanship	<input type="checkbox"/> Institute
Sheet Metal Work	Gen. Draughtsmanship	<input type="checkbox"/> Clerk of Works
Welding	Jig & Tool Des.	<input type="checkbox"/> Council Eng.
<b>ELECTRICAL &amp; ELECTRONIC</b>	Tech. Drawing	<input type="checkbox"/> Geology
A.M.S.E. (Elec.)	<b>RADIO &amp; TELE-COMMUNICATIONS</b>	<input type="checkbox"/> Health Eng.
C & G Elec. Eng.	Colour TV	<input type="checkbox"/> Heat & Vent.
C & G Elec. Inst.	C & G Radio/TV/ Electronics	<input type="checkbox"/> Hydraulics
C & G Elec. Tech.	C & G Telecomm. Tech.	<input type="checkbox"/> Inst. of Builders
Computer Elect.	Prac. Rad. Elec. (with kit)	<input type="checkbox"/> Inst. Works & Highway Sup.
Elec. Maths	Radio Amateurs Exam.	<input type="checkbox"/> Painting & Dec.
Elec. Science	Radio Servicing & Repairs	<input type="checkbox"/> Public Hygiene
Electronic Eng.	Radio & TV Eng. Trans. Course	<input type="checkbox"/> Road Engineer.
Electrical Eng.	TV Main. & Serv.	<input type="checkbox"/> Structural Eng.
Install. & Wiring	<b>AUTO &amp; AERO</b>	<input type="checkbox"/> Surveying
Metres & Measuring Instruments	Aero Eng.	<input type="checkbox"/> <b>GENERAL</b>
<b>MANAGEMENT &amp; PRODUCTION</b>	A.M.I.M.I.	<input type="checkbox"/> Agricultural Eng.
Auto. Control	A.E.C. Cert.	<input type="checkbox"/> Council of Eng. Inst.
Computer Prog.	Auto Engineer.	<input type="checkbox"/> Farm Science
Electronic Data Processing	Auto Repair	<input type="checkbox"/> General Educat.
Estimating	C & G Auto. Eng. Garage Management	<input type="checkbox"/> Gen. Plastics
Foremanship	MAA/IMI Dipl.	<input type="checkbox"/> Pract. Maths
Inst. Cost & Man. Accountants	Motor Vehicle Mechanics	<input type="checkbox"/> Pract. Slide Rule
Inst. Marketing	<b>CONSTRUCTIONAL</b>	<input type="checkbox"/> Pure & Applied Maths
Management	A.M.S.E. (Civil)	<input type="checkbox"/> Refrigeration
Metrication	Architecture	<input type="checkbox"/> Rubber Tech.
Motor Trade Man. Network Plan.		<input type="checkbox"/> Sales Engineers
Numerical Cont. Operational		<input type="checkbox"/> Tech. Report Writing
Research		<input type="checkbox"/> Timber Trade
Personnel Man. Planning Eng.		<input type="checkbox"/> University Ent.
Production Eng.		

Coaching for many major exams including ONC, C & G, etc.

**G.C.E.**  
 58 'O' & 'A' LEVELS SUBJECTS Over 10,000 group passes

**POST TODAY FOR A BETTER TOMORROW**

To B.I.E.T., Dept. BE.101 Aldermaston Court, Reading RG7 4PF

NAME \_\_\_\_\_  
 Block Capitals Please  
 ADDRESS \_\_\_\_\_

OTHER SUBJECTS \_\_\_\_\_ AGE \_\_\_\_\_

Accredited by C.A.C.C. Member of A.B.C.C.

**BRITISH INSTITUTE OF ENGINEERING TECHNOLOGY**



# Sinclair resisted the temptation...

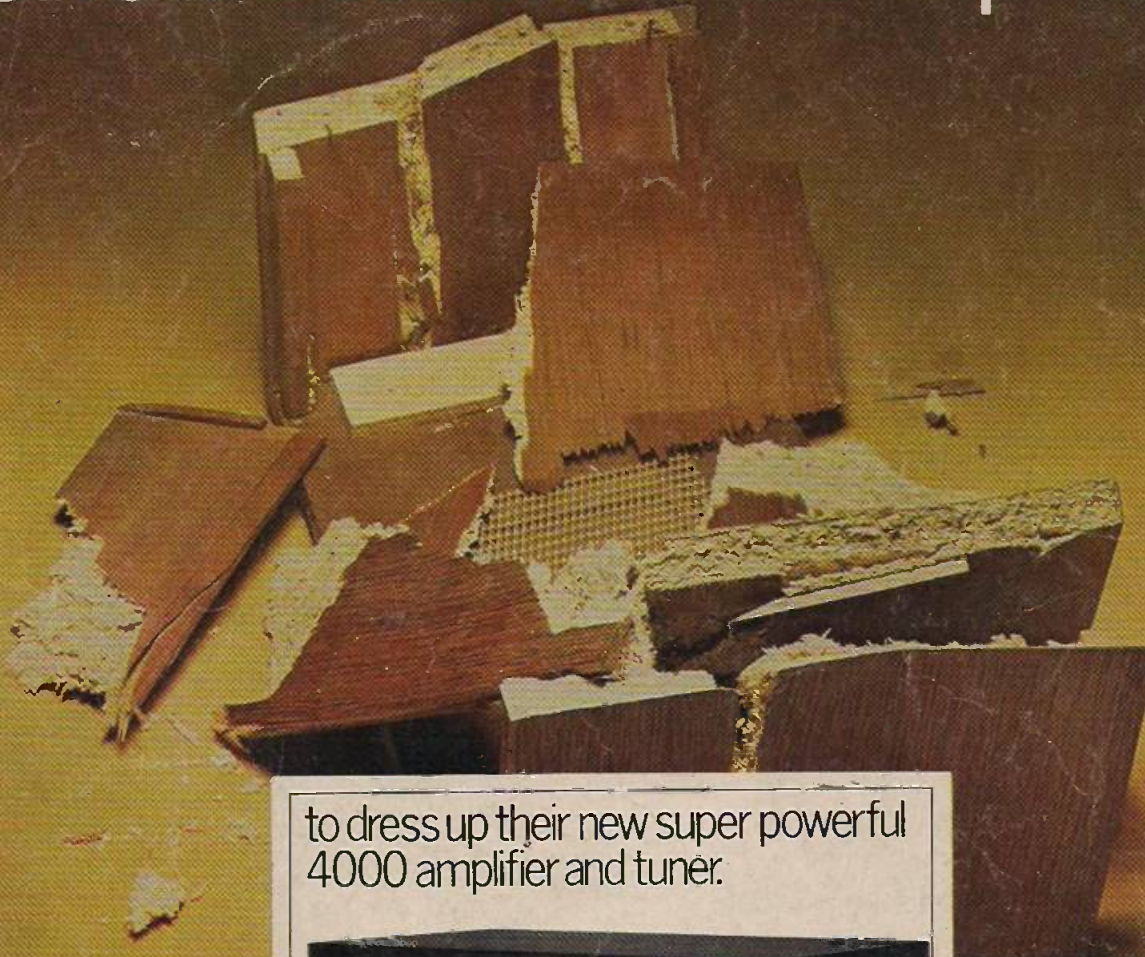

to dress up their new super powerful 4000 amplifier and tuner.



We did not feel we could improve on the simple good looks and functional excellence of our existing case.

But inside it is completely new. Just look what the sophisticated circuitry of the new Sinclair 4000 amplifier offers you.

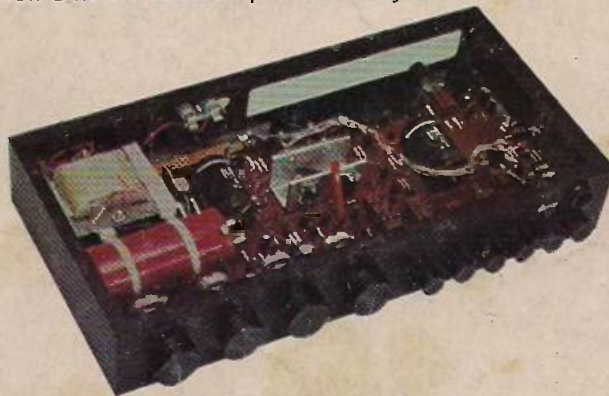

**sinclair**

**Power galore** 17 watts RMS continuous, both channels driven into 8 ohms and 60 watts per channel music power into 4 ohm speakers.

**Sensitive controls** such as the constant power balance control to avoid changes in listening level when adjusting balance, switched disc input giving required sensitivity and equalisation for both magnetic and ceramic cartridges, and switchable active scratch filter - 12 dB per octave.

**Refinements.** Active volume control circuits to come close to the perfect log response curve and to maintain balance even at very low listening levels.

**Indestructibility.** Short of taking an axe to it, the amplifier is indestructible. There is automatic protection against short circuited output and gross overloads, and all critical components are generously rated.

And we back this claim with a no nonsense five year guarantee.

Recommended retail price £65.50 + VAT.

To match it there is the new 4000 tuner giving you

**Excellent selectivity and sensitivity** with twin dual-varicap tuning and 4 pole ceramic filter IF selection, a new muting system for silent tuning between stations, and a 19 transistor integrated circuit multiplex stereo demodulator giving 40 dB channel separation.

**Freedom from drift** with switchable AFC with thermistor control.

**AM rejection** is first class from a 26 transistor integrated circuit balanced coincidence detector.

**Low distortion** 0.2% output (100 mV for 30% modulation).

Recommended retail price £39.95 + VAT.

All Sinclair hi-fi products are widely stocked throughout the country. Ask your dealer for a demonstration.

In case of difficulty contact: Sinclair Radionics Ltd, London Road, St. Ives. Hunts. Tel (0480) 64311