

BRITAIN'S DYNAMIC NEW MONTHLY — NO.1 20p

electronics

TODAY

INTERNATIONAL

APRIL 1972

**HOW
SPACE
FLIGHTS
ARE
TRACKED**

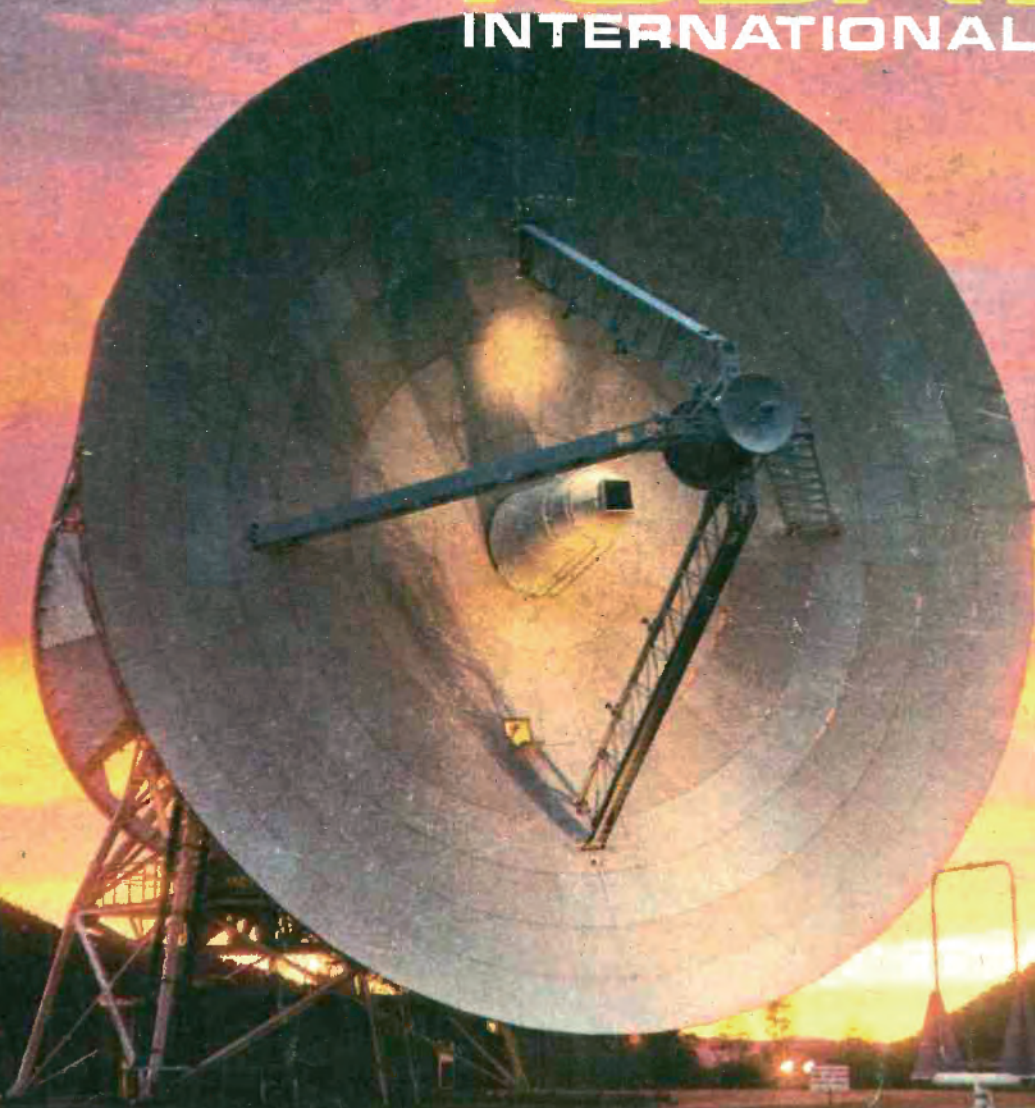

SCOOP TEST: FERROGRAPH DOLBY RECORDER

PROJECTS | HI-FI | RING MAINS FOR CARS | SEMICONDUCTOR OFFER | PRODUCT TESTS
COMPUTERS | RESEARCH | SPACE | COMMUNICATIONS | MEDICINE | INSTRUMENTATION

TTL 7400 SERIES INTEGRATED CIRCUITS

DON'T FORGET THE £1 VOUCHER ON PAGE 18

* MIX PRICES
* FULLY GUARANTEED
* LARGE QUANTITY
PRICES ON REQUEST

Type No.	1-24	25-99	100 Plus	Type No.	1-24	25-99	100 Plus
SN 7400	.18	.16	.14	SN 7491	1.00	.95	.90
SN 7401	.18	.16	.14	SN 7492	.75	.70	.65
SN 7402	.18	.16	.14	SN 7493	.75	.70	.65
SN 7403	.18	.16	.14	SN 7494	.80	.75	.70
SN 7404	.18	.16	.14	SN 7495	.80	.75	.70
SN 7405	.18	.16	.14	SN 7496	1.00	.97	.95
SN 7406	.30	.27	.25	SN 7497	6.25	5.50	5.00
SN 7407	.30	.27	.25	SN 74100	2.50	2.30	2.00
SN 7408	.20	.19	.18	SN 74104	1.45	1.35	1.20
SN 7409	.45	.42	.35	SN 74105	1.45	1.35	1.20
SN 7410	.18	.16	.14	SN 74107	.50	.45	.40
SN 7411	.23	.22	.20	SN 74110	.80	.70	.60
SN 7412	.42	.40	.35	SN 74111	1.45	1.35	1.20
SN 7413	.30	.27	.25	SN 74118	1.00	.95	.90
SN 7414	.30	.27	.25	SN 74119	1.90	1.78	1.65
SN 7415	.30	.27	.25	SN 74121	.60	.55	.50
SN 7420	.20	.18	.16	SN 74122	1.35	1.25	1.10
SN 7422	.48	.44	.40	SN 74123	2.70	2.55	2.47
SN 7423	.48	.44	.40	SN 74141	1.00	.95	.90
SN 7425	.48	.40	.35	SN 74145	1.50	1.40	1.30
SN 7427	.42	.39	.35	SN 74150	3.35	2.95	2.15
SN 7428	.50	.45	.42	SN 74151	1.10	.95	.90
SN 7430	.20	.18	.16	SN 74153	1.35	1.27	1.20
SN 7432	.42	.39	.35	SN 74154	2.00	1.75	1.55
SN 7433	.70	.61	.44	SN 74155	1.55	1.47	1.35
SN 7437	.65	.60	.50	SN 74156	1.55	1.47	1.35
SN 7438	.65	.60	.50	SN 74157	1.80	1.70	1.50
SN 7440	.18	.16	.14	SN 74160	2.60	2.40	2.25
SN 7441	.75	.72	.70	SN 74161	2.60	2.40	2.25
SN 7442	.75	.72	.70	SN 74162	3.60	3.40	3.25
SN 7443	1.00	.95	.90	SN 74163	3.60	3.40	3.25
SN 7444	1.75	1.60	1.45	SN 74164	2.75	2.30	2.10
SN 7445	2.00	1.75	1.60	SN 74165	4.00	3.50	3.00
SN 7446	2.00	1.75	1.60	SN 74166	4.00	3.50	3.00
SN 7447	1.75	1.60	1.45	SN 74167	6.25	5.60	5.10
SN 7448	1.75	1.60	1.45	SN 74170	4.10	3.55	3.05
SN 7449	1.00	.95	.90	SN 74174	2.00	1.75	1.30
SN 7450	.18	.16	.14	SN 74175	1.35	1.27	1.15
SN 7451	.18	.16	.14	SN 74176	1.60	1.35	1.20
SN 7453	.18	.16	.14	SN 74177	1.60	1.35	1.20
SN 7454	.18	.16	.14	SN 74180	1.55	1.30	1.20
SN 7460	.18	.16	.14	SN 74181	7.00	6.00	5.50
SN 7470	.30	.27	.25	SN 74182	2.00	1.80	1.60
SN 7472	.30	.27	.25	SN 74184	2.40	2.00	1.60
SN 7473	.40	.37	.35	SN 74185A	2.40	2.00	1.80
SN 7474	.40	.37	.35	SN 74190	2.95	2.85	2.75
SN 7475	.55	.52	.50	SN 74191	2.95	2.85	2.75
SN 7476	.45	.42	.39	SN 74192	2.00	1.90	1.80
SN 7480	.80	.75	.67	SN 74193	2.00	1.90	1.80
SN 7481	1.25	1.15	1.10	SN 74194	2.50	2.25	1.90
SN 7482	.87	.80	.70	SN 74195	1.85	1.70	1.60
SN 7483	1.00	.90	.85	SN 74196	1.50	1.40	1.30
SN 7484	.90	.85	.80	SN 74197	1.50	1.40	1.30
SN 7485	3.50	3.30	3.00	SN 74198	4.60	3.70	3.35
SN 7486	.45	.41	.38	SN 74199	4.60	3.70	3.35
SN 7490	.75	.70	.65	SN 74200	21.00	18.60	13.40

Type No.	1-24	25-99	100 Plus	Type No.	1-24	25-99	100 Plus	Type No.	1-24	25-99	100 Plus
AC 107	.45	.40	.35	C 450	.15	.12	.10	2N 3614	.50	.42	.35
AC 126	.22	.20	.18	OC 20	1.60	1.40	1.10	2N 3615	.60	.50	.40
AC 127	.20	.18	.15	OC 22	1.10	.90	.70	2N 3616	.65	.58	.52
AC 128	.20	.18	.15	OC 25	.40	.30	.24	2N 3617	.70	.60	.54
AC 176	.35	.31	.27	OC 26	.70	.50	.44	2N 3618	.50	.40	.30
ACY 17	.30	.25	.20	OC 29	.75	.60	.48	2N 3638	.15	.12	.10
ACY 18	.18	.15	.13	OC 35	.56	.48	.38	2N 3638A	.15	.12	.10
ACY 19	.22	.18	.15	OC 36	.62	.50	.40	2N 3641	.15	.12	.10
ACY 20	.18	.15	.13	OC 44	.40	.35	.28	2N 3642	.15	.12	.10
ACY 21	.17	.14	.12	OC 45	.38	.32	.26	2N 3643	.16	.13	.10
ACY 22	.14	.12	.10	OC 71	.25	.20	.15	2N 3644	.18	.15	.12
ACY 40	.15	.13	.11	OC 72	.35	.28	.20	2N 3645	.18	.15	.12
ACY 41	.16	.14	.12	OC 83	.18	.16	.13	2N 3646	.25	.20	.15
AD 149	.44	.38	.35	OC 139	.45	.36	.28	2N 3691	.15	.12	.10
AD 161/2	.30	.27	.24	OC 140	.70	.55	.46	2N 3692	.15	.12	.10
AF 114	.25	.21	.18	OC 141	.90	.70	.50	2N 3693	.15	.12	.10
AF 115	.25	.21	.18	OC 170	.21	.15	.12	2N 3694	.15	.12	.10
AF 116	.26	.22	.19	OC 171	.32	.27	.24	2N 3715	1.60	1.40	1.00
AF 117	.25	.21	.18	OC 200	.45	.35	.28	2N 3716	1.70	1.45	1.10
AF 118	.32	.25	.21	OC 202	.80	.64	.52	2N 3740	1.50	1.25	.95
BC 107	.14	.10	.07	OC 203	.45	.32	.24	2N 3741	1.60	1.40	1.00
BC 108	.10	.08	.06	OC 204	.45	.36	.30	2N 3771	2.60	2.20	1.80
BC 109	.15	.12	.08	OC 204	.45	.36	.30	2N 3772	2.20	1.80	1.40
BC 113	.15	.12	.10	OC 205	1.13	.90	.70	2N 3773	2.60	2.20	1.80
BC 114	.15	.12	.10	OC 206	1.00	.86	.68	2N 3790	2.50	2.10	1.70
BC 115	.15	.12	.10	OC 207	1.00	.82	.60	2N 3792	2.60	2.20	1.80
BC 116	.15	.12	.10	OC 207	.80	.70	.60	2N 4036	.52	.46	.40
BC 118	.15	.12	.10	V 435	.15	.12	.10	2N 4037	1.50	1.20	.90
BC 125	.15	.12	.10	2N 696	.42	.32	.24	2N 4140	.15	.12	.10
BC 126	.20	.18	.15	2N 697	.14	.12	.10	2N 4141	.16	.13	.11
BC 132	.15	.12	.10	2N 706	.10	.08	.07	2N 4142	.18	.15	.12
BC 134	.15	.12	.10	2N 706A	.11	.09	.08	2N 4143	.20	.17	.13
BC 135	.15	.12	.10	2N 708	.12	.10	.09	2N 4227	.16	.13	.11
BC 136	.15	.12	.10	2N 743	.15	.12	.10	2N 4228	.18	.15	.12
BC 137	.15	.12	.10	2N 744	.16	.12	.10	2N 4248	.15	.12	.10
BC 147	.10	.08	.07	2N 914	.16	.12	.10	2N 4249	.15	.12	.10
BC 148	.09	.07	.06	2N 918	.42	.35	.29	2N 4250	.16	.13	.11
BC 149	.10	.08	.07	2N 920	.18	.15	.12	2N 4286	.15	.12	.10
BC 157	.12	.09	.08	2N 923	.20	.16	.13	2N 4287	.15	.12	.10
BC 158	.11	.09	.08	2N 930	.24	.19	.16	2N 4288	.15	.12	.10
BC 159	.12	.09	.08	2N 1131	.24	.20	.17	2N 4289	.15	.12	.10
BC 167	.14	.10	.08	2N 1132	.24	.20	.17	2N 4290	.15	.12	.10
BC 168	.12	.09	.07	2N 1613	.15	.12	.10	2N 4291	.15	.12	.10
BC 169	.15	.11	.09	2N 1711	.20	.15	.12	2N 4292	.15	.12	.10
BC 177	.16	.13	.10	2N 1890	.38	.34	.30	2N 4293	.15	.12	.10
BC 178	.14	.11	.09	2N 1891	.35	.30	.25	2N 4964	.15	.12	.10
BC 179	.18	.15	.12	2N 1899	.30	.28	.26	2N 4965	.15	.12	.10
BC 257	.14	.09	.08	2N 1990	.40	.35	.30	2N 4966	.15	.12	.10
BC 258	.12	.09	.07	2N 2017	.80	.65	.50	2N 4967	.15	.12	.10
BC 259	.15	.11	.09	2N 2120	.50	.44	.34	2N 4968	.15	.12	.10
BCY 30	.35	.30	.25	2N 2218	.17	.14	.12	2N 4969	.15	.12	.10
BCY 31	.45	.40	.35	2N 2218A	.25	.23	.13	2N 4970	.15	.12	.10
BCY 32	.90	.80	.70	2N 2219	.22	.17	.14	2N 4971	.15	.12	.10
BCY 33	.35	.28	.23	2N 2219A	.26	.22	.22	2N 4972	.18	.15	.12
BCY 34	.35	.30	.24	2N 2221	.33	.27	.14	2N 5126	.15	.12	.10
BCY 70	.16	.12	.10	2N 2221A	.25	.18	.15	2N 5127	.15	.12	.10
BCY 71	.22	.14	.13	2N 2222	.23	.14	.17	2N 5129	.15	.12	.10
BCY 71A	.23	.14	.13	2N 2222A	.25	.18	.15	2N 5131	.15	.12	.10
BCY 72	.13	.10	.08	2N 2646	.42	.37	.34	2N 5132	.15	.12	.10
BF 115	.18	.14	.13	2N 2904	.18	.16	.14	2N 5133	.15	.12	.10
BF 167	.18	.14	.13	2N 2904A	.32	.24	.20	2N 5135	.18	.15	.12
BF 173	.20	.16	.15	2N 2905	.24	.20	.20	2N 5136	.15	.12	.10
BF 180	.35	.28	.25	2N 2905A	.35	.27	.23	2N 5137	.15	.12	.10
BF 194	.14	.12	.10	2N 2906	.24	.16	.16	2N 5138	.15	.12	.10
BF 195	.15	.13	.11	2N 2906A	.33	.25	.20	2N 5139	.15	.12	.10
BFX 12	.30	.25	.20	2N 2907	.30	.22	.18	2N 5142	.15	.12	.10
BFX 13	.30	.25	.20	2N 2907A	.35	.28	.23	2N 5143	.15	.12	.10
BFX 29	.30	.25	.20	2N 2923	.12	.10	.08	2N 5172	.10	.07	.05
BFX 30	.32	.27	.22	2N 2924	.12	.10	.08	2N 5180	.15	.12	.10
BFX 84	.24	.20	.16	2N 2925	.25	.18	.16	2N 5254	.36	.30	.24
BFX 85	.30	.26	.22	2N 2926 Red	.08	.06	.04	2N 5296	.38	.32	.28
BFX 86	.24	.21	.17	2N 2926 Org.	.09	.07	.05	2N 5298	.40	.36	.32
BFX 87	.27	.23	.18	2N 2926 Yel.	.10	.08	.06	2N 5490	.42	.38	.34
BFX 88	.25	.20	.16	2N 2926 Grn.	.10	.08	.07	2N 5492	.44	.40	.35
BFY 39	.90	.80	.70	2N 3053	.16	.12	.10	2N 5494	.52	.46	.38
BFY 50	.16	.13									

electronics TODAY INTERNATIONAL

APRIL

Vol. 1 No. 1

main features

- DO IT YOURSELF LOUDSPEAKER KITS** 13
A range of loudspeakers to suit your pocket
- SONEX '72** 14
ETT's guide to this important exhibition
- ICs IN VEHICLES** 16
The impact of electronics in motor vehicles - now and in the future
- SPACE TRACKING STATIONS** 20
The role of a tracking station in space exploration
- BIOLOGICAL FEEDBACK** 30
Or an exercise in self-programming
- IMPROVING ROOM ACOUSTICS** 32
Your living room acoustics can be dramatically improved
- A PRACTICAL GUIDE TO TRIACS—PART I** 41
These power control devices have many applications (first of three articles)
- SODALITE DARK TRACE TUBES** 49
These new tubes have many applications for the future
- HOW MANY WATTS** 60
Use this homograph to match your hi-fi equipment to the size of your room
- HOW TO MAKE MEASUREMENTS AUTOMATICALLY** 62
Data logging is now an important part of many manufacturing plants
- VIDEO CASSETTES** 67
Latest report on this exciting new audio/visual technology
- DOPPLER RADAR MODULE** 71
This low cost solid-state module

projects

- OSCILLOSCOPE CALIBRATOR** 12
Build this simple voltage calibrator into your oscilloscope
- WIDE-RANGE VOLTMETER** 36
This solid-state meter has 22 ranges - from 10mV to 1000V ac/dc
- DUAL POWER SUPPLY** 50
A laboratory PSU which can be programmable
- BASS REFLEX CABINETS** 57
Simplified approach to enclosure design produces very effective results

product tests

- DOLBY NOISE REDUCTION SYSTEM** 26
First test of the Dolby professional system
- A FIRST FOR FERROGRAPH** 44
We test the first reel-to-reel Dolby recorder - World Scoop Report

reviews

RECORDINGS — CLASSICAL, 77; RECORDINGS — JAZZ, 79; BOOK REVIEWS, 81

news&information

NEWS DIGEST, 6; EQUIPMENT NEWS, 73; COMPONENT NEWS, 75; SUPPLIERS GUIDE, 85; TECH TIPS, 83.

COVER: The main antenna of Australia's Honeysuckle Creek space tracking station. Full story on space tracking stations page 16.

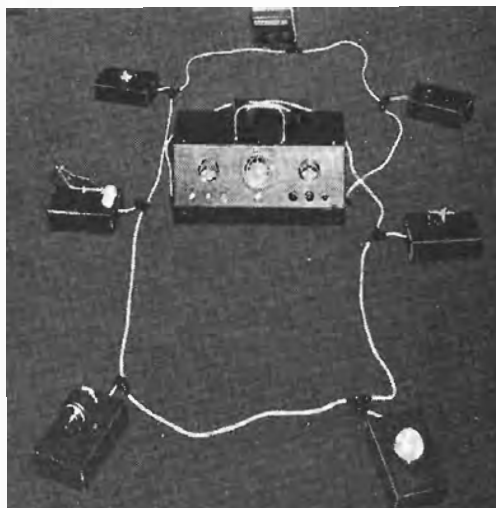

Electronics Today International, 107 Fleet Street, London EC4. Phone 01-353 1040. Published by WHITEHALL PRESS LIMITED, 29 Palace Street, London SW1. Phone 01-834 0423/4.

Australia: Modern Magazines (Holdings) Ltd, 21-23 Bathurst Street, Sydney 2000. Phones 26-2296, 26-6129. USA: A.C.P., Room 401, 1501 Broadway, New York. Japan: Bancho Media Service, Shinanomachi, Shinjuku-ku, Tokyo. Distributed by Argus Press Ltd. Printed by Alabaster Passmore & Sons Ltd, London & Maidstone.

Thermostat with Probe. Made by the famous Ranco Thermostat Co. Covers the range from approx. 0°-200°C variable by a control spindle, handles currents up to 16 amps. Length of capillary and sensor tube approx. 5'. These are ideal. These are ideal. These are ideal. Price 50p each or 10 for £4.50.

Small Tuning Condenser as fitted to many imported Japanese and Hong Kong radios. 2 gang about 200 pF per gang. Size approx. 1" by 1" with a 1/2" diameter spindle with dust cover. 25p each or 10 for £2.25.

Heat Sink. Small type as used with OOB1 etc. Price 5p each or 10 for 45p.

High Voltage Condenser. 265 mfd 1500V RMS which means that these have a D.C. rating of over 4000v. 75p each or 10 for £6.75.

125w Starter. For 8 fluorescent tubes. Mazda 1 1/2" canister 4 pin base. Price 20p each or 10 for £1.80.

IF Transformers. 465 K.C. double tuned and made for transistor circuits. 35p per set of 3. 10 sets for £3.15.

Spectacle Frames. (No lenses) with built in hearing aids. The amplifier and battery being housed in the arms. Although these are complete hearing aids we are selling them purely for the sub miniature components they contain. We give no guarantee that they are in working order also these may be second hand. Price £2.50 each.

Giant Rev. Counters. This is an 8" diameter moving coil meter with extra long (260°) pointer movement. In A full scale deflection. New and guaranteed perfect. Probably costing anything up to £20. Limited number only, our price £5.50 each plus 40p post and insurance.

Foot Switch. Twin levers each of which operates a 10 amp QMB change over switch. Price 90p each.

9V Gram Unit. On unit plate with 33-45 change lever, complete with turntable price £2.25 each plus 20p post and insurance.

18 Way Plug and Socket. 15p per pair. 10 pairs for £1.35.

1 Hour Minute Timer. Made by Smiths complete with control knob and calibrated dial. This month's special bargain at 50p. Useful in the Kitchen, Office and Dark-room etc.

Programmers. 5 Revs per minute. Made by Magnetic Devices Ltd. The contacts may be set to trigger anywhere around the shaft, ideal for relayed lighting displays, sequential switching etc. Drive motors are 200-240V 50Hz. Model A has 5 change over contacts. Price £1.50. Model B has 11 change over contacts. Price £3.00.

Programmers. 6 Revs per minute. Similar to previous items but Swiss made and having 8 sets of change over contacts. Motor 200-240V 50Hz. Price £2.50 each.

Black Heat Elements. Copper clad 1/2" tubular construction replacements in Tricity and many other cookers. Also suitable if connected in series to heat airing cupboards and for other low temperature applications. The following types are available: 200W Model 14" long x 1 1/2" wide. Made by Backer. Price 75p or 10 for £6.75. 220W Model. W shaped. 14 1/2" long x 9 3/8" wide. 85p each or 10 for £7.50.

Radiant Cooker Rings. As fitted to Tricity and many other popular cookers. We have two types. These are copper clad 1/2" tubular construction. Both models having an external diameter of 6 1/2" and the elements have been slightly flattened to increase radiation. Backer Type 7D1-2000 watt. 1 1/2" cover, size approx. 3" x 1 1/2" x 1 1/2" over the element connections. So in addition to being a replacement this could also quickly be made into a boiling ring as it only needs mounting on a simple iron frame. This element is rated 200-210v but it is perfectly safe on 240v and as these are usually thermostat controlled the lower voltage rating is not all that important. Price 75p each or 10 for £6.75. Backer Model 7D1 MkII again 2000 watt rated but 230-240v, has no cover over element ends. Price 85p each or 10 for £5.85.

Tricity Cooker Elements We have quite an assortment of these and will describe them in future issues - but if in the meantime you are needing these then please let us have a sketch, we may have the exact one in stock.

Slide Switch. 2 pole change over lamp mounting by two 6 BA screws. Size approx. 1" x 3/8" rated 250V lamp, 6p each. 10 for 54p. 100 for £5.10. 500 for £24.

Thermal Trip. Bakelite encased called the "Klixon". Current passes through the heater coil and bi-metal strip clicks the circuit open should the current exceed 3 amps. Quite small and with tag and lead connections. Ideal for protecting transformers or motors. Price 25p each or 10 for £2.25.

Mains Transformer. Primary 240v tapped 220v. Secondary 20v 1 amp. Price 60p each or 10 for £5.40.

Transformer. Primary 230-240v. Secondary 6.5-6.5v. 1 amp. With fitted primary screen. 65p each or 10 for £5.85.

Dial Thermometer - reading from 200-252F used on Tricity and other cookers. This has a flange and can be mounted through a 1 1/2" hole or alternatively it can just be rested on the object whose temperature it is required to measure. Size approx. 1 in. dia by 1 in. thick. Rated at 500 MW. wire ended. 43p. Suit most circuits.

Small Croc. Clips. Suitable for instruments etc. 5p each or 10 for 45p.

Bell Transformer. Normal mains input 4, 6, 8V output, normal bakelite case with protective connections. 75p each.

Free Fluorescent Fittings. To callers only. We offer this special opportunity to acquire some multiple fluorescent lighting units ideal for use on false ceilings or could be hung over work bench or growing plants etc., where extra lighting is required. We have units well made from heavy gauge sheet steel enamelled white models to take either 4 x 5' tubes, 4 x 4' tubes or 3 x 5' tubes. We are making no charge for the fittings only asking for the price of the control gear alone. £4.80 for the 4 x 5' tubes. £4 for the 4 x 4' tubes and £3.60 for the 3 x 5' tubes.

Sub Miniature Slide Switch. DPDT 19mm (3/4" approx.) between fixing centres. 12p each or 10 for £1.08.

LIGHT CELL
Almost zero resistant in sunlight increases to 10K. Ohms in dark or dull light, epoxy resin sealed. Size approx. 1 in. dia by 1/2 in. thick. Rated at 500 MW. wire ended. 43p. Suit most circuits.

CAR ELECTRIC PLUG
Fits in place of cigarette lighter. Useful method for making a quick connection into the car electrical system. 38p each or 10 for £3.42.

NUMICATOR TUBES
For digital instruments, counters, timers clocks, etc. Hi-vac Xh.3. Price 89p each 10 for £8.

POCKET CIRCUIT TESTER
Test continually for any low resistance circuit, house wiring, car electricals. Tests polarity of diodes and rectifiers. Also ideal size for conversion to signal injector (circuit supplied). 30p or 21or 50p. Post paid.

12 WAY SUB-MINIATURE MULTI-CORE CABLE
7000 copper cores, each core P.V.C. insulated and of different colour. P.V.C. covered overall and approx. 3/16in. thick. Price 20p per yard.



SMITHS 24-HOUR 2 ON/2 OFF TIME SWITCH
This is the popular model, as used in the Autoser and Morphy Richards time switches. Once programmed, this will repeat until reprogrammed. For window lighting, house protection, etc. Only needs a case and an output socket. 230V 50 cycles. Contacts switch up to 14 amps. Price £2.75, p & p 25p

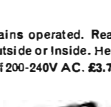

FIRE ALARM BELL
Mains operated. Really loud ring 6" gong. Size approx. 12" x 6" x 4 1/2", suitable outside or inside. Heavy cast case with 2" conduit entry. Made by A.F.A. Operates off 200-240V AC. £3.75 plus 60p.



MULLARD AUDIO AMPLIFIER MODULE
Uses 4 transistors, and has an output of 750mW into 8 ohms speakers. Input suitable for crystal mic. or pick-up. 9 volt battery operated. Size 2" long x 1 1/2" wide x 1" high. SPECIAL SNIP PRICE 60p each. 10for £5.40

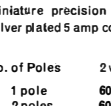

INSTRUMENT SWITCHES
Miniature precision switches with 1" dia. moulded wafers. Silver plated 5 amp contacts, standard 1/2" spindle.

No. of Poles	2 way	3 way	4 way	5 way	6 way	8 way	9 way	10 way	12 way
1 pole	60p	60p	60p	60p	60p	60p	60p	60p	60p
2 poles	60p	60p	60p	60p	60p	60p	60p	60p	60p
3 poles	60p	60p	60p	60p	60p	60p	60p	60p	60p
4 poles	60p	60p	60p	60p	60p	60p	60p	60p	60p
5 poles	60p	60p	60p	60p	60p	60p	60p	60p	60p
6 poles	60p	60p	60p	60p	60p	60p	60p	60p	60p
7 poles	60p	60p	60p	60p	60p	60p	60p	60p	60p
8 poles	60p	60p	60p	60p	60p	60p	60p	60p	60p
9 poles	60p	60p	60p	60p	60p	60p	60p	60p	60p
10 poles	60p	60p	60p	60p	60p	60p	60p	60p	60p
11 poles	60p	60p	60p	60p	60p	60p	60p	60p	60p
12 poles	60p	60p	60p	60p	60p	60p	60p	60p	60p

2 AMP VARIAC
Variacs without a doubt are a most useful device and no workshop should be without two or three of them. Special purchase enables us to offer ex-equipment but mechanically and electrically sound. 2 amp. Variac's at the very low price of £3 each, plus 50p post. etc.

THIS MONTH'S SNIP

Fluorescent Tubes 15p each. Here is a golden opportunity to light up those murals and pelmets and to put lights where you have often planned to have them or if plant growing is your hobby why not install a bank over your forcing bench - remember we can supply the control gear at very low prices too, (£1 per set).

This is a Special Spring Offer. First grade tubes all by best makers and all at the low price of 15p each in boxed lots of 24 similar type or 20p each for less than 24. All the tubes are perfectly standard having normal bi-pin ends and all are white (coloured tubes available if required). Following types available:- 18" - 15 watt; 24" - 40 watt; 36" - 40 watt; 39" - 40 watt. All at the same low price and even lower prices if you buy a large quantity. Sorry but we cannot despatch less than a box of 24 as the cost of carriage and packing would be prohibitive, however you may mix the 24 to your requirement and the special price for a mixed 24 would be £4. If not collecting please add 50p per box per 200 miles.

BATTERY CONDITION TESTER
Made by Mallory but suitable for all batteries made by Ever Ready and others, most of which are zinc carbon types but also mercury manganese - nicad - silver oxide and alkaline batteries may be tested. The tester puts a dummy load on the battery and the meter scale indicates the condition depending upon which section the pointer rests. The section reads "replace", "weak" or "good". The tester is complete in its case, size 3 1/2" x 6 1/2" x 2" with leads and prods. Price £1.75 plus 20p postage.

DISTRIBUTION PANELS
Just what you need for work bench or lab. 4 x 13 amp sockets in metal box to take standard 13 amp fused plugs and on/off switch with neon warning light. Supplied complete with 7 feet of heavy cable. Wired up ready to work. £2.25 less plug; £2.50 with fitted 13 amp plug; £2.65 with fitted 15 amp plug, plus 23p P. & P.

AMPLIFIER MAINS TRANSFORMER
50V 1 1/2 amp. Upright mounting with fixing brackets and metal shrouds to contain magnetic field, 50c/s primary, tapped 110V, 117V, 210V, 230V and 250V. 2 secondaries, one 50V 1 1/2 amp. other 6V 1 amp for pilot light, etc. £1.95 postage 30p

COMPUTER TAPE
2,400ft. of the Best Magnetic Tape money can buy, users claim good results with Video and sound. 1in. wide £1.00 plus 33p post and insurance, with cassette, 1 1/2in. wide £1.00 plus 30p post and insurance with cassette. 1/2in. wide 75p plus 25p post and insurance with cassette. Spare spools and cassettes - 1in. 75p, 1/2in 75p each plus 20p post and insurance.

CAPACITOR DISCHARGE CAR IGNITION
This system which has proved to be amazingly efficient and reliable was first described in the *Wireless World* about a year ago. We can supply kit of parts based on *Practical Wireless* circuit, June. Price £4.95 plus. When ordering please state whether for positive or negative systems. Deluxe model £6.95. Deluxe model made up ready £8.95. All plus 30p, p. & p.

SMITHS 20 AMP CLOCK SWITCH
This is a famous Smiths Clock with 20 amp on/off switch. (Switch on/off time is continuously variable.) A beautiful unit. Offered at less than the cost of the clock alone. £2 with application notes and circuits. Glass front and bezel 75p extra. Post and Insurance 20p.

SOLDER GUN
A must for every busy man, gives almost instant heat also illuminates job. Dual heat 100/140 watt £3.75 plus post & ins. 20p. BIG JOB 250 watt model £4.75 plus post & ins. 40p.

THERMOSTATS
Type "A". 15 amp, for controlling room heaters, greenhouses, airing cupboard. Has spindle for pointer knobs. Quickly adjustable from 30-38 deg. F. 471p plus 5p post. Suitable box for wall mounting. 25p. P. & P. 5p.
Type "B" 10 amp. This is a 17in. long rod type made by the famous Sumvic Co. Spindle adjusts this from 60-650 deg. F. Internal screw alters the setting so this could be adjustable over 30 deg. to 1000 deg. F. Suitable for controlling furnace, oven, kiln, immersion heater or to make flame-stat or fire alarm. 421p plus 12p post and insurance.

Type "D". We call this the Ice-stat as it cuts in and out at around freezing point, 2/3 amps. Has many uses, as of which would be to keep the lawn pipes from freezing, a length of our blanket wire (16 yd.) 50p is wound round the pipes. 371p. P. & P. 5p.
Type "E". This is standard refrigerator thermostat. Spindle adjustments cover normal refrigerator temperature. 471p, plus 5p post.
Type "F". Glass encased for controlling the temperature of liquid - particularly those in glass tanks, vats or sinks - thermostat is held (half submerged) by rubber sucker or wire clip - Ideal for fish tanks - developers and chemical baths of all types. Adjustable over range 50 deg. to 150 deg. F. Price 90p plus 10p post and insurance.

HIGH ACCURACY THERMOSTAT
Uses differential comparator I.C. with thermistor as probe. Designer claims temperature control to within 1/10th of a degree. Complete kit with power pack £5.50.
Recorded Tapes. Not cassettes but normal 5" spools. 3 1/2" speed, suit most tape recorders, Mainly World Record Club. Popular and Classical. We have over 150 titles now in stock. Price 65p each or 5 for £2.50. Send for list of titles interested.

TREASURE TRACER
Complete Kit (except wooden battens) to make the metal detector as the circuit in *Practical Wireless* August issue. £2.95 plus 20p post and insurance

DRILL CONTROLLER
New 1kW model.
Electrically changes speed from approximately 10 revs, to maximum. Full power at all speeds by finger-tip control. Kit includes all parts, case, everything and full instructions £1.50, plus 13p post and insurance. Made up model also available £2.25 plus 13p p. & p.

MAINS OPERATED CONTACTOR
220/240V 50 cycle solenoid with laminated core so very silent in operation. Closes 4 circuits each rated at 10 amps. Extremely well made by the German Electrical Company. Overall size 2 1/2" x 2 1/2" in. £1 each.

DOUBLE LEAF CONTACT
Very slight pressure closes both contacts. 6p each. 60p doz. Plastic push-rod suitable for operating, 5p each, 45p doz.
AUTO-ELECTRICAL CAR AERIAL
with dashboard control switch - fully extendable to 40in. or fully retractable. Suitable for 12V positive or negative earth. Supplied complete with fitting instructions and ready wired dashboard switch. £5.75 plus 25p post and ins.

TOGGLE SWITCH
3 amp. 250V, with fixing ring. 71p each 75p doz.

MICRO SWITCH
5 amp. changeover contacts. 9p each, £1.00 doz. 15 amp. on/off 10p each or £1.05 doz. 15 amp. changeover 15p, 10for £1.35.

MINIATURE WAFER SWITCHES
2 pole, 2 way; 4 pole, 2 way; 2 pole, 3 way; 4 pole, 3 way; 2 pole, 4 way; 3 pole, 4 way - 2" pole, 6 way 1 pole, 12 way. All at 18p each, £1.80 dozen, your assortment.

WATERPROOF HEATING ELEMENTS
26 yards length 70V. Self-regulating temperature control. 50p post free.

BLANKET SWITCH
Double pole with neon let into side, so luminous in dark. Ideal for dark-room light or for use with waterproof element near plastic case 23p 10 for £2.25 3 heat model 38p, 10 for £3.42.

HEARING AID AMPLIFIERS
(Ex behind ear deaf aids.) Transistors on tiny P.C. board with volume control whole thing only about half as big as Oxo cube. £1.75 or with sub-miniature microphone and L.S. attached £3.50.

ELECTRIC CLOCK WITH 20AMP. SWITCH
Made by Smith's these units are as fitted to many top quality cookers to control the oven. The clock is mains driven and frequency controlled so it is extremely accurate. The two small dials enable switch on and off times to be accurately set, also on the left is another time or alarm - this may be set in minutes up to 1 hour. At the end of the period a bell will sound. Offered at only a fraction of the regular price £2.50, less than the value of the clock alone, post and ins. 15p.

QUICK CUPPA
Mini Immersion Heater. 350W, 200/240V. Boils full cup in about two minutes. Use any socket or lamp holder. Have at bedside for tea, baby's food, etc. £1.25, post and insurance 14p. 12V car model also available. Same price. Jug model also available £1.50 plus P. & P. 14p.

SNAP ACTION SLIDE SWITCH
Rated 5A. 240V. Made by Arrow. Type fitted in the handles of electric drills, vacuums, etc. 5p each, 10 for 45p.

Where postage is not stated then orders over £5 are post free. Below £5 add 20p. S.A.E. with enquiries please.

J. BULL (ELECTRICAL) LIMITED
Dept. E.T.7, Park Street, Croydon, CRO 1YD

tomorrow starts today



Paul Godden
Editor
Electronics Today International



Donn Donovan,
Advertising Manager,
Electronics Today International

Collyn Rivers
Editorial Director
(International Editions)

Acoustical Consultants
Louis A. Challis & Associates

WELCOME to the first issue of **ELECTRONICS TODAY INTERNATIONAL** — a new monthly magazine covering all aspects of electronics, in Britain and throughout the world.

We've put the world **TODAY** in the title, but it's also a magazine of tomorrow — for in the fast moving world of electronics, tomorrow starts today.

ELECTRONICS TODAY INTERNATIONAL is designed to appeal not only to enthusiasts but also to everyone who becomes involved in electronics, either casually or as part of everyday life.

And most of us are involved, in one way or another.

For electronics is everywhere and in everything. The milk in your coffee was electronically tested, your mail was electronically checked; and, appropriately enough, this very journal is electronically typeset through our own IBM computer — and printed on one of the most modern presses in the world — electronically controlled, of course.

Our constructional projects will reflect the extent to which electronics is becoming an intrinsic part of life today.

They will be practical — and they will work.

Our editorial format will be wide, covering electronics' ever-growing involvement in science, industry, commerce, education, space, behavioural science — from all over the world.

The offices of **ELECTRONICS TODAY INTERNATIONAL** in London, Sydney, New York and Tokyo are teleprinter-linked to bring you the news as it happens.

Our approach will remain topical and practical. Topical because last month's news is this month's history, practical because electronics has become a way of doing things — of solving problems — it is no longer an end in itself.

This policy is reflected in our equipment reviews. We will outline what a unit does, who would use it, and how it would solve particular problems — plus the specifications for those who need them.

On the hi-fi scene, dramatic technical developments necessitate a whole new approach to equipment testing.

ELECTRONICS TODAY INTERNATIONAL has anticipated these developments by retaining one of the world's leading acoustical consultants — **Louis A. Challis & Associates** — as our testing authority.

Our test reports will be the most comprehensive and accurate reports ever published in any electronics magazine anywhere.

This is a time of change, of excitement, of achievement — and **ELECTRONICS TODAY INTERNATIONAL** is a journal of this time.



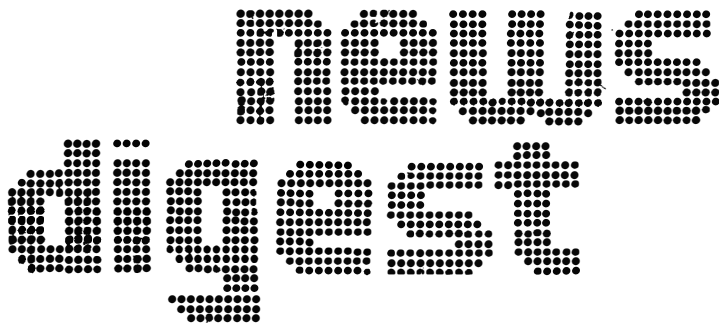

300 MPH HOVERTRAIN – PUBLIC SHOWING

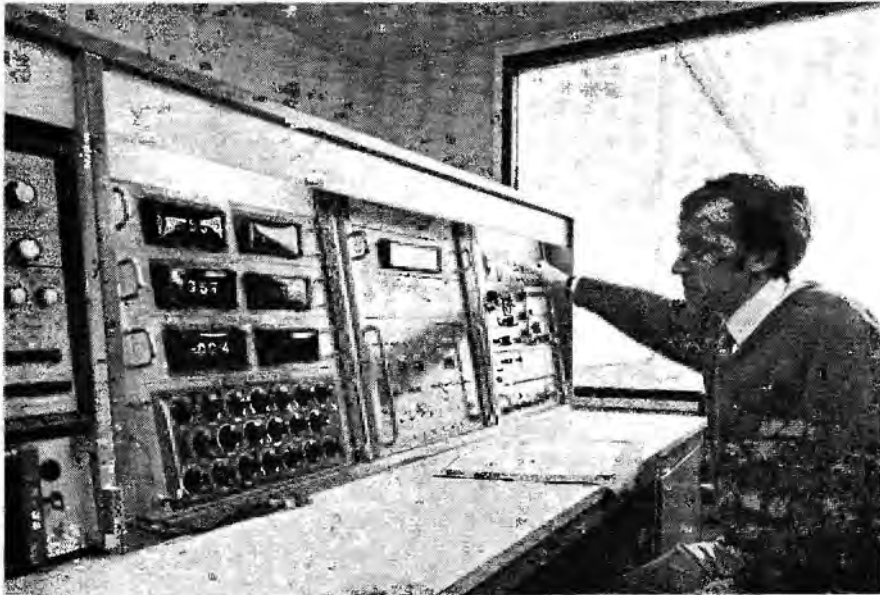

Computerised control and data recording equipment that can handle information from up to 413 different sources will be used in the development of Britain's tracked hovertrain – during its period of full-scale development.

From this console, commands will be transmitted by radio to the hovertrain and radioed signals from the measuring instruments inside the vehicle will be received, recorded and analysed.

The 25-ton vehicle straddles the track and is supported approximately an inch above it by a system of fans employing the hovercraft principle. The linear motor consists of an aluminium strip set into the top of the track as the motor's "stator", and a complex set of electrical windings mounted inside the body shell. Power is picked up from a trackside rail.

The train made its first run over a mile of the track recently, watched by visiting experts and the press from several countries. It performed perfectly during the slow-speed run and is now expected to reach speeds of up to 90 mph during the next two months.

The hovertrain has been designed and constructed by Tracked Hovercraft

Ltd., a company set up by Britain's National Research Development Council, and would be capable of providing a link between central London and the airport planned for Foulness, its passengers completing the journey in quiet pollution-free comfort in about 20 minutes.

FOUR CHANNEL DISCS

In the UK the EMI group have announced plans to release quadraphonic discs – using the CBS developed 'SQ Matrix' system – in April.

The company claims that the new discs will be fully compatible with existing stereo equipment.

EVR CASSETTES

The British EVR organization will be releasing their 1972 catalogue of Educational and training EVR cassettes in March. A list of their releases can be obtained, free of charge, from EVR Partnership, Vogue House, 1 Hanover St. London, W1.

BIAS – AUTOSELECTION

Cassette tape recorders that have been designed specifically for use with chromium dioxide tapes require special bias switching facilities.

At present this is done manually. However the latest BASF 'SM' chromium dioxide cassettes have a notch on the rear of the cassette (in addition to the tab now used to prevent erasure of recorded material) and, hope BASF – and Philips who are backing the system – future cassette players will have a switch mechanism actuated by this tab to bring in the necessary bias circuitry.

ELECTRONIC WATCHES

Motorola are marketing an electronic watch package consisting of one of their own complementary MOS circuits, an ultra-stable precision quartz crystal and a miniature motor.

The package is being developed by a special products group in the USA, and uses circuits from the Motorola Semiconductor Products Division, and crystals from the Consumer and Electronics Division.

Prices have not yet been disclosed, but Motorola say that they will quote immediately for individual orders.

IDEA LOOKING FOR A JOB

Many ideas that tantalize the scientist cannot be pursued within the normal framework of research. Often more pressing problems take priority, leaving individuals to ponder the practicality of ideas that are simple, yet teasing.

Over ten years have passed since Dr. Alan Head, a solid-state physicist of the Division of Tribophysics at the Commonwealth Scientific and Industrial Research Organization in Australia, conceived the idea of a plate that continually radiates heat to outer space, but it remains a fascinating idea in search of an application.

Dr Head noticed that the Earth's atmosphere and certain materials such as silicon monoxide had approximately the same 'radiation window'. In other words, they only transmit heat radiation in a narrow range of wavelengths and this range is not in the region where most solar radiation energy is received. Thus, Dr Head reasoned, if a surface, exposed to a cloudless sky, could be made to radiate at these wavelengths and reflect strongly at other wavelengths, there would be a net loss of radiant heat to outer space.

Surfaces with these radiation characteristics can be made, for

example, by depositing a very thin layer of silicon monoxide on a highly polished surface of aluminium. If the sheet is thermally insulated from its immediate surroundings, the temperature of the sheet should fall.

Can this idea be put to work? Independent work by Mr R.N. Morse, Chief of the CSIRO's Division of Mechanical Engineering, led to other speculations on the cold plate idea.

Mr Morse realized that transparent polyethylene sheet has a radiation window in about the centre of the region where the human body radiates most of its heat. A well-insulated cold plate with one surface covered with polyethylene should allow a person to lose heat to that plate without having to lower the temperature of the surrounding air. In this way, comfort cooling panels have been produced and tested.

But, suppose Dr Head's cold plates were used in a ceiling or wall panel of a room, with silicon monoxide on the outside, polyethylene on both inside and outside, and the entire plate insulated against heat flow from its surroundings. Would this radiant heat exchanger enable people to keep cool in the tropics without air-conditioning by radiating to the deep cold of outer space?

The answer would appear to be, for all practical purposes, no.

The National Research and Development Council of Britain and the National Research Corporation in the United States have been looking for people to take up the radiant cold plate idea and make it work. However, because the radiant intensity is so low, large areas are required and the fact that dull weather 'closes' the radiation window combines with other obstacles to ensure that the eternally radiant cold plate remains just a fascinating idea.

ECOLOGICAL CITROEN

In France, Citroen are working jointly with the Total petroleum company to produce an electrically powered commuter type vehicle. Surprisingly, present development is concentrated on producing a 'clean' efficient fuel cell, rather than high energy density batteries.

The long term objective, according to a company spokesman, is for the power source to take in dirty air and exhaust clean air!



NEW PHONE ENABLES DEAF TO "SEE" MESSAGES – THE DEAF AND BLIND TO "FEEL" THEM

A new telephone which will allow the deaf to "see" messages in coded flashes of light and the blind to "feel" them in the vibrations of a finger pad is being developed for by Bell Telephone at their Indianapolis, New Jersey laboratories.

Called the Code-Com set, it is one of two new 'phones which will make calling possible for handicapped persons. The second is a set with a volume control receiver for public coin telephones.

The Code-Com set is for people who are totally deaf, deaf and blind, or deaf and mute. It consists of a conventional telephone and a signal unit containing a light bulb, a vibrating disc, and a sending key.

While a telephone ordinarily converts speech into electrical impulses which are transmitted and reconverted to speech at the receiver, the Code-Com set converts the transmitted signals into flashes of light and vibrations of the disc or sensor pad. Thus, a deaf or deaf and blind person can "read" simple messages by using a question and answer system, or more complex messages by using a pre-arranged code such as Morse code. Using the sending

key like a telegraph key, a person without normal speech can send light or vibration signals to another Code-Com set or coded sound signals to a regular telephone.

The Code-Com set may be used with a separate signal control unit, which is connected to the ringing circuitry of a conventional telephone. A telephone "ring" is indicated when the control unit switches a light, electric fan, or some other light-duty appliance on or off.

Field trials of experimental models of the Code-Com set have been held in Indianapolis, New York City and Columbus, with the assistance of handicapped persons and local telephone companies. After some practice with Morse code users were able to attain sending and receiving speeds of about 10 words per minute.

The second set — the volume control handset — is being developed for public phone locations, such as bus, train, and airline terminals, where it must serve customers with normal hearing as well as those with impaired hearing. Customers with impaired hearing can use a three-position switch to increase the volume of sound from the receiver. Persons with normal hearing can use the phone at either normal volume or amplified volume for noisy booth locations.

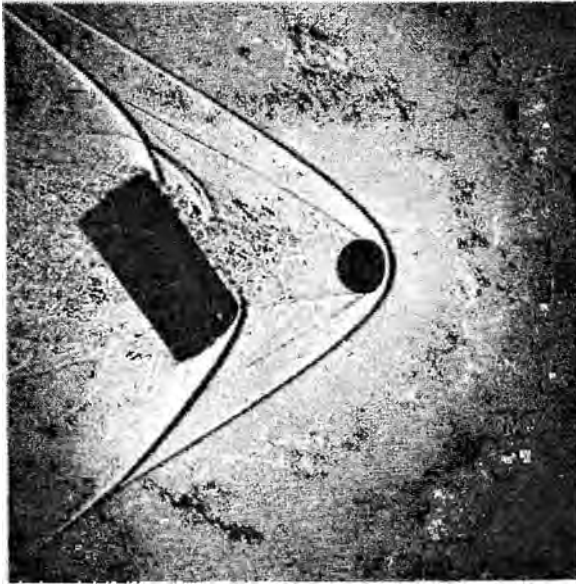

HIGH SPEED SHADOWGRAPH

This remarkable photograph of a steel ball (and wooden blank) fired from a 37 millimetre cannon, has captured their shadow as they pass between an electrical spark and a sheet of film. This shadowgraph was exposed for slightly less than one millionth of a second.

The new electro-photographic technique was developed by the Canadian National Research Council's Division of Mechanical Engineering.

PHOTOMULTIPLIERS DETECT ARCHAEOLOGICAL FORGERIES

Expert forgeries of ancient ceramics and pottery which have evaded discovery by archaeological experts can now be detected successfully by a new dating technique in which EMI photomultiplier tubes are used. This development was highlighted in a lecture, "Physics in Archaeology", given by Dr. M. J. Aitken, deputy director of Oxford University's Research Laboratory for Archaeology and the History of Art, at the Royal Institution in London recently.

Dr. Aitken explained the process of thermoluminescent dating – a technique pioneered by his department for estimating the age of ancient ceramics and pottery by analysing the luminescence glow of a heated sample. Dr. Aitken made the point that as these types of archaeological specimens age, they acquire a greater amount of energy

which gives rise to luminescence. Therefore, by using a set of parameters, it is possible to measure this "glow" and to date accurately pieces many thousands of years old.

In this research, the role of the photomultiplier tubes is to detect these low levels of luminescence and convert them into electrical quantities which can be measured accurately. One such tube is the EMI type 9635QB – a 2-inch diameter photomultiplier used in many liquid scintillation spectrometer systems throughout the world. It is also extensively employed in applications where high quantum efficiency and low dark current are important.

The 9635QB has a bialkali photocathode with a typical quantum efficiency of 27% at 3800Å. It is made with a Spectrosil (fused silica) window which extends the UV response to ca. 1650Å and reduces background owing to the low natural radioactivity in the window.

DATA ENTRY PROGRAM

Large volumes of data may be entered directly into a computer quickly and accurately through the use of a new program product announced by IBM United Kingdom Limited.

The new program, called VIDEO/370, aids operators keying data into IBM's newest family of television-like computer terminals, the 3270 information display system.

With VIDEO/370, data entered into a 3270 is passed to IBM System/370 or System/360 disk storage for use in preparing reports, performing calculations or updating files.

VIDEO/370 data entry techniques can be used to capture data right at source. This capability saves time and enhances accuracy by eliminating intermediate data preparation steps. For example, a terminal operator serving a number of loading docks can enter records of incoming shipments directly from the packing slips. VIDEO/370 helps to ensure that the information is entered easily and correctly. When errors are detected, the operator can resolve them quickly and authoritatively since he not only possesses the original documents but also is close to the actual area where the goods have been received.

IBM also announced Version II of DATA/360. This program allows 3270s to be intermixed with IBM 2260 display stations for data entry operations.

VIDEO/370 is scheduled to become available in the third quarter of this year. The monthly charge, under a license agreement, will be £87.50 for both Disk Operating System (DOS) and Operating System (OS) versions. DATA/360 Version II is scheduled to become available in the third quarter also, with a monthly charge of £52.10 for both DOS and OS versions. First customer deliveries of the 3270 information display system from Greenock are scheduled for July 1972.

TWO PUBLICATIONS

Shure Electronics have published two new brochures:—

STUDIO MICROPHONES MICROPHONE CIRCUITRY

Studio Microphones describes and illustrates 11 microphones each specifically designed and constructed for broadcast, television, recording and motion-picture studio applications. The range of models shown covers every aspect of studio use with the added advantage that practically all can equally well be used away on location, indoors or outdoors.

Microphone Circuitry describes and illustrates the Shure range of electronic equipment associated with microphone usage, including four mixers, a broadcast production unit, an audio control centre, audio level controller and pre-amplifier together with a wide range of accessories. These audio circuitry products are ideal for practical, efficient and economic audio control in studio, broadcasting, recording or sound reinforcement applications. The range of models is adequate to cover virtually any assignment on which multiple microphones or other sound sources must be controlled.

Copies of both brochures are available from Shure Electronics Limited, 84 Blackfriars Road, London SE1 8HA.

TAPE CARTRIDGE SYSTEM

A new tape cartridge system called the HIPAC system, combining the features of conventional 8-track tape cartridges and cassette tapes, has been developed in Japan.

The Pioneer Electronic Corporation fulfilled a leading role in the development of the cartridge and accompanying recording/playback equipment, and also took the initiative in the formation of a consortium that is marketing the HIPAC system.

The need for the new cartridge was dictated by a number of factors. First and foremost, it was recognized by one and all that there was a tremendous growth potential in the packaged tape market in the seventies, a potential which predicted that packaged tapes could very easily assume a position superior to disc records.

However, it was also recognized that existing 8-track tape cartridges and cassette tapes had a number of inherent problems.

Eight-track tape cartridges are bulky and cumbersome to handle and, because of their design, there is the risk of fluctuations arising in pinch-roller pressure, which often leads to undesirable "wow" and "flutter" in tape motion.

On the other hand, cassettes, while compact and handy in size, require a complex tape drive mechanism; and also require automatic reversing devices for continuous uninterrupted recording and playback.

These problems indicated that a new tape cartridge, solving these inherent shortcomings, would serve as an impetus to the popularization and widespread use of packaged tapes in the future.

The new HIPAC tape cartridge embodies the following features:

- small in size (70 x 85 x 12 mm; weight 50 g);
- unlike cassette tapes, the HIPAC uses an "endless" tape for continuous, uninterrupted operation. This also facilitates operation on a relatively simple drive mechanism; provides trouble-free operation; and also lowers production costs;
- handling is simplified; there is no need to stop the machine and then turn the tape over;
- because of the small size of the cartridges, the size of the drive mechanism can also be reduced, a

- great advantage in designing stereo systems for motor cars;
- outstanding tonal quality;
- 2-speed operation is possible (can be operated at either 4.8 cm/s or 9.5 cm/s on the same tape drive mechanism);
- 4 tracks;
- maximum playing time: 60 min (at 4.8 cm/s).

Pioneer predicts that the new cartridge and accompanying hardware will, in due course, come to occupy a position equal to, if not surpassing, that presently held by 8-track tape cartridges or cassettes.

VOICE DIALLER



Development engineers at Bell Telephone Laboratories in Holmdel, New Jersey are working on a device that can dial telephone numbers when given spoken commands.

The system consists of a clockface with ten lights labelled with the numbers nought to nine. The lights are illuminated in numerical sequence.

To 'dial' a number the user makes a sound — any sound at all will do — as the required digit is illuminated. As each number is spoken, the associated lamp remains lit for an extended period, to indicate that the digit has been registered.

Each digit is stored — in the correct sequence — in a memory bank. The stored digits are then used to initiate the telephone dialling circuit upon command.

The stored number remains in the memory bank even after the dialling sequence and can be reused if the number is not immediately available.

The number is automatically erased when a new series of digits is generated by the user.

LUNAR SAMPLES

Samples of lunar surface material collected on Apollo missions 12 to 17 are to be made available by NASA for study by a small research group led by Dr. Brian Fitton, Head of the Surface Physics Division of ESTEC's Space Science Department. Also collaborating in the study will be a high-energy optics team led by Dr. R. Haensel of the German Electron Synchrotron in Hamburg.

The aim of the studies will be to investigate the nature of the sheath of photoelectrons and secondary emitted electrons that is formed above the sunlit side of the moon as a result of bombardment of the lunar surface by the intense ultraviolet light and particle fluxes from the sun.

The formation of this negatively-charged sheath causes the surface of the moon to be positively charged and sets up local electric fields which could interfere with certain experiments placed on the moon's surface. The electrostatic repulsion between the small positively-charged surface grains may result in erosion of sharp surface features on a microscopic scale. In addition, the electron sheath will refract long-wavelength radio waves. It is therefore desirable to know the extent and magnitude of the sheath and the resulting electric fields. This will be determined by measuring the photoelectron and secondary electron emission of the samples, which will be from several landing sites.

The project has group's current emission from satellite similar process of formation occurs. It some 12 to 18 study

LOGIC SIMULATION SOFTWARE

The Aviation Division of Smiths Industries gone to Redac, the computer-aided design specialists, for more software.

The latest purchase, REDAP 22, is a general purpose Network Simulation Process handling over 3,000 elements, with user oriented facilities for subcircuits, element library and delay time.

Sinclair Project 60



Project 605

The easy way
to buy and
build
Project 60



Project 605 is one pack containing: one PZ5, two Z30's, one Stereo 60 and one Masterlink. This new module contains all the input sockets and output components needed together with all necessary leads cut to length and fitted with neat little clips to plug straight on to the modules. Thus all soldering and hunting for the odd part is eliminated. You will be able to add further Project 60 modules as they become available adapted to the Project 605 method of connecting.

Complete Project 605 pack with comprehensive manual, postfree **£29.95**

All you need for a superb 30 watt high fidelity stereo amplifier.

Project 60 offers more advantage to the constructor and user of high fidelity equipment than any other system in the world.

Performance characteristics are so good they hold their own with any other available system irrespective of price or size.

Project 60 modules are more versatile – using them you can have anything from a simple record player or car radio amplifier to a sophisticated and powerful stereo tuner-amplifier. Either power amplifier can be used in a wide variety of applications as well as high fidelity. The Stereo 60 pre-amplifier control unit may also be used with any other power amplifier system as can the AFU filter unit. The stereo FM tuner operates on the unique phase lock loop principle to provide the best ever standards of audio quality. Project 60 modules are very easily connected together by following the 48 page manual supplied free with Project 60 equipment. The modules are great space savers too and are sold individually boxed in distinctive white and black cartons. With all these wonderful advantages, there remains the most attractive of all – price. When you choose Project 60 you know you are going to get the best high fidelity in the world, yet thanks to Sinclair's vast manufacturing resources (the largest in Europe) prices are fantastically low and everything you buy is covered by the famous Sinclair guarantee of reliability and satisfaction.

Typical Project 60 applications

System	The Units to use	together with	Units cost
Simple battery record player	Z.30	Crystal P.U., 12V battery volume control, etc.	£4.48
Mains powered record player	Z.30, PZ.5	Crystal or ceramic P.U. volume control etc.	£9.45
12 W. RMS continuous sine wave stereo amp. for average needs	2 x Z.30s, Stereo 60, PZ.5	Crystal, ceramic or mag. P.U., F.M. Tuner, etc.	£23.90
25 W. RMS continuous sine wave stereo amp. using low efficiency (high performance) speakers	2 x Z.30s, Stereo 60, PZ.6	High quality ceramic or magnetic P.U., F.M. Tuner, Tape Deck, etc.	£26.90
80 W. (3 ohms) RMS continuous sine wave de luxe stereo amplifier. (60 W. RMS into 8 ohms)	2 x Z.50s, Stereo 60 PZ.8, mains transformer	As above	£34.88
Indoor P.A.	Z.50, PZ.8, mains transformer	Mic., guitar, speakers, etc., controls	£19.43

F.M. Stereo Tuner (**£25**) & A.F.U. Filter Unit (**£5.98**) may be added as required.

Sinclair Radionics Ltd, London Road, St. Ives, Huntingdonshire PE17 4HJ. Tel: St. Ives 64311

sinclair

Project 60 Stereo F.M. Tuner

Built and tested. Post free.

£25



The phase lock loop principle was used for receiving signals from space craft because of its vastly improved signal to noise ratio. Now, Sinclair have applied the principle to an F.M. tuner with fantastically good results. Other original features include varicap diode tuning, printed circuit coils, an I.C. in the specially designed stereo decoder and squelch circuit for silent tuning between stations. In terms of a high fidelity this tuner has a lower level of distortion than any other tuner we know. Stereo broadcasts are received automatically as the tuning control is rotated, a panel indicator lighting up as the stereo signal is tuned in. This tuner can also be used to advantage with most other high fidelity systems.

SPECIFICATIONS—Number of transistors: 16 plus 20 in I.C. Tuning range: 87.5 to 108 MHz. Capture ratio: 1.5dB. Sensitivity: $7\mu\text{V}$ for lock-in over full deviation. Squelch level: $20\mu\text{V}$. Signal to noise ratio: $>65\text{dB}$. Audio frequency response: 10 Hz – 15 KHz ($\pm 1\text{dB}$). Total harmonic distortion: 0.19% for 30% modulation. Stereo decoder operating level: $2\mu\text{V}$. Cross talk: 40dB. Output voltage: $2 \times 150\text{mV R.M.S.}$. Operating voltage: 25-30VDC. Indicators: Stereo on; tuning. Size: $93 \times 40 \times 207\text{mm}$.

Stereo 60 Pre-amp/control unit

Built, tested and guaranteed.

£9.98



Designed for Project 60 range but suitable for use with any high quality power amplifier. Again silicon epitaxial planar transistors are used throughout, achieving a really high signal-to-noise ratio and excellent tracking between channels. Input selection is by means of push buttons and accurate equalisation is provided for all the usual inputs.

SPECIFICATIONS—Input sensitivities: Radio – up to 3mV. Mag. p.u. 3mV: correct to R.I.A.A curve $\pm 1\text{dB}$: 20 to 25,000 Hz. Ceramic p.u. – up to 3mV: Aux – up to 3mV. Output: 250mV. Signal to noise ratio: better than 70dB. Channel matching: within 1dB. Tone controls: TREBLE + 12 to -12dB at 10 KHz: BASS + 12 to -12dB at 100Hz. Front panel: brushed aluminium with black knobs and controls. Size: $66 \times 40 \times 207\text{mm}$.

A.F.U. High & Low Pass Filter Unit

Built tested and guaranteed.

£5.98

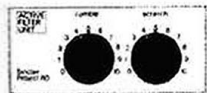

For use between Stereo 60 unit and two Z.30s or Z.50s. and is easily mounted. It is unique in that the cut-off frequencies are continuously variable, and as attenuation in the rejected band is rapid (12dB/octave), there is less loss of the wanted signal than has previously been possible. Amplitude and phase distortion are negligible. The A.F.U. is suitable for use with any other amplifier system. Two filter stages – rumble (high pass) and scratch (low pass). Supply voltage – 15 to 35V. Current – 3mA. H.F. cut-off (-3dB) variable from 28KHz to 5KHz. L.F. cut-off (-3dB) variable from 25Hz to 100Hz. Distortion at 1KHz (35V. supply) 0.02% at rated output. Size: $66 \times 40 \times 90\text{mm}$.

Z.30 & Z.50 power amplifiers

Built, tested and guaranteed with circuits and instructions manual. Z.30 £4.48 Z.50 £5.48



The Z.30 and Z.50 are of advanced design using silicon epitaxial planar transistors to achieve unsurpassed standards of performance. Total harmonic distortion is an incredibly low 0.02% at 15w (8 Ω) and all lower outputs. Whether you

use Z.30 or Z.50 amplifiers in your Project 60 system will depend on personal preference, but they are the same size and may be used with other units in the Project 60 range equally well.

SPECIFICATIONS (Z.50 units are interchangeable with Z.30s in all applications).

Power Outputs

Z.30 15 watts R.M.S. into 8 ohms using 35 volts:
20 watts R.M.S. into 3 ohms using 30 volts.
Z.50 40 watts R.M.S. into 3 ohms using 40 volts:
30 watts R.M.S. into 8 ohms using 50 volts.
Frequency response: 30 to 300,000Hz $\pm 1\text{dB}$.

Distortion: 0.02% into 8 ohms.

Signal to noise ratio: better than 70dB unweighted.
Input sensitivity: 250mV into 100 Kohms (for 15w into 8 Ω)

For speakers from 3 to 15 ohms impedance.

Size: $14 \times 80 \times 57\text{mm}$.

Power Supply Units

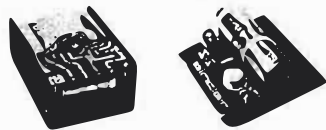

Designed special for use with the Project 60 system of your choice. Use PZ.5 for normal Z.30 assemblies and PZ.6 where a stabilised supply is essential.

PZ.6 30 volts un stabilised £4.98

PZ.6 35 volts stabilised £7.98

PZ.7 45 volts stabilised

(less mains transformer) £7.98

PZ.8 mains transformer £5.98

Guarantee

If within 3 months of purchasing Project 60 modules directly from us, you are dissatisfied with them, we will refund your money at once. Each module is guaranteed to work perfectly and should any defect arise in normal use we will service it at once and without any cost to you whatsoever provided that it is returned to us within 2 years of the purchase date. There will be a small charge for service thereafter. No charge for postage by surface mail. Air-mail charged at cost.

To: SINCLAIR RADIONICS LTD LONDON ROAD ST. IVES HUNTINGDONSHIRE PE17 4HJ

Please send

Name

Address

I enclose cash/cheque/money order.

ETD5

sinclair

OSCILLOSCOPE CALIBRATOR

ETD PROJECT 106

This simply-constructed voltage calibrator can be built into practically any existing oscilloscope.

THIS simple calibrator enables 50 Hz square waves of exact amplitude to be displayed on an oscilloscope.

The calibrator can be added to existing oscilloscopes, or built as an external accessory. It eliminates measuring errors due to gain controls, or probe dividers, as a calibration signal is obtainable by inserting the probe tip directly into the calibration output socket and checking the displayed calibration signal against the calibration control switch setting.

The oscilloscope time-base accuracy can also be checked with this calibrator — the 50 Hz square-wave signal is derived from the mains thus providing a stable 20 millisecond period.

The calibration voltage is derived from a 22 volt zener diode; this voltage is chopped at 50 Hz by the BC 108 transistor, trimmed to exactly 20 volts by the calibration potentiometer and applied across a chain of precision resistors.

The consumption of the unit is negligible and is energized by the power supplies of the oscilloscope to which the unit is fitted.

It is obviously impossible to give installation instructions for each individual make and type of oscilloscope — however all that is required is to locate an HT rail carrying between 250 and 350 volts for the main divider supply, and the

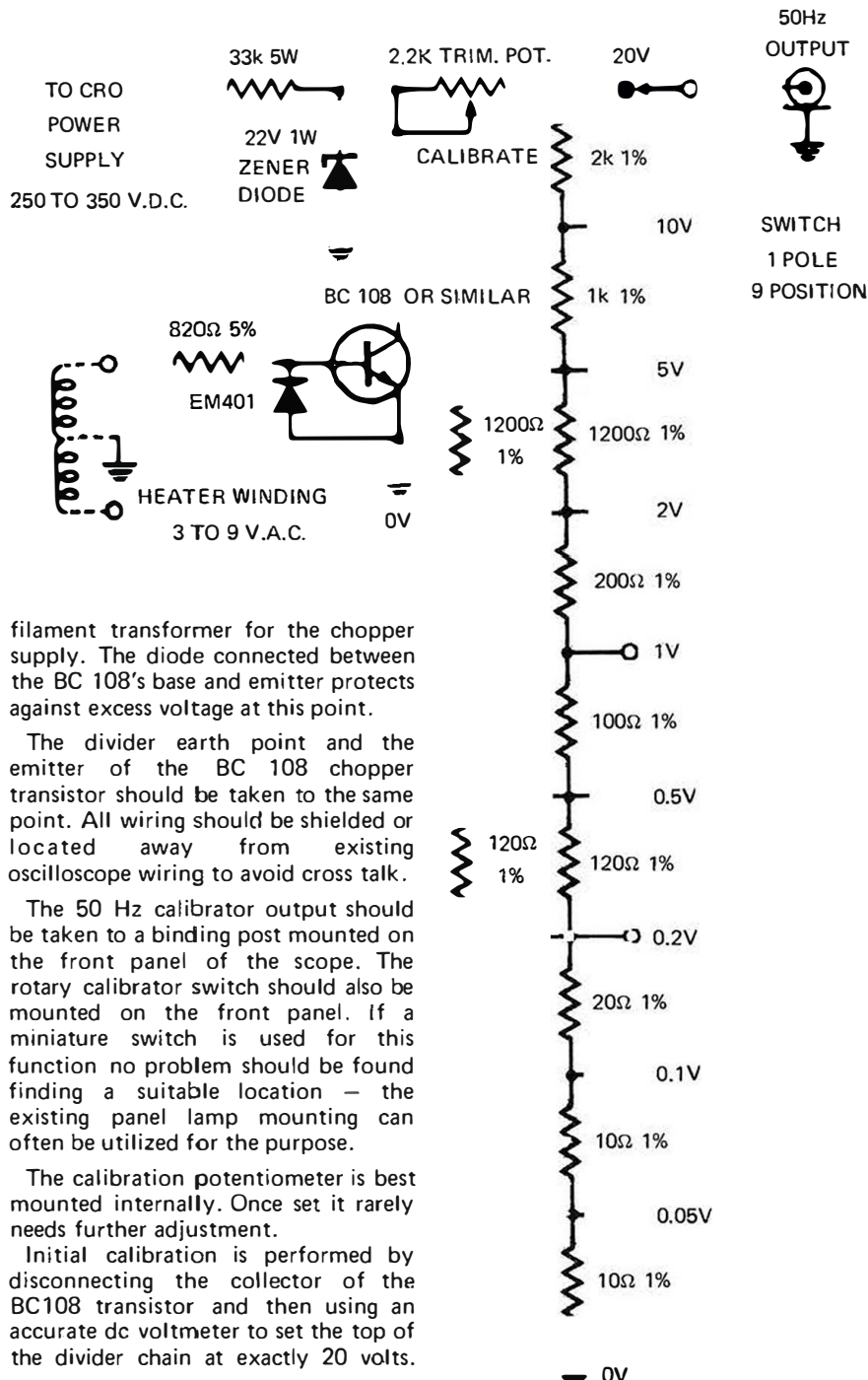

filament transformer for the chopper supply. The diode connected between the BC 108's base and emitter protects against excess voltage at this point.

The divider earth point and the emitter of the BC 108 chopper transistor should be taken to the same point. All wiring should be shielded or located away from existing oscilloscope wiring to avoid cross talk.

The 50 Hz calibrator output should be taken to a binding post mounted on the front panel of the scope. The rotary calibrator switch should also be mounted on the front panel. If a miniature switch is used for this function no problem should be found finding a suitable location — the existing panel lamp mounting can often be utilized for the purpose.

The calibration potentiometer is best mounted internally. Once set it rarely needs further adjustment.

Initial calibration is performed by disconnecting the collector of the BC108 transistor and then using an accurate dc voltmeter to set the top of the divider chain at exactly 20 volts.

Circuit of complete oscilloscope calibrator - note that some resistor values in the divider chain are obtained by parallel resistors of higher value.

DO IT YOURSELF LOUDSPEAKER KITS

ALTHOUGH the loudspeaker is the last link in the hi-fi chain it can be the weakest. And equally important is the most intimate, for this is the final link between man and machine.

This is the reason why would be purchasers of good quality hi-fi systems are always warned against buying loudspeakers too cheaply. Equally important is the fact that buying speakers from a specification sheet is not as good an idea as listening to the intended purchase.

Nowadays good speakers need not cost the earth, though the best will never be cheap, if one is prepared to exert a little effort and elbow grease. For there are on the market no end of good quality kits. But many of these contain purely the driver units themselves, not always a good

idea if woodwork is among your weak subjects. Other kits contain only the wood leaving you to find drivers to fit. Recently, however, EMI introduced a range of loudspeaker kits which may be purchased as either speakers, enclosures or both.

In order to test EMI's claim, that anyone able to handle a hammer and screwdriver could assemble one of their kits, ETI obtained a pair of the smallest – the LEK 850.

When it arrived it was duly opened and inspected on the office floor. This inspection proved EMI right in one aspect, everything needed for the assembly operation was there – even down to the glue and sandpaper. The only things missing were the necessary screwdriver, hammer and boot polish for filling any



cracks between joints in the woodwork – as specified in the instructions.

During the actual assembly the cabinet went together exactly according to plan, with one notable exception – the crossover network. Here nobody had mentioned that this needed soldering into place and worst of all there were no connection instructions for it. A quick phone call to EMI at Hayes soon sorted out that problem and the speaker became a working model.

The complete sequence of operations necessary to complete one of the speaker kits from EMI is shown in the illustrations on this page. The model shown here is the LEK 350 – somewhat larger than the LEK 850 assembled by ETI, nor did ours come equipped with a gorgeous blonde.

On completion ours gave a very pleasant sound despite its small size of $12 \times 6 \times 8$ inches. Although the bass wick on the amplifier needed turning up a bit to get the best out of it. Figures quoted for the LEK 850 give a nominal impedance of 8 ohms and free air frequency range of 75 Hz to 20 KHz. A novel feature is the use of Velco fastening to hold the grille to its support.

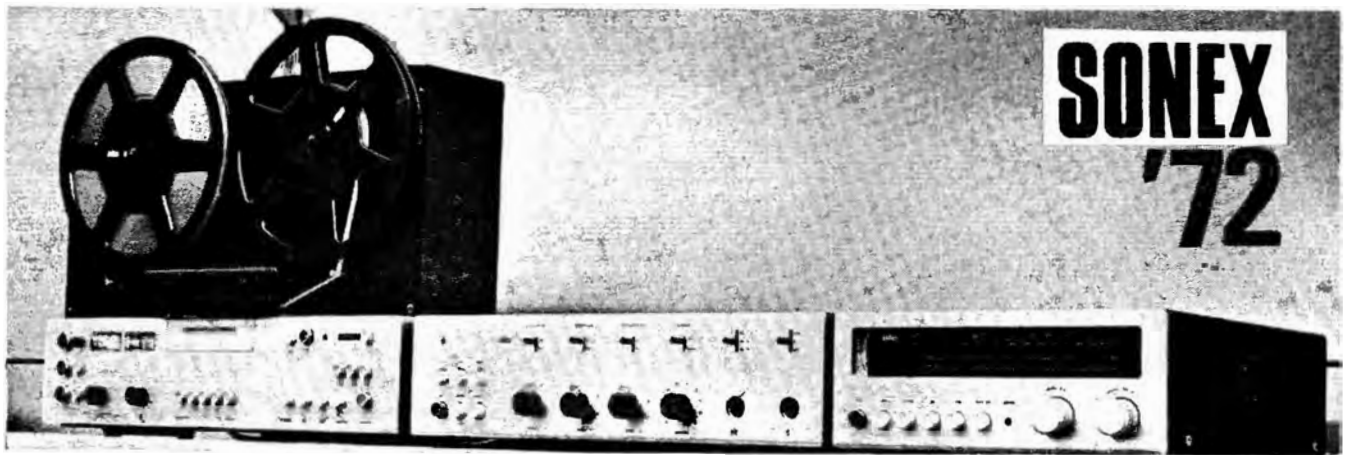

Paul Godden peeps through the doors of this year's show

ON Wednesday March 22, Heathrow's Skyway Hotel will throw wide its doors for the third Sonex exhibition — Sonex '72. This year it promises to be bigger and better than ever, with more to see and more to buy.

Apart from the hardware on show it will be interesting to analyse the type of year the manufacturers expect 1972 to be. For last year when Britain and other countries were undergoing an economic downturn, hi-fi makers were reporting record sales with the public being able to take all the manufacturers could produce. In fact, one manufacturer said that in 1971 for the first time, his hi-fi sales had exceeded his instrumentation sales.

An entirely new event for Sonex will be a number of Sound Seminars. These are scheduled to take place on the last three days of the show, that is March 24, 25, and 26, during the morning and the afternoon.

The morning sessions will cover the choice, use, and maintenance of audio equipment, while the afternoon sessions will describe trends and developments in home audio. Speakers will include a representative from Dolby Laboratories, another from Decca to talk about the Teldec disc, and a BBC engineer will discuss stereophonic broadcasting.

From the advance publicity it would appear that Sonex this year will follow the same trend as last year with the majority of new equipment on show being transducers. For instance

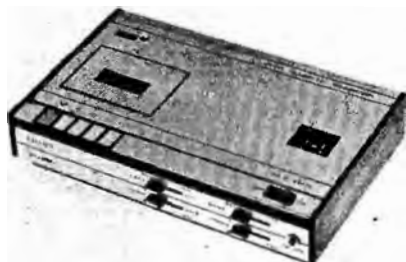

Amstrad Electronics are showing their new HPS 5A stereo headphones and the Mark II version of their 138 speaker system. Also they will have a new amplifier, the IC 2000, which they claim, is the only high quality British amplifier to be built around integrated circuits. An earlier model amplifier from Amstrad, the Stereo 8000 will be on show again this year, only this time featuring a new scratch filter.

Headphones and speakers are to be a feature of the Rogers Developments stand. Here will be seen for the first time, the Ravensbrook semi-professional stereo headphones. As far as speakers are concerned Rogers will be showing a new wafer type. Development of this was initiated by the current wave of interest in third channel and four channel stereo. Rogers will also be exhibiting their new Ravensbrook Tuner Amplifier.

Tandberg, better known for their tape systems are showing loudspeakers at this year's Sonex, in fact there will be three new ones, the TL50, TL25 and TL12. All are available in teak or rosewood veneered cabinets. The company is also displaying their TR200 FM receiver. Among the various features of this receiver are two 20 watt amplifiers, and pretuning and press button selection for six FM stations. This receiver is claimed to have exceptional FM sensitivity. Again, the unit is styled in either teak or rosewood.

The specialist loudspeaker manufacturers too, are showing new speakers in abundance. B & W for instance, will be exhibiting their brand new DM2 for the first time. This is a handsome speaker mounted on a metal

This cassette recorder from Luxor represents an excellent example of the current trend in hi-fi design featuring, as it does, a slim package combined with slider controls.

stand. The DM2 is available in three finishes, teak, walnut or white satin. Like all speakers in the B & W range a chart recording showing the individual speaker's frequency response is supplied with each unit.

Other loudspeaker systems will be on show from companies such as Mordaunt Short, who are unusual in that they do not make loudspeakers but assemble systems from 'bought out' driver units. At Heathrow they will have the three systems which comprise their range, all of them



The centre piece of the Garrard stand is Zero 100s turntable with its tangential tracking arm.

featuring cabinets fully veneered — even on the rear faces.

The KEF Company of Maidstone, who are establishing a formidable reputation as first class kits suppliers, will be exhibiting two brand new assembled systems — the Coda and the Cantor. The former is a two-way bookshelf loudspeaker capable of handling up to 15 watts. The Cantor, on the other hand, is fitted with an eight inch bass unit but is claimed to have an excellent bass response despite a profile so thin that it can easily be fitted to a wall. Facilities are provided to enable this to be done.

• • • A QUICK LOOK

Another new product to be exhibited at Sonex is Decca's new liquid-nitrogen cooled 'London' magnetic cartridge. This pick up is unusual in many ways. It is claimed to be practically immune from external magnetic fields, and has an output in the region of $1\frac{1}{2}$ mV/cm/sec, (about 50 percent higher than most top quality magnetic cartridges). The complete cartridge weighs a mere four grams.

In four channel equipment last year's serious exhibitor JVC Nivico, will be accompanied this time by Heco who are represented in Britain by Acoustico Enterprises. With the current developments in thin loudspeakers especially for the rear it will be interesting to see just how much the equipment makers have taken up the challenge of four channel stereo.

A R Sugden's Connoisseur range of belt drive turntables remain essentially the same, with the exception of the press-button speed change for the BD2 that was first shown at the Audio Fair in October last. The picture from Shure is much the same with some improvement to the V-15 type II having taken place since its last showing. Also on this stand will be the range of Shure microphones and input units including microphone mixers, audio control units, audio level controllers and the Shure Vocal Master Sound System.

Centrepiece of the Garrard stand will again go to the Zero 100 tangential tracking turntable – which we will review in these pages next month. Surrounding this will be other, time proven members of the family, the SP 25 Mk III, the AP 76 and the 401.



The new London cartridge from Decca which has many unique features – including liquid nitrogen cooling.

Highgate Acoustics, who sell equipment from a number of manufacturers, will display five new products. From Alpha, is the new Combination Unit GF2500 which has two 15 watt amplifiers complete with turntable. Luxor of Sweden have released two new tuner/amplifiers and a stereo cassette recorder in time for the show. New from Pickering are the Phase IV inductive magnetic system cartridges. Also from the USA are the complete range of Poly Planar speakers. These are suitable for a number of applications, including, if the advance publicity is anything to go by, hanging from trees in the garden! Harman Kardon are introducing a complete new range of tuner amplifiers. Cassettes also form the main attraction on the Bush Arena stand with their two new decks, the C 430 and the C 440, together with the full range of Bush Arena equipment.

Although it is not really possible in these pages to do full justice to Sonex '72 before it has happened, one hopes that a quick glance through the door can excite the imagination enough to make the enthusiast go along and see for himself just how far the designers have gone to make his music sound, and look, better.

Even though Sound '72 is more specialised, by intent, there still exists a large amount of duplication especially in the microphone field. But, one of the more interesting exhibits to be found at the Bloomsbury Centre Hotel is the modular public address equipment from Westrex. This allows the user to change the whole system simply and in a matter of minutes. Or the system may be expanded as the various demands are made on it. Also from Westrex will be their full range of call out equipment for use with fire stations and similar applications.

The K600 professional stereophones from Bush-Arena. The claimed frequency response for these 'phones is 10Hz to 16Khz. They are made by Koss for Bush-Arena.

WHEN AND WHERE

Skyways Hotel
London Airport Heathrow
March 22–23 trade days
March 24–26 public days

Who

QUAD
HECO
RICHARD ALLAN
AMSTRAD
HANS KOLBE & CO.
B. & W. ELECTRONICS
BANG & OLUFSEN
BASF
BRENELL
BSR McDONALD
CAMBRIDGE AUDIO
CECIL E. WATTS
DECCA
J.V.C. NIVICO
YAMAHA
TANDBERG
GARRARD
GOLDRING
GRAMPIAN REPRODUCERS
ORTOFON
REVOX & A.K.G.
SENNHEISER
PEERLESS & HELME
ALPHA, LUXOR PICKERING
HARMAN KARDON
JORDAN-WATTS
KEF & ADC
KMAL
KLINGER
MARANTZ
METRO-SOUND
THORENS
GABRAPHONE
CANTERBURY AUDIO
MORDAUNT-SHORT
BIB
MUSITAPES
BINATONE, BIGSTON
PHILIPS
PRECISION TAPES
Q.A.S.
BUSH ARENA HI-FI
ROGERS
CELESTION
SCAN-DYNA
SHURE
SINCLAIR
SONAB
SERVO SOUND
SPENDOR
STEEPLETONE
CONNOISSEUR
J. E. SUGDEN
AUDIO PACKS
IMF
SONOTONE SANSUI
ARISTON AUDIO
STAX, STANTON, McINTOSH

ICs FOR VEHICLES

By B. Shepherd C.Eng. M.I.E.E., Chief Electronics Engineer, Smith Industries, Witney

NO longer is the question will electronics be used in Production Vehicles, it is purely "when". Apart from certain areas effected by existing and proposed legislation the answer to this question will be, as always, "when it is economic". What is surprising, however, is that, in the majority of cases, this economic break even point is not far away.

If legislation calls for special safety features, or warning systems, to be installed then custom integrated circuits will be called for. Once one or two integrated circuits are accepted the effect will snowball, it is more economic to combine a safety belt logic system with an overspeed warning than to keep them separate. It is even more economic to add the tachometer circuit. The additional electronics needed to extend this to include a speedometer is less than the mechanical speedometer now used. So, the system will grow until vehicle electronics encompasses almost every operation. Although many IC designers feel this total systems approach is the starting point, because they see the economics of total integration, it would be disastrous to start.

The early "getting the feet wet" approach will build more confidence and help to allay the fears most car designers have of the electronics "black box" approach to car control. These fears are not without foundation. The automobile environment is extremely severe, not the least of which is electrical interference, and a strong-willed designer is needed to produce reliable instruments in the face of the economic pressures.

PRESENT

At the same time as these operational techniques begin to take place a further change will occur, in this case in the methods of displaying information. Here, the electronics represent a great barrier but nevertheless, the marriage of Large Scale Integration (LSI) techniques with some of the new displays can produce a cheaper solution. The ability to control numerous LEDs (light emitting diodes) or many segments of a Liquid Crystal, Plasma, or Electroluminescent panel, from one integrated circuit opens the door to many novel display techniques.

At the present time, the snowball is very small. Integrated circuits are in use in motor cars in tachometers, alternator regulators and car radios and in commercial vehicles in speedometers. The economics of custom ICs for commercial vehicles are still sound because, although the quantity required is smaller this area is becoming more and more conscious of reliability in design and is prepared to pay for it.

The Texas Instruments SN76810P tachometer chip is an example of a custom designed product specifically for the motor industry. Some four years ago when the probable impact on the motor industry, of mass produced ICs at low cost, became evident a design was commenced to produce an IC for use in tachometers.

A block diagram of the final IC is shown in fig. 1. An input pulse, which may be a very narrow capacitively coupled signal from the EHT, or a wide voltage wave form from the contact breaker, or a current pulse

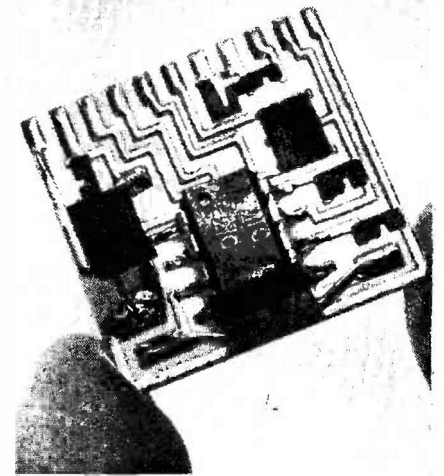

fig 2 The circuitry for the Smiths tachometer mounted on a thick film substrate.

coupled by transformer action from the coil current, is filtered and fed to the squaring circuit. In this part of the circuit, consisting of a Schmitt trigger with low hysteresis the input signal is waveshaped to provide uniform switching edges to operate the monostable.

The monostable has been designed to have good linearity, quick recovery from overload and a low temperature coefficient. The pulse width remains constant regardless of whether the input pulse is wider or narrower than the defined width. This allows $\frac{1}{2}\%$ linearity from a very low duty ratio to a high ratio such as 80% on and 20% off.

For the whole period of the monostable an output current source is switched on and fed to a moving coil meter. The particular advantage of current feeding a meter is that the overall temperature coefficient is greatly reduced. Most moving coil meters are voltage fed and their coil resistance affects the current passing through the coil. Thus the TC of the coil winding, usually copper, is important. Current feeding removes this problem and reduces the drift down to a value usually defined by the magnet material.

The current source technique is carried out by passing the required current through a fixed external resistor. The developed voltage is compared with a reference voltage and the error fed to an amplifier. The amplifier output sets the current level.

The supply voltage to the tachometer is defined by a shunt regulator. The relatively inefficient shunt regulator has been chosen, over the series regulator, for

fig 1

INTEGRATED CIRCUIT TACHOMETER

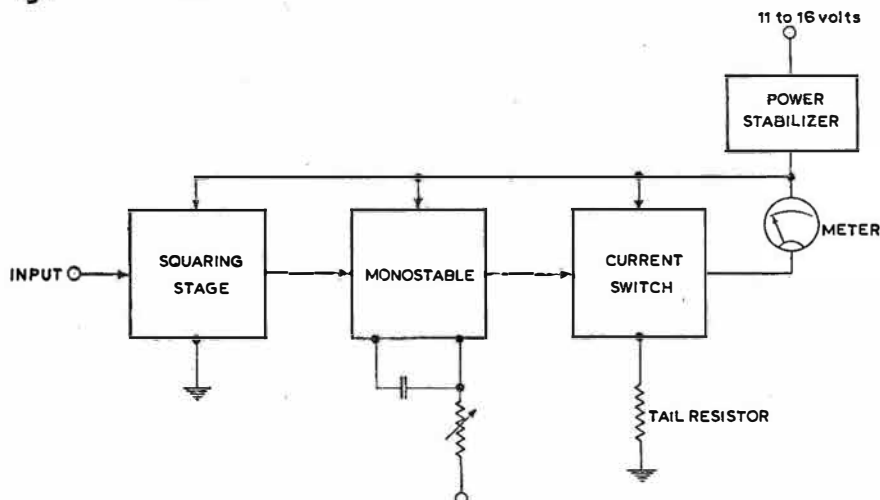

several minor and one major reason. This latter is associated with reliability under transient conditions. A shunt regulator, for example a zener diode, will turn all voltage transients into current transients. The potentially lethal high voltage spikes on a vehicle positive supply only appear at the supply end of a series resistor. Current surges, on a well designed chip, cause only a momentary temperature rise,

The whole IC, with a complexity of 20 transistors is packaged in an 8 lead DIP package and can be seen mounted on a thick film substrate in fig. 2.

SECOND

A second integrated circuit has since been designed for a commercial vehicle speedometer. Apart from minor differences the speed indication is on a moving coil meter and the circuit is similar to the tachometer previously described. The input stage differs in that the signal can be obtained from a nominal sine wave generator and need not cope with the peculiar signals of an ignition system. Included on this IC for the purpose of operating an odometer, is a 5 stage divider with logic gates enabling a division ratio of either 22 or 30 to be obtained. The division ratio is altered by the connection or disconnection of one of the IC pins to ground. The reason for this change is that certain commercial vehicles have a back axle containing a dual ratio, operated by a solenoid or motor, and controlled by the driver. This gear ratio is 1.36 :1 which approximates to 30 to 22. The accomplishment of this feature inside the IC, saves the cost of an extra solenoid operated gearbox specifically for the speedometer.

Also included on this particular IC is a trip circuit which can be adjusted externally to give an output when the speed passes through a particular level. For example an audible warning can be obtained at 83 m.p.h. to comply with proposed U.S. regulations or an inhibit can be obtained to prevent the driver of a public service vehicle opening the passenger doors above 3 m.p.h. This latter feature is being used on the new Leyland "National" bus.

This integrated circuit measures approx. $0.070" \times 0.070"$ and has about 80 transistors. It has an output capability of 40 mA peak into a meter and two outputs of 100 mA to drive a stepping motor for the odometer. A rear view of the full speedometer showing this IC can be seen in fig. 3 alongside a tachometer, incorporating the other IC.

FUTURE

This then is the position regarding production items available in vehicles now. For the future it is obvious that larger ICs with the consequent increase in possible complexity will allow more functions to be accommodated at a reasonable price level. Experience has shown that expensive inte-

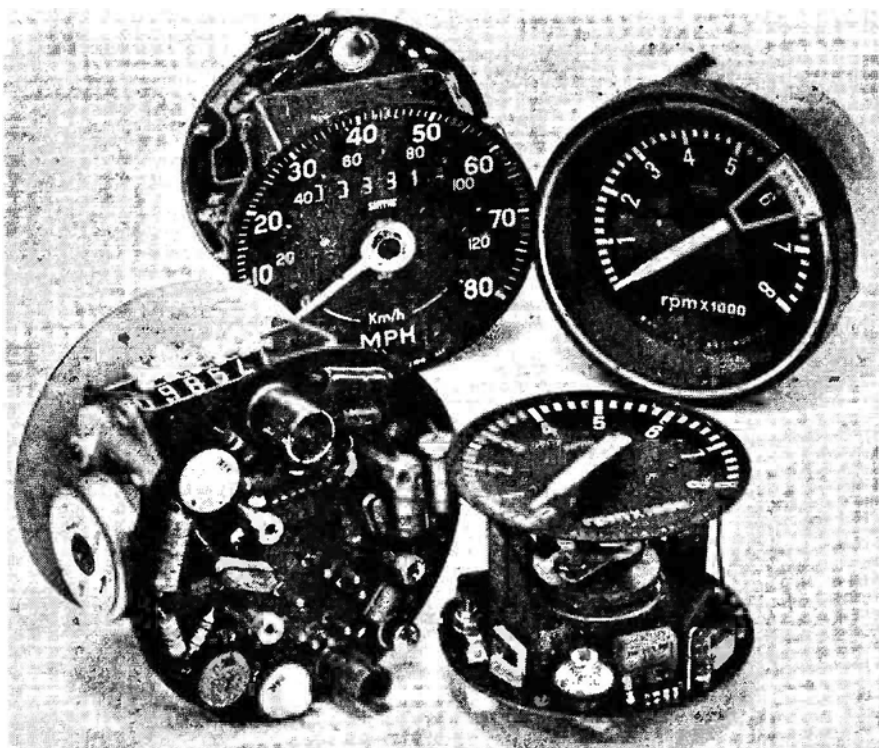

fig 3 These tachometers and speedometers from Smiths both make use of the IC technology described in this article.

grated circuits, designed for aviation or space use, fall in price to a level acceptable to the consumer and automotive regions in only a few years. Complexities of 6,000 transistors on an MOS chip having a size of $0.15" \times 0.15"$ are available even now at modest prices.

With this complexity in mind it is possible to envisage automotive sub-systems with the long term aim of one overall system. Examples of sub-systems which will use integrated circuits are:- Fuel Injection; Antilock Braking; Speed Control; overall Display Systems; One-wire Control systems and warning and safety systems. For all these systems reliability is extremely important. The few actual components used, usually an IC, one or two capacitors, a thick or thin film, and perhaps a power semiconductor, make this degree of reliability possible.

As one example of such a system Smiths Industries have produced a one wire vehicle control system with the code name ECSTASY (Electronic Control for Switching and Telemetering Automobile Systems), illustrated in fig. 4.

All the wiring on a conventional vehicle is replaced by a ring main system consisting of a power lead and a control wire passing round the perimeter of the vehicle. All electrical accessories are connected to this ring at the nearest point, via an electronic module. A control unit situated on the dashboard is also connected to the same ring.

A switch, operated on the dashboard control, alters a particular code in a main sequence, transmitted down the control wire every millisecond. The appropriate

accessory electronic module detects that code and stores the information. When the correct code is received four sequential times, nominally after four milliseconds, the accessory is operated. If the accessory fails to operate a fail signal is returned to the control module and a warning indicator is illuminated.

A particular feature of the Smith system is the ability to accept analogue, or changing level, signals. As an example, a tachometer sensor connected to the ring at the engine has a code location. This is detected; again at the control unit, decoded and displayed in the conventional way on an instrument. Further locations can be made available for other instrumentation i.e. Temperature, Fuel and Pressure gauges.

The electronic modules built so far contain discrete electronic components and as such are much larger, and more costly, than is envisaged for vehicle use. The actual modules, which are of necessity cheap would have a size of about 1 cu in. They would be completely encapsulated and coded by their channel numbers.

ADVANTAGES

Once such a system is installed on a vehicle several advantages can be demonstrated.

- a) Weight
 - Less wiring, also the main power lead could be made of Aluminium.
- b) Ease of Installation
 - Sensors and accessories become easier to fit. Panel switches pass only the signal current.

IC s FOR VEHICLES

- c) Failure Warning
The unit automatically indicates non-operation i.e. it is self-checking.
- d) Diagnosis
Connection of test signals to control wire during services can interrogate all accessories.
- e) Flexibility
Modifications and additions to vehicle electrics can be made more easily.
- f) Automatic Control and Interlocking
Signals from various sensors can control other parameters i.e. Antilock Braking, Speed Control, Automatic Transmission.
- g) Assembly Labour Costs
The loom fixture costs would be greatly reduced.
- h) Trailer connection
The connection and disconnection of trailer electrics is eased.

Obviously the acceptance of such a system will depend largely upon the cost of the individual electronic modules. The quantity of these, however, is very high, i.e. 50 per vehicle for a build of 5,000/week represents 13 million integrated circuits a year. The technology is available now, although further work is necessary to produce high current switching devices at the right price and in the right quantity.

It is envisaged that within five to ten

years such a system could be fitted to a vehicle and economically replace all the present wiring looms, plugs and sockets etc. and produce a more reliable and more versatile connection system.

When using these new techniques it is necessary that the designer fully understands them if he is to obtain the best from the technology.

An antilock braking system has been deliberately designed on a semi-digital principle so that it is more amenable to IC design. Also a more accurate detection of wheel dip is possible and the digital approach allows the use of a simplified pulse

generator at the wheel.

Integrated circuits have, then, arrived in motor vehicles. It is, however, only the tip of an iceberg. The penetration of electronics has been delayed by cost, and reliability problems consequent upon low cost, far too long. Integrated circuits are changing this. Designs are available, in various parts of the world, which use ICs in Fuel Injection, Antilock Braking, Tachometers, Speedometers, Automatic transmission, Anti-pollution circuits, safety systems and warning systems.

In a few years, a much larger piece of that iceberg should be visible.

fig 4 ECSTASY (Electronic Control for Switching and Telemetering Automobile SYstems) replaces all the conventional wiring looms and hardware on a vehicle by a power lead and control wire. All accessories are connected to this ring via an electronic module.

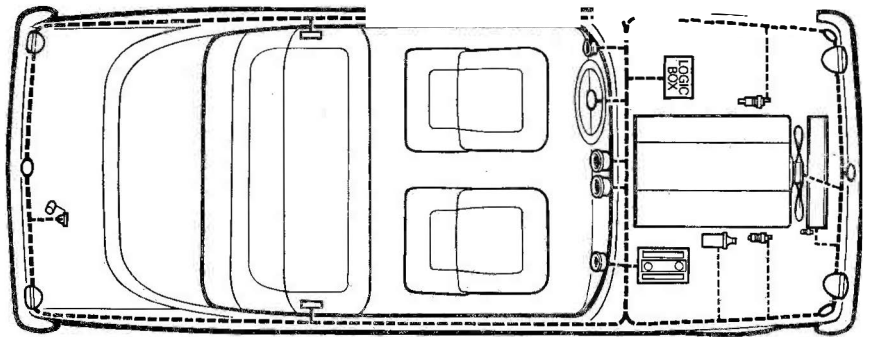

DON'T MISS . . .

THESE TWO VALUABLE COUPONS

EACH coupon is worth 50p with every order valued £5.00 or over from Semiconductor Supplies Limited.

WORTH 50p

NAME _____

ADDRESS _____

WORTH 50p

NAME _____

ADDRESS _____

See advertisement inside front cover

Now! From EMI precision speakers and enclosures in matched money-saving kits.

EMI speakers are internationally recognised—used in the highest quality sound reproduction equipment. Because of this world-wide demand, EMI matched speaker kits are available to you at a really keen price.

And now, EMI introduce the commonsense cost-saving approach to high quality speaker enclosures. Available in complete easily assembled kit form—all you need is a screwdriver—the form the ideal

combination of superb sound reproduction and good looks you'll be proud to have in your home.

There are eight kits—from compact book-shelf units to large floor standing enclosures—all finished in selected wood veneer, with matched loudspeaker kits handling from 5-35 Watts.

Realise the full fidelity of your audio system at a fraction of the cost of comparable speaker assemblies. Contact your hi-fi dealer or send to EMI for full details



A member of the
EMI Group of Companies.
International leaders in Electronics,
Records and Entertainment.



Perfection in Sound

EMI Sound Products Ltd., Hayes, Middlesex.
Telephone: 01-573 3888, Ext. 667

SPACE TRACKING

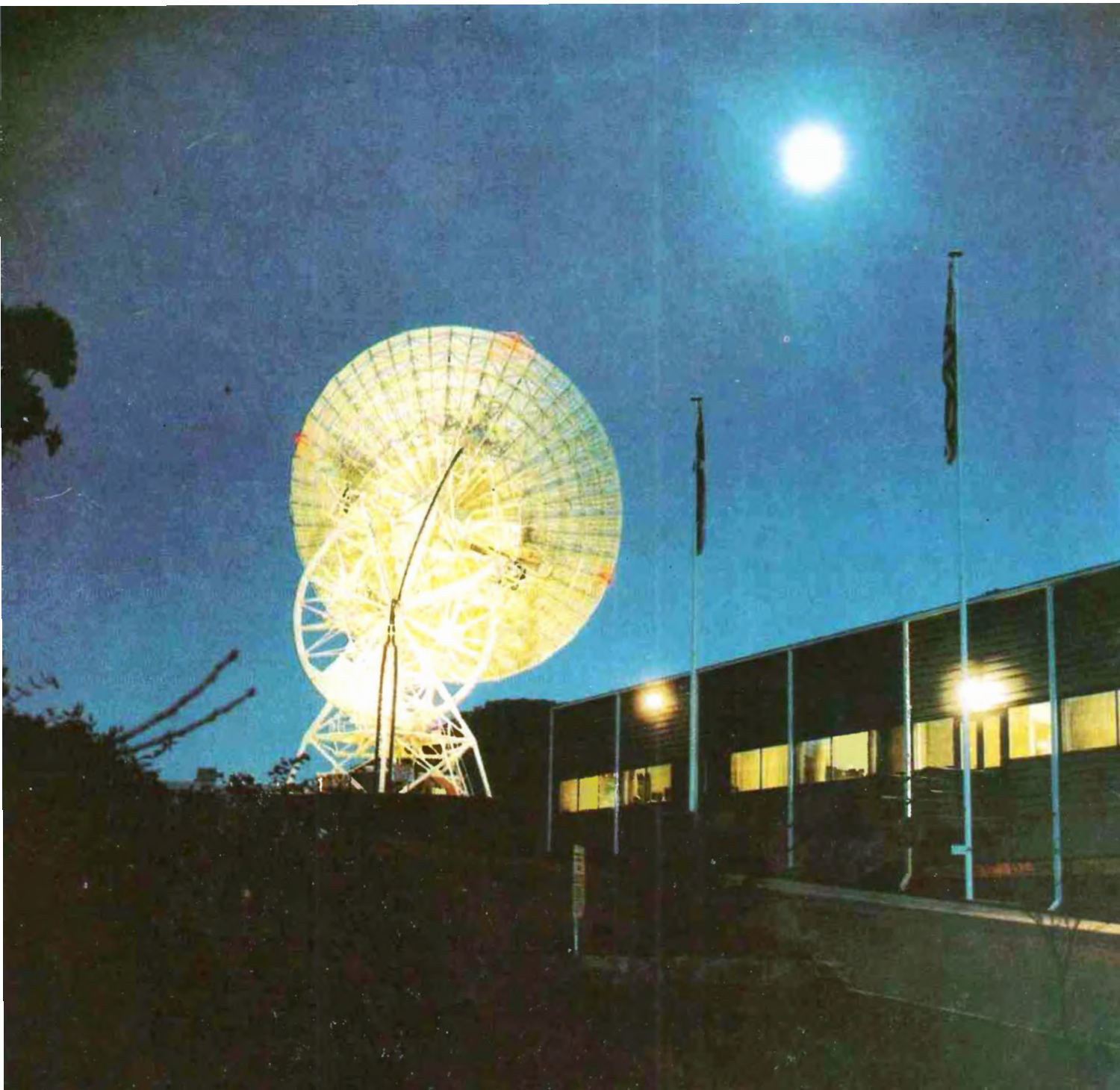

This dramatic picture, taken during the recent Apollo 15 mission, shows the main antenna of the Honeysuckle Creek Tracking Station pointing directly at the lunar surface.

The Honeysuckle Creek Tracking Station plays a major role in NASA's Apollo missions. Here is a detailed description of the equipment and techniques used.

STATIONS

ETI acknowledges the assistance of the Australian Department of Supply in the preparation of this article.

NASA's tracking network for Apollo missions has three prime sites about 120° longitude apart. They are at Madrid (Spain), Goldstone (California) and Honeysuckle Creek (ACT). Other stations, located at various sites throughout the world, support the earth-orbit phase of the missions. Once the spacecraft is about 16,000 kilometres (10,000 miles) from earth, the prime stations assume the responsibility.

Two areas in Australia are concerned with the operational aspects of Apollo missions. These are near Canberra and at Carnarvon (WA).

The Canberra complex consists of two stations, Honeysuckle Creek and Tidbinbilla, each with a 26-metre (85ft) diameter antenna.

For operational purposes the CSIRO's radio-astronomy telescope at Parkes (NSW) is also considered to be part of the Canberra Complex when it is made available for lunar-phase tracking of Apollo missions.

Honeysuckle Creek is the co-ordinating and data processing centre for the complex. Tidbinbilla and Parkes are linked to Honeysuckle Creek via microwave links.

Carnarvon, 1,000 kilometres (600 miles) north of Perth, has two 9-metre (30ft) - diameter antennas and is concerned with the earth-orbit phase of the missions, but also acts in a back-up role during the lunar phase.

TRACKING REQUIREMENTS

A glance at Fig. 1 shows the multiplicity of signals that had to be tracked at various stages of the Apollo 15 mission and Fig. 2 shows how the downlink signals were shared. In the Canberra complex, for instance, Honeysuckle Creek and Parkes tracked the lunar module and lunar rover on the lunar surface, while Tidbinbilla tracked the command module which

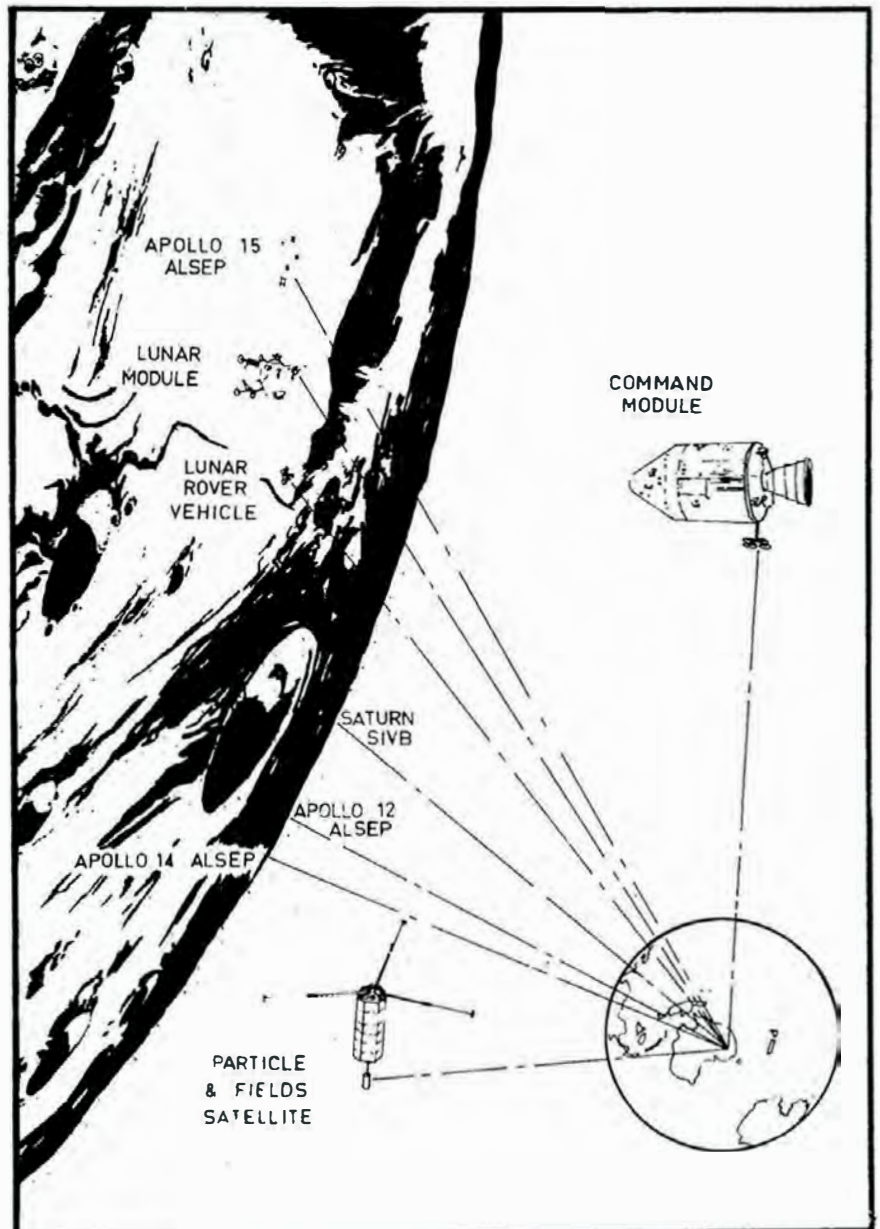

FIGURE 1. The various signal sources tracked during the Apollo 15 Mission. (ALSEP 12 and 14 operate continuously).

SPACE TRACKING STATIONS

Bill Perrin monitoring the spacecraft signals at the Telemetry Console. The oscilloscope above the chart recorder on the left shows the RF down link spectrum from the Command Module. The display in the centre shows the PCM Telemetry bit streams from the Demodulators. Upper right are the switching matrices used to select data streams to the telemetry processing equipment. Directly below this are monitoring devices for selecting an individual word out of the bit stream. Finally on the upper left level with the oscilloscope, is a monitor for the telemetry bit stream leaving the site. The operator therefore has a complete picture of the telemetry data from the RF input to the final signal to line.



was orbiting the moon at an altitude of about 100 kilometres (60 miles).

Sharing is used when more than one signal source is using the same frequency. An example of this was the instrumentation unit of the Saturn IVB launch vehicle stage, the lunar module and the particles and fields sub-satellite — all using 2282.5MHz. The instrumentation unit and lunar module transponders would be offset by 85kHz in opposite directions and

tracked in this offset frequency.

During the outward journey, the lunar module was powered down on the lunar surface. This frequency was then available for the lunar module for use during its selenographic excursion.

Finally, it too was crashed on the lunar surface and the 2282.5MHz was available for the particles and fields sub-satellite which was ejected from the command module just before its return to earth.

FIGURE 2. Frequencies used during the Apollo 15 Mission.

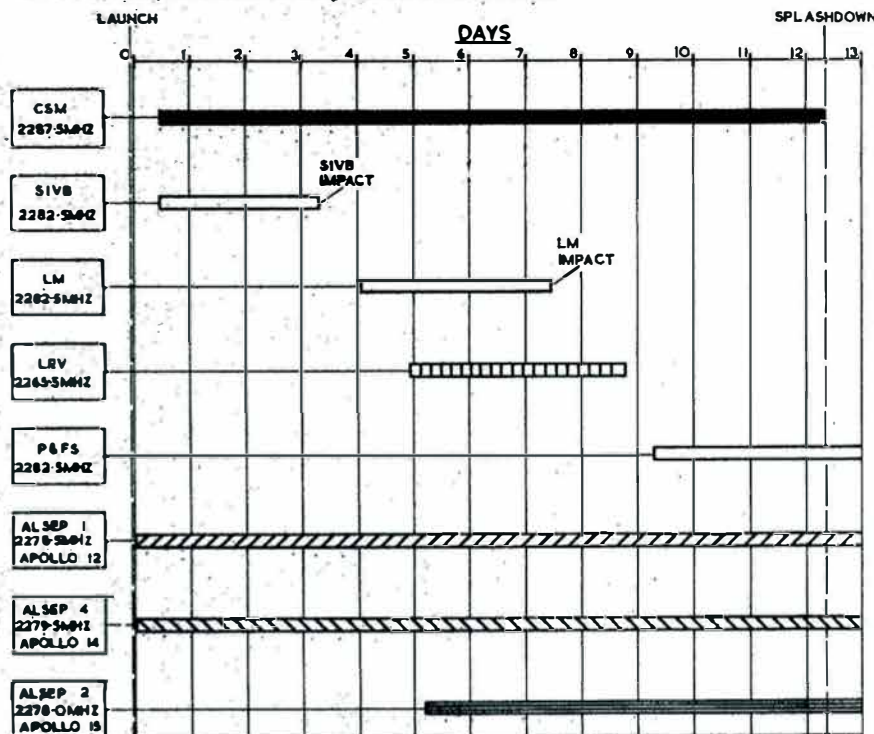

CANBERRA COMPLEX

A brief description of the operational centre of the complex (located at Honeysuckle Creek) will provide an insight into what is involved when a manned mission is in progress.

Located 3,600ft above mean sea level, and 50 kilometres (30 miles) south of Canberra, the Honeysuckle Creek operations centre can be regarded as an extension of the Mission Control Center at Houston, Texas. At the end of a link stretching across the Pacific, the station acts as a relay point between the spacecraft and the Mission Control Center. All communications and data are passed through the Canberra Switching Centre which is part of NASA's world-wide communications network.

FUNCTIONS

The station — a block diagram of it is shown in Fig. 3 — is known as a Unified S-Band site, using frequencies in the 'S' Band. All uplink and downlink signals are modulated on to single carriers. In the earlier Mercury and Gemini programs each function used a separate frequency and antenna.

Bearing in mind the station is merely a relay point, the drawing is basically a flow diagram of information (data) between Houston on the right and the spacecraft on the left.

UPLINK OR TRANSMIT PATH

Taking the simpler of the two, the link from Houston to the spacecraft is called the uplink or transmit path.

VOICE

Speech is perhaps the prime requirement of the uplink path and in simplified terms provides a telephone link between the capsule communicator at Houston and the astronauts. A communication technician at the station monitors all traffic and ensures the best channel is used. The baseband voice signal is an analogue waveform of frequency range 300-2500 Hz, modulated on to a 30 kHz subcarrier, summed with the other uplink information, and phase-modulated on the carrier.

COMMAND

Commands consist of instructions to spacecraft equipment, primarily to relieve the astronauts of regular chores. Examples are spacecraft antenna switching for optimum signal strength at the ground station, recorder control for transferring information stored on magnetic tape from the spacecraft to the ground, and the more important navigational data to update the command module/lunar module computer.

Commands are loaded into the station's Univac 642B command computer by high-speed data lines from Houston. These are transmitted, using a digital code of 57 bits at a rate of 4.8 kilobits/sec.

Commands can be called up for transmission to the spacecraft at a designated time or be sent in real time. Instructions to transmit a command are initiated in Houston and the 642B computer recalls the required command from memory and transmits it to the spacecraft, where a digital word is returned with the telemetry stream back to the computer. If no return word is received by the computer, it re-transmits the command a predetermined number of times before raising the alarm.

The command leaves the computer in

a digital 30-bit parallel code, which is converted to a serial phase-shift keyed (PSK) waveform consisting of a 2-kHz data signal combined with a 1-kHz reference. This baseband command signal is first frequency-modulated on a 70-kHz carrier before being summed with the other uplink signals and phase-modulated on the carrier.

During the Apollo 15 mission, a total of 3,540 commands were uplinked to the spacecraft from the Australian stations. Honeysuckle and Tidbinbilla uplinked 3,533. Of these 2,000 were commands to the camera unit mounted on the lunar rover.

RANGING

Ranging is a code transmitted to the spacecraft and returned for time comparison with the original code. The pseudo random-noise range code, generated by the ranging system, is a combination of five codes to form a 5.4-second period code of 5,456,682 bits, which gives a maximum unambiguous range of 800,000 kilometres (500,000 miles) or twice the distance to the moon.

The range code is summed with the other uplink information and phase-modulated on to the carrier.

Resolution within the ranging system is ± 1 metre (3ft), but system inaccuracies due to jitter and ground instabilities give an overall accuracy of ± 15 metres (50 ft).

Ranging is manually initiated by the station and once acquired is updated by doppler only. The range code is only used to measure the initial distance.

UPLINK

Both Honeysuckle Creek and Tidbinbilla can transmit two uplinks simultaneously. Both have dual equipment capable of handling two independent RF links. This provides both a backup in case of failure of one

link, or the capability of tracking two spacecraft within the antenna beamwidth.

The final modulation process on the uplink carrier is phase modulation using relatively narrow deviation to ensure that a phase stable carrier component arrives at the spacecraft, as the spacecraft transmission carrier is derived from the received carrier. The total rms phase deviation on the uplink carrier is kept at about 1 radian.

The command subcarrier of 70 kHz and voice subcarrier of 30 kHz are combined in a subcarrier oscillator system, and delivered to the exciter as normal modulation, phase-modulated on to the S-Band carrier.

The power amplifier uses a klystron and delivers a continuously variable output of 1 to 20 kW, CW. The bandwidth of 10 kHz is wide enough to accommodate both uplink frequencies. Five hundred milliwatts drive is required to produce the full 20 kW.

ANTENNAS

The 26-metre-diameter parabolic dish at Honeysuckle Creek is a steerable antenna using an XY mount, which means the antenna can tilt in two directions, in this case N to S, and E to W. With combined operation, almost the whole sky can be covered. Both axes of the XY mount are horizontal at zenith.

SOME ANTENNA FACTS

Beamwidth

7.5m rad \pm 1.0m rad (0.43° \pm 0.05°)

Pointing accuracy

0.2m rad — (40 secs of arc)

Max tracking rate

50m rad/sec — (3°/sec)

Polarisation

Right-hand circular/or left-hand circular switchable

Gain

51 dB up 53 dB down

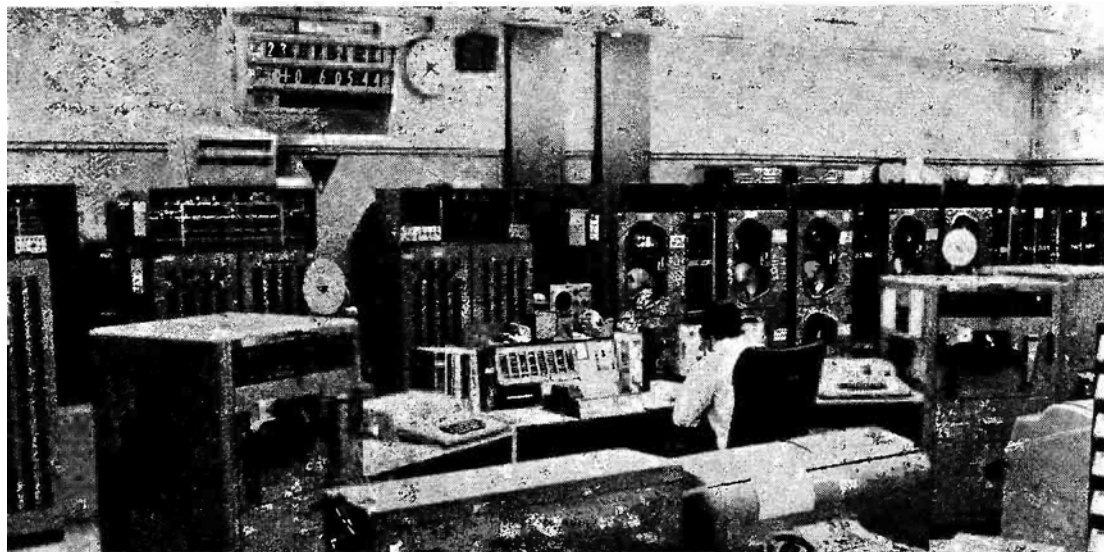

From left two Univac 642B computers with an expanded memory unit between. In the centre right are eight tape transports fully duplexed with the 642B computers. To the right are two Univac 1218 computers and associated magnetic tape unit with two tape transports. In the foreground are the I/O consoles and the operator's monitoring position.

SPACE TRACKING STATIONS

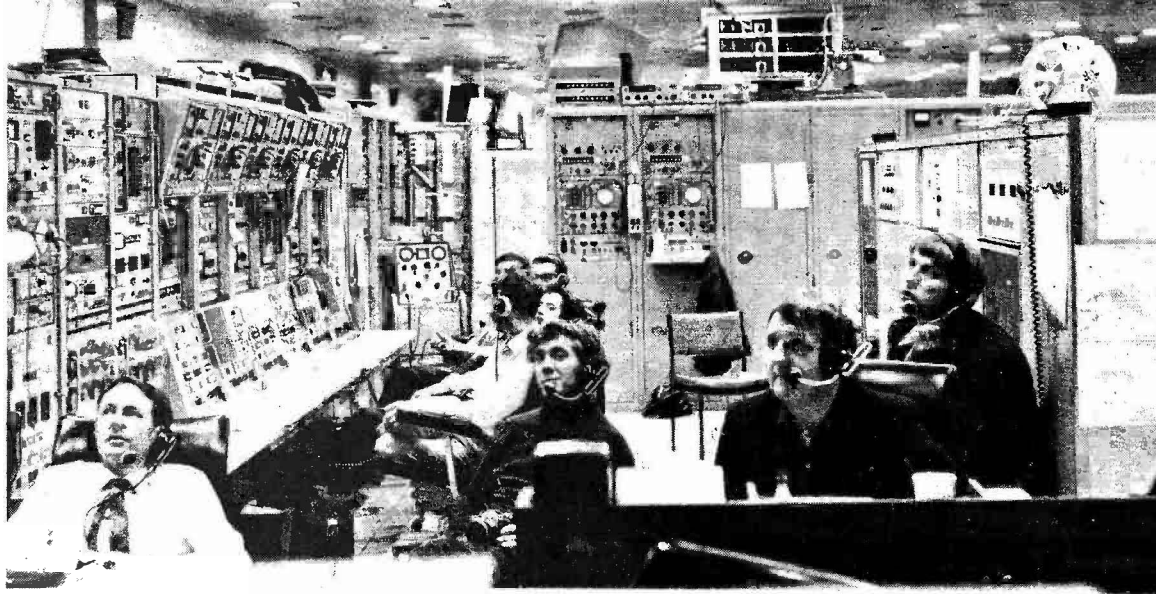

In the foreground is the servo console which controls the antenna's position. On the left are the main receivers with the Ranging System at the back. On the right is the Antenna Positioning and the tracking data (range antenna angles etc.) processing equipment.

Acceleration
 90m rad/sec^2 ($5^\circ/\text{sec}^2$)

There is a 2-metre (6ft) – diameter acquisition antenna and tracking system, but this is only useful on earth-orbit tracking, where the spacecraft is a relatively rapidly moving target. This system is not included in this discussion.

The Tidbinbilla 26-metre-diameter parabolic dish is a steerable hour angle-declination antenna and the Parkes 64-metre-diameter parabolic dish is a steerable AZ-EL antenna.

Due to the narrow beam width of the antenna it has to be extremely accurately directed. To achieve this, computers in Goddard Space Flight Center calculate the spacecraft trajectory from previous tracking and the information is then fed into a 1218 computer which can be switched to control the antenna directly.

Combined with the antenna position programmer (APP), the antenna can be directed to follow the spacecraft's path, even through a signal loss. Normally, once the spacecraft's signal has been acquired, the antenna follows the signal.

The range (determined by the ranging system) and speed of the spacecraft relative to the station, and the antenna angles relative to the station's geographical location are coded in the tracking data processor (TDP), transmitted to line and recorded. This data is coded both in high-speed data at 2400 bits per second and in teletype code.

DOWNLINK OR RECEIVE PATH

The spacecraft downlink 'S'-Band frequency can be received from the spacecraft at levels of about -150 to -90 dbm. The signals are bounced to the hyperbole focus where the feed system is split into four parts, giving a

common monopulse tracking system. This can be left or right circular polarisation, selected remotely.

The sum output of the monopulse comparator is fed into a cryogenic parametric amplifier (paramp) having a low system temperature. This paramp output is split five ways, four to independent phase-locked receivers, with tracking bandwidths switchable between 1 kHz to 12 Hz. (These receivers are capable of tracking down to -160 dbm).

The X and Y outputs of the monopulse comparator are fed to a triple-channel warm paramp and then to tracking receivers whose reference is derived from the original sum channel. The remaining channel of the warm paramp is used as a backup for the main cryogenic paramp.

The function of the diplexer (together with the band pass and reject filters) is to combine the uplink and downlink frequencies, giving a rejection of 180 db in the receive spectrum.

RECEIVERS

The S-Band frequency from the paramp is converted down to an IF of 50 MHz and reconverted to a 10-MHz reference frequency. Phase detection at this frequency drives programmable local oscillators and multiplier chains for the phase-locked operation. The outputs from the receivers, that of 50 MHz and 10 MHz, are composite signals which are fed into the demodulators where the various channels of information are stripped off and patched to the appropriate areas.

DEMOOS

The demodulators accept these composite signals from the Honeysuckle Creek, Tidbinbilla and

Parkes receivers. They contain the voice, telemetry, biomedical and television information and break them down into a pulse code modulated (PCM) bit stream, voice and biomedical data. These are patched in both PM or FM modes as dictated by operational requirements.

The television information, which was frequency-modulated directly on the carrier in the spacecraft, enters via the 50-MHz FM channel and is completely demodulated and fed to the TV processing equipment.

Now let us take each data stream in turn and see how it is transmitted to Mission Control Center at Houston.

VOICE

The recovered voice from the demodulators is fed to the communications technician who monitors and switches for best signal sources. The audio is then recorded on magnetic tape and sent to line to the Mission Control Center either by undersea cable or satellite.

BIOMEDICAL

The biomedical data are in two distinct paths. One is used while the astronauts are in the command module when the biomed data comes via the pulse code modulated (PCM) telemetry. The other is used while they are in the lunar module or in their suits for external activities. Then the biomedical data, containing information on the condition of the astronauts as they are walking around the moon's surface (such as oxygen remaining, suit cooling, suit temperature, physical condition) are routed down separate analogue FM telemetry channels to special processing equipment which converts the analogue information to digital for the computer. Both sets of information, together with the other PCM data, are presented to the 642B computer.

TELEMETRY

The PCM bit stream is routed to four decommutators in the telemetry area. The rates are variable, normally high at 51.2 kilo bits and low at 1.6 kilo bits a second.

The prime function of the PCM decommutators is to present all decoded data to the telemetry 6428 computer in 30-bit parallel form, but they also allow station personnel to monitor selected data on indicators or chart recorders. The PCM telemetry can be broken down into 6400 words of information on the spacecraft antenna direction, physical condition of the astronauts in the CSM, the quantities of engineering data etc.

COMPUTERS

As the data lines between the station and Mission Control Center have limited capability for data transmission all the telemetry is presented to the 6428 computers, where only data selected by the flight controllers in Houston are transmitted to line. The output from the computer of 30-bit parallel words is converted to a serial bit stream at 43 kilo bits a second and transmitted to line on similar circuits to the voice circuits. Both command and telemetry computers are identical and interchangeable and have 20 input and 20 output channels, 64k memory and duplex magnetic tape units, each with four tape transports. Programs used during the mission, are sent from Goddard on magnetic and paper tape and loaded into the computer at predetermined times. The magnetic tapes are used for fault analysis and storing information. They also hold the operational program.

TELEVISION

The television signal from the spacecraft is 525 lines/60 field frame sequential colour TV and also contains information on the TV camera temperature, battery voltage, etc. This TV signal from the demodulators is presented to a switch matrix which selects the best signal source available from the Honeysuckle, Tidbinbilla and Parke's receivers.

The voice and telemetry sub-carrier is filtered out with a sub-carrier cancellation device which eliminates the sub-carriers by a locally generated sub-carrier locked to the incoming signal and 180 degrees out of phase with it.

The signal is cleaned up and processed in a standard TV processing amplifier before vertical interval test (VIT) signals, multi-burst and grey scale, are inserted on line 16 and 17 of the vertical blanking period.

The composite processed TV signal from Honeysuckle Creek/Tidbinbilla is monitored on a modified colour monitor and transmitted to a centre in Sydney for selective distribution to the local networks and to Houston via the Overseas Telecommunications Commission's Intelsat satellite link over the Pacific. The TV signal from Parkes is sent direct to the video centre at Sydney.

The TV is also recorded on Ampex VR 660 video tape recorders.

TIME

All activities in the station revolve around a dual time standard which provides multiple readouts, pulses and various coded times for time tagging all data produced by the station.

Needless to say accuracy is essential, and various means are used to keep the station time within 10 microseconds of universal time. The well-known WWV and WWVH time signals are used for a coarse adjustment, but for a vernier adjustment down to ± 10 microseconds, the 100kHz Loran signals, now synchronised to universal time are used.

The North-West Pacific Chain with the master station at Iwo Jima is presently used to monitor the station's drift. Prime frequency source is a Hewlett Packard Caesium beam frequency standard giving

OPERATIONS CONSOLE

A central co-ordinating console controls and interfaces the station with external organisations. The console is supplied with numerous lamp displays giving station configuration and equipment status. The console also has facilities for communication with the spacecraft and the initiation of commands.

STAFFING

The responsibility of Honeysuckle Creek Station's activities is vested in a Station Director who is a senior officer of the Department of Supply Standard Telephones & Cables Pty Ltd have contracted to provide the operations and maintenance services, and employ about 100 professional technical, and administrative personnel at the station for this task.

Fig.3. Block diagram of the functions of Honeysuckle Creek during the Apollo 15 Mission.

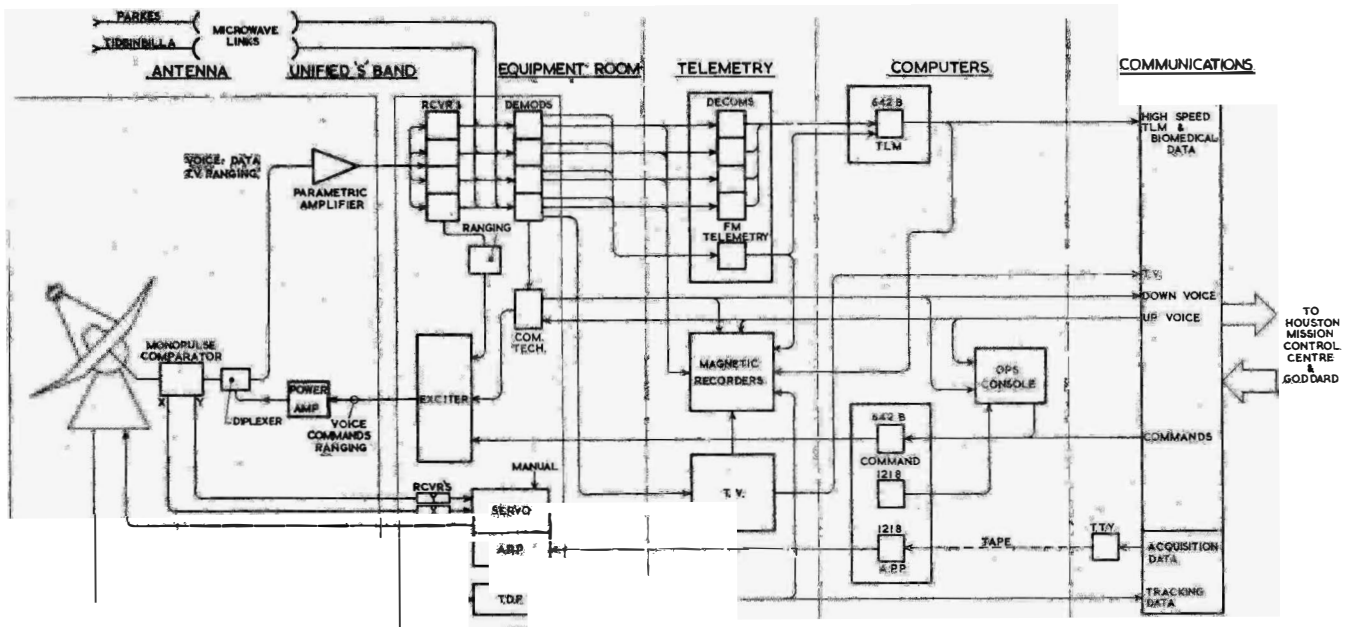



The first independent evaluation of the professional Dolby system to be published anywhere in the world — tested by Murray Wood, B.E., BSc., M.E. of Louis Challis & Associates

THE DOLBY NOISE REDUCTION SYSTEM

ONE major weakness in tape recording, radio transmission, and to a lesser extent disc recordings is the high level of hiss which is present on the medium.

Typically the maximum signal-to-noise ratio lies between 40 and 65 dB. At the maximum signal level this is adequate. At lower signal levels, the signal-to-noise ratio may drop to 10 dB (or less) at breaks between passages.

The equalisation used on tape recorders, records and F.M. broadcasting are all designed to provide an increase in signal-to-noise ratio by emphasising the treble before transmission or recording, and de-emphasising the treble on playback or reception. This gives an improvement of about 10 dB in the signal-to-noise ratio.

There are good technical reasons why this equalisation technique cannot be taken further to give an additional 10

dB signal-to-noise ratio. The first and most important of these is hum. De-emphasising the treble results in an effective increase in the bass signals. This makes the hum, rumble and other low frequency defects more obvious. The current generation of tape recorders and other electronic equipment has about 60-70 dB signal-to-noise ratio. Using the present equalisation techniques, there is a degradation of about 10 dB resulting in a signal-to-noise ratio of 50 to 60 dB. A further degradation of 10 dB,

Fig. 1. Block diagram of Dolby Processor.

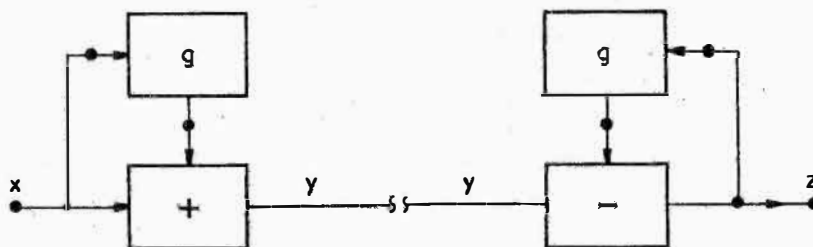

would be unacceptable to most listeners.

Another problem that occurs is the limitation that is always imposed on high frequency content.

On a record, this limitation is the maximum velocity at which the pickup stylus will track. The higher the frequency and the higher the signal level, the higher the stylus velocity and any treble pre-emphasis makes it harder for the pickup to do its job adequately.

When we look at a tape recorder we find that we have similar problems due to the demagnetisation of the tape (that has just been recorded) by the signal that is being laid down at that instant. This effect is worsened by high-level high-frequency signals. Print through of the recorded signal onto the preceding and succeeding layers of tape on the take-up reel is also increased by high-frequency high-level signals.

The bandwidth of an F.M. broadcast is dependent both on the frequency of the signal and the amplitude. Since the available bandwidth to be used is limited both by international agreement and by the receiving equipment used, there are very definite limitations imposed on this medium also.

The problem which Dr. Dolby and many others have investigated is how to increase the signal-to-noise ratio at

low signal levels where the limitations imposed on the relative levels of high frequency components are not important.

COMPRESSION AND EXPANSION

One of the solutions used in the past has been to use compressors during recording or transmitting, and expanders when replaying or receiving.

The compressor effectively reduces the dynamic range of the signal being fed into the medium by having a low gain at high levels and a high gain at low signal levels. But a major problem with a compressor is the choice of time constants. If it works too quickly, it will distort low frequency signals by following the instantaneous signal levels. If it works too slowly the resulting signal will sound unnatural, because when the signal level drops, the level will slowly increase as the compressor starts to work. When the signal level increases, the compressor once again will take some time to act, resulting in the production of excessive instantaneous levels that may cause distortion, followed by an unnatural decrease in level.

The choice of time constant is therefore very difficult. Given that an adequate time constant can be chosen, the problem is by no means solved. Having designed a compressor, it is then necessary to design an expander which *exactly* complements the characteristics of the compressor. This is usually a very difficult task to achieve, particularly when there is every possibility of an error in system level alignment.

The Dolby system overcomes many of the limitations of conventional compressors and expanders.

The first and most significant feature of the Dolby system is the use of the same nonlinear network in the compression mode as that used in the expansion mode. This guarantees that the two sets of characteristics are the same.

The direct signal, and the signal from the non-linear element are added together in the compression circuit. In the expansion circuit this signal from the non-linear element is subtracted via a feedback loop. The result is that the compression and expansion modes are exact inverses of each other.

The second major difference is that unlike earlier systems, the Dolby system does not perform any processing of high level signals. This means that at normal signal levels, there is no possibility of mistracking between the compressor and expander and at lower signal levels, the degree of mistracking is not so serious.

Inspection of the block diagram in Fig. 1 shows that.

$$y = (1 + g) x$$

and

$$z = \frac{1}{1 + g} y$$

where g is the nonlinear network. The final output from the processor is therefore exactly equal to the original input to the processor. (The frequency response and dynamic characteristics of nonlinear networks are largely unimportant so long as similar nonlinear networks are used in the record and playback modes.)

THE DOLBY SYSTEMS

The Dolby technique is available in two basic systems, the Dolby A and the Dolby B.

The Dolby A system is designed for use in professional applications and the Dolby B for domestic applications.

The Dolby A system has a nonlinear network which consists of four separate channels, covering the entire frequency spectrum. The first channel contains the information up to a frequency of 80Hz, and the second the information between 80Hz and 3kHz.

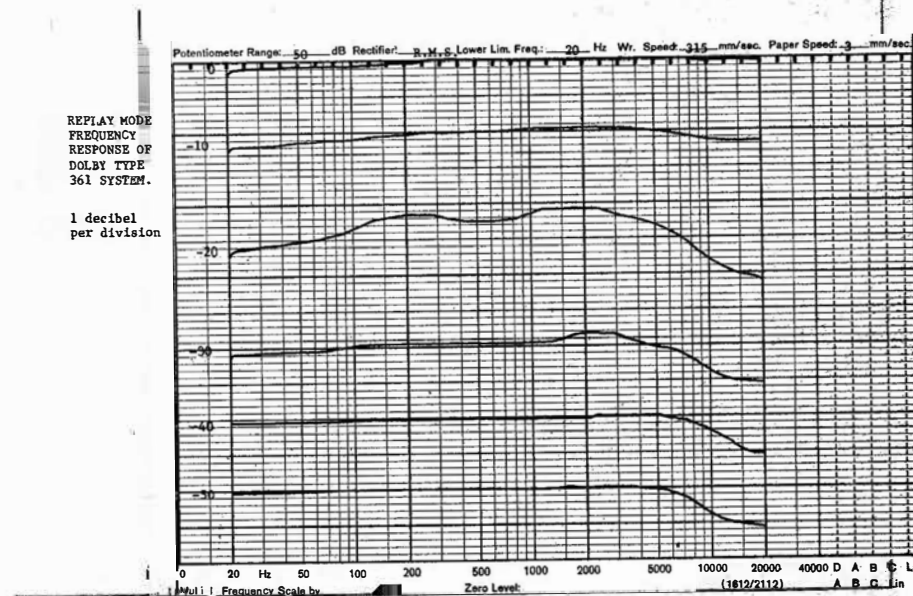
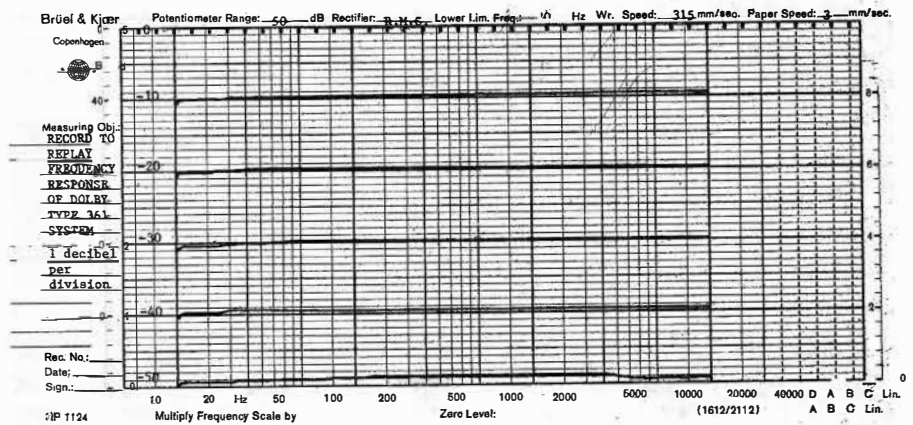
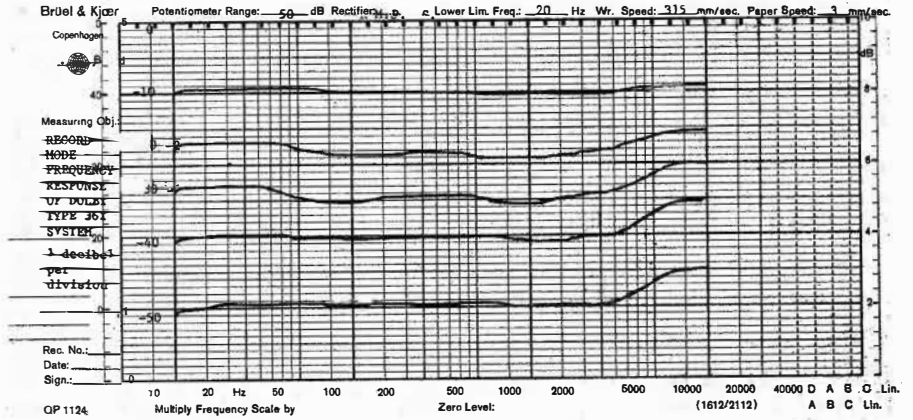

THE DOLBY NOISE REDUCTION SYSTEM

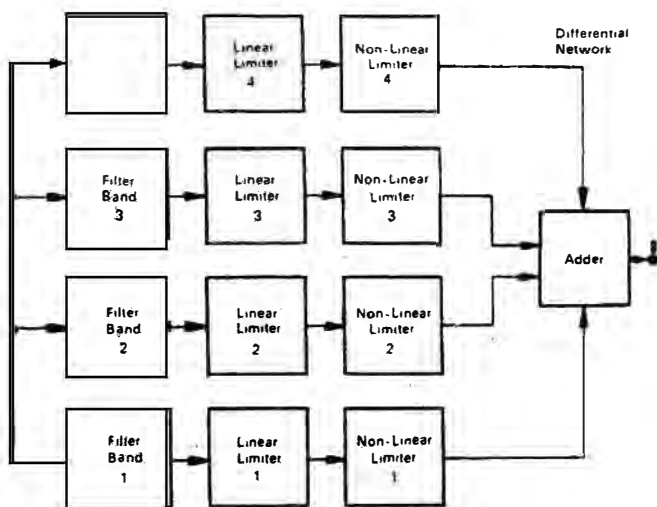

Fig. 2. Block schematic of the non-linear element in the professional Dolby system Model 361.

The third channel operates between 3kHz and 9kHz, and an additional channel operates on the information above 9kHz. The three lower frequency channels provide 10dB compression or expansion at low signal levels while the high frequency channel provides an additional 5dB at frequencies above 9kHz. Because of the use of compression only at low signal levels, the dynamics of the compressor and expander become less critical. The Dolby A unit, therefore, has an attack time constant of 0.1 seconds. This would be considered too long for normal compressors but, because of the system used, the overshoot of the output is normally

less than 2dB although it is about 15dB on the output of the actual nonlinear element. The figure of 15dB is a fairly typical overshoot of a normal type of compressor with an attack time constant of 0.1 seconds.

Because of the separation of the signal into four bands, the compressor is almost always in use in one or other of the bands. With the normal level and frequency distribution of classical music, Channel 1 is compressing fairly often, Channel 2 is compressing almost all the time, Channel 3 fairly often and Channel 4 is rarely compressed.

The Dolby B system uses the same basic principle except that only one channel is used in the interests of

simplicity and cost-effectiveness. The single filter is designed to operate in approximately the same frequency range as Channel 2 in the Dolby A system. It copes extremely well with the typical hiss problems in domestic reproduction.

HOW WE TESTED

In our testing of the professional Dolby system, we were particularly impressed by the precision with which individual Dolby processors are made. We used one processor in the record mode and a separate unit in the playback mode to allow real time testing. This enabled us to use a three head tape recorder and even an electronic simulation of a noisy tape recorder for the testing. Even using this testing procedure, the quality of the performance was exceptionally good proving the compatibility of different Dolby units. This is an essential feature for professional use where one unit may be used for the original recording and another for the final processing.

It is interesting to note that if the original signals are "Dolbyised", then mixing, editing and dubbing can all be performed on these tapes, and only the final product needs to be "re-Dolbyised". This can be very convenient, and is made possible by the relatively high tolerance of the Dolby system to level changes.

The compression provided by the Dolby A system is not applied uniformly over the entire dynamic range, but only over the range 20 dB to 40 dB below the reference level. The compression is relatively flat over the range 20 Hz to 5 kHz and has a maximum of 10 dB. Above 10 kHz another 5 dB of compression is used. It is this relatively flat performance which means that, although the level from record to replay may not be exactly correct, the only audible error that will be introduced is a slight error at the high frequency end of the spectrum. The dynamic range will be slightly altered, but this will not be audible.

It was suggested in an article (from Dolby Laboratories) on the Dolby system, that it could be used for

DOLBY 361 SYSTEM. SERIAL NUMBERS 1060 AND 1062

MEASURED PERFORMANCE
RECORD TO REPLAY FREQUENCY RESPONSE WITH TWO SEPARATE SYSTEMS
20 to 20 KHz within ± 1 dB over 50dB signal range.

TOTAL HARMONIC DISTORTION

Reference Level	20Hz	1kHz	6.3kHz
0dB	.17%	0.05%	0.05%
-20dB	.3%	0.05%	0.05%
-40dB	.1%	0.05%	0.05%

INHERENT SIGNAL-TO-NOISE RATIO 75dB TYPICAL NOISE REDUCTION CONSTANT % BANDWIDTH RANDOM NOISE

Relative Noise Level (dB)	Resultant Dolby Noise Reduction (dB)
-10	0
-20	1
-30	6
-40	12
-50	12
-60	11

CONSTANT POWER PER UNIT BANDWIDTH RANDOM NOISE

Relative Noise Level (dB)	Resultant Dolby Noise Reduction (dB)
-10	0
-20	2
-30	6
-40	10
-50	10
-60	10

PURE TONE NOISE REDUCTION

Relative 50 Hz Noise Level	Resultant Delay Noise Reduction (dB)	Relative 150Hz Noise Level	Resultant Delay Noise Reduction (dB)
0	0	0	0
-10	1/2	-10	0
-20	4	-20	1
-30	10	-30	8
-40	10	-40	9.6
-50	10	-50	9
-60	9	-60	9

reprocessing old records and other low grade material for re-release. We therefore decided to try this out. The only processing which could be used, of course, was the expansion following playback. The results of this test were quite dramatic. The record we used for the test was a 78 rpm disc in fairly good condition but with a high level of background hiss. By passing it through the Dolby expansion circuit, the only audible effect was a drop in the background noise of about 10 dB. Although we knew that there had been expansion of the signal and that those signals which were quiet were now even quieter, this effect was not readily noticeable and the overall effect was worthwhile.

Based upon this test, one of the useful applications of this 'partial Dolbyisation' would be in the area of satellite broadcasts where there may be a significant decrease in signal-to-noise ratio. Even if the signal is not 'pre-Dolbyised', post-processing would still improve the quality of the signal.

HOW IT PERFORMED

The professional Dolby system proved to be particularly well behaved

for a compressor-expander, with no apparent vices.

Alignment took only a couple of minutes and once aligned the Dolby unit performed predictably and well, with all the tests we applied.

The harmonic distortion was less than 0.2% over the entire range of levels under steady state conditions and did not exceed 1% under transient conditions. The distortion was primarily second harmonic distortion. The frequency response was within ± 0.5 dB with respect to the correct meter setting of the reference tone at the reference level.

Functionally, the professional Dolby system is very easy to use. The type we tested was the Model 361. This has only six push buttons on the front panel. The labeling on each push button indicates its function and we found no trouble in operating the unit.

The unit has provision for remote control operation from an external switch. This may be the record switch on a tape recorder or some remote panel switch. This provision will prove to be particularly useful in the normal application of the professional Dolby system.

The unit is aligned by trimming

potentiometers normally hidden under a hinged panel.

A reference tone is provided within the unit, and the use of this, together with the trimming potentiometer enables rapid alignment of the Dolby unit in conjunction with the equipment with which it is to be used.

However, the quality of construction is such that it is probable, that once installed, the only problems will come from moving parts such as the relays and the trimming potentiometers, and these should be good for many thousands of operations.

The unit is constructed in a 19" rack mounting module only $1\frac{3}{4}$ " high. The power consumption is particularly low, being about 15 watts. These two factors should allow easy installation in existing equipment without causing problems due to space requirements or overheating.

In all its characteristics, the professional Dolby system should meet the requirements of almost any user who has signal-to-noise problems.

The users may range from recording studios to television and broadcasting stations, or even to the dedicated amateur tape recorder user who can afford the price, and for whom nothing but the best will do. ●

INTRODUCING Lectronic Leo and his son Number One—a couple of lively characters dreamt up by regular E T I contributor, SUN cartoonist PAUL RIGBY. You will be meeting this pair in E T I every month.



"That's my Boy!!"



"... and That's my Dad."

BIOLOGICAL

**Move over, gurus and swamis
— what the study of
Yoga takes years to achieve,
electronics can do in minutes!**

AFTER a lifetime of study and meditation, a few Indian holy men manage to achieve limited control of heart rate and basal metabolism.

Yet, in less than one hour, 25 students at Harvard Medical School learnt to slow their heartbeat by nine beats a minute.

Just by watching an oscilloscope — and thinking about it.

It was done by biological feedback — or the conscious control of unconscious phenomena — one of the more remarkable and significant discoveries of modern science.

In 1929 Dr. Hans Berger, a German psychiatrist working at Jena University, applied electrodes to the human skull and, working with a number of sensitive galvanometers, succeeded in measuring 10 Hz 'alpha' rhythms. The results were recorded in his paper 'Über das Elektrekephalogram des Menschen'.

His discovery was ignored by the scientific fraternity until 1934, when the existence of the alpha rhythm was demonstrated to the Physiological Society by Professor Adrian (later Lord Adrian) of Cambridge University.

But it was not until the advent of modern electronic equipment capable of amplifying, filtering and correlating low-level signals that the complex wave-patterns could be reliably identified and recorded.

These wave-patterns are classified (by amplitude and frequency) as alpha, beta, theta and delta. There is evidence that each wave-pattern is associated with a different state of consciousness, although there appear to be characteristic differences in wave-patterns from one person to another.

Recently scientists have established that, when in a state of profound meditation, Zen and Yoga leaders emit primarily alpha rhythms. Alpha rhythms are also apparent in most



FEEDBACK

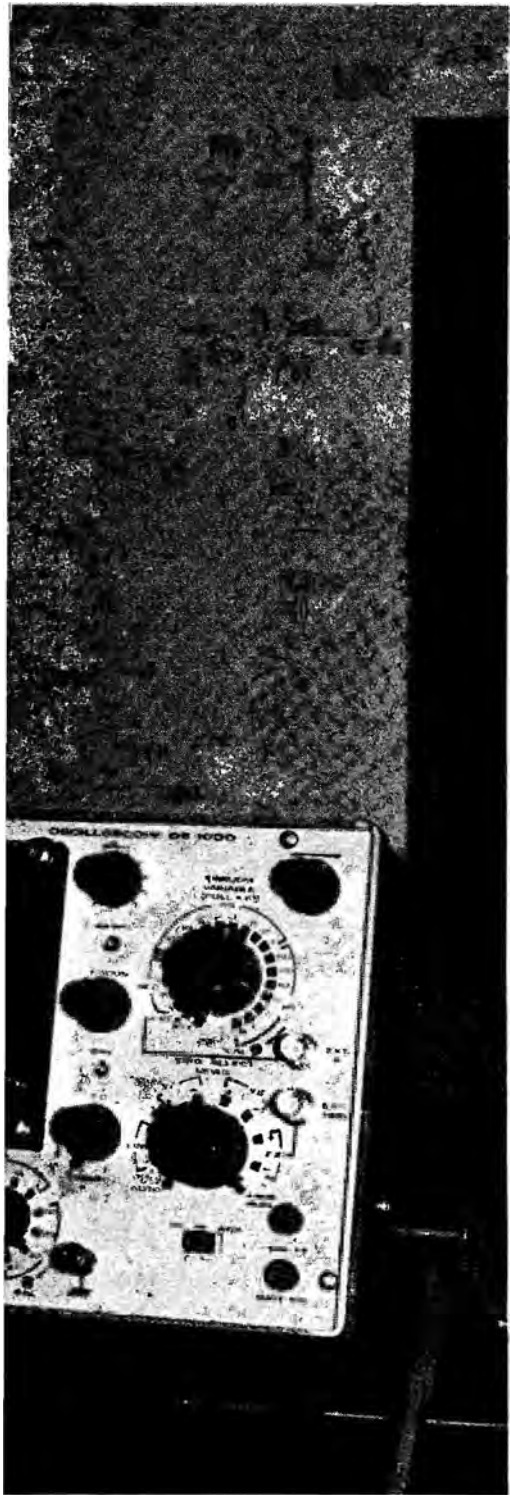

people during pleasurable activities. Creative thinking and problem-solving activities tend to be associated with alpha/theta rhythms. Beta rhythms are commonly associated with anxiety, whilst delta and theta rhythms are apparent during sleep.

These rhythmic patterns can readily be studied by using an electroencephalograph — an instrument which displays on an oscilloscope the minute electrical currents picked up by electrodes placed on the skull.

Extraordinary though it may seem, it is not a difficult matter to consciously generate the various types of wave-forms whilst watching one's own electroencephalograph — and, in so doing, experience the various effects with which each rhythm is personally associated.

It also appears possible that people can learn conscious control of blood pressure, heart rate, metabolism, muscle tension, etc.

Some behavioural scientists believe that it is quite possible the technique could even improve memory, learning ability and creativity, although they emphasize that, despite some dramatic results, the technique is in its infancy — and as yet there is no evidence that biological feedback can cure organic damage.

Nevertheless, the possibilities are so great that normally reticent scientists and psychologists find it difficult to restrain their enthusiasm. One, a research psychologist at the Menninger Foundation, states: "Without stretching the imagination, the long-range implications and effects for society of a population of self-regulating individuals could be of incalculable significance!"

Some of the results achieved during the past three years include the following:

- At Emory University, subjects have been taught to activate individual motor nerve cells out of the hundreds of thousands in the spinal cord. This work has helped the development of prosthetic devices controlled by nerve impulses for the physically handicapped.

- A number of patients at the Gerontology Research Centre were able to reduce the frequency of abnormal heart rhythms (premature ventricular contractions).

- At the Maimonides Medical Centre, in Brooklyn, bio-feedback training has partly rehabilitated patients with multiple sclerosis and has also been used to control epileptic spasms.

- The Menninger Foundation, in Kansas, has used bio-feedback to cure chronic migraine now known to be caused by a swelling of the artery that supplies blood to the external parts of the head. The technique used at the Foundation is simply to teach migraine sufferers to pump less blood through the artery.

- Tension headaches in a number of patients have been cured by bio-feedback techniques used at the Medical Centre of the University of Colorado.

- In the course of a series of fully documented experiments carried out at the Menninger Foundation, a woman was taught to raise and lower the temperature of her hands by over 10 degrees.

Bio-feedback experiments have, of course, been noted with great interest by the military — and it is believed that the U.S. Department of Defense is investigating a technique of foiling enemy lie detectors by intentionally self-generated biological 'noise'.

The technique is also being exploited commercially by a number of small U.S. manufacturers who are currently marketing 'do-it-yourself' electroencephalographs at a retail price of \$250 to \$350. Behavioural scientists are not concerned about this, as they say the machines are not sophisticated enough to have anything other than gimmick value — "the only harm will be to the purchaser's bank balance", they say.

The most significant aspects of bio-feedback are, perhaps, its apparent ability to effect self-change in human behaviour, and the evidence that electronics is quite literally a part of life. ●

IMPROVING ROOM ACOUSTICS

The acoustics of your living room can be dramatically improved, this article by acoustical expert Louis Challis tells how.

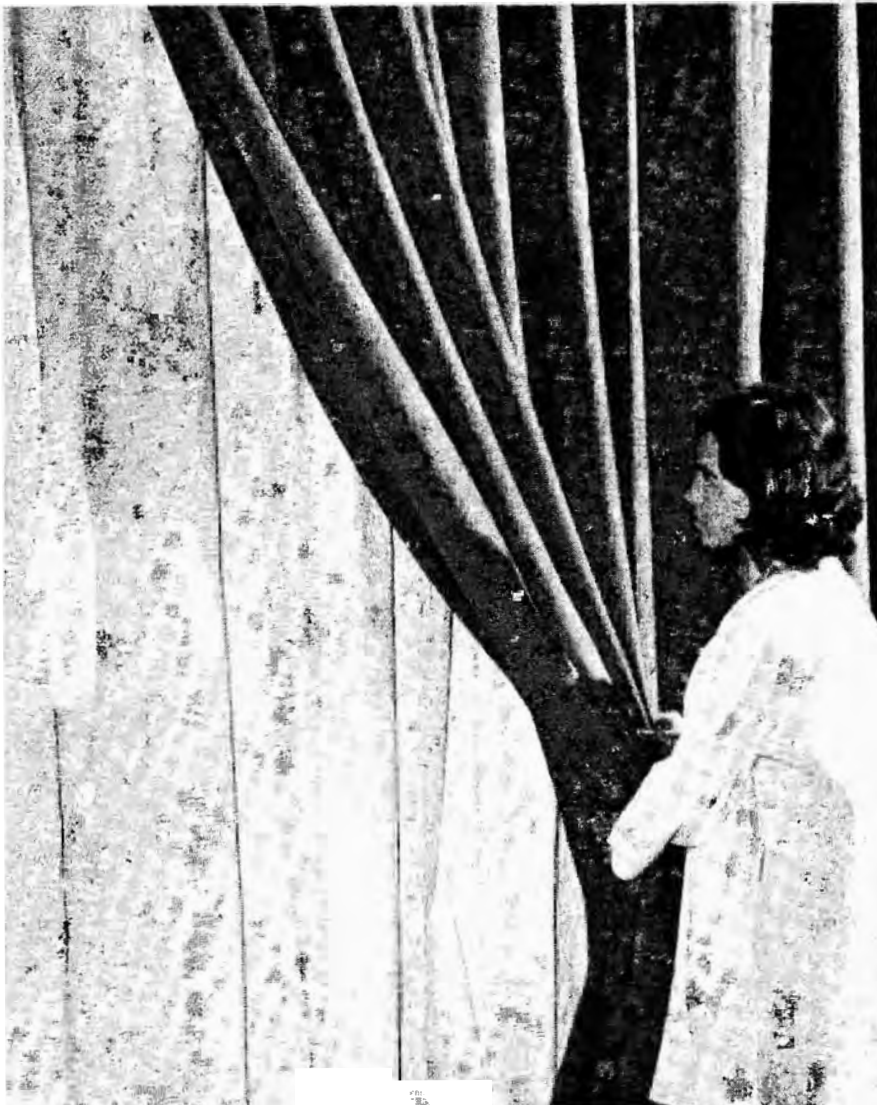

Lined woollen curtains can dramatically improve room acoustics.

SOME years ago a well-known Sydney club asked me to cure a severe acoustical problem caused by excessive reverberation. After assessing the problem and making initial proposals, I was asked why I had not considered using a number of wires stretched across the room above head height. Such wires were cheap, whilst what I was proposing would, by comparison, cost a great deal of money.

All I had to do, the club secretary explained, was to be a good fellow and tell him where to buy these wires. He added that a member of the committee, a doctor, had recommended their use as "they are the cheapest form of acoustical treatment available".

Realising that I couldn't offer the club what they wanted – I tactfully suggested that we were both wasting our time – and left.

Two years later I discovered the basis for the doctor's advice. The practice was initiated in the USA about a hundred years ago, when somebody – applying unusual scientific acumen – suggested that 'if the stretched string of a violin, harp or piano can transmit acoustical energy to a sounding board, then the same stretched string should be capable of absorbing acoustical energy from the air!

Apparently the suggestion was taken seriously and installations were made all over the USA, some using over five miles of stretched wire. In a few cases it is clear that simultaneous changes, of form or occupancy, accompanied the installations, and when these occurred, the occasional improvements in acoustics were – erroneously – attributed to the wires.

Thirty years passed before the theory was shown to be false and the practice abandoned.

The study of architectural acoustics goes back many centuries – to Vitruvius in fact – but a few of the

early students had more than a slight understanding of the subject and most early examples of good architectural acoustics were accidents for which neither architects nor builders could take much credit.

In fact some of the early concepts put forward for theatre or concert hall design varied from the extensive use of wooden panelling, to the use of large numbers of empty bottles placed under the stage!

SCIENTIFIC METHOD

In 1895, Clement Walter Sabine, then Professor of Mathematics and Natural Philosophy at Harvard, was asked to 'do something' about the poor acoustics of the new Fogg art museum.

Sabine went beyond the request to 'do something'. He initiated a basic study of room acoustics. This, in effect, started a new science, and



Scientist uses Negretti and Zambra hygrometer whilst testing characteristics of curtain material.

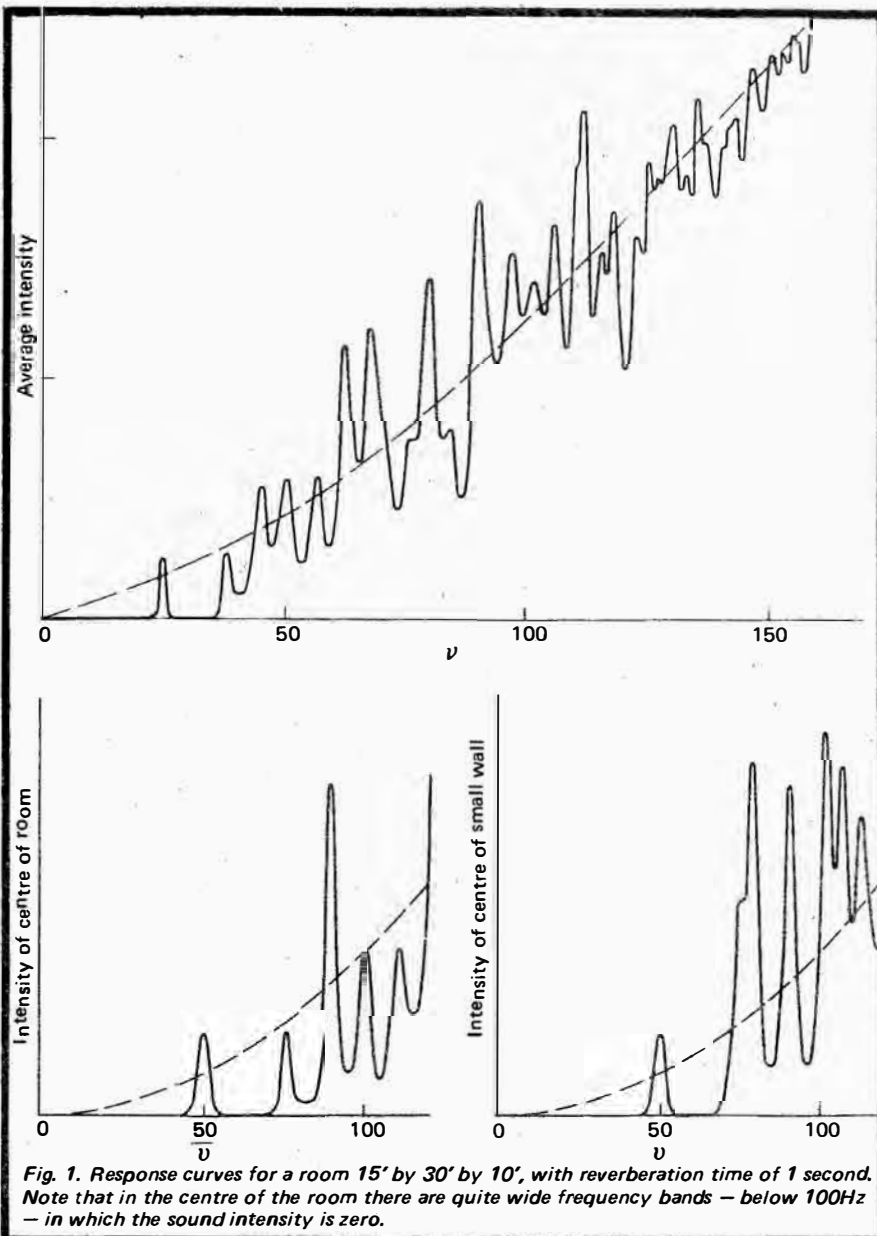

Fig. 1. Response curves for a room 15' by 30' by 10', with reverberation time of 1 second. Note that in the centre of the room there are quite wide frequency bands - below 100Hz - in which the sound intensity is zero.

earned for him the title of 'Father of Modern Acoustics'.

Professor Sabine produced a clear and concise appraisal of room reverberation (the time taken for echoes to die away). To do this, he developed a remarkably accurate measurement system based on electro-pneumatic valve operated organ pipes, a stop watch (later replaced with a chronograph) and his own ears.

When later asked to undertake the acoustical design for the new Boston Symphony Hall, Sabine applied the theoretical knowledge that he had acquired during the previous three years, to initiate the first scientifically designed theatre in the world. When the hall was opened (in 1900) it was acclaimed by musicians and critics alike, and for symphony music at least, it is still one of the best auditoria in the world today.

Sabine's initial work was quaint by modern standards, for his initial investigations were concerned with the evaluation of how the introduction of cushions, curtains, drapes and carpets affected the reverberation time of just one room.

And what he found was appreciated by very few people in his day, and by not so very many more today.

He provided qualitative and quantitative information on many materials, and proceeded further to develop a mathematical relationship, that with minor improvements, is still used today.

HOW SOUND BEHAVES

So that we may understand some of the problems of room acoustics let us

IMPROVING ROOM ACOUSTICS

REVERBERATION ROOM SOUND—ABSORPTION COEFFICIENTS

FIG. 2.

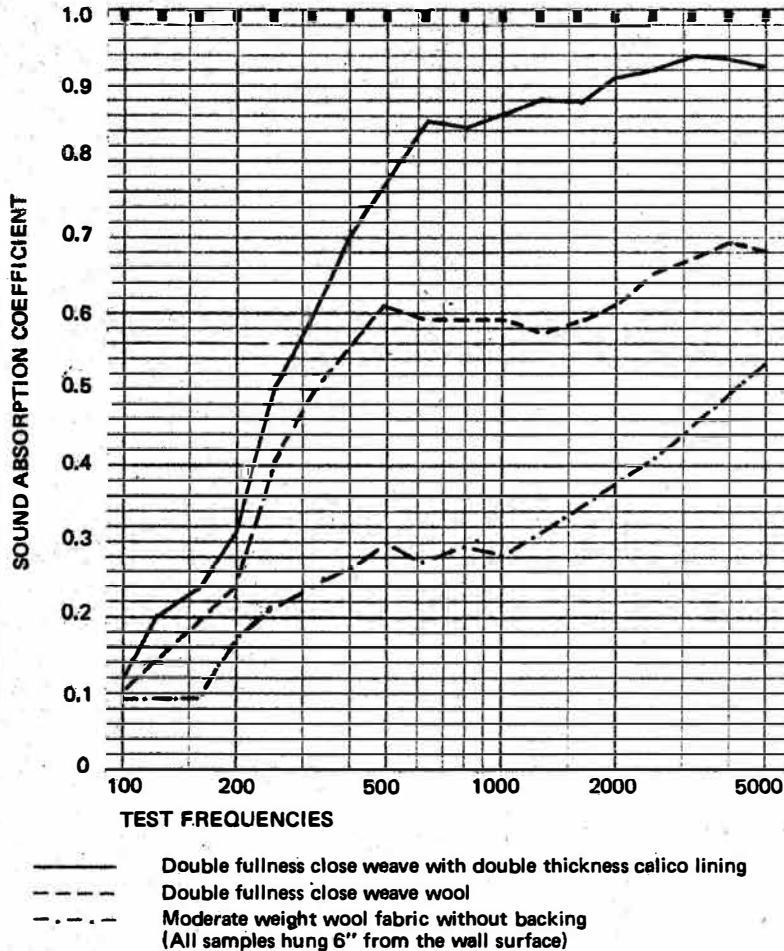

look briefly at how sound behaves in a room.

When a sound is created in a room, the sound waves are reflected back and forth between every pair of parallel walls, undergoing a diminution of intensity at each reflection. They also travel in oblique paths that incorporate any or all groupings of walls, floor and ceiling.

If the room has an irregular shape, the sound waves may take every conceivable path and set up highly complex patterns called room modes. These modes are not harmonically related as such, but are dependent only on the frequency and the room dimensions.

Such modes are a common problem in the average family living room, and may be of such dominance that music played in them suffers a colouration whereby certain frequencies are selectively favoured.

A far more serious problem is that of highly reflective parallel walls bereft of curtains, furniture or other devices to change the direction of sound waves or to absorb them.

If you clap your hands between such walls, you will notice a ringing effect in which the sound waves diminish in cyclical steps. You may have noticed

flutter echo and results from certain frequencies (related to the dimensions of the room) setting up a decay process that is prolonged by the parallel walls.

ACOUSTIC MATERIALS

Soft, porous fabrics and furnishings absorb a considerable proportion of the sound waves that impinge on them. This they do by converting the sound energy into heat.

Practically all building materials absorb sound to some extent, and the efficiency of this conversion is a measure of whether they may be correctly given the term 'acoustical material' or not. Some materials are effective at all frequencies, but most are effective over a small frequency range only.

HOW DIMENSIONS AFFECT SOUND

Rooms are classified as 'live' when they have little furniture and furnishings, and 'dead' when they have too much furnishings, carpets and drapes.

A 'live' room favours church music, choral works, and the playing of orchestral music. The sound in such a room is composed of two parts, the direct sound, and the reverberant (or reflected) sound. A listener hears the direct sound first, and the first reflections of the reverberant sound a short fraction of a second later. If the room is too live, this reverberant sound may continue for upwards of five or six seconds.

Five centuries ago the average cathedral had a reverberation time of less than five seconds and music of the day was composed to make use of the fullness of sound that such a reverberation produced.

Today a reverberation time of 1½ to 2½ seconds is considered the optimum for an orchestral concert hall, and between 0.4 and 0.7 seconds for the average living room.

The effect of room geometry and room volume upon the quality of sound is quite marked, but it is very difficult to define without the use of high powered mathematics. These effects are due to the relationship between the wavelength of the particular sound wave and the room dimensions and geometry. These relationships are particularly complex, but there are a few simple guides.

The wavelength of sound at a given frequency can be approximated by remembering that a frequency of 1 kHz has a wavelength of 1 foot and that wavelength is inversely proportional to frequency. Thus 500 Hz corresponds to 2 feet, 100 Hz to 10 feet, and 50 Hz to 20 feet.

The principle room dimensions of interest, particularly in a rectangular

room, is the longest diagonal. This is the distance between a corner of the room at floor level, and the diagonally opposite corner of the room at ceiling level. This will be the longest straight line in the room; and for a room 15' x 30' x 10' is roughly 33 feet.

For good room acoustics this measurement needs to be at least three to four times greater than the wavelength of the lowest frequency. Thus for the room that has dimensions of 15' x 30' x 10', the maximum wavelength for acceptable acoustics is roughly 10 feet and this corresponds to a frequency of about 100 Hz.

This room will have marked resonances and dips below 100 Hz and sounds below this frequency cannot be faithfully reproduced; apart from this, the response at various positions in the room will be vastly different.

And no matter what hi-fi enthusiasts and salesmen may believe to the contrary, there is no way that you can faithfully reproduce sounds below this lower limit. You will hear sounds certainly, but they will not be, even remotely, a facsimile of the original. The effect is shown in Fig. 1.

ABSORPTION CHARACTERISTICS

For live music, reverberation times of more than one second are required. A professional recording will have reverberant sound lasting at least this long, already incorporated in it, either artificially or naturally.

The ideal listening room has a reverberation time that is short by comparison with that which has been recorded. Such a short reverberation time is difficult to obtain, not because of technical difficulties, but because of the lack of decorative appeal of most acoustical materials. Usually it is necessary to rely on the acoustical properties of the normally used building and furnishing materials to obtain a compromise between appearance and acoustics.

A plaster-board wall, for instance, offers some low frequency absorption, and similarly, timber floors and plaster board ceilings provide some absorption in this region.

And as this is the method of construction commonly used in single dwellings, a suitable reverberation time is often achieved at the low end of the frequency spectrum.

But on the other hand home units and flats present a real problem (to obtain low frequency reverberation time). They are usually constructed with brick walls and concrete floors and ceilings, and these have virtually no low frequency absorption at all. Low frequency absorption may be provided only by the windows.

Absorption in the mid-frequency range may be provided by soft

furnishings. Old fashioned armchairs, sofas and carpets are very useful acoustical materials. But modern vinyl covered seats — unless they have padded arms and backs, provide very limited absorption, while the use of parquet floors often leads to undesirable acoustical properties.

Significant absorption in the mid-frequency range is also provided by people — four people may make a significant improvement to the acoustics of a living room. This may help those who wish to demonstrate their hi-fi to visitors. If the room acoustics are bad — just ask more people!

Absorption in the higher frequency range is provided by soft pile carpet, drapes, and other materials that contain fine, loosely packed fibres.

HOW TO MODIFY YOUR ROOM

The average living room is usually poorly planned for listening to music, and is much too 'live'. The speaker enclosure are usually poorly located on either side of the windows, a fireplace or a sideboard. Almost without exception they face a reflective wall and the first problem is created. They are usually fixed flat against a wall 'for appearances' sake' and all too often they are not placed far enough apart.

For optimum sound the speakers should be spaced between six and twelve feet apart, opposite a wall that has an extensive area of curtains and drapes lined with additional layers of backing cloth to increase the absorption.

Until recently there was little or no data available for the intending user (or expert) to assist in the evaluation or specification of curtain treatments. Most of the data that was available from overseas involved evaluations of

muslins, terylenes or fibreglass cloths that are not really suitable for decorating a living room.

But quite recently the Australian Wool Board commissioned a series of measurements to provide detailed results for people who wished to use woollen curtains for this purpose.

The results of this investigation are particularly interesting. They show that woollen curtains, and especially woollen curtains with backing, combine remarkably high absorptions with generally acceptable appearance.

Some of these results are shown in Fig. 2, where it can be seen that medium weight woollen cloth (double fullness) together with a cotton lining (also of double fullness) has particularly good acoustical absorption.

Either of the two 'best' cloths, shown in Fig. 2, would in fact provide dramatically enhanced room acoustics in most living rooms.

Whilst the intention of this article is to help the average hi-fi enthusiast to improve his room acoustics rather than to assist the Wool Board to sell their products, the message is clear.

And that is that woollen decorator cloth will almost totally overcome the difficult problem of excessive reflections from the rear wall behind the listeners.

The effect is to provide good frontal sound with well controlled rear wall reflections.

Finally — if you feel kindly toward your neighbours — place your speakers on a carpet, rubber pads, or some other form of resilient mounting. This will reduce the amount of structure-borne energy that they can transmit. Then remember that the sound level that is right for you is *always* too loud for your neighbours.

The results quoted in this article are consistent with the findings of a comprehensive investigation initiated by the Australian Wool Board at the Commonwealth Experimental Building Station at Ryde, N.S.W.

Further information on these results can be obtained from the Special Projects Group, Australian Wool Board, 261 George Street, Sydney, or 578 Bourke Street, Melbourne.

WIDE RANGE VOLTMETER

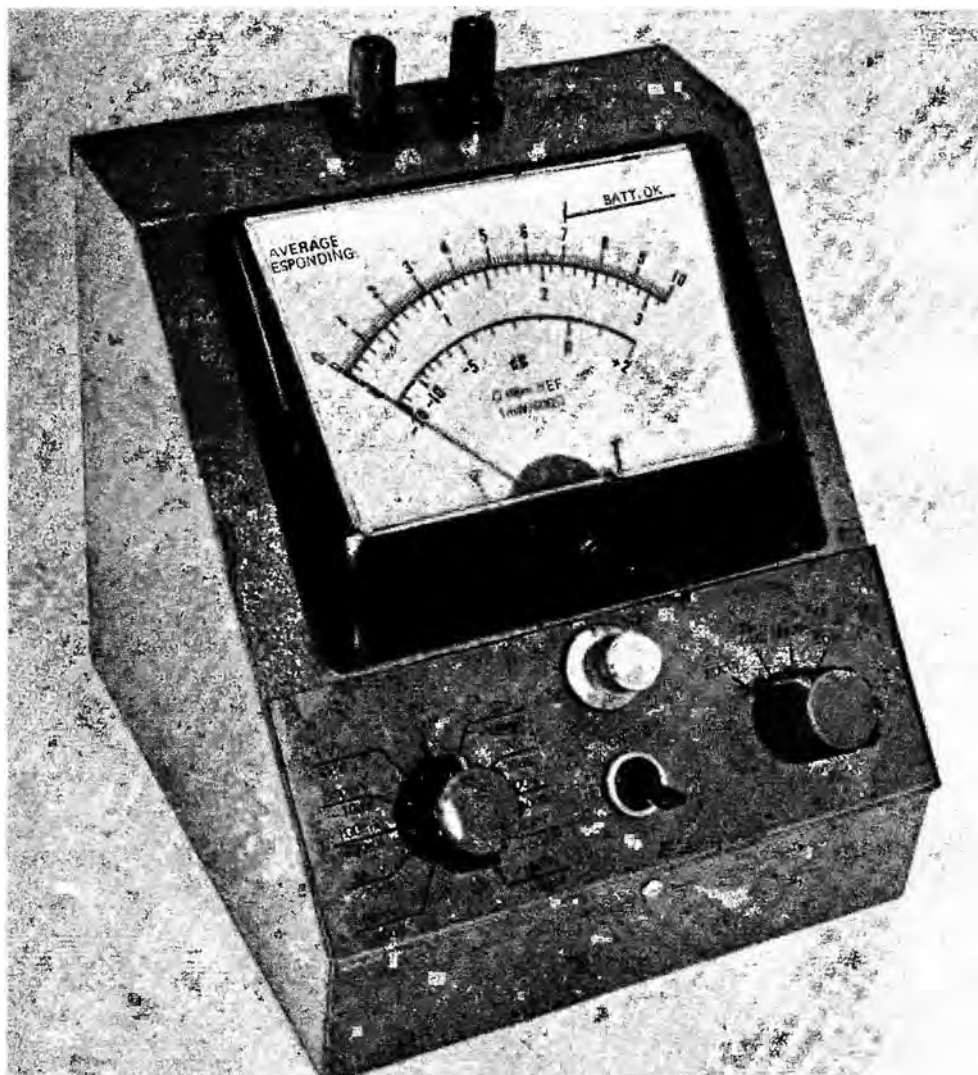

SURPRISINGLY good multimeters can now be purchased for less than £12 and these instruments will perform many of the functions of an ac/dc voltmeter.

But none of these instruments is capable of measuring low level ac or dc signals, and few have input impedances in excess of 50,000 or 100,000 ohms/volt.

The meter described in this project is necessarily more complex than a basic multimeter. The smallest measuring range is 10 mV full-scale deflection (both ac and dc) and levels as low as 0.5 mV can be measured. The input impedance of 10 Megohms on all ranges ensures that measuring errors due to meter loading are kept to a minimum.

Unlike most ac measuring instruments, the ac scale of the Electronics Today meter is linear. The same scale is used for both ac and dc measurements, thus avoiding errors due to reading the 'wrong' scale.

The meter is protected against application of excess voltage — 1000 volts can be applied to the input terminals on all ranges without damage.

The instrument uses three integrated circuits, together with 12 diodes plus capacitors and resistors, to provide voltage measuring ranges from 10mV to 1000 volts full scale deflection. If only the millivolt ranges are required, the cost of the meter can be reduced substantially by eliminating the input divider (R1 — R9), (C2 — C5), the

This solid-state ac/dc voltmeter has 22 ranges - from 10 mV fsd to 1000V fsd.

SPECIFICATION			
	DC	AC	dB
Ranges —	0- 10mV	0- 10mV	-40
	0- 30mV	0- 30mV	-30
	0- 100mV	0- 100mV	-20
	0- 300mV	0- 300mV	-10
	0- 1V	0- 1V	0
	0- 3V	0- 3V	+10
	0- 10V	0- 10V	+20
	0- 30V	0- 30V	+30
	0- 100V	0- 100V	+40
	0-1000V	0-1000V	+60
	0- 300V	0- 300V	+50
Input impedance	10M (all ranges)	10M paralleled by 33 pF. (all ranges)	
Accuracy	±3%	±3% 10Hz — 20kHz.	
Reverse polarity Protection.	meter switch.	Over voltage protected up to 1000V on all ranges.	

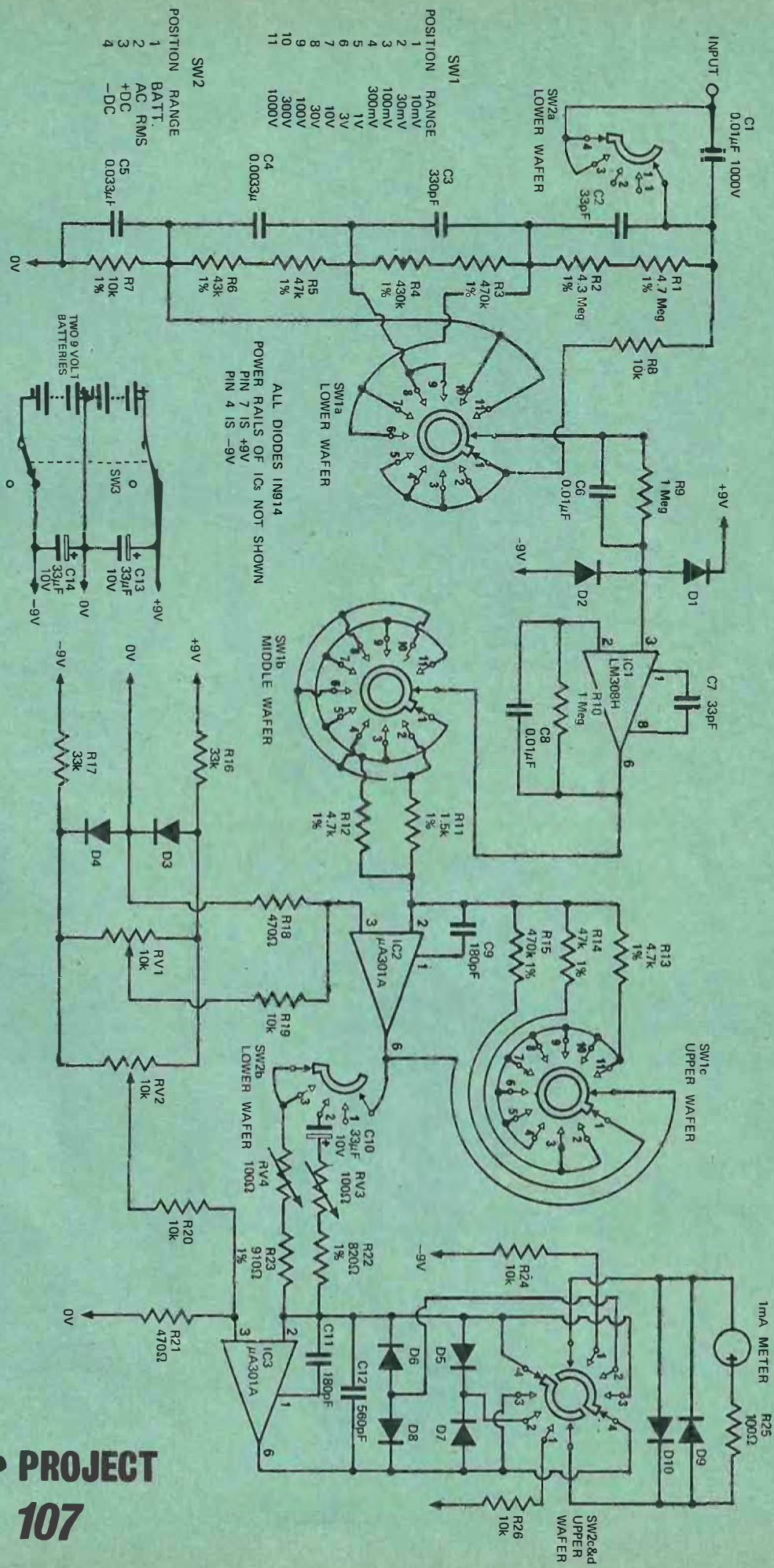

SW1

POSITION	RANGE
1	10mV
2	30mV
3	100mV
4	300mV
5	1V
6	3V
7	10V
8	30V
9	100V
10	300V
11	1000V

SW2

POSITION	RANGE	BATT.
1	AC RMS	+DC
2	AC RMS	+DC
3	AC RMS	+DC
4	DC	-DC

ALL DIODES IN914
PIN 7 IS +9V
PIN 4 IS -9V

WIDE-RANGE VOLTMETER



wafer of SW1a; and by changing SW1 to a 2 pole, 5 position switch.

Power is supplied by two nine-volt batteries (Eveready type 2512), and since the current drain of the meter is about 4 mA, the battery will have a life of approximately 500 hours. A battery check position is provided.

CONSTRUCTION

Although it is possible to construct this unit using tag strip or matrix board construction we strongly recommend using a printed circuit board. The foil pattern of the board is reproduced full size in Fig. 1.

Figure 2 shows how components are assembled on the board. Ensure that all components are orientated correctly as shown. Note that the 'tag' on the metal can type ICs indicate pin 8 and that the pins are numbered anticlockwise when viewed from above. For 8 pin plastic cased ICs — the 'notch' is between pins 1 and 8. Wiring connections to and from components mounted external to the board are shown in Fig. 3, all as seen from the rear of the components.

Mount the meter, switches, potentiometer RV1 and terminals on the front panel. The switch interconnections — shown in Fig. 3 — should now be completed, and the switch

The circuit may be studied in four separate sections.

1. INPUT DIVIDER

This is a string of resistors in series, having a total resistance of 10 Megohms. Four switch selected tappings, provide division ratios of 1, 10, 100 and 1000.

Switch SW1a selects the division ratio required. SW2a shorts out the input series capacitor when the instrument is used in the dc mode.

All resistors in the division network should be 1% tolerance, the capacitors should be 5% tolerance (or at least selected within 1% tolerance).

2. INPUT BUFFER

This consists of an operational amplifier, IC1, connected as a unity gain voltage follower. The output voltage is the same as the input voltage but at a lower impedance. The input current for this amplifier (LM308) is extremely low typically 1.5 nanoamps. To compensate for this current, 1 Megohm resistors are used in both inputs to the amplifier. Capacitors are paralleled across these resistors to eliminate noise. Capacitor

HOW IT WORKS

C7 provides frequency compensation for the IC.

Diodes D1 and D2 protect the input of this IC against over-voltage.

3. AMPLIFIER

This stage is again an op amp (IC2 — LM301A or HA101A). The gain of this amplifier may be changed by switching resistors in the input circuit (by SW1b) and resistors in the feedback loop (by SW1c). Using the values specified, the selected gains are 1, $\sqrt{10}$, 10, $10\sqrt{10}$, and 100.

A zero control (RV1) is provided on this stage to compensate for the initial offset of the IC, and to correct for any drift when measuring very low dc levels.

Diodes D3 and D4 stabilize the voltage across RV1. Capacitor C9 frequency compensates the IC.

4. METER CIRCUIT

A third operational amplifier is used in this stage. This is to enable the output of IC2 to be rectified and to compensate voltage drops across the rectifying diodes. This enables the meter scale to be linear in all ac ranges.

Contacts on SW2 enable the meter to be connected across the IC in either polarity, in all dc modes.

In the ac mode a capacitor is switched in series with the input to IC3 to eliminate any dc level that may be present on the output of IC2.

Two separate potentiometers (RV3 and RV4) are provided on the input to IC3. These enable the ac and dc meter scales to be calibrated independently. A 100 ohm resistor is in series with the meter resulting in a total meter resistance of about 200 ohms, and at 1 mA (which is full scale deflection) the voltage across the meter plus resistance will be 200mV on dc, and 340mV peak on the ac range.

The diodes D9 and D10, connected across the meter network conduct once the voltage across the meter exceeds approx 500 mV. This limits the maximum meter current to approximately 2.5 mA on any overload condition.

In the 'battery check' position the meter is connected across the battery with 20 K Ω in series. An associated marking is provided on the meter scale.

Fig. 1. Here is the foil pattern of the printed circuit board reproduced full size.

mounted components — shown in Fig. 3 — wired in place.

The completed printed circuit board is located by the terminals at the back of the meter. The board should be drilled to suit the meter, and the terminal area tinned, before final assembly.

The board can now be located in position and the remaining wiring completed. All external wires should be held together in a loom where practicable.

Before switching on recheck all wiring and component values. The unit is now ready for calibration.

CALIBRATION

Zero setting — short circuit the input terminals.

Select the + dc and 10 mV range. Adjust the zero set potentiometer on the front panel to give 'zero' on the meter. Select the 1000V range and set the meter to zero by using preset potentiometer RV2. Recheck zero on the 10 mV range and adjust RV1 if required.

Voltage calibration — the dc range is calibrated by connecting the input to a known dc voltage and adjusting RV4 to give the correct meter reading. The ac range is adjusted by connecting the input to a known ac voltage and adjusting RV3 to give the correct meter reading.

Check that all ranges work correctly, if any are faulty recheck the wiring of the switches and the components on the printed circuit board.

Once set, the calibration and zero setting of the instrument will remain constant for measurements across impedances not exceeding 1 Megohm.

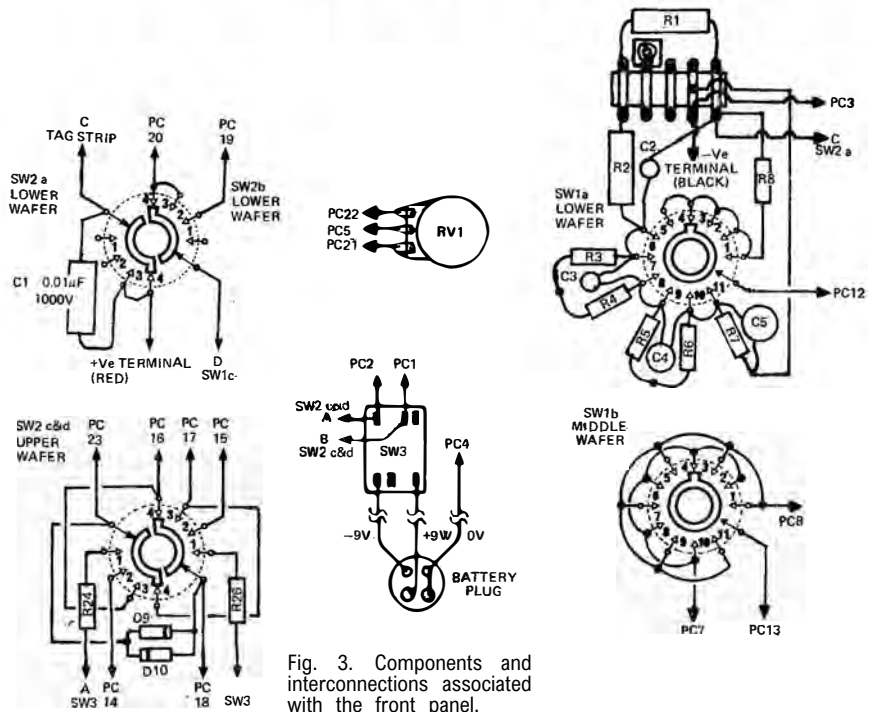
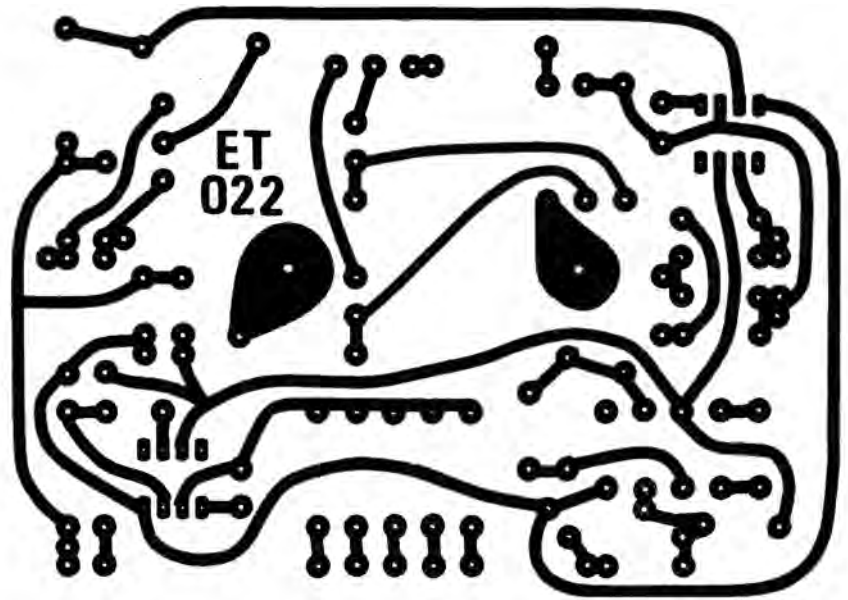
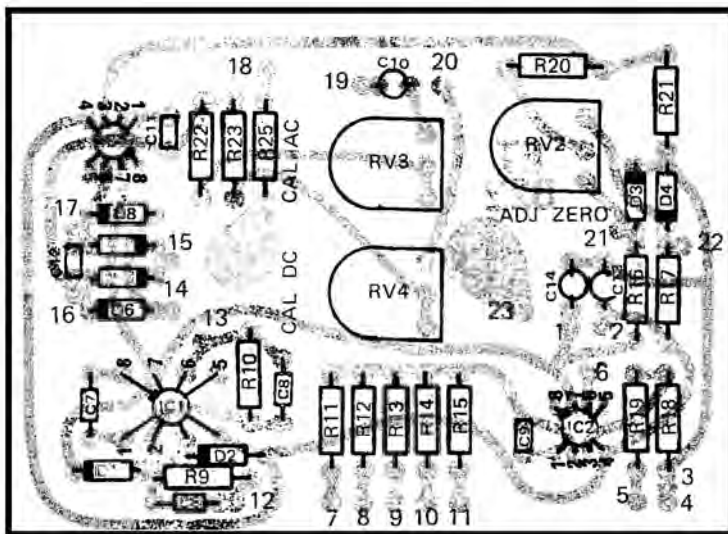

Fig. 3. Components and interconnections associated with the front panel.

Fig. 2. How the components are assembled on the printed circuit board.



WIDE-RANGE VOLTMETER

FRONT PANEL CUTOUT SHOWN BEFORE FOLDING

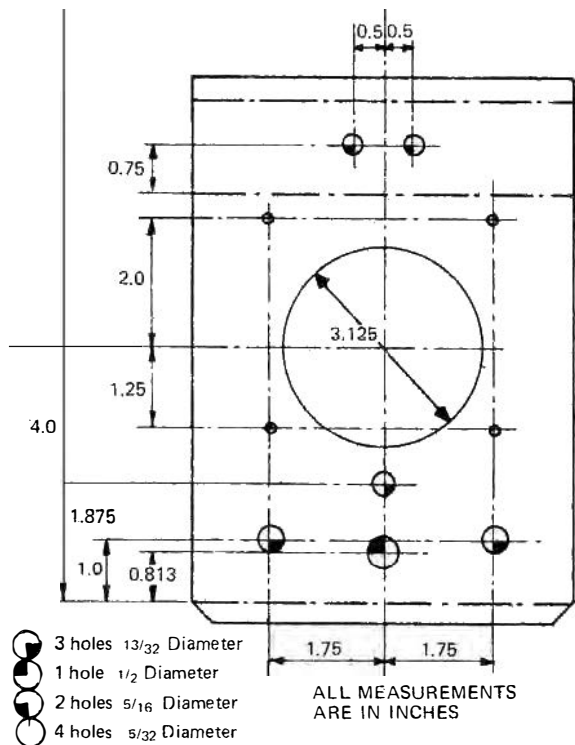
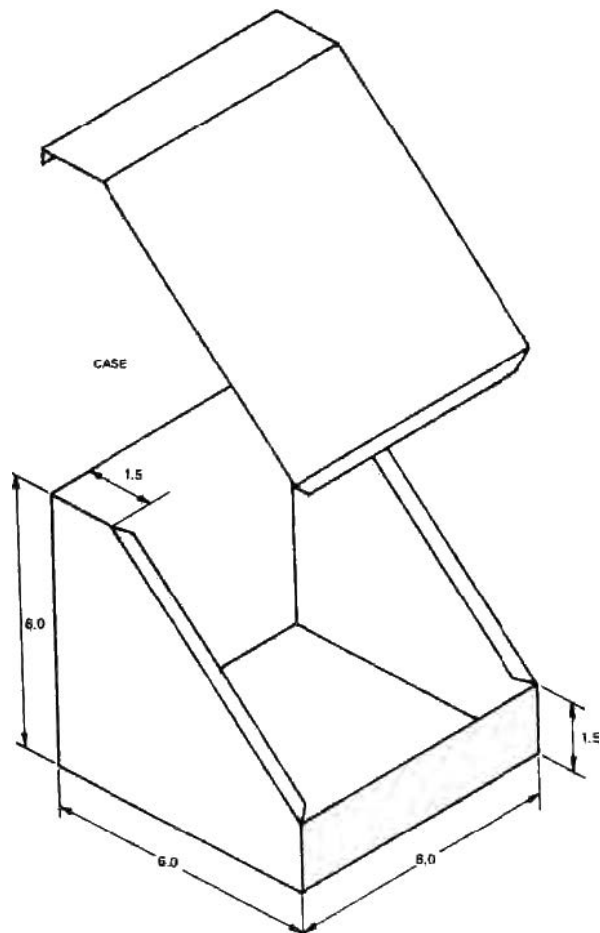

Fig. 4. Construction details of the meter case.



PARTS LIST ET107

R1	Resistor	4.7 Megohm,	1/2 Watt,	1%
R2		4.3 "	" "	
R3		470k		
R4		430k		
R5		47k		
R6		43k		
R7		10k		
R8		10k		5%
R9		1 Megohm		
R10		1 Megohm		
R11		1.5k		1%
R12		4.7k		
R13		4.7k		
R14		47k		
R15		470k		
R16		33k		5%
R17		33k		
R18		470 ohms		
R19		10k		
R20		10k		
R21		470 ohms		
R22	" "	820 ohms		1%
R23		910 ohms		
R24		10k		5%
R25		100 ohms		
R26		10k		
C1	capacitor	0.01 uF, 1000V		
C2	"	33pF, 1000V,	5%	
C3		330pF, 100V,	5%	
C4		3300pF, 100V,	5%	
C5		0.033uF, 100V,	5%	
C6		0.01uF, 100V		
C7		33pF, 25V		
C8		0.01uF, 100V		
C9		180pF, 25V		
C10		33uF, 10V, TAG electrolytic		
C11		180pF, 25V		
C12		560pF, 25V		
C13		33uF, 10V, TAG electrolytic		
C14		33uF, 10V, TAG electrolytic		
RV1		potentiometer, 10k linear CTS45 or equivalent.		
RV2		trimming potentiometer 10k, (large type)		
RV3		" " " 100 ohms, (Large type)		
RV4		" " " " " "		
IC1		integrated circuit National Semiconductor LM308		
IC2		" " " " " LM301A		
		(or Fairchild uA301A)		
IC3		As above		
		(note - ICs must be metal can type, or 8 pin plastic type)		
D1-D10	-	diodes 1N914		
SW1		rotary switch, 3 pole, 11 position		
SW2		" " 4 pole, 4 position		
SW3		toggle switch, 2 pole on-off. MSP 625 or si similar.		
Meter		1 mA movement, scaled 0-10 (Or 0-1) and 0-3.16, plus a dB scale.		
		or similar.		
		Metal case		
		Plug for batteries.		
		Metal clamp for battery		
		Terminals - 2, one black, one red		
		Knobs - 3		
		Anodized front panel (optional)		

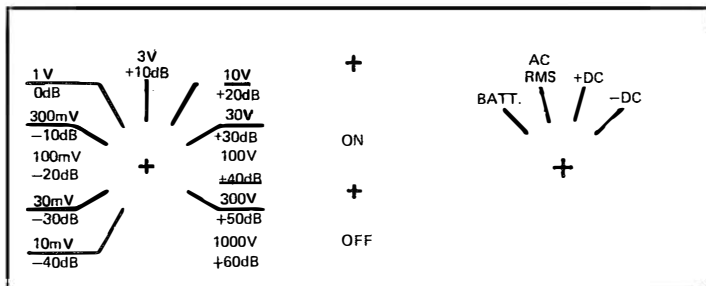

Fig. 5. Details of lettering on front panel.

PRACTICAL GUIDE TO TRIACS

Triacs are simple, versatile devices used throughout electrical and electronic engineering. Yet most electricians regard them with almost superstitious awe. This three-part article describes their uses in a totally practical way.

Part I—Switching circuits

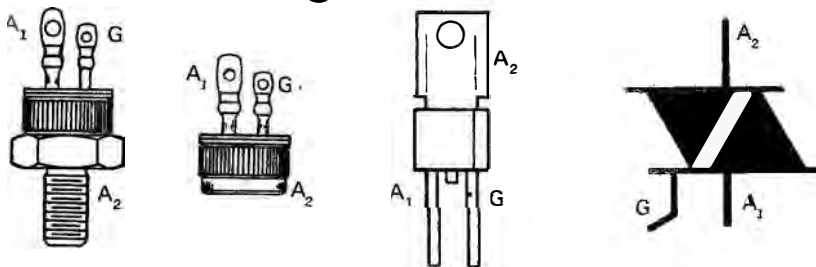

Fig. 1. Construction and electrical connections of typical Triacs.

ELECTRONICS, according to a friend of ours, is anything electrical that he doesn't use or understand.

Triacs, by this definition, must soon be considered non-electronic, for they are finding ever-increasing use throughout electrical engineering — in both consumer and industrial applications.

In effect, a Triac is similar to a latching relay. It closes — practically instantaneously — after being triggered, and remains closed until the supply voltage is reduced to zero (or changes polarity). When this occurs (twice every complete cycle if used on ac) the Triac opens, but will close again almost instantaneously if retriggered.

STATIC SWITCHING

Triacs can usefully replace mechanical switches in ac circuits. They allow the control of relatively high power by very low triggering current — and as Triacs latch each half-cycle there is no contact bounce; nor, as they open only at current zero, is any arcing or transient voltage developed due to stored inductive energy in the load or power lines. They eliminate completely the contact sticking and wear associated with electro-mechanical relay, contactors, etc.

Triggering arrangements are very flexible — most Triacs can be switched into conduction at any point on either half-cycle of the ac waveform by applying a low voltage of either polarity between the gate electrode and anode 1. (A few types of Triac can only be switched by a negative-going gate voltage or pulse.)

The triggering voltage can be obtained from a battery (Fig. 2) or simply from the ac mains (Fig. 3). In either case, full wave current will flow

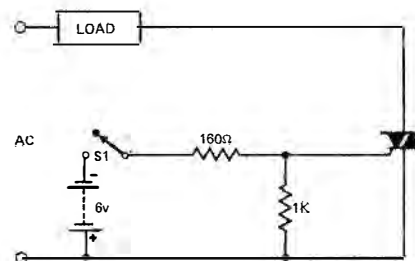

Fig. 2 Triac triggered by external dc voltage.

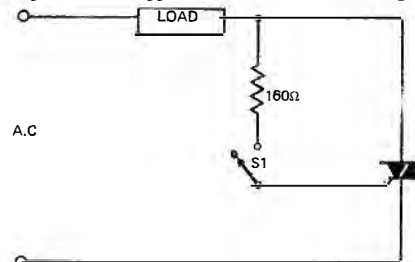

Fig. 3. Triac is triggered by input ac, in this application switch S1 will be 'live'.

when S1 is closed and current will cease to flow at the end of the half-cycle (whether positive or negative) in which S1 is opened (Fig. 4).

ELIMINATES BURNT CONTACTS

The simplest possible method of triggering is shown in Fig. 3. This circuit is often used to eliminate burnt contact breaker points in thermostats and similar devices which have to

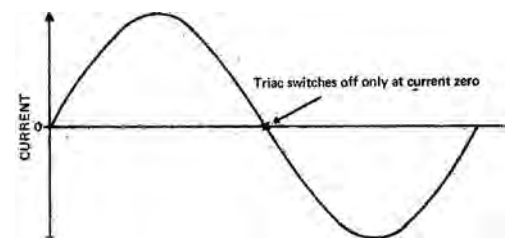
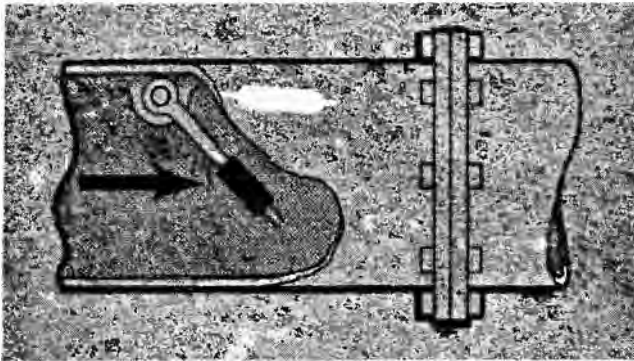

Fig. 4. A triac can be triggered into conduction at any point along the sine-wave, but will only switch off at current zero.

make and break large currents at frequent intervals. The existing make and break arrangement is retained but used only to switch the Triac, which in turn switches the main load current. The current flowing through the contacts is reduced to a few milliamps.

MOVEMENT SWITCHES TRIAC

A magnetic method of triggering may be used when a mechanical movement actuates an electrical circuit. To do this, a magnetically operated reed switch is used as S1. The switch contacts are closed when a magnet is brought near the switch. The actual distance will depend upon the sensitivity of the reed switch and the strength of the magnet (½" to 1" is typical). Various applications of this principle are shown in Fig. 5.



Magnetic reed switch used for flow control minimises restraint on moving parts and avoids perforating tube wall.

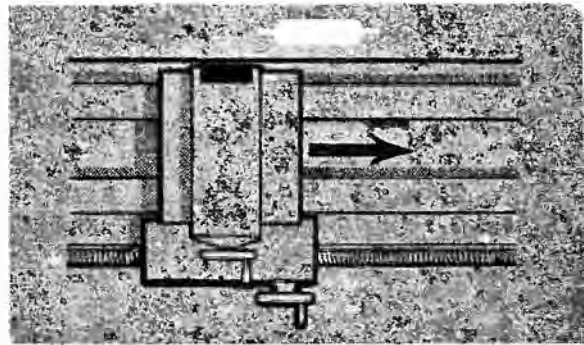

Reed switch simplifies positional control.

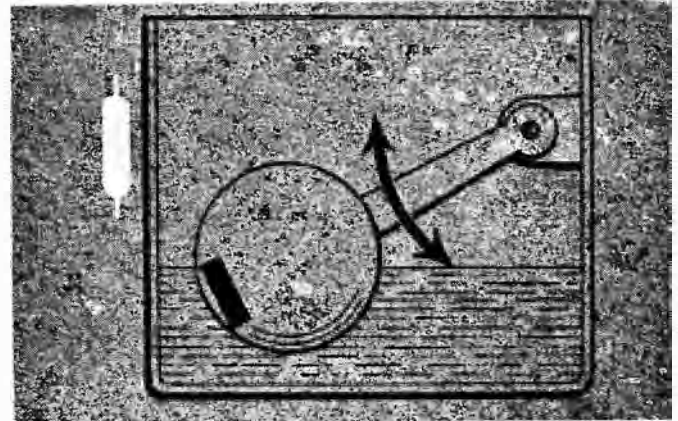

Liquid level control.

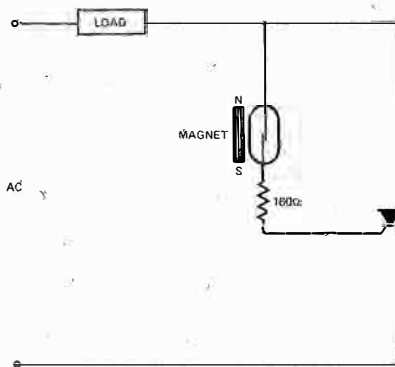

Fig. 5. A magnetically operated reed switch provides electrically isolated triggering from mechanical movement. The switch will close when the magnet is brought within half an inch or so. Suggested applications are shown in Figs 5a, 5b and 5c.

Reed switches may also be used to provide electrical isolation between the Triac and the triggering circuit. The reed is inserted in a coil which is then switched by a suitable low voltage dc supply (Fig. 6). As the life of reed switches exceeds several million operations, this is an extremely reliable method of switching.

Other simple methods used to isolate the triggering circuit from the Triac are shown in Figs. 7 and 8. The photo-cell coupling shown in Fig. 8 provides extremely high electrical isolation. Photo-cell couplers, in which a light source and photo-cell are integrally mounted, are commercially available for as little as a dollar.

An unusual off/half-power/full-power circuit is shown in Fig. 9. When half-power is required, the diode is switched in series with the triggering lead. This causes the Triac to conduct only on alternate half-cycles. The circuit is suitable for heating, or other resistive loads that have thermal inertia. It is not suitable for lighting control, as the halved frequency will cause an irritating flicker; nor should it be used for inductive loads such as motors or transformers.

A latching circuit is shown in Fig. 10. Momentarily depressing S1 will cause the Triac to conduct and to remain

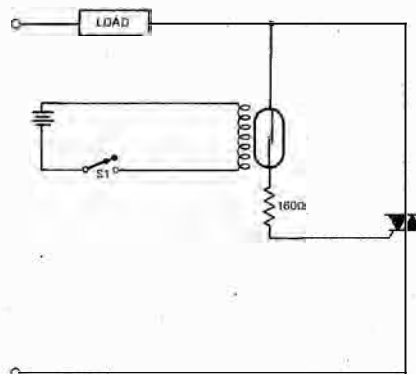

Fig. 6. Reed relay can be electrically operated to provide electrical isolation.

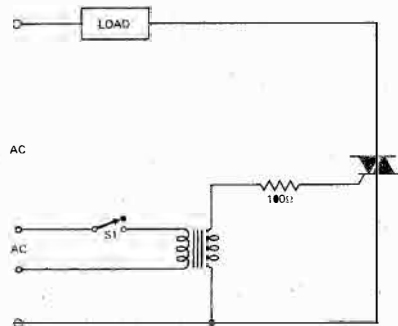

Fig. 7. Isolated ac provides triggering.

conducting after S1 is released. The circuit is reset by momentarily depressing S2. C1 should be a 0.5 μ f to 2.0 μ f, 630 volt working, non-polarised capacitor.

TIME DELAY CIRCUITS

Triac time delay circuits are shown in Figs. 11, 12 and 13. All three circuits will provide time delays up to 100 seconds or so and may be used for applications such as photographic timers, industrial machinery, etc.

In the circuit shown in Fig. 11 the Triac will conduct as soon as S1 is closed. After a time — determined by the setting of the one Megohm potentiometer — the unijunction will fire, causing SCR1 to conduct thus removing the triggering voltage from the Triac.

Other types of time delay circuits are shown in Figs. 12 and 13. In both of these circuits the Triac will conduct a predetermined time after S1 is closed. The preset time intervals are set by the 1 Megohm potentiometer.

Liquid level is used to switch the Triac circuit in Fig. 14. The Triac will conduct when the resistance between the sensing probes falls below 100K. The pulse transformer in this circuit must be well insulated to ensure that

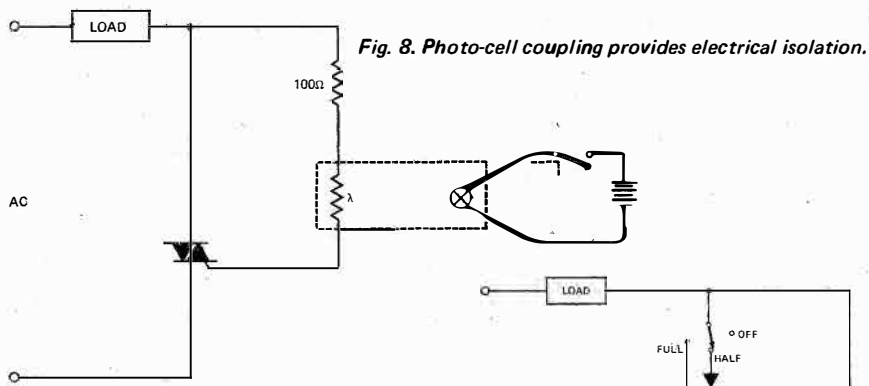

Fig. 8. Photo-cell coupling provides electrical isolation.

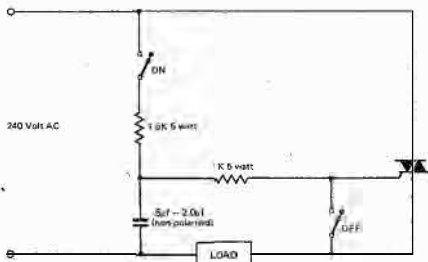

Fig. 9. Circuit can be switched to provide half or full power into load.

Fig. 10. This triggering circuit provides latching action.

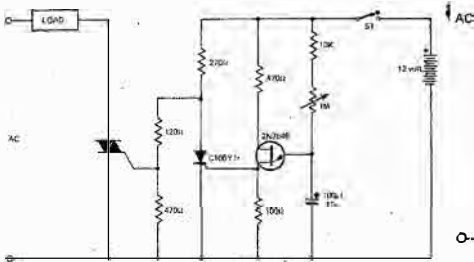

Fig. 11. Time delay circuit — power is disconnected from load after pre-set time.

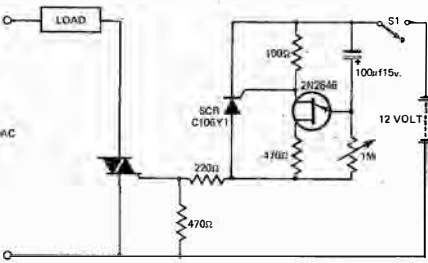

Fig. 13. Time delay circuit — power is connected to load at end of pre-set delay.

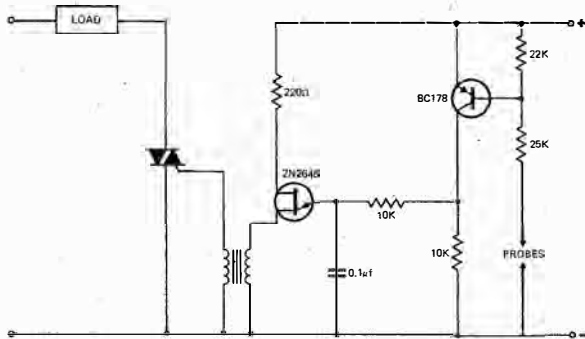

Fig. 15. Capacitor and resistor should be connected across the Triac when switching inductive loads.

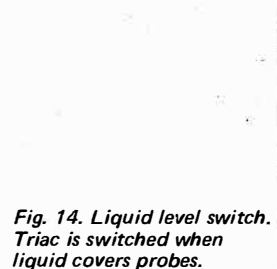

Fig. 14. Liquid level switch. Triac is switched when liquid covers probes.

mains voltage cannot appear across the probes.

INDUCTIVE LOADS

All the circuits described so far will operate reliably with resistive loads. Inductive loads present a minor problem. For reliable operation it may be necessary to limit the rate of voltage rise immediately following turn-off. This is done by connecting a capacitor and series resistor across the Triac (Fig. 15).

A Triac's power rating is a function of its operating temperature. Thus a unit of 6 amps nominal rating used without a heat-sink must be derated to 1½ amps. A rough guide can be obtained from the Triac's external case temperature. This should not exceed 75-80°C.

In the majority of circuits the outer case of a Triac will be 'live'. Because of this it is necessary either to insulate the heat-sink from surrounding metalwork, or to insulate the Triac from the heat-sink.

Two flat mica washers and a Teflon collar will effectively insulate the Triac from the heat-sink, but there will be an appreciable loss in cooling efficiency. Where possible, it is better to have metal-to-metal contact and then to use an insulated mounting for the heat-sink itself.

Providing Triacs have adequate heat-sinks, it is permissible to run them permanently at their maximum designed rating. They can also withstand considerable overloads for short periods. A typical unit can withstand ten times its nominal rating for one half-cycle of a 50 Hz waveform.

DO NOT OVERLOAD

Despite this tolerance of short-term overloads, Triacs must not exceed their designed ratings for more than a fraction of a second. A short circuit will destroy them instantaneously. Fusing is usually ineffective, as a Triac will almost invariably fail first and protect the fuse.

An almost certain symptom of overloading is loss of gate control; the Triac will appear to have a short circuit from one anode to the other, although overloaded Triacs will occasionally still operate on one half-cycle only.

The second part of this article — to be published next month — describes the use of Triacs in power control, covering both zero voltage switching and phase control circuits.

FIRST FOR FERROGRAPH

FERROGRAPH MODEL 7HD DOLBY TAPE RECORDER

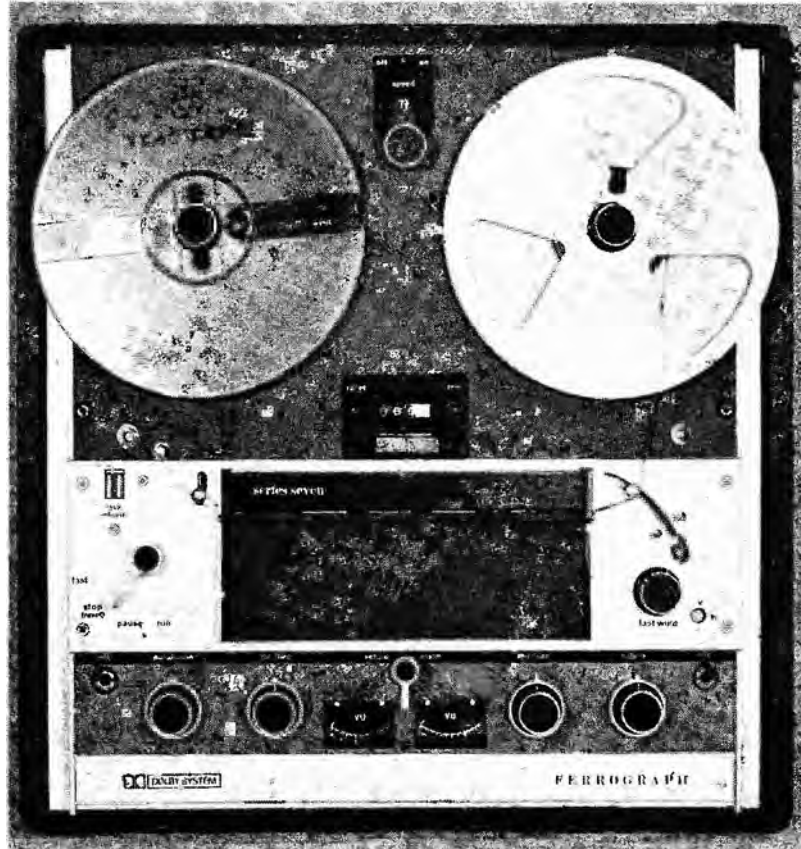
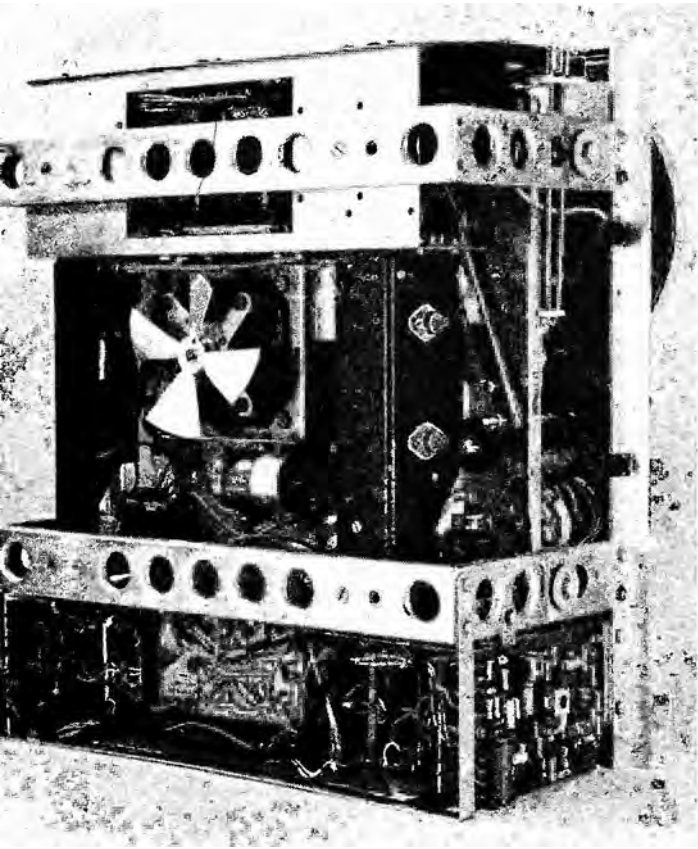

electronics
TODAY
INTERNATIONAL
product test

Ferrograph's Model 7 HD is the first reel-to-reel tape recorder to incorporate the Dolby Noise Reduction System. Here is the first test report — to be published anywhere in the world — on this superb new machine.

FERROGRAPH have gained a 'first' with the recent introduction of their Series 7 recorders incorporating the Dolby B Noise Reduction System.

The incorporation of the Dolby B noise reduction system within the recorder further enhances the already excellent performance of this machine.

Except for the Dolby trade mark on the hinge down flap at the bottom of the unit, and a black anodized aluminium cover over the tape heads, the external appearance is similar to the Ferrograph Series 7D recorder.

But other differences became apparent when we checked out the control facilities to perform our subjective evaluation and laboratory measurements. For the 7HD has been improved in a number of areas compared with the standard Series 7 and not just by the inclusion of the Dolby system. Two of the more important of these improvements are described later in this review.

The recorder is housed in a timber cabinet covered in dark grey vinyl. The top half of the deck is finished in a dark grey vinyl-coated steel and the unit has a detachable lid cunningly held on by two slide catches next to

WORLD SCOOP TEST REPORT



the carrying handle. But as this recorder weighs 49 lbs few would want to carry it very far.

CONTROL FUNCTIONS

The power on/off rotary switch and speed selector switch are centrally located at the top of the front panel between the two tape spools. The record button and turn counter are centrally located at the bottom of this panel. On the previous Series 7 the record button could be depressed at any time during playback; not so with this unit. A small inconspicuous interlock is located to the left of the record button and this must be

operated before the record button can be depressed.

A further three, horizontally separated, panels contain the mixing and operating controls.

The centre panel contains the heads (located under a large black anodized aluminium cover), a function switch with fast forward lock at the left hand end, and the fast forward or reverse control knob at the right hand end.

The function switch has four positions, these are, fast, off, pause, and run. Once the fast position has been selected it is not possible to switch through stop to the pause or

run mode without operating the interlock.

In the fast position the forward or reverse speed is steplessly variable — by turning the control knob clockwise or anticlockwise. This knob controls the power fed to each reel motor by varying the voltage to each, and thereby determining the direction of travel and speed of the tape. This arrangement provides extremely accurate cueing by making it possible to 'inch' up to any point on the tape from either direction.

The next panel, below the heads, contains two extremely accurate VU meters, centrally located, with a three

Measuring Obj.:
FREQUENCY
RESPONSE OF
FERROGRAPH
MODEL No.:
722-HD tape
RECORDER
1 Decibel
per Division
recordings
displaced
for clarity

Rec. No.:
Date: 24-12-71
Sign.:

QP 1124

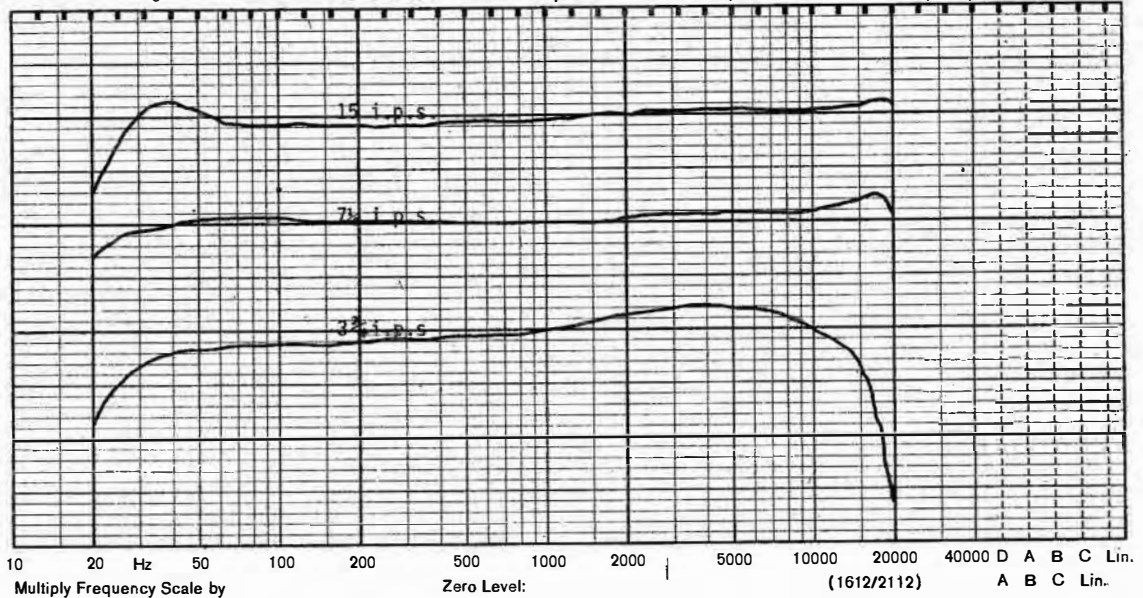

FIRST FOR FERROGRAPH

position switch mounted above them for selection of upper or lower channel record mode, or stereo record mode. The left hand end contains the upper channel 'tip and sleeve' type microphone input, the equalization selector switch and the upper channel concentric line and microphone input level controls.

The separate equalization control appears to be an unnecessary complication, as the inclusion of a fault relay makes it impossible to select the wrong equalization for a given speed anyway. Surely this function could have been incorporated as part of the speed selector knob?

The right hand end of this panel contains the lower channel 'tip and sleeve' microphone input, the concentric line and microphone input level controls, and the concentric output level controls. The output level controls are associated with the monitor amplifiers and only affect the level of signal fed to the monitor speakers or remote speakers.

A large array of switches and control knobs are located behind a hinge-down flap at the bottom of the deck. These controls are, from left to right:—

- Upper channel output select switch with two positions, namely, tape or source.
- M.P.X. switch which switches in a filter to tune out the carrier frequency when recording F.M. broadcasts with the Dolby noise reduction 'on'.
- Upper channel bass control with calibrated boost and cut positions.
- Upper channel tape level adjusting

- Upper channel treble control with calibrated boost and cut positions.
- Upper channel bias potentiometer — located behind a screwdriver access hole.
- Three position meter mode switch which switches both meters to output source, or bias level indicating modes.
- Transfer switch with three positions for upper to lower channel transfer, off, or lower to upper channel transfer.
- Lower channel bias potentiometer — located behind a screwdriver access hole.
- Lower channel treble control with calibrated boost and cut position.
- Lower channel tape level adjusting potentiometer — located behind a screwdriver access hole.
- Lower channel bass control with calibrated boost and cut position.

- Three position noise reduction switch. In the first position the Dolby 'B' record and playback circuits are switched in so that the tape being 'Dolbyized' can be monitored in the fully processed form. In the middle position, only the playback Dolby circuit is used so the previously 'Dolbyized' source material may be recorded and monitored with correct equalisation. In the third position the Dolby noise reduction circuits are switched out and the recorder functions as a standard tape recorder.
- Lower channel output select switch with two positions, namely tape or source.

The adjusting potentiometers described in (d) and (k) above, make it possible to adjust the monitored signal of a tape to the same level as the source signal level. This is to correct for different tape sensitivities.

FERROGRAPH MODEL 722HD SERIAL No. 81658

	3 3/4 ips	7 1/2 ips	15 ips
Record to replay frequency response (with Scotch 203 tape at OVU)	30Hz-15kHz ±3dB	20Hz-20kHz ±3dB	25Hz-20kHz ±2dB
Total harmonic distortion at 1kHz (OVU)	2%	2%	2%
Intermodulation distortion (1kHz & 960Hz at OVU)	2%	2%	2%
Signal/noise ratio at OVU & 1kHz	55dB	56dB	57dB
Erase ratio for 1kHz signal (prerecorded at OVU)	— better than 74dB		
Cross talk at OVU			
100Hz	47dB	47dB	47dB
1kHz	46dB	46dB	46dB
Wow & flutter	0.06% rms	0.12% rms	0.15% rms
Line input sensitivity (for OVU)	— 50mV		
Microphone input sensitivity (for OVU)	— 300µV		
Line input sensitivity (for OVU signal level)	— 300mV		
Main amplifier power output	— 10 Watts continuous power/channel into 8 ohm load		
Frequency response (of main amplifier)	— 20Hz-20kHz ±0.5dB		

All input and output sockets are located on a recessed panel located under a hinged flap adjacent to the carrying handle in the top of the timber housing. These sockets include line inputs, low level outputs, 600 ohm outputs, and 8-16 ohm speaker outputs for the upper and lower channels — all utilizing tip and sleeve jacks.

The versatility of the recorder has been increased by the inclusion of a seven-pin DIN socket providing the following facilities:—

- a) Remote stop/start, with the recorder in the pause position.
- b) Fifty volt dc supply for driving auxiliary equipment.
- c) Low level outputs.
- d) Six hundred ohm outputs.

Three fuses are also located on this panel. One fuse is in the main supply and the other two fuses protect each amplifier output stage.

INBUILT AMPLIFIERS

The Series 7 HD recorders are obtainable with full-track, half-track or quarter-track, mono or stereo channels and with or without power amplifiers. All versions are fitted with separate record, playback and erase heads with independent record and playback amplifiers.

The version that we tested was the half-track high speed model with 3¾ ips, 7½ ips, and 15 ips tape speeds.

We believe that *all* tape recorders (as opposed to tape decks) should have internal amplifiers with at least six watts continuous power rating.

Ferrograph's incorporation of two 10 Watt amplifiers (when specified) is sensible, and the addition of good quality external speakers converts this recorder into a high quality tape recording system suitable for high quality sound reproduction in the home or even a small hall.

HOW IT PERFORMED

Two important improvements are apparent when the new Series 7 HD unit is compared with the standard Series 7 recorder — The first of these is a dramatic reduction in the level of operational (mechanical) noise. The Series 7 HD unit is at least 12 dB ('A' scale) quieter than the standard Series 7 recorder.

A second worthwhile improvement is the provision of rubber inserts in the tape hubs.

During subjective tests we were once again impressed by the quality of reproduction of Ferrograph recorders. In fact only at the lower speeds or at very low signal levels was the improvement from the Dolby unit

really noticeable. But we suspect that on old or cheap tapes, the improvement in signal to noise ratio offered by the Dolby system would be a very worthwhile feature.

The provision of simultaneously useable Dolby Noise Reduction circuits on both record and playback modes is an unusual feature. All the Dolby units we have seen previously have been intended to be used firstly in the record mode, and then subsequently in the playback mode. This is done to save money, but the Ferrograph is in no way a cut-price unit. By providing four Dolby units, permanently wired in either the record or playback mode, off-tape monitoring can still be performed on the Dolbyized Ferrograph without the loss of high frequency low level components.

The specification laid down by Dolby Laboratories to its licencees appears to be a tolerance of better than 1 dB between two Dolby units. The record and playback units in the Ferrograph recorder are sufficiently matched to give a record to replay performance which is within 0.1dB of the non-Dolbyized response at all frequencies and levels. Ferrograph have made this significant technical achievement by using precision components.

We have previously commented on the ease of using 'built-in' Dolby units over 'add-on' Dolby units. As the Ferrograph has been designed to perform all its functions with the Dolby system incorporated... we suspect that the average user will probably switch the recorder to 'Dolby in' and forget the switch for ever more, unless playing non-Dolbyized tapes.

FM BROADCAST RECORDING

Recent experiments in the USA have

shown that the signal-noise ratio and effective coverage of FM broadcasting systems can be considerably enhanced by the inclusion of the Dolby noise reduction system.

Anticipating the probable use of Dolbyized FM stereo broadcasting, this machine has a switch position to enable such a signal to be recorded directly on the tape, and then be monitored directly off the tape with the correct Dolby processing. In the meantime this facility has its uses for transcribing 'Dolbyized' tapes without reprocessing.

Our only real criticism of the recorder — concerns the automatic shut-off system. On the unit tested the automatic braking at the end of a 7" reel was so violent that it resulted in the end of the tape slipping down into the space between the wound tape and its supporting reel. Whilst this may be an isolated example of this phenomena we feel that Ferrograph's quality control should not allow a machine with a fault of this type to leave the factory.

Nevertheless — the Ferrograph Series 7 HD is the finest Ferrograph recorder that we have yet seen and one of the finest AM recorders available in the world today.

The performance of the unit that we tested was impeccable. Material recorded from other sources was indistinguishable in every way from the original.

The price may deter many intending purchasers, but for those who can afford it, this must be one of the best professional-quality tape recorders yet made.

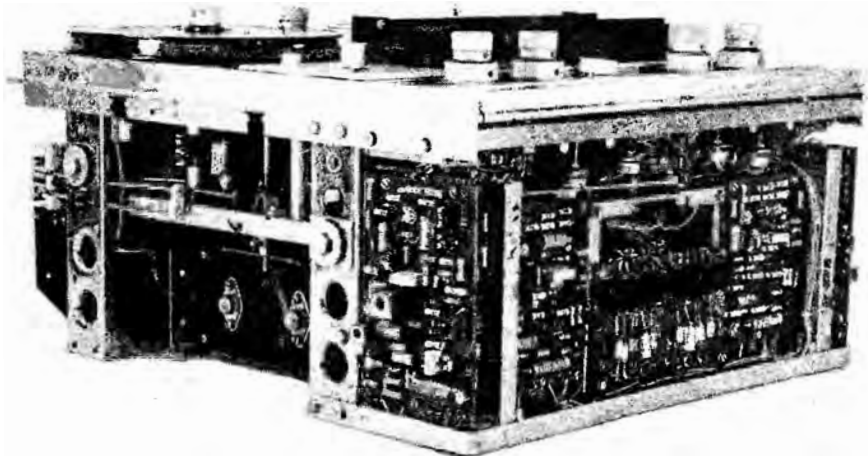

The sound you want without the noise you don't



You will find Ferrograph tape recorders all over the world where people *have* to have the best (like broadcasting stations, the Post Office, Nato, and the people who fly Concorde), or where people simply *want* the best and can afford it. Ultimately a reputation like The Ferrograph's rests on one thing only: the quality of the sound it puts out – and *continues* to put out.

Now its performance is even better – because of extraneous noise it does *not* put out. Thanks to the Dolby B noise reduction system, which is now an available option on Hi-Fi machines, tape hiss can be dramatically reduced.

Keats almost wrote it: 'Heard melodies are sweet, but noise unheard is sweeter'.

Ferrograph Tape Recorders:

Mono or stereo with reproduction as good as from disc or VHF radio. Fool-proof deck operation. Simple to operate. Variable speed spooling for easy editing and tape protection: separate volume and tone controls on each track: track transfer by means of a switch. Three-year guarantee.

The Dolby System:

The Dolby B noise reduction system reduces noise by up to 10 dB without any loss of sound quality. A recording made at $1\frac{7}{8}$ in/s with Dolby may therefore have less background noise than the ones that you now make at $7\frac{1}{2}$ in/s without it.

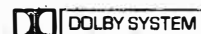

"Dolby" and "Dolby System" are registered trade marks of Dolby Laboratories Inc.

Enquiries to the Ferrograph Company.

Ferrograph International Distributors: Elpa Marketing Industries Inc – New York/Leroya Industries PTY – Subiaco Western Australia/Cineco, Champs Elysees, Paris/Atlas Sound Co – Singapore/Hi-Fi Installations (PTY) Ltd – South Africa/Audiograph (Techn. Handelsonderneming), Roelof Hartplein 23, Amsterdam/Henry Wells & Co KG – Danhausergasse 3 Vienna/S. Hoyem – Copenhagen/Harry Thellmod – Stockholm/Electrex – Zurich/The Radio People – Kowloon.

FERROGRAPH

A member of the Wilmot Breedon Group

Please send me a leaflet on Ferrograph tape recorders or Telephone 01-205 2241 Telex 27774.

NAME

ADDRESS

ET1

THE FERROGRAPH COMPANY LIMITED
The Hyde Edgware Road Colindale LONDON NW9

POWER SUPPLY

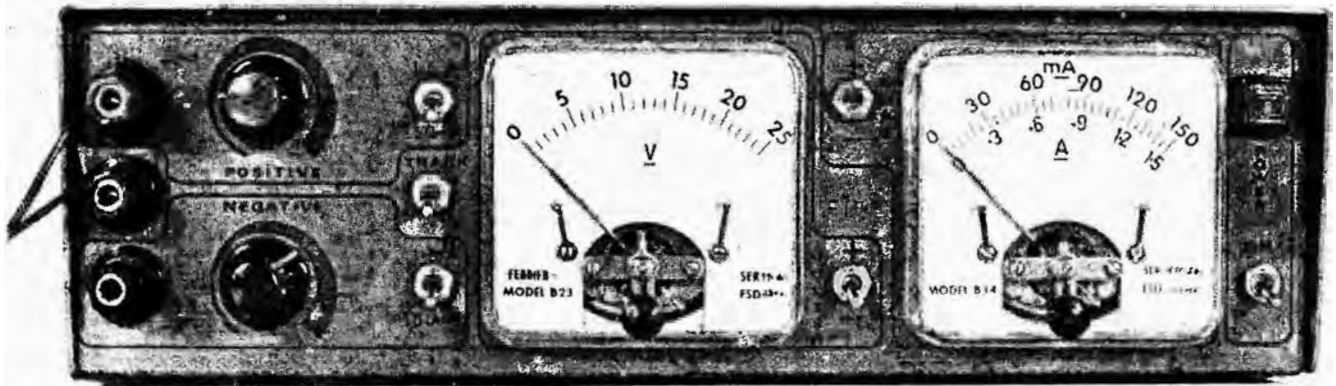

UNTIL recently, integrated circuits were priced beyond the reach of the average enthusiast, and very few constructional projects specified their use.

But as with so many electronic components, mass production and wide-spread commercial acceptance has resulted in quite dramatic price reductions, and integrated circuits costing twenty or thirty dollars a couple of years ago, are now readily available for well under two dollars. Many cost less than a dollar.

From the enthusiast's point of view this is a most exciting development for it opens up the possibility of constructing far more ambitious projects than were previously feasible using discrete components. Many such projects will soon be featured in this magazine.

But there is one minor drawback to integrated circuits and this is that many of them require both positive and negative power supplies. These supplies must also have a better level of line and load regulation than was previously necessary.

The power supply described in this project has been designed specifically for this purpose. It is intended for both the serious enthusiast and the professional development engineer.

As may be seen from the specifications, its performance is equivalent to many commercially built units at many times the price.

The unit has two outputs, one positive, and one negative — each

separately adjustable from zero to 20 Volts, or settable in such a way that the negative supply automatically tracks the positive supply.

CURRENT LIMITING

Both the unit, and your experimental circuits, are protected against damage by current limiting networks

incorporated within the power supply.

A panel mounted switch is used to select the maximum desired current at either 190 mA or 1.80 Amps. If this level is reached, the output voltage will drop and current will be held at the selected limit.

For the professional user of this unit,

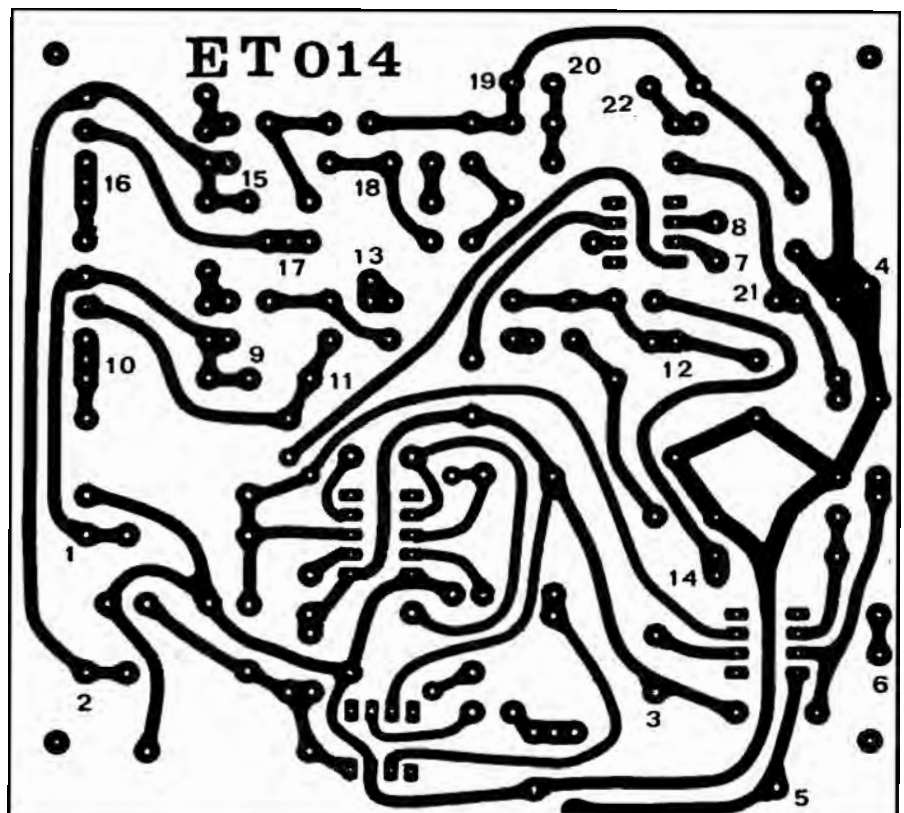

Fig. 3. Foil pattern of printed circuit board (full size).



CN.240/2 Miniature soldering iron 15 watt 240 volts, fitted with nickel plated 3/32" bit and packed in transparent display box. Also available for 220 volts. **Price £1.70**

CN.240 Miniature soldering iron 15 watt 240 volts, fitted with iron coated 3/32" bit. Up to 18 interchangeable spare bits obtainable. This iron can also be supplied for 220, 110, 50 or 24 volts. **Price £1.70**

G.240 Miniature soldering iron 18 watt 240 volts extensively used by H.M. Forces. Suitable for high speed soldering and fitted with iron coated 3/32" bit. Also available for 220 volts. Spare bits 1/8", 3/16" and 1/4" are obtainable. **Price £1.83.**



CCN.240 New model 15 watt 240 volts miniature soldering iron with ceramic shaft to ensure perfect insulation (4,000 v A.C.). Will solder live transistors in perfect safety; fitted with 3/32" iron coated bit. Spare bits 1/8" 3/16" and 1/4" available. Can also be supplied for 220 volts. **Price £1.80**

CCN.240/7 The same soldering iron fitted with our new 7-star high efficiency bit for very high speed soldering. The triple-coated bits are iron, nickel and chromium plated. **Price. £1.95**



E.240 20 watt 240 volts soldering iron fitted with 1/4" iron coated bit. Spare bits 3/32", 1/8" and 3/16" available. Can also be supplied for 220 and 110 volts. **Price £1.80.**

ES.240 25 watt 240 volts soldering iron fitted with 1/8" iron coated bit. Spare bits 3/32", 3/16" and 1/2" available. Can also be supplied for 220 and 110 volts. **Price £1.83**



SK. 2 SOLDERING KIT

This kit contains a 15 watt 240 volts soldering iron fitted with a 3/16" bit, nickel plated spare bits of 5/32" and 3/32", a reel of solder, Heat Sink, 1 amp fuse and booklet "How to Solder".

Price £2.40.



SK.1 SOLDERING KIT

The kit contains a 15 watt 240 volts soldering iron fitted with a 3/16" bit, nickel plated spare bits of 5/32" and 3/32", a reel of solder, heat sink, cleaning pad, stand and booklet "How to Solder". Also available for 220 volts.

Price £2.75



MES. 12

A battery operated 12 volts 25 watt soldering iron complete with 15' lead, two crocodile clips for connection to car battery and a booklet "How to Solder" packed in a strong plastic wallet. **Price £1.95.**

sign here

to answer all
your soldering
problems

I enclose cheque/P.O./Cash
(Giro No. 2581000)

Name _____
Address _____

ET4

Please send the Antex
colour catalogue.

Please send the following:



from electrical, radio or car accessory
shops or from **Antex Ltd., Freepost**
(no stamp required) **Plymouth**
PL1 1BR Telephone 0752 67377/8

DUAL POWER SUPPLY

provision has been made for the positive regulator to be externally programmed. The necessary wiring changes are shown in Fig. 2.

Due largely to the use of externally mounted heatsinks, and the use of integrated circuits in the control and voltage reference circuits, the complete power supply unit is quite small and compact. Yet despite this, the internal layout is spacious and all major components are readily accessible.

CONSTRUCTION

Construction is reasonably straightforward if work progresses in the correct manner. The unit may be assembled on matrix board, but we strongly recommend that the correct printed circuit board be used. The foil pattern of the p.c. board is shown in Fig. 3.

Assuming that the printed circuit board is used, commence construction

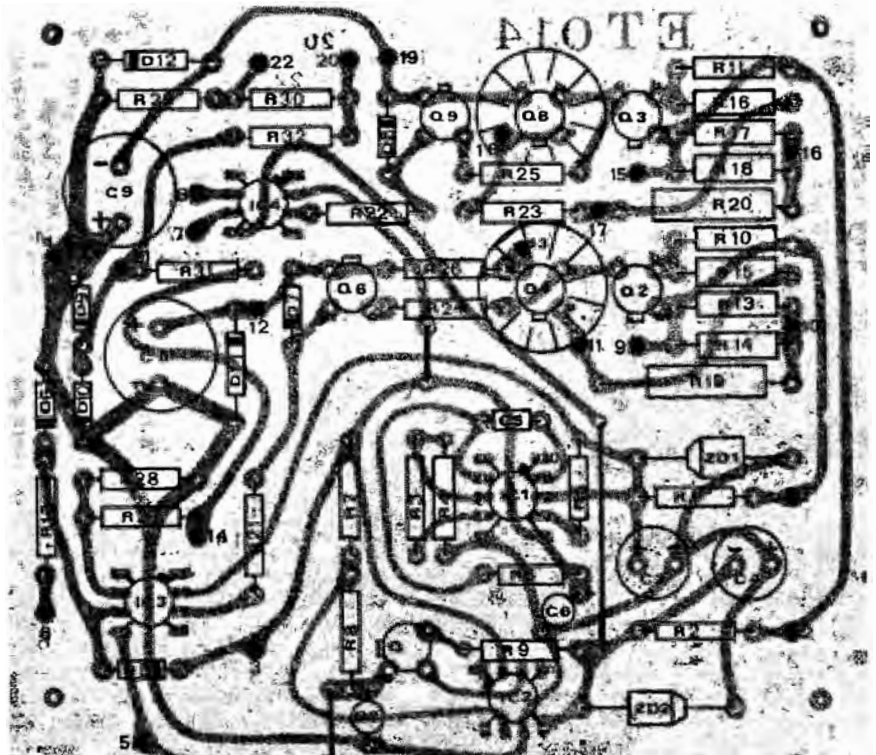

Fig. 4. How the components are mounted on the printed circuit board. Compare this with Fig. 3.

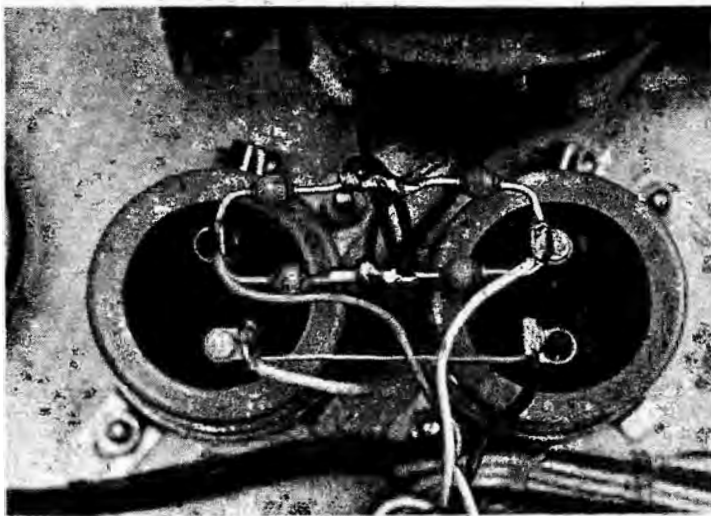

Fig. 5. Diodes D1 - D4 are mounted on top of the filter capacitors.

by inserting the pc board pins into the positions numbered on the board. These pins should be inserted with the flange (if flanged) on the component side of the board. All external wiring to and from the printed circuit board will be attached to these pins on the foil pattern side of the board.

When installing the integrated circuits ensure that they are orientated correctly before soldering. (Note that Fig. 4 shows all components, including integrated circuits, as seen from the component side of the board.)

Small heatsinks are fitted over transistors Q4 and Q8. Ensure that these do not contact any other component by mounting them about 1/8" above other nearby components.

When all components have been mounted on the board, recheck for correct orientation and polarity.

Fig. 6. This drawing shows front panel wiring details. Wires A, B and C interconnecting wires to the front panel. Wire D goes to the common of the filter capacitors.

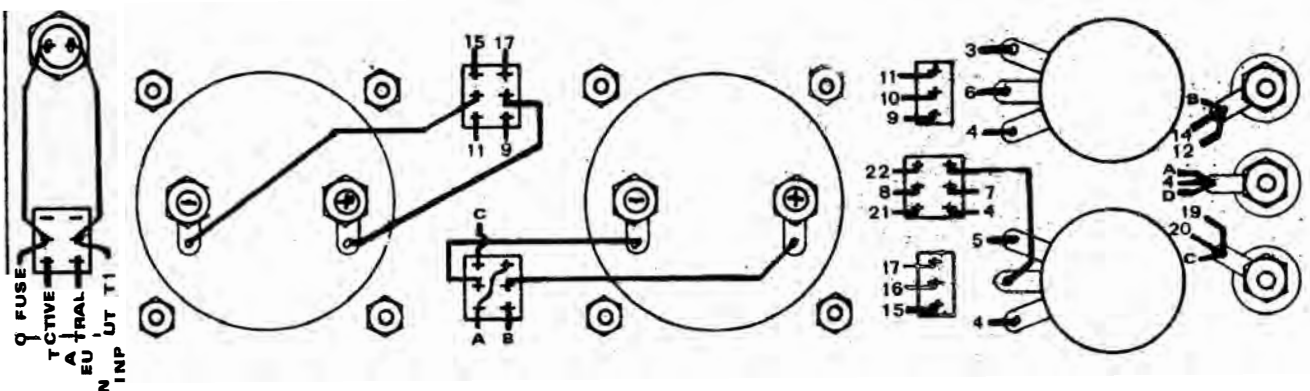

DUAL POWER SUPPLY

constructed our front panel by sandwiching a line drawing between the chassis and a piece of smoked perspex. This provides a very professional looking appearance. An even better finish can be obtained by using an anodised aluminium panel, and these may be available from parts suppliers.

Having determined the method of finishing the front panel, assemble all the relevant components onto the panel.

Wires should now be attached to the pins on the underside of the printed circuit board. Insulated 14/0076 wire

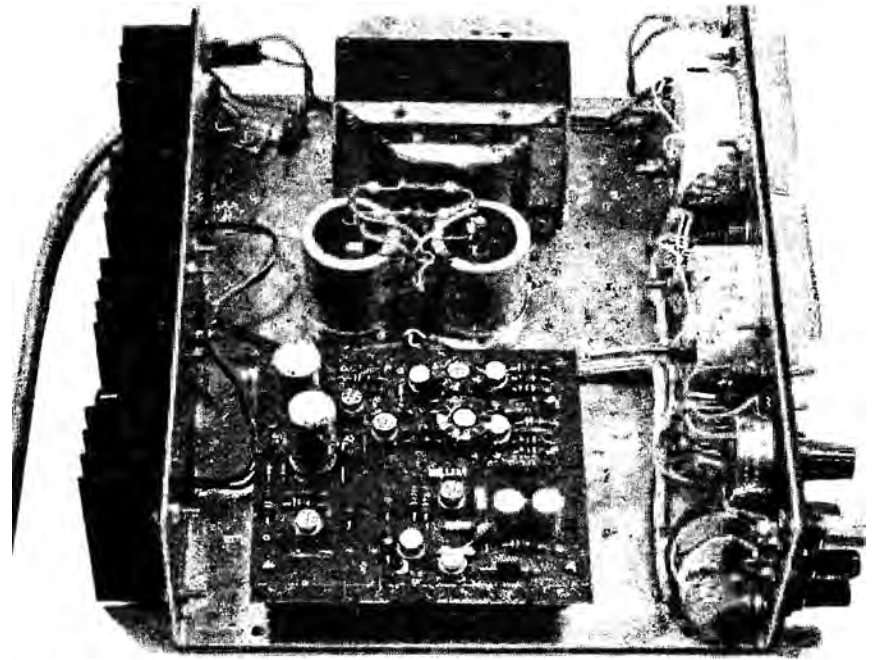

is compared against the voltage set by RV1 by operational amplifier IC3. The output of IC3 controls the series regulator configuration, and hence the output voltage. The action of IC3 is to keep the two voltages at its input at the same level. Thus, the output voltage will be four times the input voltage, and is virtually independent of load current.

When load current approaches the level set by the limit switch, transistor Q2 becomes forward biased sufficiently to cause it to conduct. This bypasses current from the base of Q4 and causes IC3 to lose control of the output. If the load continues to increase, the output voltage will fall, and the current will remain effectively constant.

The negative regulated supply works in the same manner when the power supply is used in the normal mode.

A tracking mode of operation is also included, and in this mode the negative supply tracks the positive supply. If, for example, the positive regulator is set at +14.5 Volts, then the negative supply will automatically be set at -14.5 Volts.

In the tracking mode of operation, the reference voltage is zero volts and the voltage used as the output voltage reference is the centre voltage of the two supplies. And since the IC tries to maintain both inputs at the same level (in this case zero volts), then the two output voltages must be of the same value.

Diodes D7 through D12 are used to protect the integrated circuits and output transistors against various forms of misuse, including shorting the positive and negative outputs together.

Provision has been made in the design for externally programming the positive regulator. If this facility is required, alter the wiring as shown in Fig. 2 (Resistor R12, and diodes D5 and D6 protect the IC when this mode of operation is employed).

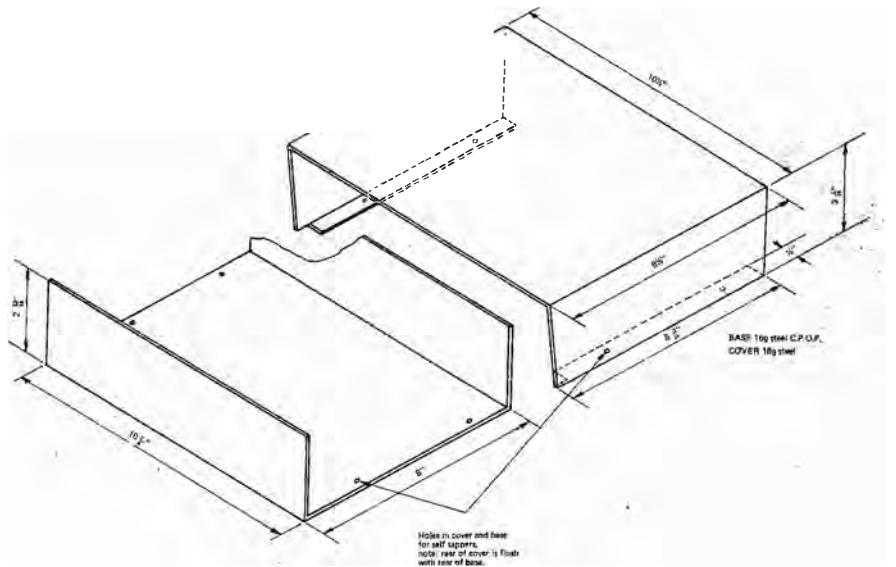
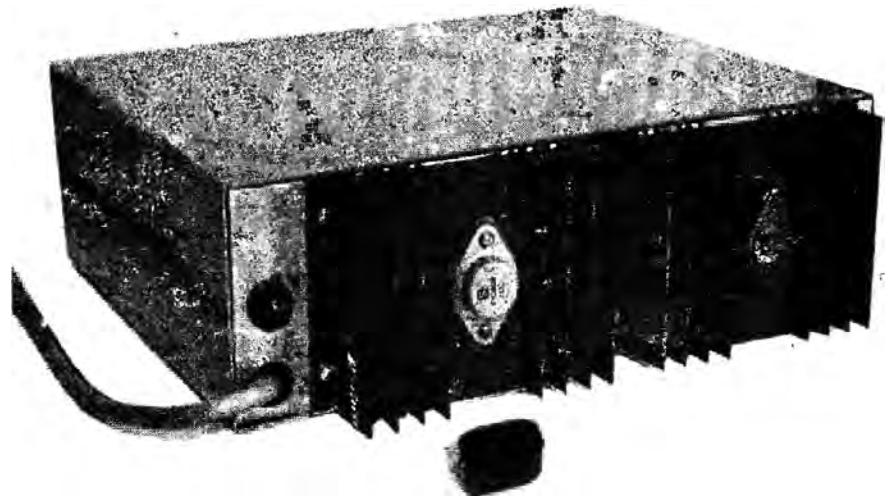

DUAL POWER SUPPLY

should be used for this purpose. Two wires should be attached to pins 9, 12, 17 and 19, three-wires attached to pins 11 and 17, and four wires attached to pin 4. All wires should be either colour coded or marked so that they may be clearly identified.

The printed circuit board should now be mounted onto the chassis and the wires loomed to their respective destinations. Note that one each of wires 11, 12, 17 and 19, together with wires 13 and 18 go to the back of the unit and to the heat sinks. Wires 1 and 2 go to the filter capacitors and a wire D comes from the common of the filter capacitors up to the loom and to

the common terminal on the front panel.

The front panel can now be wired as shown in Fig. 6.

The wires to the heat sink mounted transistors are taken through the grommets provided, and the already assembled heat sinks mounted into position.

Complete all remaining wiring taking care that all leads carrying 240 Volts are adequately insulated. The mains lead must enter the case through an insulating grommet and the lead must be securely anchored to the case. It is not sufficient merely to tie a knot in the mains cord — this is a dangerous practice.

The supply should now be ready for use, but before connecting to the mains, recheck all point-to-point wiring and all soldered connections.

One point that may not be commonly realised is that meters are calibrated specifically for one panel material. A meter calibrated for mounting on a steel panel may be as much as 30% out if it is mounted on an aluminium panel — and vice-versa. We recommend that a steel chassis is used for this project — but if you decide to use aluminium notify the meter supplier accordingly.

SPECIFICATION — POWER SUPPLY — ET 105

Output Voltage	0 — 20 Volts positive 0 — 20 Volts negative
Output Current	0 — 1.5 Amps
Current Limiting	190 mA and 1.80 Amps
Meter Ranges (current)	150 mA and 1.5 Amps
Meter Ranges (voltage)	25 Volts
Line Regulation	better than 1 mV for 15 Volt input voltage change
Load Regulation	less than 10 mV drop from no-load to full-load
Ripple	less than 2 mV peak to peak
Output Impedance	7. mΩ @ dc — 1.5. kHz 14 mΩ @ — 3 kHz 56 mΩ @ — 15 kHz 200 mΩ @ — 100 kHz

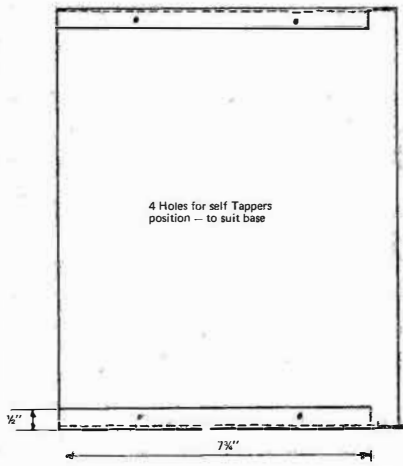
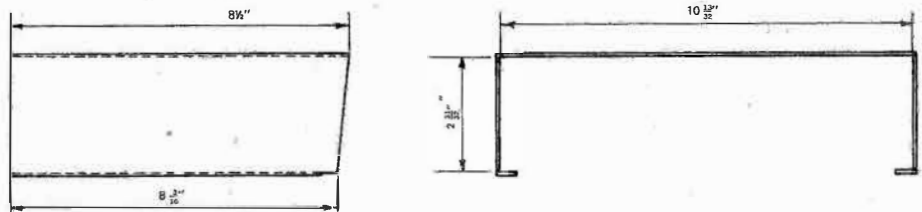
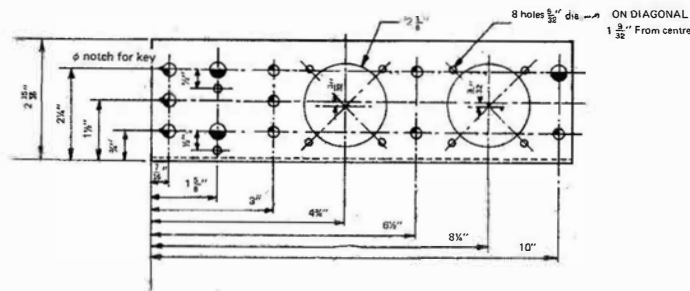
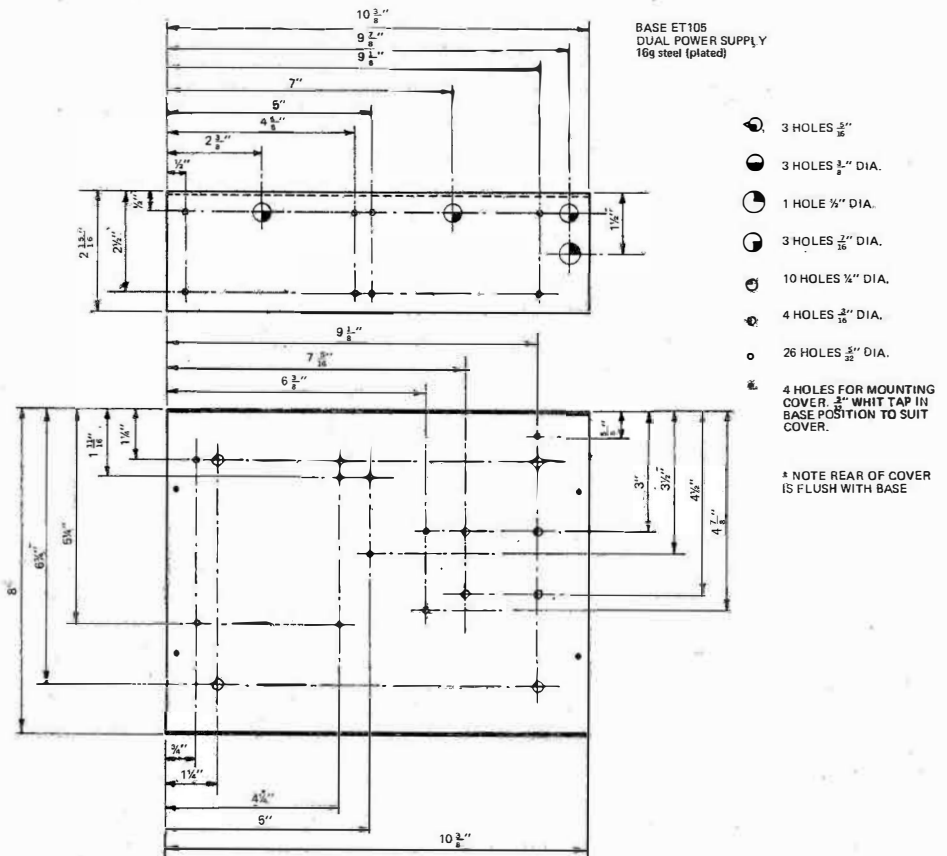

SIMPLE BASS-REFLEX CABINET

WHERE space is at a premium the only really satisfactory way of producing good high-fidelity sound is to combine a totally enclosed 'infinite baffle' type of speaker with a high powered amplifier.

There is no way in the world that a bass reflex enclosure can compete because bass reflex enclosures have certain critical dimensions below which they are ineffective.

But not everyone lives in rooms 10ft. square, nor has to fit speaker enclosures in the space normally considered adequate for a pair of china cats.

For those whose choice of speakers is not completely dictated by considerations of space, the bass reflex design has still a lot going for it.

This type of enclosure was first used commercially by the USA's Jensen company back in 1936, and was based on research by a number of workers including Voight, Olsen and Thuras, all of whom in turn based their studies on the Helmholtz resonator discovered in the 1800s (Fig. 1).

The basic bass reflex enclosure consists of a box, airtight except for a loudspeaker drive unit mounted on the front panel, and a vent (or tuned port) generally located on the front panel below the speaker.

The actual *location* of the vent is not too critical because the wavelength of the frequencies at which the vent operates is far longer than the overall dimensions of the speaker enclosure.

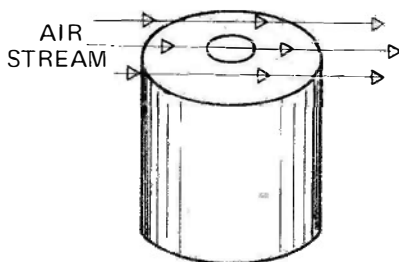

Loudspeaker enclosure design is normally a very complex procedure. But the simplified approach presented here will provide surprisingly effective results.

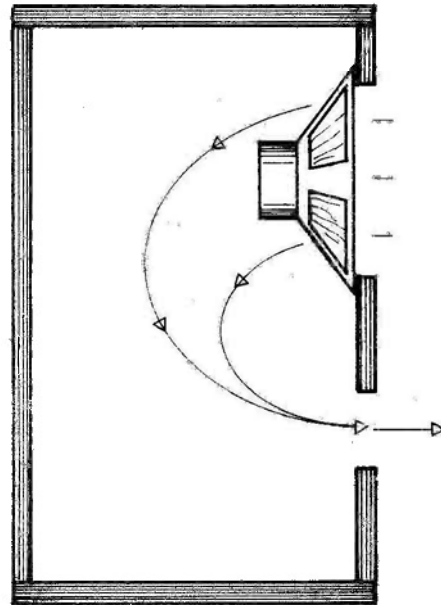

The *size* of the vent is important, for it is a combination of this and the physical dimensions of the enclosure, that determines the behaviour of the system and provides the smooth, extended low frequency response for which this type of enclosure is renowned.

The *purpose* of the vent is to allow out-of-phase radiation from the back of the cone to be 'reflexed' so as to bring it in phase with the front radiation at low frequencies.

Simple bass-reflex cabinets may be designed, either by calculating the enclosure dimensions from the speaker diameter — or more satisfactorily — by determining the speaker's free air

resonance and then designing the enclosure and vent to suit.

No matter which design method is used, the method of construction will be the same. Primarily, the aim is to produce a rigid, non-resonant enclosure, airtight except for the loudspeaker cutout and vent.

Various materials may be used — from concrete, to plywood or pineboard. The thickness of material will depend upon the size of the enclosure. Generally, 1/2" or 5/8" plywood will suffice for the smaller enclosures, increasing to 1" to 1 1/2" for the largest.

It is literally impossible to make the enclosures *too* rigid; if space allows, use the most massive material that you have available, or can afford.

Unless really heavy material is used, reinforce all diagonals (except the front panel) with 3" by 1 1/2" bracing and use wooden blocks to reinforce all joints and corners. All joints should be securely glued and screwed.

Rubber or cork gaskets should be used to seal any removable panels.

The completed cabinet should then be checked for airtightness and if satisfactory, then lined on at least

Fig. 1.
A Helmholtz resonator consists of a cavity with a single hole open to the outside air. Air blowing across the hole will cause a sound to be generated at a frequency dependent on the volume of the cavity. The bass-reflex enclosure is in reality a Helmholtz resonator in which the acoustical capacitance of the enclosed air resonates with a mass of air enclosed within the confines of the port opening.

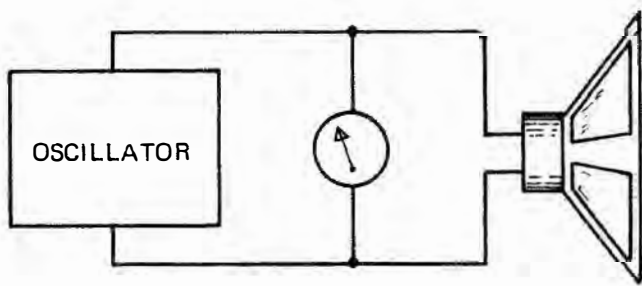

Fig. 2. The free-air, resonance of a speaker is determined by measuring the voltage across the speaker's voice coil whilst it is energised over a swept frequency range. The speaker must be suspended away from waifs or other reflecting surfaces.



DO YOU THINK YOU COULD GIVE US SOME IDEA OF HOW YOU CAME TO INVENT STEREO...

three facing surfaces with two-inch thick Fibreglass or Innerbond. The lining material should be glued in place using a contact adhesive.

If mid-range and tweeter drive units are to be incorporated, these should be boxed in with separate airtight enclosures. These secondary enclosures should be as small as possible and their cubic capacity taken into account when calculating the total enclosure volume.

The positioning of the auxiliary drive units is not critical — but keep them at least 3" from other speakers and the walls of the enclosure.

The front panel of the speaker enclosure should be painted matt black and then covered with an open weave grille cloth (this can be obtained from many specialist hi-fi dealers).

As explained above, a bass-reflex cabinet *can* be designed using the speaker diameter as a basis for the enclosure dimensions. The dimensions for a number of enclosures of this type are given in Table 1. These enclosures are based on the nominal speaker diameter — e.g., the diameter that is quoted by the manufacturer. The actual cone diameter will be less than this — probably by an inch or so. The area of the vent is shown in Table 1 and this is calculated from the *actual* measured speaker cone diameter.

The shape of the vent is not important; it may be circular, square or rectangular (as long as the ratio of length to height does not exceed five) or even divided into two or three separate vents whose total area equals that of the single correctly sized vent.

The position of the vent is also relatively unimportant, although it should not be located closer than 2" to the main speaker opening.

Whilst this design approach will result in a speaker enclosure with generally excellent performance — a more elegant approach is that based on the known (or calculated) free air resonance of the speaker.

This figure is generally quoted in the manufacturer's literature. But it is quite easy to determine — if one has (or can borrow) a suitable oscillator and ac voltmeter. All that is necessary is to connect the speaker as shown in Fig. 2 and with the speaker suspended from a cord (and well away from walls or other reflecting surfaces), to sweep the oscillator frequency *very slowly* from 10 Hz to about 150Hz. The

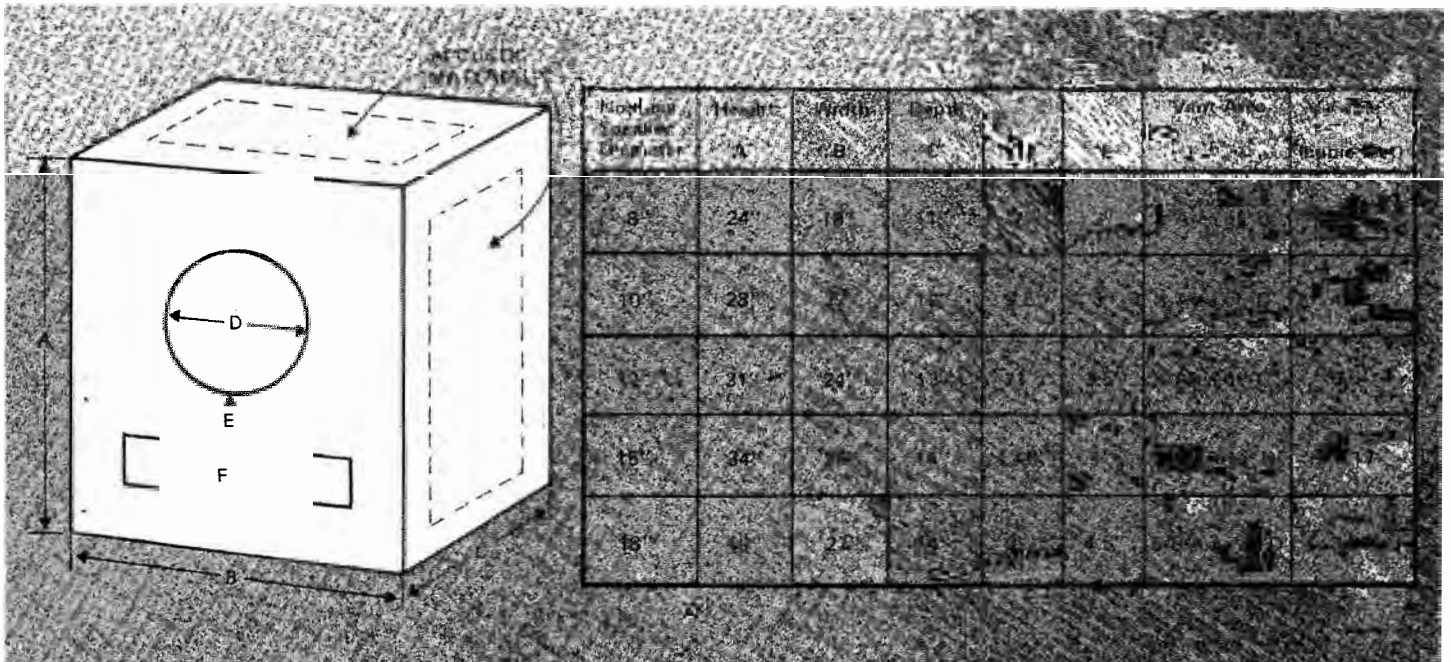

Table I -this table and the associated drawing shows how to design a reflex cabinet if no data other than speaker diameter is known.

SIMPLE BASS-REFLEX CABINET

Nominal diameter of speaker	Frequency
8"	45 – 150 Hz
10"	40 – 100 Hz
12"	30 – 85 Hz
15"	25 – 55 Hz
18"	20 – 40 Hz

Table II - Typical free-air resonances of various size speakers.

voltage indicated by the meter will rise steeply at the free air resonance point. The frequency at which this occurs depends upon the design of the speaker – typical figures for various size speakers are shown in Table II.

(The free air resonance of a speaker changes slightly as the speaker ages – the greatest change takes place within the first few hundred hours – some constructors 'run-in' their speakers in sound proof enclosures before measuring the free air resonance.)

Once the free air resonance has been established, the enclosure dimensions

can be determined from the data shown in Table III.

The important factors are the free air resonance, the internal volume of the enclosure, and the size of the vent. The shape should be vaguely rectangular, but providing the width and height are at least twice the diameter of the speaker, and the depth is at least one third the width, then the enclosure may be shaped to fit on a shelf, against a wall or as required.

The internal dimensions shown are fairly critical, and the necessary allowance must be made for panel thickness, stiffeners, crossover networks, and other internal

enclosures. Do not make any dimensional allowance for the Fibreglass or Innerbond liner.

As Table III indicates, many of the enclosures are fitted with tuned ducts, rather than just plain vents. These ducts can be made from standard cardboard mailing tubes – obtainable from many office supply companies – or may readily be made by winding glue-coated brown paper tightly around a pre-waxed former of the correct diameter. The wall thickness of the duct should be between 1/8" and 1/4". (Note that at the extremes of frequency and volume shown in Table III – no duct or vent is used – the enclosure is, in effect, an infinite baffle).

As with the first design approach described in this article the position of the duct, or vent, is not critical.

That's basically it. There are other, far more complex, ways to design bass reflex enclosures and many of these methods may well result in marginally improved performance – especially if the duct is subsequently tuned to obtain the flattest possible bass response. But the method outlined in this article will provide a basis for producing enclosures with at least the performance of most professional designs. ●

Free-air resonance	Volume in Cubic Feet							
	2.0	2.5	3.0	3.5	4.0	5.0	6.0	8.0
25Hz	(A) 5"	(A) 3.75"	(A) 2.75"	(B) 6"	(B) 5"	(B) 3.25"	(C) 8.75"	(C) 5.5"
30Hz	(A) 3"	(B) 5.75"	(B) 4.5"	(B) 3.5"	(C) 9.25"	(C) 6.5"	(C) 4.75"	11 sq. ins.
40Hz	(B) 3.5"	(C) 7.75"	(C) 5.75"	(C) 4.5"	(C) 3.25"	13 sq. ins.	18 sq. ins.	28 sq. ins.
50Hz	(C) 5.5"	(C) 3.5"	13 sq. ins.	16 sq. ins.	18 sq. ins.	29 sq. ins.	39 sq. ins.	62 sq. ins.
60Hz	11 sq. ins.	16 sq. ins.	20 sq. ins.	29 sq. ins.	35 sq. ins.	50 sq. ins.	75 sq. ins.	Closed
70Hz	18 sq. ins.	26 sq. ins.	35 sq. ins.	46 sq. ins.	58 sq. ins.	90 sq. ins.	Closed	Closed
80Hz	28 sq. ins.	41 sq. ins.	60 sq. ins.	80 sq. ins.	96 sq. ins.	Closed	Closed	Closed
90Hz	42 sq. ins.	64 sq. ins.	89 sq. ins.	117 sq. ins.	Closed	Closed	Closed	Closed

Duct Tubes (A) = 2" Inside diameter
(B) = 3" Inside diameter
(C) = 4 3/4" Inside diameter

Thus (A)-2.5" is a duct 2" inside diameter by 2.5" long.
Where a measurement is given in square inches - this implies that a vent is required - not a tuned duct.

Table III - This table provides the design data for a given speaker free-air resonance and various enclosure volumes (in cubic feet)

HOW MANY WATTS?

CHOOSING AMPLIFIERS AND SPEAKERS TO MATCH YOUR ROOM SIZE

"I am thinking of buying some hi-fi equipment and have visited a few dealers and studied a number of brochures.

"So far I have seen quite small amplifiers rated at 150 watts music power, others much the same size and price rated at 60 watts, and now a salesman tells me that his best unit has only 50 watts output yet is the most powerful of them all.

"He also says that small speakers need lots of power whilst big speakers may need much less. He seems competent enough, but what he tells me just doesn't seem to make sense.

"I am thoroughly confused. Please advise me."

This letter is typical of many received by electronic and hi-fi magazines. The puzzled correspondent has a very good point — the situation he describes IS confusing; yet what the salesman has told him is generally true. To obtain equivalent sound levels a small speaker may need 25 watts, whilst a larger one will get by with 10 watts.

The hi-fi industry has several different ways of expressing power output. Like the old English chaldron, the watt has become a remarkably flexible unit.

WHAT'S A WATT?

Engineers speak in terms of watts (average), this being the effective amplitude of an ac waveform, equal to the dc level that would produce the same power in a given load. The term 'watts rms' is also commonly used — it is technically meaningless — but used (incorrectly) as a synonym for watts.

Outputs quoted in watts peak, or peak to peak, are mainly a copywriter's way of convincing you that an amplifier produces more power than it really does. Two watts peak is one watt average.

Amplifier power output, whether expressed as average, peak, or peak to peak, is generally measured with a steady sine-wave input, and quoted as that level when waveform clipping is apparent when viewed on an oscilloscope.

A power rating quoted at a constant sine-wave input does not necessarily imply that an amplifier can handle peaks exceeding this level. For this reason the industry often quote a music power rating — this is a measure of an amplifier's ability to handle musical peaks without falling apart at the seams.

Thus one and the same amplifier can be rated from 10 watts rms to 45 watts music power without actually telling any lies. It is also not unknown for an amplifier of 20 watts *per channel* to be described as a 40 watt amplifier.

To compare power ratings, the easiest way is to convert peak, or peak to peak, ratings back to watts rms. This is readily done by dividing by what Europeans call a 'TransAtlantic Factor'. In this case it is 2 and 4 respectively.

No conversion is possible with music power ratings — but when such a rating is given, another figure will nearly always be quoted for continuous power output. Find out from the salesman, or the manufacturer's literature, what this rating is and whether the figure is rms, peak, or peak to peak.

Independent test reports such as our own — invariably quote output power in watts rms, as do many manufacturers. Unless stated to the contrary, watts rms are the units implied in this article.

Having to some extent, at least, determined what is meant by the different systems of power rating, we can now try to find out how many watts we need.

DYNAMIC RANGE

We start by determining the sound level (or rather power level) actually produced by a musical instrument. The dynamic range of these instruments is extraordinarily wide: a study undertaken by Bell Telephone Laboratories showed that a 75-piece orchestra playing flat-out creates 66.5 acoustic watts, whilst a solo violin played very softly produces less than 0.000004 watts. This is an intensity ratio of 18 million to one.

Table 1 shows the acoustic energy of various orchestral instruments played at peak intensity. Note that a piano produces less than half an acoustic watt, and that an orchestra, even at peak intensity, will generate less than 70 watts.

Full orchestral sound reproduced at concert hall level in the average living room requires half an acoustic watt.

Why, then, are amplifiers made that can deliver 100 watts or more?

The reason is that loudspeakers transduce electrical energy into acoustical energy very inefficiently. In

fact, many totally enclosed systems have an efficiency of only 1%, meaning that they require 50 electrical watts to produce half an acoustic watt.

Some speaker systems such as the Bose, are even less efficient, requiring closer to 100 Watts for the same acoustic power output.

The range of efficiencies extends from the 20% to 30% of exponential horn loaded speakers to less than 1% for the smallest totally enclosed bookshelf units. Thus the horn loaded speaker will need only two electrical watts to reproduce an orchestra at full volume, whilst (assuming it had the power-handling capacity) the bookshelf unit would require 30-50 watts to achieve the same result. (Table 2 indicates the approximate efficiency of various types of speaker enclosures.)

Low efficiency should not for a moment be taken as a disparagement of totally enclosed speakers, for the efficiency of a speaker is solely the ratio of acoustic output to electrical input. It tells you nothing at all about how the speaker will sound. Some of the world's finest speakers use the totally enclosed principle — as do some of the worst.

The power required from an amplifier is thus a function of the type of speaker — but it is also affected by the size of the listening area, the furnishings in it, and, to some extent, by the type of music you intend to reproduce.

CALCULATING YOUR REQUIREMENTS

We have reconciled these various parameters into the nomograph reproduced with this article. The nomograph indicates the power

TABLE 1. Energy of orchestral instruments played at peak intensity.

Instrument(s)	Acoustic watts
Bass drum	24.6
Cymbals	9.5
Double Bass	0.156
Trombone	6.4
Piano	0.437
15 piece orchestra	9.0
75 piece orchestra	66.5
Pipe organ	12.6

Power Nomograph

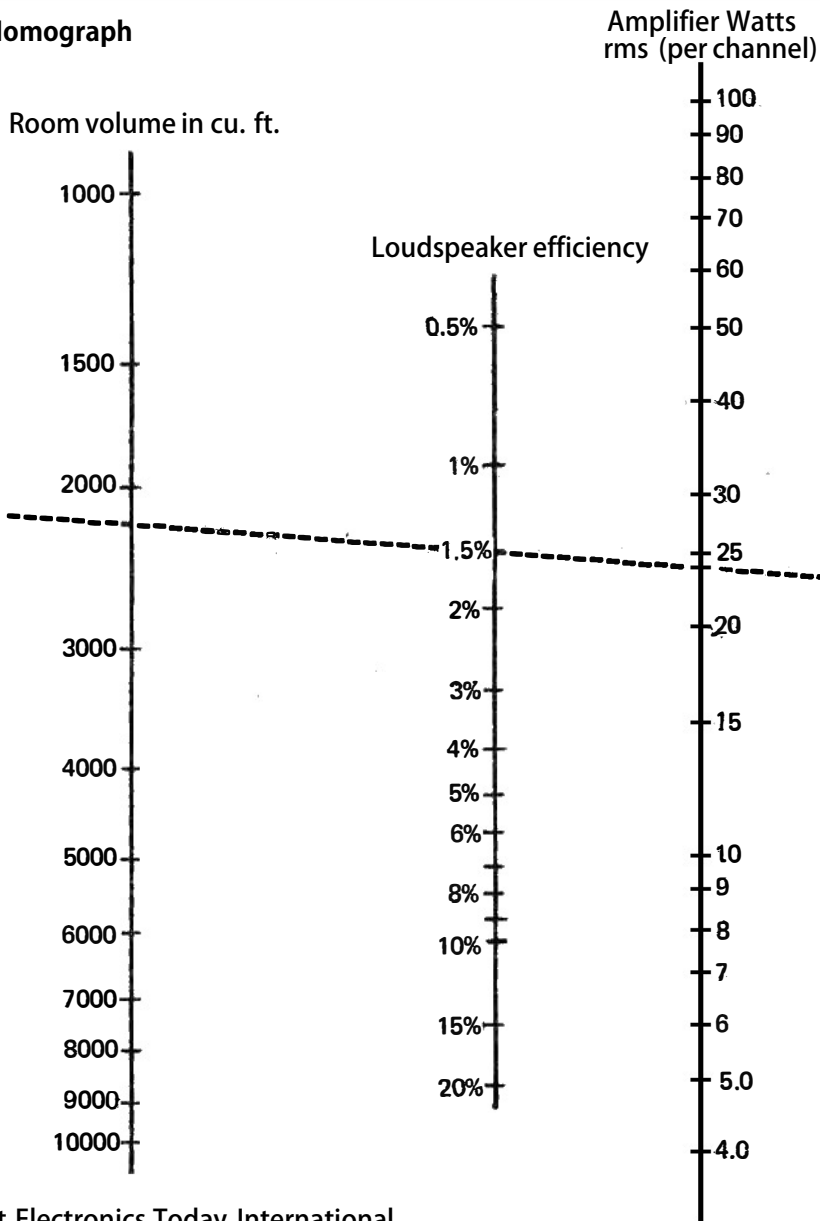

Copyright Electronics Today International

A rule bisecting any two parameters will give you the third. In example dotted line indicates that medium sized totally enclosed speaker in room of 2250 cubic feet requires 25 watts/channel.

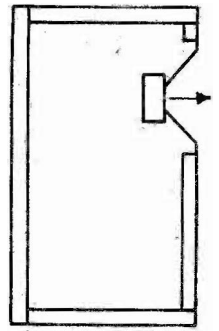

Totally enclosed (also called infinite baffle or acoustically suspended). Efficiencies vary between ½% and 2%. Small enclosures are generally less efficient than large one. Most enclosures of this type have an efficiency of approx. 1%.

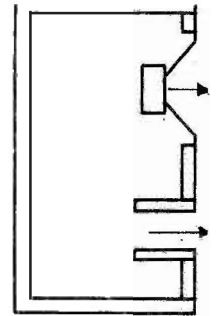

Bass-reflex. Efficiencies vary between 3% and 5%.

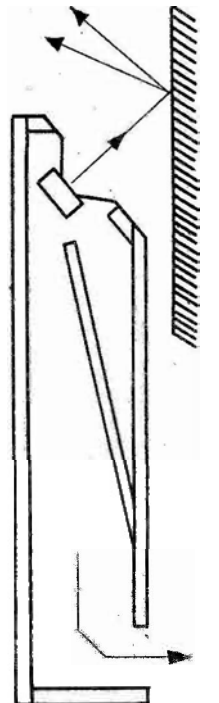

Horn loading. There are many versions of this type. Efficiency? — assume 20% and you won't be far out.

required to drive different types of speakers in different size rooms. It can also be used to determine whether the power rating of a speaker is sufficient for the size of room. Amplifier/speaker combinations calculated from the nomograph will reproduce peak orchestral sound at concert hall levels. If discotheque levels are required, the amplifier power output should be at least doubled.

The nomograph shows that a lot of power is required to drive totally enclosed speakers, especially if used in a large room. Full bass reproduction in a room 20ft. by 15ft. by 10ft. would require over 40 watts per channel and if the totally enclosed speakers were on the bookshelf type, 40 watts could well exceed their maximum dissipation.

The maximum safe dissipation of loudspeakers is invariably quoted from measurements of constant sine-wave inputs. Many manufacturers claim their loudspeakers can handle musical peaks exceeding their constant input ratings — often quoting a figure of two. However, our acoustical consultants advise that in their experience which is very considerable — a speaker should not be driven by an amplifier with a power output higher than the speaker's input rating.

If you follow this advice, you will not overload your speakers.

Nor will you be likely to emulate a certain pop group who, on one never-to-be-forgotten occasion last year, ended a concert with their two bass speakers on fire!

HOW TO MAKE MEASUREMENTS AUTOMATICALLY

Data logging:- the technique of data acquisition processing and display - increasingly used throughout research and industry to record information about any number of processes or events. Colin Rivers Explains what can be achieved and how.

A DATA LOGGER in an Australian chemical plant measures temperatures at 700 different points, displays these temperatures in degrees Celsius to an accuracy of $\pm 0.1\%$, prints out all readings every 30 minutes, or on command, and sounds an alarm if any temperature exceeds individual preset limits.

In a complex manufacturing operation, another logger collects data from 175 different positions - some indicating pressure, some velocity, some pH, some temperature, and many others of varying kinds - and transmits this data to a control area two miles away, where it is displayed in the engineering units concerned. Upon command the data can be fed into a computer which, assessing all the essential parameters, can calculate the corrections required to optimize the entire operation.

Data loggers can record one measurement a day - or millions every second. The ability to operate at very high speed may be essential to ensure that data about interrelated functions is recorded as rapidly as possible, for it is not feasible for data loggers to measure and record events simultaneously (in parallel form). They operate by scanning each input for a brief period before passing on to the next.

An example of essentially high-speed operation is an airborne data logger which plots the field-strength around a radio beacon. Apart from field-strength measurements, the data recorded includes position, altitude, barometric pressure, temperature, humidity, - and unless these measurements are taken quickly and in

rapid succession, each measurement will relate to different geographical positions. (This is what statisticians call "putting a skew in the data".)

Data loggers may be small desk-top units monitoring half-a-dozen vital operations in a small plant, or they may be sophisticated systems with thousands of inputs, monitoring or controlling a major manufacturing complex. They vary in price from a couple of thousand to several million dollars.

Despite their wide range of facilities and applications, most data loggers have similar operating principles.

HOW THEY WORK

A function of a typical (though basic) data logger is shown in Fig. 1.

Each phenomenon to be monitored is changed by a transducer into an electrical signal which is proportionate in magnitude to the phenomenon. Each electrical signal is connected to the input of a scanning device in the main part of the data logger. The scanner is programmed to select each input signal for a brief period of time (either sequentially or in any required order) and to connect momentarily the selected input to an analogue-to-digital converter.



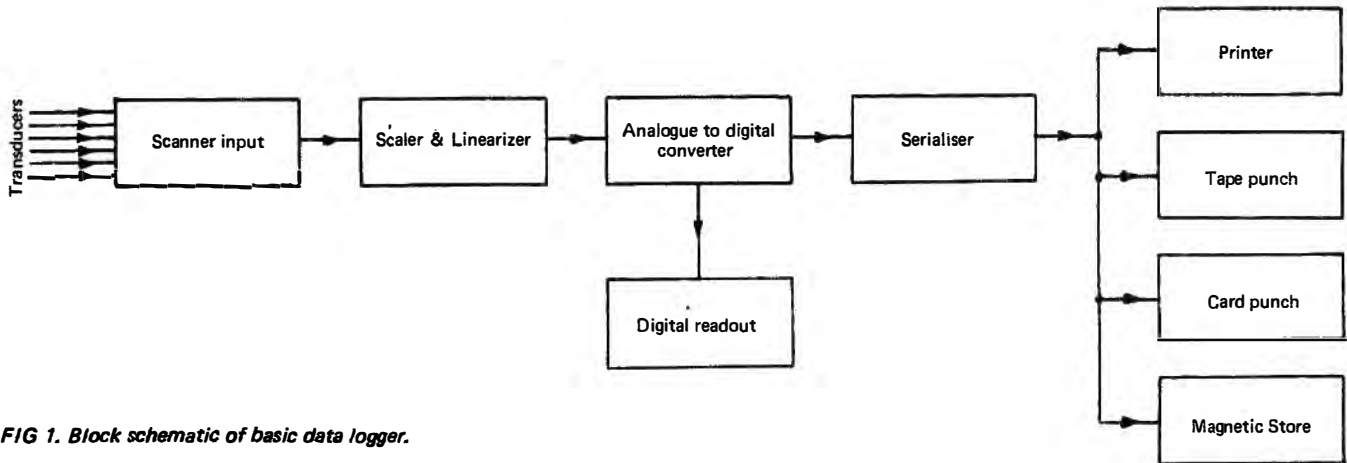

FIG 1. Block schematic of basic data logger.

The converter changes the selected input signal into digital form and passes the digitized signal to the display unit, where it is shown in numerical form.

Thus a measurement of pressure in a pipe line will be displayed in numbers directly representing so many lb/inch² or kg/cm². Temperature will be displayed directly in degrees, etc., etc.

Intermediate circuits provide the necessary calibration, amplifying or attenuating the inputs as required, and also correcting any non-linearity in the original measurement.

An indication will also be provided, identifying the input to which the displayed reading refers.

Direct visual monitoring of the displayed data is tedious and time-consuming. It also precludes input scanning speeds faster than one or two inputs a second. To overcome these limitations, most data loggers record their readings in permanent or semi-permanent form.

The data may be recorded by printing out, punching holes in tape or cards, by magnetical recording, or taken directly into a computer store or buffer.

To avoid compiling masses of possibly unnecessary data, the logger can be programmed automatically to print out a complete sequence of inputs on command, or at predetermined time intervals, or in the event of any exceptional circumstance. It can be arranged to print out only those signals exceeding or falling below preset limits. In another form,

the data logger can print out 'normal' conditions in black and 'abnormal' conditions in red.

A typical example of selective print-out is a data logger used to check the voltages of several thousand dry cells: this unit scans the total number of cells every five minutes and prints out 'exceptions' on each scan. It also provides a print-out of all cell voltages every 12 hours.

The recorded data includes input identification, time and date.

In another application, a data logger scans 200 mixed inputs every second, and on each scan transfers all data

onto magnetic tape.

To cater for the wide range of applications, and numbers of inputs, many data logger manufacturers produce their equipment in modular form; this also simplifies maintenance and enables the system to be expanded at any time.

TRANSDUCERS

There is virtually no limit to the type of phenomena that can be logged. If it is possible to find a way to measure a phenomenon, then that measurement can almost invariably be converted into a proportionate electrical signal.



RIGHT: Capacitive transducer records wave motion in 1/120th. scale model of Botany Bay. LEFT: 100 channel data logger records all relevant information.

HOW TO MAKE MEASUREMENTS AUTOMATICALLY

Some phenomena generate electrical signals that can be used directly — dry batteries, for example — others require transducers to convert temperature, pressure, strain, rate, position, weight, colour, pH, viscosity, etc., into proportionate electrical signals.

Whilst there are literally thousands of different types of transducer, they all operate on well-known physical principles. Their manufacturing problems lie not in finding a suitable operating principle but in ensuring that the transducers maintain linearity and reproducibility.

Transducers can be classified into two main types — those which derive their signal from the process they are monitoring, and those which require external electrical excitation, of which some portion becomes the measured signal.

The former type of transducer is commonly referred to as 'self-generating'. This is a misnomer, for they almost invariably take energy from the system they are monitoring (in fact, care must be taken that this type of transducer does not affect the magnitude of the phenomena that it is measuring.)

SELF-GENERATING TRANSDUCERS

A well-known example of a self-generating transducer is the piezo-electric crystal pick-up used in record players. This produces an electrical output when mechanically stressed.

Another transducer of this type is the photo-voltaic cell, which converts light energy into electrical energy.

Most electro-magnetic transducers are self-generating, one example being the permanent magnet tacho-generator, which produces a voltage proportionate to rotational velocity.

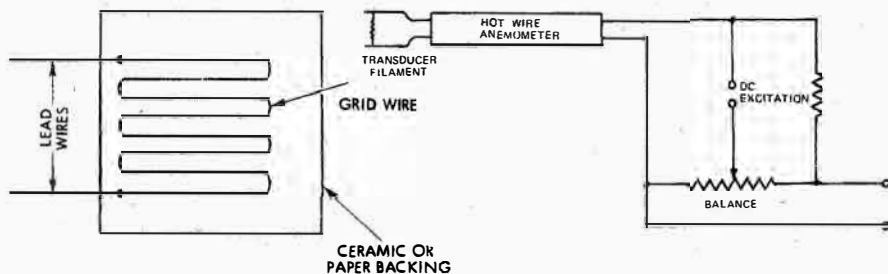

Fig. 2. Strain gauge shown above consists of a wire grid bonded to an impregnated paper backing. The resistance of the strain gauge changes when the grid is distorted.

Fig. 3. Hot wire anemometer measures small changes in wind velocity:

Thermo-couples are yet another type of self-generating transducer. These measure heat by exploiting the thermo-electric (or Seebeck) effect, in which a voltage is generated by the difference in temperature between the junctions of two dissimilar metals.

EXTERNALLY ENERGISED TRANSDUCERS

The change in resistance when a wire is stretched or heated is the basis of an extensive range of externally energised transducers.

One form of this is the resistance strain gauge (shown in Fig. 2). Resistance strain gauges are usually connected in a Wheatstone bridge circuit. One gauge is mechanically bonded to part of the structure which is subject to compression. When a load is applied, the gauge changes length (and hence resistance), unbalancing the bridge and thus producing an output voltage.

Other resistance transducers measure temperature, and this temperature measurement may be used directly or indirectly to measure other related phenomena, such as thermal conductivity or calorific value — or, in the case of the hot wire anemometer shown in Fig. 3, to monitor minute pressure changes in shock tubes, wind tunnels, air compressors, etc.

Inductive transducers require an external ac excitation voltage and facilities for resistive or capacitive balancing. This type of transducer can

be used to measure pressure, flow, displacement and vibration.

A typical example is the differential transformer illustrated in Fig. 4, which consists of three windings around a movable core of magnetic material.

The ac excitation voltage is connected to L1. When the movable core is equidistant between L2 and L3, the ac voltage induced from L1 into the windings L2 and L3 will cancel out. Any linear movement of the core from this midway position will cause the ac signal in windings L2 and L3 to become unbalanced and thus produce an output voltage which is proportionate to core movement. This type of transducer can measure displacements as large as several inches or as small as one micron.

Precise angular measurements as small as fractions of a second of arc can be made by using a differential transformer with a circular core.

SCANNERS

Electrical signals from all the various transducers are connected to the input scanner of the data logger.

The input scanner is basically a multi-way switch which connects any required transducer to the rest of the data logger's functions. The scanner normally switches the transducers sequentially at a predetermined speed, but arrangements are often made for the scanner to be programmed in various sequences and speeds.

The scanner is controlled by a master clock which also provides a reference signal, indicating which input has been selected.

Although simple in concept, scanners must be carefully designed to avoid inducing noise into the incoming signals, and to ensure electrical segregation between different signals. This is commonly achieved by using banks of reed relays or sealed diaphragm relays.

A refinement of some scanning input circuits is the charge-transfer system shown in Fig. 5, in which the transducer signal voltage is stored on a low leakage capacitor and then switched as required into the data logger. This arrangement improves the signal-noise ratio of low-level signals



PACE Data logger from EAI scans to 100 channels/sec. and is accurate to $\pm 0.05\%$.

and is often used in conjunction with thermo-couple inputs.

SCALING AND LINEARIZING

This may be done either before or after the scanning input. Scaling, in effect, calibrates each transducer input to ensure that the subsequently digitized reading will appear in the correct engineering units. For example, a resistance thermometer having an output of 1.013 Volts at 100°C may be scaled to read 1.000 Volts at this temperature, so that the final meter reading will be 100.00°C.

Linearizing is required where transducer output is not a linear function of the changing variable — as with thermo-couples. Linearizers usually operate by varying the gain of an operational amplifier.

Following the scanning and subsequent circuits, the selected, scaled and linearized signal is converted to digital form.

INTO DIGITS

Digitizing is performed by an analogue-to-digital converter which is usually designed for data logging applications. The A/D method used will depend upon a number of functions including scanning speed, accuracy required, signal-to-noise ratio of the incoming signals, etc.

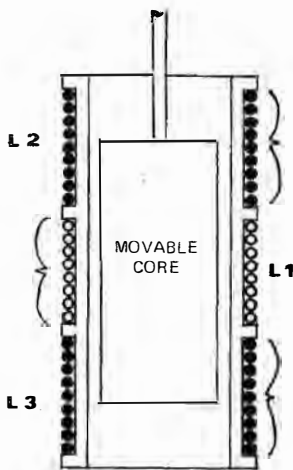

Fig. 4. Differential transformer provides output proportionate to movement.

A commonly used A/D converter is the voltage to frequency type, in which the incoming signal is integrated over a precisely controlled time period which is an exact multiple of the ac mains frequency. This ensures that the mean level of the transducer signal is sensed and that misleading transients are smoothed out; ac mains pick-up will also be cancelled out completely.

One limitation of the voltage to frequency converter is that operating speed is limited to a maximum of 40 or so readings per second.

Another type of A/D converter, which has a much higher operating speed, uses the successive approximation principle, in which the incoming signal is compared against successively smaller fractions of a reference voltage. This type of converter can operate at speeds as high as one million readings a second — but its accuracy and noise rejection characteristics are not as good as those of the voltage to frequency converter.

The output from the A/D converter is taken to the decoders and drivers of the numerical readout. (The A/D converter and readout stage is very similar to that used for digital voltmeters — in fact, some data logger manufacturers use standard dvms for the purpose).

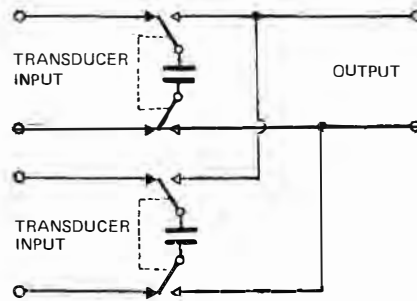

Fig. 5. Charge transfer circuit used in input scanner isolates data logger from transducers whilst taking measurements.

TYPICAL USES OF DATA LOGGING

Research Establishments

Many hundreds of data logging systems are used in Universities, Technical Colleges, Research Associations etc., for recording experimental data in pure and applied science. Computer compatible output enables direct evaluation of results.

Structural Engineering

Out-of-balance voltages from electrical resistance strain gauge bridge circuits can be readily recorded with a high degree of accuracy. Computer compatible record simplifies stress analysis. These measurements are frequently required in the field of civil, mechanical and aeronautical engineering.

Life Testing of Batteries

Voltages of a number of electrolytic cells under load can be periodically monitored with the logger under clock control. Indication can be given if the cell output falls below a predetermined level. A printed output provides a complete record of cell performance.

Engine Test Beds

The logger can be used to gain considerably more knowledge about the true operating conditions of internal combustion and gas turbine engines. Parameters which may be recorded include engine speed, oil temperature and pressures, fuel consumption etc.

Wind Tunnels

Wind tunnel operating time is expensive and considerable savings are possible if the logger is used to rapidly record pressures and strains during evaluation of models.

Medical Research

The use of electronic measurement techniques in the field of medical research is rapidly expanding, and a number of data loggers are currently in use recording physiological parameters.

Chemical Analysis

Many types of automatic chemical analysers require complete data processing for speedy analysis. This is facilitated by recording data in computer compatible form, for off-line processing.

This Data Transfer Unit from Solartron enables existing digital equipment to be assembled as a data logger.

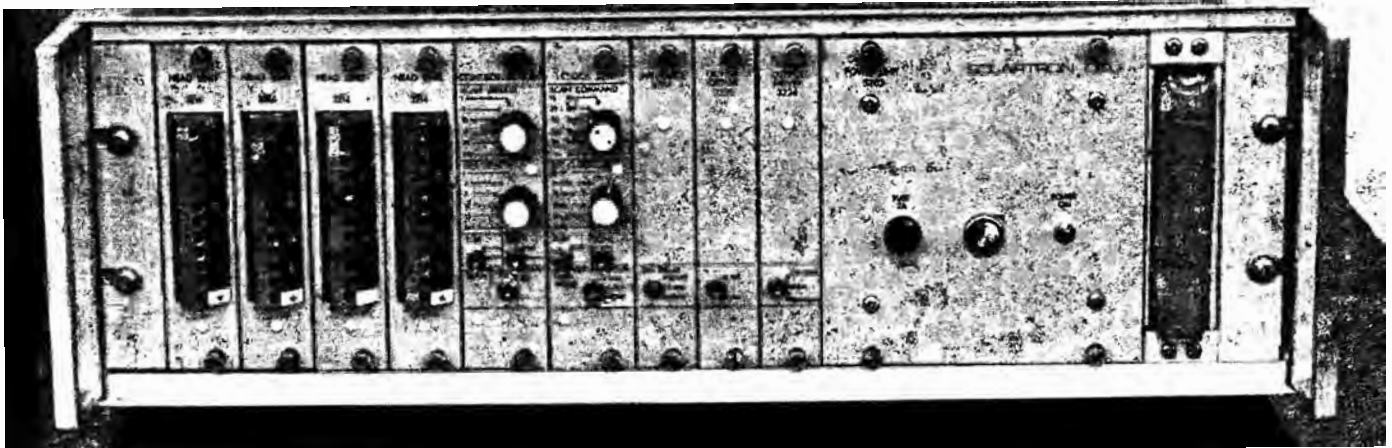

The decimal point of the displayed data will be positioned automatically, and for measurements either side of a mean position a positive or negative sign will be included to indicate polarity.

Readout systems designed for data logging provide digitized output signals for connection to various recording devices. This output may need modification before it can be used by recording devices because the output signals representing each digit occur simultaneously, while devices such as typewriters can only accept the signals serially. As an analogy, all the words on this page are in parallel form they are all there at any one time – but are read serially.

Other converters may be used to change the output format from the readout system into the various codes used by tape punches, card punches, magnetic recorders or computer inputs.

In many cases driver stages will be required, to amplify the signals to the higher level required by the recording equipment.

When the transducers are widely separated, or are grouped a long way from the readout location, the transducer signals may be amplified or converted into digital form at source, before subsequent transmission by telephone or radio links.

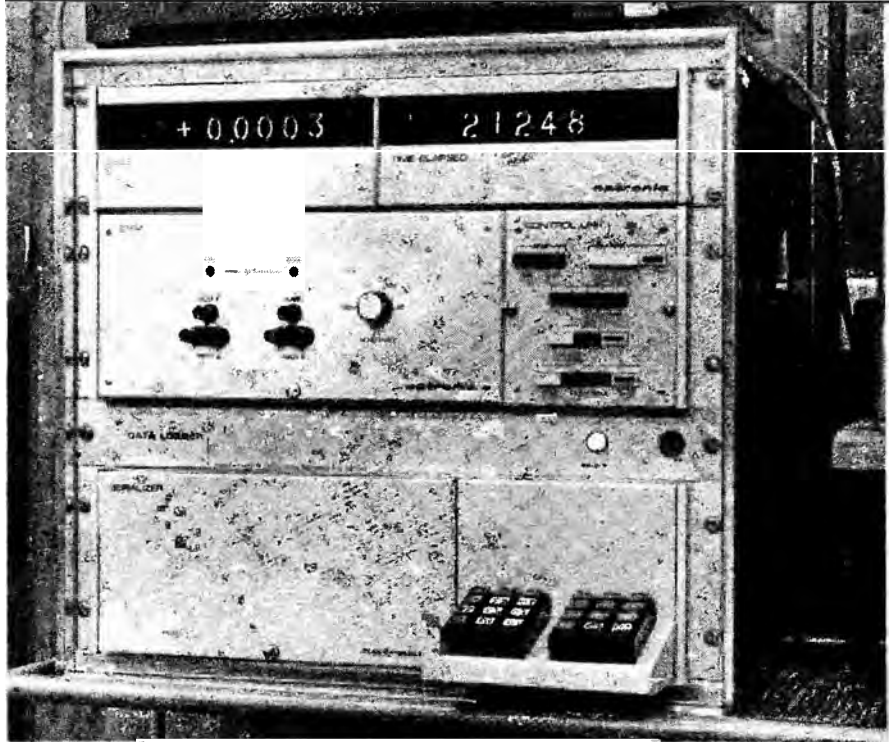

This data logger from Natronics logs output and elapsed time from a dual column gas chromatograph and records the data on punched tape.

THE BUYING DECISION

Data logging is a complex technique, and nearly every installation requires individual design or selection of function modules.

It can optimize many manufacturing operations and frequently provides

data which is virtually unobtainable by any other method.

It is a technique where specialised knowledge and engineering back-up is essential, and prospective users should establish positively that this is locally available before making a purchasing decision.

OUTPUT RECORDS

PRINTED STRIP: The record is in the form of a tally roll on which each reading is contained in one line of print, as shown in the right. The first line is a record of time, followed by ten channels of data, each line being identified as follows:- channel identity (2 digits), DVM polarity and value, and DVM range indicator.

TYPED PAGE: The record is in the form of a tabulated page on which a number of readings are contained in one line of type, as shown below. The first line is a record of the time at which the readings were made. In the example illustrated, five readings are recorded per line, in which the sequence for each reading is:- channel identity (2 digits), 'space', DVM polarity and value, 'space' DVM range indicator, and two, 'spaces'. The final two 'space' characters change to 'carriage return' and 'line feed' functions in the fifth reading. This is function of the Control 3211 and can be preset to any suitable number of readings per line.

PUNCHED PAPER TAPE: The record is in the form of coded holes punched into a 1" wide strip of paper tape, as shown below, where for comparison the punched data is identical to that contained in the lower line of the typed record.

MAGNETIC TAPE: The record is in the form of coded magnetic pulses stored on 1/2" wide magnetic tape (not illustrated), in a similar manner to that of punched paper tape. Its main advantages over punched paper tape are that recording speed is higher, has a much greater packing density and it can be re-used.

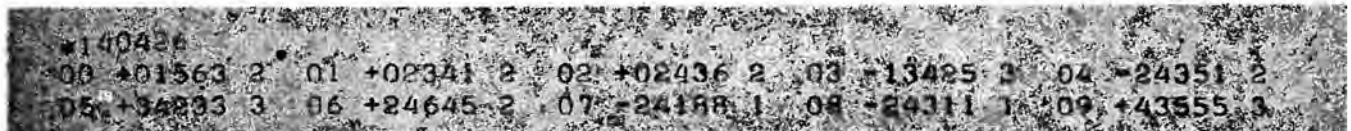
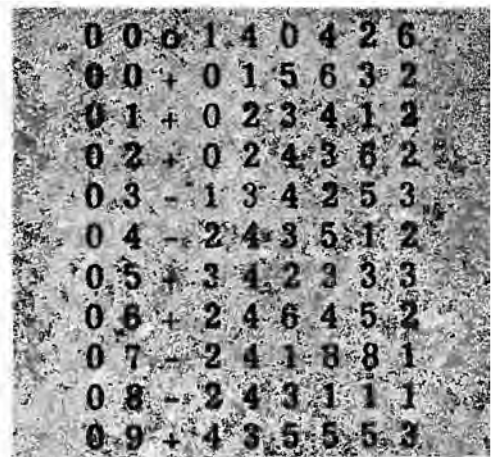

CASSETTES

.....loaded cartridges

By Martin Dworkin

EVERYONE talking about cassettes — and in the world of the information and entertainment arts-industries this means everyone — agrees that they portend a revolution. But there is little agreement on anything else. As matters stand, there are so many competing concepts and attendant incompatibilities in technology, so many variables affecting development of processes, and so many imponderables beclouding public acceptance, that it is difficult to exercise prudence without actually favouring one system or another. The choice of technology, too, will surely affect and be affected by the nature of the material to be recorded and replayed — raising profoundly serious questions concerning the ways of living that the new machinery may make possible, or, in effect, may actually enforce. The stakes are high enough to evoke the greatest concern, even as huge sums of money are ventured by established giants of the electronics and entertainment industries, and new companies are formed expressly to make the cassette revolution happen.

As with revolutions, there are cassettes and cassettes — and some that aren't cassettes at all. The word, as used by the media prophets, is increasingly being understood specifically to mean containers of recorded visual and audio materials for playback via television receivers. Often, it serves as a contraction for "tv-cassettes," or "video-cassettes," distinguishing the new system from the now-familiar (but still not standardized!) magnetic-tape magazines for sound-recording and reproducing machines; or, for that matter, from the various holders, packs, magazines, cartridges, or other devices for loading sheets or rolls of photographic film, that have gone by the name "cassettes" since the days of glass plates.

In fact, film, in what are often deliberately (if not very precisely) differentiated as "cartridges," is the

essential element of several systems considered as competing with tape videocassettes for general acceptance. But even here there are sharp differences in the ways film is used, to begin with according to whether it is optically projected, as with conventional reel-to-reel machines directly on to screens or walls — a leading example being the Technicolor Super-8mm system; or whether the film is scanned, or "read" electronically, and the sound and images converted for television receivers, in a manner modifying standard professional telecasting techniques — here two leading protagonists, both using 8mm films, are Vidicord and NordMende.

Film in cartridges, this time 8.75mm wide, carrying two picture channels and two audio tracks, also characterizes the EVR (Electronic Video Recording) system developed by CBS laboratories. But the film is produced by a unique process, combining electronic beam recording and optical printing, for replay using an oscillating spot-scanner attached to a standard television set. The EVR system has had more publicity than any other, especially in Britain and the United States — but also more actual demonstration, in a form produced by Motorola for educational and industrial applications. EVR programmes, it is important to note, can be made from conventional motion picture films — in fact, probably the greatest source of material; but the EVR films themselves, whether in cartridges or not, cannot be shown on standard or other projectors, existing or contemplated.

HOLOGRAPHY

A kind of film, also in cartridges, is used in the SelectaVision holography process announced by RCA. The "film" however, actually is chemically treated transparent stock, significantly inexpensive, on which split laser beams "emboss" patterns



of their "interference" with one another, as they are reflected from the material, such as films, photographs, and videotapes, that is being holographed. The resulting holograms in effect are "codes" which must be unscrabbled by another laser device, attached to or incorporated in a television receiver. RCA is promising that SelectaVision players and cartridges will be available by mid-1972, but only pilot models have been in operation so far, and industry observers are dubious about the projected arrival. However, RCA is already producing related laser-using devices for industry, such as a holographic lock-and-key system for plant security, and much in this technology may help to advance SelectaVision.

These systems all use "film," but they have little in common in concept or practice, and the cassettes or cartridges employed in any one of them will not work in any other. In

CASSETTES

.....loaded cartridges

the case of systems using magnetic tape, the factor of compatibility is somewhat less hopeless, although not by much. All the systems seek to exploit the instant-recording instant-replay potential of tape – in contrast to the requirement, in using films, including RCA's holographic tapes, of several, usually expensive processing and conversion steps. Here the contender with the lightest, most portable apparatus so far is Instavision, developed by Ampex (the Toshiba trade name will be used in Japan), the company that marketed the first videotape re-corder in 1956. Professional-standard equipment is planned for early release, with cheaper versions for amateurs and the home-entertainment trade to follow.

Similarly, the Sony Videocassettes system is being presented first for the enormous industrial and educational markets, with more compact, less expensive models for playback and recording in the home to come a year or so later. On the

other hand, the AVCO Corporation's subsidiary, Cartridge Television, Inc., is directing its Cartrivision (or Admiral) colour recorder and player outfit firstly to home buyers, also offering a light black-and-white

camera to be available "soon". AVCO-Cartrivision also claims to be producing adaptors for converting standard television sets for recording and playback – with the catch, of course, that only its own cassettes will fit the machinery.

EUROPE tape systems, the one coming closest to establishing a measure of general applicability is the Philips-VCR (for Video Cassette Recorder), for the reason that Philips has been able to convince a number of companies, in Europe and the Americas, to agree to make recorders and players that will accept VCR cassettes. Philips' vast size and power in the electronics industry is undoubtedly a decisive factor, but there also may be some beginnings here of the movement toward rationalizing standards that communications industrialists and professionals argue will have to take hold, for there to be realization of the potentialities of individual recording and playback systems. Such standards, however, are a long way

off, as the several systems – more than a score, by one count – compete for opening advantage in the race for acceptance. And, to make matters worse – or more interesting, as one prefers – there is no telling for sure that it will be some form of cassette or cartridge, using film, holograms, or magnetized tapes, that will win out.

For already there are systems considered whenever cassette television is discussed that do not rely on such containers of material, but on discs resembling gramophone records: for example, the Teldec Video Disc concept developed in Britain and Germany jointly by Decca and Telefunken. The Video Discs carry signals of both sound and images in grooves considerably finer, up to 150 per millimetre, than those of present "long-playing" records, which usually have from 10 to 13 per millimetre. Playing speed is even more spectacularly faster: from 1500 to 1800 revolutions per minute, as compared with 33-1/3, 45, or the older 78 rpm of sound recordings. There are claims that discs would make the cheapest and most convenient vehicles for playback television, and several companies, most notably M.C.A., the huge entertainment complex, say they are working on disc systems.

TAPE

Advocates of tape assert, however, that discs, requiring elaborate production processes, however ingenious, effectively rule out home-made television, one of the salient possibilities of cassette or cartridge technology. And such doubts, in turn, point to the questions observers, professionals, and would-be entrepreneurs are asking about playback television, whether employing cassettes or other expedients.

First, and perhaps finally, what will be in the programmes? Will they be so different from available TV that people will want to buy and keep copies? Or will these be so expensive that most people will have to rent them? How will creators of programmes, as well as performers and technicians, be paid for their work, by fees or continuing royalties? And how will the ease of making copies with home equipment – or large-scale, commercial pirating of cassettes (already the horror of audio-tape producers) affect original programming?

Dozens of companies, including the leaders in broadcasting, motion pictures, book and periodical publishing, computers, communications, and information technology, are busily accumulating programme materials – especially, films – or rights to their production or reproduction, in many cases without having committed themselves to any particular playback process. What will be the effects of cassettes or the like on theatre-going, television-viewing, radio-listening, sports attendance, reading, writing, and the myriad creative, participative, and receptive activities of modern cultural life? Even in the areas where cassette technology already has had considerable application, in education and industry, there is much less than unanimity on questions of potential growth, directions of development, and eventual significance in transforming ways of teaching and learning; gathering, storing, and retrieving information; controlling processes of manufacturing, and doing business in general.

CABLE

The questions about cassette equipment, or "hardware," and programming, or "software," actually may be incidental to those involving the other decisive development in communications of the past decade or so: cable television, or CATV. Many industry leaders consider cassettes and cable-TV to be integrally related, and that the true consumer market for "software" lies in wiring homes to central communications complexes, incorporating libraries storing every kind of programme material in cassettes, available for instant transmission to individual home receivers. In this concept, relatively few cassettes carrying specialized or favourite material, would need to be kept in the home, while an infinite variety could be dialled to show on any TV screen, at any hour.

To be sure, that possibility will make knowing what to choose more difficult than ever, with the potentialities for harm, and, hopefully, for benefit, immeasurably magnified. And the ultimate issue may be that of making sure that there are real choices, and not mere multiplication of seductive mindlessness – and, as always, that one's own judgmental "hardware" can make a difference in whatever "software" shows on screen.

SIEMENS TTL EX STOCK!!

SIEMENS QUALITY PLUS BARGAIN PRICES PLUS LST SERVICE
A full design range of high quality TTL available from LST your
officially Appointed Siemens Distributors

Part No.	Description	Equal	1-24	25-99	100 up
7400	Quad 2-input NAND gate	FLH	20p	16p	14p
7401	Quad 2-input NAND gate with open collector output	FLH	20p	16p	14p
7402	Quad 2-input NOR gate	FLH	20p	16p	14p
7403	Quad 2-input NAND gate with open collector output	FLH	20p	16p	14p
7404	Hex inverter with open collector output	FLH	20p	16p	14p
7405	Hex inverter with open collector output	FLH	21p	17p	15p
7406	Quad 2-input positive AND gate	FLH	25p	21p	18p
7407	Quad 2-input positive AND gate open collector	FLH	25p	21p	18p
7410	Triple 2-input NAND gate	FLH	20p	16p	14p
7413	Dual 4-input NAND gate	FLH	35p	29p	25p
7430	Quad 2-input NAND gate	FLH	20p	16p	14p
7432	Quad 2-input NAND gate	FLH	20p	16p	14p
7440	Dual 4-input NAND buffer	FLH	20p	16p	14p
7442	BCD to decimal decoder TTL output	FLH	28p	24p	20p
7443	Excess 3 to decimal decoder	FLH	28p	24p	20p
7444	Excess 3 to decimal decoder	FLH	31p	27p	23p
7445	Expandable dual 2-wide 2-input AND-OR-INVERT gate	FLH	15p	12p	10p
7451	Dual 2-wide 2-input AND-OR-INVERT gate	FLH	16p	13p	11p
7453	Expandable 4-wide 2-input AND-OR-INVERT gate	FLH	17p	14p	12p
7454	4-wide 2-input AND-OR-INVERT gate	FLH	18p	15p	13p
7460	Dual 4-input expander	FLH	10p	8p	7p
7470	J-K master-slave flip-flop	FLH	45p	37p	32p
7472	J-K master-slave flip-flop	FLH	11p	9p	8p
7473	Dual J-K master-slave flip-flop	FLH	12p	10p	9p
7474	Dual D-type edge triggered flip-flop	FLH	44p	36p	31p
7475	Quad bistable latch	FLH	15p	12p	10p
7476	Dual J-K master-slave flip-flop with preset and clear	FLH	45p	37p	32p
7480	2-bit full-adder	FLH	45p	37p	32p
7482	2-bit binary full-adder	FLH	67p	56p	48p
7483	Four-bit binary full-adder	FLH	23p	19p	16p
7486	Quad 2-input exclusive-OR element	FLH	34p	28p	23p
7490	Decade counter	FLH	16p	13p	11p
7491A	8-bit shift register	FLH	22p	18p	15p
7492	Divide-by-12 counter	FLH	17p	14p	11p
7493	4-bit binary counter	FLH	18p	15p	12p
7494	4-bit shift register	FLH	23p	19p	16p
7495	4-bit shift register	FLH	19p	16p	13p
7496	5-bit shift register	FLH	26p	21p	18p
74100	Dual quad 2-input bistable latch	FLH	30p	25p	21p
74107	Dual J-K master-slave flip-flop with preset and clear	FLH	27p	22p	18p
74121	Monostable multivibrator	FLK	27p	22p	18p
74141	BCD to decimal decoder and mixie driver	FLL	101	84p	70p
74190	Synchronous up down 4-bit decade counter with one line mode control	FLL	101	84p	70p
74191	Synchronous up down 4-bit binary counter with one line mode control	FLL	201	168p	140p
74192	Synchronous up down 4-bit decade counter with one line mode control	FLL	211	176p	148p
74193	As above...binary counter	FLL	241	200p	168p
74194	As above...binary counter	FLL	251	210p	176p

CONTRACT ORDER PRICES AND BULK QUANTITY PRICES QUOTED ON REQUEST
(Full range price list (126 Devices) sent to industrial users on request)
TYPES MAY BE MIXED TO QUALIFY FOR PRICE BREAKS
DATA BOOKLET 20P

LST

NEW PRODUCT: 2N5777 45p

Fantastically sensitive Photo Darlington now at lowest ever price.



1 WATT ZENERS

BZX61 series 5 per cent at 23p each. Voltages available: 7.5, 8.2, 9.1, 10, 12, 13, 15, 16, 18, 20, 22, 24, 27, 30.

NEW PRODUCT!!

LOW COST DIL SOCKETS
16 PIN DUAL IN LINE 17p
14 PIN DUAL IN LINE 15p

NEW LOW PRICE LINEAR!!

LC709C18 (DIL) 48p
LC72315 (TOS) 48p
LC72315 (DIL) 48p
LC741C15 (TOS) 93p
LC741C15 (DIL) 93p
LC741C15 (TOS) 93p
LC741C15 (DIL) 93p
LST are Official Distributors for Newmarket Transistors Ltd. Data and Volume prices on application.

TERMS: Retail Mail order subject to 50p minimum order. Cash with order only.
Schools etc.: Nett MA against Original order.
Postage: On inland: 25p Europe; elsewhere—send plenty will return.
Guarantee: All goods carry Manufacturers' warranty.
Counter sales: Same address—open to all.
Trade Enquiries only: Telephone Brentwood 226470. Telex 99443

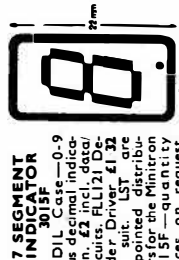

7 SEGMENT INDICATOR 3015F
1.6DIL Case—0.9 plus decimal indicator. £2 FLH. 3015F. Coder Driver. £1.32
LST are appointed distributors for the Minitor 3015F—quantity prices on request.

ULTRASONIC TRANSDUCERS
Operate at 40 kcs. Can be used for remote control systems without cables or electronic links. Type 1404 transducers can transmit and receive.
NEW Transmitter Receiver Circuit. Design now available. Free with transducers.
PRICE (Sold only in pairs) £5.90

CAPACITORS BY MULLARD/SIEMENS
Large stocks. Held of Polycarbonates, Tantalums, Polyester, Ceramics by these famous manufacturers—send for prices NOW.

LOW COST 1 AMP BRIDGES
W005 50piv 100+
W01 100piv 23 21
W02 200piv 25 23
W04 400piv 35 33
W08 800piv 38 35
W08B 800piv 38 35
Sub-miniature size. Plastic encapsulated. Larger quantity prices on application.

SPECIAL OFFER IN 4000 SERIES 1 AMP RECTIFIERS

IN4001 p.i.v. 50 045 040
IN4002 100 055 050
IN4003 200 060 050
IN4004 400 075 060
IN4005 600 100 090
IN4006 800 140 130
IN4007 1000 500+ 1000+
IN4008 100 045 040
IN4009 200 060 050
IN4010 400 075 060
IN4011 600 100 090
IN4012 800 140 130
IN4013 1000 500+ 1000+
Should any item be out of stock we will substitute a similar item at no extra charge.

NEW LOWER PRICES

AC107	BF194	OC170	25p	2N1090	30p
AC126	BF195	OC171	37p	2N1091	32p
AC127	BF196	OC172	40p	2N1132	30p
AC151	BF200	OC173	40p	2N1302	17p
AC152	BF203	OC174	40p	2N1303	17p
AC153	BF209	OC202	37p	2N1304	22p
AC176	BF284	OC203	25p	2N1305	22p
AC187	BF285	OC204	25p	2N1306	22p
AC188	BF286	OC205	25p	2N1307	24p
AC189	BF287	OC206	25p	2N1308	30p
AC190	BF288	OC207	40p	2N1507	33p
AC191	BF289	OC208	40p	2N1508	33p
AC192	BF290	OC209	40p	2N1509	33p
AC193	BF291	OC210	40p	2N1510	33p
AC194	BF292	OC211	40p	2N1511	33p
AC195	BF293	OC212	40p	2N1512	33p
AC196	BF294	OC213	40p	2N1513	33p
AC197	BF295	OC214	40p	2N1514	33p
AC198	BF296	OC215	40p	2N1515	33p
AC199	BF297	OC216	40p	2N1516	33p
AC200	BF298	OC217	40p	2N1517	33p
AC201	BF299	OC218	40p	2N1518	33p
AC202	BF300	OC219	40p	2N1519	33p
AC203	BF301	OC220	40p	2N1520	33p
AC204	BF302	OC221	40p	2N1521	33p
AC205	BF303	OC222	40p	2N1522	33p
AC206	BF304	OC223	40p	2N1523	33p
AC207	BF305	OC224	40p	2N1524	33p
AC208	BF306	OC225	40p	2N1525	33p
AC209	BF307	OC226	40p	2N1526	33p
AC210	BF308	OC227	40p	2N1527	33p
AC211	BF309	OC228	40p	2N1528	33p
AC212	BF310	OC229	40p	2N1529	33p
AC213	BF311	OC230	40p	2N1530	33p
AC214	BF312	OC231	40p	2N1531	33p
AC215	BF313	OC232	40p	2N1532	33p
AC216	BF314	OC233	40p	2N1533	33p
AC217	BF315	OC234	40p	2N1534	33p
AC218	BF316	OC235	40p	2N1535	33p
AC219	BF317	OC236	40p	2N1536	33p
AC220	BF318	OC237	40p	2N1537	33p
AC221	BF319	OC238	40p	2N1538	33p
AC222	BF320	OC239	40p	2N1539	33p
AC223	BF321	OC240	40p	2N1540	33p
AC224	BF322	OC241	40p	2N1541	33p
AC225	BF323	OC242	40p	2N1542	33p
AC226	BF324	OC243	40p	2N1543	33p
AC227	BF325	OC244	40p	2N1544	33p
AC228	BF326	OC245	40p	2N1545	33p
AC229	BF327	OC246	40p	2N1546	33p
AC230	BF328	OC247	40p	2N1547	33p
AC231	BF329	OC248	40p	2N1548	33p
AC232	BF330	OC249	40p	2N1549	33p
AC233	BF331	OC250	40p	2N1550	33p
AC234	BF332	OC251	40p	2N1551	33p
AC235	BF333	OC252	40p	2N1552	33p
AC236	BF334	OC253	40p	2N1553	33p
AC237	BF335	OC254	40p	2N1554	33p
AC238	BF336	OC255	40p	2N1555	33p
AC239	BF337	OC256	40p	2N1556	33p
AC240	BF338	OC257	40p	2N1557	33p
AC241	BF339	OC258	40p	2N1558	33p
AC242	BF340	OC259	40p	2N1559	33p
AC243	BF341	OC260	40p	2N1560	33p
AC244	BF342	OC261	40p	2N1561	33p
AC245	BF343	OC262	40p	2N1562	33p
AC246	BF344	OC263	40p	2N1563	33p
AC247	BF345	OC264	40p	2N1564	33p
AC248	BF346	OC265	40p	2N1565	33p
AC249	BF347	OC266	40p	2N1566	33p
AC250	BF348	OC267	40p	2N1567	33p
AC251	BF349	OC268	40p	2N1568	33p
AC252	BF350	OC269	40p	2N1569	33p
AC253	BF351	OC270	40p	2N1570	33p
AC254	BF352	OC271	40p	2N1571	33p
AC255	BF353	OC272	40p	2N1572	33p
AC256	BF354	OC273	40p	2N1573	33p
AC257	BF355	OC274	40p	2N1574	33p
AC258	BF356	OC275	40p	2N1575	33p
AC259	BF357	OC276	40p	2N1576	33p
AC260	BF358	OC277	40p	2N1577	33p
AC261	BF359	OC278	40p	2N1578	33p
AC262	BF360	OC279	40p	2N1579	33p
AC263	BF361	OC280	40p	2N1580	33p
AC264	BF362	OC281	40p	2N1581	33p
AC265	BF363	OC282	40p	2N1582	33p
AC266	BF364	OC283	40p	2N1583	33p
AC267	BF365	OC284	40p	2N1584	33p
AC268	BF366	OC285	40p	2N1585	33p
AC269	BF367	OC286	40p	2N1586	33p
AC270	BF368	OC287	40p	2N1587	33p
AC271	BF369	OC288	40p	2N1588	33p
AC272	BF370	OC289	40p	2N1589	33p
AC273	BF371	OC290	40p	2N1590	33p
AC274	BF372	OC291	40p	2N1591	33p
AC275	BF373	OC292	40p	2N1592	33p
AC276	BF374	OC293	40p	2N1593	33p
AC277	BF375	OC294	40p	2N1594	33p
AC278	BF376	OC295	40p	2N1595	33p
AC279	BF377	OC296	40p	2N1596	33p
AC280	BF378	OC297	40p	2N1597	33p
AC281	BF379	OC298	40p	2N1598	33p
AC282	BF380	OC299	40p	2N1599	33p
AC283	BF381	OC300	40p	2N1600	33p
AC284	BF382	OC301	40p	2N1601	33p
AC285	BF383	OC302	40p	2N1602	33p
AC286	BF384	OC			

This low cost solid-state module detects motion using microwave energy

DOPPLER effect is the shift in frequency that occurs when radiated energy bounces off a moving object: the frequency difference between the incident and reflected signals provides a direct numerical indication of the speed of the moving object.

The principle is finding increasing use in small radar systems. A typical application with which motorists are unhappily aware is the radar speed trap. The Doppler principle is also used as a movement or velocity detector in intruder alarms, collision avoidance systems for aircraft, boats and railway stock, and in experimental form as collision avoidance and moving headway control systems for automobiles and trucks.

A typical Doppler system (using electro-magnetic radiation) is shown in Figure 1. Radio energy is produced by the RF generator. An antenna beams the RF signal toward the moving object. A small part of this radio energy is picked off before it reaches the antenna and sent to a mixer. This is the Doppler reference signal and will be compared with the signal returning from the moving object: the moving target reflects a portion of the transmitted signal back toward the receive antenna. The returning signal passes to the mixer. The mixer combines the reference signal from the RF generator with the shifted return signal from the moving target.

Its output is a signal whose frequency is the difference between the reference signal and the signal reflected from the moving target. This signal will have a frequency in the audio portion of the spectrum from perhaps 10 Hz to 2 or 3 kHz, depending on the speed of the moving object. The output of the mixer is fed to an audio amplifier to boost the signal to a level that makes it

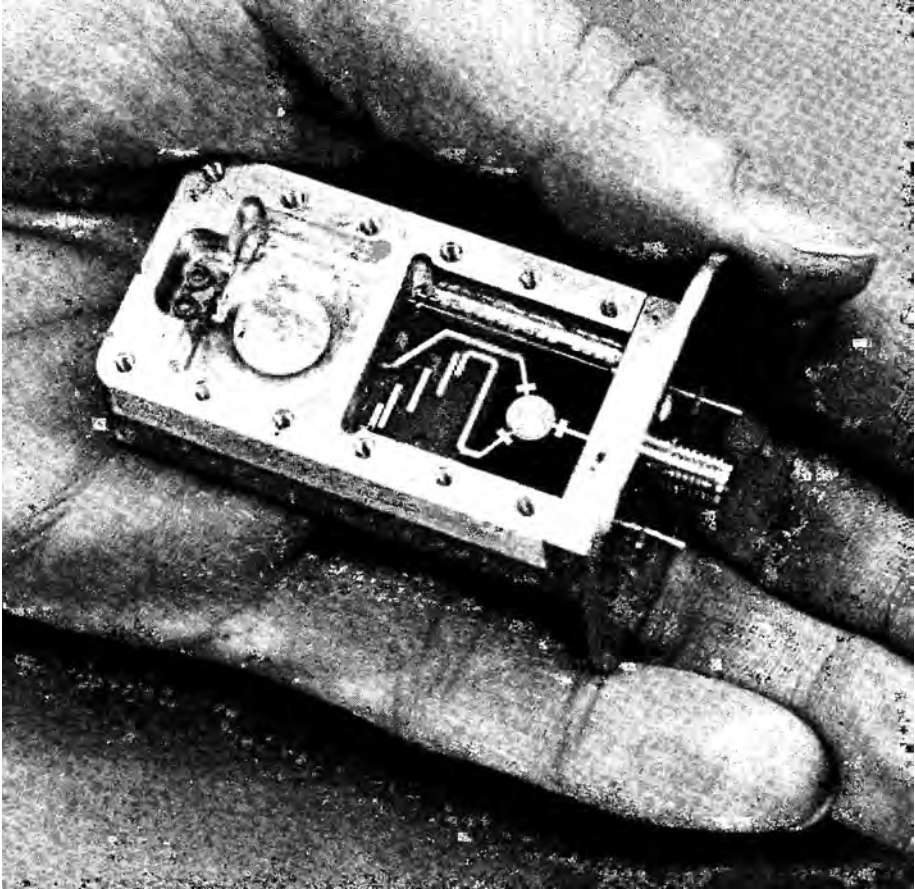

DOPPLER RADAR MODULES

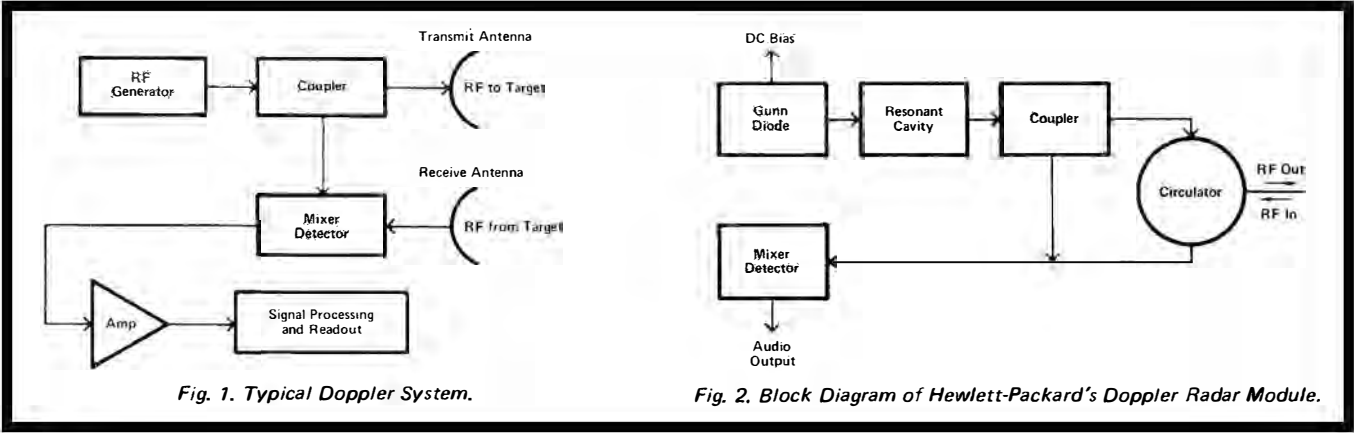

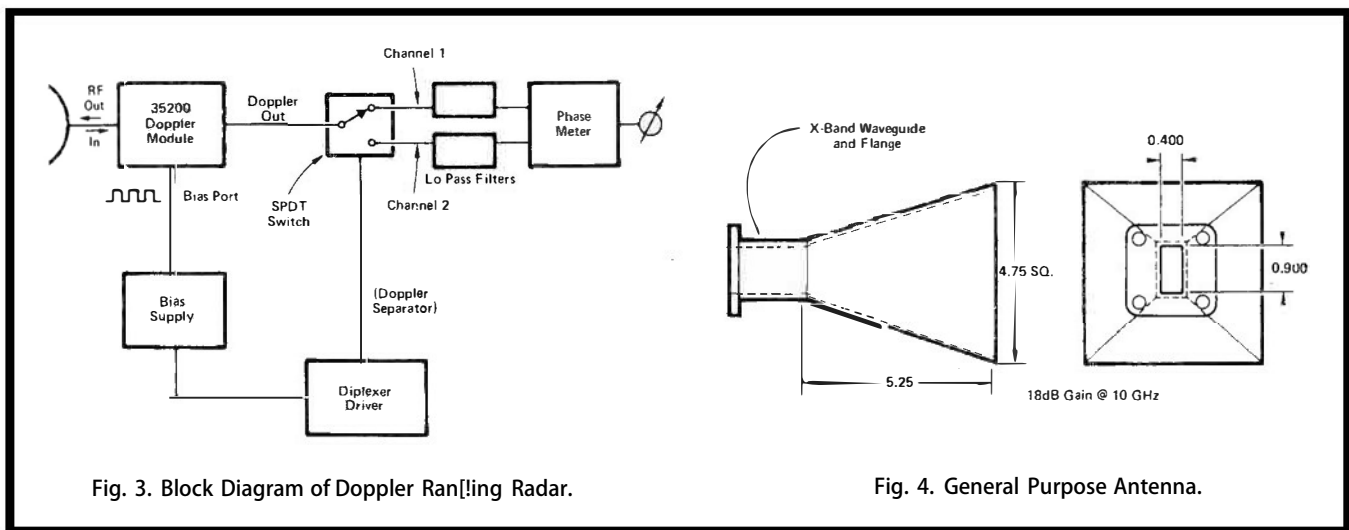

Fig. 3. Block Diagram of Doppler Ranging Radar.

Fig. 4. General Purpose Antenna.

convenient for processing and readout. The specific nature of the signal processing and readout circuitry will, of course, depend upon the task for which the Doppler radar system is being used. In their simplest form, these circuits merely provide a dc voltage to drive a meter.

Hewlett Packard have recently introduced a range of solid state X-band (9.35 to 10.6 GHz) doppler radar modules of small physical size. An adaptor enables these modules to be mounted direct on a standard X-band wave guide or antenna.

A block diagram of the module is shown in figure 2, and as can be seen, all of the typical system elements up to the mixer are included.

The RF generator, in this case, is a Gunn diode driving a resonant cavity. Gunn diodes are solid-state replacements for microwave vacuum tubes. They operate on low voltage (12 volts or less), have extremely good life, and are less expensive than their vacuum tube counterparts.

The Doppler system shown in Figure 1 uses separate transmit and receive antennae, Hewlett Packard's module eliminates the need for separate antennae by including a circulator at the output of the transmitter loop and the input of the receiver loop. The circulator isolates the outgoing and incoming RF signals from each other, even though they pass in and out through a common port and use a common antenna. The circulator thus cuts antenna costs in half. Circulators built into a thin film circuit add far less to the cost of the Doppler system than do circulators built from discrete components. Thus, the antenna savings that are achieved by using a circulator are true savings.

The circulator also serves to isolate the Gunn device from being unduly influenced by excessive reflections from targets that are very close to the antenna. Such reflections, if unchecked, lead to frequency

"pulling" (a shift in frequency) that can interfere with system performance.

As in the discrete system, a mixer is used to compare outgoing and incoming signals. Its output is then fed to an external low noise audio amplifier and additional processing and readout circuits as required.

The Doppler radar modules operate at frequencies around 10 GHz. At this frequency, each mile per hour of target velocity will produce a signal at the mixer output of about 31 Hz. The exact expression for the Doppler shift is given by:

$$f_d = \frac{v f_{rf}}{c}$$

where f_d = Doppler shift frequency in hertz

v = target velocity in meters/sec

c = speed of light = 3×10^8 meters/sec

f_{rf} = frequency of RF output in hertz

For example assume that a target is moving with a velocity of 10 metres per second (approx. 22 mile/hr), and that the radar is operating at 10GHz.

$v = 10$ metres/sec

$c = 3 \times 10^8$ metres/sec

$f_{rf} = 10^9$ Hz

$$fd = \frac{2 \cdot 10 \cdot 10^{10}}{3 \times 10^8} = \frac{2000}{3} = 666 \text{ Hz}$$

Thus a Doppler frequency range of 300 Hz to 3kHz will cover target velocities of from approximately 10 to 100 miles per hour.

RANGE CALCULATIONS

A Doppler system is, of course, simply a transmitter and a receiver in one package. The effective range of such a system depends on how much energy gets back to the receiver from the target and how strong that signal must be to make the receiver work properly.

As in any receiver, for a given signal processing scheme, a certain level of

input signal relative to the noise of the receiver (signal-to-noise level) will be required. This figure must be added to the noise power of the receiver to determine what input signal level is necessary to get successful detection.

In the Doppler module, receiver noise power is a function of the noise generated by the Gunn diode local oscillator and the conversion loss of the mixer.

Conversion loss is an inverse function of total detector current; i.e., the sum of the RF induced component and any externally applied dc component. The noise power contribution of the local oscillator (the Gunn device) goes up as a function of the RF induced mixer current.

To minimize receiver noise power, the oscillator is therefore isolated from the mixer to keep its noise contribution down and a dc mixer bias from an external supply is used to keep the conversion loss from being too high.

Provided the optimum bias is applied and assuming:

- 1) Antenna gain of 20dB (easily attainable at X-band)
- 2) doppler bandwidth of 30Hz to 3kHz
- 3) signal 10dB above noise is required.

The following range figures would be obtained.

Target	Range
10' diameter sphere	900 feet
car	800 feet
man	600 feet

DOPPLER RANGING

The Doppler module can be adapted to give range information as well as velocity. One successful method for accomplishing this task is to use a duplex phase comparison technique as shown in figure 3. The output from the Doppler module can be "switched" or diplexed between two closely spaced frequencies by

modulating the Gunn oscillator bias with a square wave. A comparison of the phase difference between the subsequently received signals from the target gives a direct measure of range. It can be shown that range is given by:

$$R = \frac{c}{2\omega_1} (\phi_1 - \phi_2)$$

where R = range
 c = speed of light
 ω_1 = frequency difference of the two RF signals
 $(\phi_1 - \phi_2)$ = phase shift of one Doppler wave with respect to the other

This system gives unambiguous readings of both range and direction so long as the range is less than $\frac{\pi c}{2\omega_1}$. As the range goes beyond the value, ambiguity can occur. Frequency differences between the two transmitted signals of 500 kHz give good range reading out to 500 feet.

The duplexing or switching rate must be chosen such that the time delay of

the return signal is much less than the period of transmission at any one frequency. A 100 kHz switching rate is adequate for ranges of about 500 feet, but is still fast enough to give a sufficient "sampling rate" to provide good resolution if the range is changing rapidly with time.

A block diagram of a typical system is shown in Figure 3.

OUTPUT SIGNAL

The output signal from the mixer is typically 1-50 microvolts, depending on target distance and size. To drive most processing equipment a low noise amplifier with at least 60dB of gain is therefore required. A further requirement of this amplifier is that low and high frequency cut-offs should be pre-settable as the module noise power contribution increases with doppler bandwidth thus reducing maximum range.

ANTENNAE

The type of antenna to be used with the Doppler module depends, in large

measure, on the particular end use to which the module will be put.

Figure 4 shows a design for a simple, general-purpose antenna that could be used in many applications. Such an antenna can be fabricated from standard X-band waveguide and sheet metal. To obtain a good match, care should be taken to see that all joints are true and smooth.

The advent of these solid state doppler modules will significantly ease the price of commercial radar equipment. Interface is relatively easy and only a single +9 to +12 Volt supply is necessary. Perhaps every police car will soon have a portable doppler speed trap as standard equipment!

Potential users should be warned that Post Office regulations governing the use of radio transmitters apply to this module. The user is cautioned to check these rules before using the module in his particular application. In almost all cases it would be necessary to obtain a license to operate the unit. ●

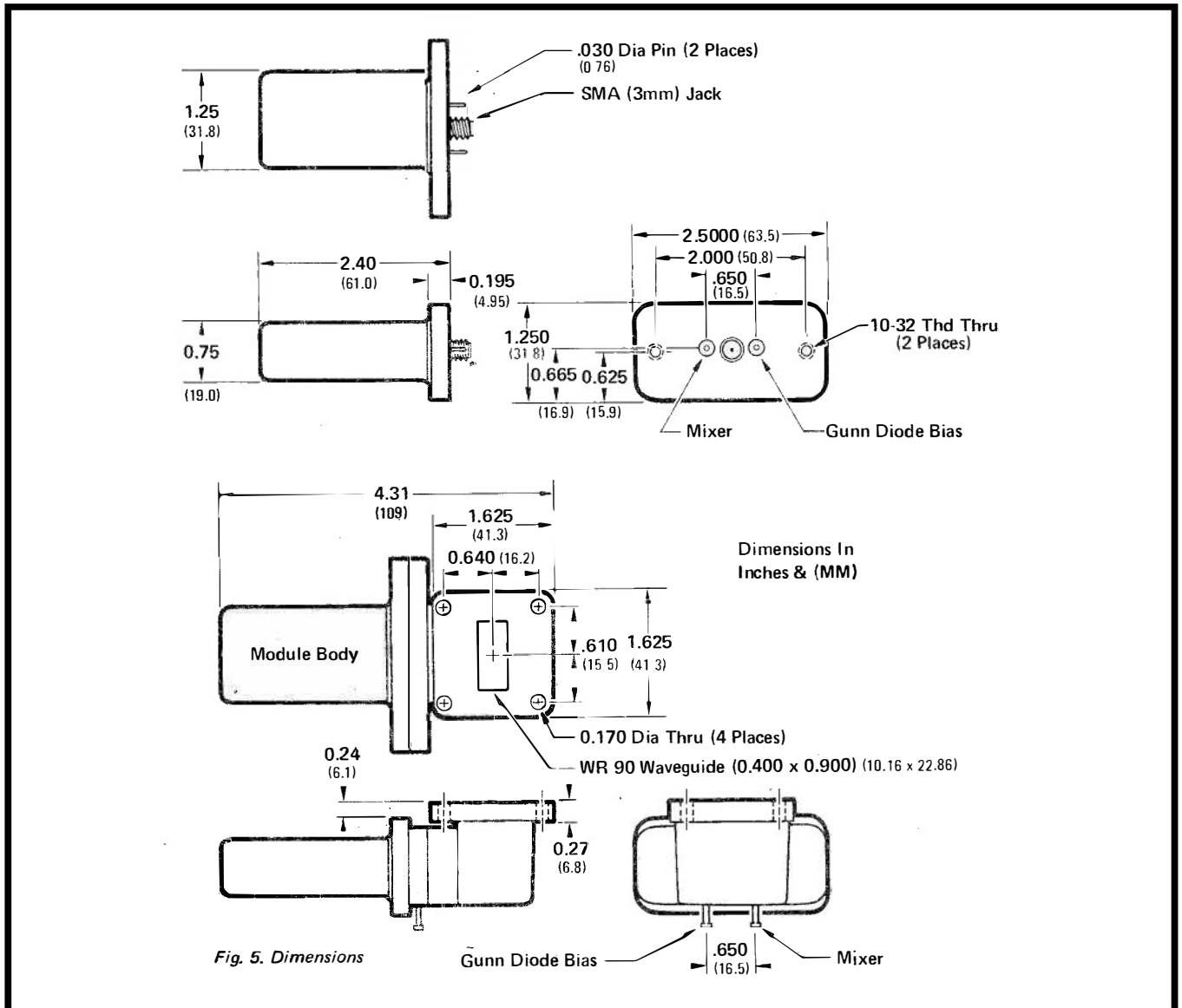

EQUIPMENT NEWS

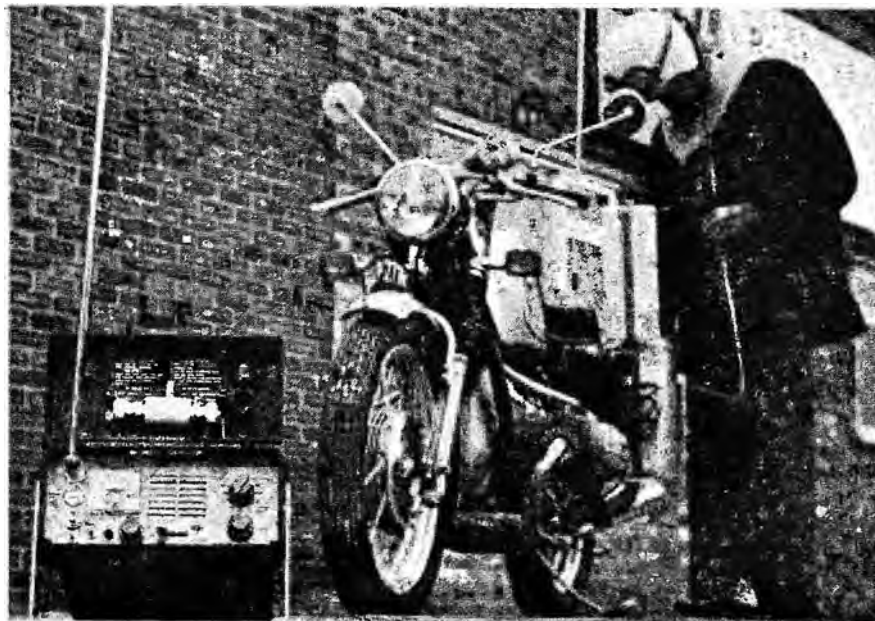

SURVEYOR

A general purpose closed-circuit television camera, incorporating an intrinsically watherproof casing and other features designed to simplify operation, installation and maintenance, has been introduced by EMI for use in education, commerce and industry. Known as the "Surveyor", this 625/525-line camera provides comprehensive operational facilities including remote operation and excellent low light performance.

High quality pictures are obtained from the camera's electrostatic pick-up tube, an EMI type 9745 or equivalent. This eliminates the need for deflection coils required with electromagnetic tubes thus simplifying maintenance and tube replacement. Extensive use of plug-in circuit modules further enhances the serviceability of the equipment.

The camera is capable of providing acceptable pictures under adverse lighting conditions. Electronic circuits automatically ensure that the camera output signal is maintained constant over a very wide range of light intensity.

The Surveyor incorporates a sync pulse generator which provides a fully interlaced picture and the waveform is such that television pictures can be displayed on any television monitor or be recorded on any compatible video tape recorder for analysis or record purposes.

IN-SITU RADIO TELEPHONE CALIBRATION

Measuring facilities not obtainable without recourse to expensive laboratory instruments are provided by two new battery-operated hf/vhf/uhf calibrators from Racal Instruments. These calibrators - model 9054 for UK use and model 9055 for overseas use - utilize sampling techniques in a novel manner to provide in-situ calibration facilities for mobile and fixed radio-telephones with operating frequencies of up to at least 500 MHz. The expense of equipment removal, transportation and testing in a central test or calibration facility is thus avoided.

The calibrators enable the pre-set tuning of both transmitters and receivers to be accurately and quickly adjusted by non-technical personnel. In addition a provision for checking the fm deviation of transmitters ensures that interference in adjacent channels is not caused by over-modulation.

The principle of operation is based on the fact that the frequencies allocated to mobile equipments are harmonically related to the channel spacing employed. If, therefore, the transmitter carrier frequency is compared, in a sampling mixer with the appropriate harmonic of a crystal controlled signal of pulsed waveform operating at a prf equal to the channel spacing frequency a beat note will be obtained which will reduce to zero when the transmitter frequency is correctly adjusted. Additionally, this pulse has sufficient amplitude of harmonic content at all required carrier frequencies up to 500 MHz to be used as an input signal for the precise calibration of receivers.

The channel spacing frequencies are derived by division from one master crystal oscillator which is a fast-warm-up frequency standard having an accuracy of 1 part in

10^7 within 3 minutes and a long term ageing characteristic of better than 2 parts in 10^9 per day. The need for multiple or plug-in crystals is thus completely eliminated.

Designed to withstand rough usage, these low cost calibrators are both compact and lightweight. Mains or battery powered models are available and a full range of accessories is included in the basic price.

Racal Instruments Ltd, Duke Street, Windsor, Berks.

SIMULATOR BREADBOARD SYSTEM

To compliment the wide range of analogue components and to fulfil a requirement in the educational and research field, Ancom has produced a simple to use simulator breadboard system.

The system is housed in an attractive modern design sloping-front unit. 19 inches long by 10 inches high by 10 inches deep, containing its own built-in dual 15 volt power supply with adjustment and balance controls.

Facilities are available to cover the use of up to five operational amplifiers or any continuation of five modules, with patchboard facilities at all points.

Ancillary units are available to cover multipliers, dividers, logarithmic functions, voltage to frequency converters, differential dc amplifiers etc., all powered from the simulator and supplied with all trimming potentiometers.

Further details from Ancom Ltd, Devonshire Street, Cheltenham, GL50 3LT. Tel: 53861.

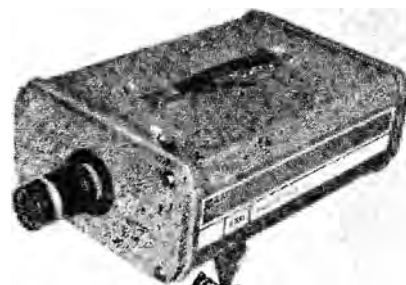

Included in the range of Surveyor accessories is a series of fixed focus and zoom lens packages, a weathershield, a pan and tilt head and various types of remote control equipment. In remote controlled applications, Surveyor can be fitted to the motorised pan and tilt head which allows movement of the camera to view a wide area. The weathershield is used to protect the camera from direct sunlight and to shield the front port of the lens package from adverse weather conditions.

EMI Electronics and Industrial Operations, Blyth Road, Hayes, Middlesex.

EQUIPMENT NEWS

PANEL MOUNTED SCANNER

A single indicator can be used to display information from any number of sensors by means of a new automatic scanner developed by East Midlands Instrument Company. The scanner is available to a wide range of specifications.

In standard form the scanner sequentially selects 12 or 24 points at a speed of 10 seconds per point using a combination of solid-state components and sealed reed switches for maintenance-free operation in adverse atmospheric conditions. Manual override and digital indication of selector position are provided.

Three-pole normally-open contacts allow the scanner to be used with an alarm module in addition to the indicator and sensors which may be any combination of resistance thermometers, thermistors, thermocouples etc.

The scanner is designed for panel mounting as a single unit and is supported by a fascia. When space is restricted, the scanner can be split into separate switch and control units for installation wherever convenient.

Further details from East Midlands Instrument Company, Laughton Lane, Morton, Gainsborough, Lincolnshire.

ANADEx IN UK

The Electronics and Instruments Division of Bell and Howell Limited has expanded its activities in the electronic instrumentation field by acquiring the sole UK marketing rights for the Anadex range of industrial analogue and digital measuring, indicating and controlling equipment.

Manufactured by Anadex Instruments Inc., of Van Nuys, California, the analogue product line consists of a broad range of ac to dc and dc to ac convertors.

The digital product range offers a wide selection of counters and digital printers. Included in the counter range are calculating counters, frequency counters, counter-timers and variable time base counters.

Anadex products, many of which utilise integrated circuit techniques, are widely used in the data monitoring and logging fields.

Mr M.S. Hayward has been appointed to handle the marketing of Anadex Products in the UK and certain overseas territories.

Further details from Bell and Howell Limited, Electronics and Instruments Division, Lennox Road, Basingstoke, Hants. Tel: Basingstoke 3681.

LOW COST POTENTIOMETRIC RECORDER

According to the manufacturers, Environmental Equipments Ltd, the accuracy and performance of a potentiometric strip chart recorder is now available at a price more usually associated with moving coil recorders.

The recording width of the new

'micro-corder' is 100mm (4 inches) with a maximum pen response speed of 0.6 sec. for full-scale deflection.

Linearity is claimed to be better than 0.5% of full scale. Reliable writing is obtained by the use of a disposable fibre-tip cartridge pen. There is a choice of three basic sensitivities; 100mV or 1V full scale with maximum source impedances of 1k, 10, or 100k respectively.

Zero may be set anywhere within the full chart width.

The recording chart is of the 'Z' fold type allowing easy access to previously recorded information, and one of nine fixed chart speeds can be specified — between 10mm/hour and 5mm/sec.

The fully floating input circuit, with positive, negative and earth terminals, allows the measurement of millivolt signals up to 400 V dc above earth potential. The recorder which is available in bench or panel mounting configurations, weighs approximately 2lbs.

Further details from Environmental Equipments Limited, Denton Road, Wokingham, Berks. Tel: West Forest 4922.

NEW PHASE JITTER METERS

Two versions of a phase jitter meter, designated type TF 2811, have been added to the range of Marconi instruments. The instruments are used in assessing the suitability of telephone lines for the passage of data signals.

Phase jitter is a line condition causing unwanted phase modulation which may interfere with a data signal to the point where the transmission is unreliable. In present telephone systems, channel noise, impulse noise and spurious signals are constantly monitored. However, now that these voice channels are being used more frequently to transmit data, including high speed data (up to 9600 bits per second), an exceptionally high standard of evidence of line fidelity becomes necessary. The TF 2811 series instruments provide such evidence by applying a signal to the line under test and measuring the phase change in the returned signal from the line.

The model TF 2811 XQ provides facility for phase jitter measurement from zero to 30 degrees. Model TF 2811/1 additionally has four counters to totalize the following parameters: Phase hits — the number of times the phase change exceeds a predetermined level. Amplitude hits — the number of times the signal amplitude exceeds a predetermined level. Coincidence — amplitude hits and phase hits occurring together. Dropouts — when the inputs drops below — 18 dBm.

Both TF 2811 and TF 2811/1 are portable and each contains its own test tone oscillator making it self contained for loop measurement.

Further details from Marconi Instruments Ltd, St Albans, Herts. Tel: St Albans 59292.



AUTOMATIC THREAD

The Ampex Model TMA digital tape drive is the lowest-priced in the industry to include automatic tape threading and vacuum chambers to prolong tape life. A phase encoding version also is available. Unlike other tape drives, the TMA fits into a standard 19-inch rack mount.

Further details from Ampex International, 72 Berkeley Avenue, Reading, Berkshire.

DIGITAL CONTROLLER FOR CONTINUOUS OR SEQUENCE CONTROL

A low-cost controller, bringing digital control to a much wider range of manufacturing and processing operations than has hitherto been possible, has been introduced by Ferranti Ltd.

The CP6 controller, as it is known, is a self-contained unit providing sequence control, or continuous control functions for up to 64 control loops in a plant. In addition to the facilities provided by conventional controllers or sequencers, the controller gives alarm limit checking, plant and operator logs, and centralised display and standby controls.

A communication link allows several units to operate together or to work into a central supervisory or management computer system. These features allied to the low cost (roughly comparable with that of analogue controllers) place the CP6 among the most significant recent advances in industrial control.

An advantage of the CP6 controller is its ability to operate in three different ways. Whether it is to control a process requiring just continuous control or sequence, or an operation where both are required hand-in-hand, the same basic equipment configuration is used. The choice of continuous or sequence control — or a combination of both — is made simply by

turn to page 78

COMPONENT NEWS

NEW POWER AMPLIFIER

A new power amplifier for audio reproduction equipment, the Cyldon KT72, is now being marketed directly by the manufacturers, Gemco (Electronics) Ltd.

Produced initially to meet the requirements of the company's own professional audio equipment, the design is claimed to lay emphasis on ruggedness and reliability. The unit is rated at 25 watts (average) into a four ohm load.

Current consumption is stated to be 850 mA at maximum output. Distortion is claimed to be less than 1/2% at 1kHz.

Further details from Gemco (Electronics) Ltd., Cyldon Works, Fleets Lane, Poole Dorset.

COMPACT TUNER FOR CAR RADIOS

Sydney S. Bird and Sons of Poole have introduced a new manual tuner for car radios.

In a high quality die cast frame, the tuner, designated the 'TT' series, can fit up to four coils in a frame 27mm square and 45mm long. A direct drive spindle provides very smooth core travel. Facilities for printed circuit board mounting are provided.

The small size of the 'TT' series tuner makes it especially attractive for use in receivers of heights down to 38mm.

Further details from Sydney S. Bird and Sons, Cyldon Works, Fleets Lane, Poole Dorset. Tel: Poole 4641M.

RESISTIVE/CONDUCTIVE LAMINATE

The Mica Corporation has developed a composite resistive - conductive laminate called "Micaply Ohmega".

It consists of an epoxy - fibreglass substrate. This has a resistive layer uniformly covering the entire epoxy surface. A conductive layer is in electrical contact with the resistive layer over its entire surface.

Using selective etching techniques, patterns of film resistors can be produced in the resistive layer connected to patterns of conductors in the conductive layer.

Typical properties available with materials now being made are stated by the manufacturer to be: - resistance variation over a 6" square laminate $\pm 5\%$. Temperature coefficient of resistivity from 25°C to 125°C, - 50 ppm per degree C. Resistance change under load of 5 watts per square inch (after 1,000 hours at 70°C), - 3%. Resistance change after exposure to 95% humidity at 40°C for 240 hours - 2%. Resistance change after 20 second solder float, 1/2%.

These are stated to be variations "as etched". However it is claimed the variations to 0.1% can be obtained by trimming. These results have been obtained using both laser and abrasive trimmers.

Further details from Micaply International Inc, Silloth, Cumberland. Tel: Silloth 571.

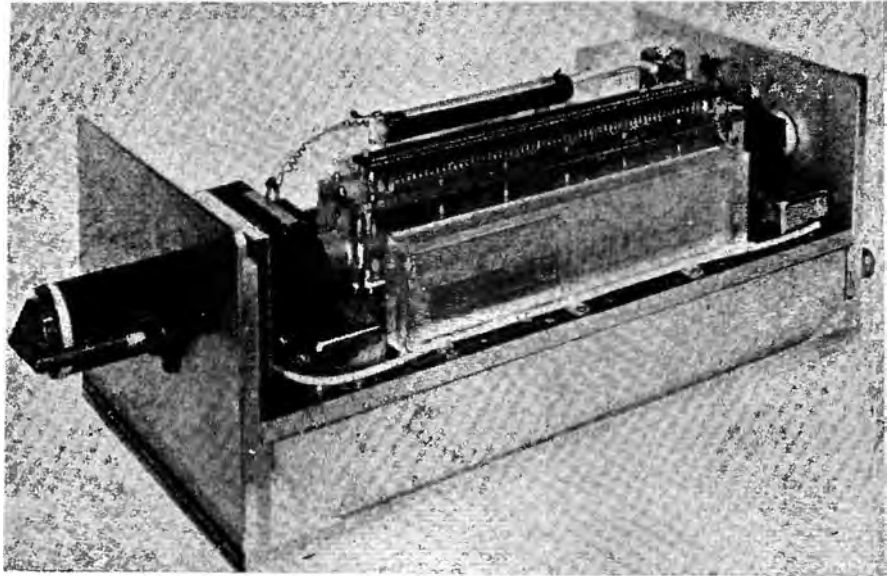

LASER

TRW Instruments announce a claimed laser breakthrough, a completely new pulsed CO₂ TEA Laser Model 120A. TRW claim this is the first CO₂ Laser providing a peak power of up to 200 kW in a Laser head only 280 mm long with a power supply only 762 x 559 x 457 mm in size.

This is achieved using a new design with the lasing medium at atmospheric pressure instead of at the usually accepted pressure of a few hundredths of an atmosphere. In addition, electrical excitation of the gas is applied perpendicularly to the lasing axis instead of parallel to it. This results in a very high gas density which enables the 200 kW peak power to be achieved, with an average

power variable to 10 W. The pulse width is 175 nsec while the repetition rate is variable to 400 pps. Pulse energy at 400 pps is 25 millijoules and 60 millijoules at a low repetition rate.

The transverse excitation of the laser reduces to a practical value the voltages essential to produce the high electric field required, whilst heat dissipated in the gas by the electrical discharge is removed by forced convection, transverse to both the lasing axis and the electrical axis.

The Model 120A is available from AVO International United Kingdom representatives for TRW Instruments, El Segundo, California, USA.

POWER TRIODES

Three additions to the range of English Electric rf power triodes for industrial service, are the BR1196, BW1196 and BW1196J3.

Of coaxial construction with ceramic/metal envelope, all three tubes have the same electrical ratings. They differ only in the method of anode cooling; the BR1196 is forced-air cooled and the other two are water cooled, the BW1196J3 having an integral water jacket and the BW1196 using a separate water jacket.

RATINGS

Anode dissipation (maximum)	5 kW
Anode voltage (maximum)	7.2 kV
up to 85 MHz	6 kV
up to 150 MHz	2.2 A
Anode current (maximum)	250 W
Grid dissipation (maximum)	

For further details apply to English Electric Valve Co. Ltd., Chelmsford, Essex CM1 2QU.

COAXIAL CONNECTOR FOR MICROSTRIP

The RF Components Division of Sealectro are marketing a new connector in the SRM (SMA) series. It is designed for microstrip applications with optimum performance and low VSWR in airborne radar equip-ments operating at X band.

The device is a four-hole, flange mounted receptacle which can be supplied with tapped or clear mounting holes. The insulator and contact incorporates carefully controlled close tolerance transition from the nominal .050 diameter at the interface, down to .010 diameter at the junction with the microstrip.

For further information contact the RF Components Division of Sealectro Limited, Walton Road, Farlington, Portsmouth PO6 1TB. Tel. Cosham 73211.

COMPONENT NEWS

CONTROLS WATER TREATMENT

Selectro have produced a Sealectroboard matrix switching system designed to function as an output selector for water treatment plant.

With the ability to actuate 62 output channels over a time cycle of 28 stages, the plugboard controls up to 62 valves in any desired sequential programme.

Through the use of a fundamental crossed busbar matrix arrangement, connected at crosspoints by diodeplugs, any combination of valve operation is possible. Cycling of the stages may either be on a time base or on receipt of command signals from the associated equipment.

For further information contact Sealectro Limited, Walton Road, Farlington, Portsmouth PO6 1TB. Tel. Cosham 73211.

LOG-PERIODIC ANTENNA

Log-periodic antennas are used in the wide range from shortwaves up to microwaves for a variety of purposes, including measurements and monitoring, as broadband exciters for parabolic reflectors and as directional antennas in the short wave range. The new antenna from Rohde &

Schwarz, the HA 226/582/50, which covers the range 1 to 15 GHz finishes a production programme of SHF antennas while at the same time replacing those which cover the range 2 to 12.7 GHz.

The basic design is two log-periodic dipole antennas, arranged in a V shape and connected in parallel at the ends, fed via a common feeder. In addition to a gain increase of 3 dB against an individual antenna, a considerable similarity between the radiation patterns in the E and H planes (which normally differ significantly), was achieved by suitable selection of the parameters of the antenna. These included angular width, radiator succession and the

distance between the two radiation centres.

At the lower cutoff frequency the patterns still show relatively high back and side lobes which decrease at 1.1 GHz to the usual value of 15% referred to maximum radiation. With frequencies above 6 GHz the main lobe shows slight deformation together with increasing side and back radiation. This effect can also be observed with antennas designed for longer wavelengths, especially if the frequency maximum ratio of the log-periodic radiator system is equal to or greater than 10:1.

For further details contact Aveley Electric (Communications Group), Arisdale Avenue, South Ockendon, Essex RM15 5SR.

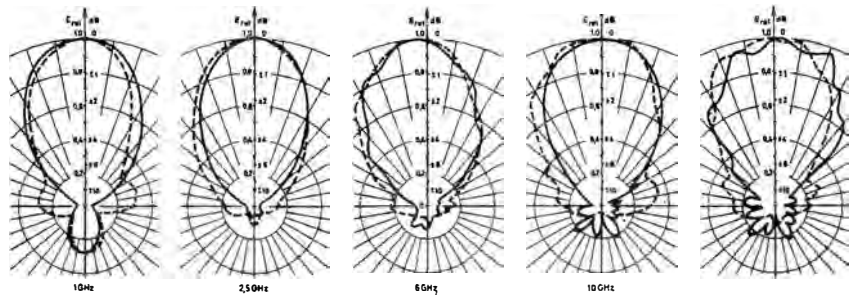

Relative radiation patterns of the log-periodic antenna. Solid curve: E plane; dashed curve: H plane.

CRESCENT RADIO LTD
11 & 40 MAYES ROAD, LONDON N22 6TL 888 3206

MAIL ORDER DEPT. No. 11 MAYES RD. LONDON N22 6TL

COMPONENTS AND HI FI FOR THE HOME CONSTRUCTOR

OUR SHOPS ARE OPEN ALL DAY FROM 9 A.M. TO 6 P.M. & 30 P.M. ON FRIDAY (WE CLOSE ALL DAY THURSDAY)

13 SOUTH MALL, EDMONTON, N.9 803 1685

WAFER SWITCHES

- 1 pole 12 way
- 2 pole 2 way
- 2 pole 3 way
- 2 pole 4 way
- 2 pole 6 way
- 3 pole 4 way
- 4 pole 3 way

18p each. Please inc. 5p P. & P. Up to 3 switches.

PSYCHEDELIC LIGHT CONTROL UNIT

Three Channel: Bass—Middle—Treble. Each channel has its own sensitivity control. Just connect the input of this unit to the loudspeaker terminals of an amplifier, and connect three 250V up to 500W lamps to the output terminals of the unit, and you produce a fascinating sound-light display. (All guaranteed) £18.50 plus 38p P. & P.

TRIVOLT BATTERY ELIMINATOR

Enables you to work your Transistor Radio, Amplifier or Cassette, etc. from the AC Mains through this compact eliminator. Just fit this little plug you can select the voltage you require: 5, 7.5 or 9 volts. Three such applications can be handled by this one unit. Approx. Size: 1 1/2" x 1 1/2". Our price £2.75 plus 10p P. & P. Same model available for the Philips Cassette: £3.50 plus 10p P. & P.

HIGH QUALITY IMPORTED HEADPHONES

1,000 Ω per phone 80p TTC
2,000 Ω per phone 88p G1105
Plus 10 P. & P. per pair.

BARGAIN S.C.R. TESTED THYRISTOR

400V 3 amp 45p each.
5 for £2. Please include 5p P. & P.

"CRESCENT" D.J. PARTY AMPLIFIER "PI00"

A completely new style 100W Amplifier especially designed for the D.J. who expects his equipment to look and sound really good, and still keep a moderate price: 10-30,000Hz response. All loudspeaker systems suitable. Full output into 4 ohm. P.E.T. at front end. Real value at £42 plus 11 P. & P. and insurance.

74 SERIES I.C.s

7400 15p; 7401 15p;
7402 15p; 7410 15p;
7430 15p; 7441 67p;
7473 37p; 7474 37p;
7490 67p.

Please include 5p P. & P. per three I.C.s.

EA1000 3 WATT AUDIO AMPLIFIER MODULE

An Audio Amplifier designed around the TAA921 Linear I.C.—

Supply Voltage 9-24V
Speaker Imp. 8-16 ohm
Frequency 50Hz-25kHz
Overall Size 5in x 3in x 1in
Ideal Amplifier for radios, record players, stereo units, etc.
Full technical data and diagrams with each module. All guaranteed and a bargain at £2.63 + 5p P. & P.

CRESCENT CASSETTES

Top quality cassettes at unbeatable prices (complete with standard storage case): C60 28p, C90 38p, C120 48p plus 5p P. & P.

EMI LOUDSPEAKER 450

10W 15in. : 8in. \pm two 2.2in tweeters and cross-over. All wired and ready for use. This ever-popular 450 in 3-8-15 ohm imp. £3.25 plus 38p P. & P. each.

LIGHT DIMMER

The unit comes complete with MK Ivory Front Plate and Control Knob, when used in place of Light Switch it will control your room lighting from off to full brightness. Power—up to 300 watts interference suppressed. £2.75 P. & P. 8p

MAINS KEYNECTOR

Keynector connects any Electrical Equipment to the mains supply in seconds. Ideal for bench, garage, demonstrations, etc. Multi connections can be made (max load 13A fused). ONLY £2.75 P. & P. 6p.

MIDGET FLEX CONNECTOR

Approx. 2 amp rating. Two-pin non-reversible midget flex connector. Approx. size: 2in. x 1in. Ideal for loudspeaker connections, etc. 8p plus 2p P. & P.

CAPACITORS

Mini Electrolytic all values up to 100MFD @ 15V 7p each. Small PF Capacitors only in packs of 10 but you can mix values—25p for 10.

250MFD @ 25V—15p
500MFD @ 25V—21p
1000MFD @ 25V—27p
2000MFD @ 25V—34p
3000MFD @ 25V—43p
5000MFD @ 25V—58p

Please inc. 10p. P. & P. with orders under £2 value.

PRINTED CIRCUIT KIT

Everything for producing your own printed circuits. £1.40p plus 10p. P. & P.

I.C. SOCKETS

A must for the experimenter! Makes your I.C.s. plug in devices. Standard 14 and 16 pin: 20p plus 5p P. & P. each.

POTENTIOMETERS

All types 1" and less diameter. SINGLES DUAL

5K Log or 5K 10K Lin Less 10K
25K Switch 25K Less
50K 50K Switch
100K 100K 45p
250K Double 250K
500K Pole 500K each
1M Switch 1M
2M 25p ea, 2M

ALUMINIUM CHASSIS

Made from 18 gauge aluminium 4 sided chassis with corner brackets. All are 2" depth.

6 x 3—41p
6 x 4—45p
8 x 6—58p
10 x 7—88p

12 x 3—58p
12 x 6—61p
12 x 8—88p
12 x 12—80p

14 x 9—84p
16 x 6—80p
18 x 10—1.08p

Please send 10p per chassis P. & P.

MINI LOUD-SPEAKERS

2 1/2 inch 40 ohm 38p
2 1/2 inch 8 ohm 38p
2 1/2 inch 26 ohm 38p
3 inch 8 ohm 48p

Plus 5p post & packing each

BARGAIN CAR AERIAL

1000 mfd at 25 volts Approx size: 2" x 1 1/2" dia. 20p each. 2 for 35p.

3000 mfd at 25 volts Approx size: 2" x 1 1/2" dia. 30p each. 2 for 45p.

Please inc. 10p P. & P. with orders under £2.

MAINS TRANSFORMER

Fused Primary 240V. Secondary 220V @ 50M/A. 6.3V, @ 1A. This transformer is made to a very high standard and is in a small size: 2in. x 2 1/2in. x 2 1/2in. 68p plus 10p P. & P.

ADD LUXURY TO YOUR CAR WITH A MOTOR DRIVEN CAR AERIAL

Spec: 5 Section Extended Length 1000m Length under Fowler 40in Cable Length 1200m

Supplied complete with Fitting Bracket and Control Switch. £5.50 plus P. & P. 25p.

7" x 4" LOUDSPEAKER

A top quality speaker ideal where small size is important. Manufactured by E.M.T. for a well known hi-fi set maker. Size: 7in x 4in. Impedance: 15 ohm. Flux: 38,000 Max. Free range: 90Hz to 12kHz. Power handling: 5W. Unbeatable Price: £1.60. Free postage on this item.

REISTORS

We stock all recognised values of resistors all at 10% or closer tolerance. We regret we can only mail them in lots of ten. You can send for mixed values. All Midget types.

1 watt lots of 10—18p
1/2 watt lots of 10—15p
1 watt lots of 10—20p

Please include 3p P. & P. for each 10 resistors.

CLASSICAL

REVIEWERS

John Clare

Christopher Wagstaff

DELIUS-SEA DRIFT- HASSAN Bruce Boyce, Leslie Fry (baritone) Royal Philharmonic Orth. & BBC Chorus, Beecham (cond.) CBS 61224 (mono).

DELIUS-A MASS OF LIFE Soloists, London Philharmonic Choir, Royal Phil. Orch. Sir Thomas Beecham (cond.) CBS 61182-3 {mono}.

The notion that Delius was essentially a miniaturist is quite justified, most of his extended works having unrelieved stretches or else one seems to be hearing a string of miniatures. But Delius successfully captured an almost epic utterance in Paris (1899-1900), Sea Drift (1903), and A Mass of Life (1904-05). None of these works is familiarly known to present day listeners, performances being few, and it is an even more shocking state of affairs when none of these works is currently available in up-to-date recordings. The ordinary listener has had to wait for these reissues to get to know A Mass of Life and Sea Drift, while no currently available recording exists of Paris. Sea Drift is Delius' masterpiece and almost certainly among the most eloquent settings in the literature. Taking one of Whitman's most successful poems, Delius is uncannily responsive to all its nuances – the various levels of reminiscence, the juxtapositions of childhood and maturer experiences, of the natural and human. And how well Delius understands the Whitmanesque ambiguity of point of view (lover, brother, friend, what does it matter) and his musical portrayal of loss is rightly both personal and of greater significance. With this piece Delius remains the most successful composer to set Whitman, not an easy task as anyone who has tried his hand at it can testify. But it is especially in the evocation of the sea that makes this setting so memorable. In using this poem, Delius chose to omit Whitman's opening and closing sections (not the strongest portions of the poem, one must admit) preferring to suggest the "cradle endlessly rocking" with a swaying motion that establishes Whitman's intended atmosphere naturally and without direct statement, a device of course, easier to use in music than in words. This swaying motion pervades the entire setting, and is not only appropriate to the pattern of recall, but also calls to mind those other musical narratives of loss – Tristan, Pelleas with their evocation of the sea as a primordial and desolate presence. So accurate in fact is Delius' observation of this common emotional experience of the sea that one cannot help but note how rightly the swaying ceases at "O rising stars!", resuming shortly after and climaxing at "O darkness! O in vain!", then silence and the baritone's "I am very sick and sorrowful". One almost does not notice the rocking

resume and fade gradually as the setting ends in a complex of emotion.

Beecham here gave one of his greatest performances and it would be hard to better this in a newer recording. His baritone soloist Bruce Boyce and the choir directed by Leslie Woodgate were also very much caught up in the spirit of the work. The recording is remarkably good although I am told by some that certain copies reveal a very slight wow. On the reverse of this disc is Delius' very pleasant incidental music to Hassan in a good enough performance. Most of the numbers on this side are also otherwise unavailable.

Less successful than Sea Drift and perhaps showing dated spots is Delius' setting of selections from Nietzsche's Zarathustra, A Mass of Life. At the risk of seeming ungrateful and especially since CBS has taken the trouble to release these records locally I must state that the recording on these discs were never good to begin with and the refurbishing improves things very little indeed. Sound is constricted and the wealth of orchestral detail in this score is not very much apparent. Nor I regret to say, is Beecham's performance one of his best. The opening is not rousing enough and the "Grosser Mittag" section seems rather sluggish. Elsewhere things go well enough but all is definitely not the best. Inasmuch as HMV has announced a new recording under Charles Groves it would perhaps be well to wait a bit although in all fairness to CBS I am almost tempted to think this new release should have happened a long time ago. – J.A.A.

RAVEL-Fanfare from L'Eventail de Jeanne FRANCK-Symphony in D minor. Stokowski, Hilversum Radio Philharmonic Orchestra DECCA Phase Four PFS-4218.

This record opens with a brilliant fanfare written by Ravel for a composite ballet *L'Eventail de Jeanne*. A tiny masterpiece of orchestration this fanfare certainly is, and Stokowski is very much in his element here. I am not in a position to say whether Stokowski has added or retouched anything but his performance here is all too brief. If the rest of the ballet is anything like this perhaps a complete recording should have been made. The cover notes list the rest of the numbers, each composed by some contemporary of Ravel's: Poulenc, Auric, Milhaud, Ferroud, Delannoy, Schmitt and Roussel.

In the past year or so, at least three new recordings of the Franck Symphony have been released, which seems a bit strange,

considering that Franck's music is hardly the most popular fare these days. There are a dozen or so other recordings currently listed in the Schwann and Gramophone catalogues, and since I can hardly think of one version which is anything less than good, this new effort seems to reflect the usual absurd marketing practices most recording companies have today. Be that as it may Stokowski is at least never uninteresting and when he conducts something from the basic repertoire the results are usually at least stimulating. Give Stokowski an old war-horse and one is bound to learn a thing or two about the work. Well, yes, this performance is in fact interesting. Certainly there are very few conductors today who pay as much attention to detail and inner voices. Having been a turn of the century organist Stokowski would rather naturally bring out the "romantic organ" aspects of this score. Phrasing is rather fine if at times a trifle exaggerated (not always inappropriate in this work). There are undoubtedly some very fine moments, especially those flute/oboe trills at 485-90. Nevertheless I find it very hard to say why I cannot enjoy this performance as much as the recent Karajan (HMV) or the Martinon (ERATO). There almost seems to be a lack of conviction to this performance which belies Stokowski's admiring notes on the record jacket. Certainly this is a less fiery performance than Karajan's. Also, the Hilversum Radio may well be one of Holland's best but it is no Concertgebouw. The all-important English horn has, for instance, a rather wooden quality to it and is often just accurate. And why must Stokowski insist at times on a very *vibrato* string ensemble?

Recording and surfaces on this record are superb. – J.A.A.

SIBELIUS-Kullervo Symphony, Op. 7. Kuolema-Scene with Cranes, Op. 44. Swanwhite, Op. 54- Incidental Music: nos. 2-4, 6. Soloists, Helsinki University Male Voice Choir, E. Pohjola (dir.) Bournemouth Symphony Orchestra, Paavo Berglund (conductor). HMV SLS-807 (2 records).

At the premiere of his Eighth Symphony, Mahler is said to have told Sibelius, "A symphony must be like the world, it must embrace everything." Sibelius in 1910 already possessed very different ideas as to what a symphony should be. The Third Symphony (1907) was already behind him and he was working on his Fourth, to be his finest achievement and certainly very different from Mahler's Eighth.

Admiration for Sibelius' symphonic achievement and the uniqueness of his "sound" as compared to most

CLASSICAL

post-Wagnerian writing has tended to neglect altogether any discussion of influences on his work. While an almost grudging concession to the presence of Tchaikovskian elements is made with regard to the First Symphony, any talk about Wagnerian sounds in say, the Fourth Symphony has generally been avoided.

This recording does set things in their right perspective. Begun during his student days in Vienna, the Kullervo Symphony enables us to hear the various lines along which the composer might have developed. One, for instance, recognizes Bruckner in the length of themes and pedal basses, the writing for horns in the second movement, and the transitions in especially the first movement. More obviously, the form of the symphony (five movements, choral sections) links this work to late German romantic writing, although it must be remembered that Kullervo does precede Mahler's Resurrection, so that whatever its relationship to the German stream, the form of this work must still have been something of a novelty to most audiences of the time. But while some aspects of this symphony seems to set Sibelius as starting off from late German romanticism, it must be admitted that already very little in this work sounds German, and that is in great part due to a greater influence on Sibelius than anything in the Wagnerian vein, that of Tchaikovsky. By virtue of hindsight we realize that it was Tchaikovsky who veered Sibelius away from the post-romantic German elements. It was Tchaikovsky which impressed Sibelius with the fact that symphonies could, in fact, be written without Wagnerian chromaticism and in more classical lines. The First Symphony is final proof of this. But once again it is only too easy to emphasize the antecedents in this work. There is very little here that is an personal as Tchaikovsky. Nor is this work a "world" or else it is the confined world of the Kalevala. One has to admit that much of the writing here already reflects Sibelius' own voice, for instance, the illusion of movement not so much by means of counterpoint as by alternating dynamics and speed (Harold Truscott). Whatever moments of poor quality this work has, it is

nevertheless rather remarkable and avid Sibelians will definitely want a copy of this work. Performances from all concerned are always on a high level, recording is excellent, and surfaces on my copy are good.

The Kullervo is, however, not the only cause for joy in this album. We are also given the only recordings of the Scene with Cranes from Kuolema and four excerpts from Swanwhite. No cause for complaint here except that too little of Swanwhite is included. While none of these pieces is top level Sibelius, there are very lovely moments and the writing for two clarinets in the Scene with Cranes is very haunting indeed. And now will HMV or anybody give us a complete recording of the Tempest music? - J.A.A.

PANUFNIK - Universal Prayer. Soloists, Louis Halsey Singers, Nicholas Kynaston (organ) Leopold Stokowski (conductor). Unicorn RHS-305.

Panufnik's Universal Prayer is most certainly not "one of the most original musical creations of the middle Twentieth Century" nor is it "an entirely new development of music" whatever Stokowski may say on the cover of this record.

For someone responsible for numerous premieres of truly original works (Ives, Symphone No. 4, Varese Arcana, for example) Stokowski can be strangely and irritatingly naive at times when he does talk about some of the music he conducts. Nor are Panufnik's own notes and graph of the geometrical symmetry of his work more inviting. If these are not naive, one is strongly tempted to think them pretentious. Ultimately of course it is the music that must stand up to the test and whatever Panufnik's ruminations as to the work's being neither twelve-tone nor aleatory but based strictly upon one triad only, everything sounds very much old hat to me. Certainly this work is carefully organised, or one is tempted to say too rigidly perhaps, without any musical compensations. Panufnik's earlier symphonies, the Rustica and Sacra may have been conventional but one felt at least the man was trying to write music not mathematics, and I have nothing against very mathematical composers like

Boulez or Xenakis who can also be musical. For those who do not agree with me, here is a very good performance indeed from a conductor who seems to believe in this work. Recordings is very good, except for some distortion towards the end of each side. - J.A.A.

"O SACRUM CONVIVIVUM" - Modern French Church Music. Jean Langlais - "Messe Solennelle"; Maurice Durufle - Quatre Motets; Gabriel Faure - "Messe Basse"; Francis Poulenc - "Litanies a la Vierge Noire" - Choir of St. John's College, Cambridge; Stephen Cleobury, organ; Andrew Brunt, solo treble; George Guest, director. Argo ZRG-662.

The diversity of style in modern French church music becomes vividly apparent with this new release. All the works have their own individuality and are fascinatingly dissimilar - the lyrical approach to the words of the mass by Faure; the modal tonalities and contrapuntal texture of four motets by Durufle; the frequent mood changes in Poulenc's "Litanies"; the mystic colouring of the Messiaen, and the intense dissonances amidst contrapuntal textures of the Langlais Mass. It might be argued that the Faure Mass is out of place on a recording devoted to Modern French music but this is really immaterial.

The work which stands apart in originality is the "Messe Solennelle" by Jean Langlais - a remarkable piece of writing; intense, exciting and forceful. It deserves the marvellous rendering given to it here. From the opening suspense-laden organ dissonances to the crowning glory of the 'trompettecials' peeling above the choir one just becomes immersed in the work. Mention should be made here of the organist, Stephen Cleobury. His understanding of the work and the application of a fine technique together with control of suitable registration schemes give the work a strong individuality.

The quality of singing is just as fine. Entries are firm and balance of voices (including the alto line!) is clear. One can almost feel the tension in their voices as they convey this general feeling of intensity. Certainly their voices do not blend as well as their neighbours at King's, but they are probably not meant to. In any case the contrapuntal lines are transparently clear and there is a sense of freshness and gentle radiance in their voices.

Faure's "Messe Basse" contains a few anticipations of his "Requiem" and is set for treble voices. A charming rendering, especially from treble soloist Andrew Brunt who sings confidently and with a delicate lilt. Incidentally the organ accompaniments here are simply gorgeous.

The other works are given equally fine renditions. I single out the Langlais as it is the most striking and leaves a more lasting impression.

Sound is particularly clear and there is a commendable balance between organ and choir (full organ as used in the Langlais never drowns the choir). Some slight background noise (passing cars, I think) in the Durufle. The disc comes complete with texts (and translations) and an excellent sleeve note by Philip Radcliffe.

Possibly the finest recording the choir has made. - C.M.W.

NEXT MONTH IN ETI

- We test the Garrard Zero 100 turntable
- Anti Skid Braking
- Electronics in the Antarctic

PLUS

Great new Projects and regular features covering the world of electronics with review features of Classical, Jazz and Pop Music



Stan Getz. *The Very Best Of Stan Getz*. Verve Stereo 2304 024. *Manha De Carnival, So Dance Samba, Menina Flor, O Pato, Trains And Boats and Planes, What The World Needs Now, Desafinado, O Grande Amor*, etc. With Gary Burton, Luiz Bonfá, Maria Toleda, Charlie Byrd, Jobim, Laurinda Almeida, Chick Corea.

Stan Getz first made his mark in the Woody Herman band of 1947 as part of that famous sax section known as the four brothers. He had always been impressed by the light singing quality of Lester Young's tenor playing, and in turn impressed many tenor players – and alto players too, such as Paul Desmond, I shouldn't wonder – with the rather remote and lovely solo he played on a Herman recording of *Early Autumn*. Lester Young was to say to him, shortly before Lester died, "You are my singer", a tribute which moved the younger man very deeply.

Later, Getz was to play more aggressively, in a conscious attempt to move away from the cool sound, almost without vibrato or reedy overtones, which had brought him to prominence. On ballads he even showed some tonal similarities to John Coltrane.

It would be extremely interesting to have a recording which traced the development of Getz's style, one which included his *Early Autumn* solo as well as tracks from recordings he made with Chet Baker, JJ Johnson and Dizzy Gillespie. Such a recording might more accurately be called the 'Very Best Of' than the one under review. This recording is confined to Stan's *Bossa Nova* period.

Getz plays here with a lean, and often quite edgy sound, and even manages to strike out with stinging effect over the simultaneous shuffle and lilt of the *Bossa Nova*. However, he rarely takes a very long or a very adventurous solo, and is usually content to paraphrase the melody.

This is very pleasant and occasionally exciting music. Just forget the 'very best of' tag.

Gary Burton, whose name is quite prominent on the cover, can be heard only on *Manha De Carnival*, and he is rather badly recorded. The recording balance is often less than brilliant. – J. C.

CHARLIE MINGUS - *Pithycantropus Erectus*. America, Stereo, 30 AM 61 09 ***Erectus, Peggy's Blues Skylight, Love Is A Dangerous Necessity***. Mingus, bass; Charles McPherson, alto sax; Bobby Jones, tenor sax; Jacki Byard, piano; Dannie Richmond; drums, Eddie Preston trumpet.

It is almost a relief to review a Mingus recording without having to drag out all the superlatives. This is not an earth shaking record, but it is quite a satisfying one. Superb musicians not trying terribly hard, producing the kind of relaxed jazz you might hear on Arch McKirdie.

Pithycantropus Erectus takes up all of side one, but do not be put off if you are averse to long 'raves'. This is all very disciplined, and sections of doubled tempo smooth harmonised theme statements alternating with brief somewhat wilder collective improvisations, plus solos by all except Richmond and Mingus sustain interest throughout without ever stirring up much excitement. The theme is a very simple bluesy one, in fact little more than a series of chords held for two bars at a time by the wind instruments while the rhythm section walks buoyantly, carrying as it were a long pole of wind sound, mounting with it to a level a semitone above and carrying it again, and so on.

Mingus, Byard and Richmond play beautifully together, and it sounds as though the soloists, rather than using the rhythmic foundation as a springboard, decided to just relax on it for a change. McPherson's performance is far removed from his long howling solo on *Mingus At Monterey*. One of the few altoists who have been able to capture the spirit of Charlie Parker in their playing, he doesn't sound at all like Parker here, even when playing a Parker phrase. He plays quite nicely at a low, for him, level of intensity and invention.

Preston has a nice clear brassy sound and he plays mostly simple declamatory blues phrases with a few more fluid passages. Byard plays the best solo on the record, full of humour and strength. Jones is interesting. A white man, he would have to be pretty good to be hired by the rather angry Chaz

Mingus. He gets a big, slightly hollow sound, reminiscent at times of Roland Kirk's river barge sound on tenor, and he has obviously been influenced by contemporary players such as Shepp, perhaps Joseph Jarman, but like the others he is taking it easy here.

Peggy's *Blues Skylight*, contrary to the name is a melodic theme over a ballad chord sequence, with rather a West Coast feeling. Everyone plays the changes with sensitivity, particularly Byard who is overflowing with invention within a fairly restrained context. I've always felt that it was a mistake to dismiss the so-called West Coast school as an aberration having little to do with jazz. Mingus himself played with West Coast musicians for quite a while, and the influence is obvious here, but then so is that of Thelonius Monk.

Love Is A Dangerous Necessity is a showcase for trumpeter Preston. His sound is very brilliant here. I like the way he makes his notes break out as though they are too big to be contained by the instrument, the same feeling that Lee Morgan gets. However, his concept seems a little old fashioned for a Mingus sideman. McPherson's solo has hardly begun before it is arbitrarily cut off. Seems they just ran out of record. Sound is good and clear, bearing in mind that this is a low priced recording. – J.C.

BENNY GOODMAN - *Benny Goodman Today* Decca DDS 3, Stereo. ***Let's Dance, Sweet Georgia Brown, Stealin' Apples, Sing Sing Sing, Don't Be That Way, Willow Weep For Me, Big John's Special, Body And Soul, A String of Pearls, Poor Butterfly, Blue Skies, One O' Clock Jump*** etc. (Double Album).

If your copies of the Carnegie Hall concerts are wearing out, do not despair – replace them with this double album and you'll hardly notice the difference, because Benny Goodman *Today* sounds exactly like Benny Goodman circa 1938.

This album records a performance in Stockholm by a band which Benny recruited, so I understand, in England. The charts are generally very similar to the originals – indeed, I haven't checked them but I imagine that many are not altered at all – and the band, with the exception of the rhythm section, play them EXACTLY as they would have done in the thirties.

Willow Weep For Me is an exception. Never a Goodman tune so far as I know, the lovely ballad is here debased by a weird attempt on the part of arranger and the

JAZZ

exhibitionist trumpet soloist to turn it into a declamatory blues. Most of the other performances are less offensive than funny. Big John's Special is a priceless period piece. You can just see them dancing to it with a stiff jerky strut as though pumped along by their rigid arms clamped down at their sides, hands clasping suddenly switching direction with a violent action befitting store window dummies galvanised by some diabolic occurrence as the brass suddenly increases volume with that 'I'm gonna GRAB you!' feeling of comic opera menace. Oh, boy! Goodman fans will love this.

Benny himself is as ever the Frankie Laine of the clarinet. He tries so hard to break everything up, and he is certainly not without feeling but nothing happens, because he has no ideas; he swings in his fashion, but it is just not enough: without ideas it is all bluster and undirected energy. I love his sound whether pure or gritty, and he is a superb technician, but I have no idea how anyone could have mistaken this for good jazz.

None of the soloists is particularly distinguished, but the trumpeters are positively bad. One keeps throwing in Harry James' corniest devices, in an attempt I suppose to get into the spirit of things.

Benny Goodman's version of the Mozart clarinet concerto is still the highest selling performance in England. In my opinion that is where Mr. Goodman's talents lie. This album is beautifully packaged and recorded. Goodman fans will love it. — J.C.

DUKE ELLINGTON. *New Orleans Suite.* Atlantic SD 1580, stereo. *Blues For New Orleans, Bourbon Street Jingling Jollies, Portrait Of Louis Armstrong, Thanks For The Beautiful Land On The Delta, Portrait Of Wellman Braud, Second Line, Portrait Of Sydney Bechet, Aristocracy A La Jean Lafitte, Portrait Of Mahalia Jackson.*

This recording qualifies as a collector's item without the benefit of antiquity and before one has even heard the music. I hope it turns out not to be the case but this could be the last suite Ellington will write. It contains what was unfortunately the last solo of the late Johnny Hodges, and it represents a looking back by Ellington at the very roots of his music.

What a fascinating and rewarding view of New Orleans it is! There are no traditional jazz reconstructions — which is a bit of a shame: a contingent from the Ellington band played beautiful 'mouldie' jazz at Newport in the Fifties — but the spirit and the atmosphere of old New Orleans as one feels it through the reminiscences of Louis Armstrong and Jelly Roll Morton — the unique blend of subtropical langour, rich raucous passion, French elegance syncopation, musical rivalry and miraculous empathy — are expressed in solo and orchestral terms.

Bourbon Street features Norris Turney on flute — an instrument hardly typical of New

Orleans jazz — over a gliding sonorous flow of trombones, flugelhorn and bass clarinet, in a slow fluid rhythm something like a samba. Yet this exotic, languid mysterious piece achieves exactly Ellington's aim, which was to write "a rhythmic tone parallel to the excruciating ecstasies one finds oneself suspended in, when one is in the shoes of the jingling rhythmic jollies of Bourbon Street."

Turney is again featured on *Portrait Of Mahalia Jackson*, through which run, not inappropriately, rock and roll triplets. Thanks for the *Beautiful Land On The Delta*, also has a Latin feeling in the rhythm, and *Stanley Dance* does not mention in his excellent cover notes the similarity of this to the sort of rock beat he holds in such contempt! Ellington, unlike his more fanatical devotees, has never been above absorbing elements of current musical trends, though it is true that the seeds of everything that has happened in popular music and jazz have always existed in Ellington's work. Harold Ashby's hoarse fervent cries on tenor over the ensemble in the abovementioned piece are most stirring.

Again, we have Wild Bill Davies on electric organ, an instrument that did not even exist in the earliest days of jazz, on *Blues For New Orleans*. I must admit, though, that this track seems to me the least relevant to the New Orleans theme. Sure, it's a fine rocking blues, and the blues were essential to the development of New Orleans jazz, but there is nothing about it which makes it more suitable than a lot of other fine blues performances. However, it's great stuff and it does have Johnny Hodges' last solo, which is a good strong one, though not a great one — let us not pretend.

The closest approaches to reconstruction are in the tracks *Second Line* and *Portrait of Louis Armstrong*. The first has some beautiful clarinet descant in traditional style by Russell Procope, over romping, charging ensembles. *Portrait* catches exactly the spirit of Louis, both in the playing of Cootie Williams, and in the ebullient theme. Cootie has the most massive trumpet sound of anyone, including Harry Edison. The feeling of ponderous weight is increased by his penchant for playing his notes very broadly (giving an impression at first of ineptitude) but with maximum attack. Whitney Baillieaut, an American writer who generally irritates more than somewhat, wrote that Williams expresses a percheron emotion, and I must admit that he hit it on the head that time. It is also very much an old man's grand passion. One is pulling with him as he labours in the trough between beats; one feels rewarded as he emerges magnificently on the crest like a galleon in full sail. Take note of his elephantine but inexorably swinging coda over Joe Benjamin's ostinato bass. That is really Louis.

My copy has a lot of surface noise, and I think that in many cases the soloists could have been recorded more prominently but this should not deter Ellington collectors. This is not the greatest of Ellington's suites, but there is a great deal of lovely and exciting music here. J.C.

continued from page 72

selecting the appropriate software programme.

Because of the broad sweep of industrial control requirements met by the company's new controllers, the potential range of applications is correspondingly comprehensive. Whether it involves the control of a single discrete plant or a section of a large plant, the basic simplicity and built-in security of the CP6 package, allied to its flexibility and economy of operation, is calculated to meet a long-standing demand in many industrial sectors. In addition, the inherent power of the Argus CP6 Processor and its communication software simplifies incorporation into larger, more comprehensive control schemes.

The basic simplicity of the CP6 systems means that the user need not be familiar with computers, or even conscious of any computer influence on his operations. This same simplicity, based on a selective build-up of standard equipment and software modules chosen to suit the specific demands of the plant being controlled, is a vital factor in preventing interface problems between the plant operator and the CP6 systems. The operator's control panel allows plant monitoring of the setpoint variations to be effected very easily, and control parameters are adjusted without interrupting production cycles.

The controller is also geared to work with existing standard instruments and actuators in a plant. It will accept variable analogue inputs in the range normally provided by pH meters, GLCs, thermocouples, radiation pyrometers, resistance thermometers, power meters and most other industrial measurement instrumentation.

Digital inputs can be accepted from normal on/off switches, push-button alarm contacts, limit switches and other similar devices. Normal outputs are raise/lower signals with maximum ratings of 110-V and 250-mA, and external equipment is readily available for converting electrical to pneumatic signals where necessary.

Installation and in-plant commissioning of the controller is quick and easy because each system is based on standard programmes and is tested rigorously before delivery. Thus, the risks of costly initial on-site delays are eliminated. Moreover, the controllers occupy less space than conventional control equipment and they need no special air-conditioning and power supplies.

Once commissioned and in on-line operation, the system's control scheme can be changed without had severe operational limitations. data lists which are referred to by the standard programmes controlling the plant; any adjustments to the control scheme are made by merely altering the data appropriately.

Each CP6 system also makes full provision for the need to revert to manual operation in fault conditions. The operator can display measured process values (selected by rotary switches) and raise or lower control valve positions. Should a failure occur, the computer is automatically isolated from the plant and control passes to the standby panel, the control valves retaining the previously correct position.

Further details from Ferranti Limited, Automation Systems Division, Simonsway, Wythenshawe, Manchester.

BOOK REVIEWS

REVIEWERS:
Brian Chapman
Jan Vernon

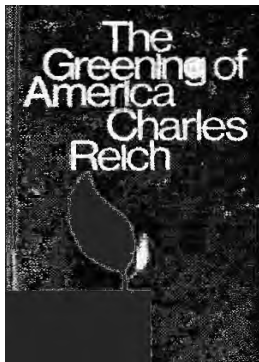

PLAN FOR A NEW SOCIETY

THE GREENING OF AMERICA, by Charles A. Reich, published by Allen Lane, The Penguin Press, London, and Random House Inc. New York. Hardback, 294 pages, price, £2.50 (hardback), 40p (paperback). Our copy was supplied by the publishers.

The Greening of America is an optimistic book about American society.

The author sees the youth revolution as the forerunner of a complete change of society. The youth of today, he says, are a new type of people with different values, emotions, philosophy – a different consciousness. (Reich uses the term consciousness throughout the book to mean the way of life and thought of a person or a society.)

Reich describes the history of American society through several eras of consciousness.

Consciousness I is the traditional outlook of the American farmer, small businessman and worker who is trying to get ahead. Consciousness II represents the values of an organizational society. Consciousness III is the new generation.

American society at present contains examples of each type of Consciousness but Consciousness II predominates. Consciousness II people are tremendously concerned with one another's comparative status; they speak of others in terms of their abilities or lack of abilities. They believe that the individual should do his best to fit himself into a function that is needed by society – subordinating himself to the requirements of the occupation or institution that he has chosen.

Both Consciousness I and II see life as a fiercely competitive struggle for success, whereas Consciousness III postulates the absolute worth of every human being – every self.

Much of Reich's criticism of current society is aimed at the corporate status – the vast impersonal organisations of government and commerce that are dominated by technology – whose goal is progress regardless of human needs. Therefore, streams are polluted, forests are cut down, a pointless Asian war is maintained, all with no reference to the needs or the wishes of the people.

The corporate state, says Reich, is an immensely powerful machine, ordered, legalistic, rational, yet utterly out of human control, wholly and perfectly indifferent to any human values. In fact, the corporate state only has one value – the value of technology – organisation – efficiency – growth – progress. The man in the executive suite – the place from which power hungry men seem to rule our society, does not run the machine – he *tends* it.

Reich is far from an anti-technologist – nor does he advocate return to nature. He points out the extent to which technology is used by today's youth. Light motorbikes for camping and trail riding electronic equipment for music and light shows, pills for safe sex.

Consciousness III, in fact, is the product of two interacting forces: the promise of life that is made to young Americans by society is affluence technology, liberation and ideals; and the threat to that

promise, posed by everything from neon ugliness and boring jobs, to the Vietnam war and the shadow of nuclear holocaust. The new people feel that if machines can take care of our material wants, then why should not man develop the aesthetic and spiritual side of his nature.

Many reviewers have felt that this is a flaw in Reich's argument; sooner or later machines break down – will there be workers to repair them? But Reich is not concerned about this. Most employers refuse to believe it, but generally people *want to work – if they can see their work as meaningful* – Consciousness III people, with their awareness of others' needs, would presumably find ways of working to keep their society going.

Reich most often quotes the philosopher Marcuse and the novels of Kurt Vonnegut and Ken Kesey. Conspicuous by their absence are any quotes from economic theorists, (yet of Reich's book, J. K. Galbraith says, "His social evidence and interpretations are wide-ranging; his conclusions well beyond my imagination – or courage".) Almost always, says Reich, men have lived subject to rigid custom, to religion, to an economic theory or political ideology. Consciousness III seeks freedom from all of these. It declares that *life* is prior to all of them. Consciousness III sees the world as a community.

Whether or not Reich's theory is supported, must depend on ones own beliefs about human nature. Reich's own is optimistic – at present he says, the individual has been systematically stripped of his imagination, his creativity, his heritage, his dreams and his personal uniqueness in order to style him into a productive unit for the mass technological society.

Consciousness III could only have come into existence given today's technology: Only Consciousness III can make possible the continued survival of man as a species in this age of technology. Read this book. – J.V.

"ABCs of Infra Red" by Burton Bernard. Published by W. Foulsham & Co. Ltd., 1971. 144 pages 8! x 5-h hard covers. Price £1.40.

"The infra red spectrum was discovered 170 years ago but very little technical progress took place in the field for the first 130 years".

"The Second World War renewed interest in the infra-red spectrum, and rapid advances in the state of the art have taken place". "Today, infra-red techniques are commonplace in domestic, industrial, military, medical, and space applications".

This introduction to the book is given by the author in the preface, and exemplifies how many discoveries, made decades, and in some cases, centuries ago, have only recently found useful application. The reason for this is that it is one thing to know what needs to be done, but quite another to develop the tools and technology to do it.

The first four chapters of the book deal with the history of infra-red, the laws and principles of electromagnetic radiation, infra-red sources and infra-red detectors.

Chapters 5 and 6 deal with practical instrumentation and systems based on the previously developed theory. Data is included on such topics as infra-red thermometers, spectrometers, communications, temperature measurement and control, gas analysers, etc.

Chapter 7 provides a further treatment of infra-red applications in astronomy, space technology, ecology, fishing, air pollution, criminology and the study of oil paintings – a fascinating and varied cross-section.

Each chapter is followed by a series of questions designed to consolidate the reader's understanding of the subject matter. Answers to questions are provided in an appendix, and an index provides quick access to the appropriate text.

Mathematical equations are provided wherever necessary, but the text is not obscured by mathematics and can, therefore, still be understood even if the sums are passed over.

The text is well written and adequately illustrated and the book provides a well rounded coverage of the topic for those who are interested in the field. – B.C.

BOOK REVIEWS cont....

TRANSISTOR AUDIO AMPLIFIERS by P. Tharma. Published 1971 by Iliffe Books, London. • Hard covers; 413 pages 8 1/2 x 5 1/2. Published 1971 by Butterworth Group, London. Hard covers, 413 pages. Price £6.00.

This book presents the various aspects of the design of audio amplifier and is based on the work done by the audio application group of the Mullard Central Application Laboratory.

The first two chapters deal with transistor characteristics. Chapters 3 to 10 consider the various aspects of circuit design and measurements. In chapters 11 to 16 various applications are considered and circuits given to illustrate the design principles.

All necessary mathematical formulae and graphical diagrams are included at a level that is adequate for the majority of engineering design purposes. Although the mathematical treatment may be beyond the hobbyist, the remainder of the text is very practical.

The text is profusely illustrated with 245 diagrams including many circuits designed by Mullard for general use. All component values are given and each circuit is discussed fully. The advantages and disadvantages of various circuit arrangements are discussed in a manner which give the reader insight into the reasons for using particular configurations.

Many ancillary factors are discussed which results in a well rounded treatment of the subject. Such topics as distortion, amplifiers for high fidelity, public address systems and radiograms together with circuits for tape recorders hearing aids and power supplies are also included.

The final chapter briefly discusses the integrated circuit audio amplifier chips now coming onto the market in greater profusion.

In all a good book for the technician or engineer but too advanced for the beginner. – B.C.

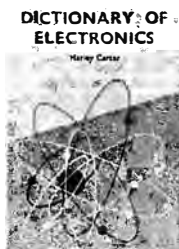

DICTIONARY OF ELECTRONICS by Harley Carter. "Dictionary of Electronics" - Published by Butterworth Group, London. Hard covers, 410 pages. Price £1.75

Over the last two decades the field of electronics has expanded at such an explosive rate that even those who are very proficient in a particular area may be totally unaware of significant details of other areas. Hence the relevance of a dictionary of electronics.

The fulfillment of this need however is attended by certain difficulties. Foremost amongst these must be the problem of keeping such a publication up to date.

This present dictionary has overcome this problem to some degree by reprinting every two years with an expanded addenda section. But even with this we find that in some areas there is no, or at least insufficient coverage. For example nowhere can any reference be found to the various types of integrated logic, although there are references to AND/OR, NAND/NOR gates. This sort of deficiency however is really inevitable, due, as was said before, to the rapid expansion of the field.

Apart from the above criticism the dictionary does provide an excellent reference facility. Whilst the average reference is dealt with in about 30 or 40 words, wherever there is a need the explanation may run to a full page or more. Graphs, drawings and circuit diagrams are all included where necessary to further clarify the written description. The text itself has been carefully written to convey all the necessary facts in the briefest possible way without sacrifice of clarity. Good value. – B.C.

"ABCs of Integrated Circuits" by Rufus P. Turner, Ph.D. Published by Foulsham-Sams Technical Books, England 1971. 96 pages 8 1/2 x 5 1/2, hard covers. Price £1.25.

Few people can now be unaware of the impact on modern living that the development of solid state devices such as the transistor has made. Without the transistor our computer, space age would not be possible.

Less well-known, is the impact of integrated circuits. These devices combine in one 14 or 16 pin case, measuring approximately one inch long by three-eighths of an inch wide, up to several hundred transistors and their associated resistors and capacitors (all in solid state form). ICs, as they are commonly known, are increasing in complexity every day and it is possible to buy such things as dual differential amplifier, 4096 bit random access memories, phased locked loop and complete TV detector, audio output stages, all complete in the one chip and only requiring a few extra components and power supplies to perform the desired function.

An example of the cost reduction effectiveness of these devices is that of the latest generation of small computers. These machines costing approx. \$30,000 occupy about 9 inches in height of a standard 19" rack and have the same capabilities as discrete component machines of 10 years ago which were housed in approximately three full 6' high 19" racks and which bore price tags of \$200,000 or more.

Yet another example of the impact of ICs is in the space industry. The accuracy and precision required for the Apollo moon landings can only be obtained by enormous electronic complexity. Several computers are required for the various functions of launch guidance, space navigation, spacecraft housekeeping and lunar landing control, etc. With discrete components the equipment weight would be prohibitive. Here the extra functional packaging density is of utmost importance.

So much for the areas of science and computation, but additionally, ICs are now invading the domestic scene and they are unobtrusively finding their way into the most seemingly unlikely applications such as washing machine control. As unit prices continue to come down and chip complexity increases we can expect to see ICs take over more and more applications which have been traditionally mechanical.

As well as offering increased reliability the new solid state controls will offer increased versatility and by their unified black box construction, dramatically reduce prices of the equipment to which they are applied.

All technicians should note, therefore, that it is imperative to gain a good working knowledge of the operation and application of these devices as the revolution will be in many ways more far reaching than that engendered by the change over from valves to transistors.

At every technological change some people inevitably find themselves, if not redundant, relegated to a lower income bracket. Remember radio mechanics were 30 years ago highly paid and eagerly sought after people. Now it is just another not-too-well paid trade. So be warned – keep moving with times or you will be left behind.

This book offers a simple introduction to the integrated circuits of one of the two main families of devices. These families are:—

1. Linear: Where the output of the circuit is proportional to the input and usually varies linearly with the input.
2. Digital: Where the output has only two stable states dependant on the input level and the built-in logic function.

Although digital ICs are described briefly, the main accent of the book is on the linear devices which are finding increasing application as operational amplifiers, IF amplifiers, modulators, video amplifier, voltage comparator and voltage regulator, to mention just a few.

The text is well written in simple unmathematical terms and is ideally suited to the needs of technicians who wish to improve their scope or to the electronic hobbyist who wants to use these devices in his projects. Many typical applications are provided under the general headings of Amplifier, Oscillators, Controls, Communications, Test Instrument and Supplementary Applications.

Well worth the modest outlay. – B.C.

TECH-TIPS

PULSE COUNT TO SPEED CONVERTER

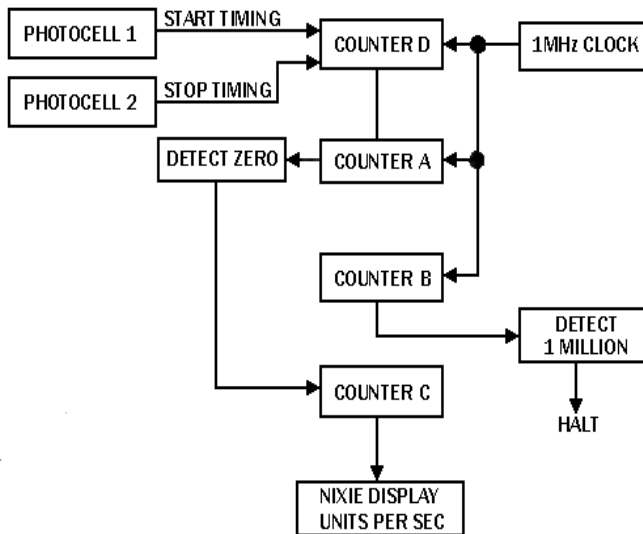

A customary way to find the speed of an object is to measure the time it takes to go between two points. In applications from traffic intersection control to laser beam projectile tracking, this kind of measurement is made by a pair of spaced photocells that start and stop counting of a known timebase.

A disadvantage of this method is that the counter measures elapsed time, not speed. To obtain a speed measurement, the reciprocal of the pulse count must be determined. This involves division, and when BCD quantities are involved, arithmetic dividers can require a lot of hardware.

A system has been designed using logic modules to employ a simple serial counting technique that forms a four-BCD digit conversion of a 16-bit binary count in about one second. Using a one MHz clock, the circuit provides speed readout in "units per second" where the unit is the distance between the photocell sensors. Thus, if the photocells are one yard apart, the readout is in yards per second. A negative pulse from the first photocell enables counter D to accumulate 1MHz clock pulses. Counting continues until a negative pulse from the second photocell disables the counter. The information in counter D is then jammed into counter A, which is counted down on each clock pulse, while counter B is counted up. When counter A reaches 0, counter C is incremented and counter D is again jammed into counter A. Counter A again counts down, while counter B continues to count up with counter C incrementing each time counter A reaches 0. The process continues until counter B reaches one million. At this time counter C and the Nixies hold the final answer. The logic in effect determines the number of times the accumulated count can be divided into one million. Since counter C counts in BCD, a decimal answer is displayed on the Nixie indicators.

Many duration-to-speed applications are obvious, and the same conversion system can be employed whenever reciprocal relationships must be determined: photometrics; automatic photo processing equipment, etc.

From Hewlett-Packard News Sheet

CAREER OPPORTUNITIES

EMPLOYERS - Seeking Staff? Electronics Today is read by the very people you seek! (and our copy deadline is only 10 days). Managers, Engineers, Technicians, Draftsmen, Salesmen, etc. You already have a good job but seek a better one. Here they are.

ELECTRONIC DESIGN Location NEW FOREST

Racal Thermionic is located on the fringe of the New Forest and Southampton Water which provides a stimulating living and working environment with short Journeys to work and excellent recreational facilities.

The Company, an expanding member of the world-wide Racal Group, is involved in the design and manufacture of Europe's widest range of quality Data Recording equipment. We now seek the following design personnel capable of contributing to the future growth and prosperity of the company.

SENIOR PROJECT ENGINEERS

Capable of accepting responsibility for major new recording system design projects. Degree or HND with several years' experience of developing industrial products in the electronic or electro-mechanical field.

SENIOR ELECTRONIC ENGINEERS

Capable of sophisticated circuit design in the linear field, but knowledge of control systems and some experience of mechanical design problems an advantage. Degree or HND, with several years' design experience.

SENIOR MECHANICAL ENGINEERS

Capable of advanced mechanical design in the precision light engineering field. An appreciation of electronic principles is desirable but not essential. Degree or HND, with several years' design experience.

ELECTRONIC/ELECTROMECHANICAL ENGINEERS

Vacancies exist for engineers capable of contributing to the design and packaging of electronic and electromechanical products. Degree or HNC, with a few years' industrial design experience.

Commencing salaries are up to £2500, plus a first class superannuation and life assurance scheme.

Please apply:-
The Technical Director
Racal Thermionic Limited
Shore Road
Hythe
Southampton
Hythe 3265

RACAL
The Electronics Group

CAREER OPPORTUNITIES

Electronic Engineers

Bradley Electronics, a member of the Joseph Lucas organisations has two vacancies for qualified engineers to work on the development of digital voltmeters, counters and related equipment.

The successful applicant for the first vacancy will have about eight years appropriate post graduate experience, with at least three years in a senior position.

The second vacancy is for an engineer with about four years relevant post graduate experience in electronic circuit design.

These appointments offer realistic salaries with conditions of employment associated with an international organisation.

Please apply with full details of training and industrial experience to The Personnel Manager, G. & E. Bradley Limited, Neasden Lane, London, NW10 1 RR

**BRADLEY
ELECTRONICS**

Design Engineer

An experienced designer is required for the development of a range of instruments for the Telecommunications Industry. A knowledge of Linear i.e. amplifiers, and an ability to translate requirements into effective and economical designs suitable for quantity production, are essential. While the work is mainly in the audio/video field, a knowledge of h.f. techniques would be an advantage.

The successful applicant who is expected to be between 27 and 35 will receive an attractive salary, LV.s. four weeks' holiday, and be eligible for the Company's Superannuation scheme.

Apply with details of experience to Chief Engineer.

Sales Engineer

Due to promotion within the Company, a vacancy exists for a Sales Engineer to work in the West of England based on the Bristol area. He must have a good background of selling electronic equipment and be prepared to visit a wide range of customers from Universities to Production Plants. We are looking for a keen engineer around 30 years of age with reasonably broad experience. Our product range includes Automatic Test Equipment, Distance and Vibration Monitors as well as the best a.c. bridge range in the World. The successful applicant must be prepared to work hard and will be rewarded accordingly. Apply with details of experience to General Sales Manager, The Wayne Kerr 1 Company Ltd., Tolworth Close, Tolworth, Surbiton, Surrey KT6 7ER

For more information on the Careers Opportunity Columns of Electronics Today International (Advertising rate 75p per line)

contact :-Donn Donovan

01-3531040

COPYRIGHT-ALL RIGHTS RESERVED

Devices or circuits illustrated or described in ELECTRONICS TODAY INTERNATIONAL may be the subject of patent protection. Information is given without prejudice to patent rights and without responsibility for any circumstances arising from its application.

ELECTRONICS TODAY INTERNATIONAL'S product tests are unless otherwise stated-performed by our independent testing consultants, whose name will be supplied on request. No product test, or part thereof, may be reproduced for any purpose without the written authorisation of the Editor.

TECH-TIPS

BOOSTING VR TUBES

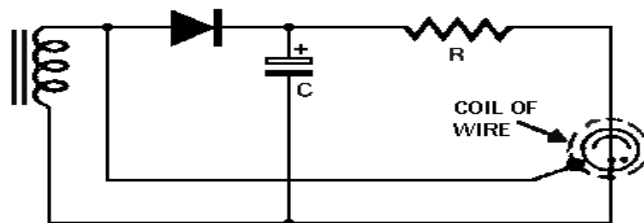

In some applications, VR tubes prove reluctant starters. This can often be overcome by wrapping a coil of insulated wire around the tube and then connecting it to the high voltage ac side of the supply. This circuit is particularly useful when a number of VR are to be operated in parallel.

DIODE CHECKER

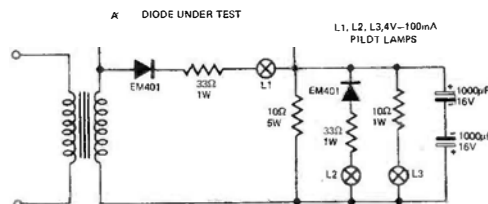

A simple unit for checking diode condition is shown above. The diode to be checked is connected across the points shown as A and K (observing the polarity indicated). If the diode is functioning correctly, both lamps will light; if the diode is shorted, lamp L2 will light; if the diode is open circuit, Lamp L 1 will light.

TRANSISTOR PRODUCT DETECTOR

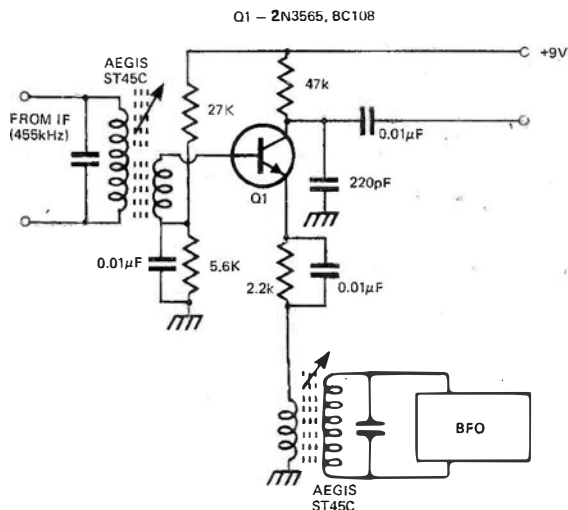

An excellent product detector can be assembled from locally available IF transformers and a few other components.

The circuit shown here is simple to construct, and non-critical in operation. Several volts of RF should be available at the emitter of Q1. The BFO may be any conventional circuit providing the required stability and output.

READER INFORMATION SERVICE

for further information on Suppliers listed below, complete the coupon/s stating information required, including company and position held (if relevant). Cut out the coupon and post to:

ELECTRONICS TODAY INTERNATIONAL, 107 Fleet St., London, EC4

ADVERTISERS	Page No.
Alabaster Passmore & Sons	86
Antex	52
Bull, J.	4
B.I.E.T.	87
Crescent Radio	76
Electrovalve	88
EMI	19
Ferroglyph	48
Semiconductor Supplies	2
Sinclair Radionics	10, 11

EDITORIAL

Ampex	74
Ancom	73
Aveley Electric	76
Avo International	75
Bell & Howell	74
East Midland Instrument Co.	74
EMI	73
English Electric Valve Co.	75
Environment Equipments	74
Ferranti	74
Gemco Electronics	75
Marconi Instruments	74
Micaply International	75
Racal Instruments	73
Seaelectro	75, 76
Sydney S. Bird	75

Four reply coupons are provided here for your convenience. Please list only ONE supplier and ONE product on each coupon. If you require information on more than four individual products, make as many copies of the coupons as you like preferably typed again using one coupon form for each product.

Send to **ELECTRONICS TODAY INTERNATIONAL, 107 Fleet St., London, EC4.**

ADVERTISER.....
 PRODUCT.....
 NAME.....
 ADDRESS.....
 COMPANY.....
 POSITION.....

4:72

Send to **ELECTRONICS TODAY INTERNATIONAL, 107 Fleet St., London, EC4.**

ADVERTISER.....
 PRODUCT.....
 NAME.....
 ADDRESS.....
 COMPANY.....
 POSITION.....

4:72

Send to **ELECTRONICS TODAY INTERNATIONAL, 107 Fleet St., London, EC4.**

ADVERTISER.....
 PRODUCT.....
 NAME.....
 ADDRESS.....
 COMPANY.....
 POSITION.....

4:72

Send to **ELECTRONICS TODAY INTERNATIONAL, 107 Fleet St., London, EC4.**

ADVERTISER.....
 PRODUCT.....
 NAME.....
 ADDRESS.....
 COMPANY.....
 POSITION.....

4:72

NEWSAGENT

Please deliver **ELECTRONICS TODAY INTERNATIONAL** for 12 months, starting with the issue:

NAME

ADDRESS

GIVE THIS COUPON TO YOUR LOCAL NEWSAGENT

USE THIS COUPON



**costs
no
more
delivered
to your
door..**

by your local newsagent

For only £2.40 a year (12 issues at 20p each) you ensure that every copy of **ELECTRONICS TODAY INTERNATIONAL** will arrive on your doorstep as soon as it is published - and that you'll never miss out on it if an issue happens to sell out.

electronics
TODAY
INTERNATIONAL



Alabaster Passmore & Sons Ltd

33 Chancery Lane, London WC2A 1ES

Telephone 01-405 3251

and

Tovil Printing Works, Maidstone

Telephone Maidstone 55361

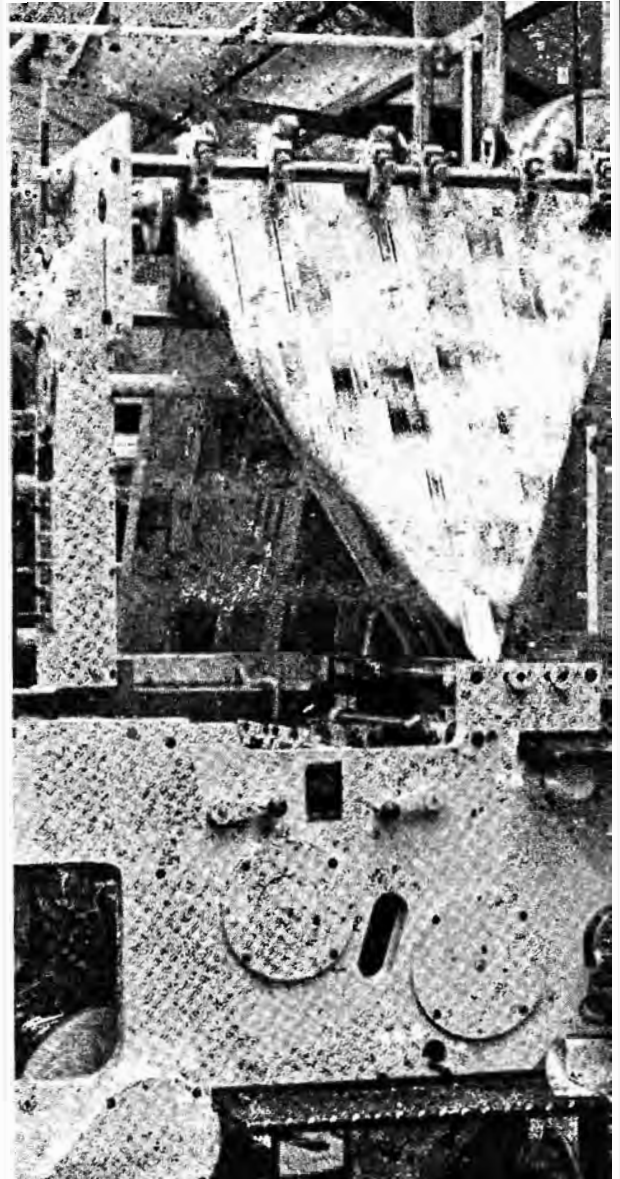

Printers of

ELECTRONICS TODAY INTERNATIONAL

on their 1972 Albert Web Offset press

Colour work on one of their

Roland 4-colour presses

In just 2 minutes, find out how you can qualify for promotion or a better job in Engineering . . .

That's how long it will take you to fill in the coupon below. Mail it to B.I.E.T. and we'll send you full details and a free book. B.I.E.T. has successfully trained *thousands* of men at home—equipped them for higher pay and better, more interesting jobs. We can do as much for YOU. A low-cost B.I.E.T. Home Study Course gets results fast—makes learning easier and something you look forward to. If you'd like to know how just a few hours a week of your spare time, doing something constructive and enjoyable, could put you out in front, post the coupon today. No obligation.

WHICH SUBJECT WOULD INTEREST YOU?

Mechanical
A.M.S.E. (Mech.)
Inst. of Engineers
Mechanical Eng.
Maintenance Eng.
Welding
General Diesel Eng.
Sheet Metal Work
Eng. Inspection
Eng. Metallurgy
C. & G. Eng. Crafts
C. & G. Fabrication

Draughtsmanship
A.M.I.E.D.
Gen. Draughtsmanship
Die & Press Tools
Elec. Draughtsmanship
Jig & Tool Design
Design of Elec. Machines
Technical Drawing
Building

Electrical & Electronic
A.M.S.E. (Elec.)
C. & G. Elec. Eng.
General Elec. Eng.
Installations & Wiring
Electrical Maths.
Electrical Science
Computer Electronics
Electronic Eng.

Radio & Telecomms.
C. & G. Telecomms.
C. & G. Radio Servicing
Radio Amateur's Exam.
Radio Operators' Cert.
Radio & TV Engineering
Radio Servicing
Practical Television
TV Servicing
Colour TV
Practical Radio & Electronics (with kit)

Auto & Aero
A.M.I.M.I.
MAA/IMI Diploma
C. & G. Auto Eng.
General Auto Eng.
Motor Mechanics
A.R.B. Certs.
Gen. Aero Eng.

Management & Production
Computer Programming
Inst. of Marketing
A.C.W.A.
Works Management
Work Study
Production Eng.
Storekeeping
Estimating
Personnel Management
Quality Control
Electronic Data Processing
Numerical Control
Planning Engineering
Materials Handling
Operational Research
Metrication

Constructional
A.M.S.E. (Civ.)
C. & G. Structural
Road Engineering
Civil Engineering
Building
Air Conditioning
Heating & Ventilating
Carpentry & Joinery
Clerk of Works
Building Drawing
Surveying
Painting and Decorating
Architecture
Builder's Quantities

General
C.E.I.
Petroleum Tech.
Practical Maths.
Refrigerator Servicing
Rubber Technology
Sales Engineer
Timber Trade
Farm Science
Agricultural Eng.
General Plastics

General Certificate of Education
Choose from 58 'O' and 'A' Level subjects including:
English
Chemistry
General Science
Geology
Physics
Mathematics
Technical Drawing
French
German
Russian
Spanish
Biology
B.I.E.T. and its associated schools have recorded well over 10,000 G.C.E. successes at 'O' and 'A' level.
WE COVER A WIDE RANGE OF TECHNICAL AND PROFESSIONAL EXAMINATIONS.

Over 3,000 of our Students have obtained City & Guilds Certificates. Thousands of other exam successes.

THEY DID IT—SO COULD YOU

“My income has almost trebled . . . my life is fuller and happier.” – Case History G/321.

“In addition to having my salary doubled, my future is assured.” – Case History H/493.

“Completing your Course meant going from a job I detested to a job I love.” – Case History B/461.

FIND OUT FOR YOURSELF

These letters—and there are many more on file at Aldermaston Court—speak of the rewards that come to the man who has given himself the specialised know-how employers seek. There's no surer way of getting ahead or of opening up new opportunities for yourself. It will cost you a stamp to find out how we can help you.

Free!

Why not do the thing that really interest you? Without losing a day's pay, you could quietly turn yourself into something of an expert. Complete the coupon (or write if you prefer not to cut the page). We'll send you full details and a FREE illustrated book. No obligation and nobody will call on you . . . but it could be the best thing you ever did.

BRITISH INSTITUTE OF ENGINEERING TECHNOLOGY

Dept. B28, Aldermaston Court, Reading RG7 4PF.

Accredited by the Council for the Accreditation of Correspondence Colleges.



Write if you prefer not to cut this page.

POST THIS COUPON TODAY

To: B.I.E.T., Dept. B28, Aldermaston Court, Reading RG7 4PF
Please send me book and details of your Courses in

Name

BLOCK CAPITALS PLEASE

Address

Subject of Interest..... Age

NATION WIDE SERVICES + ATTRACTIVE DISCOUNTS

Everything brand new and to spec. No surplus, 'seconds' or surplus lines

ELECTROVALUE

ELECTRONIC COMPONENT SPECIALISTS



Minitron DIGITAL INDICATOR TYPE 3015F

Seven segment indicator compatible with standard logic modules and power supplies. Figs 0-9 from combinations of well illuminated filament segments to give character height of 9mm plus decimal point. Power requirement 8mA from 5v d.c. per segment. A limited number of alphabetical symbols also available. In 16 lead dual case **£2.00**

Suitable BCD decoder driver type FLL121T **£1.45** DIL Socket: 16 lead **30p.**
Alternative type No. 3015G showing + or — and fig. 1 and decimal point

RIVLIN PRECISION RESISTORS 0.1 - 0.01% TOLERANCE

Prices and details on request.
Example—values under 100K **£1—2.**

RESISTORS—10%, 5%, 2%

Code	Power	Tolerance	Range	Values available	1 to 9 (see note below)	10 to 99	100 up
C	1/20W	5%	82 Ω - 220K Ω	E12	9	8	7
C	1/8W	10%	4.7 Ω - 470K Ω	E24	1	0.8	0.7
C	1/4W	10%	4.7 Ω - 10M Ω	E12	1	0.8	0.7
C	1/2W	5%	4.7 Ω - 10M Ω	E24	1-2	1	1-9
C	1W	10%	4.7 Ω - 10M Ω	E12	2.5	2	2
MO	1/2W	2%	10 Ω - 1M Ω	E24	4	3.5	3
WW	1W	10% ± 1/20 Ω	0.22 Ω - 3.9 Ω	E12	7	7	6
WW	3W	5%	12 Ω - 10K Ω	E12	7	7	6
WW	7W	5%	12 Ω - 10K Ω	E12	9	9	8

Codes: C = carbon film, high stability, low noise. MO = metal oxide, Electroisol TRS, ultra low noise. WW = wire wound, Plessey.
E12 denotes series: 10, 12, 15, 18, 22, 27, 33, 39, 47, 56, 68, 82 and their decades.
E24 denotes series: as E12 plus 11, 13, 16, 20, 24, 30, 36, 43, 51, 62, 75, 91 and their decades.
Prices are in pence each for quantities of the same ohmic value and power rating. NOT mixed values. (Ignore fractions on total value of resistor order.)

SOLDERSTAT SOLDER IRON



Type HMS, 16 or 24 watt, AC mains. We are appointed distributors for the whole range of these fine irons by Elremco-Wolf. Type HMS. **£1.70**

CAPACITORS

SIEMENS 5% POLYCARBONATES

250V up to 0.1mF; 100V 0.1mF and above
0.01, 0.012, 0.015, 0.018, 0.022, 0.027 ... 5p
0.033, 0.039, 0.045, 0.056, 0.068, 0.082, ... 5p
0.1, 0.12, 0.15, 0.18, 0.22 ... 4p
0.27, 7p; 0.33, 0.39, 9p; 0.47, 10p; 0.56, 13p; 0.68, 15p.

MULLARD polyester C280 series

250V 20%; 0.01, 0.022, 0.033, 0.047 3p each; 0.068, 0.1, 4p each; 0.15, 4p; 0.22, 5p, 10%; 0.33, 7p; 0.47, 8p; 0.68, 11p; 1μF, 14p; 1.5μF, 21p; 2.2μF, 24p.

MULLARD SUB-MIN ELECTROLYTICS C426 range, axial lead ... 6p each

Values (μF/V): 0.6/4; 1/4; 1.6/2.5; 2.5/1.6; 2.5/6.4; 4/10; 4/40; 5/6.4; 6.4/16; 6.4/25; 8/4; 8/40; 10/2.5; 10/16; 10/6.4; 12.5/2.5; 16/10; 16/40; 20/16; 20/6.4; 25/6.4; 25/2.5; 32/4; 32/10; 32/40; 32/6.4; 40/16; 40/2.5; 50/6.4; 50/2.5; 50/40; 64/4; 64/10; 80/2.5; 80/16; 80/25; 100/6.4; 125/4; 125/10; 125/16; 160/2.5; 200/6.4; 200/10; 250/4; 320/2.5; 320/6.4; 400/4; 500/2.5.

LARGE CAPACITORS

High ripple current types: 1000/25, 28p; 1000/50, 41p; 1000/100, 82p; 2000/25, 37p; 2000/50, 57p; 2000/100, £1.44; 2500/6.4, 77p; 2500/70, 98p; 5000/25, 62p; 5000/50, £1.10; 5000/100, £2.91.

SIEMENS POT CORES

In a range of types having air gaps from 1.0 mm. to zero at prices from 19p for cores and 14p for adjusting screw. Full details, see our catalogue.

CARBON TRACK POTENTIOMETERS, long spindles, Double wipers

SINGLE GANG linear 100Ω to 2.2M Ω, 12p; Single gang log, 4.7K Ω to 2.2M Ω, 12p; Dual gang linear 4.7K Ω to 2.2M Ω, 42p; Dual gang log, 4.7K Ω to 2.2M Ω, 42p; Log/antilog, 10K, 47K, 1M Ω only 42p; Dual antilog, 10K only, 42p. Any type with 2A D.P. mains switch, 12p extra.
Only decades of 10, 22 & 47 available in ranges quoted.

DUAL CONCENTRIC in any combination of above values, 60p; with switch, 72p.

CARBON SKELETON PRE-SETS

Small high quality, type PR, linear only: 100Ω, 220Ω, 470Ω, 1K, 2K, 4K, 10K, 22K, 47K, 100K, 220K, 470K, 1M, 2M, 5M, 10M Ω. Vertical or horizontal mounting, 5p each.

ZENER DIODES 5p full range E24 values:

400mV; 2.7V to 36V, 15p each; 1V; 6.8V, to 82V, 27p each; 1.5V; 4.7V to 75V, 60p each.
Clip to increase 1.5V rating to 3 watts (type 266F), 4p.

10W/15Ω BAXANDALL SPEAKER

As originally designed by P. J. Baxandall and described in Wireless World. 10 watt/15 ohm loudspeaker with equaliser network speaker unit and specially designed cabinet in kit form. Size when built: approx. 18" x 12" x 10". Price, inc. carriage paid in U.K. **£13.90**

COMPONENT DISCOUNTS

Not allowed on net price items
10% on orders for components for £5 or more.
15% on orders for components for £15 or more.
Prices subject to alteration without prior notice.

MISCELLANEOUS ITEMS FROM OUR CATALOGUE

30W BAILEY AMP. PARTS Transistors and PCB for one channel ... £6.46 Rs and Cs for one channel £1.95 Power Supply Kit (Unreg.)

MAIN LINE AMP. KITS

70 watt power amp module kit ... £12.68 nett Power supply kit ... £6.00 nett Matching pre-amp kit ... £3.30 nett (Above prices for mono.) Stereo Kit, 2 power amps, pre-amp kit, power supply and matched controls for building into your own cabinet £38.40 nett

LIGHT DEPENDENT RESISTORS

Cadmium Sulphide type TPMD (enval. ORP.12), 40p.

ENAMELLED COPPER WIRE

Even No. SWG only: 2 oz. reels: 16-22 SWG 25p; 24-30 SWG 30p; 32, 34 SWG 35p; 36-40 SWG 35p; 4 oz. reels: 16-22 SWG only 41p.

S-Dac £1.44, Four pack £5.10. DecSTOR pack £2.88. T-Dec may be temperature-cycled (208 points), £2.88. μDecA, £3.18. μDecB, £5.94. Also i.c. carriers.

THERMISTORS VAI039, VAI040, VAI055, VAI066, VAI077, CZ-6, KISI-1K, VAI100, 15p. R24, R53, £1.35.

HANDBOOK OF TRANSISTOR EQUIVALENTS 40p HANDBOOK OF TESTED TRANSISTOR CIRCUITS (M. Ness) 40p RADIO & ELECTRONICS. Colour-codes and data wall chart. 15p (Add 3p for each of above if bought separately.)

INSULATED SCREW TERMINALS in range of seven colours, each 12p Matching plugs 2mm each 5p 4mm each 7p

Plugs, sockets, hardware, Veroboard, edge connectors, switches, etc., in stock at keen prices.

APPOINTED DISTRIBUTORS FOR SIEMENS FINE PRODUCTS

TTL INTEGRATED CIRCUITS, CAPACITORS, THYRISTORS, RECTIFIERS, POT CORES, ETC.

SPECIAL TRANSISTOR OFFER SIEMENS 2N3055 POWER TYPE



with free insulating set. Tested and to spec. Special price, only **50p.**

THE ELECTROVALUE CATALOGUE

1972 Edition (No. 6)—our biggest yet—over 80 pages packed with bargains, information, diagrams, etc. Well printed and illustrated Post free. **10p**

COMPONENT DISCOUNTS

Not allowed on net price items
10% on orders for components for £5 or more.
15% on orders for components for £15 or more.

Prices subject to alteration without prior notice.

POSTAGE AND PACKING

FREE on orders over £2. Please add 10p if orders under £2. Overseas orders welcome: carriage and insurance charged at cost. U.S.A. CUSTOMERS are recommended to contact ELECTRO-VALUE AMERICA, P.O. Box 27, Swarthmore PA 19081.

SEMI-CONDUCTORS

Brand new, guaranteed to spec. No seconds or surplus.

1B40K10	175p	2N2925	22p	2N6163	25p	AD142	50p	BC149	10p	BF167	18p	NKT212	25p
1N914	5p	2N2926	11p	2N5172	18p	AD149	50p	BC153	18p	BF173	19p	NKT213	25p
1N316	10p	2N3053	27p	2N6192	125p	AD150	50p	BC164	30p	BF177	25p	NKT214	25p
1N125A	34p	2N3054	90p	2N5195	147p	AD161	35p	BC175	15p	BF178	14p	NKT217	21p
1N374	20p	2N3055	60p	2N5497	49p	AD162	35p	BC186	15p	BF194	14p	NKT261	21p
1N6399	21p	2N3326	55p	2N5459	48p	AD163/162	60p	BC159	12p	BF195	15p	NKT271	18p
1N6402	20p	2N3403	60p	40250	71p	AF114	24p	BC167	11p	BF244	30p	NKT274	18p
1N6407	40p	2N3663	82p	40261	80p	AF116	24p	BC168	10p	BF244	14p	NKT275	22p
1844	19p	2N3702	13p	40361	55p	AF118	22p	BC169	11p	BF255	15p	NKT403	20p
18940	5p	2N3703	13p	40362	55p	AF117	22p	BC170	14p	BF218	90p	NKT404	21p
2N696	17p	2N3704	13p	40406	78p	AF118	22p	BC178	15p	BFX29	31p	NKT405	21p
2N697	18p	2N3705	13p	40408	79p	AF124	24p	BC179	14p	BFX84	25p	NKT603F	30p
2N706	12p	2N3706	13p	40412	67p	AF125	24p	BC182L	21p	BFX85	32p	NKT613F	30p
2N900	21p	2N3707	13p	40430	140p	AF126	25p	BC1838	10p	BFX87	20p	NKT674F	24p
2N1131	20p	2N3708	19p	40492	185p	AF127	22p	BC184L	11p	BFX88	30p	NKT677F	25p
2N1132	20p	2N3709	14p	40521	180p	AF128	22p	BC185	75p	BFX89	30p	NKT713	25p
2N1302	19p	2N3710	13p	40802	68p	AF239	25p	BC212L	10p	BFY51	30p	NKT773	35p
2N1303	19p	2N3711	13p	40669	140p	AL102	77p	BC214L	18p	BFY52	20p	OA47	9p
2N1304	20p	2N3731	18p	AC107	40p	A8V26	27p	BC269	18p	BFY90	104p	OA90	9p
2N1305	20p	2N3794	15p	AC126	30p	ABY27	30p	BC267	9p	BRX20	10p	OA91	9p
2N1306	20p	2N3819	25p	AC137	29p	ABY28	27p	BC268	8p	BY164	45p	OA93	70p
2N1307	20p	2N3920	30p	AC138	30p	ABY29	30p	BC269	8p	BYE38	12p	OC200	9p
2N1308	30p	2N3904	35p	AC141H	34p	AU111	37p	BC267	17p	BYX38-300R	30p	OA292	10p
2N1309	30p	2N3908	37p	AC141H K	24p	BC268	37p	BC268	18p	BYX38-300R	30p	OC19	60p
2N1396	100p	2N4036	65p	AC142H	25p	BC269	35p	BC303/300	34p	C407	17p	OC25	42p
2N1699	125p	2N4058	65p	AC145H K	80p	BC300	40p	BC300	40p	C702	19p	OC28	70p
2N1613	20p	2N4126	50p	AC153K	30p	BC301	37p	BC312	27p	C1412	100p	OC29	70p
2N1711	80p	2N4060	11p	AC176	18p	BA102	22p	BC303	60p	E2512	184p	OC35	60p
2N1893	80p	2N4061	11p	AC176K	17p	BA130	22p	BC303	60p	EA403	10p	OC36	60p
2N2147	90p	2N4062	12p	AC187K	17p	BA145	27p	BCY31	75p	EA343	10p	OC41	40p
2N2218	30p	2N4124	25p	AC188K	80p	BA165	18p	BCY70	18p	EC461	184p	OC42	40p
2N2518A	44p	2N4226	27p	AC187K/188K	80p	BA175	15p	BCY71	30p	EA402	17p	OC44	40p
2N2518	20p	2N428	24p	AC192	40p	BA183	15p	BCY72	18p	ER900	54p	OC45	30p
2N2919A	55p	2N4286	15p	ACV17	31p	BB103/B	10p	BD121	100p	MJC140	85p	OC70	21p
2N2270	60p	2N4289	15p	ACV18	19p	BB103/G	10p	BD123	100p	MJ481	150p	OC71	20p
2N2389A	60p	2N4291	15p	ACV19	20p	BC107	12p	BD124	100p	MJ491	150p	OC72	20p
2N2483	20p	2N4292	15p	ACV20	20p	BC108	11p	BD125	100p	MJ371	100p	OC73	20p
2N2484	20p	2N4410	15p	ACV21	21p	BC109	11p	BD131	100p	MJ381	100p	OC81	20p
2N2546	47p	2N4443	11p	ACV22	21p	BC122	21p	BD132	80p	MJE265	185p	OC81P	20p
2N2904	30p	2N4906	30p	ACV39	18p	BC125	18p	BD133	80p	MJE265S	185p	OC83	20p
2N2904A	40p	2N4915	31p	ACV40	17p	BC136	22p	BD136	44p	MPF102	37p	OC84	20p
2N2905	40p	2N4991	61p	ACV41	18p	BC140	30p	BD141	30p	MRF884	30p	F345A	20p
2N2906A	47p	2N5002	91p	ACV44	18p	BC147	31p	BDY20	90p	MRF853H			