

Founded 1925

Incorporated
by Royal Charter 1961

To promote the advancement
of radio, electronics and kindred
subjects by the exchange of
information in these branches
of engineering

The Radio and Electronic Engineer

The Journal of the Institution of Electronic and Radio Engineers

NEWS AND COMMENTARY

Post Office Ambitions for Electronic Information

To the accompaniment of much self-congratulatory publicity, the Post Office has just announced that its viewdata service, Prestel, is available to residential customers in London. (The rental for suitable receivers will be about £24 per month.) Undeniably, the British-invented viewdata system, combining telephone and television to give the viewer access to a central computer information bank, represents a notable technical achievement which, so far, appears to be unrivalled anywhere else in the world, certainly not as a fully-engineered and publicly-available system.

The Post Office has all along set ambitious targets for itself and the television industry, and its investment, both past and projected, cannot be termed niggardly or cautious. The set makers have however expressed reservations about the initiation of a public service so soon and would have preferred it to be delayed until the Autumn when receiver production—which has brought hitherto unfamiliar digital technology into their factories—will be able to meet the expected demands. Until then a demonstration service in dealers' showrooms would be regarded by the industry as a more realistic objective.

The information currently stored in the PO computer in London is nearly 150,000 pages of 23 lines of 40 characters and it is being added to at a rate of 10,000 pages each month. The software necessary for linking this computer with those serving other centres—Birmingham, Manchester and Edinburgh are to be the next—has proved difficult to complete and progress lags here. The target for subscribers, both domestic and business, is 1,000,000 over the next five years: a category of user whose employer provides him with Prestel for work at home is seen as a significant area of expansion, probably superior to the 'private' home user. If utilization of Prestel expands as expected, one may wonder whether the saturation level of 200 simultaneous calls to a particular computer address is realistic, despite the Post Office's acknowledged familiarity with traffic loading on telephone exchanges, and skilful placing of computers at the centres of traffic.

Our welcome to Post Office enterprise in promoting this technically admirable service must therefore be linked with the hope that it will successfully navigate around the many obvious rocks in its path.

The Electronics Enthusiast

Those members who visit the Institution's offices and pass along nearby Tottenham Court Road regularly will surely share our amazement at the transformation in this short time of this one kilometre long, fairly typical West End shopping and commercial street into the 'electronics quarter' of London. There seem almost to be more retail outlets for 'hi-fi' equipment, portable radios and television, and, above all, electronic calculators and watches, than for all other trades put together.

Now we see establishments specializing in micro-computers and mini-computers and associated peripherals, mainly in-

tended for those wishing to construct systems for scientific or business applications but also for such purposes as games or entertainment. Elsewhere in London consumer-orientated exhibitions are now held regularly which feature electronic techniques and applications of a degree of sophistication that would have been considered 'professional' not very long ago.

'Do it yourself' is the phrase that describes the amateur employing professional techniques in the building or automobile engineering field: 'd.i.y. electronics' seems rather an inadequate term for the employment of Boolean algebra and microcircuit techniques for pleasure!

Space Satellite Count-down

Final adjustments are being made to UK6, the last in the *Ariel* series of scientific satellites, which is due to be launched from NASA's Flight Center at Wallops Island, Virginia, appropriately on Ascension Day, May 25th.

British Aerospace Dynamics Group at Bristol, under contract to Marconi Space & Defence Systems, have designed and built the satellite's structure and the mechanical ground support equipment.

The programme is financed by the Science Research Council, and a £4M contract was placed on the Council's behalf by the

MoD Procurement Executive; the RAE Farnborough is acting in a technical advisory capacity.

The UK6 mission will last two years and is to undertake investigations in the field of high energy astrophysics with three on-board experiments from the Universities of Bristol and Leicester and University College London.

Launch will be made using a NASA Scout vehicle which will place UK6 in a 600km circular orbit where it will circle the earth every 96 minutes. On achieving its operational orbit UK6 will, like its predecessors, be re-named *Ariel*.

Financial Support for Courses on Microprocessor Application

Proposals totalling £½M which will more than double the volume of microprocessor training available to industry in 1979, have been approved by the Department of Industry. Announcing this on January 25th, Mr Alan Williams, Minister of State for Industry, said:

'Since the Prime Minister's announcement on December 6 of the Government's commitment to a major programme to promote the application of microelectronics, the Department of Industry working in close conjunction with the National Computing Centre, has been stimulating major semiconductor manufacturers, universities, polytechnics, consultants and others to increase the amount of short courses on microelectronic systems for engineers from industry.

'The Microprocessor Applications Training Scheme provides up to 50% of development costs, including equipment costs. Proposals under the scheme already approved will in total more than double the volume of microprocessor training available to industry in 1979. Approved courses will be available in Bedford, Belfast, Birmingham, Brighton, Cranfield, Leeds, Liverpool, Reading, Southampton, Strathclyde and three centres in London. Courses should, in the future, become available at other regional centres.

'Funds committed so far total over £500,000 and proposals are on average being cleared within one month.

'The Department of Industry is at the same time supporting the development by the Open University of an awareness course for managers and a technical course for engineers. The Department is also commissioning a feasibility study of the use of Prestel as a medium for microelectronics training and is examining other possibilities to provide microprocessor training on a much larger scale over the next few years.

'Additional to this activity D.o.I is in close touch with the TUC, following their Industrial Strategy Conference at which delegates pointed to the critical need for greater training for existing engineers in microcircuit systems, to discuss how best the TUC can play a full role in the national awareness programme.'

The Institute of Energy

On 6th February 1979, at a meeting of Her Majesty's Privy Council, formal approval was given of the change of name of the Institute of Fuel to the Institute of Energy. The Designatory initials of its members have been changed to read F. Inst. E. and M. Inst. E. as appropriate.

The change of name signifies a positive shift of emphasis. Hitherto, although its members have been involved in all fields of energy, including alternative sources, the Institute has tended to be identified with conventional sources alone and with a natural bias towards fossil fuels. It is the intention of the Institute of Energy more visibly to be involved in the whole spectrum of energy, including, for example, nuclear energy, energy policy and energy management.

The Institute has 6,000 members, of whom approximately 5,000 work in the United Kingdom.

Business Survey of the British Electronic Components Industry

Yet another survey of the UK electronic components industry has been published, this time by Key Note Publications of Islington. The survey provides a concise overview of the industry's structure, market background, recent developments and future prospects. In addition recent major press references are listed, and a financial appraisal is given for the industry's major companies, together with salient ratios. Finally many sources of further information are identified, together with

names, addresses, and telephone numbers of people to contact. One table examines the financial performance of selected component companies. Among these EE Valves, EMI Electronics and AMP of Great Britain achieve the highest profit margins.

The UK market for electronic components in 1978 is estimated at £920 million, of which valves and tubes are thought to account for £135 million and audio components for £332 million. Electronic connectors are believed to be an £80 million market. The future for the UK at least lies in systems development rather than in components, according to the authors, since Britain's talents are more likely to prove successful here than in component production which is overwhelmingly in US and Japanese hands.

As a concise overview of the industry for market analysts, career masters, business executives, consultants and others the survey is useful and moderately priced at £12.25. Further information from R. W. Coghill, Key Note Publications Limited, 22 Danbury Street, London N1 8JU (Tel. 01-226 5269).

ECIF Seminar at 'Electronics 79'

The Electronic Components Industry Federation is to stage a four-day seminar during the 'Electronics 79' exhibition which is being held at Olympia, London from November 20th-23rd 1979.

The theme of the seminar will be 'Components of Assessed Quality—The Contribution of UK Industry' and it will include the presentation of papers covering related aspects of design, manufacture testing, inspection and usage. Each of the four days will be devoted to a particular subject: Electromechanical components, Passive components, Active components, and Microprocessors.

The ECIF now invites submission of 200-300 word abstracts of technical papers for consideration by the Sub-Committee. State-of-the-art review papers covering the four specialist areas will be especially welcome. Commercial bias should be avoided as far as possible.

Abstracts should be sent by not later than 14th May 1979 to: The Technical Secretary, Electronic Components Industry Federation, 7/8 Savile Row, London W1X 1AF (Tel. 01 437 4127). Authors of accepted abstracts will be notified by June 1st and the deadline for final manuscripts will be July 14th.

Computerized Public Payphones for Worldwide Dialling from the Moscow Olympics

Microcomputer-controlled public coinbox telephones for making calls to Europe and overseas are to be supplied to Russia by Standard Elektrik Lorenz (SEL), ITT's German telecommunications company, in time for the 1980 Moscow Olympic Games. SEL is to provide 117 of its type NT 2000 public payphones (originally developed for the German PTT), which feature pushbutton dialling, by the end of this year. The phones will be installed around Moscow at airports, railway stations and traffic junctions as well as in the Olympic complex.

A microcomputer in each phone calculates the cost of a call according to the country phoned and the length of the call. A lighted display shows the current credit and, at the end of a call, the caller can use up the balance on further calls. The heart of the NT 2000 is an m.o.s. 8-bit standard microprocessor with external read only memory and random access memory, which is capable of handling 300,000 instructions per second. The microcomputer handles all the logic, supervisory and control functions. For example, it registers the coins as they are inserted, pulses out the dialled numbers and constantly works out the credit and instructs the display to show the balance while the call is in progress.

CEI News

Annual Report for 1978

In his foreword to the Report, the Chairman Sir John Atwell suggests that the most significant event in 1978 was the grant of the CEI Supplemental Charter and By-Laws. These give the Council greater powers and a new constitution and therefore mark an important stage in the development of CEI. Of the principal changes arising from the grant of the Supplemental Charter and By-Laws perhaps the most important is that relating to individual membership of CEI, which is now the right of every Chartered Engineer.

Another important activity during the year was the response made to the Government Inquiry into the Engineering Profession (Finniston Committee). With the endorsement of the Officers and the Executive Committee the Chairman made a written submission to the Committee in May; separate submissions being made by the Engineers Registration Board and by the Fellowship of Engineering. Substantial support was given to the Finniston Committee by CEI through the series of meetings arranged by CEI branches throughout the country and in London at which engineers were given the opportunity of addressing members of the Committee.

A Chartered Engineers section has now been established within the Engineers Registration Board and a central register of Chartered Engineers is in operation. Five new Affiliates were elected to CEI during 1978 so bringing the total to seven. According to the figures given by the Engineers Registration Board the total Corporate membership of the 16 Corporation Members on 1st July 1978 was 218,515, an increase of 1135 over 1977 while the non-corporate membership at 121,722 had increased by 2874.

Branch activities have continued to flourish and the Chairman visited eleven of the 16 Branches during 1978.

Copies of the Annual Report, which also includes the accounts and balance sheet for the year, may be obtained from CEI, 2 Little Smith Street, London SW1P 3DL.

'Individual' Members Elected to CEI Board

The names of the 16 candidates who have been elected by individual Chartered Engineers to the Board of the Council of Engineering Institutions were announced at the Council's Annual General Meeting on 15th March. They are:-

Robert James CLAYTON, C.B.E., F.I.E.E., F.I.E.R.E., F.R.Ae.S., Technical Director GEC. (Age 62)

Ella Georgina DODD, F.I.Mech.E., F.I.E.E., Manager, Balancing & Machine Dynamics Department, C.A. Parsons Turbine Generators. (Age 52)

Dr Keith William Arthur GUY, M.I.Chem.E., Manager of Design Engineering, Air Products. (Age 34)

Martin Richard HANNEN, M.I.E.E., Engineer, Philips. (Age 30)

Air Marshal Sir Reginald Edward Wynyard HARLAND, K.B.E., C.B., F.R.Ae.S., F.I.Mech.E., F.I.E.E., Technical Director, W. S. Atkins & Partners. (Age 58)

Bryan HILDREW, C.B.E., F.I.Mech.E., F.I.Mar.E., Managing Director, Lloyd's Register of Shipping. (Age 58)

Peter Thomas HOULDCROFT, F.I.M., M.I.M.M., F.Weld.I., Director of Research, Welding Institute, Abington. (Age 55)

Sir Charles HUSBAND, F.I.C.E., F.I.Mech.E., F.I.Struct.E., Senior Partner, Husband & Co., Consulting Engineers. (Age 69)

Arthur Williams JACOMB, F.I.C.E., F.I.Mun.E., F.I.H.E., County Surveyor, Hampshire County Council. (Age 50)

Dr H. Peter JOST, C.B.E., F.I.Prod.E., F.I.Mech.E., Group Chairman & Managing Director, K. S. Paul Products. (Age 57)

Brigadier Tony Brian PALMER, M.I.Mech.E., Director of Electrical and Mechanical Engineering (O and T) REME. (Age 47)

Desmond Henry PITCHER, F.I.E.E., Managing Director Plessey Telecommunications International. (Age 43)

Derek Arthur Hugh ROBERTS, M.I.Gas.E., Training Officer, Mersey Area, North West Gas. (Age 43)

John Douglas SAMPSON, F.I.Mech.E., F.I.Mar.E., General Secretary, UKAPE. (Age 56)

Ernest Henry WAKEFIELD, F.I.C.E., F.I.H.E., Assistant County Surveyor (Design & Contracts), Berkshire County Council. (Age 44)

John Devereux WARD, C.B.E., F.I.C.E., F.I.Struct.E., Managing Director, Taylor Woodrow (Arcon). (Age 53)

The total number of valid ballot papers received was 26,921 which is 14% of the estimated number of those eligible to vote. There were 119 nominations for the 16 vacancies. The average age of the nominated candidates was 52 years, the average age of those elected is 51 years.

This election of Individual Members to the Board is the first to be carried out under the Supplemental Charter and By-Laws of the Council of Engineering Institutions which was granted in July 1978. The first meeting of the newly restructured Board was held at the Caxton Hall, London, on April 10th when the 'Individual Members' joined the CEI Officers, the nominees of the 16 professional engineering institutions which are 'Corporation Members' of the Council, the Chairmen of the three Sections of the Engineers Registration Board and the Chairman of the Standing Committee for Regional Affairs.

Personal Services Unit

Reference was made in the Journal last April to the establishment of a CEI Personal Services Unit. A consultant, Mr C. P. Morton, has now been appointed to study in detail the needs of the profession for personal services and the best way of meeting them.

Mr Morton expects to produce his final report by mid-September 1979, and his study will be carried out in two phases. Phase one will entail a broad investigation so that priorities may be determined. Phase two will comprise detailed evaluation of the higher priorities.

The main headings for consideration in the study are:-

- Statutory responsibility of members
- Career development
- Unions and pressure on members
- Register of retired members
- Employment contracts
- Financial services
- Information dissemination

The CEI Executive Secretary has invited the secretaries of CEI's Corporation and Affiliate Members and of those bodies which are members of the ERB's Technician Engineer and Technician Sections to express the views of their institutions on this topic.

Mr Morton would also like to hear from individual engineers of their own ideas on this subject, and IERE members are invited to write on this subject, as soon as possible, to: Mr C. P. Morton, c/o Public Affairs Unit, CEI, 2 Little Smith Street, London SW1P 3DL.

We have been asked to make it clear that, although CEI can guarantee that each letter will be read and considered, neither they nor Mr Morton can undertake to reply individually in the interests of economy in both money and time.

Forthcoming Institution Meetings

London

Friday, 11th May

JOINT IEE/IERE MEDICAL AND BIOLOGICAL ELECTRONICS GROUP

Colloquium on MINIATURE TRANSDUCERS FOR MULTI-PARAMETER CLINICAL DIAGNOSTICS

IEE, Savoy Place, London WC2, from where further information may be obtained.

Tuesday, 15th May

JOINT IERE/IEE MEDICAL AND BIOLOGICAL ELECTRONICS GROUP

Colloquium on STORAGE DEVICES FOR MEDICAL AND BIOLOGICAL SIGNAL ANALYSIS AND RECORDING

Royal Institution, Albemarle Street, London W1, 10.00 a.m.*

Tuesday, 5th June

COMMUNICATIONS GROUP IERE/RSGB

Colloquium on MICROWAVE COMMUNICATIONS IN THE AMATEUR SERVICE

Royal Institution, Albemarle Street, London W1, 10.00 a.m.*

Tuesday, 12th June

COMPONENTS AND CIRCUITS GROUP

Colloquium on PERIPHERAL COMPONENTS FOR MICRO-PROCESSORS

Royal Institution, Albemarle Street, London W1, 10.00 a.m.

Beds and Herts Section

Thursday, 26th April

ANNUAL GENERAL MEETING

followed by

Loudspeakers

By J. Akroyd (*Decca Radio and Television*)

Hatfield Polytechnic, 7 p.m. (Tea 6.45 p.m.)

Northern Ireland Section

Wednesday, 25th April

Electronic development in the automotive field

By R. Bird (*Lucas Electrical*)

Castlereagh College of Further Education, 7.00 p.m.

* Advance registration necessary. Further details from Colloquium Registrar, IERE.

North Western Section

Thursday, 26th April

Automobile electronics

By a lecturer from Rolls-Royce Bolton Institute of Technology, Deane Road, Bolton, Lancs 6.15 p.m. (Light refreshments available before lecture.)

Southern Section

Thursday, 26th April

Microcomputers and their applications

By H. Kornstein (*Intel Corporation*) Farnborough College of Technology, 7.00 p.m.

South Midland Section

Tuesday, 24th April

Some thoughts and experiments on audio topics

By P. J. Baxendall

followed by the

ANNUAL GENERAL MEETING

Carlton Hotel, Parabola Road, Cheltenham 7.00 p.m.

South Wales Section

Tuesday, 24th April

JOINT VISIT WITH INSTITUTE OF PHYSICS British Steel Corporation of Wales Research Laboratories, Port Talbot.

Tour of Instrumentation Laboratories from 3.00 p.m. to 5.00 p.m. (Tea 5.00 p.m.)

Lecture on Research Laboratory Function in British Steel Corporation, 6.00 p.m.

South Western Section

Wednesday, 25th April

JOINT MEETING WITH IEE

Impact of LSI on logic circuit design

By Professor D. W. Lewin (*Brunel University*)

The Canteen, Westinghouse Brake & Signal, Chippenham, 6.00 p.m. (Tea 5.30 p.m.)

Wednesday, 2nd May

JOINT MEETING WITH IEE

Digital television studios—when?

By J. Baldwin (*IBA*)

Chemistry Lecture Theatre No. 4, University of Bristol, 6.30 p.m. (Tea 6.00 p.m.)

Thames Valley Section

Tuesday, 8th May

ANNUAL GENERAL MEETING

followed by

Recent advances in frequency synthesis

By K. Thrower (*Racal Advanced Developments Division*)

Caversham Bridge Hotel, Reading, 7.30 p.m.

West Midland Section

Wednesday, 25th April

ANNUAL GENERAL MEETING

followed by **Quadraphonics**

By R. I. Collins and C. P. Daubney (*IBA*) Wolverhampton Polytechnic, 7.00 p.m. (Tea 6.30 p.m.)

Tuesday, 10th May

JOINT MEETING WITH RAES

Luminescence: the cold light phenomenon

By Dr. T. F. Palmer (*University of Nottingham*)

RAF Cosford, Albrighton, 7.15 p.m. (Tea 6.45 p.m.)

Yorkshire Section

Tuesday, 24th April

Conference on Microprocessing

CANCELLED

Thursday, 17th May

ANNUAL GENERAL MEETING

and Ladies Evening

YTV Studios, Leeds, 6.30 p.m.

Other than any special meetings which may be arranged during the Summer recess, this list completes the London and Local Sections Meetings Programmes for the Session 1978/79. Programme booklets for the Session 1979/80 will be sent to members in the respective areas in the Autumn.

Members' Appointments

CORPORATE MEMBERS

Dr A. D. Booth, D.Sc. (Fellow 1956) retired last summer from the post of President and Vice Chancellor of Lakehead University, Thunder Bay, Ontario. He moved to this new university in 1972 following 9 years as Dean of the College of Engineering at the University of Saskatchewan.

Many members will recall Dr Booth's contribution to the design and use of computers and notably in the field of magnetic storage techniques, when he was at Birkbeck College, University of London. In addition to having been Chairman of the Programme and Papers Committee, Dr Booth was first Chairman of the Computer Group Committee and he contributed to the special issue of the Journal on the occasion of the 25th anniversary of the



stored-program computer in 1975. Dr Booth served on the Council of the Institution from 1957 to 1962 and when he went to Canada he was active in the early years of the Canadian Division, serving as its Chairman, and he was also elected as one of the overseas Vice Presidents of the Council.

A prolific author of books and papers, Dr Booth is currently serving on several Advisory Committees, and he has set up a consultancy practice with his wife Dr Kathleen Booth, herself a well-known computer scientist, and his son, which will operate from their new home in Sooke, British Columbia.

S. H. Perry (Fellow 1975, Member 1952) who has been Quality Assurance Manager at Philips Croydon since 1970, has recently retired from this post and will leave the company



later in the year after a total of just over 40 years service. During this period he has been concerned almost wholly with the production of radio and television receivers, particularly from the quality assurance aspect.

Mr Perry has a considerable record of service to the Institution to his credit: he served on the Programme and Papers Committee from 1957 to 1962 and on the Membership Committee from 1967 to 1978. In addition he was a member of Conference Committees in 1967 and 1969 and he was for a year one of the joint examiners in the subject of Television for the Graduateship examination. He also took part in the deliberations of one of the CEI syllabus Study Groups as an IERE representative.

Sqn Ldr D. R. Ainge, RAF (Member 1963, Graduate 1967) has taken up the post of Officer Commanding Electrical Engineering Squadron, RAF St Mawgan. He was previously Senior Project Officer, Joint Trunk Communications, in the Radio Introduction Unit at the School of Signals, Blandford Camp.

G. P. Barton (Member 1970) has been appointed Head of External Planning and Works Division, Exeter Telephone Area of Post Office Telecommunications. He previously held an appointment as an Executive Engineer in the Bournemouth Area.

W. B. Bishop-Miller, B.A. (Member 1973, Graduate 1968) has been appointed Head of the Department of Electrical Engineering and Science at Barrow-in-Furness College of Further Education. He was previously Senior Lecturer in Computer Science at the London College of Printing.

D. E. C. Brown (Member 1973) who is with the BBC has been appointed Assistant Workshop Manager in the Equipment Department.

J. T. Crocker (Member 1969) is now Deputy General Manager of the Bedford Telephone Area, Post Office Telecommunications. He was previously Head of Maintenance in the Cardiff Telephone Area.

A. A. R. Edet (Member 1973, Graduate 1969) who has been with the Department of Posts and Telecommunications, Government of Nigeria, since 1958, has been promoted to Principal Engineer/Manager at Port Harcourt. From 1964 to 1969 Mr Edet was at Faraday House Engineering College, and subsequently at the Northern Polytechnic, London, from where he obtained the Diploma in Electronics and Communication Engineering.

A. Foord (Member 1973, Graduate 1964) has been promoted to Senior Scientific Officer at the Royal Signals and Radar Establishment, Malvern. He joined the Establishment in 1959 as a student apprentice and is currently working on systems and circuits for infra-red thermal imaging.

D. V. Foster (Member 1973) is now Head of Design and Development with Hunting Hivolt, Shoreham-by-Sea. From 1975 to 1978 he was Chief Engineer with Roband Electronics, Horley, Surrey.

M. J. Furniss (Member 1973, Graduate 1967), who joined British Rail in 1960, has been appointed a Principal Scientific Officer in the Research and Development Division, working on a microprocessor-based system of interlocking for railway signalling.

A. B. Hunt, B.A. (Member 1967) has been appointed Mechanical & Electrical Engineer with the Taff Division of the Welsh Water Authority. He was previously with the Morgannwg Division.

T. E. Hyde (Member 1974, Graduate 1967) is now Quality Planning Manager with the Electronic Switching Division of Plessey Telecommunications, Huyton. He joined the Company in 1974 as Head of the Quality Engineering Department.

H. Jackson, M.Sc. (Member 1973, Graduate 1970) has been appointed Head of the Computer Unit at Darlington College of Technology. He joined the College as a Lecturer II in 1971 following several years with the Army in a civilian capacity, initially with REME and subsequently as an instructor with the 8th Signal Regiment, Catterick Camp. He obtained his CNAA Master's Degree in Control Engineering in 1978 following studies at Sunderland Polytechnic, his dissertation being entitled 'Automatic tuning of a flow process controller'.

J. M. Keble (Member 1973, Graduate 1967) has taken up an editorial appointment with the Northwood Publications monthly magazine *Communications International*. For the past five years Mr Keble has been with the Institution as Technical Officer responsible for professional activities; he was latterly a member of the Editorial Board of *National Electronics Review* which the Institution published up to the end of 1978 for the National Electronics Council.

E. MacKinnon (Member 1970, Graduate 1967) has recently been appointed Head of the Department of Radiocommunication Engineering at the newly founded Australian Maritime College in Launceston, Tasmania. Since 1972 he has been Principal Lecturer in Marine Electronics at The Nautical College, Fleetwood.

A. W. Moss (Member 1961) is now Head of the Communications Systems and Services Division at the Head Office of Cable & Wireless. He was previously Group Manager, Divisional Services.

B. W. Oliver (Member 1969) is now a Principal Radio Communications Assistant in the Department of the Chief Signalling Engineer, London Transport. For the past 12 years he has been with the Marconi Company.

Colloquium Report

The New 16-bit Microprocessors and Their Impact on Control and Automation

Organized by the Automation and Control Systems Group and held in London on 20th February 1979

An audience of over one hundred were privileged to hear an impressive array of speakers including engineers from the 'big four', Motorola, Intel, Zilog and Texas, describing their latest machines and software; they were supported by applications specialists from Modular Business Systems and Solartron, describing their experience on the two currently available machines.

The morning session, chaired by Brian Mann who did much of the organizing of the Colloquium, was begun by Peter Beckett of Zilog UK. He admitted that the Z 8000 was not yet available but he promised something by May 1979. This machine will give an incredible 8 megabytes of directly addressable memory with 128 variable-size segments of up to 64 kbytes each. Hardware multiplication with an operational time of about 17 μ s will also be available later.

The second lecture was presented by Scot Dixon, who described the Intel 8086, a machine which has been commercially available since December 1977. It was claimed that this machine is one hundred times more effective than the 8008 and at least ten times more effective than the 8080. It was emphasized that this is not an accumulator-orientated machine and has one megabyte of directly addressable memory. It was claimed that this machine has effectively 64,000 input-output ports. Multiply (26 μ s) and divide (33 μ s) are available.

Dave Leiper of Motorola was the third speaker of the morning and described the proposed 6800 machine which is to be the first of a family of such v.l.s.i. processors from that company. It contains 70,000 active devices on a single chip, is 10 times faster than the 6800 and has 61 instruction types with five flexible addressing modes. Perhaps the most startling revelation to some of those present was that the major language is to be that computer scientists' favourite, Pascal!

The afternoon session, chaired by Peter Atkinson, was opened by Chris Gare of Texas Instruments whose 9900 has been available for several years and is now quite well known.

Consequently the speaker was able to concentrate more on company policy and he stated that Texas had committed themselves to bringing down the cost of 16-bit m.p.u.s for many applications and would maintain full software and system compatibility as integration techniques advanced. Workable high-level languages (Power Basic and Pascal) would be provided and allow the principles of structured programming to be implemented. Texas are going to offer common architecture, common software, common input-output and common documentation on their 9900, 9980, two-chip 9985 and their single-chip microcomputer 9940.

The second talk of the afternoon was presented by Peter Jackson (Modular Business Systems) whose company have used the Intel 8086 in data handling systems. He expressed satisfaction with this machine and described the restrictions placed on companies who had to make business systems which would satisfy customers' needs for reliability and simplicity. The use of 'adaptive' systems which degrade gracefully was explained and the need for 16-bit machines in this work was justified. A microcomputing system for use with a large-scale public display was described.

After the tea break Mike Page of Solartron entertained the audience with a talk which began with a general discussion on how an engineer should decide on whether or not to use a microprocessor and how to decide which microprocessor would be suited to his particular problem. He also outlined how he had successfully used a Texas 9900 machine in an on-line computing task in the implementation of a Kalman filter.

In the general discussion session an interesting dichotomy emerged: several control engineers in the audience stressed the importance of working in assembly code in their field, while others, including the manufacturers, felt that the move towards the use of high-level languages was a good one. The manufacturers suggested that high-level language should generally be used, but in time-critical sections jumps into assembly code could be used. Some engineers were worried about the problems of tracking down software errors in high-level programs. Several speakers stressed the importance of good documentation and hoped that the move to high-level languages might help; others were less optimistic. There was some agreement in the audience that the manufacturers were guilty of producing very poor documentation in support of their machines and that this problem should be rectified forthwith.

However the audience were unanimous in the view that the Colloquium had been well worth while.

P. ATKINSON

EUROCON '80 – Fourth European Conference on Electrotechnics

The fourth European Conference on Electrotechnics, EUROCON '80, will be held in Stuttgart, on 24th to 28th March 1980. The Conference theme is 'From Electronics to Microelectronics'—Trends and Applications.

The Conference theme will be covered in some 160 papers under four main headings:

Technology of microelectronics

—from l.s.i. to v.l.s.i.,

—microprocessors,

—large memories and systems,

—computer-aided design

Microelectronics in telecommunications and data processing

—transmission, switching, integrated networks, computers and communications,

—microelectronics in radio and television

—new services and terminals

Electronics in electrical power systems and control

—technology of power-electronic components

—electronics and computer control in power generation, transmission and distribution

Electronics and microelectronics in other fields

—medicine, signal processing, automotive applications, traffic control, consumer products, instrumentation.

Papers are now invited, and should be submitted to:

Professor Dr W. Kaiser, Chairman, Programme Committee EUROCON '80, University of Stuttgart, Breitscheidstrasse 2, D—7000 Stuttgart 1, Germany.

Abstracts of not more than 500 words should arrive not later than 30th June and the complete text of accepted papers not later than 31st December. The Conference language is English.

Further information on EUROCON '80 including the exhibition can be obtained from:

Professor Dr W. E. Proebster, Chairman, EUROCON '80, IBM Deutschland GmbH, Postfach 80 08 80, D—7000 Stuttgart, Germany.

EUROCON '80 is sponsored by the Convention of National Societies of Electrical Engineers of Western Europe (EUREL), the Institute of Electrical and Electronics Engineers (IEEE) Region 8 and the Verband Deutscher Elektrotechniker (VDE).

Applicants for Election and Transfer

THE MEMBERSHIP COMMITTEE at its meeting on 7th March 1979 recommended to the Council the election and transfer of the following candidates. In accordance with Bye-law 23, the Council has directed that the names of the following candidates shall be published under the grade of membership to which election or transfer is proposed by the Council. Any communication from Corporate Members concerning the proposed elections must be addressed by letter to the Secretary within twenty-eight days after publication of these details.

March Meeting (Membership Approval List No. 256)

GREAT BRITAIN AND IRELAND

CORPORATE MEMBERS

Transfer from Member to Fellow

MACKINNON, Norman Ronald F. *Salisbury, Wiltshire.*

Transfer from Graduate to Member

READ, Michael David. *Pinner, Middlesex.*

Transfer from Associate Member to Member

BROOKS, Stuart Henry. *Yeovilton, Somerset.*

Transfer from Student to Member

LOWE, Kenneth Roy. *London.*

Direct Election to Member

BOYD, Alan Stuart G. *Brighton.*
CHURCHYARD, Eric Graham. *Bridgnorth, Salop.*
CRAMP, Harry Donald. *New Malden, Surrey.*
FENNER, Graham Edward. *Parkstone, Dorset.*
FEWSTER, Andrew Ellis. *Portsmouth.*
MEJALLIE, Igrid Dib. *Swansea.*
PARKER, Adrian David. *Sandy, Beds.*
PARSONS, Roger John. *Burton-on-Trent, Staffs.*
PEILL, Malcolm. *Stevenage, Herts.*
USHER, Michael John. *Reading, Berks.*

NON-CORPORATE MEMBERS

Transfer from Associate Member to Graduate

AGBOLA, Titus Omatayo. *Southall, Middlesex.*

Transfer from Student to Graduate

BURKE, Martin James. *Dublin.*
DIAMANT, Yariv Haim. *London.*
PUROHIT, Naresh S. *London.*

Direct Election to Graduate

ISHAG, Mustafa Hamouda. *Old Portsmouth, Hants.*
JONES, Aneirin Wyn. *Llanwrda, Dyfed.*
REHMAN, Mohammad Ainur. *Northampton.*
SPARVELL, David Ian. *Teddington, Middlesex.*
SUBZWARI, Syed Salim Adil. *London.*
TAYLOR, William Andrew. *Muckamore, Antrim.*
TROTT, Peter Alan. *Portchester, Hants.*

Transfer from Graduate to Associate Member

BRADLEY, Alexander. *Glasgow.*

Transfer from Associate to Associate Member

NEWCORBE, Ian Franklyn V. *Driffield, E. Yorkshire.*

Direct Election to Associate Member

BRABON, Terence Desmond. *Bournemouth, Dorset.*
CHARALAMBOUS, Panayiotis L. *East Twickenham, Middlesex.*
DONNELLY, Christopher A. *Glan Conwy, Gwynedd.*
DRAKE, Raymond William. *Gillingham, Kent.*
HAMID, Altaf Hussain. *Bristol.*
REYNOLDS, Christopher John. *Gosport, Hants.*
SMITH, Graham Stanley. *Bo'ness, Central Scotland.*

Direct Election to Associate

MUPESO, Edward Chitembwe. *Plymouth.*
RADBAND, Ernest David. *Shillingford, Oxon.*

Direct Election to Student

MEDCRAFT, Geoffrey Walter. *Bexley, Kent.*
VYAS, Bharat. *London.*
WHITE, Richard Alan. *Northallerton, N. Yorkshire.*

OVERSEAS

CORPORATE MEMBERS

Direct Election to Member

CHADWICK, Peter. *Downsview, Ontario, Canada.*
FEROZE, Khalid. *Ottawa, Ontario, Canada.*
KESAVAN, Prasannan. *Singapore.*
LAM, Hau Chung. *Hong Kong.*
LI, Shu Kei Raymond. *Hong Kong.*

NON-CORPORATE MEMBERS

Transfer from Associate Member to Graduate

AKANNI, Adebisi Mosiudi. *Ibadan, Nigeria.*

Transfer from Student to Graduate

KO, Yiu Chi. *Hong Kong.*
YIP, Ho Tung. *Hong Kong.*

Direct Election to Graduate

AYOADE, Olatunde Oyebamiji. *Ibadan, Nigeria.*
IDOWU, Samuel Adetunji. *Lagos, Nigeria.*
LEUNG, Cheung Hoi. *Hong Kong.*
LIM, Kee Beng. *Bandar Seri Begawan, Brunei.*
NG, Chiu Keung. *Hong Kong.*

Transfer from Student to Associate Member

ODONGO, Zephaniah Owidi. *Nairobi, Kenya.*
WONG, Siu Man. *Hong Kong.*

Direct Election to Associate Member

AWUHE, Peter Aster. *Makurdi, Benue State, Nigeria.*
KWOK, Siu Hung. *Hong Kong.*
LEE, Kim Yung. *Hong Kong.*
LIM, Hock Lye. *Singapore.*
McKAY, Roderick Thomas. *Singapore.*
MAK, Pak Lum. *Singapore.*
MOHAMED, Tahir Bin Yusoff. *Seremban, Negri Sembilan, Malaysia.*
NORMOHAMMAD, Abdul Hamid. *Kelang, W. Malaysia.*
TYO, Eng Khoo. *Singapore.*
WONG, Bong Yuk. *Hong Kong.*
WONG, Kam Shun. *Aberdeen, Hong Kong.*
WONG, Wing Shu. *Hong Kong.*
ZAMBIRNIS, Georgios Michael. *Nicosia, Cyprus.*

Direct Election to Student

CHAN, Chi Wai Andrew. *Hong Kong.*
HENG, Cher Hoon. *Singapore.*
HUI, Cheung Shui. *Hong Kong.*
KWOK, Kwan Fat. *Hong Kong.*
LAM, Ying Chung. *Hong Kong.*
LAU, Chin Hung Jackson. *Hong Kong.*
LAU, Tat Yin. *Hong Kong.*
LI, Wing Kay. *Kowloon, Hong Kong.*
MANHO, John William. *Kowloon, Hong Kong.*
NG, Chi Wan. *Hong Kong.*
NG, Kwok Fai M. *Hong Kong.*
POON, Si Pang. *Hong Kong.*
TSO, Shi Ching J. *Hong Kong.*
WONG, Wai Ping. *Hong Kong.*
WU, Chong Pheng F. *Singapore.*
YU, Chiu Woon. *Hong Kong.*

CONFERENCES TO BE HELD BY THE I.E.R.E. IN 1979

- | | |
|-------------------|---|
| 21st-23rd May | TELEVISION MEASUREMENTS
at the Commonwealth Institute, London. |
| 24th-27th July | VIDEO AND DATA RECORDING
at the University of Southampton. |
| 4th-7th September | LAND MOBILE RADIO
at the University of Lancaster. |

Copies of the volume of Papers read at these Conferences will be obtainable from the opening date of each Conference. If you wish to be notified of the price of each volume, please write to:

Publications Sales Controller,
Institution of Electronic & Radio Engineers,
99 Gower Street,
London, WC1E 6AZ

The V.D.U. and the Operator

A programme of research into the likelihood of damage to operators' eyes resulting from the increasing use of visual display units was recently commissioned by the Association of Optical Practitioners. In general the study by two members of the A.O.P. Occupational Visual Welfare Committee, S. Rosenthal and J. Grundy, showed that no evidence existed of damage or harmful effects on eye-sight as a result of visual display unit work or the radiation effects of visual display units. Their report, a shortened version of which follows, will be of interest to engineers concerned with the design or application of v.d.u.s.

Although v.d.u.s have been used throughout the world for many years, they have aroused little comment in the health field until recently. Their increased use in a wide variety of work situations have highlighted certain problems which have led to considerable press comment concerning the possible effects on eyesight and general health. As a result, the Association of Optical Practitioners is being asked more and more whether this work presents any special visual problems or has any significant effect on eyesight.

Investigations show that a number of complaints, including eyestrain, headaches and tiredness have been made, especially among those who are required to work in front of a display screen for long and uninterrupted periods. It is, of course, well known that any type of work which requires individuals to remain in the same position and concentrate on a specific task for long periods without a rest is likely to cause feelings of strain and tiredness, the incidence and severity of the symptoms increasing with the time spent on the task. Undoubtedly, many of the symptoms can be accounted for by ocular defects, improper use and design limitations of the equipment, conditions of work, the surroundings, and psychological factors.

OCULAR DEFECTS

The most sensitive link between the terminal operator and the display unit is the visual contact between the eyes and the screen. It is not surprising, therefore, that in cases where operators have complained of discomfort, most of these complaints have referred to eyestrain or more specifically to burning sensations in the eye, twitching of the eye muscles, headaches, and in some cases even impaired vision and disturbance of colour vision.

Eyesight defects and other conditions which can cause an overload of the visual system inevitably aggravate the risk of eyestrain during periods of long concentration. Research backed by the Association of Optical Practitioners indicates that up to one-third of the employee population have uncorrected or insufficiently corrected visual defects which affect both visual and general

comfort. The likelihood of visual fatigue associated with close work or work requiring constant visual attention increases with age. Experience of visual screening in industry shows that the visual performance on near visual tasks starts to fall during the late thirties although the age at which help and advice is sought is often five to ten years later.

It is essential, therefore, that the operative has a visual acuity which is adequate for the size of the characters displayed on the v.d.u. screen.

Oculo-motor defects should be corrected. Ocular media should be free of incapacitating opacities and the eye should be healthy. Where spectacles are indicated their form will be governed by the particular work involved. Where the person is employed for long periods on v.d.u. work and has an amplitude of accommodation of less than three dioptries, then spectacles for intermediate and near vision will be required, but where the person has to frequently move around, provision for distance vision may be necessary. Multifocal lenses may be less suitable than 'E' type bifocals where any transscript is positioned to the side of the v.d.u.

DESIGN LIMITATION AND IMPROPER USE OF EQUIPMENT

The use of v.d.u.s, particularly of the older type, frequently necessitates a lowering of the general level of lighting to a degree which would be considered unacceptable for general office lighting. The development of v.d.u.s with the use of non-reflective screen surfaces and a raising of the general level of internal screen illumination, will improve the situation, and minimize discomfort glare caused by specular reflection from the surfaces of the screen.

Basically good lighting requires adequate background lighting plus extra lighting on areas which need special attention or concentrated vision. As previously mentioned the use of many v.d.u.s entails reduced background attention or concentrated vision. As previously mentioned the use of many v.d.u.s entails reduced background lighting with even less light (dark screen) on an area of concentrated vision. It is tiring for the eye to move repeatedly between areas of markedly different brightness or for there to be glare sources in the field of vision when the eye is virtually still.

The manufacturers' recommended level of background illumination for v.d.u.s is 100-300 lux, which compares unfavourably with normal recommended levels of lighting of, say, 300-500 lux for other visual tasks requiring the same degree of concentration.

The drop in lighting standards occasioned by the use of v.d.u.s is particularly hard on older operatives, and to enable them to work in a higher level of illumination, light switches should be fitted with dimmers which younger operatives can use to reduce the light to the recommended level for them.

Local lighting should be available for additional illumination of any documents. This should be suitably screened from the field of vision of other operatives.

Fluorescent light fittings should be installed in a direction parallel to the sides of the v.d.u.s and not parallel to the screen face. All tubes should have diffusers covering them.

Keyboards are normally movable and should be placed in a position most comfortable for the user.

Regular servicing and maintenance of v.d.u.s is essential to avoid, for example, a drop in brightness contrast of the screen characters, and reduction in legibility of the display.

Apparent movement of the display can arise from the characters being electronically generated on a phosphorescent material applied to the rear surface of the v.d.u. face. The rate at which the phosphorescent image decays and the rate at which it is refreshed by the electronic pulse are critical. If the pulse refresh rate is slow and the decay rate of the phosphor is high the normal scanning movements of the eye (saccadic eye movements) and eye tremor will interact with intermittent electronic formation of the image causing different parts of the retina to be stimulated at different times.

As a result the display appears to 'jump' along the line of scanning in the case of saccadic eye movements, and to 'dance' in the case of eye tremor. These may be reduced or avoided by the use of a refresh pulse frequency of 35-40 per second and a medium duration phosphor. Although the use of a long duration phosphor would reduce 'jump' and 'dance' it would also cause a persistent after-image ('smear') when the character is changed.

CONDITIONS OF WORK AND SURROUNDINGS

There should be sufficient space behind the v.d.u. for the operator to be able to look up past the screen on to a background free of movement or distracting patterns or marked contrast with the work area. This could be achieved by surrounding the v.d.u. with a transparent non-reflective screen of a Gradutint design becoming uniformly less dense from the edge of the v.d.u. outwards.

Temperature and humidity are important factors especially when concentration may reduce the blink rate. This is of even more significance to contact lens wearers.

Ventilation must be adequate and any cause of distracting noise minimized.

PSYCHOLOGICAL FACTORS

The mental concentration and unfamiliar use of the eyes, which training personnel to operate v.d.u.s entails, must be expected to cause eyestrain in a large number of people. In many cases such strain will be transient and will disappear when familiarity with the work allows the

operative to be more relaxed. However, frequently ocular changes and problems caused by normal ageing processes will be attributed by the individual to his work even when a period of years has elapsed since its commencement.

If the operator thinks his v.d.u. work will give problems it generally does. In a survey carried out by one of the authors, it was noticeable that people who had been trained to use v.d.u.s, even after they had been using them for some years, kept their work in a very different manner to those operators still using other systems. The operators using the other systems had personalized their work area with pictures and other personal possessions whilst the v.d.u. area had a clinical, temporary appearance and discussion with the v.d.u. operators indicated that they did not fully associate with their work or their work area even though it was their permanent position.

CONCLUSIONS AND VISUAL FACTORS

Before training for v.d.u. work each person should be checked to ensure they can achieve the following standards:

- (1) The ability to read N6 at a distance of two-thirds of a metre down to one-third of a metre.
- (2) Monocular vision or good binocular vision.
- (3) No central (20° degrees) field defects in the dominant eye.

Occasionally characters smaller than normal (7 point) are used on the v.d.u. screen and where this is the case, it is recommended that the operative should have the ability to read N5 at a distance of two-thirds of a metre down to one-third of a metre.

Careful records of the ocular condition should be kept. For example, although no evidence of damage or harmful effects on eyesight exists from either v.d.u. work or from radiation effects of v.d.u.s, it is possible that an operative may attribute a pre-existing condition to his work with the v.d.u.s. Alternatively, the practitioner may find himself in the position of being the first person to discover such changes. In either case, a detailed record will help to clarify the position.

Where careful consideration is given to the ocular suitability of the operative, the good design and proper siting of the equipment, and a detailed investigation of specific complaints, then it should be possible to have a comfortable and efficient workforce.

Whilst there is a strong case for employers to have an ophthalmic optician as 'on site' consultant where the use of v.d.u.s is widespread, in any instance where a full ocular examination needs to be carried out, this should be done by the individual's own ophthalmic practitioner, who should not hesitate to contact the employers if there is doubt about any aspect of the work. Alternatively, should any problems arise, the Occupational Visual Welfare Committee of the Association of Optical Practitioners is always willing to assist.

Letters to the Editor

From: H. Arthur, Ph.D., M.Sc., C.Eng., F.I.E.R.E.
J. G. Cottrell, C.Eng., F.I.E.R.E.
J. H. S. Craig, A.M.B.I.M., C.Eng., M.I.E.E., M.I.E.R.E.

The Chartered Engineer's Degree

I am extremely pleased to see, in the article on pages 63–64 of the February journal, that the IERE is still pursuing the policy and philosophy which encouraged me to join back in 1961: namely a good balance of practical experience allied with a good engineering (theoretical) education, be it polytechnic or university.

As is pointed out in the article, it is little use going overboard on a continental system based on higher and higher degrees if the results cannot be clearly shown as a benefit to the engineering profession, which I take to mean the translation of the theoretical possibilities into practical, marketable products.

Further, I believe that the university-trained and industry-trained engineers can be very complementary pairs, the one to keep theoretical advances in the foreground and to think through the possibilities, and the other to seize these possibilities and translate them into good engineering: it is usually the practical man who exerts the pressure on the machine tool and supply manufacturing industries to advance technology to the point where it can be used.

Again we must beware in extending engineering courses to take in management at the early stage of an engineer's career as they are, to some extent, not compatible. Engineering is reasonably precise and needs a lot of uncompromising dedication, whereas management is a 'consensus' discipline needing rather different attitudes. I believe the better method would be to finish the engineering theory, spend five years in industry, then take management theory as a thick or thin sandwich—there is no discipline better in learning management than exposing oneself to one's peers at a time when substantial knowledge has been gained in a working environment.

As the country is in a state of extreme educational flux and without a clear social ethos, it is quite rightly implied that we should not jump too far too quickly without a clear prediction of the likely results. For instance, where the balance is improperly moving away from the manufacturing to the service industries so that we are becoming less able to finance growth in real living standards, it might be viewed as both illogical and unsocial to place a greater emphasis on longer university training and higher degrees when it should be argued that the emphasis should be on creating wealth by physically making things.

107 Fulbridge Road,
Peterborough,
Cambridgeshire
7th March 1979

JOHN H. S. CRAIG

I read with considerable interest the views expressed by the Institution on this subject in the February issue and I think they are worthy of the strongest support. Perhaps I could have the opportunity of emphasizing a few of the important points raised.

We should only be seeking to lay down minimum standards of education, training and experience for chartered membership. The engineering profession covers a very wide range of work, and each type of work requires its own combination of standards in these three facets to be carried out effectively. The requirement of professional engineers will reflect the standards considered necessary by employers, e.g. for high technology research and development a good honours degree will normally be required, while for engineering services work more emphasis

is likely to be placed on good training and practical experience (ignoring for the moment the transient needs of training and career development). Considering this wide range of work it would seem to me that a pass degree is an adequate minimum standard.

Technician and professional engineers must work closely together and no artificial barriers should be allowed to prevent the technician of good proven potential becoming a professional engineer. It is often not easy for such a technician to achieve pass degree standard and it would be unrealistic to raise the minimum standard to that of an honours degree. For the older technician it is even unrealistic to expect him to resume education courses, and it is important that alternative tests should be available to satisfy academic requirements. Institutions do have mature candidate regulations, but my experience is that these are not widely enough known in industry.

My last point concerns the possible inclusion of management training in first degree courses or in immediate postgraduate courses. It would certainly help the new graduate in industry if he had an appreciation of elementary economics and the crucial importance of industry to a country's economy and standard of living, and perhaps an idea of how industry is organized, but more sophisticated management studies are largely a waste of time. Many of the human problems can only be appreciated after some working experience, and I see little merit in a young graduate being immersed in problems of managing director level when he has yet to prove himself in a junior management job. Management studies have to be geared with career development.

7 The Stables,
Station Lane, Guilden Sutton,
Chester CH3 7SY

H. ARTHUR

12th March 1979

I am writing to say how pleased I and some of my colleagues are to note the Institution's stand on the question of making an honours degree mandatory for corporate membership. This trend by CEI is, we consider, most harmful to the interests of industry, since in closing this avenue to becoming a chartered engineer, a whole class of people, who for one reason or another could not attend university, will be unable to advance themselves either for their own benefit or that of the industry.

Industry, as I am sure you must know, is increasingly short of engineers and first-class technicians. To encourage new entrants to the field of electronics the incentive of eventual acceptance as a recognised professional engineer is essential and a great spur to many young men. Membership of the major institutions is the ultimate recognition of such an achievement, and if it is to be closed to candidates, other than those who can attend university, then the industry will suffer even more from the reduced inflow of new recruits, as has been the case for the past 10 years.

Obviously this stand by the Institution is fully backed by the Council, and I am sure, as you must already be aware, there is a great support from the industrial sector of your membership. It is time that a stand is taken against the academics who seem to rule the CEI, and in particular its educational requirement, and who, in the eyes of some of us, are not exactly in tune with the needs of the industry. It is good to see this happening.

Standard Telephones and Cables Ltd.,
Christchurch Way,
Greenwich,
London SE10 0AG
14th March 1979

JOHN COTTRELL

Energy Sources of the Future: A Challenge to Man's Ingenuity



ARTHUR GARRATT, M.B.E., B.Sc., F.Inst.P., F.R.S.A.

The reserves of fossil fuels are analysed and some of the methods being developed to improve the energy yield from existing reserves are looked at, including enhanced oil recovery and magnetohydrodynamics. Other sources of energy not relying on fossil fuels are considered. Some could be tapped immediately or with some straightforward development, e.g. nuclear fission, solar, tidal and wave power. A proposed 2MW French prototype solar power station under construction in the Pyrenees is described. Future large-scale production of power by deep gasification of coal and by nuclear fusion are discussed and their role as potential replacements for coal, gas and oil are considered.

Based on a lecture to the Beds and Herts Section on 11th May 1978

Introduction

The history of man is linked inextricably with the development of technology.¹ It may be slightly unfashionable today to imply that progress and technology go hand-in-hand, yet it needs but little reflection to see that when man was destined to spend his life grubbing a living from the land, working every daylight hour of his life, civilization as we know it was impossible.

Technology owes a curious debt to the tin mines of Cornwall which suffered from serious flooding. It was to drain these mines that Thomas Savery built 'The Miner's Friend' (1699) an ingenious steam pump with no moving parts. Unfortunately the technology of the time made the use of high pressure steam impossible and the pump could not provide sufficient lift to drain mines although it was used for fire-fighting. But another Devonian, Thomas Newcomen, built an atmospheric steam engine (1712) that worked well enough to be used for mine drainage in many countries. It was a working model of a Newcomen engine which, given for repair to a Glasgow instrument-maker, one James Watt, inspired the modern steam engine and led to the industrial revolution. This was the true beginning of the emancipation of man, he had power available almost anywhere, steam took the place of muscles, it became possible for every man to have one or more servants at his command, servants in the form of power.

It was the steam engine which was the first large-scale consumer of fossil fuels—it was no accident that the industrial revolution thrived in England with its then plentiful coal supplies. As time passed and other prime movers came into use, so other fossil fuels, notably oil, became more and more significant.

Arthur Garratt took an honours degree in physics at University College London, and during the War worked in armaments research. In 1950/51 he was Staff Physicist for the Festival of Britain and he then became Industrial Liaison Officer at the National Physical Laboratory. For the last twenty years he has devoted his time to broadcasting, television, film-making, management consultancy and writing. He is a Past Master of the Worshipful Company of Scientific Instrument Makers, a Member of the British Academy of Film and Television Arts, and Honorary Life Member of the London Association of Engineers.

Arthur Garratt now lives in the Dordogne in France.

Reserves of Fossil Fuels

The fossil fuels, peat, coal, shale-oil, natural gas and petroleum—to name the significant ones—were all laid down many millions of years ago. They are almost certainly still being formed, although it is probable that peat and coal are today produced at a much slower rate than when the world was young. Today we are using fossil fuels at an incomparably greater rate than they were being formed, it is as though past generations had built up a large bank account which we are now prodigally spending and must eventually exhaust—or, to be more accurate, reduce to the point where the laws of supply and demand will make it uneconomic to exploit except in special circumstances.

Unfortunately a great gap in our knowledge is the size of the underground bank account. It has been estimated that there are 10^{12} tonnes of coal at depths accessible to conventional mining which means several centuries of coal at the present rate of consumption. We shall see later that this figure of 10^{12} tonnes may be increased perhaps by an order of magnitude by using different methods of energy extraction.

There is considerable confusion about how much oil exists.^{2,3} The oil industry speaks of *Proven Reserves*: quantities of oil known with *reasonable certainty* to be present and *commercially recoverable by today's techniques*; *Probable Reserves*: reserves contained in probably oil-bearing areas in an oilfield in development or additional reserves likely to be obtained if secondary recovery is applied; and *Possible Reserves*: oil which may be expected from areas outside the proven and probable areas or from more remote secondary recovery possibilities. Ignoring for the moment secondary recovery, it is clear that to quote proven reserves as being equivalent to possible reserves, which is often done by people outside the oil industry, is extremely misleading. In fact proven reserves are generally measured in terms of a few years and have risen with time as better exploration methods have become available. The phrase 'commercially recoverable by today's techniques' covers a lot of ground as it is based on relatively cheap oil and today's techniques, both of which could change dramatically with time.

Although proved reserves can be estimated quite accurately, possible reserves are little more than organized guesswork. Unfortunately even the most sophisticated exploration techniques can only detect the presence of geological features which are often associated with the presence of oil, none of them detects the oil itself. Finding oil

is expensive gambling and it has been quoted that in recent years in the USA only one exploration well in 219 found a major field—the odds are rather better in the Middle East. So when people make statements like 'we shall have run out of oil in twenty years' or 'we have enough oil for several centuries' they have no hard evidence to support what they are saying. All that can be said is that eventually oil will become an expensive form of energy and that we have to plan for such times, whenever they may come.

Secondary recovery, or enhanced oil recovery to give it another name, is an interesting possibility. The average amount of oil extracted from a well is about 25% of the total oil present, much of the oil is left behind trapped in the pore spaces in the rock. To extract this needs special techniques which, in the days of cheap oil, were not generally economic. Today as costs rise there is renewed interest in getting more out of a well by pumping in saline solutions or using *surfactants* which break down interfacial surface tension and improve recovery. One can never extract all the oil, but in many cases the yield from a well may be doubled. There is, however, a caveat, enhanced oil recovery costs both money and energy. Unfortunately many of the chemicals used, such as surfactants, are manufactured from oil and their costs reflect current oil costs, which makes the procedure less attractive than it might appear at first sight and it must be realized that even if we doubled the extraction from every well that had ever been drilled, this would add only a decade or two to the time when oil becomes an uneconomic fuel.

Other Sources of Energy

At the present time the only practical alternative to fossil fuel for large scale energy production is nuclear fission. Nuclear fission introduces problems, the most serious of which is not technical but political. It can make available separated plutonium with a low radioactive component which could be used to manufacture a nuclear bomb if it fell into the wrong hands.

A technical problem is the disposal of the waste products, some of which have a high level of radioactivity. There are various ways of dealing with such waste, some being used at present, others still theoretical. A recent assessment of the feasibility of disposing of vitrified high-level wastes into deep geological strata suggest that such methods are intrinsically very safe and proof against even earthquakes, volcanoes or nuclear holocausts.^{1,5} Future possibilities include 'reprocessing' of nuclear waste in reactors which transmute the dangerous products into safe or safer ones.

The second disadvantage of nuclear power is that because the capital cost of a station is high, which is offset by low running costs, it is not attractive economically to operate nuclear stations part time in the way that fossil stations are in order to match variable loads. This is a similar situation to a hydroelectric system and these traditionally supply the base load, i.e. the minimum requirement. What is needed here is economic storage of energy, be it pumped storage, like the 1800MW Dinorwic scheme, where the topography is suitable, or other means such as the manufacture of hydrogen or the use of sophisticated batteries (perhaps sodium/sulphur cells).

Another possible source of energy is wind power, but it must be realized that there are limits to the fraction of the power required by an advanced nation that can be supplied by windmills.^{6,7} At present a 60 m diameter prototype is being studied which would produce 3.7M Wand cost perhaps £2M. This is obviously a far cry from the Longannet power station in Scotland which produces 2400MW. The fact that even in high winds the power flux is low makes the production of thousands of megawatts very unlikely. Much the same can

be said about solar energy where the maximum flux never exceeds a kilowatt per square metre (noon at the equator). There are, however, some mitigating circumstances.

Using photovoltaic cells to convert sunshine directly into electricity, as in space vehicles, has been prohibitively expensive in terms of capital cost for general use. However, the American General Electric Company is experimenting with roofing shingles with built-in solar cells. GE cells tested by JPL in California have generated a maximum average power of 98 watts per square metre, an efficiency of about 10%, and GE are talking in terms of a capital cost of a dollar-a-watt by 1985. One trick GE hope to perform is to trap sunlight inside the system by multiple reflections so that all of it is eventually absorbed by the cells.*

Research in Israel at the Weizmann Institute of Science has led to the development of a solar cell which also stores electricity, so that energy can be converted when the sun shines and used later, perhaps after dark for lighting.⁹ At the moment storage cells with an efficiency of over 3½% have been built and the three scientists involved, Professor Joost Manassen, Dr Gary Hodes and Dr David Cahen, are confident that this can be raised to between 6% and 8% at a capital cost of under \$1 a watt. They believe that their technique of construction which electroplates a thin layer onto a conducting base instead of the more usual preparation of single crystals, is potentially much more economic and that it should lead to a rapid growth of the solar cell industry in the foreseeable future. (Fig. 1).

France is spending a great deal of effort exploiting solar energy. In addition to the giant solar furnace at Odeillo in the Pyrenees, the French have just announced the building of an experimental solar power station.¹⁰ Like the solar furnace, this station, known as THEMIS (Thermo-helio-electric-megawatt-1-simplified), will use heliostats—350 plane mirrors which reflect sunlight onto a cavity boiler with an aperture of 40 square metres placed on top of an 80 metre tower. Each heliostat automatically tracks the sun with an accuracy of 4×10^{-3} radians (13 minutes of arc) and the total area of mirrors in each heliostat is 50 square metres, about the size of the side of an ordinary house. (Fig. 2). What makes the system attractive is that there is a heat storage mechanism exploiting the latent heat of crystallization of a eutectic mixture (53% NO_3K , 40% NO_2Na and 7% NO_3Na , melting point 140°C) which stores heat in the temperature range 250°C – 425°C . With 600 tonnes of salts circulating between two reservoirs of 400 cubic metres, 6 hours of 'nominal sunshine' can be stored. Figure 3 is a simplified schematic diagram of the power station.

THEMIS will be constructed at Cerdagne in the Eastern Pyrenees and will occupy a total area of 5 hectares. The nominal energy received by the mirrors will be 13MW (solar flux 800 Wm^{-2} at noon at the equinoxes) and the station will have a nominal power output of 2 MW when it is complete in 1980.

Other projected experimental solar power stations are:

Barstow (US)	10 MW	1980
ECC (Italy)	1 MW	1980
Shikoku (Japan)	1 MW	1980
Tabernas (Spain)	1 MW	1980

It must be remembered that, with the exception of nuclear and tidal power, all our power is originally of solar origin, most of it through the process of photosynthesis. Photosynthesis may still prove the most attractive way of using solar energy in the future, particularly in the developing countries where there is often plentiful sun and suitable conditions for large-scale cultivation of plants like hibiscus which can be fermented to produce alcohol and hence methanol and gasoline.

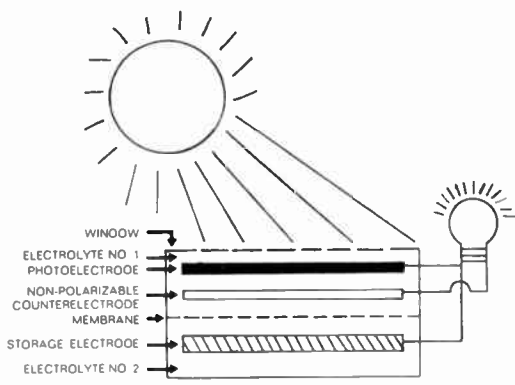

Solar cell with internal storage.

Fig. 1. The Israeli storage solar cell .

The Cinderella of energy conversion has been wave power, yet potentially this is very attractive, particularly for countries like Britain which have oceanic seaboard. Figures of 70 kilowatts of power per metre of coastline have been put forward with the advantage that the supply is continuous.⁷ There are several possible ways of extracting the energy: floats which drive shafts through ratchet mechanisms, reservoirs which fill from the tops of the waves and submerged tubes which expand and contract somewhat like the pumps used to inflate air mattresses. With more financial backing wave-power might provide a useful energy source, although there is the problem of upsetting the ecological balance of the shoreline if a large amount of the action of the waves were diverted. There are also complex engineering problems to construct equipment capable of withstanding storm conditions.

Tidal power unfortunately suffers from two serious disadvantages. Except in one or two favoured spots, notably the River Rance in France where a tidal station exists and the Severn, the tidal head is too small to make the capital outlay

economically attractive. Secondly it only produces power at certain times of the day, and these are not fixed throughout the year.⁷

Some countries, notably USA, Italy and New Zealand, have exploited geothermal energy on a large scale.¹¹ The figures for 1976 are as follows:

Country	Installed generating capacity (megawatts)	Non-electrical uses (megawatts)
USA	522	15
Italy	421	21
New Zealand	202	340

Unfortunately natural steam fields, which lead to economic utilization of geothermal energy, occur only in certain parts of the world, generally near active tectonic plate boundaries. But there is the possibility of using dry rock sources such as is being done experimentally in France. This entails drilling pairs of wells to depths of between 2 and 3 kilometres, one to extract hot water at temperatures up to 100°C, the other to discharge the water after heat has been extracted—this avoids



Fig. 2. Artist's impression of the French 2 MW solar power station to be built in Cerdagne in Pyrénées-Orientales. The boiler is mounted on top of the 80m tower and faces north. (Centre National de la Recherche Scientifique).

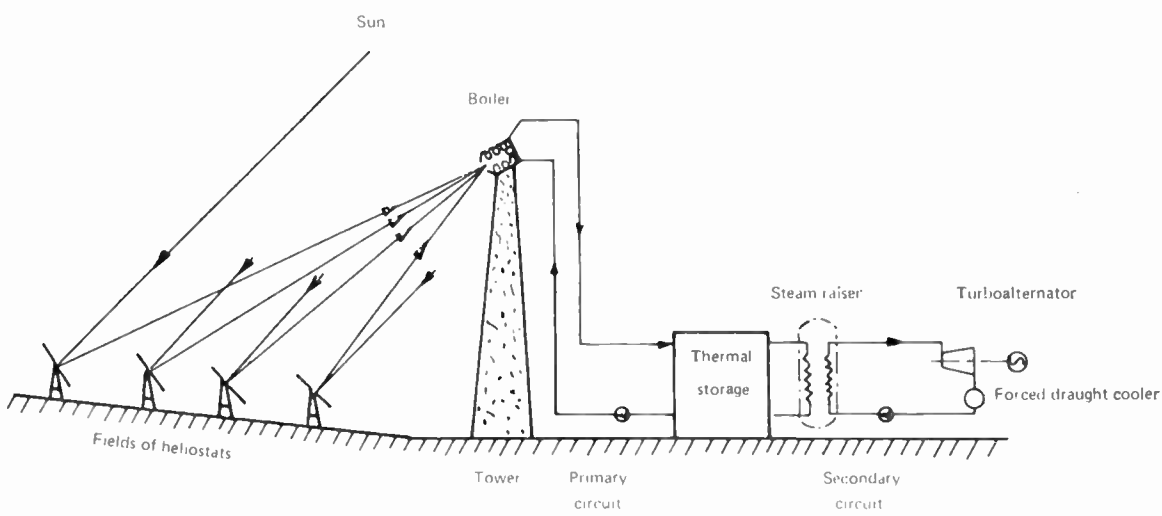

Fig. 3. Diagram showing the principle of a tower type solar power station. (Centre National de la Recherche Scientifique).

pollution from the significant quantities of dissolved solids in underground water. The French scheme uses two production wells and two reinjection wells supplying 13 MW of heat, about 80% of the annual requirement of a space heating system.

Possibilities for the Future

When we look into the future there are a number of potential energy sources or variations on present power generators.

Magnetohydrodynamics (MHD)

Any really practical source of industrial power has to produce electricity and most of our present-day power comes from steam plants, whether the steam is raised by oil, coal or nuclear fission. The laws of thermodynamics make the efficiency of a thermal engine dependant on the temperatures involved, the higher the temperature differential between source and sink, the higher the efficiency. Superheated steam turbines run at temperatures of the order of 540°C giving a maximum efficiency of about 35%.

Clearly what is required is means of converting heat directly into electricity without using a thermal engine, and this is possible by using magnetohydrodynamics.¹² The principle is simple in the extreme but the engineering problems to be solved are formidable. Faraday stated the law of electricity generation in 1831, all that is needed is a conductor in a variable magnetic field. Traditionally the conductor is a coil which rotates in a magnetic field, in MHD the conductor is a stream of plasma produced by heating a gas to such a temperature (about 2700°C or more) that it is fully ionized. When such a gas is driven through a magnetic field the positive ions and free electrons separate and can be collected by electrodes so that a high d.c. potential appears between them, in other words one has a generator which should have an efficiency of some 50%.

A great deal of research on MHD is going on in the USA (Avco Everett Research Laboratory, Massachusetts, General Electric Space Science Laboratory, Valley Forge, Pa. etc.) as well as in Japan, Germany, Poland and USSR with promising results. The magnets used are usually superconducting and the only serious problem still to be solved is to design electrodes with adequate life under the arduous temperature and aerodynamic conditions. US Energy Secretary, James Schlesinger said recently at Princeton that next year's budget for the development of MHD would probably exceed \$100 million. So the US certainly thinks this is a horse worth backing.

Deep Gasification of Coal

The idea of gasifying coal underground is old, it probably goes back to the great Russian chemist Mendeleev who suggested it a century ago. Perhaps fittingly most of the large-scale experiments have been carried out in the Soviet Union, starting about fifty years ago, while later work has taken place in the USA.

To appreciate the significance of underground gasification, we must see how the depths at which coal is found can be divided into three categories:

1. Down to the limit for open-cast mining—about 80 m.
2. Down to the point where carboniferous shales begin to behave like plastic materials under the weight of the overlying strata—about 1000 m.
3. Depths below which the temperature is too high for the economic use of human labour—about 1000 m to 2000 m or more.

Both Russian and American gasification has been carried out in depths regions 1 and 2 where a number of serious snags are found. One is that the regions are not gas-tight and gas leakage causes both losses and pollution. Another is the presence of water which implies poor thermal efficiency and the production of low calorific gas. There is also the problem of gas pollution of nearby sources of public water supply. So the results have not been economically promising, although the American experiments at Hanna, Wyoming, have shown greater promise than the Russian experiments. Under the best conditions the US engineers say that low heating value gas can be produced at a cost of the order of \$5 per gigacalorie which compares favourably with underground mining (depth category 2). The production of electricity is even more attractive because it is much cheaper to desulphurize gas than coal and electricity generation should be able to compete with generation from open-cast coal. However, it must be said that Hanna is not a typical site and might well yield a better return from open-cast mining than from gasification.

West European Underground Gasification

Experiments at Liège in Belgium look much more promising. Here at the Institut National des Industries Extractives, INIEX, a government establishment under the direction of M. Pierre Ledent, the approach has been different.^{13,14} INIEX believe the future of the art lies in working relatively thin seams at great depths well below the point where carboniferous shales behave plastically and, of course, well below the limits of conventional mining. This approach has three important features:

1. Absence of water,
2. Impermeability of the rocks to gas,
3. Ability of the rocks to withstand high gas pressures.

Belgium and West Germany have combined resources to carry out full-scale trials at great depths and high pressures, using many techniques borrowed from the oil industry. Taking the simplest system two boreholes would be sunk about 10 m apart. There are then two possibilities. One is to pump air down one borehole and get gas at high temperatures out of the other which would run a gas turbine the exhaust of which would still be hot enough to drive a steam turbine, each turbine driving alternators with a total output for the two holes of 10 MW. The second possibility is to pump a mixture of steam and oxygen down one hole when the other hole would supply a gas which could be used as a chemical feedstock which could produce methanol and gasoline.

In either case, of course, one would think not in terms of two boreholes but hundreds. Preliminary cost estimates, because at this stage one can only estimate, look good. INIEX state 'it seems highly probable that underground gasification could compete with the coal won in open-pit mines. Underground gasification could become very competitive compared with coal won from underground workings and more particularly from European workings at medium and great depths'. Another attractive feature of deep gasification is the possibility of energy storage by pumping down the gas at one time and releasing the upcoming gas at another, during peak load times for instance. In addition, to quote Pierre Ledent, 'The industrial success of a method of exploitation of deep deposits by means of underground gasification would result in freeing men from the hard labour of the miners and in making available to him, in fluid form, the huge reserves of solid fuels which constitute the main energy resources of the earth's crust'.

The reserves look impressive too. The field being tapped by the Belgian/German test drillings spreads from Belgium through the Netherlands and part of Germany under the

Fig. 4. Coalfields of North Europe.

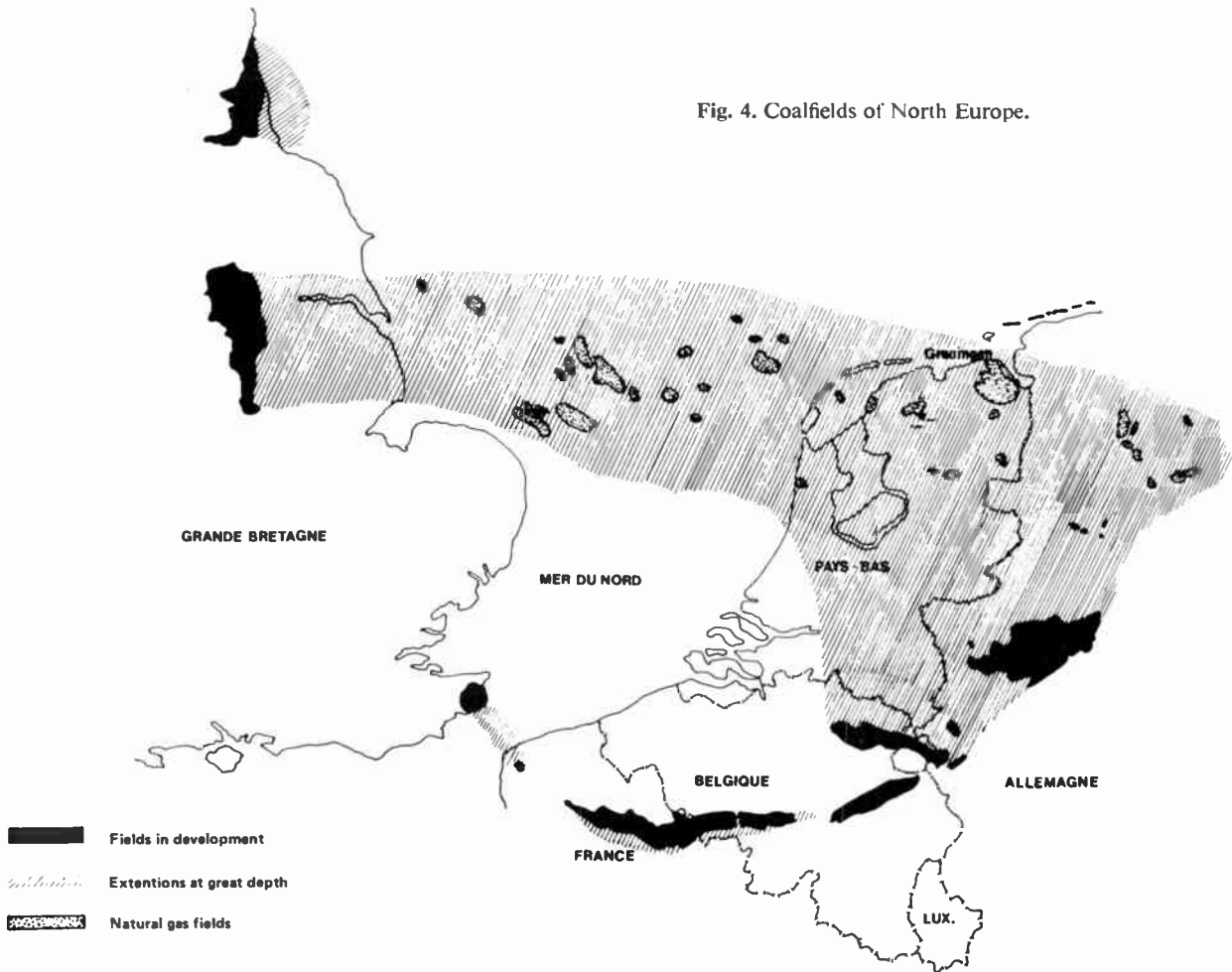

North Sea (the natural gas and oil area) emerging eventually in Nottinghamshire. The amount of coal present in this one field is estimated at 10^{12} tonnes, equal to the whole of the world's conventional coal reserves. (Fig. 4).

The Final Emancipation of Man

Western man lives a better life today than princes did in the past because the availability of power provides him with the equivalent of at least a dozen personal servants. If it were possible to provide every man woman and child in the world with perhaps a tenth of the power available to an American, the Third World would be changed out of all recognition. No longer would one see potentially fertile land unwatered and unploughed, instead food production could be increased manifold and one of the consequences of the population explosion—chronic malnutrition—could be alleviated if not eliminated.

Is it feasible to think of a future with virtually limitless power? The answer is yes, if we can solve the technical problems of nuclear fusion. We know nuclear fusion is possible, man can exploit it for a microsecond at a time in a hydrogen bomb, nature can perform the same feat over a few hundred million years in a star, the problem is to sustain a controlled reaction for minutes or hours at a time.¹⁵

The engineering problems are indeed formidable, one must operate at unthinkable temperatures, hundreds of millions of degrees, which make any material container for the plasma produced impossible to contemplate. Fortunately plasma can, theoretically, be contained in a magnetic bottle, so the project is not doomed to failure. Yet no one can really say whether

it is practical at this stage, although recent work in the USA and USSR shows great promise. At Princeton University temperatures of 60 million degrees have been attained for half a second and the director of the Plasma Physics Laboratory there is quoted as having said, 'We're going to make it, we're going to demonstrate the scientific feasibility of fusion ... we need to reach temperatures of 100 million degrees ... there is no reason we cannot reach these temperatures in the next machine, which is a larger machine than we're now operating, it took us seven years to go from 5 million degrees to 25 million degrees, it has taken us six months to go the last 35 million degrees and reach the 60 million degree mark. The results came in much better than we anticipated.'

These are indeed optimistic words from someone who is deeply involved in the field. John Deutch, director of energy research for the US Department of Energy is more cautious, but he has stated that the first fusion plant might be built in 2005 and that fusion power could be a commercial proposition in 2025.

Successful fusion power, quite apart from the massive technical problems involved in building practical plants, has certain advantages over fission power. For one thing no materials are produced which might be used for the production of bombs. For another the environmental effects are reduced. Studies on what is called the Culham Conceptual Tokamak Reactor Mk IIB together with work in the USA indicates between one and two orders of magnitude less radioactivity for fusion compared with fission and careful selection of the materials of the reactor can reduce long-lived activity, i.e. in excess of one hundred years, very significantly.

There are, of course, immense social problems to solve if one day we can effectively turn our oceans into seas of oil many times over and social scientists would face their greatest challenge, compared with which the Industrial Revolution would pale into insignificance.

Even if fusion power becomes a practical energy source, this would not mean in any sense that there would be no other energy sources exploited. There seems no feasible replacement for petroleum products for aircraft, for example, and there will almost certainly be developments to improve the efficiency and working of fission reactors. The future, like the present, will undoubtedly use a variety of energy sources appropriate to particular needs.

Conclusion

Despite the possibility of our supplies of cheap energy from fossil fuels slowly disappearing, there are other energy sources of great potential significance. Some of these like nuclear fission, solar energy and improved methods of using fossil fuels, e.g. deep underground gasification, are technically feasible at the present time and can be exploited when the economics dictate. Others, such as fusion power, represent a challenge to man's inventiveness and courage. What technologists must realize is that the present energy crisis, if there is such a thing, must not be an excuse to step backwards in time by returning to a lifestyle common centuries ago. Instead it must be regarded as the latest and greatest challenge to the ingenuity of man.

References

- 1 Derry, T. K. and Williams, T. I., 'A Short History of Technology'. (Oxford University Press, 1960).
- 2 'Our Industry-Petroleum', 5th edn, (British Petroleum, London, 1977).
- 3 'The Petroleum Handbook'. (Shell International Petroleum Co., London, 1966).
- 4 Chapman, N., Gray, D. and Mather, J., 'Nuclear waste disposal: the geological aspects', *New Scientist*, 27th April 1978.
- 5 Lewis, J. B., 'Underground waste disposal', *Atom*, No. 262, pp. 218-9, August 1978.
- 6 'The Development of Alternative Sources of Energy', Cmnd 7236, HMSO, 1978.
- 7 Tombs, F., 'Electricity—new possibilities for its generation and use', *J. Roy. Soc. Arts*, 126, No. 5266, pp. 605-18, September 1978.
- 8 *Electronics*, 17th August 1978
- 9 'Solar cells that work in the dark', *Research*, No. 4, June 1978. (The Weizmann Institute of Science, Tel Aviv).
- 10 'La Centrale Solaire Experimentale THEMIS', Electricité de France, Centre National de la Recherche Scientifique.
- 11 Garnish, J. D., 'Geothermal energy and the UK', *Atom*, No. 263, pp. 242-8, September 1978.
- 12 'Magnetohydrodynamics', *Popular Science*, August 1978.
- 13 Ledent, P., 'Report on Working Party on Coal Technology', INIEX, Paris, 19th July 1977.
- 14 Ledent, P., 'Underground coal gasification', *Annales des Mines (France)* 184, No. 4, pp. 83-96, April 1978.
- 15 'Nuclear fusion: way to limitless energy', *International Herald Tribune*, 16th August 1978.

Some recent solar power developments

Space Solar Power Stations Could Provide Energy for Earth

The possibility of giant solar space power stations providing energy for domestic and industrial uses on Earth was discussed at an RAeS-AIAA Energy and Aerospace conference in London December 5-7th. In his paper entitled, 'A review of some critical aspects of satellite power systems' Ivor Franklin, Project Manager, Solar Power Systems, British Aerospace Dynamics Group, stated that if pilot studies to develop solar arrays into space power sources prove economically feasible, then by the end of the century giant orbiting solar power stations could be in use. Covering many square miles, these would be constructed in space from basic units and materials transported from Earth by advanced launch vehicles.

The British Aerospace Dynamics Group at Bristol are heavily involved in solar arrays for spacecraft applications and recognize this activity as a business which will expand dramatically in the years to come. By using solar cells which convert the sun's rays to electrical energy, the large arrays of today will, over the next decades, emerge as the early stepping stones which could lead to the utilization of space initiated by the forthcoming Space Shuttle era.

Under contract to the European Space Agency, the Dynamics Group's Electronic and Space Systems organization are already designing the 33 sq.metre 4kW solar array that will power NASA's Space Telescope. A 6kW lightweight flexible fold-out array is also being developed for communication satellites of the next decade and proposals are in hand to augment the Space Shuttle power using solar power modules of up to 60kW.

Other proposals exist to develop arrays up to 500kW as space power sources. These could form modules for further develop-

ment up to 2MW to provide a space power station pilot scheme which, if proved economically feasible, would provide a basic source of energy for use on Earth.

First UK Solar Power Generating Station

Ferranti Electronics have commenced construction of the main array of a 2kW peak output photovoltaic solar system and power generation is expected to start in the middle of this year. When completed this system will be one of the largest in Europe and the first photovoltaic solar generating station in the United Kingdom.

The 2kW system is being built at Ferranti's Poynton production facility under a recently awarded EEC contract. This required design, manufacture and installation of a system to demonstrate the feasibility of using this method of power generation in an industrial environment at a northerly latitude.

The Ferranti system will comprise approximately 160 photovoltaic panels generating a total of 2kW d.c. power under good sunlight conditions. This power will be stored in a battery bank and then inverted to 240V 50Hz to provide a continuous mains supply.

Solar Powered Railway Communication System

A £¼M contract has been signed by the Australian National Railways with the Solar Power Corporation, (part of the Esso Group) for the supply and installation of solar energy equipment for the communications system of the new Tarcoola-Alice Springs railway. This is an integrated microwave-v.h.f. radio system with 72 channel capacity; it will span 850km and will include 24 solar powered repeater stations at intervals of about 35km.

The solar cell modules would recharge batteries providing power for the line communications equipment. Each repeater station will have its own solar power unit with an output of 1280W, and the total solar electric generating capacity will thus be more than 30kW.

Solar power will eliminate costly diesel fuelling and maintenance procedures on the new lines. It is believed to be the largest commercial solar electric contract ever awarded.

Contributors to this issue

Prof. Alec Gambling (Fellow 1964, Member 1958) has held a Chair in Electronics at the University of Southampton since 1964, and has been Head of the Department since 1974; he graduated in electrical engineering from the University of Bristol, his Ph.D was awarded by the University of Liverpool and his D.Sc. by the University of Bristol. Before going to Southampton, Professor Gambling was a Lecturer at the University of Liverpool and he also spent two years as a Postdoctoral Research Fellow at the University of British Columbia. He has held appointments as Visiting Professor at the Bhabha Atomic Research Centre, Bombay, and at the University of Colorado. He is a member of the Optics and Infra-Red Committee of the Electronics Research Council and of the Technology Subcommittee of the UGC.



Actively involved in Institution affairs for many years, Professor Gambling has served as Chairman of the Southern Section Committee and of conference organizing committees, on the Education Committee, and as an Ordinary Member of the Council; he was a Vice President from 1970-1973 and from 1974-1977, and President in 1977-78. He is the IERE member on the Board of CEI and was recently elected to the Fellowship of Engineering.

Martin Smith obtained a first-class honours degree in theoretical physics at Trinity Hall, Cambridge, in 1971 and went on to work on radio-wave propagation theory under Dr K. G. Budden at the Cavendish Laboratory. He was awarded his doctorate in 1974 and for the next two years held an SRC Research Fellowship at the Laboratory. In September 1976 Dr Smith joined the Radio and Navigation Department at the Royal Aircraft Establishment as a Senior Scientific Officer. He is the author or co-author of some 16 papers on radio wave propagation and on antennas.



Charles Jones did his National Service in the RAF and in 1950 he entered the Scientific Civil Service at the Signals Research and Development Establishment (now part of the Royal Signals and Radar Establishment) to work on military communications. He graduated in 1964 in electrical engineering, receiving the external B.Sc. honours degree of London University. Mr Jones worked for several years in the fields of design and of failure analysis of micro-electronics, and he contributed a paper to the Journal in April 1972 on aspects of this work. His present interests are in the design of ground stations for satellite communications.



Brian Davies obtained a first-class honours degree in physics from the University College of South Wales, Cardiff, in 1971. He went on to investigate ionic migration on the surface of polycrystalline oxides and received a Ph.D from the University of Wales in 1974. He then joined the Royal Signals and Radar Establishment at Christchurch. As well as the tactical modem project his work has included mobile digital communications at u.h.f. and forward error correction for satellite communications circuits. He is now concerned with packet-switched communications with special interest in gateways and internetworking.



Richard Davies studied physics at Oriel College, Oxford, receiving an honours degree in 1974. He then joined the Signals Research and Development Establishment (now RSRE) and has worked on digital system design for a computer-controlled switch, a cascaded surface acoustic wave correlator, and the project that is the subject of this paper.



Recent advances in optical fibre communications

Professor W. A. GAMBLING,
D.Sc., Ph.D., F. Eng., F.I.E.E., F.I.E.R.E.*

*Based on an invited paper to the International
Commission for Optics in Madrid in September 1978*

SUMMARY

Optical fibre cables are currently available having transmission losses of 3 dB/km and bandwidth \times length products of 1 GHz km at an operating wavelength of 0.85 μm . At the longer wavelength of 1.3 μm attenuations as low as 0.5 dB/km, and repeater spacings of 50 km, have been demonstrated in the laboratory. The corresponding bandwidth of graded-index multimode fibres can be large, even with light-emitting diodes, while the combination of semiconductor lasers with single-mode fibres is capable of several hundred GHz km. Practical problems of cabling, jointing, connectors, strength, sources and detectors are close to being solved.

* Department of Electronics, University of Southampton, Southampton SO9 5NH.

1 Introduction

The purpose of optical-fibre communications is quite revolutionary—namely to introduce a completely new form of transmission line using optical techniques. The transmission distances required can be up to tens of kilometres and the potential applications are seen to be very widespread. In short we wish to replace electric currents and copper wires by glass fibres and light, not only in complete telephone networks but in other communications systems as well, such as aircraft, ships, computers and so on.

In a typical long-distance transmission system, such as the trunk telephone network for example, the signal has to be reamplified (or regenerated in the case of digital modulation) in so-called 'repeaters' when the power level has fallen by about -40 dB (i.e. to 10^{-4} of its initial value). The transmission loss of coaxial cables is such that this process has to be carried out after distances of only 2 or 3 km. To increase the repeater separation by, say, a factor of 10, implies attenuations of 1 or 2 dB/km, corresponding to extinction coefficients of 10^6 cm^{-1} and impurity levels of 1 part in 10^8 or less. How can this be done?

One practical requirement, apart from low loss, is that the material should be capable of being drawn easily into long lengths of fibre and glass meets this requirement particularly well.

2 Fabrication

If we study absorption losses in most conventional glasses the attenuation curve indicates immediately that the only feasible wavelengths of operation lie in the near infra-red region $\sim 1 \mu\text{m}$ which is fortunate since this means that existing semiconductor lasers will suffice. At shorter wavelengths the tails of the electronic resonances in the ultra-violet, as well as Rayleigh scattering as will be shown later, have a dominating influence. Further into the infra-red the wings of the intrinsic vibrational resonances, such as that of the silicon/oxygen bond in silica for example, have a similar effect. When work began in England in 1966 commercially-available fibres had attenuations of 10^3 dB/km and an improvement of 2 or 3 orders of magnitude was necessary.

Two general types of approach to the fabrication of fibres have been used. One is via conventional glass-making techniques starting with solid raw materials and perhaps the best result obtained so far is that by the British Post Office¹ showing a minimum attenuation of 4 dB/km measured at 0.85 μm with numerical aperture of 0.25 or 3.4 dB/km with a semiconductor laser (Fig. 1). Precautions which have to be taken include ensuring a very high degree of purity in the glass-melting crucible, the avoidance of airborne contamination through indirect heating, and a clean ambient gas flow coupled with careful materials handling. Part of the difficulty with this method is that solid starting materials are not easy

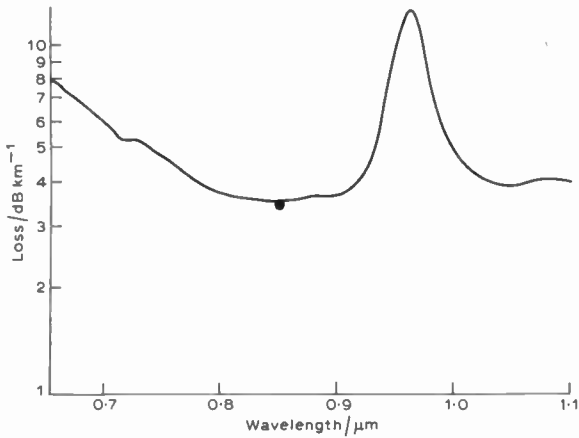

Fig. 1. Transmission loss¹ of sodium borosilicate glass fibre over a length of 2.2 km and with 0.18 numerical aperture. The solid circle represents the loss of 3.4 dB/km at 842 nm measured with a GaAlAs laser.

to obtain in sufficiently pure form and in particular that the OH radical is stubbornly persistent.

When the two pure bulk glasses for core and cladding, respectively, have been prepared they are drawn into long rods. The core and cladding rods are then fed at a carefully controlled rate into the inner and outer regions of a suitably-heated concentric crucible arrangement from which fibres are drawn in the usual way.² The process is a semi-continuous one in which long lengths of fibre of moderate bandwidth may be obtained economically.

An alternative approach involves starting with liquids, because they are easy to purify, and then depositing from the vapour phase. The most refined method, first reported independently by Southampton University³ and Bell Telephone Laboratories⁴—the homogeneous or modified CVD method—gives the direct deposition of glass layers normally ~10 μm thick, on the inside of a supporting tube. The optical properties of the latter are not important but the wall thickness must be uniform, both azimuthally and longitudinally, and it must be homogeneous as well as mechanically and thermally compatible with the layers to be deposited.

As illustrated in Fig. 2 the starting materials are halides which are vaporized by the passage of a carrier gas and combined with oxygen before entering the supporting tube. A short furnace, producing a temperature of 1400–1600°C, is traversed along the tube, thus causing oxidation of the halides which are simultaneously sintered into a thin smooth glass layer. The composition of the glass in the deposited layer, and hence its refractive index, can be varied by changing the relative gas flows. Thus by tailoring the composition of successive layers an appropriate refractive-index distribution can be obtained over the cross-section of the fibre. After deposition the composite tube is collapsed into a solid rod preform and drawn into fibre. At present this is a batch process producing lengths of up to 4 or 5 kilometres or so but preliminary results with a continuous version of the process are encouraging.

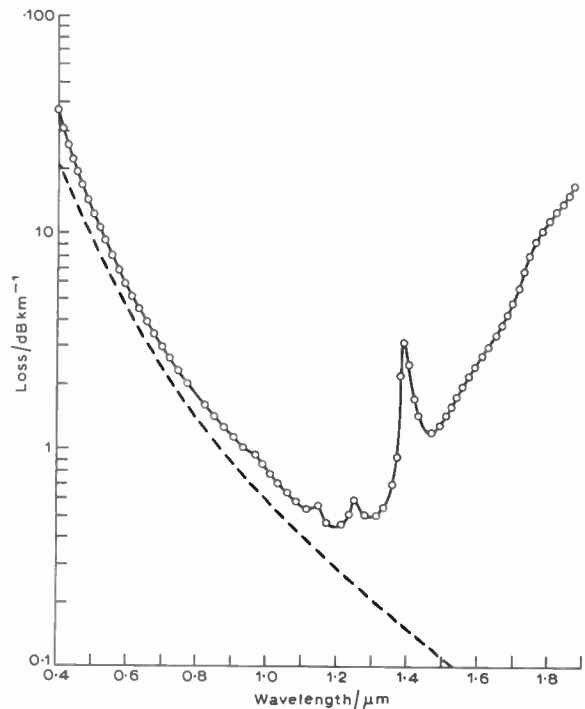

Fig. 3. Transmission loss⁶ of optical fibre comprising phosphosilicate core in borosilicate cladding. The fibre length is 1.2 km and the effective numerical aperture at the source is 0.05.

After fabrication the fibre consists of a high-refractive-index core, a lower-refractive-index cladding and a surrounding region of supporting tube material.

The lowest attenuation reported so far† was obtained with a fibre of Southampton University design⁵ but fabricated at the NTT and Fujikura laboratories⁶ in Japan. The curve shown in Fig. 3 was measured with the rather small launching numerical aperture of 0.05 and shows four main features.

† Since this paper was prepared an even lower attenuation of 0.2 dB/km has been obtained, but at a wavelength of 1.55 μm where convenient sources and detectors are not available.¹³

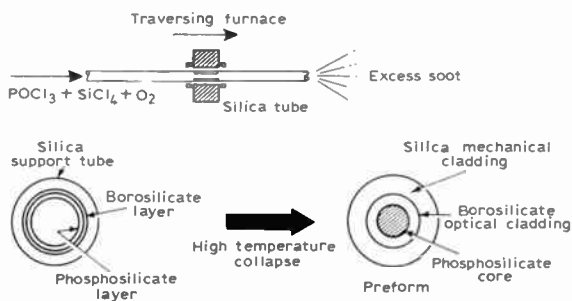

Fig. 2. Schematic diagram of homogeneous chemical vapour deposition process and collapse of multilayer tube preform into a solid rod.

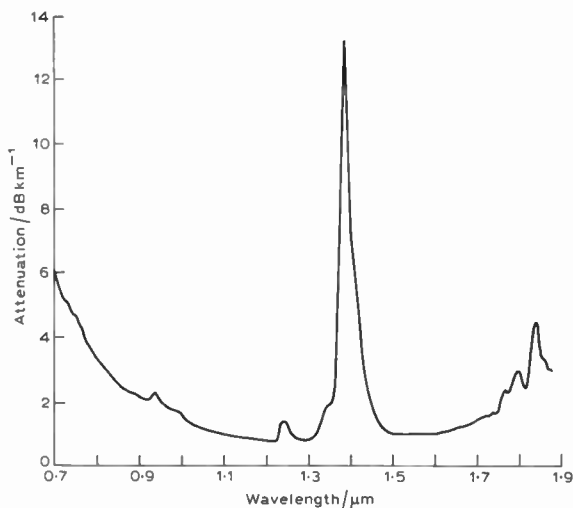

Fig. 4. Attenuation of 3 km length of fibre drawn at Southampton University. The fibre numerical aperture of 0.25 was fully excited and the minimum loss is 0.8 dB/km.

Firstly, a minimum attenuation of 0.5 dB/km at $\lambda=1.2 \mu\text{m}$. As will be shown later this is also the wavelength at which the material dispersion is zero. Secondly, at shorter wavelengths the attenuation is largely due to Rayleigh scattering caused by thermodynamic density fluctuations frozen in at the glass-hardening temperature.

Thirdly, a rise in the attenuation at larger wavelengths thought to be due to the Si-O bond resonance at $\sim 9 \mu\text{m}$.

Fourthly, small superimposed peaks due to OH radical impurity.

Figure 4 gives a similar result but drawn to a linear and not a logarithmic scale. It was obtained at Southampton University, with a launching numerical aperture of 0.25. Thus 25 times as much light was carried by the fibre over a length of 3 km, which is very important from a practical point of view. The pulse dispersion was 0.5 ns/km corresponding to a bandwidth \times length product of about 2 GHz km.

3 Bandwidth

In a fibre having a constant refractive index in the core the various rays travelling in straight lines at different angles to the axis arrive at the output at different times. This causes pulse spreading and a limitation on bandwidth due to multipath dispersion, as indicated in Fig.5.

The range of possible angles is determined by the numerical aperture of the fibre, which is a function of the refractive indices of the core and cladding materials, see Table 1. For a core refractive index $n_1 = 1.5$ and a typical value of relative index difference between core and cladding of $\Delta=0.01$ the range of acceptance angles (in

Table 1

Refractive index: core n_1 ; cladding n_2 ; $\Delta = \frac{n_1 - n_2}{n_1}$
Permitted range of angles to axis in core = $\pm \cos^{-1} \frac{n_2}{n_1}$
Difference in propagation times of axial and extreme rays = $n_1 \Delta L / c$
$L = \text{fibre length}$ $c = 3 \times 10^8 \text{ ms}^{-1}$
Bandwidth \times length product $\approx 20 \text{ MHz km}$ for $\Delta = 0.01$
$NA = (n_1^2 - n_2^2)^{1/2}$ $a = \text{core radius}$
$V = 2\pi(NA)(a/\lambda) = \text{normalized}$ } radius frequency
Number of modes $\approx V^2/2 \approx 2500$
for $NA = 0.2$; $a = 50 \mu\text{m}$; $\lambda = 0.9 \mu\text{m}$

air) is $\pm 10^\circ$ corresponding to a numerical aperture of 0.17. The bandwidth \times length product is thus limited to about 20 MHz km if the launched energy is distributed over all possible ray angles.

The multipath, or multimode, dispersion effect can be reduced by introducing a radial variation of refractive index, as shown on the right-hand side of Fig. 5. In effect the fibre now becomes a weak continuous lens, in which rays at a large angle to the axis spend most of their time in a region of low refractive index and therefore travel faster than an axial ray which traverses a shorter geometrical path length. For the particular refractive-index distribution⁸ shown in Table 2 the spread of ray transit times is reduced by a factor ($\Delta/8$) which, for $\Delta=0.01$, is nearly three orders of magnitude. Thus, in principle, bandwidth \times length products of 20 GHz km are possible, compared with a corresponding figure for coaxial cables of a few tens of MHz km.

In practice there are severe difficulties in achieving,

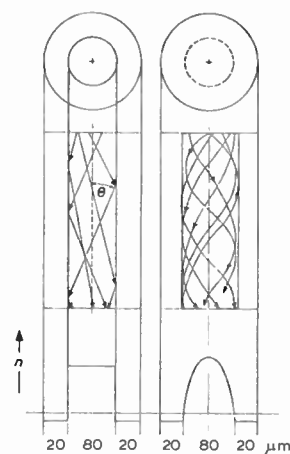

Fig. 5. Ray propagation in multimode fibres having stepped and graded refractive-index distributions.

with a sufficiently high degree of precision, the required refractive-index distribution. Another problem is that the variation of refractive index with wavelength changes with the radial variation of material composition. Nevertheless bandwidths of 1 GHz over a kilometre can be achieved as shown by the input and output pulses over a 3 km length of fibre shown in Fig. 6. The corresponding pulse dispersion is 0.5 ns/km.

Another method of reducing pulse dispersion is by decreasing the number of modes which are capable of propagating. Table 1 shows that the number of modes

Table 2

$n(r) = n_0 \left[1 - 2\Delta \left(\frac{r}{a} \right)^\alpha \right]^{1/2}$
Spread in ray propagation times $\approx n_1 \Delta^2 L / 8c$
Bandwidth \times length product ≈ 20 GHz km
for $n_1 = 1.5; \Delta = 0.01$
NA varies radially
Leaky modes propagate

depends on the ratio of core diameter to wavelength. Thus by reducing the core diameter to, say, 5 μm compared to $\sim 50 \mu\text{m}$ for a multimode fibre, only one mode is allowed to propagate. The bandwidth is then limited primarily by mode dispersion, i.e. the variation of mode group velocity with wavelength, and by material dispersion.

The mode dispersion is always finite in the single-mode regime but recently⁹ it has been demonstrated that effective single-mode operation can be obtained under conditions where the mode dispersion is zero. The remaining major limitation is then due to the material itself. The property which causes a propagating pulse to broaden is not what is normally known as dispersion, namely $dn/d\lambda$, but the second derivative¹⁰ with respect to

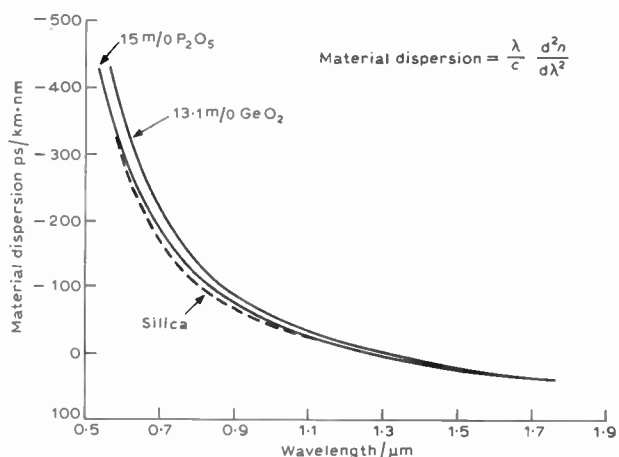

Fig. 7. Material dispersion in phosphosilicate, germano-silicate and silica fibres.

wavelength λ , namely $(-\lambda/c)(d^2n/d\lambda^2)$. For the types of glass in fibres made by the homogeneous chemical vapour deposition technique the material dispersion falls to zero at a wavelength of about 1.3 μm (see Fig. 7), thus enabling its effect to be removed, or at least considerably reduced.

The advantage to be gained by operating at the longer wavelength depends on the residual waveguide dispersion and on the source linewidth. An illustration is given in Fig. 8 in terms of the maximum pulse rate which can be transmitted along multimode and single-mode fibres and for linewidths of 2 and 4 nm (representing semiconductor

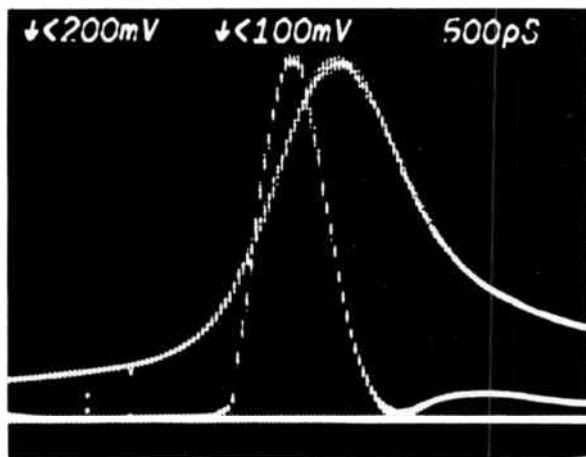

Fig. 6. Pulse dispersion in graded-index multimode fibre. The input pulse of 0.6 ns is broadened to 1.4 ns in transmission over a 3 km length. This corresponds to a pulse broadening of 0.5 ns/km. The fibre was fabricated at Southampton University.

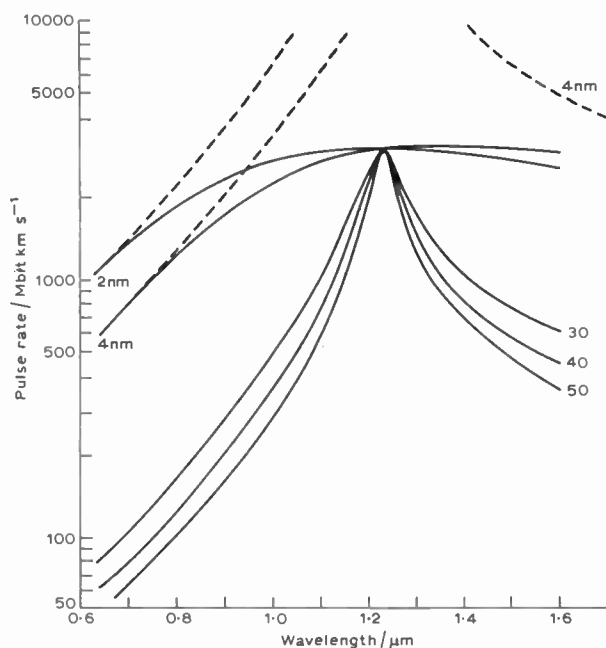

Fig. 8. Maximum possible pulse rates in phosphosilicate-cored fibres for the source linewidths indicated on the curves. The solid lines represent a multimode graded-index fibre having a waveguide dispersion of 0.2 ns km⁻¹ while the broken lines are for a single-mode fibre.

lasers) and 30 to 50 nm (representing light-emitting diodes). It can be seen that by changing the wavelength of operation from that of GaAs devices, 0.85 to 0.9 μm , to 1.3 μm an increase in information rate of over an order of magnitude can be obtained for the two combinations of (i) an l.e.d. with a multimode fibre and (ii) a laser and a single-mode fibre. As a result a considerable amount of work is being done on the development of devices operating at about 1.3 μm , based on quaternary materials such as GaInAsP. In fact a transmission distance of 50 km without repeaters has already been reported¹¹ with a system of this kind.

4 Conclusions

Methods have been developed for fabricating both multimode graded-index fibres and single-mode fibres with attenuations as low as 0.5 dB/km at a realizable operating wavelength of 1.3 μm . In practice multimode fibres have been made into cables with attenuations, after installation in the ground, of less than 5 dB/km at a wavelength of 0.85 μm . Bandwidth \times length products so far realized are approaching 1 GHz km and can be improved upon by at least an order of magnitude by exploiting single-mode fibres at longer wavelengths.

The practical problems to be solved are of equal importance to the fundamental ones which have already been tackled so successfully. Thus considerable progress has been made¹² in preserving fibre strength, in developing methods of jointing and coupling and in improving the lifetime and efficiency of suitable sources. Already experimental systems have been installed in many countries and the application of optical fibre communications is on the threshold of an explosive growth.

5 References

- 1 Beales, K. J., Day, C. R., Duncan, W. J., and Newns, G. R. 'Low-loss compound-glass optical fibre', *Electronics Letters*, **13**, pp. 755-6, 1977.

- 2 Beales, K. J., Midwinter, J. E., Newns, G. R., and Day, C. R., 'Materials and fibre for optical transmission systems', *Post Office Elect. Engrs J.*, **67**, pp. 80-7, 1974; Beales, K. J., Day, C. R., Duncan, W. J., Midwinter, J. E., and Newns, G. R., 'Preparation of sodium borosilicate glass fibre for optical communication', *Proc. Instn Elect. Engrs*, **123**, pp. 591-6, 1976.
- 3 Payne, D. N., and Gambling, W. A., 'New silica-based low-loss optical fibre', *Electronics Letters*, **10**, pp. 289-90, 1974.
- 4 French, W. G., MacChesney, J. B., O'Connor, P. B., and Tasker, G. W., 'Optical waveguides with very low-losses', *Bell Syst. Tech. J.*, **53**, pp. 951-4, 1974.
- 5 Payne, D. N., and Gambling, W. A., 'A borosilicate-cladded phosphosilicate-core optical fibre', *Optics Communications*, **13**, pp. 422-5, 1975.
- 6 Horiguchi, M., and Osanai, H., 'Spectral losses of low-OH-content optical fibres', *Electronics Letters*, **12**, pp. 310-2, 1976.
- 7 Osanai, H., Shioda, T., Moriyama, T., Araki, S., Horiguchi, M., Izawa, T., and Takata, H., 'Effect of dopants on transmission loss of low-OH-content optical fibres', *Electronics Letters*, **12**, pp. 549-50, 1976.
- 8 Gloge, D., and Marcattili, E. A. G., 'Multimode theory of graded-core fibres', *Bell Syst., Tech. J.*, **52**, pp. 1563-78, 1973.
- 9 Gambling, W. A., Matsumura, H., and Ragdale, C. M., 'Zero mode dispersion in single-mode fibres', *Electronics Letters*, **14**, pp. 618-20, 1978.
- 10 Payne, D. N., and Gambling, W. A., 'Zero material dispersion in optical fibres', *Electronics Letters*, **11**, pp. 176-8, 1975.
- 11 Ito, T., Nakagawa, K., Aida, K., Takemoto, K., and Suto, K., 'Non-repeated 50 Km transmission experiment using low-loss optical fibres', *Electronics Letters*, **14**, pp. 520-1, 1978.
- 12 Gambling, W. A., and Payne, D. N., 'Optical fibre systems', *Phil. Trans. Roy. Soc. London.*, **A289**, pp. 135-50, 1978.
- 13 Miya, T., Terunuma, Y., Hosaka, T., and Miyashita, T., 'Ultimate low-loss single-mode fibre at 1.55 μm ', *Electronics Letters*, **15**, pp. 106-8, 1979.

Manuscript first received by the Institution on 16th November 1978
(Paper No. 1872/Comm 178)

A test equipment for the measurement of phase and frequency instability in v.h.f. and s.h.f. sources

C. H. JONES, B.Sc., C.Eng., M.I.E.E.*

SUMMARY

This paper describes a simple method of measuring instabilities in communication systems such as satellite links. The technique is based on the use of a modified commercial phase meter and frequency synthesizer. This can linearly measure the magnitude of phase variation of a source, in a bandwidth of 1 kHz with a resolution down to 0.5 deg peak to peak, relative to a stable reference. Frequency instabilities of less than 0.1 Hz can also be measured.

The paper includes typical measurements of noise introduced by high stability frequency sources, medium and high-power travelling-wave tubes and klystrons, and low-noise parametric amplifiers.

* Ministry of Defence, Royal Signals and Radar Establishment, Christchurch, Dorset BH23 4JB.

1 Introduction

In satellite communication systems which use forms of angle modulation, there has to be special concern about phase disturbances. These detract from the theoretical traffic capacity of the network and result in waste of satellite radiated power.

Some sources of phase noise in such a system are as follows:

- (a) That generated within transmitters and receivers, especially from impure master oscillators subsequently multiplied to s.h.f. Also phase noise due to power supply ripple and mechanical vibrations.
- (b) Phase variations resulting from diurnal satellite movement and eccentricity of satellite spin etc.
- (c) Phase variations due to movement of Earth station aerials, for example those used on ships. Such variations can be many thousands of degrees with periods from seconds to minutes due to wave motion and ship manoeuvres.
- (d) That arising from thermal noise generated by the Earth station receiver amplifier and associated components. Also to a lesser extent, noise radiated by the satellite.
- (e) Minor phase variations caused at low aerial angles by atmospheric effects.

The phase measuring equipment which is the subject of this paper can be used to measure any of the above phenomena. It has found its most common application to date in measuring items (a), and examples are included in this paper.

2 Effects of Phase Disturbances on Angle Modulation

A common modulation system used in satellite links is digital phase reversal keying (p.r.k.). Here a phase reversal of the carrier corresponds to the change between mark and space. Excursions of phase noise of 90 degrees or more, occurring during an information digit, have a high probability of corrupting that digit. Satellite traffic is usually carried in the presence of a poor signal/thermal noise condition, which is just acceptable for the required error rate; however extra noise, resulting from phase instability of the link, requires increased satellite radiated power if the required error rate is to be maintained.

A detailed study of the effects of phase noise on current p.r.k. modems is not within the compass of this paper, though it is appropriate to make the following observations. A modem using phase detection can be perturbed by noise at frequencies considerably lower than the data rate due to the narrow bandwidth of its timing recovery circuit. For a system whose phase noise has a 'falling characteristic', such as that originating from its master oscillator, within the bandwidth of the latter circuit can lead to its instability although that at the data rate may not cause digit errors.

3 Definitions of Phase and Frequency Instability

3.1 Frequency Domain

Consider a signal $s(t)$ whose instantaneous output is of the form

$$s(t) = [A + v(t)] \sin [2\pi f_c t + \phi(t)] \tag{1}$$

where A and f_c are the nominal amplitude and frequency respectively. It is assumed that

$$\frac{v(t)}{A} \ll 1 \quad \text{and} \quad \frac{\dot{\phi}(t)}{2\pi f_c} \ll 1 \tag{2}$$

Also the instantaneous phase

$$\Phi(t) = 2\pi f_c t + \phi(t) \tag{3}$$

and instantaneous frequency

$$f(t) = f_c + \frac{\dot{\phi}(t)}{2\pi} \tag{4}$$

Apart from amplitude variations $v(t)$, there are three spectra of interest¹ in describing the noise properties of the signal $s(t)$:

- (i) The complete spectrum of $s(t)$ including the carrier and all sidebands, termed the r.f. power spectrum $S(f)$.
- (ii) The spectral density of phase $\phi(t)$ termed $\Phi(f)$.
- (iii) The spectral density of frequency $\dot{\phi}(t)$ termed $\dot{\Phi}(f)$.

The simplest measurement of the quality of a source is the r.f. power spectrum $S(f)$, though it is not considered a good primary measure of stability on two counts. First, fluctuations in the amplitude $v(t)$ contribute directly to the spectrum; and secondly even if $v(t)$ is negligible, the r.f. spectrum is not simply related to the frequency fluctuations unless the latter are very small.² The normalized r.f. spectrum is defined as the ratio of the phase noise power in a unit bandwidth to the total signal power, as a function of the offset frequency f_n . Since the upper and lower sidebands are similar, only one is normally considered. Even with the above limits on the quality of this parameter, it is however commonly used in quantifying commercial high quality sources.

The method of r.f. power spectrum measurement normally used^{1,2} consists of mixing two similar frequency sources and filtering out the noise components about zero frequency. These are analysed by means of a narrow band wave analyser or spectrum analyser. The results are corrected by multiplying individual component amplitudes by $1/\sqrt{2}$ to allow for the combination of the noise from the two sources.

A direct inter-relation between the r.f. power spectrum $S(f)$ and the resultant phase deviation follows from the definition of $S(f)$ derived in Appendix 1

$$S(f) = \left(\frac{\phi}{2}\right)^2 \text{ rad}^2 \text{ Hz}^{-1} \tag{5}$$

where ϕ is the resultant peak phase deviation. Also within the frequency domain, the two spectra $\Phi(f) \text{ rad}^2 \text{ Hz}^{-1}$ and $\dot{\Phi}(f) (\text{rad/s}^{-1})^2 \text{ Hz}^{-1}$ can be obtained by passing the signal $S(t)$ through either a phase or frequency detector respectively and measuring the resultant spectra. It can be shown¹ that the two spectra are related by the expression:

$$\Phi(f) = (2\pi f)^2 \dot{\Phi}(f) \tag{6}$$

Both of these are important in defining the noise behaviour of an equipment, as they enable individual noise components to be identified and measured.

In assessing the noise behaviour of a system it is convenient to be able to relate the manufacturer's quoted noise generated by station master oscillators, when published in the form of an r.f. power spectrum $S(f)$, and the noise spectrum of the total system measured as a spectral density of phase. Meyer³ has shown that for small phase noise disturbances

$$2S(f) = \Phi(f). \tag{7}$$

Hence for a practical system measurement, the contribution from the master oscillator and that from the rest of the system may be identified.

3.2 Time Domain

An ideal time-domain measurement of the phase or frequency instability of a test signal would consist of a comparison with a signal of identical mean frequency, but infinitely good frequency and phase stability. In practice, for a low instability signal, it is measured against a source of similar instability and the result corrected to that from a single source by multiplying the result by $1/\sqrt{2}$. More unstable signals are measured against a low instability source and the noise contribution of the latter neglected.

The result of such measurements may be recorded on a continuous timebase as the appropriate phase or frequency instability waveform. Alternatively some statistical measurement, such as standard deviation of frequency or phase, may be derived. Commercially available frequency sources often have their instabilities defined statistically in the time domain using the multiple period technique.¹ Here the test signal and the reference source, which are slightly offset in frequency from each other, are combined in a mixer. The resultant difference frequency contains all the instabilities of the test signal and source, but the increased deviation ratio simplifies the measurement. Repeated measurements are made of the time taken for a given number of cycles of the difference signal to elapse. From these results the standard deviation of the frequency is derived.

4 Proposed Method for Linear Frequency and Phase Instability Measurements

This enables the frequency and phase behaviour of single carriers in the frequency band 1 MHz to 500 MHz

to be measured with resolutions better than 0.1 Hz and 0.5 deg peak-to-peak respectively. The frequency reference is obtained from a high quality frequency synthesizer. The scope of this method is also extended to cover higher frequencies especially microwaves. The latter are translated to the above frequency band to be analysed by the basic equipment. At the centre of the method is a commercial vector voltmeter. This contains a counter-type phase comparator having the advantage of good linearity for phase displacements approaching ± 180 deg and rejection of amplitude variations of the test signal. This is preferable to a conventional mixer method^{1,3} since, although the amplitude variations can be suppressed by correct phasing of the two signals, the output has a cosine function. To measure phase disturbances $\Phi(f)$ at rates up to 0.5 kHz, the vector voltmeter comparator output circuit was modified to respond to the full bandwidth of the preceding i.f. amplifier. This modification, termed the phase unit, also includes circuitry for phase calibration and measurement of frequency instability $\Phi(f)$.

An immediate visual examination of the resulting phase or frequency noise in a signal can be made from a display on an oscilloscope against a known time-base, and in many cases a photograph of a single 'shot' trace has been found to be a satisfactory record of the phenomenon. For more detailed studies the noise can be recorded as a continuous waveform using a strip recorder. From such records the major noise components can often be identified. For accurate spectral measurement of all components reproduced, the data $\Phi(f)$ or $\Phi(f)$ can be analysed by the use of a spectrum analyser or suitably programmed computer.

5 Test Equipment for the Measurement of Phase and Frequency Instability

A laboratory instrument, used for accurate measurement of static phase displacement between a signal and a reference, is the Hewlett-Packard vector voltmeter type 8405A, which covers the range 1 MHz to 1 GHz. Its phase comparator, which operates at an intermediate frequency of 20 kHz, consists of a bistable circuit alternately switched by the two signals being compared. One of the comparison signals is internally delayed such that, when the two signals are in phase, the comparator produces a unity mark/space output waveform. Hence ± 180 deg phase shift is represented by either a permanent mark or space. Integration of the constant amplitude but varying mark/space output is a direct measure of the relative phase displacement.

The test equipment described in this paper consists of the above vector voltmeter modified to give a self-calibrating flat response to phase components up to 500 Hz from the test carrier. This instrument is used in conjunction with the Hewlett-Packard frequency synthesizer and driver type 5105A/5110B, to generate a low phase noise reference carrier. The long-term drift be-

tween the reference and the test carrier is stabilized by means of a control loop as detailed in Appendix 2. This enables the dynamic instability of sources in the range 1 MHz to 500 MHz to be measured. Extra 'add-on' units enable this range to be extended to s.h.f. with some deterioration in resolution.

The modification to the vector voltmeter consists of an extra plug-in printed circuit board, termed the phase unit, which is fitted within the instrument. This uses the spare 'edge socket' originally provided to stow the test extender board. The new board is powered directly from the instrument and the specification of the latter is not deteriorated in any way. The extra front panel controls required are mounted below the instrument on an extension of the original front panel.

The circuit diagram of the phase unit is shown in Fig. 1. The vector voltmeter phase comparator output, tapped off within the instrument, is buffered by TR1 and applied to the limiter TR4. The collector of TR4 switches symmetrically about earth between ± 8 V determined by the Zener diodes D2, 3, 4, 5. These potentials are heavily decoupled, as any supply line ripple at these points would be directly introduced into the following amplifier. These two potentials also correspond to ± 180 deg, hence the resistor network and press switches SW4-1/6 between R10 and R9 define levels corresponding to ± 90 , ± 10 and ± 1 deg. The dynamic phase noise, appearing as a varying mark/space waveform at the collector of TR4, or the above calibration levels, are selected by the switch SW1a for amplification and filtering. The following circuit consists of an active 4-pole Butterworth low-pass filter with gains of 0.5, 2, 10 or 100 selected by SW2. The filter half-power-point is at 500 Hz with a roll-off of 24 dB/octave to ensure that the comparator switching components are at least 60 dB down on the maximum excursion within the filter pass-band. The filter incorporates operational amplifiers using the technique proposed by Shepard.⁴ The first stage gives an overall voltage gain of two and provides a level shift control RVI. The latter enables small phase noise components, that are well displaced from zero static phase, to be moved into the linear region of the following amplifier. The level shift consists of a 'push-pull' emitter follower pair TR5 and TR6 fed from a multi-turn potentiometer connected between the supply rails. When the filter/amplifier is fed from the calibration levels as selected by SW1a, the level shift control is removed by SW1b, and the level returned to zero.

The phase unit also provides suitable interface circuitry for a first or second-order frequency/phase control loop in conjunction with the frequency synthesizer decade sweep oscillator. The signal at the collector of TR1 is an inversion of the comparator output. For a second-order loop this is integrated by the network R4, R5 and a suitable capacitor selected by the switch SW3 positions 1 and 2. For position 3 the capacitor is removed and the loop is of the first order. The practical values

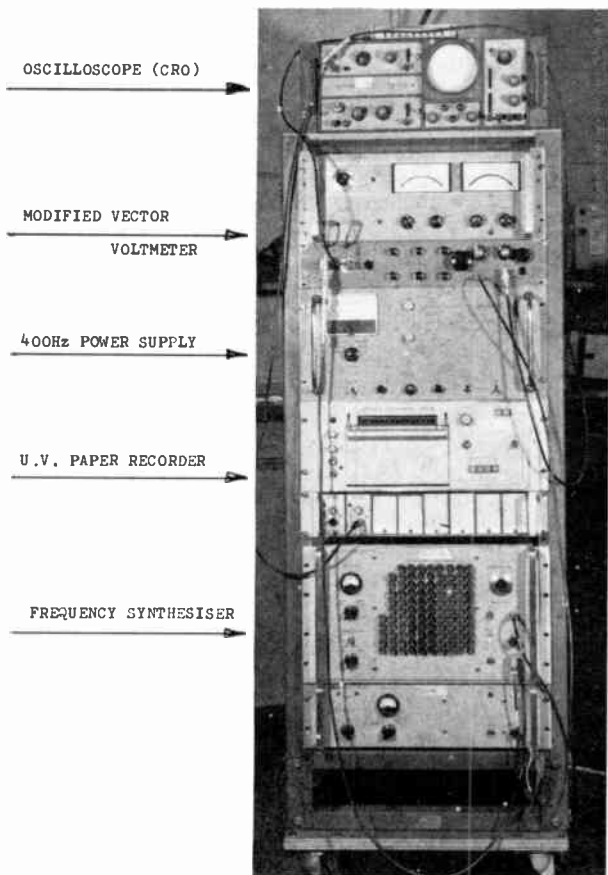

Fig. 3. Phase and frequency instability test rack.

(f) For a relatively stable test signal, the longest time-constant integrator is selected (SW3-1).

(g) Should the phase-noise level of the test signal be high, the loop bandwidth and gain is increased. The

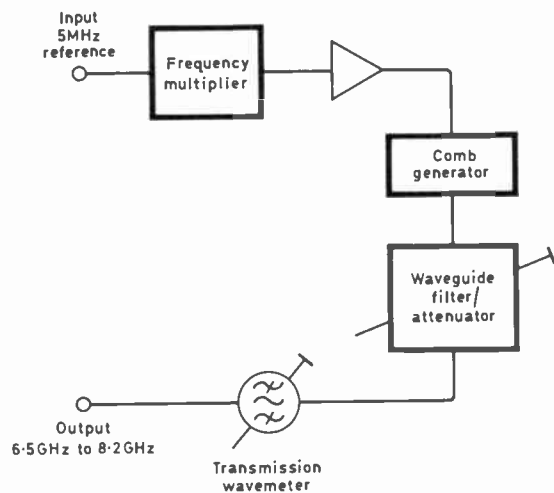

Fig. 4. Signal generator and receiver test unit.

synthesizer sweep oscillator is set to control the 100 Hz decade, and the loop integrator time constant shortened (SW3-2).

(h) The waveform now displayed on the c.r.o. is the resultant instantaneous peak-to-peak phase noise $\Phi_{(t)}$. The gain of the filter amplifier is increased as appropriate to improve the resolution. D.c. shifts introduced at the same time are corrected by means of the level control. For each change of gain the display is recalibrated as above with the ± 90 , ± 10 or ± 1 deg levels as appropriate, to ensure the absence of overload.

(i) For frequency instability measurement, the integrator capacitor is removed (SW3-3) and the loop gain increased by controlling the synthesizer 1 kHz decade with the sweep oscillator. The loop is now of the first order, and the frequency variation $\Phi_{(t)}$ of the test source is now indicated by the variation of the loop voltage recorded as shown in Fig. 2. In this case calibration is achieved by incremental offset of the synthesizer frequency output.

7 Additional Test Equipment for the Measurement of Phase Instability of S.H.F. Sources

Three additional units were developed to extend the range and versatility of the test equipment.

7.1 Signal Generator and Receiver Test Unit (Fig. 4)

This generates an s.h.f. source tunable in discrete steps over the required frequency band. It is produced by multiplication of a high-stability low-phase-noise source of 5 MHz. The resulting phase noise is directly related to the multiplication ratio (Appendix 3). This results in an s.h.f. source whose phase-noise amplitude is at best about 5 deg peak-to-peak. This generated output can be applied at a suitable level to the input of an s.h.f. receiver under test. The phase instability of the resulting receiver intermediate frequency can be measured using the v.h.f. test equipment previously described.

7.2 Transmitter Test Unit (Fig. 5)

With this unit the phase noise of an s.h.f. source can be measured. This and an 8.1 GHz signal from a frequency multiplier, similar to that used in the receiver test unit, are each mixed with a common frequency of 8.27 5GHz from a stable oscillator. The resulting v.h.f. components are in turn mixed with each other after amplification, to form a third intermediate frequency in the v.h.f. band. Since the mixing in each case is balanced, this final signal contains only the phase noise components of the s.h.f. signals. These may now be measured at the lower v.h.f. carrier frequency as before.

The phase-noise contribution of the above test units are measured by setting the output of the receiver test unit to 8 GHz and using it as an input for the transmitter test unit. Since the noise contributions of both units are

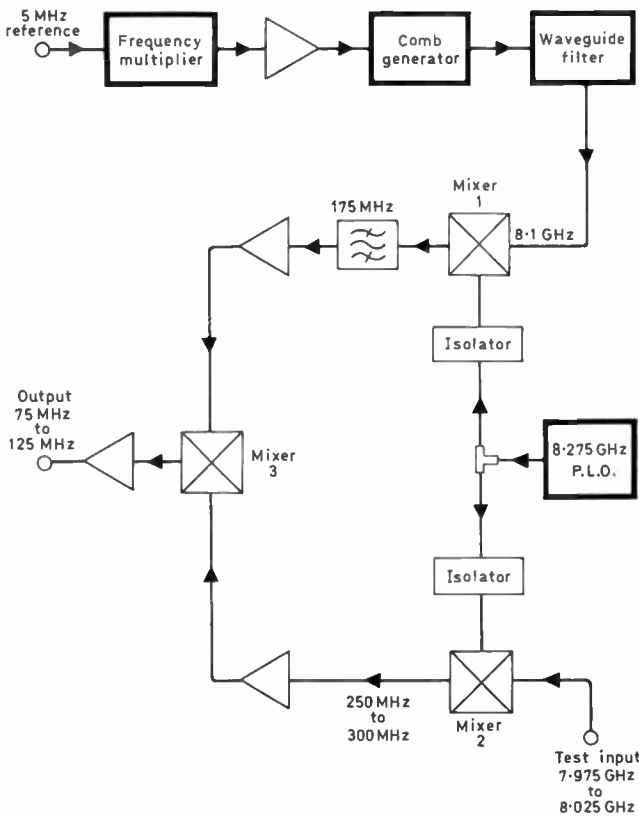

Fig. 5. Transmitter test unit.

similar, it can be assumed that each unit contributes half the total noise (Fig. 8).

7.3 S.H.F. Component Test Unit (Fig. 6)

This unit measures the phase noise generated by two-port devices such as s.h.f. amplifiers, attenuators etc.

An internal 375 MHz oscillator forms the reference frequency for the phase measuring equipment. This frequency is also mixed with a second 7.625 GHz oscillator to produce side-bands of 7.25 GHz and 8.0 GHz. These are selected by means of a waveguide switch and filters to form the nominal frequencies of the reception and transmission bands associated with some satellite ground stations. The appropriate signal is applied to the s.h.f. component under test. The resulting output, attenuated in the case of an amplifier, is remixed with the above 7.625 GHz oscillation to revert the former to 375 MHz. Again, due to the balanced configuration, this signal contains only the phase noise introduced by the test component which can be measured as before.

The residual noise introduced by this test unit is measured by substituting a short length of s.h.f. cable in place of the component under test, and making a phase-noise measurement as previously described (Fig. 9).

8 Examples of Phase and Frequency Instability Measurements

The recorder charts, Figs. 7 to 15, show a small selection of results obtained using the test equipment detailed in

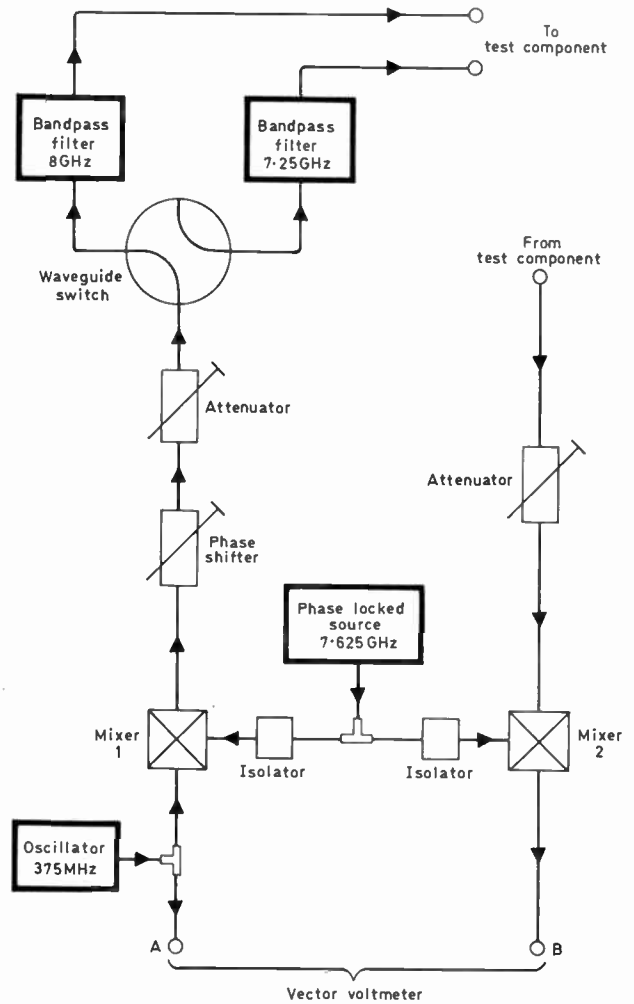

Fig. 6. S.h.f. component test unit.

this paper. To the left of each are marked the vertical calibration levels, in degrees for phase variation and hertz for frequency variation. The horizontal time scales are 0.1 sec and min. per division respectively. Two of the examples are of particular note. Figure 12 shows the phase-noise behaviour of an early cryogenic parametric amplifier, while Fig. 13 shows the greatly improved noise performance of a recent non-cooled development. Secondly, Fig. 15 demonstrates the frequency 'stepping' behaviour of a quartz crystal oscillator.

9 Other Uses of the Measuring Equipment

In the introduction to this paper there are mentioned several sources of phase disturbance in a complete Satcom system which cannot be measured in isolation, such as those due to the transmission path and the space vehicle. To estimate these effects a complete c.w. link is set up and the resulting phase or frequency variation of the received intermediate frequency measured. The phase-noise contribution of certain components in the link can now be eliminated by their measurement in isolation, as indicated previously, and by improvement in the link signal-to-noise ratio by increasing the transmitted power. Such a

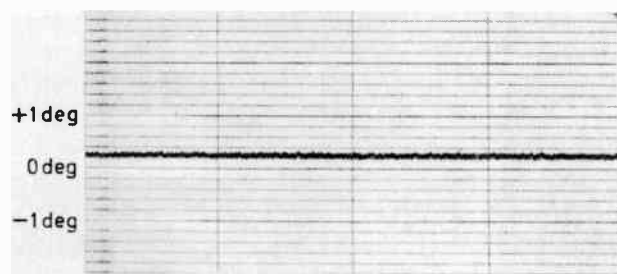

Fig. 7. Residual phase noise of the vector voltmeter at 100 MHz

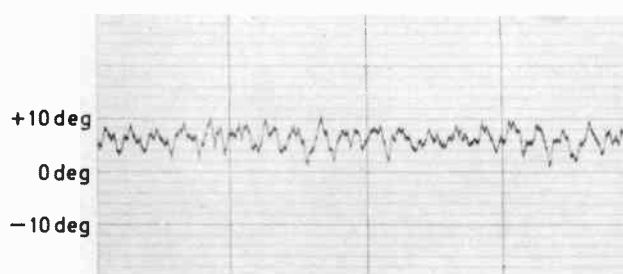

Fig. 8. Total phase noise of the receiver and transmitter test unit.

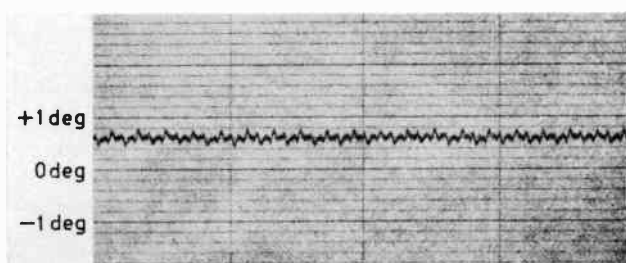

Fig. 9. Residual phase noise of the s.h.f. component test unit.

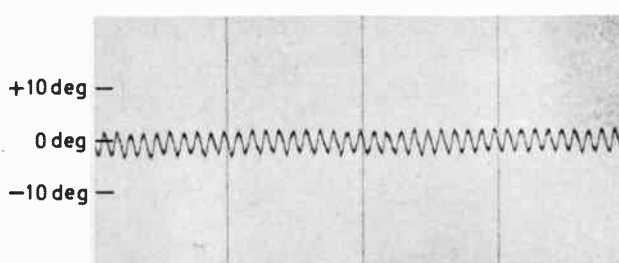

Fig. 10. Phase noise generated by a travelling wave tube driver amplifier at 8 GHz.

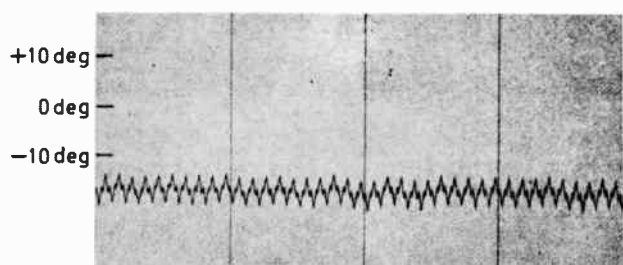

Fig. 11. Phase noise generated by a travelling wave tube driver amplifier and klystron at 8 GHz r.f. output 5 kW.

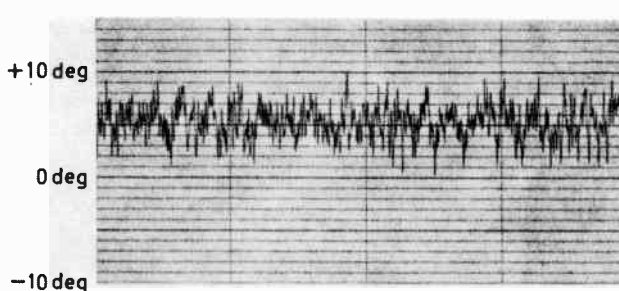

Fig. 12. Phase noise generated by a cryogenic parametric amplifier.

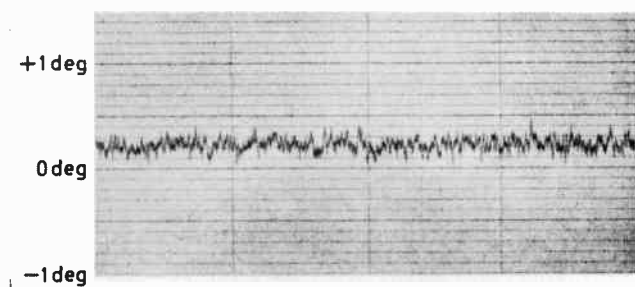

Fig. 13. Phase noise generated by a recently developed non-cooled parametric amplifier VX536 (SERL). Input -40 dBm at 7.25 GHz.

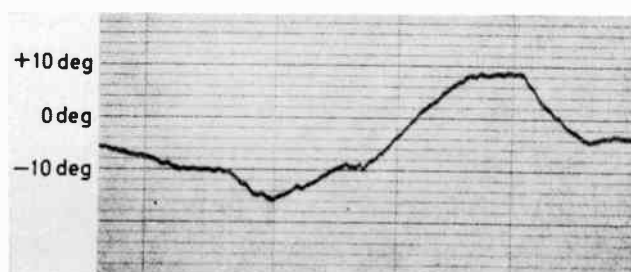

Fig. 14. Phase noise generated by a medium-quality ovened crystal oscillator oscillating at 100 MHz.

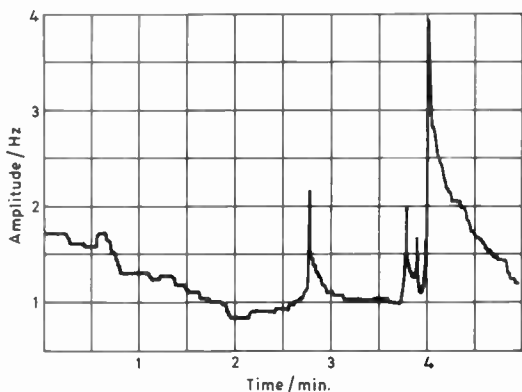

Fig. 15. Frequency instability of a medium-quality ovened crystal oscillator oscillating at 100 MHz.

system can now be used to study the Doppler effects introduced by the satellite movement as well as moving Earth station aerials. For ship-mounted stations these are slow but can be very large and are hence recorded as a frequency variation.

10 Limitations on the Measurement of Phase Noise

There are certain limitations in the use of the measuring equipment which must be considered if meaningful results are to be obtained. First, the resolution of the measurement is defined by the residual noise of the vector voltmeter used. With the instrument operating from a 400 Hz supply, this is less than ± 0.3 deg peak-to-peak (Fig. 7). Secondly, we must consider the phase instability of the reference frequency source used. With a high-quality frequency synthesizer as a reference source up to 500 MHz, the resulting phase noise contribution is of a similar magnitude to that generated by the vector voltmeter. Thirdly, where phase measurements are made on carriers above 500 MHz, and especially at microwaves, as detailed in Sections 7.1 and 7.2, the reference used is obtained by large multiplication of a low-frequency standard. Due to this multiplication the phase purity of the reference deteriorates as explained in Appendix 3. This is not the case with the measurement of noise introduced by s.h.f. components using the s.h.f. component test unit as detailed in Section 7.3. Here the true resolution of the vector voltmeter is also achieved.

Where the carrier to be examined is part of a wide spectrum of unrelated frequencies such as noise, the non-selectivity of the vector voltmeter input circuit must be considered. To make meaningful measurements under these conditions, the test signal must be passed through a bandpass filter to eliminate unwanted responses.

Finally, residual noise can be due to external earth currents injected into, and subsequently modulating, the test equipment via an earth loop. This can be overcome

by single-point earthing of the measuring equipment to the unit under test. Care must be exercised for personal safety when the earth link between the two is broken.

11 Conclusions

From the work in support of the development of communication satellite Earth stations, the author has found there is a continuing need for a relatively simple test equipment to measure phase instability close to the carrier, both at v.h.f. and at s.h.f. The equipment described in this paper has been used for such measurements over the past two years. It has been particularly useful in assessing microphony in frequency sources such as synthesizers, and phase disturbances in s.h.f. amplifier due to power supply ripple. S.h.f. power amplifiers rated at up to 5 kW and s.h.f. receiver amplifiers with noise temperatures down to 50 K have been measured for such noise by these methods.

12 References

- 1 Cutler, L. S. and Searle, C. L., 'Some aspects of the theory and measurement of frequency fluctuations in frequency standards', *Proc. IEEE*, 54, no. 2, pp. 136-54, February 1966.
- 2 Brandenberger, H., Hadorn, F., Ebauches, S. A., Halford, D. and Shoaf, J. H., 'High quality quartz crystal oscillators: frequency domain and time domain study', Proc. 25th Annual Symposium on Frequency Control, Fort Monmouth, N.J., USA, April 1971.
- 3 Meyer, D. G., 'A test set for the accurate measurement of phase noise on high-quality signal sources', *IEEE Trans. on Instrumentation and Measurement*, IM-19, no. 4, pp. 215-27, November 1970.
- 4 Shepard, R. R., 'Active filters: XII. Short cuts to network design', *Electronics*, 42, no. 17, pp. 82-92 August 1969.
- 5 Gardner, F. M., 'Phase Lock Techniques' (Wiley, New York 1966).

13 Appendix 1: Inter-relation between R.F. Power Spectrum $S(f)$ and the Resultant Phase Deviation

Consider a carrier which is shifted in phase by ϕ due to a noise frequency ω_n .

$$A = C \sin(\omega_n t + \phi) \tag{8}$$

Let ϕ be of the form $\phi \sin \omega_c t$ where ϕ is the peak phase deviation. Then

$$A = C \sin(\omega_c t + \phi \sin \omega_n t) \tag{9}$$

If the deviation is much less than 1 radian all side-bands greater than $\omega_c \pm \omega_n$ are negligible. Hence

$$\frac{A}{C} = \sin \omega_c t + \frac{\phi}{2} [\sin(\omega_c + \omega_n)t - \sin(\omega_c - \omega_n)t]. \tag{10}$$

By definition

$$S(f) = \left(\frac{\text{noise sideband amplitude}}{\text{carrier amplitude}} \right)^2 \text{ for a power spectrum}$$

From expression (10):

$$S(f) = \left(\frac{\phi}{2} \right)^2 \text{ rad}^2 \text{ in 1 Hz bandwidth} \tag{11}$$

14 Appendix 2: Measurement of Relative Phase Instability with Reduction of Phase Drift

The measurement of phase instability can be greatly simplified if the relative long-term drift between the source and the reference are reduced. This can be achieved by using a suitable low-frequency phase-locking loop. Since this loop must respond to the rate of change of drift between the sources, some attenuation of noise components close to the carrier will occur.

Consider the feedback network shown in Fig. 16.⁵

Let the phase detector gain factor be K_d V/rad. Therefore

$$v_d = K_d(\phi_1 - \phi_0) \tag{12}$$

The filter is of the form illustrated in Fig. 17.

$$F(p) = \frac{pCR_2 + 1}{p(CR_1 + CR_2) + 1} \tag{13}$$

where

$$CR_1 = \tau_1$$

$$CR_2 = \tau_2$$

$$\tau_1 + \tau_2 = T.$$

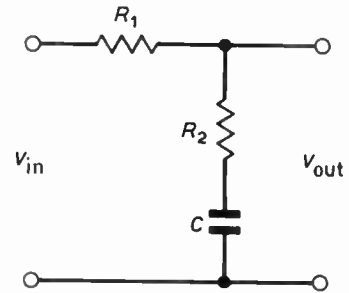

Fig. 17. Filter circuit.

The v.c.o. gain constant is K_0 rad $V^{-1} s^{-1}$. Therefore

$$p\phi_0 = K_0 v_2$$

$$p\phi_0 = K_0 K_d (\phi_1 - \phi_0) \frac{p\tau_2 + 1}{pT + 1} \tag{15}$$

From which the resulting phase noise becomes

$$v_d = \frac{K_d \phi_1 p(p + 1/T)}{p^2 + p \left(\frac{1 + K\tau_2}{T} \right) + \frac{K}{T}} \tag{16}$$

where $K_0 K_d = K$. This expression has poles at

$$-\frac{1}{2} \left(\frac{1 + K\tau_2}{T} \right) \pm \frac{j}{2} \left[\frac{4K}{T} - \left(\frac{1 + K\tau_2}{T} \right)^2 \right]^{1/2} \tag{17}$$

These must always lie in the second and third quadrant of the phase-locus plot and the loop, which is of the second order, must be stable for all practical values of $CR_1 R_2 K_0$ and K_d .

Solving for v_d :

$$\frac{v_d}{K_d \phi_1} = \exp \left[\frac{-(1 + K\tau_2)t}{2T} \right] \left\{ \frac{1 - K\tau_2}{[4KT - (1 + K\tau_2)^2]^{1/2}} \times \sin \left[\frac{K}{T} - \left(\frac{1 + K\tau_2}{2T} \right)^2 \right]^{1/2} + \cos \left[\frac{K}{T} - \left(\frac{1 + K\tau_2}{2T} \right)^2 \right]^{1/2} \right\} \tag{18}$$

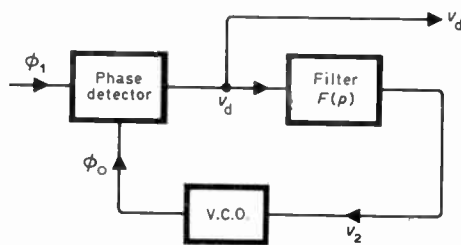

Fig. 16. Feedback network.

This lag-lead type filter enables the natural frequency (ω_n) of the system and the damping factor (η) to be separately designed.

Hence

$$v_2 = K_d (\phi_1 - \phi_0) \frac{p\tau_2 + 1}{pT + 1} \tag{14}$$

The v.c.o. gain constant for the frequency synthesizer (K_0) is inherent in its design and is quoted as

$$K_0 = \frac{2\pi}{10} \times 10^D \text{ rad } V^{-1} s^{-1} \tag{19}$$

where D is the index of the selected synthesizer decade.

The phase detector gain factor (K_d), due to the design of the phase unit, has a slope of $10/2\pi$ $V \text{ rad}^{-1}$ and is limited in range to fully-modulate any decade (D) of the synthesizer.

Hence

$$K_0 K_d = 10^D s^{-1}. \tag{20}$$

It can be shown that loop natural frequency⁵:

$$\omega_n = \left(\frac{K_0 K_d}{T} \right)^{1/2} \tag{21}$$

and damping factor

$$\eta = \frac{1}{2} \left(\frac{K_0 K_d}{T} \right)^{1/2} \left(\tau_2 + \frac{1}{K_0 K_d} \right) \quad (22)$$

Table 1

$f_n = 1/T$ Hz	$v_d/K_d\phi_1$ (theory)	$v_d/K_d\phi_1$ (practice)
5	0.74	0.8
10	0.87	1
100	0.99	1
500	1.00	1

To produce a flat well-damped response for v_d down to 10 Hz, let $\omega_n = 1$ rad/s, $\eta = 0.707$ and $D = 1$, i.e. $K_0 K_d = 10$.

From these, $T = 10$ s and $\tau_2 = 1.4$ s resulting in the required filter components as follows:

$$R_1 = 5 \times 10^4 \Omega, R_2 = 8.2 \times 10^3 \Omega \text{ and } C = 170 \mu\text{F}.$$

Hence, by substitution in (18),

$$\frac{v_d}{K_d\phi_1} = \exp(-0.75t) [\cos 0.66t - \sin 0.66t] \quad (23)$$

Calculating the relative phase-noise amplitude at various frequencies f_n gives the theoretical values in Table 1.

The validity of the above expression is confirmed practically as follows. The test input ϕ_1 is produced from a second frequency synthesizer which is angle modulated by the output from a low-frequency oscillator. Constant peak phase modulation is produced by adjusting the amplitude of the modulating signal to be proportional to its frequency over the range of interest. Practical phase measurements of this signal confirm the flat response of the test equipment to below 10 Hz as shown in Table 1.

As stated earlier, the effect of the above loop is to stabilize the mean level of the phase-noise waveform in the face of slow drift between the two compared sources. Suitable choice of filtering and damping, as calculated above, enables a compromise to be achieved between the wanted signal and the drift. For measurement of high stability, low-noise sources, the above loop parameters are suitable even when the sources are multiplied up to s.h.f. This gives good noise resolution down to 1 Hz and a level stability that contains the signal between the ± 10 deg calibration levels.

Many lesser-quality oscillator crystals suffer from 'stepping and phase walking' effects shown as sudden random changes in frequency. These are usually in the lower noise frequency range and cause transient misbehaviour of the loop. Such sources require a higher loop gain if the drift is to be contained between the limits of ± 180 deg. This is achieved by selection of the next higher synthesizer frequency decade ($D = 2$) and the filter components recalculated to maintain the optimum damping factor. To ensure a noise resolution below 10 Hz these are:

$$R_1 = 6 \times 10^4 \Omega, R_2 = 8000 \Omega \text{ and } C = 17 \mu\text{F}.$$

15 Appendix 3: Frequency Multiplication of Spectrally Impure Signals

Consider a phase modulated signal of the form:

$$A = C \sin(\omega_c t + \phi \sin \omega_n t) \quad (24)$$

On passing through a multiplier of power N :

$$A^N = K \sin^N(\omega_c t + \phi \sin \omega_n t) \quad (25)$$

This may be expanded to give the N th harmonic:

$$A_N = K_N \sin(N\omega_c t + N\phi \sin \omega_n t) \quad (26)$$

which shows that the peak phase deviation is also increased by a factor N . Again, assuming $N\phi$ small compared with 1 rad, a further expansion gives:

$$\frac{A_N}{K_N} = \sin N\omega_c t + \frac{N\phi}{2} [\sin(\omega_c + \omega_n)t - \sin(\omega_c - \omega_n)t] \quad (27)$$

(neglecting other terms)

By definition:

$$S(f) = \left(\frac{N\phi}{2} \right)^2 \text{ or } S(f)|_{dB} = 20 \log \frac{\phi}{2} + 20 \log N. \quad (28)$$

It should be noted that for cases where N is large, the value of $N\phi$ may not be small compared with 1 rad and the above approximation cannot be justified. In these cases further terms of the expansion of A_N/K_N must be included.

Manuscript first received by the Institution on 10th March 1978, in revised form on 5th October 1978 and in final form on 27th November 1978.

(Paper No. 1873/M110)

Experimental analysis of v.h.f. antennas for helicopter homing systems using scale-model techniques

M. S. SMITH, M.A., Ph.D., M.Inst.P.*

SUMMARY

The use of scale modelling for assessment of helicopter homing systems is described, including appropriate measurement techniques for different frequency bands. The interaction of the antennas with the metal fuselage is of primary importance, and this is illustrated in three different homing applications.

* Radio & Navigation Department, Royal Aircraft Establishment, Farnborough, Hants.

1 Introduction

1.1 Homing

Azimuthal or 'left-right' homing antenna systems operating in frequency bands between 30 and 400 MHz have been used on aircraft for some time. A typical requirement is for a facility to enable the pilot to home on to a ground transmission. As an example, the transmitter may be a distress buoy in the sea supporting a whip antenna (which could be tilted relative to the vertical). Ideally the homing system determines the direction of the transmitter to within a few degrees, and indicates to the pilot which way to turn the aircraft to head towards it. In some circumstances the final location of the transmitter cannot be made visually, and then an on-top or 'fore-aft' homing system is also required. Both left-right and fore-aft systems are considered in this paper.

1.2 Phase Comparison Systems

There are two main types of homing antenna system,¹ namely (a) phase comparison and (b) amplitude comparison. For (a) signals are obtained from a pair of antennas spaced by approximately a quarter wavelength; the antennas should ideally have identical radiation patterns which offer good coverage in the appropriate plane, either azimuth (for left-right) or pitch (fore-aft).

The antennas are spaced laterally for left-right and longitudinally for fore-aft homing. The design polarization is vertical for left-right homing, and vertical/horizontal in the pitch plane for the fore-aft case. Signals A and B from the two antennas are passed through a 90° 3 dB hybrid coupler, producing two outputs X and Y , where

$$X = \frac{1}{\sqrt{2}}(A + jB), \quad Y = \frac{1}{\sqrt{2}}(A - jB). \quad (1)$$

The homing indication is obtained by comparing the amplitudes of X and Y . In general the incident radiation comes from a direction θ, ϕ relative to the normal to the line joining the two antennas. The plane $\phi = 0$ is the azimuthal plane for left-right homing, and the pitch plane for fore-aft. In free space a pair of omnidirectional antennas with spacing $d = \lambda/4$ would produce outputs $X(\theta)$ and $Y(\theta)$ whose radiation patterns in the plane $\phi = 0$ are approximate cardioids.² Figure 1 shows the effect of varying the spacing d for a pair of such ideal antennas. The crossover of the two lobes provides the homing indication. If the two antennas are not omnidirectional but still have identical radiation patterns then the amplitude ratio (in dB) $|X| - |Y|$ will be the same as in Fig. 1. In practice the difference in position of the antennas on the aircraft fuselage causes deviations from ideal behaviour. Each antenna interacts with the airframe in a manner dependent on siting, and the radiation patterns of the antennas are not identical in amplitude or phase, causing errors in the homing indication such as

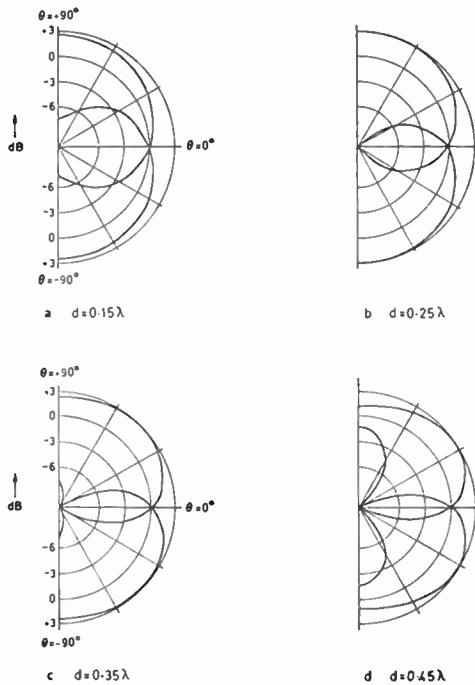

Fig. 1. Ideal homing patterns derived from two omni-directional antennas spaced a distance d apart and fed via a 90° , 3 dB coupler.

squints (bearing errors compared to the true direction) or multiple homing indications.

1.3 Amplitude Comparison Systems

An amplitude comparison system utilizes the fuselage interaction to shape the individual antenna radiation patterns into approximate cardioids, for example by placing the two antennas in symmetrical positions to the left and right of the aircraft (for left-right homing). In this case the radiation pattern shapes are a complex function of wavelength and of the geometry of the antennas and airframe, and empirical optimization may be required. For fore-aft homing there is not usually the appropriate airframe symmetry for amplitude comparison.

1.4 Applications

The frequency bands considered in this study are (a) 135–175 MHz and (b) 30–75 MHz. Larger helicopters have lengths of about 15 m, which is (a) ~ 7 or 8λ , (b) 1.5 to 4λ . The helicopter width and height are about 2.5 m, which is (a) ~ 1 or $1\frac{1}{2}\lambda$, (b) $\frac{1}{4}$ to 0.6λ . The interaction of the antennas with the fuselage consequently differs appreciably between the two bands. Three applications are described, (i) left-right homing, 135–175 MHz, (ii) left-right homing, 30–75 MHz and (iii) fore-aft homing, 135–175 MHz. Section 2 discusses the different measurement techniques required for each case, and some examples of the results obtained are presented in Section 3. Finally a general discussion is given of the homing antenna problem.

2 Measurement Techniques

2.1 Scaling Factors

Scale models have been used previously for aircraft antenna work, for example 1/30th scale for h.f. communications antennas.^{3,4} The choice of scaling factor for different applications is usually a compromise between several conflicting requirements. The smaller the model is made, the more difficult it is to reproduce detailed features accurately, to make connections to antennas and to house equipment such as oscillators or hybrid couplers inside the model. When phase comparison is used small errors in modelling can introduce appreciable phase errors which will affect the homing radiation patterns. Opposing this are the cost of manufacture and, more importantly, the accuracy of the radiation pattern measurements. The higher the frequency of operation (the frequencies used are scaled up as the size is scaled down), the more directive are the available receiving antennas, and this minimizes effects such as ground reflections on a horizontal measurement range.

A scaling factor of 1/6th was chosen in this case, and a detailed model of a large helicopter constructed with a wooden framework clad with copper sheet. Gaps in the metal cladding were used to simulate windows, etc. A wooden mount was used to fix the 90 kg model on top of a retractable fibre glass pole, shown in Fig. 2. The fibre glass pole is a hollow tube capable of supporting models up to 250 kg in weight. The wooden mount attaches to the model aligned with its centre of gravity on the side remote from the antennas, and it is varnished to prevent the ingress of moisture. Possible pattern errors due to the presence of the mount and the pole should thus be minimized.

The scaled frequency ranges become (a) 800–1050 MHz, (b) 180–450 MHz. The smallest antenna used has a scaled height of 2 cm, and pairs of antennas could be made using printed circuit techniques. At 1000 MHz a length error (for example in the antenna leads to the hybrid coupler) of 1 mm would produce a 1° phase error; the lead lengths were checked electrically to be equal to at least that accuracy.

Other scale factors could be used, and in particular for frequency band (b) a smaller model could certainly be used with consequent simplification of the measurement technique (Sect. 2.3). This would however require two models rather than one.

2.2 Measurement Method, 800–1050 MHz

A horizontal measurement range of length 80 m was used for frequency band (a) 800–1050 MHz, and the arrangement is shown in Fig. 3(a). Radiation patterns were measured by transmitting from the antennas under test; by reciprocity they should be identical for reception. A double-screened cable is used to pass the r.f. signal from a transmitter at the ground up the pole and into the model, entering from the opposite side to the antennas. The signal is passed through a 6 dB attenuator into one

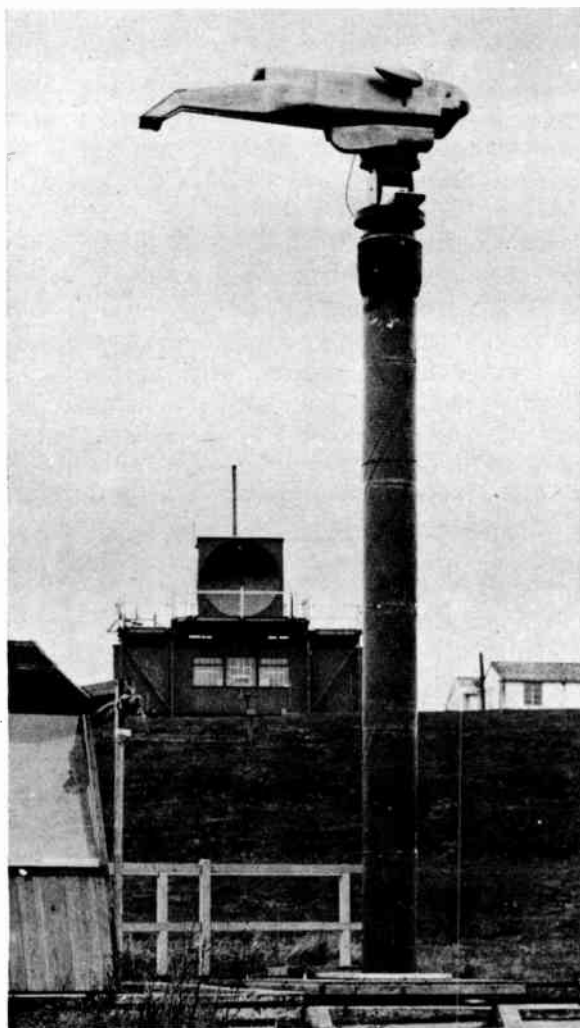

Fig. 2. The 1/6th scale helicopter model on the fibre glass pole elevated to half full height.

input of a 90° 3 dB hybrid coupler (for phase comparison) or directly into one antenna (for amplitude comparison). The other input port is terminated in 50Ω . The input connections are interchanged to give the second homing lobe. For phase comparison two equal-length cables connect the outputs of the coupler to the two antennas.

The fibre glass pole is rotated in synchronism with a polar plotter at the receiver to record the radiation pattern. For plots in the azimuth plane the helicopter is mounted upside down; for plots in the pitch plane (fore-aft homing) it is mounted on its side. The receiving antenna is a $\lambda/2$ dipole in a 3 m dish, and this has a $6^\circ/9^\circ$ beamwidth (for horizontal/vertical polarization) at 1000 MHz. The ground reflection angle is $\sim 15^\circ$ from the horizontal, so that good discrimination against a ground reflected signal is obtained.

2.3 Measurement Method, 180–450 MHz

For lower frequencies, band (b), we can expect a strong ground reflection with the above arrangement, and so a reduced length (20 m) range with a three-element Yagi

receiving antenna was used, shown in Fig. 3(b). For these frequencies, a self-contained r.f. oscillator was available and this was placed inside the model. The antennas used were electrically short and hence inefficient radiators, so that any spurious signals from external cables could interfere with the measurements.

The model length is 2.4 m, and a 20 m range length is the shortest which can be employed without introducing excessive near-field errors into the radiation patterns. (The Rayleigh distance at 450 MHz is 20 m, and the semi-angle subtended by the model is ~ 0.1 radians at 20 m.) Such errors may be 'traded off' against errors due to the ground reflected signal. Several tests were made of the measurement accuracy with this arrangement.

The first test was to measure signals from a test dipole which produces harmonics of 60 MHz.³ The relative signal level received with the dipole either (i) vertical, or (ii) horizontal and pointing at the Yagi antenna, can be used to deduce the strength of the ground reflected signal. This was found to be 20 dB down for vertical polarization. For left-right homing we also wish to measure partly cross-polarized signals, and so the dipole was tilted at 45° and rotated from being parallel to the Yagi (also tilted at 45°) to being perpendicular to it. The ground reflection has roughly the opposite 45° polarization for this angle of incidence and its strength

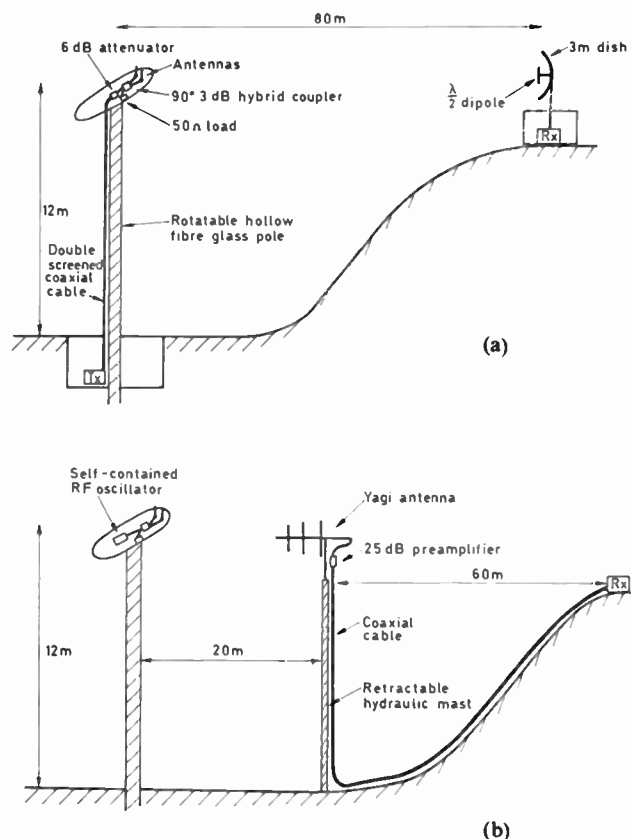

Fig. 3. Measurement ranges employed for: (a) 800–1050 MHz; (b) 180–450 MHz.

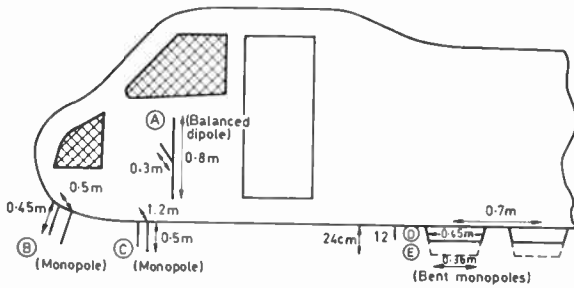

Fig. 4. Antenna siting on the helicopter model.

is given approximately by the perpendicular measurement. This was found to be ~ 17 dB down.

The second test was to alter the range length by several metres (or the range height by $\sim \frac{1}{2}$ metre), and then to repeat the measurements made on the actual helicopter model. The relative phase of the direct and indirect signals is then altered and the ground reflection effect assessed. The radiation patterns obtained were closely comparable at each of five frequencies used through the band; for example, the squint angles measured (see Figs. 7 and 8) were found to be accurate to within 2 or 3°.

2.4 Antenna Types and Siting

Three different homing applications were investigated,

and the various antennas and their sites on the helicopter are shown in Fig. 4. Antennas A and B are for left-right homing at 135–175 MHz. Antennas A are balanced dipoles placed on either side of the helicopter to provide an amplitude comparison system. Antennas B are a pair of $\lambda/4$ monopoles spaced by $\sim \lambda/4$ to give a phase comparison system.

The antennas C are a pair of electrically short monopoles acting as a phase comparison system for left-right homing between 30 and 75 MHz. A 50 Ω resistor in parallel with each antenna provides a reasonably matched load for the hybrid coupler. The antenna spacing (1.2 m full scale) varies from $\sim \lambda/8$ to $\sim \lambda/3$ through this band. It should be noted that the results (Sect. 3.2) indicate a poor homing performance.

Antennas D and E are both bent monopoles, either 12 \times 42 cm or 24 \times 36 cm respectively. Either type is used in a phase comparison system for fore-aft homing at 135–175 MHz.

3 Results

3.1 Left-right Homing, 135–175 MHz

Two options with acceptable homing properties were established for left-right homing in the band 135–175 MHz. Figures 5 and 6 respectively show radiation patterns in the azimuth plane at 155 MHz for antennas A (amplitude comparison) and B (phase comparison), as

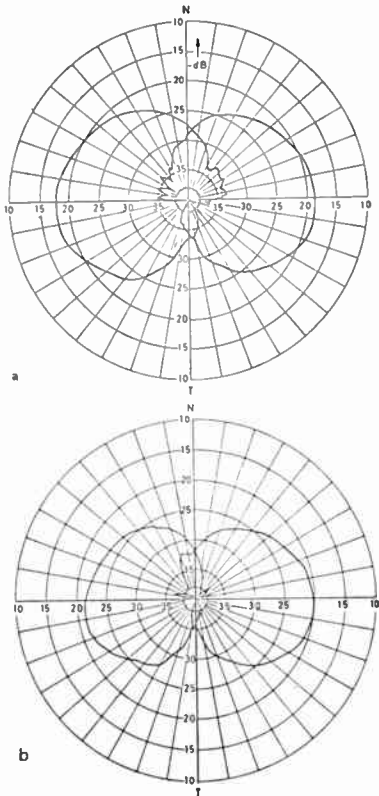

Fig. 5. Results for antennas A at 155 MHz (full scale frequency) with: (a) vertical polarization; (b) 45° cross polarization.

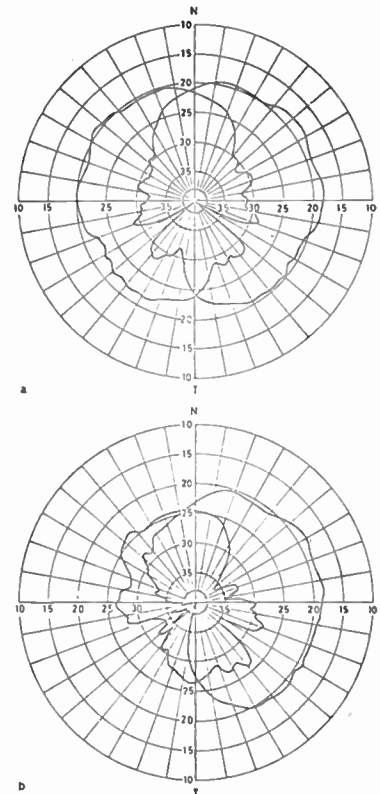

Fig. 6. Results for antennas B at 155 MHz with: (a) vertical polarization; (b) 45° cross polarization.

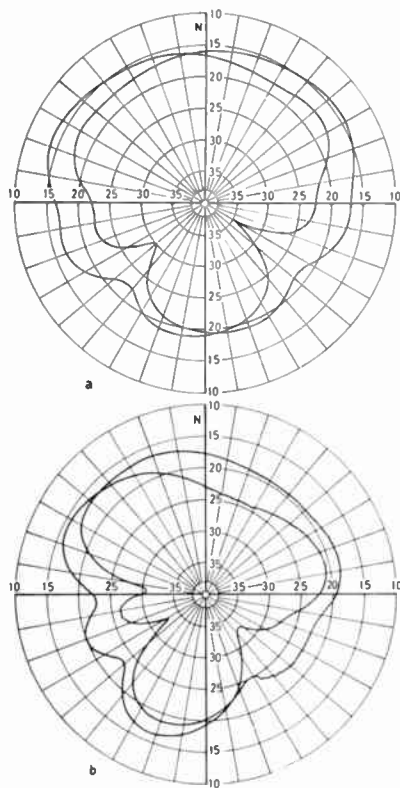

Fig. 7. Results for antennas C at 30 MHz with: (a) vertical polarization; (b) 45° cross polarization.

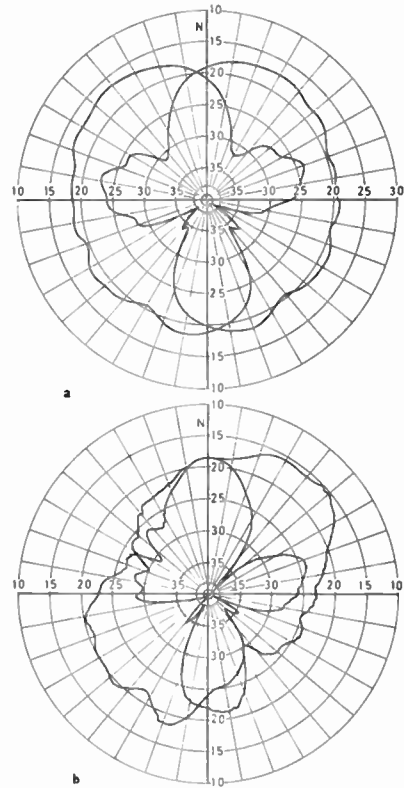

Fig. 8. Results for antennas C at 75 MHz with: (a) vertical polarization; (b) 45° cross polarization.

in Fig. 4. The performance against partly cross-polarized signals is an important factor in the assessment, and both systems retain an unambiguous crossover close to the nose (N) direction when the polarization is changed from vertical to 45°. The discrimination between the lobes is distinctly better for system A; for system B the airframe excitation degrades performance under cross-polarized conditions. The positioning of the dipoles A is of crucial importance to obtain the right lobe shapes; for example a position further back along the side gives insufficient forward coverage.

3.2 Left-right Homing, 30–75 MHz

A possible antenna system (antennas C) for left-right homing in the band 30–75 MHz was evaluated on the helicopter model. Radiation patterns in the azimuth plane for 30 and 75 MHz are shown in Figs. 7 and 8. Acceptable homing patterns are obtained for vertical polarization, but the results for 45° cross polarization show large squints in the homing indication.

The antennas are mounted on an electrically small ground plane (the helicopter underside), and the difference in position of the two antennas (each is halfway from the centre line to either edge of the helicopter underside) means that their ground planes are asymmetric with opposite senses. Under these conditions the two individual antenna radiation patterns will contain large horizontally-polarized components with opposite phases.

This causes the poor homing radiation patterns observed for 45° cross polarization. For this case measurements were made both with and without the helicopter rotor blades (each 9 m long full-scale) and qualitatively similar results were obtained.

Modulation of the radiation patterns by the helicopter rotors can occur;⁵ however the sampling rate of the homing receiver is relatively high, and the meter response time is relatively long, so that the modulation effects tend to be averaged out.

3.3 Fore-aft Homing, 135–175 MHz

Two antenna designs were compared for a phase comparison system for fore-aft homing, antennas D and E in Fig. 4. The centre-to-centre spacing of the antennas is $\sim \lambda/3$; this gives a sharper cross-over of lobes compared to a $\lambda/4$ spacing, at the expense of introducing small side-lobes (e.g. Fig. 1(c)).

Radiation patterns in the pitch plane and with pitch plane polarization (horizontal in the measurements) are given as Figs. 9(a) and 10(a). Measurements were also made with the model rotated through 20° in the roll plane, to simulate a flight path going past rather than directly over a ground transmitter, and for various signal polarizations. Figures 9(b) and 10(b) show results for this case with 45° polarization.

The longitudinal excitation of the airframe, which is 7 or 8 wavelengths long, produces interference effects in

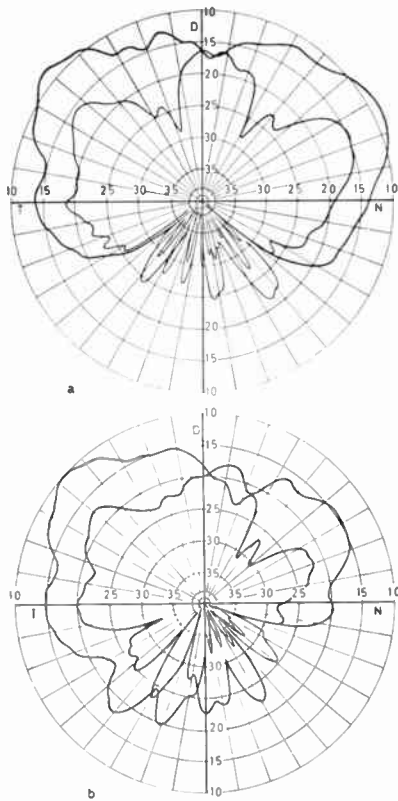

Fig. 9. Results for antennas D at 155 MHz with: (a) pitch plane, pitch polarization; (b) 20° plane, 45° cross polarization.

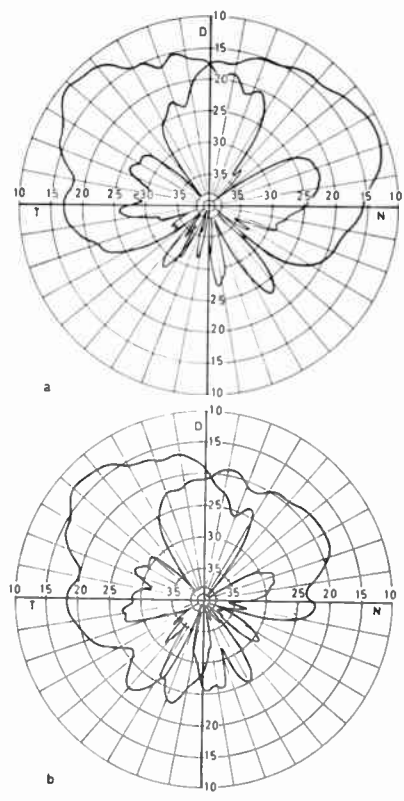

Fig. 10. Results for antennas E at 155 MHz with: (a) pitch plane, pitch polarization; (b) 20° plane, 45° cross polarization.

the antenna radiation patterns. As the two antennas are spaced longitudinally by $\sim \lambda/3$, the effects differ between them, and the resulting homing lobes show the interference (Figs. 9, 10). This can produce squints in the homing indication relative to the down (D) direction. Antennas D and E are both bent monopoles with similar relative horizontal/vertical coverage. The interference effects are considerably reduced for the taller antenna E, producing smaller squints (compare Figs. 9 and 10). The major difference between D and E is their intrinsic efficiency-bandwidth product; the radiation resistance of E is ~ 4 times greater than that of a simple bent monopole the size of D. The antenna D was in fact folded to give a better impedance match at mid-band, but this does not alter the radiation pattern characteristics significantly.

3.4 Full-scale Trials

A short flight trial using full-scale antennas, types B and E, has been carried out against a ground beacon. Left-right homing patterns were obtained measuring meter deflection against bearing, while flying over a fixed reference point. Fore-aft patterns were assessed qualitatively by flying over the beacon and observing the meter indication. In both cases the homing accuracy was of the same order as that predicted from the model measurements.

4 Discussion

The overall performance of an airborne homing system is limited by that of the antennas fitted to the airframe. The individual radiation patterns of the (two) antennas determine this performance, and these are dependent on (i) antenna design, (ii) the airframe geometry and size (relative to the wavelength) and (iii) the antenna siting. For phase comparison systems we require the two antennas to be placed $\sim \lambda/4$ or $\lambda/3$ apart and to have closely similar radiation patterns; for amplitude comparison we require 'left-hand' and 'right-hand' cardioid-like patterns. In both cases the airframe geometry and size form a basic limitation, but antenna design and siting can still be optimized according to certain criteria which are now discussed.

4.1 Amplitude Comparison

Amplitude comparison systems (e.g. antennas A) are highly installation dependent and must be carefully tailored to suit the individual airframe and frequency range. For left-right homing their essential feature is (vertical) polarization purity, so that a balanced antenna is normally required. For a balanced dipole on the side, the aircraft 'height' needs to be $\geq \lambda$ so that the airframe acts as a reflector to give a cardioid-like radiation pattern. The antennas should be placed about a wavelength back

from the nose, spaced by $\sim \lambda/4$ ($\lambda/6$ was used for A above) from a clear metal area on the side of the aircraft. At low frequencies (30–75 MHz), vertical rail antennas have been used for amplitude comparison.¹

4.2 Phase Comparison

Phase comparison systems for left-right homing (antennas B and C) can degrade badly for partially cross-polarized signals if the interaction of the antennas with the airframe is strong. Usually the antennas are attached directly to the airframe (straight or bent monopoles are fed against it), and the airframe is a limited ground plane. It may be regarded partly as a counterpoise to the monopole and partly as an antenna itself. The relative magnitude of these two roles depends on the airframe size in wavelengths. In most cases the latter action is detrimental to the homing antenna performance and an antenna with a relatively low radiation resistance will be most strongly affected by it. The antennas used should therefore have an intrinsically high radiation resistance. Tuning (or folding) an electrically small antenna does not circumvent the 'airframe interaction' problem.

For vertical polarization the left-right symmetry of the airframe helps to preserve homing pattern symmetry, but the inevitable lateral asymmetry (due to the antenna spacing of $\sim \lambda/4$) introduces a horizontally-polarized component into each antenna radiation pattern. For partial cross-polarization this can cause degradation of the homing radiation patterns. The relative magnitude of this component depends on the intrinsic radiation efficiency of the antennas (as above) and on the airframe width in wavelengths. For antennas B ($\lambda/8$ long) this width is 1λ to $1\frac{1}{2}\lambda$, while for C ($\lambda/20$ – $\lambda/8$ long) it is $\lambda/4$ to 0.6λ . The two antennas are also closer together for B than for C. In the former case the partially cross-polarized degradation is fairly small (Fig. 6), but in the latter case it is a serious problem (Figs. 7 and 8).

One way of minimizing the airframe interaction in the 30–75 MHz band is to detach the antennas from the airframe as much as possible. Balanced dipoles (1.3 m long) on the nose of a small helicopter have been used for phase comparison left-right homing, using this principle.¹

For fore-aft homing it is the longitudinal airframe excitation which limits the homing performance, with degradation occurring just as much for the wanted polarization as for partial cross-polarization. Making the antennas intrinsically efficient and allowing them as large a clear area of ground plane as possible then gives optimum performance.

5 Acknowledgments

The author would like to thank Mr. L. Earl and Mr. A. A. Hamshere for constructing the helicopter model and providing technical support at the measurement site.

6 References

- 1 Pavey, N. A. D., 'Design and performance of helicopter homing aerial systems for the band 30 to 76 MHz', unpublished MOD(PE) report (1977).
- 2 Kraus, J. D., 'Antennas' (McGraw-Hill, New York, 1950).
- 3 Smith, M. S. and Nichols, D. E. T., 'Design and performance of a vertical range for antenna radiation pattern measurement using aircraft scale models', *The Radio and Electronic Engineer*, 48, pp. 209–14, 1978.
- 4 Pavey, N. A. D., 'Radiation characteristics of h.f. notch aerials installed in small aircraft', Proc. AGARD Symposium on Antennas for Avionics, Munich, 1973.
- 5 Langrish, W. W. and May, D. P. L., 'Helicopter rotor-produced modulation and aerial field distribution in the band 30 to 76 MHz', R.A.E. Technical Report. TR 74032 (1974).

*Manuscript first received by the Institution on 29th September 1978 and in final form on 10th January 1979.
(Paper No. 1874/AMMS 91)*

Microprocessor implementation of tactical modems for data transmissions over v.h.f. radios

B. H. DAVIES, Ph.D., B.Sc.*

and

T. R. DAVIES, B.A.*

Based on a paper presented at the IERE Conference on Radio Receivers and Allied Systems held at Southampton from 11th to 14th July 1978.

SUMMARY

The advent of the single-chip microprocessor has made possible the use of digital signal processing in low-cost communications circuitry. The all-digital approach has been used in a high-performance data modem for the transmission of burst messages through the voice channel of v.h.f. narrow band f.m. radio sets. The techniques used in this novel design of software modem are illustrated by reference to the version using coherent quadrature phase shift keying (q.p.s.k.) modulation and constraint length 48 convolutional encoding with sequential decoding.

* Royal Signals and Radar Establishment, Leigh Sinton Road, Malvern, Worcestershire WR14 1LL.

1 Introduction

In recent years both military and civil communicators have considered the idea of providing for transmission and reception of digital information over existing v.h.f. radio sets. It is important to emphasize that this digital facility may be additional to the presently available voice links. Two main advantages accrue from digital information transmissions:

- (i) A great reduction in air time is achieved because the redundancy of the spoken word is eliminated.
- (ii) Automatic data processing may be applied at the receiving station thus ensuring that messages obtain correct priority of handling and do not get mislaid.

This paper describes the basic techniques used in a novel design of 'software' modem for the transmission and reception of burst messages via v.h.f. radios. It does not consider the protocols required for a mixed data/voice net radio system. A key result of the work is that by opting for an all-digital implementation sophisticated modulation and coding techniques may be employed that would not be economically feasible in a hard-wired form.

2 Design Considerations

The following design considerations evolved during the initial period of the project.

- (1) The modem is to work well when operating through an ordinary voice channel v.h.f. radio (baseband 350 Hz to 3.2 kHz) bearing in mind that there are wide limits on the frequency response and that the group delay characteristics are undefined and vary from set to set. These properties are likely to pertain to any set which was designed for voice only.
- (2) Due to the flexibility of a completely microprocessor based unit, it is possible to offer a number of modulation schemes. Not only standard schemes such as coherent q.p.s.k. but also multi-subcarrier schemes with up to eight subcarriers in the audio band have been developed in the first stage of the project.
- (3) The use of forward error detection and correction (f.e.d.c.) to achieve the desired undetected error rate and eliminate errors due to impulsive interference is essential if the user is to have any faith in the validity of the received messages. Interleaving to a sufficient depth must be employed so that the performance of the error protecting code is not degraded by error bursts on the link.
- (4) Easements arising from the burst nature of the messages to be transmitted by the modem would be taken into account. For example, a number of symbols may be appended to the beginning of the message for symbol synchronization. Because the receiver must be capable of storing a complete message, the f.e.d.c. decoding may be performed after the receipt of the message without real time constraints.

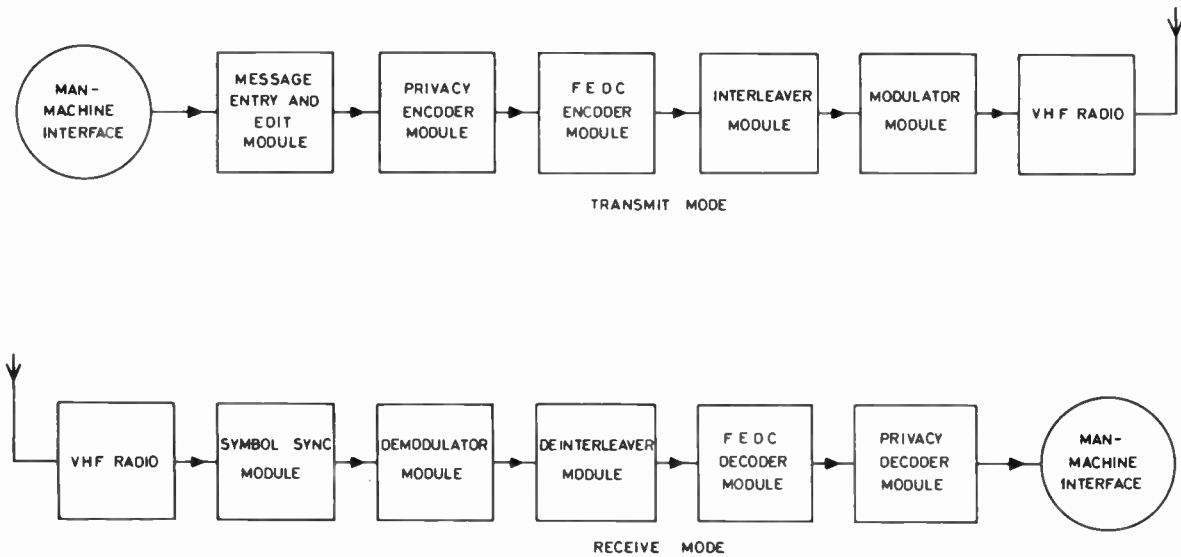

Fig. 1. Block diagram of functional modules of tactical modem.

(5) A privacy scheme involving a non-linear transformation of the digital bit stream would be offered as an optional extra. This is similar in form to a scheme proposed by IBM for security in large computer installations.

(6) A fixed length 1024-bit message protected by a half-rate code would be transmitted over the air at 1200 bits/second.

A block diagram of the functional modules of the modem is shown in Fig. 1.

With the increasing speed, decreasing size and power consumption coupled with the falling costs of digital technology, a microprocessor based implementation is both logistically attractive and convenient for development. The idea that all the functions of the modem

should be carried out by the microprocessor was stimulated by the following facts.

- (a) A large percentage of the costs of military hardware is often due to the fact that it contains many specialized components developed solely for that piece of equipment.
- (b) Many single-chip processors and their associated circuitry are currently available in military versions (e.g. Ferranti F100L and Texas SBP 9900).
- (c) All modules of the modem would be modifiable in the field by simply changing the p.r.o.m. card.

A block diagram of the hardware is shown in Fig. 2. A Plessey MIPROC was used initially to develop four modulation/demodulation schemes, and also two coding

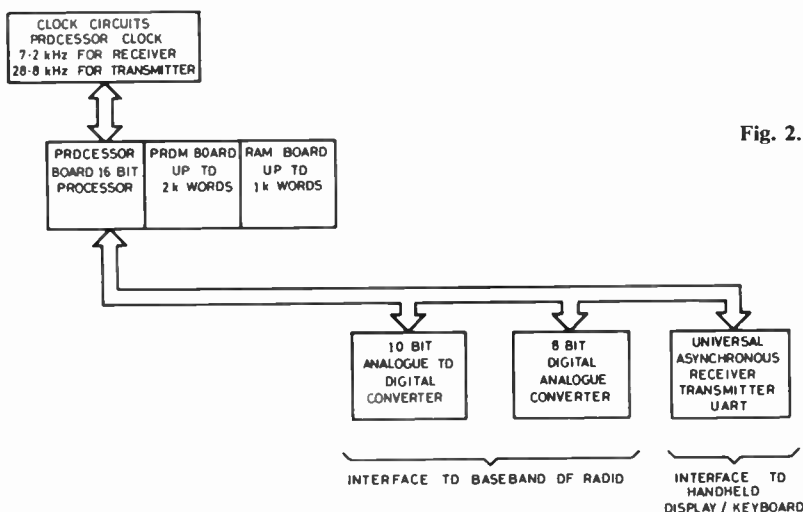

Fig. 2. Block diagram of hardware for tactical modem.

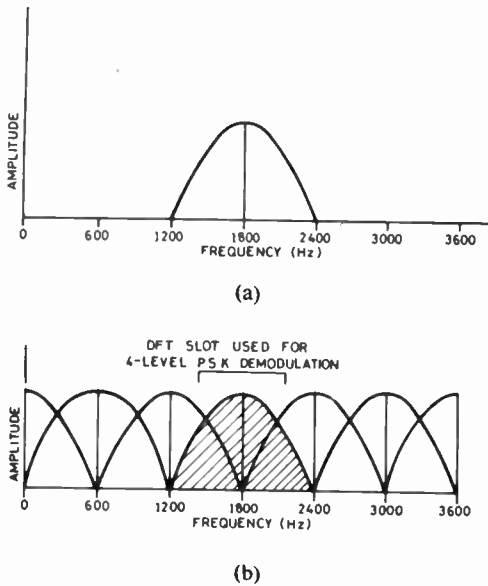

Fig. 3. Transmitted spectrum and discrete Fourier transform response.

schemes, a (127, 64, 7) block code and constraint length 48 convolutional encoding with sequential decoding. Due to its excellent performance and low processing power requirements, 4-level p.s.k. lends itself to a low-power high performance modem using a single-chip microprocessor, the Texas TMS9900.

3 Techniques

The software structure of the modem is based upon the functional modules being written as subroutines and interrupt service routines, overall task command being made by a round-robin scheduler. The techniques used in the main functional modules are described below.

3.1 Modulation

The modulation method employed in the modem is coherent 4-level or quadrature phase-shift keying of an 1800 Hz carrier at a symbol rate of 600 per second. Provided that coherent detection is used, this gives the same performance against white Gaussian noise as 2-level p.s.k., but occupies half the bandwidth. The bandwidth to the first zeros is 1200 Hz (Fig. 3(a)) and the transmitted spectrum is therefore well clear of the ill-defined band edges.

One cycle of the 1800 Hz carrier is stored as 16 digital samples, and three cycles are output to a digital to analogue converter for each symbol, the starting point, and hence phase, being determined by the particular pair of bits represented by that symbol. Each message is preceded by a synchronization preamble of phase reversals, and a 32-bit pattern used to establish the start-of-message and the focal point of the interleaving.

3.2 Demodulation

The signal processing technique used for demodulation

is the discrete Fourier transform (DFT). A twelve-point transform is used with a sampling rate of 7200 per second, giving an amplitude response as a function of frequency as shown in Fig. 3(b). The response of the 1800 Hz slot matches the spectrum of the transmitted signal, and may be arranged to perform matched-filter detection.

The general form of the DFT is given by

$$X_k = \sum_{n=0}^{n=N-1} x_n \exp \left[-j \frac{2\pi nk}{N} \right] \quad (1)$$

where x_n are the waveform samples periodic in N , and X_k is the contribution from the k th frequency slot. With a sampling rate of 7200 per second, we have for the 1800 Hz slot:

$$N = 4k \quad (2)$$

$$\begin{aligned} X_{N/4} &= x_0 - jx_1 - x_2 + jx_3 + \dots + jx_{11} \\ &= R_{rec} + jI_{rec}. \end{aligned} \quad (3)$$

The 1800 Hz phasor is therefore produced using only twelve additions. It is compared with a reference to determine its phase relative to that of the reference, and so complete the demodulation process. The reference is continuously updated, it being formed from the phasors of the previous 32 symbols having first removed the modulation. The phasors are integrated by a 'leaky integrator', which has the characteristics

$$A(n+1) = \alpha A(n) + a(n+1) \quad (4)$$

where $a(n+1)$ is the new contribution, $A(n)$ the existing sum, and $\alpha = 31/32$.

3.3 Synchronization

The requirements of the synchronization section are:

- (i) To ensure that the 12 samples upon which a DFT is performed during demodulation all pertain to one symbol.
- (ii) To establish the reference phasor.
- (iii) To indicate the start of the message, and hence the focal point of the interleaving.

With a waveform of phase reversals, when a DFT as for demodulation is performed on successive groups of twelve consecutive samples (one new sample brought in, the first one dropped off for each DFT) the magnitude of the phasor as a function of time is a triangular wave as shown in Fig. 4. The peaks of this waveform then give the correct synchronization instants.

The DFT of a set of samples shifted by one is related to the DFT before the shift by

$$X_k(n+1) = X_k(n) \exp \left[-j \frac{2\pi nk}{N} \right] \quad (5)$$

so in the case of $N = 4k$

$$\begin{aligned} R_{rec}(n+1) + jI_{rec}(n+1) &= I_{rec}(n) + \\ &+ j[R_{rec}(n) + x_{n+1} - x_{n-11}] \end{aligned} \quad (6)$$

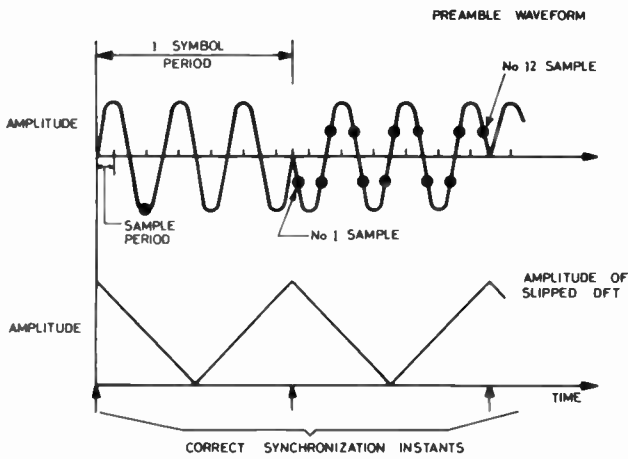

Fig. 4. Synchronization technique for q.p.s.k.

It is not therefore necessary to compute separately each shifted DFT, since each one is related to the previous one in a simple manner.

To improve the signal-to-noise ratio of the triangular waveform, sixteen cycles of this waveform are summed in a leaky integrator as described by equation (4) with, $\alpha = 15/16$.

The reference phasor is produced with a 2-fold ambiguity from the DFT phasor once symbol synchronization has been achieved, and this ambiguity is resolved by the polarity of the correlation between the incoming data stream and the stored version of the 32-bit start-of-message timing marker. This 32-bit pattern was chosen for good correlation properties when preceded by phase reversals (Fig. 5) and up to six errors are allowed before the modem fails to detect it.

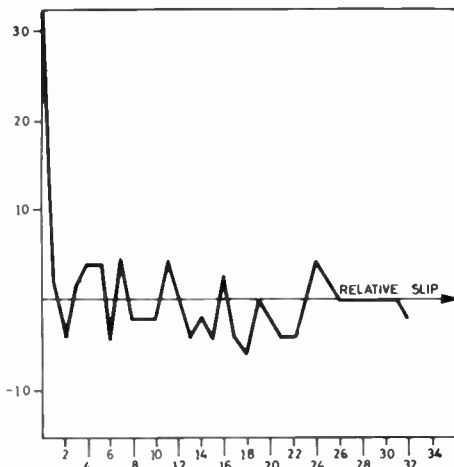

Fig. 5. Correlation between stored 32-bit sequence and 32-bit sequence embedded in phase reversals (q.p.s.k.).

3.4 Forward Error Detection and Correction

3.4.1 The code

The most powerful of the error correction techniques which have been developed since Shannon¹ enunciated his channel coding theorem is that of convolutional encoding with sequential decoding. Because of the complex nature of the decoder this scheme has, to date, only been used on expensive satellite and troposcatter channels. However, we will show that it is ideally suited to a burst transmission system and that no more than 10% is added to the hardware costs.

The convolutional code is a half-rate systematic one of constraint length 48 and is given in the paper by Forney.² Because it is systematic the information bits are transmitted as well as the parity bits, thus if the decode fails because there are too many errors the corrupted information bits are available for inspection.

3.4.2 Error correction performance

At the voice limit range of the radio set the q.p.s.k. modulation scheme yields a bit error rate of about 2×10^{-3} (1200 bits/s) so that without forward error correction it is highly probable that a 1024-bit message would have at least one error in it. Allowance must also be made for more errors than this due to interference and short fades. Thus, in terms of error-free message handling, the link without coding is poor. The convolutional code discussed below would yield a message error rate of $< 1 \times 10^{-8}$ assuming statistically independent errors at a channel error rate of 2×10^{-3} . Even at a channel error rate of 1×10^{-2} the message error rate would be $< 2.5 \times 10^{-4}$. Figure 6 shows the performance of the scheme on an additive-white-Gaussian-noise (a.w.g.n.) perturbed p.s.k. link for comparison purposes. However it must be stressed that the v.h.f. radio channel is not an a.w.g.n. channel and that the purpose of the coding is to eliminate errors due to impulsive interference and short fades.

3.4.3 Error detection performance

An additional bonus for using a long code is the ability of the decoder to detect the situation where there are too many errors to be corrected and thus 'flag' the output as erroneous. A measure of this latter property is called the undetected error rate.

Short block and convolutional codes have no useful measure of error detection if they are being used for error correction. However, long block and convolutional codes do have a useful measure of error detection even though their redundancy is being used for error correction. This is because the fraction equal to the number of 'correctable' vector sequences (i.e. code vector sequences with correctable errors) divided by the number of all possible vector sequences decreases with increasing block/constraint length. Therefore the probability that a code vector sequence will be so corrupted by noise that when received it will look more like another possible code vector

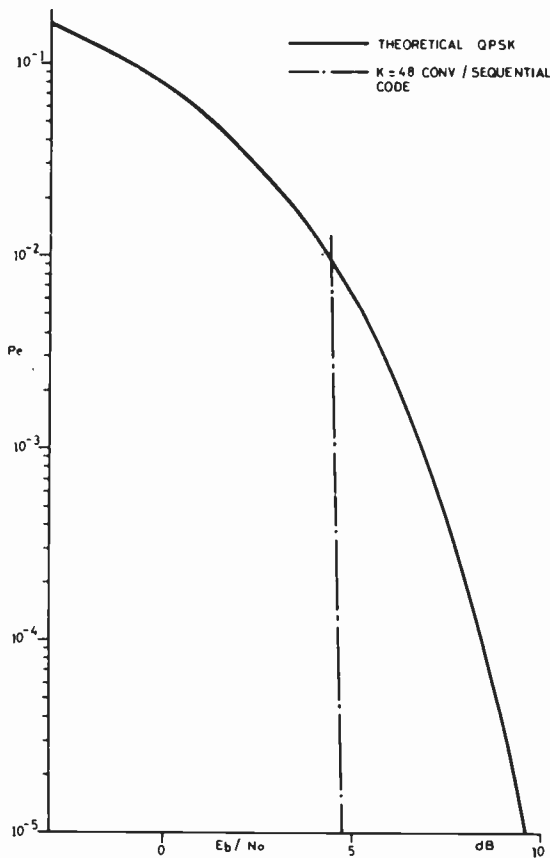

Fig. 6. Error rate improvement for convolutional code with coherent q.p.s.k.

sequence with a correctable error becomes less likely as block/constraint length increases.

There is no simple way of calculating an upper bound for the undetected error rate of a sequential decoder.³ The undetected error rate depends upon constraint length, metric ratio, threshold spacing and backsearch limit. Furthermore since at channel error rates $>4 \times 10^{-2}$ the decoding times become essentially infinite for the sequential decoder parameters used, a value for the 50% error rate would be meaningless. Simulation results for these parameters indicate a worst undetected bit error rate of 3×10^{-7} .

3.4.4 Decoding algorithm

The sequential decoding algorithm is basically a modified Fano algorithm, which generates hypotheses as to the correct information bits and hence correct parity bits. It compares these hypotheses to what was actually received and keeps a running sum called the metric scoring M_1 for a bit which agrees with the received bit and M_2 for a disagreement. The choice of M_1/M_2 , called the metric ratio, is very important as if this is too large enormous amounts of searching are performed whenever an error occurs and if it is too small the undetected error rate will be very high. As long as the hypotheses are correct the metric tends to increase and

the search moves forward. During an unsuccessful search however the metric tends to decrease and soon falls below a certain internally set threshold. At this point the search turns backwards and hypotheses are changed one by one until the metric increases again. The separation between the thresholds is called the threshold spacing Δ . It is immediately obvious from this description that the number of computations (i.e. backward and forward moves) is a variable. In fact the number of computations required to decode a bit follows a Pareto distribution.⁴

This type of coding is particularly well-suited to the burst message modem because the two major problems usually associated with it do not arise. Due to the variable speed of decoding, a buffer must be used and the question arises how big should this buffer be so that its probability of overflow is very small at reasonable error rates? Obviously the buffer need be no bigger than the total message size and the modem must store this anyway. The second problem is usually one of speed, but in the burst message modem the decoding is not performed in real time. In order that the initial and final bits of the message are equally well protected from errors as the middle bits it is necessary to start the encoder from the all zeros state and terminate the message with a string of zeros. In the present case this means transmitting 96 additional bits.

3.4.5 Software implementation

The analogue of the hardware technique of shifting the whole bit stream n times through a tapped shift register for encoding and syndrome determination is completely impractical (n is the total number of bits to be encoded). An alternative is to shift the encoding mask (of parity operation taps) which covers 4 processor words, but even this would entail 12-shift-and-move instructions for each bit encoded. A way around this is to store 16 versions of the encoder mask, one applicable for each bit position in the processor word.

The decoder uses a small modification to the Fano algorithm called quick threshold loosening (q.t.l.). It can be shown that if there have been no errors since the threshold was last tightened then when the next error occurs the threshold may be immediately loosened without any backsearching. The main effect of q.t.l. is to reduce the amount of searching required to correct single errors. It can also be shown that q.t.l. in no way degrades the performance of the decoder.

In essence the control of the decoder is performed by a 'look-up' table. The address of the look-up table is a function of:

- (i) whether or not the last move was forward or backward?
- (ii) what is the present value of the metric?
- (iii) whether or not the q.t.l. bit is set?
- (iv) hypotheses of information and parity bits at the pointer?

The contents of the look-up table at the address pointed to instruct the decoder to:

- (i) Move forward or backward.
- (ii) How to increment the metric.
- (iii) Whether or not to hypothesize further errors.

There are 48 entries in the decoder look-up table.

The additional hardware requirements of the coder/decoder are 1k of p.r.o.m. and $\frac{1}{4}$ k of r.a.m.

Decoder synchronization is automatically achieved from the frame synchronization of the timing marker.

3.4.6 Interleaving

The effectiveness of randomly error correcting codes such as the one described above is greatly degraded by bursts of errors. The effects of bursts of errors can be alleviated by interleaving the bit stream before transmission and deinterleaving before decoding. The 'depth' of interleaving indicates the maximum size of burst which is completely broken up. It can easily be seen that for short block transmission the optimum depth of interleaving is \sqrt{n} where n is the number of bits on the block. Thus for a 2048-bit message interleaving should be to depth 45. However it is very convenient to interleave to a simple multiple of the processor word length and in this case interleaving to depth 32 was used.

3.4.7 Soft decisions

A demodulator may provide 'confidence' information to give a measure of the correctness of its decision as to whether the received bit is a 0 or a 1. Certain types of decoder can make use of this confidence information if the noise characteristics of the channel are known. An improvement in coding gain up to 2 dB may be obtained in the case of an a.w.g.n. channel. There were three main reasons why soft decision decoding was not used.

- (i) The extra coding gain of a sequential decoder using soft decisions is very sensitive to the setting of the quantization levels in the receiver, unlike Viterbi decoding.
- (ii) The required storage in the modem would be increased by a factor of three for 8-level quantization.
- (iii) Although the gain in an a.w.g.n. channel is 2 dB this may not be the case when the errors are mainly due to impulsive interference and fades.

4 Results

The measured error-rates in the 1200 bits/s data stream are shown as a function of signal-to-noise ratio in Fig. 7, together with the theoretical curve for white Gaussian noise. The measurements were made under the following conditions.

- (i) Back to back with additive white Gaussian noise.
- (ii) Through v.h.f. radio sets at high s.n.r., with white

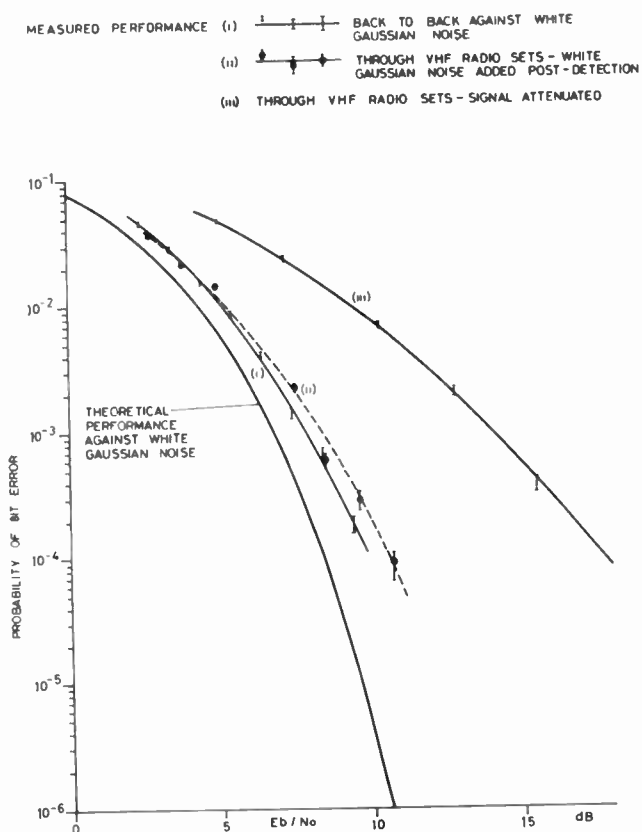

Fig. 7. Coherent 4-level p.s.k. performance against noise.

Gaussian noise added post-detection, to isolate performance degradation due solely to band-limiting, group delay, etc.

(iii) Through v.h.f. radio sets, signal attenuated. This shows the total degradation due to band-limiting effects and non-Gaussian discriminator noise.

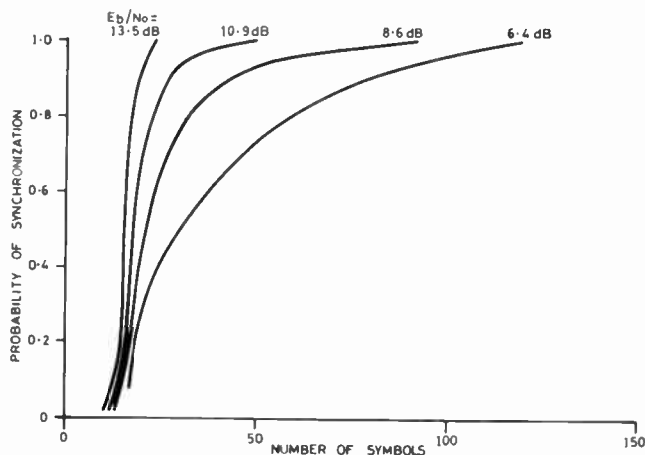

Fig. 8. Synchronization performance.

The measurements include any degradation caused by synchronization inaccuracy, etc.

The curves show a small implementation loss, and a further small loss as a result of band-limiting in the radio set. The third curve shows the effect of non-Gaussian noise originating from the discriminator of an f.m. receiver operating below threshold. When the i.f. envelope in the radio set falls momentarily below the limiting threshold, a sharp noise spike appears at the discriminator output. The noise energy therefore tends to be concentrated in short bursts, each with sufficient energy to reduce considerably the probability of correct detection of a symbol being transmitted at that time.

The measured probability of synchronization as a function of preamble length is shown in Fig. 8. These were also measured through v.h.f. radio sets with the signal attenuated. At a signal-to-noise ratio of 8.6 dB, which would yield an error rate of 1.4×10^{-2} , the probability of synchronization is 0.96 for a 60-symbol preamble.

5 Conclusion

The main conclusion of the paper is that a coherent

q.p.s.k. 1200 bit/s burst message modem can be implemented completely in software on a cheap medium-speed microprocessor (Texas TMS 9900) using less than 3k of program memory. Furthermore the microprocessor approach permits the use of sophisticated forward error correction and detection schemes which would not be economically feasible in a hard wired form. The logistic advantages of such a modem include the use of 'off-the-shelf' hardware components to military specifications and field modifiability of any module by merely changing the programmable read only memory board.

6 References

- 1 Wozencraft, J. M. and Jacobs, I. M., 'Principles of Communication Engineering' (John Wiley, New York, 1965).
- 2 Forney, G. D. and Bower, E. K., 'A high speed sequential decoder: prototype design and test', *IEEE Trans on Communications*, COM-19, no. 5(2), pp. 821-35, October 1971.
- 3 Bucher, E. A., 'Error mechanisms for convolutional codes', Ph.D. Thesis, M.I.T. Cambridge, Mass., 1968.
- 4 Gilhousen, K. S., *et al.*, 'Coding systems study for high data rate telemetry links', Linkabit Corporation, Final Report, 1971.

*Manuscript first received by the Institution on 30th January 1978 and in final form on 8th January 1979.
(Paper No. 1875/Comm 179)*

Standard Frequency Transmissions

(Communication from the National Physical Laboratory).

**Relative Phase Readings in Microseconds
NPL—Station
(Readings at 1500 UT)**

February 1979	MSF 60 kHz	GBR 16 kHz	Droitwich 200 kHz	February 1979	MSF 60 kHz	GBR 16 kHz	Droitwich 200 kHz
1	2.6	3.1	29.4	15	2.5	3.5	47.8
2	2.6	2.6	30.7	16	2.3	3.9	47.7
3	2.4	—	32.0	17	2.3	2.7	46.4
4	2.6	3.6	33.0	18	2.1	1.9	45.2
5	2.6	4.4	34.5	19	2.1	3.7	44.1
6	2.6	4.4	35.7	20	2.1	4.4	42.8
7	2.6	4.5	37.2	21	1.8	3.7	41.4
8	2.6	4.1	38.5	22	1.6	5.7	40.1
9	2.6	4.9	39.9	23	1.6	3.7	38.8
10	2.6	4.4	41.4	24	1.6	5.7	37.4
11	2.6	4.2	42.8	25	1.4	6.0	36.1
12	2.6	4.1	44.1	26	1.4	6.6	34.8
13	2.5	3.7	45.4	27	1.2	5.7	33.6
14	2.6	3.7	46.8	28	1.2	5.4	32.3

Notes: (a) Relative to UTC scale ($UTC_{NPL-Station} = +10$ at 1500 UT, 1st January 1977).
 (b) The convention followed is that a decrease in phase reading represents an increase in frequency.
 (c) Phase differences may be converted to frequency differences by using the fact that $1\mu s$ represents a frequency change of 1 part in 10^{11} per day.