

JOURNAL OF The British Institution of Radio Engineers

(FOUNDED IN 1925—INCORPORATED IN 1932)

*"To promote the advancement of radio, electronics and kindred subjects
by the exchange of information in these branches of engineering."*

Vol. XIV No. 11

NOVEMBER, 1954

REPORT OF THE TWENTY-NINTH ANNUAL GENERAL MEETING

THE INSTITUTION'S TWENTY-NINTH ANNUAL GENERAL MEETING (the twenty-first since incorporation) was held at the London School of Hygiene and Tropical Medicine, Gower Street, London, W.C.1, on Wednesday, October 27th, 1954.

Mr. William E. Miller (President) was in the Chair and was supported by other Officers of the Institution and members of the General Council. Sixty-two corporate members had signed the minute book when the meeting opened at 6.5 p.m.

1. To confirm the Minutes of the 28th Annual General Meeting held on October 21st, 1953

A report of the last Annual General Meeting was published on pages 517-520 of the November 1953 *Journal*. The President's proposal that these Minutes be signed as a correct record of the proceedings was approved unanimously.

2. To receive the Annual Report of the General Council

Mr. G. A. Marriott (Chairman of the Council) stated that the Annual Report, published in the October *Journal*, gave a very detailed account of the activities which the Council had undertaken during the year.

Emphasizing that the work of the Institution carried with it many responsibilities, Mr. Marriott referred to the need for encouraging the younger engineer. Throughout the Report the Council had been anxious to show how the Institution was measuring up to its responsibilities but Mr. Marriott stated that:—

"The engineering profession as a whole can not be easily satisfied with its present position. Nationally and internationally a great deal depends upon our labour, and all members might well review the papers read before Section G of the British Association Conference which was held in Oxford in September. One of the papers read at the Conference argued that there was an 'eclipse of the engineer in management.' Whilst many may not agree with some of the arguments advanced, there is a need for

engineers to 'keep abreast in their own field,' and one of the objects of the Institution is to stimulate new ideas."

The evidence of the Institution's work must depend to a large extent upon the membership. It was pleasing to note the continued increase in membership, but all members would share the disappointment of the Education Committee in that the results of the Graduateship Examination were not so high as had been hoped.

The educational side of the Institution's work was of the utmost importance to the profession and to the industry and it would be realized that although progress may be slow, in general the work of promoting training in radio and electronic engineering was now having an effect and would undoubtedly be to the advantage of the Institution in terms of membership.

One important matter which Mr. Marriott stressed was the need for the Institution to be situated in its own permanent building. Apart from the desirability of having larger accommodation, a great saving would be made in present expenditure on rent, repairs, etc. He was sure that all members would appreciate the advantages to be gained from such a venture and hoped that everyone would note that section of the Report dealing with the Building Appeal.

Mr. Marriott concluded:—

"As the retiring Chairman of the General Council, I am sure that I speak on behalf of all members in thanking the various Committees who have tried, in this last Annual Report, to

give facts and figures which will be of interest to the entire membership. In these terms I formally propose that the Annual Report be adopted."

This proposal was supported by Mr. L. H. Paddle (Member) in the following terms:—

"I welcome this opportunity to comment on the work of the Council during the year, and to support Mr. Marriott's remarks. Whilst I am no longer resident in Great Britain, having now made my home in Canada, my experience overseas has given me a unique opportunity to note from afar the importance of the Institution's work.

"Members overseas do not, of course, have much opportunity of observing at close quarters the work which goes on behind the scenes, and are, therefore, very dependent on the information given in the Annual Report of the Council. I am sure that I speak on behalf of all members, wherever they may be, in thanking the various Committees who help to compile the report for the interesting way in which they give an account of their work, and especially for the broad-minded policy which is revealed.

"I am especially interested in that Section which deals with overseas activities and the problems which arise both in this country and elsewhere in the recruitment of suitably qualified engineers.

"In Canada, for example, the development of that country creates a considerable manpower problem and as it cannot be solved wholly by the present population there must inevitably be some immigration of engineers. This will affect the movement of some of our members, and it is encouraging to those who go abroad to know that the Council of the Institution is anxious to be of service wherever they may be.

"Since the war, successive Councils of the Institution have shown great courage in setting up overseas sections and thus trying to give members abroad the same opportunity for meeting and discussing their current problems as you enjoy here in Great Britain. We are not a commercial body, but I do feel that considerable enterprise has been shown in this work and I realize that the finance and effort involved has thrown a great burden upon the Institution.

"I cannot at this stage say whether the deliberations of Council will result in the form-

ing of an active section in Canada, but I do know from the work already done that it is the Institution's policy to co-operate with similar engineering organizations abroad to the mutual advantage of those bodies and our own membership.

"In this and other connections, of course, the work of the Institution in the education and training field is of supreme importance. Other countries tend to take note of any mistakes which we have made here and I do feel that the experience of the Institution in stimulating technical training in the radio and electronics field will be of enormous advantage as overseas radio industries become established.

"With the growth of the Institution the conditions of admission tend to get more stringent. This I know creates certain difficulties for engineers abroad, who may not have the same opportunities in their country for technical training as are available in Great Britain. Nevertheless, it is obviously a very sound policy to insist that the conditions of membership shall be the same for all, and I feel that it is a matter of satisfaction to every member to note that our Institution has consistently been able to show an increase in its membership. Not only in Canada, but in America and in every country of the British Commonwealth, the Institution is well known, and in all those countries our membership is growing.

"Consequently, our *Journal* now has a wide distribution. These proceedings are a valuable record of progress and I am particularly interested to note the encouragement given to engineers overseas to contribute papers. I am sure that as we continue to grow, we shall be able to do more and more to make our *Journal* a valuable mirror of international progress in the whole field of radio and electronic engineering.

"I feel, Mr. President, that no comment on the Annual Report would be complete without an expression of thanks from the members to the Officers, Council and Committees of the Institution who have done so much to make the Annual Report interesting and the work of the Institution so valuable.

"In these terms it gives me much pleasure to second Mr. Marriott's proposal that the 28th Annual Report of the Institution be adopted."

The 28th Annual Report of the Council was then unanimously adopted.

3. To elect the President

In referring to the nomination of Rear-Admiral (L) Sir Philip Clarke, K.B.E., C.B., D.S.O., as the next President of the Institution, Mr. Miller gave a brief account of Admiral Clarke's career.*

The retiring President stated that Admiral Clarke was elected a Vice-President of the Institution in 1952 and had brought to Council meetings a very broad outlook which was of considerable value to the Institution as a whole. He was a man with fresh views and tremendous enthusiasm for the work of the Institution and Mr. Miller felt sure that his election as President would be a considerable step forward in the Institution's development.

The election of Rear-Admiral Sir Philip Clarke as President of the Institution for 1954/5 was received with acclamation.

4. To elect the Vice-Presidents

Mr. Miller felt that all members would be sufficiently aware of the services rendered by Messrs. L. H. Paddle and J. L. Thompson, and Professor E. E. Zepler to support their re-election as Vice-Presidents.

The Council were unanimous in recommending that the vacancy for a fourth Vice-President should be filled by Mr. G. A. Marriott. Apart from the services he has rendered to the Institution as a member of Council, and latterly as Chairman, Mr. Marriott had also undertaken the duties of Chairman of the Finance and Professional Purposes Committees.

The election of Messrs. G. A. Marriott, L. H. Paddle and J. L. Thompson, and Professor E. E. Zepler as Vice-Presidents of the Institution was approved with acclamation.

5. To elect the General Council

The Council's nominations for the vacancies on the General Council had not been opposed and Mr. Miller formally declared that the following members would serve on the Council:—

D. R. Chick, F. G. Diver, H. J. Leak, Captain A. J. B. Naish, R.N. (Members);

F. T. Lett, Lt.-Col. J. P. A. Martindale, E. W. Pulsford (Associate Members).

Mr. Miller also thanked the retiring members of Council for their services.

* See *Journal* for January 1953, page 50.

6. To elect the Honorary Treasurer

Moving the re-election of Mr. G. A. Taylor as Honorary Treasurer, Mr. Miller referred to the time which had to be given to the Institution's financial affairs by the Treasurer. Mr. Miller felt that the Accounts which Mr. Taylor would be presenting provided evidence of the time which he gave to these onerous duties.

The election of Mr. G. A. Taylor as Honorary Treasurer was approved unanimously.

7. To receive the Auditor's Report, Accounts and Balance Sheet for the year ended March 31st, 1954

Dealing with the Income and Expenditure Account, Mr. Taylor stated that the Finance Committee had been mainly concerned with reviewing expenditure in an endeavour to place the finances on a basis which would allow for a regular excess of income to reduce the liability of the reserve account.

The Institution was growing at a very rapid rate and expenditure must increase accordingly; the cost of many of the services offered by the Institution, however, tended to increase for reasons beyond the control of the Committee. One example of this was in the increasing cost of the *Journal* and, indeed, all printed material.

The method now used for presenting the Accounts clearly showed how income was allocated. It was not easy to equate any section of expenditure to any particular item of revenue but Mr. Taylor felt that the Finance Committee could fairly claim to have regulated expenditure with caution, but with full regard to the demands of a growing Institution.

The total amount allocated to Administration Expenses showed a slight increase, but this was to be expected with additional membership and activities. Otherwise, most items of expenditure compared favourably with last year.

The Finance Committee was, however, very much concerned with the continual rise in the cost of maintaining the Institution's premises. It would be seen that the excess of expenditure over income for the year was almost wholly accounted for by this item. The Institution's premises were very old and the Committee felt that expenditure on repairs and alterations to accommodate the Institution's growing needs would continue to increase yearly.

Both from the viewpoint of accommodation and saving of expenditure, therefore, it was

essential for the Institution to acquire its own permanent headquarters. To this end, the Committee were hoping to secure a good response to the Building Appeal so that negotiations could be started for the purchase of a building and site appropriate to the Institution's future requirements. Mr. Taylor continued:—

“The Annual Report states that we have been reluctant to widen the scope of the Appeal until we were assured that there would be adequate support from the membership. I believe that we have had sufficient indication from the membership to be assured that a general appeal to all members would be well supported. I am confident that every member will realize that we can hardly ask industry to give greater support to the Appeal if we are not prepared to play our part.

“It is the Council's intention to make a general Appeal to members within the next few weeks, and I very much hope that we shall secure sufficient response so that we may reach our target figure of £50,000.”

Referring to the income for the year, Mr. Taylor felt that members would be well pleased to note the considerable increase in normal revenue. Donations to the Building Appeal were not, of course, regarded as normal income as Council had agreed that such contributions should be set aside for the sole object of purchasing a building. These monies were, therefore, ultimately invested for that purpose.

The Balance Sheet showed in a detailed manner the Fixed and Current Assets and members would realize that immediately the Institution was in a position to purchase a building the monies standing to the credit of the Building Appeal would be transferred to the item “Fixed Assets.”

Mr. Taylor hoped that his comments, in conjunction with the Committee's report, would show members that considerable improvement had been achieved, and he formally moved that the Accounts and Balance Sheet for the year under review be adopted.

Wing Commander W. Dunn (Member), in seconding the motion, felt sure that all members would agree that the clear way in which the Accounts were published, together with the report of the Finance Committee, made it very easy to understand the Institution's financial position.

It was quite obvious from the report, and from the comments made by Mr. Marriott, that it

would be a great step forward in the Institution's life when larger and permanent headquarters were secured.

The adoption of the Accounts and Balance Sheet was approved unanimously.

8. To appoint Auditors

Mr. Miller felt that all members would wish to show their appreciation for the way in which the Institution's Auditors had continued to carry out their duties by approving the re-appointment of Gladstone, Jenkins & Co.

The proposal was carried unanimously.

9. To appoint Solicitors

During the year the Institution's Solicitors had continued to give valuable guidance on all legal matters and Mr. Miller formally moved the re-appointment of Messrs. Braund and Hill.

The proposal was received with unanimous approval.

10. Awards to Premium and Prize Winners

Mr. Miller regretted that he was unable to award personally some of the Premium and Examination Prizes as the recipients were resident abroad. Arrangements were, however, being made for the awards to be presented to the authors and candidates in their own countries.

Mr. Miller congratulated all those who had qualified for an award and distributed the Clerk Maxwell, Heinrich Hertz, Louis Sterling and Marconi Premiums, and the Audio Frequency Engineering examination prize. (Details of the examination and premium awards were given in the Annual Report—see pages 452 and 455, October 1954 *Journal*.)

After this presentation a welcome was extended to several members who had recently been elected to the Institution and Mr. Miller handed to them the certificate of membership.

11. Any other business

The Council had not received notice of any other business but before closing the meeting Mr. Miller stated that he would like to take the opportunity of thanking the Council and Committees, and the membership, for their support and encouragement during his two years as President. His experiences had been memorable and added to his regret at retiring from this Office, but he was especially happy that the membership had so cordially welcomed as his successor Rear-Admiral Sir Philip Clarke.

REPORT OF THE ANNUAL GENERAL MEETING OF SUBSCRIBERS TO THE BENEVOLENT FUND

(The Annual General Meeting of subscribers to the Benevolent Fund commenced immediately after the conclusion of the Institution's Annual General Meeting on October 27th, 1954.)

1. To receive the Income and Expenditure Account and the Balance Sheet for the year ended March 31st, 1954,

and

2. To receive the Annual Report of the Trustees.

Mr. G. A. Marriott stated that the Annual Report of the Trustees, together with the Accounts and Balance Sheet, were published on pages 397-399 of the September 1954 *Journal*.

As the Annual Report dealt in great detail with the Accounts, Mr. Marriott felt that it would be helpful, and would meet with the approval of subscribers, to deal with the first two Items on the Agenda together.

Dealing with Income, Mr. Marriott expressed thanks to the subscribers for their support of the Fund. The Trustees regretted that, for the first time, donations to the Fund had dropped and it had only been possible to show a slight increase in total revenue due to the interest received on further investments. It was most important at least to maintain income from donations, and one way of achieving this would be for all members who regularly subscribed to complete a Deed of Covenant. The Annual Report clearly indicated how this would greatly increase the value of members' donations without any additional cost to the subscribers, and the Trustees hoped that subscribers would extend their support by responding to the appeal.

On the expenditure side, Mr. Marriott stated that the Trustees had been able to meet every reasonable claim made upon the Fund during the year, and had continued to render assistance to a number of cases referred to in previous reports. Apart from actual financial help, each applicant was given guidance and advice towards helping to overcome problems caused by financial difficulties. As usual the Report itself quoted the case histories of some of those applicants who had been assisted during the year.

Mr. Marriott formally moved the adoption of the Accounts and the Annual Report of the

Trustees, and the proposal was carried unanimously.

3. To elect the Trustees for the year 1954-55.

The Rules governing the election of Trustees had been included in the Agenda published in the September 1954 *Journal*. Subscribers had not submitted nominations for new Trustees and Mr. Marriott proposed that the following be elected Trustees for the year:—

The President of the Institution

The Chairman of the General Council

E. J. Emery (Member)

(For the third successive year)

A. H. Whiteley (Companion)

(For the fifth successive year)

G. A. Taylor (Honorary Treasurer)

G. D. Clifford (Honorary Secretary)

The proposal was carried unanimously.

4. To elect Honorary Solicitor and the Honorary Auditor.

The Trustees recommended the re-appointment of Braund & Hill as Honorary Solicitors, and Mr. R. H. Jenkins as Honorary Auditor, who continued to give their services to the Trustees without reward. Mr. Marriott felt that all subscribers would wish to show their appreciation for this work by accepting the Trustees' proposal.

The motion was carried unanimously.

5. Any other business.

There had not been notice of any other business and Mr. Marriott closed the meeting by thanking the retiring Trustees for their past services, and all subscribers who had supported the Fund during the year.

At the conclusion of the Annual General Meeting, Rear-Admiral (L) Sir Philip Clarke, K.B.E., C.B., D.S.O., gave his Presidential Address. This will be published in the January 1955 issue of the Journal.

APPLICANTS FOR MEMBERSHIP

New proposals were considered by the Membership Committee at a meeting held on October 12th, 1954, as follows: 25 proposals for direct election to Graduateship or higher grade of membership and 28 proposals for transfer to Graduateship or higher grade of membership. In addition, 52 applications for Studentship registration were considered. This list also contains the names of four applicants who have subsequently agreed to accept lower grades than those for which they originally applied and the names of 38 Students omitted from the previous list.

The following are the names of those who have been properly proposed and appear qualified. In accordance with a resolution of Council and in the absence of any objections being lodged, these elections will be confirmed 14 days from the date of the circulation of this list. Any objections received will be submitted to the next meeting of the Council with whom the final decision rests.

Direct Election to Member

THEILE, Richard, Dr.Phil. *Furth, Bavaria, Germany.*
THOMAS, Horace Augustus, D.Sc. *Port Sunlight, Cheshire.*

Transfer from Associate Member to Member

NAISH, Captain (L) Arthur John B., R.N., M.A. *London, S.E.3.*

Direct Election to Associate Member

GOURGEY, Lieut.-Com. Reginald Elias, R.N. *London, N.W.6.*
MALHOTRA, Major Lalit Kumar, M.Sc., Indian Army. *New Delhi.*
METCALF, Ronald Albert Henry. *London, S.E.23.*
MOWAT, Geoffrey Creighton. *London, S.W.18.*
RICHARDS, James Henry Clayton. *Ruislip, Middlesex.*

Transfer from Associate to Associate Member

BLAIR, Gabriel Matthew. *Hildenborough, Kent.*
ELVY, Montagu Terrell. *Whitstable, Kent.*
GILLMAN, George Godfrey. *London, S.E.18.*
RITCHIE, Roy. *Welwyn Garden City, Hertfordshire.**
SIMPSON, Raymond Frank, B.Sc. *London, S.W.16.*

Transfer from Graduate to Associate Member

GUPTA, Ramesh Chandra, M.Sc., B.Sc.(Hons.). *Lucknow.*
HUTTON, Flt. Lt. Leslie, R.A.F. *Sheffield.*
JOHNSON, Antony Bevis, B.Sc.(Hons.). *Gurnard, Isle of Wight.*
MCCRIRICK, Thomas Bryce. *London, N.14.*
PEACOCK, Gerald Page. *Wallington, Surrey.*
SARIN, Capt. Jagdish Chandra, B.Sc., Indian Army. *Mhow, India.*
SURI, S. K., B.A.(Hons.). *Bloomington, Indiana, U.S.A.*

Direct Election to Associate

DAVIES, Kenneth Julius. *Zomba, Nyasaland.*
DAVEY, Ronald James. *Kampala, Uganda.*
DUMEE-DUVAL, Joseph. *Mauritius.*
FAYED, Mohamed Riad. *Liverpool.*
HUNT, Ronald Edward. *Tripoli, Lebanon.*
ROBBINS, Richard Alan David. *Zomba, Nyasaland.*
SHAH, Girishchandra Manilal. *Rajkot, Saurashtra.*
SHUKLA, Flt. Lt. Rama Kant, I.A.F. *Agra.*

Direct Election to Graduate

CHANNON, Dennis Edward. *London, W.2.*
DOUGHTY, Donald John. *Greenford, Middlesex.*
GRAY, Bertram Charles. *London, E.17.*
GREENWOOD, John Russell, B.Sc. *London, N.W.1.*
HOPKINS, William Thomas. *London, S.E.9.*
LATIF, Moiz Ebrahim. *Bombay.*
PASFIELD, Arthur Edmund. *London, S.E.24.*
SEN-GUPTA, Ajoy Kumar, B.Sc.(Eng.). *London, N.W.3.*
SOHRABI, Nariman. *Welwyn Garden City, Hertfordshire.*

Transfer from Student to Graduate

CLEAVE, John Percival, B.Sc. *Greenford, Middlesex.*
HARUN, Daniel. *London, N.16.*
LEAK, Malcolm Saunders, B.Sc. *Stoneleigh, Surrey.*
ROSS, William Anderson. *Dundee.*
SAWANT, Vasant Narayan. *Bombay.*
SHANNON, John Daniel. *Edinburgh.*
SIPAHIMALANI, Bhagwan Kishinchand. *London, S.E.27.*

* Reinstatement.

STUDENTS' REGISTRATIONS

Elected at meeting on August 24th

PANDAZIS, Georgios. *Athens.*
PAPADOPOULOS, Emmanuel. *Athens.*
PAPAKITSOS, Christos. *Athens.*
PENNICOTT, Lloyd Hale. *M.E.A.F.*
PEZIRDJOGLU, Evangelos. *Piraeus, Greece.*
POLITS, Athanasius. *Athens.*
PUNJABI, Hari Mangharam. *Bombay.*
PYRICHOS, Demetrios. *Athens.*
RAI THAKRAL, H. B. *Hounslow, Middlesex.*
RAMANATHAN, Chandrasekarapuram. *Madras.*
RASDELL, Gordon. *Limavady, Co. Derry.*
REDFERN, Frank Cundill. *Shrewsbury.*
RODOPOULOS, Nicolas. *Athens.*
ROMANIDIS, D. *Drama, Greece.*
SERGHIU, D. Costas. *London, N.7.*
SERVETAS, Evangelos. *Aegaleo, Greece.*
SETH, Maharaj Inder, B.A. *London, W.2.*
SIBLEY, George Brian. *London, S.W.19.*
SIKARWAR, Raghvendra S., B.Sc. *Jabalpore.*
SMITH, Terence William. *M.E.A.F.*
SPYRAKOS, Basil. *Athens.*
SPYROPOULOS, Nicholas. *Athens.*
STAMATIOU, George. *Athens.*
STAMATOGU, Stylianos. *Athens.*
STEVENS, Lionel. *Chorlton-cum-Hardy, Lancs.*
SUVARNA RAJA, Polinatti Jonah, B.A. *Peddapuram, India.*
THOM, William Edward. *Dublin.*
THOMAS, Achilles. *Athens.*
TUCK, Leslie. *Bloemfontein, South Africa.*
VADERA, Balbir Chandar, B.A. *Srinagar.*
VARMA, Ramesh Chandra. *Allahabad.*
VASSILIOU, Athena. *Athens.*

VED RATNA, B.Sc.(Hons), M.Sc. *Delhi.*
VENKATARAMAN, Gourisankaran, B.Sc. *Negombo, Ceylon.*
WATERHOUSE, Robin B. *London, S.W.19.*
WATSON, Michael C. *Milton Combe, Devon.*
WEEDON, Antony John, B.Sc. *Amersham, Bucks.*
WOOLFORD, Alan John. *Harrow, Middlesex.*

Elected at meeting on October 12th

AHMAD, Akhward Fayyaz, B.Sc. *Multan City, Pakistan.*
ARIF, S. Z., B.Sc. *Unnao, India.*
ATKINS, Peter J., B.Sc. *New Romney, Kent.*
BAKSH, Philip. *London, N.9.*
BALCOMBE, Jack. *Old Coulsdon, Surrey.*
BANNOCK, Keith. *Hounslow West, Middlesex.*
BARDWELL, Kenneth Oliver. *Calgary, Alberta.*
BAULK, Kenneth. *London, N.11.*
BHAGAT, Shiv Raj Huria. *Agra.*
CHATURVEDI, Ram Nath. *Bareilly, India.*
CLARK, Edward Bromfield. *Epping, N.S.W.*
COLMAN, Milton Henry. *Bury.*
COSTON, Geoffrey William. *Bracknell, Berks.*
DAMERELL, Anthony George. *London, W.5.*
DARVELL, John Louis. *London, N.13.*
DEAN, Imam Kamal-Ud. *Suva, Fiji.*
DEO, Anant. *New Delhi.*
DESAI, Capt. Anant Gururao. *Bombay.*
D'SOUZA, James Edward. *Bombay.*
FATMI, H. A., B.E. *London, S.W.17.*
GANDOTRA, Indar Mohan. *Gurdaspur, India.*
GOGATE, Bhalchandra D. *Gurgaon, India.*

HERLEKAR, Balvant Vishnu. *Bombay.*
HING, Henry. *Hong Kong.*
HOWICK, Douglas William. *Chelmsford.*
HUDSON, Harry. *Bradford, Yorkshire.*
JAMES, David Benjamin, B.Sc.(Hons.). *Swansea.*
JOHRI, Pratap Narain. *Meerut, India.*
KAPOOR, Mulk Raj. *Karnal, India.*
KAR, Saroj Kumar. *New Delhi.*
KARTAR SINGH, Bawa. *Gurdaspur, India.*
LEVY, Yermiyahu. *London, N.16.*
MEYER, Leighton Francis. *Wellington, N.Z.*
MURPHY, Joseph William. *Blackburn.*
NANAYAKKARA, Deegodagamage Piyadasa Abaya. *Kadugannawa, Ceylon.*
OVERDYKING, Raoul Jacques. *Torquay.*
PADMANABHAN, C. *Madras.*
PITCHER, Edward Henry. *Salisbury, Southern Rhodesia.*
QUINN, Edward Ronald. *Plymouth.*
RAHEJA, Udhavilal Topandas. *Madras.*
RAMACHANDRA RAO, N., B.Sc. *Trivandrum.*
REGÉ, Gopal Keshav. *Bombay.*
SACHDEV, Ved Parkash. *New Delhi.*
SADANANDAN, Amat. *Jorhat, Assam.*
SCHUITEMAKER, Jozef J. *Gemert, Holland.*
SHARMA, Kailash Prasad, B.Sc., M.Sc. *London, N.W.3.*
SIANG, Peter Wu Chi. *Hong Kong.*
SIMMS, Terence. *York.*
SINCLAIR, Roland William. *Johannesburg.*
SYLVESTER, Anthony Bradbury. *Wembley.*
TRIVEDI, Yogenra Ramshanker, B.Sc. *M.Sc. Ahmedabad.*
VISWANATH, S., B.Sc.(Hons.). *Madras.*
WHEELER, Stanley Charles. *Gillingham.*

PARTITION COMPONENTS OF FLICKER NOISE*

by

T. B. Tomlinson, B.Sc., Ph.D. (*Associate Member*)†

SUMMARY

The flicker noise fluctuations in the space current of a thermionic valve are reduced by operating the valve under space charge limited conditions. In a pentode, this "smoothing" is less effective due to the division of the current between the anode and the screen grid; consequently, a partition component of flicker noise may be said to occur. Experiments are described which confirm the presence of this phenomenon and which give useful evidence on the origin of the flicker noise. When making measurements on standard valves, there were encountered a number of defects which lead to the generation of excess noise at low frequencies.

1. Introduction

In addition to the usual shot noise, there is another cause of anode current fluctuations in multi-collector valves. The additional noise is known as partition noise since it is due to the division of the total current between the collector electrodes. Three distinct cases may be studied.

1.1. Case 1: Temperature-limited emission from the cathode

As for a temperature-limited diode, the emission of an electron is a completely random process. The further uncorrelated process of collection by one of several electrodes will make no difference to the "degree of disorder" so that the mean square value of the anode current fluctuations, for an elementary bandwidth δf , is given by the Schottky formula

$$\overline{i_a^2} = 2eI_a\delta f \dots\dots\dots(1)$$

1.2. Case 2 (hypothetical)

It is assumed that the cathode current is completely free from fluctuations so that the total current to be divided between the collecting electrodes may be considered as a uniform nonvariant stream of electrons. This would correspond to a complete suppression of emission fluctuations by the space charge effect. The partition noise is then entirely caused by the random division of the electrons between the collector electrodes. For a pentode, the mean

square anode current noise is

$$\overline{i_a^2} = 2eI_a \cdot \frac{I_s}{I_a + I_s} \cdot \delta f \dots\dots\dots(2)$$

The symmetry of this formula indicates that the mean square value of the screen current fluctuations has the same magnitude. This must be so if the cathode current is, as assumed, completely smooth.

1.3. Case 3: Space charge limited emission from the cathode

The effect of the potential minimum produced by the space charge is to reduce the fluctuations of the space current. Thus,

$$\overline{i_k^2} = \Gamma^2 \cdot 2eI_k\delta f \dots\dots\dots(3)$$

where $I_k = I_a + I_s$. Γ^2 is a factor, less than unity, often referred to as the "space charge reduction factor." Clearly, this case is intermediate between the two preceding ones and $\overline{i_i^2}$ will be expected to have a value between those given by equations (1) and (2). The analysis has been carried out by North¹ and Bakker;² the anode current fluctuations are shown to have a mean square value:—

$$\overline{i_a^2} = 2eI_a \cdot \frac{I_s + \Gamma^2 I_a}{I_a + I_s} \cdot \delta f \dots\dots\dots(4)$$

This third case is the most important as it is the one invariably encountered in practice. The variations of space charge density which lead to the reduction of shot noise may be said to produce a compensating fluctuation current of opposite polarity which neutralizes a part of the initial fluctuation. In the tetrode and pentode there are two collector electrodes and the division of the compensating current between the anode

*Manuscript received May 4th, 1954. (Paper No. 287.)

†Department of Electronics, University of Southampton.

U.D.C. No. 621.385.

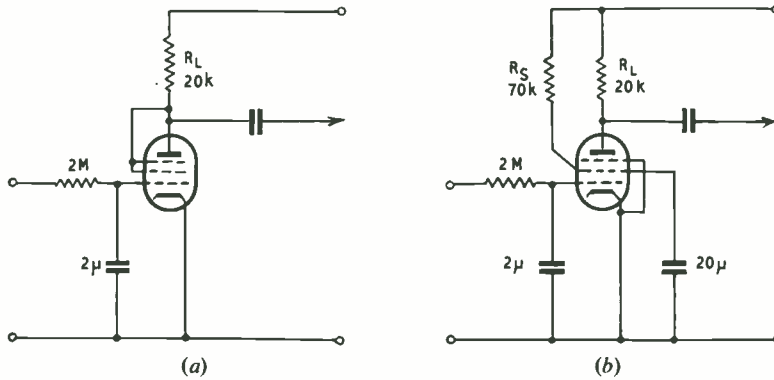

Fig. 1.—The circuit arrangements of Experiment 1, to compare the noise of the test valve when (a) triode connected, (b) pentode connected.

and the screen grid will not necessarily follow the same pattern as the division of the initial fluctuation current. Thus an initial fluctuation which is largely collected by the anode will lead to a compensating current which is shared between anode and screen grid more or less in the ratio of the d.c. components collected by each. Similarly, an initial fluctuation mainly collected by the screen grid will lead to a shared compensating current and so on. The net result of this division of current is the presence in the anode current of fluctuations which are not compensated to the same extent as those in a corresponding triode. There will also exist in the anode current components which are indirectly the result of initial fluctuations collected by the screen grid. The extra components so produced are the partition noise components.

Thus, partition noise is the direct result of the division of current between two or more collectors. The mean square value of the anode current fluctuations, for a given anode current, increases with the number of collectors. Its value may approach, but cannot exceed $2eI_0\delta f$, since this corresponds to a completely random condition.

Now the low-frequency fluctuations of anode current in a pentode operated under normal space charge limited conditions will be considered. In addition to the statistical fluctuations referred to above, there will be extra components due to the "flicker" effect at low frequencies; the emission fluctuations due to the flicker effect may be considerably in excess of the shot noise. They are also reduced in the presence of the potential minimum produced by space charge,³ so that the effect of current division

should be to cause a partial neutralization of this reduction as for the shot partition noise in Case 3. Consequently, at low frequencies, the anode current fluctuations of a pentode will be due to

- (a) the shot effect
- (b) the partition effect (normal)
- (c) flicker effect in the emission current
- (d) an extra component which will be referred to as "flicker partition."

The purpose of the investigation described in the following pages was to identify such a "flicker partition" effect and to compare it with the partition effect proper. This comparison enables one to make certain deductions regarding the nature and origin of the low-frequency fluctuation components.

2. Experiment No. 1

Eight sample pentodes of the type 6SJ7 were used: they were first connected as triodes with anode, screen grid and suppressor grid strapped together (Fig. 1a). The anode voltage was 110 V, grid bias voltage — 4.5 V, total anode current 1.7 mA, the heater supply voltage being set at the normal 6 V. The anode load was a 20-kΩ wire-wound resistor, the output noise voltage across this resistor being applied to the pre-amplifier with the usual C-R coupling circuit. As a basis for comparison, the shot noise and the corresponding partition effect were measured first.

2.1. Measurements at 35 kc/s

Tests were made on all eight specimens at a frequency high enough for the flicker effect of an average valve to be negligible. A selective

amplifier with a mid-frequency of 35 kc/s was used in conjunction with a thermo-couple and galvanometer. A more complete description of apparatus for such noise measurements has been given previously.³ This set-up was calibrated in terms of the thermal noise produced in resistors of known value placed across the input terminals of the first amplifier stage. A measurement was also made with these terminals shorted. The mean square output voltage \overline{V}^2 , as measured by the galvanometer deflection, was plotted against corresponding resistance values R_0 (Fig. 2). Resistors exceeding 20 k Ω were not used since the effect of the shunt capacitance would lead to inaccurate calibration at the frequency concerned. By extrapolating this curve backwards the equivalent noise resistance of the pre-amplifier plus the following stages could be read off directly. As seen from the graph its value was 10 k Ω .

2.2. Triode connected

The galvanometer deflection produced by each specimen valve in turn was noted. By reference to the calibration curve it was possible to read off directly the value of a resistance which, as a thermal noise generator at room temperature, would produce the same mean square noise output voltage. This resistance value is a measure of the valve and load resistor as a noise voltage source and will be defined as the "effective resistance" R_T (triode connected). The results for the eight specimen valves are tabulated in column 1 of Table 1. A deduction of 10 k Ω has been made in order to account for the noise contributed by the pre-amplifier and following stages.

The equivalent noise resistance R_{eq} of the test specimen, in the normally accepted definition, will be equal to the figure of the first column divided by the square of the voltage gain. Accordingly, the stage gain of all eight specimens was measured in the actual test circuit, the valves being operated under the stated conditions. The equivalent noise resistance (at 35 kc/s) was then derived for each specimen and is tabulated in column 2.

For confirmation, a second method of measuring R_{eq} was used. Resistors, of the same order of magnitude as R_{eq} , were placed in the grid circuit of the test valve itself. Then, as for the initial calibration, the total equivalent noise resistance of the test valve and subsequent stages was

obtained from the plot of the mean square noise versus resistor magnitude. A correction must be made for the noise of the pre-amplifier, etc., and this also requires knowledge of the stage gain of the test specimen. Values of R_{eq} found in this manner are given in column 3 of the table and are seen to be in good agreement with those obtained by the first method.

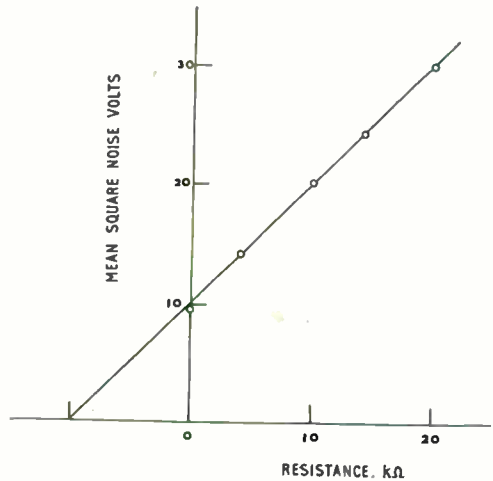

Fig. 2.—Calibration of the 35-kc/s noise measuring equipment, in terms of the thermal noise generated in known value resistors. By extrapolating the curve backwards the equivalent noise resistance of the pre-amplifier plus the following stages can be read off directly.

The total mean square noise voltage appearing across R_L for the valve operated under space charge limited conditions, and including the thermal noise generated in R_L , is given by

$$\overline{V_a^2} = (\Gamma^2 \cdot 2eI_k R_L^2 + 4kTR_L) \cdot \Delta f \cdot \left(\frac{r_a}{r_a + R_L} \right)^2$$

where Δf is the effective (integrated) bandwidth. With the experimental technique outlined above, $\overline{V_a^2}$ is measured in the form of an equivalent resistance R_T , i.e.,

$$\overline{V_a^2} = 4kTR_T \Delta f$$

Therefore,

$$4kTR_T \Delta f = (\Gamma^2 \cdot 2eI_k R_L^2 + 4kTR_L) \cdot \Delta f \cdot \left(\frac{r_a}{r_a + R_L} \right)^2$$

which gives

$$\Gamma_r^2 = \frac{2kT}{eI_k R_L^2} \cdot \left[R_r \left(\frac{r_a + R_L}{r_a} \right)^2 - R_L \right] \dots \dots \dots (5)$$

The anode slope resistance r_a of all test specimens was measured and found to lie close to an average value of 16.4 kΩ. With the method of calibration employed, the bandwidth does not enter in the final expression for Γ_r^2 . This is an advantage since it obviates the laborious process of plotting a frequency response characteristic of the amplifier and then deriving the effective bandwidth Δf .

The values of Γ_r^2 obtained for the eight specimen valves (triode connected) are given in column 4 of Table 1. It appears that the low-frequency component of noise is not in fact negligible for specimen valve No. 4 at the frequency of 35 kc/s. This extra noise might have been due to a valve defect such as a leakage path from anode to cathode. A list of such defects is included later. Specimen valve No. 4 was found to be free from these; the high noise level is solely due to the flicker effect.

Table 1
Results at 35 kc/s

Specimen	R_T MΩ	R_{eq} kΩ First Method	R_{eq} kΩ Second Method	Γ_r^2	R_p MΩ	Γ_p^2	$\frac{\Gamma_p^2}{\Gamma_r^2}$
1	0.71	3.5	3.6	0.28	5.4	0.56	2.0
2	0.52	2.6	2.5	0.20	4.2	0.43	2.1
3	0.66	3.3	3.6	0.26	5.1	0.53	2.0
4	1.75	8.6	9.1	0.69	7.6	0.79	(1.1)
5	0.51	2.8	2.6	0.20	4.1	0.42	2.1
6	0.59	2.9	3.1	0.23	4.2	0.43	1.9
7	0.78	3.9	3.8	0.31	5.2	0.54	1.7
8	0.55	2.8	2.6	0.22	4.6	0.48	2.2

2.3. Pentode connected

The test circuit was reconnected so that the specimen valves were operated as pentodes (Fig. 1b). Since the experiment is concerned with the partition effect only, it is important that the fluctuations of the emission current shall not be affected by this change. Consequently, the same heater and grid bias voltages were applied and a resistor (70 kΩ) was connected in series with the

screen grid lead so that the d.c. potentials of the anode and screen grid could again be set at 110 V. The same total current of 1.7 mA was therefore drawn; this divided in a ratio of 1.3 mA anode current to 0.4 mA screen grid current. The screen grid was by-passed to earth for a.c. purposes by a 20-μF capacitor whose reactance was sufficiently small at the low frequency.

By a procedure similar to that for the triode connection, the effective noise resistance R_p (pentode connected) was measured; the results are tabulated in column 5 of Table 1. A convenient way of expressing the noise current under the pentode conditions is in terms of the mean square value given by the Schottky formula, thus:—

$$\overline{i_a^2} = \Gamma_p^2 \cdot 2eI_a \delta f.$$

Here Γ_p^2 is a factor which takes into account both the reduction by the space charge of the random emission fluctuations and also the further increase due to partition. The anode slope resistance r_a has a value of approximately 2.5 MΩ under the pentode conditions and the thermal noise in R_L is quite negligible, so that expression (5) takes on the simpler form,

$$\Gamma_p^2 = \frac{2kTR_p}{eI_a R_L^2}$$

The values obtained for Γ_p^2 are given in column 6. In all cases $\Gamma_p^2 > \Gamma_r^2$; this verifies the presence of partition noise. The ratio Γ_p^2/Γ_r^2 , given in column 7, is a measure of the magnitude of this effect. This ratio is smaller than normal for valve No. 4 because of the large proportion of low-frequency noise present. This is evident from the low-frequency results which follow.

2.4. Measurements at 20 c/s

Similar measurements were made at a frequency of 20 c/s. This frequency was sufficiently low for the flicker noise to be predominant under the given operating conditions. The selective amplifiers provided an overall effective bandwidth of 1.7 c/s. The output from the thermocouple was fed in push-pull to a balanced d.c. amplifier with cathode follower output circuits; a pen recording milliammeter was connected between the two cathodes. Long time-constant

Circuits were incorporated in the d.c. amplifier to reduce the short-term variations of the current in the recording meter. The mean square value of the fluctuations was derived from the recording by visually averaging the deflections over a long time interval. The equipment was calibrated in similar manner to the 35-kc/s equipment; the equivalent resistance at the input terminals was 65 kΩ.

The effective resistance R_T' of each test specimen (as a noise generator at room temperature) is given in Table 2, column 1, for the triode connection. A wide range in noise level is noticeable. The equivalent noise resistance R_{eq}' is given in column 2. By substituting R_T' in expression (5) a factor F_T , corresponding to the shot noise reduction factor, is obtained:—

$$F_T^2 = \frac{2kT}{eI_k R_L^2} \cdot R_T' \left(\frac{r_a + R_L}{r_a} \right)^2 \dots\dots\dots(6)$$

The thermal noise in R_L is quite negligible in this case. F_T^2 is a measure of the total current fluctuations including shot noise. The fact that F_T^2 is so very much larger than Γ_T^2 is proof that the shot noise is negligible in comparison with the extra fluctuations which appear at the low frequency.

Results for the pentode connection are given in columns 3 and 4 of Table 2.

Here,

$$F_p^2 = \frac{2kTR_p'}{eI_a R_L^2} \dots\dots\dots(7)$$

Finally, in column 5, values of the ratio F_p^2/F_T^2 are tabulated. It is immediately obvious that a fundamental difference exists at the low frequency since the ratio F_p^2/F_T^2 is less than unity. If any flicker partition effect does exist, its significance is considerably less than that of the partition effect proper. Apart from specimens 6 and 7, all valves show a value of F_p^2/F_T^2 between 0.76 and 0.91.

2.5. Conclusions from Experiment 1

If the anode and screen current fluctuations were completely correlated, i.e., if the space current fluctuated as a whole, then these

fluctuations would divide in the ratio of the d.c. currents. In this case,

$$\frac{\overline{i_a^2}}{\overline{i_k^2}} = \frac{I_a^2}{I_k^2}$$

But $\overline{i_a^2}$ (pentode) = $F_p^2 \cdot 2eI_a \cdot \delta f$

and $\overline{i_k^2}$ (triode) = $F_T^2 \cdot 2eI_k \cdot \delta f$

Hence $\frac{F_p^2}{F_T^2} = \frac{I_a}{I_k} = \frac{1.3}{1.7} = 0.76$.

It is worth noting that the same result would be obtained by assuming that the fluctuations of anode and screen currents were completely uncorrelated and that each obeyed the law most commonly encountered in practice, namely:—

$$\overline{i_a^2} = \frac{A \cdot I^2}{f^n}$$

where A is a constant, I the mean current and f

Table 2
Results at 20 c s

Specimen	R_T' MΩ	R_{eq}' MΩ	F_T^2	R_p' MΩ	F_p^2	$\frac{F_p^2}{F_T^2}$
1	200	0.98	79	580	60	0.76
2	160	0.79	63	500	52	0.82
3	320	1.8	130	1050	110	0.85
4	1450	7.7	570	5050	520	0.91
5	9.8	0.053	3.9	32	3.3	0.85
6	90	0.45	35	110	11	(0.31)
7	70	0.35	28	120	12	(0.43)
8	510	2.6	200	1500	160	0.80

the frequency, and where the value of n usually lies between 1 and 2.

Here also,

$$\overline{i_a^2} \text{ (pentode)} \propto I_a^2$$

and $\overline{i_k^2}$ (triode) $\propto I_k^2$

so that $\frac{F_p^2}{F_T^2} = 0.76$.

However, this second model must be considered inadmissible because of the high degree of space charge, as is evidenced by the reduction of shot noise. The evidence of Section 3 removes any doubt on this point.

The results therefore indicate that a considerable amount of "in phase" fluctuations is present, i.e., emission fluctuations which, in the main, cause the anode and screen grid currents

to increase and decrease together, though not completely so. From this it can be concluded that variations of emission are not spread uniformly over the cathode surface as a whole. If the fluctuations are indeed due to emission variations from patches on the cathode surface, these patches must be small compared with the diameter of the screen grid wires so that the initial fluctuations of emission are not divided between anode and screen grid in the same ratio as the direct currents. This would account for values of F_p^2/F_T^2 in excess of 0.76. In order to obtain further information on this point the experiments of Parts 3 and 4 were carried out.

2.6. Abnormal results of Specimens 6 and 7

The results of specimens 6 and 7 were different from all the remainder, therefore it was thought that an external source of low-frequency noise was present in these two valves when triode connected, but not when pentode connected. Since the screen grid was by-passed in the latter case but not so in the former, it seemed likely that the extra noise was introduced at the screen grid. By a series of tests it was possible to prove that it was "current" noise generated in an internal leakage path between the screen grid and the cathode, possibly due to an evaporated film of oxide coating between connecting wires at the glass pinch, or across the mica supports.

In a later section, reference will be made to other defects which may play a considerable part in the generation of low-frequency noise in practical electronic valves.

3. Experiment No. 2

The test circuit was pentode connected as in Fig. 1b, the output voltage being taken once

more from the anode. The root mean square value of the anode voltage was measured with:—

- (a) the 20-μF screen by-pass capacitor disconnected,
- (b) this capacitor in circuit.

The measurements were carried out both at 35 kc/s and at 20 c/s for all the specimen valves.

3.1. Results at 35 kc/s

Column 1 of Table 3 shows the ratio of the two root mean square output voltages for conditions (a) and (b) above. The average ratio for all eight specimens is approximately 2.0. The effect of thermal noise generated in R_s must be investigated for condition (a). The variation of screen grid voltage is

$$\overline{V_s^2} = 4kTR_s \delta f \cdot \left(\frac{r_s}{r_s + R_s} \right)^2$$

in which $r_s = \frac{\partial V_s}{\partial i_s}$, i.e., the internal slope resistance at the screen grid, V_s being the screen potential. This variation of screen voltage will produce at the anode a mean square voltage

$$g_t^2 R_L^2 \cdot \overline{V_s^2}$$

where $g_t = \frac{\partial i_a}{\partial V_s}$, i.e., the transconductance from screen to anode. Consequently, the effective resistance at the anode which takes into account the thermal noise in both R_s and R_L is

$$R_s \left(\frac{r_s}{r_s + R_s} \right)^2 g_t^2 \cdot R_L^2 + R_L$$

The average values under the stated conditions were:—

$$r_s = 60 \text{ k}\Omega$$

$$g_t = 0.055 \text{ mA/V.}$$

If the appropriate values are substituted, this effective resistance is found to be 36 kΩ. This is small compared with the figures of column 4 of Table 1, therefore the thermal noise in R_s and R_L has negligible effect on the 2:1 ratio. Hence it can be assumed that this ratio is solely due to the partition effect. A qualitative explanation follows.

Assume, at first, that the partition noise effect in the pentodes

Table 3

Specimen	Ratio of r.m.s. noise voltages for conditions (a) and (b) at 35 kc/s	Ratio of r.m.s. noise voltages at 20 c/s	Ratio of voltage gains
1	1.9	0.87	0.54
2	2.0	0.88	0.53
3	2.0	0.83	0.48
4	1.6	0.89	0.53
5	2.2	0.87	0.55
6	2.1	(1.2)	0.56
7	1.9	(1.0)	0.52
8	2.0	0.74	0.51

used under the stated conditions is mostly that of case 2 described in the introduction. To a first approximation then, an instantaneous increase of anode current δi may be assumed to be accompanied by a corresponding decrease of screen current $-\delta i$, the cathode current being smooth and continuous. With a by-passed screen grid, the change in anode voltage δV_a is $-R_L \delta i$, the screen grid voltage remaining constant. With the screen grid un-bypassed the change of screen grid voltage will be

$$\delta V_s = \delta i \cdot \frac{r_s R_s}{r_s + R_s}.$$

This change δV_s will produce an increase of cathode current which supplies a further change of anode current, equal to

$$g_t \delta i \frac{r_s R_s}{r_s + R_s}.$$

The total change of anode current becomes

$$\delta i' = \delta i \left(1 + g_t \cdot \frac{r_s R_s}{r_s + R_s} \right) = 2.8 \delta i.$$

The conclusion is that the effect of removing the screen grid by-pass capacitor should be to *increase* the root mean square value of the anode current fluctuations by a factor somewhat less than 2.8. If one allows for the presence of shot noise in the cathode stream, a factor in the region of the measured value 2.0 is conceivable.

3.2. Measurements at 20 c/s

The ratio of the root mean square noise voltages for the two conditions is given in column 2 of Table 3. The first important observation is that, apart from the unreliable results of specimens 6 and 7, the noise voltage is *reduced* when the screen grid by-pass capacitor is removed. This supports the evidence of Section 2 which shows that the fractional increase of low-frequency noise due to "flicker partition" is much less than the increase of shot noise due to the usual partition effect. The magnitude of the ratio under the two conditions at 20 c/s is now considered. At first it is supposed that the fluctuations involve the space current as a whole. These fluctuations of space current will divide up between anode and screen grid in the same way as the variations of space current caused by an a.c. signal at the control grid. This means that the ratio of the noise voltages

measured under the two conditions (a) and (b) should be equal to the ratio of the two voltage amplifications under the same two conditions.

This ratio of voltage amplifications is readily calculated and has a value:—

$$1 - \frac{g_s r_s R_s}{r_s + R_s} \cdot \frac{g_t}{g_m}.$$

In the formula, the new parameters and their average measured values are:—

$$g_m = \frac{\partial i_a}{\partial V_g} = 1.0 \text{ mA/V}$$

$$g_s = \frac{\partial i_s}{\partial V_g} = 0.3 \text{ mA/V}.$$

The ratio so calculated is approximately 0.5.

To verify this, a 20-c/s signal of magnitude 1 mV was applied to the grid circuit and the output voltage at the anode measured (after further amplification) under the two conditions. The ratio of the two signal output voltages so obtained is given in column 3 of Table 3. The average value of this signal ratio is 0.54. When this figure is compared with that of column 2 for the ratio of the low-frequency fluctuations, it can be seen that the latter cannot be fluctuations of the space current as a whole.

In addition, this experiment rules out the possibility of completely uncorrelated fluctuations for the following reason. When the screen grid is un-bypassed, the mean square noise voltage set up at the screen grid will be

$$\overline{V_s^2} = \overline{i_s^2} \cdot \left(\frac{r_s R_s}{r_s + R_s} \right)^2.$$

This will produce at the anode an additional mean square voltage equal to

$$g_t^2 R_L^2 \cdot \overline{i_s^2} \cdot \left(\frac{r_s R_s}{r_s + R_s} \right)^2.$$

If $\overline{i_a^2}$ and $\overline{i_s^2}$ were completely uncorrelated, the total mean square noise voltage at the anode would be

$$R_L^2 \overline{i_a^2} + g_t^2 R_L^2 \overline{i_s^2} \cdot \left(\frac{r_s R_s}{r_s + R_s} \right)^2.$$

Consequently, the effect of an un-bypassed screen grid would be to *increase* the noise voltage at the anode. This result is true, regardless of the law governing these fluctuations in relation to the corresponding d.c. currents.

If, for instance, $\overline{i_a^2} \propto I_a^2$ and $\overline{i_s^2} \propto I_s^2$, the

ratio of mean square anode voltages for the two conditions would reduce to

$$1 + g^2 \cdot \frac{I_s^2}{I_a^2} \cdot \left(\frac{r_s R_s}{r_s + R_s} \right)^2$$

In the stated working conditions this has a value of 1.32. It follows that a system of uncorrelated fluctuations would give a completely incorrect result.

In order to produce a ratio of less than unity for this experiment, the anode and screen current fluctuations must be mainly *in phase*. However, the fluctuations do not divide up as the ratio of d.c. currents since, in that case, the figures of column 2 and 3 would be equal.

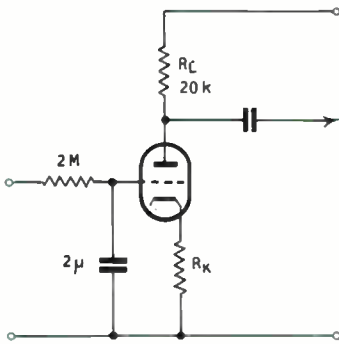

Fig. 3.—Circuit used to measure the effect of negative current feedback on the low-frequency fluctuations of current in a triode.

This evidence, in addition to that in Section 2, tends to suggest small patches as the origin of the fluctuations. The relative magnitudes of the “in phase” and the “flicker partition” components are still undetermined. To obtain this information, the more sensitive test of Section 4 was devised.

To conclude this Section, reasons will be supplied for three anomalous results which occur in Table 3. Firstly, the low result of 1.6 for specimen 4 (column 1) is due to the high proportion of flicker noise still measurable at 35 kc/s. This noise is reduced by the removal of the by-pass capacitor so that a result lower than the average is obtained. The two ratios exceeding unity for specimens 6 and 7 at 20 kc/s (column 2) are due to the defect investigated in experiment No. 1. The leakage

current flowing from the screen grid will lead to excess low-frequency noise when the screen grid by-pass capacitor is removed. No undue importance should therefore be attached to these three results.

4. Experiment No. 3

All the measurements are made at 20 c/s; the basic idea is as follows. Negative feedback is used to reduce the magnitudes of the anode and the screen current fluctuations by unequal factors in order to examine the relationship between them. There is no apparent reason why the anode current noise fluctuations of a triode should not be reduced by negative current feedback due to a resistor in the cathode lead. Nevertheless, it was considered advisable to confirm this before setting up more elaborate circuits.

A 6J5 triode was therefore used in the circuit of Fig. 3. By using different values for R_k in the cathode lead, the feedback could be varied. The d.c. supply voltages were adjusted so that the operating conditions were $V_a = 100$ V, $I_a = 1.6$ mA. The root mean square noise voltage appearing at the anode was measured. The feedback was next largely removed by placing a 16- μ F capacitor across R_k and the noise output voltage was measured again. After making a correction for the noise introduced by the pre-amplifier and the following stages (this was most important for high feedback ratios) the ratio of the two measured noise voltages was calculated. This ratio gives the reduction of the fluctuations of anode current due to feedback.

The gain of the main amplifier was then reduced until the noise output voltage was negligibly small. A small 20-c/s signal voltage was applied to the grid of the test triode and the signal voltage at the anode was measured with and without feedback. The ratio of the two signal voltages gives the reduction of amplification due to feedback. The noise reduction ratio and the amplification reduction ratio were each measured for a number of values of R_k . The results for a typical triode are shown in Fig. 4, in which the noise reduction ratios are plotted against corresponding amplification reduction ratios. The experimental points lie close to a straight line of unit slope through the origin; this proves that the effect of negative

current feedback on the noise current fluctuations is the same as that on the signal amplification.

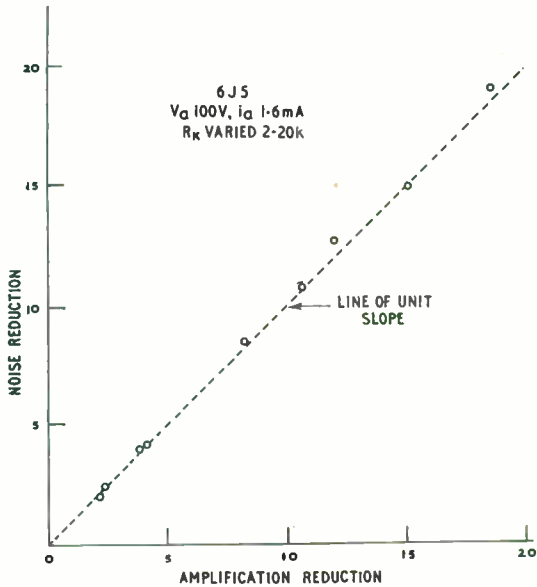

Fig. 4.—Comparison of the reduction of noise in a triode with the reduction of amplification, due to negative current feedback resulting from different values of a resistor R_k in the cathode lead.

As a second test, the feedback resistor R_k was held constant at 20 k Ω and the anode current was varied by changes of grid bias voltage. For numerous values of anode current, the noise reduction and reduction of amplification due to feedback were again measured. The results are plotted in Fig. 5; once more the effects of feedback are the same for signal and for noise. The noise measurements necessarily include the shot noise as well as other low-frequency components.

Several valves were encountered in which the noise reduction ratio was considerably less than the amplification reduction ratio. In all cases this was proved to be due to external sources of noise caused by valve imperfections, usually leakage currents between electrodes.

Measurements were next made with several specimen valves connected as pentodes. Here, it makes a decisive difference whether the screen by-pass capacitor is connected to the cathode or to earth. In the circuit of Fig. 6a the by-pass capacitor is returned to the cathode. With this

arrangement, the screen current fluctuations flow externally, direct from screen to cathode, so that no noise voltage due to the screen current fluctuations appears across the cathode resistor R_k . Consequently, only the anode current fluctuations are concerned in the noise reduction ratio due to feedback, and results similar to those of a triode are to be expected. This was fully confirmed by the experiments. Fig. 7 shows the results of specimen 4 for various degrees of feedback. The curve for a faulty 6SJ7Y is also plotted. Fig. 8 illustrates the effect of varying the cathode current when the feedback resistor R_k is kept constant.

Here, also, exceptions were found to be due to valve imperfections. In fact, the very first pentode tested gave low noise reduction ratios due to noise generated in a leakage path between anode and metallizing. A whole batch of valves of this type suffered from this defect

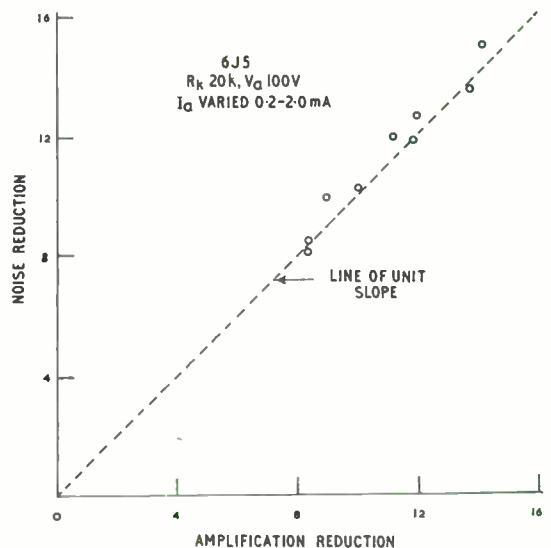

Fig. 5.—Comparison of the reduction of noise with the reduction of amplification in a triode for different values of anode current, the feedback resistor R_k being held constant.

to varying degrees. Other defects which caused false results are listed below:—

- (1) 6SJ7Y: with special high-frequency base material which was subject to multiple leakage paths. This valve was perfectly

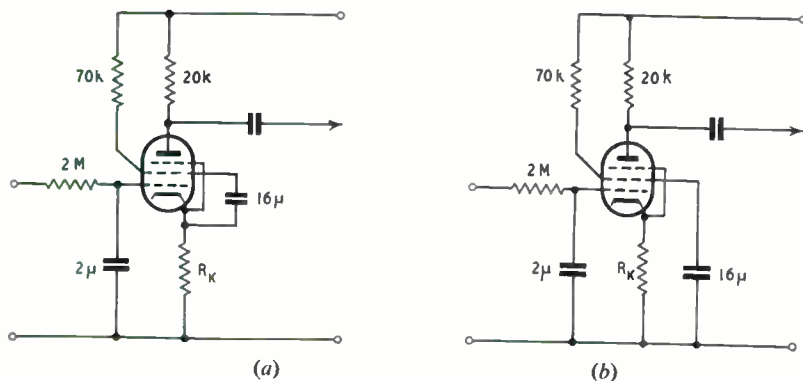

Fig. 6.—The two different circuit arrangements for the negative current feedback tests with a pentode.

normal after the base was removed (see Fig. 7).

- (2) 6AC7: leakage path anode to metal casing.
- (3) 6SJ7GT: extra noise due to direct emission from heater filament to an internal screen which is connected to the screen grid.
- (4) 6AC7: two such valves, subject to emission from the cathode lead to the adjacent screen grid connector lead. This was characterized by a protracted cut-off of cathode current: thus one specimen was virtually cut-off with -120 V at the control grid but the second valve still passed $15\ \mu\text{A}$ cathode current at this bias potential.

valves 1 and 4. It is seen that the noise reduction due to negative feedback is much less than the reduction of amplification whereas the two were equal for condition (a).

An immediate deduction is that the fluctuations of current do not involve the cathode emission as a whole. If this were so, the waveforms of the anode and screen current fluctuations would be identical and the reduction of noise output would necessarily be equal to the reduction of signal gain. If a separate partition current is considered, behaving as if it flowed from anode to screen, then with the connection of Fig. 6b, this current does not flow through

The tracing of these defects was an interesting study but, as it is of technical interest only, the details have not been recorded here. Before leaving this circuit it is interesting to note that the a.c. components of anode current flow through R_k and R_s as a parallel combination. The feedback ratio is therefore not as great as a first inspection would suggest. When R_s is taken into account, calculated reductions of amplification (using the measured parameters) agree with the measured values.

There follows the most interesting of these measurements, namely, the effect of cathode current feedback on the noise output voltage at the anode when the screen grid by-pass capacitor is connected to earth as in Fig. 6b. The methods of noise and signal measurement were as before; only those specimens which had been proved free from external noise sources were used. Fig. 9 shows the results of specimen

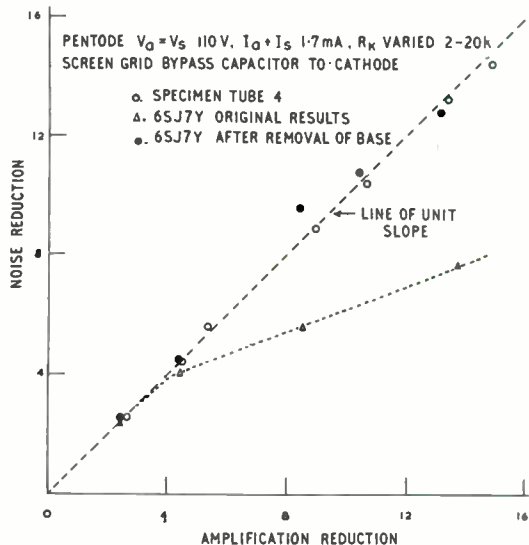

Fig. 7.—Comparison of noise reduction with gain reduction, using different values of R_k in the circuit arrangement of Fig. 6a.

the cathode resistor R_k . Consequently, noise voltage at the anode due to such a cause will not be modified by feedback. The presence of this partition current could therefore lead to a plot of the kind shown in Fig. 9. The curve is asymptotic to a line of constant noise reduction corresponding to an approximate ratio of 4 : 1.

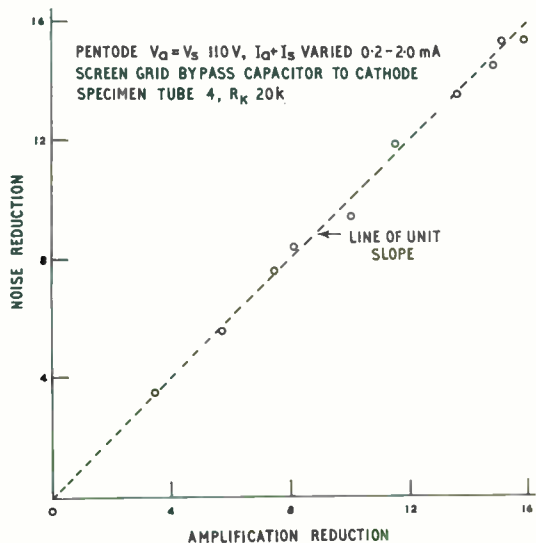

Fig. 8.—Comparison of noise reduction with gain reduction for different values of anode current in the circuit of Fig. 6a.

This indicates that, although the initial fluctuations are largely reduced by negative feedback, the remaining root mean square noise current is equal to one quarter of the total unreduced root mean square noise current. The effect of heavy negative feedback is equivalent to a virtually complete reduction by space charge of the initial fluctuations. Now the results of Tables 1 and 2 show that the flicker noise of specimens 1 and 4, at 20 c/s, greatly exceeds the normal shot noise. Consequently, the magnitude of the shot partition noise is much too small to account for the results of Fig. 9. The presence of "flicker partition" is therefore confirmed and in the given circumstances this has a root mean square value equal to approximately one quarter of the total root mean square anode noise current.

In comparison, the noise reduction factors Γ_p^2 and Γ_r^2 at the high frequency were in the

approximate ratio 2 : 1. The root mean square value of the extra noise current due to partition was therefore equal to that of the original shot noise. A possible reason for the smaller increase of low-frequency noise (due to partition) compared with the increase of shot noise is now given.

The reduction of flicker noise by space charge limitation of current has been shown to be greater than the corresponding reduction of shot noise.³ This may be explained in terms of a theory such as that of Schottky,⁴ or Macfarlane⁵ in which localized areas or patches are involved. When a patch on the surface yields an instantaneous increase of emission, the extra electrons cause a more dense electron cloud in the region of the patch. The height of the barrier due to the space charge minimum of potential is increased so that the space current of electrons from the surrounding area is decreased. So far this is in qualitative agreement with the reduction of shot noise. The difference between the two cases lies in the correspondence between the initial emitting area and region over which the change of space charge is effective. For the very small areas concerned with the emission of single electrons this correspondence is not

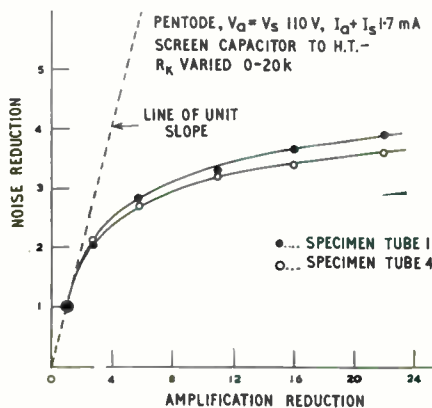

Fig. 9.—Comparison of noise reduction with gain reduction using different values of R_k in the circuit arrangement of Fig. 6b.

high so that only partial space charge smoothing of shot noise occurs. With the much larger areas expected to be concerned with the flicker effect, the correspondence would be better so that an increased smoothing action of the space charge should result.

Now, in a pentode, the initial statistical fluctuations of emission will divide between anode and screen in random manner. The compensatory current changes due to space charge will be spread over a larger area and will divide between anode and screen more or less in the ratio of the d.c. currents.¹ Thus, the smoothing action of the space charge is largely reduced. With the larger patches involved in the flicker effect, the area involved in the initial fluctuation and the area involved in the compensating current are of much the same size. Therefore, if the initial fluctuation divides between anode screen grid in a certain ratio, then the compensatory current divides up in much the same way. Consequently, the increased smoothing of flicker noise due to space charge is not greatly cancelled by the division of current between the collector electrodes.

5. Conclusions

The presence of a "flicker partition" effect in pentodes has definitely been confirmed. The fractional increase of flicker noise (due to partition) is less than the corresponding fractional increase of shot noise.

In low-frequency amplifier practice the question often arises as to the relative merits of a triode or a pentode as the first valve from the point of view of signal-to-noise ratio. Due to the presence of "flicker partition," a pentode would appear to be less suitable. This is confirmed by the results of Table 2 in which column 3 shows the equivalent noise resistance R_{eq} when triode connected. Now the stage gain, when pentode connected, had an average value of 20 ($g_m = 1 \text{ mA/V}$, $R_L = 20 \text{ k}\Omega$). The equivalent noise resistance, pentode connected, is therefore equal to the figure R_p' of the fifth column divided by 400. In all cases except those of specimens 6 and 7 the equivalent noise resistance is about 50 per cent.

higher when pentode connected. The results for specimens 6 and 7 are discredited for the reason explained previously. It is therefore evident that a triode is to be preferred as the first valve.

If, because of other considerations, a pentode is chosen, and if an un-bypassed cathode resistor is used, then it is important that screen by-pass capacitor is returned to cathode and not to h.t. negative. This follows from the results of experiment 3 above. In any case, it is not advisable to use a cathode bias resistor. It is not possible to by-pass this with an electrolytic capacitor because of the excess low-frequency noise produced in this component. An un-bypassed resistor causes a reduction of gain, so that the noise generated in the anode circuit and in the second stage becomes more important. The simplest course is to use a negative bias supply which is adequately decoupled with a high-stability type carbon resistor in conjunction with a low-leakage paper-type capacitor.

6. References

1. D. O. North. "Fluctuations in space-charge-limited currents at moderately high frequencies: III, Multi-collectors." *R.C.A. Review*, 5, October 1940, pp. 244-260.
2. C. J. Bakker. "Current distribution fluctuation in multi-electrode radio valves." *Physica*, 5, July 1938, pp. 581-592.
3. T. B. Tomlinson. "Space charge reduction of low frequency fluctuations in thermionic emitters." *J. Appl. Phys.*, 23, August 1952, pp. 894-899.
4. W. Schottky. "Small-shot effect and flicker effect." *Physical Review*, 28, 1926, p. 74.
5. G. G. Macfarlane. "A theory of contact noise in semiconductors." *Proc. Phys. Soc., B.*, 63, October 1950, pp. 807-814.

THE AUTOMATIC INDICATION AND RECORDING OF MINUTE CONCENTRATIONS OF ORGANIC GASES IN AIR*

by

H. A. Thomas, D.Sc. (Member)†

A paper presented during the Industrial Electronics Convention held in Oxford in July 1954.

SUMMARY

The presence of methanol in an industrial plant is detected by catalytic conversion to CO_2 and estimation by infra-red gas analysis. The equipment continuously and sequentially samples the atmosphere from ten points in the plant and gives automatic warning when the methanol concentrations at these points exceed 200 and 1,000 parts in 10^6 . A continuous record is also provided.

1. Introduction

In many industrial processes minute concentrations of organic gases in the atmosphere constitute a hazard to the health of the operatives. In some cases the hazard is so serious that special protective measures have to be taken; in others no special protection is normally adopted when the plant is functioning correctly but maloperation or the development of faults in the equipment may lead to conditions which are dangerous. In these cases continuous and automatic examination of the atmosphere is desirable and provision must be made for warning to be given of dangerous conditions.

In this paper a description is given of such an automatic warning system constructed to detect minute concentrations of methanol in air. The equipment has been in continuous operation (24 hours a day) for over two years and has given entire satisfaction. Although specifically designed for the detection of methanol the basic principle has wide application to other tramp gases in the atmosphere.

The specific problem which has been solved relates to plant for fractionating fatty acid mixtures into oleine and stearine, in which 90 per cent. methanol is used as the partitioning agent. Diffusion of methanol into air constitutes an industrial hazard because concentrations of methanol in air exceeding 200 p.p.m.‡ are generally considered to be injurious to health if maintained for a long period of time§ and this concentration can be greatly exceeded in the plant if leakage occurs.

As protection of plant operatives is important, it was considered desirable to develop and install a fully automatic monitoring and warning system which would provide a continuous record of the methanol concentration at a number of points in the plant and give visual and audible warning of dangerous concentrations. The envisaged equipment would provide visual warning of concentrations in excess of 200 p.p.m. at any one of ten selected positions in the plant and, also, audible warning of concentrations in excess of 1,000 p.p.m.

Development of a system capable of satisfying the requirements has involved:—

- (i) Selection of the most suitable physical method of detection.
- (ii) Development of a practicable method of detection.
- (iii) Development of a fully automatic equipment embodying detecting, recording, indicating and alarm systems capable of reliable and "foolproof" continuous operation under plant conditions.

In this paper these three aspects of the development work are briefly presented and a description is given of the final equipment.

2. Development of Method of Detection

The continuous and rapid monitoring of an industrial atmosphere for small amounts of methanol necessarily involves means of measuring its concentration by a physical method; the

‡ Gas or vapour concentrations are expressed in parts per million (p.p.m.) by volume.

§ The American Standards Association has adopted "200 parts of methyl alcohol per million parts of air by volume as the maximum allowable concentration for exposure not exceeding a total of eight hours daily." (F. A. Patty, *Industrial Hygiene and Toxicology*, 2, 1949, p. 942.)

* Manuscript received 31st March, 1954. (Paper No. 288.)

† Research Department, Unilever Ltd., Port Sunlight, Cheshire.
U.D.C. No. 545.82:621.37/8:661.721.

method must be selective for methanol and must not indicate other impurities. Of possible means of detection¹⁻⁴ it was decided that the infra-red absorption technique was likely to be most useful, but that a pneumatic gas analyser^{5, 6, 7} in which the detector cells were filled with methanol, gave inadequate sensitivity and did not provide satisfactory discrimination between methanol and water vapour, the concentration of which can be quite high.

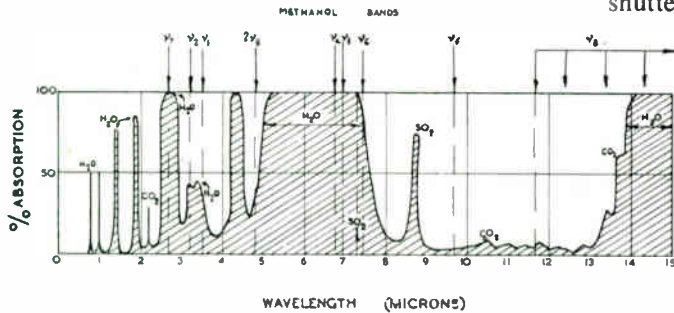

Fig. 1.—Infra-red absorption spectrum of a typical industrial atmosphere.

Examination of the infra-red absorption spectrum of a typical industrial atmosphere,^{8, 9} shown in Fig. 1, shows that of the two strongly absorptive wavelengths of CO₂, namely 4.3 μ and 15 μ , the lower is well removed from any of the H₂O bands or the principal resonances of SO₂, a likely impurity in a typical industrial atmosphere. On theoretical grounds, therefore, conversion of methanol to CO₂ and its subsequent detection as CO₂ appeared to offer good prospects of adequate discrimination. It is comparatively easy to detect CO₂ at concentrations as low as 5 p.p.m. by a pneumatic infra-red gas detector; consequently, if satisfactorily rapid oxidation of methanol to CO₂ can be achieved it should be possible to effect a satisfactory solution.

After considerable experimentation the arrangement shown in Fig. 2 was found to be satisfactory. The gas stream is divided equally; one portion flows through the combustion chamber and the examination tube of the infra-red gas analyser while the other flows through a dummy chamber, having the same pneumatic resistance and capacity, and the reference tube of the analyser.

The analyser itself¹⁰ consists essentially of two sources of infra-red radiation, an examination

tube, a reference tube, a rotating shutter, and a sealed detector cell. These components are arranged so that radiation from one source passes, via the examination tube (through which flows gas from the combustion chamber), to the detector cell, while radiation from the other source also passes, via the reference tube (through which flows untreated gas), to the detector cell, the radiation from both sources being chopped simultaneously by the rotating shutter.

The detector cell is fitted with two mica windows to admit the infra-red radiations and is divided internally into two equal compartments by a very thin aluminium-alloy diaphragm. It is filled with a mixture of carbon dioxide and nitrogen (1 part of CO₂ to 14 parts of N₂ by volume) at atmospheric pressure, and the two compartments are interconnected through a

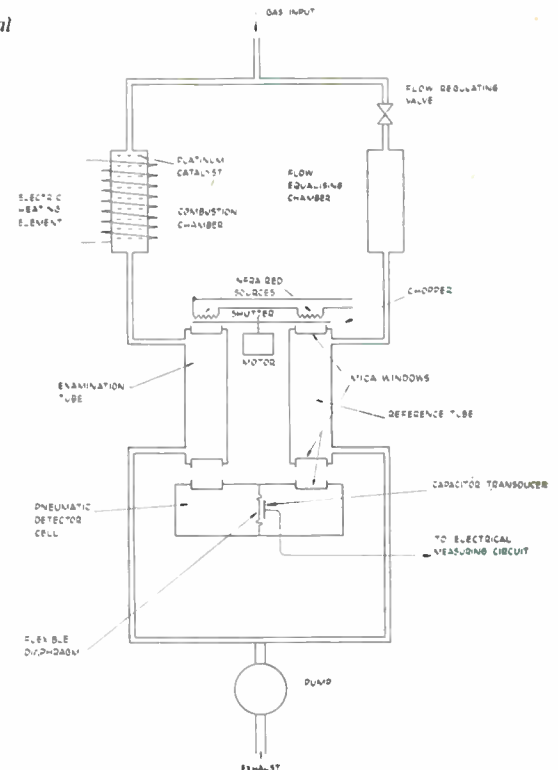

Fig. 2.—Arrangement of gas analyser and combustion chamber.

minute capillary which permits equalization of the normal gas pressure on either side of the diaphragm.

The two beams directed onto the detector cell are interrupted about five times a second by a rotating shutter; when the radiation intensity of the two beams is similar the pressure produced in each cell compartment during each short pulse of energy is the same and the diaphragm is undeflected; if, however, the radiations are dissimilar then, since the thermal capacity of the detector gas is small, the pressure in one compartment during each pulse of energy will exceed that in the other and, in consequence, the diaphragm will vibrate.

If a wire grid mounted on insulation is located parallel to and about 0.002 in. from this diaphragm the vibrations appear as capacitance changes. It is exceedingly difficult to compute the pressure changes which occur because the temperature differences cannot be measured; for a differential of 1,000 parts in a million of CO_2 in air the peak value of the pulsating capacitance change is 0.0025 pF.

The dummy or flow-equalizing chamber is necessary to give correct "phasing" of the gas streams, i.e., it compensates for the resistance and capacity of the combustion chamber to gas flow. Random changes in the CO_2 concentra-

tion in the atmosphere thus reach both detector tubes simultaneously and, in consequence, a reasonable degree of compensation for atmospheric variations of CO_2 is provided. Complete immunity from transient CO_2 fluctuations is provided by a time-integrating system in the output circuit of the analyser.

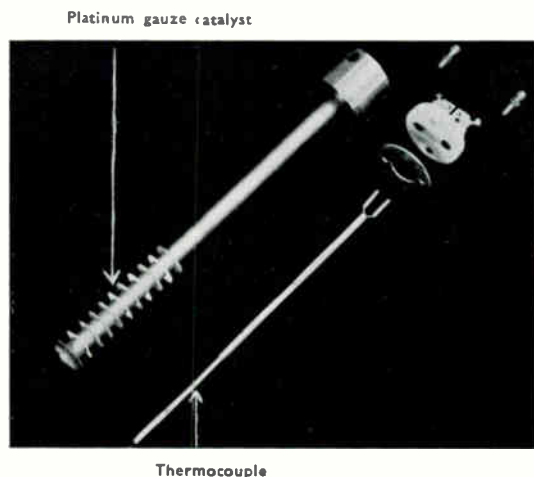

Fig. 4.—Combustion chamber—catalyst stem and thermocouple.

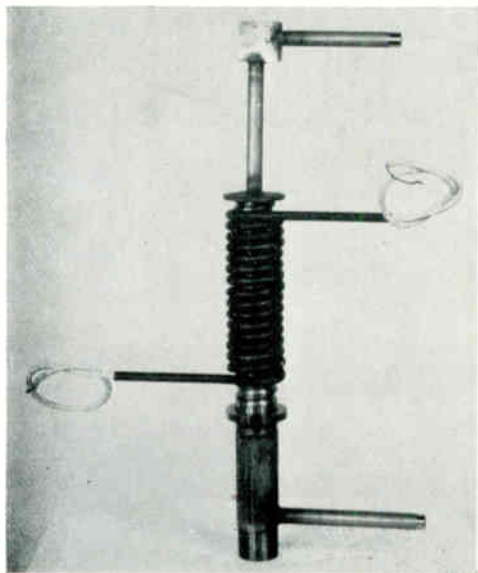

Fig. 3.—Combustion chamber—heating element.

The combustion chamber shown in Fig. 3 comprises a 1-in. bore high-temperature-resistant stainless steel tube fitted at one end with a plug carrying a fabricated "L" section of $\frac{3}{8}$ -in. bore tube of similar material and at the other end with a length of similar small diameter tube. The outside of the tube is grooved to take a 750-watt heating element with an Inconel sheath and is fitted with collars to support a protective sheath. This heating element is maintained at a temperature of 680°C with 230 watts by means of an electrical energy regulator.

The catalyst is mounted as shown in Fig. 4 on a stem of heat-resisting stainless steel tube welded to a nut at one end. There are eleven pads of 40-mesh platinum gauze $\frac{1}{16}$ -in. diameter clamped between loose fitting collars on a section of the stainless steel tube reduced in diameter to accommodate them; these pads and collars are retained by a perforated disc which screws onto the end of the stem and serves to protect the catalyst as it is inserted into the larger tube.

The thermal insulation comprises a 2½-in. thick covering of "Newtempheit" surrounded by an asbestos cover as shown in Fig. 5 which also shows the complete assembly of the combustion chamber, flow-equalizing chamber, and pressure-regulating valve. It will be noticed that the gas under examination enters at the mid-point union shown on the right of the photograph, divides into two streams, and leaves via the two unions shown at the left of the photograph; the top and bottom unions are connected respectively to the sample and comparison tubes of the analyser.

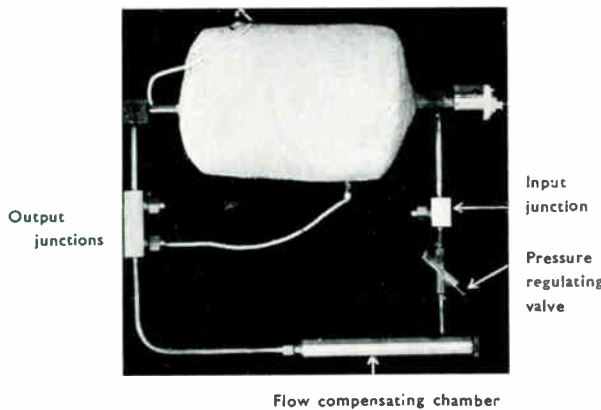

Fig. 5.—Assembly of combustion chamber, flow-equalizing chamber and pressure-regulating valve.

With the arrangement described above a conversion efficiency of 80 per cent. was attained for an air flow of 3 litres per minute and a methanol concentration of 200 p.p.m.; the response time taken to convert all the methanol to CO₂ was 5-10 seconds. Transient fluctuations in output due to random changes in atmospheric CO₂ content were observed which could not entirely be eliminated by adjustment of the flow-equalizing chamber. Since such fluctuations are of short duration, the incorporation of a time-integrating system in the output circuit of the infra-red analyser permits discrimination between changes in the ambient CO₂ concentration and changes in the concentration of the combustion products of methanol.

Substances other than methanol produce CO₂ when burned; hence, when other organic vapours are present, the method is not selective to methanol. Organic dust must be prevented

from entering the system by careful filtering of the incoming air stream; also, there is some danger of poisoning the catalyst if tramp substances are allowed to enter the combustion chamber.

3. Modifications to the Commercial Gas Analysers

Experience in operating the commercial analysers showed that the stability of the standard electronic system utilized to detect vibration of the diaphragm was inadequate for continuous operation. Study of alternative means of detection resulted in the development of an improved system in which very small changes in capacitance can be detected at the interruption frequency of the infra-red sources; by such means the effects of slow or steady changes in capacitance, such as may be produced by "ageing" or by thermal effects in the detecting chamber, have been eliminated.

The improved system utilizes a particular property of certain multi-electrode valves^{11, 12} which can best be described by reference to Fig. 6. A low-loss resonant circuit is connected between earth and the third grid of a hexode valve while a sinusoidal reference voltage is applied to the first grid. The coupling between these two grids is sufficient to excite the resonant circuit and, when its natural fre-

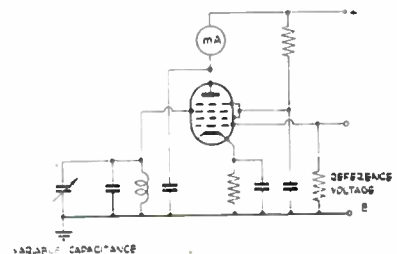

Fig. 6.—Arrangement of basic detector circuit.

quency is adjusted approximately to that of the reference voltage, an appreciable current is induced in it. The phase and amplitude of the resultant voltage appearing at the third grid varies considerably for small deviations of the natural frequency from the reference-voltage frequency; as the anode current depends on the relative phase and amplitude of these two vol-

tages (if the normal operating potentials are applied to the other electrodes) then the net result is that the relationship between anode current and natural frequency (or capacitance) and anode current and frequency of the reference voltage is somewhat as shown in Fig. 7. Over a restricted range of both capacitance and frequency a linear relationship exists between anode current and either capacitance or frequency.

Using a low-loss inductor, tuning with the capacitor detector and associated cables to 7 Mc/s, it was found that pulsating movement of the diaphragm produced corresponding changes in anode current. These current changes were converted to voltage changes by means of a resistor connected as anode load of the valve. Owing to imperfections in the infrared beam system and stray pick-up from 50 c/s mains it was also found necessary to suppress unwanted signals by passing this voltage through a low-pass valve-assisted resistor-capacitor filter before using it to operate the recorder amplifier and alarm detectors.

It will be noted from Fig. 7a that slow changes in the stray capacitances associated with the electrode supports, etc., can disturb the operating conditions of this simple circuit with consequent loss of sensitivity and linearity; Fig. 7b shows, however, that the circuit can be

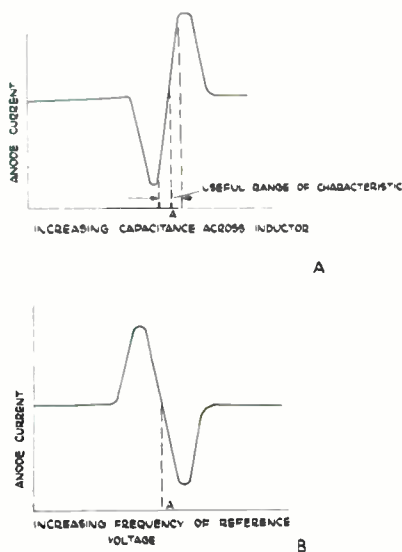

Fig. 7.—Characteristic of basic detector circuit.

restored to its correct operating condition by adjusting the frequency of the reference oscillator.

In the improved method this adjustment is applied continuously and automatically. A second low-pass resistor-capacitor filter connected to the anode of the valve rejects all signals of frequency exceeding about 0.2 c/s. Its output voltage is equal to the approximate mean value of the input over a period of about 20 seconds and is used to control a "reactor valve" which in turn varies the frequency of the reference-voltage oscillator in such a manner that the simple circuit is maintained in the correct

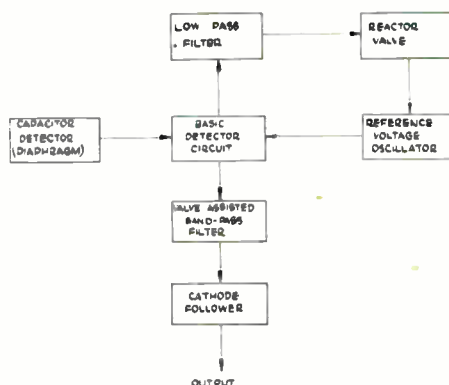

Fig. 8.—Block diagram of improved detector for gas analyser.

operating condition. Fig. 8 shows a block diagram of the improved system and Fig. 9 a simplified circuit diagram.

4. Description of Equipment

4.1 Requirements

It has already been stated in the Introduction that the equipment should "examine" the atmosphere at ten points in the plant. Continuous examination at each of these points would involve duplicate detecting, indicating, and recording equipment together with suitable alarm circuits for each channel as well as a control system to co-ordinate their operation. Although such a system would give a very detailed record, its high cost was not justifiable; it was considered that sequential examination at ten points (referred to hereafter as stations) by means of a common detecting system would be adequate. The decisions relating to operational technique were, therefore, as follows:—

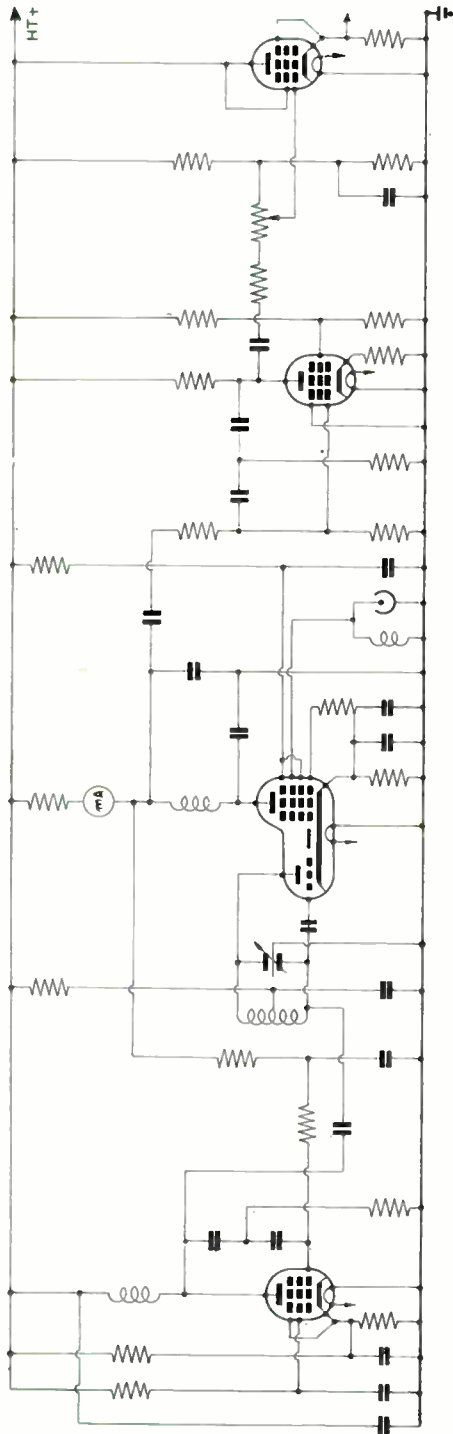

Fig. 9.—Circuit diagram of improved detector for gas analyser.

(i) The common detecting system would comprise two identical gas analysers operating in parallel so as to prevent interruption of the service in case of failure of one unit; a continuous record would be given by each analyser; and the records would be presented, with means of identification, on a "duplex recorder" chart.

(ii) Examination of the atmosphere at each station would be for a period of $1\frac{1}{2}$ minutes with an allowance of half a minute at the beginning of each examination period for removing from the system all traces of gas from the previously examined station.

(iii) To avoid operation of the 200 p.p.m. alarm by transient concentrations of gas in excess of this value, this particular concentration must occur for a total period of 30 seconds during any examination before the appropriate alarm is raised; and, in the case of the 1,000 p.p.m. alarm, that operation would occur if this concentration existed for any single period in excess of five seconds during any examining period. Either detecting channel must be capable of raising these alarms independently of the other.

(iv) Visual indication would be provided of the particular station under examination at any instant as well as of the alarms which had been raised previously at any of the other stations. Furthermore, these alarms would be maintained for that particular station until it had been re-examined; if at the end of the second examination the alarm had not been confirmed the particular alarm would automatically be cancelled as the "station selector mechanism" proceeded to the succeeding station.

(v) Duplicate external alarms would be provided comprising a signal lamp, illuminated if the alarm for 200 p.p.m. methanol had been raised at one or more stations, and a hooter sounded immediately the alarm for 1,000 p.p.m. methanol occurred at any station. Means would be needed for making inoperative these external alarms for any of the stations without interrupting the record on the duplex recorder, the indication of alarms on the "indicator panel," or the external alarms for the remaining stations; in addition, means for transferring the hooter from continuous operation to operation for one minute once every half-hour would be required.

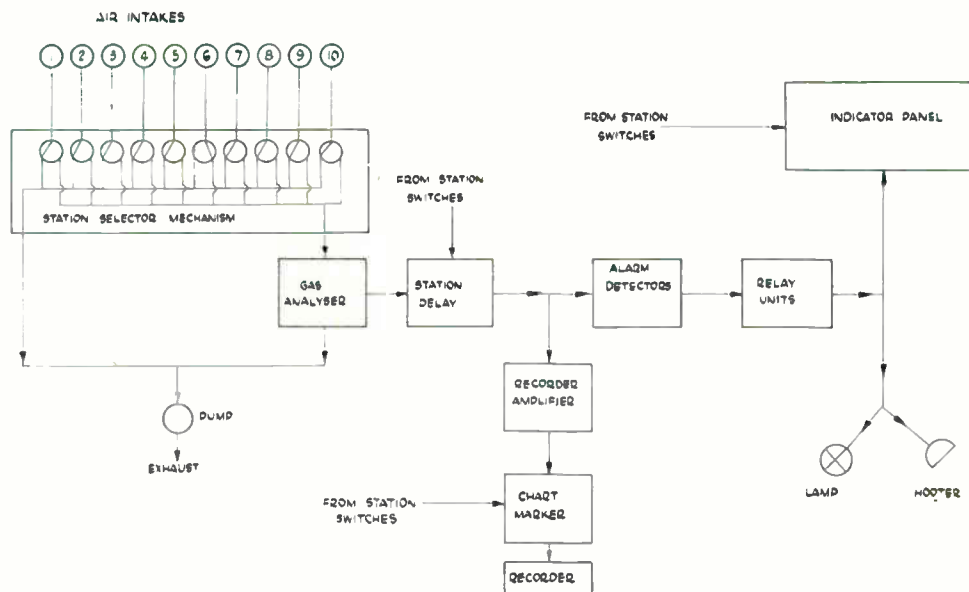

Fig. 10.—Basic components of system.

(vi) Ancillary test equipment would be needed to simulate the electrical output from the "gas analysers" to permit checking of the alarm signal system and amplifiers driving the duplex recorder. A further unit would be required to enable a test gas, of adjustable concentration between zero and 1,000 p.p.m. methanol, to be substituted in either gas analyser for the gas from the stations while the plant service was maintained by the other gas analyser. Also it should be possible to pass this test gas simultaneously through both gas analysers so that direct comparison of their performance can be obtained. Finally, rapid test facilities would be required to check operation of the relay circuits by simulating all the electrical signals which can normally be supplied to them.

4.2 Basic Components

Consideration of the above requirements and the developed technique of detection shows that the basic components of the system must be somewhat as shown in Fig. 10.

The air/methanol mixture is drawn continuously by a pump from all the ten selected inspection points in the plant. Sequential inspection is provided by temporarily diverting

the gas from any one station through the analysis system instead of exhausting it to the atmosphere. This sequential selection is provided by the station-selector mechanism which comprises ten two-way valves operated in turn by a motor-driven cam. A switch mounted on each of the two-way valves is arranged to operate when the valve has completely diverted the flow of gas to the gas analysers and to reset immediately the valve commences to return the gas flow direct to the exhaust.

The electrical output from the gas analysers is interrupted by the "station delay circuit" which is actuated by the station switches. This circuit interrupts the signal from the analyser for about half a minute at the beginning of each examination period whilst the gas from the previous station is being expelled from the gas analysers.

The signal from the station delay circuit is applied to the "recorder amplifier" and also to the "alarm detectors." The recorder amplifier raises the power level of the signal from the gas analyser sufficiently to operate the recorder to which it is connected through the "chart marker circuit"; this circuit introduces a discontinuity in the record to enable each complete cycle of the sequential inspection to be identified.

The alarm detectors operate mechanical relays (which in turn raise the appropriate alarms) when the input signal reaches a level of 200 p.p.m. and 1,000 p.p.m. methanol. As previously stated, the 200 p.p.m. alarm is given only when this concentration is exceeded for at least 30 seconds during any one examination and the 1,000 p.p.m. alarm only when this concentration has existed for five seconds. Both detectors comprise an "integrator" and a "trigger" unit. The integrator which summates the periods of concentration in excess of 200 p.p.m. is interposed between the relays in the trigger units and those which operate the "indicator panel" and the alarms; if the total period does not reach 30 seconds no alarm is raised and the integrator is reset when the station switch is changed to the next position.

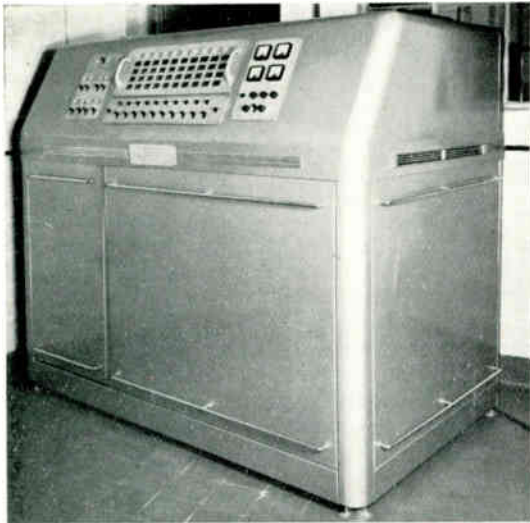

Fig. 11.—Front view of complete equipment.

In the trigger circuit, which operates only when the methanol concentration reaches 1,000 p.p.m., a slightly different integrator circuit is used; this is arranged to raise the alarm when this concentration has existed for about five seconds, and does not respond to signals of shorter duration.

The indicator panel co-ordinates the alarm signals from the trigger and integrator units with the station switches; it shows at a glance which station is being examined, whether a concentration of 200 or 1,000 p.p.m. exists, and

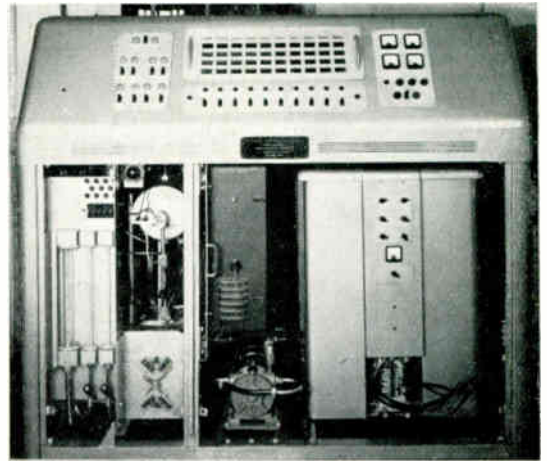

Fig. 12.—Front view of complete equipment (with covers removed).

what concentration existed at the other nine stations during their previous examination.

4.3 General Arrangement

Since methanol can form an explosive mixture with air all the heavy electrical equipment in the plant conforms to standard specifications for flameproof equipment. It would have been very difficult to design the monitoring equipment to conform to these same specifications; consequently, to overcome the fire hazard, a separate room is provided to house the equipment, the air pressure in this room being maintained slightly above that in the plant by continual intake of fresh air from outside the building.

The general arrangement of the various components, except for the two test units and the duplex recorder, is shown in Figs. 11, 12 and 13; Fig. 11 illustrates the general appearance of the complete equipment, while Figs. 12 and 13 show the internal arrangements with the covers removed.

The station-selector mechanism is shown in Fig. 14 and also at the right of Fig. 13; the large gear which drives the cam can be seen mounted on the left-hand side of the plate to which is fixed radially all the change-over gas valves and station switches.

The two combustion and flow-equalizing chambers can be seen in Figs. 12 and 13 mounted back to back and occupying the full space between the front and back panels.

The two gas analysers are mounted side by

side on detachable frames as shown in Fig. 15 and also occupy the full depth of the equipment. Below them, as seen in Figs. 12 and 13 are mounted the two rotary vacuum pumps, with their associated pneumatic and electrical change-over mechanism shown in Fig. 12 mounted below one of the flow-equalizing chambers. The three rotameters which measure the gas flows in various parts of the system are shown on the left of Fig. 12.

All the electronic components, namely, the station-delay circuits, alarm detectors comprising trigger units and integrators, and recorder amplifiers are contained in one removable electronic unit shown on the left of Fig. 13. The duplicate alarm detectors are at the top, the recorder amplifiers in the middle, and the timers for controlling intermittent operation of the external hooters and the power unit respectively at the bottom left and right-hand side. The electrical connections and the monitoring system for checking the anode currents in all the valves in this unit are clearly shown at the right of Fig. 12.

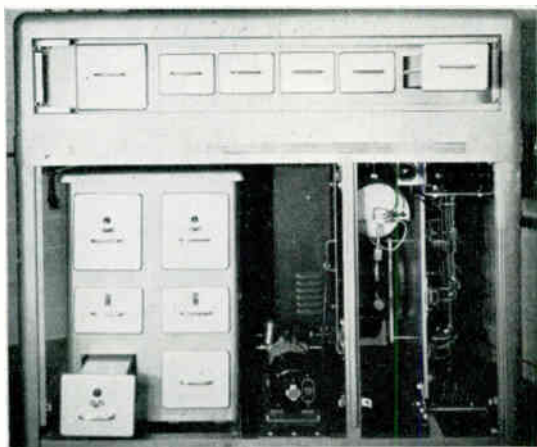

Fig. 13.—Rear view of complete equipment (with covers removed).

The majority of the relays together with their power supplies are accommodated in the top portion of the equipment. The relays associated with individual stations are grouped into five units each containing the relays for two stations. These units are interchangeable and can be seen at the top of Fig. 13, one unit being partly withdrawn; the associated power supplies are contained in the larger unit at the left. The

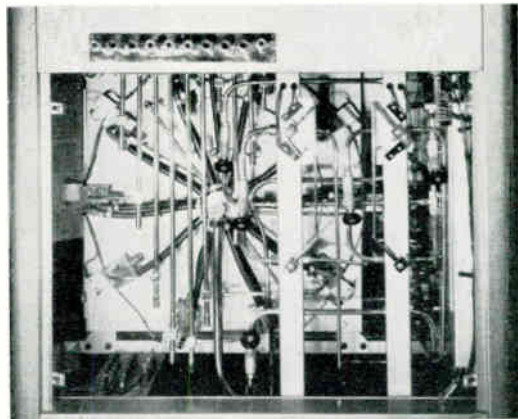

Fig. 14.—Cam unit and internal pipework.

relays which operate the external alarms as well as those in the test-relay circuits and those which co-ordinate the signals to the relay units from the electronic unit are mounted on a fixed panel immediately behind the main indicator panel.

The main indicator panel is shown in Figs. 11 and 12. The indicator lamps for the ten stations are arranged in groups of five; the top lamp is white and indicates which station is under examination, the second is amber and when illuminated indicates that the alarm for 200 p.p.m. methanol has been raised at that station, the third is red and when illuminated indicates that the alarm for 1,000 p.p.m. methanol has been raised; the fourth indicator lamp is also red

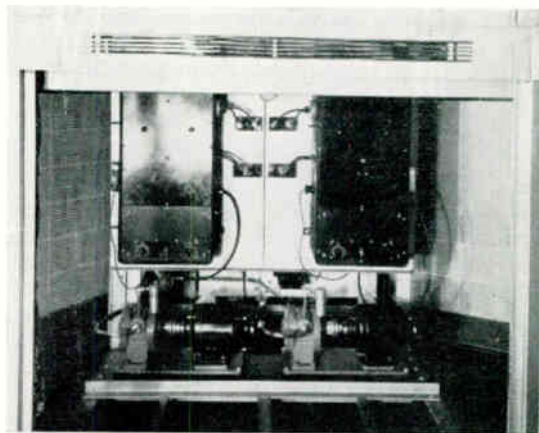

Fig. 15.—Mounting for gas analysers and pumps.

and is illuminated when the internal buzzer (which is energized when the 1,000 p.p.m. alarm is raised) is cancelled by operating the push button immediately below the associated group of lamps; and the fifth again is red and is illuminated when the lower switch cancelling the external alarms for the station has been operated.

All the switches controlling the power supplies to the various units are mounted on the left of the panel together with neon lamps indicating when they are operated.

On the right of the panel are mounted four meters; the top two are arranged in series with the duplex recorder and indicate the output of the two recorder amplifiers; the lower two, which are connected to the thermocouples in the combustion chambers, indicate the operating temperature. Immediately below these meters are mounted the push button and three indicator lamps of the circuit testing all the relay units in the equipment. Below these is the switch which brings the standby vacuum pump into operation when the equipment is to be tested with methanol vapour from the methanol generating plant. On either side of this switch is a lamp to indicate which gas analyser has been transferred from plant operation to test.

4.4 Gas Flow System

At each station in the plant where the atmosphere is withdrawn for examination a sampling chamber is mounted about 4 ft. above floor level. Gas is admitted to these chambers through a stainless-steel gauze (40 mesh) backed by a 4-in. diameter ceramic disc 1 inch thick. After passing through these, the gas is withdrawn from the chamber through $\frac{3}{8}$ -in. bore copper pipes to the equipment, particular care being taken that all the pipe runs are inclined slightly so that condensed moisture may flow either towards the filters or towards the equipment and not form a blockage in the pipe.

All ten pipes from the sampling chambers are terminated by a change-over cock mounted on the wall of the pressurized room as shown in Fig. 16. These cocks connect the pipes either to the equipment via pressure-regulating valves or alternatively to a compressed-air reservoir charged with air from the main plant supply reduced to 35 lb./in.² By this means the pipe runs may be scavenged occasionally. The pressure-regulating valves enable the pneumatic resistance of each pipe run to be equalized and

so prevent differences in the rate of gas flow through the equipment as successive stations are examined.

Beyond these valves the ten pipes are connected to the main unit, the points of entry being clearly visible in Fig. 14. This figure also shows the moisture traps associated with each pipe and the ten change-over valves arranged around the cam.

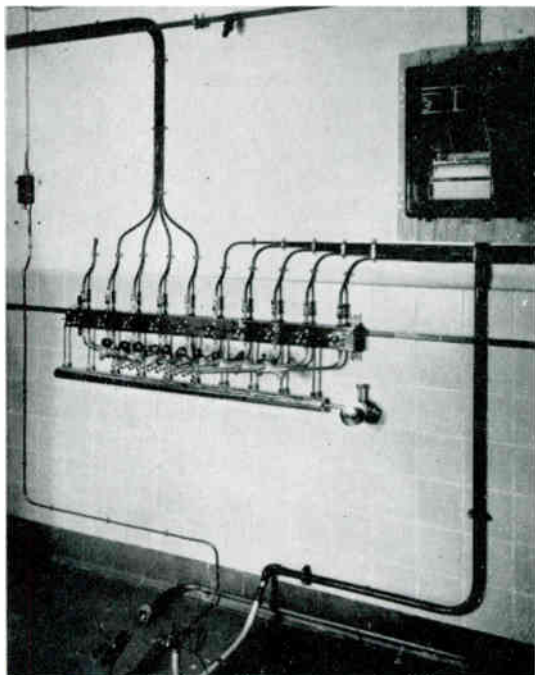

Fig. 16.—Terminating arrangement of incoming gas pipes.

As previously mentioned, the gases are pumped continuously from all the ten stations and the cam selects each in turn for examination by diverting the gas so that, instead of flowing directly through to the exhaust, it flows through the gas analysers. Operation of any one of the ten change-over valves by the cam, which makes one complete revolution in $17\frac{1}{2}$ minutes—allowing $1\frac{3}{4}$ minutes per station—diverts the flow of gas from the front manifold shown in Fig. 14 to the rear manifold.

The gas then passes via a large sintered-bronze filter to cocks which split the flow into three parts, two of which pass through pressure-regulating valves to rotameters for indicating the rate of flow. After passing through these

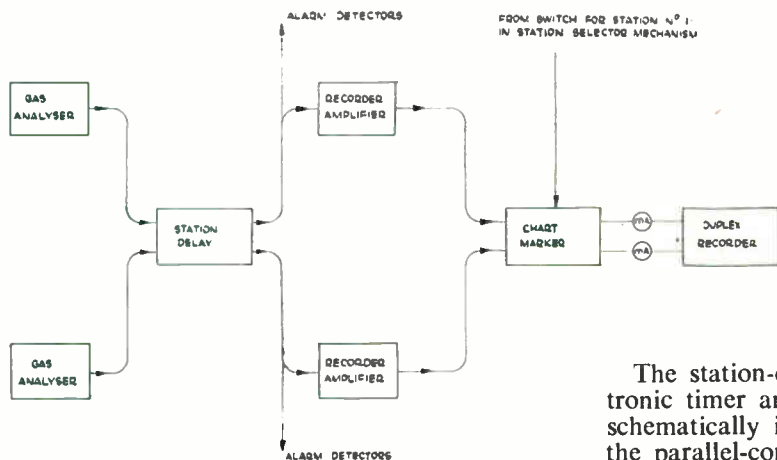

Fig. 17.—Schematic diagram of gas analysers, recorder amplifiers, duplex recorder, station delay, chart marker and station marker.

rotameters the gases enter the gas-analyser units comprising the combustion chambers, pressure-regulating valves, flow-equalizing units, and infra-red gas analysers. The exhaust from the gas analysers joins the gases from the other nine stations which have by-passed these units, and the gases then pass via the selector valve to one of the two pumps shown in Fig. 15 which exhaust them to atmosphere. The complete gas-flow diagram is shown in Fig. 23.

4.5 Recording System

Mention has already been made of the requirement to provide a continuous record of the electrical output from the two gas analysers. The electrical output from these analysers is insufficient to operate directly a robust recording instrument; it is necessary, therefore, to amplify the signals and to introduce markers which permit identification of the records for each station.

A schematic diagram of the general arrangement is shown in Fig. 17. As the station-selector mechanism advances from station to station, a time delay circuit—the station delay—is operated; this circuit disconnects the electrical output of the gas analysers from both the recorder amplifier and the alarm detectors for a period (25 sec) sufficient to ensure that all the gas previously examined has been displaced from the analysis system. This temporary disconnection also produces a discontinuity in the record which facilitates identification of the concentration at each station, as can readily be seen from the typical record shown in Fig. 19.

The station-delay circuit comprises an electronic timer and two control relays as shown schematically in Fig. 18. It is controlled by the parallel-connected station-selector switches which, during the 3-second interval between resetting of one switch and operation of the next, release relays EG/3 and EF/3. Consequently, the contact EG3 maintains the electronic timer (comprising the valve V and its associated components) inoperative during this period; therefore relay EH/1 is released and the capacitor C becomes charged to full h.t. potential.

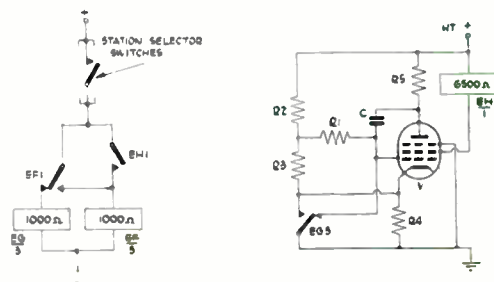

Fig. 18.—Simplified schematic diagram of station-delay circuit.

Closure of any one of the station-selector switches operates relay EG/3 and thus transfers the earth connection from the control grid of the valve to the cathode. The valve starts to conduct immediately and, in consequence, the anode potential falls; the capacitor C transfers this change to the control grid, thus tending to reduce the current, but the grid resistor R1 opposes this change. Equilibrium is quickly established with the capacitor being discharged through the space current of the valve at a constant rate dependent upon the values of components C and R1 and the voltages applied to the resistor R1 by the potential divider R2, R3.

Eventually the anode potential falls to a value which is insufficient to permit any increase in anode current: thereafter the anode potential remains constant whilst capacitor C continues to discharge through grid resistor R1 thus causing the grid potential to become more positive and the cathode current to increase. As no further current can flow to the anode, the increased cathode current flows to the screen grid of the valve and quickly reaches a value sufficient to operate relay EH/1. Closure of contact EH1 on this relay operates relay EF/3 which in turn releases relay EG/3 and locks itself in by its contact EF1. Release of relay EG/3 resets the timing circuit by contact EG3. (The time interval between operation of relays EG/3 and EF/3 is controlled by the values of capacitor C, resistor R1, and the voltage applied to R1 by potential divider R2 R3, and is approximately 25 seconds.) When the station-selector switch resets at the end of an examination period relay EF/1 is released and the unit is ready to repeat the cycle for the next station.

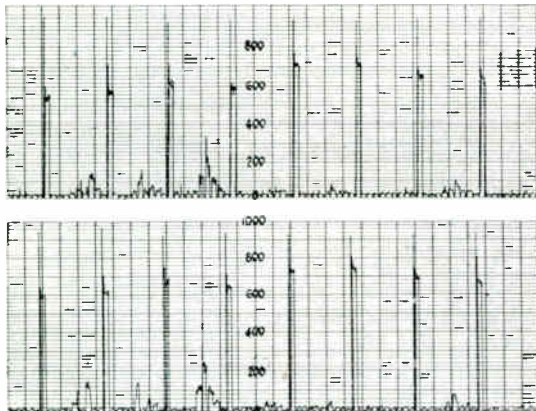

Fig. 19.—Sample duplex recorder chart.

The recorder amplifiers raise the power level of the electrical output of the gas analysers sufficiently to operate the indicating meters on the control panel and the duplex recorder. The wave form of the signal from either gas analyser is approximately sinusoidal, its frequency is 6.6 c/s, and its amplitude is 1 volt r.m.s. when the methanol content of the examined gases is 1,000 p.p.m.

Each amplifier comprises a voltage-amplifying stage, a phase-splitting stage, and a push-pull power output stage which is coupled to the

load by a special low-frequency transformer having two secondary windings; one winding supplies a bridge-connected metal rectifier, the output of which is supplied through a low-pass filter comprising two very large capacitors and a resistor to one half of the duplex recorder and one of the indicating meters on the control panel; the other winding applies a negative-feedback voltage to the amplifier by injecting a fraction of the output voltage into the cathode circuit of the first valve—this greatly improves the low-frequency response of the amplifier and makes it almost insensitive to variations of supply voltages and variations in valve characteristics caused by ageing or replacement.

The discontinuities provided by the station delay are insufficient to give complete identification on the record because they occur regularly as each station is sequentially examined. It is necessary, therefore, to introduce a further distinctive mark on the chart to identify the commencement of each complete cycle, i.e., to identify No. 1 station. This is effected by the "chart marker" which is connected in series with the outputs of the two recorder amplifiers and which is operated each time the station-selector mechanism moves to No. 1 station. This chart marker comprises two simple delay circuits operated in sequence; the first has a delay of about 15 seconds and is initiated immediately the selector mechanism moves to station No. 1 while the second has a delay of about five seconds. During the period of the first delay the output from the recorder amplifier is zero owing to operation of the station marker; at the end of the first delay period the second timer is energized; during this second period the recording and indicating instruments are excited from a power supply to produce about 80 per cent. full scale deflection and at the end of the second delay period the whole circuit is reset.

Figure 20 shows a simplified schematic diagram of the station and chart-marker circuit connections with the recorder amplifiers and duplex recorder. When all the station-selector switches are open, the relays EF/3 and EG/3 (Fig. 19) are released and therefore relays EJ/3 and EK/3 are operated through contacts EG1, EF1, EG2 and EF2. The outputs from both recorder amplifiers are connected therefore via contacts EJ1, EJ2, EK1 and EK2 to dummy loads, while the indicating meters and the duplex recorder are disconnected. On closure

of a station-selector switch and after the station-delay period, relay EF/3 (Fig. 18) operates and EG/3 is released. Consequently relays EJ/3 and EK/3 are also released and the circuit between the two recorder amplifiers and their corresponding meters is completed. When the station-selector switch resets, relay EF/3 releases and operates EJ/3 and EK/3, and the circuit thus returns to its initial condition.

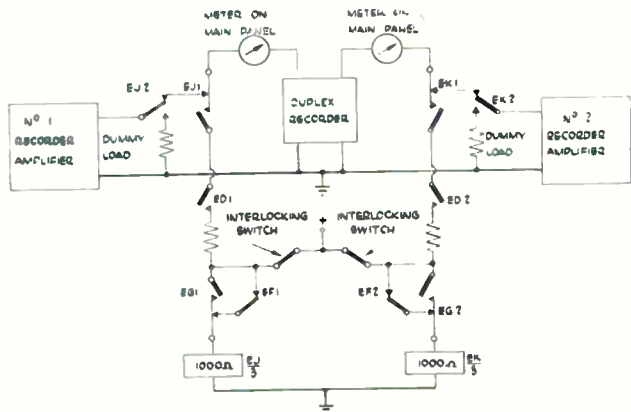

Fig. 20.—Simplified schematic diagram of station- and chart-marker circuit connections with recorder amplifiers and duplex recorder.

Hence, from the instant that the station-selector switches reset to the end of the station-delay period there is no input to the duplex recorder. As was indicated earlier, during the remainder of the examination period there is always some recorder indication because, even when no methanol is present in the examined gas, there is a small signal from the gas analysers; the station delay circuit, therefore, in addition to preventing spurious operation of the alarms, provides means for identifying the record for successive stations.

As previously explained complete identification of stations on the record requires that some distinguishing mark be introduced at the beginning of each complete cycle, and this is provided by the chart-marker circuit shown in Fig. 21.

Initially the two 100-μF capacitors associated with relays EC/1 and ED/2 are charged to about 150V through two resistors connected to a potential divider. Closure of station selector-switch No. 1 operates relay EA/1; closure of contact EA1 discharges one of the 100-μF capacitors through relay EC/1; at the same

time current builds up slowly through relay EB/1 owing to the combined effect of a resistor in series with its coils and a shunt capacitor. The timing is arranged so that interruption of this rising current is effected by contact EC1 before relay EB/1 can operate and the capacitor proceeds to discharge through the relay coil without external effect. The charge on the 100 μF capacitor and the resistance of the coil are arranged so that relay EC/1 remains operated for about 12 seconds. When it releases, contact EC1 reconnects the supply to relay EB/1 which operates after a further small delay; contact EB1 then discharges the second 100-μF capacitor through relay ED/2. The circuit constants of this latter circuit are selected so that this relay remains operated for about three seconds, after which the circuit remains inactive until the station-selector switch resets, thus releasing both relays EA/1 and EB/1 and allowing both 100 μF capacitors to recharge.

Since this chart-marker circuit is initiated at the commencement of a station-delay period, relay ED/2 operates at a time about mid-way between connection and disconnection of the duplex recorder from the recorder amplifiers. A

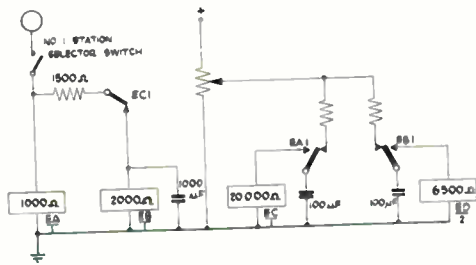

Fig. 21.—Chart-marker circuit.

suitable supply can, therefore, be switched by this relay to drive the recorder to approximately 80 per cent. of full-scale deflection and so produce the mark on the record necessary to identify No. 1 station.

These various marks are clearly visible on the typical chart shown in Fig. 19.

Interlocking switches coupled mechanically to the cocks used to transfer the gas analysers from "plant operation" to "test with methanol" interrupt the supply to relay EJ/3 or relay

EK/3 when No. 1 or No. 2 gas analyser, respectively, is being tested. Thus the station and chart markers are suppressed during such tests. These switches also disconnect the alarm circuits from the alarm detectors and so prevent both internal and external alarms from being raised during tests. These connections are not shown in the schematic diagrams.

4.6 Indicating System

Continuous visual indication of the state of the atmosphere in the plant is provided on the front panel of the equipment by fifty illuminated indicators arranged in ten columns of five, each column being associated with a particular station. As the station-selector mechanism moves from station to station, relays are operated to illuminate a top indicator (white) to show which station is under examination, and to transfer the alarm circuits to the particular station.

As mentioned previously, the output from the two gas analysers is supplied through the station delay to both the recorder amplifiers and the alarm detectors comprising the trigger and integrator units. These circuits provide two separate signals, one when the output from the gas analysers exceeds that corresponding to 200 p.p.m. methanol for a total of 30 seconds after operation of the station delay, and the other when the output exceeds that corresponding to 1,000 p.p.m. methanol for a period of five seconds.

The general arrangement of this assembly is shown in the block diagram Fig. 22. A voltage amplifier supplies two voltage-doubling rectifiers, one of which controls a trigger unit and an integrator actuating the 200 p.p.m. alarm, whilst the other controls an integrator and a trigger unit for the 1,000 p.p.m. alarm. The overall function of the assembly is to operate the alarm circuits when the signal from the gas analysers has exceeded the appropriate value for the pre-chosen period of time. The trigger units detect when the electrical signals from the gas analysers have reached or exceeded the appropriate levels; and the integrators ensure that the alarm is not raised until the level has been reached or exceeded for the "correct" period. The trigger units for both alarms are identical but the integrators are different.

The trigger units are a variant of a circuit originally described by O. H. Schmitt¹³ which

has two stable states; in one state a relay is operated and in the other it is released, the transition from one to the other being almost instantaneous and governed only by the control potential.

When the station delay has operated the outputs from the two gas analysers are passed separately to the two alarm detectors. If the concentration of methanol in the examined gases is less than 200 p.p.m. no alarm indication is given; if, however, the concentration exceeds this value, the first trigger operates and initiates the integrator. If the level falls below 200 p.p.m. after a few seconds this trigger resets and the integrator then memorizes the period during which the trigger has been operated. If the level rises again above 200 p.p.m. during the examination period the trigger operates again and releases the integrator. As soon as the total period during which the trigger has been energized exceeds 30 seconds a relay is operated

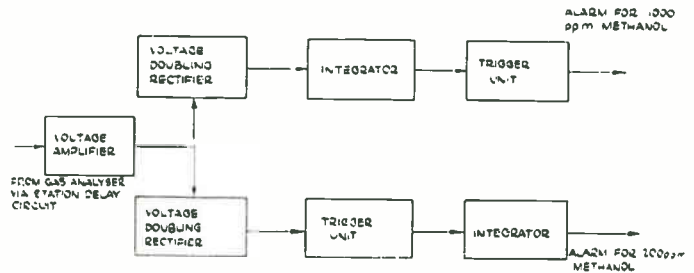

Fig. 22.—Block diagram of alarm detectors comprising trigger units and integrators.

which excites the 200 p.p.m. alarm and illuminates the amber indicator lamp in the second row associated with the appropriate station.

If the electrical output from the gas analysers corresponds to more than 1,000 p.p.m. then a second trigger circuit operates after a time period of five seconds; this operates relays which then illuminate the red indicator lamp in the third row associated with this station and set in operation a buzzer inside the equipment. The push button immediately below the group of lamps associated with each station operates relays which cancel the internal buzzer and illuminate the red indicator lamp in the fourth row.

There are two groups of external alarms located in the plant, each comprising a flame-proof lamp and flameproof hooter. The lamps are operated as soon as the alarm for 200 p.p.m.

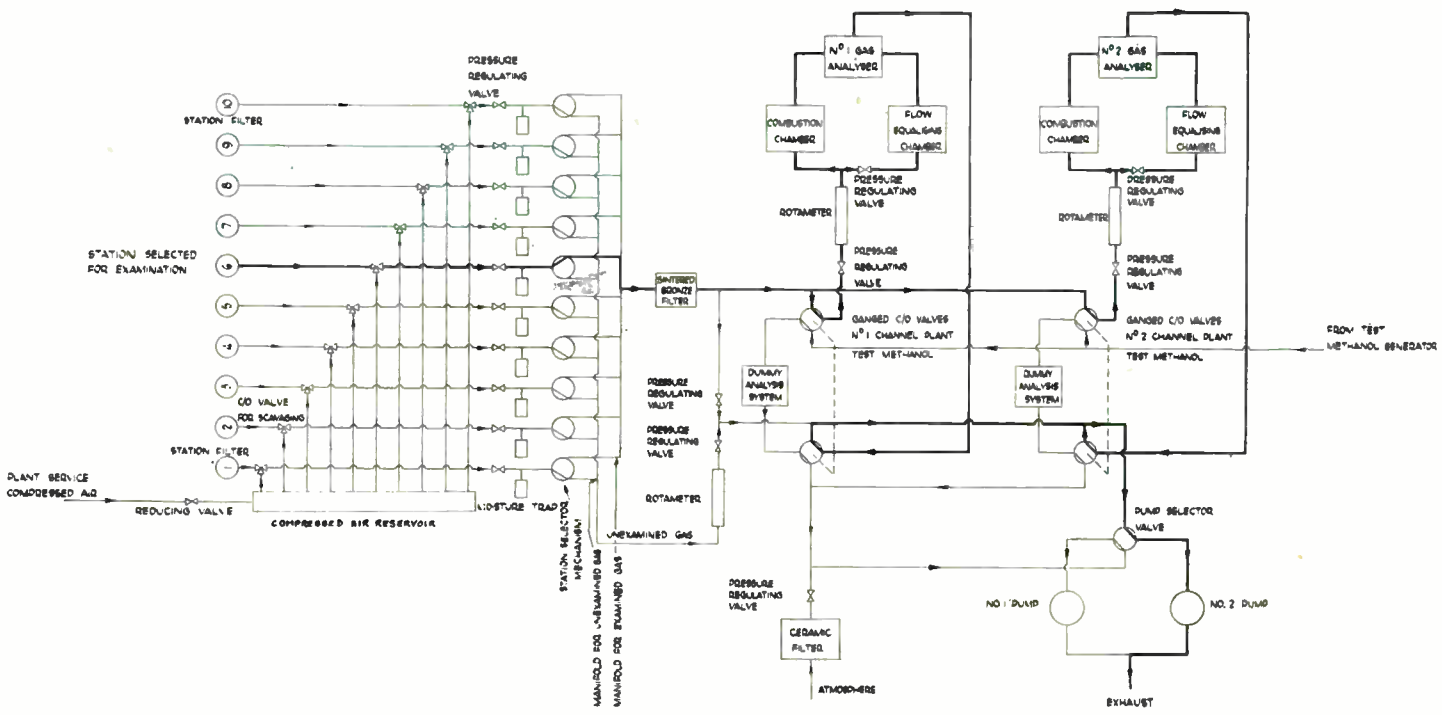

Fig. 23.—Flow diagram of methanol detector.

methanol is raised at any one station and the hooters when a concentration of 1,000 p.p.m. is detected. Both are maintained until every station has been examined and found clear of the appropriate concentration of methanol.

The external alarms can be made inoperative for any of the stations by the switch below the indicators for that station. These switches only control the external alarms for their associated station; they do not interrupt indication of the alarms on the main panel, and the record from the duplex recorder is unaffected; the red indicator lamps in the fifth row indicate whether any of these switches have been operated.

Provision is made to transfer the hooters from continuous operation, once an alarm for 1,000 p.p.m. methanol has been raised, to operation for one minute every half hour. The unit which controls this is initiated by either of the extreme push buttons on the main indicator panel.

Co-ordination of the signals from the alarm detectors with the station-selector switch positions and operation of the indicating system and alarms is performed by a complex system of relay circuits which is designed to cater for the many different sets of conditions which can arise and to provide satisfactory safety interlocks to prevent false alarms being raised.

4.7 Calibration Equipment

It is essential to check the calibration of the equipment periodically, and for this purpose two units are provided; one simulates the gas input to the analysis system and comprises a generator of methanol/air mixtures of known concentration; the other simulates the electrical output from the gas analysers and is used to check the operation of the alarm detectors and the calibration of the recorder amplifiers.

The arrangement of the test-methanol generator is shown in Fig. 23. In essence, measured quantities of air saturated with methanol vapour at known temperatures (25°C) are diluted with measured quantities of air and passed through the analysis systems. However, in making a test with the unit, sufficient time (15 minutes) must be allowed for the gas flows and temperatures to stabilize themselves. This is achieved by using the standby pump to draw the test gas through dummy-analysis systems—each comprising a pressure-regulating valve set so that the pressure drop across it is equal to that across its associated analysis system—interconnected with the analysis systems by ganged change-over valves.

To make a test, the standby pump is started and the flows of the air saturated with methanol and the diluent air are adjusted approximately to the values required. When the generator has stabilized, the flows of gas through one of the analysis systems and its associated dummy are interchanged by operation of a ganged pair of change-over valves. This arrangement permits the transfer of either analysis system from plant service to test without disturbing the gas flows in either the test generator or the main equipment; alternatively, both analysis systems may be checked simultaneously, in which case the plant service is interrupted but the gas flows are maintained to prevent blockage of any pipe runs in the plant due to condensation and freezing.

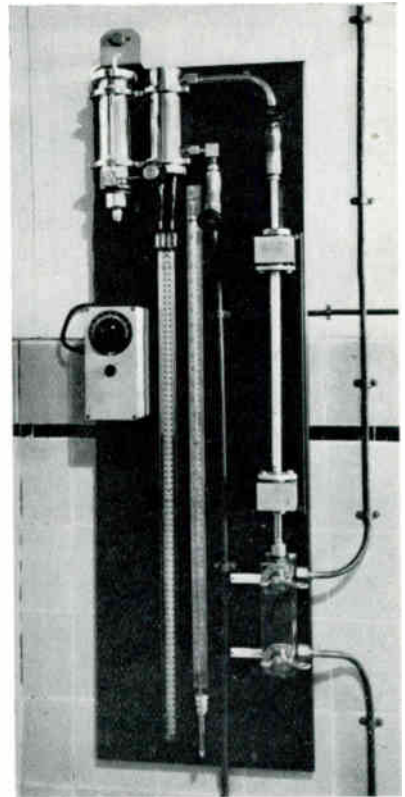

Fig. 24.—Photograph of "test-methanol" generator.

Switches mounted on the ganged change-over valves prevent the alarm circuits from being operated by an analysis system on test. The complete flow diagram illustrating these interconnecting valves is shown in Fig. 23.

The test unit which simulates the electrical output from the gas analysers comprises a valve oscillator, an amplifying stage, a valve-voltmeter and a decade potentiometer. When the output of the amplifier is adjusted so that the valve-voltmeter indication coincides with a particular calibration mark on the scale, then the voltage developed across the potentiometer is identical in wave form, frequency and amplitude with the signal from a gas analyser if the methanol content of the examined gas is 1,000 p.p.m.; it can be applied in steps corresponding to 10 p.p.m. methanol to check the alarm detectors and recorder amplifiers.

5. Summary and Conclusions

Leakage of methanol from fractionating plant and its subsequent diffusion into the atmosphere constitutes an industrial hazard. It is necessary, therefore, to detect the presence of methanol by continuous analysis of the plant atmosphere and to give warning when dangerous concentrations are reached.

Laboratory studies of methods for detecting low concentrations of methanol in air showed that, for the purpose in view, catalytic conversion of methanol to CO_2 and estimation, by means of infra-red gas analysis, of the resulting increased CO_2 content of the atmosphere afforded the most suitable method of detection.

Based on this method, an equipment has been developed which samples, continuously and sequentially, the atmosphere from ten points in the plant and gives automatic warning when the methanol concentrations at these points exceed 200 and 1,000 p.p.m. A continuous record of the concentration is also provided.

The complete equipment has been operating satisfactorily for over two years during which period only minor adjustments and replacements have been necessary.

The method can be applied to other continuous gas-analysis problems, and it may be concluded that equipment of the type described is eminently suitable for continuous operation under industrial conditions.

6. Acknowledgments

This paper is published by permission of the Research Division of Unilever Limited. The author wishes to express his appreciation of the physical investigation conducted by Mr. K.

Goldsmith and of the involved design work executed by Mr. E. H. Higham and his assistants, Messrs. A. K. Lloyd and N. L. Moss.

7. References.

1. G. G. Sherratt and E. Griffiths. "Thermal conductivities of gases by hot wire method." *Phil. Mag.*, 27, January 1939.
2. E. G. Watts. "Thermal conductivity type gas analysers." *Gen. Elect. Rev.*, April 1940.
3. "Rapid gas analysis by vapor control." *Electronics*, 17, September 1944, p.148.
4. F. W. Pritchard. "A modified 'thermal conductivity' gas analyser for measuring methane in air or CO_2 ." *J. Sci. Instrum.*, 29, April 1952.
5. K. F. Luft. *Zeit. f. Tech. Physik.*, 24, May 1943, p. 97.
6. R. C. Fowler. "A rapid infra-red gas analyser." *Rev. Sci. Instrum.*, 20, March 1949.
7. J. M. Devine. "Application of infra-red gas analysers." *Instruments*, 24, No. 16, November 1951.
8. G. B. B. M. Sutherland and G. S. Callender. *Reports Prog. Physics*, 9, 1942-43, p. 22.
9. G. B. B. M. Sutherland. "Infra-Red and Raman Spectra," p. 102. (Methuen, London, 1925.)
10. Such apparatus is now marketed by the Infra-Red Development Co. Ltd., Welwyn Garden City, and Sir Howard Grubb & Parsons Co. Ltd., Newcastle-upon-Tyne, in England, and by Baird Associates Inc., Cambridge, Mass., Leeds & Northrup Co., Philadelphia, Penn., and the Mines Safety Appliances Co., Pittsburgh., Penn., in the United States.
11. W. Alexander. "An electronic ultra-micrometer." *Electronic Engineering*, 23, December 1951, pp. 479-480.
12. E. Lukacs. "Frequency changing with the octave. Effects found on short waves." *Wireless World*, 42, March 17th, 1938, pp. 238-340.
13. O. H. Schmitt. "Thermionic trigger." *J. Sci. Instrum.*, 15, January 1938, pp. 24-26.

THE RADIO TRADES EXAMINATION BOARD

formed by

THE RADIO INDUSTRY COUNCIL
THE RADIO & TELEVISION RETAILERS' ASSOCIATION

THE BRITISH INSTITUTION OF RADIO ENGINEERS
THE SCOTTISH RADIO RETAILERS' ASSOCIATION

RADIO SERVICING CERTIFICATE EXAMINATION—1954

Of the 370 candidates who sat the examination which took place in May of this year, 116 candidates satisfied the examiners in both the written and practical parts; 95 candidates passed the written examination but were referred in the practical test, and 28 candidates completed the examination, having previously been referred in the practical test in the 1953 examination.

PASS LIST

The following candidates satisfied the examiners in the entire examination:

ALLISON, Glen. *Burgess Hill, Sussex.*
ANDERSON, Frank. *Glasgow.*

BALLENTINE, Samuel. *Belfast.*
BATTIN, William James. *London, N.11.*
BUCHANAN, William T. R. *Stenhousemuir, Stirling.*

CAMPBELL, Geoffrey George. *Liverpool.*
CHALMERS, Alexander James. *Dundee.*
CHRISTIE, Francis Dickson. *Glasgow.*
CHESSUN, Dennis Eddie. *Wallington, Surrey.*
CLAPPISON, Ronald. *Kingston-upon-Hull.*
COCKITT, Michael Clare. *Congleton, Cheshire.*
COLE, Philip. *Middlesbrough.*

CONCANNON, William. *Altrincham, Cheshire.*
CORR, Michael F. *Dublin.*
CRAIG, William. *Irvine, Ayrshire.*
*CRAWFORD, John. *Stirling.*
CRISP, Frederick Joseph. *London, S.E.23.*
CROSS, Dennis. *Knutsford, Cheshire.*
CROSS, Raymond. *Darwen, Lancashire.*

DALLY, Peter. *Farington, Lancashire.*
DOCHERTY, Daniel. *Paisley.*
DORMAN, John. *Glasgow.*
DYKES, Ivor Kenneth. *Leeds.*

EASON, Charles F. *Horsham, Sussex.*
EVERETT, R. *London, S.W.11.*
EWEN, Charles. *Clydebank.*

FARMER, W. R.A.F. *Boscombe Down, Wiltshire.*
FAULKNER, Eric Brian. *Birmingham.*
FAY, Thomas. *Dublin.*
FENTON, David Reginald. *Leeds.*
FLOWER, George William. *Pickering, Yorkshire.*

GADSBY, William John. *Croydon.*
GAWDZIK, Jerzy. *Derby.*
GIBBONS, Michael Joseph. *Birkenhead.*
GILBERT, Michael. *Barrow-upon-Sour, Leicestershire.*
GILLIAM, Peter Geoffrey. *Winchester.*
GOLDSMITH, Dennis Alfred. *Broadstairs, Kent.*
GRAY, Anthony Gerard. *Glasgow.*

HALPIN, Robert Joseph. *Walkin town, Co. Dublin.*
HARDWICK, Gerald. *Harrogate.*
HARRIS, William. *Glasgow.*
HASAN, Mahmood-Ul. *London, E.1.*
HERRINGTON, Leonard Henry. *Watford.*
HOBSON, Peter. *Sale.*
HOOLE, Anthony William. *Southampton.*
HOPWOOD, Francis Raymond. *Manchester.*
HUBBARD, Frederick. *Northwich, Cheshire.*
HUNT, Kenneth Leonard. *Wembley Park, Middlesex.*
HUNTER, Thomas. *South Shields.*

JACKSON, Fred Minshall. *Altrincham, Cheshire.*
JOHNSTON, William M. M. *Perth.*
JOHNSTON, William. *Paisley.*
JONES, Richard Arthur. *London, S.W.20.*
JONES, Ronald Edgar. *Llanrwst, Denbighshire.*
JORDON, Roy Sidney. *Saltash, Cornwall.*

KIDD, Alexander McEwan. *Stirling, Scotland.*
KNIGHT, Michael John. *Bristol.*
KNIGHT, William Rex. *Stoke-on-Trent.*

LAFFERTY, Archibald. *Stirling.*
LANCASHIRE, Thomas William. *Boothstown, Manchester.*
LAWLESS, Terence Malcolm. *Malahide, Co. Dublin.*

MCCUBBIN, John. *Glasgow.*
MCKENNA, Walter Desmond. *Bray, Co. Wicklow.*
MAJOR, Kenneth. *Leeds.*
MAUDE, Roger. *Huddersfield.*
MEAD, Albert William. *London, S.E.9.*
MILES, Ronald Arthur. *Sutton Coldfield, Warwickshire.*
MILLS, Barry Ronald. *Birmingham.*
MOORE, Henry Armitage. *Haslingden, Lancashire.*
MORRIS, John William. *Doncaster.*

NASH, Cyril Victor. *Warminster, Wiltshire.*
NEWBERRY, John Edward. *Brenwood, Essex.*
NUNN, Eric Hamilton. *Wallasey, Cheshire.*

OSTINS, Geoffrey Malcolm. *Smethwick.*

PARFREY, William Michael John. *London, S.E.9.*
PAYNE, Kenneth Rutherford. *Brighton.*
PEARCE, Denis. *Grantham, Lincolnshire.*
PEARSON, Thomas Anthony. *Preston.*
PHILLIPS, Joseph. *Greenock.*
PITT, Ernest. *Cullercoats.*
PRIESTLEY, Michael. *Bredbury, Cheshire.*
PRIMROSE, William Wallace. *Newcastle-upon-Tyne.*
PURROTT, Norman Cecil William. *Uxbridge, Middlesex.*

RAWE, Dennis Gerald. *Hadleigh, Essex.*
REDDISH, George. *Kirkby-in-Ashfield, Notts.*
REECE, Raymond Dennis. *West Hartlepool.*
REINLO, Endel. *Mansfield, Nottinghamshire.*
RICHARDSON, Gordon Brian. *Wickford, Essex.*
ROGERS, Christopher. *Dublin.*
RUSSELL, Robert Pollock. *Paisley.*

SCOTT, Lawrence. *Leeds.*
SHACKLETON, John. *Rochdale.*
SINGH, Francis Cuthbert. *Sidcup, Kent.*
SLACK, Thomas Adrian. *Smethwick.*
SLADDIN, Douglas Arthur. *New Malden, Surrey.*
SMITH, Neville Keith. *Austerfield, Nr. Doncaster.*
SMITH, Ronald. *Ilkley, Yorkshire.*
STIVEY, Douglas Arnold. *St. Budeaux, Devon.*
SUTHERLAND, Peter. *Billingham-on-Tees.*

TAYLOR, Stanley. *Rawtenstall, Lancashire.*
TOMALIN, John Adrian. *Boxmoor, Hertfordshire.*
TOMLINSON, Edward George. *Derby.*
TOOHEY, Joseph Bernard. *Liverpool.*
TURNBULL, Peter Elliott. *Edinburgh.*
TURNER, Raymond Stanley. *Northampton.*

WALLACE, Dennis Frank. *Theiford, Norfolk.*
WALTON, Brian. *Osselt, Yorkshire.*
WARRINGTON, Alan. *Heywood, Lancashire.*
WEBLEY, Edward John. *Broadstone, Dorset.*
WERTHEIM, Martin. *Manchester.*
WEST, Christopher Robert. *Derby.*
WILLIAMS, Dennis Norman. *Todham, Kent.*
WILLIAMS, John Robert. *Warrington, Lancashire.*
WILSON, Brian Mawson. *Stockport.*
WINCKLE, George Albert. *Ilford.*

YEKEWICZE, Charles. *Glasgow.*

* Awarded the Muir Shield.

The following candidates satisfactorily passed the written papers but were referred in the Practical Test:

- ADAMS, Bertram Kenneth. *Bristol.*
 ADAMSON, Arnold William. *Kingston-upon-Hull.*
 ALLEYNE, William John. *Prittlewell, Essex.*
 ANDERSON, George Alexander. *Manchester.*
 ANDREWS, James Walter. *Southampton.*
- BAGNALL, John William. *London, S.W.17.*
 BARRETT, John. *Twickenham, Middlesex.*
 BATESON, Peter Lanaway. *Halton, Lancashire.*
 BEEDLE, William Edmund. *South Shields.*
 BENNET, Robert John. *Liverpool.*
 BENNETT, Ronald. *Liverpool.*
 BERRY, Peter Leslie. *Botley, Oxford.*
 BERZINS, Gunars. *Richmond, Surrey.*
 BLACK, Norman. *Newcastle-upon-Tyne.*
 BLAKE, John. *Glasgow.*
 BOLTON, Ivor. *Canterbury.*
 BOND, George Frederick. *London, S.W.16.*
 BRACEGIRDLE, Cecil Albert. *Birmingham.*
 BRADELEY, William Joseph. *Stoke-on-Trent.*
 BROWN, John Murray. *Romford, Essex.*
 BURNS, Robert Alan. *Gillingham.*
- CAHILL, Daniel Joseph. *London, S.W.1.*
 CHAPPELL, Vernon. *Bradford.*
 CHINAMOI, Desmond. *Sidcup, Kent.*
 CLARK, John Alex. *Liverpool.*
 CLEOBURY, John. *Walsall, Staffordshire.*
 COLCLOUGH, Dennis Edward. *Stoke-on-Trent.*
 COMPTON, Gordon. *Carshalton, Surrey.*
 COOK, Ernest William. *South Normanton, Derbyshire.*
 CORBETT, John Douglas. *Birmingham.*
- DAWES, Frank Robert. *Stockport.*
 DIGBY, Robert William. *London, S.W.9.*
 DODOO, Theophilus. *London, W.9.*
- FINCH, Norman. *Birmingham.*
 FORSTER, Aubrey. *Liverpool.*
 FREEMAN, Brian John. *Smethwick.*
- GILCHRIST, Angus. *London, S.W.19.*
 GOLDING, Neville L. *Ringwood, Hampshire.*
 GORDON, John. *Hoole, Lancashire.*
 GREENBERG, Maurice Bernard. *Edgware, Middlesex.*
 GREENWELL, Robert. *Gateshead.*
- HALEY, Nathaniel. *East Boldon, Co. Durham.*
 HECKLES, Keith. *Liverpool.*
 HENDERSON, Alan. *Crawcrook-on-Tyne, Co. Durham.*
 HEYWOOD, Fred. *Huddersfield.*
 HINDMARSH, Kenneth John. *Castleford, Yorkshire.*
 HIRST, Cyril. *Oldham, Lancashire.*
- JAMES, Trevor. *Leicester.*
 JENNINGS, Kenneth. *Redruth, Cornwall.*
- JESINSKIS, Theodor Eric. *London, N.16.*
 JONES, Donald. *Conisbrough, Yorkshire.*
- KARZYCKI, Stanislaw. *Aberdare.*
 KENNEY, Terence. *Leicester.*
 KIRBY, Lawrence Walter. *Westcliff-on-Sea, Essex.*
- LAMMERS, Leslie Albert. *Rochford, Essex.*
 LANE, Edward Albert. *Havant, Hampshire.*
 LAZENBY, Arthur Wood. *Withernsea, East Yorkshire.*
 LIGGINS, Trevor. *Whitstable, Kent.*
 LINES, Royston William. *Bristol.*
 LLEWELLYN, John N. *Southampton.*
- MCCANN, Alec. *London, S.E.9.*
 MCFRUI, Norman. *Liverpool.*
 MAKHIJA, Gobindram. *Sutton, Surrey.*
 MITCHELL, Albert David. *Shrewsbury.*
 MOONEY, Gerald. *Bury, Lancashire.*
 MORELAND, Hugh Samuel. *Glasgow.*
- NELSON, Alan. *Leyland, Lancashire.*
 NEWMAN, Roger Robert. *Fareham, Hampshire.*
 NEWPORT, Cecil Joseph. *Bordon, Hampshire.*
- OKRASA, Stefan. *London, W.4.*
- PARKES, Ronald. *Hessle, Yorkshire.*
- QUINLAN, Harry. *Oldham, Lancashire.*
- RICHARDS, Graham Gordon. *Ilkeston, Derby.*
 RUTLAND, Bernard. *Stoke-on-Trent.*
- SCHNEIDERMAN, Harry. *Manchester.*
 SEYMOUR, Dudley Henry. *London, S.E.10.*
 SHEPPERSON, Michael James. *Sutton-in-Ashfield, Notts.*
 SIMMONS, William Mervyn. *Southampton.*
 SKELTON, Geoffrey Kay. *Doncaster.*
 SMITH, George Frederick. *Washington, Co. Durham.*
 SPARY, William Edwin. *London, S.E.3.*
 SWEATMAN, Leslie Eric. *Emsworth, Hampshire.*
- TAYLOR, Cedric. *Birmingham.*
 TAYLOR, G. *Great Malvern.*
 TUCKER, Leslie Percival. *Plymouth.*
- WALTON, Eric Harvey. *Liversedge, Yorkshire.*
 WEBB, Brian David. *Nottingham.*
 WELLS, Donald Thomas. *London, S.W.2.*
 WERNHAM, George Clifford. *Reading.*
 WILLEY, Kenneth Edward. *Canterbury.*
 WILSON, William Arthur. *South Shields.*
 WINNING, Matthew. *Carlisle, Lanarkshire.*
 WOO SAM, Joseph Roseberry. *London, N.5.*
 WORSELL, Roland James. *Sevenoaks, Kent.*
 WRAY, Brian. *Manchester.*

The following candidates who were referred in the Practical Test in 1953 now qualify for the certificate:

- ARMITAGE, Harry. *Honley, Yorkshire.*
- BAIGRIE, William Stewart Skirving. *Edinburgh.*
 BAKER, Gerald Henry Frank. *Uckfield, Sussex.*
 BAKER, Gilbert Howard. *Combe Martin, Devon.*
 BUTLER, George James. *London, S.W.11.*
 BURBIDGE, William John. *Leicester.*
- CLEMENT, Peter Ernest. *Leigh-on-Sea, Essex.*
 CRAIG, Thomas. *Larkhall, Lanarkshire.*
 CRONIN, Patrick. *Cahiriveen, Co. Kerry.*
 CUNNINGHAM, Dennis. *Leeds.*
- DRURY, Brian. *Leeds.*
 DUNCAN, Norman. *Glasgow.*
- FOLL, John Alfred. *Rossendale, Lancashire.*
- MCLAUGHLIN, Robert Cairns. *Hamilton, Lanarkshire.*
 MANLEY, John Gordon. *Bristol.*
- NAYLOR, Joseph Wilfred. *Dinnington, Yorkshire.*
- OATLEY, Charles. *Dartford.*
- POWELL, Thomas William. *London, S.W.8.*
 PRISK, Simon Gerald. *Helston, Cornwall.*
- RAPLEY, Thomas Herbert. *London, E.13.*
 RENARD, Charles Hubert. *London, S.W.16.*
 ROBINSON, Roy Arthur. *Sale.*
 ROGERS, Thomas. *Sidcup, Kent.*
- SHILTON, James H. *Keighley, Yorkshire.*
 SPANSWICK, Kenneth George. *Walsall, Staffordshire.*
 STAFFORD, Cyril. *Bradford.*
- TAYLOR, Derek Thomas. *Otley, Yorkshire.*
 TAYLOR, James Gray. *Port Bannatyne, Bute.*

THE RADIO TRADES EXAMINATION BOARD

formed by

THE RADIO INDUSTRY COUNCIL
THE RADIO & TELEVISION RETAILERS' ASSOCIATION

THE BRITISH INSTITUTION OF RADIO ENGINEERS
THE SCOTTISH RADIO RETAILERS' ASSOCIATION

TELEVISION SERVICING CERTIFICATE EXAMINATION—1954

Of the 104 candidates who sat the examination which took place in May of this year, 36 candidates satisfied the examiners in both the written and practical parts, 20 candidates passed the written examination but were referred in the practical test, and 19 candidates completed the examination, having previously been referred in the practical test in the 1953 examination.

PASS LIST

The following candidates satisfied the examiners in the entire examination:

APPLETON, Roy Charles. <i>Alresford.</i>	HALL, Reginald David. <i>Newport.</i>
BERRIMAN, Michael Francis. <i>Hull.</i>	HENNING, Geoffrey John. <i>London, S.E.25.</i>
BICKNELL, Alan Roy. <i>Bury St. Edmunds.</i>	HODGES, Reginald. <i>Bristol.</i>
BIVARD, Michael. <i>Glasgow.</i>	HOLLAND, Richard Derek. <i>Shrewsbury.</i>
BRADLEY, Denis John. <i>Kingswinford, Staffordshire.</i>	KENNEDY, William Kelton. <i>Thornliebank, Renfrewshire.</i>
BRAVERY, Ronald Arthur. <i>Brighton.</i>	MONAGHAN, Thomas. <i>Bradford.</i>
BUDGE, John Stewart. <i>Glasgow.</i>	MURPHY, Daniel. <i>Glasgow.</i>
CATT, William John. <i>Bradford.</i>	NESS, Walter. <i>Glasgow.</i>
CHANDLER, Francis James Stewart. <i>Birmingham.</i>	PODLASKI, Jan. <i>Manchester.</i>
CLEMENTS, George Herbert Arthur. <i>Leicester.</i>	REID, Lawrence. <i>Liverpool.</i>
COX, Albert Edward. <i>Coulsdon, Surrey.</i>	ROGERS, Barclay David. <i>Dundee.</i>
COX, Arthur William Frank. <i>Dartford.</i>	RULE, Robert James. <i>Chessington, Surrey.</i>
DENTON, Eric. <i>Wakefield.</i>	SMITH, Frank. <i>Leicester.</i>
FLOWER, Wilfred. <i>Grimsby.</i>	SQUIRES, Walter Arthur John. <i>London, S.E.2.</i>
FOSTER, Edward. <i>Birmingham.</i>	STEWART, Geoffrey. <i>Mirfield, Yorkshire.</i>
GLENDINNING, Robert Bewley. <i>Glasgow.</i>	WILD, Ernest. <i>Oldham.</i>
GOSLING, Lincoln John. <i>Birmingham.</i>	WILLIAMSON, Peter John. <i>Sheffield.</i>
GRAY, Neville. <i>Skipton, Yorkshire.</i>	
GRIMSHAW, Cedric. <i>Dewsbury.</i>	

The following candidates satisfactorily passed the written papers but were referred in the Practical Test:

APPLEBY, Peter William. <i>St. Albans.</i>	IDDON, Walter Edward. <i>London, N.17.</i>
AVIS, Thomas George. <i>East Grinstead.</i>	KNIGHT, David Richard Joseph. <i>Salisbury.</i>
BAMPFIELD, Thomas Anthony. <i>Wolverhampton.</i>	MCCARTHY, Thomas Bilizeria. <i>Leeds.</i>
BUCK, John. <i>Huddersfield.</i>	PECK, Dennis Antony. <i>Littlehampton.</i>
CONNOR, William George. <i>Leeds.</i>	POUSTIE, Alan. <i>Kirkinch, Perthshire.</i>
DURLING, Bernard Maurice. <i>London, S.W.1.</i>	RICHARDSON, Harold Walter. <i>London, N.8.</i>
FARMER, Donovan Stephen. <i>Birmingham.</i>	SALISBURY, Thomas Harry. <i>Nuneaton.</i>
FRASER, Alasdair Mackintosh. <i>Glasgow.</i>	STOREY, Sidney Ernest. <i>London, S.E.18.</i>
FRIEND, Alan Walter. <i>London, W.12.</i>	WILTSHIRE, Ronald Frederick. <i>London, S.E.13.</i>
HEWES, Robin Sherwood. <i>Leicester.</i>	WOOD, Richard Robert. <i>Leicester.</i>

The following candidates who were referred in the Practical Test in May, 1953, now qualify for the certificate:

BLACK, Wallace John. <i>Crayford.</i>	ILLIDGE, Martin. <i>Runcorn, Cheshire.</i>
BROWN, John Cyril. <i>London, E.13.</i>	PRIDELL, James Albert. <i>London, S.W.2.</i>
CROSSLAND, George Henry. <i>Wakefield.</i>	SAGER, Julian Frank. <i>Liverpool.</i>
DAYNES, Robert Stanley. <i>Bilston, Staffs.</i>	STROUD, John Philip. <i>Birmingham.</i>
GALLON, Arthur Anderson. <i>Sutton-in-Ashfield.</i>	TAYLOR, Alan. <i>Cambridge.</i>
GIBSON, Kenneth. <i>Wakefield.</i>	TERRAS, Robert Thomson. <i>Prestwick.</i>
GODDARD, Frederick Edward. <i>Glossop.</i>	THOMPSON, Frederick Charles. <i>Harrogate.</i>
GODDEN, Bertram John. <i>Romford, Essex.</i>	WEADEN, John Henry. <i>Bristol.</i>
GREENHILL, Gerald Henry. <i>Birmingham.</i>	WHITE, Brian Charles. <i>New Malden, Surrey.</i>
HATELY, John Norman. <i>Paisley.</i>	

ELECTRONIC HEATING AND THE WOODWORKING INDUSTRY*

by

M. T. Elvy (*Associate Member*)†

A paper presented during the Industrial Electronics Convention held in Oxford in July, 1954

SUMMARY

The principal methods of applying r.f. dielectric heating are recalled, with particular reference to the use of synthetic resin glues. Jig and electrode design are discussed. Aspects of the design of suitable electronic generators are outlined in conjunction with practical systems for coupling and matching the work. Some of the commercial applications of electronic heating of wood in the furniture and wood waste utilization branches of the woodworking industry are described. Applications considered cover the seasoning of timber, the bonding of laminated structures, flat, curved and moulded plywood sections, tapeless veneer splicing, edge gluing of panel and core stock, spot gluing and assembly gluing.

1. Introduction

The use of electronic heating as a production tool in the Woodworking Industry of Great Britain has expanded rapidly since 1947. The credit for this expansion rests with the electronic heating equipment manufacturers, the manufacturers of synthetic resin adhesives, the Woodworking Industry itself and the Forest Products Research Laboratory of the D.S.I.R.

Some of the potentialities of radio frequency heating in relation to wood technology were appreciated and covered by a British patent specification of 1928. The 1930's witnessed American and Russian experimental applications concerned with the employment of r.f. heating for the seasoning of timber. It was not, however, until the early 1940's that the wartime requirements of aircraft construction led to the development of r.f. heating as an aid to rapid glue setting. At the end of the war, the large-scale application of electronic heating to the British woodworking industry was hindered by the shortage of wood, but by the end of 1947 the demands placed upon the furniture and plywood manufacturers for increased production resulted in the commencement of successful r.f. heating applications on a commercial scale.

It is not claimed that electronic heating is ideal for all heating applications in the woodworking industry, but where it is applied rationally, the advantages over older and more conventional heating methods are often considerable.

The principal advantages to the Woodwork-

* Manuscript first received 20th April, 1954, and in revised form on 17th May, 1954 (Paper No. 289.)

† Redifon Ltd., Wandsworth, S.W.18.

U.D.C. No. 621.365.55: 674.

ing Industry of r.f. heating are: rapid glue setting, considerable savings in the number of jigs required for assembly work, cleaner operating conditions, savings in floor space, and, in some applications, the quality of the finished product is improved by less warping of the wood.

2. Synthetic Resin Glues

Gelatine glues, prepared from animal hide and skin or bones and sinews, or even from fish offal, have been known and used in the woodworking industry for centuries. In recent years, however, synthetic resin glues have become generally available. Animal glues will set at normal or slightly raised temperatures but they are liable to loss of strength or even to destruction from damp and bacteria. Synthetic resin glues may be either cold or hot setting and are much less affected by damp and hardly at all by bacteria.¹ Both animal and synthetic resin glues are capable of making very strong joints. For certain types of loading, the joints can be as strong as the wood itself.

Synthetic resin glues suitable for use with electronic heating may be divided into four principal types.² All are set by chemical catalytic action which is accelerated by heat.

- (a) *Urea formaldehyde*—a good all-purpose adhesive but not sufficiently resistant to moisture for some out-of-doors uses.
- (b) *Phenol formaldehyde*—high joint strength can be retained under severe conditions of exposure to moisture. More troublesome to use with electronic heating than the urea adhesives.
- (c) *Resorcinol formaldehyde*—easy and pleasant to use and capable of withstanding severe

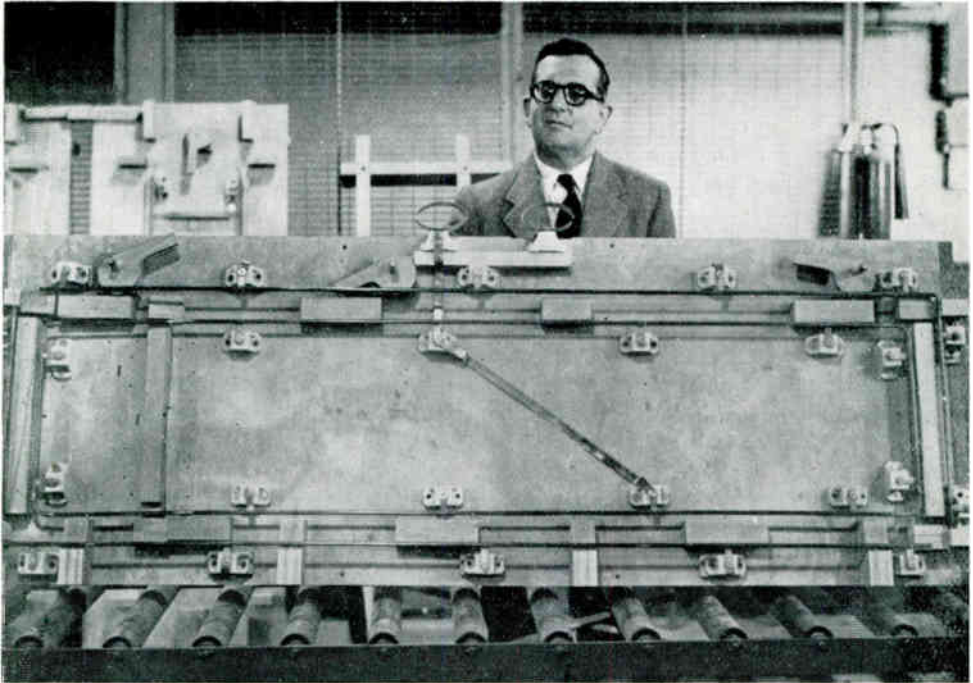

Fig. 1.—Detailed view of a wardrobe end jig showing the electrode assembly. Centre “live” electrode fed at the top contact. Outer “earthy” electrode fed from underneath the jig.

(Courtesy of Tyne Furniture, Ltd.)

exposure. Good gap-filling properties. Rather expensive.

(d) *Melamine formaldehyde*—easy to use, requiring less heat for setting. More expensive than urea adhesives.

When these basic types of synthetic resin glues are brought into contact with special catalysts, extenders and hardeners, the time taken for the actual setting of the glue is controllable and application requirements may be varied. Sometimes the glues are used in combination to provide a desired property not contained in an individual glue, e.g., urea formaldehyde is often fortified with melamine or resorcinol formaldehyde for improved resistance to high temperature and humidity.

The synthetic resin glues may be obtained in either powder or liquid form—the powder possesses the advantage of a long storage life.

Of the principal types of synthetic resin glues it is generally accepted that urea formaldehyde enjoys the widest application with electronic heating. It cures at a relatively low temperature;

it is cheaper, and is more stable³ electrically with less tendency for arcing.

The moisture content of the wood is of some importance when using synthetic resin glues since the glue penetration is inversely proportional to the moisture content. With through heating, too much moisture can adversely affect the strength of the glued joint especially when the heating rate is rapid for the escaping steam will blow holes in the setting glue. A minimum moisture content of 6 per cent. is required to prevent a dry glue line and approximately 8–10 per cent. moisture content is preferred.

3. Jig Design

The successful application of electronic heating as a production tool in the woodworking industry depends very much on the design and construction of the jigs employed.

Since an electronic glue setting jig has not only to hold together firmly the component pieces of a wooden assembly but also form a support for an electrode system, the material used for accommodating the electrodes should be such that it

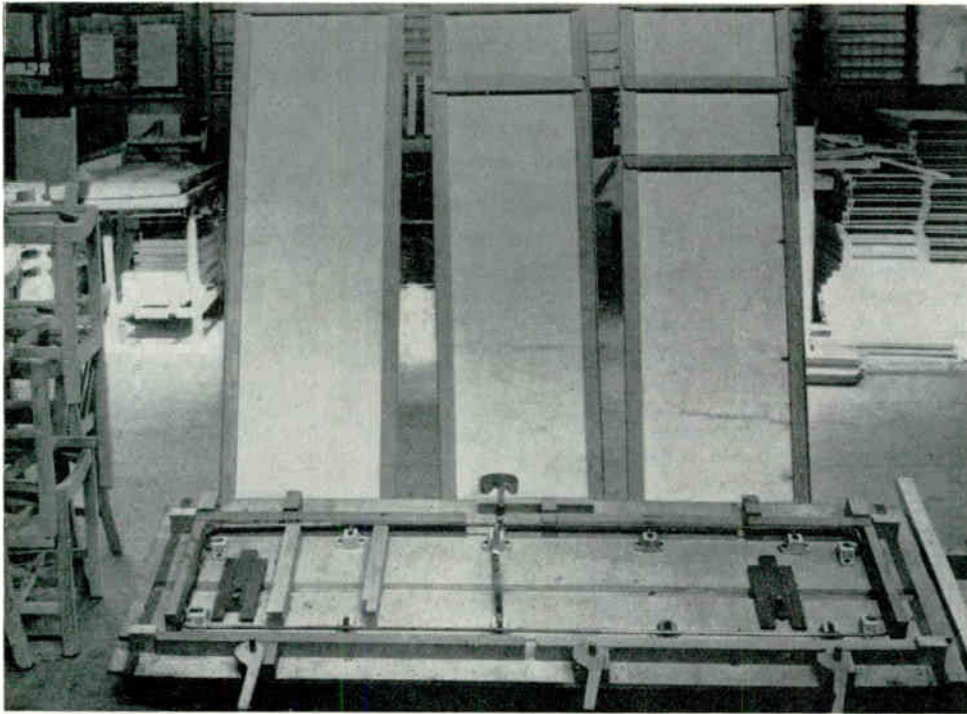

Fig. 2.—General view of a wardrobe end jig showing electrode arrangement. Only the “earthy” electrode is shown. The “live” electrode is attached to a jig fixed to air cylinders inside the work cage. This jig has been made adjustable in width to cater for the two sizes of wardrobe end shown in the photograph.

(Courtesy of Tyne Furniture Ltd.)

will not itself become unduly heated. Dry wood is a suitable and readily workable material, provided it is reasonably free from resin. Care has to be exercised in avoiding the use of metal nuts, bolts and springs, etc., especially of a ferrous nature in any position near to where the electrodes are fitted.

R.f. heating assembly jigs should possess facilities for the rapid loading, application of pressure and unloading of the work, as well as providing a mounting for an electrode system and connecting leads. For small jigs a wooden base table is generally used, clamping pressure being obtained by manually operated toggle action clamps or wooden cams. For large jigs it is usual for a press to be constructed with a steel angle framework and supporting compressed air rams above the work table.

In order to exploit the advantage of rapid glue setting made possible by r.f. heating, tandem arrangements are often used so that while one job is undergoing heating, another is being glued

up in readiness. At the termination of the heating cycle the new jig is pushed forward, automatically ejecting the previous glue-cured assembly.

Figures 1 and 2 show large jigs.

3.1. *Electrodes*

Electrodes are made of either copper, brass, aluminium or stainless steel. Copper and brass are employed for bar, rod and tube type electrodes. Copper and aluminium are used for strip and sheet electrodes. Stainless steel is preferred when the electrodes are in contact with the glue line since it is more easily cleaned of glue than either copper, brass or aluminium.

Electrodes should not be larger than is necessary to create the desired field. Copper tube electrodes find favour since they are ductile enough to be bent into shape easily. Ferrous electrodes, such as might be made from steel, are never used because their high r.f. resistance

would cause too much power to be dissipated.

Sharp edges to electrodes should be avoided, otherwise high field concentrations will occur with a tendency for arcing and consequent damage to both the work and the electrodes. The curves and edges of plates or strips should be radiused to a minimum of 1/16 in.

3.2. *Insulation and Mounting of Electrodes*

With the majority of electrode systems the "earthy" electrodes are connected to the common low reactance tie between the r.f. generator and the metal work of the woodworking handling equipment. The "live" electrodes should be mounted where practicable on insulators. Suitable insulators for this purpose possessing low dielectric loss at the r.f. frequencies being considered are the electrical glasses of the Pyrex and Phoenix type, glazed ceramics and Grade II S.R.P.B.

In cases where it is not convenient to mount the "live" electrodes on to insulators, it may be possible to screw the electrode assembly to the jig itself. In such cases hard dry maple impregnated with paraffin has been found to be a suitable material.⁴ When this method of mounting is used it is very important that the distance between the live electrodes and any earthy objects such as pneumatic pressure cylinders, etc., should not be less than the distance between the live and earthy electrodes. This is to ensure that r.f. power is not wasted, arcing does not occur and the geometry of the electric field is not distorted.

3.3. *Voltage Distribution along Electrodes*

The heating of a dielectric load is directly proportional to the square of the applied voltage—

$$P_v = 1.41 f E_1^2 e'' \dots \dots \dots (1)$$

Where: P_v = Power density in watts per cubic inch

f = Frequency in Mc/s

E_1 = Dielectric voltage gradient in kilovolts (r.m.s.) per inch

e'' = Loss factor of the work

and the voltages which appear along the electrodes follow a sine wave law with a variation of the voltage distribution between the point of feed and another point (Fig. 3). It will be seen, therefore, that the heating of a load between these points will not be uniform.

The electrodes may be considered as a section of an unterminated transmission line with standing waves of length determined by the applied

frequency and the dielectric constant of the material between the electrodes.

The effective electrical length of the electrode, in terms of frequency and dielectric constant of the material between the electrodes, and allowing for the slowing down in the velocity of transmission of the electromagnetic wave along the electrode when influenced by a dielectric of constant e , may be given as—

$$\lambda = \frac{984}{f \sqrt{e}} \text{ feet} \dots \dots \dots (2)$$

Where: λ = Wavelength along electrodes in feet
 f = Frequency in Mc/s
 e = Effective dielectric constant of region between electrodes

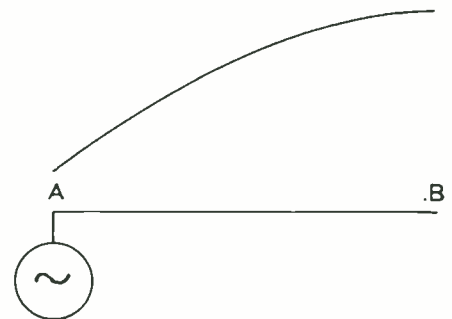

Fig. 3.—Variation of voltage along electrodes.

If the distance from the point of feed to the electrodes and another point is $\lambda/8$ the difference in heating of the load will be as much as 50 per cent. If the distance is $\lambda/16$ the difference in heating is reduced to 15 per cent. A distance of $\lambda/16$ representing a voltage variation of approximately 7.5 per cent. is considered in practice to be the maximum allowable for uniform heating of the load.

If the voltage variation should exceed 7.5 per cent. an effective shortening of the electrodes may be obtained by centre feeding. For a given frequency this method allows the employment of twice the electrode length permissible with end feeding. Longer electrodes are practicable by feeding at more than one point.

With operating frequencies higher than 10 Mc/s, a widely employed method of using electrodes longer than $\lambda/16$ is to shorten the electrodes electrically by placing inductive stubs about the edges of the electrodes.

This method of minimizing standing waves shown in Fig. 4 overcomes any difficulty which might be experienced when using a network of individual transmission lines, since one transmission line only need be connected from the generator to the electrodes at an end or any other convenient point.

The spacing of the tuning stubs for any desired voltage ratio and frequency may be obtained from:—

$$d = \frac{5.48}{f\sqrt{e}} \cos^{-1} \frac{E_{min}}{E_{max}} \text{ feet} \dots \dots \dots (3)$$

Where: *d* = Spacing between tuning stubs in feet

f = Frequency in Mc/s

e = The average dielectric constant of the material between and around the electrodes.

The inductance of each tuning stub is given by—

$$L = (n \times 10^6) / (4\pi^2 f^2 C) \dots \dots \dots (4)$$

Where: *L* = Inductance of each tuning stub (μH)

n = The number of equally spaced tuning stubs

f = Frequency in Mc/s

C = Capacitance of electrodes (pF)

3.4. Air Gaps

Due to dimensional tolerances on woods and the presence of glue squeeze-out, an air gap of at least 1/8 in. is generally necessary between the electrodes and the work. The main effects of such an air gap are that it reduces the effective power factor of the work circuit, therefore necessitating a higher applied work circuit voltage than when an air gap is not employed. The air gap should be kept as small as possible with the ratio of width of air gap to width of work not exceeding 0.1.

3.5. Glue Lines

The various glue lines associated with wood gluing jigs may have different widths. Similarly, the glue lines may vary in width along their length. In order to obviate any uneven heating which would result from unequal voltage gradients due to such variations, compensating air gaps and/or inductances should be introduced at appropriate points on the electrode system.

When glue lines of different widths occur in the same jig, air gaps may be introduced to effect even heating. Without the air gaps the r.f. potential gradient across the irregular glue line

would be higher at some parts of the jig than at others. Since the rate of r.f. heating depends, amongst other things, upon the square of the applied voltage gradient, the wood-glue combination would heat unevenly. Air gaps should be used sparingly since their large scale employment in a jig will render it electrically inefficient.

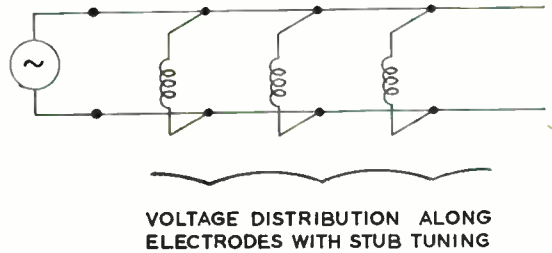

Fig. 4.—Method of controlling and minimizing standing waves on an electrode system by stub tuning.

In some jigs there may only be a small amount of wide glue line. In such a case, air gaps distributed throughout the system would result in considerable inefficiency. A more satisfactory method of equalizing the voltage gradients is to arrange for the electrodes at the wide glue line to have their voltages raised by the appropriate amount through the insertion of series inductances in the connecting leads to the electrodes concerned.

4. R.F. Voltage Gradient and Power Concentration in Wood

With a given generator frequency, the concentration of r.f. power in the work will be limited by the voltage gradient that may be safely applied to the work without causing electrical breakdown of the dielectric. The presence of moisture in the wood and glue, or the generation of a conductive vapour such as steam, may give rise to an arc type of disruptive discharge if the peak voltage gradient across the work exceeds a certain value.

In practice it is found that for most r.f. wood gluing applications the voltage gradient is limited to 4,000 volts peak per inch⁵ and may be as low as 1,000–2,000 volts peak per inch where considerable moisture is present.

The relationship between power concentration and frequency for various voltage gradients for one particular type of timber is illustrated by Fig. 5.

Taking into account the above-mentioned voltage gradient limitations and the frequency

range of 1-50 Mc/s, the power concentrations experienced in r.f. wood gluing applications may be said to vary between 5-75 watts per cubic inch.

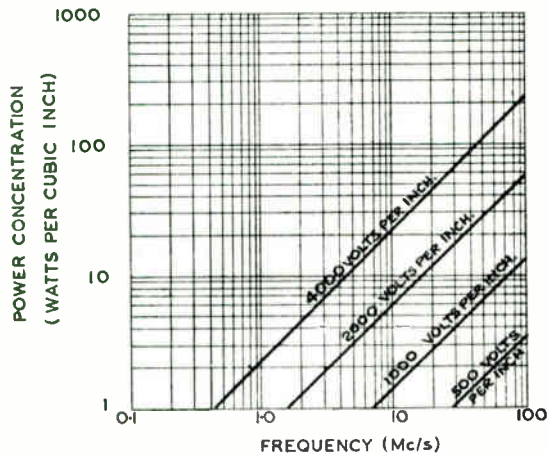

Fig. 5.—Relationship of power concentration and frequency at various voltage gradients for obache with 8.4% moisture content.

5. Generators

R.f. heating generators suitable for applications in the woodworking industry generally operate in the frequency spectrum 1 Mc/s-200 Mc/s. Power outputs range from a few hundred watts at the highest frequencies for applications such as spot gluing, to power outputs of up to 30 kW for equipments operating between 1 Mc/s-20 Mc/s on applications such as the edge gluing of block-boarding. The overall efficiency of an r.f. generator will usually be about 50 per cent.

Power oscillators of the feedback class are used with the various types of r.f. generators. Several circuits are in everyday use—principal amongst them being the Hartley, Colpitts, and reversed feedback grid circuits. The choice of circuit is usually determined by the frequency of operation of the equipment. The circuit of a standard 7 kW 10 Mc/s electronic heater designed for use in the woodworking industry is shown in Fig. 8.

6. Work Circuit

The various sources of loss associated with the work circuit may be considered as a whole with the resultant impedance of the circuit represented as a perfect capacitance either in series or in parallel with a pure resistance.

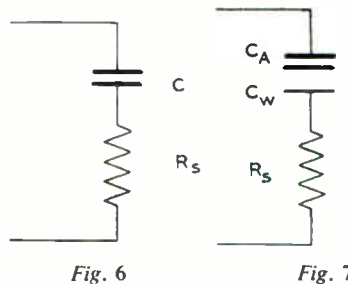

Approximate values for the dielectric constant and power factor of various kinds of wood are given in Table I in the Appendix.

6.1. Without Air Gap

For a work circuit utilizing simple sheet type electrodes in contact with the work (Fig. 6), capacitance may be obtained from the equation—

$$C = \frac{0.22 A.K}{d} \text{ pF} \dots\dots\dots(5)$$

- Where: *A* = Area of one electrode in square inches
- K* = Dielectric constant of the work
- d* = Distance between the electrodes in inches

For work with power factors less than 0.1 the effective series resistance *R_s* may, with small error, be expressed as—

$$R_s \text{ (ohms)} = X_c \times \cos \phi \dots\dots\dots(6)$$

- Where: *X_c* = Reactance of capacitor with the work as dielectric
- $\cos \phi$ = Power factor of the work

6.2. With Air Gap

For a work circuit utilizing simple sheet type electrodes with an air gap or spacing filled with some insulating material of dielectric constant *K₂*, between the work and one electrode (Fig. 7), the capacitance may be obtained from the equation—

$$C = \frac{0.22 A. K_1.K_2}{(K_1.d_2 + K_2.d_1)} \text{ pF} \dots\dots\dots(7)$$

- Where: *A* = Area of one electrode in square inches
- d₁* = Thickness of the work in inches
- d₂* = Thickness of insulation or air gap in inches
- K₁* = Dielectric constant of the work
- K₂* = Dielectric constant of insulation (unity for air gap)

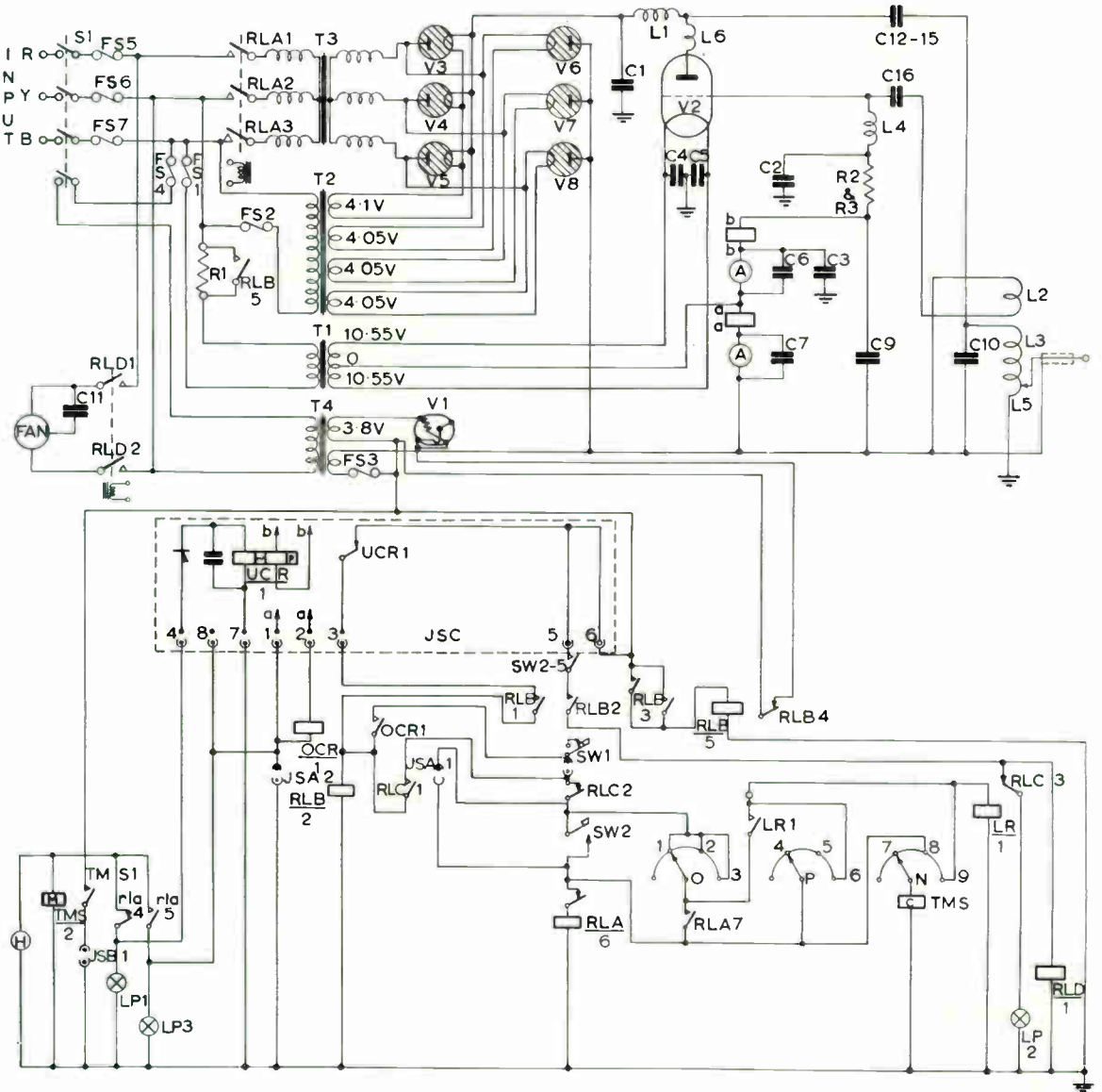

Fig. 8.—Circuit diagram of typical 7 kW 10 Mc/s r.f. generator suitable for the woodworking industry.

The effective series resistance of the work circuit

$$R_s \text{ (ohms)} = [X_w \cos \phi_w + X_A \cos \phi_A] \dots \dots (8)$$

Where X_w and X_A are the reactances of the work and air gap respectively, and $\cos \phi_w$ and $\cos \phi_A$ are the power factors of the work and the air or insulation respectively.

When an air gap is used the power factor (when the work is subjected to potentials below the onset of ionization) will be zero, therefore the effective series resistance of the air gap will be zero and—

$$R_s \text{ (ohms)} = X_w \cos \phi_w \dots \dots \dots (9)$$

By introducing an air gap the effective re-

actance of the work circuit is increased but the resistive component of the circuit remains the same. Thus, the effective Q of the work circuit is increased.

6.3. Effect of Heating Cycle on Work Circuit Characteristics

Both the dielectric constant and the power factor of wood will alter during a heating cycle. Fig. 9 illustrates changes of the dielectric constant and power factor of beech with change of temperature.

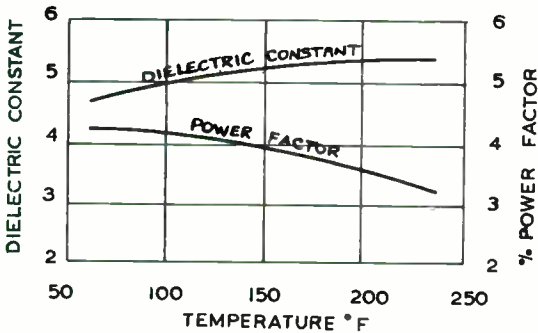

Fig. 9.—Change of dielectric constant and power factor of beech with change of temperature.

Variations of the dielectric constant and power factor of the work circuit during the heating cycle will result in a change of the work circuit capacitance, thereby detuning the circuit and altering the loading on the r.f. generator. The

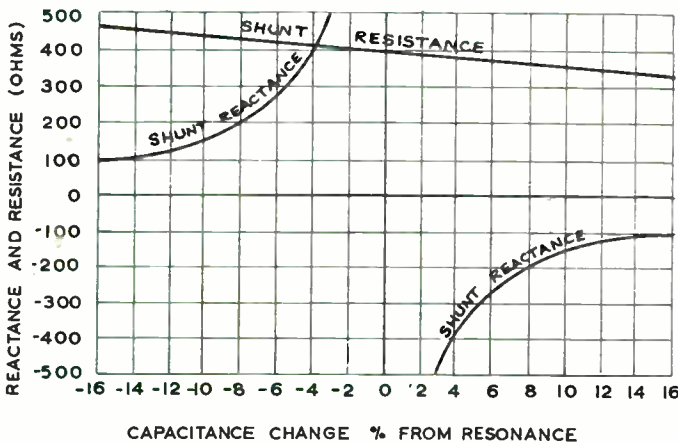

Fig. 10.—Effect of work circuit capacitance change on the shunt reactance presented to the generator. (Work: Through heating of beech at 10 Mc/s.)

variation in capacitance will often be of the order of 10 per cent. or more and the deloading effect on the generator will remain appreciable as shown in Fig. 10.

For general application work the most satisfactory method of compensating for changes of work circuit capacitance is to feed the work circuit through a 1:1 transformer, such as a half wave-length of transmission line or multiples thereof, and to provide for an automatic work circuit tuning device.

7. Coupling and Matching the Work

The electrical capacitance of work circuits for wood varies from tens to thousands of picofarads. Similarly, the output voltage requirements vary from hundreds to thousands of volts. Impedance matching must be employed to transform the work circuit impedance to an

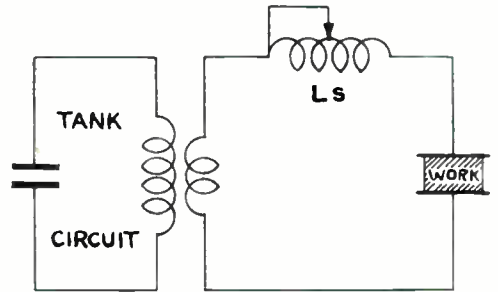

Fig. 12.—Series resonant circuit.

impedance which will take full advantage of the current and voltage available from a given generator.

The method of feeding power from the generator to the work will depend on whether the generator is situated in close proximity to, or is remote from, the work. For the woodworking industry two principal methods of feeding are employed, i.e. (a) *high impedance*—where the generator is adjacent to the work and, (b) *low impedance*—where the generator is remote from the work.

7.1. High impedance

By employing a resonant or near resonant condition of a wide range of work circuit voltages and currents can be realized.

Figure 12 illustrates a method of using a series resonant circuit which is often used in practice. The variable inductor L_s is usually a built-in feature of the generator. It is so constructed that it is as near a perfect reactance as is economically possible. (A high Q inductor is necessary for minimizing losses when dealing with high Q loads.)

As the variable inductor L_s is adjusted away from resonance the voltage across the work will decrease and thus provide a convenient power control for the generator.

The range of work circuit capacitance for which the circuit of Fig. 12, at a given output frequency, will cater, is limited by the minimum and maximum values of inductance present in the series circuit. For example, a typical r.f. generator operating at a frequency of 10 Mc/s has, when allowance is made for the inductance of the internal leads and the link coil, minimum and maximum inductance values of $1.5 \mu\text{H}$ and

$8.0 \mu\text{H}$ respectively. The LC product at 10 Mc/s is $250 (\mu\text{H} \cdot \text{pF})$, therefore, the range of capacitances which can be connected to the generator terminals for resonant conditions will be from 31 pF – 167 pF . Under practical conditions this range may be slightly extended if less than the resonant voltage is of value for any particular application.

Where the work circuit capacitance lies outside the matching range of the generator, either tuning inductance or tuning capacitors may be added in series or in parallel with the jig.

7.1.1 Jig matching inductors

- (i) Work circuit capacitance below the capacitance matching range of the generator—requires the addition of a series inductor.

Required series inductance $L =$

$$\frac{10^6}{4\pi^2 f^2} \left(\frac{C_G - C_J}{C_G C_J} \right) \mu\text{H} \dots\dots(10)$$

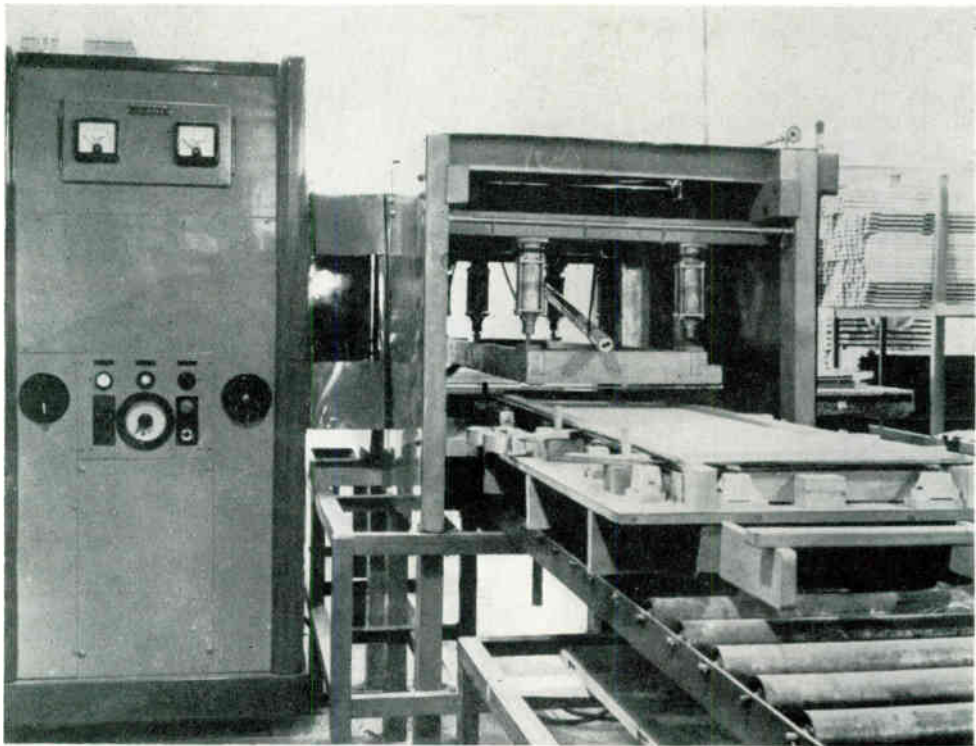

Fig. 11.—High impedance—with the generator situated adjacent to the work.

(Courtesy of Tyne Furniture Ltd.)

Where: f = Frequency in Mc/s
 C_G = Generator matching capacitance (pF)
 C_J = Capacitance of jig (pF)

(ii) Work circuit capacitance above the capacitance matching range of the generator—requires the addition of a parallel inductor.

Required parallel inductance $L = \frac{10^6}{4\pi^2 f^2 (C_J - C_G)} \mu\text{H} \dots\dots(11)$

Where f = Frequency in Mc/s
 C_G = Generator matching capacitance (pF)
 C_J = Capacitance of jig (pF)

7.1.2 Jig matching capacitors

Jig matching capacitors, usually of the ceramic dielectric type, are often used for extending the capacitance matching range of a given generator.

(i) Work circuit capacitance below the capacitance matching range of the generator—requires the addition of a capacitor in parallel with the jig.

(ii) Work circuit capacitance above the capacitance matching range of the generator—requires the addition of a capacitor in series with the input to the jig.

Required series capacitance $C = \frac{C_G C_J}{C_J - C_G} \text{ pF} \dots\dots\dots(12)$

Where: C_G = Generator matching capacitance (pF)
 C_J = Capacitance of jig (pF)

7.2. Low impedance

When conditions of the application call for space saving in the work area, it may be necessary for the generator to be remote from the work. In cases such as these, and they are not uncommon in the woodworking industry, a coaxial type of transmission line is used to feed power from the generator to the work station. For this operation the coaxial cable feed line is ideal since it minimizes external radiation and enables the outer shell to be earthed, thus eliminating any probability of human contact with high r.f. voltages.

To obtain maximum efficiency, the impedance presented to the output of the cable should be resistive and equal in value to the characteristic impedance of the cable. This necessitates a parallel tuned circuit resonating at the generator

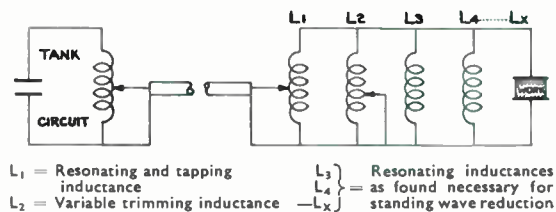

Fig. 13.—Parallel resonant circuit.

frequency; and the appropriate impedance is tapped off as shown at L_1 in Fig. 13. The operation is simplified in practice with the aid of a grid dip wavemeter.

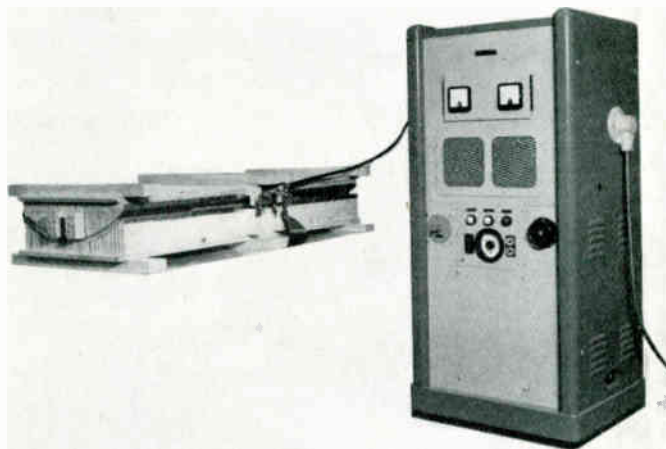

Fig. 14.—Low impedance—with the generator remote from the work.

The total value of the required resonating inductor is obtained from the LC product for the operating frequency of the generator. The inductor may be composed of one or more coils in parallel, depending upon the physical size of the electrode system and the circulating current to be carried in the work circuit. The required inductor will often comprise only a single turn of 1 in. to 2 in. wide copper strip connected

directly across the electrodes. The inductance of a coil of this type may be estimated from Table 2 given in the Appendix.

An estimate of the resonant impedance of the tuned work circuit is required in order that the coaxial cable may be tapped on to the resonating and tapping inductor correctly. This calculation can only be approximate due to the large variation in power factor between different samples of similar materials and even the same material at different temperatures. Table 1 in the Appendix gives average power factor values for various kinds of woods. The resonant impedance R^l may be derived from:—

$$R^l = \frac{L}{CR} = \frac{Q}{\omega C} = \frac{10^9}{2\pi f C \cos \phi} \text{ ohms} \dots (13)$$

Where: f = Frequency in Mc/s
 C = Capacitance of the work in pF
 $\cos \phi$ = Power factor of the work

8. Screening and Screening Cages

With dielectric heating installations the electrodes which are sometimes of large dimensions,

as for example with certain r.f. gluing applications, will function as fairly efficient radiators. It is preferable for the r.f. equipment to be located as near to ground level as possible in order to reduce the effectiveness of the radiation. At the same time it is advisable to situate the equipment as far as is practicable from any metallic objects such as pipes or ducts which might pick up r.f. energy by capacitive or inductive coupling.

In order to reduce unwanted interference to radio communication and television channels as well as to protect the equipment operator from r.f. burns, it is necessary to shield the work electrodes by suitable screening cages. A typical r.f. screening cage is shown in Fig. 15.

For effective screening, wire mesh made of either aluminium, brass or copper is used. A gauge of 16-mesh is generally satisfactory—the screen hole dimensions should not exceed $\frac{1}{4}$ in.

When sheet metal panels are required for screening purposes they are fabricated from aluminium, brass, copper or copper plated steel.

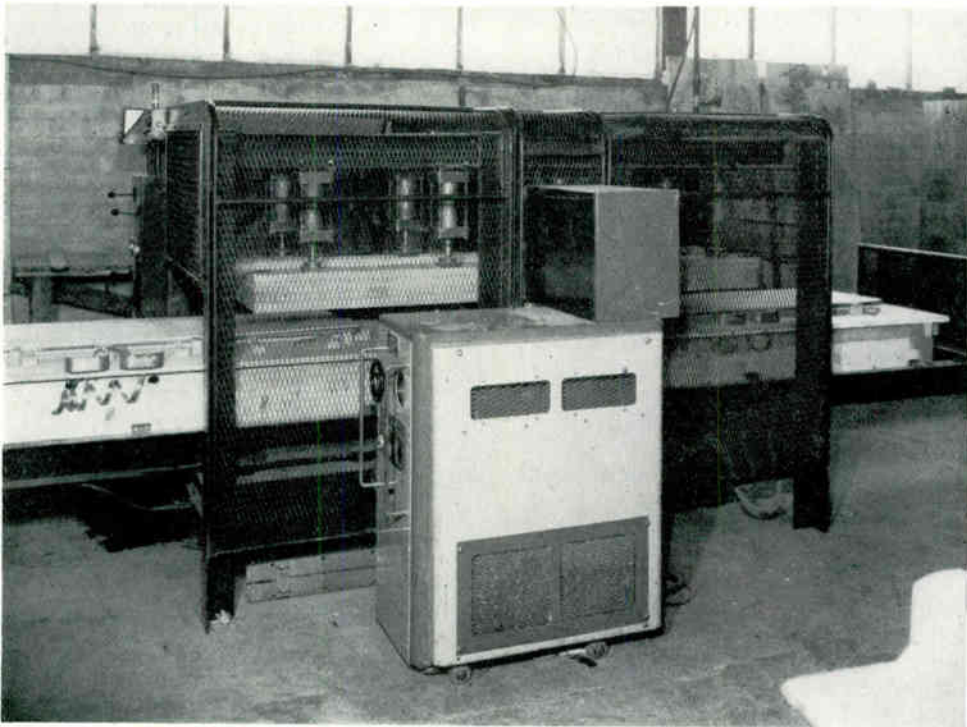

Fig. 15.—R.f. screening cage.

(Courtesy of Lebetkin Products Ltd.)

It is important that the edges of such panels are securely bonded together by brazing or welding, although in certain cases closely pitched screws may suffice. If louvres and windows are part of the equipment, these may be effectively screened by wire mesh. A method of bonding the door is shown in Fig. 16.

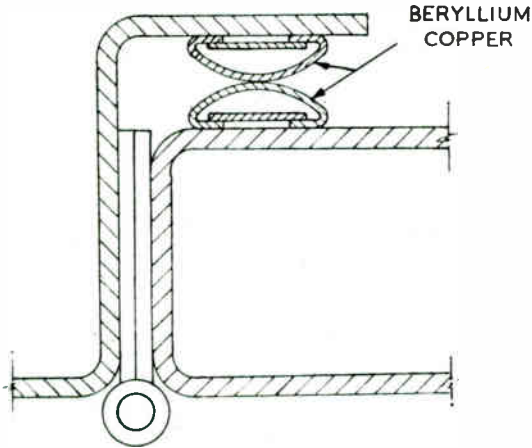

Fig. 16.—Suggested method for door bonding with beryllium copper strip.⁶

Correct earthing of r.f. equipment is important for minimizing unwanted radiation. To avoid r.f. currents circulating in loops other than those of the tuned circuits, it is advisable to earth the equipment at one point rather than have a multiplicity of earth connections to various parts of the equipment.

9. Industrial Applications

The application of r.f. heating to the wood-working industry commenced on a production basis in 1947. One of the earliest experimental applications of the r.f. heating of wood was in 1928 concerning wood drying, and it is described in British patent specification 310,925. Several American patents were taken out in the early 30's to cover the "drying of lumber with r.f. electric fields". Immediately prior to the 1939 war, the Russians were experimenting with the application of r.f. heating to the large scale seasoning of soft woods. It was not, however, until 1942 that r.f. heating was being considered seriously in American laboratories for the manufacture of curved wooden parts and the rapid glue setting of laminated spars for wooden aircraft, as well as the spot welding of moulded plywood hull sections for assault boats.

At the end of the war the knowledge gained was turned, quite naturally, to applications in the furniture and cabinet making industries. At the present time, r.f. heating is also used for the manufacture of boarding, special containers for car batteries, electrical insulators, etc., from a compressed mixture of wood waste shavings and synthetic resin glue.

9.1. Through Heating

Through heating was the method first used for applying r.f. heating to wood. In the furniture and plywood industries this method of heating wood and glue together is used for glue curing and forming operations where laminated sections are glued together in stacks to make plywood sheets and curved panels. It is also used in a number of cabinet assembly operations since it often allows of the use of simple and inexpensive jigs.

9.1.1. Timber drying

The employment of r.f. heating for the seasoning of timber on a commercial scale has not in general been a success. The Russians, who enjoy electric power at low cost, initiated the large-scale application of r.f. heating to wood drying and appear to have confined their work to soft woods using a frequency of 250 kc/s.⁷

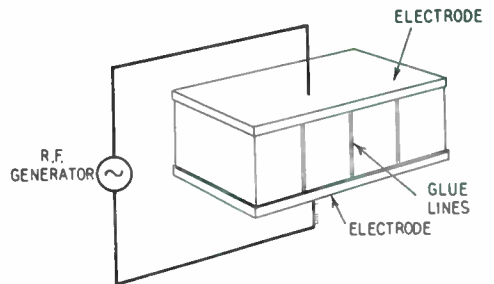

Fig. 17.—Through heating of glued sections.

The chief problem involved in any accelerated drying of timber such as could be readily achieved by r.f. heating is of a fundamental nature. The moisture content gradient related to the vapour pressure gradient has to be kept within a safe limit. Raising the temperature accelerates the water vapour transfusion, but each species of wood has associated with it a maximum temperature which cannot be exceeded without damage and distortion to the structure of the wood.

9.1.2. Through heating of glued sections

In through heating the electrodes are placed at the top and bottom of the work as shown in Fig. 17, with the result that the whole mass of the wood and glue attain almost the same temperature. When laminated sections are being heated, the curing cycle should not be too rapid and the temperature of the wood must be kept below 212°F, otherwise internal pressures may build up with consequent damage to the wood structure.

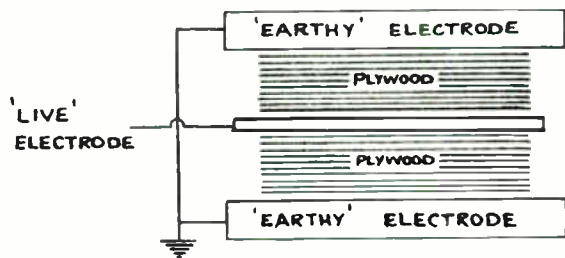

Fig. 18.—Bonding plywood and laminated sections.

Most types of synthetic resin glues may be used with this method of heating—suitable glues include high and intermediate room temperature setting urea formaldehydes, some of the hot pressing melamines and cold pressing resorcinol and phenol resorcinol.

9.1.3. The bonding of flat plywood and laminated sections

Laminated sections are spread with glue and placed one on top of the other until the desired thickness of wood is obtained. The stack is then placed in a suitable shaped jig, the two halves of which are covered with metal plate type electrodes, which in turn are connected to the electronic heater. Pressure is applied to the jig, usually by way of air cylinders. The period of the heating cycle, which is predetermined and controlled by a process timer, is just long enough for the stack to be uniformly raised to the correct glue setting temperature. In order to keep the voltage gradient across thick wood stacks within reasonable limits (below 15 kV peak), the plywood sheets are usually arranged to form two stacks as shown in Fig. 18, with a flat "live" electrode placed in the centre of the stack, whilst the upper and lower press platens are used as the "earthy" electrodes.

9.1.4. Production of curved and moulded plywood

Electronic heating finds a very ready application in the woodworking industry for the manufacture of curved plywood having a curve in one plane and the moulding of plywood having curves in more than one plane.

With electronic heating only one die or mould is required for each shape, regardless of the quantity required. This is a considerable advantage over cold pressing which necessarily limits the number of sections that may be produced at any one time, as the radius of curvature changes with each section, thus requiring a large number of dies as well as press loadings and unloadings. Hot pressing presents a similar problem. Electronic heating enables single opening presses to be used with inexpensive wooden dies and at the same time accelerates the curing cycle. (See Fig. 19.)

In many commercial plywood bonding installations each generator is arranged to feed two or maybe three presses with press operation being synchronized to balance loading, unloading and curing cycles. This provides maximum bonding capacity and versatility of application, as well as improving the load factor of the generator by keeping it in almost continuous operation. With certain shape forming operations the stresses set up while curing the laminations are very considerable and it is desirable to maintain pressure up to two or three minutes after the removal of the r.f. voltage. During this period the generator can be conveniently switched to feed another press. (See Fig. 20.)

9.1.5. End gluing

Electronic heating has, in conjunction with scarf jointing, made the processes of utilizing short lengths of timber to provide lengths longer than standard, and of removing a poor quality section and replacing it by one of improved quality, economical operations.

9.1.6. The manufacture of moulded wood products from woodwaste

At the present time, approximately 60 per cent. of every tree felled is wasted or used uneconomically. Any process, therefore, which could make good use of this woodwaste would be making a major contribution to the economic importance of wood as a constructional material.

Recent but very important applications of through heating have been the "Pali" and "Curvi

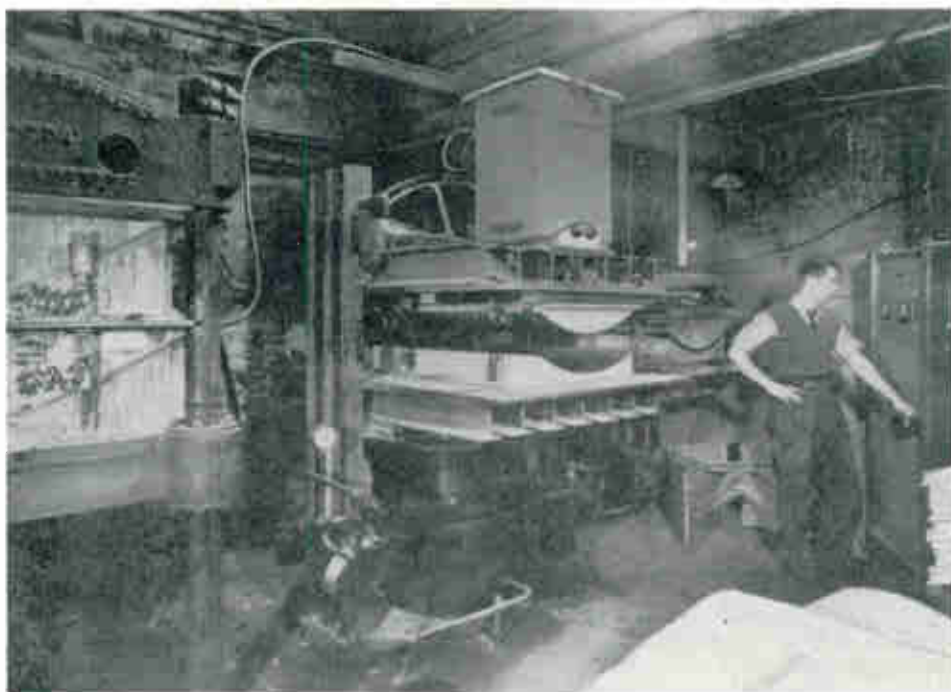
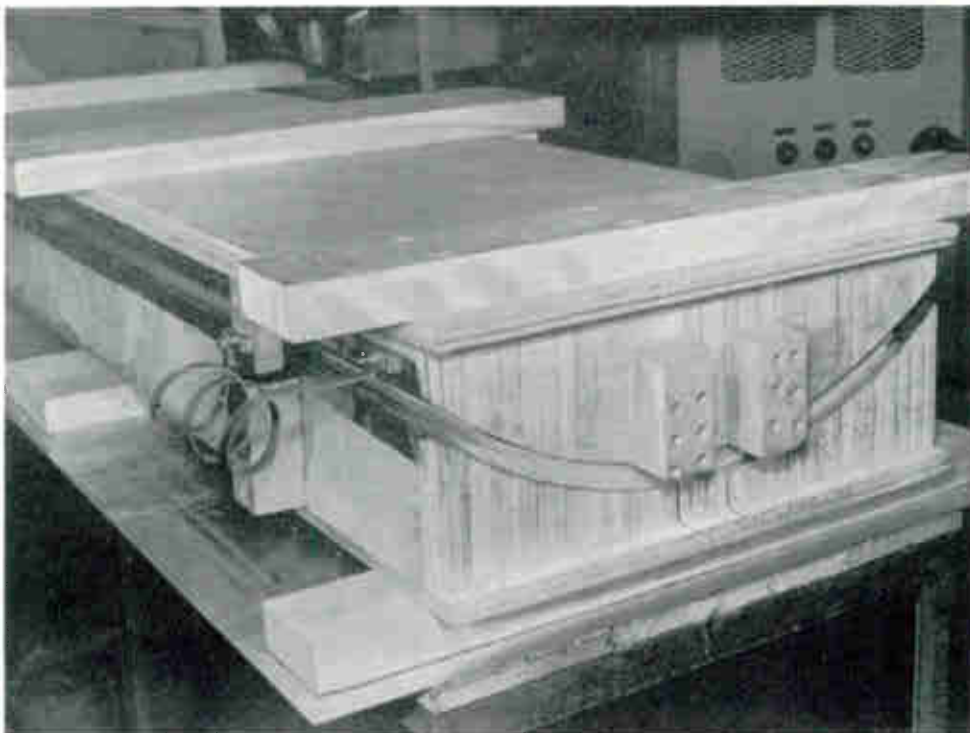

Board" so-called dry processes, for the manufacture of board and moulded wood products of various shapes from woodwaste.

Small particles of wood such as sawdust, shavings, etc., are dried down to a moisture of less than 10 per cent. and mixed with approximately 8–15 per cent. of either urea formaldehyde or phenol formaldehyde synthetic resin glue. The curing of the agglomeration is achieved with the aid of electronic heating.

For the production of boarding from an agglomeration of woodwaste and synthetic resin glue the mixture is compressed in a press, and for boards of thickness in excess of $\frac{3}{8}$ in., electronic heating of the agglomeration offers considerable advantages over steam-heated platens.

Commercial presses have their electrodes electrically resistance heated in order to avoid condensation on the electrodes and also to provide the facility for the simultaneous gluing of veneers on to the surface of the agglomeration.

In the Pali process⁸ the mixture is composed chiefly of:—

Wood waste (principally wood shavings)	80%
Synthetic resin glue (Urea formaldehyde)	5%
Water	15%

The r.f. voltage across the work at a frequency of 10 Mc/s ranges between 250 volts/inch to 1,250 volts/inch.

9.2. Glue Line Heating (Fig. 21)

Glue line heating being a combination of dielectric and induction heating is the most efficient of the three principal methods of applying r.f. heating to wood gluing. It is employed extensively for veneer splicing, the edge bonding of core and panel stock and much assembly work.

9.2.1. Veneer splicing

Electronic heating is being used with tapeless splicers for the continuous edge gluing of heavy veneer stock ranging in thickness from $\frac{1}{8}$ – $\frac{1}{2}$ in., and resulting in a shorter glue curing cycle and avoiding the undesirable over-drying of the wood when resistance heating only is employed.

Electronic tapeless veneer splicers usually operate in conjunction with a veneer jointer which joints the edges square and runs the stock over a glue spreader prior to delivery at the in-feed table. The two strips of veneer are laid flat on the in-feed table and then fed together at right angles to the run of the grain into converging rollers which automatically carry the stock forward. The edges are brought tightly together by a V-way. Pressure is applied to flatten the veneers while they are being joined.

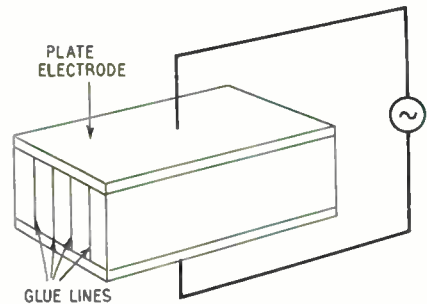

Fig. 21.—Glue line heating.

As the edge glued veneer sheet emerges at the out-feed table, gang saws can be arranged to automatically cut the stock into any desired width,⁹ usually production sheets of stock 4 ft. × 8 ft.

9.2.2. Edge gluing machines

The employment of a specially designed press for the production of edge glued core or panel stock is justified economically if requirements are in excess of 3,000 feet of board per day. Commercial automatically operated continuous edge gluing presses, working in conjunction with electronic heaters, are available with a production capacity of up to 14,000 feet of finished core or panel stock per eight-hour day.

For general panel work side clamp pressure up to 350 lb./in² and higher is required for hardwoods. Just enough down pressure is used to hold the stock flat, usually about 20 lb./in².

Some commercial edge gluing presses incorporate a pressure "breathing" facility, whereby the down pressure is released while the side clamp pressure remains on the panel and after a short period the down pressure is re-applied. The purpose of this "breathing" of the press is to release any mechanical stress which might be set up in the panel by the application of side

Fig. 19 (top left).—R.f. jig for bending plywood.

(Courtesy of Renn's Shaped Ply Ltd.)

Fig. 20 (bottom left).—Three presses for shapes, wardrobe doors, and chair backs being fed by way of three-way co-axial r.f. switch and co-axial cables from 6 kW 10 Mc/s generator.

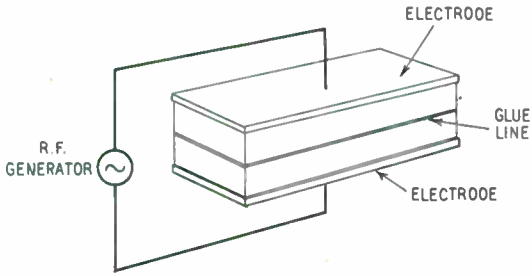

Fig. 22.—Plate electrodes.

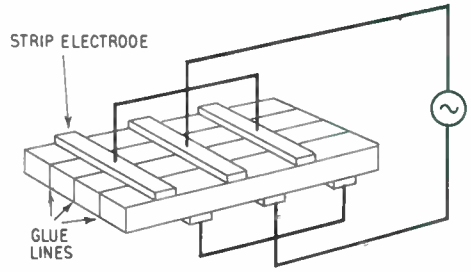

Fig. 23.—Strip electrodes.

clamp pressure, and a restriction being imposed by the relatively large area of the top platen.

Edge gluing presses incorporate either plate electrodes for curing the complete glue line as shown in Fig. 22, or strip electrodes as shown in Fig. 23 for curing sections only of the glue line. The choice of plate or strip electrodes will depend on whether maximum panel strength is required immediately the panel is removed from

the press or whether partial curing of the glue line is permissible. Practical experience has shown that partial curing resulting in the highest production rate is favoured in most edge gluing applications. The glue joints will have attained approximately 40 per cent. of the ultimate strength which will permit handling and piling for air curing at room temperature. Within about 90 minutes after the stock has come from

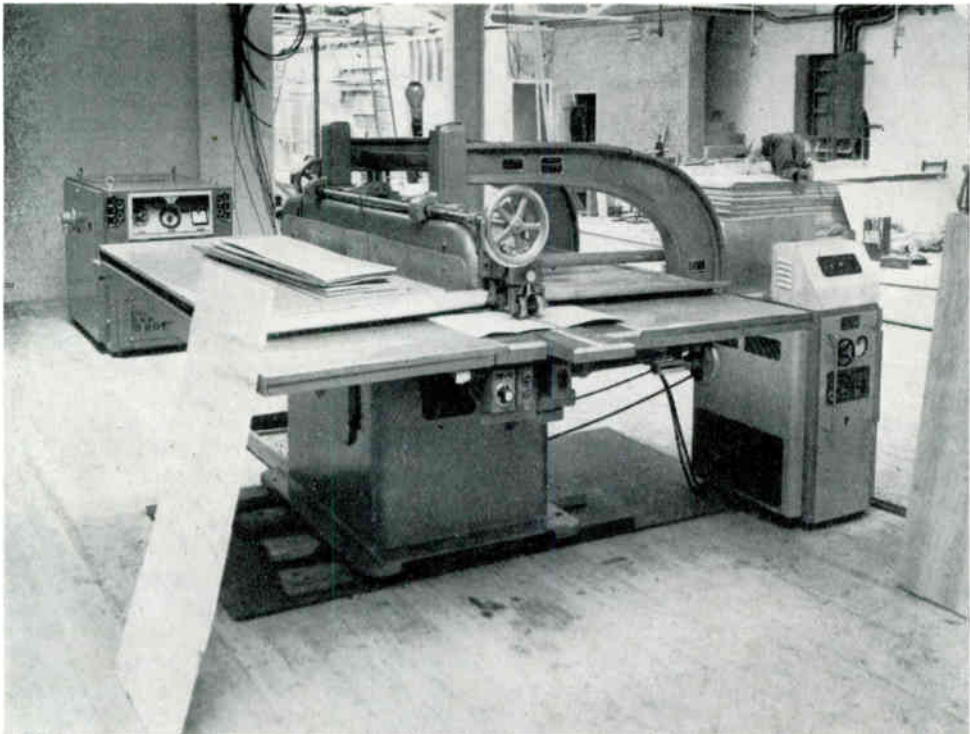

Fig. 24.—Electronic tapeless veneer splicer.

(Courtesy of Diehl Machine Works Inc. U.S.A.)

the machine the joint strength will be approximately 80–90 per cent. of its ultimate strength.

The approximate production capacity of electronic heating for edge gluing applications may be obtained from the following empirical assessment:—

Gluing of soft woods (8%–10% moisture content)
80 in² of glue line can be partially cured per kW-minute

60 in² of glue line can be completely cured per kW-minute

Gluing of hardwoods (8%–10% moisture content)
40 in² of glue line can be partially cured per kW-minute

30 in² of glue line can be completely cured per kW-minute

9.3. Stray Field Heating

The stray field heating technique is of considerable value in furniture assembly work for the attachment of structural members such as shelf bearers to the inner side of wardrobe ends

or the gluing of mounting blocks to the inside of radio and television cabinets, etc.

Considerable economies may be shown in cabinet assembly work by employing r.f. stray field heating. The use of numerous clamps may be avoided and labour saved by eliminating nailing and the filling of nail holes.

9.3.1. Panel to frame glue setting

Assembly presses are used with stray field heating electrodes, often arranged in the form of a grid of alternate high and low potential electrodes for the rapid glue setting of panels to frames. For this type of work only sufficient down pressure (of the order of 25 lb./in²) to flatten the panels is required. A shuttle bed is generally used for carrying the panels into and out of the press, although an endless belt type of conveyor is sometimes employed for this purpose.

The performance of r.f. stray field heating presses is dependent mainly on panel thickness,

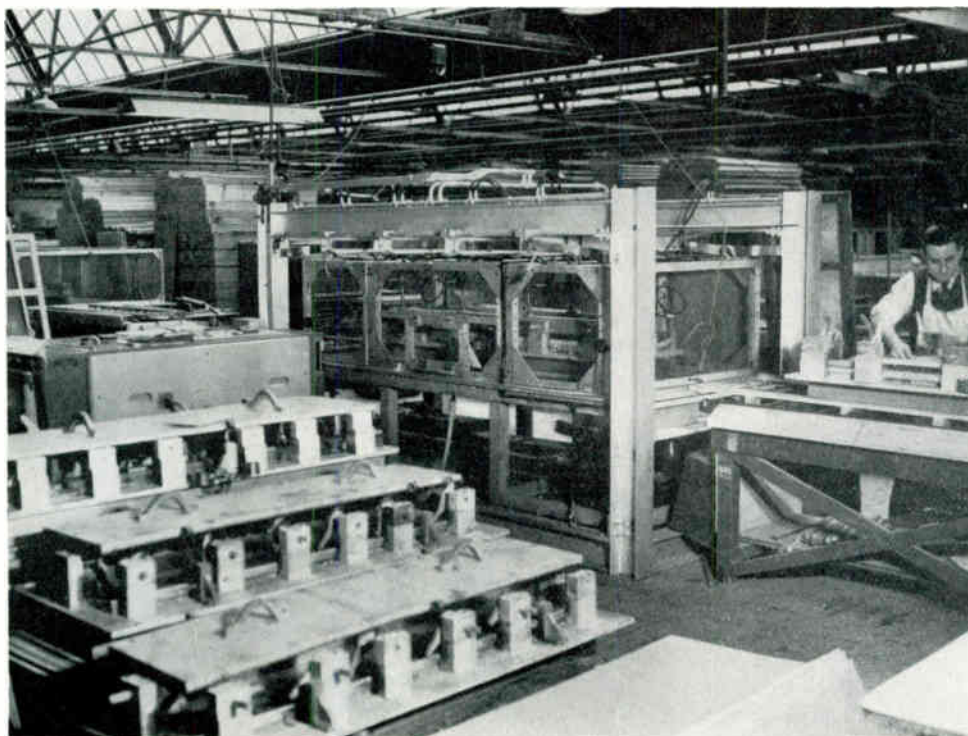

Fig. 25.—Gluing shaped wardrobe doors. Jig in foreground is being loaded ready to replace jig in screening cage.

(Courtesy of C.W.S. Ltd., Enfield.)

being suitable for thicknesses of panel up to $\frac{1}{2}$ in. With panel thicknesses in excess of $\frac{1}{2}$ in. the glue curing time becomes progressively longer and reaches a point where r.f. stray field heating is not usually justified.

9.4. *Assembly Gluing*

Assembly gluing applications cover a wide variety of manufactured articles such as furniture, pianos, television and radio cabinets, etc. This type of application involves individually, and in combination, through heating, glue-line heating and stray field heating for the glue setting of the many types of wood joints which are used.

An operating frequency of 10 Mc/s is considered to be suitable for most assembly gluing applications. For purposes of power estimation, 100 in² of glue line completely cured per kW-minute is the generally accepted assessment of production capacity.

With assembly gluing the individual applica-

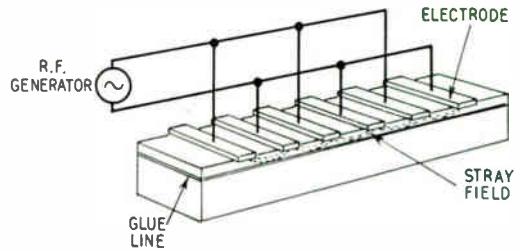

Fig 26.—Stray field heating.

tions are usually quite different from each other. Jigs, fixtures, and presses have to be engineered to suit each particular product or piece part. Similarly, electrode arrangements vary considerably since they may have to be applied in external or internal relation to a particular joint. When the electrodes are close to the glue line a peak r.f. electrode voltage of 2,500 volts is generally found satisfactory for butt, dado, dovetail, dowel, mitre, mortise and tenon joints.¹⁰

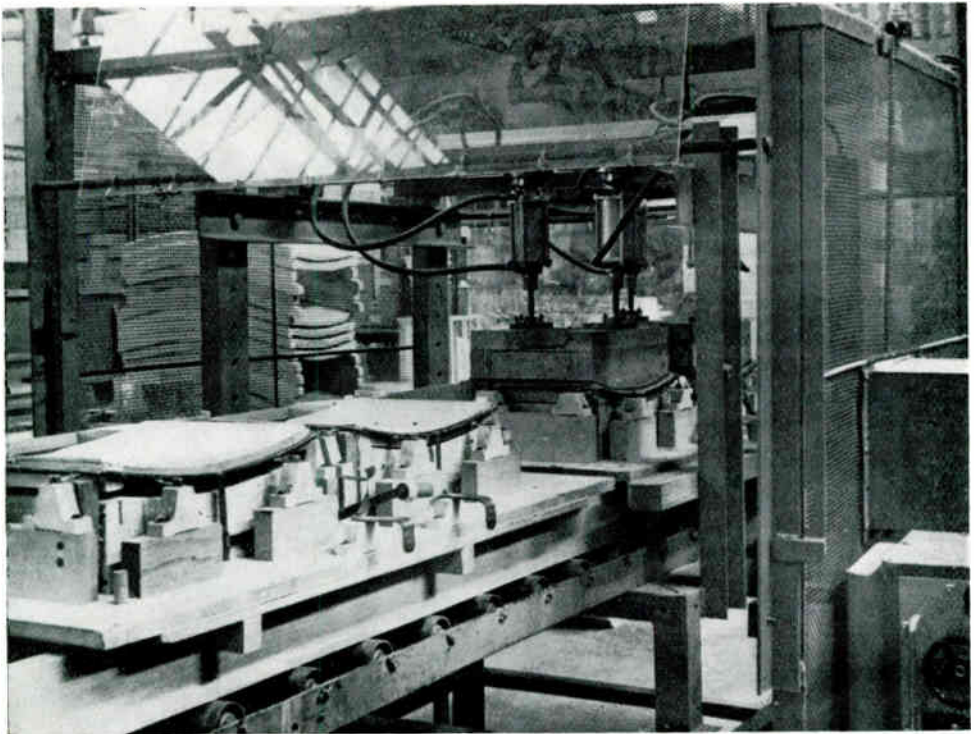

Fig. 27.—General view of two stage double-ended jig for the fixing of plywood backs to chair frames—Complete cure—55 seconds. 1.5 kW, 18 Mc/s.

(Courtesy of Tyne Furniture Ltd.)

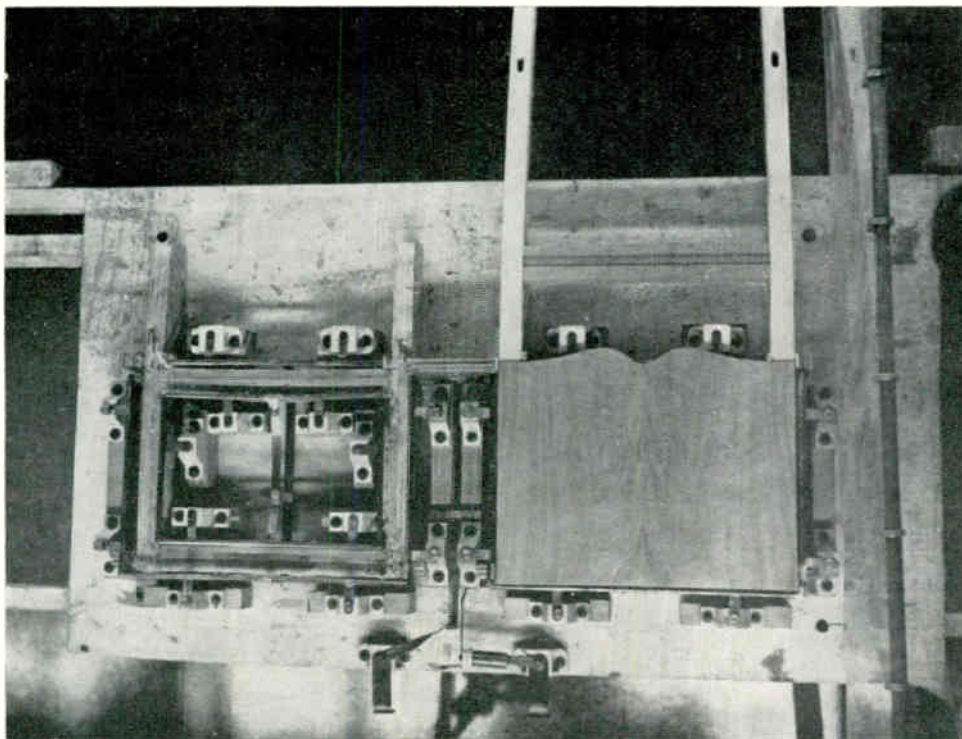

Fig. 28.—Chair back jig showing electrode arrangement with one side loaded.

(Courtesy of Tyne Furniture Ltd.)

In cases where it is not practicable to arrange the electrodes very close to the glue line, such as the inside of an assembly, which is not accessible for the mounting of electrodes, the required peak r.f. voltage may be of the order of 3,000–4,000 volts.

10. Conclusion

Electronic heating now enjoys application in the woodworking industry on a national scale. This new form of heating is being proved daily to be thoroughly reliable with valve life in excess of 10,000 hours being commonplace. The combination of r.f. heating and synthetic resin glues has brought considerable benefit to users, with the result that more woodworking concerns are adopting this electronic aid to production.

11. Acknowledgments

The author wishes to thank the Directors of Redifon Ltd. for permission to publish this paper.

12. References and Bibliography

1. K. A. Zandstra, "Wood gluing in industry", *Transactions of the Society of Engineers, London*, June 1952, p. 48.
2. P. H. Graham. "Electronic Gluing", p. 86. (Reprint of a survey published in 6 parts in *Wood Working Digest*, Chicago, from September 1952 to March 1953 inclusive.)
3. B.E.A.M.A. "A Survey of Applications of British Industrial High Frequency Dielectric Heating Equipment", Section 4—No. 413, p. 820. (111e Congrès International D'Electrothermie, Paris, 1953.)
4. D. G. Hatchard. "Wood gluing", *Wood Working Digest*, December 1953, p. 70.
5. G. H. Brown, C. N. Hoyler and R. A. Bierwirth. "Theory and Application of Radio-Frequency Heating", p. 268. (D. Van Nostrand Co., New York, 1947.)
6. "Recommended Practice for Minimization of Interference from Radio-Frequency Heating Equipment", p. 11. (American Institute of Electrical Engineers, 1950).

7. Report No. RFP1/5, p. 3. Forest Products Research Laboratory, D.S.I.R., 1947.
8. J. L. Jaudon. "Application of High Frequency to the Agglomeration of Wood Waste", Section 4—No. 420, p. 5. (IIIe Congrès International D'Électrothermie, Paris, 1950.)
9. R. E. Nelson. "Dielectric heating cuts woodworking costs", *Electronics*, 26, June 1953, p. 179.
10. P. H. Graham. *Ibid.*, p. 77.
11. R. F. S. Hearmon and J. N. Burcham. "The Dielectric Properties of Wood", pp. 2-3. (Forest Products Research Laboratory, D.S.I.R., 1950.)
12. R. A. G. Knight, "Requirements and Properties of Adhesives for Wood". (F.P.R.L. Bulletin No. 20, H.M.S.O.)
13. L. Hartshorn, "Radio Frequency Heating". (Allen and Unwin, London, 1949.)
14. L. Grinstead, "Dielectric heating by the radio frequency method", *J. Brit. I.R.E.*, 5, June, 1945, p. 128.

13. Appendix

In addition to the data and formulae quoted in the body of the paper the following informa-

tion is relevant to the application of electronic heating to the wood-working industry.

Thermal power requirements of the work

$$P = 17.6 mc \Delta t$$

- Where: P = Thermal power requirements of the work in watts
 m = Weight of work in pounds heated per minute
 c = Specific heat of the work
 Δt = Temperature rise of the work °F.

Inductance of multi-turn solenoid type coil

$$L = r^2 N^2 / (9r + 10l)$$

- Where: L = Coil inductance in μH
 r = Inside radius of coil in inches
 N = Number of turns
 l = Length of coil in inches

Table 2
Inductance of Single Turn Strip Coils

Coil diam.	Width of Strip			
	½ in.	1 in.	1½ in.	2 in.
4 in.	0.19 μH	0.15 μH	0.12 μH	0.10 μH
6	0.32	0.26	0.22	0.19
8	0.47	0.38	0.33	0.29
10	0.62	0.51	0.44	0.40
12	0.78	0.65	0.57	0.51

Table 1
The Dielectric Properties of Wood ¹¹

Common Name	Moisture Content %	Density gm/cm ²	1.0 Mc/s			4.0 Mc/s			10.0 Mc/s			25.0 Mc/s			60.0 M/cs		
			<i>e</i>	<i>P.F.</i>	<i>e"</i>	<i>e</i>	<i>P.F.</i>	<i>e"</i>	<i>e</i>	<i>P.F.</i>	<i>e"</i>	<i>e</i>	<i>P.F.</i>	<i>e"</i>	<i>e</i>	<i>P.F.</i>	<i>e"</i>
			Obeche	8.4	0.29	2.28	.028	.064	2.28	.051	.117	2.13	.052	.111	2.00	.057	.114
Spruce	10.5	0.47	3.15	.036	.113	3.12	.045	.140	2.97	.061	.181	2.77	.074	.205	2.61	.082	.214
Western red cedar	7.9	0.38	2.46	.037	.091	2.44	.040	.098	2.33	.050	.117	2.23	.061	.136	2.08	.060	.125
Yellow pine	8.9	0.41	2.66	.034	.091	2.62	.045	.118	2.47	.061	.150	2.33	.063	.147	2.25	.070	.158
Balsa	5.0	0.18	1.71	.016	.027	1.64	.027	.044	1.65	.033	.055	1.63	.033	.054	1.56	.035	.055
Jelutong	7.2	0.37	2.42	.030	.073	2.42	.040	.097	2.31	.049	.113	2.18	.062	.135	2.12	.059	.125
Mugongo	6.6	0.25	2.01	.070	.141	2.03	.063	.128	1.92	.059	.113	1.79	.053	.095	1.77	.057	.101
Ceiba	7.9	0.29	2.16	.045	.097	2.23	.045	.100	2.07	.047	.097	1.95	.051	.100	1.87	.061	.114
American whitewood	8.8	0.60	3.98	.052	.207	4.10	.059	.241	3.84	.065	.250	3.52	.083	.292	3.29	.083	.271
Beech	10.8	0.83	4.71	.041	.193	4.52	.057	.258	4.30	.069	.296	4.17	.083	.346	4.00	.090	.360

e = dielectric constant

P.F. = power factor (cos ϕ)

e" = loss factor

DISCUSSION

R. E. Bazin (Member): I think that the use in this country of dielectric heating in the woodworking industry was firmly established much earlier than the 1947 date given by Mr. Elvy. It was already in use on several applications in 1944, and in one of the largest cabinet-making organizations in this country I personally applied it to the curing of synthetic resin in joints of the main spar of the Mosquito aircraft around that date.

A particular feature which may be of interest was the use made of the standing-wave effect. A problem with which engineers in this field are frequently confronted is that of producing uniform heating over comparatively large areas. Non-uniform heating results from the establishment of standing waves, giving rise to "hot spots" where the glue is satisfactorily cured or the wood even over-heated, and other areas where heat has not been generated due to reduced voltages as antinodes are approached. In this particular application the main spar, which was some 30 ft. in length, included various blocks of wood and corresponding joints ranging from the size of large boot-boxes to match-boxes. At the frequency of 10 Mc/s which was employed, advantage was taken of the roughly corresponding length of a half-wave and lumped inductance and capacitance was arranged to produce a voltage node in the middle of the spar where the larger joints were located, with characteristic tapering off towards the ends where the "match-boxes" were to be found. Satisfactory curing was effected in 11 minutes with a power of about 3 kW.

Mr. Elvy quoted a matter of minutes for the time required to achieve glue-setting. This is, of course, dependent on a number of factors and by the selection of suitable resins and their hardeners, complete curing and perfect bonding may be effected in as little as $1\frac{1}{2}$ seconds.

I find that my experience differs considerably from that of Mr. Elvy on the question of valve reliability. When he states that he is obliged to use transmitter valve types, I think it should be made clear that this applies to only one or two types of equipment. As is well known, there is a range of silica valves available which has been specifically developed for industrial use. Lives up to 17,000 hours have been known and if it is reckoned that 2,000 hours correspond to something like one year's use on a 44-hour week basis, I think the user

has little grounds for complaint. Rectifiers appear to have a life of about 3,000 to 4,000 hours.

I would suggest that one important factor influencing the premature failing of valves is the type of protection which is usually provided. In almost every case, this takes the form of protection against excessive anode current. As will be readily appreciated, this does not necessarily afford protection against excessive anode dissipation and it is to this latter, or effects arising therefrom, that premature failure may frequently be attributed. If the load is not matched to the valve, and in industrial applications only too rarely is this state of affairs maintained for more than 20 per cent. of the work cycle, there is always the danger of excessive anode dissipation despite the fact that the maximum permissible anode current has not been exceeded.

M. T. Elvy (Associate Member) (in reply): The fact that one firm had applications for the Mosquito in 1944 does not, in my opinion, constitute the commencement of applications on a general scale. I still consider 1947 to be the date when firms started operation on a national basis.

With regard to making use of standing waves, I agree with Mr. Bazin entirely. Generally speaking, however, standing waves are undesirable because they cause non-uniform heating.

In practice very short setting times are not often made use of because the operator cannot handle the loading and unloading of the jig so rapidly. He will take a certain time, usually about a minute, to spread glue and load the jig.

Many valves used in r.f. heating are of the silica type and I agree that from the point of view of reliability they are often proved to be superior, although they are not always suitable for r.f. heating due to frequency limitation. In my experience some of the smaller hard glass radiation-cooled valves, which are otherwise suitable, are not really reliable, and quite often fail within the guaranteed life which is usually of the order of 2,000 hours.

I agree that many of the smaller equipments do not cater for high-anode dissipations, but quite a lot of the larger equipments do have grid under-current relays included for this purpose. In any case high-grid dissipation and grid-filament shorts cause more trouble than high-anode dissipation.

SCIENTISTS AND THE PRESS*

by

W. Harford Thomas†

This contribution follows an informal discussion during the Industrial Electronics Convention

Most journalists would, I think, agree that there is too little science news in the newspapers and that there could be and ought to be more. Probably most scientists (a term which I use here to cover both research and production) would agree with them. Why, then, is there not more science news in the newspapers? The answer from the journalist's point of view is simple. It is because it is difficult to get. And this raises problems which cannot be solved by the journalist alone. He will need the active co-operation of the scientist.

Here the scientist, who has agreed in general terms that there ought to be more science news in the papers, may pause when he is told he needs to give some time and thought to providing the news. Is it worth it, he may ask. To answer this question it is necessary to outline some of the arguments for what is sometimes known as "popularized science." For the scientist may feel that it is enough to publish reports of what is going on in his own technical journals, and not bother about the people who are unequipped to understand it, and may end simply in misunderstanding it.

There is one crude but powerful reason for telling the layman and his wife what is going on. Increasingly scientific research is financed by government money, and in the long run the taxpayer will want to know why. This is a particularly powerful reason on close inspection, for the Member of Parliament who controls the flow of public money is as a rule a person without expert scientific knowledge, and must draw a great deal of his information from such easily accessible popular sources as the newspapers.

If scientific developments are to make rapid progress a great deal depends on the understanding of what is available and possible among directors and managers. And here once again the decisions are often taken by men without expert scientific knowledge. Though they will presumably have technical advisers, they may be quicker to see new

possibilities if they have acquired some general idea of what is going on in the field of science.

Industrial applications of electronics are already beginning to make many clerical and accountancy jobs redundant in large concerns. Electronic devices can control some machines more accurately than a human operator. The completely automatic factory is no longer a dream but a reality. These facts are well known to electronic scientists, but they are still virtually unknown to the public at large. Yet they are obviously of the greatest significance. Many people are going into blind-alley jobs without realizing it. And when the applications of electronics in industry come to be introduced on a wide scale there will almost certainly be labour unrest if the trade unions have not come to realize well in advance what the new equipment involves.

The Chancellor of the Exchequer, Mr. R. A. Butler, has said that it is possible to double our standard of living in the next 25 years. Few scientists would disagree; this may well be possible—but it does depend on how intelligently scientific developments are used, and this depends upon how well informed people are. Sir Ben Lockspeiser, in an address to the Parliamentary and Scientific Committee last May, said, "In the final analysis the contribution which science can make to industrial advance depends on people, on their knowledge, on their attitude of mind and on their social outlook."

The Press is still one of the most influential mediums for imparting information and creating new attitudes and outlooks. Radio and television grow increasingly important, but they share with the Press some of the same problems in reporting and explaining science to the lay public. Both the reporter and the radio writer have two hurdles to clear. They have to understand the scientist and they have to be understandable to their audience, and in the process of trying to make themselves understandable they sometimes create distrust in the mind of the scientist.

Some of this distrust exists because of actual experience or of hearsay accounts of the treatment given to scientists by a few (in fact, very few) of

* Manuscript received 19th October, 1954 (Contribution No. 13).

† Editor, *The Oxford Mail*, Newspaper House, Oxford.

U.D.C. No. 002 : 5/6.

the most sensational newspapers. It is unfortunately true that sometimes a newspaper, usually one with a very large circulation, will unscrupulously distort and sensationalize scientific information in the attempt to make it "news." The effect has been to make scientists in general highly suspicious of all newspapers.

The fact the editor must face is that neither he nor any of his sub-editors will be able to tell whether a reporter turning in a science story has got it right. It is newspaper routine for the sub-editor to check that the facts in (for example) a political story are as far as is ascertainable correct. But confronted with science news he has to take it on trust. To some extent the risks of taking it on trust are reduced if the paper can afford to keep a full-time qualified science correspondent, but even he cannot hope to be at home in every specialized field. Taking it on trust is one of the main sources of mistakes, and often of the kind of mistakes which are extremely embarrassing to the scientist whose words or work are being reported. The mistake may be invisible to the lay eye (I recall a story about a micrometer which misplaced the decimal point), but is exasperating to the expert.

The editor has only one way out of this dilemma. He must ask his expert informant for help in checking the story. Now this is a practice many editors dislike because of the petty little jack-in-office who sometimes insists quite unreasonably on seeing a report before publication. Every editor must resist that kind of attempt to interfere with his independence. But he must accept the fact that if he is to make sure that his science news is accurate he must have the co-operation of the expert in checking it.

Once that point is established I believe that journalists and scientists can work harmoniously and profitably together. It requires some give-and-take on both sides. The journalist must recognize that some work only warrants tentative conclusions about its application. On the other hand, the scientist must not object to the journalist's stock questions, "What is this for, what will it do, what will it mean to people?" Research scientists are inclined to be fastidious about this sort of question, but this is what the ordinary person wants to know. As Sir Walter Puckey remarked at the Brit.I.R.E. Convention in Oxford, "There is great virtue in the simple approach, which gets the customer interested first of all by showing how the equipment will help him rather than by showing how and why it works."

This simple approach will require some mental gymnastics on the part of the scientist, and some discretion on the part of the journalist. There was the lecturer on atomic physics who explained that the nuclear power locked up in a pound of butter would run a one-bar electric fire for 20,000 years (if I remember the figure correctly) and not unreasonably sought the assurance of the reporter afterwards that this would not be made into a headline. The scientist must also sometimes accept that technical information can only be conveyed in a somewhat rough and ready paraphrase if it is to be understood by the non-expert. As a non-expert myself I was interested recently to read of one system of colour television that it is "a rare example where it is almost impossible to describe the mode of operation, unless a certain amount of mathematical reasoning is used."

Supposing the scientist feels that informing the public of what he is doing is important enough to justify taking time and trouble to help the journalist express it correctly in simple terms, we come up against two more snags. First, the journalist is nearly always working against the clock and may have to get into print in a hurry. This will often preclude his manuscript being checked, though it should be possible for him to clear up doubtful points. Where it is a matter of an interview which is not being given to another paper the editor ought to allow reasonable time for a manuscript to be checked—but "reasonable time" in editorial terms does not mean sitting on it for a few weeks. Secondly, delays and difficulties occur for security reasons. There is little the editor can do about that other than protest that some commercial firms seem quite absurdly cautious about trade secrets.

When one looks at American magazines one can see what an enormous quantity of science news there is that never reaches the British lay public. The Americans are much more receptive to new technical ideas, much more gadget-conscious. That could explain why they get so much more science news. Alternatively, the flow of science news may have something to do with their attitude to technology. However that may be, British reporting of scientific and technological developments is thoroughly inadequate. A good many editors are aware of this, but it is not exclusively an editorial problem and they need help, or even better, a lead from the scientists.

Since these notes were written, an article on the subject has appeared in Nature (Issue of November 6th, pages 847-850).

THE RELIABILITY OF NUCLEONIC INSTRUMENTS*

by

Denis Taylor, M.Sc., Ph.D.†

A paper presented during the Industrial Electronics Convention held at Oxford in July 1954.

SUMMARY

The paper discusses the servicing of nucleonic instruments under factory conditions and considers some of the problems which have arisen in the British Atomic Energy Project. The annual failure rates of some of the standard instruments are given and attention is called to the component failures. It is noted that much progress has been made in improving the reliability and life of some of the newer components, e.g. Geiger-Muller counters, and that the failure rates are highest for the more orthodox components, e.g. thermionic valves and resistors. Experiences are quoted from British, American and Canadian sources. Reviewing the analyses presented, an attempt is made to lay down a number of guiding principles to follow when designing complete instruments.

1. Introduction

Up to the present the main uses of radioactive isotopes and the associated measuring instruments, usually called nucleonic instruments, have been in research and medicine, but many industrial uses for radioactive isotopes have been proposed and a proportion of these are finding important application. This is particularly true of the radioactive thickness gauge about which we are to hear more at this convention. However, many industrialists are of the opinion that nucleonic instruments are scientific gadgets, which have their place in the laboratory, but have not yet reached the stage of engineering development to give reliable service under factory conditions. This is partly true, but already a number of nucleonic instruments of very high reliability have been produced. They are more expensive than their laboratory counterparts and they must therefore sell themselves on the score of the improved trouble-free service which they offer.

There is, of course, all the difference between a device designed to indicate the presence or the magnitude of some material or quantity and one whose function is to control the process. In the latter case, failure of the device to control adequately will not just give a wrong indication, but is liable to result in great danger to life and financial loss to the owners. It is undoubtedly the incidence of faults in the former

case which tends to dissuade engineers from using such devices as widely as they could with safety. The present paper considers the general question of the reliability of nucleonic instruments and discusses the possibility of giving a higher standard of reliability by improved design. Since the majority of the instruments discussed use thermionic valves or gas-filled discharge tubes much of what follows applies equally to the more orthodox electronic instruments

2. The Servicing of Electronic Instruments

Experience of the servicing of electronic instruments in the factories of the Atomic Energy Department is that the real problem here remains one of design. However, good designs are possible only with good components and, at the present time, many of the components which the instrument designer must use fall far short of the performance required. Much progress has already been made, as has already been reported^{1, 2} in improving the reliability and life of some of the newer components, e.g. Geiger-Müller counters, but failure rates remain fairly high and, even in the case of the specialized measuring instruments using radiation-detector counter-elements, the failure rates are highest for the more orthodox components, e.g. thermionic valves, resistors and capacitors.

In the Atomic Energy Department's factories and establishments all faults arising with electronic apparatus are logged and a complete analysis is made of them every twelve months and the information is made available to the design groups at Harwell and the Instrument Manufacturers concerned.

* Manuscript received June 15th, 1954. (Paper No. 290.)

† Atomic Energy Research Establishment, Harwell, Berkshire.

U.D.C. No. 621.387.4.

A recent review at one factory where several thousand electronic instruments are in continuous use showed that more than 70 per cent. of the total failures were due to thermionic valves. It is believed that this failure rate is typical of the performance of the more orthodox electronic instruments used under industrial conditions, but information on this point is lacking.

At the Atomic Energy Research Establishment much use is now being made of cold-cathode tubes both in portable and fixed instruments and the reliability obtained is very high — the failure rate being about $\frac{1}{4}$ per cent. per annum at the present time. Transistors of both the point and the junction types have so far only been used experimentally, but if the lives suggested in the literature^{3, 4, 5} prove to be true, there is no doubt that this component will be of considerable value in improving reliability and hence reducing the servicing required.

The process-control instruments used in the atomic energy factories provide some special problems for both the designers and the maintenance men. However, it is often possible to simplify servicing by the use of jack points on all circuits to allow the routine measurement of the appropriate voltages, currents and waveforms. Such tests can often be made by unskilled personnel. In other cases, and this refers particularly to the detecting elements used for the measurement of gamma-ray flux, alpha-

activity and temperature, the high radiation levels often render maintenance of the instrument in situ impossible. In these circumstances instruments of the highest reliability are essential, since faulty units must be replaced immediately the fault occurs and residual radioactive contamination on the faulty unit may prevent a detailed examination of it for several days.

Much use is made in the atomic energy factories of radioactive assay instruments comprising a radiation or particle detector, an amplifier, a high-voltage power unit and a scaler or counting-rate meter. Several hundred such instruments are used in the larger factories and the servicing of these is carried out in two stages. Certain servicing personnel are responsible for routine inspection of the complete instruments and first-line maintenance, but repair work involving the replacement of components, e.g. resistors, capacitors, etc., is carried out away from the plant room or laboratory and it is the duty of the visiting servicing man in such cases to localize the fault to a particular unit and replace this unit. The repair of a faulty unit is then undertaken in the repair shop by industrial labour using as far as possible standard test rigs. This method involves the use of really good servicing personnel for the inspection work, but only a few such men are required even in a large factory. Even so the servicing wage bill in the atomic energy factories is very high and special efforts must be made to reduce it to more

Table 1
Failure Rate for Nucleonic Instruments
21-Month Service Period from 1st January, 1950 to 30th September, 1951.

Instrument Type	Number in Service	Instrument Failures	Tubes	Capacitors	Resistors	Transformers	Months Service Per Instrument Per Failure
Scalers	277	1210	1642	259	120	62	4.8
Amplifiers	20	67	158	13	32	4	6.3
Rate Meters	37	115	300	22	18	15	6.7
Health Monitors	232	998	1163	154	43	39	4.9
Electrometers	51	163	109	12	12	1	6.6
Totals	617	2553	3372	460	225	121	

reasonable proportions. Of course, it is true that the instrumentation and indeed much of the plant itself of the atomic energy factories⁶ has been designed direct from the "test tube" stage without awaiting the results obtained with pilot plants; this was necessary to allow the early availability of plutonium. The result has been extremely flexible instruments with a wide-range of sensitivities, but for the purposes for which the instruments are used they are unnecessarily elaborate and much simplification could now be made allowing both the use of lower-grade operating personnel with a consequent reduction in operating costs, and a lower failure rate with a possible reduction also in maintenance costs.

3. Statistics of Reliability

Statistics of reliability are difficult to obtain and even when the data are available care must be exercised not to read too much into the figures. For example it is often impossible to know how many valves and components were replaced unnecessarily. Preventive maintenance is to be encouraged, but components can frequently be replaced which are still within the performance limits and which may stay that way for an indefinite period. The only way to find out how often this occurs is to collect all the "failed" components and valves for examination and testing. This procedure is now followed in the British Atomic Energy Department. Some results of this new procedure

Table 2
Annual Failure Rates for Selected Nucleonic Instruments for the Year 1953.

Components	Totals in use	Failures	Percentage Failures	Percentage Failures for Selected Equipments.					
				Scaler 1009B	Amplifier 1008	Monitor 1021	Power Unit 200	Probe Unit 1014	Timing Unit 1003
				No. in use 113	107	165	108	276	132
Valves									
Rectifiers	3,858	350	9.1	11.2	12.55	5.04	7.2	—	—
Double Diode	7,511	125	1.66	2.05	—	1.82	—	2.1	—
Double Triode	9,077	618	6.8	5.56	4.24	0.81	—	—	—
Pentode	15,413	413	2.67	3.48	2.53	7.09	9.98	4.33	—
Stabilisers	3,371	141	4.18	2.69	10.86	0.99	6.13	—	—
Resistors									
High Stability	66,929	484	0.73	1.33	0	0.05	—	0.43	—
Carbon G. II.	127,984	323	0.25	0.13	0.22	0.08	0.44	0.38	0
Wirewound	34,676	105	0.30	0.88	0.16	0.19	0.07	—	0
Pots. Carbon	4,170	10	0.24	0	—	1.38	—	0	—
„ Wirewound	13,184	28	0.21	0	0	0.39	0.19	—	—
Capacitors									
Paper	34,981	77	0.22	0.1	0.55	0.07	2.24	0.11	0
Visconol	693	2	0.29	—	—	—	0.92	—	—
Nitrogol	4,000	6	0.15	0	—	—	—	—	0
Mica	12,533	23	0.18	0.06	0	0.05	—	0.43	—
Ceramic	17,640	26	0.15	0.21	0	1.21	—	—	—
Electrolytic	7,471	71	0.95	—	0.44	0.58	1.78	0.86	—
Inductors									
Transformers	4,440	91	2.06	2.08	1.65	0.99	3.62	—	1.12
Chokes	4,835	8	0.17	0	0.36	—	—	—	0
Miscellaneous									
Relays G.P.O.	5,181	15	0.29	—	—	—	—	—	0.24
„ High Speed	1,767	15	0.85	1.48	—	—	—	—	0
Meter	1,870	24	1.28	—	—	1.52	0.9	—	—
Call registers	618	39	6.32	11.34	—	—	—	—	—
Selenium Rectifiers	3,465	21	0.61	0	3.31	—	0	—	—
				Percentage 18.0 Failures	5.7	6.1	3.8	3.74	1.19

can be quoted in the present paper, but a more detailed statement must await the publication of a report by R. L. Elliott of the A.E.R.E.

Very little information is available from American sources about the reliability of nucleonic instruments, but C. L. Borkowski of the Oakridge National Laboratory has recently quoted some results obtained at that Laboratory. These results are reproduced in Table I above.

As will be seen these figures apply to standard laboratory apparatus. The health monitors included a number of instruments for monitoring radioactive contamination on the hands and feet of a type similar to that to be described by R. B. Stephens⁷ in a later paper at this convention. By comparison with the other instruments the hands and feet monitor is very elaborate and it is not surprising to note the high failure rate of 2.5 faults per instrument per annum for the health monitors.

A summary of faults on selected laboratory instruments at the A.E.R.E. is given in Table 2. It is interesting to note that of the selected instruments, the scaler is the worst offender and the timer unit causes the least trouble. In fact, however, the 18 per cent. recorded for

the scaler may not prove to be a typical figure. The corresponding figure for the same scaler in 1952 was only 7.4 per cent. However, the figure for the scaler type 1009A, an earlier version of scaler type 1009B, was always much higher than 18 per cent. Whatever the exact figure, however, the fact remains that these scalars produce an appreciable fraction of the total servicing load and a more reliable scaling unit offering equivalent facilities is urgently needed. It would seem that scalars using decade gas-filled counting tubes will provide a satisfactory solution, but although over one hundred of these scalars are in use at Harwell it is still too early to quote figures for annual failure rates.

It should be noted that the timing unit type 1003 contains no thermionic valves, or gas-filled discharge tubes; selenium rectifiers are used in the power supplies of this timer and no failures were recorded.

Component failures are, of course, a function not only of the components themselves, but also of the goodness of the design of the instrument in which they are used. For example, the Atomic Energy of Canada Ltd. had recently reported⁸ the results of a fault analysis of

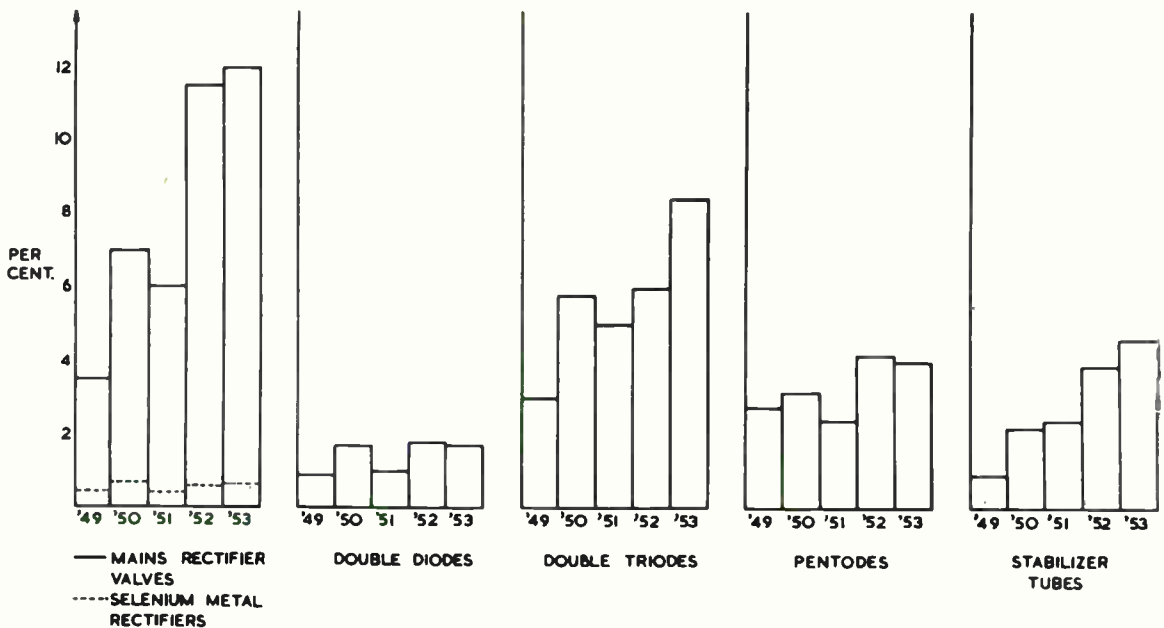

Fig. 1.—Yearly record of population failure rate of valves of various types.

Table 3
Variation of Annual Fault Rate since 1949

Year	Faults per Annum
1949	0.55
1950	0.70
1951	0.88
1952	1.33
1953	1.36

nucleonic apparatus in use at the Chalk River Laboratory. It was noted for example that the replacement rate for almost all components*, but particularly for valves, was higher in the Hands and Feet Monitors than in all other instruments. This is obviously associated with the fact that this instrument is relatively large and elaborate. On the other hand the Canadian Kick-sorter or pulse-amplitude analyser is of comparable size and complexity and the failure rates were very much lower. On the other hand the H/F monitor is totally enclosed with only

* For example, 65% of the 5R4G's were replaced in the H/F Monitor as compared with none in the Kick-sorter, where it is run at half its rated current and well ventilated.

louvres for ventilation, whereas the kick-sorter is fan-cooled and has a layout more conducive to effective heat removal. In general, it has been found possible to find a satisfactory reason to account for any very high or low incidence of failure and usually these reasons involve the adequacy or inadequacy of heat removal from the heat generating components.

To supplement the information given in Table 2, further data covering a 5-year period are given in Figs. 1, 2 and 3. Fig. 1 gives details of the yearly record of population failure rate for all valves, whereas Figs. 2 and 3 give the corresponding information for various types of resistors and a number of miscellaneous components respectively. In assessing these failure rates it is worth considering the rates not only as a percentage of the total population, but also as a percentage of the total failures of the year. This latter figure is a fairer estimate of the nuisance value of the fault.

It may be noted from an examination of tables such as Table 2 for various years as well as from an examination of Figs. 1-3 that the fault-rate per instrument per annum has increased over the past five years. The requisite data for the A.E.R.E. are summarized in Table 3. A part of the increase may be attributed to the increasing age of the components, but a part may also be due to a falling standard in the quality of the servicing staff with the rapid expansion of the project.

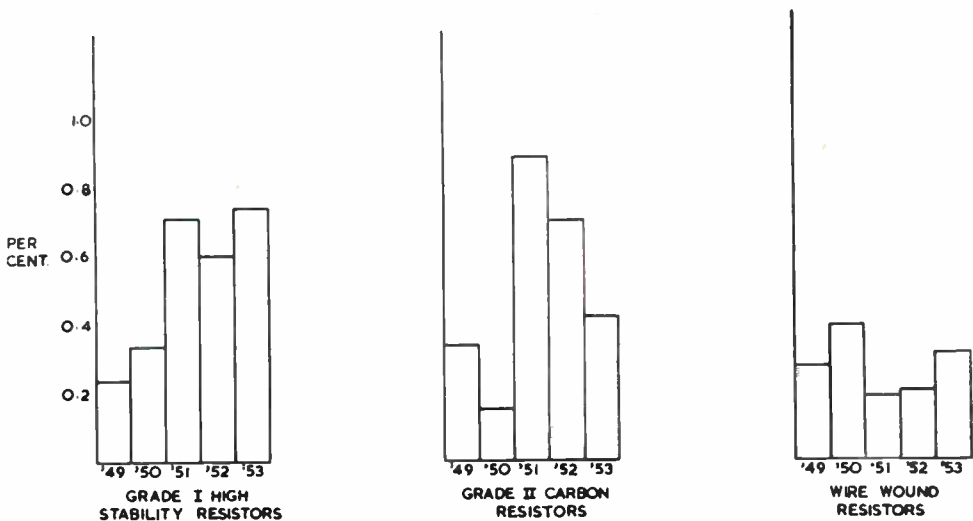

Fig. 2.—Yearly record of population failure rate of resistors of various types.

Referring now to Figs. 1-3 some general comments can be made. In the case of rectifier tubes the fault rate is very high and increasing annually possibly due to the use of low-impedance "C" core transformers. The reliability of metal rectifiers has been good. It is interesting to note that American and Canadian experience with metal rectifiers has not been so good. For example, the annual failure rate for metal rectifiers in the Canadian Atomic Energy Project has increased from 2.9 per cent. in 1949 to 9.0 per cent. in 1953 (see Table 4) compared with a figure below 1 per cent for metal rectifiers in use in the British Project. The increasing fault-rate for the double triodes is almost certainly due to preventive maintenance of scaler type 1009B. The figures for pentodes are impressive since series stabilizers and the valves for the input stage of linear amplifiers are included. The situation regarding voltage regulator tubes is seen to be deteriorating, but recent re-design and increasing use of type-approved tubes seems likely to bring about some improvement.

Much the same experience with valves has been obtained in the Canadian project. The overall replacement for all valves remains at about 6 per cent., but has not increased in the same way as in the British project. In a recent discussion J. Hardwick of the Canadian project stated that most valves and rectifiers generally are over-rated and the necessity for de-rating or

fixed air cooling is now accepted in cases where manufacturers' specifications on ratings are available. Specifications now often refer to maximum hot spot bulb temperature (T_m), but recommend operation at $T_m - 50^\circ\text{F}$ for "optimum service life." A high incidence of cathode sparking on failed rectifier valves, due to excessive cathode current, demonstrates the importance of providing a suitable anode supply impedance or reducing the size of the input filter capacitor.

Referring now to Fig. 2 the population failure rate for high stability resistors is high. The flattening off of the failure rate is attributed to preventive maintenance started three years ago in which resistors found to be outside tolerance are replaced. It is useful to compare these failure rates with those obtained in the Canadian project using American-manufactured resistors. This data together with some data relating to valve performance are summarized in Table 4. Canadian design office policy is to derate all resistors 50 per cent. and they are of the opinion that this explains at least in part the good reliability record they obtain.

Referring again to Fig. 2 it may be noted that the high peak in the grade II carbon resistors coincided with the large-scale use of scalars types 1009A and 1009B. The decreasing failure rate of capacitors (see Fig. 3) is accounted to the improved methods of manufacture.

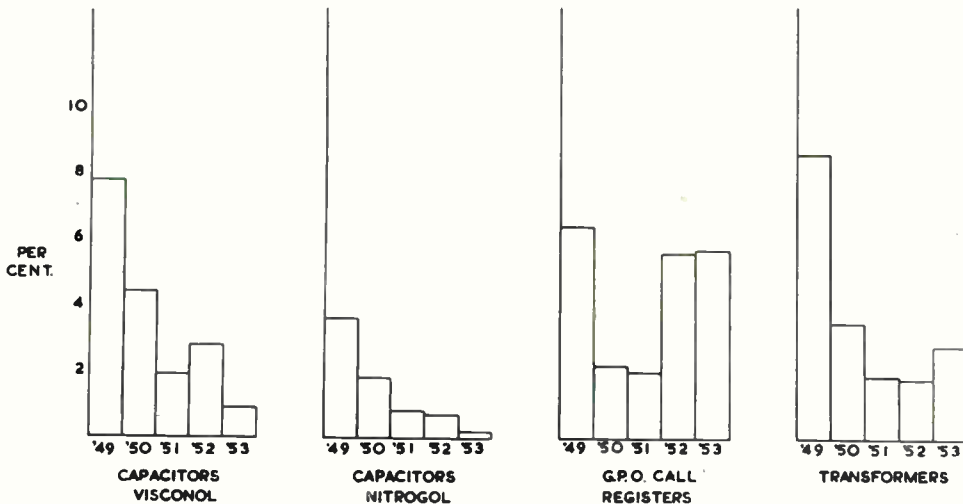

Fig. 3.—Yearly record of population failure rate of capacitors and other components.

The improvement in the performance of transformers is due to the use of "C" cores and control on use by the A.E.R.E. transformer design office. Canadian experience with transformers has been similar as will be seen from Table 4.

4. Designing for Reliability

It is useful to consider tables such as Table 1 and determine the nuisance value of different components. For the years 1951-52 the valve figures were 40 per cent. and 60 per cent. respectively, and of these rectifiers accounted for 6.5 per cent. and 11 per cent. respectively. In the case of resistors the figure was about 30 per cent. for both periods—no significant change occurring during the intervening period. Capacitors, on the other hand, have shown a real improvement (see Fig. 3), but unfortunately this has to a large extent been nullified by the increased nuisance value of valves (see Fig. 1). To complete the picture it may be noted that the corresponding figure for metal rectifiers was only 0.4 per cent. Looking at these figures

it is possible to lay down a number of guiding principles when designing complete instruments. The value of re-rating both valves and resistors to obtain longer life is particularly worth noting.

The first important point is that failures in power rectifiers and stabilizing units are out of all proportion to the number of components involved compared with other units. It would appear that the design of common power units feeding, in each case, all units in one counting (or flux-measuring channel in the case of a nuclear reactor), where failure of any one unit is equivalent to the failure of all of the units of the channel, is an obvious step.

In the past there has been a tendency to design counting equipment of the type required for radioactive tracer work into a number of large individual units, which may be built up into a number of complete assemblies for different purposes. This provides an extremely flexible system, but in many cases it also leads to a greater number of valves and other components being used in the final assembly. The modern tendency in the British Atomic Energy

Table 4
Comparison of Failure Rates for Electronic Components in the Canadian A. E. Project.

YEAR	Annual Failure Rate (% of population)					Percentage of Total Failures (Nuisance Value)				
	1949	1950	1951	1952	1953	1949	1950	1951	1952	1953
Component										
1. Valves	7.9	8.4	5.6	5.7	6.2	81	72	74	73	70
(a) rectifiers	21	19	19	18	21	26	14	14	14	14
(b) other valves	6.2	7.4	4.8	4.9	5.3	55	58	60	59	56
2. Resistors	.02	.04	.07	.04	.04	2.1	2.4	4.7	3.3	3.2
(a) carbon	.02	.02	.09	.05	.05	.7	.6	4.3	2.7	2.0
(b) Nobleloy	.06	.08	.01	.008	.02	.7	.9	.2	.2	.4
(c) wire wound	0	.1	0	0	.1	0	.6	0	0	.4
(d) potentiometer	.3	.3	.1	.3	.4	.7	.3	.2	.5	.5
3. Metal rectifiers	2.9	3.1	4.3	8.1	9.0	1.4	2.4	3.8	6.6	5.9
4. Transformers	2.0	1.2	.7	.5	.5	2.1	1.2	1.2	.7	.5

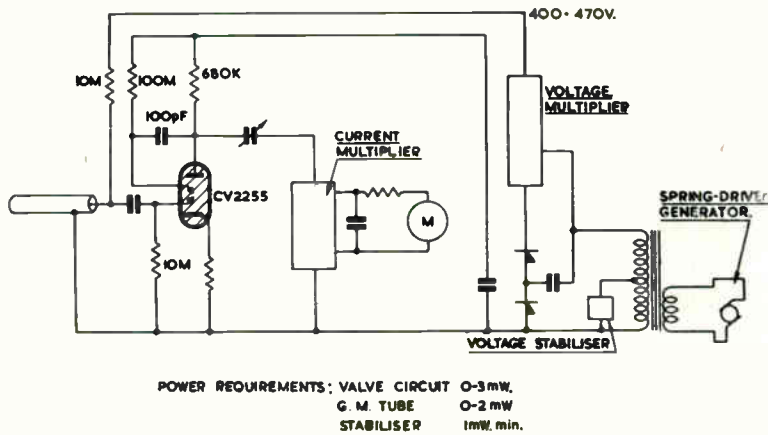

Fig. 4.—Geiger counter survey meter using a cold-cathode tube and powered using a spring-driven electric generator.

Department is to build a final assembly for a particular job and use, consistent with satisfactory performance, the minimum number of components, choosing components as far as possible of low-nuisance value; this is particularly so in the case of instruments designed for industrial plant.

Considering alternative designs to overcome the large number of valve failures, is the possible change to scaling tubes where divide-by-ten is carried out in one valve with a given number of associated components. The number of valves of this type with a high resolving time of 2–5 microseconds is very limited, and the reliability of such tubes has not been fully established. However, this approach looks promising for the future.

A feature which can give the user some improvement, which is being used now, is the facility for complete and extensive test each time the equipment is used. This is to counteract the slow drift of the characteristics of valves and other components, thereby reducing the actual nuisance factor as far as the user is concerned. An important property of most cold-cathode tubes is that they seldom show a gross discontinuity during use. It is therefore satisfactory to consider incorporating marginal testing facilities in the equipment. Kandiah at the A.E.R.E. has recently⁹ designed a scaling unit using Dekatron tubes which incorporates facilities for carrying out a number of simple marginal tests on the cold-cathode tube elements. This feature is liked both by the users and the servicing staff and is fairly certain to reduce maintenance costs, but factual information on

this point is still lacking. Marginal testing facilities are also being incorporated on more elaborate equipment, notably on the control instrumentation for the automatic start-up of nuclear reactors.

It may also be mentioned that published figures of failure in American Service equipment showed that $33\frac{1}{3}$ per cent. were caused by slow changes of characteristics which eventually resulted in a catastrophic failure of the equipment. The indications are that a similar state of affairs exists with resistors which, as noted already, contribute the next major cause of failure in equipment. The principle of marginal testing, where the equipment is subjected artificially to changes in currents and voltages in such a way as to narrow the margin of safety, will prevent the actual failure of the equipment in use due to such slow drifts. In the majority of cases the effect of drifts in components and valves is equivalent to a change of the supply voltage. Hence the use of common transformers, rectifier and stabilizing circuits for a complete channel will facilitate the marginal testing of the channel. The design of the individual units must be initially worked out with a view of applying such tests.

Other components which are being used which should aid reliability are magnetic amplifiers and transistors. It is, in fact possible¹⁰ to design the instrumentation for the control of a nuclear reactor without using any thermionic valves. This is probably not a course of action to advocate; nevertheless the limited use of magnetic amplifiers is now a definite policy at A.E.R.E. for reactor instrumentation.

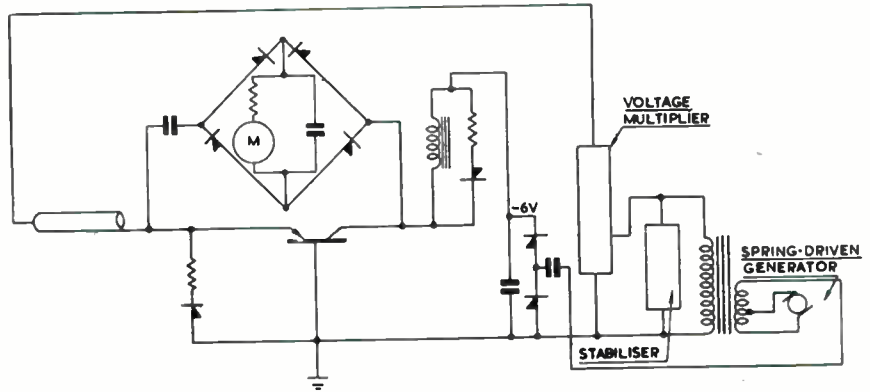

Fig. 5. — Geiger counter survey meter using a transistor and powered using a spring-driven electric generator.

POWER REQUIREMENTS: TRANSISTOR 3mW. WITH POINT TYPE (LESS WITH JUNCTION TYPE)
 G.M. TUBE 2mW.
 STABILISER 1mW.

Experience with transistors at the A.E.R.E. is not yet sufficient for these components to be used on a large scale, but all recent evidence appears to point to very long lives being obtainable. Apart from the use of transistors at the A.E.R.E. in scaling units and digital computers, most of our recent experience has been in the use of these components in radiation monitors for field survey. For many years now cold-cathode trigger tubes have been used in such monitors and excellent maintenance records have been obtained (see Section 2). Transistors offer the possibility of a more compact instrument, but in addition they can both simplify the power supply and perhaps improve the reliability still further.

Franklin at the A.E.R.E. has given much thought to avoiding the use of batteries in portable survey meters by reducing the total power requirements to the order of a few milliwatts and replacing the battery by a spring-driven electric generator. Such a generator can be of small dimensions and can operate for several hours on one wind. Portable non-battery survey meters of this type have important application for field survey and perhaps for radiological defence purposes, although they are not necessarily of such interest in industry.

Two circuits for a field survey equipment using a spring-driven electric generator are shown in Figs. 4 and 5. The first circuit uses a cold-cathode tube in the counting circuit and to economize in power supplies still further

a pulse transformer is employed as a current multiplier in the meter circuit of the valve. The spring-driven electric generator is stabilized electronically and a Cockcroft and Walton circuit is used as a voltage multiplier to produce the high voltage for the Geiger counter.

Point-type transistors are used in the circuit shown in Fig. 5. As will be seen they do not in this case offer any real advantage over the cold-cathode trigger tube from the power supply point of view. However, junction-type transistors will offer a definite advantage as is noted in the caption under this figure.

5. Special Problems with Nucleonic Instruments

In some cases the use of nucleonic instruments raises special problems. Thus, the continuous monitoring of alpha-activity in solution to obtain an index of the amount of uranium (or other alpha-emitting material) present has been satisfactorily solved¹¹ so far as the instrument itself is concerned. The sort of performance obtained under factory conditions for one month's working is shown in Fig. 6. Here the dotted line corresponds to test measurements made by obtaining samples which were submitted to independent measurements in the chemical laboratory. However, in some cases it is difficult to arrange for a representative sample of the liquor to be monitored to flow past the measuring head, and in these cases the mechanical complication of producing satisfactory sampling arrangements often involves greater expenditure than the expenditure on the instrument proper.

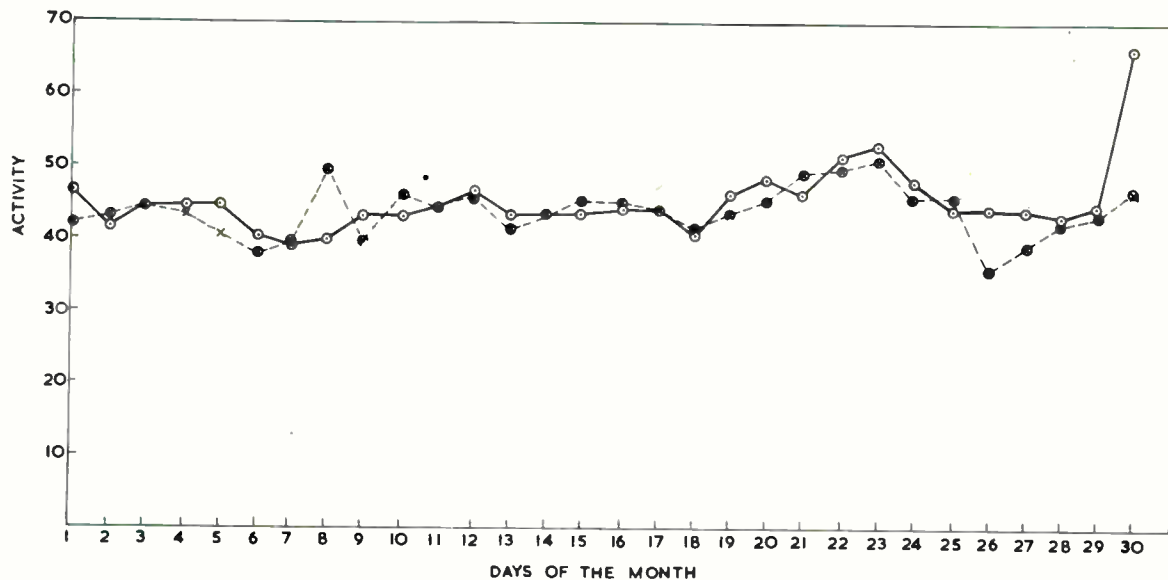

Fig. 6.—Typical monthly record for continuous measurement of α -activity.
 ————— readings of plant instrument - - - - - check measurements in the laboratory.

Nucleonic instruments for use under factory conditions need to be reasonably robust. This is often difficult to achieve in the case of the radiation or particle detector itself, particularly if the measurement of low-energy beta-particles, or alpha-particles is involved. In some cases, however, the problem of producing a robust window sufficiently thin to allow the transmission of the particles to enter the detector may be avoided. This has been done for example by E. N. Shaw¹² in his Alpha Gauge, to be described at this convention, by using an air ionization chamber with one side of the chamber open to the atmosphere, i.e. no window is used. It is also possible on occasions to avoid the problem of detecting the alpha-particles by allowing them, for example, to interact with suitable material and produce a more penetrating particle which is detected. This is the method employed, for example, in assaying certain alpha-emitting material under plant conditions. In this case a (α -n) reaction takes place and it is the neutrons which are finally detected and give an index of the amount of alpha-emitting material present. It is therefore worth while to consider methods of this sort for avoiding thin windows of high nuisance value before accepting the direct method as necessarily the best to employ under factory conditions.

6. Acknowledgments

I am indebted to several of my colleagues, who have supplied me with data for inclusion in this paper notably Messrs. H. Bisby, R. G. Powell, E. Franklin and K. Kandiah. I am also indebted to Messrs. J. Hardwick and R. Shields of the Atomic Energy of Canada Ltd., who have allowed me to use data presented at a recent meeting at A.E.R.E.

7. References

1. D. Taylor, "Radiation and particle detectors in modern nucleonic instruments," *J. Brit. I.R.E.*, **11**, 1951, pp. 247-259.
2. D. Taylor, Discussion on Servicing and Maintenance of Electrical Instruments, I.E.E., 4th December, 1951.
3. F. C. Williams and G. B. B. Chaplin, "A method of designing transistor trigger circuits." *Proc. Instn Elect. Engrs*, **100**, Part III, 1953, pp. 228-244.
4. E. H. Cooke-Yarborough. "A versatile transistor circuit." *Proc. Instn Elect. Engrs*, **101**, Part III, 1954, pp. 281-287.
5. G. B. B. Chaplin. "The transistor regenerative amplifier as a computer element." *Proc. Instn Elect. Engrs*, **101**, Part III, pp. 298-307.
6. "Britain's Atomic Factories" (London, H.M.S.O., 1954).

7. R. B. Stephens. "Instruments for radiation protection," *J. Brit. I.R.E.*, **14**, August, 1954, pp. 377-386.
8. R. Shields. "Fault Analysis at Chalk River," Unpublished Report, Atomic Energy of Canada Ltd.
9. K. Kandiah. "A scaling unit employing multi-electrode cold-cathode tubes," *Proc. Instn Elect. Engrs*, **101**, Part II, June, 1954.
10. D. Taylor. Discussion on Symposium of papers on Nuclear Reactor Instrumentation. *Proc. Instn Elect. Engrs*, **100**, Part I, 1953, pp. 116-117.
11. D. Taylor and W. Abson. "Radiation measuring instruments for X-rays to cosmic rays." *Proc. Instn Elect. Engrs*, **98**, Part II, 1951, pp. 760-770.
12. E. N. Shaw. "The alpha gauge." *J. Brit. I.R.E.*, **14**, September, 1954, pp. 414-418.

POINTS FROM THE DISCUSSION

N. Armitage: I am interested in protection problems on power lines and in these circumstances reliability is most important. We have begun experiments with cold cathode tubes for various switching relay circuits. We have no operating experience of the life of these tubes and I would therefore like to ask if Dr. Taylor can give us actual figures of their life? We have been unable to get any information from the manufacturers apart from "several thousand hours."

I would also like to ask a question of Mr. Kandiah.* We may use cold cathode tubes for counting fault incidence. When the tube comes to an end of its useful life, is that end indicated rapidly; or does the valve gradually become unreliable, and, if so, in what manner?

Dr. D. Taylor (in reply): I do give one figure in the paper for the life of cold cathode tubes. Replying to the question further, the type of trigger tube used in the monitor described by Stephens⁷ has a failure rate of the order of $\frac{1}{4}$ per cent. per annum. We have used the multi-electrode tube that Mr. Kandiah describes in one of our digital computers, and the life figures are of the same general order as the better-type thermionic valves.

K. Kandiah (in reply): I would like to make one further comment in addition to what Dr. Taylor has said about cold cathode switching tubes. I feel that there has been some conflict in the general

opinion on the life of cold cathode trigger tubes. When it is stated that reliability is poor, I am certain that this is due to lack of appreciation of the limitations of these tubes, which are of quite a different character to thermionic valves. Taking those limitations into mind there is no doubt that the life of these tubes is very long.

Multi-electrode tubes and switching tubes do not fail catastrophically. If a particular characteristic is measured, it is extremely unlikely that this will have changed appreciably in the next few days except in a few special cases. The few special cases are those in which the characteristic is a function of the nature of the surface inside the tube, such as in some types of activated tubes or when the tube contains hydrogen or similar gases. Some of those tubes can change their characteristics in a few hours, but in general it is a very slow process and this sort of defect can very easily be overcome by marginal test before the tubes are put into use.

C. Guyot (Graduate): I would like to ask Dr. Taylor whether spring-driven generators are available now?

Dr. D. Taylor (in reply): The answer is that they are not commercially available at this moment and it is doubtful if they will be for a year or two years. As soon as they are available I am afraid we shall be using them on such a large scale that it is doubtful whether anyone else will get a look in. We are sufficiently confident to have taken our design to two different firms who are making up experimental models.

* K. Kandiah and D. W. Chambers, "Multi-cathode counting tubes." *Brit. I.R.E. 1954 Convention Paper*. To be published.