

JOURNAL OF
The British Institution of Radio Engineers

(FOUNDED IN 1925—INCORPORATED IN 1932)

*“To promote the general advancement of and to facilitate
the exchange of information and ideas on Radio Science.”*

Vol. VI (New Series) No. 4

JULY-AUGUST 1946

NOTICE OF THE TWENTY-FIRST ANNUAL GENERAL MEETING

NOTICE IS HEREBY GIVEN that the TWENTY-FIRST ANNUAL GENERAL MEETING (the Thirteenth since Incorporation) of the Institution will be held on WEDNESDAY, SEPTEMBER 25th, 1946, at 6 p.m., at the London School of Hygiene and Tropical Medicine, Keppel Street (Gower Street), London, W.C.1.

AGENDA

1. To confirm the Minutes of the Annual General Meeting held on October 5th, 1945, and reported on pages 185-187 of Volume 5 (New Series) of the Journal dated December, 1945.

2. To confirm the Minutes of the Extraordinary General Meeting held on December 21st, 1945.

3. To receive the Annual Report of the General Council (presented on pages 130 to 138).

4. To elect the President.

The Council are unanimous in recommending the election of Admiral Lord Louis Mountbatten, C.B., G.C.V.O., D.S.O., as President of the Institution for the year 1946-7.

5. To elect the Vice-Presidents of the Institution.

The Council unanimously recommend the election of:—

Air Vice-Marshal R. S. Aitken, C.B., C.B.E., M.C., A.F.C. James Robinson, M.B.E., Ph.D., D.Sc.
Leslie H. Bedford, O.B.E., M.A. Paul Adorian.

6. To elect the General Council.

Corporate Members have already been advised of nominations and have received the ballot papers. The result of the postal ballot will be announced by the scrutineers at the Annual General Meeting.

7. To receive the Auditor's Report, Accounts and Balance Sheets for the year ended March 31st, 1946.

The Accounts for the General and other Funds of the Institution are given on pages 139 to 142 of this Journal.

8. To appoint Auditors. Council recommend the reappointment of Messrs. Gladstone, Titley & Co., 74, Victoria Street, London, S.W.1.

9. To appoint Solicitors. Messrs. Braund & Hill, 6 Gray's Inn Square, London, W.C.1, are recommended for re-election as Solicitors to the Institution.

10. Awards to prize winners.

11. Any other business followed by a paper by L. H. Bedford on “The Strobe principle in Radio and Radar”.

The British Institution of Radio Engineers

(FOUNDED IN 1925—INCORPORATED IN 1932)

20th ANNUAL REPORT OF THE COUNCIL OF THE INSTITUTION

The report covers the twelve months ended March 31st, 1946. As announced on page 129, the Annual General Meeting will be held on September 25th, 1946.

INTRODUCTION

Five months of the period under review cover the concluding stages of the second world war whilst in the last few months the application of post-war plans has already encountered the difficulties expected in the reconstruction of society. Victory has, however, marked an era of scientific progress unparalleled in any other period of history, and in remembering present opportunities the Council again expresses regret at the loss of many Institution members who, during the war, made the supreme sacrifice.

The efforts and ingenuity of the British radio engineer played a considerable part in securing victory; the record of industrial progress published by the Radio Industry Council during 1945 well emphasised the achievement of British scientists and engineers in the radio field. The report very truly states that "The world must know that what they have accomplished in the last five years has turned the course of history, and in the times to come will accelerate human progress at a rate and in directions which we are only just beginning to glimpse."

Certainly the Institution now has a greater opportunity than ever before to fulfil its object of promoting the general advancement of and facilitating the exchange of information and ideas on radio science. Apart, therefore, from the maintenance of normal activities of the Institution, the last few months of the past year have shown progress in the special work of applying the post-war plans referred to in the last and preceding annual reports.

The 1945/6 session of meetings commenced last September when there were five active Sections of the Institution holding regular monthly meetings. During the year, there were also eight meetings of the General Council and seventy-one meetings of the various Standing and Section Committees. As indicated in the preface to the last Journal,* the President and Officers wish especially to give thanks to those members of the Council and Committees who continued to give so much assistance in the Institution's work.

In the past, the membership has approved the custom of dividing the Annual Report into sections representing the work of the various Committees, and the Council propose to continue this practice.

PROFESSIONAL PURPOSES COMMITTEE

The Committee has been primarily concerned with formulating and advancing policy under three main headings. Firstly, the constitution and objects of the Institution; secondly, the promotion of meetings and conferences which will aid the dissemination of technical knowledge, and thirdly, implementation of the Institution's two main post-war development reports so far as they affect the training of radio engineers and recognition of the status of the profession as a whole.

The Constitution and Objects of the Institution.—The resolutions taken at the Extraordinary

General Meeting held on December 21st, 1945, altering the objects of the Institution, were approved by Mr. Justice Vaisey, in the High Court of Justice (Chancery Division) on January 14th, 1946.

These alterations make clear that the main object of the Institution is the advancement and practice of radio engineering. The opportunity has also been taken to alter the term "wireless" to "radio"—a term which embraces electronics and is defined in the Post-War Report (Part I).

Since the Institution was incorporated in 1932, the growing membership and the increasing scope of radio science have necessitated five

* Page 81, Vol. 6 (new series).

separate sets of alterations of the Articles of Association. The articles governing election to membership could not, in the opinion of the Committee and Council, be further strengthened or improved at the present stage of the art, but increasing membership makes it necessary to secure wider representation of the membership on the Council of the Institution, which is at present confined to 19 in number; the present method of election to Council does not ensure adequate representation from the Sections or Overseas members. Moreover, it is desirable that the Chairmen of certain Standing Committees should serve on the Council—especially in the case of Committees engaged on “long term” work, e.g., The Charter and Professional Purposes Committees.

The Committee hopes that the membership will comment on this proposal when, if thought fit, Article 29 might be revised.

General Meetings and Convention.—The Council has adopted the recommendation providing for an annual, or, perhaps, a bi-annual meeting of the Chairmen and Honorary Secretaries of all the Sections; with the cessation of hostilities, it has become apparent that to meet the needs of the membership as a whole, further local Sections will have to be formed in addition to the five which already exist in the British Isles. Intercourse between the Sections is highly desirable in order to ensure maintenance of the Institution's standards and, in relation to papers, a real understanding and working arrangement with the Papers Committee of the Institution.

With the development of all Sections, it must be possible to arrange for an even greater variety of subjects to be read and/or discussed. These matters come within the purview of the Papers and Programme Committee, but the Council continues to examine the means whereby ample facility and opportunity can be obtained for the dissemination of knowledge, apart from the Journal of the Institution.

The fund of material which should now form the subject matter of papers and discussions—and be reasonably free from restriction—also affords an unprecedented opportunity for the holding of a Radio Engineering Convention in Great Britain; it will be recalled that in the 1943/44 annual report, the Council of that time stated the Institution's intention to hold such a Convention in England within 12 months of the cessation of hostilities against Japan. For

various reasons, it was not possible to hold that Convention in 1946, but arrangements have now been completed for the holding of the Convention in Bournemouth from May 19th to May 23rd, 1947. The response from members indicates that the Convention will be very well attended with very good representation from the membership overseas.

Further activity on the Post-war Reports.—In the last annual report reference was made to the conference which was being arranged by the Ministry of Education. The Council was asked to nominate representatives to meet others from the Institution of Electrical Engineers and the Institute of Physics. The conference which was held on September 11th, 1945, dealt with the difficulties of introducing individual National Certificate schemes and the Ministry's representatives expressed the view that the syllabus proposed by the Institution* was too comprehensive to be taught thoroughly in the available time. It was also pointed out that the theoretical desirability of having one ordinary National Certificate for all branches of engineering had broken down.

The Institution also raised the question of a Higher National Certificate in Radio Engineering and the Ministry was prepared to consider such a proposal after the Institution had had discussions with the Institution of Electrical Engineers who were prepared to meet the Institution to discuss the matter.

The meeting with the Institution of Electrical Engineers took place on November 26th, 1945, and the proposals made at that meeting have still to be considered by the Council of the Institution of Electrical Engineers with a view to an exchange of further opinion between them and the Council of the Institution.

Thus the Institution has again demonstrated its wish to co-operate with Ministries and cognate bodies in framing a more generally acceptable scheme of training, and it is to be hoped that more promising and definite information may be laid before the membership at the next Annual General Meeting.

Finally, the Committee wishes to express the thanks of the Institution to the President for his considerable activity during the past 12 months in visiting the Sections of the Institution and for the able way in which he has represented the

* Page 158, Brit. I.R.E. Jnl., 1944 (Vol. 4—new series).

Institution on a number of official occasions.

Other members of the Institution have been good enough to respond to the invitations of the Admiralty, the War Office, and the Air Ministry in giving lectures to members of the Services.

MEMBERSHIP COMMITTEE

Notwithstanding the further alterations to the Articles governing election, which have upgraded the requirements for election, the twelve months ended March 31st, 1946, show that the total of new proposals received has practically equalled the figures for 1944/5. Whilst there has been a fairly considerable reduction in the number of proposals for registration as Student members, there has also been a corresponding increase in the number of applications for election to the other grades of membership.

The reduction in the number of Studentship proposals was to be expected in view of the conversion of industrial activity from war to peace and more particularly the reduction of war-time schemes of training and present unsettledness in the availability of approved courses of technical training. The arrangements for pre-selection of proposals have also reduced the number of Studentship applications, having

regard to the Council's policy that candidates for membership must have received their technical training at approved technical institutes. In this connection, reference is made to the last Annual Report regarding the use of the common preliminary examination conducted by the Engineering Joint Examination Board for which the Council has now made the appropriate application.

The present requirements for registration as a Student member may need strengthening on the clause regarding the candidate's general training and education. An appropriate recommendation will be laid before the membership in due course.

The Council has approved the recommendation that registered Students who have been unable to complete their preparation for the Graduateship Examination because of war service shall be granted an extension of the 5-year maximum period of Studentship Registration.

The following tables give the actual figures of new proposals received and accepted, and this year a separate table is given showing the number of applications for transfer to higher grades of membership :—

Summary of Proposals for Election, 1945/6

| | Members | Associate Members | Associates | Companions | Graduates | Students | Total |
|-------------|---------|-------------------|------------|------------|-----------|----------|-------|
| Received .. | 28 | 116 | 149 | 5 | 6 | 287 | 591 |
| Accepted .. | 10 | 65 | 145 | 4 | 4 | 287 | 515 |

Summary of Proposals for Transfer, 1945/6

| | Associate Member to Member | Associate to Member | Associate to Associate Member | Associate to Companion | Graduate to Associate Member | Graduate to Associate | Student to Associate Member | Student to Associate | Student to Companion | Student to Graduate | Total |
|----------|----------------------------|---------------------|-------------------------------|------------------------|------------------------------|-----------------------|-----------------------------|----------------------|----------------------|---------------------|-------|
| Received | 16 | 1 | 39 | 1 | 1 | 2 | 13 | 38 | 1 | 16 | 128 |
| Accepted | 7 | 1 | 25 | 1 | — | 3 | 3 | 40 | 1 | 17 | 98 |

N.B.—The figures relating to accepted proposals include elections for an alternative grade of membership to that applied for by a number of applicants.

Transfers.—The fifty per cent. increase over last year's figures both in proposals received and proposals accepted is an illustration of the growth of the Institution; henceforward, there should be a similar or even greater increase as younger members qualify for transfer to higher grades of membership. In such comparatively young Institutions as our own, the value and future strength of membership does, of course, lie in the quality of its younger membership.

Membership Overseas.—Proposals are now being received from countries which had been overrun by the enemy, whilst the number of enquiries for details of membership and examination are now as numerous as before the war. These comments particularly apply to countries of the British Empire and Commonwealth and are really a tribute to the wartime supremacy of the British radio engineer. The Committee is now also receiving a number of applications for reinstatement of those members who, because of war conditions, were unable to keep contact with the Institution.

The Council also wishes, under this heading, to express its pleasure of having been able, during the past 12 months, to welcome at Institution meetings many overseas members who have visited this country, including many representatives of the Australian Institution of Radio Engineers. A Vice-President of the Australian Institution had the opportunity to discuss a number of matters with members of the General Council. All these discussions will be of great help in developing the plans which the Council has made for greater activity for the benefit of those members not normally resident in Great Britain.

Honours Conferred on Members.—Notices in each of the Journals published during the year have recorded many Honours and Distinctions conferred on members during the twelve months under review.

Conclusion.—The Committee has been pleased to be able to resume publication, although under difficult circumstances, of the Year Book and List of Members, which gives up-to-date details of the membership. Offsetting the net increase, during the year, of 515 members of all grades, the Committee regrets the loss of 73 members due to deaths (recorded in the various Journals), resignations and expulsions; 45 removals from the registers were Students who were unable

to continue complying with the regulations governing their registration.

There seems little doubt that in the first full year of peace there will be an even greater increase in membership than the 442 which the Committee is able to report for the year 1945/46.

EDUCATION AND EXAMINATIONS

It is satisfactory to note that the Graduateship Examination continues to attract more candidates each year. The results of the May and November 1945 examinations have been published in various issues of the Journal.* Two hundred and sixty-one candidates entered for the examination during the year, but the arrangements made for some candidates, including prisoners of war, had to be postponed. Thirty-four per cent. of the candidates who entered for the entire examination succeeded in all subjects and of the remainder, 71 per cent. satisfied the examiners in part(s) only of the examination.

The experience of the Institution in conducting examinations over the past 15 years very much confirms the oft expressed opinion that there is a great lack of facilities available for those who wish to make a thorough study of radio engineering. The knowledge required to ensure the development and advancement of radio science should be made as freely available in peace time as was the urgent necessity of war time. Examination results show that there are a number of excellent colleges able and willing to provide a suitable curriculum for those who wish to study radio engineering, but there are far too few of these technical institutes. It is, indeed, truly stated in the Radio Industry Council report that making men is always harder than making goods.

A well-earned compliment to the Radio Industry Council is the fact that the radio industry was the first which, during the war, pioneered the method of supplying technically trained personnel, originally leading to the appointment of the Government Wireless Personnel Joint Subcommittee and the arrangements which were subsequently made at the universities and technical colleges. This experience alone fully justified the comments made in the Institution's Post-War Development Report (Part 2).

It is worthy of comment that the value of the special war-time courses has been reflected in the

* June/Sept., 1945; Jan./Feb., 1946; June/July, 1946.

better percentages of candidates satisfying the Institution's examiners; the Council is still advocating the recommendations made in the Post-War Report without, however, asking for the introduction of early specialisation into the junior courses—a criticism which has sometimes been made by those who have not thoroughly studied the 1944 report.

Examination Centres.—Thanks are again extended to the Universities and technical colleges both at home and throughout the British Empire and Commonwealth, to the Colonial Office, to the British Council, the Admiralty, the War Office and the Air Ministry authorities, for again providing facilities for the examinations.

Representation on Other Committees.—The Institution continues to be represented on the City and Guilds of London Institute Advisory Committees for Telecommunications and Radio Service Work.

The Advisory Committee on Telecommunications has, during the 12 months under review, been concerned with examining the separately grouped courses in Telephony, Telegraphy and Radio Communication, which have been in existence since 1930. Under that scheme, the selection of specialist subjects will not occur until the second and later years of the course; the present draft of the new Telecommunications Engineering group courses introduces Principles of Telecommunication and Telecommunications Practice in the first year, and then, as before, the candidate may specialise in Radio (Grade 1) in the second year, proceeding to Radio (Grade 2) in the third year, ending in the fifth year with a new Grade 4 examination in Radio, which is a more specialised paper than has hitherto been possible in the scope of the Grade 3 examination.

The draft of this Telecommunications Engineering course is being completed during the current year (1946), but the Council will very shortly be issuing a revised regulation in regard to exemption from the examination of candidates who have taken the City and Guilds Examinations. It is not, therefore, appropriate at this juncture to make further comment except to state that the new Grade 4 course in Radio is very akin to the draft syllabus given in the Post-war Report.*

In connection with the City and Guilds Advisory Committee on Radio Service Work, the Council is pleased to record the arrangement which has now been made for the Radio Trades Examination Board and the City and Guilds of London Institute to co-operate in holding a joint examination in Radio Service Work.

Reference to the 1942/3 Annual Report shows how the Radio Trades Examination Board was first formed, and now that the Board and the City and Guilds of London Institute have agreed to hold a joint examination, there is, in effect a single and national certificate examination for radio service mechanics.

Council wishes to express appreciation for the continuous services which have been given during the past three years to the Radio Trades Examination Board by Mr. S. A. Hurren (Past President) and other members of the Institution who have served on the Board, as well as the Examinations Committee of the R.T.E.B.

Revisions in Syllabus and Regulations.—The Committee has had discussions with the appropriate departments of the Admiralty, the War Office and the Air Ministry regarding the post-war technical training schemes of the three Services.

The arrangements made with the Admiralty regarding exemption from the Institution's Graduateship Examination of officers who have taken certain technical courses have already been announced in the Journal.

The Committee has also received applications from a number of technical colleges requesting exemption of candidates who have completed the college's own interpretation of the existing National Certificate scheme. All of these applications have, of course, been left in abeyance pending the final decision to be taken by the Ministry of Education. The Council has, however, accepted the recommendations of the Committee on the application made by the Union of South Africa (Education Department) regarding the South African national certificates in radio science.

It is expected that during the next twelve months the Committee will be able to make recommendations to Council regarding further revisions in the list of examinations and courses which are recognised for the purpose of obtaining exemption. The Committee has very much appreciated the way in which representatives of

* Page 158, Brit. I.R.E. Jnl. (Vol. 4—new series).

the three Services have received suggestions made by the Institution.

Technical Books.—Council is now examining proposals put forward by the Committee on the co-operation which the Institution might afford to publishers of technical books, as well as to the authors in stimulating the publication of reliable British works of reference. Several members have been assisted under this scheme which is, of course, mutually beneficial to the publisher and to the British radio engineer, as well as to students of radio science.

Finally, the Council again expresses thanks to the Committee, and to the panel of examiners who have assisted so ably in this important part of the Institution's work.

PROGRAMME AND PAPERS COMMITTEE

During the 12 months ended March 31st, 1946, 45 general meetings were held in Great Britain by the London and Provincial Sections. This shows an increase on the number of monthly meetings held during the previous 12 months, and there will undoubtedly be a greater increase during the next 12 months, covering the first full year of peace.

Thanks are again expressed to the Institution of Structural Engineers for their continued courtesy in making available the I.Struct.E. Lecture Theatre for the holding of London Section meetings, and to the authorities of Neville Hall, Newcastle, the University of Birmingham and the Birmingham Chamber of Commerce, the Liverpool University, the Manchester College of Technology, the Institution of Engineers of Glasgow, and the Heriot Watt College, Edinburgh, for their help in providing accommodation for meetings of the other Sections.

Notices of meetings and frequently a report of the proceedings have been given in *The Wireless Engineer*, *Electronic Engineering*, *The Wireless World*, *The Wireless Trader*, and *Radio and Electrical Marketing*, as well as in a number of technical and other journals overseas, and the Council expresses thanks to the various editors for their co-operation.

Premiums.—As will be seen from the accounts, the Council has been able to consolidate the Dr. Norman Partridge Memorial Fund, the interest on which will enable a Premium to be awarded annually in the name of Dr. Norman Partridge.

The Institution is also now in the position of being able to honour the names of Clerk Maxwell, Heinrich Hertz, and Senatore Marconi. Details of Premiums bearing these names are given on page 15 of the Year Book and the Committee looks forward to making recommendations for the first awards during 1946/7.

Papers.—In addition to the papers read before the various Sections, several papers were accepted for publication in the Institution's Journal. All papers have, of course, involved the Committee in careful examination of manuscripts and in preparation of detailed and analytical criticisms.

In the latter connection, it must be noted that it is one of the basic objects of the Institution to disseminate knowledge, to survey the art of radio, and to put on record progress, analysis, and survey of this branch of engineering. It should be regarded as a privilege of membership to contribute, whenever possible, to this dissemination of knowledge; in view of certain papers received by the Committee during the past year, but not accepted for publication, it is desirable to point out that the factors of originality and analysis are essential to the acceptance of any paper. The Institution's objective would not be reached by relying upon, or accepting material already well known and, perhaps, published elsewhere.

For some of the period under review, secrecy restrictions were, of course, still in force, but co-operation has always been given by manufacturers and Government Departments in enabling papers to be read by members of their staffs, for which courtesy the Council is grateful. A noticeable trend in the papers submitted is that emphasis is laid more on electronic and industrial engineering, rather than on actual communication problems. This may be due to war-time restrictions, and the Committee hopes to be able to achieve a better balance during the next year.

Papers suitable for presentation at the Section meetings and at the conference to be held in May, 1947, are still desired. It is hoped that members will co-operate in submitting papers of appropriate standard which will be of value to the membership.

The development of new ideas and methods and any other important developments should be discussed by professional Institutions, and the importance of co-operating in this way cannot be over-stated. With a view to stimulating the flow of papers which is required, the Committee will

shortly be writing to every member of the Institution, and all members are asked to return the questionnaire as quickly as possible.

Local Sections.—Towards the latter part of the year, there was evidence of a return to the pre-war activity of the Local Sections, and for the next session all five Sections have arranged to resume regular monthly meetings. It was emphasised in the last Annual Report that the success of the Provincial Sections during the first peace years would depend very largely upon the energy of the local Section Committees; these Committees have, in the main, already given great satisfaction to the Council by the energy with which they have tackled resumption of their normal activities.

Some Sections were able to arrange social functions, and although these were necessarily modest affairs, they afforded a very much desired opportunity for members to meet under informal conditions. On many of these occasions, the President and other officers were able to be present. One result of these visits is referred to in an earlier part of this report, dealing with the annual meeting of Chairmen of local Sections.

Mathematical Group.—In view of the success of the Symposium of Mathematical Methods for Radio Engineers, held in London, the Council has accepted the recommendation that during the next 12 months a mathematical group of the Institution be formed for the purpose of having informal discussion meetings on mathematical problems of direct concern to the radio engineer. A further notice on this subject will be sent to all members during the early part of next session.

Finally, the Committee has been very pleased to receive a few papers from members resident outside Great Britain. Whilst it has not been possible to accept these papers for publication in the Institution's Journal, the trend will be encouraged, and it is hoped that members overseas will, whenever possible, contribute papers suitable for publication in the main Journal.

Students and Graduates Section.—Conscription may still affect the resuscitation of the Graduates and Students Sections of the Institution, but the Council is anxious that such Sections should be formed again as soon as possible and it is proposed to form, first of all in London, a Students and Graduates Section with a view to exploring the possibilities of recommencing meetings for Graduates and Students in all Sections and also publishing a Students Journal.

Co-operation with other Institutions.—The Institution continues to have reciprocal arrangements with the Institution of Radio Engineers of Australia and has very friendly relationship too with the Engineering Institute of Canada.

In recent months, the Council has had an opportunity of discussing with overseas members development of the Institution's activities abroad, particularly in New Zealand. The Council is anxious to form Sections of the Institution in all the countries of the British Commonwealth and further information on this development will be published in the Journal from time to time.

Lastly, the year in question has seen, once again, the resumption of the pleasant practice of the Sections holding their annual dinners. Council is now arranging for an Institution dinner this year and the first national function of this character will be held on October 31st, 1946—a date which exactly marks the 21st Anniversary of the first meeting of the Institution. This reunion of members, many of whom have been serving with the Royal Navy, Army, Royal Air Force and Civil Defence Services, will be an attractive festival, at which members will celebrate victory and give thanks to all who have played their part in this great achievement.

TECHNICAL COMMITTEE

The main report published by the Committee during the past 12 months was the report on Aerial and Earth Facilities for the Reception of Sound Broadcasting in Prefabricated Houses.*

In surveying the problem and conducting random tests, the Ministry of Works gave every facility for viewing various types of prefabricated houses, and the Council expresses appreciation for co-operation thus given. Copies of the report were requested by engineers other than members of the Institution and by a number of authorities and contractors engaged in erecting prefabricated houses. The report had a circulation, outside the membership of the Institution, of over 2,000 copies and was the very first of its kind published by the Institution on what might be termed codes of practice. The success attending publication of the report will justify the Committee issuing further reports of this character. For example, television reception

* The report and the Committee's terms of reference were published in the December 1945 Journal (Page 224, Vol. 5—new series).

installation affords special problems, particularly in connection with installation in prefabricated houses.

Radio Interference.—The subject of limitation of radio interference has also concerned the Committee, and recommendations have been made to the Council, through the Parliamentary Committee, on the possibility of pressing for legislation, in company with other bodies who are interested in this subject, including the British Standards Institution, on whose Committee on radio interference there is an Institution representative.

Allocation of Radio Frequencies.—In the last Annual Report, reference was made to the importance of early settlement of the post-war allocation of radio frequencies. The Committee was favoured by an early draft of the report published by the Radio Industry Council on Post-War European Broadcasting. By agreement with the Radio Industry Council, their report was widely circulated amongst the membership prior to the holding of five Section meetings at which the report was discussed. An account of these meetings appears on pages 33 and onwards of the present volume of the Journal (Volume 6—new series).

The complexity of the political problems involved made compilation of the R.I.C. report a most difficult matter and the Council appreciated the opportunity afforded to add the views of the Institution to such constructive proposals.

Report of the Television Committee.—During the 12 months under review, the report of the 1943 Committee was published. Reference to the 1943/4 Annual Report of the Council* shows that during that year the Committee responded to an invitation of the Chairman of the Television Committee, the Rt. Hon. Lord Hankey, to submit evidence and recommendations. Those recommendations were, in fact, included in the Post-War Report (Part 1), a copy of which was also sent to the Television Advisory Committee. The report of the Television Committee and the Post-War Report of the Institution provide very interesting comparison, particularly in relation to the comments made by the Institution in the proposal for the formation of a British Radio Research Institute.

The extension to the provinces of a television service is of major interest to the membership of

the Institution, and during the next session the Papers Committee has arranged for papers to be read in the provincial Sections dealing with television services in the provinces.

Future Reports.—The Committee submitted to the General Council several proposals regarding the subject matter of reports and the Council appointed in December a special Sub-Committee for the purpose of making a first draft on the present state of the miniaturisation of valves and other radio components, their use and possible applications. This Sub-Committee has been assisted by contributions submitted by several members and the Ministry of Supply has provided facilities for the Committee to visit special Government Establishments where particularly useful data has been obtained.

The Committee hopes to issue its report before the commencement of the next session of the Institution.

Representation on other Technical Committees.—The Institution continues to maintain close contact with the British Standards Institution, particularly by representation on all the B.S.I. Committees concerned with radio practice. The B.S.I. is to be congratulated on having kept abreast of the work of these various Committees throughout the period of hostilities, and it should soon be possible for several reports to be published which will be of major interest to the membership, particularly the report upon which Sub-Committee E.L./9/5 has been engaged for the last three years. The importance of clear definitions in radio nomenclature and symbols has never been made more apparent than at the present time.

Finally, the Committee wishes to place on record its particular appreciation of the services given by Mr. P. Adorian, who served as Chairman of the Committee for two of the most difficult years of the war.

PARLIAMENTARY COMMITTEE

Again the main work of this Committee has been to co-operate in the work of the Parliamentary and Scientific Committee. Under the ægis of this latter Committee, members of both Houses of Parliament have met and discussed with representatives of technical institutions major matters affecting the advancement of science in a number of branches, as well as the whole subject of research including the formation and development of research associations.

* Page 170, Brit. I.R.E. Jnl. (Vol. 4—new series).

Nearly all the major engineering Institutions are represented on the Parliamentary and Scientific Committee and the Institution's representatives have also served the Parliamentary and Scientific Committee on several panels and deputations.

In other matters affecting the Institution, the Committee has emphasised the desirability of a separate Charter Committee being established, the Chairman of which should be an ex-officio member of the General Council. The importance of such a step is self-apparent and will, it is hoped, meet with the approval of the membership.

FINANCE COMMITTEE

The accounts of the Institution are appended to this report. The Committee is pleased to be able to present such a satisfactory account showing clearly how well the Institution has been able to surmount the financial difficulties to be expected in the first 21 years, growth of any Institution.

The beginning of the war very naturally affected the Institution's finances, but even this problem has been overcome and the accounts now presented show a further increase in the excess of income over expenditure.

A particularly happy feature is the increase, exceeding £1,500, in subscriptions received. This is accounted for by the increase in membership, as well as the reinstatement in full subscription of a number of members. In respect of every other source of income, there was a similar percentage of increase, with the exception of donations, and here again the Council wishes to express deep appreciation to various manufacturers who have again subscribed to the general fund of the Institution and who have, by their support in the war years, enabled the Institution to overcome war-time financial problems.

The increase in expenditure during the year is reflected in the increased activities of the Institution, necessitating additional staff which

the Institution has been able to obtain since the cessation of hostilities.

In accordance with a suggestion made at the last Annual General Meeting, it will be noted that the Committee has not included in the Income and Expenditure Account arrears of subscriptions which have not been recovered and which have been written off.

BENEVOLENT FUND

The accounts of the Benevolent Fund continue to be satisfactory, and although in the 12 months under review no application was received for assistance, several applications have been made during the first few months of the 1946/7 year.

Such applications impel the Council to advocate continued and even greater support of the Benevolent Fund so that it may never be necessary to deny assistance to members in distress, or to widows and orphans of deceased members.

The Trustees greatly value the contributions made by so many members, a number of whom have now covenanted to subscribe for seven years; in addition, contributions have been made by manufacturers and this help is greatly appreciated.

GENERAL

Reports of this character can only summarise the main work of the Institution. Throughout the whole year there has been need for much work by all members of Council and Committees and the membership will wish especially to thank those six members of Council who must now, under the Articles, retire from the Council. In their place, the Council has already nominated other members and further nominations may, of course, be made by the membership.

Already a great deal has been accomplished in the 1946/7 year of the Institution and the entire membership looks forward to a most successful year to mark the 21st anniversary of the Institution, under the Presidency of Admiral The Viscount Mountbatten of Burma.

GENERAL ACCOUNT FOR THE YEAR ENDED 31st MARCH, 1946

| <i>EXPENDITURE</i> | £ | s. | d. | £ | s. | d. |
|--|-------|----|----|--------|----|----|
| To Examination Expenses, including | | | | | | |
| Printing of Examination Papers | 170 | 16 | 9 | | | |
| „ Printing of Proceedings, Reports, etc., <i>less</i> Advertising Receipts .. | 57 | 10 | 2 | | | |
| „ Printing of Regulations | 162 | 1 | 0 | | | |
| „ Salaries and State Insurance .. | 2,307 | 17 | 4 | | | |
| „ Postage and Telephone | 367 | 13 | 2 | | | |
| „ Rent, Rates, Light, Heat and Insurance | 568 | 19 | 9 | | | |
| „ Printing, Stationery and Certificates | 320 | 14 | 11 | | | |
| „ Secretary's, Delegates and Members' Meeting Expenses | 1,084 | 0 | 11 | | | |
| „ Legal Fees | 116 | 16 | 0 | | | |
| „ Audit and Accountancy Fees .. | 26 | 5 | 0 | | | |
| „ Bank Charges and Cheque Books .. | 14 | 11 | 0 | | | |
| „ Subscriptions to Outside Institutions | 52 | 18 | 6 | | | |
| „ Repairs to Premises | 213 | 10 | 3 | | | |
| „ Sundry Expenses | 131 | 18 | 2 | | | |
| | | | | 5,595 | 12 | 11 |
| „ Depreciation, viz :— | | | | | | |
| Office Furniture and Fittings .. | 106 | 10 | 1 | | | |
| Library | 32 | 18 | 2 | | | |
| | | | | 139 | 8 | 3 |
| „ Balance being excess of Income over Expenditure carried to Reserve Account | | | | 815 | 1 | 5 |
| | | | | £6,550 | 2 | 7 |

| <i>INCOME</i> | £ | s. | d. |
|---|-------|--------|-----|
| By Subscriptions, including arrears | 4,239 | 15 | 1 |
| „ Sundry Donations | 594 | 1 | 9 |
| „ Examination and Exemption Fees | 589 | 19 | 11 |
| „ Entrance and Transfer Fees | 600 | 14 | 0 |
| „ Sale of Examination Papers, Reprints and Journal | 388 | 5 | 3 |
| „ Radio Trades Examination Board for proportion of expenses chargeable | 135 | 1 | 0 |
| „ Interest on Investment | 2 | 5 | 7 |
| | | | |
| | | £6,550 | 2 7 |

BALANCE SHEET AS AT THE 31st MARCH, 1946

| <i>LIABILITIES</i> | | | | <i>ASSETS</i> | | | |
|---|-----|----|----|---------------|----|----|---|
| | £ | s. | d. | £ | s. | d. | |
| <i>Sundry Creditors</i> | | | | 388 | 15 | 2 | <i>Office Furniture and Fittings</i> as at 1st April, 1945 |
| <i>Subscriptions and Examination Fees</i> in Advance | | | | 747 | 3 | 11 | 748 12 8 |
| <i>Prize Fund</i> :— | | | | | | | <i>Additions</i> during year |
| Balance at 1st April, 1945 .. | 22 | 3 | 6 | | | | 1,065 3 1 |
| <i>Less</i> Awards during year .. | 13 | 0 | 6 | | | | <i>Less</i> Depreciation for Year .. |
| | | | | 9 | 3 | 0 | 106 10 1 |
| <i>Library Reserve Account</i> | | | | 500 | 0 | 0 | <i>The Louis Sterling Library</i> as at 1st April, 1945 |
| <i>Reserve Account</i> :— | | | | | | | 268 18 8 |
| Balance as at 1st April, 1945 | | | | | | | <i>Additions</i> during year |
| <i>Debit</i> | 65 | 19 | 7 | | | | 55 1 6 |
| Transfer of Building Fund Reserve Account as at 1st April, 1945 | 185 | 7 | 8 | | | | <i>Less</i> Depreciation for Year .. |
| | | | | 119 | 8 | 1 | 324 0 2 |
| <i>Less</i> Donations to Dr. Norman Partridge Memorial Fund .. | 72 | 14 | 0 | | | | 32 18 2 |
| | | | | | | | |
| | | | | | | | 291 2 0 |
| | | | | | | | <i>Investments at cost</i> —£200 3 per cent. Defence Bonds |
| <i>Add</i> Excess of Income over Expenditure for Year .. | 815 | 1 | 5 | | | | 200 0 0 |
| | | | | | | | <i>Stock of Stationery, Journals and Examination Papers</i> at cost |
| | | | | 861 | 15 | 6 | 524 15 0 |
| | | | | | | | <i>Sundry Debtors</i> , including Subscriptions in arrears |
| | | | | £2,506 | 17 | 7 | 398 14 1 |
| | | | | | | | <i>Cash</i> —At Bank |
| | | | | | | | 131 7 4 |
| | | | | | | | <i>In Hand</i> |
| | | | | | | | 2 6 2 |
| | | | | | | | 133 13 6 |
| | | | | | | | £2,506 17 7 |

We have audited the above written balance sheet dated 31st March, 1946. We have received all the information and explanations which we have required and have satisfied ourselves as to their accuracy. In our opinion the Balance Sheet referred to herein is properly drawn up and contains a full, true and accurate statement of the Institution's affairs according to the best of our judgement on the information and explanations given to us and the facts shown by the books of the Institution.

2nd July, 1946.
74 Victoria Street, London, S.W.1.

GLADSTONE TITLEY & CO.,
Chartered Accountants.

J. W. RIDGEWAY (*Chairman, Finance Committee*).
S. R. CHAPMAN (*Treasurer*).
G. D. CLIFFORD (*General Secretary*).

THE PRESIDENT'S PRIZE FUND
INCOME ACCOUNT FOR THE YEAR ENDED 31st MARCH, 1946

| 1946 | | £ | s. | d. | 1946 | | £ | s. | d. |
|-----------|-----------------------------|---|----|------------|------|-----------|---|----|------------|
| Mar. 31st | To Awards | | | 15 | | Mar. 31st | | | 3 |
| | „ Balance being Surplus for | | | 19 | | | | | 0 |
| | Year carried to Reserve | | | 6 | | | | | 0 |
| | Account | | | 37 | | | | | 50 |
| | | | | 0 | | | | | 0 |
| | | | | <u>£53</u> | | | | | <u>£53</u> |
| | | | | 0 | | | | | 0 |

BALANCE SHEET AS AT 31st MARCH, 1946

| <i>LIABILITIES</i> | | | | <i>ASSETS</i> | | | | | |
|----------------------------------|-----|---|----|---------------|------------------------------------|-----|---|----|-------------|
| | | £ | s. | d. | | | £ | s. | d. |
| <i>Reserve Account :—</i> | | | | | <i>Investments at Cost :—</i> | | | | |
| As at 1st April, 1945 .. | 200 | 0 | 0 | | £200 3 per cent. Savings | | | | |
| Add Surplus for Year .. | 37 | 0 | 6 | | Bonds | 200 | 0 | 0 | |
| | | | | | £50 3 per cent. Defence | | | | |
| | | | | | Bonds | 50 | 0 | 0 | |
| <i>Due to General Account ..</i> | | | | 237 | | | | | 250 |
| | | | | 0 | <i>Due from Benevolent Fund ..</i> | | | | 1 |
| | | | | 14 | | | | | 10 |
| | | | | 9 | | | | | 0 |
| | | | | <u>£251</u> | | | | | <u>£251</u> |
| | | | | 10 | | | | | 0 |
| | | | | 0 | | | | | 0 |

DR. NORMAN PARTRIDGE MEMORIAL FUND
INCOME ACCOUNT FOR THE YEAR ENDED 31st MARCH, 1946

| 1946 | | £ | s. | d. | 1946 | | £ | s. | d. |
|------------|------------------------------|---|----|-----------|-----------|------------------------------|---|----|-----------|
| Mar. 31st. | To Balance being Surplus for | | | | Mar. 31st | By Interest Received | | | |
| | Year carried to Reserve | | | | | | | | 2 |
| | Account | | | 2 | | | | | 5 |
| | | | | 5 | | | | | 7 |
| | | | | 7 | | | | | 7 |
| | | | | <u>£2</u> | | | | | <u>£2</u> |
| | | | | 5 | | | | | 7 |
| | | | | 7 | | | | | 7 |

BALANCE SHEET AS AT 31st MARCH, 1946

| <i>LIABILITIES</i> | | | | <i>ASSETS</i> | | | | | |
|---------------------------------------|-----|----|----|---------------|---|-----|---|----|-------------|
| | | £ | s. | d. | | | £ | s. | d. |
| <i>Reserve Account :—</i> | | | | | <i>Investments at Cost :—</i> | | | | |
| Balance as at 1st April, 1945 | 126 | 16 | 0 | | £200 3 per cent. Defence Bonds .. | 200 | 0 | 0 | |
| Add Donation from | | | | | <i>Due from Benevolent Fund</i> | | | | 2 |
| General Account .. | 72 | 14 | 0 | | | | | | 5 |
| Add Surplus for Year .. | 2 | 5 | 7 | | | | | | 7 |
| | | | | | | | | | <u>£202</u> |
| <i>Due to General Account ..</i> | | | | 201 | | | | | <u>5</u> |
| | | | | 15 | | | | | 7 |
| | | | | 0 | | | | | 7 |
| | | | | <u>£202</u> | | | | | <u>£202</u> |
| | | | | 5 | | | | | 7 |
| | | | | 7 | | | | | 7 |

We have audited the foregoing Balance Sheets dated 31st March, 1946, in respect of the President's Prize Fund and the Dr. Norman Partridge Memorial Fund. We have received all the information and explanations we have required, and in our opinion the Balance Sheets represent the true and accurate state of the funds.

GLADSTONE TITLEY & CO.,
Chartered Accountants.

2nd July, 1946.
 74 Victoria Street, London, S.W.1.

LESLIE McMICHAEL (*President*)
 J. W. RIDGEWAY (*Chairman, Finance Committee*)

GRADUATESHIP EXAMINATION

PASS LIST—MAY, 1946 (First List only)

129 candidates entered for examination, compared with 122 candidates who wrote the November, 1945, examination.

A subsequent Pass List will be published after scripts from overseas centres have been examined.

Passed entire Examination

The following list includes candidates who are exempt from, or who have previously passed, part of the examination and who have now passed the remaining subjects.

| | |
|--|----------------|
| CARVILLE, William Willett | London, N. 17 |
| CAVE, Sidney Robert | Romford |
| COOPER, Wallace | London, N.4. |
| DEAN, Kenneth John | Croydon |
| FIDLER, George Harcourt | Ashford, Mddx. |
| GEARING, George Douglas | Leeds |
| HODGES, Hugh Walter Charles | Chilton Polden |
| HUPPLER, Desmond | Henley |
| KRAICER, Alec | London, N.W.3 |
| MAUNSELL, Thomas | Tralee |
| MORLEY, Gilbert | Manchester |
| MORRIS, Gordon William | Penrith |
| O'NEILL, Daniel | Co. Dublin |
| O'RORKE, Arthur Breffne | Co. Dublin |
| OSBORNE, Basil Whitworth | Bournemouth |
| PICKERING, William Stuart Frederick | Surbiton |
| READ, Geoffrey Leonard | Hayes, Mddx. |
| REDMOND, James | London, N.3 |
| SANYAL, Gitindra Saran | Chelmsford |
| STAUNTON, Eric Douglas | Orpington |
| STULAND, Tor | Norway |
| SUGDEN, Stuart Morton | Liverpool |
| TEER, Cyril Arthur, B.Sc. | Portland |
| WALLWORK, Allan | Accrington |
| WILCOX, William John | Ebbw Vale |

Passed Parts 2, 3 and 4

| | |
|--------------------------|---------------|
| NAWIESNIAK, Jau Augustyn | London, N.19 |
| OKE, Domingo | London, W.C.2 |

Passed Parts 3 and 4

| | |
|-------------------|------------|
| SMITH, Roy Edward | Portsmouth |
|-------------------|------------|

Passed Parts 2 and 3

| | |
|-------------------------|---------------|
| BROADBERRY, Noel Edward | Dublin |
| GILL, Own John | London, W.4 |
| GREEN, Arthur Eric | Liverpool |
| HEISLER, George Henry | London, N.W.6 |
| JARDINE, William | Chislehurst |
| MILLETT, David Trevor | Birmingham |

| | |
|--------------------------|--------------|
| O'HIGGINS, Colm | Dublin |
| PATRICK, George Benjamin | Birmingham |
| TAAFFE, Peter Albert | London, N.10 |

Passed Parts 1, 2 and 3

| | |
|-----------------|------------------|
| HOLDEN, Stanley | Westcliff-on-Sea |
|-----------------|------------------|

Passed Part 3

| | |
|------------------------------------|---------------|
| ARMSTRONG, James Patrick | Dublin |
| BAKER, Ransome Charles Lawrence | Mitcham |
| D'ARCY, Joseph Edward | Dublin |
| HANCOCK, Robert Philip | Oxshott |
| HAUGHEY, Patrick Joseph | Portarlington |
| O'SULLIVAN, James Patrick | Co. Kerry |
| PITENDRIGH, Lewis Walter Duff | Great Malvern |
| PLANT, Victor Ernest | London, E.17 |
| POWELL-TOWNEND, Herbert | Hereford |
| SHACKLE, George Edward | Bolton |
| SMITH, Frederick George | Bristol |
| STERNKUKER, Juda | London, W.2 |
| WATSON, George Ernest | Ipswich |

Passed 1 and 2 only

| | |
|-------------------------|--------------|
| FIDDYMENT, John Russell | Leatherhead |
| HELM, Frank | Harrogate |
| MEEK, Charles | Glasgow |
| WARD, Douglas Arthur | London, N.10 |

Passed Part 2 only

| | |
|---------------------------|----------------|
| CADOGAN, Alexander Joseph | London, S.W.11 |
| MURTAGH, Patrick Joseph | Co. Cavan |
| PERRY, John | Blandford |

Passed Part 1 only

| | |
|------------------------------------|---------------|
| DOWLING, Patrick Joseph | Dublin |
| GARD, Ronald Lionel | Swansea |
| HODGSON, Alfred Ernest Musgrove | York |
| MICHIE, Joseph Lawrence | Skelmersdale |
| MONAHAN, Leo Joseph | Dublin |
| MOTT, Richard John | London, N.12 |
| PARNABY, Leonard Gretton | Hull |
| ROOME, Eric Howard Vernon | Plymouth |
| ZYMANSKI, Roman | Wolverhampton |

RECEIVER AERIAL COUPLINGS FOR MEDIUM WAVELENGTHS

by

S. W. Amos, B.Sc.(Hons.), (Associate Member)*

(A paper read before the Midland Section of the Institution on February 20th, 1946, the North-Western Section on March 26th, 1946, and the London Section on May 20th, 1946)

SUMMARY

The paper discusses the electrical nature of an outdoor aerial at medium wave frequencies and the problems which arise when such a generator has to be coupled to a tuned circuit as occurs in the aerial input circuit of a receiver. It is shown that those two desirable features, high voltage transfer and high selectivity, are mutually conflicting and that the kind of coupling circuit which favours one, necessarily gives a poor performance with respect to the other, so that a compromise solution has to be adopted in practice. Another point to be considered, when choosing a circuit for aerial coupling purposes, is the capacitance reflected into the tuning circuit; ideally, to permit accurate ganging, this should be constant and independent of frequency but in practice it may vary considerably, depending on the nature and constants of the circuit used. Three simple types of coupling circuit are analysed, namely, by means of mutual inductance, series capacitance and shunt capacitance, and graphs are given illustrating their performance with respect to voltage gain, selectivity and reflected capacitance. The paper ends with two appendices, one devoted to a detailed mathematical analysis of mutual inductance coupling, and the other to a summary of the principal formulæ derived in the text.

The Nature of the Problem

When an aerial-earth system is connected to the aerial and earth terminals of a receiver, a generator is connected to a load. Any aerial-earth system may be represented as a generator of modulated R.F. power, as pictured in Figs. 1 (a) and (b), its internal impedance being a complex quantity as suggested in the figure.

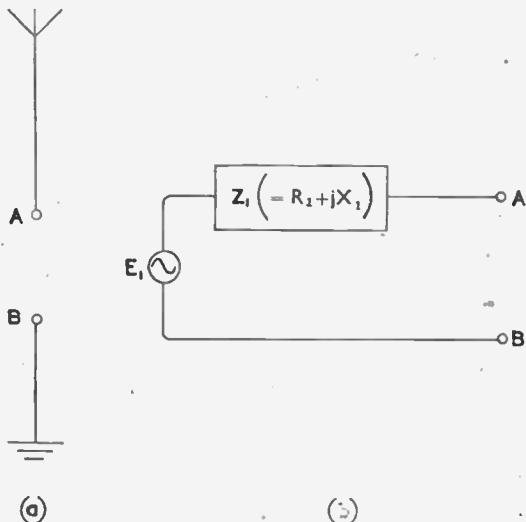

Fig. 1. An Aerial-Earth System (a) and its Equivalent Generator (b)

Similarly, the input to a receiver, measured between the aerial-earth terminals, may also be a complex quantity. Essentially then, we are connecting two complex impedances together, and if we were only

concerned with power transfer at one frequency, and if the problem were one of arranging for maximum power transfer from generator to load, then the solution would be simply to make the impedances conjugate, i.e., to make

$$R_1 = R_2 \text{ and } X_1 = -X_2$$

In this the receiver input impedances, Z_2 , is assumed to be given by $Z_2 = R_2 + jX_2$. Unfortunately in receiver aerial couplings we are not interested in one frequency only but in a range of frequency that may be quite wide, although in this paper we have focused our attention on the medium wave range of 550-1,500 kc/s only. Over this frequency range the impedance-frequency characteristic of an outdoor aerial is very similar to that of a series circuit of inductance, capacitance and resistance, and typical values of L_1 , C_1 and R_1 are given in Fig. 2.

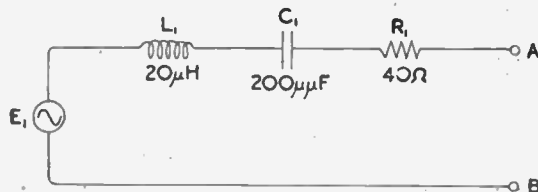

Fig. 2. The Impedance-frequency Characteristic of a typical Outdoor Aerial is similar to that of the Series Tuned Circuit illustrated above

The value of E_1 in this diagram is given by the product of the field strength of the transmitter and the effective height of the aerial. The impedance-frequency characteristic for the values of L_1 , C_1 and R_1 given in Fig. 2 is plotted in Fig. 3. From this the value of Z_1 is seen to decrease with increase of frequency. This is because the wave range of 550-1,500 kc/s is below the resonant frequency of

* The British Broadcasting Corporation

the circuit L_1C_1 (approximately 2.5 Mc/s). Hence the aerial generator impedance is capacitive in nature over the wave range in which we are interested, and we should not be making a very great error in impedance if we neglected the inductive term completely and assumed the aerial impedance to be composed of C_1 and R_1 only. This is borne out by the dotted curve in Fig. 3 which is the impedance-frequency curve for a capacitance of $200 \mu\mu\text{F}$ in series with a resistance of 40 ohms. Throughout this paper the equivalent aerial generator impedance will be regarded as being thus composed of capacitance and resistance only.

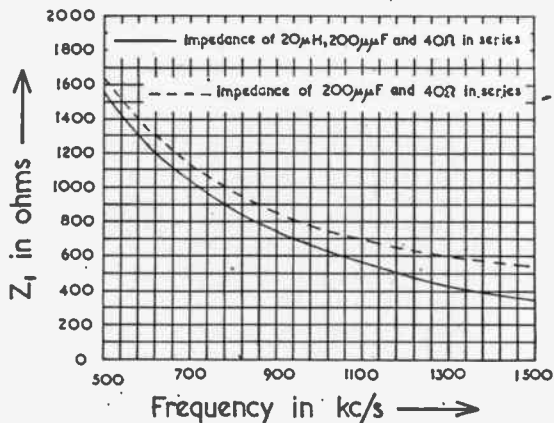

Fig. 3. The Impedance-frequency Characteristic of Two Types of Aerial Generator

Results Desired from an Aerial-Coupling Circuit

A question that was left unanswered above is whether we want an aerial coupling circuit to deliver maximum power into the first tuned circuit of the receiver or not. Now at a given frequency the R.F. resistance of a tuned circuit is fixed, and accordingly if the aerial coupling circuit is arranged to deliver maximum power into it, this condition will also be the same as that for obtaining maximum potential difference across the tuned circuit. Certainly it is a good thing to have a high voltage transfer from aerial to tuned circuit, but unfortunately voltage transfer is not the only thing with which we are concerned in aerial coupling circuits. There is also the question of selectivity. We do not want the connection of an aerial-earth system to affect the Q of the first tuned circuit unduly. In a T.R.F. receiver a considerable fraction of the total selectivity is contributed by the first tuned circuit and even in superheterodyne types, where the selectivity is provided almost entirely by the I.F. amplifier, some selectivity is desirable in the signal frequency circuits in order to give protection against second channel interference and image effects.

Now the dependence of selectivity and voltage gain on the degree of coupling between two circuits has

been evaluated by Reed* and the curves deduced by him are reproduced in Fig. 4. From these it can be seen that optimum coupling ($kQ = 1$), that is, the degree of coupling that gives maximum voltage transfer (and maximum power transfer), gives only 50 per cent. of the maximum possible selectivity. Tighter couplings give lower voltage transfer and lower selectivity. To get high selectivity very weak couplings are necessary, but these give poor voltage transfer. The best compromise between gain and selectivity is undoubtedly given by half the optimum coupling, for this gives 80 per cent. of the maximum possible gain, and the same percentage of the maximum possible selectivity. We will consider the relatively simple example of the tapped coil aerial coupling circuit to show how this particular degree of coupling can be achieved practically.

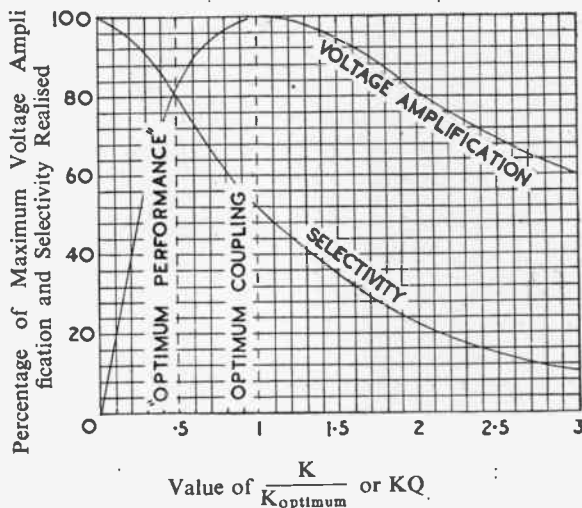

Fig. 4. Voltage Amplification and Selectivity expressed in terms of the degree of Coupling between two Coils

Tapped Coil Aerial Coupling

A very simple type of aerial coupling is that illustrated in Fig. 5, in which the aerial is connected to a tapping point on the tuning inductance. The problem is to find the best position for this tapping point. Replacing the aerial-earth system by its equivalent generator gives the circuit of Fig. 6. In this, as mentioned above, if the generator has constants similar to those of an average out-

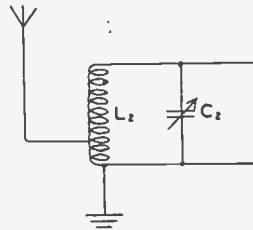

Fig. 5. Fundamental Circuit for Tapped Coil Aerial Coupling

* The Design of H.F. Transformers. M. Reed. *Wireless Engineer*, July, 1931, p.349.

door aerial C_1 and R_1 will have the values $200 \mu\mu\text{F}$ and 40 ohms respectively. Now at any given frequency the series arrangement of C_1 and R_1 can be replaced by a parallel network of capacitance and resistance. Designating the values of these by C_p and R_p respectively, we have from the series to parallel transformation formulæ

$$X_p = \frac{R_1^2 + X_{c1}^2}{X_{c1}} \quad R_p = \frac{R_1^2 + X_{c1}^2}{R_1}$$

These expressions can be simplified considerably, however, for the reactance of C_1 is considerably greater than R_1 over the frequency range in which we are interested, and so we have

$$C_p = C_1 \quad R_p = \frac{1}{\omega^2 C_1^2 R_1}$$

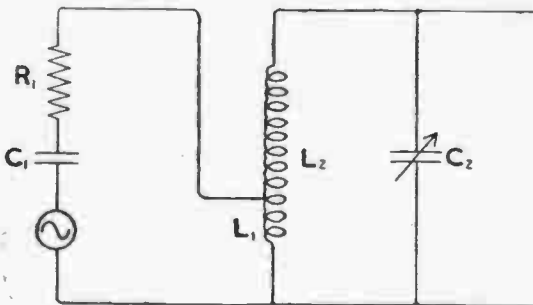

Fig. 6. Electrical Equivalent of Fig. 5

The electrical equivalent circuit is now as given in Fig. 7. It is now possible to consider separately the effects of the capacitance and resistance of the generator on the tuned circuit $L_2 C_2$.

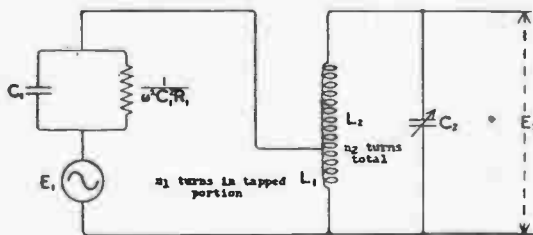

Fig. 7. Modified Electrical Equivalent, the Tapped Coil being regarded as a Matching Transformer

The resistance, of course, damps the circuit so that its full selectivity is not realised in practice as suggested by Reed's curves. The generator capacitance causes a mistuning effect since it effectively increases the capacitance in the tuned circuit and so makes it resonant at a lower frequency than would be obtained if no generator were present. This is an illustration of another feature of aerial coupling circuits to which attention should be paid

if a satisfactory performance is desired. In this example some capacitance was effectively added to the tuning circuit by the connection of the aerial-earth system. It is easily possible for this capacitance to be so great that it prevents complete coverage of the medium wave band. The maximum capacitance that can be added to a circuit, which includes a variable condenser of $500 \mu\mu\text{F}$ maximum capacitance, whilst still permitting tuning over the range 550-1,500 kc/s may be calculated as follows. The ratio of maximum to minimum capacitance is equal to the square of the ratio of maximum to minimum frequency and so we have

$$\frac{500 + \Delta C_2}{\Delta C_2} = \left(\frac{1500}{550}\right)^2$$

in which ΔC_2 is the maximum capacitance that may be added. From this

$$\Delta C_2 = 77.7 \mu\mu\text{F}$$

This result is approximate only since it was assumed in the calculation that the minimum capacitance of the tuning condenser was zero. If we denote the total number of turns in L_2 by n_2 , and if we suppose that the aerial is attached n_1 turns from the earthy end (see Fig. 7) then, assuming the coil to obey normal transformer laws,

$$\begin{aligned} \left(\frac{n_1}{n_2}\right)^2 &= \frac{\text{Capacitance added to tuning circuit}}{\text{aerial general capacitance}} \\ \therefore \left(\frac{n_1}{n_2}\right)^2 &= \frac{77.7}{200} \\ \therefore \frac{n_1}{n_2} &= .623 \end{aligned}$$

Hence we are immediately limited to tapping points lower than that for which $\frac{n_1}{n_2} = .623$ by the necessity of covering the entire medium waveband. If we transfer the capacitance from the generator to the tuned circuit as shown in Fig. 8, then the circuit

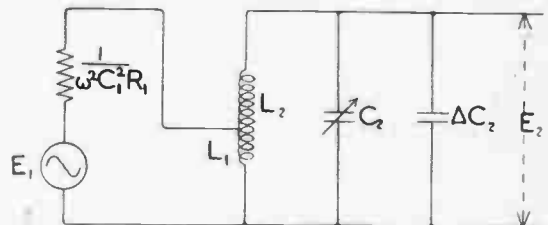

Fig. 8. Generator Capacitance transferred to Tuning Circuit

immediately resolves itself into an example of a matching transformer (or auto-transformer to be exact) which connects the generator resistance

$$R_p \left(= \frac{1}{\omega^2 C_1^2 R_1} \right) \text{ to the dynamic resistance } R_d \left(= \frac{L_2^2 \omega^2}{R_2} = QL_2 \omega \right) \text{ of the tuned circuit.}$$

Applying the usual matching transformer rules the condition for maximum power transfer to the tuned circuit is given by

$$\left(\frac{n_1}{n_2}\right)^2 = \frac{R_p}{R_d} = \frac{1}{\omega^2 C_1^2 R_1} \cdot \frac{1}{L_2 \omega Q}$$

As explained earlier, this will also be the condition for maximum transfer voltage across the tuned circuit. The condition is

$$\frac{n_1}{n_2} = \frac{1}{\sqrt{\omega^2 C_1^2 R_1 L_2 Q}}$$

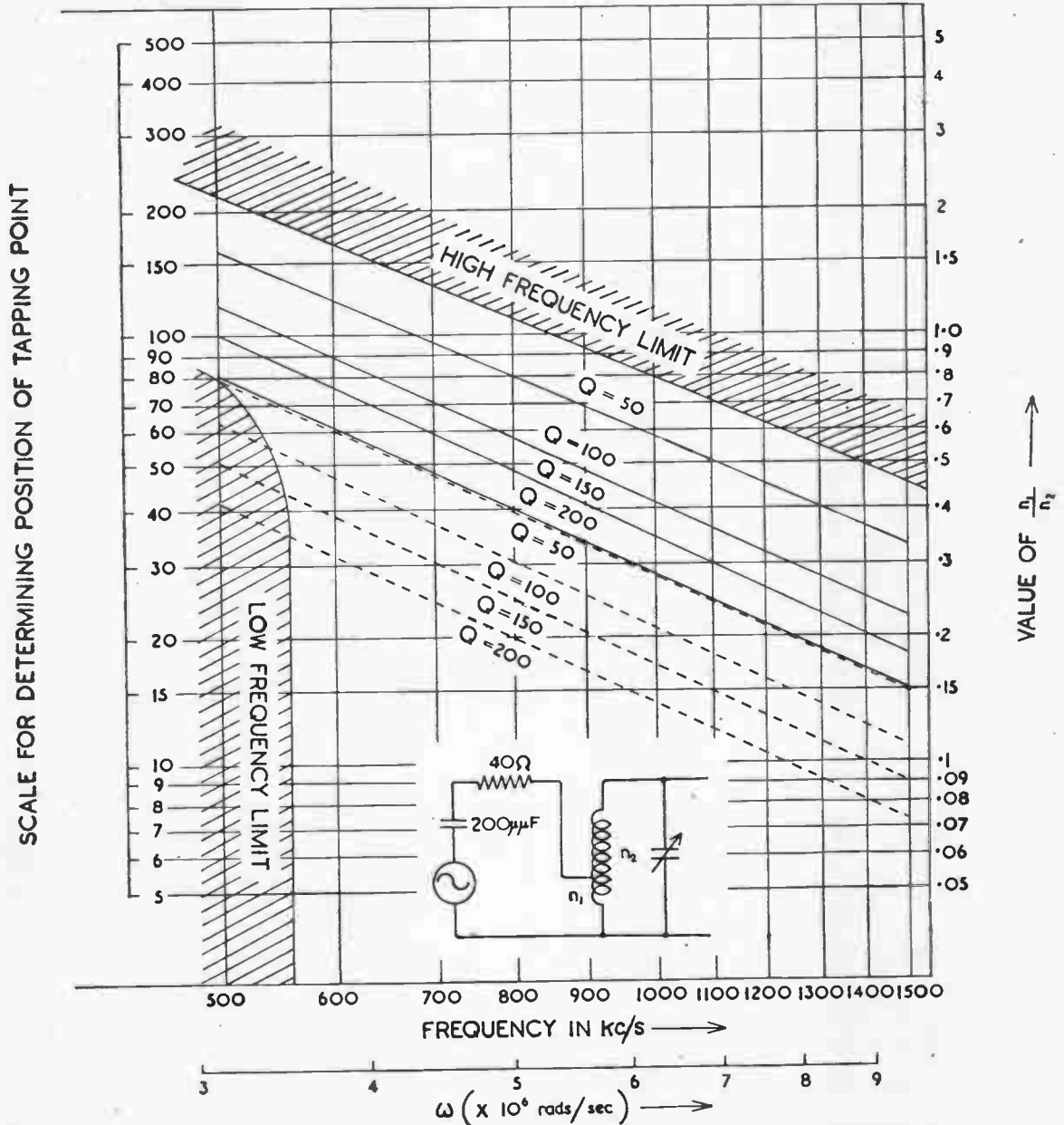

Fig. 9. Curves for determining the Position of Tapping Points for Optimum Coupling (Full Curves) and for "Optimum Performance" (Dotted Curves)

This tapping point gives 50 per cent. of the maximum possible selectivity as evidenced by Reed's curves. If we want the best performance, that is 80 per cent. of the maximum gain and the same percentage of the maximum selectivity, then we must let

$$\frac{n_1}{n_2} = \frac{1}{2\sqrt{\omega^2 C_1^2 R_1 L_2 Q}}$$

For example, suppose $\omega = 2\pi \times 1,000$ kc/s, $C_1 = 200 \mu\mu\text{F}$, $R_1 = 40 \Omega$, $L_2 = 157 \mu\text{H}$ and $Q = 100$.

Then $\frac{n_1}{n_2} = .4$ for optimum coupling and
 $= .2$ for best performance.

From this expression it is clear that the value of $\frac{n_1}{n_2}$ and hence the position of the tapping point for best performance will vary quite a lot with frequency, since the expression involves ω and Q , both of which vary with frequency, the remaining quantities being fixed. It is thus not possible to find one tapping point which gives the best performance at all frequencies in the waveband. This is illustrated in Fig. 9, which gives the values of $\frac{n_1}{n_2}$ for optimum coupling and for best performance for a circuit in which $C_1 = 200 \mu\mu\text{F}$, $R_1 = 40 \Omega$, $L_2 = 157 \mu\text{H}$ and $Q = 50, 100, 150$ and 200 . The figure also illustrates the frequency range

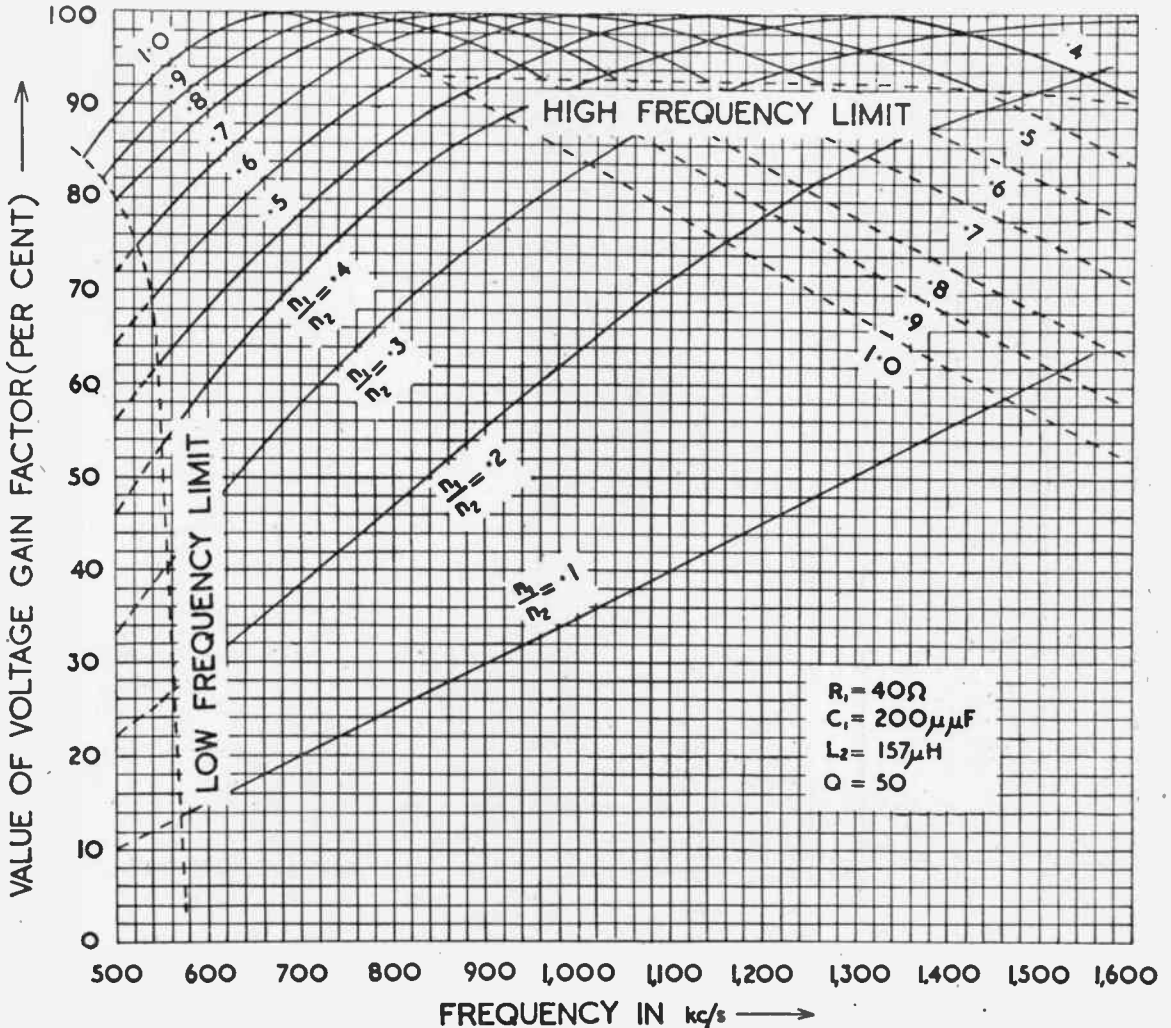

Fig. 10a. Variation of Voltage Gain Factor with Frequency for various Tapping Points

secured with each value of $\frac{n_1}{n_2}$ and bears out the point made earlier that there is an upper limit to the value of $\frac{n_1}{n_2}$ if the medium waveband is to be covered.

The upper value of $\frac{n_1}{n_2}$ from this figure is seen to be about .45. This doesn't agree with the upper value of $\frac{n_1}{n_2}$ deduced above. This is because Fig. 9 is intended to be a practical diagram and so it was

seen that it is necessary for low Q values, and at low frequencies, to use values of $\frac{n_1}{n_2}$ of greater than unity to secure maximum voltage transfer. This simply means that the whole coil should contain n_1 turns, and that the inductance of part of it of n_2 turns should be $157 \mu\text{H}$. The aerial-earth connections are made across the entire coil, the tuning condenser being across the tapped portion of $157 \mu\text{H}$ inductance.

If we have a coil of $157 \mu\text{H}$ with a Q value of 200 which is to be used in a fixed-tuned aerial coupling

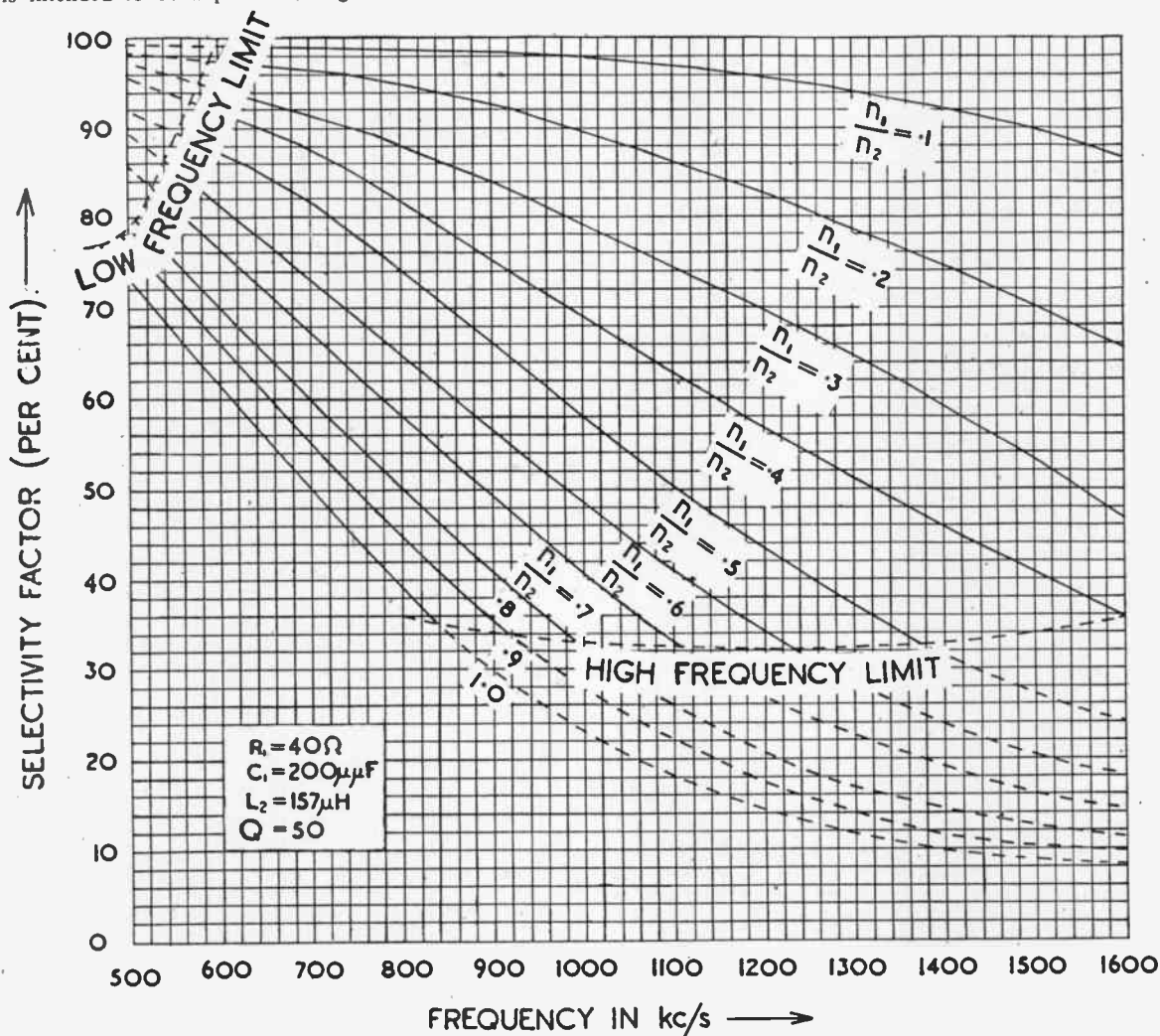

Fig. 10b. Variation of Selectivity Factor with Frequency for various Tapping Points

assumed in its preparation that stray capacitances in parallel with C_2 are $10 \mu\text{F}$, and that the minimum capacitance of C_2 is $20 \mu\text{F}$. From this figure it is

circuit resonating at 800 kc/s , then the correct value of $\frac{n_1}{n_2}$ to use for optimum coupling is .4 from Fig. 9, i.e.,

if the whole coil contains 80 turns then the aerial should be attached at $4 \times 80 = 32$ turns from the earthy end. A movable scale is located at the left of Fig. 9, which enables these numbers of turns to be evaluated at once. This scale should be placed so that the total number of turns on the coil coincides with unity on the vertical scale of the graph, and then the value of $\frac{n_1}{n_2}$ given by the curve for the appropriate Q value and frequency will register the number of turns required in the tapped part.

From Figs. 4 and 9 it is possible to deduce the values of voltage gain factor (i.e., the values of actual gain/maximum gain) and selectivity factor (actual selectivity/maximum selectivity) for any value of tapping point. For example, suppose we wish to investigate the performance of the middle tapping point. If $Q = 50$ then from Fig. 9 perfect matching occurs at 1,100 kc/s. At this frequency, then, from Fig. 4, voltage gain factor is 100 per cent. and selectivity factor 50 per cent. Fig. 9 also shows us that at 700 kc/s when $Q = 50$ the optimum tapping point is given by $\frac{n_1}{n_2} = 1$. Our particular example in which $\frac{n_1}{n_2} = .5$ represents, at this frequency, half the optimum coupling, and we therefore have optimum performance so that the selectivity factor = the voltage gain factor = 80 per cent. At 1,280 kc/s optimum coupling is from Fig. 9 given by $\frac{n_1}{n_2} = .4$ for $Q = 50$. If $\frac{n_1}{n_2} = .5$ then the coupling is greater than optimum and is actually equal to $1.25 \times$ optimum coupling. Fig. 4 tells us when $k/\text{optimum } k = 1.25$ that the voltage gain factor equals 98 per cent. and selectivity factor equals 40 per cent. By continuing in this way the curves of Figs. 10(a) and 10(b) were deduced. These illustrate the performance of a $157 \mu\text{H}$ coil with $Q = 50$

for values of $\frac{n_1}{n_2}$ between .1 and 1. From these we can see that possibly the best tapping point, if a reasonable performance with respect to voltage gain and selectivity is wanted over the entire medium wave band, is $\frac{n_1}{n_2} = .3$ for which the voltage gain factor varies from 40 per cent. at 550 kc/s to 98 per cent. at 1,500 kc/s, and the selectivity factor varies from 95 per cent. at 550 kc/s to 53 per cent. at 1,500 kc/s. Lower tapping points give better selectivity; higher tapping points better voltage gain. If we take the capacitance reflected into the tuning circuit $L_2 C_2$ as being $\left(\frac{n_1}{n_2}\right)^2 C_1$ then we have that the resonant frequency of the arrangement is given by

$$f = \frac{1}{2\pi \sqrt{\left(C_2 + \frac{n_1^2}{n_2^2} C_1\right) L_2}}$$

With the aid of this expression we can determine the

frequency range obtained with any particular tapping point. Suppose, for example, $\frac{n_1}{n_2} = .6$. The reflected capacitance is then $\left(\frac{n_1}{n_2}\right)^2 C_1 = .36 \times 200 = 72 \mu\text{F}$.

We will assume the capacitance of the tuning condenser when it is at minimum to be $20 \mu\text{F}$ and stray capacitance to be $10 \mu\text{F}$, making a total of $102 \mu\text{F}$. The high frequency limit is then given by

$$f = \frac{1}{2\pi \sqrt{LC}} = \frac{1}{6.284 \sqrt{157 \times 10^{-6} \times 102 \times 10^{-12}}} = 1,257 \text{ kc/s}$$

Similarly, the low frequency limit can be evaluated. Both limits are indicated in Figs. 9, 10(a) and 10(b).

In calculating these frequency ranges the expression for reflected capacitance used was given earlier, namely

$$\Delta C_2 = \left(\frac{n_1}{n_2}\right)^2 \cdot C_1$$

This is in actual fact only approximately true. An accurate mathematical analysis of the equivalent electrical circuit of a tapped coil shows that the simple expression given above is approximately true at low frequencies, but that as frequency increases the value of ΔC_2 also increases, and in theory ultimately reaches the value given by

$$\Delta C_2 = \frac{L_1}{L_2} \cdot C_1$$

at the high frequency end of the frequency range covered, i.e. when $C_2 = 0$. In this expression L_1 is the inductance of the lower part of the coil, the "tapped portion" containing n_1 turns. This maximum value of ΔC_2 occurs at the resonant frequency of L_1 and C_1 . An accurate expression for the value of C_2 is

$$\Delta C_2 = C_1 \cdot \frac{L_1}{L_2} \cdot \frac{k^2}{1 - A(1 - k^2)}$$

in which L_2 is the total tuning inductance, L_1 is the "tapped" portion of it (see Fig. 8), and k is the coefficient of coupling between L_2 and L_1 . A is $\omega^2 C_1 L_1$.

From this we can see that $\Delta C_2 = C_1 \cdot \frac{L_1}{L_2}$ if $k = 1$.

Also it is clear that if $A = 1$, $\Delta C_2 = C_1 \cdot \frac{L_1}{L_2}$ again.

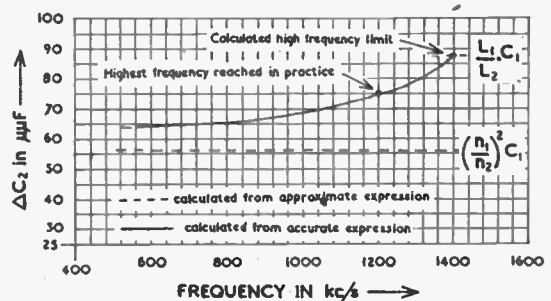

Fig. 11. Variation of ΔC_2 with Frequency for Tapped Coil Aerial Coupling

Now $A = 1$ when $l = \omega^2 C_1 L_1$, i.e., when $\omega L_1 = \frac{1}{\omega C_1}$ that is at the resonant frequency of the primary circuit $C_1 L_1$ and this is the highest frequency to which it is possible to tune the aerial coupling circuit. This is so since $C_1 L_1$ is the only frequency determining network present if $C_2 = 0$. In practice it is never quite possible to reach the frequency

$$f = \frac{1}{2\pi\sqrt{L_1 C_1}}$$

since the condenser C_2 has a certain minimum capacitance, which is increased by stray wiring capacitance and the self-capacitance of L_2 . This point is borne out by Fig. 11 in which the theoretical frequency

$$f = \frac{1}{2\pi\sqrt{L_1 C_1}}$$

(1,400 kc/s in this example) is indicated, together with the practical value (1,200 kc/s). This figure is the result of measurements on a circuit in which $C_1 = 225 \mu\text{F}$

and $\frac{n_1}{n_2} = .5$. Thus in practical tapped coil aerial coupling circuits the value of the reflected capacitance never reaches $C_1 \cdot \frac{L_1}{L_2}$ and we can conclude that its value lies between $C_1 \cdot \left(\frac{n_1}{n_2}\right)^2$ and $C_1 \cdot \frac{L_1}{L_2}$

R.F. Transformer Coupling

Possibly the most usual method of coupling an aerial-earth system is that of the R.F. transformer, illustrated in Fig. 12. This method has something in

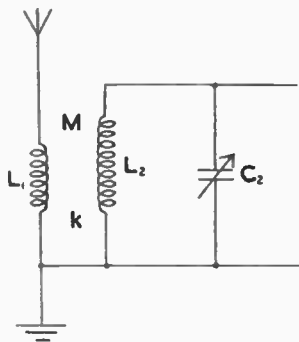

Fig. 12. Aerial Coupling by means of an R.F. Transformer

common with that of the tapped coil method, just described, but is superior to it in this respect, that there are two factors in mutual inductance coupling, namely, M and L_1 , which influence the performance of the circuit and over which we have complete control. In the tapped coil method there was only one such independent variable, namely, the position of the tapping point. The values of both L_1 and M depend on the position of the tapping point and hence M depends on L_1 according to some law over which we have little or no control. In actual fact one can vary M independently of L_1 over a limited range of values by changing the form factor, i.e.: the ratio of length to diameter of the coil L_2 . It therefore can be expected that the performance of an

R.F. transformer aerial coupling circuit may be superior to that of the tapped coil.

We must begin the design of an R.F. transformer by choosing a value for L_1 . From the equivalent electrical circuit of Fig. 12—given in Fig. 13—it is immediately obvious that L_1 and C_1 form a resonant circuit. It is undesirable that the resonant frequency of this

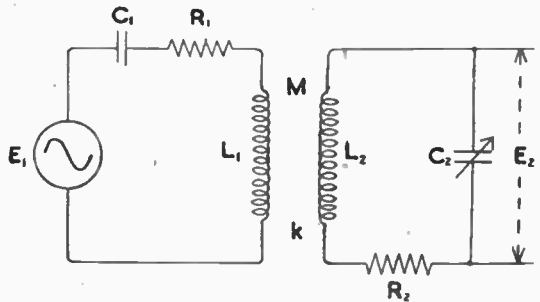

Fig. 13. Electrical Equivalent of Fig. 12 (the R.F. resistance of L_1 may be assumed to be included in R_1)

primary tuned circuit should fall within the frequency range 500-1,500 kc/s which we wish to receive. When this occurs, as the tuning condenser C_2 is rotated so that the resonant frequency of the secondary circuit passes through that of the primary circuit, there is a change in the sign of the reactance reflected into the secondary circuit, which makes accurate ganging of this circuit with others practically impossible.

Moreover, the rapid changes in the value of the reflected resistance which occur around the resonant frequency of the primary circuit causes anomalies in the values of the selectivity factor which are undesirable. These points are illustrated in Figs. 14a and 14b.

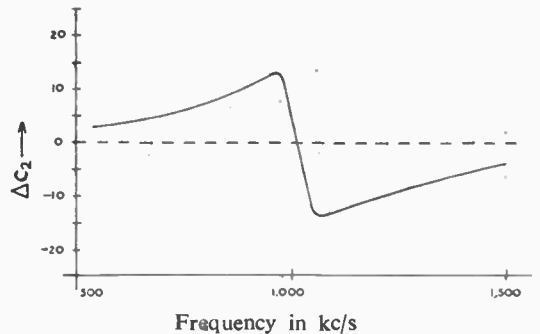

Fig. 14a. Variation of ΔC_2 with Frequency when the Primary Circuit is resonant within the received Waveband

Accordingly the resonant frequency

$$f = \frac{1}{2\pi\sqrt{L_1 C_1}}$$

must be placed either lower than 550 kc/s or else above 1,500 kc/s.

If we take the value of C_1 as 200 $\mu\mu\text{F}$ then we find that L_1 must either be less than 50 μH or else greater than 500 μH .

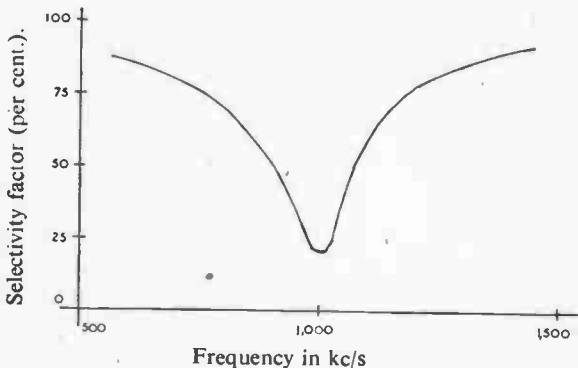

Fig. 14b. Variation of Selectivity Factor with Frequency when the primary Circuit is resonant within the received waveband

R.F. Transformer Performance (Low Inductance Primary)

Both systems are in common use and for the low inductance primary it is usual to employ a value of L_1 of 30 μH with $M = 10 \mu\text{H}$. The effect of varying M is similar to that of varying the position of the tapping point in the tapped coil system, and is illustrated in the curves of Fig. 15.

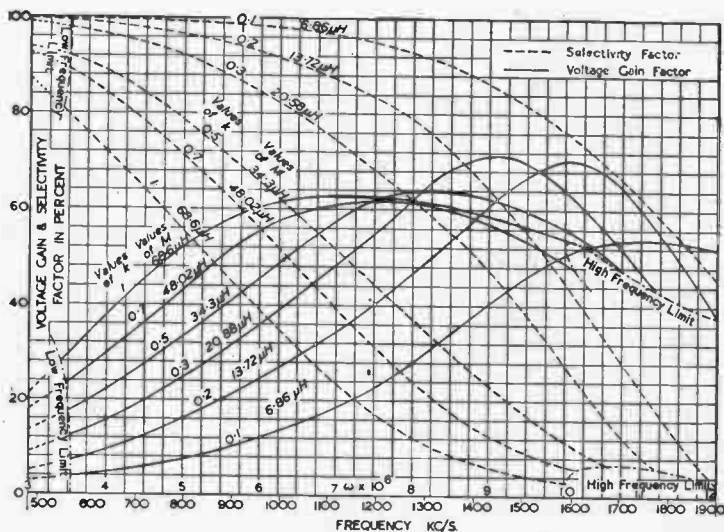

Fig. 15. Variation with frequency of Voltage Gain and Selectivity Factors for RF Transformer with Low Inductance Primary

Voltage gain and selectivity both vary considerably with frequency. This is not surprising as the matching condition for the circuit of Fig. 13 is identical with that for the tapped coil circuit, namely

$$\frac{n_1}{n_2} = \frac{1}{2\sqrt{\omega^2 C_1^2 R_1 L_2 Q}}$$

for optimum performance. This expression shows that $\frac{n_1}{n_2}$ depends on $(\text{frequency})^{-\frac{1}{2}}$ for constant Q . A mathematical analysis of the performance of this circuit is given in Appendix I at the end of this paper. In this it is shown that the voltage gain of the circuit is given by the expression

$$\frac{E_2}{E_1} = \frac{M}{C_2 \left[R_2 \left(j\omega L_1 + \frac{1}{j\omega C_1} \right) + R_1 \left(j\omega L_2 + \frac{1}{j\omega C_2} \right) \right]}$$

To obtain approximate results we may neglect ωL_1 in comparison with $\frac{1}{\omega C_1}$ and we may take $j\omega L_2 + \frac{1}{j\omega C_2}$ as zero. (This is equivalent to assuming that ΔC_2 is zero, which is justified if k is small.) This gives

$$\frac{E_2}{E_1} = M\omega^2 Q C_1$$

which shows that the voltage gain is directly proportional to the square of the frequency. To show the agreement between results evaluated from the approximate and accurate expressions Fig. 16 (a) has been prepared. The agreement is good at low frequencies, but becomes poor at higher ones.

Selectivity Factor

Accurately the selectivity factor is given by

$$\text{S.F.} = \frac{1}{1 + \frac{k^2 L_1 Q \omega R_1}{\left(\omega L_1 - \frac{1}{\omega C_1} \right)^2}}$$

but this may be simplified as follows :

$$\text{S.F.} = \frac{1}{1 + k^2 L_1 C_1^2 Q \omega^3 R_1}$$

if ωL_1 is neglected in comparison with $\frac{1}{\omega C_1}$. From this expression it is plain that its selectivity factor decreases as ω and hence frequency increases. This is illustrated in the curves of Fig. 15.

Reflected Capacitance

The value of the capacitance "reflected" into the secondary circuit for the R.F. transformer method of aerial covering is given by the expression

$$\Delta C_2 = C_1 \frac{L_1}{L_2} \cdot \frac{k^2}{1 - A(1 - k^2)}$$

in which $A = \omega^2 C_1 L_1$, which is the same, of course, as for the tapped coil circuit. If L_1 is small so that the resonant frequency of the circuit $L_1 C_1$ is above the

frequency range of the secondary circuit then $\omega^2 C_1 L_1$ will be less than unity so that ΔC_2 is positive.

In ganging then it will be necessary to add capacitance to the other R.F. circuits in the receiver. It is also obvious that as frequency increases the denominator of

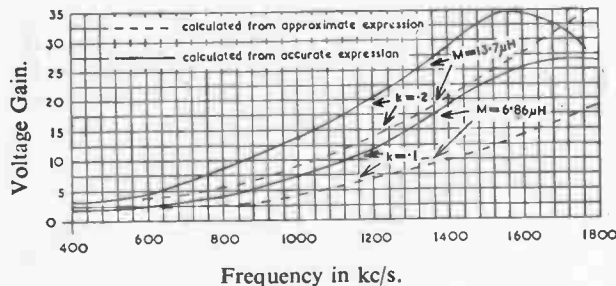

Fig. 16a. Variation of Voltage Gain with Frequency for RF Transformer with Low Inductance Primary

the above expression decreases and so ΔC_2 increases. We can also deduce that a small value of C_1 or L_1 (or both) is necessary to make ΔC_2 independent of frequency, a condition for facilitating ganging. The greatest value ΔC_2 can have is $C_1 \cdot \frac{L_1}{L_2}$ which is reached when k is unity, or at the resonant frequency of the circuit $L_1 C_1$. Thus we shall expect that ΔC_2 will tend to reach the value $C_1 \cdot \frac{L_1}{L_2}$ as frequency increases. This is illustrated in the curves of Fig. 16 (b). In the preparation of these curves L_1 was taken as $30 \mu\text{H}$, C_1 as $200 \mu\text{F}$, R_1 as 40Ω , L_2 as $157 \mu\text{H}$, C_2 as $500 \mu\text{F}$ (maximum). The R.F. resistance of L_1 was assumed negligible in comparison with R_1 and the Q of L_2 was regarded as constant at 100 for all frequencies.

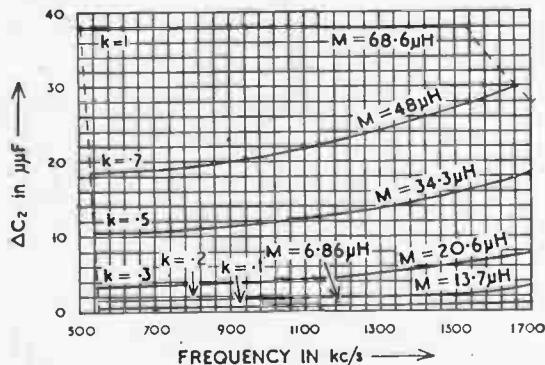

Fig 16b. Variation of ΔC_2 with Frequency for RF Transformer with small Primary

R.F. Transformer (High Inductance Primary)

If a high inductance primary winding is used in an R.F. transformer so that resonance of the primary

circuit occurs at a frequency below 550 kc/s then, over the wanted frequency range, the primary circuit is inductive.

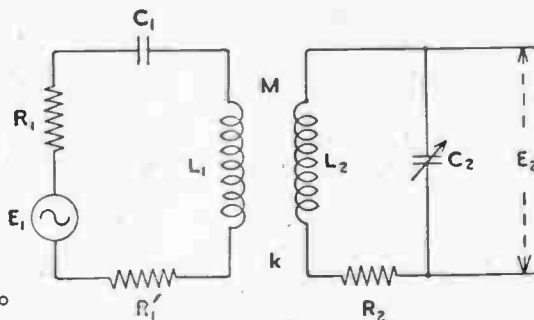

Fig. 17a. Electrical Equivalent Circuit for RF transformer with High Inductance Primary. R_1' is the R.F. resistance of L_1

In the electrical equivalent circuit of Fig. 17 (a), therefore, the inductive reactance in the primary circuit greatly exceeds the capacitive and it is hence possible to redraw the circuit as in Fig. 17 (b).

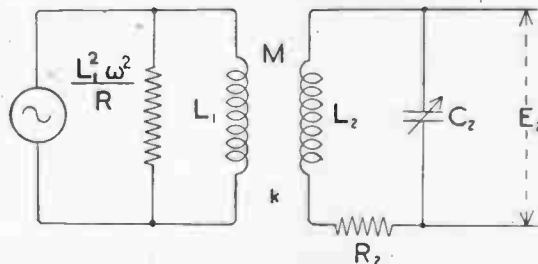

Fig. 17b. Rearrangement of Fig. 17a with Primary Resistance drawn in parallel with L_1 . $R = R_1' + R_1$

The reactance "reflected" into the secondary circuit is thus positive, and the effect of the primary circuit on the secondary is similar to that of placing another inductance in parallel with L_2 , thus effectively reducing the value of L_2 . To keep the secondary circuit resonant, therefore, the value of C_2 has to be increased, i.e. ΔC_2 is negative for this circuit. Moreover, the matching condition for this circuit for optimum performance is given by

$$\frac{n_1}{n_2} = \frac{1}{2} \sqrt{\frac{L_1^2 \omega^2}{R_1 + R_1'} \cdot \frac{R_2}{L_2^2 \omega^2}} = \frac{1}{2} \cdot \frac{L_1}{L_2} \cdot \sqrt{\frac{R_2}{R_1 + R_1'}}$$

This expression does not involve ω but does include R_1' and R_2 , the R.F. resistances of L_1 and L_2 respectively, which will vary with frequency. (L_1, L_2 and R_1 are, of course, constant.) It is quite likely in practice, however, that R_1 will be negligible compared with R_1' and that R_1' and R_2 will vary with frequency according to practically the same law, so that the matching condition is not unduly upset. We should not, therefore, expect the selectivity factor and the voltage gain

factor of this particular type of aerial coupling transformer to vary greatly with frequency, and this prediction is borne out in practice. The curves of Fig. 18 confirm these remarks. They were calculated from the following data: $L_1 = 2,000 \mu\text{H}$, Q of $L_1 = 50$, $C_1 = 200 \mu\text{F}$, $R_1 = 40 \Omega$, $L_2 = 157 \mu\text{H}$, Q of $L_2 = 100$ and $C_2 = 500 \mu\text{F}$ (max.).

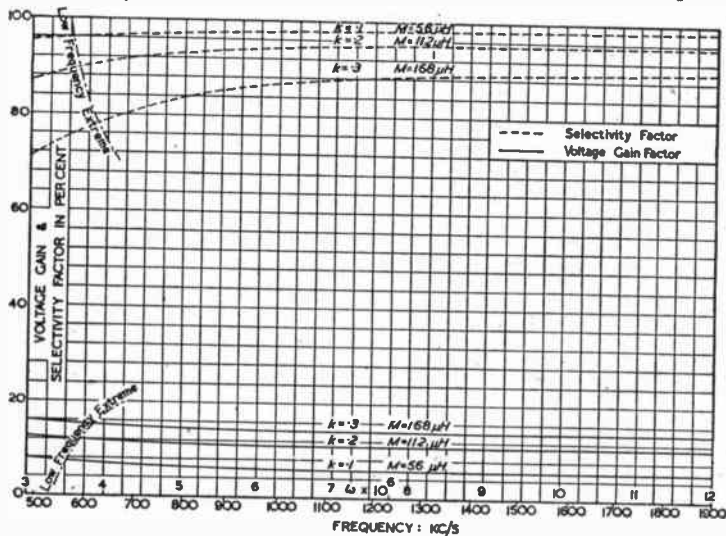

Fig. 18. Variation with frequency of Voltage Gain and Selectivity Factors for RF Transformer with High Impedance Primary

Reflected Capacitance

The expression for the reflected capacitance of this particular type of aerial coupling circuit has already been mentioned. It is

$$\Delta C_2 = C_1 \cdot \frac{L_1}{L_2} \cdot \frac{k^2}{1 - A(1 - k^2)}$$

where $A = \omega^2 C_1 L_1$. In this case $\omega^2 C_1 L_1$ will exceed unity since $\omega^2 = \frac{1}{L_1 C_1}$ at a frequency lower than the

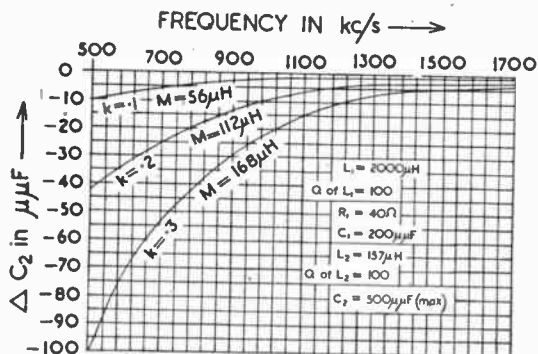

Fig. 19a. Variation of ΔC_2 with frequency for RF Transformer with High Inductance Primary

received waveband, and so ΔC_2 is negative, i.e. capacitance will need to be added to the aerial coupling circuit in order to gang it with other circuits with similar inductance and capacitance values in the receiver. As $\omega^2 C_1 L_1$ exceeds unity it follows that as ω (i.e. frequency) increases the denominator increases and so ΔC_2 decreases. To obtain an approximate idea about how ΔC_2 varies with frequency suppose $\omega^2 L_1 C_1$ is very much greater than unity, and that k is small so that k^2 is negligible compared with unity. We then have

$$\Delta C_2 = - \frac{k^2}{\omega^2 L_2} = - k^2 C_2$$

For a given value of k or L_2 , ΔC_2 is inversely proportional to the square of the frequency, i.e. ΔC_2 is directly proportional to C_2 . Thus ΔC_2 varies in the proportion of $1 : \left(\frac{1,500}{550}\right)^2 = 1 : 7.44$, and so ganging is not so easy as in the case of the R.F. transformer with the low inductance primary. This is illustrated in the curves of Fig. 19 (a).

Voltage Gain

The accurate expression for the voltage gain of an R.F. transformer is, as given before

$$\frac{E_2}{E_1} = \frac{M}{C_2 \left[R_2 \left(j\omega L_1 + \frac{1}{j\omega C_1} \right) + (R_1 + R_2) \left(j\omega L_2 + \frac{1}{j\omega C_2} \right) \right]}$$

and this can be simplified by assuming that ωL_1 greatly exceeds $\frac{1}{\omega C_1}$ and that the mistuning effect is negligible.

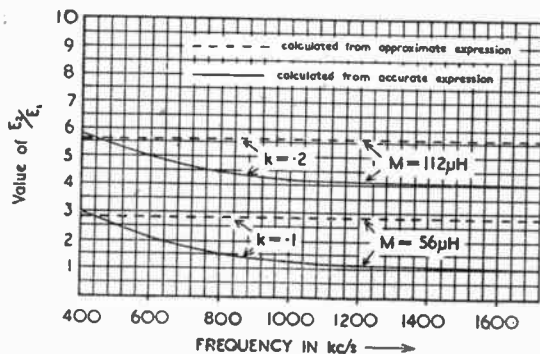

Fig. 19b. Variation of Voltage Gain with Frequency for RF Transformer with High Inductance Primary

We then have $\frac{E_2}{E_1} = \frac{MQ}{L_1}$

showing that the gain is independent of frequency. The agreement between the accurate and approximate results is shown in Fig. 19 (b).

Selectivity Factor

Accurately, as proved in the analysis of Appendix I, this is given by

$$S.F. = \frac{1}{1 + \frac{k^2 L_1 Q (R_1 + R_1') \omega}{\left(\omega L_1 - \frac{1}{\omega C_1}\right)^2}}$$

but it can be simplified to

$$S.F. = \frac{1}{1 + \frac{k^2 Q (R_1 + R_1')}{\omega L_1}}$$

by making the same simplifying assumptions set out above. From this it is seen that the selectivity factor increases as frequency increases, as shown by the curves of Fig. 18.

Series Capacitance Aerial Coupling

A particularly simple, and in some ways a quite satisfactory, method of aerial coupling, is the series capacitance method.

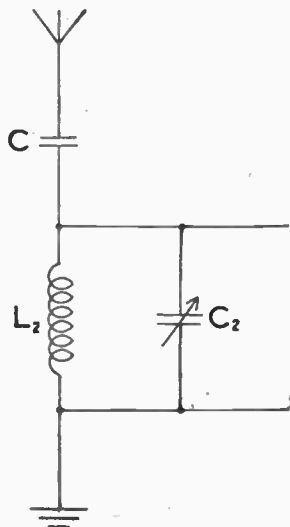

Fig. 20a. Series Capacitance Aerial Coupling

The circuit for it is given in Fig. 20 (a) and the electrical equivalent in Fig. 20 (b). Since R_1 is so small the capacitance reflected into the secondary circuit is given by $\frac{cC_1}{c+C_1}$. If the

circuit is to cover the entire medium waveband, 500-1,500 kc/s, then this must not exceed 77.7 $\mu\mu\text{F}$ as deduced earlier. If $C_1 = 200 \mu\mu\text{F}$ we then have $\frac{200c}{200+c} = 77.7$, which gives $c = 127 \mu\mu\text{F}$. The coupling capacitance should not exceed this value.

The calculation of an expression for the voltage gain of the circuit shown in Fig. 20 can be made by

methods similar to those employed in Appendix I. The full expression is:

$$\frac{E_2}{E_1} = \frac{L_2}{C_2 \left[R_2 \left(j\omega L_2 + \frac{1}{j\omega c} + \frac{1}{j\omega C_1} \right) + (R_1 + R_2) \left(j\omega L_2 + \frac{1}{j\omega C_2} \right) \right]}$$

If, however, c is very small—say 10 $\mu\mu\text{F}$ —then $j\omega L_2 + \frac{1}{j\omega C_2}$ will tend to equal nothing. Moreover, in the first term of the denominator all terms are negligible in comparison with $\frac{1}{j\omega c}$ and the whole expression simplifies to

$$\frac{E_2}{E_1} = \frac{L_2}{C_2 R_2 \cdot \frac{1}{j\omega c}} = \frac{Q L_2 \omega}{\frac{1}{j\omega c}} = \frac{\text{dynamic resistance of the circuit } L_2 C_2}{\text{reactance of the coupling condenser}} = jQ L_2 \omega^2 c$$

Thus if $Q = 100$, $L_2 = 157 \mu\text{H}$, $\omega = 6 \times 10^4$ (equivalent roughly to 1,000 kc/s) and $c = 10 \mu\mu\text{F}$, we have, neglecting the j term, which indicates that E_2 and E_1 are at 90° to each other.

$$\frac{E_2}{E_1} = 100 \times 157 \times 10^{-6} \times 36 \times 10^{12} \times 10 \times 10^{-12} = 5.76$$

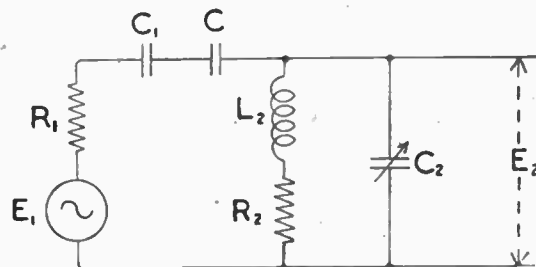

Fig. 20b. The Electrical Equivalent of Fig. 20a.

From the expression above it is clear that the gain is directly proportional to Q , L_2 , C_1 and to ω^2 i.e., to the square of the frequency.

This supposition is closely borne out by detailed calculations of the voltage gain and in the curves of Fig. 21, both the approximate and the accurate expressions are plotted. The close agreement between the two for small values of c is evident from this. The expression for the selectivity factor, namely

$$S.F. = \frac{R_2}{R_2 + \omega^4 L_2^2 C_1^2 (R_1 + R_2)} \text{ in which } C_1' = \frac{cC_1}{c+C_1}$$

cannot be conveniently simplified. The variation of selectivity factor and voltage gain with frequency is illustrated in Fig. 22 for $Q = 100$, $L_2 = 157 \mu\text{H}$, $R_1 = 40 \Omega$, $C_1 = 200 \mu\mu\text{F}$ and for various values of c . The mistuning effect of this particular type of aerial coupling circuit is such as to add in parallel with C_2 a capacitance ΔC_2 equal in value to the aerial generator capacitance C_1 and the series capacitance c in series. This correction, ΔC_2 , hence has a maximum value of

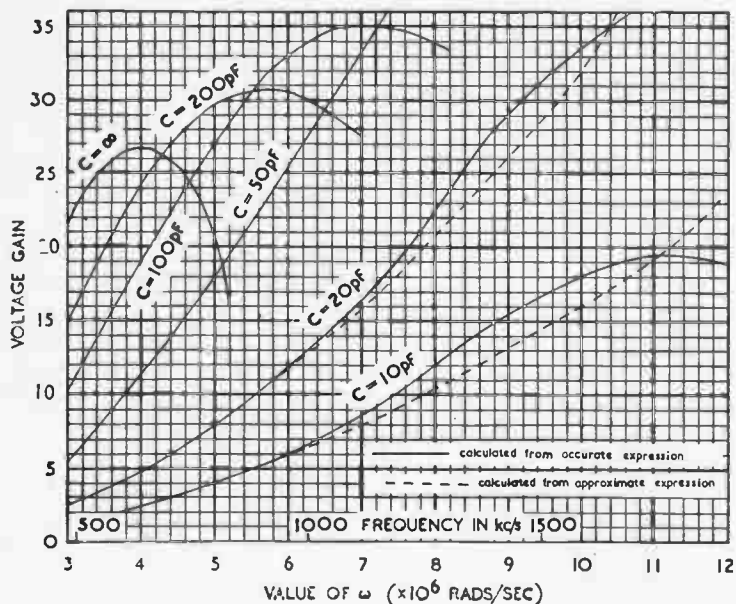

Fig. 21. Variations of Voltage Gain with frequency for Series Capacitance Aerial Coupling

C_1 ($200 \mu\text{F}$) realised when C_1 approaches infinity, but very small values of c the correction ΔC_2 is approximately equal to the value of c .

The value of ΔC_2 depends only on the value of C_1 and c , being given by

$$\Delta C_2 = \frac{cC_1}{c + C_1}$$

and is hence independent of frequency.

This is in general not true of other types of aerial coupling circuit, and makes ganging of the aerial tuned circuit with the others in a receiver particularly simple in this case. Unfortunately unless c is very small, when $\Delta C_2 \approx c$, the calibration of the tuning condenser will depend to some extent on the value of the aerial capacitance and so will be different for every different aerial used. The curtailment of the frequency ranges of the tuning circuit L_2C_2 due to reflected capacitance ΔC_2 is evident in the curves of Fig 22.

Shunt Capacitance Aerial Coupling

This method, illustrated by the circuit diagram of Fig. 23 and the theoretical equivalent of Fig. 24, is a particularly useful one when high and constant selectivity is particularly desired and

where voltage gain doesn't matter so much. The mathematical analysis of the performance of the circuit carried out by methods similar to those employed in Appendix I. Accurately, the voltage gain is given by

$$\frac{E_2}{E_1} = \frac{1}{R_2 \left(R_1 + \frac{1}{j\omega C_3} \right) + R_1 \left(j\omega L_2 + \frac{1}{j\omega C_4} \right)}$$

in which

$$C_3 = \frac{C_1 C}{C_1 + C}, C_4 = \frac{C C_2}{C_2 + C}$$

$$\text{and } C_2 = \frac{1}{\omega^2 L_2} - \Delta C_2$$

If, however, C is large compared with C_1 and C_2 then $C_4 \approx C_2$ and $C_3 \approx C_1$. Thus the mistuning effect in the secondary circuit is negligible, and hence

$$j\omega L_2 + \frac{1}{j\omega C_2} = 0$$

Moreover, in the denominator of the above expression we are justified in neglecting R_1 in

comparison with $\frac{1}{j\omega C_3}$. If all these points are

taken into account it is possible to simplify the expression for the voltage gain to

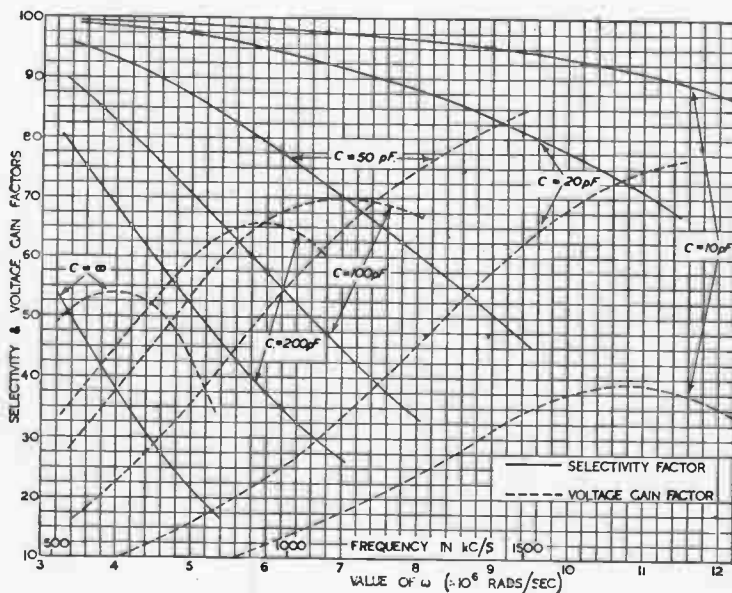

Fig. 22. Variation with frequency of Voltage Gain and Selectivity Factors for Series Capacitance Aerial Coupling Circuit

$$\frac{E_2}{E_1} = \frac{\frac{I_1}{\omega_2 C C_2}}{R_2 \cdot \frac{I_1}{j \omega C_1}} = \frac{j C_1}{\omega C C_2 R_2}$$

$$\therefore \left| \frac{E_2}{E_1} \right| = \frac{C_1}{\omega C C_2 R_2}$$

But $\frac{1}{\omega C_2} = \omega L_2$

$$\therefore \left| \frac{E_2}{E_1} \right| = \frac{\omega L_2 C_1}{C R_2} = \frac{Q C_1}{C} = \frac{Q \times \text{aerial capacitance}}{\text{coupling capacitance}}$$

The gain is thus directly proportional to the Q value of the tuning inductance and to the aerial capacitance,

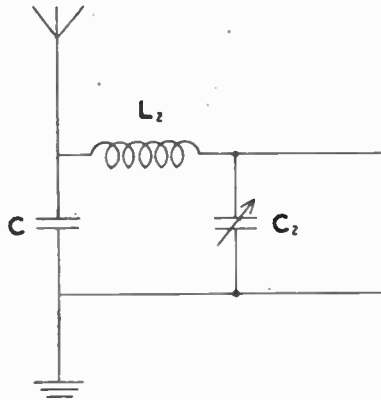

Fig. 23. Current diagram for Shunt Capacitance Aerial Coupling

and is inversely proportional to the coupling capacitance. If we put $Q = 100$, $C_1 = 200 \mu\text{F}$ and $C = .005 \mu\text{F}$, we have

$$\frac{E_2}{E_1} = \frac{100 \times 200 \times 10^{-12}}{5000 \times 10^{-12}} = 4$$

A small voltage gain this, but one which is presumably independent of frequency since there is no term in ω involved in the simplified expression for the voltage gain.

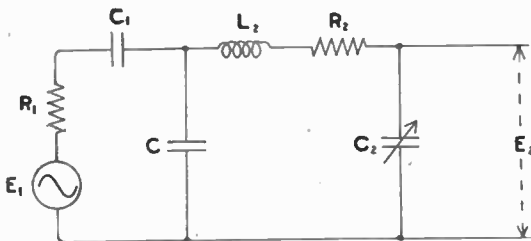

Fig. 24. Theoretical Equivalent for Fig. 23

To indicate the degree of correlation between voltage gains calculated from the accurate and approximate expressions Fig. 25 has been prepared. For values of

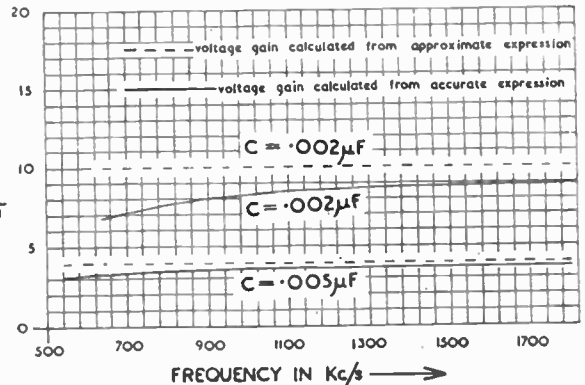

Fig. 25. Voltage Gain of Shunt Capacitance Aerial Coupling Circuit

C less than about $.002 \mu\text{F}$ the approximate expression is too inaccurate to be of any practical use. The selectivity factor of this circuit is given accurately by the expression

$$\text{selectivity factor} = \frac{1}{1 + \frac{R_1}{R_2 \left(1 + \frac{C}{C_1}\right)^2}}$$

which can be simplified to $\frac{1}{1 + \frac{R_1 C_1^2}{R_2^2}}$

if C is very much greater than C_1 as is often the case.

To obtain high selectivity the expression $\frac{R_1 C_1^2}{R_2^2}$ must be small. As R_1 , R_2 and C_1 are fixed for a given aerial and given tuning circuit this means that a large value of C is necessary to give high selectivity. This is borne out by the curves of Fig. 26. This graph also shows the variation with frequency of the voltage gain factor and the projections of each curve on the horizontal axis gives the frequency range obtained with each value of C . The extreme constancy of the voltage gain and selectivity for large values of C is noteworthy. For this reason this type of aerial coupling circuit is sometimes used in the communications type receivers, where one is particularly interested in high selectivity, and where gain, which is independent of frequency, is a great advantage. The reflected capacitance of this type of aerial coupling is given by the expression

$$\Delta C_2 = \frac{1}{\omega^2 L_2} \cdot \frac{1}{1 - \omega^2 L_2 (C_1 + C)}$$

and normally $\omega^2 L_2 (C_1 + C)$ greatly exceeds unity so that ΔC_2 is negative. This is fairly clear from the nature of the circuit. As C is in series with C_2 it

naturally reduces the capacitance in parallel with L_3 , this necessitating the addition of capacitance to preserve the calibration of the condenser. In this respect, namely, that capacitance has to be added to the circuit, this circuit resembles the R.F. transformer with large primary inductance.

such as series capacitance and shunt inductance (Fig. 28) have not been treated; neither have band pass circuits, or circuits for long and short wave reception, but it is hoped that this treatment will serve as a convenient introduction to what is a very interesting subject. By way of conclusion two appendices are

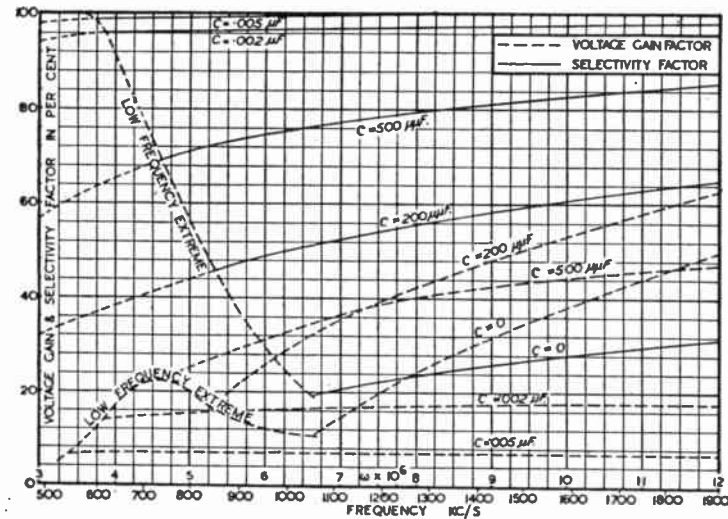

Fig. 26. Variation with frequency of Voltage Gain and Selectivity Factors for Shunt Capacitance Aerial Coupling Circuit

Unfortunately ΔC_2 is far from constant over the frequency range as shown in Fig. 27. This makes ganging rather difficult for all values of C save the very large ones. This figure (and the preceding one) gives a rather pessimistic estimate of the frequency coverage possible with this circuit. It would appear, for example, that the lowest frequency obtainable with $C = 0.002 \mu F$ is about 630 kc/s. This is quite true, but it is possible, even desirable, to connect a trimmer condenser in parallel with L_2 or C_2 in order to lower the frequency obtained when $C_2 = 0$. This also gives a lower frequency when C_2 is at maximum. For example, with $C_2 = 0.002 \mu F$ and a trimmer of $40 \mu F$ capacitance the entire medium wave-band, 550-1,500 kc/s, is receivable.

This does not by any means exhaust the subject of aerial coupling circuits; their number and variety is almost legion, but it does serve as an introduction to the subject. Circuits involving two types of coupling

included. Appendix I gives a mathematical analysis of the R.F. transformer method of aerial coupling and shows the derivation of expressions for the voltage gain, selectivity and reflected capacitance. Appendix II gives accurate and approximate expressions for the voltage gain factor, selectivity factor and reflected capacitance for the types of aerial coupling circuit described in the text. The tapped coil method is not listed separately here, as it is really a special case of the R.F. transformer method.

A number of the diagrams used in this paper have been previously published in a series of articles by the author in *Electronic Engineering* for February, March, April and May, 1945.

APPENDIX I

Applying Kirchoff's laws to Fig. 29 we have

$$E_1 = i_1 Z_p - j\omega M i_2 \dots \dots \dots (1)$$

in which $Z_p =$

$$R_p + jX_p = (R_1 + R_1') + j\omega L_1 + \frac{1}{j\omega C_1}$$

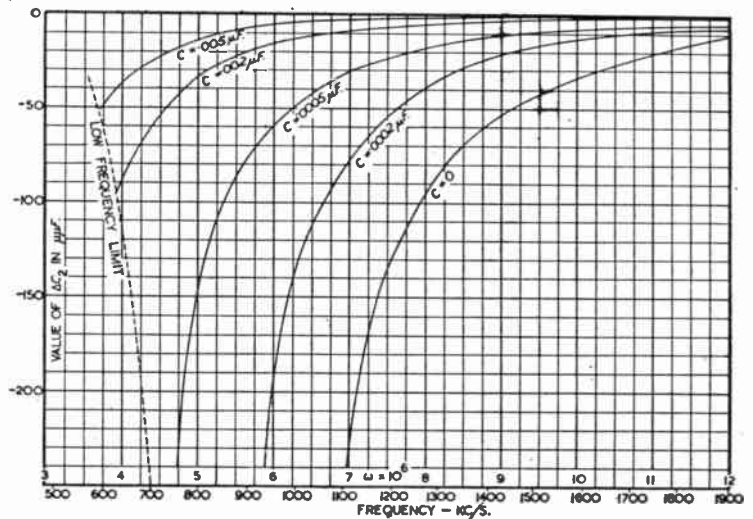

Fig. 27. Variation with frequency of ΔC_2 for Shunt Capacitance Aerial Coupling

and $O = i_2 Z_s - j\omega M i_1 \dots \dots \dots (2)$

in which $Z_s = R_s + jX_s = R_s + j\omega L_2 + \frac{1}{j\omega C_2}$

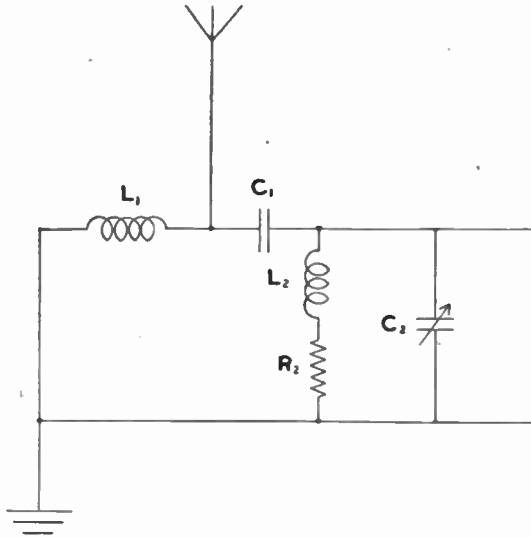

Fig. 28. A "Mixed" type of Aerial Coupling involving Series Capacitance and Shunt Inductance. Such circuits are not treated in the text.

From (2) $i_1 = \frac{Z_s}{j\omega M} \cdot i_2$

Substituting for L_1 in (1)

$E_1 = \frac{Z_p Z_s}{j\omega M} \cdot i_2 - j\omega M i_2$

Since $E_2 = \frac{i_2}{j\omega C_2}$

$$\frac{E_2}{E_1} = \frac{M}{C_2(Z_p Z_s + M^2 \omega^2)}$$

$$= \frac{M}{C_2 Z_p \left(Z_s + \frac{M^2 \omega^2}{Z_p} \right)}$$

$$= \frac{M}{C_2 Z_p Z} \dots \dots \dots (3)$$

in which Z represents the impedance of the secondary circuit in the presence of the primary. Rationalising Z we have

$$Z = Z_s + \frac{M^2 \omega^2}{Z_p}$$

$$= R_s + jX_s + \frac{M^2 \omega^2}{R_p + jX_p}$$

$$= R_s + jX_s + \frac{M^2 \omega^2}{R_p^2 + X_p^2} (R_p - jX_p)$$

$$= R_s + \frac{M^2 \omega^2 R_p}{R_p^2 + X_p^2} + jX_s - j \frac{M^2 \omega^2 X_p}{R_p^2 + X_p^2}$$

By neglecting resistive terms in comparison with reactive ones

$$Z = R_s + \frac{M^2 \omega^2 R_p}{X_p^2} + jX_s - j \frac{M^2 \omega^2}{X_p}$$

at resonance the reactive terms vanish, giving

$$jX_s - j \frac{M^2 \omega^2}{X_p} = 0$$

i.e., $M^2 \omega^2 = X_p X_s \dots \dots \dots (4)$

The value of Z at resonance is thus given by

$$Z = R_s + \frac{M^2 \omega^2 R_p}{X_p^2} \dots \dots \dots (5)$$

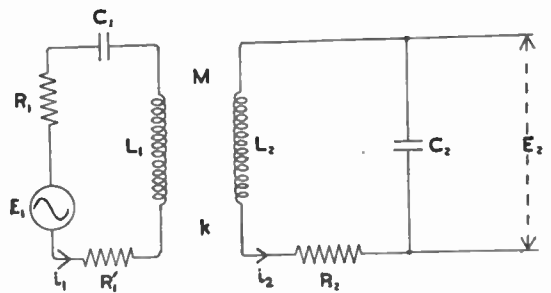

Fig. 29. Equivalent circuit of an RF Transformer with Aerial-Earth Generator. (R_1 is the RF resistance of L_1 .)

Substituting for X_p and X_s in (4)

$$M^2 \omega^2 = \left(\omega L_1 - \frac{1}{\omega C_1} \right) \left(\omega L_2 - \frac{1}{\omega C_2} \right)$$

$$\therefore M^2 \omega^2 = \omega^2 L_1 L_2 + \frac{1}{\omega^2 C_1 C_2} - \frac{L_2}{C_1} - \frac{L_1}{C_2}$$

Remembering that $M = k\sqrt{L_1 L_2}$ and rearranging

$$\omega^2 L_1 L_2 (1 - k^2) + \frac{1}{\omega^2 C_1 C_2} - \frac{L_2}{C_1} - \frac{L_1}{C_2} = 0$$

Multiplying throughout by $\omega^2 C_1 L_2$ and rearranging

$$C_2 = \frac{1}{\omega^2 L_2} \cdot \frac{1 - \omega^2 C_1 L_1}{1 - \omega^2 C_1 L_1 (1 - k^2)}$$

In the absence of a primary circuit $C_2 = \frac{1}{\omega^2 L_2}$ so that the reflected capacitance ΔC_2 is given by

$$\Delta C_2 = \frac{1}{\omega^2 L_2} - \frac{1}{\omega^2 L_2} \cdot \frac{1 - \omega^2 C_1 L_1}{1 - \omega^2 C_1 L_1 (1 - k^2)}$$

$$= \frac{1}{\omega^2 L_2} \cdot \frac{k^2 \omega^2 C_1 L_1}{1 - \omega^2 C_1 L_1 (1 - k^2)} \dots \dots \dots (6)$$

$$= C_2 \cdot \frac{L_1}{L_2} \cdot \frac{k^2}{1 - \omega^2 C_1 L_1 (1 - k^2)}$$

The Voltage Gain at Resonance

Substituting in (3) the value of Z given in (5)

$$\frac{E_2}{E_1} = \frac{M}{C_2 Z_p \left(R_s + \frac{M^2 \omega^2 R_p}{X_p^2} \right)} \approx \frac{M}{C_2 \left(Z_p R_s + \frac{M^2 \omega^2 R_p}{X_p} \right)}$$

But, from (4) $\frac{M^2 \omega^2}{X_p} = X_s$

$$\therefore \frac{E_2}{E_1} = \frac{M}{C_2 (Z_p R_s + X_s R_p)}$$

Substituting for Z_p , R_s , X_p and R_p

$$\frac{E_2}{E_1} = \frac{M}{C_2 \left[R_2 \left(R_1 + R_1' + j\omega L_1 + \frac{1}{j\omega C_1} \right) + (R_1 + R_1') \left(j\omega L_2 + \frac{1}{j\omega C_2} \right) \right]}$$

In evaluating $\frac{E_2}{E_1}$ for small primary coils it will be possible to neglect R_1' in comparison with R_1 and $R_1 + R_1'$ in comparison with $j\omega L_1 + \frac{1}{j\omega C_1}$ and so we have

$$\frac{E_2}{E_1} \approx \frac{M}{C_2 \left[R_2 \left(j\omega L_1 + \frac{1}{j\omega C_1} \right) + R_1 \left(j\omega L_2 + \frac{1}{j\omega C_2} \right) \right]} \dots \dots \dots (7)$$

For the large primary coil R_1' will probably exceed R_1 and the following version is then sufficiently accurate.

MIDLANDS SECTION DISCUSSION

The Chairman (Mr. D. E. Head) : I am sure we have all appreciated the extremely clear and interesting paper contributed by Mr. Amos. Manufacturers were faced with the fact that users of a receiver might have anything from a yard of wire to a 40-ft. aerial, and with ganged condensers the mistuning due to differences in the aerial was such that they dare not inject a sensible voltage. What difference, he asked, did the aerial circuit actually make in the case of a yard of wire and a 40-ft. outdoor aerial?

Mr. G. F. Knewstub : The lecturer has referred to the frequency ratio in the medium wave band of 3 to 1, which gave a capacitance ratio of 9 to 1, and showed the limiting effect this had on the permissible capacitance in the aerial. I should like to know whether larger aerial capacitances would be permissible if one had a larger ratio of capacitance to inductance in the tuned circuit?

J. Lapworth : When using the R.F. transformer with high inductance primary, is any advantage gained because we had a loss when going from the low frequency end of the band to the high frequency end? Did that tend to flatten out the voltage curve developed

$$\frac{E_2}{E_1} \approx \frac{M}{C_2 \left[R_2 \left(j\omega L_1 + \frac{1}{j\omega C_1} \right) + (R_1 + R_1') \left(j\omega L_2 + \frac{1}{j\omega C_2} \right) \right]} \dots \dots \dots (8)$$

Selectivity Factor

Expression (5) has already shown that, at resonance the resistance of the secondary circuit in the presence of the primary is greater than the normal amount R_s by $\frac{M^2 \omega^2 R_p}{X_p^2}$. Substituting for R_p and X_p and remembering

that the selectivity factor is defined by the expression selectivity factor = $\frac{\text{normal resistance}}{\text{normal resistance} + \text{added resistance}}$

we have

$$\text{selectivity factor} = \frac{R_s}{R_s + \frac{M^2 \omega^2 (R_1 + R_1')}{\left(\omega L_1 - \frac{1}{\omega C_1} \right)^2}} = \frac{1}{1 + \frac{k^2 L_1 Q \omega (R_1 + R_1')}{\left(\omega L_1 - \frac{1}{\omega C_1} \right)^2}} \dots \dots \dots (9)$$

For a small secondary coil we are justified, as before, in neglecting R_1' in comparison with R_1 whereas, for large primary windings it is better to use expression (9) as it stands.

The Author wishes to express his thanks to the Editor and Publisher of "Electronic Engineering" for their courtesy in allowing Figs. 15, 18, 21, 22, 26 and 27 to be reproduced for the purpose of this paper

across the tuning capacitance, and would that give a more even voltage response?

G. Knewstub : I have seen a device applied to an inductive coupling in the shape of a small condenser coupling between the aerial connection and the top end of the secondary coil, the idea being to mitigate the variation of output voltage with frequency. Is such a device effective?

Mr. Doughty : Can the same coupling principles apply in the case of bandpass input circuits?

Mr. F. H. Alston : Is there any reason why a non-inductive resistance should not be used in place of a condenser in a circuit similar to the series capacitance coupling?

Mr. S. G. Button (proposing a vote of thanks to Mr. Amos) : Having had a fair amount of experience with aerial coupling circuits, I can appreciate the difficulties which such circuits give to designers. I feel that too many people consider aerial circuits of very little importance compared with other portions of the receiver, with the result that very often the aerial coupling circuits had to look after themselves. We have

APPENDIX II

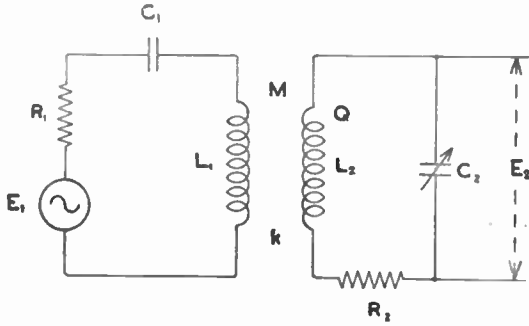
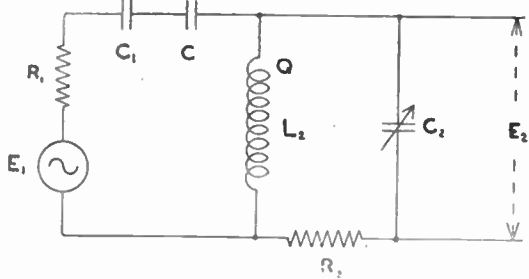
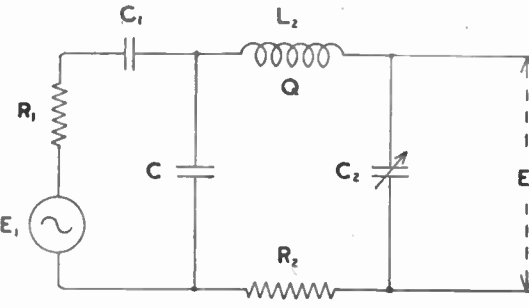
|  <p style="text-align: center;"><i>R.F. Transformer</i></p> | <p style="text-align: center;">VOLTAGE GAIN</p> <p>Accurately</p> $\frac{E_2}{E_1} = \frac{M}{C_2 \left[R_2 \left(j\omega L_1 + \frac{1}{j\omega C_1} \right) + (R_1 + R_1') \left(j\omega L_2 + \frac{1}{j\omega C_2} \right) \right]}$ <p>Approximately (for low inductance primary)</p> <p>if $\frac{1}{\omega C_1} \gg \omega L_1$</p> $\frac{E_2}{E_1} = MQ\omega^2 C_1$ <p>Approximately (for high inductance primary)</p> <p>if $\omega L_1 \gg \frac{1}{\omega C_1}$</p> $\frac{E_2}{E_1} = \frac{MQ}{L_1}$ | <p style="text-align: center;">SELECTIVITY FACTOR</p> <p>Accurately</p> $S.F. = \frac{1}{1 + \frac{k^2 L_1 Q \omega (R_1 + R_1')}{\left(\omega L_1 - \frac{1}{\omega C_1} \right)^2}}$ <p>Approximately (for low inductance primary)</p> <p>if $\frac{1}{\omega C_1} \gg \omega L_1$</p> $S.F. = \frac{1}{1 + k^2 \omega^3 L_1 C_1^2 Q R_1}$ <p>Approximately (for high inductance primary)</p> <p>if $\omega L_1 \gg \frac{1}{\omega C_1}$</p> $S.F. = \frac{1}{1 + \frac{k^2 Q (R_1 + R_1')}{\omega L_1}}$ | <p style="text-align: center;">REFLECTED CAPACITANCE</p> <p>Accurately</p> $\Delta C_2 = C_1 \frac{L_1}{L_2} \frac{k^2}{1 - A(1 - k^2)}$ <p>where $A = \omega^2 L_1 C_1$</p> <p>Approximately (for high inductance primary only)</p> $\Delta C_2 = - \frac{k^2}{L_2 \omega^2} = - k^2 C_2$ |
|---|---|--|--|
|  <p style="text-align: center;"><i>Series Capacitance</i></p> | <p>Accurately</p> $\frac{E_2}{E_1} = \frac{L_2}{C_2} \frac{Q}{R_2 \left(j\omega L_2 + \frac{1}{j\omega C^1} \right) + (R_1 + R_2) \left(j\omega L_2 + \frac{1}{j\omega C_2} \right)}$ <p>where $C^1 = \frac{cC_1}{C + C_1}$</p> <p>Approximately</p> $\left \frac{E_2}{E_1} \right = QL_2 \omega^2 C$ <p>if $C \ll C_1$ and if $C \ll C_2$</p> | $S.F. = \frac{R_2}{R_2 + \omega^2 L_2^2 C^{12} (R_1 + R_2)}$ <p>where $C^1 = \frac{cC_1}{c + C_1}$</p> | $\Delta C_2 = \frac{cC_1}{c + C_1}$ |
|  <p style="text-align: center;"><i>Shunt Capacitance</i></p> | <p>Accurately</p> $\frac{E_2}{E_1} = \frac{1}{\omega^2 C_1 C_2} \frac{Q}{R_2 \left(R_1 + \frac{1}{j\omega C_3} \right) + R_1 \left(j\omega L_2 + \frac{1}{j\omega C_4} \right)}$ <p>where $C_3 = \frac{C_1 C_2}{C + C_1}$ and $C_4 = \frac{C C_2}{C + C_2}$</p> <p>Approximately</p> $\frac{E_2}{E_1} = \frac{QC_1}{C}$ <p>if $C \gg C_1$ and if $C \gg C_2$</p> | <p>Accurately</p> $S.F. = \frac{1}{1 + \frac{R_1}{R_2 \left(1 + \frac{C}{C_1} \right)^2}}$ <p>Approximately</p> $S.F. = \frac{1}{1 + \frac{R_1 C_1^2}{R_2 C^2}}$ <p>if $C \gg C_1$ and if $C \gg C_2$</p> | $\Delta C_2 = \frac{1}{\omega^2 L_2} \cdot \frac{1}{1 - \omega^2 L_2 (C_1 + C)}$ |

all learnt a lot from Mr. Amos, and we very much appreciate his paper.

Mr. Amos (replying) said, in answer to the Chairman's question, that the difference depended on the type of circuit. With weak couplings it would not matter what was connected to the receiver.

On the queries raised by Mr. Knewstub, the answer to the first was in the affirmative.

As to Mr. Knewstub's question about types of coupling, I have not given much time to this problem, but I do know that by using a mixed type it is possible to obtain some very good results. I think that mixed type couplings, properly designed, would give a very promising performance.

My answer to Mr. Doughty is "no." In bandpass coupling one of the troubles is to keep the bandwidth constant and independent of frequency. If one of the circuits was going to be affected by the aerial being coupled to it, and not the other, then it was quite likely

that there would be trouble. The golden rule was to have the loosest possible coupling.

The suggestion made by Mr. F. H. Alston was interesting. It might be possible to obtain a voltage gain independent of frequency, which was, perhaps, important.

In reply to Mr. Lapworth if the aerial circuit is made inductive the circuit has then to be coupled by an inductive aerial circuit to a tuning circuit, the dynamic resistance of which goes up as the frequency increases, so that the coupling factor can remain optimum over nearly the whole band. I am assuming that Q of the tuning circuit remains constant and independent of frequency. Roughly speaking, I think it is a fair assumption that Q is independent of frequency. This is a subject in which there are so many variables that it had to be accepted that, say, 7 out of 10 are constant, or the result would be mathematical confusion.

NORTH-WESTERN SECTION DISCUSSION

H. Whalley : I rather gathered from the literature on the subject that a lot of stress seems to be placed on making gain independent of frequency. I cannot see why this should be important. It is understandable if the receiver to be used has a signal strength meter ; but in the average broadcast receiver is constancy of gain valuable for any other reason? Secondly, it is rather outside the scope of the paper, but is mentioned in your closing remarks. Can you give any indication how such mixed couplings are designed?

Mr. Friedlaender : I have realised during these meetings that when one concentrates on one subject one loses touch with other subjects ; and it is surprising what an amount of work is put into such a small subject as aerial couplings. Also, I was rather astonished to see that Mr. Amos uses Q values as low as 50 to 100. I notice, too, that nothing is said of dust iron core. Secondly, I wonder how much redesigning of circuits with regard to push-button tuning has affected his aerial coupling circuits ; and particularly how he has compensated for the introduction of permeability tuning.

Mr. Connett : I should like to say just a few words about the permeability tuning side of the subject. The chief problem with aerial couplings of any type is the fact that generator impedance decreases with frequency. If a straight aerial is used, it has to be matched with a tuned circuit with a dynamic impedance. If a variable capacitance tuning is used, the dynamic impedance is $Q \cdot \omega L$. Assuming Q is reasonably constant, then dynamic impedance increases with frequency, and consequently one gets those large variations in gain with a tapped tuned circuit. One way of overcoming

that is to put the series inductance in the aerial which makes the aerial have inductive impedance, which increases the frequency and matches the tuned circuit more. But when uses permeability tuning, dynamic impedance can then, of course, be represented by $\frac{Q}{\omega \cdot C}$ and when C is fixed the dynamic impedance then decreases with frequency.

In actual practice, coils I have tried which are permeability tuned produce remarkably constant results, because the Q tends to increase at the low frequency end, but there is more iron in the magnetic circuit then, and, therefore, there will be more losses. One of the best coupling circuits I have come across is the shunt capacitance circuit, with permeability tuning, and the gain has been found to be remarkably constant, as well as a fairly high average standard.

There is just another point about these mixed circuits ; one can never avoid the mixed circuits in practice, even if one tries to achieve a simple circuit, because of strays. While these stray capacities are not very important in circuits over the received waveband, they are extremely important as regards image rejection on superheterodyne circuits, as capacitive impedance is low at the image frequency, and it affects the image rejection characteristic quite a lot. Though stray capacity couplings can be designed, in fact so as to make the image rejection very good, much more than could be otherwise achieved.

H. Exwood : The first point on which I should like Mr. Amos's views is the case where the aerial is not connected directly to a receiver, but via a transformer. It becomes a practice more and more to introduce some

system of aerial where the aerial is placed in interference-free surroundings to achieve a good signal to noise ratio, and it is coupled by means of an R.F. cable to the receiver. The supplier of such apparatus usually includes an additional transformer to put at the receiver end to step up from the cable impedance to the normal impedance, which does seem a waste. I think it should be easy to provide a tapping on the input coil to suit the low impedance aerial.

The second point is that in so many cases the best coupling depends on what one has in mind. Mr. Amos mentioned that the tapped coil coupling was not used very greatly, because of certain disadvantages. There are a number of cases when one is dealing with single frequency receivers, and there the tapped coil type of coupling is very easy to calculate, and is consequently an advantage.

The third point I wish to raise has nothing to do with aerial coupling at all: it is the question of the effective height of an aerial. When an aerial is considered from the point of view of receiving, one always thinks of effective height; and when considered from the point of view of transmitting, of radiation resistance. If one calculates for optimum power transfer from the aerial to the receiver, the radiation resistance of the aerial appears as a loss. In other words, if there were no radiation resistance there would be more power transferred into the receiver. I have often sought a formula which would show that if an aerial had no radiation resistance it would have no effective height, but I have not found one yet.

F. Scoles : Mr. Amos referred to aerial coupling circuits, but in the actual household radio receiver the coupling is to an aerial and an earth. This earth may

vary from an excellent connection to an uncertain contact to a gas pipe, which brings in another variant. How does one include such effects in the analysis?

Mr. Kershaw : I should like to ask the author about the tapped coil type of circuit. I understand that in the calculations the usual turns ratio formula used for iron core transformers were adopted. But in the case of air-cored transformers, however, leakage inductance rather upsets this formula. His suggestion was naturally that the turns ratio should be made larger so as to increase selectivity, and reduce transfer of capacitance, but I rather imagine that accentuates the errors due to leakage inductance. Can he tell me if it has an effect; if so, if it is a very marked effect? Also what is the trend of whatever conclusions he has formed?

K. Dagleish : I should like to ask Mr. Amos if he has had experience of the installation of cathode followers between aerial and receiver. The aerial can be considered as a generator of internal impedance which varies very widely in the medium waves. From calculations I found the impedance varies in the ratio of about three to one. Instead of trying to terminate this variable impedance in some load whose impedance varies similarly, one might try to terminate it in very large impedance, the results across which will be independent of the variants in the internal generating impedance. I found that such a device would be a cathode follower. Has he tried that, or what does he think of it as a method of coupling?

Mr. Reece : Might I just mention one point regarding the high inductance aerial transformer coupling? It is very easy to run into trouble due to resonance of primary circuit at the I.F. frequency, but it is rather difficult to avoid without the use of a series circuit accepted across the aerial terminals.

REPLY TO NORTH-WESTERN DISCUSSION

In answer to Mr. Whalley, I am inclined to agree that too much stress might be laid on the variation of voltage gain with frequency; but here is a point one should watch. I assumed all through in this discussion that the Q of the tuning circuit was independent of frequency, which is not strictly true. If Q's vary at all, one usually finds that they give rather large gain at the high frequency end. If the aerial coupling is going to do the same, one tends to get a receiver with sensitivity approaching that of a communications receiver at the high frequency end, but with marked loss in gain at the other end. If there is much variation, it would be a bad thing. I think it would be better to try to make the gain of the aerial coupling circuit rise with decreasing frequency, so that it offsets that loss and gives an approximation towards constant gain.

In regard to Mr. Friedlaender's queries, in the first place I must point out that in one diagram the Q value is 200. But I have been concerned in this paper almost

entirely with the kind of coil one winds oneself, and I think it will be agreed that a Q of 50 is reasonable, with 100 as a possible maximum. The introduction of dust iron cores will, however, upset some of my arguments. I should, however, like to make this point, that in this subject of aerial coupling circuits, one has so many variables to worry about that some of them have to be tied down, or else considerable mathematical confusion arises. Just think of the variables there can be. Aerial capacitance can vary with different aerials and the tuning inductance from 157 microhenrys. One's tuning capacitance can also vary, so can one's Qs, so can R.F. resistance of coils with frequency. So many things can vary that some of them must be tied down to particular values and assumed to be constant. The only justification I can offer for assuming Q and other things as constant is that without those assumptions I could not have prepared the paper.

The remarks made by Mr. Connett bear on what I

said—that if you have an aerial coupling circuit, and it is to give constant voltage gain over the band, then care must be taken that matching of one type of impedance is made with another of similar characteristics. But I am glad to have the information about the performance of dust iron cores.

In regard to the first point raised by Mr. Exwood, I am afraid I know nothing about the system mentioned. I agree with the second point. If a receiver is being built which will only receive one station, then possibly the tapped coil is the easiest way out of the difficulty. It is easy to calculate what the optimum position of the tapping point is, and one can then get any desired degree of voltage gain ratio and selectivity. In regard to the third question, I must confess I do not know the answer.

The answer to Mr. Scoles' question is that the effect of a long earth wire with a high resistance contact is to put additional inductance and resistance in the generator circuit, and the best thing to do to get rid of them is to have low resistance wire and take it as quickly to earth as possible.

The point raised by Mr. Kershaw is one which I purposely rather skimmed over in the paper, though I have actually devoted some time to it. One is told one cannot use low frequency transformer methods on radio frequency coils, but my experience tends to prove the reverse is the case. As Mr. Kershaw has said, the co-efficient of coupling between primary and secondary

can be far from unity, which tends to cause losses. In other words, there is a big leakage inductance. There is, however, another factor which rectifies it, namely, that the inductance of primary and secondary are no longer directly proportional to the square of the number of turns. The result is that the normal transformer rules do apply, with the exception of reflected capacitance. There it does not apply because of making inductance resonate with the capacitance. Apart from the case of reflected capacitance one can use transformer rules, and get away with it. I am hoping some time in the near future to write an article on that particular point.

The scheme advocated by Mr. Dagleish does not seem very attractive, for the difficulties of watching the low output impedance of a cathode follower to the frequency-dependent dynamic resistance of a tuned circuit seem just as great as those of watching an aerial generator to the tuned circuit. There seems little point in using another valve to find oneself fixed in the same problem at its output terminals.

Mr. Reece raised an interesting point which had not occurred to me. One knows, of course, that if one is using high impedance transformers, one should keep stray capacitance in that winding as low as possible. If an ordinary layer winding is used it is possible it may resonate within the received wave band. If one uses wave winding or some other means of reducing the self-capacitance then it might happen unluckily on the higher frequency.

LONDON SECTION DISCUSSION

M. M. Levy : Will the author give some information regarding the design of an aerial coupled circuit to get the best signal/noise ratio ?

P. Adorian : The author has mentioned an interesting point with regard to variations of voltage gain with frequency. I do not know whether it is generally realised that this variation of voltage gain causes differential amplification of the upper and lower side bands. I do not know exactly what that means in terms of harmonic distortion, but I believe it is considerable; perhaps the author could give an explanation of the point.

W. M. Dalton : Would it not be feasible to employ a type of transformer coupling using condenser transformers instead of inductance transformers ?

Mr. Beatty : Although the author has mentioned various types of coupling, the thing which the average designer of a radio receiver is concerned with, is what type of aerial coupling is the one he should have if he were designing, say, a receiver with 3-gang condensers for sale to the public at a reasonable price, and taking into consideration such things as stability of calibration ?

Mr. Amos has indicated that there are quite a number of difficulties with regard to transfer of capaci-

tance from the aerial, which sometimes varies as the square of the frequency. In one formula, it has been shown that the transferred capacitance is proportional to the frequency raised to the power $3/2$. I should welcome a short summary from the author saying which of the various combinations discussed would be of the greatest assistance to the designer of an ordinary commercial radio receiver.

Mr. Hiscock : With reference to ΔC_s , I should like to know what the author thinks is the maximum possible variation to be expected.

Mr. Harrison : Would it be possible to use dipole aerials in connection with the various tuned circuits the author has shown ?

Mr. Lane : I should like the author to give some information on the effect of resistance in parallel with shunt capacitance, sometimes used in commercial receivers.

Mr. Puckle : Has the author any idea of the size that a medium coil should be ? Would it be possible to have coils so small that they could be wired up in a similar manner to resistors, being completely self-supporting ?

REPLY TO LONDON SECTION DISCUSSION

If Mr. Harrison has in mind medium wave dipoles, a little calculation shows that a 500 ft. dipole is necessary to tune to 300 metres, and that would be very large for an average house. Therefore, I suggest that a non-resonant capacitive aerial would be the thing to use. The problems associated with short wave aerials do not come within the scope of the paper, but these bring in a different technique because it is impossible to use resonant aerials of reasonable dimensions.

Mr. Lane has mentioned aerial coupling circuits which consist of a shunt capacitance in parallel with a shunt resistance. I do not think the shunt resistance is part of the aerial coupling circuit at all. It is merely there to give a d.c. path between the grid of the first valve and its cathode.

In reply to Mr. Dalton about the use of condenser transformers, the comparison between the shunt capacitance coupling and the high inductance transformer coupling really substantiates Mr. Dalton's point.

The point raised by Mr. Adorian concerning the differential amplification of the upper and lower

sidebands is an interesting one, and it had not occurred to me. What it means in terms of audio-frequency distortion I do not know.

I have been asked by Mr. Beatty for recommendations as to a particular type of aerial coupling circuit to use, but it all depends on what is wanted. If one requires high selectivity, and is not worried about voltage gain, then I recommend the use of a shunt capacitance or a high impedance primary radio frequency transformer, but if one is interested solely in voltage gain, then the other types of coupling circuit should be used, namely, series capacitance or R.F. transformer, with a low impedance primary.

I hesitate to answer Mr. Levy. It seems to be a condition of getting a small amount of noise that the greatest voltage gain possible should be obtained. That means poor selectivity.

In answer to Mr. Puckle, coils are getting very much smaller. In the modern receiver, the medium wave coils are frequently only half an inch in diameter, and can often be wired between the tags of a Yaxley type switch.

TRANSFERS AND ELECTIONS TO MEMBERSHIP

The following elections and transfers have been recommended by the Membership Committee since May 3rd, 1946, to August 1st, 1946. The following is the second list published during the current year (1946/7), and in these four months the Committee has considered a total of 153 proposals for election or transfer to Graduateship or higher grade membership.

The following elections and transfers have now been confirmed by the General Council.

Transferred from Associate Member to Full Member

| | |
|---|--------------------------|
| WILLS, Cecil Raymond B.Sc.(Eng.) | Northampton |
| <i>Transferred from Associate to Associate Member</i> | |
| FAIRBAIRN, Archibald John | Scotland |
| FINN, Edward James | Southampton |
| HUNT, Henry Bruce | Crowborough |
| OLIVER, Ernest | London, S.W.11 |
| THOMSON, Francis Paul | Upper Norwood, S.E.19 |

Transferred from Student to Associate Member

| | |
|------------------------------------|--------------|
| THRELFALL, Andrew James Clifton | Burton Joyce |
|------------------------------------|--------------|

Transferred from Student to Associate

| | |
|-------------------------------|----------------|
| DALTON, John | Folkestone |
| DAVIS, Haskel Barshach | Tel-Aviv |
| DEAN, Kenneth Croydon | Croydon |
| HAMILTON, John Stewart | Royston |
| PARTRIDGE, Jack Edward | Wellingborough |
| POULTER, Thomas Geoffrey | Loughton |
| SAGE, Ronald William | Sittingbourne |
| SANYAL, Gitindra Saran, M.Sc. | Assam |
| SHELLEY, Irving John | Nottingham |
| SMITH, Granville | Henlow, Beds. |
| SMITH, Horace William | Grimsby |
| TUNSTALL, Herbert Roy | Chester |
| WEINBERG, Hans W. | Tel-Aviv |

Transferred from Student to Graduate

| | |
|------------------|-------|
| EPSTEIN, Jan Leo | Haifa |
|------------------|-------|

Elected to Full Member

| | |
|----------------------|---------|
| DYSON, Arthur Albert | Edgware |
|----------------------|---------|

Elected to Associate Member

| | |
|---|------------------------|
| BALDWIN, Gilbert | Walsall |
| BATES, Harold Raymond Kingsmill | Guildford |
| BOSWORTH, Alan Mellor | Liverpool |
| BROWN, Leslie Alan, Commander | Southsea |
| CAVE, Sidney Robert | Romford |
| CHAPMAN, John Huntington, B.Sc. | Rhos-on-Sea |
| GALPIN, Frank Harry | Kent |
| MADDOX, Herbert Frederick | Palmers Green, N.13 |
| MCCORMICK, Harold Duncan B.A.(Hons.) | Canada |
| PLANER, Felix Ernest, Ph.D., M.Sc., B.Sc.(Hons.) | London, W.8 |
| QUARRINGTON, Cecil Albert George | Norbury, S.W.16 |
| RAO, M. V. S. | Madras |
| SCHREUER, Walter | London, N.W.11 |
| SLACK, Wilfrid | Reading |
| THORNE, Kenneth Gilbert | Slough |
| WATKINS, Arthur Horace | Brighton |
| WEBB, John Le Plastrier, B.Sc.(Hons.) | Cheltenham |
| WINCHESTER, Charles | Leeds |

Elected to Companion

| | |
|-------------------|---------------------|
| KLEIN, Rene Henri | Hampstead, N.W.6 |
|-------------------|---------------------|

Elected to Associate

| | |
|---------------------------------------|-------------|
| ADAMS, Ian Ross, B.Sc. | Edinburgh |
| AITKEN, William Alexander Sinclair | Staines |
| BAILEY, Reginald Beaton | Bournemouth |
| BUDDEN, George Fothergill | Altrincham |
| BURBERRY, William Herbert | Norwich |

STUDENTSHIP REGISTRATIONS

The following were registered as Student members of the Institution at meetings of the Membership Committee held since May 3rd to August 1st, 1946. In the first four months of the current year (1946/7) the Committee has considered a total of 64 proposals for Studentship Registration. The following have now been confirmed by the General Council.

Student Registrations

| | | | |
|--------------------------------------|--------------------------|------------------------------------|-------------------|
| ALEXANDER, Ronald Geoffrey Morley | Wandsworth, S.W.18 | MARSHALL, Raymond Victor | Alliestree |
| ALI, Ahmad | Agra, India | MATHEWS, Leonard Frederick | Leeds 6 |
| ALLBON, Ernest Edwin | Kings Langley | MITRA, Niharranjan | Bengal |
| BERRY, Geoffrey | Surbiton | MOHEKEY, James Robert | New Zealand |
| BRADLEY, Wilfred | Westcliff-on-Sea | O'HAGAN, Michael | Kingsbury, N.W.9 |
| BROWN, Arthur Malcolm | Queensland, Australia | PALANDE, Vasant | Bombay |
| BROWN, John Albert | Bristol | PASFIELD, Darrell Edgar | Daventry |
| BUCKMAN, Robert Augustus Saka | Accra | PEATFIELD, John Albert | New South Wales |
| COLLIER, William Marshall | Darlington | PRESTON, Herbert John Robert | Southampton |
| ELVEN, Jack Noel | London, W.13 | RAFI, Masud Akhtar | Delhi |
| FARRELL, William Nixon | Jarrow | ROBINSON, Raymond Gray | Salisbury |
| FISHWICK, Harold | Westmoreland | Rippon | |
| HAWKINS, Geoffrey William | Heston, Mddx. | SEARS, John | Potters Bar |
| HITCHCOX William Dudley | Ontario, Canada | SHWARZKACHEL, Moshe | Palestine |
| HODSON, Alfred Ernest Musgrove York | | SMAILES, George | Penarth |
| JAGO, Peter William Claude | Liskeard | SMITH, Thomas Wallace | North Shields |
| JARDINE, William | Chislehurst | STEDMAN, Noel Warneford | South Africa |
| JUBBLE, Pal Singh | Wood Green, N.22 | STRETTON, Arthur Lionel | Nottingham |
| JUDE, Peter Vivian Wilson | Reading | THOMPSON, Robert Frederick | Durban, S. Africa |
| KNIGHT, Barry Peter | Sileby, Leics. | VAIDYANATHAN, G. S., B.Sc. | Madras |
| KNOTT, William Roderick | Brighton | VISWESWARA, Rao Varanasi, B.Sc. | Madras |
| | | WALKER, Arthur Clifford Richard | Greenford |
| | | WILES, Arthur Douglas | East Tilbury |

NOTICES

Birthday Honours

In addition to the Notices in the June Journal, the Council has tendered congratulations to the following members on their appointment as Members of the Most Excellent Order of the British Empire (Military Division) :—

Lieutenant-Commander Thomas Morgan Brangwin, R.N. (Associate Member).

Arthur Frederick Bulgin (Member).

Note.—The General Secretary would be glad to be notified of recent Honours conferred upon members of the Institution which have not yet been published in the Journal.

Mrs. Leslie McMichael

It is with deep regret that we record the death of Mrs. McMichael on August 20th. after a very long illness. On behalf of all members, the Council have expressed sympathy with the President on his bereavement.

First Post-War Radiolympia

The Radio Industry Council announces that it is planning to hold the first post-war Radiolympia in late September or early October, of 1947.

Negotiations are now in train for a tenancy of Olympia in the autumn of 1947 for this purpose.

Election of General Council for 1946/7

In accordance with Article 29 the following members will remain on Council for the year 1946/7 :—

Sir Ernest Fisk (Honorary Member).

E. Cattanes.

Col. J. D. Parker, M.B.E., B.Sc.

W. W. Smith, B.Sc.

G. A. V. Sowter, Ph.D.

G. A. Taylor (Associate Member).

} Members

In accordance with Article 32, the General Council has nominated the following members for the six vacancies which now arise :—

C. E. Bottle, M.B.E. (Member)

Air Comdr. W. C. Cooper, M.A., C.B.E. (Member)

W. E. Miller, M.A. (Member)

J. W. Ridgeway, O.B.E. (Member)

Com. L. A. Brown (Associate Member)

H. E. Drew (Associate Member)

Hon. Treasurer : S. R. Chapman, M.Sc. (Member)

Surrey
London

Surrey
Surrey

Hants
Hants

Oxford

Corporate members wishing to nominate any other duly qualified persons must complete and return the nomination form which was circulated on August 15th, 1946. The form must also be signed by nine other corporate members.

Additional forms may be obtained on application to the Secretary of the Institution, and completed forms must be lodged with the Secretary not later than the first post on Friday, September 6th, 1946.

Radio Trades Examination Board

Following the notice in the Annual General Report the next Radio Servicing Certificate Examination will be held in May, 1947. This examination will be held under new regulations, drawn up jointly by the City and Guilds of London Institute and the Radio Trades Examinations Board, with the object of reducing to a minimum the number of recognised certificates in Radio Service work. This examination will supersede the present examinations in Radio Service Work, held separately by the City and Guilds of London Institute and by the Radio Trades Examinations Board.

On behalf of the board, the Institution's Secretariat will continue to handle the examination arrangements, and application forms and details of the examination may be obtained on application to the Secretary to the Board at 9 Bedford Square, London, W.C.1.

Dinner on October 31st, 1946

The Savoy Hotel have permitted a slight increase in the number of the reservations for the dinner, but it is still imperative that members wishing to attend should apply for their tickets not later than September 15th next.

Members who wish the Institution to obtain hotel accommodation for that night should make their request when applying for their dinner ticket.

Australian Parliament Broadcast

The proceedings of Parliament were broadcast throughout Australia for the first time on July 10th. To help listeners to follow them the newspapers have been publishing explanations of parliamentary procedure and guides to the membership of both Houses. As the Senate did not sit, only the sitting of the House of Representatives was broadcast. A record of the questions without notice asked at the beginning of the sitting, which is usually the liveliest part of the parliamentary day, was rebroadcast during the dinner adjournment.