

No. 96

CRYSTAL SET CONSTRUCTION

SIMPLE INSTRUCTIONS FOR MAKING
NINE CRYSTAL SETS

by **B. B. BABANI**

There is to-day a marked revival of interest in crystal receivers, and this book has been specially prepared to introduce the home constructor to the design and building of the various types. The text is simple and free from technicalities, so that even the young reader may confidently embark on the construction of any of the receivers shown.

CONTENTS

- | | |
|-------------------------------------|---|
| 1. AERIALS. | 9. HIGH SELECTIVITY RECEIVER. |
| 2. EARTHS. | 10. BATTERY AIDED CRYSTAL RECEIVER. |
| 3. CRYSTAL DETECTORS. | 11. MEDIUM AND LONG BAND RECEIVER. |
| 4. COILS. | 12. ULTRA SENSITIVE ALL WAVE RECEIVER. |
| 5. THE BEGINNERS' CRYSTAL RECEIVER. | 13. AN ADVANCED CRYSTAL DIODE RECEIVER. |
| 6. FRAME AERIAL RECEIVER. | |
| 7. LONG DISTANCE RECEIVER. | |
| 8. HIGH GAIN RECEIVER. | |

THERE ARE 12 DIAGRAMS

L O N D O N : BERNARDS (PUBLISHERS) LIMITED



VARIABLE CONDENSER



TUNING COIL



CRYSTAL DETECTOR

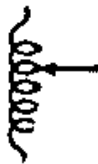

TUNING COIL WITH TAPPINGS



FIXED CONDENSER



SINGLE POLE DOUBLE THROW SWITCH



BATTERY POSITIVE SIGN



SINGLE POLE SINGLE THROW SWITCH



BATTERY NEGATIVE SIGN



DOUBLE POLE SINGLE THROW SWITCH



AERIAL

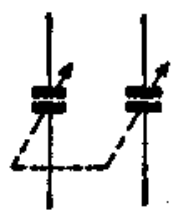

"TWO-GANG" VARIABLE CONDENSER



EARTH



PHONES

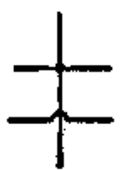

WIRES CONNECTED



WIRES NOT CONNECTED



FRAME AERIAL



SOCKET AND PLUG

FIG. 1 SYMBOLS USED IN THE CIRCUITS DESCRIBED.

I. Aerials.

One of the essentials for satisfactory reception with crystal sets is an efficient aerial. Four different types are suggested and are shown in Fig. 2.

There are several important points to be noted when erecting an aerial for a crystal set.

(1) See that it is suspended as high as possible and is not screened by tall buildings, obstructions, etc.

(2) The aerial itself and the lead-in from the aerial must be adequately insulated. Be sure that the porcelain or plastic insulators do not permit the aerial or lead-in to touch the building, tree, or post from which they are suspended. The lead-in should be brought into the house through an insulated rod.

(3) It is exceedingly important to use insulated copper wire, either single or multi-stranded, for both the aerial and the lead-in.

2. Earths.

An adequate and efficient earth contributes to the good performance of any well-designed crystal set and Fig. 3 shows the best method of obtaining an efficient earth where there is a garden or patch of ground available at a short distance from the receiver.

Obtain a 3-ft. length of $\frac{1}{2}$ -in. galvanised iron pipe and at one end drill a hole right through. Insert a bolt with spring washer and locking nut in the hole. Connect the earth lead-in wire to the bolt; the other end of the lead-in to the earth connection on the receiver. Leave both ends of the pipe open. Insert the end opposite the bolt into the ground vertically until only 3-in. are showing above the surface of the surrounding earth.

It is important to see that the surrounding ground is kept damp, if necessary by occasionally pouring a pint or two of water down the open projecting end of the pipe.

Ready-made copper earthing rods with a pointed end for easy hammering into the earth are sometimes obtainable from radio dealers.

Should a garden not be available, an alternative earth is a cold water pipe coming from a rising main. Simply file very lightly the pipe at the back of the tap and wind the copper wire earth lead-in round the filed part and cover the joint with insulating tape.

In no circumstances should a gas pipe be used for an earth.

3. Crystal Detectors.

Most radio dealers can supply very efficient permanent or semi-permanent crystal detectors of proprietary makes. However, there are always available quite a number of ex-Government surplus units which are called crystal valves and, though these were originally designed for a very different use in service equipment, they are easily adaptable and will give extremely efficient results when used in circuits designed for them. To enable the constructor to purchase suitable types for this purpose—and they cost very little—the following list gives the Government reference numbers.

CV 101, CV 102, CV 103, CV 111, CV 112, CV 113, CV 226, CV 241, CV 246, CV 247, CV 253, CV 291, CV 351, CV 361, CV 364, CV 367, CV 727, CV 749, and CV 1785.

One of the satisfactory proprietary makes of this class of crystal detector is the BTH CS7A, which, incidentally, is the commercial equivalent of the CV 253.

For all these Government types, one connection should be made to each end by arranging a holder to fix them into or by carefully soldering the appropriate connecting wires to each end.

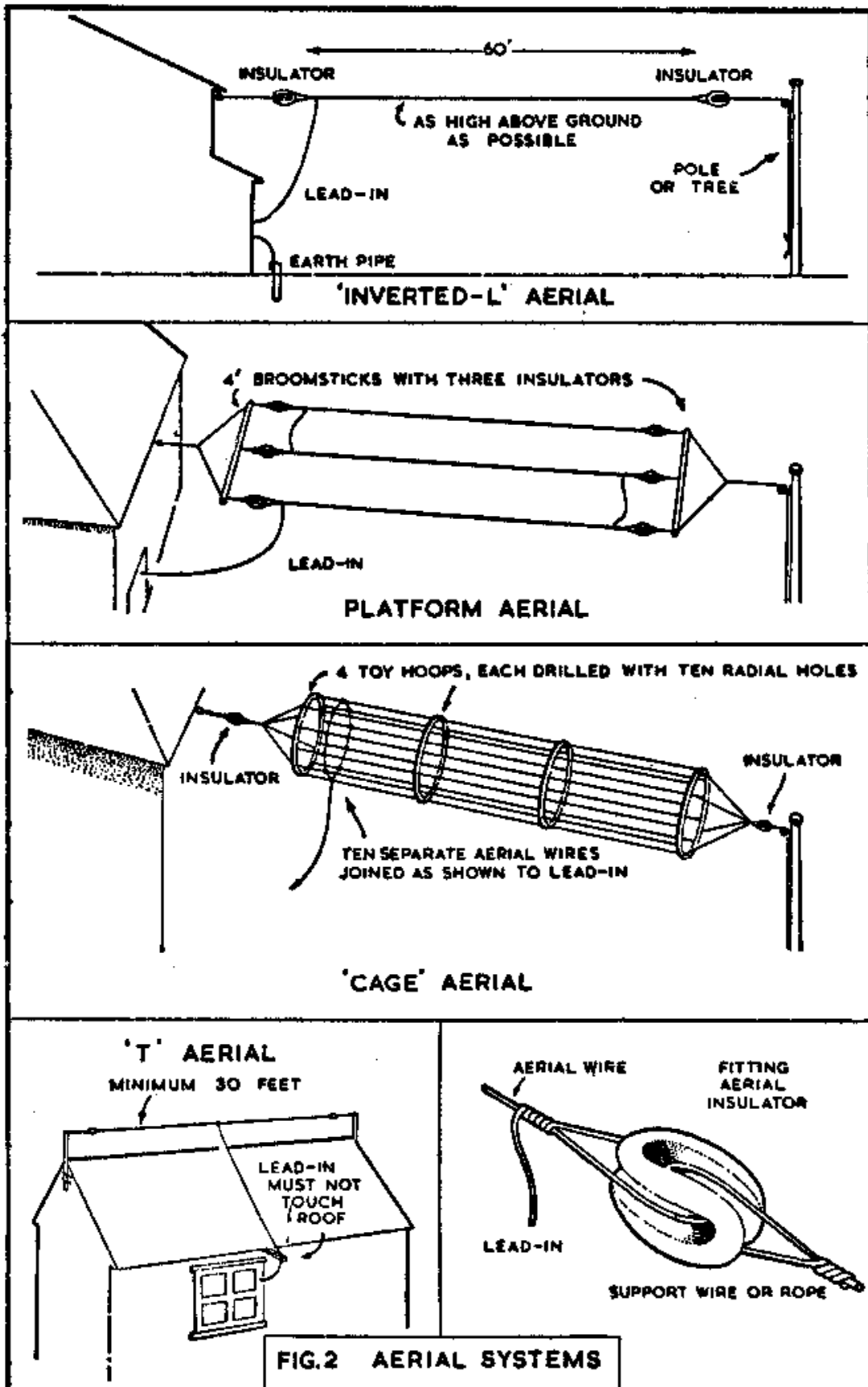

FIG.2 AERIAL SYSTEMS

4. Coils.

In Fig. 3 two methods are shown of fixing the coil to the chassis. However, the ingenious constructor may evolve another arrangement.

The important thing to remember is that the coil should be fixed so that it is completely insulated from the metal chassis that may be used.

It is also important to remember that if a metal chassis is used, one must see that all components and wiring, with the exception of earth connections, are adequately insulated from this chassis so as to make sure that no short circuits take place. It is recommended that all crystal sets should be built on a panel, and that both panel and chassis should be of bakelite, paxolin or perspex, as these three materials are efficient insulators in themselves.

5. The Beginners' Crystal Receiver.

The popularity of the crystal receiver among beginners is undoubtedly due to the very modest outlay necessary, and the ease with which such receivers may be built. It is not always appreciated that, to obtain worth while results,

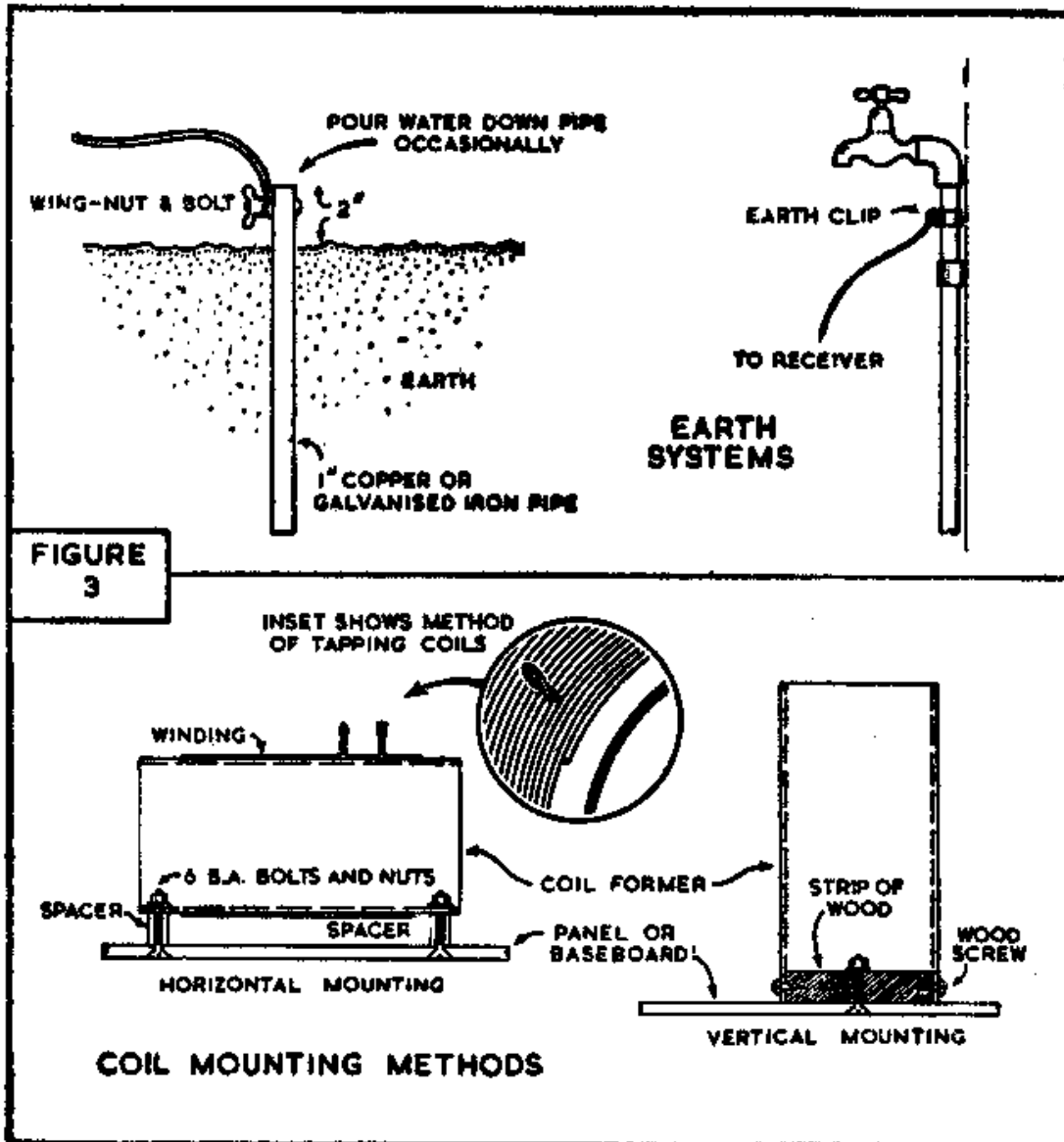

far more care in avoiding losses is necessary than with a three or four valve receiver. One reason for this is the fact that the crystal receiver can offer no help by way of amplification and it is therefore dependent on an efficient aerial/earth system, low loss design within the receiver itself, and the use of sensitive headphones. The experience gained is well worth the time expended since, when more ambitious receivers are attempted, the constructor will remember the benefits gained by efficient construction and installation with the result that each receiver attempted will be an instrument capable of giving a first class performance.

Losses within the receiver itself may be considerably reduced by efficient coil design. Unfortunately, selectivity is a factor which must not be overlooked; it is this factor which governs the sharpness of the tuning and permits the separation of adjacent powerful stations. The greater the selectivity, the greater the ease with which signals may be separated; but at maximum selectivity the received signals are at minimum strength. In Fig. 4, the coil is tapped at four points, which enables the best point between selectivity and sensitivity to be chosen. The nearer the aerial tap to the earth end of the coil, the greater the selectivity. The pre-set condenser C1 also aids selectivity; at minimum capacity the selectivity is high, and *vice versa*.

Used in conjunction with the coil taps, the constructor should have no difficulty in selecting a condenser setting and tapping point which permit the reception of strong signals and at the same time effect the required separation of powerful stations.

The coil is constructed on a former 3-in. diameter \times 2-in., and consists of 50 turns 36 S.W.G. enamelled wire close wound and tapped at every tenth turn. These taps are brought out in the form of loops twisted firmly so that there is no actual break in the winding continuity. After completion the winding may be painted with Durafix to prevent any movement, and the taps and two free ends cleaned with emery cloth to remove the enamel. The layout and wiring is shown in Fig. 4. The headphones should have a resistance of some 4,000 ohms or more and should be of reputable manufacture. Any of the materials previously described are suitable for use with this receiver.

C2 .0005 variable condenser.	2 oz. 30 S.W.G. enamelled copper wire.
C1 .0002 pre-set condenser.	
C3 .001 mica condenser.	1 Coil former 3-in. dia. \times 2-in.
1 Crystal detector, semi-permanent pattern.	1 Ebonite or Bakelite panel 6-in. \times 5-in. \times $\frac{1}{2}$ -in.
	4 terminals, connecting wire, etc.

6. Frame Aerial Receiver for Local Station use on Medium wave bands.

This receiver was specially designed for constructors who are within 5 to 10 miles of a powerful station and who have no facilities for constructing a good outdoor aerial.

The frame itself consists of two $\frac{1}{2}$ -in. \times $\frac{1}{2}$ -in. square section wooden rods each 36-in. in length. These are placed together at their centre line to form a cross; they are fastened by a nut and bolt and these in turn pass through an upright piece of wood $\frac{1}{2}$ -in. \times 1-in. section 2-ft. in length. This upright support is then screwed into a baseboard 8-in. \times 8-in. \times 1-in. thick. At each of the arms of the 36-in. cross a 4-in. strip of $\frac{1}{2}$ -in. square section wood is placed. Reference to Fig. 5B will give the details of the construction of this aerial quite clearly.

It will be noted that approximately 85-ft. of 20 S.W.G. double cotton-covered wire are required for the inductance to cover the medium wave broadcast band. The wire should be wound around the four crossbars, thereby creating

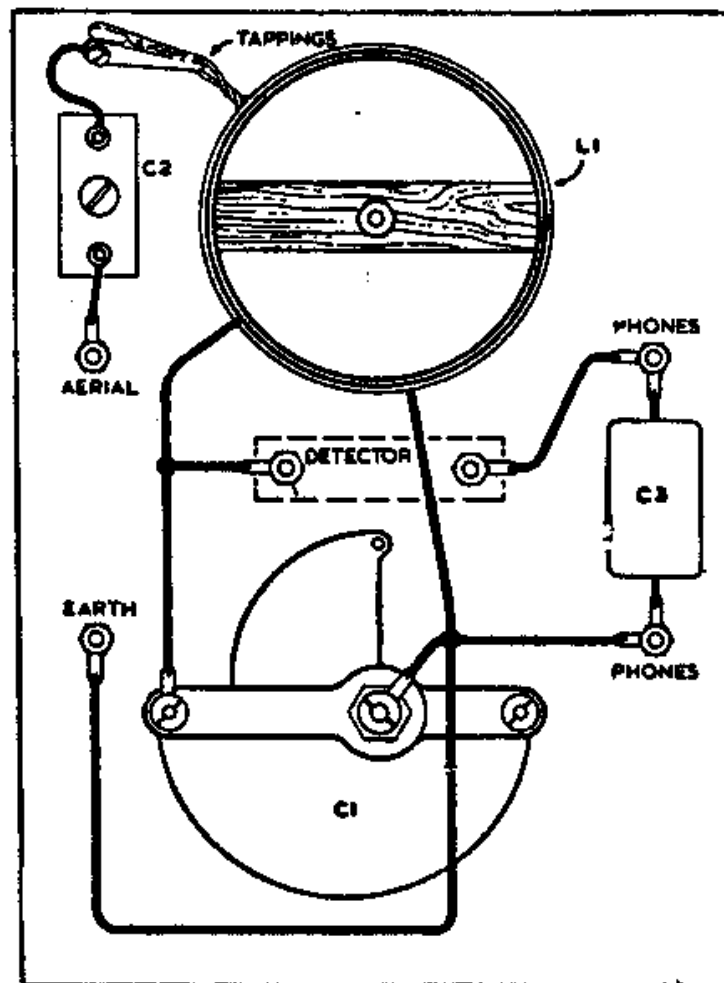
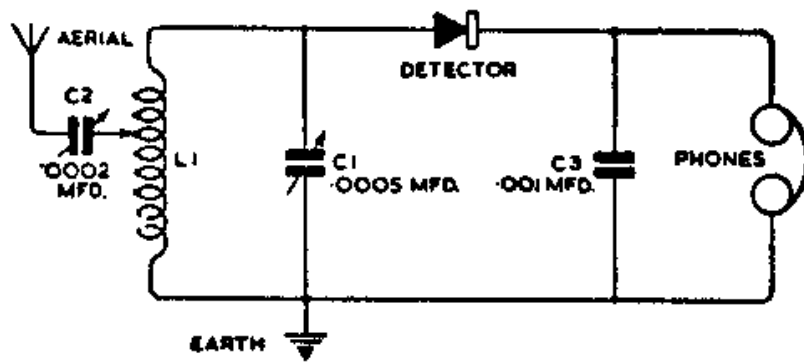

FIG. 4 THE BEGINNER'S CRYSTAL RECEIVER.

a square wire frame, and each turn of the wire should be spaced approximately $\frac{1}{4}$ -in. The best way to effect this spacing accurately is to file on the 4-in. crossbars a number of small nicks at $\frac{1}{4}$ -in. intervals. The two ends of the wire should then be brought down on the two terminals which may be screwed into the baseboard and two leads taken from there to the crystal set itself.

The actual set may be constructed on a small ebonite, paxolin or perspex panel 8-in. \times 5-in. which may be screwed to one side of this base supporting piece of wood, thereby making the set virtually self-contained except for the earphones. Fig. 5A shows the circuit of the receiver.

To obtain the best results with this receiver, the aerial should be rotated by hand until the signals become loudest.

1 Semi-permanent crystal detector.	1 pair of high sensitivity earphones.
C1 1 .0005 mfd. variable condenser.	85-ft. to 90-ft. of 20 S.W.G. double cotton covered wire. (8oz.)
C2 1 .0005 mfd. fixed condenser.	Sufficient connecting wire for wiring purposes.
1 condenser dial marked 0 to 100 or 0 to 180.	

7. Long Distance Receiver.

This receiver has been specially designed to achieve high sensitivity. With a sufficiently good outdoor aerial effective reception has been obtained up to 150 miles.

The circuit is quite straightforward, as can be seen from Fig. 6 and the only special point is in winding the coil L1.

This coil consists of a 2 $\frac{1}{2}$ -in. diameter former on which are wound a total of 51 turns using 24 S.W.G. double cotton wire. Starting at one end, tap every two turns until there are eight taps; wind a further 15 turns and tap; then a further 10 turns and tap; finally, add 10 turns to end the winding. The wire should be close wound, *i.e.*, with turns touching.

To obtain the best results, the two crocodile clips A and B should be tried on the various coil taps until the loudest reception is obtained. It may be found in use that the loudest reception of any particular station causes another station to be heard at the same time; care should, therefore, be taken to select the appropriate tapping point to separate any two powerful stations that may interfere with one another.

4 oz. 24 S.W.G. DCC copper wire.	1 Permanent crystal detector.
Coil former 2 $\frac{1}{2}$ -in. dia. \times 3-in.	C3 .001 fixed condenser.
C1-2 single variable condensers .00035 mfd.	1 pair of high sensitivity earphones (preferably between 4,000 ohms and 8,000 ohms impedance).
2 Condenser dials marked from 0 to 100 or 0 to 180.	2 Crocodile clips.

8. High Gain Receiver.

This receiver has been designed to give good reception up to 50 miles distance from any normal power broadcasting station in the medium band. It is a very selective circuit and will therefore enable the user to separate closely situated stations.

It will be noticed in the circuit (Fig. 7) that the variable condenser C1, has an on/off switch S1 to throw it out of circuit if necessary. It is used to increase the selectivity of the receiver and, in operating, it should be tried with this condenser either in or out of circuit on the various tappings on the coil L1.

L1 consists of 90 turns of 22 S.W.G. double cotton covered wire wound on a 2-in. diameter former and tapped every ten turns. L2 separately wound on a 2-in. former, consists of 90 turns of 22 S.W.G. double cotton covered wire, also tapped as L1. The components required are given on page 7

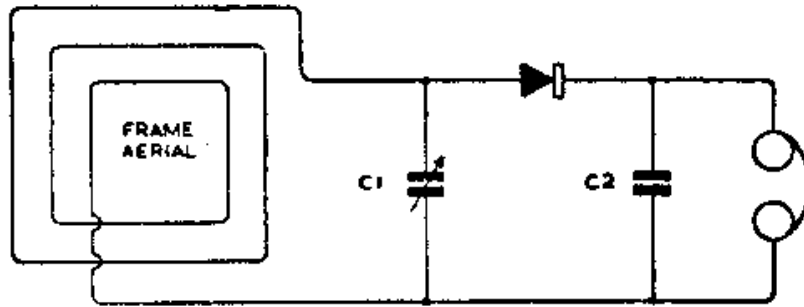

FIG. 5A FRAME AERIAL CRYSTAL RECEIVER

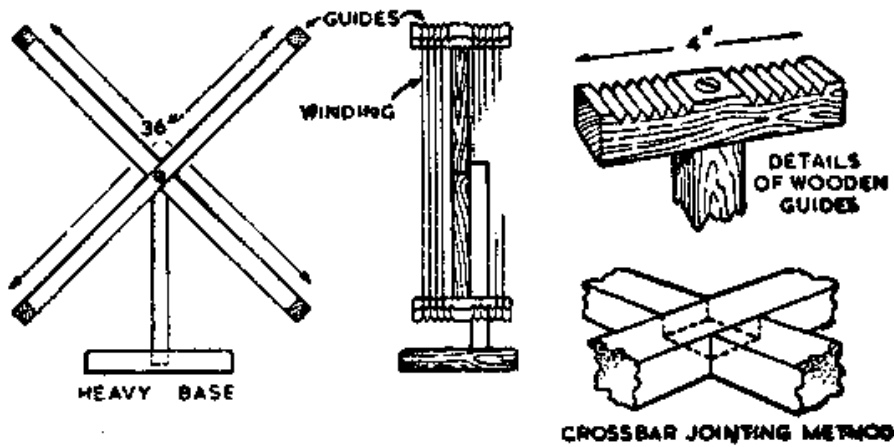

FIG. 5B. DETAILS OF FRAME AERIAL

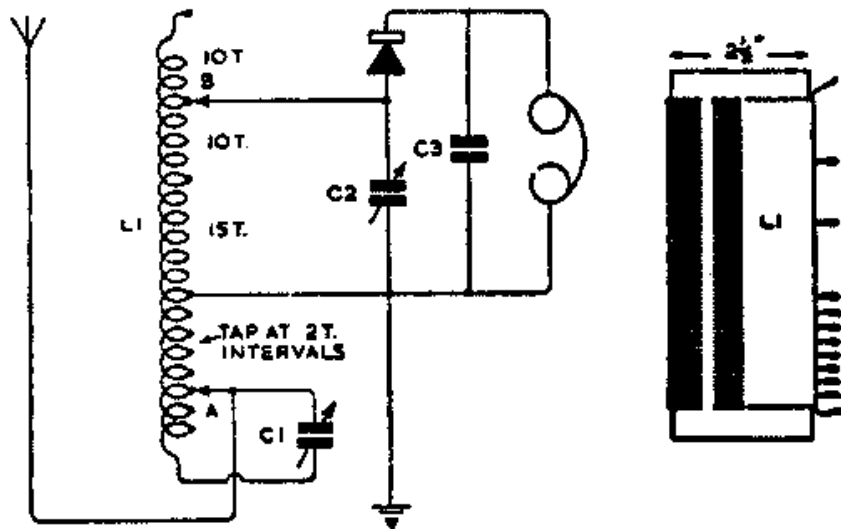

FIG. 6 LONG-DISTANCE CRYSTAL RECEIVER

- | | |
|--|--|
| C1-2 Single variable condensers
.00035 mfd. | 1 Pair of high sensitivity earphones.
8 oz. 22 S.W.G. DCC. |
| S1 Single pole single throw switch. | 2 Dials for variable condenser
marked 0 to 100 or 0 to 180. |
| C3 .0001 preset condenser. | |
| 1 Permanent crystal detector. | |
| C3-4 .001 mfd. fixed condenser. | |

9. High Selectivity Receiver.

This circuit (see Fig. 8) is for use in high saturation strength areas where it is desired to separate powerful stations. The circuit is not complicated and is extremely effective.

It will be noted that C1 and C2, each .00035 mfd. capacity, are 2 gang unit.

The only special point in this set is the design of coils L1, 2 and 3, which are constructed as follows: L1, 60 turns of 22 S.W.G. double cotton covered wire on a 3 x 4 inches former tapped every five turns; L2, 15 turns of 22 S.W.G. double cotton covered wire on a 3 x 6 former; and L3, 85 turns of 22 S.W.G. double cotton covered wire wound on the same former as L2, the two windings being separated by approximately 1/4-in. (see Fig. 8).

Note that the aerial lead is brought down to one of the tapings on wire L1. This should be tried on each of the tapings and the one giving the required selectivity should be used.

- | | |
|---|------------------------------------|
| C1-2 2-gang variable condenser
.00035 mfd. | C3 .0005 fixed condenser. |
| 2 3-in. formers for coils L1-2-3. | 1 Semi-permanent crystal detector. |
| 8 oz. 22 S.W.G. DCC. | |

10. Battery-aided Crystal Receiver.

Fig. 9 shows a design which utilizes a 9-volt grid bias battery to improve performance.

The charge built up in the .02 mfd. fixed condenser is changed to a positive current when it passes through the coil L1. This, in turn, is superimposed on the positive charge that is commencing to be rectified by the crystal detector and thereby increases the signal strength.

Coil L1 consists of a 4-in. diameter former wound with 85 turns of 24 S.W.G. double cotton covered wire tapped at 5, 25, 45 and 65 turns from the earth end. The earth end and these four taps are brought out to five small sockets and the connection from the earth is taken to a small socket. The plug should be tried in each of the five positions to find which one gives the greatest signal strength.

The 9-volt battery is connected across the .02 mfd. condenser and special care should be taken to see that the battery is connected correctly, *i.e.*, negative pole to earth.

- | | |
|----------------------------------|--|
| 1 Permanent crystal detector. | C3 Fixed condenser .02 mfd. |
| 1 4-in. dia. x 3-in. former. | 1 pair of high sensitivity headphones. |
| 8 oz. 20 S.W.G. DCC copper wire. | 1 Clix plug. |
| C1 Variable condenser .0005 mfd. | 5 Clix sockets. |
| C2 Fixed condenser .005 mfd. | 1 9-volt grid bias battery. |

11. Medium and Long wave band Receiver.

This set has been designed for reception on two wave bands.

Care must be taken in winding the coils L1, 2, 3 and 4. These are wound on a single 3-in. diameter former. L1 consists of 30 turns of 28 S.W.G. DCC tapped at 8, 16 and 24 turns. L2, 60 turns of 32 S.W.G. DCC. L3, 40 turns of 28 S.W.G. DCC, and L4, 80 turns of 32 S.W.G. DCC. All are close wound and are separated from each other as follows: between L1 and L2, 3/16-in.;

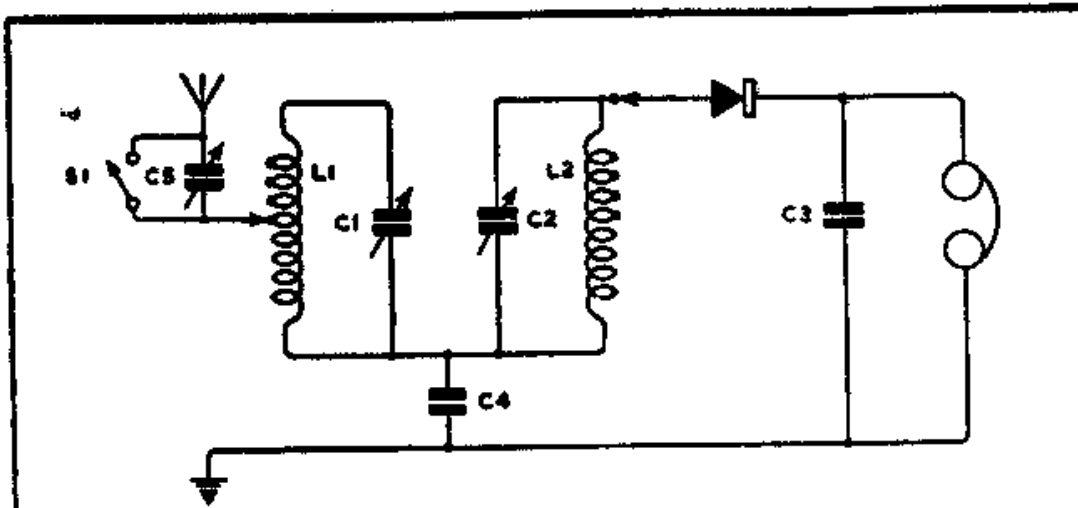

FIG. 7 HIGH-GAIN CRYSTAL RECEIVER

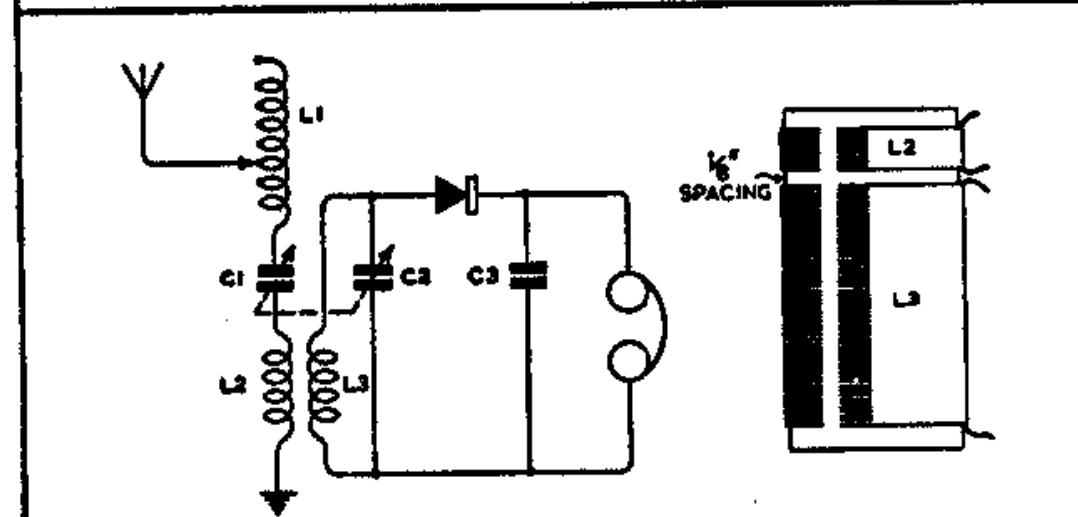

FIG. 8 HIGH SELECTIVITY CRYSTAL RECEIVER

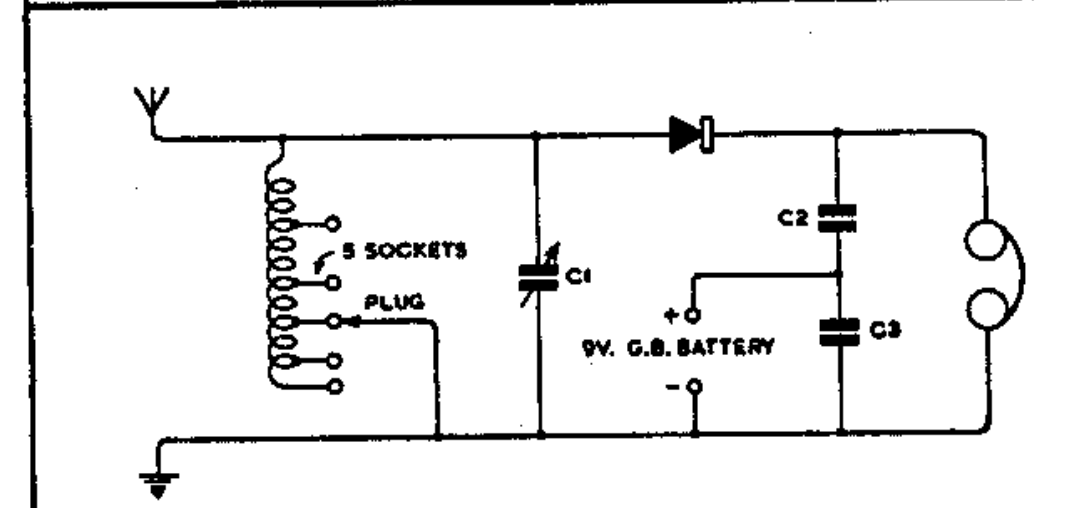

FIG. 9 BATTERY-AIDED CRYSTAL RECEIVER

between L2 and L3, 1-in.; and between L3 and L4, 3/16-in. See Fig. 10.

C1-2 single variable condensers
.0005 mfd.

2 Variable condenser dials marked
0 to 100 or 0 to 180.

1 Clix plug.

3 Clix sockets.

S1 Single pole double throw switch.

C3 .001 mfd. fixed condenser.

1 Pair of high sensitivity earphones.

1 3-in. dia. × 8-in. former.

2oz of both 28 and 32 S.W.G.
double cotton covered wire to
make these 4 coils.

1 Permanent crystal detector.

In use, the plug should be tried in each of the three sockets to find the point which gives the best results. The switch is used as a wave band change switch.

12. Ultra Sensitive All Wave Receiver.

The receiver shown in Fig. 11 is for long distance reception. It is a novel circuit and, though apparently complicated in construction, it is really very simple to assemble with the minimum of tools and labour.

It will be seen from the circuit diagram that there are two banks of sockets, five black and six red. When using this set the appropriate black and red plugs should be inserted in whichever of the similar coloured sockets give the best results. The coil is quite easy to construct and consists of a primary winding which is inserted at the earth end of the secondary winding. For the medium wave band, the secondary winding L2 consists of 54 turns of 20 S.W.G. enamelled or cotton covered wire. This coil has four taps in addition to the starting point and the end connection, and these taps are taken at six turns, 14 turns, 27 turns and 40 turns from the earth end. The taps are taken out and a connection is made to an appropriate socket, as shown in the diagram.

The coil is wound on a 3-in. diameter former which may be a paper tube, bakelite, paxolin or perspex, and spacing is approximately 17 turns to the inch.

For short wave work down to about 30 metres, L2, the secondary coil, will consist of the same diameter former wound with 15 turns of the same gauge wire, the four taps being taken at 3, 6, 9 and 12 turns from the earth end.

L1, the primary coil, is used for both wave bands and consists of 11 turns of similar gauge wire to that used for L2, wound on a 2-in. × 1-in. former, the winding to be spaced the same as L2. The coil is then inserted at the earth end of whichever secondary coil L2 is being used.

The crystal detector may be one of the semi-permanent types freely available to-day; the old-fashioned cat's whisker pattern; or one of the silicon permanent detectors which are sold by many surplus dealers.

The 'phones should be of a standard type 4,000 ohms impedance although 'phones of other values will probably operate quite satisfactorily with this powerful receiver. It should, however, be stressed that the better the headphones used, the more satisfactory the reception.

Coils for other wave bands may be experimentally designed by the constructor, remembering that four tappings are advisable for the secondary coil L2.

A long aerial is very desirable with this receiver, placed as high as possible. It is recommended that a minimum length of 70-ft. be allowed, to include the aerial and lead-in.

The values of the components are shown in the following components list. The constructor should experience no difficulty in obtaining excellent results from this cleverly designed receiver.

C1 .0005 variable condenser.

C2 .002 fixed condenser.

1 semi-permanent crystal detector.

1 coil former 3-in. dia. × 4½-in.

1 coil former 2-in. dia. × 1-in.

½ lb. 20 S.W.G. enamelled or DCC
copper wire.

6 red wander plug sockets.

6 black wander plug sockets.

1 red and 1 black wander plug.

Headphones, terminals, connecting wire

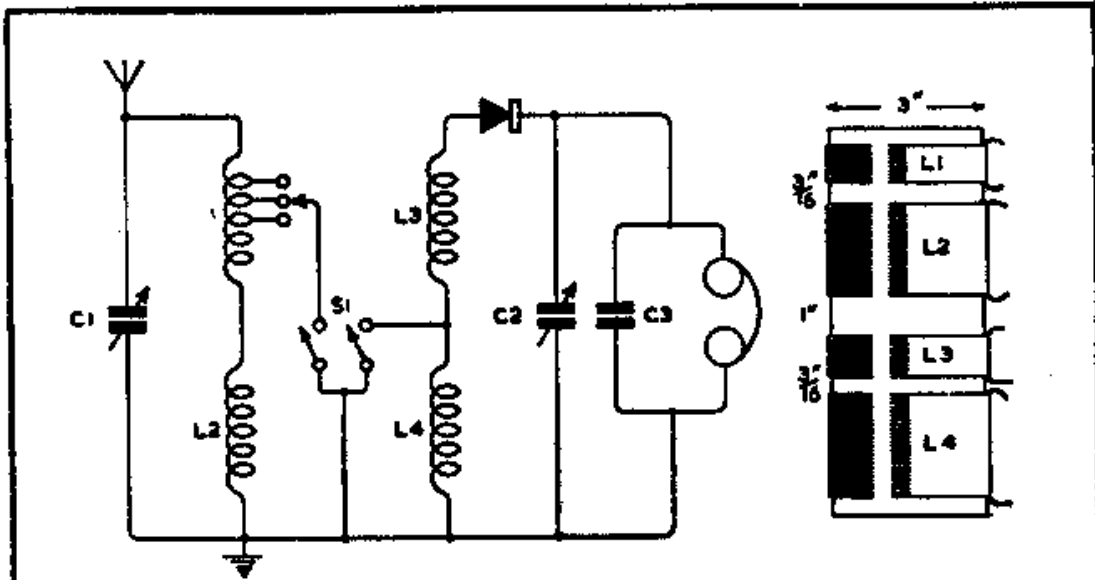

FIG. 10 MEDIUM AND LONG-WAVE CRYSTAL RECEIVER

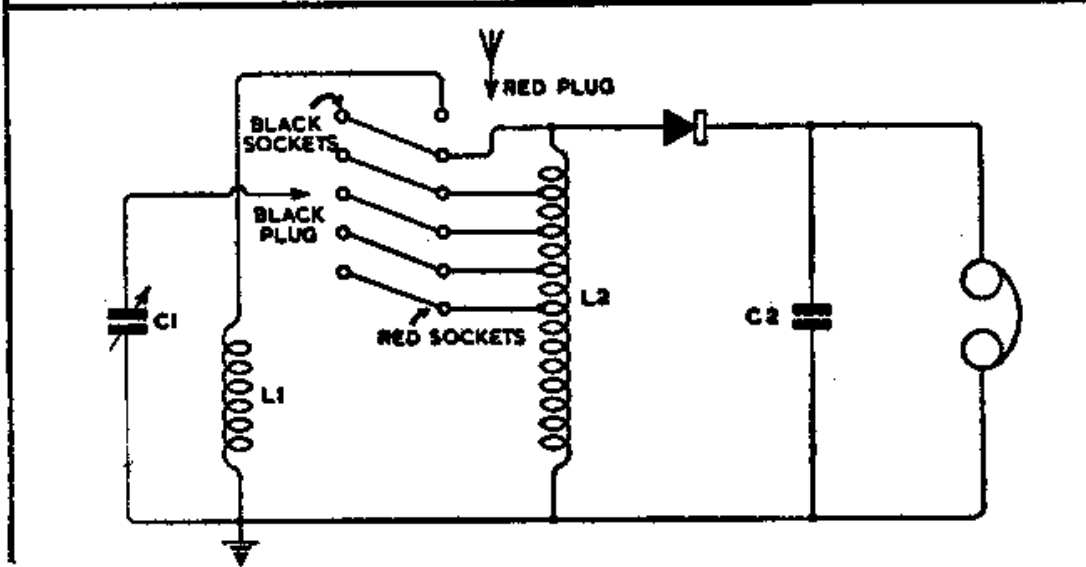

FIG. 11 ULTRA-SENSITIVE ALL-WAVE CRYSTAL RECEIVER

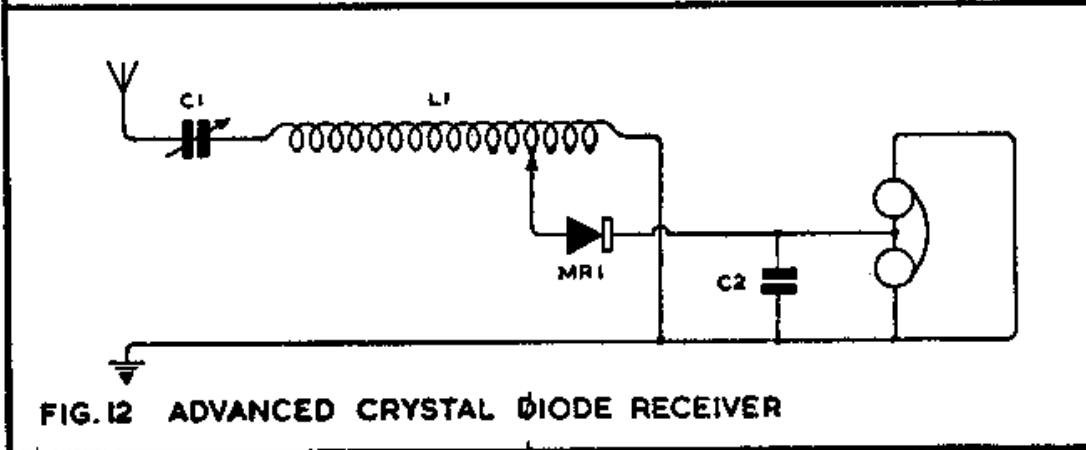

FIG. 12 ADVANCED CRYSTAL DIODE RECEIVER

13. An Advanced Crystal Diode Receiver.

The modern crystal diode of the radar type does not require any adjustment and thus has a distinct advantage over the ordinary crystal detector which needs delicate adjustment—even the semi-permanent type.

Such crystals are now obtainable on both the regular and the surplus markets, and a popular type is the B.T.H. CS7A silicon crystal (also coded as CV 253).

A rather different circuit from the usual crystal set arrangement is needed to suit the characteristics of a crystal diode. The diode must be tapped on to the tuning coil, and it is found that the tuning circuit itself gives best results if a series-tuned acceptor circuit is used. The circuit of a radar crystal receiver is shown in Fig. 12. The type of aerial used with this circuit has a very great bearing on the behaviour of the receiver for, in effect, the tuned circuit, with a series resistance equivalent to the reflected crystal load resistance, is in series with the capacitance of the aerial to earth and the aerial's effective series resistance.

At resonance—when the combination is tuned to any particular signal—the inductance resonates with the capacitances of the tuning condenser and the aerial in series, and the final effect is that the reflected load of the crystal, in series with the coil's R.F. resistance, is paralleled across the aerial's series resistance.

For maximum power transfer, the crystal load resistance must be made equal to the sum of the aerial series resistance and the coil R.F. resistance, and so the method in which the crystal is tapped into the tuning coil, and the exact capacitance required to tune the receiver to any required signal, must depend to a very great extent on the aerial itself.

At the same time the crystal resistance varies with the signal strength, the resistance being high for weak signals and dropping by as much as 50 per cent. and more for strong signals, so that this effect also has a bearing on the correct coil tap. The output impedance of the crystal also varies similarly, affecting the matching of the headphones into the crystal diode, and so for any set of conditions, the receiver requires to be matched up to both the aerial and the signal being received for best results. This would mean a series of coil taps and (theoretically, not practically) a matching transformer between the diode and the headphones; but in practice it will be found that a receiver using standard parts can be built up to give very good results under various conditions.

It has been shown already that the tuning of the receiver depends to a great extent on the characteristics of the aerial, and while a .0005 mfd. variable capacitor is shown in Fig. 12 as the tuner, the constructor must be prepared to experiment with different capacitance values until the required station is tuned in. The range of reception given by the receiver is quite good, if a really long and high aerial, and a good earth connection, are used; but no more than the local station signal can be expected, and the tuning therefore must be adjusted to suit the station frequency.

It must be mentioned that the headphones are shown parallel connected. High resistance headphones of the 4,000 ohm type must be used, and if two of these are connected in parallel rather than in the more usual series method, they will provide a roughly accurate match to the crystal. If more than one pair of headphones are to be connected in, then the pairs of headphones may be left series connected in the usual manner, the sets of headphones being connected in parallel.

The capacitor across the headphone terminals completes the crystal R.F. circuit, and any value between about 0.001 and 0.005 mfd. will serve. The higher capacitance will, of course, by-pass some of the higher audio frequencies, so

that if good steady reception is obtained some experiment with this condenser is also worth while.

C1, .0005 mfd. variable condenser.

M.R.1 CV 253 Crystal diode.

C2, .005 mfd. fixed condenser.

Coil former $1\frac{1}{4}$ -in. dia. \times $4\frac{1}{4}$ -in.

4oz. 26 S.W.G. enamelled copper wire.

Coil details are as follows: 150 turns of 26 S.W.G. tapped at 20, 25, 30, 35, 40 and 45 turns from the earth end. At each tapping-point the wire should be twisted up into a loop and the winding then continued without breaking the wire; when the coil is completed and the ends anchored the tapping loops can be bared.

BERNARDS RADIO BOOKS

No.		Price
56.	Radio Aerial Handbook	2/6
57.	Ultra-Shortwave Handbook	2/6
58.	Radio Hints Manual	2/6
64.	Sound Equipment Manual	2/6
68.	Frequency Modulation Receivers' Manual	2/6
73.	Radio Test Equipment Manual	2/6
83.	Radio Instruments and their Construction	2/6
96.	Crystal Set Construction	1/-
99.	One Valve Receivers	1/6
100.	A Comprehensive Radio Valve Guide, Book 1	5/-
103.	"Radiofolder" A. The Master Colour Code Index for Radio and T.V.	1/6
104.	Three Valve Receivers	1/6
107.	Four Valve Circuits	1/6
108.	Five Valve Circuits	2/6
121.	A Comprehensive Radio Valve Guide, Book 2	5/-
123.	"Radiofolder" F. The Beginners' Push-Pull Amplifier	1/6
126.	Boys' Book of Crystal Sets and Simple Circuits	2/6
129.	Universal Gram Motor Speed Indicator	1/-
134.	F.M. Tuner Construction	2/6
135.	All Dry Battery Portable Construction	2/6
138.	How to Make F.M. and T.V. Aerials, Bands 1, 2 and 3	2/6
141.	Radio Servicing for Amateurs	3/6
143.	A Comprehensive Radio Valve Guide, Book 3	5/-
145.	Handbook of AM/FM Circuits and Components	2/-
146.	High Fidelity Loudspeaker Enclosures	5/-
147.	Practical Tape Recording Handbook	5/-
148.	Practical Transistor Receivers, Book 1	5/-
149.	Practical Stereo Handbook	3/6
150.	Practical Radio Inside Out	3/6
151.	Transistor Superhet Receivers	7/6
155.	Portable Transistor Radio and Radiogram	2/6
156.	Transistor Circuits Manual, No. 1	2/6
157.	A Comprehensive Radio Valve Guide, Book 4	5/-
158.	Radio, Television, Industrial Tubes, Semiconductor and Diodes Equivalents Handbook (206 pages)	9/6
159.	Realistic High Fidelity	5/-
160.	Coil Design and Construction Manual	5/-
161.	Radio, Television and Electronics Data Manual	3/6
162.	High Fidelity Stereo Gramophone	5/-
163.	Transistor Circuits Manual, No. 2	2/6
164.	High Fidelity Tape Recorder for the Home Constructor	2/6
165.	Hartley on Hi-Fi, Book 1, Radio Tuners	5/-
166.	Public Address Systems	2/6
167.	Transistor Circuits Manual, No. 3	2/6
168.	Transistor Circuits Manual, No. 4	2/6
169.	Hi-Fi Transistor F.M. Tuner for the Home Constructor	3/6
170.	Transistor Circuits for Radio Controlled Models	7/6
171.	Super Sensitive Transistorised Pocket Set Construction	3/6
172.	International Radio Stations List	2/6
173.	Practical Transistor Audio Amplifiers... ..	3/6
174.	Transistor Subminiature Receivers Handbook	5/-
175.	Transistorised Test Equipment and Servicing Manual	3/6
176.	Transistor Audio Amplifiers Manual	6/-
177.	Modern Transistor Circuits for Beginners	7/6
178.	Comprehensive Radio Valve Guide, Book 5	6/-
179.	Transistor Circuits Manual No. 5	5/-
180.	British Semiconductor Survey	15/-
181.	22 Tested Circuits Using Micro Alloy Transistors	5/-
182.	"At A Glance" Radio Valve & T.V. Tube Equivalents... ..	3/6
183.	How to Receive Foreign T.V. Programmes on your Television Set by simple Modifications	5/-
	Resistor Colour Code Calculator	1/6
	Engineers' Reference Tables	1/6
	International Radio Tube Encyclopaedia—3rd Edition	63/-