

BBC ENGINEERING

Number 91 July 1972

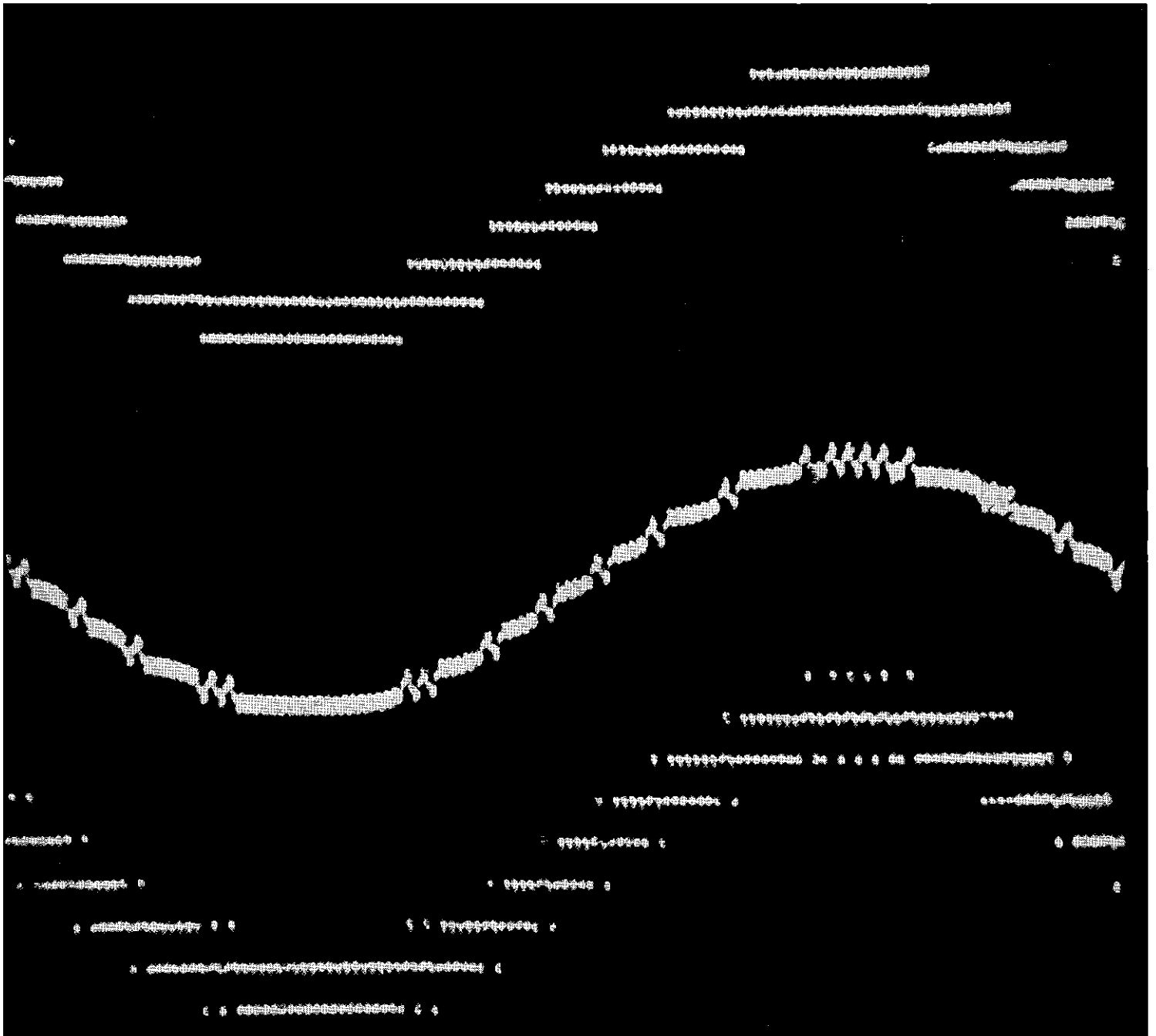

BBC Engineering

including Engineering Division Monographs

A record of BBC technical experience and developments
in radio and television broadcasting

Published approximately four times per year by
BBC Publications,
35 Marylebone High Street,
London W1M 4AA
ISBN 0 563 12357 5

Edited by
BBC Technical Publications Section,
Harewood House,
Hanover Square,
London W1A 1AA

Printed by
The Broadwater Press Ltd,
Welwyn Garden City,
Herts.

Price
40p or \$1.00 per issue post free
Annual Subscription
£1.50 or \$4.00 for 4 issues post free

Articles are copyright © 1972 by the
British Broadcasting Corporation
and may not be reproduced in whole
or part without written permission.

The cover photograph shows waveforms in the coding and
decoding processes in delta modulation, using a 1 kHz sinu-
soidal input signal. An article on delta modulation appears
on page 4 of this issue.

Contents

Editorial: Towards Television-Camera Quality from 16mm Film	2
Principal Articles	
Delta Modulation for Sound-Signal Distribution: A General Survey C. J. Dalton	4
Pre-programming of Telecine Controls D. J. M. Kitson, R. H. Spencer, A. B. Palmer, J. R. Sanders, and M. Weston	15
The Suppression of V.H.F. Harmonic Interference from H.F. Broadcast Transmitters D. I. Price	20
Short Items	
Vertical and Horizontal Aperture Correction for 16mm Flying-Spot Telecine Channels	14
An Important Patent Lawsuit	25
Colour Negative in the Telecine	26
Acoustic Modelling	26
Hybrid Quadrature Modulation (H.Q.M.): An Efficient System for M.F./L.F. Broadcasting	27
A New Means of Remotely Controlling Unmanned Television Cameras J. A. Kett	27

The major contributions are preceded by individual lists of
contents.

Towards Television-Camera Quality from 16 mm Film

The history of colour film in television has been one of continuing technical development. Film stocks, lenses, cameras, processing and printing controls and telecine machines have all been improved, in many cases to the benefit of both the 16 mm and 35 mm gauges.

For the first two years after the 1967 start of colour on BBC-2 both gauges were extensively used; 16 mm for mobility and 35 mm for technical quality. By 1969, however, there was strong pressure for a wholly 16 mm operation; 16 mm film was convenient to use, its quality was improving and with the imminence of colour on BBC-1 in November 1969 the economy of 16 mm operation became increasingly important.

An investigation was therefore started to find ways of raising 16 mm quality to a fully acceptable standard and of reducing the variability experienced under practical conditions. It covered all stages of the film system, from the camera lens to the telecine channel, and all interests were involved including the film staff and the operational and specialist engineers.

In comparison with 35 mm film, the smaller 16 mm format implies, for the same film emulsion and perforation accuracy, lower resolution, greater visibility of film grain and increased picture unsteadiness. The investigation was concentrated on these problems; it was also directed at the negative/positive system, since this is generally used by the BBC except for news filming.

Resolution

A test chart was prepared incorporating horizontal and vertical gratings, and a step wedge; these were located in the central area and set in a grey background. The chart was filmed in the workshop using fixed focal-length and zoom lenses and also on a variety of locations. The negatives and prints were analysed on a recording microdensitometer and the modulation level of the gratings was corrected, by reference to the step wedge, to take account of changes in contrast due to the photographic process. Several conclusions emerged.

First, the viewfinder of a 16 mm camera is not ideal for focusing, particularly under location conditions. The scope for improvement appears limited, but a number of different focusing-screen materials were investigated and on comparative statistical tests one new material has produced promising results. Field trials will begin shortly on six cameras.

Secondly, zoom lenses develop appreciable variations in

performance with age. It is therefore important to have not only the means of checking these lenses precisely when they are new or undergoing overhaul, but also a rapid method of verifying at regular intervals that they meet certain minimum standards. As a result of the tests a number of older lenses were replaced or overhauled and a rapid certification system is being set up using test patterns and a television camera.

The analysis of the prints showed that the combined loss due to the printer and print stock was smaller and less variable in the horizontal than in the vertical direction. The variability in the vertical direction is due mainly to misregistration between the negative and positive films during printing, and indicates the need for close control of the mechanical tolerances on contact printers.

A major improvement in the sharpness of the television picture resulted from the use of a newly-designed, low-noise aperture corrector (described on page 14 of this issue) in the telecine channel, with the corrections optimally balanced in the horizontal and vertical directions.

Grain

The test chart was also used in a film grain assessment, which was undertaken partly subjectively and partly on a microdensitometer specially equipped for this purpose. Grain was shown to be related to negative exposure, but no conflict emerged between the conditions for minimum grain and those required to achieve the best contrast range and colorimetry. It was also confirmed from a detailed analysis of the printer light settings used in the laboratories that the accuracy of exposure achieved on location was generally good.

A reduction in grain remains desirable, but this is already forecast as the result of improvements in negative film stock.

Unsteadiness

For the unsteadiness, measurements timing marks were introduced in the test chart, which was then photographed and printed on 16 mm film. The negatives and prints were run on a telecine machine at normal speed, and the timing variations were measured on the reference marks and Fourier analysed by means of a computer programme. By this technique it is possible to establish the magnitude of the unsteadiness and to relate the Fourier harmonics to particular mechanical components in the film system. Also, since the harmonics can be weighted according to the subjective impairment which

they produce, it is possible to detect any instances of unsteadiness requiring immediate attention.¹

Negative Transmission

The improvements already described were largely based on increased control and attention to detail at all stages of the film process; further progress was now only possible by more radical changes.

The most promising possibility was to avoid the print losses by transmitting directly from the negative. This offered the prospect of a major improvement in resolution, steadiness, colorimetry and contrast handling range, a much better match to television camera pictures and savings in time and money. The development of a successful system involved some critical signal processing in the telecine channel and a much brighter telecine scanning tube; both requirements have now been met, however, and negative colour transmission has been in regular operation since September 1971. The results have fulfilled initial expectations and use of the system is being extended. An abstract of an SMPTE paper on this subject appears on page 26 of this issue.

Pre-programmed Corrections

During negative film transmissions, corrections must be made for variations in negative exposure and colour balance, which would normally be removed during the printing process. This requirement has been simplified by a pre-programming system, which records the electronic corrections applied by the telecine operator during his normal rehearsal and back-dates each correction to the last shot-change. On transmission the corrections are applied automatically and instantaneously

at each shot change, and the original adjustments are not seen. A further facility allows the corrections to be incrementally up-dated if a second rehearsal is planned.

The shot-change times can be identified either by metallic cue patches applied to the negative film during editing or by a newly developed automatic shot-change detector; this identifies shot-changes with a high degree of success by inspecting and applying certain criteria to the telecine picture signal.

The pre-programming system (which is described in an article on page 15 of this issue) can also be used with advantage when transmitting 16 mm and 35 mm colour prints.

Further Developments

The outstanding problems on 16mm negative transmission are largely mechanical; splices must be strong but must not cause picture disturbance; dirt and blemishes must be reduced and made less obtrusive. Work is proceeding actively on a number of possibilities.

Negatives for normal printing processes are usually made up into two rolls each containing alternate scenes, and it is important to develop telecine facilities for dealing with them in this form.

Substantial progress has already been achieved towards making 16mm colour film comparable with television-camera quality, and continuing effort is being made to extend the present improvements.

Reference

1. Wood, C. B. B., Sanders, J. R., and Wright, D. T., 1971. Image unsteadiness in 16-mm film for television. *J.S.M.P.T.E.*, Vol. 80, No. 10 (Oct. 1971).

Delta Modulation for Sound-Signal Distribution: A General Survey

C. J. Dalton, Ph.D., B.Sc. (Elec. Eng.)

Designs Department

UDC 621.376.5:534.86

Summary: Delta modulation has been proposed as an alternative to pulse code modulation (PCM) for sound-signal distribution.

This article describes the theory of operation of delta modulation and some of the modifications to the basic system which can be used to improve the overall performance or to optimise particular parameters to suit the form of the input signal. A comparison is made between delta modulation and PCM, and certain cases are pointed out in which delta modulation might be used with advantage as an alternative to PCM within the BBC.

- 1 Introduction
- 2 Theory of delta modulation (ΔM)
 - 2.1 Operation of basic system
 - 2.2 Single integration ΔM
 - 2.3 Double integration ΔM
 - 2.4 Threshold and overload
 - 2.5 Quantising noise
- 3 System parameters
 - 3.1 ΔM for the transmission of high-quality sound signals
 - 3.2 ΔM for the transmission of telephone-quality speech
- 4 Noise reduction techniques
 - 4.1 Instantaneous companders
 - 4.2 Syllabic companders
 - 4.3 Compandor performance
 - 4.4 Slope overload protection
- 5 Direct feedback coding
 - 5.1 Delta-sigma modulation ($\Delta \Sigma M$)
 - 5.2 Generalised form of direct feedback coders
- 6 Comparison between PCM and ΔM
- 7 Conclusions
- 8 References

1 Introduction

Delta modulation (ΔM), also known as 1-digit code PCM or 1-digit differential PCM, is a way of transmitting information by means of uniform pulses. In conventional pulse code modulation systems an n -digit code is generated which contains information on the absolute magnitude of each sample. In delta modulation a single digit only is generated at each sampling time, indicating in which direction the signal amplitude has changed; the transmitted pulses therefore carry information corresponding to the derivative of the input signal. At the receiving terminal the pulses are integrated and filtered to obtain the original signal.

Delta modulation was first proposed in the French labora-

tories of the ITT organisation and was the subject of French patents in 1946 and 1948.^{1,2} A paper by de Jager (1953)³ adequately explained the theory of operation of ΔM and the system performance. Over the last ten years there have been many written contributions on the subject. These have covered mathematical analysis as well as several modified forms including companders and other techniques for improving the system performance. Alternative forms of coding have also been suggested, which are generally classified as direct feedback coding, delta modulation as originally proposed being a particular case of this general classification.

Although much has been written about delta modulation, practical applications have been few and largely restricted to telemetry, telephones and low-quality military communication systems. More recently it has been proposed as the method of modulation for the sound channel of a Sound-in-Syncs⁴ system and also for the video channel of the Bell Picturephone⁵ system.

Delta modulation has the advantage over pulse code modulation of simpler codec instrumentation, less stringent requirements for filters and greater resistance to transmission channel errors; moreover it does not require word synchronisation. In exchange for these advantages there are restrictions on input signal parameters, while for equivalent noise performance in high-quality applications, ΔM requires a higher transmission bit rate than PCM.

In this report the principles of delta modulation are explained and the system parameters discussed in connection with the transmission of sound signals. Some of the modified forms are discussed and comparisons are drawn between ΔM and PCM. The conclusions suggest where ΔM could be used with advantage in the BBC.

2 Theory of Delta Modulation

2.1 Operation of Basic System

At each sampling instant a delta modulation coder transmits a pulse which indicates the direction in which the input signal

has changed since the previous sample; a block diagram of a basic ΔM system is shown in Fig. 1.

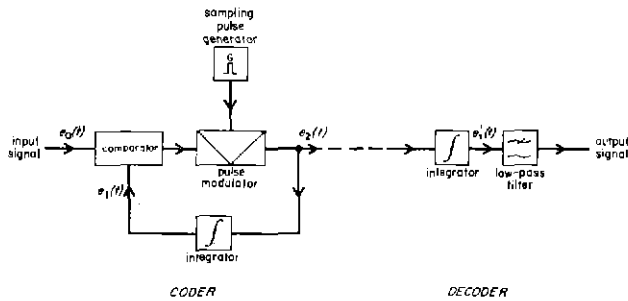

Fig. 1 Basic circuit for ΔM

The modulator operates on the sampling pulses in such a manner that positive pulses are delivered to line if the difference signal from the comparator is positive, and negative pulses if the difference is negative. The transmitted pulse train $e_2(t)$ therefore consists of positive or negative pulses at the same rate as the sampling pulses and there is no zero pulse state. The difference signal is obtained by comparing the input signal $e_0(t)$ with a signal $e_1(t)$ synthesised from the output pulses by integration. The comparator thus decides what polarity the output pulse should have in order to reduce the difference between the two voltages $e_0(t)$ and $e_1(t)$. The feedback signal $e_1(t)$ consists of a series of steps up or down, of amplitude δ , and is a 'quantised' approximation of the input signal.

In practice, the negative pulses are usually omitted from the transmission path to give a unipolar pulse train. The original pulse train can easily be reconstructed in the decoder by superimposing on the positive pulses a series of half-amplitude negative pulses at sampling frequency; positive pulses are thus reduced to half amplitude and zeros are replaced by the negative pulses.

In the decoder the received pulses $e_2(t)$ are integrated in a network similar to that in the coder to give a signal $e_1'(t)$ which is a close approximation of the input signal; error components due to the quantum nature of the pulses are present. Sampling components are removed in a low-pass filter. The difference between the original signal and the reconstructed approximation can be regarded as noise. This noise can be reduced by increasing the sampling pulse frequency so that, for the same peak signal capability, δ is smaller.

It will have been seen that for ΔM the transmitted bit rate is equal to the sampling rate, which must be several times greater than the highest frequency component of the input signal for satisfactory signal-to-noise ratio. In comparison, the sampling rate in PCM is approximately twice the highest input frequency but the transmitted bit rate will be n times the sampling rate where n is the number of digits in the PCM code; n also determines the signal-to-noise ratio.

2.2 Single Integration ΔM

The simplest form of integrating network in the feedback path is a simple resistance-capacity combination $R_1 C_1$ which has a large time constant. The response of this network to an impulse will approximate to a unit step. A typical transmitted

pulse train and quantised feedback signal for a single integration system is shown in Fig. 2.

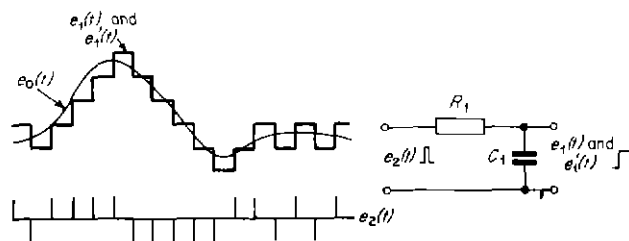
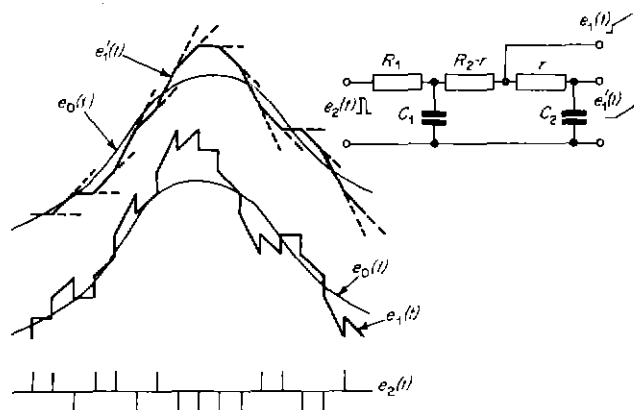

Fig. 2 Single integration ΔM

2.3 Double Integration ΔM

A much closer approximation to the original signal can be achieved by using a double integration network as in Fig. 3(a). The time constants $R_1 C_1$ and $R_2 C_2$ are both large and the response of the network to a unit impulse is a voltage which has a slope that either increases or decreases by a fixed amount with positive or negative input pulses. The feedback waveform is now a much smoother curve and is generally a much closer approximation to the input signal. A disadvantage of double integration, however, is that large changes in the slope of the input signal may not be recognised soon enough, since the comparator senses amplitude differences only, and large errors in the feedback signal may occur as illustrated in Fig. 3(a). Such errors are a form of overshoot which indicates



(a)

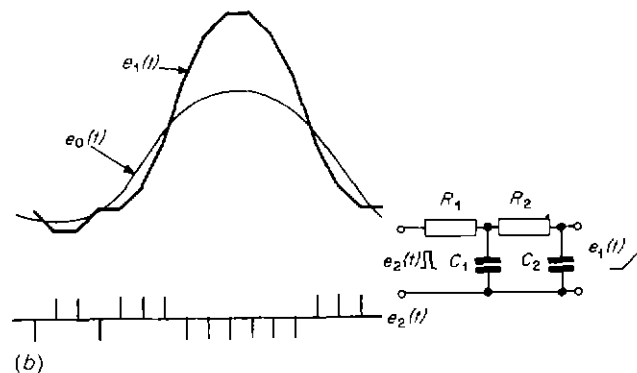

(b)

Fig. 3(a) Double integration ΔM
(b) Double integration ΔM with prediction

that the system can tend towards instability. To overcome this disadvantage a further modification is made to the feedback network in the coder to afford a degree of prediction. The circuit of the integrator is now as shown in Fig. 3(b) and the response to a unit impulse $e_3(t)$ at the feedback point in the coder is a step followed by a voltage of constant slope. By virtue of the step, the output feedback signal, $e_1(t)$, in the coder is a prediction of the level to which $e_1'(t)$, the voltage on C_2 in the decoder, will rise. This prediction is equivalent to extrapolation and the effect on the coding process can be seen from the curves of Fig. 3(b).

$$\text{Let the prediction time } \tau = rC_2 \quad (1)$$

then

$$\begin{aligned} e_1(t) &= e_1'(t) + rC_2 \frac{d}{dt} e_1'(t) \\ &= e_1'(t) + \tau \frac{d}{dt} e_1'(t) \\ &= e_1'(t + \tau) \end{aligned}$$

that is, $e_1(t)$ is the value that the voltage across C_2 will have at a time $(t + \tau)$.

If τ is too large the predicted signal deviates too far from the actual curve, and if τ is too small the system approaches that of normal double integration with its inherent instability. In addition, τ should be small compared to R_1C_1 and R_2C_2 . The optimal value of τ is of the order of the time interval between sampling pulses.

Prediction is required only in the coder to obtain a closer approximation to the input signal, and in the decoder a conventional double integration network is used having time constants R_1C_1 and R_2C_2 .

2.4 Threshold and Overload

In the absence of an input signal, the output from a single-integration ΔM coder will consist of a series of alternating positive and negative pulses, and the feedback approximation signal will appear as in Fig. 4(a). This idling signal contains only high-frequency components and there will be no signal from the output of the low-pass filter in the decoder.

If the input signal has a peak-to-peak amplitude of less than δ , the alternating pulse sequence will be undisturbed and the output from the decoder will remain at zero. There is therefore a threshold below which information will not be transmitted.

For double integration the idling pattern is dependent on the degree of prediction, and can take either the form shown in Fig. 4(a) or a paired alternate pattern, i.e. $++--++--$. Other patterns are possible but would indicate a value of τ not equal to the optimum value.

In considering the threshold condition as described above, it has been assumed that the contributions of positive and negative pulses to the integration process are equal; under this condition the coder is said to be balanced. If the contributions from the positive and negative pulses are not equal, an unbalance will exist in the integrator output which is observed as a disturbance in the idling pattern as shown in Fig. 4(b). The effect is analogous to a saw-tooth waveform added to the input signal and producing an unwanted signal in the decoder

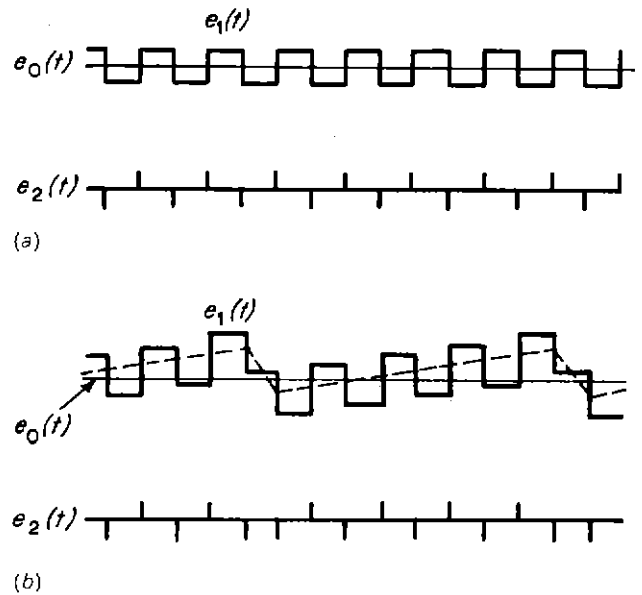

Fig. 4 ΔM idling signals
(a) Balanced condition (b) Unbalanced condition

output. However, it was found experimentally that if the saw-tooth frequency is sufficiently far above the signal frequency band, then the unwanted output is negligible. Under these conditions the effect of unbalance is equivalent to the addition of a perturbing or dither waveform which has the effect of reducing the threshold level. It has been found by several investigators that it is difficult to maintain threshold stability in ΔM systems. Feedback techniques can be employed to maintain a balanced condition but it is extremely difficult to hold a precise degree of unbalance. The tendency towards instability increases with sampling rate.⁶

In a ΔM system the information conveyed by the transmitted digits correlates with the first derivative of the input signal. There is therefore no fixed maximum amplitude of the input signal but the system will overload when the slope of the input signal exceeds a value defined by the system parameters; this condition is referred to as slope overload.

The largest slope that the system can transmit without error is one which changes by one level per sample. Thus for a sampling frequency of f_s samples per second and a step amplitude of δ volts the maximum slope will be δf_s volts per second.

The maximum slope for a sinusoidal signal of frequency f , and peak amplitude S_m volts is $S_m 2\pi f$ volts per second. In order to transmit this signal without distortion we have:

$$S_m < \frac{f_s \delta}{2\pi f} \text{ volts} \quad (2)$$

It follows that the maximum amplitude that can be transmitted without distortion is reduced by 6 dB/Octave as the frequency increases; the number of discrete levels in the integrated signal will also decrease.

Fig. 5(a) shows, as a function of frequency, the maximum signal amplitude that can be transmitted without distortion by a single integration ΔM system. The overload characteristic may be modified as shown in Fig. 5(b) for the case of double integration ΔM if the break frequency, $f_2 = 1/(2\pi R_2 C_2)$, of the second stage of the integrator is lower than the upper

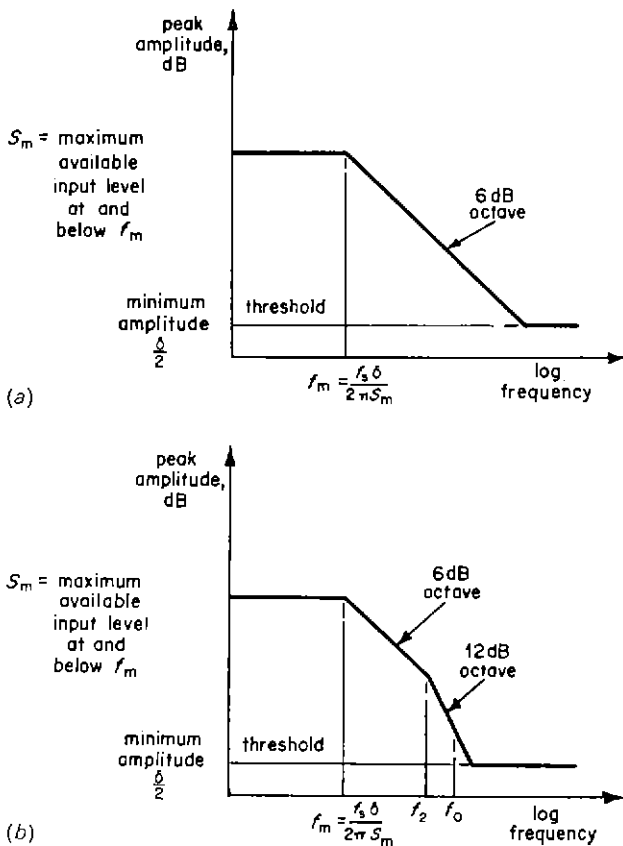

Fig. 5 Maximum amplitude that can be transmitted without distortion for ΔM
 (a) Single integration (b) Double integration

frequency limit, f_0 , of the input signal; in this case the slope of the overload characteristic is increased at frequencies above f_2 .

The characteristics of delta modulation systems are well matched to speech signals which have a power spectrum that falls off with increasing frequency. However, for music, which can have large-amplitude high-frequency components, ΔM may introduce distortion through slope overload.

2.5 Quantising Noise

Quantising noise is defined as the error between the coder input signal and the filtered decoder output signal. In ΔM the quantising noise has a random amplitude which is dependent on the input signal level. This can be fairly easily demonstrated by considering the nature of the error at three signal levels. At zero input signal there is no noise component in the filtered output signal. For signals between threshold and overload the output signal is delayed by one clock period with respect to the input signal, due to the code-decode process; the error is therefore dependent on signal frequency and amplitude. Above overload the output delay increases and the error will depend on the degree of overload.

Several contributions have been made towards analysis of ΔM noise,^{3,7,8,9,12} the simplest presentation being for the case of a sine wave near overload.

It is usual to assume⁷ that quantising noise is of random magnitude, having however a spectral periodicity at sampling

frequency f_s ; it is also assumed that the frequency distribution of the noise power is in the form $(\sin x/x)^2$ with the first null at f_s . The total power of this distribution equals the power that results if the level at the origin is held constant over a band $f_s/2$. Tomozaura and Kaneko¹³ give a formula:

$$\frac{S_m}{N} = \frac{\pi}{16a} \left(\frac{f_s}{f_0} \right)^{\frac{1}{2}} \left| \frac{H(f)}{H(f_s/2)} \right| \quad (3)$$

for the maximum signal level S_m at the overload point to the average quantising noise level N at a given modulation frequency f . In Equation (3), as before, f_s is the low-pass bandwidth; $H(f)$ is the transfer function of the decoder and a is the ratio of the r.m.s. quantising error to the quantising step. It was found¹² that

$$\begin{aligned} a &= 0.376 \text{ for single integration} \\ a &= 0.668 \text{ for double integration} \end{aligned} \quad (4)$$

For single integration, $H(f)$ must be replaced by $H_1(f)$

$$H_1(f) = \frac{1}{1 + j(f/f_1)} \quad (5)$$

$f_1 = 1/(2\pi R_1 C_1)$ and $f_1 \leq f \leq f_s$. It follows that the last factor on the right-hand side of Equation (3) can be taken as $(f_1/f) \div (2f_1/f_s)$ or $(f_s/2f)$, and therefore Equation (3) reduces to:

$$\begin{aligned} \frac{S_m}{N_1} &= \frac{\pi}{32 \times 0.376 f} \cdot \frac{f_s^{3/2}}{f_0^{\frac{1}{2}}} \\ &= 0.261 \cdot \frac{f_s^{3/2}}{f \cdot f_0^{\frac{1}{2}}} \end{aligned} \quad (6)$$

This agrees with de Jager's formula³ for single integration, except in so far as de Jager's numerical coefficient is 0.20.

For double integration, on the other hand, $H(f)$ must be replaced by $H_2(f)$ where:

$$H_2(f) = \frac{1 + j(f/f_3)}{[1 + j(f/f_2)][1 + j(f/f_1)]} \quad (7)$$

$$f_3 = 1/(2\pi R_2 C_2), f_2 = 1/(2\pi R_1 C_1) \text{ and } f_1 \leq f \leq f_3;$$

in practice, f_2 is made equal to f_0 .

Whatever the relative values of f, f_1, f_2, f_3 and f_s , a formula for the double integration signal-to-noise ratio, S_m/N_2 , can be obtained from Equation (3) by substituting $H_2(f)$, and $H_2(f_s/2)$ from Equation (7). The value of a is now 0.668, and it is again assumed that for stability $f_s = 2\pi f_3$, i.e. $f_s \leq f_1$.

Then:

$$\frac{S_m}{N_2} = 0.0223 \cdot \frac{f_s^{3/2}}{f \cdot f_0^{\frac{1}{2}}} \cdot \left[\frac{4f_2^2 + f_s^2}{f_2^2 + f^2} \right]^{\frac{1}{2}} \quad (8)$$

By applying the further condition of $f \ll f_2 = f_0$ we have:

$$\frac{S_m}{N_2} = 0.0223 \cdot \frac{f_s^{3/2}}{f \cdot f_0^{\frac{1}{2}}} \quad (9)$$

which agrees with de Jager's formula³ with the exception of the numerical constant which de Jager quotes as 0.026.

Similarly, formulae for signal-to-noise ratio quoted in other references^{7,8,11,13} can be obtained from Equation (8) by applying the appropriate assumptions.

The Equations (6) and (9) are the forms that are usually quoted, and it can be seen that quantising noise varies with sampling frequency according to a three-halves power law for single integration and a five-halves law for double integration. For both systems the signal-to-noise ratios are inversely proportional to signal frequency.

3 System Parameters

For the present purpose theoretical and practical examinations were made of delta modulation parameters and performance. Two applications were considered, one a system for the transmission of high-quality sound signals, the other, a lower quality system for the transmission of speech.

3.1 ΔM for the Transmission of High-quality Sound-signals

From Equations (6) and (9) in Section 2, but substituting the coefficients given by de Jager, the curves in Fig. 6 have been constructed to show the variation of signal-to-noise ratio with bit rate. For a ΔM system the parameters have been chosen as 14 kHz for the bandwidth and 1 kHz for the signal frequency. These figures are representative of the bandwidth and 'mean' frequency of a high-quality system. In a practical system 1 kHz would probably be chosen as the highest frequency that could be transmitted at peak level. For comparison the equivalent curve for a PCM system is shown for a 32 kHz sampling rate and the number of digits per sample as indicated. This latter curve is applicable for all signal frequencies in a 14 kHz bandwidth.

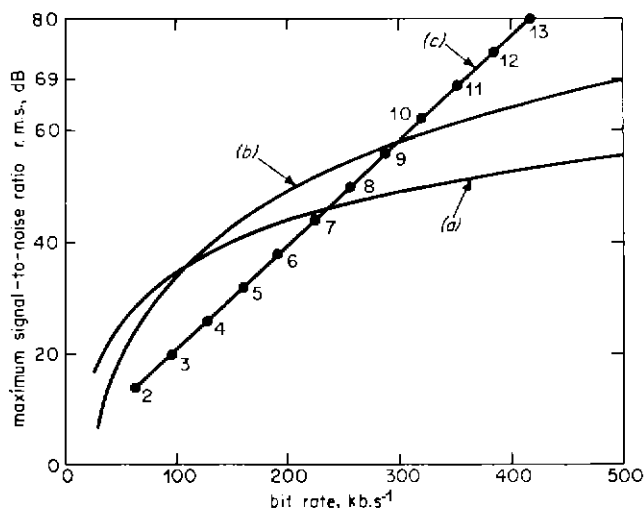

Fig. 6 Variation of signal-to-noise ratio with bit rate: wide band audio system
 (a) Single integration $\Delta M f = 1 \text{ kHz}$, $f_o = 14 \text{ kHz}$
 (b) Double integration $\Delta M f = 1 \text{ kHz}$, $f_o = 14 \text{ kHz}$
 (c) PCM $f_s = 32 \text{ kHz}$ No. of digits as shown

The acceptance figure for the ratio of r.m.s. signal* to r.m.s. unweighted white noise of a high-quality sound-signal system is 69 dB.¹⁰ Assuming for simplicity that the system comprises nothing more than one coder and decoder, Fig. 6 shows that this level can only be obtained with double integration ΔM at a rate of 500 kb.s⁻¹ and at a considerably higher rate for single integration ΔM. In comparison, the acceptance figure can be obtained with a straight 11-digit PCM system requiring a bit rate of 352 kb.s⁻¹.

As with PCM, the noise performance of a ΔM system can be improved by employing companding techniques, and such a system has been proposed⁴ for a high-quality sound channel

* By convention, the input signal is assumed to be a sinusoid which fully loads the system.

employing a bit rate of 256 kb.s⁻¹. For this and lower bit rates straight ΔM shows a noise advantage over PCM.

For the present investigation, it was decided to construct a 14 kHz bandwidth ΔM system based on a bit rate of 256 kb.s⁻¹, the resulting signal-to-noise ratios being such as would allow simple measurements and comparisons with PCM, and also offer a system for testing various companding techniques.

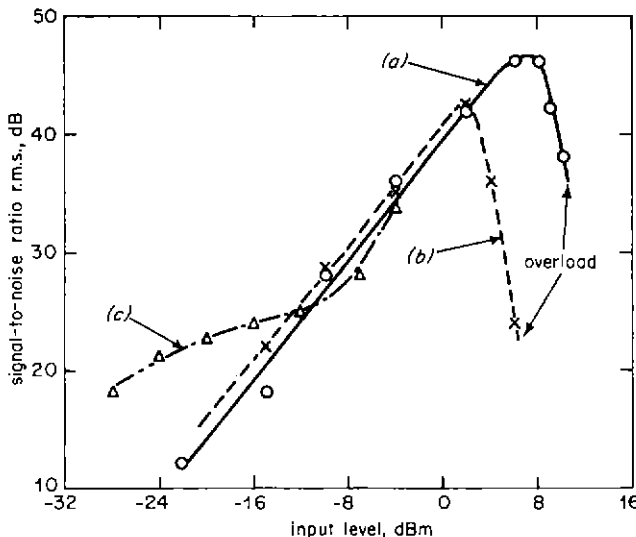

Fig. 7 Input level/noise characteristic signal integration ΔM
 $f_s = 256 \text{ kHz}$ $f_o = 14 \text{ kHz}$
 (a) $f = 1 \text{ kHz}$ (b) $f = 2 \text{ kHz}$ (c) $f = 1 \text{ kHz}$, unbalanced coder

The experimental coder was adjusted to handle peak signals of +8 dBm up to a signal frequency of 1 kHz. The measured variation of signal-to-noise ratio with input level for single integration ΔM is shown in Fig. 7, which also illustrates the 6 dB change in overload point when the input frequency is raised by one octave from 1 kHz to 2 kHz. Also shown in this figure is the effect of an unbalanced coder with the fundamental of the sawtooth components at 28 kHz; the signal-to-noise ratio at low signal levels is increased by the dither, although as pointed out previously, this condition of unbalance is difficult to maintain accurately.

Fig. 8 shows the increase in signal-to-noise ratio obtained by double integration. Curve (b) is for the preferred case where the second integrator break frequency f_2 is at f_n - in this case 14 kHz - and the overload characteristic has a 6 dB/Octave slope; for curve (c), f_2 has been reduced to 1 kHz resulting in a further increase in signal-to-noise ratio, obtained, however, at the cost of an overload characteristic falling at 12 dB/Octave.

It was observed during listening tests that for double integration ΔM the quantising noise was not only at a lower level but differed in character from that obtained with single integration, especially in the reproduction of low-level signals near threshold. For single integration the noise has the characteristics of a line spectrum, whereas the double integration noise has a smoother spectrum and is not dissimilar to PCM quantising noise. For the chosen system parameters, the experimental double-integration ΔM system was judged to be equivalent to a 9-digit PCM system, a result which is in good agreement with theoretical prediction. The cover photographs, which are repeated in Fig. 9 for convenience, show the feed-

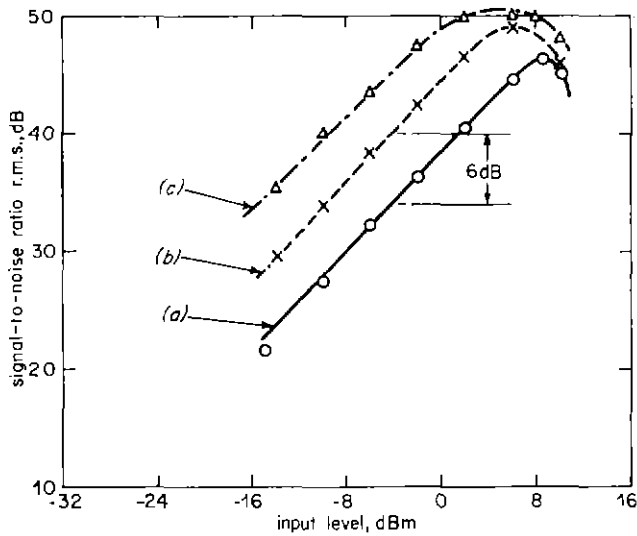

Fig. 8 Input level/noise characteristics of ΔM with 1 kHz input signal
 $f_s = 256 \text{ kHz}$ $f_o = 14 \text{ kHz}$
 (a) Single integration
 (b) Double integration, $f_2 = 14 \text{ kHz}$, overload 6 dB/Octave
 (c) Double integration, $f_2 = 1 \text{ kHz}$, overload 12 dB/Octave

back waveforms of single and double integration for a 1 kHz signal 10 dB below the overload point, and illustrate the smoother approximation of double integration to an original sine-wave input.

During overload in a ΔM system an input sine wave is transformed to a triangular wave, the slope of which is equal to the maximum slope of the system. Distortion during overload therefore takes the form of the introduction of high-order harmonics, which are subjectively very annoying. High-quality sound signals can contain high-level high-frequency components which can cause overloading and the subjective effect of momentary distortion can be very disturbing.

3.2 ΔM for the Transmission of Telephone-quality Speech

The spectral distribution of average speech falls off at approximately 6 dB/Octave above a frequency of about 800 Hz. Delta modulation is therefore well suited as a transmission system for speech. Fig. 10 shows the variation of signal-to-noise ratio with bit rate for single- and double-integration ΔM having a 3.5 kHz bandwidth, and for comparison purposes, PCM with an 8 kHz sampling frequency. A cross-over exists at a bit rate of approximately 40 kb.s^{-1} below which ΔM offers advantages over PCM in signal-to-noise ratio. At these bit rates the signal-to-noise ratio is low and applications of ΔM are therefore mainly restricted to communication systems where it is required to transmit intelligible speech over a low-capacity channel. A simple subjective test indicated that speech would be understood without significant concentration on the part of the listener when the signal-to-noise ratio is 22 dB. This performance can be obtained with ΔM operating at a bit rate of 22.5 kb.s^{-1} provided that the

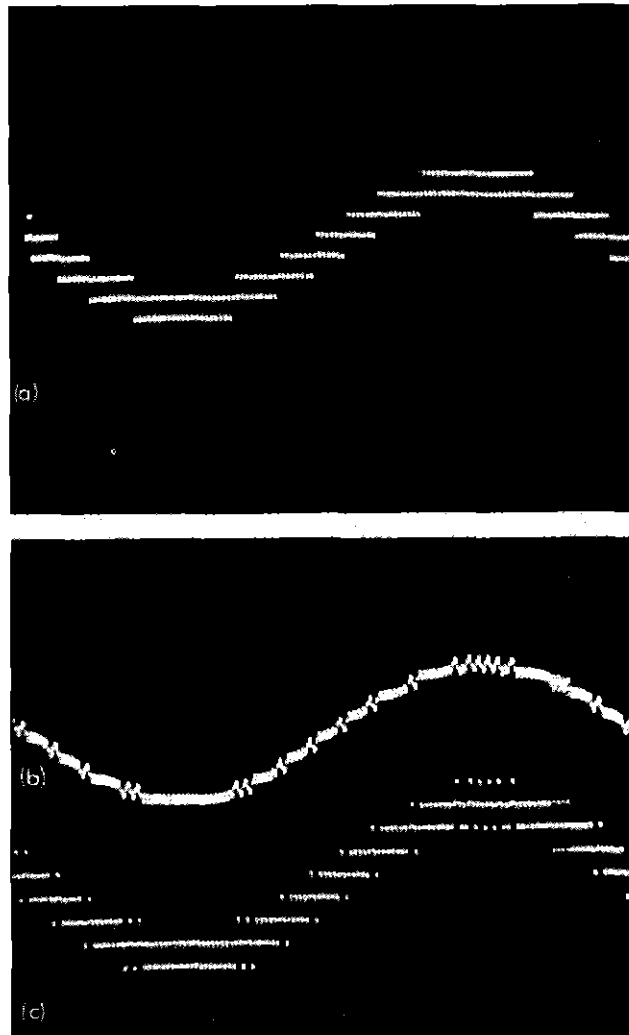

Fig. 9 ΔM coder waveform: $f_s = 256 \text{ kHz}$, $f = 1 \text{ kHz}$ at 10 dB below overload
 (a) Feedback signal: single integration
 (b) Feedback signal: double integration
 (c) Output of first integrator: double integration

signal fully loads the system. The dynamic range of the system would be low, but could be increased by using companders or other noise reduction techniques. Several methods of companding have been proposed and these will be discussed in the following section.

4 Noise Reduction Techniques

Noise reduction techniques used in digital communication systems operate on the principle of compressing the dynamic range of the input signals so that the quantising step remains small compared to the signal, or alternatively, of graduating the size of the quantising steps. In the decoder a complementary expansion takes place to restore the signals to their original level, with a corresponding reduction in quantising noise. The noise reduction is beneficial mainly for low-level signals since high-level signals usually mask the quantising noise.

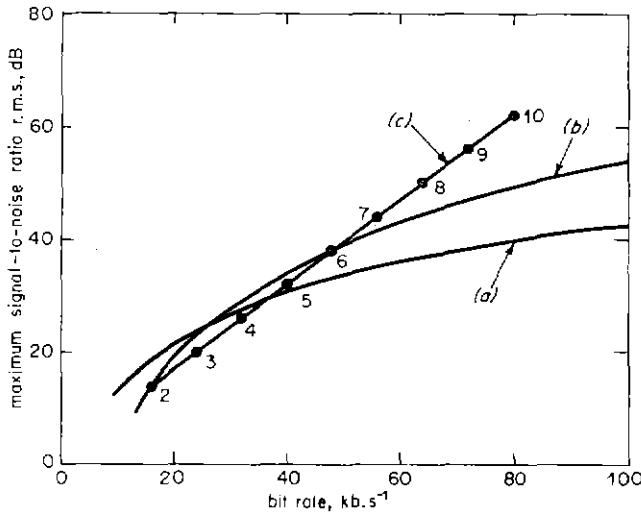

Fig. 10 Variation of signal-to-noise ratio with bit rate: narrow band audio system
 (a) Single integration ΔM , $f = 800$ Hz, $f_o = 3.5$ kHz
 (b) Double integration ΔM , $f = 800$ Hz, $f_o = 3.5$ kHz
 (c) PCM $f_s = 8$ kHz, number of digits as shown

There are two forms of compandor; instantaneous compandors which employ some fixed non-linear device, or graduated quantising steps, and syllabic compandors in which gain is varied in accordance with the level of the input signal but is substantially constant over a number of cycles of the signal waveform. In the latter case it is often necessary to convey the companding information to the decoder, preferably by the main digit stream, or by an additional communication channel if sufficient capacity is available.

In all cases the aim of companding is to modify the signal-to-noise/input level characteristic to a form as shown in Fig. 11.

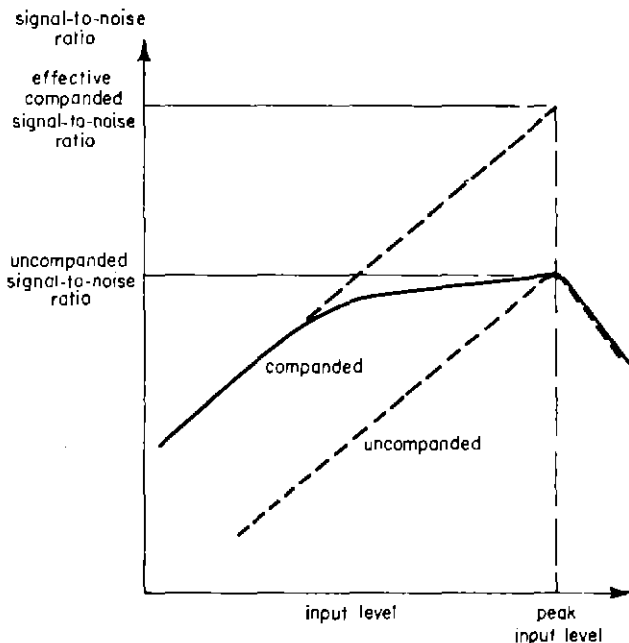

Fig. 11 Effect of companding on signal-to-noise ratio/level characteristics

Pre- and de-emphasis as used for noise reduction in analogue modulation systems and PCM cannot be usefully applied to ΔM since the pre-emphasis at the coder will cause premature overloading at high frequencies.

4.1 Instantaneous Compandors

Instantaneous compandors are usually restricted to low-quality systems for the following reasons. Waveform distortion can occur if the transfer characteristics of non-linear devices used for compression and expansion are not exactly complementary; errors in matching are more likely if a large range of companding is required. Distortion can also arise in systems using graduated quantising steps due to the inability to reproduce accurately low-amplitude information that may be superimposed upon large-amplitude components of the input signal. With graduated quantising there is no difficulty in making the compression and expansion laws accurately complementary.

4.2 Syllabic Compandors

Syllabic compandors as devised for ΔM operate mainly in the feedback network and fulfil the dual role of noise reduction and the reduction of slope overload distortion. All the methods to be described function by changing the quantising steps in the feedback loop.

Fig. 12 illustrates two basic forms of syllabic compandor; the first derives its control from the input signal and requires a separate channel, which can be either analogue or digital, to convey the control to the decoder.¹¹ The second derives the control from the transmitted digits and therefore uses the digit stream as carrier for the control information.^{4,12,13,14} Full details of the various proposed systems will not be described here since this information can be obtained from the quoted reference, and it will be sufficient to outline the suggested methods of level detection and control.

Level detection and generation of the control signal may be realised as follows:

- (a) By differentiation, rectification and filtering of the input signal. The differentiation is included to obtain information on the slope of the input signal, and the filter determines the control time constants. A system using this technique¹¹ transmits the control signal to the decoder by a secondary ΔM coder operating at approximately one-sixteenth the bit rate of the main coder, the output pulses being multiplexed into the main digit stream.
- (b) By using a secondary integrating decoder network on the output digit stream, followed by a peak detector.¹² The time constant of the additional integrating network will determine the rate of control. This technique operates indirectly on the amplitude of the input signal, and a threshold must be included in the detector so that the compandor operates only over a predetermined dynamic range.
- (c) By extracting the derivative of the input signal by means of a low-pass filter on the digit stream.¹³ The filter bandwidth will determine the control time constants. In a system adopting this technique the control signal could be transmitted to the decoder as a low-frequency signal component below the nominal low-frequency cut-off of

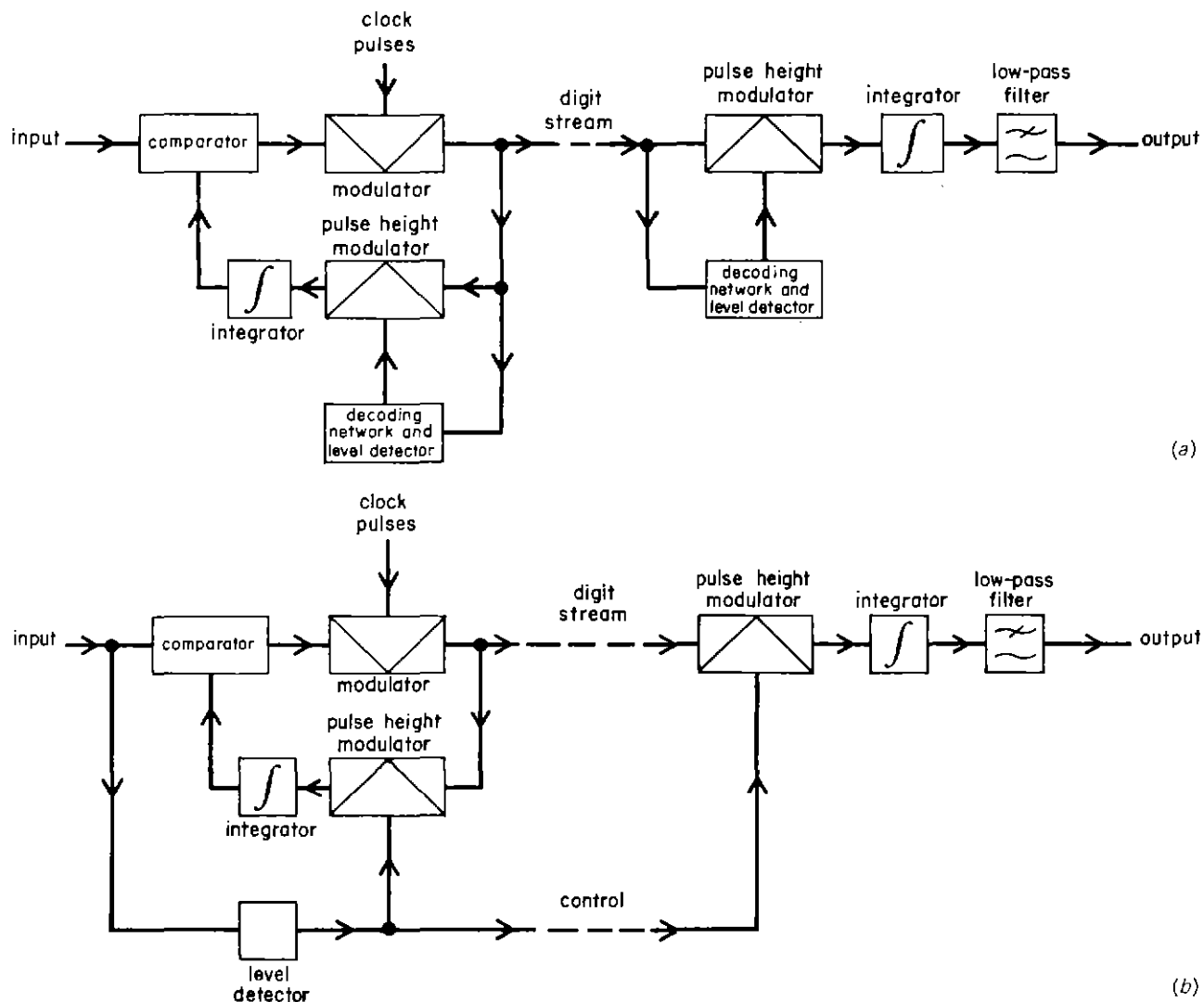

Fig. 12 Companded ΔM systems
 (a) Companded ΔM system with separate control chain (b) Companded ΔM system with integral control chain

the input signal. The control signal is then simply extracted at the decoder with a L.P. filter. In such a system, however, the rate of change of the control signal would be low.

(d) By examining the digit stream in logic networks to detect successive strings of 1's or 0's;¹¹ these digit states indicate slope overload. Separate smoothing of the logic output is needed to obtain the required time constant of the control signal.

Control of the coder and decoder quantising step sizes may be realised as follows:

- (a) By using the control signal to vary the height of the digit pulses feedback into the integrating network.^{11,12,13} Pulse height modulators performing this function can be very simple, for example a transistor, operating near cut-off, whose bias is varied by the control signal.
- (b) By changing the quantising step size according to a pre-determined pattern.¹⁴ For example if the transmitted digit stream contained a series of 1's (or 0's) the step size would be progressively increased in say the ratios 1:2:4:8: etc. At the end of the series of like digits the step size would

either immediately return to unit value, or return through the intermediate ratios. There are many forms which adaptive systems like this can take and the ratios can be individually optimised to suit the form of the input signal.

4.3 Compandor Performance

The syllabic companding systems as described have been mainly applied to telephone systems, where the inherent low quality and narrow bandwidths have masked some of the undesirable side effects of companding. In these circumstances degrees of companding up to 26 dB have been achieved thus making the signal-to-noise performance of low-bit ΔM systems quite acceptable for the transmission of intelligible speech.

Syllabic companding has also been proposed for a wideband music system.⁴ The degree of companding suggested gives an effective r.m.s. signal-to-r.m.s.-noise ratio for a 14 kHz bandwidth, 256 kb.s⁻¹ system, of approximately 62 dB.

To evaluate the performance of a high-quality companded system, the experimental laboratory equipment referred to in

Section 3 was modified to include a secondary integrator and pulse height modulators. The modifications gave approximately 8dB increase in the signal-to-noise ratio and some protection against slope overload.

The instrumentation of this experimental arrangement was not ideal and difficulty was experienced in maintaining an accurate coder balance, but it was possible to carry out some rough listening tests. Although the average noise level was reduced by the action of the compandor there was a slight increase in the programme-modulated noise component over that which normally occurs with straight ΔM . With the amount of companding available it was difficult to detect any change in the amount of overload distortion.

Although the tests were by no means comprehensive it was felt that the shortcomings of the system were too great for any further companding to render the system satisfactory for the transmission of high-quality music.

4.4 Slope Overload Protection

A novel scheme has been recently proposed¹⁵ to reduce the distortion due to slope overload. A delay line of time delay T is included at the input to the coder, so that the difference in level, y , between the input and output of the delay line gives an indication of the slope of the input signal y/T . When this value exceeds the maximum slope for the coder appropriate modifications are made to the coder parameters.

5 Direct Feedback Coding

Direct feedback coding, so called since no processing takes place in the feedback loop, is a refinement of delta modulation; in fact, the latter could be regarded as a particular case of single-bit direct feedback coding. There are many forms of direct feedback coding, each one having its parameters optimised for a particular input signal. The most well-known form is delta-sigma modulation ($\Delta\Sigma M$)¹⁶ and the principles of operation can best be examined by considering modifications to conventional ΔM .

5.1 Delta-sigma Modulation

It has been shown that conventional ΔM has the disadvantage of the dynamic range and signal-to-noise ratio being inversely proportional to the signal frequency. This disadvantage arises through the inevitable differentiation of the input signal, but it can be overcome if an integration process precedes the coder input with complementary differentiation following in the decoder. A ΔM system thus modified is illustrated in Fig. 13(a). The input to the pulse modulator is the difference between the input signal $e_0(t)$ and the output signal $e_2(t)$ after each has been integrated. The transfer characteristics of the integrators are identical and the two networks can therefore be replaced by a single integrator following the comparator. At the decoder the integrator and differentiator are exactly complementary and can therefore be omitted. The modified system now appears as in Fig. 13(b) which is a basic delta-sigma modulator.

The advantage of $\Delta\Sigma M$ is that the system has a flat amplitude/frequency characteristic and overload occurs at the same level for all frequencies. In exchange for a flat frequency

characteristic the spectrum of the quantising noise is no longer flat but rises at 6dB/Octave and the coding threshold is similarly modified.

By a process similar to that already illustrated in Section 2, the r.m.s. signal to quantising noise ratio for maximum signal amplitude can be shown to be:

$$K_s \left(\frac{f_s}{f_0} \right)^{3/2} \quad (12)$$

where K_s is a constant which has been computed⁷ to be $3/(4\pi)$.

The output pulses carry information corresponding to the amplitude of the input signal, and as the input signal increases in amplitude the output pulses appear more frequently. Demodulation of the pulses at the decoder is performed with a low-pass filter only.

Syllabic companding can be applied to $\Delta\Sigma M$ in a similar manner to that previously described for ΔM . A control signal can be developed by logical examination of the digit stream¹⁷ (a series of 1's or 0's will represent maximum amplitude), or the input signal can be reconstructed by filtering and a control signal generated by peak detection.

5.2 Generalised Form of Direct Feedback Coders

The integrator preceding the pulse modulator in the $\Delta\Sigma M$ coder may be a single or double integrator, or more generally, any signal processing network that modifies the quantising noise spectrum to suit a particular system performance or form of input signal. Similarly, in addition to shaping the noise spectrum, it is possible to modify the signal spectrum by adding appropriate pre- or de-emphasis networks before the coder with the complementary networks at the decoder.

Direct feedback coders can therefore be tailored to suit the parameters of the signal to be transmitted.¹⁸

6 Comparison between PCM and ΔM

In making a comparison between PCM and ΔM it is clear that the latter has advantages in the form of simpler instrumentation, less stringent requirements for filters, and with its 1-bit code does not require word synchronisation.

When comparing the ability of the two systems to transmit a signal it has to be remembered that the performance depends on the nature of the input. For high-quality low-noise applications ΔM requires a larger transmission bandwidth than PCM, whereas the converse is true for low-quality systems in which the presence of noise is not a serious impairment as long as the message is intelligible. The maximum amplitude/frequency characteristic and noise spectrum for PCM are flat, whereas ΔM has a flat noise spectrum but a 6dB/Octave roll-off in the maximum amplitude/frequency characteristic. In the latter case, however, the system parameters can easily be modified to suit the form of the input signal. This can be advantageous, for example in the case of speech which does not have a flat spectral distribution.

Further comparisons between PCM and ΔM have been made mathematically from the point of view of information theory.^{7,9} Both systems have nearly the same capacity for transmitting information for an equal number of quantising levels, provided the number of levels is larger than 10. How-

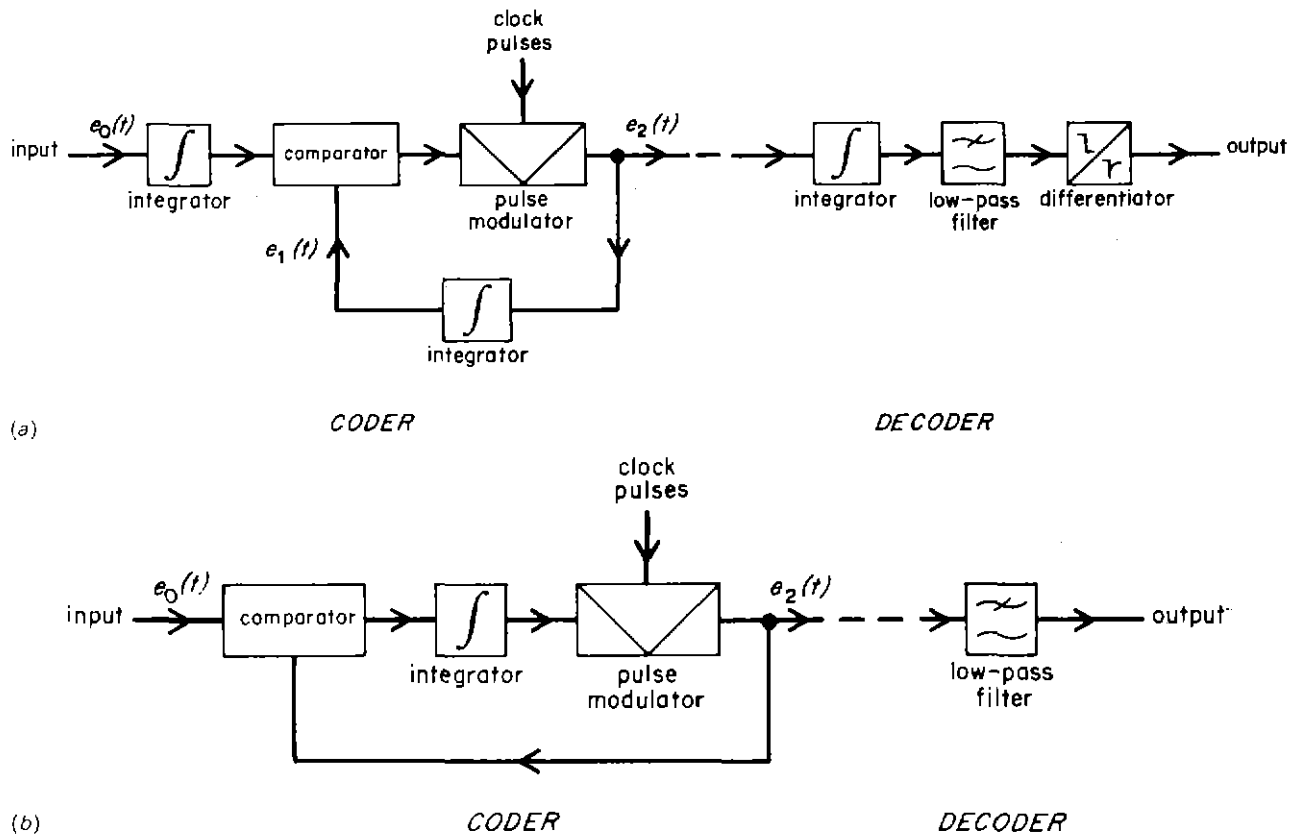

Fig. 13 Derivation of $\Delta\Sigma$ modulation for ΔM (a) Modified ΔM system (b) $\Delta\Sigma$ system

ever, as already stated, for high signal-to-noise ratios ΔM needs a larger bandwidth.

In PCM, successive samples can take any of the 2^n possible quantised levels, whereas in ΔM the quantised signal can only change by one positive or negative quantising step δ at each sample. This means that the number of pulses to be transmitted for a given change of input signal is on average less for ΔM than for PCM and it follows that less signal power is required for ΔM .

The lower power requirements of ΔM imply that the system is more resistant to transmission channel errors than PCM. Certainly the end effect of digit errors in the two systems is different. In PCM, the error in the output will depend on which digit within a group is wrong. If a most significant digit is wrong, the error in the output can be half the maximum peak-to-peak signal level, whereas if a least significant digit is wrong, the error in the output is equal to the level of a quantising step. In ΔM the effect of digit errors is always the same, that is an output error equal to twice the quantising step. However, in the event of a burst of digit errors the error in the decoder output can be large, due to the cumulative effect of the integration process. It is of interest to note that with a delta-sigma system, which does not have a decoding integrator, a greater number of digit errors can be tolerated than with ΔM .

Following a break in a transmission link, PCM will return to the correct absolute level from the decoder as soon as word synchronisation is restored. In ΔM no word synchronisation is necessary but the absolute level will not be correct until the integration process has re-established the mean level.

7 Conclusions

This survey has described the fundamentals of delta modulation and some of its variants. The system parameters and performance have been examined and compared with pulse-code modulation.

Delta modulation has the advantage over PCM of relative simplicity and low cost of the coding equipment, but in exchange puts restrictions on input signal parameters and for high-quality applications requires a higher transmission bandwidth for the same signal-to-noise ratios.

A broadcast authority is required to maintain a high quality yet must have due regard to the efficiency with which the high standards can be achieved. To this end, delta modulation offers no advantages over PCM for the transmission of high-quality sound. However, some low-grade internal communications are often required within a broadcasting network for the purposes of administration and control. These communications may take the form of data, speech or possibly facsimile, and it is here that delta modulation can offer advantages over PCM by reason of lower transmission bandwidth and reduced cost of terminal equipment.

8 References

1. Deloraine, E. M., Van Mierlo, S. and Derjavitch, B. French Patent 932.140, 10 August 1946.
2. French Patent specification No. 987.238, 22 May 1948.
3. De Jager, F. 1952. Delta modulation, a method of p.c.m. transmission using the 1-unit code. *Philips Res. Rep.*, 1952, 7, pp. 442-66.

4. Fanthome, E. O., and Chow, H.S. T.V. audio video time division diplexing over a satellite line. International Electronics Conference and Exposition, Toronto, October 1969.
5. O'Neal, J. B. 1966. Delta modulation quantising noise analytical and computer simulation results for gaussian and television input signals. *Bell Syst. tech. J.*, 1966, XLV, 1, pp. 117-41.
6. Wang, P. P. 1968. An absolute stability criterion for delta modulation. *IEEE Trans. Commun. Technol.*, 1968, COM16, 1, pp. 186-8.
7. Johnson, F. B. 1967. Calculating delta modulator performance. *IEEE Trans. Audio & Electroacoustics*, 1968, AU-16, 1, 121-9.
8. Panter, P. F. 1965. Modulation, noise and spectral analysis. New York, McGraw Hill, 1965, Chapter 22.
9. Zetterberg, L. H. 1955. A comparison between delta and pulse code modulation. *Ericsson Tech.*, 1955, 11, 1, pp. 95-154.
10. The assessment of noise in audio frequency circuits. BBC Research Department Report No. EL-17, Serial No. 1968/8.
11. Brolin, S. J., and Brown, J. M. 1968. Companded delta modulation for telephony. *IEEE Trans. Commun. Technol.*, 1968, COM16, 1, pp. 157-62.
12. Tomozaura, A., and Kaneko, H. 1968. Companded delta modulation for telephone transmission. *IEEE Trans. Commun. Technol.*, 1968, COM16, 1, pp. 149-57.
13. Greekkes, J. A., and de Jager, F. 1968. Continuous delta modulation. *Philips Res. Rep.*, 1968, 23, 2, pp. 233-46.
14. Jayant, N. S. 1969. Adaptive delta modulation with one-bit memory. *Bell Syst. tech. J.*, 1970, 49, 3, pp. 321-42.
15. Newton, M. B. 1970. Delta modulation with slope-overload protection. *Electron. Letters*, 1970, 6, 9, p. 272.
16. Inose, H., and Yasuda, Y. 1963. A unity bit coding method by negative feedback. *Proc. IEEE*, 1963, 51, 11, pp. 1518-23.
17. Petford, B. and Clarke, C. M. 1970. A companded delta-sigma speech digitiser. IEE Conference on Signal Processing Methods for radio telephony. May 1970.
18. Brainard, R. C., and Candy, J. C. 1969. Direct-feedback coders: design and performance with television signals. *Proc. IEEE*, 1969, 57, 5, pp. 776-86.

Vertical and Horizontal Aperture Correction for 16mm Flying-Spot Telecine Channels

UDC 621.397.6 : 778.55

The aperture corrector type EP6M/50F has been designed for use in a 16mm flying-spot telecine channel, where it is placed in the red, green and blue colour-component signal paths. Correction can be applied to signals reproduced from either positive or negative film.

The three input signals are coded to produce R-Y and B-Y colour-difference signals and a luminance signal to which the correction is applied. All these signals are subjected to a time delay of one picture-line period, and correction is then applied to the luminance signal in a unit which receives three inputs:

- (i) the luminance signal, delayed as described;
- (ii) the undelayed luminance signal, and
- (iii) the luminance signal, delayed by a further picture-line period.

In the correction unit, the undelayed and two-line-delayed signals are mixed and the resulting signal is subtracted, at half-amplitude, from the one-line-delayed signal to form a 'vertical' aperture-correction signal.

A 'horizontal' aperture-correction signal is derived by subtracting the one-line-delayed signal to a further 150 nanoseconds delay in an unterminated delay line and subtracting from the output-signal from this line the input and reflected signals, which are 300 nanoseconds apart in time and of half-

amplitude. The two correction signals are combined, and low-amplitude components of the combined signal, arising mainly from grain detail on the film, are removed by a 'coring' circuit adjustable by means of a preset control. The resulting final correction signal, after amplitude-control which may be either by means of a front-panel control or via a circuit extended to a remote point, is added to the one-line-delayed luminance signal which then forms the output signal from the correction unit.

The one-line-delayed R-Y and B-Y colour-difference signals are each subjected to a further 'trimming' delay to bring them into accurate time coincidence with the corrected luminance signal. The three signals are then decoded to obtain aperture-corrected red, green and blue colour-component output signals.

The complete equipment comprises seven plug-in units (four of which are similar) in a 5½ in. panel to fit a 19 in. equipment bay.

General Data

Power requirements	1.6A at +12V 1.6A at -12V
Signal inputs	R. G. B colour components
Signal outputs	R. G. B colour components
Impedances	Input: 75Ω Output: 75Ω

Pre-programming of Telecine Controls

D. J. M. Kitson, R. H. Spencer, A. B. Palmer,

Designs Department

Designs Department

Television Film Studios

J. R. Sanders, and M. Weston

Research Department

Research Department

UDC 621.397.6 : 778.55

Summary: The pre-programming of telecine controls by determining the correct settings during rehearsal, storing the information and recalling it at precisely the right time during replay is now a practical possibility. The article discusses the potential advantages and the operational requirements and describes the system in use in the BBC for the programming of TARIF exposure and colour correction controls. The use of such a system for other telecine functions is also considered.

- 1 Introduction
- 2 Advantages of Pre-programming
- 3 The Principles of Pre-programming
- 4 The Practical Requirement
- 5 Equipment Design
- 6 Automatic Shot-change Detection
 - 6.1 Requirements
 - 6.2 Principle of operation
 - 6.3 The detector
 - 6.4 Practical problems
- 7 Conclusions
- 8 References
- 9 Acknowledgment

1 Introduction

The improvements in the general quality of colour television pictures which have been made over the past few years have thrown into sharper relief those areas in which the quality does not match up to the surrounding level of performance. In no case is the contrast greater than between the pictures which can be obtained from a television camera in the carefully controlled conditions of a studio and a film which may have been shot on location in highly adverse conditions. This contrast may be heightened by inter-cutting the two picture sources in a single programme.

Improvements in the picture quality of film have been under continuing development for a long time and a number of electronic aids have been developed. These have included TARIF to compensate for exposure and processing errors, Electronic Masking to correct cross-talk between the dyes in the film, Vertical Aperture Correction and most recently the introduction of direct telecine replay from Negative Film.

These aids are together capable of producing very acceptable pictures from 16mm colour film provided that shooting conditions remain constant. A problem arises when the conditions change, as almost invariably occurs. When the conditions change the correction must be changed and the prob-

lem is to make the error and the correction coincide. The most obvious example is of a film which has been shot under widely varying conditions of lighting. Editing of such a film produces abrupt changes of density and colour cast at each shot change and efforts to correct for these changes with TARIF after they have occurred are often obvious.

Developments in the technology of process control over the past few years have offered the possibility of pre-programming the TARIF correction settings. That is to say, determining the correct settings during rehearsal and storing those settings, along with the frame numbers at which they should be applied, so that the corrections can be recalled during transmission at precisely the time they are wanted.

This technique can be applied to other telecine control functions which are required to act at a precise point in the film and indeed the first use of such a system in the BBC was for the transmission of Cinemascope films in which the scanning raster in the telecine is shifted horizontally to follow the significant action in the picture. This has to be arranged to coincide exactly with a change in the film and some kind of pre-programming of the raster shift settings is essential.

2 Advantages of Pre-programming

Improvements in the quality of presentation of films is far from being the only advantage which can be gained from pre-programming. As far as colour correction is concerned, the extra tolerance to errors in the film which the system gives means that it is often not necessary to ask for a second print where this might otherwise be needed to being the colour variation within the range of acceptable manual control. It is possible to tolerate the variations of exposure in a negative film, despite not having a grading operation to smooth them out, because pre-programming allows large amounts of correction to be applied accurately and at precisely the right time. It is also possible to salvage old feature films in which the colours have changed so much with age that it is not possible to achieve satisfactory manual control. It opens up the possibility of using other cheaper methods of presenting sub-titles in foreign language films because of the ability to synchronise

precisely a caption generator, rather than having to use a complete telecine to run a separate sub-title film.

There are, therefore, considerable cost savings possible, but whether they can actually be achieved depends very much on the way the system is engineered. The present average rehearsal time for films in the BBC is about 1.5 times the transmission time. If it takes a lot longer than that to prepare the correction programme the savings will very soon be cancelled out by the increased costs of running the telecines. The target to be aimed at is that the total rehearsal time, including preparation of the programme, should take no longer than it does at present.

3 The Principles of Pre-programming

It has already been said that the possibilities of pre-programming extend beyond colour correction by TARIF. Cinemascope, sub-titles, aperture correction, masking (particularly for films compiled from a number of different sources) can also be treated in this way and there are a number of purely machine control functions (such as duplex cue pulses) which could be actuated on a particular frame number.

It was clear at a very early stage in the development that it was highly desirable that some way should be found of treating all these cases in a consistent manner so that when more than one control was to be programmed the whole system would fit together.

The preparation of the program might be carried out in a number of different ways, depending on the control being considered. Decisions about the correct position and speed of pan for a Cinemascope film are best made on a specially adapted editing bench. For colour correction, aperture correction and masking, playing the film in a telecine is essential. Sub-titling needs much less expensive equipment. In each case the decisions have to be recorded on some medium and retrieved from that medium at the appropriate time during the replay of the film. The two major choices to be made here were the medium to use and the code to use to record the programming decisions.

Possible available media are paper tape, core stores, magnetic disc and magnetic tape, either as a cassette or as a Sepmag film run in synchronism with the telecine. The choice finally made was paper tape because it is easy to store and transport with the film, the data transfer rate is adequate for most purposes using medium priced punches and readers, and a point not to be ignored in the development stages is that it can be read visually by a reasonably experienced operator. A disadvantage is that it cannot readily be corrected or edited, but this may be overcome by having an electronic buffer store in the programmer.

The choice of code has been discussed at length elsewhere.¹ The International Telegraph Alphabet No. 5 has been used throughout. This assigns a unique 8-bit word (including one parity bit) to each letter of the alphabet (upper and lower case), the numbers 0 to 9, common symbols and punctuation marks and a number of control codes which may be specially assigned but have conventional applications in teleprinter and computer usage. One very great advantage of using this code is that it makes it relatively easy to interface with standard units; for example a program tape can be printed out directly on a standard teletype machine.

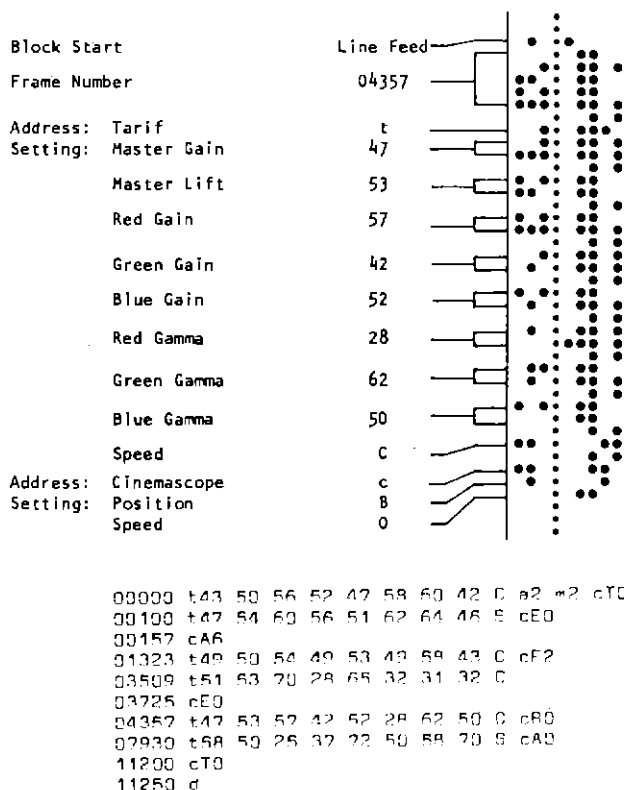

Fig. 1 Section of paper tape with a typical print out

Fig. 1 shows an example of a section of paper tape and also a typical print out. The information on the tape is divided into blocks, each block being associated with a frame number (i.e. the number of frames from the start of the film) at which a particular action is to happen. Each telecine control is given an address code, which is unique and is always a lower case letter (t for TARIF, a for aperture correction and so on) and the numbers following correspond to the settings of the various controls. These settings are in a standard order so that on replay the programmer having, for example, first identified the unique letter as TARIF can identify the subsequent numbers as the settings for Master Gain, Master Lift etc. There may, of course, be more than one address at any particular frame number. The unique address codes will allow the machine to sort out the various controls and pass the settings to the appropriate unit in the telecine.

A number of practical problems arise when an attempt is made to combine more than one function together on one paper tape. A foreign, colour cinemascope film requiring sub-titles is, after all, a distinct possibility. The nature of these practical problems will be discussed later in this article.

4 The Practical Requirement

A prototype programmer based on these principles has been in service in the BBC since October 1971. This machine incorporates many of the features needed for a generalised system but was designed primarily for pre-programming the control of colour correction, both for positive and negative films.

The operational requirements are as follows:

- (a) It must be possible to record the programme during rehearsal without stopping the telecine. This is important for two reasons: firstly because if the machine takes a long time to start and stop the rehearsal time soon becomes excessive, and secondly because it is important to maintain visual continuity to match one sequence to the next.
- (b) Despite what has just been said it may be necessary on occasions to stop the telecine, go back, and repeat a short section which might be particularly difficult to get right. In this case the settings stored on the first run should be recalled on the second so that the second run starts from settings which are nearly correct. It should also be possible to repeat the entire film, updating the settings arrived at on the first run.
- (c) It should be possible to override the recorded settings on transmission so that the corrections are the sum of the recorded settings and the settings of the corrector controls. In this way it is possible to add small adjustments on transmission.
- (d) It is important that the operation of the programmer should not add to the load on the telecine operator and ideally he should not have any extra controls to worry about.
- (e) It is essential that the equipment must be sufficiently reliable to use on live transmissions. Any necessity to transfer to video tape would considerably reduce its value.

The implications of these requirements are as follows:

- (a) The final program tape must have recorded on it the TARIF settings together with the frame number at which these settings are to take effect. The telecine must not be stopped to find the frame at which the error occurs so a different technique must be resorted to. The assumption is made that an error will only occur at a shot change. This is not completely valid because errors can arise during a scene which may include a developing shot or a pan; in this case a slow change of correction is required and this is difficult to programme accurately in a limited time. In the vast majority of cases the assumption is valid. Ideally, what is required is an automatic detector which will examine the output of the telecine and give an indication whenever there is a change of shot. This solution is discussed later in this article. Another possible way, for locally edited films, is to attach a marker to each splice which can then be detected in the telecine. This method has been used successfully during the transmission of negative films; the extra operation of attaching the marker imposes little extra load on the editor. If neither of these methods can be used (for example an old feature film may include opticals which introduce large colour errors with no change of scene content) then resort must be made to the use of a frame cue tape and this was the method used initially. This involves examining the film on a modified rewind bench and punching a paper tape with the frame numbers of all the shot changes. This is a time-consuming business but at least it does not have to be done on the telecine. The frame cue tape may then be loaded into the tape reader of the programmer and is advanced each time the frame pulse count from the telecine coincides with the frame number punched on the frame cue tape.

Whichever method is used to obtain the information,

the frame number at the beginning of each shot is stored until the end of the shot when the TARIF settings from the control panel are punched on to the program tape along with the frame number at the beginning of the shot. The operator therefore has the duration of the shot in which to set up his controls, and his settings are then backdated to the start of the shot.

- (b) The duration of a shot may not be very long and it is unfortunately not true that errors are less noticeable the shorter the shot, at least up to a point. It can be argued that a manual TARIF operator cannot cope with rapid cutting but it is clearly desirable to be able to offer the possibility of getting these sequences right because there are occasions on which the extra time taken is not of much consequence. Hence the need to go back and make a second attempt, updating the previously recorded settings.

It has already been pointed out that one of the disadvantages of using paper tape is that it cannot be edited or revised. It is therefore necessary to include in the programmer an electronic buffer store which is capable of holding enough blocks of information so that when the telecine runs back, the blocks are recalled from the store. Clearly there must be enough capacity in the store to be able to run back far enough without emptying the store completely. The prototype programmer could only store five blocks and this was not enough. A second version includes storage for ten blocks. When the buffer store has been filled the contents of the end store are punched out on to paper tape.

The need to be able to update the settings which have been recorded, either in the buffer store (partial updating), or on a complete re-run using the previous paper tape programme as a starting point (full updating) involves the summing together (either addition or subtraction) of the recorded settings with the settings derived from the TARIF control panel. The settings are stored as binary coded decimal (BCD) numbers. Each of the eight TARIF controls (Master Gain, Master Lift, Red Gain, Green Gain, Blue Gain, Red Gamma, Green Gamma, and Blue Gamma) is quantised by an analogue to digital converter into 100 levels between 0 and 99, mid-range being 50. The setting for each control is therefore stored as 8 bits (4 for the units, and 4 for the tens) although it is punched on to paper tape as two 8-bit words (units and tens). The updating process therefore requires a simple addition or subtraction of two BCD numbers.

- (c) Override of the recorded settings on transmission also requires an addition or subtraction of the control panel settings from the recorded settings. As already stated the recorded settings are quantised by the analogue to digital conversion process into 100 levels. This is perfectly adequate resolution as far as the correction is concerned and the process of conversion of the recorded setting back to an analogue voltage provides a stable setting. However, the continuously variable voltage from the control panel which must be added to the recorded setting in the override mode may be hovering between two of the quantised levels. As a result a small disturbance of the control voltage can produce a change in the control signal corresponding to one quantum level. With 100 levels this can become obvious on the transmitted picture. It is therefore

necessary to use 1000 levels for the voltage from the control panel but it is still only necessary to store and record 100 levels. When the control panel setting is added to the recorded setting, the units of the latter are always zero.

(d) Apart from the normal TARIF control panel which is fitted with two joystick controls, one for colour gain with master gain and the other for colour gamma with master lift, the only additional controls required are a mode selection switch to choose between the record mode, with or without updating, and the transmit mode, with or without override. There is also a row of lamps to indicate how many of the buffer stores are full so that there is a warning of what is happening when running backwards. There are also buttons to load the paper tape reader and run out the paper tape punch. There are therefore no extra controls to be operated during the making of the programme or during transmission other than those which are needed for normal manual control.

5 Equipment Design

Fig. 2 shows a block diagram of the equipment which was built to embody the proposals which have been discussed.

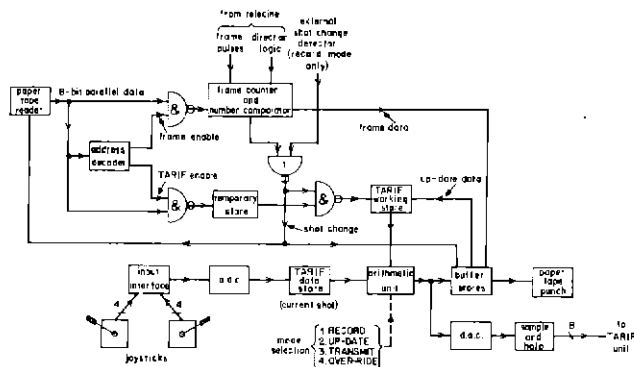

Fig. 2 Pre-programmer. Block diagram

The TARIF control panel is fitted with two joysticks to control the channel gains and the channel gammas. This method of control allows much easier operation than is possible with rotary switches and knobs. One of the most expensive items in the equipment is the analogue to digital converter which is required to quantise each voltage from the joysticks into 1000 levels with a cycle time of 5mS. Rather than have one a.d.c. for each of the eight control voltages (Master Gain, Master Lift, Red, Green and Blue Gains and Red, Green and Blue Gammas), a multiplexer is used to time division multiplex the eight analogue voltages before conversion by the single a.d.c. into three binary coded decimal digits per control (i.e. 0 to 999). The conversion time for all eight control voltages is 40mS.

In the record mode the other signal fed into the programmer is shot-change information. This can come either from an external shot-change detector (this may be either an automatic device looking at the output signal from the telecine or a detector looking at marks applied to the film) or from a comparator which compares frame numbers read from a frame cue paper tape with a counter clocked by frame pulses from the telecine. The fact that a shot change has been de-

tected is fed to the buffer store which then stores the frame number currently in the frame counter.

Each section of the buffer store (and there are ten in all) contains the frame number together with the appropriate TARIF settings. In the record mode the settings are derived directly from the output of the TARIF data store (current shot) and are entered into the buffer store at the same time as the next shot change is detected. When all the buffer stores are full, the contents of the end store are punched out on to paper tape. This punch operates at seventy-five characters per second so that it takes just under half a second to punch out the thirty-one characters of a complete block.

In the update mode it is possible to go back and revise the settings arrived at on the first run. On the second run the appropriate settings already in the buffer store are transferred to the TARIF working store and are added in the arithmetic unit to the setting from the joysticks before being returned to the appropriate section of the buffer store.

On replay the paper tape is loaded into the reader and the first block read off. The frame number is held in the frame counter and number comparator where it is compared with a counter which is clocked by frame pulses from the telecine. The address code is identified by the address decoder and the subsequent settings routed to the appropriate part of the equipment, in this case the TARIF programmer. The TARIF settings are held in the temporary store until a pulse from the frame counter and number comparator indicates that the shot change has been reached. The settings are then transferred from the temporary store to the TARIF working store. In the transmit mode the settings pass through the arithmetic unit directly to the digital to analogue converter. A sample and hold unit on the output demultiplexes the signal and transfers the control voltages to the appropriate correction circuits in the TARIF unit. At the same time the paper tape reader is advanced by one block so that the process may be repeated on the next shot change.

In the override mode the settings from the joysticks are added in the arithmetic unit to the settings from the paper tape.

The finite speed of the paper tape punch (seventy-five characters per second) places a limitation on the length of shots which can be programmed; a minimum of twelve frames is permitted. Use is not made of the buffer store to smooth out rapid sequences because of the unpredictable limitations which this would impose. For the same reason problems occur when an attempt is made to punch more than one function on to one length of tape when the other functions do not coincide with shot changes.

6 Automatic Shot-Change Detection³

6.1 Requirements

It will be appreciated from the foregoing description of a pre-programming system that the use of a 'frame cue tape' containing a record of all the film frame numbers at which some change in correction may be required, is essential if the pre-programming operation is to be carried out within the normally allocated review time. The preparation of a frame cue tape can be relatively quickly and cheaply carried out, but it is an additional operation which it is highly advantageous to eliminate if possible.

If it can be assumed that a change of correction is only required at a shot change which is visually significant, and that the subject matter changes completely between two successive frames, then it becomes possible to anticipate that such changes can be detected by examining the characteristics of the video waveform from the telecine itself. It will be appreciated that dissolves and fades cannot be detected, but fortunately these do not occur very frequently in films made by the BBC and are not at present possible in single roll negative working where pre-programming is essential.

6.2 Principles of Operation

A shot change may be identified by comparing the characteristics of the telecine video signals on successive fields. This may be achieved by storing video signals for one television field (20ms) duration so that information from two successive fields is continuously available for comparison. The basic principle used in this particular design is that the signals from successive fields are subtracted and the resulting difference signal full wave rectified and integrated over each active field period. This integral thus represents a measure of the difference of detail distribution between successive fields and a shot change may be indicated when the value of the integral exceeds a predetermined minimum. This simple form of detector is not, however, satisfactory since if the minimum integral value is adjusted so that the detector is sufficiently sensitive to detect, for example, 98 per cent of all shot changes a high output of spurious indications will be produced with normal camera and subject movement since this will often be sufficient to produce the necessary rate of frame-to-frame picture difference. A means of distinguishing a shot change from movement is therefore essential.

6.3 The Detector

Fig. 3 shows a simplified block diagram of a detector incorporating 'movement protection'. The basic 20ms delay is provided by encoding the incoming video into serial binary

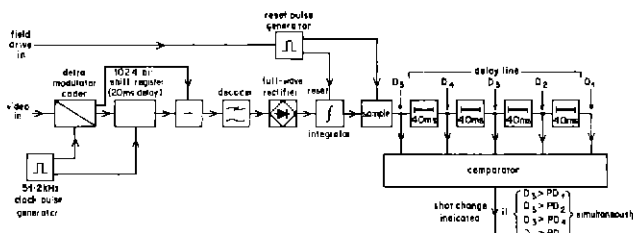

Fig. 3 Shot-change detector. Block diagram

form by delta modulation⁴ using a sampling frequency of 51.2kHz. The resulting train of binary digits is then delayed in a 1024-bit M.O.S. shift register also clocked at 51.2kHz. Comparison of information from successive fields is achieved

by subtracting the undelayed bit stream from the delayed bit stream, the resulting output being decoded by low-pass filtering to produce a low-frequency difference signal. The difference signal is then rectified and integrated over a field period to produce a signal which is sampled at the end of each field. This sampled output thus represents the total detail difference between successive fields. This signal is then passed into an analogue bucket-brigade delay of eight stores, each being used to retain the field-to-field difference signal for 20ms. It is thus possible by examining the magnitude of successive frame-to-frame differences to distinguish between a sudden change from one still scene to another (indicating a definite shot change) from a succession of frame-to-frame differences resulting from smooth movement. Fig. 3 shows the logic condition required, the choice of the factor P (protection ratio) must be made empirically by extensive testing since, if it is too great shot changes occurring during moderate movement will not be indicated. If it is too small insufficient movement protection will be provided.

6.4 Practical Problems

The simplified detector described is basically capable of a sufficiently good performance and detects shot changes from electronic cameras with a very high success rate. Film shot changes are, however, rarely ideal due to the incidence of many different types of splices and non-ideal characteristics of printer light valves. At the time of writing most of these problems have been solved, but some further work is required to achieve the optimum performance.

Prototypes of the equipment are in use and have proved very successful in reducing the time and cost of pre-programming operations.

7 Conclusions

The system described has proved of great benefit in obtaining consistency of output from both positive and negative films with little increase in running costs. It has demonstrated the feasibility of this method of operation in the day-to-day running of a television service both from the point of view of technical performance and reliability.

8 References

1. D. J. M. Kitson. The choice of codes for film editing and telecine pre-programming. Film '71 Technical Paper.
2. Provisional BBC Patent No. 42574/71.

9 Acknowledgment

The authors wish to thank their many colleagues in the BBC for assistance with this work and the Director of Engineering for permission to publish this article.

The Suppression of V.H.F. Harmonic Interference from H.F. Broadcast Transmitters

D. I. Price

Transmitter Capital Projects Department

UDC 621.396.72 : 758.38

- 1 Introduction
- 2 H.F. Transmitters
- 3 Remedies
- 4 Skelton Transmitters
- 5 Transmitter Harmonic Suppression
- 6 Results
- 7 References
- 8 Acknowledgments

1 Introduction

Maintaining adequate spectral purity in radio transmissions is a corollary of providing selectivity in receivers, since both are necessary to allow efficient use of the available frequency space. Although transmitters have to meet generally accepted criteria in respect of unwanted radiation,¹ the practical constraint on the transmitter operator is normally that his transmissions must not result in harmful interference with other existing services,² the degree of suppression of unwanted radiation required depending to a considerable extent on the amount of radio facility and spectrum usage in the region of the transmitting station.

The United Kingdom has one of the highest concentrations of radio facilities in the world and a corresponding liability to mutual interference problems, the most difficult situations arising when sensitive receivers are used in the vicinity of powerful transmitters operating on harmonically-related frequencies. A general expansion of v.h.f. services has produced a number of harmonic interference problems in the broadcasting field, most of them being associated with h.f. transmitting sites.

2 H.F. Transmitters

H.F. broadcast transmitters are particularly liable to cause harmonic interference with nearby v.h.f. services. This is because:

- (a) Power levels are high, generally in the range 100–500 kW with aerial gains producing effective radiated powers of several megawatts.
- (b) The r.f. circuits used to obtain adequate power conversion efficiency generate high-order harmonics.
- (c) Operating frequency schedules are subject to frequent changes.

(d) V.H.F. communication systems are often designed to work with very low field strengths.

Services most vulnerable to v.h.f. harmonic interference include domestic television reception, civil aircraft communications and land mobile systems of various kinds. The area affected is normally very much greater in the case of aircraft communications because the aircraft height results in a low path loss over considerable distances from the interfering transmitter.

A complicating factor in harmonic interference prevention is that although the h.f. transmitter may have adequate harmonic suppression, harmonic frequencies at significant levels are often generated externally to it in areas where a high field strength exists at fundamental frequency. This may occur in the v.h.f. receiver itself, or in metallic structures associated with or near the receiver or transmitting site. V.H.F. receivers are not generally designed to reject strong h.f. signals, domestic television receivers being particularly susceptible to h.f. pickup, and intermittent or rectifying contacts in aerial rigging, fences and building metalwork are common sources of harmonic radiation.

3 Remedies

The simplest and cheapest way of avoiding harmonic interference is, of course, to arrange the operating frequencies within the prospective interference range so that they have no harmonic relationship. Provided the interference range is small this can often be done without serious loss of overall frequency utilisation. With long-range h.f. broadcasting, however, the choice of frequency is generally determined by extraneous factors, and flexibility in frequency scheduling is necessary to cope with ionospheric variations and other contingencies. Since each v.h.f. channel may have several submultiple broadcast frequencies, providing protection for a number of v.h.f. channels can seriously affect the operation of the h.f. station.

Although there are relatively few v.h.f. channels with no submultiple frequency in the h.f. broadcast bands, the probability of interference can be reduced considerably in some cases by frequency selection, one approach being to take advantage of the general inverse relationship between harmonic amplitude and harmonic number. Fig. 1 shows a section of a simple probability chart in which frequency multiples of h.f. broadcast bands are accorded a relative

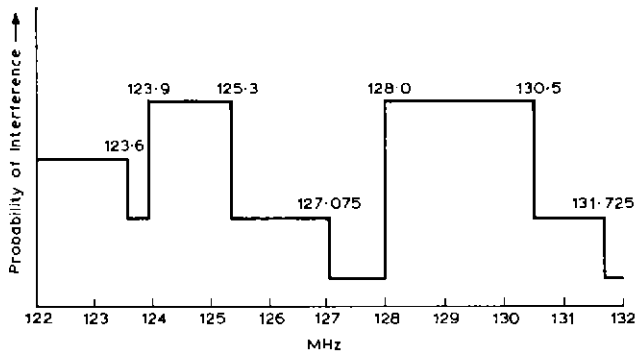

Fig. 1 Section of an interference probability chart. The vertical scale is roughly proportional to the prospective harmonic amplitude

interference probability dependent upon their associated multiplying factors; if the v.h.f. allocations in the vicinity of the h.f. station can be selected from the lower levels of the chart the prospective interference range, and the probability of interference, are correspondingly reduced.

Another aspect of frequency selection concerns the v.h.f. channel spacing, most modern equipment being designed for channel separations of 50 or 25 kHz. The general adoption of 12.5 kHz channelling as currently used in the Private Mobile Radio bands would mitigate harmonic interference problems because new v.h.f. channels would exist which fitted between prospective harmonic frequencies, and also because narrower receiver bandwidths would reduce the susceptibility of existing channels to harmonics with frequency offsets.

Apart from their overall bandwidth, v.h.f. receiving installations vary considerably in their ability to reject h.f. sub-multiple frequencies. Many receiver designs allow h.f. signals to be coupled into the receiver by unsuspected routes, thus reducing the effect of the inherent r.f. selectivity. One common example, particularly in television receivers, is through the screen conductor of the aerial lead which is often terminated effectively within the receiver chassis instead of on the outer surface. The length of the aerial lead is usually more conducive to h.f. pick-up than the v.h.f. aerial itself. Although the use of a v.h.f. isolating transformer to break the screen continuity usually provides a simple remedy, interference from this cause is often attributed to v.h.f. pick-up because it is not affected by a standard high-pass input filter, which maintains the screen connection.

Harmonic suppression at the h.f. transmitter is not usually a simple matter of filtering the r.f. output. The associated engineering effort varies considerably with the particular circumstances, and when very low harmonic levels are required over a wide frequency range the work can be time-consuming and expensive. Apart from the r.f. circuits, the dimensions of which are comparable with the harmonic wavelengths, significant harmonic radiation commonly occurs from the numerous power supply and control circuit leads, air and water pipes and control rods, the contribution of each of which may have to be assessed in order to obtain consistent results. Consequently it is important to establish that the degree of suppression proposed will resolve the interference problem on a reasonably permanent basis, and will not require an excessive degree of vigilance from the operating staff.

With modern, fully screened, relatively compact h.f. trans-

mitter designs it is practicable to reduce the radiation levels for most low-order harmonics to some 90–100dB below fundamental carrier power. In practice, however, situations requiring more than about 80dB suppression for low-order harmonics are undesirable in that they are likely to involve elaborate on-site monitoring arrangements, together with a continuing liability to investigate spurious interference complaints.

4 Skelton Transmitters

The BBC's h.f. transmitting station at Skelton in Cumberland provides a recent example of harmonic suppression methods. The station was built during the war, and prior to the harmonic suppression work its v.h.f. interference potential was determined mainly by the harmonic radiation from six of the original ST & C type CS-8 transmitters.

At Skelton the major interference problem concerned the aeronautical ground-to-air communication services, the station being mid-way between the main North-South air lane¹ and the Civil Aviation Authority ground station at Great Dun Fell, a peak in the Pennine Chain. Dun Fell is 'line of sight' from Skelton and sufficiently high for the path attenuation to be roughly comparable with that for an aircraft. Preventing interference with the v.h.f. services had meant forgoing the use of a considerable number of h.f. broadcast channels at Skelton, and by 1966 protecting the Dun Fell frequencies alone involved the loss of thirteen broadcast channels. A steady increase in the number of v.h.f. services operating within interference range eventually made the harmonic suppression work necessary.

With the help of the Authority an investigation was made into the degree of protection required for the v.h.f. receivers. The basic requirement was that potential interfering signals should be kept below the receiver muting threshold, and also some 30dB below the normal service signal strengths. From information on the various v.h.f. equipments and prospective flight paths, together with actual measurements at Dun Fell, it was concluded that the harmonic radiation levels would have to be reduced to about 1mW to produce a negligible probability of interference.

From previous experience it was considered practical to restrict the harmonics at the transmitter to about the 1mW level, but that certain of the v.h.f. channels would still be liable to interference by externally generated harmonics. Fortunately the Authority was able to back up the harmonic suppression work by re-allocating some of the Dun Fell frequencies to lower levels of the probability chart, thus considerably reducing the residual risk.

The investigation involved taking a large number of harmonic field strength readings in the Skelton area, and a series of measuring points was established for local reference purposes. Because of day-to-day variations in the v.h.f. polarisation and standing wave patterns a degree of experience was found necessary to obtain consistent results, but with reasonable care readings could be repeated within 1–2dB with different operators.

The harmonic radiation was invariably found to emanate from the transmitter building rather than the h.f. aerial system, and no characteristic polarisation or directivity could be found which was not attributable to the transmission

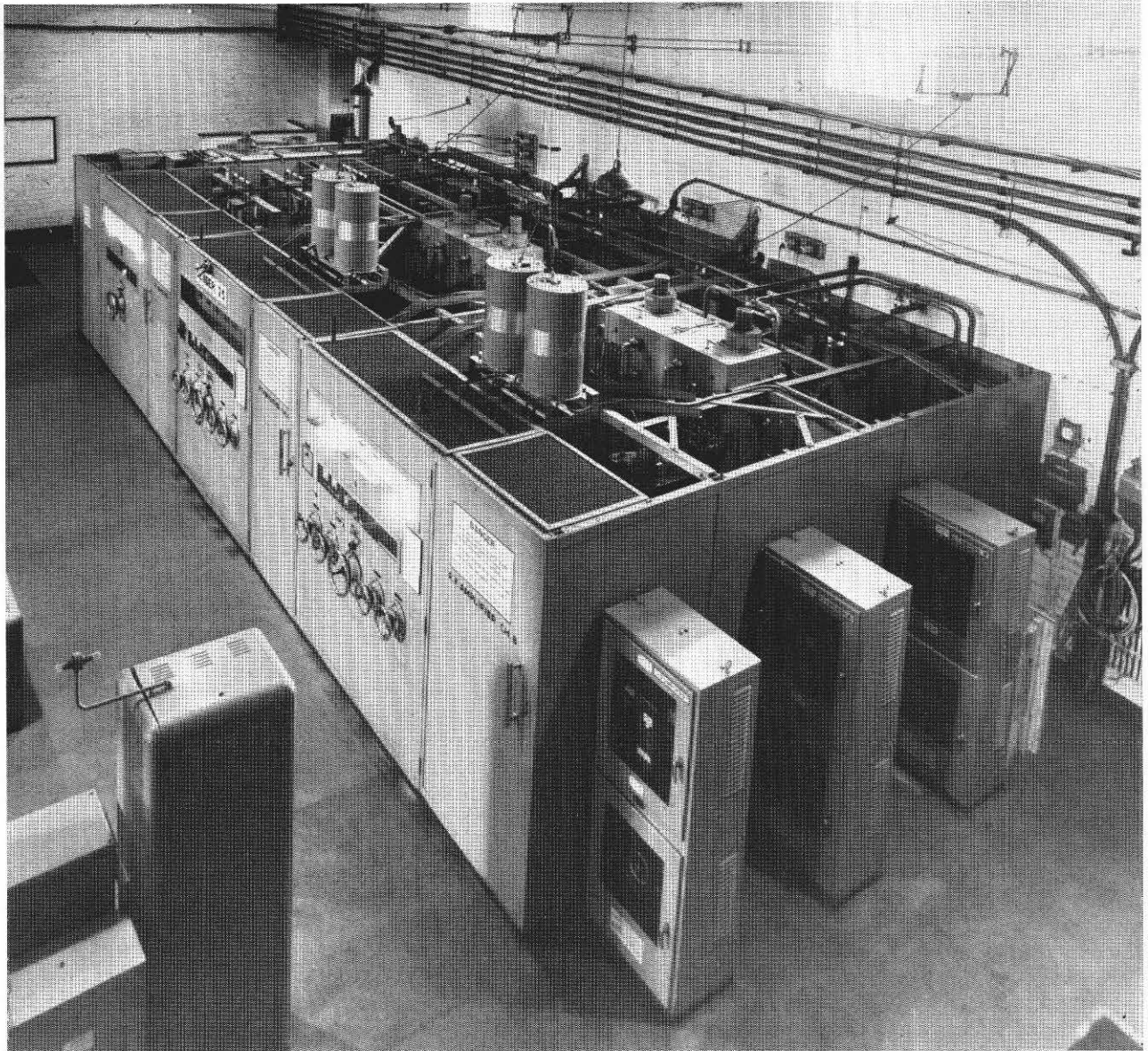

Fig. 2 CS-8 transmitter showing open-top cubicles before screening

paths. Harmonic power was measured by a comparison method, using a signal generator to radiate a known power at the harmonic frequency and comparing the field strength readings at several measuring points. When checking the transmitters after modification the point giving the highest readings was taken as representative.

5 Transmitter Harmonic Suppression

The CS-8 transmitters are of pre-war design and were installed in 1943. Each consists basically of three open-top cubicles (Fig. 2) containing the modulator and two separate 100kW r.f. amplifiers, which can be operated singly or together on any frequencies in the 6–21 MHz broadcast bands. The r.f. outputs are carried by balanced transmission lines to an aerial switching arrangement outside the building, v.h.f. filter units being connected at the transmitter ends of the output lines to reduce harmonic radiation at Band I television

frequencies. The modulation transformer and other large oil-filled components are in a separate room behind the brick wall at the rear of the cubicles, the main power supplies to the amplifiers being carried originally by bare conductors supported on stand-off insulators.

In order to determine the extent of the necessary harmonic suppression work, one of the transmitters was screened on an experimental basis by covering the tops of the cubicles with copper mesh and the rear wall with copper sheet. The open high-voltage conductors were replaced with screened cable and a number of minor improvements made. Tests on this transmitter showed that further measures would be required for fully effective suppression, and these were incorporated in subsequent transmitters. They included double-mesh screening of the r.f. cubicle tops, filtering of most of the power and control circuit leads and modifying the r.f. output filters to extend their rejection frequency range.

Identifying the harmonic leakage paths from the screened

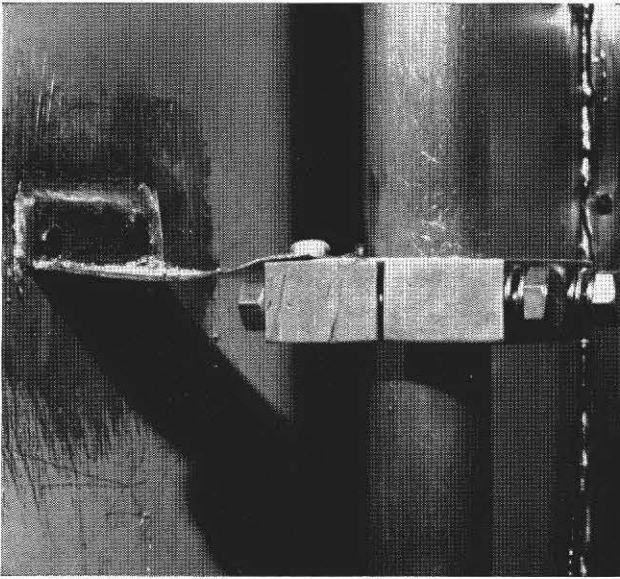

Fig. 3 Experimental earthing bush on control shaft

enclosure presented an initial problem, since the high power levels at fundamental frequency prevented any effective location of the very much weaker harmonic sources, and also many of the leads were not accessible in any case while the transmitter was operating. The method used was to test with the transmitter switched off by connecting a signal generator, tuned to the harmonic frequency, to the grid circuit of the final amplifier stage. The leaks could then be traced with a fair degree of discrimination by means of a small pick-up probe used with the v.h.f. field strength measuring receiver. These tests confirmed the need for thorough electrical bonding of the screenwork, and showed that the single-layer mesh screen did not produce the expected degree of attenuation, either because of resonance effects⁴ or from energisation by internal circulating currents.

Resonance effects in control shafts were also found to contribute to the harmonic leakage by creating a low impedance drive point where the shaft passed through the screening. The solution adopted was to spoil the resonances by means of earthing bushes at the appropriate points on the shafting. An experimental earthing bush is shown in Fig. 3.

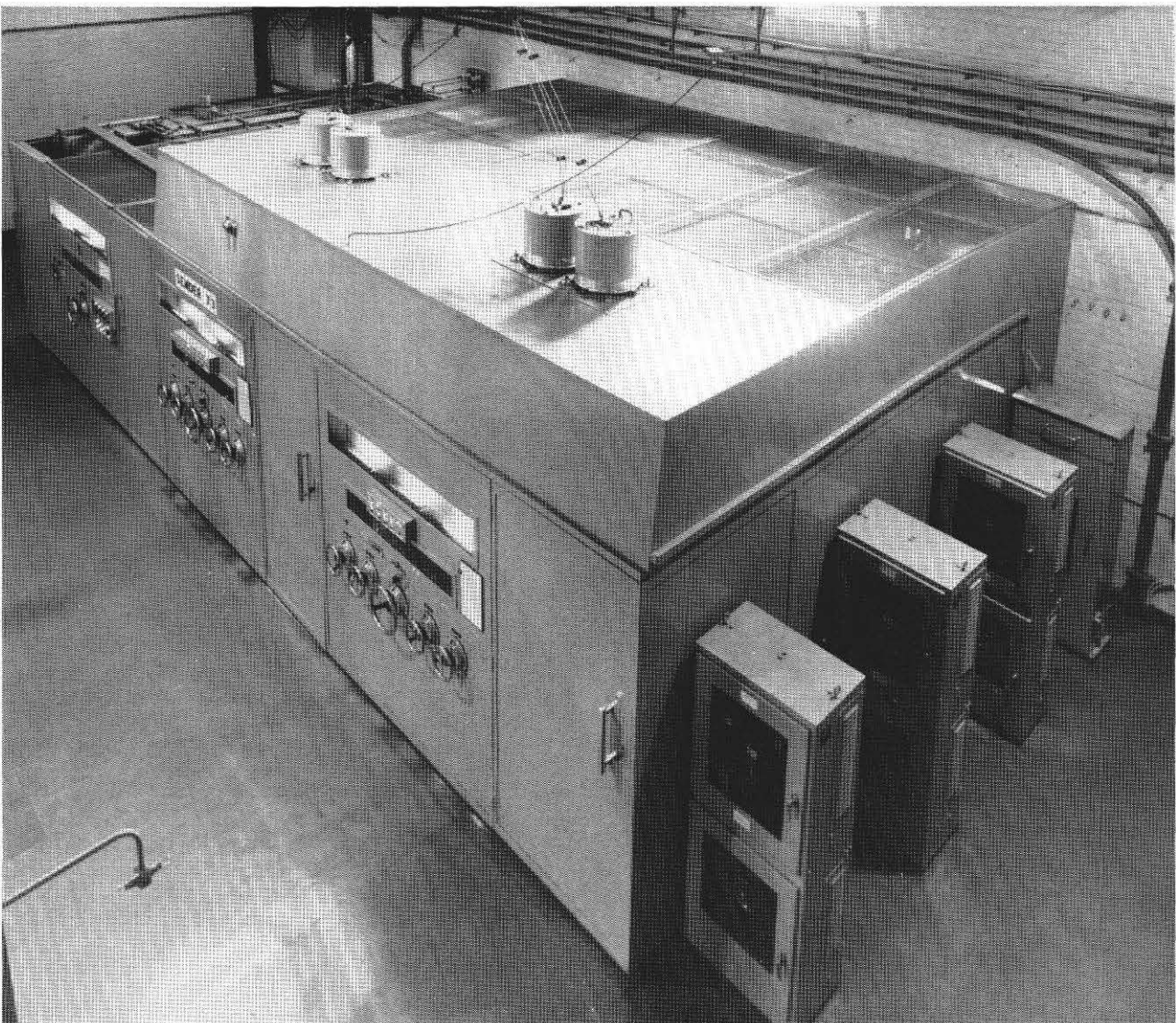

Fig. 4 CS-8 transmitter after modification

In conjunction with the harmonic suppression work it was necessary to replace most of the original transmitter wiring, the condition of which had deteriorated considerably over the years. The opportunity was taken to modernise and simplify the power distribution and control systems, making the transmitters more convenient to operate and reducing the amount of maintenance and supervision required. A remote switching facility was also provided to enable the transmitters to be operated by the Skelton automatic switching system.⁵

The overall arrangement of the screenwork can be seen in Fig. 4. and Fig. 5 shows how the output filters are fitted to the

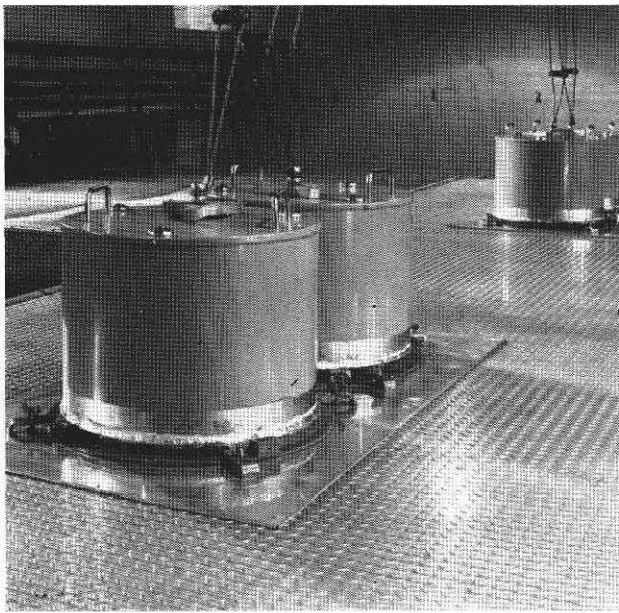

Fig. 5 Method of fitting output filters to the top screen

top screen in order to make them easily removable for maintenance purposes.

6 Results

The harmonic radiation performance of the first fully modified transmitter is plotted in Fig. 6. The figures were obtained at an elevated point overlooking the transmitter site, and without any critical adjustment to the transmitter, since none is provided. It will be seen that the 1 mW target was achieved for all except the 6 by 21 MHz harmonic, which measured 6dB higher. This could probably be reduced by additional filtering in the transmitter r.f. output should this become necessary.

Apart from the effect on the aeronautical frequencies, the harmonic suppression work has also provided protection for a number of other essential services, which had previously involved the loss of additional h.f. channels.

7 References

1. ITU Radio Regulations 1968, Article 12 and Appendix 4.
2. *Ibid*, Article 4, Reg. 697.
3. *UK Air Pilot*. Published by the Aeronautical Information Service of the Civil Aviation Authority.
4. Miedzinski, J., *Electromagnetic Screening Theory and Practice*, Electrical Research Association Technical Report M/T135, 1959.
5. Oxley, G., *Automation at Skelton Short-wave Transmitting Station*, *BBC Engineering*, No. 84, October 1970.

8 Acknowledgments

The author wishes to thank the BBC's Director of Engineering for permission to publish this article, and also to acknowledge the co-operation of the Civil Aviation Authority and the Engineer-in-Charge and staff at Skelton in the harmonic suppression work. Photographs in this article are by Alec Fraser Studios, Penrith.

Harmonic power in 118-136 MHz band

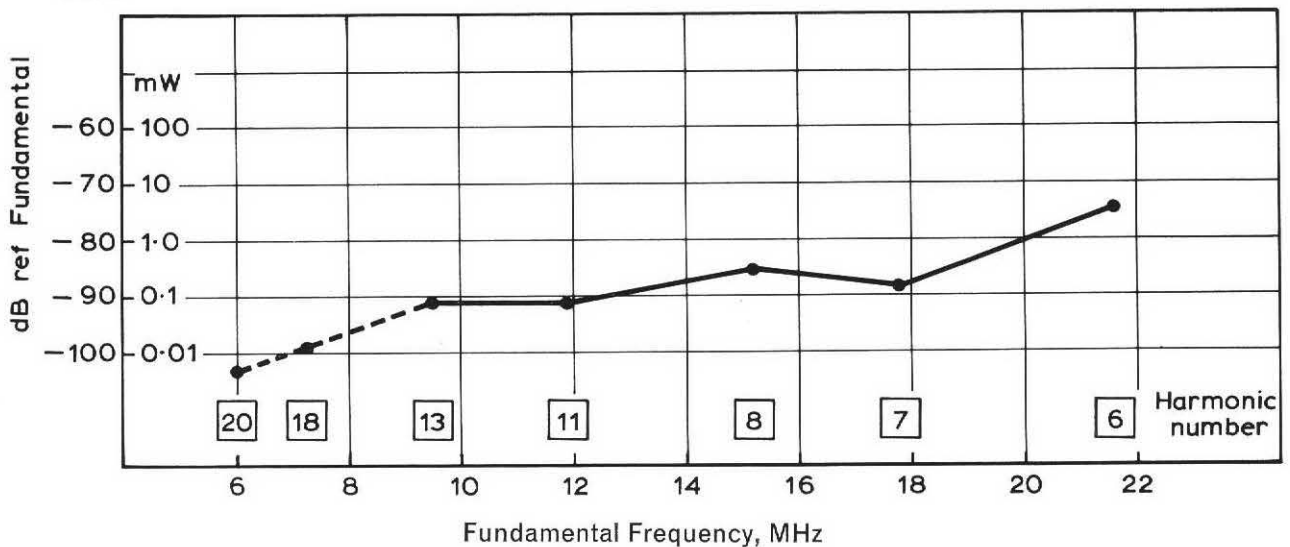

Fig. 6 Harmonic radiation levels in aeronautical band after transmitter modification, measured by comparison method

An Important Patent Lawsuit

In a recent case* before the Court of Appeal relating to a thirty-two-years-old colour television patent, the BBC's Chief Engineer, Research and Development, Mr Geoffrey Gouriet, was called in to sit with the three appeal judges as a scientific adviser because of the difficulty of the technical problems involved. This is believed to be the first time since 1935 that the Court of Appeal has sat with a scientific adviser.

The British Radio Corporation were appealing against a decision in the Chancery Division in February 1971 that colour television receivers manufactured by the BRC infringed the 1939 patent held by M. Georges Valensi, an inventor who lives in Geneva, and Electric and Musical Industries, the exclusive licensees of the patent. The BRC manufacture about half the colour television receivers sold in this country, and although the patent finally expired in June 1971 after several extensions, they might have been liable for substantial damages if the finding at the original hearing had been upheld. This decision was, however, reversed by the Court of Appeal. The defendants, BRC, counterclaimed for revocation of the patent. This counterclaim was rejected at the original hearing but was upheld at the appeal 'unless there be some principle against the making of an order revoking a patent that has expired.'

The Patent Proposals

Although it was known before 1939 that areas of colour could be accurately described in terms of hue, saturation and brightness, the inventor appears to be the first who thought of transmitting colour television by analysing the scene in terms of these three parameters, and he proposed a number of alternative systems for generating signals describing one or more of these parameters and deriving a colour picture from them in the receiver. He did not concern himself with methods of transmitting these signals by radio, except in so far as he was aware of the need to save bandwidth. In one of the systems, which was intended to transmit information on hue and brilliance (but not saturation), a colour spectrum of each successive element of the picture was to be thrown on the mosaic of an iconoscope camera tube. The specification also called for a cathode-ray oscilloscope tube masked with a six-step grey-scale transparency, and a photocell. An approximation to the predominating colour of each picture element was

* Court of Appeal of the Supreme Court of Judicature. Valensi and Electric and Musical Industries v. British Radio Corporation. Judgment given 18 May 1972.

to be conveyed by one of six quantised voltages. Another arrangement described in M. Valensi's specification conveyed information on all three of the parameters, but both hue and saturation were defined in terms of quantised approximations – six for hue and four for saturation. Some of the proposed systems saved one-third of the bandwidth needed for separate R, G, and B channels (i.e. they required twice the bandwidth of a black-and-white channel), but this was achieved at the cost of transmitting one or more of the parameters in terms of a small number of quantised approximations.

Infringement

In order to establish that receivers manufactured by BRC infringed any of the inventor's proposals, it would have been necessary first to establish that the present PAL transmissions constituted an infringement of the patent. The Appeal Court ruled that the present system of multiplexing by quadrature modulation had not been anticipated by M. Valensi's proposals, because he warned against the use of any form of multiplexing although quadrature modulation was known at that time. The PAL system of transmitting R-Y and B-Y signals by quadrature modulation of a sub-carrier was held not to be an infringement of the inventor's proposals for transmitting hue and saturation signals, since the demodulation process in the PAL system makes no use of the fact that the phase of the sub-carrier varies with hue and the amplitude varies with saturation.

The Principle of Compatibility

Although some of the systems proposed in the specification included a separate monochrome picture signal which could be received by existing monochrome receivers, the Appeal Court held that this did not anticipate the now-universal principle of forward compatibility, as this feature was mentioned only incidentally in the specification, there was no suggestion that it was a novel one, and no reference was made to it in the inventor's claims.

Revocation

The counterclaim made by BRC for revocation of the patent was upheld by the Court of Appeal on the ground that the proposals were insufficiently described in the specification. It is of interest to note that a patent which was at one stage extended because of 'the exceptional merit of the invention' should ultimately be revoked.

Colour Negative in the Telecine

UDC 621.397.132:778.55

Abstract of a paper by C. B. B. Wood, A. B. Palmer and F. A. Griffiths read on 3 May at the 111th SMPTE Conference in New York.

When colour motion picture film and colour television are used in cascade, it might reasonably be expected that the end result would be inferior to either of them taken singly. The very rapid evolution of the colour television camera has resulted in contrast and colour fidelity in 'live' pictures not usually obtained from the film-plus-telecine combination. Furthermore, the stringent requirements placed upon colour balance accuracy by typical viewing conditions for television make it desirable that there shall be a further control of the colour balance and other technical parameters of the picture where such adjustments would not be necessary in the darkened cinema. There is a real problem when the programme contains intercut sequences from film and from electronic cameras and this technique is widely used in Europe.

An investigation to find the best possible way of combining film and the television process led to an examination, stage by stage, of the distortions being introduced. It was found that whenever a duplicate is made of an image recorded on film, either as a print from a negative or as a reversal duplicate or by any intermediate process, there is significant distortion of the linearity of the luminance characteristic, loss of colour fidelity and loss of resolution.

Hence for television purposes, the best technical approach is to cut out all duplication processes and to use the original camera material. This may be either a reversal positive or a negative but for the best preservation of the original scene information a colour negative is much to be preferred. It was considered in the BBC that a telecine could be designed to give a very good television translation of the information in the colour negative film, considerably better than that obtainable from a colour print.

Telecine Design

It is, of course, a fairly simple matter to invert television signals from negative to positive with appropriate gamma correction, and in a colour telecine the use of separate inverters in the R, G and B channels produces R, G and B signals, representing the colours in the original scene, from their complements in the negative. To obtain the full advantage from scanning the original colour negative, however, a

sophisticated electrical signal processing is necessary. This involves a logarithmic amplifier in order that the television signals properly relate to the images on the film. Since the three colour images are superimposed in the conventional tri-pack film it is necessary to have an electrical matrix to make possible the derivation of signals directly related to the original stimulus from the scene, and thereby to correct for any cross-coupling between the three colour layers. This gives signals comparable with those from the three pick-up tubes in a colour television camera.

Consideration of telecine design quickly leads to noise problems. The conventional colour negative includes an orange-coloured mask which attenuates the light in the green channel by 12dB and that in the blue channel by 18dB. This loss must be made up by extra light at the source—i.e. the flying-spot tube—otherwise the signal-to-noise ratio will suffer.

A considerable development programme for the telecine was necessary before the benefits of direct access to the information on the colour negative were realised but it was then possible to come to grips with the operational problems of using colour negative directly on the air or transferred to video tape. The crucial factor is that the printing stage has been eliminated but as well as avoiding the distortions inherent in any duplication of colour film, the benefits of incorporating colour grading and exposure correction in the print have also been lost and it is necessary to have a sophisticated system for pre-programming the electrical timing or 'paint-pot' corrections, controlled by a paper tape or some other means.

Furthermore, the possibilities of adding titles, fades etc., to the film are lost as also is the 'invisible-splice' advantage of A and B roll working. These facilities could all be achieved by use of a twin-telecine installation with electronic mixing but in the BBC trials undertaken so far, the colour negatives are used in a single roll, butt-welded together upon the frame line.

The benefit of using colour original film for television presentation is very great indeed; the improvement in picture quality is frequently quite dramatic and the experience of the BBC so far is that the ability of the colour negative to handle a scene contrast of about 100:1, virtually without distortion, gives a technical quality to the pictures which cannot be achieved by positive film of any sort. The practical difficulties of operating the telecine with colour negative are not to be underestimated but the advantages are so substantial that there is growing support for this approach.

Acoustic Modelling

UDC 534.846.6

Experiments in acoustic modelling of the orchestral studio in Maida Vale have continued with an examination of the possible acoustical implications of various changes to the studio. These have included the effects of hanging reflectors or diffusers, the application of acoustic absorption to walls or ceiling and finally a proposal advanced by Pierre Boulez, the new principal conductor of the BBC Symphony Orchestra.

In this proposal the permanent chorus seating is to be removed and new movable orchestral rostra installed to give greater flexibility to the orchestra placement. The effects of these changes have been demonstrated in the model to all concerned with the modifications and the acoustic effects were generally approved. The work is now in hand and it is hoped that the changes will be complete by July.

Hybrid Quadrature Modulation (H.Q.M.): An Efficient System for M.F./L.F. Broadcasting

UDC 621.376.2

A paper by G. G. Gouriet, Chief Engineer, Research and Development, in Issue No. 129 (October 1971) of the *EBU Review*, Part A, describes a novel combination of base-band coding and carrier modulation which could be applied with advantage to either m.f. or l.f. sound broadcasting, particularly the latter if national coverage is required using a single channel. The improvement in signal/noise ratio over a.m. for a given transmitter e.r.p. would be about 24dB, which is similar to that obtained when wide-band f.m. is substituted for a.m. in a v.h.f. system: the r.f. bandwidth, however, would be identical to that required for double-sideband a.m.

In the proposed system, the audio information is contained in two signals which are transmitted using quadrature modulation. This implies that an unmodulated reference carrier signal for synchronous detection must also be transmitted. One of the quadrature signals is a coarse quantised version of the original modulating signal with a limited number of discrete levels (sixteen is a typical figure). The other quadrature signal, which may be called the interpolating signal, is an analogue signal describing and correcting the error due to coarse quantisation. By selecting a specific phase relationship between the carrier reference signal and the quadrature signals, the combined modulating signal can be made compatible with a receiver employing a single synchronous detector, but the realisation of the potential improvement in signal/noise ratio requires a receiver with two synchronous detectors.

At the present time the proposal is of academic interest only for reasons of incompatibility; nevertheless it is considered worth while to put the proposal on record since the problem of incompatibility would be eased considerably if at any time in the future domestic receivers using synchronous detectors were to be introduced for other reasons.

A New Means of Remotely Controlling Unmanned Television Cameras

UDC 621.397.61-52

J. A. Kett

A rapid and easy means of obtaining selected shots with a remotely panned and tilted television camera is under development with the use of a light pen.

It is considered that it would be especially useful where neither pre-planning nor rehearsal is possible. Such a situation applies to parliamentary broadcasting, party and similar conferences, and some audience participation programmes where neither fixed seating arrangements nor a rigid timetable are observed.

In one version the light pen is pointed at the required object appearing on a monitor screen which is displaying a wide-angled view of the required area. The information obtained by the pen is then used to provide the necessary signals to drive another, or possibly the same, television camera to point in the required direction. Other control information such as zoom, iris and focus lift and gain can all be passed at the same time.

Other possible systems not requiring the fixed wide-angle display are under investigation. These require the use of memory stores and feedback information so that the sensitivity and reference data of the system vary dependent on the position and angle of a shot at any instant in time. Because of the complexity a small computer would be required and advantage would be taken of its use, amongst other things, to select the most appropriate camera to operate.